



United States
Department of
Agriculture

Forest Service

Forest
Products
Laboratory

General
Technical
Report
FPL-GTR-149



Fundamentals of Composite Processing

Proceedings of a Workshop

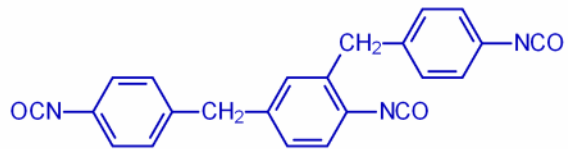
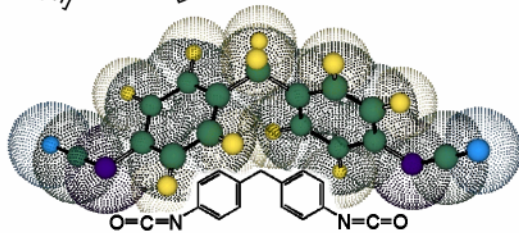
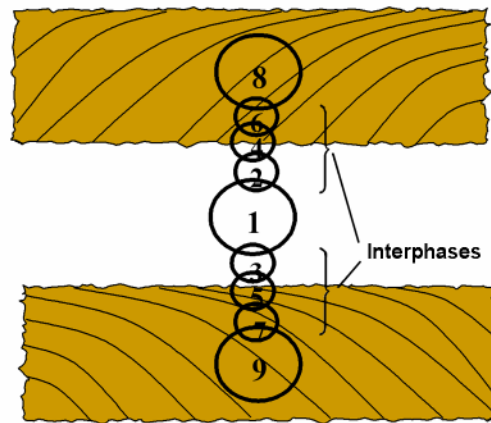
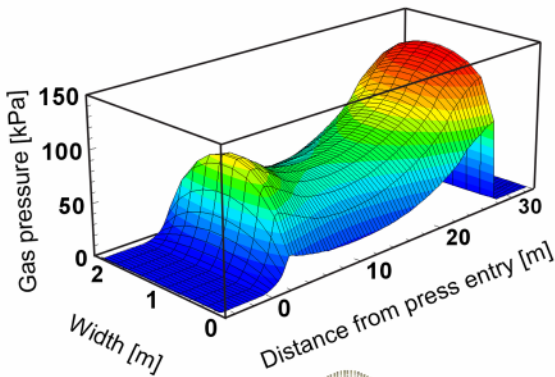
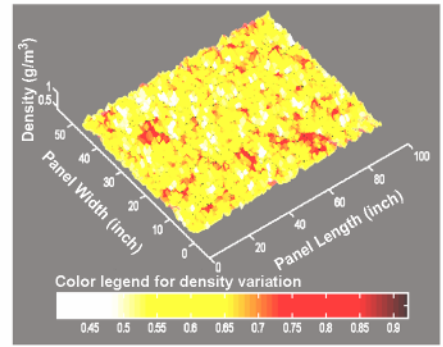
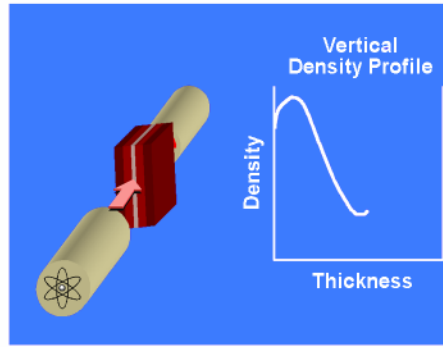
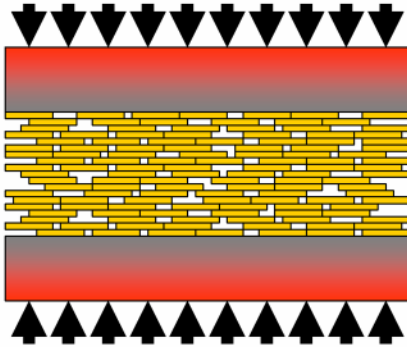

Presented by the U.S. Department of Agriculture, Forest Service, Forest Products Laboratory, Madison, Wisconsin in cooperation with the Wood-Based Composites Center, Virginia Tech, Blacksburg, Virginia

Abstract

The USDA Forest Service, Forest Products Laboratory (Madison, Wisconsin) and the Wood-Based Composites Center of Virginia Tech (Blacksburg, Virginia) co-sponsored a conference, held November 5–6, 2003, in Madison, Wisconsin, on the fundamentals of composite processing. The goals were to assess what we know, define what we need to know, and then establish the state of the art in hot-pressing of wood-based, particulate composites. Academic and industrial professionals from around North America and Europe were invited to participate because of their expertise and interest in this area of research. The workshop covered four critical topics associated with hot-pressing of composites: resin curing and bonding, press control, physics of hot-pressing, and computer simulations of the pressing process. This report is the official record of the presentations and discussions that occurred during this workshop.

Keywords: composites, processing, engineered wood

June 2004

Winandy, Jerrold E.; Kamke, Frederick A., Eds. 2004. Fundamentals of composite processing. Proceedings of a workshop; November 5–6, 2003; Madison, WI. Gen. Tech. Rep. FPL-GTR-149. Madison, WI: U.S. Department of Agriculture, Forest Service, Forest Products Laboratory. 118 p.

A limited number of free copies of this publication are available to the public from the Forest Products Laboratory, One Gifford Pinchot Drive, Madison, WI 53726–2398. This publication is also available online at www.fpl.fs.fed.us. Laboratory publications are sent to hundreds of libraries in the United States and elsewhere.

The Forest Products Laboratory is maintained in cooperation with the University of Wisconsin.

The use of trade or firm names in this publication is for reader information and does not imply endorsement by the U.S. Department of Agriculture of any product or service.

The United States Department of Agriculture (USDA) prohibits discrimination in all its programs and activities on the basis of race, color, national origin, sex, religion, age, disability, political beliefs, sexual orientation, or marital or familial status. (Not all prohibited bases apply to all programs.) Persons with disabilities who require alternative means for communication of program information (Braille, large print, audiotape, etc.) should contact the USDA's TARGET Center at (202) 720–2600 (voice and TDD). To file a complaint of discrimination, write USDA, Director, Office of Civil Rights, Room 326-W, Whitten Building, 1400 Independence Avenue, SW, Washington, DC 20250–9410, or call (202) 720–5964 (voice and TDD). USDA is an equal opportunity provider and employer.

Contents

	<i>Page</i>
Preface	iii
Overview of Composites Processing	iv
General Processing Considerations	iv
Oriented Strandboard	iv
Fiberboard	v
Fundamentals of Composite Processing	vi
Workshop Introduction	1
Physics of Hot-Pressing	3
Discussion	19
Monitoring Resin Cure in the Mat for Hot-Compression Modeling	26
Adhesive Interactions With Wood	29
Discussion	39
Press Control for Optimized Wood Composite Processing and Properties—Part 1: Pressing Variables and Sensors	54
Press Control for Optimized Wood Composite Processing and Properties—Part 2: Properties and Press Control Strategies	65
Discussion	83
Simulation of the Pressing Process	90
Discussion	102
Summary and Wrap-up	113
Appendix—Participant List	116

Fundamentals of Composite Processing

**Proceedings of a Workshop
Presented by the**

**U.S. Department of Agriculture, Forest Service,
Forest Products Laboratory,
Madison, Wisconsin**

in cooperation with the

**Wood-Based Composites Center
Virginia Tech, Blacksburg, Virginia**

November 5–6, 2003

Madison, Wisconsin

**Jerrold E. Winandy, Workshop Co-Chair and Editor
U.S. Department of Agriculture
Forest Service
Forest Products Laboratory
One Gifford Pinchot Drive
Madison, Wisconsin 53726–2398**

**Frederick A. Kamke, Workshop Co-Chair
Wood Science and Forest Products
1650 Ramble Road
Blacksburg, VA 24061**

Preface

The goals and objectives of this November 2003 workshop were related to those of an earlier workshop on composite consolidation held at Virginia Tech, Blacksburg, Virginia, in September 1990. The consensus from that first workshop was that process engineering required knowledge of the levels and rates of heat and mass (that is, moisture) transfer within a consolidating mat, considering that it could consist of a diverse array of materials. That knowledge was then used to explain why and how much those thermodynamic factors influenced both the chemistries and physical states of wood materials and resins within a consolidating composite mat. The use of models to interpolate between known conditions was endorsed. But, participants also reached consensus that models should not be black boxes spouting conditions. Rather, they should facilitate our understanding of what is going on and when events occur within a mat.

The goal of this second workshop is to assess what have we learned since 1990, identify what it is that we still need to know, and then re-establish the state of the art in hot-pressing of wood-based, particulate composites. Academic and industrial professionals from around North America and Europe were invited to participate because of their expertise and interest in this area of research. This workshop was hosted by the U.S. Department of Agriculture, Forest Service, Forest Products Laboratory, in cooperation with the Wood-Based Composites Center at Virginia Tech in Blacksburg, Virginia. It was chaired by Jerrold E. Winandy (FPL), with formal presentations offered by

Chunping Dai (Forintek–Canada Ltd)

Charles Frazier (WBC Center, Virginia Tech)

Charles Frihart (FPL)

Frederick A. Kamke (WBC Center, Virginia Tech)

Heiko Thoemen (University of Hamburg)

Siqun Wang (University of Tennessee)

More than 30 participants also attended the workshop at their own expense. Those participants are listed in the Appendix. The organizers of this workshop would like to thank the presenters and all the workshop attendees for their valuable contributions to this re-appraisal of the state of the art and the fundamentals of composite processing.

Jerrold E. Winandy
Workshop Chairman
Madison, Wisconsin

Overview of Composites Processing

Before we begin this review of the presentations and discussion that occurred during our workshop, a brief, general overview may be appropriate to help some readers understand the current state of the art in composites processing.

Today, many wood-based composite materials are normal materials in our day-to-day lives. These composites are usually available in panel form and are widely used in housing and furniture. Wood composites are typically made with a heat-curing adhesive that holds the wood fibers or wood-particle components together. Each type of wood-based fiber or wood-particle panel composites uses different wood materials and resins and has different physical and mechanical properties and surface characteristics. Thus, their manufacturing processes and intended uses vary accordingly.

General Processing Considerations

Still, most products in the family of particle and fiber composite materials are processed in similar ways. Raw materials for oriented strandboard (OSB), waferboard, and fiberboard are obtained by flaking or chipping roundwood. For fiberboard, chips are reduced to wood fiber using refiners that usually use steam to soften the wood. The comminuted wood flakes or fibers are then dried, a thermosetting adhesive is applied, and a mat of wood particles, fibers, or strands is loosely formed. That mat is then pressed in a platen-type press under heat and pressure until the adhesive is cured. The bonded product is allowed to cool and is further processed into specified width, length, and surface qualities. Two important wood composite products manufactured in North America are OSB and medium-density fiberboard (MDF). While the two end products are intended for different uses, many of the manufacturing and processing parameters used to make these two products are similar.

Oriented Strandboard

Oriented strandboard is an engineered structural-use panel manufactured from thin wood strands bonded together with waterproof resin under heat and pressure. It is used extensively for roof, wall, and floor sheathing in residential and commercial construction. Orientation of wood strands with a typical aspect ratio (that is, strand length divided by width) of at least 3 can produce a panel product with greater bending strength and stiffness in the oriented or aligned direction.

Aspen was used as the raw material for the original waferboard product, which was made from square wafers. As this industry expanded and OSB became the predominant product manufactured, other species such as Southern Pine, white birch, red maple, sweetgum, and yellow-poplar were found to be suitable raw materials as well. Small amounts of other low- to medium-density hardwoods are also commonly used for OSB.

In the general manufacturing process for OSB, debarked logs are often heated in soaking ponds and then sliced into thin wood elements. The strands are dried, blended with resin and wax, and formed into thick, loosely consolidated mats that are pressed under heat and pressure into large panels. Figure 1 shows an overview of the OSB manufacturing process. Oriented strandboard is made from long, narrow strands, with the strands of each layer aligned parallel to one another but perpendicular to strands in adjacent layers, like the cross-laminated veneers of plywood. It is this perpendicular orientation of different layers of aligned strands that gives OSB its unique characteristics and allows it to be engineered to suit different uses.

Typically, logs are debarked and then sent to a soaking pond or directly to the stranding process. Long log disk or ring stranders are commonly used to produce wood strands typically measuring 114 to 152 mm (4.5 to 6 in.) long, 12.7 mm (0.5 in.) wide, and 0.6 to 0.7 mm (0.023 to 0.027 in.) thick.

Green strands are stored in wet bins and then dried in a traditional triple-pass dryer, a single-pass dryer, a combination triple-pass/single-pass dryer, or a three-section conveyor dryer. A relatively recent development is a continuous chain dryer, in which the strands are laid on a chain mat that is mated with an upper chain mat and the strands are held in place as they move through the dryer. The introduction of new drying techniques allows the use of longer strands, reduces surface inactivation of strands, and lowers dryer outfeed temperatures. Dried strands are screened and sent to dry bins.

The blending of strands with adhesive and wax is a highly controlled operation, with separate rotating blenders used for face and core strands. Typically, different resin formulations are used for face and core layers. Face resins may be liquid or powdered phenolics, whereas core resins may be phenolics or isocyanates. Several different resin application systems are used; spinning disk resin applicators are frequently used.

Mat formers take on a number of configurations, ranging from electrostatic equipment to mechanical devices containing spinning disks to align strands along the panel's length and star-type cross-orienters to position strands across the panel's width. All formers use the long and narrow characteristic of the strand to place it between the spinning disks or troughs before it is ejected onto a moving screen or conveyor belt below the forming heads. Oriented layers of strands within the mat (face, core, face, for example) are dropped sequentially, each by a different forming head. Modern mat formers either use wire screens laid over a moving conveyor belt to carry the mat into the press or screenless systems in which the mat lies directly on the conveyor belt.

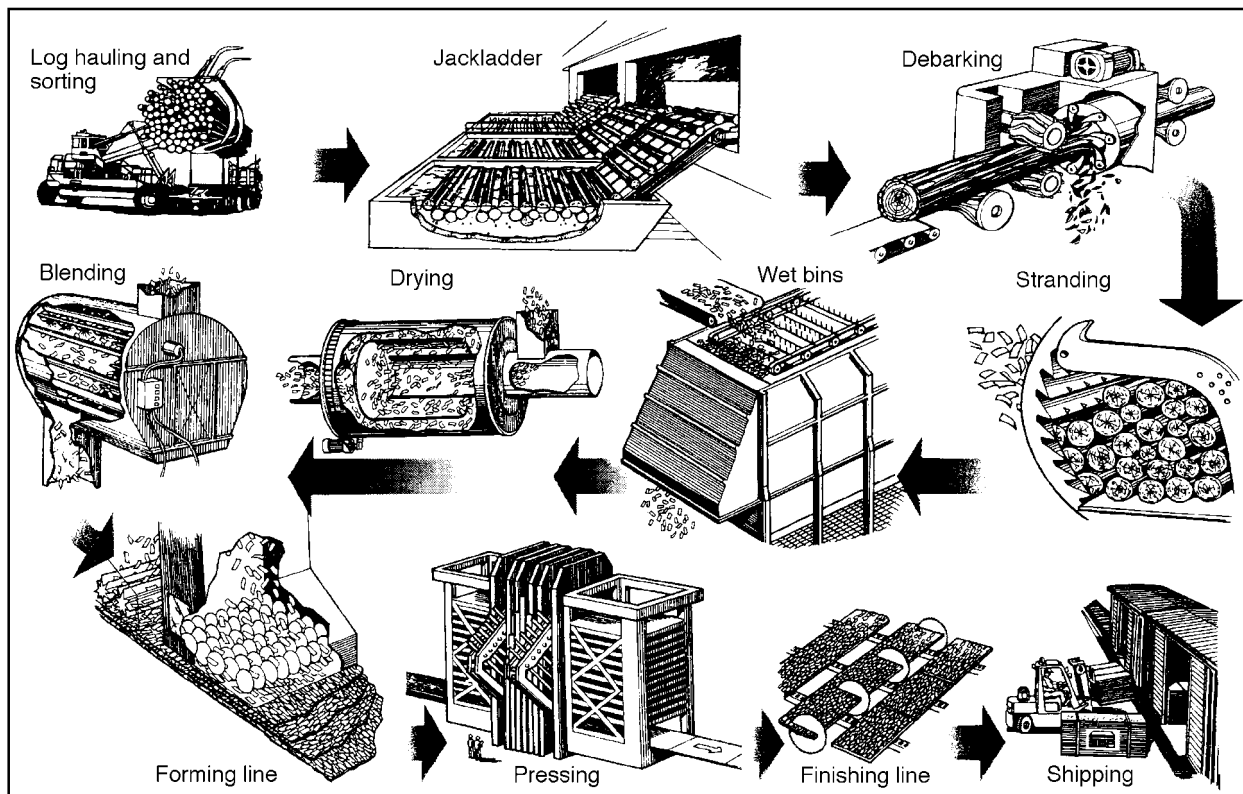

Figure 1—OSB manufacturing process (Courtesy of Structural Board Association, Willowdale, Ontario, Canada.)

In hot-pressing, the loose layered mat of oriented strands is compressed under heat and pressure to cure the resin. As many as sixteen 3.7- by 7.3-m (12- by 24-ft) panels may be formed simultaneously in a multiple-opening press. A more recent development is the continuous press for OSB. The press compacts and consolidates the oriented and layered mat of strands and heats it to between 177°C and 204°C (350°F and 400°F) to cure the resin in 3 to 5 min.

Fiberboard

The term fiberboard includes hardboard, MDF, and insulation board. Several things differentiate fiberboard from OSB and particleboard. Most notably, the physical configuration of the comminuted material is that of wood fiber, not a chip, flake, or strand of wood fibers. Because wood is fibrous by nature, fiberboard exploits the inherent strength of wood to a greater extent than does particleboard.

To make fibers for composites, bonds between the wood fibers must be broken. In its simplest form, this is accomplished by attrition milling. Attrition milling is an age-old concept whereby material is fed between two disks, one

rotating and the other stationary. As the material is forced through the preset gap between the disks, it is sheared, cut, and abraded into fibers and fiber bundles. Grain has been ground in this way for centuries. Attrition milling, or refining as it is commonly called, can be augmented by water soaking, steam cooking, or chemical treatments. Steaming the lignocellulosic material weakens the lignin bonds between the cellulosic fibers. As a result, the fibers are more readily separated and usually are less damaged than fibers processed by dry processing methods. Chemical treatments, usually alkali, are also used to weaken the lignin bonds. All of these treatments help increase fiber quality and reduce energy requirements, but they may reduce yield as well. Refiners are available with single- or double-rotating disks, as well as steam-pressurized and unpressurized configurations. For MDF, steam-pressurized refining is typical.

Fiberboard is normally classified by density and can be made by either a dry- or wet-forming process. Dry processes are applicable to MDF. The following discussions briefly describe the manufacturing of medium-density dry-process fiberboard. Suchsland and Woodson (1986) and Maloney (1993) provide more detailed information.

Dry-process fiberboard is made in a similar fashion to OSB, except wood fibers instead of wood flakes are formed into a mat. Urea-formaldehyde (UF) or phenol-formaldehyde (PF) resin and other additives may be applied to the fibers by spraying in short-retention blenders or a blow-line blender-dryer. The adhesive-coated fibers are then air-laid into a mat for subsequent pressing, much the same as mat formation for OSB without the elaborate layering or strand orientation.

Pressing procedures for dry-process fiberboard differ somewhat from particleboard procedures. After the fiber mat is formed, it is typically pre-pressed in a band press, the densified mat is then trimmed by disk cutters and transferred directly to a multi-opening hot press. MDF is usually pressed at approximately 140°C to 165°C (284°F to 329°F) for UF-bonded products and just greater than 190°C (410°F) for PF-bonded products. Continuous pressing using large, high-pressure band presses is also gaining in popularity in mills built since 1997, especially those in Europe. Board density is the basis for classification and properties and is an indicator of board quality. Since density is greatly influenced by moisture content, this is constantly monitored by moisture sensors.

Fundamentals of Composite Processing

Many aspects involved in the hot-pressing of wood composites and the chemistries and physical processes occurring within those wood mats during high-temperature consolidation have commonalities. To address these commonalities, this workshop involved four critical topics associated with hot-pressing of composites:

- Physics of hot-pressing,
- Resin curing and bonding,
- Press control strategies, and
- Computer simulations of the pressing process.

One or two formal presentations on each topic were presented by recognized authorities in those fields, those presentations were then followed by open discussion intended to identify what we now need to investigate and to re-establish the state of the art in hot-pressing of wood-based, particle composites. This workshop proceedings is a record of the presentations and discussions that took place between the workshop participants. It is made available to the general public as an FPL-produced General Technical Report (GTR) to help everyone involved in composite processing understand the fundamental chemistry and physics of composite processing. We also want to acknowledge and thank our workshop co-sponsor, the Wood-Based Composite Center of Virginia Tech, Blacksburg, Virginia.

Workshop Introduction

Jerry Winandy, Supv. Research Wood Scientist

Chris Risbrudt, Director
Forest Products Laboratory, Madison, Wisconsin

Jerry Winandy

I want to welcome you all and just want to say a couple of brief things before we have a word of introduction from our Director Chris Risbrudt. First of all, I would like to thank you all for attending. We appreciate the efforts and costs you have undertaken to help us generate the revised state of the art in the fundamentals of composite processing.

I also want you to be aware that everything will be recorded today, both video and audio. We're going to make a transcription of this and send it out to all members so people can make sure that what you said was what you said. There will also be a published proceedings and each of you will be sent a copy of that as soon as we get it published and it will be publicly available. With that, I'd like to introduce Chris Risbrudt, the Director of the Forest Products Laboratory.

Chris Risbrudt

Okay, thanks Jerry. Jerry and I share the first 15 min of the agenda I saw and I will try and get through my remarks relatively quickly because I know our project leaders can hardly get warmed up in 10 min so I will try and get through mine in 5 so we will stay on schedule. As always, it is my responsibility and my pleasure to welcome participants in meeting to the Forest Products Laboratory and in Madison so welcome to you all that are from outside of town and I hope you will enjoy your stay here at the FPL and in the fine city of Madison. I am sure during the course of this if you haven't been to the lab before we can make arrangements to show you the various parts of the laboratory you may have not seen before. We want you to leave here with solid knowledge of the kind of work that is going on here at the lab that you might be interested in. I also want to thank you all for participating in this workshop on the fundamentals of composite processing. You are the academic and industrial professionals from around North America and Europe who are the experts in this area and you have been invited here to participate because of your expertise and your recognized interest in this area of research. I also want to thank our workshop cooperator, the Wood Based Composite Center of Virginia Tech University in Blacksburg. So Fred, thank you and the other people that you had at Virginia Tech helping you make arrangements for this.

I know you all know that the use of composites is growing because they are efficient both in cost and environmental

impact, and they give us an ability to combine the desirable characteristics of a variety of materials, and they allow us to tailor material properties to end use performance requirements, which I think is an important aspect of the research in this area today. Now I want to talk particularly about Forest Service perspective on composites and I am sure these facts also apply to many of your own organizations. We strongly feel that composites are an important tool in helping us achieve sustainable forest management. I think it is the hot area of research in forest products utilization that has a major potential to change or to provide more options for forest management. Composites give us the ability to meet user needs for wood products while still using small-diameter trees from fire-prone forests. I know you are all aware of the critical fires now raging just outside San Diego in southern California, which follows on the heels of major fires throughout the west. In fact, of all the forest service leaderships meetings I have been at throughout the past year, virtually all of them have featured a tour of one mega fire or another. You know, when I started my career in the Forest Service, we thought a 5,000-acre fire was a monster. And now we talk about 1-h slopovers that reach 5,000 acres. And some of those fires, one last year in Colorado burned 16 miles in one 8-h period, and the fires that I visited in Arizona a few months ago, at the peak of the burning period on the hottest day of the fire, I think I have got this right, it was burning 2 square miles an hour of forest. Just tremendous fire behavior that we have never imagined before, let alone seen. And so we are faced with trying to manage about 200 million acres for United States forest that are in unhealthy condition and they are unhealthy because they have too many small trees. What can we do with small trees?

One good alternative is turning them into products through composites. And then also using residues from sawmilling operations and then using recovered post-consumer materials. So composites constitute a very important area of research for not just the forest products industry, but for forest management in general to provide those managers cost effective options for doing something with that material. For the Forest Service, because of the way we do business and the cost of doing business under the rules of Federal forest management, our costs range between \$500 and \$1,000 an acre for thinning these forests, and we have 73 million acres of national forest that need treatment.

So we need to figure out ways that we can reduce that cost by turning some of that material into useful products, and so this is an important area of research. But for all our advantages, we still need to improve the performance of these wood-based composites if they are to continue to grow into new end-use applications and to prevent substitution by alternative materials. What we learn in this workshop will help us make improvements in composite durability, dimensional stability, create performance, decay resistance, and termite resistance. The last workshop of this type was held 13 years ago at Virginia Tech. A lot has been learned in that time, and I am looking forward to the results of this workshop. We expect that these results will help many organizations identify and prioritize the needed course and direction for composites research for the next number of years until we decide to hold another one of these kinds of meetings. I want to thank you for helping us synthesize this state of the art in hot-pressing wood-based composites, and I will turn it back to you Jerry.

Jerry Winandy

Now, I think you each have a copy of the agenda. We've broken down the two-day workshop into a series of discussions into four different areas. These areas will be physics of hot pressing, resin curing and bonding, press control, and computer simulations. We are going to start with physics of hot pressing, but in each discussion we will have a presentation by a group leader followed by a group discussion that I encourage you all to participate in. I want to encourage you all to participate because the knowledge base we put together in this workshop will identify the critical needs that are important to the users of composites, which is our public at the Forest Products Laboratory, the industry that produces these materials, and the engineering community that designs with these materials. The knowledge base that we put together is only as good as what you and the rest of us put into it. So my challenge to each of you is that I would like to ask everyone sitting at these tables to add some value to each discussion. Your comments are critical to getting the best information out there and helping us synthesize this knowledge base.

Now, the goal of this workshop is to assess what exactly it is we know and where exactly we should go in the future research of hot-pressing wood-based particulate composites. We ask that you work with us to define what is happening with respect to wood and resin chemistry to consider the physics of mat consolidation, consider how do we control these events to get the performance and properties we want, and to learn to use this knowledge to improve current composites, and to develop the next generation of wood-based particulate composites. As I mentioned before, there will be a published report, which will be published as a USDA Forest Service General Technical Report. My goal is to have that report published within 6 months of this event. My goal is to get it transcribed and to you in draft form within 6-8 weeks from now. So I would then ask you to return your comments back to me within 30 days after receiving that and I will send out a note afterwards detailing all this information. Each one of the speakers will give us a written paper on their presentations and those speakers will be Fred Kamke, the director from the *Wood-Based Composite Center* at Virginia Tech University, Charles Frazier from the *Wood-Based Composite Center* at VA Tech and Charles Frihart, the project leader of the Forest Products Lab's *Wood Adhesive Science and Technology* group. They will then be followed by Chunping Dai, the head of the *Composites* group from Forintek, Siqun Wang at the University of Tennessee, and the simulation of processing Heiko Thoemen from University of Hamburg. So with that, I would like to start our talk by introducing Fred Kamke. Fred is a professor in the forest products and wood science technology, he earned his Ph.D. at Oregon State University and is the founder and director of the Wood-Based Composite Center. Fred's research specialization is heat and mass transfer in wood-based composites.

Physics of Hot Pressing

Frederick A. Kamke, T.M. Brooks Professor and Director
Wood-Based Composites Center, College of Natural Resources, Virginia Tech, Blacksburg, Virginia

Introduction

Wood is a complex natural material. It may be characterized as capillary-porous, cellular, anisotropic, and viscoelastic. In addition, the structure and properties of wood are widely variable in comparison to concrete, metals, and synthetic polymers. These characteristics present a formidable challenge for the design and manufacture of wood-based composites. Whether the composite is made of fibers, particles, strands, or veneer, the natural characteristics of wood play an important role in the manufacture and performance of the resulting composite. Current wood-based composite manufacturing technology relies on consolidation of a mat, or billet, of wood elements using thermal energy and mechanical compression. The thermal energy is used to cure the thermosetting adhesive, and the mechanical compression is needed to mate the surfaces of the wood elements for the creation of an adhesive bond. This paper will address the physics of consolidation of a particulate, wood-based composite. The focus will be on heat and mass transfer and the mechanics of mat compression. Temperature and gas pressure data will be used to illustrate the active heat and mass transfer mechanisms. The term particle will be used in a generic sense to include fibers and strands, as would be found in fiberboard and OSB products.

Temperature, wood moisture content, compression stress, and time are the primary factors, along with the intrinsic wood properties, that create the properties of the resulting composite. A forming machine establishes the mat structure by controlling particle orientation and separation into layers by particle size and moisture content. The hot-press provides the thermal energy and mechanical force of compression to consolidate the mat. Hot-presses are either batch-type with heated platens, or continuous-type with moving, heated belts (Maloney 1993). Most presses rely on conduction heat transfer from the platens, or belts, to the mat surface. Some presses employ steam-injection through the platens to accelerate heat transfer (Geimer 1982). A few presses use high frequency electric fields to augment heat transfer. Regardless of the press design, the mechanisms of heat and mass transfer in the mat are the same but vary by degree of importance and direction of flows. For simplicity, the present discussion will consider batch-type hot-presses.

Internal Mat Conditions

The study of the fundamental physics of mat consolidation began with experimentation of hot-pressing parameters and their influence on final properties. Kelly (1977) provided an excellent review of prior research relating manufacturing parameters to composite properties. The rate of temperature rise has an obvious impact on the rate of adhesive cure, and therefore, received early attention. Using thermocouples, Maku and others (1959) and Strickler (1959) monitored the rate of temperature change in the core of particleboard mats during hot-pressing. The influence of initial mat moisture content was clearly demonstrated, which indicated heat transfer and mass transfer are interdependent and that latent heat of vaporization significantly impacts the temperature rise (Fig. 1). It was also demonstrated that particle geometry affects water vapor flow, and consequently temperature rise, in the mat. The authors recognized that pressure gradients result in steam flow from the mat surface to the core early in the press cycle and then laterally from the mat core to the edges. Farni (1954) saw the benefit of steam flow for rapid heat transfer during hot-pressing and proposed the “steam-shock” effect, whereby higher moisture content wood particles are used in the surface layers of the mat.

Because the bulk flow of steam in the mat was an important means of heat transfer and excessive steam pressure at the end of a press cycle could cause delamination, a technique to measure gas pressure in the mat was developed and demonstrated (Denisov and Sosnin 1967, Kavvouras 1977, Kamke and Casey 1988). The technique utilizes a small-diameter (approx. 0.25-mm inside diameter) rigid tube, with the open end inserted inside the mat and the other end connected to a sensitive pressure sensing device. The tube may be filled with a liquid, such as a low vapor pressure silicon oil, to eliminate condensation of water vapor inside the tube. This method can only measure total gas pressure and can't differentiate partial pressures. For example, the manufacture of OSB using polymeric-diphenylmethane-diisocyanate (pMDI) adhesive produces significant amounts of CO₂ as a product of polymerization, which would falsely indicate high steam pressure during hot-pressing (Geimer and others 1991). This technique is a point measurement. Mats with a low permeability, such as high-density strand mats made from low-density wood, may have a high gas pressure gradient through the thickness and laterally from center to edge.

The measurement of temperature and gas pressure inside a mat during hot-pressing has now become common practice in the industry with the introduction of PressMAN[®] mat monitoring system in 1993 (Alberta Research Council 2003). The PressMAN[®] system includes specially designed temperature–pressure probes for measuring internal mat temperature and gas pressure during pressing. Systems for single and multi-daylight presses and systems for continuous presses are currently in use at more than 80 manufacturing facilities and research laboratories in 20 countries. Direct measurements of internal mat conditions are also necessary for the verification of hot-pressing simulation models (Zombori and others 2003). These measurements have also been adapted to continuous presses (Steffan and others 1999).

Heat and Mass Transfer

Suchsland (1967) reviewed some of the fundamental aspects of mat structure, heat transfer, and mat compression. Bolton and Humphrey (1989) provided a more recent review of the physics of hot-pressing, which they implemented into a hot-press simulation model. Simulation modeling of the hot-pressing process relies on a thorough understanding of the fundamentals of heat and mass transfer, mat rheology and the physical properties of wood. Several modeling studies have provided original data, or adapted the data of others, for describing the physics of hot-pressing (Humphrey and Bolton 1989; Bolton and others 1989a,b; Dai and others 2000; Carvalho and others 2001; Garcia and others 2002; Humphrey and Thömen 2003; Zombori and others 2003).

During the hot-pressing cycle, the internal conditions of the mat change rapidly. Heat is transported by conduction from the hot platens to the mat surface. The abrupt increase of temperature vaporizes the moisture within the particles at the surface. The air (which also contains water vapor) that resides in the voids of the mat also increases in temperature and thus increases in pressure in proportion to the temperature rise. The addition of evaporated water at the surface of the mat, plus the heated air, causes a pressure differential that drives the heated gases by hydrodynamic flow toward the center of the mat. If the water vapor gives up enough heat to the surrounding mat during its journey to the center, it will condense. The amount of condensation depends on the rate at which it is able to reach equilibrium with the wood at the prevailing temperature. Some of the condensate will become bound water and some will become liquid water. Therefore, a vertical water vapor flow from the surface of the board towards the center can be observed at the beginning of the press cycle.

The initial rise of surface temperature is often followed by a temperature plateau. The plateau in temperature is due to the latent heat of vaporization and the vapor pressure–moisture content–temperature equilibrium. The more moisture present in the surface particles, the more pronounced is the temperature plateau. A low moisture content will not produce a

plateau. When present, the temperature plateau is approximately 100°C, which corresponds to the boiling point of water at 1 atmosphere of pressure. The presence of the hygroscopic wood substance tends to reduce the equilibrium vapor pressure and suppress the temperature. However, restrictions to gas flow cause an elevation in vapor pressure, which may elevate the plateau temperature slightly above 100°C. As the rate of moisture evaporation at the surface declines, the surface temperature continues its rise to reach the platen temperature. The rate of temperature rise at this stage is dependent on the resistance to conduction heat transfer from the platens and the loss of heat toward the center of the mat.

At the beginning of the press cycle, the increase of temperature in the center of the mat is delayed due to the low thermal conductivity of the porous mat and time required for the steam to migrate from the surface. Convection heat transfer from the steam to the particles is small, since the heat capacity of water vapor is small. However, when the steam condenses, the latent heat of vaporization is recaptured as sensible heat energy, and the temperature rise in the center is then rapid. The gas pressure in the center increases as steam continues to arrive from the direction of the surface. Furthermore, conduction heat transfer, that now has accelerated due to the compaction of the mat and corresponding increase of thermal conductivity, helps to increase the temperature of the gas phase, and thus increases gas pressure. As temperature continues to increase, the condensed moisture will change back to vapor and consume latent heat energy, thus inhibiting further temperature rise. The build-up of gas pressure in the center creates a hydrodynamic potential for flow toward the edges of the mat. Gas flow occurs laterally and escapes to the surrounding environment. Eventually, the vertical flow of steam to the center will be less than the sum of lateral flow and steam loss due to condensation. At this time, the gas pressure in the center will have reached a maximum and begin to decline.

The temperature rise in the center of the mat is a delayed response until significant steam flow arrives from the surface. A plateau in temperature is pronounced and at a value that corresponds to an equilibrium with vapor pressure. The greater the vapor pressure, the greater the plateau temperature. The center temperature may never rise above the plateau if there is sufficient condensed water in the center. Indeed, the temperature may actually decline when venting occurs or if the lateral steam flow is excessive.

The process of venting the mat prior to press opening serves to reduce the internal gas pressure and minimize the potential for panel delamination. Venting is caused by a slow and controlled rate of mat expansion in the vertical direction as the press platens separate. The wood particles exhibit elastic expansion and minute voids between the particles open, thus increasing mat permeability and gas flow. The venting gas may move to the edges and toward the surfaces of the mat.

The placement of a screen caul on one surface of the mat reduces the resistance to mass flow and accelerates venting. The presence of the screen caul will also reduce the rate of steam flow to the center of the mat early in the press cycle, because the steam will have an alternative pathway for flow.

The rate of vertical and horizontal mass transfer is influenced by the porous structure of the mat. During press closure, the voids between the particles are reduced, but not entirely eliminated. Particle geometry, wood density, and compression of the wood particles all affect mat porosity and permeability. Wide and thin particles, such as wafers and strands, are able to align themselves in a planer orientation, thus creating strong resistance to gas flow. Thick particles promote gaps at their edges where particles overlap. Low-density wood requires more particles to produce a panel of fixed density compared with high-density wood. The low-density wood particles must then be compressed to a greater degree, thus eliminating more void space. The compression of the wood particles is not uniform from the surface to the center of the mat. The viscoelastic behavior of the wood, and dependence on temperature and moisture content, creates a vertical density profile. Thus, the porous structure of the mat, and consequently permeability, varies from surface to center.

Heat Transfer Mechanisms

The mechanisms of heat transfer during conventional hot-pressing include

- Conduction from platen to mat surface
- Conduction within the mat
- Convection between gas and particles in the mat
- Convection at the mat edges
- Bulk flow of gas in the mat
- Bulk flow of gas at the boundaries

Conduction heat transfer at the surface is absolutely essential to introduce energy into the mat from the heated platens. The degree of contact between the mat surface and the platen will influence the amount of resistance to conduction at this boundary. The insertion of a caul plate or caul screen will introduce more resistance. Instead of accounting for surface resistances between platen and caul, conduction through the caul, and caul to mat surface, an overall surface conduction heat transfer coefficient, U , may be defined and measured experimentally. The rate of heat transfer is then directly proportional to the difference between the platen temperature and mat surface (Eq. (1)). When the mat is under compaction pressure, the resistance at the mat surface is likely to be small.

If only conduction is considered, the steady-state heat conduction through the mat is represented by Eq. (2), where flow is in the thickness direction.

$$\dot{q}_z = U(T_{Platen} - T_s) \quad (1)$$

$$\dot{q}_z = -k_z \frac{\partial T}{\partial z} \quad (2)$$

where

- \dot{q}_z = heat flux in thickness direction, J/s/m²
- U = surface conduction heat transfer coefficient, J/s/°C/m²
- T = temperature, °C (s refers to the mat surface)
- k_z = thermal conductivity of the mat in thickness direction, J/s/°C/m
- z = distance in Cartesian coordinates, m.

The thermal conductivity may be dependent on the direction of heat flow. This is the case with oriented strand mats since the thermal conductivity of solid wood is approximately 2.5 times that in the radial or tangential directions (Siau 1995). In any of the flat-pressed particulate composites, where the particle aspect ratio corresponds with the grain, there will be a difference between thermal conductivity in the thickness direction and lateral directions. This occurs because the particles tend to lay in a plane parallel to the lateral plane of the mat. Furthermore, the thermal conductivity of the mat is dependent on the combined thermal conductivity of the particles, moisture, and voids between the particles. Thermal conductivity increases with moisture content and density (Siau 1995; Kamke and Zylkowski 1989). Empirical equations have been derived for estimating the thermal conductivity of wood particle mats and panels (von Haas 1998, Kamke and Zylkowski 1989). Zombori and others (2003) estimated thermal conductivity of wood strand mats during hot-pressing based on the thermal conductivity of the mat components: wood cell wall substance, moisture, and air (adhesive and wax were ignored). With a thermal conductance analogy after Siau (1995), the thermal conductivity of the strand mat in the thickness direction was given as

$$k_z = \frac{k_a k_T}{k_a (1 - v_m) + k_T v_m} \quad (2a)$$

$$k_T = G (k_{cw} + k_w m) + k_a v_d \quad (2b)$$

where

- k_a = thermal conductivity of air, J/s/m/°C
- k_T = thermal conductivity of wood in transverse direction, J/s/m/°C
- k_{cw} = thermal conductivity of cell wall substance, J/s/m/°C
- k_w = thermal conductivity of water, J/s/m/°C

v_m = inter-strand fractional void volume of mat
 v_d = fractional void volume of lumens in wood
 m = moisture content fraction of wood
 G = specific gravity of wood

The thermal conductivity of the mat in the lateral directions was estimated in a similar manner, with consideration for the strand orientation and the degree of alignment, and assuming the thermal conductivity of wood in the longitudinal direction is 2.5 times greater than the transverse directions.

The specific heat of the mat is the property that determines the amount of energy necessary per unit of temperature change, per unit of mass. It may be defined for the combined wood, moisture, and void system, using the method of mixtures. Liquid water or bound water has a greater heat capacity than wood substance, which has a greater heat capacity than water vapor or air. Higher moisture content means a higher specific heat.

The flow of gas through the mat is accompanied by the energy content of the moving gas, and thus energy is transported by bulk flow. This flow is initiated by a total pressure gradient, limited by the permeability of the mat, with the energy content of the gas represented by its enthalpy. The steady-state, bulk flow component of heat transfer is given by Eq. (3), with flow in the thickness direction. There is also a phase change associated with the bulk flow, which impacts the temperature change. The evaporation of bound water consumes energy equal to the sum of the latent heat of vaporization and differential heat of sorption. During vaporization, the sensible heat energy is reduced. Depending on the rate of vaporization, the temperature raises slowly, remains constant, or the temperature may decline. A declining temperature occurs when there is a drop in water vapor pressure coincident with rapid vaporization, such as occurs during venting. When water vapor condenses, the change in phase to a lower energy state releases energy and a rapid rise of temperature occurs.

Figure 2 illustrates the significance of the latent heat effect on energy exchange. A purely convection heat transfer would transfer energy from water vapor to the wood particles without condensing the vapor. The amount of energy exchanged per unit volume would equal the change in enthalpy that is associated with the loss of temperature, multiplied by the density of water vapor. If the temperature of the vapor dropped from 200°C to 100°C, the enthalpy change is only 200 kJ/kg. If the water vapor density were 0.46 kg/m³, this would be an exchange of energy of 92 kJ/m³ (200 kJ/kg × 0.46 kg/m³). Alternatively, if the water vapor condenses to liquid water at 100°C, the energy released is 1.0 × 10³ kJ/m³ (2.2 × 10³ kJ/kg × 0.46 kg/m³), which is more than 10 times the energy exchange due to convection.

$$\dot{E}_{bulk} = -\frac{K_z M P}{\eta_g R T} \left(\frac{\partial P}{\partial z} \right) h_g \quad (3)$$

where: \dot{E}_{bulk} = heat flux due to bulk flow, J/m²/s

K_z = gas permeability in thickness direction, m²

P = total gas pressure, Pa

h_g = enthalpy of the gas, J/kg

M = molecular weight, kg/mol

η_g = viscosity of gas, Pa·s

R = gas constant, J/mol/K

Mass Transfer Mechanisms

The mechanisms for mass transfer during hot-pressing include hydrodynamic flow and diffusion. Hydrodynamic flow, or bulk flow, occurs as a result of a total pressure gradient. This mass transfer mechanism is coupled with heat transfer, as discussed previously. The amount of moisture present in the mat will have a direct influence on the maximum pressure experienced in the mat during hot-pressing. However, other factors, such as mat permeability, the type of caul system, mat size, and the rate and amount of heat transfer into the mat, will also influence the gas pressure.

Permeability is a property of the mat that will be dependent on the shape of the wood particles, size of the particles, density of the wood, and degree of compression of the mat. Large cube-like particles will not pack together closely, and this creates many gaps for gas flow. Wide and thin particles, such as OSB strands, may pack together to form small gaps that are more widely spaced apart. As the mat is compressed, the gaps are diminished but not completely eliminated. This means that during press closing the mat permeability is high. After closure, the permeability is considerably smaller (Fig. 3). Permeability will not be uniform from surface to center of the mat. Since the particulate composites form a density gradient, the permeability will be greater in the lower density regions. Permeability is also a directional property. Von Haas (1998) measured the greatest permeability in the direction parallel to the grain of the strands in OSB, and the lowest permeability in the thickness direction. Near the end of the press cycle, when venting begins, the press opens very slowly. With the restraining force reduced, the wood particles are able to expand slightly, which opens up additional gaps between particles, and increases mat permeability. The resistance to hydrodynamic flow is then reduced and rapid mass transfer occurs. The pathway for flow is tortuous, with gas expanding around particles rather than through particles.

The ratio of mat density to wood density, called compaction ratio, will impact mat permeability. The greater the compaction ratio, the greater the compression strain of the particles, and thus the smaller the gaps between the particles. High-density wood species would tend to have higher mat permeability than low-density wood species when pressed to the same panel density.

At the mat surface and edge, convective mass transfer, diffusion, and bulk flow may occur. If a solid caul plate is present, with sufficient compression stress, no mass transfer will occur at that surface boundary. A caul screen would permit bulk flow and gas phase diffusion. At the edges of the mat, all three mechanisms may occur. Convection is promoted by rapid air flow of the surrounding environment and driven by a concentration difference between the mat edge and the moving air stream. Bulk flow occurs at the boundaries due to a total pressure difference. At the edges, the resistance to bulk flow is essentially zero. Diffusion is driven by a concentration difference between the mat edge and the surrounding environment.

$$\dot{n}_x = k_c \Delta c \quad (4)$$

k_c = convective mass transfer coefficient, m/s

Δc = Concentration difference at boundary,
kg/m³

Diffusion inside the mat during hot-pressing consists of gas phase diffusion and bound water diffusion. It occurs as a result of a chemical potential gradient, which usually coincides with a concentration gradient. Gas phase diffusion occurs in the gaps between the particles. Random molecular motion will result in a high concentration of a gas dispersing in a direction of a lower concentration, until equilibrium is reached. Similarly, bound water moves through wood as a result of random motion of the water molecules. In solid wood, gas phase diffusion and bound water diffusion are usually lumped together, and a single diffusion coefficient is defined (Eq. (5)). Gas phase diffusion is much more rapid than bound water diffusion. Therefore, low-density wood, which has a large proportion of void volume, has a greater diffusion potential (large diffusion coefficient).

$$\dot{n}_z = -D_z \frac{\partial c}{\partial z} \quad (5)$$

where D_z = combined diffusivity of water vapor
and bound water in thickness direction, m²/s

c = moisture concentration, kg/m³

Compared with other mass transfer mechanisms, diffusion is a slow process, particularly for bound water in the wood, and therefore, has a negligible influence on total mass flow during hot-pressing. Zombori and others (2003) studied the relative significance of several heat and mass transfer

mechanisms using a simulation model. Diffusion was found to be negligible during the short time associated with hot-pressing. After hot-pressing, when total pressure gradients have diminished, diffusion will become a significant factor for moisture movement.

Mat Compression

The compression behavior of the mat is influenced by its structure and the mechanical properties of the wood. The mat structure is comprised of particles and voids. The voids are large and dominate the mat early in the press cycle. Particles with a large aspect ratio are able to bridge gaps and contribute to compression resistance as a result of bending. Cube-like particles experience essentially no resistance to compression strain until continuous columns of wood are formed from bottom to top (Fig. 4). Bending or sliding of the wood particles contributes to nonlinear compression behavior. At the beginning of press closure, the mat compresses in a linear elastic manner, as shown in Figure 4A. The compression modulus of the mat is so low that the stress is barely measurable. During this time, the particles are largely unrestrained and slide past one another. A yield point (Fig. 4B) is reached when particle to particle contact is made from bottom to top of the mat and wide spread particle bending occurs. This region is marked by large strain with little or no stress. Period C begins when individual particles begin to compress and lumen volume starts to diminish. Period D begins when the majority of the cell lumens have been eliminated and cell wall substance is being compressed.

Figure 5 illustrates the void structure in an OSB mat during compression. At 0% strain, large voids are evident, which are readily accessible for bulk flow. As the strain is increased, the voids become smaller. Many voids are completely eliminated, as shown by the arrow that follows the progression of one void from zero strain to 75% strain. Figure 5 also demonstrates that the randomized mat structure causes some vertical regions to be completely filled with particles, and thus under stress, while other vertical regions still have voids and no compression stress. This nonuniform void structure is more prevalent in mats with large particles.

The wood particles have their own cellular structure, with the cell lumens comprising the voids. While under compression perpendicular to the grain, the cell walls will bend and subsequently buckle. With excessive strain, or large strain rate, the cell walls may fracture. The collapse of the cell wall is the primary reason for the nonlinear compression behavior of wood (Gibson and Ashby 1988). Wolcott and others (1994) demonstrated that wood under transverse compression behaves similarly to other cellular materials and that the nonlinear behavior is adequately attributed to cell wall collapse.

When placed under a compression stress, wood responds with elastic strain, delayed elastic strain, and viscous strain

(Fig. 6). The elastic strain is recoverable immediately after removal of the stress. The delayed elastic strain is also recoverable but not immediately. The viscous strain is not recovered upon removal of the stress. This behavior is called viscoelasticity and is a characteristic of the natural polymers that comprise the cell wall. Temperature, moisture content, and time influence the viscoelastic behavior.

It is the amorphous structure of lignin, hemicelluloses, and portions of the cellulose that cause the viscoelastic nature of wood. These polymers appear to be glass-like (stiff and brittle) over a short time domain, low temperature, or low bound water content. At long time, high temperature, and high bound water content, the cell wall exhibits rubbery behavior (ductile and soft). Between these two distinct regions is a transition zone. Considering a constant moisture content, constant time domain, and varying temperature, this transition phase is called the glass transition temperature (T_g). Increasing the time domain, or increasing bound water content, will reduce the T_g (Fig. 7). The master curve shown in Figure 7 explains the change in modulus of an amorphous polymer across a broad domain of time and temperature. In effect, time and temperature have an equivalent influence on the modulus. Wolcott and others (1994) showed that moisture content also has an equivalent influence on the modulus of wood, as demonstrated by the master curve shown in Figure 8. The tensile modulus data was shifted for temperature and moisture content.

A wood particle mat during hot-pressing behaves like a cellular, viscoelastic material. There are two levels of cellularity, the lumens in the particles and the voids between the particles. The collapse of the voids, and subsequently the lumens, leads to nonlinear compression behavior. Furthermore, the transient temperature and moisture content straddles the T_g at various times and locations throughout the mat. Once a region in the mat reaches the T_g , there is a sudden reduction in modulus and densification occurs. Even after the press has reached the target thickness, stress is still evident. As certain regions in the mat reach T_g , the compression modulus will be reduced and stress will be relieved. Since another region in the mat may have a greater modulus, because it is below the T_g , that region may recover some of the elastic and delayed elastic strain. This means the vertical density profile continues to develop after the target thickness is reached.

The viscous strain component is particularly important in hot-pressing. With sufficient temperature, moisture, and time, the nonrecoverable viscous strain is increased. This happens because of the enhanced ability for the amorphous polymer segments in the cell wall to reorient themselves in a new configuration, rather than merely stretching the chains. The increased viscous strain is realized as reduced spring-back out of the press and a lower potential for thickness swell when the composite is exposed to moisture. In addition, thermal decomposition may reduce the

hygroscopicity of the cell wall, thus reducing water adsorption potential.

Another phenomenon that probably occurs during hot-pressing is mechanosorption. Mechanosorption (MS) is characterized by a sudden stress relaxation or increase in strain rate coincident with a rapidly changing moisture content. It occurs with both adsorption and desorption of bound water. Wu and Milota (1995) demonstrated that MS strain is the dominant factor in creep of small wood specimens during desorption. They also found that MS in compression is approximately three times MS in tension perpendicular to the grain. Several theories have been proposed as to the cause of MS. One theory suggests that the movement of water molecules to or from a sorption site in the polymer network requires more intermolecular space and thus a lesser degree of polymer entanglement and fewer, or less energetic, secondary bonds between polar molecular groups. Since hot-pressing produces a sudden loss of bound water in the surface regions and a sudden bound water gain in the center, mechanosorptive strain is highly probable.

The viscoelastic behavior of amorphous polymers may be modeled using springs and dashpots. The springs represent the elastic component, and the dashpots represent the viscous component. A spring and a dashpot in parallel (Fig. 9) simulates the delayed elastic response. Figure 9 shows one such spring and dashpot arrangement. A changing temperature and moisture content will change the value of the spring constant and viscosity of the dashpot.

This discussion of the compression behavior of particulate mats has neglected the contribution of the adhesive. The degree of cure, penetration of adhesive into the wood particles, and mechanical properties of the cured adhesive, will surely influence stress and strain behavior of the mat throughout the press cycle. This topic is beyond the scope of this paper.

Effect of Mat Structure and Press Cycle on Internal Mat Conditions

Examples of measured internal mat conditions are given in Figures 10 through 15. These data were collected on laboratory OSB mats of final dimension 19 by 610 by 610 mm (0.75 by 24 by 24 in.) (Zombori and others 2003). Gas temperature and pressure were monitored at six locations in each mat, with reference to a vertical mid-plane. Platen temperature, target density, and mat moisture content were parameters in the study. Figures 10 and 11 illustrate the influence of platen temperature on mat temperature. The rate of temperature rise is much greater with the higher platen temperature seen in Figure 10 than Figure 11. Plateau temperatures at the center horizontal plane are evident at both temperatures. Position 6 in Figure 10 actually shows a declining

temperature after the peak gas pressure is reached and begins to decline (Fig. 12). The 200°C platen temperature produced the higher internal gas pressures, with the highest at location 5 (center-surface) and the lowest at location 2 (center-edge). The lower density at the center and the proximity to the edge, provided the least resistance to gas flow, which led to the low pressure. The gas pressure increase was more gradual with the lower platen temperature, as a result of less intense vaporization early in the press cycle and lower gas pressure at the surface (Fig. 13). In both cases, gas pressure was greater near the platen and lower near the edge, which supports the idea of bulk flow from the surface toward the center and from the center toward the edge.

Figures 14 and 15 depict the influence of target density on heat and mass transfer. The medium-density mat had the greatest rate of temperature rise in the center, while the highest density mat had the slowest rate. Mat density has contrasting effects on bulk flow and thermal conduction. A high-density mat is less permeable and experiences less heat transfer by bulk flow. However, a high-density mat is a better thermal conductor. Since heat transfer by bulk flow is the dominant heat transfer mechanism, the high-density mat has the lowest rate of temperature rise (Fig. 14). In addition, a higher density mat has a higher thermal mass, and therefore, requires more energy per degree change in temperature. The gas pressure in the center of the low-density mat has the lowest peak value (Fig. 15). This occurs because it has a higher permeability and gas can more easily escape to the edges. The low-density mat has the lowest plateau temperature, due to its inability to hold water vapor pressure by more than 0.4 bar (gage pressure).

Summary

The hot-pressing of particulate wood composites involves simultaneous heat, mass, and momentum transfer. Although not discussed here, chemical reactions, such as thermal decomposition or adhesive polymerization, also are active during hot-pressing. The particle mat is a complex structure on multiple levels, including the cellular structure of the wood and the pseudo cellular structure of the mat. The transport mechanisms are interdependent. Many characteristics of wood are manifested in the mat behavior, such as thermal conductivity, specific heat, and compression modulus. However, the mat structure reorients the orthogonal nature of the individual wood particles, which leads to some unique characteristics. Permeability is heavily influenced by the mat structure, and plays a critical role in both heat and mass transfer. Direct measurement of temperature, gas pressure, and compaction pressure during hot-pressing opens a window onto the manifestations of the mechanisms discussed in this paper. However, a better understanding of the implications of the observed behavior will require a mathematical model, which will have the ability to investigate the interdependence of the transport mechanisms.

Literature Cited

- Alberta Research Council.** 2003. PressMAN[®] Monitoring System, Forest Products Business Unit, Alberta Research Council, Edmonton, Alberta, Canada. <http://www.arc.ab.ca/forpro/ForestProductsBU.asp>.
- Bolton, A.J.; Humphrey, P.E.** 1989. The hot pressing of dry-formed wood-based composites, Pt. I. A review of the literature, identifying the primary physical processes and the nature of their interaction. *Holzforschung*. 42: 403–406.
- Bolton, A.J.; Humphrey, P.E.; Kavvouras, P.K.** 1989a. The hot pressing of dry-formed wood-based composites. Pt. III. Predicted vapor pressure and temperature variation with time, compared with experimental data for laboratory boards. *Holzforschung*. 43: 265–274.
- Bolton, A.J.; Humphrey, P.E.; Kavvouras, P.K.** 1989b. The hot pressing of dry-formed wood-based composites. Pt. IV. Predicted variation of mattress moisture content with time. *Holzforschung*. 43: 345–349.
- Carvalho, L.M.H.; Costa, M.R.N.; Costa, C.A.V.** 2001. Modeling rheology in the hot-pressing of MDF: Comparison of mechanical models. *Wood and Fiber Science*. 33(3): 395–411.
- Dai, C.; Knudson, B.; Wellwood, R.** 2000. Research and development in oriented strandboard (OSB) processing. In: *Proceedings, 5th Pacific Rim bio-based composites; 2000 December 10–13; Canberra, Australia*: 556–563.
- Denisov, O.B.; Sosnin, M.S.** 1967. Characterization of changing temperature and steam pressure inside a particleboard mat during pressing. *Derev. Prom.* 16(8): 11 (in Russian).
- Farni, F.** 1954. Das Verpressen von Spanplatten bei ge- feuchteten oder fauchteren Deckspänen. *Holz als Roh- und Werkstoff*. 14(1): 8–10.
- García, P.J.; Avramidis, S.; Lam, F.** 2002. Three-dimensional heat and mass transfer during oriented-strandboard hot-pressing. In: *Proceedings, 6th Pacific Rim bio-based composites symposium. Vol. 1; 2002 November 10–13; Portland, OR*: 268–277.
- Geimer, R.** 1982. Steam injection pressing. In: *Proceedings, 16th international particleboard symposium; 1982 March 30–April 1; Pullman, WA. Pullman, WA: Washington State University*: 115–134.
- Geimer, R.L.; Johnson, S.E.; Kamke, F.A.** 1991. Response of flakeboard properties to changes in steam injection pressing environments. Res. Pap. FPL–RP–507. Madison, WI: U.S. Department of Agriculture, Forest Service, Forest Products Laboratory.
- Gibson, L.J.; Ashby, M.F.** 1988. Cellular solids: structure and properties. Oxford, England: Pergamon Press. 357 p.

- Humphrey, P.E.; Bolton, A.J.** 1989. The hot pressing of dry-formed wood-based composites. Pt. II. A simulation model for heat and moisture transfer, and typical results. *Holzforschung*. 43: 199–206.
- Humphrey, P.; Thömen, H.** 2003. Continuous pressing and beyond: Computer simulation models as tools for present and future technologies. In: Proceedings, 37th international wood composite materials symposium and technical workshop: Computer applications for improved products and processes; 2003 April 7–10; Pullman, WA.
- Kamke, F.A.; Casey, L.J.** 1988. Fundamental of flakeboard manufacture: Internal mat conditions. *Forest Products Journal*. 38(6): 38–44.
- Kamke, F.A.; Zylkowski, S.C.** 1989. Effects of wood-based panel characteristics on thermal conductivity. *Forest Products Journal*. 39(5): 19–24.
- Kavvouras, P.K.** 1977. Fundamental process variables in particleboard manufacture. Ph.D. dissertation, University of Wales, Bangor, UK. 156 pp.
- Kelly, M.** 1977. Critical review of relationships between processing parameters and physical properties of particleboard. Gen. Tech. Rep. FPL–10. Madison, WI: U.S. Department of Agriculture, Forest Service, Forest Products Laboratory.
- Lenth, C.A.; Kamke, F.A.** 1996a. Investigations of flakeboard mat consolidation. Pt. I. Characterizing the cellular structure. *Wood and Fiber Science*. 28(2): 153–167.
- Lenth, C.A.; Kamke, F.A.** 1996b. Investigations of flakeboard mat consolidation. Pt. II. Modeling mat consolidation using theories of cellular materials. *Wood and Fiber Science*. 28(3):309–319.
- Maku, T.; Hamada, R.; Sasaki, H.** 1959. Studies on the particleboard. Report 4: Temperature and moisture distribution in particleboard during hot-pressing. *Wood Research Kyoto University*. 21: 34–46.
- Maloney, T.M.** 1993. Modern particleboard and dry process fiberboard manufacturing. 2d ed., San Francisco, CA: Miller Freeman. 688 p.
- Siau, J.F.** 1995. Wood: Influence of moisture on physical properties. Blacksburg, VA: Virginia Polytechnic Institute and State University, Department of Wood Science & Forest Products. 227 p.
- Steffen, A.; Haas, G.V.; Rap, A. [and others].** 1999. Temperature and gas pressure in MDF-mats during industrial continuous hot pressing. *Holz Roh-Werkst.* 57: 154–155.
- Strickler, M.D.** 1959. The effect of press cycles and moisture content on properties of Douglas fir flakeboard. *Forest Products Journal*. 9(7): 203–207.
- Suchsland, O.** 1967. Behavior of a particleboard mat during the press cycle. *Forest Products Journal*. 17(2): 51–57.
- von Haas, G.** 1998. Untersuchungen zur Heißpressung von Holzwerkstoffmatten unter besonderer Berücksichtigung des Verdichtungsverhaltens, der Permeabilität, der Temperaturleitfähigkeit und der Sorptionsgeschwindigkeit. Dissertation, Hamburg, Germany: University of Hamburg. 264 p.
- Wolcott, M.P.; Kamke, F.A.; Dillard, D.A.** 1994. Fundamental aspect of wood deformation pertaining to manufacture of wood-based composites. *Wood and Fiber Science*. 26(4): 496–511.
- Wu, Q.; Milota, M.R.** 1995. Rheological behavior of Douglas-fir perpendicular to the grain at elevated temperatures. *Wood and Fiber Science*. 27(3): 285–295.
- Zombori, G.B.; Kamke, F.A.; Wastson, L.T.** 2003. Simulation of the internal conditions during the hot-pressing process. *Wood and Fiber Science*. 35(1): 2–23.

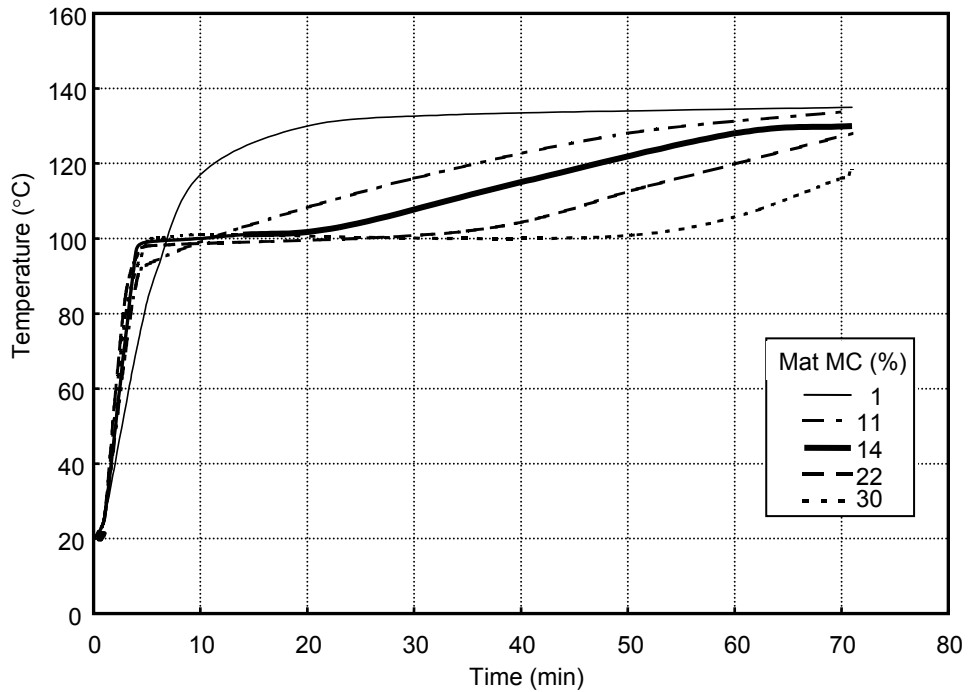

Figure 1—Core temperature of particleboard during hot-pressing as influenced by initial mat moisture content (Maku and others 1959). Platen temperature is 135°C.

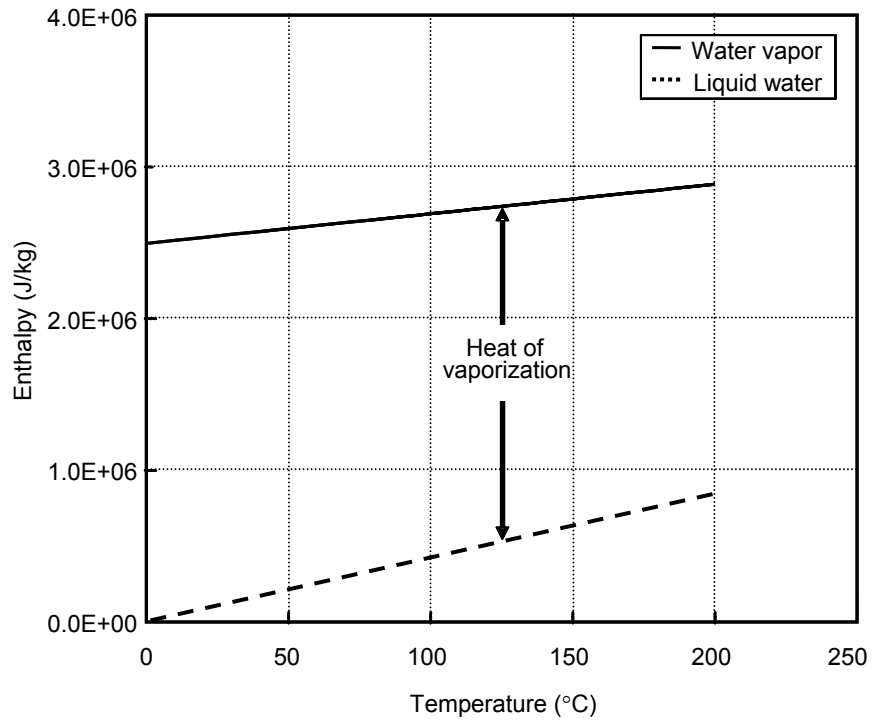

Figure 2—Enthalpy of liquid and vapor water as a function of temperature.

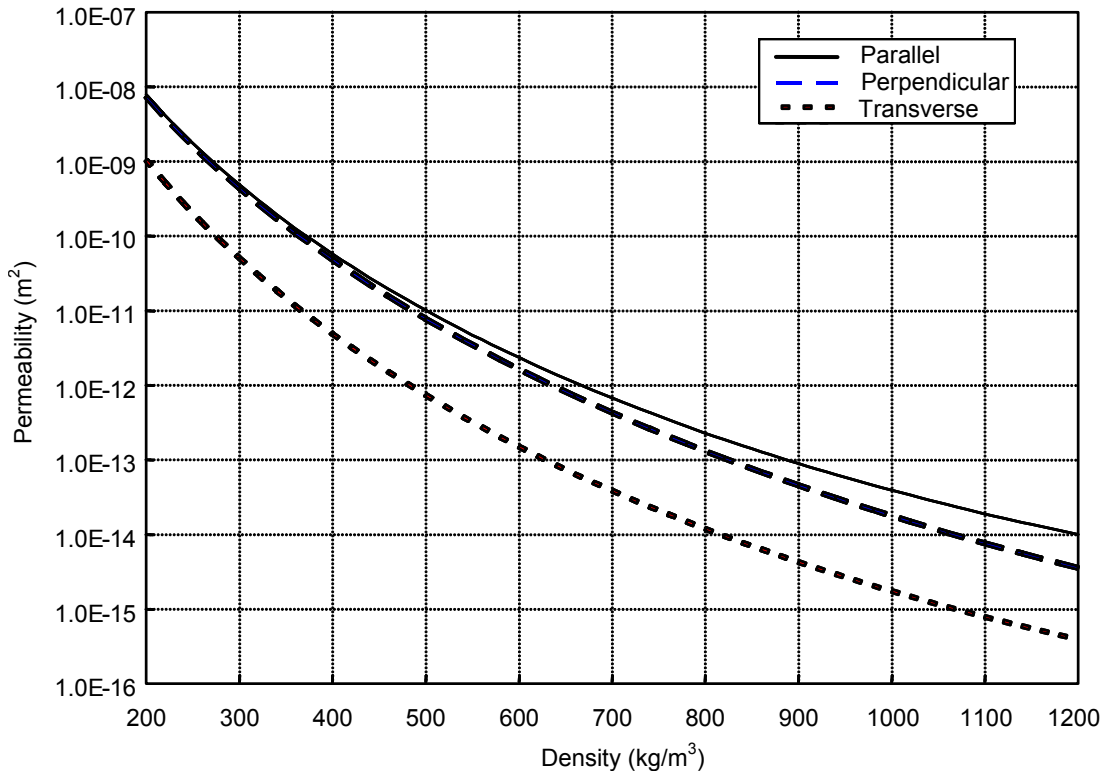

Figure 3—Oriented strandboard mat permeability as a function of direction and mat density for resin content of 5% (von Haas 1998).

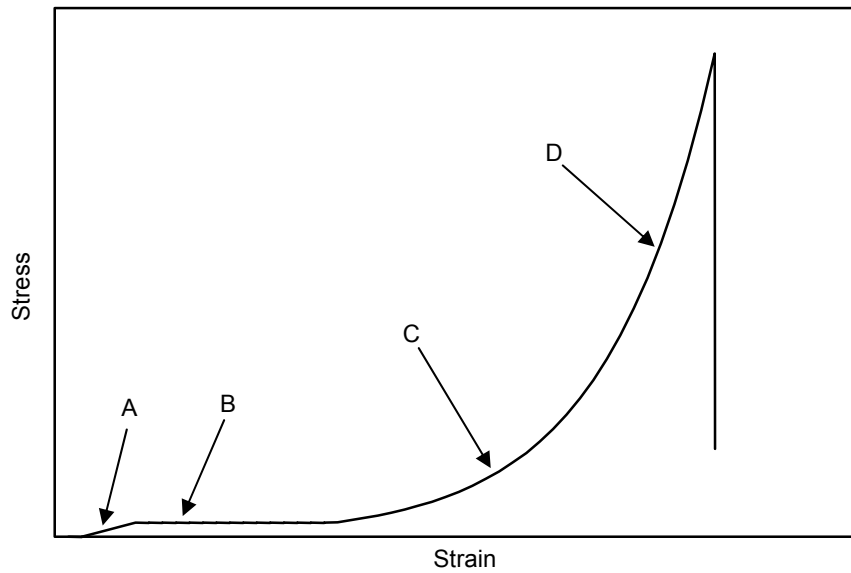

Figure 4—Stress and strain diagram for wood particle mat under compression.

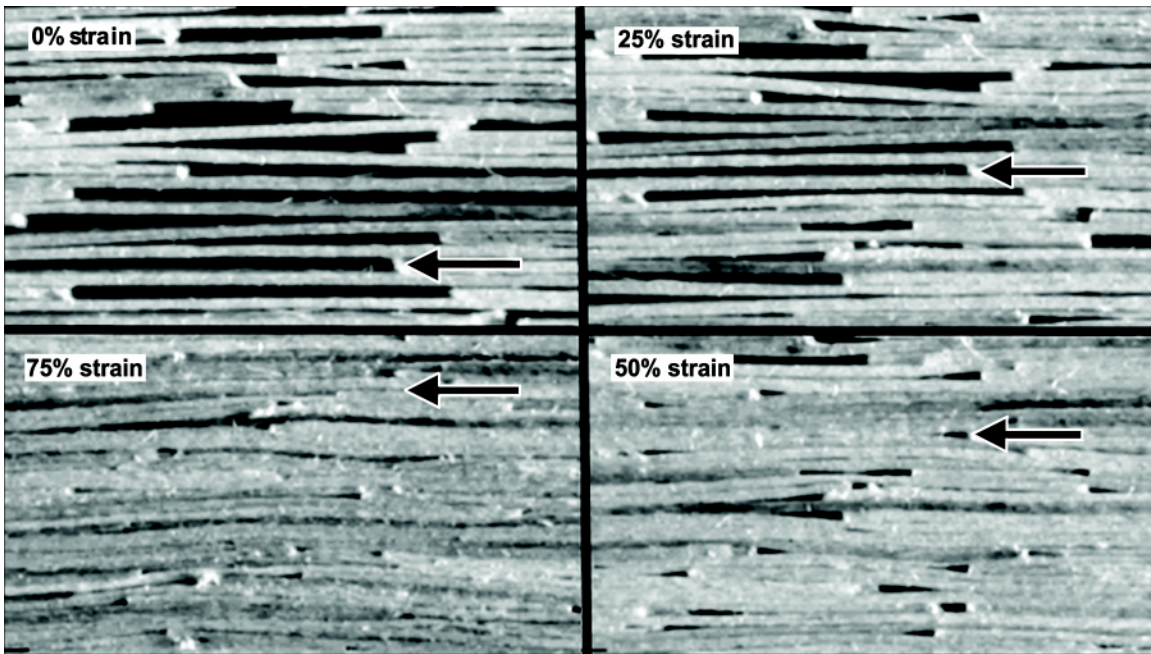

Figure 5—Oriented strandboard mat undergoing compression from zero to 75% strain. Arrows indicate the progression of one void (Lenth and Kamke 1996a,b).

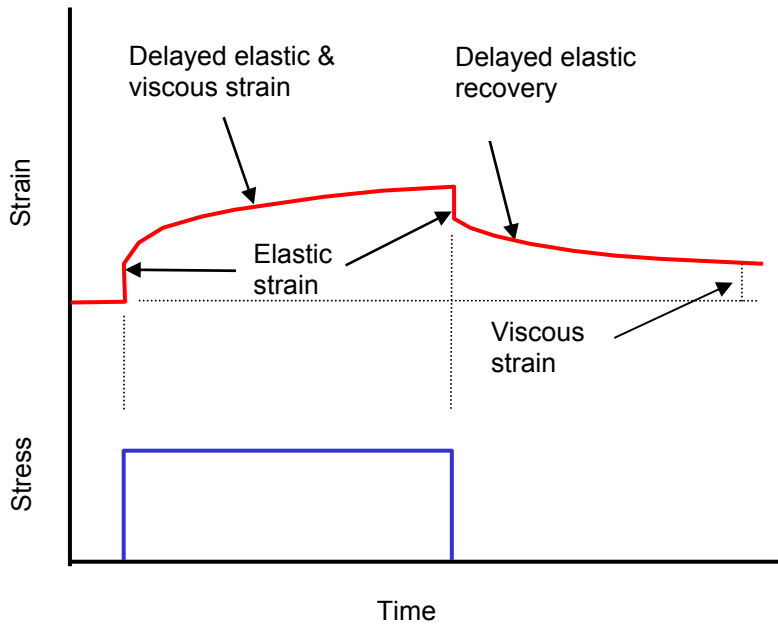

Figure 6—Stress and strain behavior for a linear viscoelastic material.

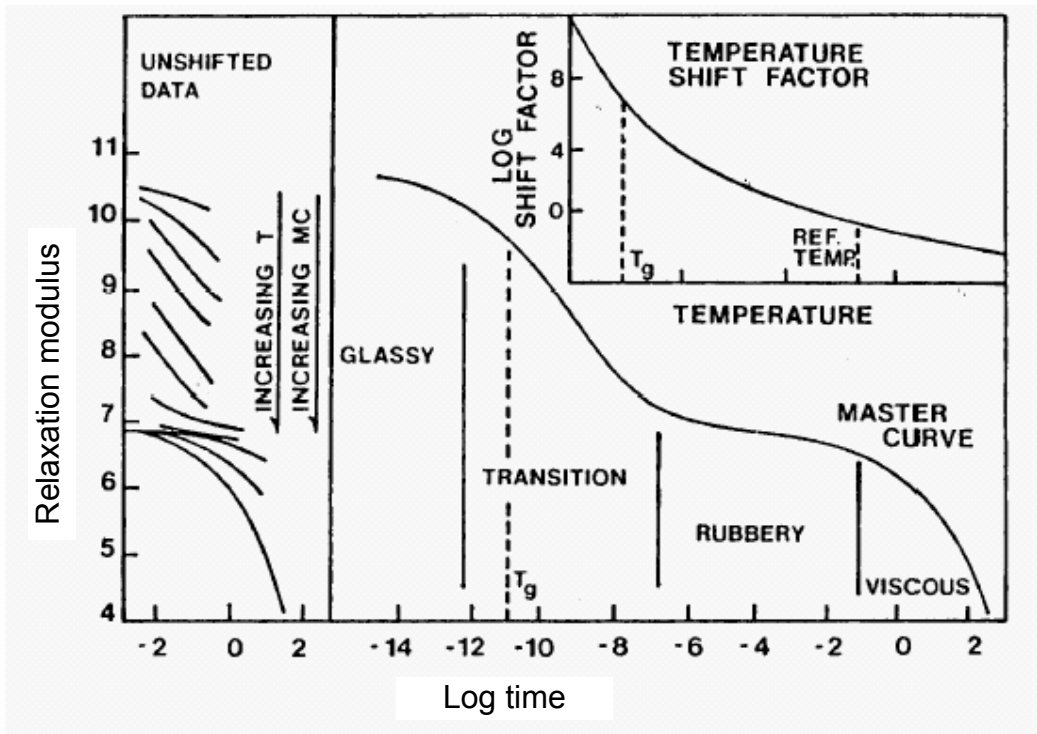

Figure 7—Typical relaxation modulus for an amorphous polymer with time, temperature, and diluent concentration.

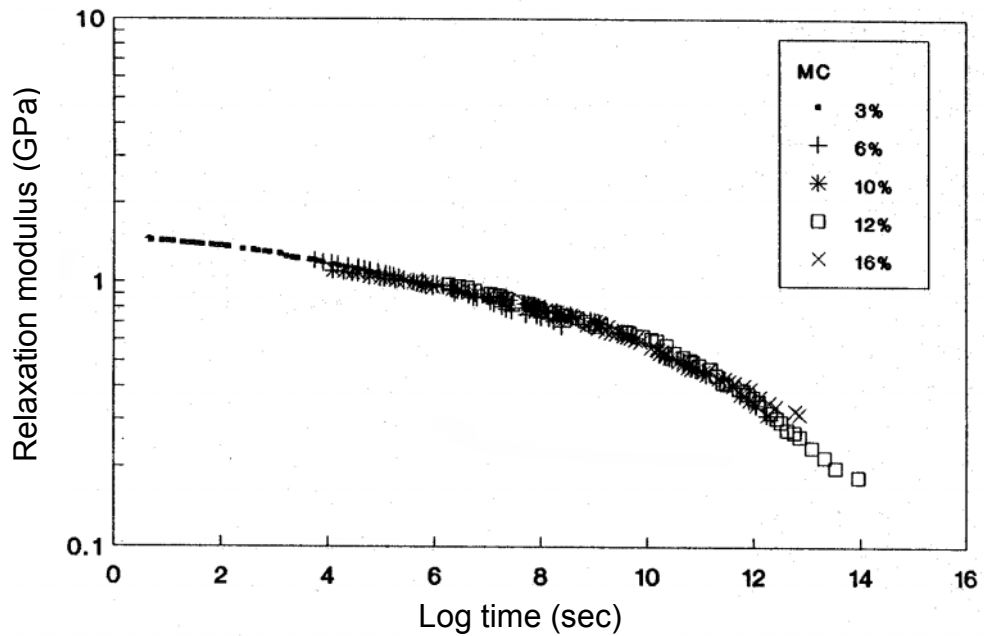

Figure 8—Master curve for relaxation modulus of yellow poplar shifted for temperature and moisture content. Reference conditions are 3% MC and 60°C.

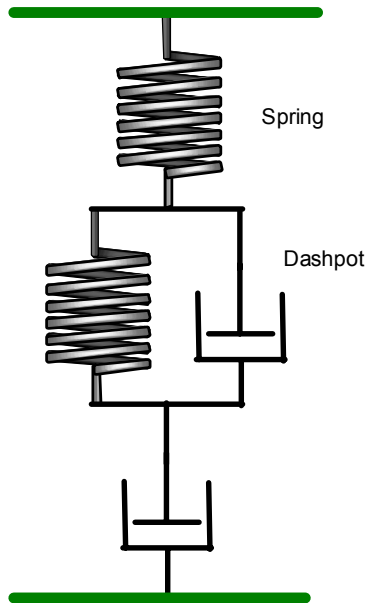

Figure 9—A Burger element of springs and dashpots representing the elastic, delayed elastic, and viscous components of a viscoelastic material.

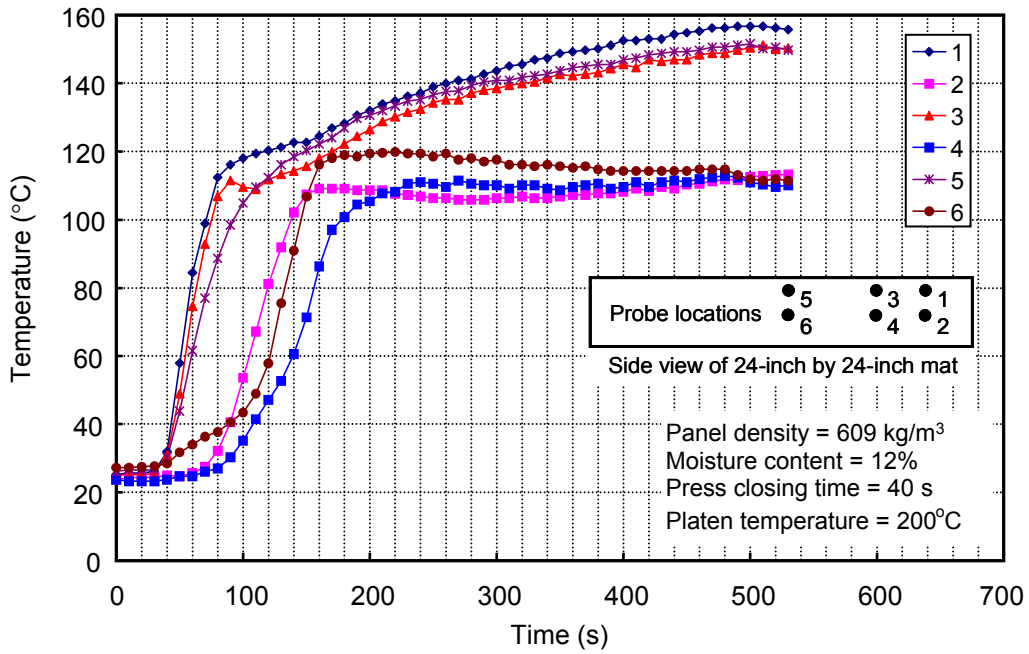

Figure 10—Example of internal temperature at six locations during hot-pressing of a laboratory oriented strandboard mat. Platen temperature is 200°C.

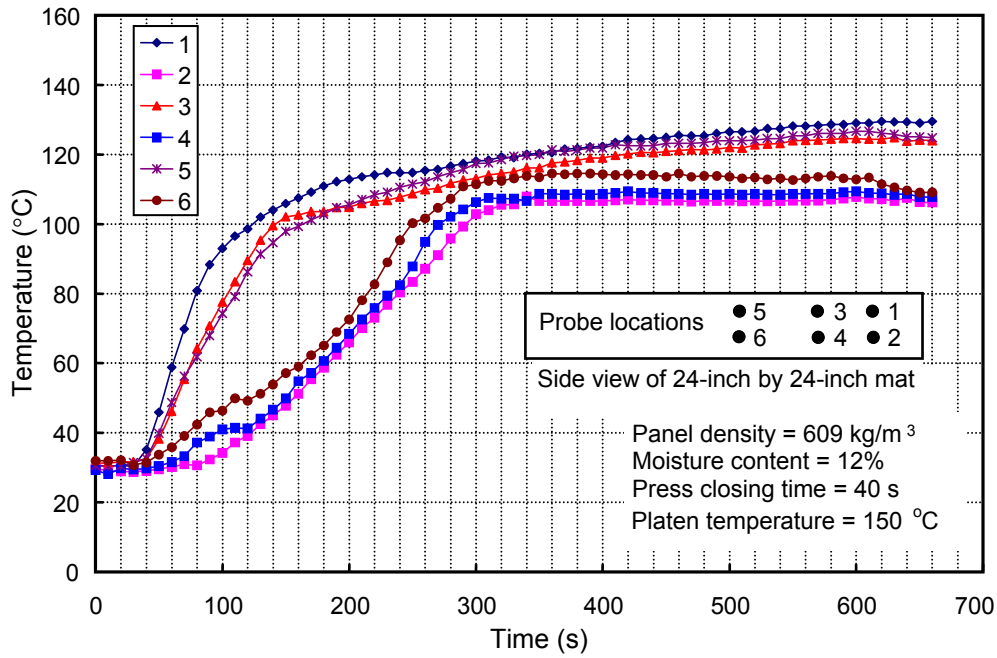

Figure 11—Example of internal temperature at six locations during hot-pressing of a laboratory oriented strandboard mat. Platen temperature is 150°C.

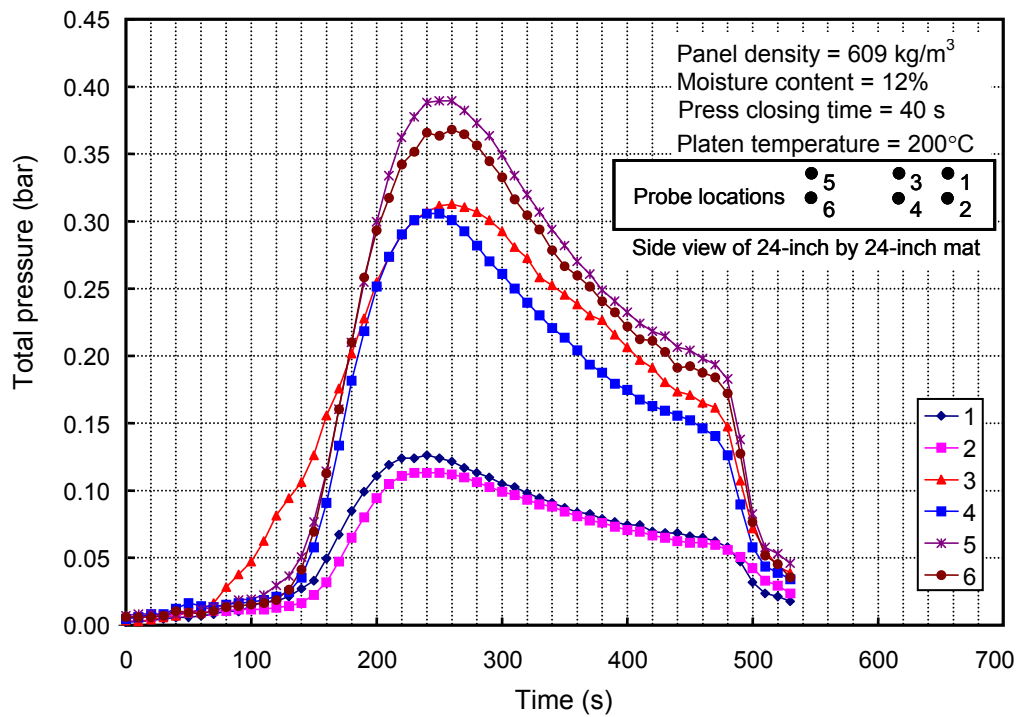

Figure 12—Example of internal gas pressure at six locations during hot-pressing of a laboratory oriented strandboard mat. Platen temperature is 200°C.

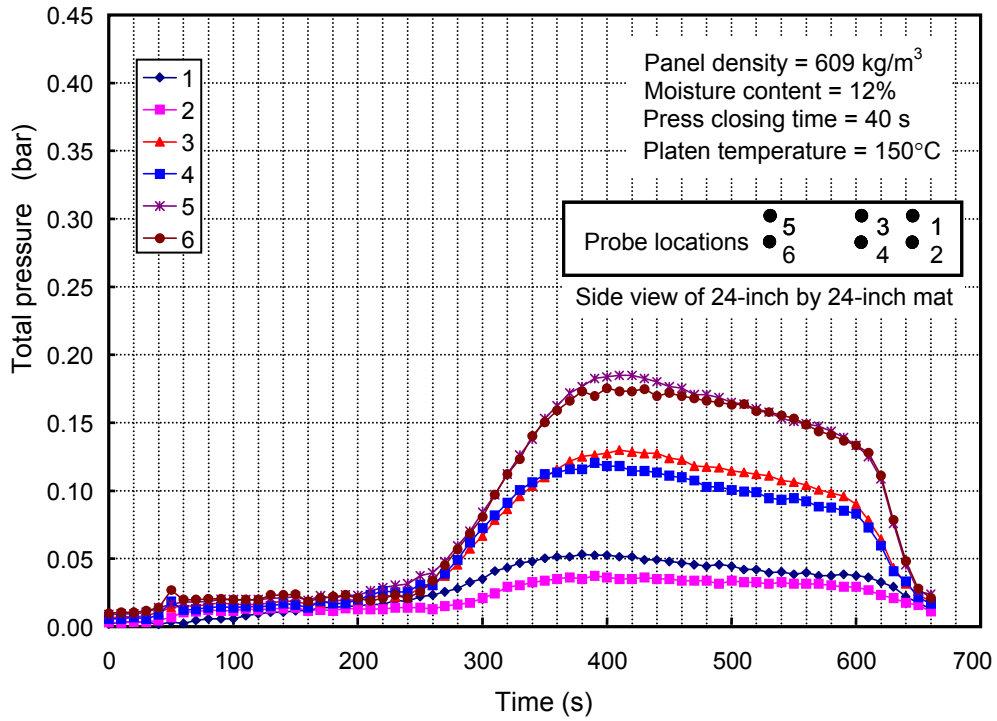

Figure 13—Example of internal gas pressure at six locations during hot-pressing of a laboratory oriented strandboard mat. Platen temperature is 150°C.

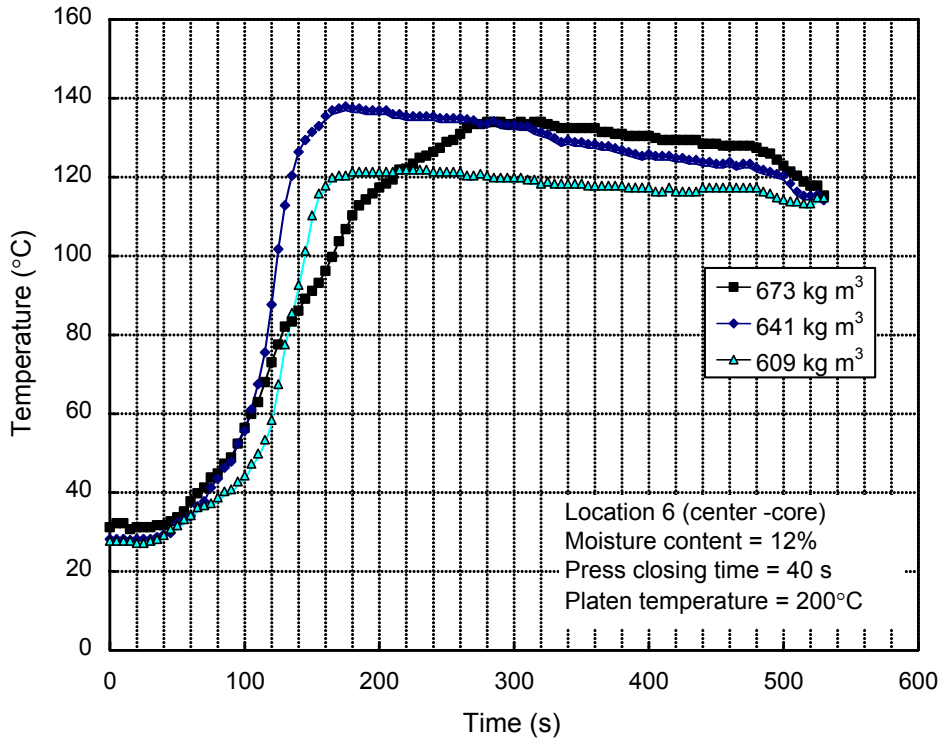

Figure 14—Center mat temperature during hot-pressing of oriented strandboard for three target densities.

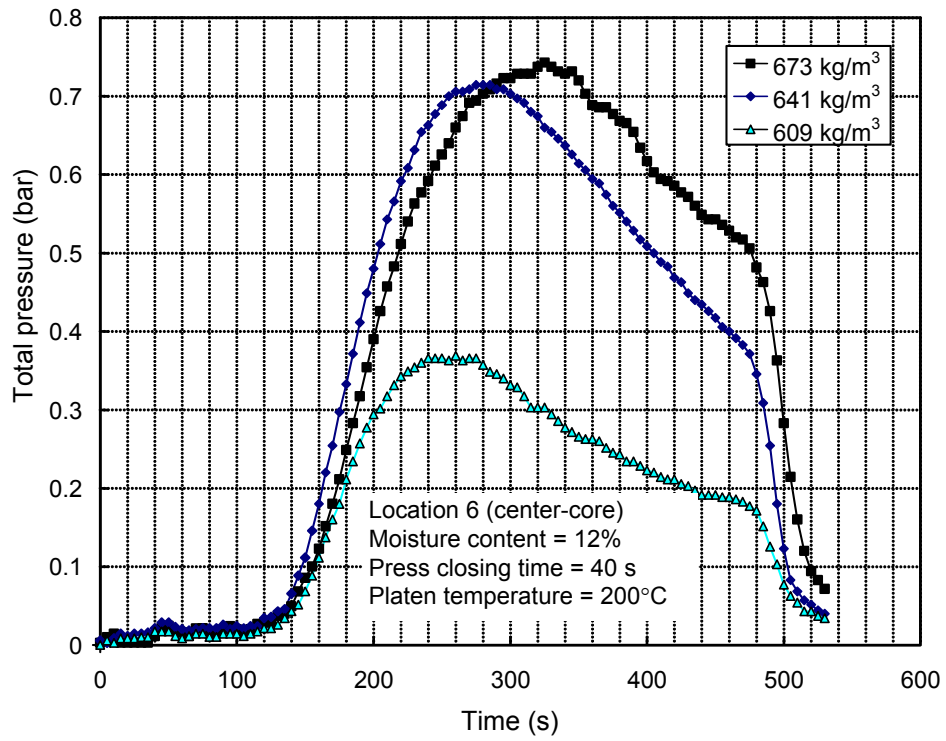

Figure 15—Center mat gas pressure during hot-pressing of oriented strandboard for three target densities.

Discussion—Physics of Hot Pressing

Fred Kamke

Pablo Garcia: For the glass transition temperature of wood, do you know what is the significance of 200°Celsius, both hemicellulose and lignin seem to have the same glass transition temperature?

Kamke: Yes, the data that you are referring to came from one particular study (Kelley and others 1987 Journal of Material Science 22:617–624). You have to realize that when you bring wood up to 200°C, you are going to start getting some thermal decomposition happening. Some of the polymers are going to start to decompose, and when that happens, you are actually changing the structure of the polymer. So what is the significance of 200°C here, for this particular experiment, I think that they have reached the limit at which they are able to collect data. How reliable is that data at 200°C? I would say it is questionable. The lines that you see here are just a fit of the equation to their data points and then that fit converges at 200°C. But is that some hard and fast number for dry wood? I would guess that if you look in the literature you will find some other results for the glass transition temperature of dry wood.

David Harper: Referring to this particular study, can you recall what form the lignin and hemicellulose is in, or is this just estimated from a DMA result of whole wood?

Kamke: Good question. This particular study used whole wood in a DMA. If you are not familiar with DMA, it is just a bending experiment, but in a dynamic way. You have some frequency and amplitude in which you are bending these small specimens. These were solid pieces of wood. They were only about 1-1/2 in. long and about a millimeter thick. You have to make some assumptions. You've got a mixture of polymers in this case that are contributing to the behavior and you have to then make a leap of faith and say well, that little peak that I see is due to hemicellulose and that peak is due to lignin. That is exactly what they did. They didn't just make wild guesses obviously, but they used results of others, who have been able to isolate lignin. I don't know if they isolated hemicellulose. Perhaps they were able to isolate hemicellulose and test it in another manner and then assume that those peaks could be attributed to hemicellulose or to lignin.

Heiko Thomen: The question about the density profile development is a very interesting question. We cannot look into the mat, so it is good there are a lot of unknowns. So far, what I always assumed at least for MDF, is that most of the density profile develops before the final thickness has been reached. I think I remember these graphs from Siqun Wang and Paul Winistorfer's work. So I am interested in your

opinion about the difference between OSB and MDF. Are there differences and do you agree that for OSB most of the density profile develops after the final position of the platens has been reached?

Siqun Wang: You are right, a good question. Tomorrow I have one slide to show the difference between OSB and MDF. My opinion is MDF is very soft, and is very easy to compress. Another difference is MDF is pressed using a very long press schedule. Specifically, we can say the closing time for 3/4 in. MDF was probably 200-s to close to the final position, but for OSB we probably used a 50-s cycle to close press to final position. The resistance from both mats of course, is different. OSB mats are higher resistance, so that means we need to use the higher ram pressure to close the press. MDF is much lower. Because the mats are different, we press the panels in different ways. Because we are closing the press so slow for the MDF, I agree the density profile probably is mainly formed during the closing period time. Of course after closing, they still change, but maybe is a slight change compared to OSB.

Thomen: I don't really agree about the slow closing time for MDF, at least in a continuous press MDF is compressed relatively fast. But maybe one reason for this difference is that when the environmental conditions that reach one layer in the OSB mat that does not mean that the temperature and the moisture content of the strand changes immediately. This is much slower than in MDF, because in MDF, if the temperature and the moisture reach one position, then you immediately have a change in the stiffness of this fiber. Probably in OSB it is not like that. It takes some time until the strand picks up the temperature and the moisture content, so maybe that is one important difference between OSB and MDF. Maybe that is one of the reasons that you have delay in the density profile development in OSB.

Chunping Dai: Sounds like a very serious talk. On this topic of vertical density profile, I sort of agree with Heiko on the timing of the formation. It is a very interesting subject, when is it formed and whether there is a continuous formation after the platen reaches to the target position. Most of us probably know the traditional belief is that density is formed during platen closing. We did some work that sort of helped to explain that. When you do a loading and unloading test of a mat, it is very easy to do, you compare the strain and stress relationship. During loading you have this very slow pressure build up in the beginning, and then suddenly, the pressure goes up. Then when you unload, that is the stress relaxation, that is sort of an unloading situation. When you unload, if you plot the load against the strain, you are going to see a dramatic difference in the paths. When you unload a lot of the compression wouldn't recover, so it is a form of plasticity. When you densify a mat, it stays there pretty much although you talk about a springback and the elasticity of it. Yes, there is some springback. I wonder if that springback is really negligible compared to what has to permanently stay

after you densify it. So in that sense, once you reach the platen target position, that is your loading period, and you densify it. The surface is densified more and core is less, because of the temperature and moisture difference there. And then you go to this stress unloading, basically, relaxation. How much of the core can recover and the surface continue to densify. I think there might be some experimentation to be conducted, namely this loading and unloading test, that is my opinion. I have another point about the effect of density on temperature. Maybe you can comment on this before I go into the next question.

Kamke: Well I guess my comment is to both Heiko and Chunping in regards to fiber mats as opposed to strand mats. I have to admit that most of my observations are related to stand mats, since this is the work that I have been primarily involved with. So that just means that I don't have experience with fiber mats and whether or not this actually occurs before or after press closure with fiber mats. There may be a fundamental difference between the two types of mats. I still would stick by my earlier statement regardless whether we are talking about particles or strands or fibers. It is really the press closing time that establishes the conditions that will later influence the developments of the vertical density profile. So, for example, those of us that have fooled around with press schedules and press closing times know that we can change the shape of the vertical density profile by changing the press-closing rate. Siqun has shown some fairly intricate press closing strategies that can move the density profile around based on how he manipulates the press closing time and various stepwise procedures and so forth. But my point is that by changing the press closing time you are going to change the dynamics of temperature, gas pressure and moisture content within the mat, which will subsequently have a big influence on the development of the vertical density profile. As to the comment you made about recovery of the mats after compression, in addition to some viscous response that takes place in the wood, of course that is a response that is in the wood, you probably also have some reorientation of particles or fibers as a result of compression. As you compress them, the fibers may slide past one another and reach a more favorable conformation, so that when you take the load off, they have been packed together a little more orderly and there is not going to be as much recovery. I am not sure that is a real strong indication of viscous flow or viscous strain. And now I am going to finish my comment by just saying that since there are so many things that are happening simultaneously, I am positive that I can't work it out in my head which way it should go. That is why I think having these models is a way for us to play around with some of these relationships. Are these models 100% accurate? Well, no I don't believe they are 100% accurate, but they certainly do better than what I can work out in my head.

Rick Rammon: I just wanted to comment and add another factor into all of the discussion, I think you have to combine

the fact that there is an adhesive curing in the system at the same time. That is obviously going to have some impact, not only on the development of the stress and strain as you close, but also as you release the load particularly when you have face and core resin systems. We can do an awful lot to impact the density profile by the rate of the cure of the resins and the adhesives that we are using. This throws another complication into the whole mix I think.

Dai: Fred, can you go back to your experimental test on the effect of mat density or core temperature. I guess you mentioned the fact that density affects the temperature variation in terms of the conductivity and the permeability. I think there might be another factor, that is the specific heat. The heavier mat has a higher specific heat, so in a way it takes more energy to increase temperature by 1 degree.

Kamke: I am glad you brought that up because I agree with you. The specific heat stays the same because specific heat is based on mass of material present. There is more material present in a higher density mat isn't there? Therefore, you have a higher heat sink. That is a good point.

John Hunt: My question has to do with property development, where you had the 24-in. square mat, and you measured temperature at the core and 12 in., 6 in., and 3 in. from the edge. You had talked about a study where they looked at the relationship of the 24 × 24 in. mat versus a full size mat. I don't have a good feel for the effect of property change as you get closer to the edges. Is it a 1% loss as you go toward the edge, is it a 5% loss or 10% loss? That leads me into the second question. If it is significant, and it is due to steam pressure, is there an effect that we can have by pinching off around the perimeter so we control the amount of steam that goes off the edge, and therefore, have a more uniform board? So I guess my first question is, is there anything in the literature that you know of that has property differences.

Kamke: First of all, I could go back to the study we did with the ARC (Alberta Research Council) in 1991. I probably could find the numbers that would tell you what percentage differences there were, in IB strength for example, from the edge to the center, but I think that difference would only be relevant for that particular panel type that was made with that schedule. The schedules were exactly the same, the only thing different was the size of the mat. With some of these properties you know there is an upper limit, if they were just related to degree of adhesive cure. Near the edge maybe we weren't getting the degree of cure that we wanted. But if you have just a longer press schedule the edges would catch up and then the end result is that you may not see a significant difference between the edge and the center of the mat. So, I don't think I can answer your question about a percentage difference in certain properties from edge to center. There may not be any if you have a conservative enough press schedule. Is there data out there that has been published about this effect? I seem to recall that there was and it was

done here at the FPL, and it was Dobbin McNatt, but my memory escapes me. Maybe somebody here can recall.

Thoemen: I am not sure about the literature, but someone from the industry might tell you there are differences between the center and the edges. From continuous presses I know that the density profile is pretty different between the cores or maybe really different between the centerline and edges. And I think your last question was what can we do about it. At least with continuous presses you have flexibility. You can change the pressing pressure over the width of the mat, so there are some possibilities to play around with and to work against these differences.

Kamke: I am going to throw out a question here to John Noffsinger about this, since he seems to be one of the few people here today who is involved on a daily basis with hot pressing in the mill. Do companies also perhaps build up the mat thickness on the edges to counteract this variation from center to edge?

John Noffsinger: Not intentionally, no we do not. If it happens, it's only because our foremen are not laying it down like they should be.

Chuck Frihart: Obviously one of the things that you've looked at is resin penetration. Does the resin penetrate on the chips when the adhesive is applied or does it go in during the pressing? Obviously if you're starting to distort cells you will greatly affect the penetration, so I was wondering if you have any feel for that.

Kamke: I don't have a feel for that because I have never measured resin penetration on strands coming out of the hot press, just resin distribution. This sounds like a topic for this afternoon. Maybe we can talk about it more.

Alain Coutier: First of all I would like to thank you for this presentation, I think you have covered it pretty well, it was excellent. I want to come back on the heat and mass transfer model. I have been working on lumber drying in the past and was starting to work on that kind of topic and I am still in the learning curve about that. Marsha here has been working on the heat and mass transfer model over the last year. When we look at the different models and the literature it seems there is kind of an agreement on how those models should be laid out, or developed. However, when we programmed this, what we found is that some physical parameters or characteristics of the mat are tremendously important, and greatly impact the results we get. For instance, gas permeability is one of them. Also absorption in terms of high temperatures seems to be very important in the results. My question is what do you think are gaps in the knowledge that we should be looking at in terms of characterizing the mat to get those results?

Kamke: I think that is a very good observation and excellent question. I think this is a topic that we will be able to cover much more effectively when Heiko is up here tomorrow

afternoon, because I know that is going to be part of his presentation. I will just make one brief comment now because you asked about what knowledge gaps we may have. I think you hit it on the head that the physical properties of these mats are not real well known. There is some data for certain types of mats over limited ranges of conditions and that is it. That is all we have. Obtaining that data is not simple.

Dai: Fred, you mentioned about trying to increase the density around the mat edge for industrial panels. Actually some of the mills intentionally do that. The reason is to hopefully seal the steam and contain it, so that when you press you increase the effect of thermal softening, and the heat treatment, of the strands. Therefore, you actually have better properties and particularly dimensional stability. As a matter of fact, I have done some laboratory work to compare data in terms of dimensional stability or thickness swell with industrial panels. You find that your laboratory made panel is a lot worse than an industrial panel. One of the big reasons is that the industrial panel is so big that steam or gas pressure is well sealed during pressing. That creates so much heat and steam treatment that you have better properties. And also in going back to John Hunt's question about whether there has been study on steam sealing. I only saw one actually. I think it is in German and published in one of those European journals. This fellow looked at a study where he actually purposely sealed the edge and tried to contain the steam inside so he compared that to a case without sealing the edge. He measured the temperature difference and the gas pressure difference and also he compared the properties. And if you can give me your name card I can probably forward that to you. I don't know if that is in German or English, but if it is German we probably had it translated somehow.

Wang: Just following your comment of the core and edge, based on my experience, the vertical density profile would be much flatter on the edge compared to the core. So what we do at the lab is cut one straight strip that goes from one edge to the other edge and then compare the density profiles. A single specimen doesn't represent the whole panel. I think an industry panel would be another story. Another question I want to ask, we know conductivity may not be a player to transfer heat from the platen into the core area, and probably condensation would be the major key. The question here is what is the percentage between how much heat is coming from conduction and how much heat is coming from the steam condensation? Another related question, if we press the panel, is the steam condensation higher in a specific layer? When we measure the temperature inside a mat, we know that somehow a layer would start to increase the temperature really quick. Does that mean the water vapor will go there and condense to raise the temperature? This is the case if we use the conventional press. The steam is transferred layer by layer to the core. Another question is related more to the afternoon session. We know steam is a transfer

mechanism. Do we have tests to know what the resin does if we use the different types of resin systems? Is there any research related to this, or the case if you used steam-injection? So that means we also have a condensation problem. Can you comment on that?

Kamke: I would agree with the comments that you made. My simple explanations up here were kind of a gross separation between face and core. I think one of the points that you were making is that it's really a phenomenon that is happening throughout the thickness of the mat as this vapor is making its travels from the surface areas towards the core. We get condensation along the way and it's a continuum of condensation from surface to core rather than just a discreet event that happens just in the core. I agree with you, it's hard for me to think in those terms, it is easier to talk about it just from discreet layers of surface and core. In reality it actually happens in continuous fashion from surface to core, which adds to the complexity of the whole process.

Jerry Winandy: I have a comment. If you could go to your glass transition slide showing the difference between lignin and hemicellulose. We've been studying the effect of heat on the chemical composition of wood and on the properties of wood for a number of years at the Forest Products Laboratory. We have developed kinetic models that talk about properties of solid wood and how they degrade over time at temperature and at moisture content and we have also developed preliminary chemical composition models as a function of thermal degrade. What I want to point out is that we know that glass transition temperature is a very critical function of a difference between lignin and hemicellulose. What we are finding out is that the various hemicelluloses each have a very distinct degradation rate. We haven't even begun to look at the glass transition temperature of those five basic components of the hemicellulose and I think that before we get into a very important assumption of any kind of modeling of stress build up and stress relaxation in pressing, we have to have a much better definition of glass transition temperature of hemicellulose, of the various components of the hemicellulose, and how those temperatures actually change as the components change. We see from some of the early data that, certain components, for example, arabinose, just from preparation of the flakes and of the drying of the flakes, that you have already seriously degraded the arabinose and you may only have 50% of the virgin arabinose left in the material just from initial processing. And we can go through each of the components and we can see that they degrade, or they have the potential to deteriorate, as a function of their temperature environment. We have to look at the temperature environment of the whole process, from the time we harvest a tree to the time we actually put that flake or the fiber material in the press, and we need to define those characteristics.

Al Christiansen: One thing building on what Jerry just said, is that when Bob Geimer and I were doing some experiments

on steam-injection pressing, he measured the pH of water coming off the press at about 3. This is with an alkaline phenolic resin, but you are getting de-acetylation of the wood. You may be changing the resin curing kinetics by the wood itself having an effect on the resin.

Kamke: Al, I remember back when that was done, I can't remember the date, but I remember having conversations with Bob Geimer about making those measurements. Was that ever published?

Christiansen: I don't think we said that specifically in a paper. I think there was a summary paper that we wrote together (Geimer & Christiansen 1996) where we mentioned it, but I don't think we did a study of it of any sort.

Kamke: And so the data was never reported, you just commented on it?

Christiansen: I think so.

Kamke: By the way, Al Christiansen just reminds me Jerry had talked about a similar workshop that we had back in 1990 in Blacksburg, VA. As I look around the room I think the only other person there, besides myself, was Al. Correct me if I am wrong.

Dave Marr: I have a question on the permeability graph you have there, I was wondering why the perpendicular permeability wasn't closer to the transverse permeability?

Kamke: Well, I think I am going pass this question onto Heiko because I suspect that Heko might have given this more consideration than I have.

Thoemen: I am not really so familiar with these measurements, but from what I understand, just by introduction I would say that the transverse permeability must be different from the vertical permeability. Okay, it has to do with the mat factors I am not really so deep into it so that I can explain exactly why it would be bigger in the one direction, but I am not surprised to see this big difference.

Kamke: I will follow up on that and point out that the data shown here on this graph is for an oriented strand mat. So with an oriented strand mat you've got strands, I don't know what the size was here, but perhaps they are 4 in. long and maybe only 1/2 or 1 in. wide. The pathways represented by the gaps are quite long along the length of the strand as opposed to the perpendicular direction. That is just how I would visualize it, but I can't really say with certainty.

Marr: Thank you Fred. It just seemed to me that since it was an oriented strand mat I can definitely see the pathways parallel to the orientation being the higher permeability. It just seemed like you had potential for the permeability to drop perpendicular because of the orientation.

Kamke: Okay, I think I missed your question to begin with. You were actually asking the question between the

perpendicular direction and the parallel direction in relation to strand orientation?

Marr: Correct.

Kamke: In this case again, keep it in mind this is a strand mat, we have relatively wide particles and the gas is going to move around the particles, not through them, they will follow the path of least resistance and so in the transverse direction these OSB strands tend to lie flat in the plane of the panel. The pathway around the strands is somewhat a torturous path. It has to move around the strand as it moves in the vertical direction. Whereas in the transverse direction, or in the lateral plane, of the mat it can follow edges of strands in that direction rather than having to go around strands. Perhaps parallel to the strand orientation the pathway is less torturous.

Ted Laufenburg: I want to make a comment on a different subject about compaction ratios. Chunping talked a little bit about this. In the past we selected species based on their density characteristics because we thought we knew we had to get these particles in close proximity to each other but since then we have been moving more and more toward more dense species. Eddie Price's work with high-density hardwoods was an eye opener for us because he mixed the two and we didn't see as much plasticization of the hardwoods as we did from the lower density softwoods. But it brings us to that point about how much plastic deformation do we have in our strands and how much of it is elastic? Our compaction ratios used to be targeted something like 20%, so you are choosing a panel density that is approximately 20% higher than the native wood density in order to achieve a good quality panel. Sort of a rule of thumb, we may be closer to the actual density of the base wood material now because of the higher density species we are using. There are some trade-offs to be made there and I just wanted to comment. In order to get to a compaction ratio of 20% in the past, we probably induced between 30 and 40% plastic deformation in the transverse direction on these strands, and now we may be much less than that. At the same time that elastic recovery has not changed. That percentage should stay approximately the same and I am sure someone wants to comment on that.

Kamke: I don't know if I can comment intelligently or not. I think the point you bring up is an important one. Upon changing raw material mix and the need to use higher density species, that may impact how we have to modify the press schedule to accommodate the higher densities. The scenario you just described, for example, would mean that we would have mats with higher permeabilities because we are not going to compress those higher density strands as much as we? We are going to have more gaps between the high-density particles and therefore, the higher permeabilities, which might make it more difficult to build up that steam pressure that Chunping was talking about, and getting

those temperatures in the core up higher. It is an interesting comment in that it has implications beyond just compaction ratios and how much force is required in bonding, but also the internal mat conditions are going to be influenced.

Noffsinger: I am not sure how to answer that question or even comment, but we run over 21 different species in our mats we make at the mill in West Virginia. In order to get decent properties to compare with aspen board we run densities considerably higher than what Eddie Price referred to or any others. We compensate for the denser species. In fact we are now running oak in our board, as much as 10%, and it requires that you run some high panel densities to get the properties.

Dai: It is a very interesting subject talking about that compaction ratio to achieve close contact between strands. I did some work with Paul Steiner on what degree one has to densify the mat to achieve 80% of contact. The relationship, if you plot the compaction ratio on the x-axis, and you look at your bonding area between strands, you are going to see this very distinct "s" shape. In the beginning it is a little slow, but after initial slow starting period, it is going to go up linearly, very quickly and then after that, it is going to level off. This is based on a model that we developed. With this mat structure model you can predict the strand to strand contact. Knowing the strand size and the mat density variation you should be able to calculate that the level off point is around 1.55 to 1.6. You have to densify the mat 50 to 60% higher than the original wood density. If you are making OSB using a wood density like 0.4, and you densify lets say 50%, your end density would be 0.6 and at that point you pretty much reach that plateau area which is giving you something like 90% contact between strands. Now that relationship changes with two very important factors. One is species; with denser species you have to densify more to achieve that 90% contact. The other factor is strand thickness, lets say you use thinner strands, you can densify less. If you use very thick strands, you have to densify more. I will talk a little bit about that tomorrow, but we have sort of an equation or model in order to calculate that or calculate the effect of species and strand thickness.

Noffsinger: What strand thickness are you talking about?

Dai: Strand thickness in the model can be anything. It can be, lets say 0.4 to 1.5 mm, that's input and you can use anything you want. Species, as long as you know the density, can be input into the equation and you can calculate that. It is species and density related.

Garcia: That reminds me of something else, the quality of the strand. Up in Canada you have aspen and you get very large, flat strands. Down in the South you tend to look at them more as splinters. I don't know if it is just a species thing or also something that up in Canada they controlled. I don't know if anyone has any comment on that?

Noffsinger: Log conditioning will have an influence on strand quality. Not much conditioning happens in the Southern U.S., so you will have a lot more fines content coming through. I am just wondering how the fines affect mat consolidation and even heat transfer and everything else that is going on inside that board, because we will have a lot more fines in some of our boards at different times of the year. We will have to worry about resin content to compensate for those fines so that our bond durabilities are there and so on.

Kamke: How does the content of fines affect mat permeability and perhaps some other properties of the mat? I don't think I can answer that with any degree of confidence. I can make some guesses and my guess would be that in regards to an OSB product that the inclusion of fines is going to increase permeability. I would say that simply because they may be smaller voids but you are going to have more voids. And also a big wide strand presents more of a barrier to gas flow certainly in the thickness direction than fines would. That would be my guess. We actually are doing a study right now on permeability of strand mats. But unfortunately we are not using fines content as one of the variables. We are using fairly nice looking, big strands, so we won't be able to answer that question even after this study is completed. And I know that fines were not included in that work presented by Von Haas (1998 dissertation, University of Hamburg; also see Von Haas and others 1998, Holz als Roh- und Werkstoff 56(6):386–392). Maybe someone else could comment on that.

Hunt: I don't have anything to comment on that last one, but I do have a question though. If you were to create your ideal mat, how would you describe that mat if you were to optimize your physics and what would you like to see in an ideal world? How would you like that process to go?

Kamke: Well, that is really going to depend on what the product is that you are trying to produce and what other properties you would like to have in this product. I should probably say that this development of the vertical density profile is actually quite advantageous for sheathing products in a bending mode. You put the high strength and stiffness densified material in the outside layers of the panel and that works out pretty nicely for that application, but maybe not so good for others. It really depends on the end application that you are interested in. I would say that overall mat uniformity is important. If you can produce a uniform mat, with particles that are well defined the way that you would like them to be, that would be my ideal mat. And then after that, it really depends on how you want to manipulate the vertical density profile or perhaps manipulate the curing of the adhesive. But if you start with a more uniform mat structure, that is well defined, then your chances of achieving the latter conditions are going to be greatly improved.

Jim Wescott: Fred, going back to the physics of the hot pressing, and this is probably something that most of the people in this room already figured out, but I have looked at

the slides for 2 h and can't figure it out so I will ask the question anyway. You are showing on your estimated moisture content slide that there is an increase in moisture content for both the face and the core. I am assuming that you have attributed this to the resin curing or something to give off the water. I guess I have two questions on this. Are you actually attributing this to resin curing condensation to increase moisture content? The second question is why so much more in the core? Why are you not seeing that in your actual vapor pressure of the mat?

Kamke: This is a calculation as you pointed out, and it is actually a calculation of the equilibrium moisture content. This calculation is the equilibrium moisture content condition. Then I have assumed that the moisture content at a specific location is equal to that equilibrium moisture content. So our assumption is that we have local thermodynamic equilibrium. Of the water that is moving throughout the mat, some of it is in the vapor phase, some of it is in the bound water phase and some may be in the liquid phase. It is only the water that is in the bound water phase that is going to be part of the equilibrium moisture content. That is going to be the only component that has an influence on the glass transition temperature, for example, so that is kind of the build up to answer your question. We have got moisture that is migrating to the core and we also have change of temperature of the core. In our calculation we used a sorption equilibrium relationship which is just data that is fit to an equation that we use to estimate the equilibrium moisture content. It includes both temperature and the surrounding water vapor pressure. That is what that equation depends on, temperature and water vapor pressure. Initially in the core, we have the temperature increasing but the water vapor pressure hasn't increased a great degree, and so the equilibrium moisture content declines. Unfortunately I don't have the pressure plotted on here, but when that water vapor pressure increases, then the EMC increases along with it. You can kind of see this shape right here, if I had the water vapor pressure plotted on here it would follow this same pathway. Right here is where venting begins, water vapor pressure decreases, temperature stays high and so the equilibrium moisture content drops off dramatically as well. So the result of the shape of the EMC curve is due to changing temperature and water vapor pressure in the core. Out in the surface region the trend is more of just a general reduction in the water vapor pressure with a dramatic increase in temperature. So it just drops off. You see a little bit of movement up and down here but again that is only because of pressure differential.

Hunt: In your heat of vaporization slides, the slides that show the enthalpy change, is there any data that shows the energy requirement to release water from the saturated fiber to a vapor stage? There is an additional energy required to release that? Is there anything in the literature?

Kamke: Yes, the graph you are referring to is just showing the heat of vaporization, so it is the change from pure liquid water to the water vapor state. If you have bound water instead of liquid water there is a little extra energy required to break that hydrogen bond with the wood substance. The term used for that is “differential heat of sorption,” and it is a relatively small effect in comparison to the heat of vaporization. But is it a real effect. It is there, but you can ignore it, I think, in most practical cases.

Wang: Fred, today you didn’t talk about relative humidity related to adhesive cure? I am not really sure, is that an important issue or maybe it is not very important. I know they did research a couple years ago to see what the effect relative humidity had on resin bonding.

Kamke: I think that sounds like a good question for this afternoon session. We talked about the gas pressures and some of the vast differences we have in gas pressure from core to edge and core to surface. Most of that gas pressure increase is water vapor and we’ve got adhesive systems that interact with water vapor. We’ve got these aqueous systems like the PF’s and UF’s, and the we’ve got the PMDI that actually reacts with water to polymerize. Does this change in water vapor pressure actually affect the polymerization, not only the rate but perhaps even the structure of the final polymer? If someone would like to comment on that now, I think it might be a good use of our time. Otherwise, I think we might defer it until later for an in-depth discussion.

Christiansen: That is not directly what I was going to comment on actually. I was thinking about pure water too. When you’ve got hot water in wood, you are not going to have a lot of pure water, at least in the condensed phase. Even in the vapor phase you are probably going to get a mixture of things happening in there. Especially in pine, so you have a very complicated system.

Kamke: You always have to throw things in there that are going mess things up, don’t you? In these saturated water vapor pressure relationships that we use in these calculations we do assume you have pure water. If you do put some impurities in that water, then, yes, things are going to change. There are other gaseous components that contribute to these total gas pressure measurements that are made with these probes. Southern pine has a lot of pinene in it. It is quite volatile. I actually did a calculation one time on how much pinene could contribute to a total gas pressure just based on some information that was available on vapor pressure of pinene. It was pretty small, at the temperatures that were involved, and so I just assumed it was insignificant, but it is there, you cannot deny it is there, it has got to be there.

Marr: I have another question. Speaking of gas pressure, one of the things that I have noticed on some of your graphs, and some of the pressing that we have done since we have been monitoring gas pressures toward the end of the press cycle, before we go to the degas or venting stage, the gas pressure suddenly dropped. I am not sure exactly what that is?

Kamke: I assume you eliminated any hiccup in the press control system. Actually, we have seen that also. Sometimes we have observed a pressure drop that occurs at some location where we happen to put that gas pressure probe. Do you know how I explain that? It is actually in a publication from quite some years ago (Kamke and Wolcott 1990. Fundamentals of flakeboard manufacture: wood-moisture relationships. Wood Sci. and Tech. 25(1):57–71). It had to do with this delayed elastic response and the continued formation of the density profile. I think that could happen. I don’t know if that is what happened in your case, but it could happen. The region where you had the tip of your probe perhaps was able to expand a little bit at the expense of some compression somewhere else in the mat at that stage of the press cycle. It could happen, I don’t know if it actually happens.

Pablo: Some of the drops are quite dramatic. I always put it down to maybe the mat shifting a little bit. The pressure is high enough to blow a fine out and suddenly give a venting path to the side. It could suddenly blow it out because some of the drops are quite immediate.

Wang: During the venting period, we know the press will open a little bit. I can’t find a good term, maybe we can use springback. With overpressing, that means we first press the panel a little bit thinner, then during the venting period time it opens a little bit and the panel goes back a little bit. Depending on the panel thickness, that could be 20 thousandth or 30 thousandth inch difference in the thickness. One of the research studies I did a couple years ago found that springback was not uniform during the venting period. The core springback is more than the face springback.

Kamke: Our time is up. I think we really had a great discussion and I really appreciate everyone stepping forward and making their comments known. I enjoyed this session and I hope you continue on throughout the rest of today and tomorrow.

Jerry: First of all, I want to thank you Fred and let’s give him a round of applause. Fantastic lead in for the workshop and in leading of this discussion. I also want to thank everyone in attendance for jumping right in and facilitating the discussions.

Monitoring Resin Cure in the Mat for Hot-Compression Modeling

Charles E. Frazier, Associate Professor, Wood-Based Composites Center
Department of Wood Science and Forest Products, Virginia Tech, Blacksburg, Virginia

Introduction

The hot-compression and cure of wood-based composites is a process for which accurate modeling would be extremely useful. The many variables and their interactions are enormously complex, too complex to understand without advanced modeling. Appropriately, many contemporary research and development activities are directed towards this challenging goal. Success will require the convergence of several disciplines and the collaboration of many people in industrial, federal, and academic laboratories.

Much of the recent activity has focused on heat and mass transfer since these are the critical variables that control wood cell wall properties and resin cure. Lagging far behind is the associated modeling of resin cure. Why is this? By necessity, accurate modeling is preceded by reliable measurements under realistic conditions. Herein lies the problem. The conditions within the particulate wood mat are as hostile as they are dynamic. Particularly troubling are the extremes in pressure and moisture; when coupled with resin levels of only 2% to 3%, one wonders if accurate cure monitoring is even possible. These difficulties have so far prevented substantial progress towards in situ cure analysis.

What techniques are available, and which strategies should we devise? Under idealized laboratory conditions, we currently exploit many physical and chemical phenomena to evaluate thermoset cure; a few of those are

- volumetric changes as in thermomechanical analysis and dilatometry,
- rheological changes as in dynamic mechanical analysis, acoustics and viscometry,
- capacitance and conductivity changes as in dielectric analysis,
- chemical changes as in nuclear magnetic resonance, infrared, Raman, and ultraviolet spectroscopies, and
- heat capacity changes and heat flow as in differential scanning calorimetry.

There are other methods of course, and perhaps their omission will spark discussion in this forum. Depending on one's

perspective, many methods listed above are immediately excluded. Naturally, methods such as dynamic mechanical analysis and differential scanning calorimetry are not amenable to continuous in situ cure analysis. We must therefore consider separately our desires for modeling on the one hand and in-line process control on the other. Continuous in situ cure analysis would be ideal in all cases, but the practical barriers currently leave continuous analysis wanting for important details. The combination of continuous and discontinuous methods may be essential for building accurate models.

Continuous In Situ Resin Cure Analysis

Presently, it would seem that perhaps only three methods could be suitable for continuous in situ resin cure analysis: Infrared spectroscopy using optical fiber, acoustics, and also dielectric spectroscopy.

Infrared Spectroscopy

Infrared (IR) spectroscopy could be an extremely fruitful technique since it provides direct chemical structure information. Obviously, there are several complications within the wood particle mat that challenge IR analysis. One is that wood and resin spectral details often overlap, an obstacle which may render IR useless since wood signals will be so strong. In this respect, in situ analysis of isocyanate resin cure may be very rewarding. The isocyanate IR absorption is well resolved from wood signals, and monitoring isocyanate consumption should be possible. This will require optical sensors that are not only optimized for signal transmission but also for mechanical strength, size, and geometry. The author is unaware of optical fiber technologies that can withstand the bending forces present in the mat. However, it seems probable that the material science of optical fiber will meet this challenge. Considering the expected improvements in fiber technology, perhaps two other obstacles are more serious: (1) assuring resin-probe contact, and (2) localized pressure sinks near the sensor. It would be difficult to ensure that the optical sensor will actually contact an isocyanate resin droplet. Consequently, IR analysis will probably require sensor doping. While sensor doping will provide signal, it may mask wood-resin interactions that could modify

cure kinetics. Likewise, small voids will form near the sensor tip because of inadequate compaction. Such voids will be steam pressure sinks that could alter the signal. Are very small, and/or flat optical fibers possible? Small round fibers are feasible, but flattened fibers may not be.

Acoustical Analysis

There has been a great deal of research in acoustical analysis of high performance composites and also wood-based materials. The speed of sound waves traveling through a thermo-setting resin may be correlated to viscosity and cure state. Efforts from the University of California, Berkeley, reveal that the acoustic monitoring of wood-based composite hot-compression is feasible. However, the potential of this method has not been fully developed. Recent improvements in hardware and signal processing have yet to be focused on wood mat hot-compression. This methodology deserves further study because it will provide novel information that will nicely complement other in situ methods such as IR and dielectric analysis.

Dielectric Analysis

Presently, dielectric analysis (DEA) may be the most promising for in situ cure analysis. Several researchers within the wood research community have been active with this method. Consequently, many wood-resin DEA fundamentals are understood. Furthermore, DEA hardware can be mechanically robust and simply integrated into hot-press platens. The outstanding obstacle is that press platen DEA sensors will observe all dipolar species, which includes wood, resin, and most importantly moisture. The resulting dielectric spectra are complex, and in this regard, dielectric and acoustic methods suffer a similar flaw. Many of the observable relaxations are convolutions of molecular response, complex summations from interacting effects. Fortunately for DEA, various dipoles display different frequency responses. The tremendous range of useable dielectric frequencies may offer an avenue to deconvolute the varied responses. As an aside, we should also recognize that DEA should be useful for monitoring nonresin responses, such as moisture movement and wood cell wall relaxations.

Currently, it would seem that DEA may offer the greatest potential for in situ cure analysis. However, the great complexity of DEA relaxations in the wood mat will require other complementary methods. We must improve our knowledge of the events which correlate with DEA relaxations. For example, DEA may help us observe cure levels, but it cannot reveal other important details that would be desirable for hot-compression modeling; details such as mechanical strength development, chemical structural changes, and cell wall resin penetration. A concerted effort is required to develop correlations to continuous analysis.

This is why discontinuous methods will be important to achieve better models of resin cure.

Discontinuous Resin Cure Analysis

Even as continuous in situ methods improve, we will need to correlate continuous data streams with more traditional resin analyses. This requires the insertion of specialized samples into strategic locations within the mat. The mat is hot-compressed for discrete time periods, and samples are retrieved for analyses in the laboratory. This discontinuous approach will be challenging and labor intensive. Furthermore, special methods will be required to quench cool samples so that accurate correlations are developed with continuous methods. The need for sample quenching presents a considerable challenge. On the one hand, it would seem that very small mats (less than 0.6 by 0.6 m (2 by 2 ft)) would be most amenable to quench cooling in liquid nitrogen. However, such small wood mats may not accurately reflect industrial conditions. On the other hand, larger mats may be difficult to handle, particularly if the test sample must be quenched after removing the panel from the hot-press. Perhaps rapid sample removal and quenching requires the use of nonresinated wood mats. This would provide a realistic mat environment and would also allow for the rapid removal of a sample.

Aside from an effective sample quenching strategy, other aspects of sample preparation must also be considered. Obviously, the sample must not be damaged during retrieval. Consequently, techniques must be developed to prevent adhesion of the sample to the surrounding wood particles. Also and depending upon the subsequent analysis, extreme bending forces must be prevented from acting on the sample. Finally, the sample form must not influence the localized heat and mass transfer. It is likely that careful thought and ingenuity could solve these challenges. What methods will be useful for the subsequent analysis of these retrieved samples?

Differential Scanning Calorimetry

Differential scanning calorimetry (DSC) could be very useful because this will provide a direct measure of residual heat of thermoset cure. However, it is unlikely that DSC could detect the very low resin loadings that are typical for particulate wood-based composites. The only way around this problem is to prepare samples that have unusually high resin loadings. Naturally, we must understand if high resin loadings influence the very observations we wish to make.

Rheological Analysis

DSC should be useful. However, it does not reveal gelation and so cannot tell us about mechanical strength development. Could dynamic mechanical analysis be an effective discontinuous analytical method? Perhaps, but this would require a great deal of method development. As with DSC, higher than normal resin loadings might be required.

Solid-State Nuclear Magnetic Resonance

Solid-state nuclear magnetic resonance (NMR) could be very helpful to correlate continuous data streams with chemical changes in the resin. It can also track morphological information through relaxation measurements. The associated complication with this approach is that the resins must be synthesized with magnetic isotopes to provide detection sensitivity. In the case of formaldehyde resins such as phenol- or urea-formaldehyde, this is not a difficult task. Carbon-13 labeled formaldehyde is readily available for direct use. However, it would be best if an industrial manufacturer could prepare these labeled formaldehyde resins so that the properties better match industrial preparations.

Labeled isocyanate resins are quite a bit more difficult to prepare, but fortunately, an experienced chemist can closely match (but not exactly match) the properties of industrial isocyanate resins.

In summary, the industrial development of wood-based composites will be improved with accurate modeling of the hot-compression process. So far, most modeling efforts have correctly focused on heat and mass transfer. However, we should strive to incorporate resin curing in these models. The most desirable methods would provide continuous in situ cure analysis, as in the case of infrared, acoustic, and dielectric spectroscopy. However, none of these methods will provide all of the information that we will desire. Consequently, there will also be a need to correlate these continuous methods with discontinuous techniques that involve sample retrieval and subsequent analysis. Presently, a great deal of work is required to establish valid correlations between continuous and discontinuous methods.

Adhesive Interactions With Wood

Charles R. Frihart, Project Leader
Forest Products Laboratory, Madison, Wisconsin

Summary

While the chemistry for the polymerization of wood adhesives has been studied systematically and extensively, the critical aspects of the interaction of adhesives with wood are less clearly understood. General theories of bond formation need to be modified to take into account the porosity of wood and the ability of chemicals to be absorbed into the cell wall. Sufficient penetration is important for good bond formation, but it is not clear whether the penetration into lumens or the cell wall is more critical. For the bond forming process, thermodynamic wetting and viscosity are critical, but viscoelastic energy dissipation is important for the debonding process. The interphase formed during bond formation should influence the bonded assembly's ability to dissipate the internal and external stress during use, but the exact relationship is not clear. Studying of the bonding and debonding processes can be broken down into examination on the millimeter, micrometer, and nanometer spatial scales. The millimeter and larger scale is what is used for typical evaluations. However, the micrometer scale plays an important role because this scale relates to the cross-sectional size of cells that are the basic structural unit of wood. In this study, models are proposed for the adhesive-wood interphase that would reduce the stress concentration between the wood and the adhesive as the dimensions of the wood vary with changes in the wood moisture content. The nanometer scale is important because it relates to the interaction of the adhesive with the wood on the scale of the cellulose fibrils and the hemicellulose and lignin domains. The internal and external forces on the adhesive wood bond vary considerably for different products, such as laminated lumber, plywood, oriented strandboard (OSB), and fiberboard. A better understanding of the critical aspects of the adhesive-wood interaction should lead to a more efficient development of improved adhesives.

Introduction

Adhesion and adhesive strength are often confused. Adhesion is the interaction of the adhesive with the substrate surface and is mainly influenced by thermodynamic wetting and rheological properties. Adhesion is critical to forming a bond, but the wood-adhesive interface is not the only location where energy is dissipated in adhesive strength testing. Adhesive strength is the ability of the bonded assembly to remain intact under some set of conditions that test its ability to viscoelastically dissipate energy and withstand chemical

degradation. For most processes, it is important to consider the differences between wood and other substrates, which will alter the models for bonding and debonding.

An adhesive goes through three stages. In the first stage, the adhesive is a liquid that needs to flow to wet the surface of the substrate. To wet a surface well, the adhesive needs a lower surface energy than the substrate; the difference in surface energies between the substrate and the adhesive is determined by the contact angle. A low contact angle indicates that the adhesive will wet the substrate surface given enough time. However, a highly viscous adhesive may not sufficiently wet the surface especially those with substantial microroughness (Pocius 1997). Thus, the rheological properties in the adhesive are also very important. Without the adhesive coming into contact with the substrate on a molecular level, it is not possible to form a bond.

The second stage is for the liquid adhesive to turn into a solid. The three main processes for converting the liquid to a solid adhesive are polymerization, loss of solvent, and solidification from the melt. Polymerization is the most common for making composite wood products. A number of these adhesives also contain solvent, mainly water, which is lost in the process. It is important for the adhesive to wet the substrate before the solidification process takes place because during polymerization or drying, the viscosity of the adhesive increases, which reduces wetting.

The third stage is the ability of the bonded assembly to stay intact under the desired end-use conditions. Durability is a very important issue in bonded wood assemblies since most adhesives give strong bonds to wood initially. How durability is determined depends upon the product and how it is used. Because bonded wood products have a long lifespan, accelerated tests are usually used to determine durability. It needs to be understood that integrity is dependent upon the viscoelastic energy dissipation in all portions of the product and not just the adhesive-wood interface. In addition, the internal stresses from the dimensional changes in the wood need to be considered as well as the applied forces.

Why is it important to understand the interaction of the adhesive with the wood? Currently, there are no good ways to screen new or improved adhesives by measuring their physical and chemical properties. The only accepted way to measure the performance of the adhesive is to bond the selected wood or fiber into a desired product and test it under accepted standards. Thus, an extensive amount of

work is needed to test each formulation. If we understood how the adhesive interacts with the wood, we could possibly evaluate new adhesives through other properties and accelerate development of new or improved adhesives.

Performance of Bonded Assemblies

Because there are many different domains in which a bonded assembly can come apart, it is important to understand where in the bonded assembly the failure has occurred and why. If the failure occurs within the wood, then the adhesive has acceptable performance. In this instance, improving the adhesive performance does not add to the strength of the overall assembly. Cohesive failure in the bulk of the adhesive indicates a need to improve the cohesive strength of the adhesive. These first two types of failure are generally easy to observe. However, failure in the interphase region is much harder to analyze. The interphase region is defined as the point where the local properties begin to change from that of the bulk adherend to the point where the local properties reflect that of the bulk adhesive (ASTM 2003). Part of this region is the true interface where the bulk material changes from adhesive to the wood. The adhesion process reflects mainly what takes place at the true interface. If the adhesive does not sufficiently wet the wood, the interface is the most likely place for failure to occur. It is important to consider that failure often occurs in the adhesive and the wood interphase regions.

There has been investigation on the strength of the wood interphase in bonded assemblies. The preparation of the wood surface for bonding has a significant effect on the strength of the wood surface (River 1994). The most common occurrence is the collapse of the wood cell structure to form a mechanically weak interphase (River and Minutti 1975, Stehr and Johansson 2000). If the adhesive does not penetrate and strengthen this region, then it will serve as the weak link in the bonded assembly. The preparation of wood surfaces can also induce fracture in the cell walls that can lead to cleavage of the cell wall layers. Another aspect is a chemically weak interphase (Stehr and Johansson 2000); this usually occurs when there is a layer of low molecular weight compounds, such as extractives, on the surface. Examples of this problem are bonding to an oily wood such as teak and bonding to creosote-treated wood. Fracture within the adhesive interphase has not been discussed much in wood bonding literature, but will be covered later in this paper.

Determining where this failure occurs is much more difficult with wood than it is with most other adherends. One difficulty is the relatively rough surface of the wood that makes it hard to use light microscopy, scanning electron microscopy (SEM), and atomic force microscopy (AFM). A second difficulty is the chemical complexity and inhomogeneity of the surface that makes it hard to use many surface

compositional analysis techniques, such as x-ray photoelectron spectroscopy (XPS) and secondary ion mass spectroscopy (SIMS). Light microscopy is somewhat easier for dark colored adhesives, but it is hard with uncolored adhesives. A main problem with the literature is that it only gives percentage wood failure (ASTM 1999), if it indicates at all where the failure occurs. When the failure occurs in a bondline, there is no indication if the failure occurs in the bulk adhesive or in which part of the interphase.

The examination of where and why bondline failure occurs is under investigation. Many epoxy adhesives give a high percentage wood failure when dry, but usually all give low wood failure when wet (Vick and others 1996). The failure of the epoxy is unexpected given the fact that epoxies give durable bonds to most substrates. Given the polarity of the epoxy, it should be able to form strong secondary bonds to the wood, and therefore interfacial failure seemed unlikely. In trying to understand where in the bondline the failure was occurring when epoxy bonds were subject to water and drying but no external loads, we have relied upon a number of techniques. The first was to use light at an obtuse angle to look at the glossiness of the surface because adhesives give a smoother surface that tends to increase the gloss compared with wood. Another method was to use stain of the surface, which reacts with the amine groups of an epoxy, such as p-dimethylaminocinnamaldehyde (Frihart 2003a). These techniques show that the fracture surface ran along the plane of the wood with morphology very similar to the wood, but containing a significant amount of adhesive residue on the surface (Fig. 1). In addition to the light microscopy studies, scanning electron microscopy gave support to our observations. The SEM images showed adhesives filling the lumens with evidence of viscoelastic failure of the adhesive. Thus, failure in the adhesive interphase has to be considered as well as in the wood interphase, interfacial, and adhesive bulk when there is bondline failure.

Spatial Level of Examination

Wood bonding surfaces and failed bondlines need to be examined on three different spatial scales (millimeter, micrometer, and nanometer). The millimeter or larger scale is most often used in examining wood bonding (Frihart 2003b). In preparing wood surfaces, one looks for the crushing of cells and roughness of the surface usually using cross-sectional analysis at this spatial scale. This scale is also used for measuring wetting of the surface, although wetting can be affected by factors in smaller dimensions. In addition, the percentage wood failure is determined at this level. Even though it is important to look at fracture bondlines at this level for the initial evaluation, it is also important to understand what is happening at finer levels.

Understanding what is happening at the micrometer level in both bond formation and bond breakage is essential to

understanding the adhesive performance. Because cells are in tens of micrometers in diameter, this level indicates the interaction of the adhesive with the basic unit of construction of the wood. Given the variety of wood cell types, it is unwise to consider the adhesive–wood interaction being of a single type. For example, in hardwoods, there should be large differences between the flow into the vessels compared with the fiber cells. The vessels should be easy to fill given their large diameters compared with the fiber cells and rays. The trachid cells of softwoods are in between these two. During bond fracture, it is important to consider the stress concentration as the dimension of the cells changes during swelling, as will be discussed in more detail later.

The nanometer scale has a profound effect on the bonding process that contributes to bond strength, but it is the hardest of the three spatial scales to examine. For bonds to form, the adhesive and wood have to interact on the nanometer scale. This is independent of whether this interaction involves mechanical interlock or primary or secondary bonds. The literature indicates that cell fibrils and hemicellulose and lignin domains are in the order of ten nanometers (Fengel and Wegener 1984). Thus, the interaction of the adhesive with the wood components in the cell wall is taking place at this level. Fracture of the bonded substrate requires the breaking of primary and secondary bonds, which are nanometer scale events.

As evidence that one needs to consider what is taking place in all three scales, we will examine events during bond formation. First, the adhesive needs to wet the surface of the wood; this process depends upon the thermodynamics because the surface energy of the adhesive needs to be less than that of the wood. For this event to take place in a reasonable time frame, the viscosity of the adhesive needs to be low enough. General observation of the wetting process takes place at the millimeter scale. However, penetration into the lumens that has been shown to have a significant effect on bond strength is on the micrometer scale. The adhesive flow into the cell lumens may be different from the flow of the adhesive itself due to the filtration of the fillers from the adhesive. In going to the nanometer scale, a completely different series of factors become critical. For penetration into this cell wall, the molecular size and shape of the cell and the solubility parameter become critical.

Cellular Level Processes

Because wood is made up of a variety of cells and the cells are made up of different cell layers, it is a mistake to think of wood as a single type of surface. Consideration needs to be given to what types of surfaces are available for bonding for each product class. For lamination, OSB, and particleboard binding, it is desirable for the adhesive to wet the exposed lumen walls to give greater area for bonding. Longitudinal transwall fracture should make the lumen walls available for bonding (Fig. 2) (River 1994). Depending upon species and

cell type, the lumen wall may be the S 3 layer that has high cellulose content or it may be the warty layer that has high lignin content. For some earlywood cells and vessels, the lumen walls can be up to 80 percent of the bonding surface. When the walls split, it is not known whether it is through the lignin, hemicellulose, or cellulose domains. If the types of molecules on the surface are not known, the type and strength of bonds between the adhesive in the wood are a matter of conjecture. However, under some conditions, such as high cleavage temperatures of latewood cells, the cells may be split along the middle lamella giving a surface that is high in lignin content. The chemical composition of the surface can play a major role in determining the type of surface interaction with the adhesive and therefore the interfacial bond strength. When using a water-borne adhesive, a cellulosic surface should be easier to wet and should more readily form polar bonds and potentially covalent bonds with the adhesive. On the other hand, a lignin surface will be harder to wet with a water-borne adhesive and will show preferential interaction with only a limited number of adhesives.

In the bonding process, sufficient penetration is important for forming strong bonds. This is generally considered to be the flow into the lumens of the cells that have an opening on the wood surface. The tendency is to fill the large diameter cells like vessels first and then the smaller cells for those that have a portion of their cell wall removed on the surface. It has not been demonstrated that the adhesive flows from one cell to another through the pits. The flow into lumens depends upon the viscosity of the adhesive, applied pressure, temperature, and time. On the other hand, some of the adhesive components can flow into the cell wall, as will be discussed in a later section. Thus, it is not clear whether penetration into the lumens or into the cell wall is the most critical.

As in the bonding process, the cellular structure of wood is important in evaluating the durability of bonds. For example, the adhesive could bond strongly to the surface of the wood, but that surface layer could peel away from other layers of the cell (Fig. 3). This has been shown in at least one case with epoxy adhesive (Saiki 1984). In some cases, the cell walls may be weakened by cracks that developed during the drying process or the preparation of the surface by cutting or planing. Even if the cell is not damaged, we still need to know how the adhesive responds as the cell expands and shrinks upon absorption and desorption of moisture. Although drying of the wood should cause compressive force on the adhesives, the tensile forces upon moisture pickup generally are more critical because many adhesives are weaker in tension than in compression.

Adhesion Models

The various models for the interaction of the adhesive and the substrate can be classified in a number of ways. For this

discussion on wood bonding, the four general categories are mechanical interlocking, diffusion, interface interactions, and electrostatic interactions. Given the porosity of wood, mechanical interlocks through the filling of the lumens was the original concept (McBain and Hopkins 1925). It certainly has to play a role because it allows the stress to be distributed over a greater volume. Stress concentration is bad because it causes the breakage of chemical bonds leading to fracture of the bonded assembly. For mechanical interlock to occur, the adhesive has to wet the surface of the wood and be low enough in viscosity to flow into the pores. Although wood is a relatively polar substrate, water-borne adhesives usually contain additives or solvents to aid in wetting of the wood. Diffusion can be thought of as a molecular level mechanical interlock. With most adhesive bonds, diffusion does not play a significant role in bond formation. It is clear that few adhesives have the ability to penetrate metals, and most adhesives are not compatible enough with organic polymers to flow into them. On the other hand, it has been shown that wood will swell by absorbing small molecules into the cell wall. Thus, diffusion may play a more important role for wood bonding than in most other adhesive applications. Interface interactions were proposed to be important to wood bond strength more than 70 years ago using the terminology specific adhesion (Browne and Brouse 1929). The interface interactions are generally classified into primary and secondary bond categories. The primary bonds are covalent bonds whose existence in wood adhesion has been an area of disagreement due to the complexity of wood that makes it difficult to carry out definitive experiments. However, recent work supports the formation of primary bonds with polymeric diphenylmethane diisocyanate (Frazier 2003). The secondary bonds fall into several categories, ranging from weak to strong interactions. The weakest force is the van der Waals forces that exist between all molecules in close proximity. For wood adhesives, stronger interaction forces are available because both the wood and the adhesives possess polar groups. Dipolar interactions should be plentiful between any of the main components of wood and the common wood adhesives. Because hydroxyl groups are present in the cellulose, hemicellulose, and lignin fractions, hydrogen bonding to the wood adhesives should also occur. The other type of bond that has been proposed is electrostatic interaction, but this type of mechanism is more likely to occur in debonding rather than during bond formation.

An interesting issue in wood bonding is the penetration of the adhesives into the cell walls. The migration of phenol-formaldehyde resins into the cell walls has been shown using fluorescence microscopy (Saiki 1984), audioradiography (Smith 1971), transmission electron microscopy (Nearn 1965), scanning electron microscopy with x-ray dispersive emissions (Smith and Coté 1971), dynamic mechanical analysis (Laborie and others 2002), and antishrink efficiency (Stamm and Seborg 1936). For polymeric adhesives (methylene diphenyl diisocyanate), the presence of adhesives in

the cell walls has been shown by x-ray micrography, nuclear magnetic resonance spectroscopy (Macinko and others 2001). Some of the same techniques and other techniques have been used to show the presence of urea-formaldehyde, melamine-formaldehyde, and epoxy resins in the wall layers (Bolton and others 1985, 1988; Furuno and Goto 1975, Furuno and Saiki 1988), as well as UV microscopy (Gindl and others 2002) and nano-indentation (Gindl and Gupta 2002). The question is whether the presence of the adhesives in the cell wall is just a byproduct of the process or actually contributes to the strength of the bond. Most certainly, the presence of sufficient adhesive material in the cell wall should change its properties, especially altering the swelling and shrinking properties. Four different models are proposed here to explain the possible interactions of the adhesives and the walls. The simplest model is that the adhesives migrate into the expanded wall and occupy the free volume reducing the shrinkage and re-expansion of the wall during the loss and gain of moisture. The second model is that fingers of the adhesive penetrate into the wall to form a molecular interdigitation; this can be thought of as nanometer scale mechanical interlock (Fig. 4) (Berg 2002). The third model involves the adhesive forming a separate network in the wall as either a cross-linked adlayer or a fully interpenetrating polymer network. The fourth model involves the adhesive components reacting with the cell wall components to cross-link them. All of these models would involve limiting the ability of cell walls to expand and contract.

Reducing the volume change of the wood would also reduce the stress concentration between the wood and the adhesive. Swelling of the wood causes a large stress gradient at the adhesive-wood interface if the adhesive expands in a similar fashion. Some work indicates that phenol-resorcinol-formaldehyde adhesives expand in water like wood, but not as much as wood in the tangential direction (Muszyński and others 2002). Because wood expands greatly when wet in the radial and tangential directions, the adhesive at the interface is under a great deal of tensile stress in those directions but is under less stress in the longitudinal direction. For adhesives with limited ability to elongate, such as epoxy adhesives, fracture can be initiated at the adhesive surface. Because there is limited swelling in the longitudinal direction, the fracture pattern should have similar directionality and morphology to the wood. Adhesives that are more ductile are more likely to resist fracture.

The importance of considering the cellular structure of wood in relation to bond strength developed from trying to understand why epoxies do not give durable wood bonds. Some of this work was discussed in an earlier section. Additional work has involved the examination of bonding to acetylated wood, which involves converting the exposed hydroxyl groups to acetates. If the interface interactions were the critical link in this adhesion, then acetylation of the wood should reduce the adhesion due to decreased strength of the polar interactions. Surprisingly, the acetylated wood gave a

more durable bond with the epoxy than did the unmodified wood. The much greater percentage wood failure in the wet shear block test of the acetylated wood compared with the unacetylated wood is consistent with reduced swelling forces at the interface of the acetylated wood. In support of this theory, planing of the acetylated wood gave less durable bonds probably because of the opening of unacetylated sites on the surface of the wood by the planing process that led to increased swelling forces (Frihart and others 2004) (Fig. 5).

Effect of Composite Type on Adhesive Performance

Each type of composite places different demands on the adhesive for acceptable performance. All applications require sufficient shear strength—dry strength for interior applications and both dry and wet strength for exposure to high moisture levels and exterior applications. For most applications, the adhesive needs to be cross-linked to have sufficient creep resistance because there are generally applied forces in addition to the internal forces. However, both the applied and internal forces vary considerably for the different types of composites.

For laminated materials, usually an entire film of adhesive exists between the pieces, allowing the stresses to be distributed across a large surface area. Laminated lumber has significant applied loads in the longitudinal direction that the adhesive bond has to withstand while the wood swells and shrinks with variations in moisture levels in the cross direction. In contrast, plywood bonds need to withstand high internal stress levels rather than high strain levels because cross plies restrict swelling of the wood. In addition, plywood adhesives are sometimes formulated to give better hold, but the surface roughness can limit the ability to obtain close contact in some areas of the surface. Some plywoods are rated for exterior applications; thus, they have to withstand greater swelling and shrinking internal forces as well as not being hydrolyzed by the water.

For products made of smaller pieces of wood, the adhesive does not cover the entire wood surface. This is a significant difference in that the adhesive is applied as droplets instead of a continuous film; thus, it is like the comparison of a spot weld to a continuous weld. With a spot weld there is a higher stress concentration in the bond than there is with a continuous weld. At high moisture conditions, the bonds feel not only the normal swelling stresses but also the stress from the wood wanting to spring back to its normal shape from the distorted shape it obtained during the compression step. Composites made from chips, like OSB, have very different performance requirements than do laminated assemblies. Most laminated products are subjected to shear tests; OSB is tested using an internal bond test that exerts a normal force on the bond. A complication of this test is that most adhesives are weaker in the normal direction than they are in a

shear direction, and full cure is more likely to be important in this test. It is well known for bonding OSB that there are large temperature and moisture gradients that alter the adhesive cure rates. This becomes critical when the internal steam pressure exceeds breaking stress of the adhesive, leading to a blowout if the adhesive is not highly cured. The stress at break is low for the uncured resins, but increases as the polymerization and cross-linking take place.

There are dramatic differences when talking about making fiberboard. In making fiber, the normal mode for fracturing the wood structure is to separate the cells in the middle lamella as opposed to a planing operation that aims to split the cells open. Consequently, the aim is to bond to the exterior part of the cell rather than the interior part. The adhesive is more likely to experience a very different bonding surface with fiberboard than it does with other applications. Given the differences in the wood surface between fiberboard and other applications and the ability to bring fibers closer together in fiberboard, self-adhesion is a more significant factor with fiberboard than with other applications, especially in the case of high-density fiberboard.

Nanometer Scale Interactions

For adhesion to occur, the adhesive has to encounter the wood on the nanometer scale level. This is the level about which we know very little, and there are many limitations in advancing our understanding on this spatial level. The complexity of the wood on both the morphological and chemical aspects makes it difficult to understand exactly what makes up the bonding surface. For example, earlywood cells split by longitudinal transwall fracture have a large ratio of lumen walls to other cell wall surfaces leading to a large difference in bonding area compared with latewood cells split in the middle lamella. The lumen wall can be composed of a high lignin content warty layer or high cellulose content S 3 wall. The cleavage of cell wall layers can yield both lignin and cellulosic compounds on the surface. The different cell types can be cleaved in different locations due to their ability to bear the applied load. In addition, the wood is comprised of more than the normal tracheid and fiber cells that offer different bonding surfaces. The fiber that goes into fiberboard probably has a quite different surface from the wood produced by cleavage for plywood or OSB. A surface that has high lignin content would have different bonding interaction with the adhesive than a surface that is high in cellulose or hemicellulose. Thus, without a clear idea what components are at the surface, it is hard to predict how the adhesive is going to interact on a molecular basis with the wood.

Diffusion of the adhesive into the cell wall is also important. It has been shown that some adhesive components will migrate into the cell wall, but it has not been demonstrated that these components play a role in bond durability or how

these components interact with the cell wall components. The voids between the polymeric components in the cell walls must be small, and the migration of the adhesive components is likely to be determined by their molecular sizes and shapes and their solubility parameters. This is also a nanometer scale process. When wood swells, water most likely inserts itself between the components that are hydrogen bonded together, such as the cellulose and hemicellulose. The adhesives might play a somewhat similar role of migrating between the polymer chains. However, only certain adhesive components can enter the cell wall. Generally, the cutoff is about three thousand molecular weight for linear polymers (Tarkow and others 1966). Penetration is also dependent upon the solubility parameter of the adhesive relative to the wood components. Bulkier molecules are less likely to fit in-between the other polymers and may not penetrate as well. These adhesive components can then polymerize to form a reinforcing network within the cell wall (Fig. 6). However, some of the less polar adhesives might prefer swelling the lignin rather than the cellulosic components.

Summary

Understanding the role of wood adhesives is difficult because of the complexity of wood, which allows the proposal of many models. In trying to understand wood bonding, it is important to realize that the factors related to bond formation are probably not identical to those related to the debonding process. In general, the bond formation process is highly dependent upon thermodynamic wetting and the rheology of the adhesive. The chemical composition of the wood surface also plays a large role in the bonding process; the portion of the cellular structure that is exposed controls the interaction with the adhesive. Lignin on the surface would lead to poorer wetting by the adhesive and less hydrogen bonding between the adhesive and the wood surface. On the other hand, more cellulose or hemicellulose on the surface would have the opposite effect. From the models of bond formation, it is likely that the bond formation would involve more than interfacial interactions. It is known that many adhesives will migrate into the cell wall. These adhesive molecules could form nanometer scale mechanical interlocks, an interpenetrating polymer network, or crosslink cell wall components. Understanding whether these adhesive components stabilize the cell wall could lead to the design of improved adhesives.

Bond strength is dependent upon the ability of the assembly to distribute both the internal and applied stresses. The internal stresses can be large due to swelling and shrinking of the cells as the moisture changes. For example, penetration of and reaction of the adhesive components in the cell wall may play a role in bond durability by reducing the volume changes during the moisture cycling and therefore the stress concentration at the wood adhesive interface. The type of

assembly also plays a large role in the type of forces to which the bond is subjected. For laminated products, the laminated lumber needs more ductile adhesives to cope with the swelling, while the plywood requires adhesives that have high stress at break because the cross plies limit the elongation. For other composites, the normal bond properties are as important as the shear properties, because these products need to pass internal bond tests.

For both the bonding and debonding processes, the understanding has to be done on three very different spatial scales. The normal consideration is on the millimeter or larger scale because this is the easiest to observe. Given that wood is composed of cells, the micrometer scale is important for understanding the more detailed interaction of the adhesive. Finally, all the processes are actually taking place on the nanometer level.

Literature Cited

ASTM. 2003. Standard terminology for adhesives. ASTM D 907–03. West Conshohocken, PA: American Society for Testing and Materials.

ASTM. 1999. Standard practice for estimating the percentage of wood failure in adhesive bond joints. ASTM D5266–99. West Conshohocken, PA: American Society for Testing and Materials.

Berg, J.C. 2002. Semi-empirical strategies for predicting adhesion. In: Chaudhury, M; Pocius, A.V., eds. Adhesion science and engineering—2: Surfaces, chemistry and applications. Amsterdam: Elsevier.

Bolton, A.J.; Dinwoodie, J.M.; Beele, P.M. 1985. The microdistribution of UF resins in particleboard. In: Proceedings, IUFRO symposium Forest Products Research International: Achievements and the Future. Pretoria, S. Africa: 6: 17.12–1 to 17.12–19.

Bolton, A.J.; Dinwoodie, J.M.; Davies, D.A. 1988. The validity of the use of SEM/EDAX as a tool for the detection the UF resin penetration into wood cell walls in particleboard. *Wood Science and Technology*. 22: 345–356.

Browne, F.L.; Brouse, D. 1929. Nature of adhesion between glue and wood. *Industrial and Engineering Chemistry*. 21(1): 80–84.

Fengel, D.; Wegener, G. 1984. *Wood: Chemistry, ultrastructure, reactions*. Berlin: Walter de Gruyter.

Frazier, C. 2003. Isocyanate wood binders. In: Pizzi, A.; Mittal, K.L., eds. *Handbook of adhesive technology*. 2nd ed. New York: Marcel Dekker: 681–694.

- Frihart, C.R.** 2003a. Durable wood bonding with epoxy adhesives. In: Proceedings, 26th annual meeting; 2003 February 23–26; Myrtle Beach, SC; Blacksburg, VA: Adhesion Society, Inc.: 476–478.
- Frihart, C.R.** 2003b. Wood structure and adhesive strength. Characterization of the cellulosic cell wall; 2003, August 25–27; Grand Lodge, CO. Madison, WI: Society of Wood Science and Technology.
- Frihart, C.R.; Brandon, R.; Ibach, R.E.** 2004. Selectivity of bonding for modified wood. In: 27th Annual Meeting of the Adhesion Society, Inc.; 2004 February 15–18; Wilmington, NC: The Adhesion Society, Inc.: 329–330.
- Furuno, T.; Goto, T.** 1975. Structure of the interface between wood and synthetic polymer. VII: Fluorescence microscopic observation of glue line of wood glued with epoxy resin adhesive. *Mokuzai Gakkaishi*. 21(5): 265–334.
- Furuno, T.; Saiki, H.** 1988. Comparative observations with fluorescence and scanning microscopy of cell walls adhering to the glue on fractured surfaces of wood-glue joints. *Mokuzai Gakkaishi*. 34 (5): 409–416.
- Gindl, W.; Gupta, H.S.** 2002. Cell wall hardness and Young's modulus of melamine-modified spruce wood by nano-indentation. *Composites: Pt. A*. 33: 1141–1145.
- Gindl, W.; Dessipri, E.; Wimmer, R.** 2002. Using UV-microscopy to study diffusion of melamine-urea-formaldehyde resin in cell walls of spruce wood. *Holzforschung*. 56 (1): 103–107.
- Laborie M.P.; Salmén, L.; Frazier, C.E.** 2002. The cooperativity analysis of segmental motion in the wood adhesive interphase: A probe of nanoscale morphology. In: Proceedings, 6th Pacific-rim bio-based composites symposium & workshop on the chemical modification of cellulose; 2002, November 10–13; Portland, OR: Oregon State University, Wood Science and Engineering Department: 18–25.
- Macinko, J.; Phanopoulos, C.; Teachey, P.** 2001. Why does chewing gum stick to hair and what does this have to do with lignocellulosic structural composite adhesion. In: *Wood Adhesives 2000*; 2000 June 22–23; South Lake Tahoe, NE. Madison, WI: Forest Products Society: 111–121.
- McBain, J.W.; and Hopkins, D.G.** 1925. On adhesives and adhesive interaction. *Journal of Physical Chemistry*. 29: 188–204.
- Muszyński, L.; Wang, F.; Shaler, S.M.** 2002. Short-term creep tests on phenol-resorcinol-formaldehyde (PRF) resin undergoing moisture content changes. *Wood and Fiber Science*. 34(4): 612–624.
- Nearn, W.T.** 1965. Wood–adhesive interface relations. *Official Digest. Federation of Paint and Varnish Production Clubs*. 37 (485):720–733.
- Pocius, A.A.** 1997. Adhesion and adhesives technology: An introduction. Munich, Germany: Hanser Publishers.
- River, B.H.** 1994. Fracture of adhesively bonded wood joints. In: Pizzi, A.; Mittal, K.L., eds. *Handbook of Adhesive Technology*. New York: Marcel Dekker: 151–177.
- River, B.H.; Minutti, V.P.** 1975. Surface damage before gluing—weak joints. *Wood and Wood Products*. 80 (7): 35–36, 38.
- Saiki, H.** 1984. The effect of the penetration of adhesives into cell walls on the failure of wood bonding. *Mokuzai Gakkaishi*. 30 (1): 88–92.
- Smith, L.A.** 1971. Resin penetration of wood cell walls—implications for adhesion of polymers to wood. Syracuse, NY: Syracuse University. 193 p. Ph.D. thesis.
- Smith, L.A.; Coté, W.A.** 1971. Studies of penetration of phenol-formaldehyde resin into wood cell walls with the SEM and energy-dispersive x-ray analyzer. *Wood Fiber*. 3 (1): 56–57.
- Stamm, A.J.; Seborg, R.M.** 1936. Minimizing wood shrinkage and swelling. Treating with synthetic resin-forming materials. *Industrial and Engineering Chemistry*. 28 (10): 1164–1169.
- Stehr, M.; Johansson, I.** 2000. Weak boundary layers on wood surfaces. *Journal of Adhesion Science and Technology*. 14:1211–1224.
- Tarkow, H.; Feist, W.C.; Southerland, C.** 1966. Interaction of wood with polymeric materials, II. Penetration versus molecular size. *Forest Products Journal*. 16(10): 61–65.
- Vick, C.B.; Richter, K.H.; River, B.H.** 1996. Hydroxymethylated resorcinol coupling agent and method for bonding wood. U.S. Patent 5,543,487.

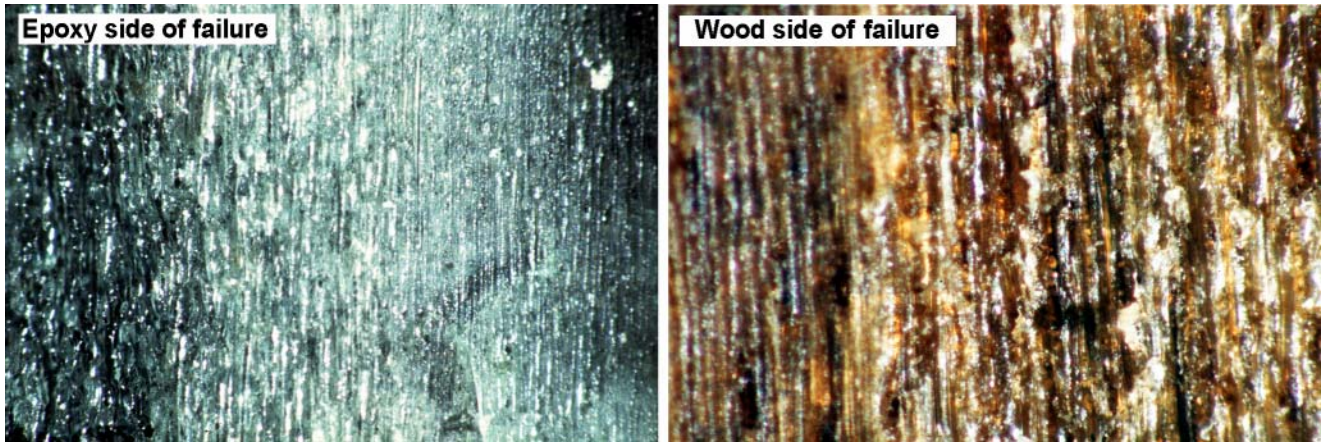

Figure 1—Tangential surface of bondline failure of epoxy wood, using ASTM D 2559.

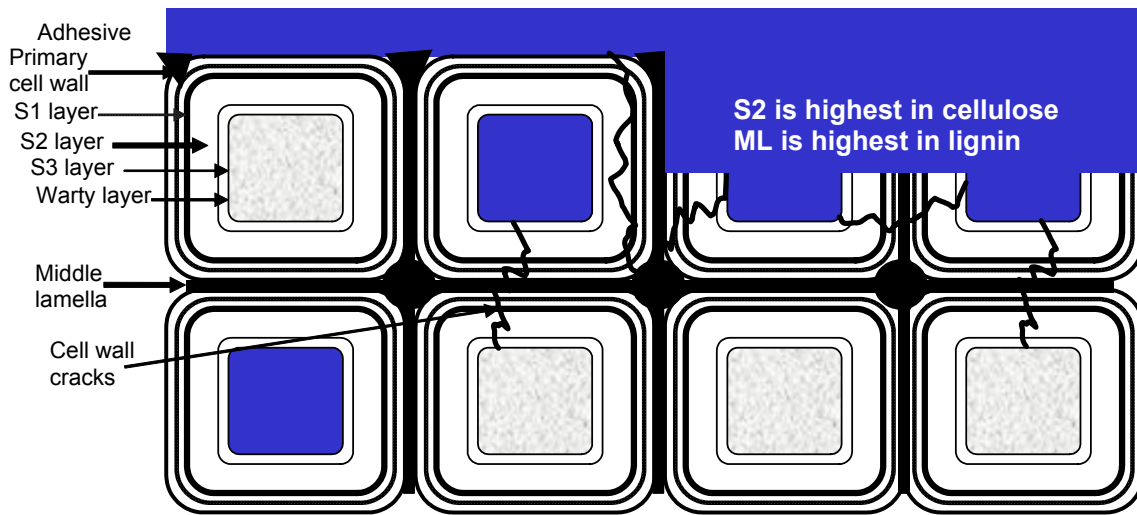

Figure 2—Possible bonding surfaces for the tangential or radial plane of wood.

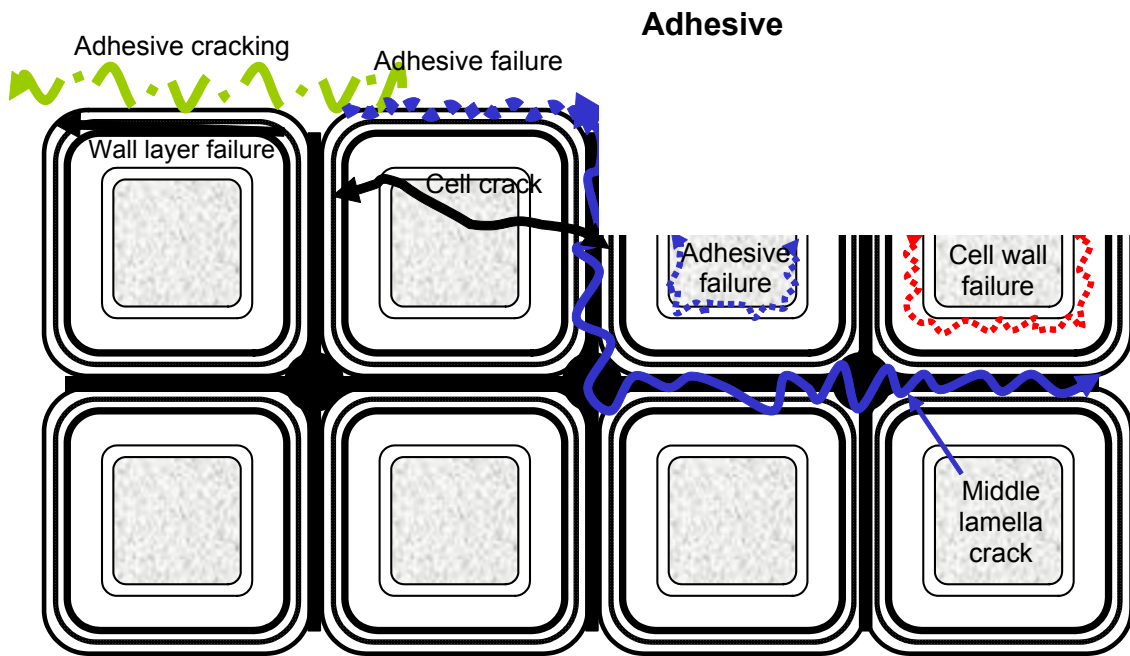

Figure 3—Failure in the interphase region of adhesively bonded wood.

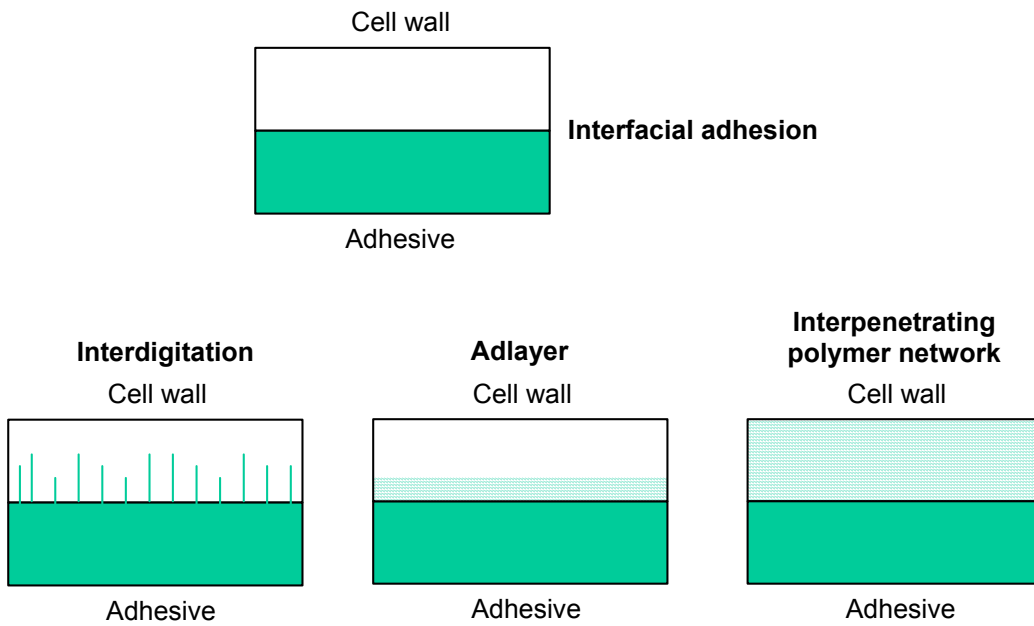

Figure 4—Model adhesive interactions with the cell walls.

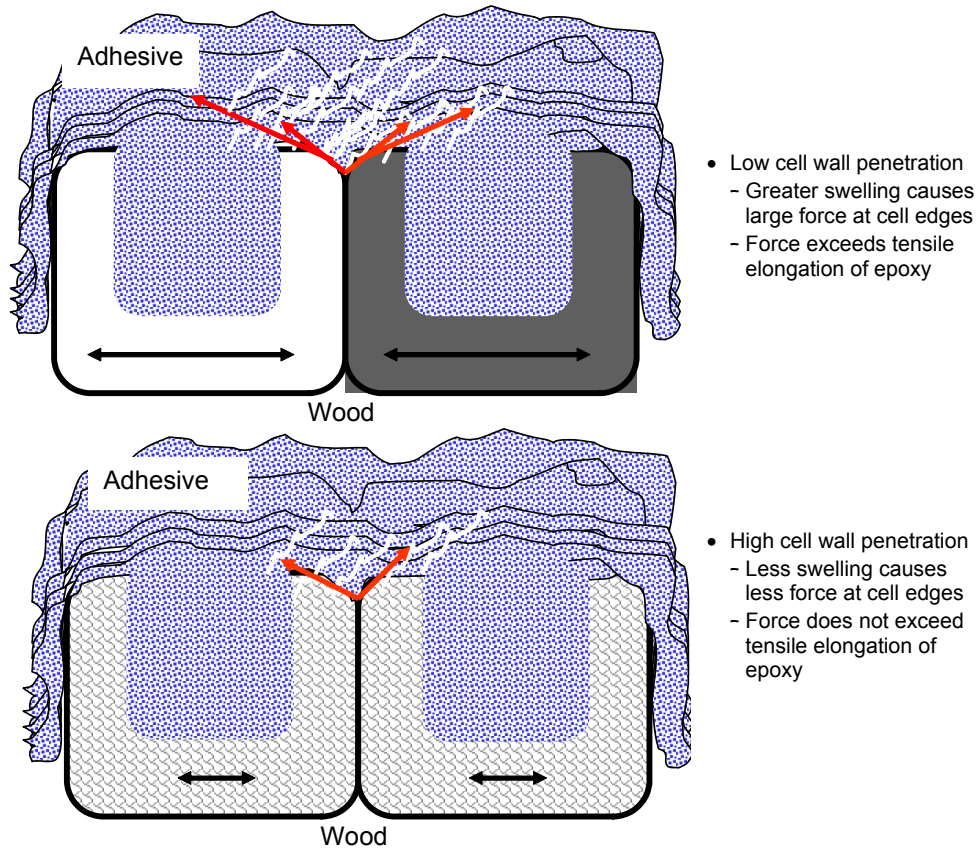

Figure 5—Models for adhesive–wood interactions.

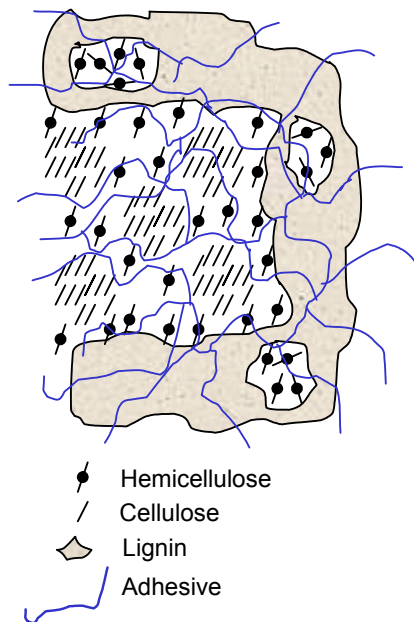

Figure 6—Model for adhesive forming an interpenetrating polymer network with the wood. Adhesive may form a cross-linked network mainly through the hemicellulose and lignin portions that can limit the ability of the wood to swell.

Discussion—Adhesion and Controlling Resin Cure For Optimized Wood Composites

Charles E. Frazier and Charles R. Frihart

Siquan Wang: To Frihart: You have one slide showing the rate of penetration, can you tell me how much resin is loaded on the fiber?

Frihart: Do you mean the PF or the pMDI?

Wang: Both.

Frihart: Do you have some idea Fred, since I borrowed the slides from you?

Fred Kamke: The question was how much resin was applied? I have no idea off the top of my head. The images that were shown by Frihart were both prepared with same amount of adhesive solids added but I do not recall how much that was on a square centimeter basis.

Frazier: I believe it was 20 grams per square meter. I just was writing a publication for this but they were continuous bond lines, not sprayed.

Kamke: This is a question for Chip. You were talking about this dielectric technique for monitoring adhesive cure and you talked about the technique in general but I know that are different types of dielectric techniques, one using a microprobe and I know you have a lot of experience using a microprobe, and then you also have that system that does the parallel plate arrangement. You indicated that there is a possibility for a lot of influence by the moisture that may be present around that adhesive and interfering with the signal. Can you comment on the possibilities of the parallel plate arrangement as opposed to the microprobe arrangement?

Frazier: Not really. I am not so familiar. I think that you have complications in both cases. I'm not sufficiently familiar to be able to distinguish between the two; perhaps there is less of a problem with the moisture in the case of the parallel plate measurement, particularly if the surface material is dried out like we think it is. So maybe the parallel plate measurement is not as complicated by electrode polarization in particular, which is one of the things that happens. So maybe it is not as bad but in terms of the overall complexity of the signal, I don't know there is a great deal of difference and it is still complex signal. I don't think I can really comment on that with any authority.

David Harper: I was curious about using the dielectric analysis, especially the micro dielectric system. It could be used as a way of monitoring moisture permeability through the panel, at specific locations, which would be the permeability you described in your talk.

Frazier: Some of the data that was supplied to me by Signature Control Systems, their results indicated just that. That it is an effective method for tracking moisture movement. So yes, that is one thing that can be done readily with the dielectric approach.

Pablo Garcia: Dielectric analysis has strong correlation with moisture content; they really don't like that because they want it to be a cure predictor. Moisture meter and I think with working with cure, we might be able to look at moisture content effect on the cure, whether it is pMDI, maybe it has some moisture absorption a bit or pre-polarization of phenol formaldehyde resins. Both the bulk parallel plate signal and the local signals are very much affected by moisture content. The bulk signal would be affected by more of the average of the shines right through from the top to the bottom, the micro dielectric probe will give you more of a localized reading from wherever you place it.

Frazier: That is why I am really interested in the acoustic method. It is not as complicated by moisture as dielectrics so perhaps acoustics is something that we really need to get back into.

Kamke: I wanted to comment on the dielectric influence by moisture content. Isn't the dielectric properties also highly influenced by temperature and trying to monitor the migration of moisture through a mat during the hot pressing process, you would have to somehow account for the change in temperature as well and correct for that.

Frazier: Yes. Temperature is going to have a big effect.

Jong Lee: To Frihart: As a modeler trying to predict engineering properties of the OSB, I want to see if there is an applicable method, to quantify the bond line strength or bond line performance because when I deal with the elasticity or mechanical properties of wood, we have to assume that there is 100% bonding in interface.

Frihart: The problem with being able to do the modeling is that you could probably get an estimation of your contact area between your segments by looking at your resin distribution. You can know the mechanical properties of the wood, you can get it for the bulk adhesive, but I am not sure how you can get the mechanical properties in the interphase region. If you are not having failure there, maybe it doesn't matter and you can just discount that area. But obviously, if it is an area that doesn't have enough strength to hold up, then that becomes really difficult without some data for that region. I don't know if you can do it by applying extremely thin films, doing extremely thin wood and measuring each layers mechanical properties or not. But that is certainly a real problem, it is very hard to model across adhesive bond lines just because you have so many different zones and you don't know the mechanical properties of those zones.

Garcia: Getting back to the comments of dielectric probes. The dielectric probes impart an alternating electric field on a polar material. This material then tries to align with the field. Moisture is the smallest, freest dipole, so it will dominate the signal. The effect of temperature I think is especially with respect to bound water, is that what we look at is I think is in the thermodynamic state of that bound water has a big effect because temperature has an effect on the signal. We increase the temperature where essentially the bound water becomes less bound and starts moving toward the free water. It is essentially still bound but still has a bit more energy so I think we might be able to account for the temperature effect somehow thermodynamically through energy of activation, calculations or something like that. I started to look at that a bit and I presented some of that work at the last Forest Products Society meeting, I have done a little bit more work on moisture content effects now and I am getting that all together now and hope to have some papers out on that soon.

Frazier: I think that those points are well taken. When you want to talk about monitoring resin cure, you can see that there is so much more information than just about the resin, it is difficult but obviously it is still a valuable method for all those other things particularly moisture movement. It is challenging to learn about the resin.

Kamke: I will keep the discussion going about dielectrics again. What about using multiple frequencies in this dielectric monitor. Each of these polar components that are found in wood whether it is water or the hydroxyl sites or some other polar groups in there, they each have a different time response to an alternating electric field. If you change the frequency and measure the response and change the frequency and measure the response again, some of those polar components are going to change their response and others will not. If you do enough multiple frequencies perhaps you can use some type of multi-varied analysis or whatever and break that down and isolate the influence of just the adhesive polymer and the water then would be a separate component.

Frazier: That is exactly right. You have different frequency response and also the different materials, the different dielectrics are going to have a greater or lesser capacitants or conductivity response so it is really two other dimensions that you could work on. So it is a lot of work there but yes, there are going to be different frequency responses and the moisture should give you a greater capacitant or loss response so I think there is still some hope that you could deconvolute some of those things.

Chunping Dai: To Frihart: I have a question, you show that the effect of water soaking or the moisture absorption on bonding with epoxy glue in wood, did you ever look at the MOE or modulus of elasticity for epoxy glue itself? I am asking that because I remember way back there was a paper published by Mark Irle and James Bolton (Irle and Bolton 1988) of durability of urea formaldehyde versus phenol

formaldehyde. Their study not only looked at the assembly between wood and glue, but also the cured glue itself. When glue cured in the case of urea formaldehyde, urea becomes very brittle, like glass. Whereas, PF resin is more elastic or more forgiving for deformation. I don't know if that is the case here with epoxy glue.

Frihart: In the urea formaldehyde, there was work at FPL done a number of years ago in which they looked at the assemblies and what they found was that there were cracks in the UF, shrinkage cracks which then when you put it in water, propagated into the wood (Ebewele and others 1994). So part of the solution was to make UF more flexible and that seemed to solve the problem. They used one approach. There has been a recent paper that used another approach, for the UF to try to do that. Epoxies are generally tough enough that they don't form shrinkage cracks upon cure. On the other hand, they do have very limited tensile strain to failure. I don't know if people in industry have good tensile data on PF resins, we found it hard to make a film and really measure strain to failure. One of the things that Chip and I have talked about is better understanding mechanical properties and we probably have to develop some methods to try and figure out how to get those properties. Along this line, there is a recent paper out at the University of Maine where their answer was the PRF was more durable because when you water soaked it, it would tend to elongate similar to the wood and so you didn't build up the stress factor. And that certainly might be a mechanism of doing it. I think whatever you do you have to really distribute the stress, which is the way most people go about making better adhesives is prevent stress concentration. So in some cases, a flexible adhesive is valid and there are some people who flexibilize epoxies. We are doing some work to see if that really does relate to some of the performance properties. So it is a good question.

Harper: To Chip: I know he worked with Marie Laborie (Laborie 2001) along these lines with the interaction of resins with wood. I was wondering if you could comment on the change that pMDI would impart on the glass transition of wood as opposed to the PF and UF.

Frazier: Well, I wish I could. We haven't looked yet at that system. Just to give a little background, Marie did look at two different phenolic systems, one of a high molecular weight, one of them a very low molecular weight, which was mostly monomers and dimers, and her work demonstrated that those small molecules enter the cell wall and influence the relaxation, the distribution of relaxations for whatever the major softening was, lignin or whatever you want to call it. There is no change in the TG, but there was just a change in the mechanism of that relaxation. And interestingly, the high molecular weight resin did not influence the distribution of relaxations but it did actually reduce the TG and so those are two very different and subtle effects. Now how isocyanate influences that, we don't know, although some

work out of Huntsman Polyurethanes by Joe Marsinko demonstrated that the isocyanate does I believe depress the glass transition temperature or the, I struggle with the term glass transition temperature in wood or the softening relaxation because that seems a more generic term, perhaps a safer term, but I think he demonstrated that there is a reduction in that softening transition. And it is pretty well established although not all the data has been published, but also work by Marsinko from Huntsman, established that the isocyanate does get into the cell wall and plasticize those polymers. So there is an intimate association there, so you would expect that it would have some influence on the relaxations. But the other thing is the phenolics do it as well, if you have just the right system. I don't know this from experience, but I think it is about the issue of molecular size more than anything else.

Frihart: Along those lines, if the adhesive forms a separate network within the wood, it is not going to change the Tg because you are not changing that domain. On the other hand, if it is being dissolved within the material, then it would affect the Tg so that may tell you something about where the adhesive is going in your system. As Chip points out, these things that are somewhat elusive for really knowing exactly what you are measuring.

Frazier: In Laborie's work, she demonstrated that for a low molecular weight resin, the distribution of relaxations associated with the softening suggests strongly that you are impeding the reorganization. Therefore, something must be in there or it's at least consistent with this concept of interpenetrating network. In the case where the softening temperature is reduced by the high molecular weight resin, the hypothesis is, even in the high molecular weight resin, there is a tail or some component of the resin, which is monomeric. There is always going to be some of that. And so that stuff gets in there and plasticizes or creates free volume, which could reduce the TG, but it does not have connectivity to the bulk adhesive layer and so it doesn't have the same influence. But it is curious, if you are depressing the TG, that is a whole other influence perhaps in terms of changing the relaxations and the stress relaxations and who knows how that works. So it is complicated.

Kamke: No, I don't want to comment on that because I don't know about that. I was hoping that Chuck could pull up his slide there that showed his list of adhesive mechanisms and I want to talk about durability of the adhesive bonds and in particular resistance of adhesive bonds to the intrusion of moisture. I guess resisting the shrinking and swelling that you have been talking about.

Frihart: This is the one of how molecules interact or the cells?

Kamke: You had a list of bonding mechanisms slide.

Frihart: This one?

Kamke: Yes, the adhesion models. My question is, which one of those mechanisms would play the most important role in resistance to moisture?

Frihart: Certainly if you get to where it is determined strictly by interface interactions, the covalent bond would resist moisture more. With the hydrogen bond, water can always intersperse itself, same way with other polar interaction such as dipole interactions or Van der Waals bonds. It really depends upon contact and if water intersperses itself. The mechanisms for epoxies de-adhering from metal is that water preferentially absorbs on metal to displace the adhesives. So if water gets into that interface, it will want to intersperse itself. On the other hand if you get into where the adhesive is actually penetrating the wall, that has got to be more durable than covalent bonds because covalent bonds you are only going to get a few of those and so you are really depending upon that bond strength of how many of those you form. So I think that a good adhesive is one that can get in the wall and do some effects on it and tie back into your network. I don't know. That is just my feeling. I don't know if Chip has a different feeling on it.

Frazier: Well, I would just add that when you pose a question on what the effects of moisture are, my first question is, what do you mean exactly? Do you mean about the adhesion mechanism perhaps or do you mean about swell? There are all kinds of things of course. In terms of swell, this concept of the interpenetrating network morphology could be important just by removing those absorption sites.

Kamke: Well my question was really relating to the strength of that adhesive bond as it may be affected by the intrusion of moisture. From what I hear from both of you, if you were going to design an adhesive system for wood to make it better in terms of resistance to moisture you would go after this interpenetrating network.

Frazier: I would go after something that requires cleavage of primary bonds. And so that would be covalent bonding or if you have a truly interpenetrating network, then to cleave that you would also have to break primary bonds so either way, yes, covalent bonding or some type of molecular level interpenetration.

Kamke: And so if I could add on to my question, what about just plain old creep?

Frazier: Just plain old creep, good question. I would presume then that if, I guess than the presumption might be that the interface would be sufficiently sizable to influence creep. I kind of see as a bulk effect and the interface being such a small component, I am not certain that you could influence it. That is a great question, but if you look at that I would probably go with an IPN type of a morphology because that would likely inhibit any type of reorganization, whereas

as covalent bonding you inhibit relaxation to a point but perhaps not like you would with molecular level interpenetration.

Frihart: If I can interject along this point, a lot of this discussion assumes that you have a nice strong wood surface and from your slides of showing a lot of change of the wood structure and you don't know how much the walls are fracturing. If you are introducing a lot of fracture in the walls at that process, you can bond as strongly as you want to the initial wall but it is going to serve as a weak point. For years, one of the areas that we worked in was to make adhesives that were used for bags and people would come back and say your adhesive is no good. Well, we found out the adhesive stuck very well to the ink but the ink wasn't stuck strong enough to the paper. It was coming off. So what you have to look at is where your failure is really occurring. Because it may be that a good adhesive, like a PF, just goes in there and reinforces weak cells so that your whole interphase region which goes from your bulk adhesive to your bulk wood is strong enough. This is the part that we really don't know and obviously are areas we want to understand in the future.

Garcia: Do you know of any work or published work that deals with fiber optic probes into mat during hot pressing.

Frazier: I do and I know that Bayer has done some of that work; I have forgotten the name of the gentlemen who did that work. Yes, and so I think that was the most recent use of fiber optics and I know that Fred also has dabbled in that area but I think he had some difficulty with the mechanical integrity of the probe. Yes, Rosthauser and others (1997) was the other name on that publication. That was a publication from the Washington State University Particleboard Symposium.

Dai: I have a comment and question regarding the question you raised, Fred, about the intrusion of moisture on quality and stuff like that. I just remembered one of the interesting publications and subsequent modifications on the property on the molecular weight distribution of resin on MDF board property. Professor Kowiee and his research team from the University of Kyoto did some work while he was working on agricultural fiber and he had to find a way to reduce thickness swell of this product. One of the work he did was that he had to use low molecular weight resin to, like we are talking about curing and you try to use the high molecular weight more advanced so you cure faster and stuff, however, in this case you have to use lower molecular weight and it is going to cure slower, however, that helps to penetrate into the wood fiber better therefore actually substantially reduce the thickness swell of the product. We actually heard his presentation while he was visiting Forintek, and we actually did some mill trial helping one of our members and we found that you can just do that to improve dimensional stability of MDF. I don't know if you guys can comment on the mechanism of that. I also have a question about the

curing of MDI versus PF: Why is it that MDI is so much stronger than PF? We are talking about the bonding, is there a high degree of covalent bonding going on there? Also, is it true that MDI can cure at lower temperature and at a faster rate? Can you comment on that?

Frazier: Well, let me go back to the question about the low molecular weight material and improving the shrinkage properties. I think it is well established that if you are able to get something into the wood cell wall, then you are going to bind up an absorption site for water and it relates to this anti-shrink efficiency.

Frihart: And it may also be changing your properties if you have another network in here, which is basically serving as a framework for preventing a lot of the swelling and shrinkage as indicated in this drawing, that even though there may be a tendency, it is restricted from doing that. Epoxy adhesives for example, like to absorb moisture, but they are so tightly cross linked that they can't absorb moisture. On the other hand, if you have a crack in epoxy and you put it in water the crack will tend to expand because it wants to absorb moisture and it has a way to expand, but in a regular network it can't.

Frazier: I guess that the fact the shrinkage and swelling has changed, really is proof that the molecules are going into the cell wall. If you go back to the work by Alfred Stamm (1964) many years ago here at the FPL, that is how he demonstrated whether or not certain molecules enter the cell wall. If after exposure to the small molecules it can no longer shrink and swell under the effects of water it means that something is in there occupying that site. The mere fact you do change the shrinkage and swelling properties is very strong evidence that the small molecules are in there. I am sorry you will have to repeat your specific questions about the isocyanate and the PF.

Dai: It is just I asked that why is MDI so much stronger compared to PF at the same amount of the dosage? The other factor is it is so much more expensive I guess. And the other aspect is that is it true that MDI can cure faster at the lower temperature?

Frazier: I believe that it can cure at lower temperatures, I think that other folks here who can comment at that with some authority. I believe it does, but then again, I think you can tweak the other systems to meet certain cure rates. Why it's stronger? I don't know, that is very difficult, in fact I need to applaud Chuck for his early distinction between adhesion and adhesive strength and I might have to ask you what you mean by a stronger bond. It is so difficult to know. You have a measurement, but then what does that actually reveal about adhesion? Because it is a very subtle difference there but a very importance difference. I am not certain that, I don't know that there are great differences, I do know that there are differences in the shrinkage effects for example,

that's likely a strong relationship to the low molecular weight of isocyanate and the other thing of course that when the isocyanate cures it forms a polyurea network and if you had to design a hydrogen bonding material, that would be it. Polyurea would be about the strongest hydrogen bonder that we know of. On the flip side, phenolic, also phenolic hydroxyl groups or aphenolates are extremely effective for hydrogen bonding. But perhaps there is not as many of those. I am not sure I can comment and it's because again do we really know that there is a difference in the nature of adhesion or that we have these measured differences in whatever we feel is adhesive strength? And it is a big difference, it is a subtle difference and I am not certain that often times the measurement are influenced by the measurements themselves that is the mechanics of the system so I am not certain one is really better than the other but they are vastly different, just the fact that isocyanate has such a low molecular weight, the other thing that is fascinating about it of course is that is it essentially a two part adhesive and the second part being moisture is everywhere around in there. When you talk about the phenolic needing to be, is a great analogy that I heard earlier from Jim, was that with the phenolic adhesive is like field position in a football game, if you start at the ten yard line and you are going to the goal line, to the end zone, you're closer and so if you start with the higher molecular weight you are getting there more readily. And the question would be, what is the deal with isocyanate, how come you don't have a similar effect there? It is just an entirely different cure and the fact that moisture is the other integral component and that it is everywhere in the substrate, that you essentially do have a network an existing network of water and isocyanate molecules, all they are just waiting to do is just kick over instantly, so in that regard I think it is faster but I think you can manipulate the phenolic system to be as fast perhaps.

Ted Laufenberg: I had to follow up on the question. I believe that when Fred asked about creep, we are really talking about the number of binding sites that are available for movement within a composite and the equilibrium moisture content seems to be strongly affected by molecular weights. That is what I found when I did my creep studies at least, that EMC was a much better predictor of creep capability and that was strongly influenced by the adhesive type. At the time, I am not a chemist, but at the time, I didn't go into it any further but perhaps you can comment on that. How EMC affects creep, dimensional stability, all these other volumetric properties strength aside.

Frazier: I don't know that I can comment, well, if the EMC is higher, then I would expect a greater plastic response, but how the adhesive influences creep, a big big issue there is that we compare apples to apples and so if there is some concern about differences in creep response caused by resins, my first question would be were those systems consolidated in hot press under identical conditions or are folks

imposing the contemporary hot press conditions that are specific to those adhesives? In which case the thermal treatment of the wood cell wall is different. So I have heard people talk about creep with different resins and I think that unless they are compared under identical temperature, time, moisture conditions, it is difficult to say that okay the adhesive really has a contribution to this creep effect. It could, but if you are adapting the hot press system to two different resins that may have two different cure requirements then of course the thermal treatment of the wood cell wall is different. And so I think that it is critical when you talk about how creep is influenced by the resin that you recognize that by using different resins and process conditions, you are not using the same thermal treatment. I don't know the answer to that, but I think it is an important distinction.

Wang: I'd like to follow up the comment on the durability. When we compare durability, we often either boil the sample or soak a sample in the water. If we look for the micro-scale or cellular-scale, we can imagine that on the interface we have a lot of internal stress. I mean that these swelling stresses can easily destroy the bonds. In the research that I did with Tony Pizzi a few years ago, we tried to use another way to see if maybe the bond lines were possibly too strong and not flexible enough. We thought that if we could improve the bond line, for example by putting other molecules inside and making those molecules more flexible, then the bond lines would be more flexible and, maybe this could improve their durability. The research that we did, we broke down long nylon fiber to small nylon fiber and added it to a UF resin system and made plywood. Then we tested durability to see if we could improve the durability. The concept worked, in that it significantly improved the durability. So that meant, that when we added the nylon molecule, which was more flexible compared than UF, the nylon fiber was connected at one end to UF and the other end was connected to another UF molecule. This made the bonding line more flexible so that during the boiling test, bonding lines within the mat were not as easy to destroy when they were undergoing swelling or shrinkage.

Jim Wescott: I have a couple of comments to add on the urethane discussion, as well as on the durability. Urethanes, isocyanates obviously are very unique. The things about them I have observed over the last couple years of reading on this and Chuck showed a couple of excellent slides. A couple of things separates them from the phenolics; one is that the fact there is no water present vastly affects how they spread throughout the material, their surface tension is so different. I think that they are greatly more efficient because in my opinion the phenol formaldehyde that is filling the lumen is inefficient because basically it is phenol formaldehyde bonding to itself within inside the lumen. I think that is primarily the reason why isocyanates give you comparable performance at a lower load, it because of how they wet. In particular how they wet inside the lumens themselves. The

rate of the reaction is certainly vastly greater than PF and to what Chip stated, we really can't increase the rate of the reaction of phenol formaldehyde, all we can do is start the ball closer to the goal line, and that is really all we have been doing over the years is going with more aggressive higher molecular weight systems trying to counteract the high molecular weight with the addition of the urea and other modifiers to decrease the viscosity so we don't decrease the overall flow. You don't have that problem obviously with the isocyanates and you are not trying to do a condensation of a manic type reaction, which for those of you have done DSC see that that typically is a 130 to 150 degree exotherm. Isocyanates are tremendously much faster once they are catalyzed with a small amount of water so there really is no comparison to the rate of the reaction. Chip is exactly correct as part of the reason why they are also better is if you were to actually try to build the highest molecule with the greatest amount of hydrogen bonding, you would build a polyurea, which is what you have here with this system so it is phenomenal hydrogen bonding and of course there is a big debate whether or not there is any reaction or substantial reaction of the isocyanate with the actual wood itself. I think it is generally considered that this is minimal at best, but probably the majority of the actual bonding is taking place of hydrogen bonding as a result of the very strong urea linkage in there. Hope that helped a little bit there anyway. Back on the water swell. A couple of questions on that. I like what you mentioned about trying to flexibilize the adhesive and some of the things that we try to look at. I think most people really struggle with thickness swell and then really overall durability, not only how much does the wood swell, but after the wood swells, what types of properties do you still retain? And certainly I would think that if you are getting tremendous failure of the glue line, as a result of the swelling, than that should basically be a nonreversible exchange for your adhesive and when you try to do an internal bond by redrying the wet sample, you should see substantial loss, if the resin is more flexible and gives with the water absorption then I think that you would lose less of your internal bond upon redrying. Now I haven't seen any data to support that, but I would be curious on cases where you try to make the adhesive more flexible, and even making the adhesive more flexible it doesn't really matter how flexible it is if you are still in a condition where you are below the T_g, it is still going to fail when you test it. So I mean you can try to make it more flexible but unless you have a couple different domains where you are basically have a soft and hard domain if the whole molecule itself still has a high enough T_g it is still going to have a very high modulus under those conditions where you are applying the stress. So I am not sure if it would work if you didn't do it in the right manner. One last comment on the use of phenol formaldehyde today, we've looked at a lot of commercial phenol formaldehydes and curing them up and doing extractions, I would think that one of the problems with durability today is as we try to fight press times by going with higher molecular weight PF resins

and throwing in the urea type modifiers to them, I've seen PF resins that when I cure them and do a water extraction, I can pull out 35% of the cured resin. So obviously, if your adhesive bond itself is still a third water-soluble you are probably going to have a difficult time of having good durability. So obviously we are trying to win one battle at the same point and time most of the time, at least in the United States, not worrying about boil we mask a lot of the water problems with wax, which is really a mask because ultimately it is not going to do its job in the future. That is just a couple comments and I don't know if anybody really wants to add to that.

Frazier: The whole issue, without going too far down this path, in terms of covalent bonding with isocyanated wood we have studied this for a long time and have come down on both sides in our results and we have used labeled compounds and solid state NMR and based on most recent results, we feel that we have a tentative identification of urethane linkage using the double label, N15 and C13 label isocyanate molecule. The problem with this, we see a signal that we attribute to the urethane carbonyl. There is still some question about the identification of that signal because with solids NMR you know you can get things moving around the chemical shifts as you know change not only because of the environment but how they, well because the environment, because of the interactions it may not be just chemical identity, but the interactions with the environment. But what I am trying to get to is that we've made a tentative identification of a urethane linkage and it is not rock solid. It is not completely proven but nevertheless I feel more confident now that we do have the identification, I can't say that we have it for certain, I think we do. The point I want to make is, IF we do, there is a lot of urethane formation. If we have identified what I think we have, there is quite a bit. We are still working on that.

Wescott: If you had the wood extremely dry, then it is not able to have as much water to catalyze the isocyanate to form the urea. Then you should see a greater amount of your urethane system in a dry wood environment. Would you agree with that?

Frazier: Yes, well what we have done is using different moisture contents we have seen a change in the signal that we attribute to the urethane carbonyl. We have not though with this double-labeled resin, which is the system that we think is useful now; we have not driven that with a completely dry wood sample. We have done that before just with nitrogen 15 labeling just to get the model urethane chemical shift. But no, we haven't done that experiment, we have only looked a difference in moisture content from about 4 or 5 up to about 12 and see a difference in the peaks that we attribute to urea but the urethane still, the peak that we identify as urethane is still there. No, the answer is no. We have not done that, an absolutely dry wood system with this

double-labeled resin, which is the one that we think is so useful for this analysis.

John Noffsinger: Can you have too much moisture? Could I leave my strand too green or too wet and affect the pMDI reaction?

Frazier: I don't believe so. I think the issue there is the one that Fred touched on earlier is more about gas pressure, I believe. There is such a huge excess of water anyway that I am not certain that the isocyanate sees that as a difference.

Al Christiansen: Yes, I think it would affect the surface energy of the wood so as Jim points out that would affect how it wets and penetrates.

Frazier: Well, based on just a theoretical analysis, if you increase the moisture content typically that is attributed to increasing the surface energy. And that would enhance wetting and enhance penetration.

Christiansen: Two things. One of which is you've got a lot of sodium hydroxide in your resin and that probably doesn't stay with the resin entirely, because a lot of it goes into the lignin, which is also phenolic, so you are probably weakening your wood that way. And the second thing is, you probably don't get great cure in the center of the board, maybe they get hot enough, but for phenolic resin, the higher temperature you take it to, the better the cure you get. With the isocyanate you are probably getting almost complete cure, with the phenolics you are probably not curing them fully in commercial processes and often not in our lab pressings.

Frazier: What I don't have an appreciation for is, what is overcure? I think we do know what overcure is for a phenolic, that it can become brittle. We don't know if there is a similar type of overcure for isocyanates. I am not aware of it. I would suspect that there would be. We do know that there is a lot more urea formation and if urethane formation is occurring, if, there is a more than urea in urethane formation, there is a lot of other cross linking occurring, and so we know that the cross linking those other side reactions for biurete formation are occurring and what we don't know, what I don't know, is if that has a negative influence on the toughness of the network and if over cure is a possibility for those materials.

Kamke: Question for Al Christiansen. Can you explain the influence of sodium hydroxide on the lignin and why you think that would weaken the wood?

Christiansen: My thought would be that sodium hydroxide strongly attracts water and so it will probably selectively absorb maybe even more water than you would normally see in wood but in those regions especially. And so if the sodium hydroxide goes to lignin it may disrupt the cell wall to some extent by absorbing more water where sodium is associated with the lignin molecules. It's probably not going to absorb

as much into the hemicellulose and cellulose because it just isn't attracted as much as it would be to the phenolic hydroxyl. And so once it gets there, the sodium is probably going to take more water into that location and free things up a bit.

Frazier: And also you have to remember that it is not present as sodium hydroxide, it is present as sodium phenolate or sodium lignolite or something like that. Not that that changes the issue but if you still have those salts in there, those are certainly hydrophilic. The negative influence on the chemical structure, there is some indication that you can harm the carbohydrate, but again, since it is in the form of phenolate in one sense or the other, I don't have a feel for how much chemical degradation it causes but the hydrofality is certainly unquestionable.

Wang: Can anybody comment on how bonding would be affected by wood structure? When we look at the surface of the wood, what we are really looking at, is it really hemicellulose or cellulose. But they are separate components. Of course when we cut wood into flakes or fiber, the three components are exposed to the surface differently. So different resin system working with three components I guess would be different and who can comment to which kind of bonding would be stronger. For example, PF is more likely bonded to lignin or bonded to hemicellulose.

Frazier: Yes, thanks for that question. Actually that reminds me of something that is interesting. I sure don't know in the case of the isocyanate what it prefers to bond to. I suspect also lignin and Jim, I want to make sure you hear this comment because it relates to this issue of urethane formation; we have some indirect evidence that perhaps the isocyanate has a preferential reaction with the lignin. Because one of the things about the urethane linkage is it's thermally unstable. Depending upon the temperature and depending upon the hydroxyl group that reacts to the isocyanate, if you have a urethane linkage between an aromatic isocyanate and a phenolic compound, the thermal decomposition of that will occur on the order of about 100°C to 120°C, and so we do see evidence of the thermal decomposition of the peak that we identify as a urethane and it occurs at this lower temperature. Based on just pure theory alone, that would suggest that it is a preferential reaction of the lignin. But, that could be extremely naïve; I mean that would be ignoring the influence of environment on the thermal stability of other urethanes, aliphatic urethanes, that is if you had hydroxyl groups from, aliphatic hydroxyl groups from cellulose or hemicellulose. They could perhaps also be more thermally liable because of the environment but based just on what we know of model compounds and that we see that the peak that we identify is urea thane thermally decomposes at around 120°C, that suggests based on theory alone that it is a reaction with a phenolic compound and so that perhaps it is preferential reaction with lignin. But that is conjecture. I mean that is just consistent with theory.

Kamke: I am going to keep asking questions until someone shuts me up. This is a question for either Charles the first or Charles the second, not quite sure who, is who but the question is, is there any influence on the molecular morphology of these cured adhesive systems in the presence of steam? In other words, pre-polymerization in the presence of steam, and perhaps we are talking about a saturated steam environment.

Frihart: I would guess yes, but I am not aware of any data.

Frazier: Yes, I would say the same thing. The problem is that we really don't have any really good measurement of that. We had a project a few years ago working on that and we couldn't find a strong indicator. Based on just our freshman chemical expectations you would expect to change the kinetics and that you might promote one chemical pathway over another. And that would influence the morphology but I don't think that anyone has shown that conclusively. All that I recall from our work on that was that the steam enhances heat transfer and so the resin kicks over more rapidly, but at the same time if you have moisture present, particularly in the condensation reaction, you know our freshman chemistry tell us that it should change it, it should change the bonding pattern and then how that would influence the morphology, morphology defined as this wood resin material in the interface, and so it should change it, but I don't know that anyone has a good idea about how it does that. It should, that's too bad though, and that's the problem with it. We have a theoretical expectation but very little evidence one way or the other how that should go.

Kamke: The project that you were referring to was Aldo Ballerini Ph.D. project (Ballerini 1994) from years ago. I cannot recall all the results but one of the results I do recall is that when the phenol formaldehyde, it was a liquid phenol formaldehyde system that we were looking at being polymerized in a saturated steam environment, was subjected to solvent swelling the amount of swelling in the adhesive system cured in the saturated steam environment was much greater than the amount of swelling of the same adhesive system that was cured in a non-saturated environment.

Frazier: Yes, well that would be a very clear indication then of the change in the network properties. The other thing also is what does it do to the formation of bubbles; you know the small microvoids that I think are typical for phenolic resins. Those are I believe toughening mechanisms for phenolics, you often have small nano or micro voids from gas from water vapor because of the polymerization and what does saturated steam do to that. And that is sense; it is purely a mechanical influence and not a chemical effect. But don't know the answer there but so in that particular case what you refer to Fred is the clear effect on the network properties, if the swelling is changed.

Dai: I have a comment, going back to what Jim was saying about the difference between the MDI and phenolic resin being mainly the penetration to the cell wall rather than into the lumen. I think that is a very interesting observation and this reminds me of the need for using MDI for bonding residue like straw. You know that straw is very difficult to penetrate if you use urea other adhesive you won't penetrate because of the waxy surface and inorganic compound on the surface. Whereas, if you use MDI it works very well and you almost have to use MDI, otherwise you have to treat the straw surface, enabling it to absorb or penetrate better. I guess that is something that I like to reinforce what Jim was saying. I have a question probably for you two and also mainly for Al Christiansen. You and Geimer did some work on mechanism curing, I remember the paper talking about the process of chemical curing versus mechanical curing (Geimer and Christiansen 1996). At that time I didn't quite understand what that was and I still don't understand, maybe you can shed some light on that.

Christiansen: It means that we didn't write the paper very well I guess. Basically, a lot of the cure that goes on in phenolic adhesives is just building up molecular weight and maybe branching. You only get your mechanical properties at the end of that process. But when you look at cure by DSC, you are looking at the whole process. And so you think everything is building up mechanical properties. Well you are not yet, not until you get to the point where you are actually getting gelation and other things. So basically, the cure you detect depends on what part of the curing process you are in. Early on, you are not building up mechanical properties, later on you are. The trouble is we tend to confuse the one with the other.

Frazier: Yes, that is exactly right. The question is, where does gelation occur and more importantly when does vitrification occur after that? So those are the two critical aspects of mechanical strength development. Just as Al indicates, there are a lot of methods that show us chemical changes, but unless we can pick off specifically gelation vitrification, we cannot have an appreciation of when we can open the press for example and when there is enough mechanical integrity to open the press.

Christiansen: And I might add to that that really building up molecular weight does not necessarily mean that you have to build up a lot of molecular weight. For cross-linking and that sort of thing, a little goes a long way. If you see a gelation diagram for a PF adhesive, it goes up really fast.

Heiko Thoemen: I have a question about the thermodynamics, not so much about the strength development. We know if we talk about reaction rates that some water gets free and that the thermal reaction alters some energy. How much does it contribute to the temperature rise and how much water actually is liberated?

Frazier: That is a great question. I don't know the answer but it would be very easy to calculate how much heat and how much temperature would be, easy to calculate in a DSC you could easily get the heat of reaction for the neat resin, the question would be, what is the heat of reaction in the presence of wood and then you could still even get that information. So that would be easy to measure and calculate. The amount of moisture produced in terms of the phenolic cure is not as clear to me, although still you should be able to calculate that based on what you expect from the known mechanisms.

Thoemen: Okay, when I prepared my presentation for tomorrow, I asked one of my colleagues from the chemistry department actually the same question and we came to the conclusion that between 0.5% and 1.5% moisture content added and was thought to be pretty much.

Frazier: That sounds like a lot.

Thoemen: I just want some comments on whether it is realistic or not. We calculated that between 2°C and 5°C of the temperature may be added due to the extra thermal reaction of the adhesive. Sounds pretty much to me as well.

Frihart: I have a little problem with the amount of water because it depends on how much adhesive you are using but....

Thoemen: Okay, we talked about UF resin and we talked about like 10% adhesive content.

Frihart: Yes, if you've got enough resin, if you are doing something like particleboard it is probably more significant than if you are talking about 3% resin on oriented strand-board, it's probably a lot less.

Rick Rammon: How many moles of water you generate depends on how far that reaction goes, so I don't think it is going to go completely.

Thoemen: Yes, we already had this in our mind. I am curious whether anybody in this room maybe has some ideas about literature or did such calculations.

Ted Frick: This doesn't apply to the UF question but there is a lot of literature about that for MDIs and the different heats of reaction for isocyanate urethane reaction or isocyanate urea reaction and the order of magnitude similar, I think, to what you've calculated a little bit less on the amount of temperature that you would have contributed by that exothermic reaction because the binder amounts are lower, so well less than 5°C contributed, and then on the moisture side of course because of the stoichiometry even 5% MDI would only consume about 0.3% moisture, so again a very, very minimal effect there. But there is literature if you are interested in heats of reaction for isocyanates.

Garcia: I've done some experiments looking at internal bond strength versus hot pressing time. If I were to redo them, have you got any recommendations on quenching method, I mean what worked for you if you've done some in the past?

Frazier: No, I don't have any recommendations, well liquid nitrogen is good. The problem is getting, you know, what's the form of your sample? We have done some quenching where we had small tiny mats where you can just readily grab it and throw it into the liquid nitrogen. But with the larger mat, I think that is a more significant problem and I was talking to Fred actually yesterday about the concept of injecting liquid nitrogen into a pilot scale system, but it really doesn't seem feasible when you consider the drop in permeability that Fred discussed earlier. You know, it could be feasible at the early stages perhaps. The other thing also it might be interesting to simply press a mat with no resin, but with resonated samples in there and if that would allow you to open the press and inject liquid nitrogen you know to open up the permeability, but no, we haven't done any work in that regard and that would be a significant obstacle to overcome.

Garcia: Do you think freezing the wood might have an effect on the properties I'm trying to measure, trying to measure internal bond strength, the strength of the wood?

Frazier: Yes, yes.

Frihart: I wonder on the method, if you have a lot of water around and you are freezing the water, does it cause fracture?

Frazier: Yes, yes. If you are talking about pulling a sample out to observe the properties of the resin, you will not influence residual heat, you know, you will freeze that, if you are able to devise some type of mechanical analysis you may cause some fractures and that could be a problem. So yeah, yeah, but if you have an analysis where you are looking at residual heat or chemical structure, it shouldn't be a problem, it should be okay to freeze it, but any type of mechanical analysis and I'd be in particular, I think it would have an effect, so again the concept of the observation affecting the sample is a problem there.

Harper: I have a question: What size is your sample?

Garcia: 18 by 18 [cannot hear]

Harper: Okay, because what I did previously for like lap shear specimens, I just put it between two steel plates at room temperature and that was enough of a quenching effect for a mechanical test.

Frazier: Yes, for a lap shear specimen I could see that, but for a mat it will take quite awhile. But what's the thickness?

Garcia: 3/4 in.

Frazier: That will take quite a bit of time for that to cool down.

Kamke: I would like to throw up a question to the group here and get some comments back on it. In regards to adhesive cure rates and press times, it seems like the trend has been for many years, if you come with faster and faster adhesive systems and reduce press time so people can make more product in a shorter period of time, it seems to me that certain properties such as moisture resistance and thickness swell are not going to react very well. What I am getting at is the process of hot pressing is also a thermal treatment of the wood and making it less hygroscopic and therefore reducing its potential to absorb water and swell. By reducing press time, what the industry is actually doing is making their problem even worse in regards to thickness swells and resistance to water. I would like to get some comments on that. Are we going in the wrong direction in terms of trying to improve process efficiency and fighting a losing battle?

Rammon: Yes, I tend to agree with what Fred said. I've seen that as we go quicker, not only do you lose the effect of the thermal treatment, I think you lock in some more residual stresses into that panel that is like allowing spring then when you do get moisture back into it, it has got a lot more stress built in there that is just ready to burst. I remember years ago, I think it was here at FPL, that they had done some work on an UF system, the inherent effect of the work really significantly slowed down the cure of the resin. It was very slow curing resin but ultimately because it cured slowly, it ended up being very stable to moisture and we just assumed it was because it cured so slow, residual stresses were dissipated and weren't locked into the system. So I think there is a whole lot to go that we may be avoiding or problems that we are inducing because of this desire for speed.

Winandy: We've been considering the same thing for a couple of years and we have been trying to work with some of the industrial folks to find out why people are doing this. The primary reason is production speed. Everyone recognizes that there could be benefits to longer press time and you could impart higher properties. The down side is in general they sell these products in a commodity market and standards do not differentiate. So everybody makes an OSB that meets this minimum level and only this minimum level. There is no way to grade out their product so that they can command a premium price for a premium product. People have tried that privately and some companies have been very successful in it, but until the standards allow the people to grade out their products, there are no incentives from the manufacturing community. That is the opinion that we've come to, there is no incentive.

Kamke: The question to our moderators then is, can we achieve both, and can you design an adhesive system that retains its rate of cure but also performs some of the same functions as an extended press time? I mean can you

enhance stress relaxation, for example, or impart some type of moisture resistance because you tie up some of these hydroxyl sites?

Frazier: I think you could, but you might be running up against a similar barrier and the added expense having to, and not just meaning adding more resin, you could add other components as well, but I think you could, you can plasticize the cell wall with the adhesive depending upon how you do it, so that could be a component of the relaxation that you may get aside from the heat and mass transfer that you get in the press anyway. So, yes you could, I believe, but you just have the similar problem of the added expense. So perhaps its more about the issue that Jerry brings up because I think Jerry is right on the money. It's a matter of whoever it is that controls the whole situation or that everyone gets together and talks about changing that standard. Because it could, in my opinion and I am very naïve on this and forgive me if I am out of line, we could be going down the wrong path in terms of the consumer perception of the product and if we keep going this way and we end up harming the material and in the long run harm ourselves because folks get the negative perception of the product.

Noffsinger: That standard is changing, Huber is come up with a board that they call Advantek, LP's got a board that they call Home Advantage, Weyerhaeuser's got a product that they call Performance Plus Panel. So those are all supposed to have less thickness swell, but there is still the pressure to get more volume out of the middle because you've got millions of dollars tied up in that capital asset, so how do I get more through. Fred, I like your question to the two speakers, how can we have both, eat my cake and the whole nine yards. Time is precious in a plant, but at the same time we found out if you pull it out too soon, you will have thickness swell problems. The other question comes in too though is something that Mike Wolcott in 2000 WSU Composites symposium talked about raising MDI levels up to I think he extracted up in his regression model up to 10% or 12% MDI to try and reduce the thickness swell, and he proposed that when you do swell that board you are actually breaking bonds and losing strength. So the question comes to my mind, if I get a customer complaint because the floor has been rained on for 4 months while he hadn't gotten the roof over it, what's the strength now in that floor? That is kind of a scary question to ask.

Thoemen: Maybe to answer your question, I am not a chemist but I remember that Phil Humphrey and Mohammed Chowdhury, they did some work on using ammonia to elasticized the material so that may be one interesting way to go into this direction. And in another track there have been projects at the WKI in Germany, I think they didn't publish it so far, but they overpressed their mat and then they relax the mat a little bit and after relaxation they hardly had any residual stresses, so that may be another way to think about it.

Frick: Just a general comment Fred on that. We talked a lot this morning about the physics of the pressing process and the thermal history of the wood when you run a shorter cure, you are really only chopping the last x number of seconds off of that curing cycle and the ideas you presented about the vertical density profile, one that develops, that's all set in the board to begin with I think so we probably have much more flexibility to change things up to that point before you open the press, irregardless of the resin but controlling things about how you close the press, how you set up your press program, that will affect the thickness swell a lot more than, is that resin 99% cured or 99.9% cured? That would be my guess that you could make the resin faster and to be able to have the strength to withstand opening the press and still through your moisture grading and through your pressing cycle, control the other variables that influence that thickness swell even more than how cured the resin is.

Frazier: But the point there is that the longer time and the heat exposure that you are talking about imparts chemical changes to the cell wall. That doesn't relate to what the adhesive is doing so that might be a separate issue.

Karl Englund: I kind of agree with Heiko in a sense that maybe we need to stop looking, or not stop looking at the resin and chemistry, but maybe start looking at new process development, and start looking at what can we do to the mat before it enters the press. Can we do some type of post treatment to it after it exits the press? Maybe we need to start looking at the dinosaur of the continuous and batch pressing procedures that we have and start changing some of those things.

Frihart: One way of compensating for shorter times is higher temperature. Obviously there is a trade off in that too high of a temperature will speed up your cure and certainly some of the other processes, such as some dehydration to get more of a case hardened material. However, now that it is bonded, the dehydration may not interfere with the bonding. This could reduce some moisture absorption of your product so it might be a way of looking at temperature of your platens or doing some programming temperature of the platens instead of constant temperature.

Frazier: Perhaps. Because if you think back to what Fred taught us this morning, why we need modeling, the platen temperature may not necessarily influence the core temperature for example depending upon the details of the heat and mass transfer so its perhaps.

Noffsinger: Can I carry your comment one step further, Chuck, and that is, what is high temperature?

Frihart: I don't know what they normally run at but that is obviously one of the variables. I mean most industries, if they try to speed up, they have to end up increasing

temperature and sometimes you have to change the rest of the system to compensate for that.

Noffsinger: I mean, is there a point when you get too much temperature and we start to do something negative to the wood itself and in effect we start breaking it down? 210°C? What is that in Fahrenheit?

I guess we are hearing there are some folks out there that are running it up to 425°F on the press, one concern you have to worry about are press fire. Big capital investment out there and you burn it down.

Wescott: I have pressed some boards at around 215°C, and the surfaces of my boards are noticeably darker and they bond well too.

Wang: Regarding the continuous press, I know that the industry uses a much higher temperature in early stage because the press is controllable in different stages at different temperatures. I think it is around 450°F or 460°F. But you know, when they reach that certain severe condition and then go to the following the stage, their temperature goes down so it only spends a short period at the higher temperatures.

Wescott: Chip, you can probably answer this question better than most people for sure. The temperature at which can start to degrade the wood, I assume it is a function of how much moisture is in there because you know you can press a board very quickly with high temperatures and be okay. I assume the reason why it starts to get dark at the 415 or the 210°C to 215°C is simply too much time and too dry in the surface.

Frazier: Yes. I think that you get degradation at much lower temperatures, but then it is about time. So it is a time-temperature thing. Getting your oven dry moisture content is a degradative process.

Christiansen: I don't know if people have been doing anything, but is there any way of increasing the mat temperature slightly before even going into the press somehow? Does that help?

Harper: I have a question based on pMDI from Chip's work: Between 100-160 degrees there is a wide range of reaction products with pMDI, or there might be a shift in products as you change the different temperature and cure rate. In my own work, I saw different lap shear strengths at different press temperatures.

Frazier: Yes, yeah, there are shifts in the cure chemistry of isocyanate as a function of time and temperature and also to a degree of the moisture content, which just goes to show that through the thickness if you have all isocyanate material, that the cure chemistry differs and what we don't know is how that translates into performance and gross density and those kinds of things. So yeah, there are changes, we know

that, but we don't really know what the changes mean exactly in terms of performance.

Winandy: We did not do it in a press, we did it in a kiln-like environment on solid wood particles. For a number of years, we have been studying the desequencing in the chemical composition of wood because of problems with wood degrading when used in high temperature environments. Currently, we don't believe that there is a threshold. The bottom line, every piece of data that we have says that wood is constantly degrading at any temperature. It is just a matter of time-temperature (i.e., kinetics). We have gone out to 6 months at 50°C, which is about 130°F, and we have measured no reduction in density or change in property, but at 150°F, which is 65°C, in as little as a month you can have up to a percent of mass loss and you can have a measurable probably 4% to 5%, strength loss, and that process continues on relatively a pure kinetic basis (Lebow and Winandy 1999). You had talked about discoloration in the press at some of these high temperatures and you were talking minutes at 200°C. Our work would show that we can create the same kind of degradation by degrading the arabinose, which is a pentose-structured ring which degrades into furfural. Furfural is a dark chocolate brown color, which is normally what you see as the first degradation product of the carbohydrate as we have seen that discoloration in just a few months at 65°C, and basically for every 18°F, you have a doubling of the reaction rate every 10°C, that is not exactly true but it is a good rule of thumb, so you can see that going from 200°C to 220°C in a press would have not a doubling but a quadrupling in your reaction rate in the degradation of these carbohydrates. They would be accelerated by steam because steam would enhance the hydrolysis which the main degradation method that these things degrade. There are papers by Patti Lebow and myself in *Wood and Fiber Science* (1996, 1999) modeling kinetic degradation rates.

Christiansen: Jerry, does that mean that boards put on our roofs which get very hot are likely to become less tough and strong as time goes on?

Winandy: With our work we talk of energy absorption rather than toughness because toughness is a just one particular test, whereas energy absorption describes a category of properties (including toughness) dealing with how much energy is required to cause some kind of failure criteria in the material. Our work has shown that you do get a decrease in energy absorption in materials as soon as you start to degrade some of these hemicelluloses. If you'll allow me to use an analogy that we often use in our talks on this subject, we think that the secondary bonding of polymers in wood is similar to how we might think of Velcro. As you begin to degrade these side chains off the hemicellulose, you get less and less stress transfer and strain transfer from one polymer to another similar to if you start to cut the little ringlets off your piece of Velcro and it can carry progressively less and less stress. Thus, you get less stress transfer from one

polymeric unit to the next. Eventually you start to see strain energy build up which then causes the fracture and that's why you get big reductions in energy absorption. It's related to how quickly you can dissipate a high concentration of stress in a very specific location away from that area. As you lose these little Velcro hooks you end up with bigger strain. Eventually you get to the point where you create fracture because you get enough fracture energy that you get a catastrophic failure. This is why we believe that heat treated or thermally degraded wood almost always fails in a brash manner rather than the ductile manner that we often see with clear wood material.

John Hunt: I have just a question related with Karl (Englund)'s questioning difference processes and I am not sure. I am not in this area of research necessarily, but the question is, if there are multiple resin systems where, for example, you put MDI in the core and phenolic in the faces, then does the MDI still catalyze as fast in that core? How about the PF on the surfaces? Maybe someone has experience or any comments on that.

Noffsinger: In the industry, MDI in the core will definitely speed up your process so you could do that, so that's standard. The real question is there something else we could add, nobody's used in the past, and I think somebody called it gorilla juice. Is there some gorilla juice out there someplace that we can make this board go faster?

Frazier: Yes, it costs \$5 a pound. That's the problem.

Winandy: I just wanted to reiterate a point that I made earlier is that the way we sell composites in this country, you had mentioned that there were private industrial entities that are selling those products, but they are basically self-standardizing it too. Yes, it meets PS-2, the OSB sheathing standard, but it way exceeds that. The problem is that there is nothing in ANSI PS-2 that allows you to say that "my product exceeds level three or level four of PS-2." PS-2 only has level one.

Noffsinger: Actually, what is happening is we are finding two companies come out with design value products, evaluation products through the code agencies. Huber's already has theirs, and Weyerhaeuser is going to have one very shortly so that takes care of that part of the equation.

Winandy: I guess that is my point, they are doing it privately through the codes. We have now seen this in treated products, fire retardant treated products, and preservative treated products, that the standards won't differentiate these products. So the people go directly to the code and they differentiate their products that way. But the bottom line is that you could do it through the standards if you were to pursue commodity differentiation. If there was a consensus in the industry that I can add value, then I can afford to keep something in the press for 30 s longer, while slowing my

process by 25%. We can slow up by 25% if we can add 30% value, but until you put those gradations in these standards, I don't think small companies can get that kind of payback on value added.

Noffsinger: That is correct, you would be able to slow the press down by 25% if you could add a value of 30%, but that doesn't happen in the marketplace. The issue that you run into is how do I reduce thickness swell and make sure that the customer realizes that that is a value to them. One of the problems is if you build a house and get it covered quickly before it rains on it, you don't need to have these high end boards, in fact I was with a builder who builds over a 1,000 homes in the Baltimore, Washington, DC, area, and he says he has maybe 30 homes where he actually has to sand the edges where they have swollen too much. So why would he pay as much as \$10 more a pound for some high-end board. So you get the pushback from users on why do I need this high-end board when I normally can get by with standard PS-2 board. And oh, by the way, wait until the hurricanes come through or the fires in California hit, you will see the market shoot up because everybody runs out and buys it all anyway. I believe that is why, right now, OSB is priced as high as it is. It is nice to be there because we can afford to take 5 s longer to press with the prices we are getting.

Wang: I have a question probably for everybody. We know when we create adhesion between two surfaces we need a good surface, so that means we have wettability or maybe scientific term is a good surface energy. In that sense does it play the key the rule what we consider bonding or maybe we forget about this part, because we know the resin companies focus more trying to decrease the pressing time and to let the resin cure faster. For panel industry maybe they do the same thing, but I am not sure we have anybody looking at what kind of process could make better boards. Of course, before we apply the resin on the surface, surface energy is consistent. But when we press it then, inside the press conditions change. Assume surface energy would be changed. I don't know any research related to this area or not.

Frihart: Well certainly as far as wetting is concerned, one of the factors is pressure. I mean if you put enough pressure, you will tend to get spreading across the surface. We measure things under atmospheric pressure, but really do not know how does this relate to actually wetting in the press where you would have high moisture contents and high pressures, I am not sure how you would do that relationship, so I don't know the answer. One of the things, which we tend to do in most studies, is use one species of wood. I guess one question is, how much of a problem is it out there in industry when your dealing with multiple species of wood which have different penetration rates, and how big of an issue is that for industry to deal with?

Noffsinger: I try to ignore as much as I can because like I said earlier, we run over 20 different species in our products,

so if I knew all that you all know about 1 species, with 20, I probably would go home because I would be scared to think about what I am doing. I've got a question: We start off with pressing, and we start off with blending, but what about the effect that I have on the outlet temperature of my dryer on strand quality and surface quality and its effect on bonding? We have got a Canadian mill that runs at 1200-1400°F, on their outlet temperature. We have other mills that are running down lower than that. Is it better to run a lower temperature than a higher temperature, or has anybody looked at that?

Frazier: Well, I think the critical question there is what is the surface temperature on the particle? The high temperatures at the end of the dryer may not necessarily mean that the surface temperature of the wood is extreme. But coupled with that is the distribution of moisture contents, and as you know, you get a tail of that distribution that is low in the MC and then you start to get excessively high temperatures and then the negative impact is the reduction of surface energy. So it is definitely a potentially important issue and so perhaps the question is what is the distribution of moisture, how much of that low-end MC tail is getting harmed or how much of that low MC material is present which is the stuff that is going to be susceptible to thermal deactivation. And getting back to that, it is certainly important you know the surface chemistry, but I think I have no idea but based on a theoretical argument, I think that we don't see the effect unless it is a severely deactivated surface, then we know we can't bond it, like if we had bad veneer, but many times it may be deactivated but not bad enough that it prevents you from getting a good mechanical bond in the plant, and so there is no notion that there is a problem. But the real issue with surface energy of the wood is a durability issue. If you don't maintain a good high wood surface energy, down the road is where it may end up becoming more apparent in the durability in the fact that if you have a low wood surface energy, not so low that you can't wet it all and can't bond it there, but low enough that you can get a mechanical bond, and you can ship it out but still it is low enough that you don't appreciate that at that surface you still have an energy potential there, that moisture wants to go there to reduce energy and so that would be a durability issue.

Frick: I think that brings up a general point we are talking about: Are we making a higher grade of composite and do we have the right standard or code to quantify that? But really what are we testing also, and are we testing the right thing? I mean, we can design a composite that can meet whatever tests we say that composite has to pass but if we have the wrong test we are going to come up with the wrong composite?

Frazier: Yes, the whole concept of the test is so complicated and again getting back to the very important point that Chuck made earlier, the difference between adhesion strength and adhesion. I mean there is a difference there, and we can

talk about it, but you would ask appropriately, well okay, let's talk, tell me what the test is? That is not a trivial issue, I don't know the answer, what the test is, and it is very difficult.

Lee: I have a comment on the test, well actually we were doing some OSB creep testing for about 3 months and after that we wanted to see some change in the interface by doing the IB test. I had two different faculty members have different ideas. One wanted to test IB, the other one didn't want to do that because it was unknown what relationship IB had with other types of the testing. Currently many people depend on the IB test, but there are lots of different variables with IB testing. If you have a whole lot of the variabilities with the IB specimens, you cannot determine what you want to from that testing.

Frihart: Yes, that certainly goes to the point that I made before on different materials, if you are doing IB, you are doing a normal force type of test on the material. But if you are doing creep, you are doing a shear type of test. They are not really the same thing; so trying to compare one to the other without understanding the mechanics of the bonded assembly is not a good idea.

Frazier: Yeah, I just don't know what to say about testing, it is such a complicated issue, I mean we have to live with what we've got obviously, we are never going to replace IB, we can complain about it, and I know that some of us do, I do, but it all we have got, I don't know the answer. It is a very difficult question, difficult problem. Maybe down the road as we develop these statistical models and correlations maybe in the end it is not going to be a mechanical property that we test, maybe it is going to be some 4th order of the response to x-rays or something like this that we don't really have a feel for, kind of like, you know, the new theories in physics, we can't understand them but mathematically they make sense and perhaps that is going to be the way to go, but not in the near term.

Garcia: It seems to be, I think, the state currently is the dielectric cure sensing. At the moment like you said there is a lot of things to incorporate a lot of temperature effects, moisture effects, I know this, I think you guys did some work on glass transition temperature detection with the dielectric system.

Frazier: Of the wood cell wall?

Garcia: Yes, so all of that gets jumbled up into one signal. The current state is maybe we can't say what the signal actually means. We can roughly say a little bit safer there is a greater temperature, or very much higher, there is good moisture content but from a process control prospective maybe you don't need to know exactly what that signal is. Last time we pressed a good panel we got that sort of signal and signal was changing.

Frazier: I couldn't agree more, I think there is a big difference between modeling and process, and the dielectric is going to be extremely useful for in-line process control, particularly coupled with statistical analysis and I think acoustics could be as well. I think there is some huge potential for process control and I think that is great, you know, there is a lot of work to be done there.

Garcia: The acoustics stuff is quite interesting, while I was working with a bunch of ex-navy guys on this dielectric stuff and I was telling them about the acoustic things and they go "oh yeah, you ping the board" and we are all thinking about the sonar. The noise stuff that seems to hold a lot of promise but it is not exactly the quietest environment and inside a mill and so that has a lot of limitations on it.

Frazier: Yes, I have no knowledge of the hardware but certainly there must be some signal isolation issues there, but perhaps if you get the right frequency, maybe it is not a problem, but that is interesting. And the other question, back to modeling, I thought to put this in my presentation, but maybe we don't have to model resin cure at all, perhaps we just need to perfect our models of heat and mass transfer and then simply devise special apparatus for exposing our resins to these conditions and measuring what happens to the resins in an indirect fashion and then back that information into a model. I think that Rick Rammon's comment is the one that puts that whole approach into question is that if the resin is influencing the relaxation and the heat and mass transfer effects then we are not going to be able to back that information up correctly, so I think that is a good observation, a good comment that Rick made earlier, important one. Because these methods of pulling samples out of mats and analyzing them, it can be done, it is just extremely labor intensive. That is why I think the more important point is that we have to have larger, collaborative efforts, we have to get together and agree that that is the thing that we want to do. Maybe it is not the thing that we want to do presently because it seems like there is still quite a bit that we need to learn about heat and mass transfer modeling, but those are huge projects so we have to agree that that is important, get together and work together on that and remain persistent because that is not even a four year project.

Frihart: A lot of questions were raised; I know they are not going to be solved within the next couple years so that they can be discussed at the Wood Adhesives 2005, which will be November in San Diego so everybody can work out the solutions by then.

Someone in crowd: Are they going to have the fires put out by then?

Frazier: Not only will the fires be out, but there will be new products coming out of the forest from small diameter timber, right?

Winandy: Does anybody have any other questions?

Lee: Any specific idea about the benefit we can have by using the nanoscale technology to the adhesion research?

Frihart: The first problem that you run into doing nanoscale work is that with wood you have a huge number of surfaces. So what surface are you actually measuring? It works nice if you have got single crystals, monolayers, etc., where you can know what you are studying. However, if you try to apply the same thing like atomic force microscopy, normally what happens is you fall into the lumens and you can look at the pits nicely. But how do you really look at all the surfaces on the wood? So I think that maybe we can eventually work our way there but I think we really have to try and understand what is happening at the cellular level first before we go to a smaller scale. At least that is my assessment of the surface analysis issue.

Frazier: Of course there are always those carbonados. Haha. I think that we can but perhaps not for improving the properties but maybe as sensors. And maybe nano technology is a new type of sensor and not necessarily an electronic sensor. Perhaps it could be something that could store information electronically but perhaps it is something that just is when it is in a particular environment exposed to a temperature or pressure it undergoes its own morphological change, which is very well characterized. Then we could retrieve that material and essentially observe its thermal history and then deduce what the environment was. So I think nano technology may be valuable for us, not in terms of material science of our material, but in a part of this modeling and learning about what the local environment is really about, maybe. It seems feasible, question is when would it be economically feasible and of course for it to be economically feasible for you and I. Jong is different, you know, because in research you can afford to put more into sensors and so forth, so it may not be that far off actually. I hope.

Lee: Some of the literature review that I made with the resin impression cutting was that in Europe or some Japanese colleagues worked on that and they used the nano-indentation techniques for the AFM to see if there is a significant changing material properties by the wetting impregnation and mostly they did with melamine formaldehyde, but in the U.S., we use phenol, so is it worth it to work with this kind of technique to see if there is any feasibility using the low molecular weight PF resin as a reinforcement material.

Frihart: I think certainly that understanding how chemical treatment may alter the physical properties of the surface of the wood is important because that is obviously where the adhesives are interacting. If you are studying how the resins are interacting with that surface, I think that can provide some additional information. And the thing is that you have to then correlate that to the adhesive performance test you are doing. I think that there are some things that can be done and we have gotten some other ideas from that in some of the work we are doing.

Frazier: I would also add regarding the impregnation of phenolics into the cell wall, you know much of that has been done of course way back long time ago, I forget the name is it impreg or compreg, I mean much of the fundamental of understanding of low molecular weight phenolics and how those interact with the wood cell wall and how they change the anti-shrink efficiency and all of that is well established, so perhaps we have a lot of answers already in the old literature.

Winandy: Well it looks like we are at a point where the conversation is starting to slow down quite a bit. For a number of questions, we actually had 3 or 4 seconds between questions, so it must be time to stop.

It has been a very exciting day, both the morning and afternoon session. I congratulate each of you on making it through almost 1-1/2 hours without anyone taking a breath; I think that we ought to thank our two speakers for leading this wild group of people.

Press Control for Optimized Wood Composite Processing and Properties

Part 1: Pressing Variables and Sensors

Chunping Dai, Senior Scientist
Wood Composites, Forintek Canada Corporation, Vancouver, BC

Siqun Wang, Assistant Professor
Tennessee Forest Products Center, University of Tennessee, Knoxville, Tennessee

Introduction

Hot-pressing is a key operation in wood-based composite manufacture. During such an operation, mats of resinated wood fibers, particles, or flakes are consolidated under heat and pressure to create close contact and form bonds between the wood constituents. Due to limited amount of resin usage, effective bonds rely on a high degree of mat densification. Increasing mat density, on the other hand, causes negative effects such as heavier products, more wood consumption and more importantly excessive thickness swell in service when the product is subjected to high humidity conditions (Kelly 1977). The necessity and detrimental effects of mat densification suggest the importance of process optimization.

The pressing of a wood composite mat involves physical, mechanical, and chemical interactions. Once the press closes, moisture and heat transfer takes place between the hot platens and the mat. During the course of pressing, temperature and moisture content inside the mat are both spatially and temporally dependent (Humphrey and Bolton 1989). At the same time, the platens exert compressive forces onto the mat causing reduction of voids and compression deformation in wood constituents (Dai and Steiner 1993, Lang and Wolcott 1996). The mat deformation is usually not uniform across the mat thickness due to the variations of heat and moisture content from the surface to the core layers. Besides softening the mat, elevated temperature also accelerates resin polymerization, which combines with mat deformation to form permanent bonds between wood constituents. With little springback, the glue bonds also freeze the overall and layered mat deformation upon press opening. This leads to formation of the well-known vertical density profile (VDP) in pressed wood composite panels, which in turn has a significant effect on the physical and mechanical properties of the final products (Suchsland 1959; Kelly 1977; Harless and others 1987; Wolcott and others 1990; Winistorfor and others 2000, Wong and others 1999, Dai and others 2000).

Press control is important not only because pressing affects the board properties but also it is closely associated with the production costs. Regardless of product types, board dimensions always need to be controlled within specifications. In this regard, pressing plays a critical role in maintaining the final board thickness or minimizing the sanding waste. While heat is necessary to soften the mat and accelerate the resin curing, the combination of high temperature, moisture content, and time can sometimes lead to development of excessive gas pressure inside the mat and therefore cause blows upon press opening. Thus, certain press opening procedures are needed to vent the gas, which often means extra pressing time. The press opening time and the total pressing time should be minimized from the productivity standpoint. Less pressing time normally means higher productivity and lower manufacturing costs. The manufacturing costs can be further reduced by the control of the hot-pressing operation because it also represents one of the biggest energy consumption items in wood composites manufacture.

The general objective of the paper is to provide a state-of-the-art analysis of press control for wood composites. The specific objectives for Part 1 of this publication series are

- to introduce the basic concepts and variables of press control,
- to evaluate the responses of press variables during hot-pressing, and
- to review the sensing and control technologies for hot-pressing.

Basics of Press Control

Automatic Control Process

Process control is widely used in our daily life and manufacturing operations. Control of ambient temperature in a room and driving speed of a car are common examples. Figure 1 identifies the elements of a typical process control

system: process, measurement, controller, and control element (Johnson 2000). In general, a process can consist of a complex assembly of phenomena which relate to some manufacturing sequence. The process may involve many variables. Therefore one must define the control variable (c) first. To control a variable in a process, information about the variable must be gathered usually through measurements using a sensor or sensors. The measurements are usually in the form of electrical signals (e.g., 4-20 mA) which can then be further converted to real values (b) meaningful to the controlled variable. The measured values are compared with the reference points (r). If an error is detected between the real value and the reference value, the controller will send a signal (p) to the control element for necessary adjustments to the process (u) until the controlled variable reaches the reference value. Since the variable is controlled automatically in real time, such a control is often referred to as automatic control.

The automatic control process is applicable to control some hot-pressing variables such as platen temperature, pressure, and position. Here, the pressing process involves changes in thickness and pressure of resinated wood furnish mats. The mat pressure and position are measured using pressure probes and LVDT sensors, respectively. The measurement and the error detection along with the controller are all enclosed in a programmable logic controller (PLC) in which input (I) and output (O) signals are linked from the sensors and to the control element—servo valve (Fig. 1). The hydraulic valve can regulate the pressure and position based on the output signals from the PLC.

Program Control and Press Control Variables

When it comes to control hot-pressing, not all the variables can be controlled automatically or in real time. Probably due to lack of effective monitoring sensors, most of the pressing variables are currently controlled by predetermined programs or often known as pressing schedules. The pressing schedules control such important variables as mat core temperature and gas pressure, vertical density profile, degree of resin cure, and minimum pressing time. The key to the program control of hot-pressing is solid understanding and accurate modeling of the responses of these control variables during hot-pressing and their relationships with all other variables before and after pressing. The pre-press variables include species, furnish types and dimensions, moisture content, resin content, mat density, and mat structure. The post-press variables are product types and dimensions as well as board properties. Variations of these variables would require adjustments of the pressing schedules to achieve maximum product performance and minimum production costs.

Responses of Press Variables During Hot-Pressing

Significant progress has been made in understanding hot-pressing processes over the past 15 years both through modeling and experimentation. Bolton and Humphrey (1988) were among the first to provide a comprehensive investigation of the heat and mass transfer process in hot-pressing. An excellent review on hot-pressing was first reported and then followed by the development of a model for heat and mass transfer (Humphrey and Bolton 1989). Their stimulating work identified primary physical mechanisms of the hot-pressing process and at the same time revealed the complexity and interactive nature of the subject. Three main aspects of hot-pressing: heat and mass transfer, mat consolidation, and resin curing will now be discussed with respect to press control.

Heat and Mass Transfer

The variations of mat internal environmental conditions have been extensively documented in many studies both through experimentation (Maku 1954, Strickler 1959, Kamke and Casey 1988) and modeling (Humphrey and Bolton 1989, Zombori and others 2003, Dai and Yu, unpublished data). Figure 2 shows typical variations of mat core temperature and core gas pressure for a 11-mm-thick, 0.9- by 0.9-m (7/16-in.-thick, 3- by 3-ft) laboratory oriented strandboard (OSB) panel. Due to the nature of the heat and mass transfer process, the core temperature change is highly nonlinear. Particularly, the core temperature does not experience significant changes until 40 s after pressing. Then, it quickly rises probably due to convective flow and condensation of steam generated from moisture evaporation in the surface layers. As the core temperature rises, the steam accumulates and gas pressure starts to build up. The increased core gas pressure forces the trapped steam to escape from the edges, which leads to energy loss. As a result, the core temperature starts to level off and the core gas pressure usually reaches a maximum before it starts to drop. At the end of pressing, the press starts to open allowing the internal gas to release its pressure by flowing from the core to the surface and to the atmosphere, which also leads to a drop in the core temperature.

The fore-mentioned core temperature and gas pressure variations are typical of small panels. In the cases of commercial production, both the core temperature and the gas pressure usually experience some noticeable changes. First, the use of a screen caul plate can slow down the heat transfer from the platen to the mat surface, leading to slower core temperature rise (Fig. 3). Second, larger panel size reduces the energy loss from the edges, resulting in higher maximum core temperature and much higher core gas pressure. Particularly, the core gas pressure tends to always increase with pressing time again due to the reduced edge

effect. Because of this, a prolonged degas time is usually needed to allow for gas pressure release before press opening. Finally, the increased panel size can magnify the effects of furnish moisture content, furnish geometry, and mat density on the core temperature and gas pressure.

Mat Consolidation

Nonlinear Compression Stress–Strain Relationship

A simple compression test of a composite mat can reveal a highly nonlinear stress–strain curve, which is characterized by an extended low-stress plateau at the beginning and steep stress rise towards the end. Such a relationship is similar to pure transverse compression behavior of solid wood except that solid wood clearly exhibits a linear elastic behavior at the start. Figure 4 compares the compression stress–strain relationships between solid wood (or stack of strands) and a randomly formed strand mat. The similarity in both compression trends is probably due to the fact that wood substances are under compression in both cases whereas the difference can probably be attributed to random mat structure. This phenomenon was first identified by Suchsland (1959) and then later modeled by Dai and Steiner (1993). The model was based on the Poisson distribution of random strand overlaps (Dai and Steiner 1994a, b) and a modified Hooke's law for transverse wood compression (Wolcott and others 1994). The strand overlap variation results in uneven stress distribution; only higher density areas contribute to load bearing at the beginning and lower density areas do not bear significant load until larger deformation occurs. The nonlinear compression behavior of mats was later reported with presentation of similar models by Lang and Wolcott (1996) and Lenth and Kamke (1996).

Viscoelasticity and Elastoplasticity

Since wood is a viscoelastic material (Wolcott and others 1990), mats of wood elements exhibit qualitatively similar but quantitatively different time-dependent behavior, namely strain creep under constant load and stress relaxation under fixed deformation. The difference is also attributed to the random mat structural formation. The knowledge of mat structure allows for the derivation of viscoelasticity relationships between mats and wood elements (Dai 2001).

The combination of high pressure and heat also results in both permanent mat deformation and springback upon and after pressing. Such mat behavior can be best described by the concept of elastoplasticity (Dai and others 2000). Elastoplasticity states that the mat compression stress–strain curves go through different paths during loading and unloading, and the mat deformation only recovers to a limited extent upon load removal. This implies that the

mat properties can be manipulated by both pressing closing and opening.

Mat Pressure and Thickness Relationship

The hot-pressing process is mechanically controlled by mat thickness and pressure through controlling the total deformation and stresses equally applied to each layer. At any given time in pressing, the overall mat deformation is controlled either by position or pressure. Thus, one is the resultant of the other.

Figure 5 is a predicted relationship between overall mat pressure and thickness for OSB hot-pressing (Dai and others 2000). During the first stage of press closing, the press platens are usually controlled by position. Mat pressure increases as mat thickness decreases. The variation of mat pressure and thickness is governed by the mat stress–strain relationships, which vary from surface layers to core layers due to the variations of temperature and moisture content. During the second stage, the mat reaches maximum pressure and the press is switched to pressure control. Mat thickness is determined by the layer stress–strain relationships and creep properties at the maximum pressure. Each layer behaves differently again due to the difference in temperature and moisture content. During the third stage, the mat reaches the target thickness and maintains it for resin curing. In the same time, mat pressure sharply drops and then gradually levels off. The decrease in mat pressure is a coupled response of mat softening (decrease of compression modulus) and viscoelastic stress relaxation (Fig. 5). During the last stage of pressing, the press is switched back to pressure control during which the mat pressure linearly drops to zero. This allows the internal gas pressure to release before the press opens. The removal of mat pressure also leads to a certain degree of mat thickness springback. The springback is characteristic of elastoplasticity which is affected by degree of resin cure, mat densification, temperature, and moisture content. The springback varies from surface layers to core layers and always results in the out-of-press panel thickness being greater than the press opening (Wang and Winistorfer 2002).

Vertical Density Profile

At any given time, the stresses applied to each layer are the same and equal the mat pressure. While the total mat deformation is controlled by the press opening, the deformation in each layer is distributed according to its viscoelastic and elastoplastic properties, which are functions of temperature, moisture content, and degree of resin cure. Figure 6 shows predicted density profiles at various stages of pressing (Dai and others 2000). Before pressing, the mat density is assumed to be uniform in all layers. During press closing (Fig. 5), the layer deformations are calculated based on their stress–strain relationships. The layer and overall mat densities in this stage incur the biggest increases. Particularly, the surface densities increase at

remarkably higher rates than core densities because of their lower compression modulus due to higher temperature. The density differences are much less noticeable in surface layers. This stems from the fact that mat softening due to high temperature in the surface layers adjacent to the heated platens is masked by the hardening effect of rapid moisture loss and thus softening effect of increased moisture content in the subsurface layers. Such a dry-out effect becomes more pronounced as the mat continues to be consolidated. By the time the mat reaches the target thickness, a slightly lower density is formed in the outer layer, leaving the density to peak in the inner surface layers. At this point in pressing, most of the density profile is formed. In other words, VDP is substantially formed during press closing.

After the mat reaches the target thickness, VDP seems to experience only minor changes (Fig. 6). As mentioned earlier, mat pressure decreases rapidly during the early stage of the period of holding target thickness (Fig. 5). The elastoplastic nature of mat deformation implies that a certain degree of springback can occur in the low temperature core layers, leading to further deformation in the softer surface layers. Such a give-and-take phenomenon of mat deformation may or may not lead to density changes because of the concurrent mass movement due to moisture flow between layers. As shown in Figure 6, neither the core density nor the surface density changes appear to be noticeable. This is because the core layers experience significant increases in moisture content, while the opposite is true in the surface layers at this time of pressing. The opposite mass movement seems to counter out the mat deformation exchanges, leaving the layered density more or less unchanged in this case (Wang and Winistorfer 2000).

In Figure 7, the mat exhibits some immediate (and delayed) springback upon press opening. It is believed that springback occurs mostly on the surface layers immediately adjacent to the platens due to so-called resin pre-cure (resin is exposed to premature heating and dry-out before the surface layers reach their maximum densities). In fact, springback due to pre-cure can lead to significantly lower density surfaces. In some cases, the surface density is even lower than the core.

Resin Curing and Bond Strength Development

One of the fundamental objectives of hot-pressing is to accelerate resin curing and develop bond strength between wood elements. Pressing operations can be best controlled if the conditions for optimum curing and bonding are known. Although the chemistry of resin curing for pure adhesives is well documented (Pizzi 1994), the curing and bond strength development of resin-wood mix seems much less understood probably due to several general reasons.

First, the resin amounts for most of the wood composite products are very low (usually much less than 15% by oven-dry weight of wood) and yet the resin distribution and penetration are not well defined. The amount of resin added to OSB furnish is low and is typically about 2% (wt.) resin solids based on oven-dry weight of wood. These factors can significantly affect the accuracy and variability of resin analyses. Second, the common chemical analytical methods can no longer be applied to analyze resin curing when resin is mixed with wood. Third, the physical, chemical, and mechanical properties of wood can change dramatically when wood is subjected to compression stresses and elevated temperatures. These changes, which should have a significant effect on resin curing and bond strength development, are not well defined. Finally, the interactions between resin and wood also need to be taken into account when resin is analyzed. Nevertheless, several studies have been performed to understand the curing mechanisms (Troughton and Chow 1968, Chow and Steiner 1969, Humphrey 1997, Geimer and Christiansen 1996). Some of the details were discussed in the previous papers in this proceedings by Frazier and Frihart.

It is generally understood that resins accelerate curing under elevated temperature and curing needs time to complete. Therefore, most of the pressing schedules are developed to achieve a certain core temperature and maintain the temperature for a certain period of time. Table 1 lists curing conditions for some typical composite products. Besides product types, resin types and board thickness also have defining effects on pressing schedules. For example, methylene diphenyl diisocyanate (MDI) resins seem to accelerate curing at a lower temperature than phenol formaldehyde (PF) resins. Thicker boards create a greater heat-sink effect after pressing and therefore usually require lower core temperatures.

Table 1—Curing conditions for some typical composite products^a

Product type	Thickness (in.) ^b	Resin type	Target core temp (°C)	Holding time (s)
Plywood	3/8	PF	110–115	
LVL	1.5	PF	100–105	
OSB	7/16	PF	>100 130	60–90 10
OSB	7/16	MDI	100–110	30
MDF/PB	3/4	UF	95	100

^aLVL, laminated veneer lumber; OSB, oriented strand board; MDF, medium-density fiberboard; PB, particleboard; PF, phenol formaldehyde; MDI, methylene diphenyl diisocyanate; UF, urea formaldehyde.

^b1 in. = 25.4 mm.

Another important factor concerning resin curing is that the curing should normally take place after platens reach the target position. As an example, many composite boards experience low surface density due to pre-curing, which occurs before the surface layers are consolidated. More precisely, resin curing in each layer should take place after the layer density is formed.

Figure 7 depicts a pressing schedule for OSB. During the press closing, platens come to the target position to form the desired board thickness and vertical density profile. The governing variables in this stage include maximum allowable mat pressure and closing rate. During the second stage, the mat thickness is maintained to allow the heat to transfer into the core and cure the resin. Core temperature and holding time need to be controlled to achieve a certain degree of resin curing before the press starts to open. Mat pressure must gradually drop during a certain period of time to allow internal gas pressure to release to avoid blows.

Challenges and Knowledge Gaps

Hot-pressing of a resinated wood furnish mat presents a very complex subject. Most pressing variables except platen pressure, position, and temperature are program controlled and subjected to real time process variations. Program control requires quantitative understandings of responses of pressing variables. Despite the efforts by many researchers, mechanisms of hot-pressing have yet to be fully understood. The data on physical and mechanical properties of mats during pressing is particularly lacking.

Sensor and Monitoring Technologies

The current sensing and monitoring technologies concerning press control may be classified into three categories: automatic control sensors, on-line post-press sensors, and off-line/laboratory sensors.

Automatic Control Sensors

Automatic control sensors are usually an integral part of press equipment. Standard pressure and position sensors can be used to monitor and control platen (mat) pressures and openings. Thermocouples are also available to monitor and control platen temperatures.

On-line Post-Press Sensors

Commercial systems are available to measure on-line board thickness using LVDT and detect blisters in pressed boards using ultrasonic methods. Figure 8 also shows an X-ray system that has been developed and used for on-line monitoring of vertical density profile of pressed boards (Dueholm 1996). The technology is of significant

importance in improving press control, although the measurements are carried out after pressing with a speed of 20 to 40 s per scan.

Off-line/Laboratory Sensors

Several sensing technologies have been investigated or developed to monitor in-situ behavior of wood composites during pressing. A system called PressMAN has been developed by Alberta Research Council (Edmonton, Alberta, Canada) and widely used for monitoring and controlling laboratory presses (Wellwood and others 1999). It uses special probes to measure mat gas pressure and temperature (Fig. 9). The system has also been used for trouble shooting in many commercial productions.

Winistorfer and others (2000) developed a unique laboratory radiation system to monitor in-situ density development during pressing. This technique is a step forward compared with the traditional post-press X-ray methods, and the data provide valuable insight into vertical density profiles at various stage of pressing (Wang and Winistorfer 2000).

Several researchers also used dielectric or ultrasonic sensors to monitor resin curing in laboratories (Wolcott and Rials 1995, Magill and Sauter 1999, Chen and Beall 2000, Wang and Winistorfer 2003). Although promising results were reported, none of the methods seemed to gain wide use.

One other useful method is that of Humphrey (1999). The automatic bond evaluation system (ABES) unit essentially consists of a mini-press and a lap-shear testing device. The bonding strength of two overlapped strands can be pressed under controlled temperature and pulled at any given time immediately after pressing. Such a system was used by researchers to evaluate resin performance.

Knowledge and Technology Gaps

Most sensors are limited to laboratory or off-line applications. It is not clear whether and how on-line sensors can be developed due to the complexity of hot-pressing. Methods for monitoring resin curing in composite boards during pressing are particularly lacking.

Summary

Hot-pressing processes are controlled by two methods: automatic control and program control. While the platen pressure, opening, and temperature are automatically controlled, mat internal environmental conditions, vertical density profile, and curing are controlled by predefined pressing schedules, which are subjected to process variations. Optimum control requires more quantitative understanding of variable responses during hot-pressing.

More accurate sensors are needed for lab experimentation and on-line monitoring-control.

Literature Cited

- Bolton, A.J.; Humphrey, P.E.** 1988. The hot-pressing of dry-formed wood-based composites. Pt I. A review of the literature, identifying the primary physical process and the nature of their interaction. *Holzforshung*. 42(6): 403–406.
- Chen, L.; Beall, F.C.** 2000. Monitoring bond strength development in particleboard during pressing using acousto-ultrasonics. *Wood and Fiber Science*. 32(4): 466–477.
- Chow, S.Z.; Steiner, P.R.** 1969. A kinetic study of the polymerization of pheno-formaldehyde resin in the presence of cellulose materials. *Wood Science*. 1(4): 215–221.
- Dai, C.** 2001. Viscoelastic behaviour of wood composite mats during consolidation. *Wood and Fiber Science*. 33(3): 353–363.
- Dai, C.; Steiner, P.R.** 1993. Compression behaviour of randomly-formed wood flake mats. *Wood and Fiber Science*. 25(4): 349–358.
- Dai, C.; Steiner, P.R.** 1994a. Spatial structure of wood composites in relation to processing and performance characteristics. Pt. II. Modelling and simulation of a randomly-formed flake layer network. *Wood Science and Technology*. 28(2): 135–146.
- Dai, C.; Steiner, P.R.** 1994b. Spatial structure of wood composites in relation to processing and performance characteristics. Pt. III. Modelling and simulation of a random multi-layered flake mat. *Wood Science and Technology*. 28(3): 229–239.
- Dai, C.; Yu, C.; Hubert, P.** 2000. Modeling vertical density in wood composites during hot pressing. In: *Proceedings, 5th Pacific Rim bio-based composites symposium*; 2000 December 10–13; Canberra Australia.
- Dueholm, S.** 1996. Determination of density profiles of wood-based panels: from traditional off-line laboratory techniques to continuous-in-line real time monitoring. In: Maloney, T.M., ed. *Proceedings, 30th international particleboard/composites materials symposium*; 1996 April 15–18; Washington State University, Pullman. WA: 45–57.
- Geimer, R.L.; Christiansen, A.W.** 1996. Critical variables in the rapid cure and bonding of phenolic resins. *Forest Products Journal*. 46: 67–72.
- Harless, P.E.; Wagner, F.G.; Short, P.H. [and others].** 1987. A model to predict the density profile of particleboard. *Wood and Fiber Science* 19(1): 81–92.
- Humphrey, P.E.** 1999. The bonding speed of adhesives: an automatic evaluation system. In: *Proceedings, 33d international particleboard/composites materials symposium*; 1999 April 13–15; Washington State University, Pullman. WA: 139–146.
- Humphrey, P.E.** 1997. Thermoplastic characteristics of partially cured thermosetting-to-wood bonds. In: *Proceedings, 3d Pacific Rim bio-based composites symposium*, Kyoto, Japan. P 366–373.
- Humphrey, P.E.; Bolton, A.J.** 1989. The hot pressing of dry-formed wood-based composites. Pt. II A simulation model for heat and moisture transfer, and typical results. *Holzforshung*. 43(3): 199–206.
- Johnson, C.D.** 2000. *Process control instrumentation technology*. 6th ed. Upper Saddle River, NJ: Prentice-Hall, Inc. 678 p.
- Kamke, F.A.; Casey, L.J.** 1988. Fundamental of flake-board manufacture: Internal mat conditions. *Forest Products Journal*. 38(6): 38–44.
- Kelly, M.** 1977. Critical review of relationships between processing parameters and physical properties of particleboard. Gen. Tech. Rep. FPL–10. Madison, WI: U.S. Department of Agriculture, Forest Service, Forest Products Laboratory.
- Lang, E.M.; Wolcott, M.P.** 1996. A model for viscoelastic consolidation of wood strand mats: Pt. II: Static stress-stain behavior of the mat. *Wood and Fiber Science*. 28(3): 369–379.
- Lenth, C.A.; Kamke, F.A.** 1996. Investigations of flake-board mat consolidation, Pt. II. Modelling mat consolidation using theories of cellular materials. *Wood and Fiber Science*. 28(3): 309–319.
- Magill, R.; Sauter, S.L.** 1999. In-situ impedance sensors provide real-time monitoring and intelligent control for the curing of engineered wood products. In: *Proceedings, 33d international particleboard/composites materials symposium*; 1999 April 13–15; Washington State Univ., Pullman. WA: 181.
- Maku, T.** 1954. Studies on the heat conduction in wood. *Wood Research (Kyoto)* 13: 1–80.
- Pizzi, A.** 1994. *Advanced wood adhesives technology*. New York, NY: Marcel Dekker Inc 289 p.
- Strickler, M.D.** 1959. The effect of press cycles and moisture content on properties of Douglas fir flakeboard. *Forest Products Journal*. 9(7): 203–207.
- Suchsland, O.** 1959. An analysis of the particle board process. *Michigan Quarterly Bulletin*. 42(2): 350–372.

Troughton, G.E.; Chow, S. 1968. Evidence for covalent bonding between melamine formaldehyde glue and wood. Pt. 1—Bond degradation. *Journal of the Institute of Wood Science*. 21(9): 29–34.

Wang, S.; Winistorfer, P.M. 2000. Fundamentals of vertical density profile formation in wood composites. Pt. 2. Methodology of vertical density formation under dynamic condition. *Wood and Fiber Science* 32(2): 220–238.

Wang, S.; Winistorfer, P.M. 2002. Monitoring *in-situ* density change for in-process measurement and control of hot pressing. *Forest Products Journal* .52(7/8):77–82.

Wang, S.; Winistorfer, P.M. 2003. Monitoring resin cure during particleboard manufacture using a dielectric system. *Wood and Fiber Science*. 37(4):532–539.

Wellwood, R.; Kirincic, S.; Mallas, B. 1999. Techniques for measuring internal panel environments in the laboratory and plant. In: *Proceedings, 33d international particleboard/composites materials symposium*; 1999 April 13–15; Washington State University, Pullman. WA.

Winistorfer, P.M.; Moschler, W.W.; Wang, S. [and others]. 2000. Fundamentals of vertical density profile formation in wood composites. Pt. 1. In-situ density measurement of the consolidation process. *Wood and Fiber Science*. 32(2): 209–219.

Wolcott, M.P.; Rials, T.G. 1995. In-situ cure monitoring of isocyanate adhesives using microdielectric analysis. *Forest Products Journal*. 45(2):72–77.

Wolcott, M.P.; Kamke, F.A.; Dillard, D.A. 1990. Fundamentals of flakeboard manufacture: viscoelastic behavior of the wood component. *Wood and Fiber Science*. 22(4): 345–361.

Wolcott, M.P.; Kamke, F.A.; Dillard, D.A. 1994. Fundamental aspect of wood deformation pertaining to manufacture of wood-based composites. *Wood and Fiber Science*. 26(4): 496–511.

Wong, E.D.; Zhang, M.; Wang, Q.; Kawai, S. 1999. Formation of the density profile and its effects on the properties of particleboard. *Wood Science and Technology*. 33: 327–340.

Zombori, G.B.; Kamke, F.A.; Wastson, L.T. 2003. Simulation of the internal conditions during the hot-pressing process. *Wood and Fiber Science*. 35(1): 2–23.

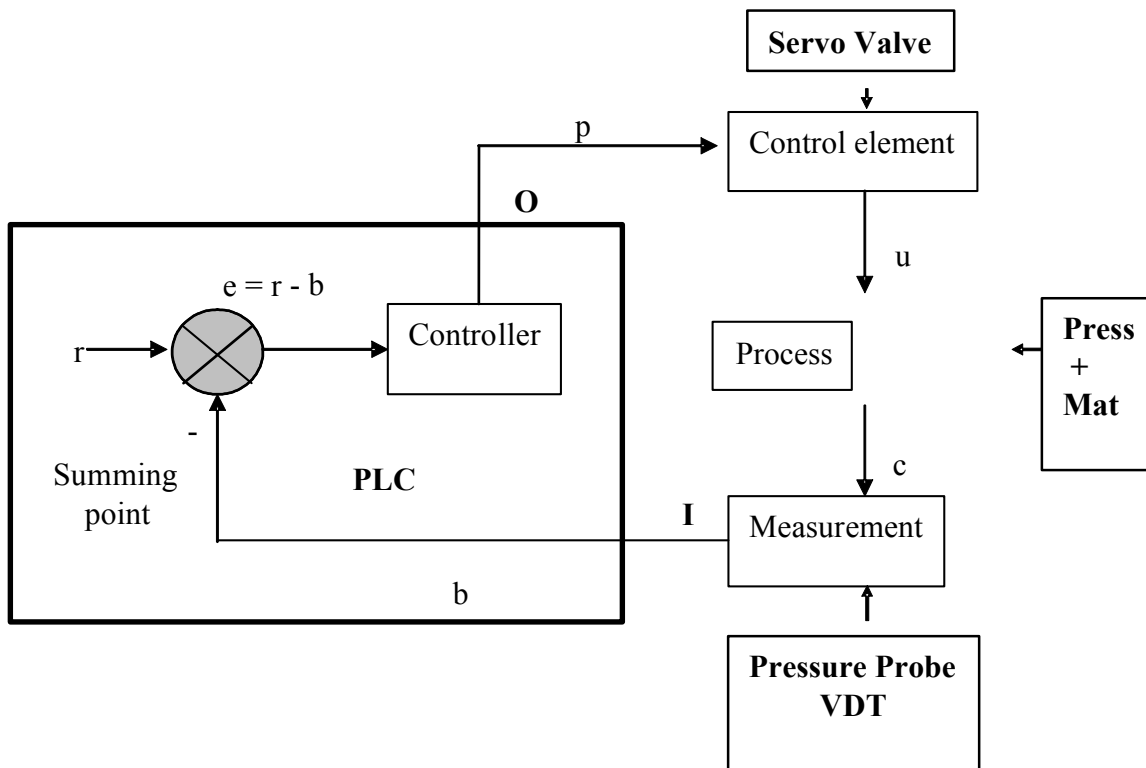

Figure 1—Typical process control system.

PressMAN Press Parameters

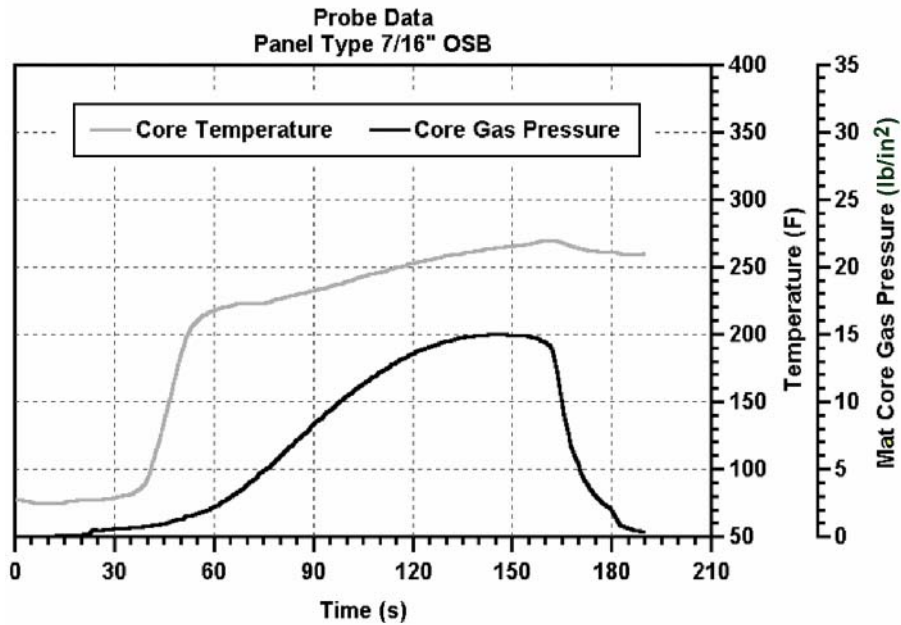

Figure 2—Mat core temperature and gas pressure for a 11-mm-thick, 0.9- by 0.9-m (7/16-in.-thick, 3- by 3-ft) laboratory oriented strandboard (OSB) panel (1 lb/in² = 6.9 kPa; °F = 1.8(°C) + 32).

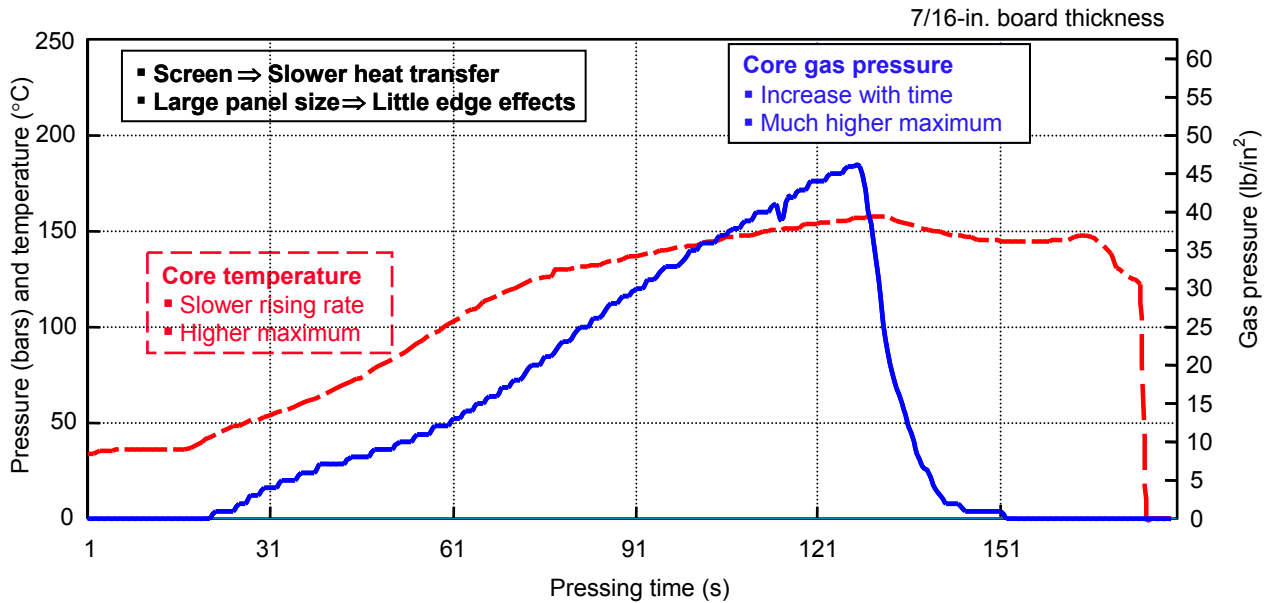

Figure 3—Effect of screen caul plate on heat and mass transfer in a large panel (1 lb/in² = 6.9 kPa).

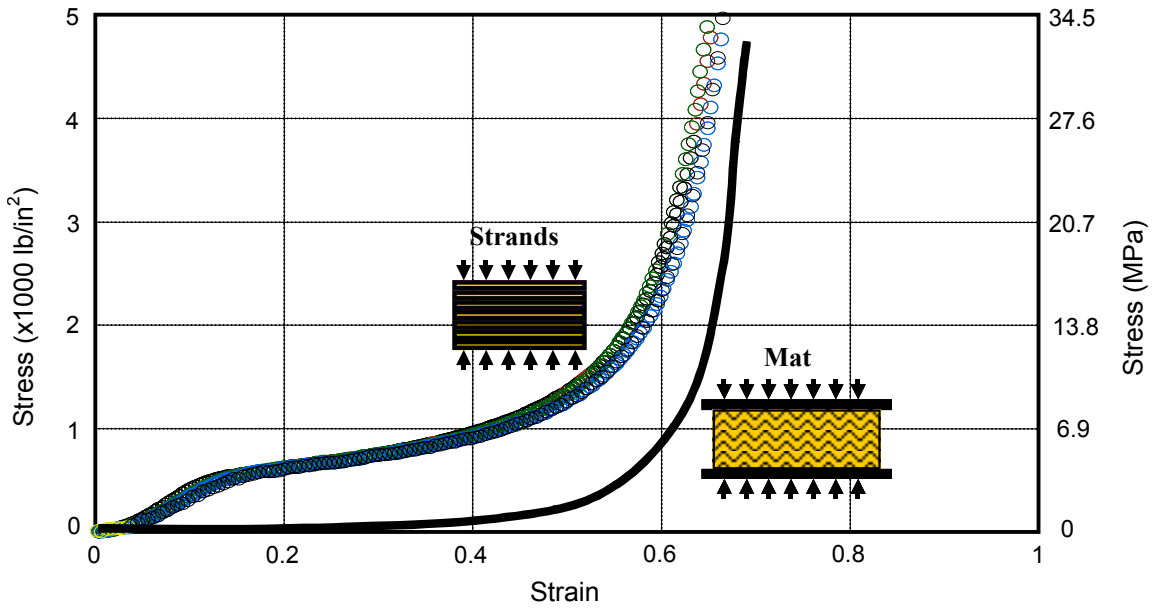

Figure 4—Comparison of compression stress–strain relationships between solid wood (or stack of strands) and a randomly formed strand mat.

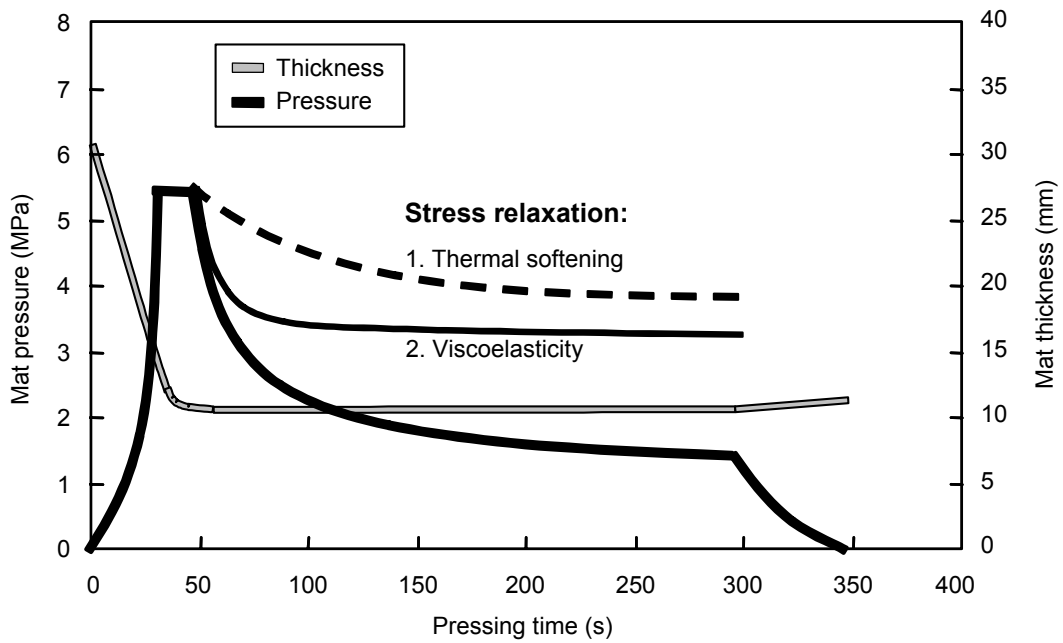

Figure 5—Predicted relationship between mat pressure and mat thickness.

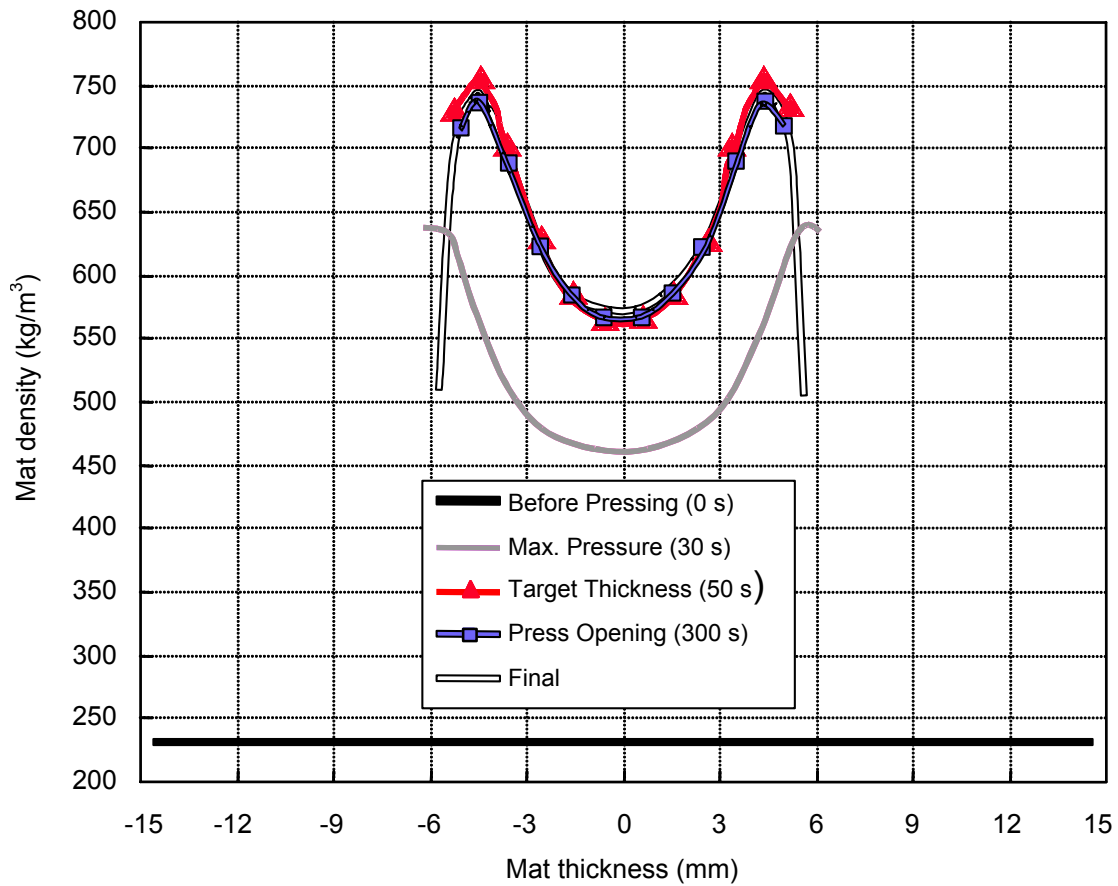

Figure 6—Predicted density profiles at various stages of pressing.

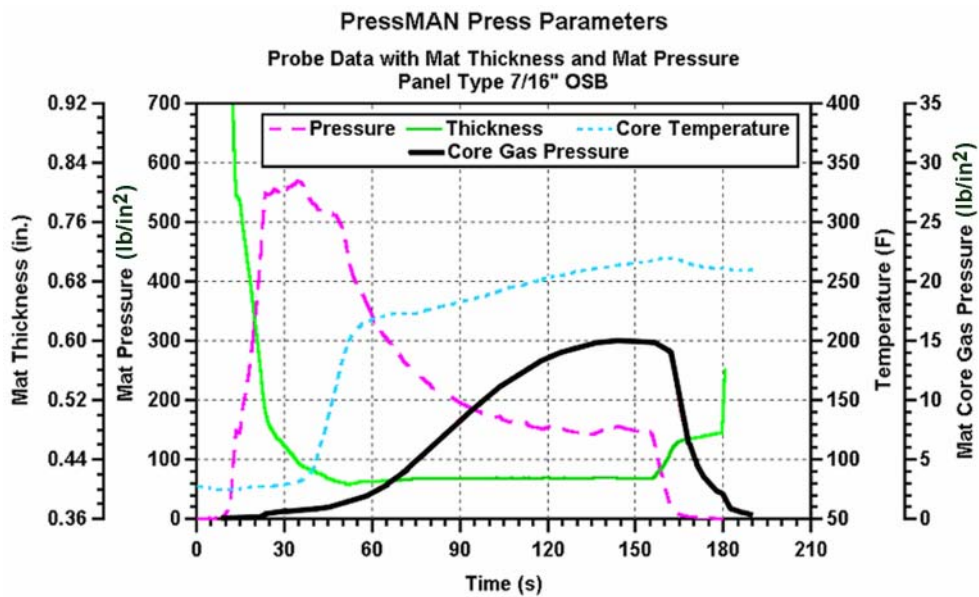

Figure 7—Typical pressing schedule for oriented strandboard (OSB)
 (1 lb/in² = 6.9 kPa; °F = 1.8(°C) + 32; 1 in. = 25.4 mm).

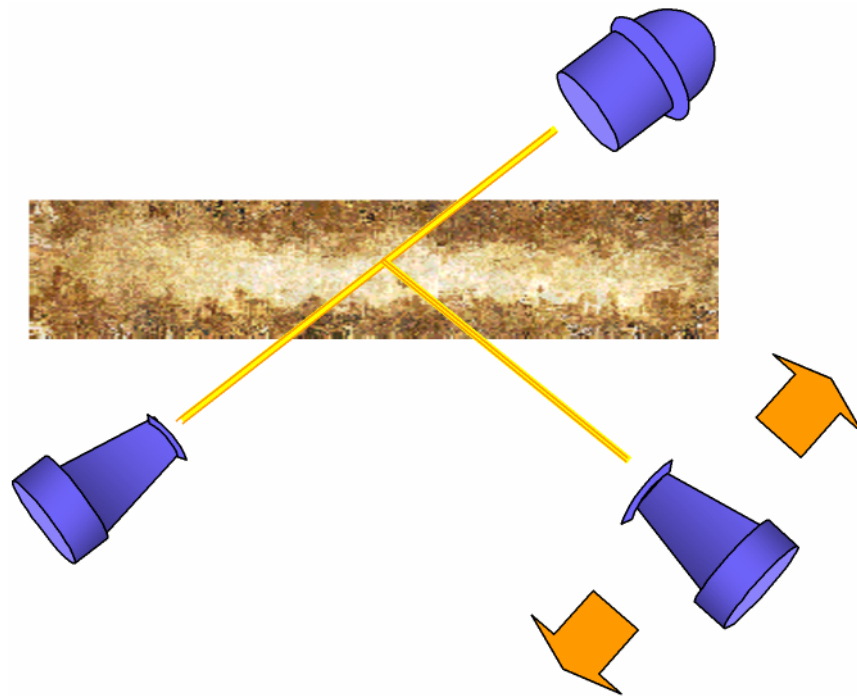

Figure 8—X-ray monitoring system for on-line measurement of vertical density profile.



PressMAN Probes

PressMAN ContiProbe
Courtesy of ARC.



PressMAN Probes

Figure 9—PressMAN probes (Alberta Research Council, Edmonton, Alberta, Canada).

Press Control for Optimized Wood Composite Processing and Properties

Part 2: Properties and Press Control Strategies

Siqun Wang, Assistant Professor

Tennessee Forest Products Center, University of Tennessee, Knoxville, Tennessee

Chunping Dai, Senior Scientist

Wood Composites, Forintek Canada Corporation, Vancouver, BC

Introduction

The hot-press is a key piece of equipment in composite panel production. It determines the performance of products and the processing efficiency of the whole production line. There is a philosophy that says, in simple terms, when the press closes, 90% of the cost of production has been incurred, and 96% of the oriented strandboard (OSB) panels must be good panels because quality cannot be added in the warehouse (Lin 1996). However, the press cannot be regarded as a quality control cure-all. Any problem that already existed before pressing, including furnish preparation, resin blending, and mat formation, may be only partially compensated for in the pressing operations.

The previous paper in this series discussed the importance and complexity of hot-pressing in wood composite manufacturing, material behavior during hot pressing and sensing, and control of hot-pressing process. The purpose of this paper is to discuss the optimized panel properties and press control strategies.

Manipulated Board Properties During Pressing Process

Manipulating panel properties can be done through the whole panel process including furnish preparation, drying, blending, forming, pressing, and post-treatment. For a specific formed mat, manipulating panel properties has to be done during the pressing. Correct pressing parameters can result in an improved vertical density profile and consequently alter product performance.

There are several ways to control and change the vertical density profile of panels to alter product performance. Closing rate, mat MC, and distribution, steam-injection pressing, pressing temperature, wood species, and species distribution have been effectively used by the board industry and by laboratory researchers to manipulate the vertical density profile. Because of the strong relationship between panel

density, compaction characteristics, and subsequent panel properties such as bending strength, dimensional stability, surface quality, edge machining, and fastener performance, understanding the nature of the density gradient and through-the-thickness properties in wood composite panels is of critical importance to manufacturers and researchers.

Basic Property Requirements

Based on furnish geometry and preparation methods, wood-based particulate composites can be divided into three categories: fiber-based products including medium- and high-density fiberboard; particle-based products including chipboard, particleboard, and flakeboard; and strand-based products including OSB, rim board, and laminated strand lumber. The clear line of demarcation among the three categories has been blurred in the past decade. To compete with thin fiberboard, thin particleboard is made of very fine particles that are similar to wood fibers.

Medium- and high-density fiberboard thickness ranges between 1.5 and 80 mm. Table 1 shows the individual qualities for fiberboards available in the market. Medium- and high-density fiberboard are widely used in the manufacture of furniture, kitchen cabinets, door parts, moldings, millwork, and laminated flooring. Each type of panel is manufactured in a variety of sizes, average densities, and density profile to provide the end product with the desired properties.

Through-the-Thickness Properties

Vertical Density Profile

Previous researchers have examined various aspects of through-the-thickness properties of wood composite panels. Perhaps the most commonly obtained through-the-thickness panel property is the density, or the vertical density profile (VDP) (Strickler 1959) The VDP is typically reflected by the presence of high-density face layers and low-density core layers within the panel.

Table 1—Properties and market for fiberboard^a

Board type	Properties	Field of application
Board thickness 2-4 mm	<ul style="list-style-type: none"> • Smooth and paintable on one side • Surface layer density more than 1,000 kg/m³ on the painted side 	Drawer bottoms, rear panels of furniture, door surfaces formed or smooth, rear panels of posters
	<ul style="list-style-type: none"> • Smooth and paintable on both side • Thickness swelling below 20% • Good internal bond • Thickness tolerance + 0.1 mm 	Building cars and RV, interior trim of railway compartments, picture frames, packing materials, printed circuit board, surface layers for OSB, underlay for, e.g., drills, formwork
Board thickness 4-8 mm	<ul style="list-style-type: none"> • Light MDF with densities below 650 g/m³ 	Wall facing, furniture
	<ul style="list-style-type: none"> • MDF with densities from 650 to 850 g/m³ 	Partition walls, furniture, conversion of attics
	<ul style="list-style-type: none"> • HDF with densities from 850 to 1,050 kg/m³ • Quality depending on 24-h thickness swelling 	Flooring board with lamination
Board thickness 8-80 mm	<ul style="list-style-type: none"> • high surface and edge-machining • Uniform density throughout the panel 	Kitchen cabinets, molding, furniture, picture framing and photo mounting, window components
	<ul style="list-style-type: none"> • Good surface properties • high bending properties 	Furniture, kitchen cabinets, door core, counter tops

^aPart of information from the Dieffenbacher's brochure; MDF, medium-density fiberboard; HDF, high-density fiberboard; OSB, oriented strandboard.

When the density distribution through the panel thickness is plotted on an x–y axis, the resulting plot is frequently referred to as the “shape” of the density profile. Shape is a qualitative descriptive term used to refer to the relationship between face layer density, core layer density, and panel thickness. The density profile is usually symmetrical in shape when viewed about a midpoint that is the centerline representing total panel thickness. Historically, the density profile has been measured using a gravimetric approach, but in the last decade, nondestructive nuclear and x-ray instruments have become the standard means of analysis (Wang 1986; Haag 1992; Quintek Measurement Systems, Inc. 1999). A drill resistance technique and an air-coupled acoustic emission sensor technique were also used to measure density profiles in wood-based products (Winistorfer and others 1995; Lemaster and Green 1992). Europe has developed an on-line system for full-scale production monitoring of the density profile immediately after pressing (Dueholm 1996).

The shape of a density profile is commonly described as the letter M or U (Fig. 1). Comparing and modeling the VDP is a necessary step to investigate the relationship between the

VDP and other panel properties. There are two basic methods to analyze the VDP quantitatively. The first method is using some characteristics to describe the shape of VDP. Wang (1987) calculated the following characteristic data of oriented strand composite plywood: maximum density in the surface layers and its relative positions, minimum density, and the difference between maximum and minimum densities. Schulte and Frühwald (1996a,b) calculated the following characteristic data of medium-density fiberboard (MDF) and particleboard: mean density, minimum density, maximum density in the surface layers, their relative positions, the average density in a window of ±1 mm around the minimum density, the slope from the maxima to the inner part, and the angle between the outer maxima and the first inner maxima of the profile. Winistorfer and others (1996) calculated mean density, the average density in a window of ±1 mm around the minimum density, and the average density in a window of ±1 mm around the maximum density to describe the VDP of commercial MDF and particleboard.

Another method is to describe the VDP quantitatively by fitting a mathematical expression to the relationship of density and panel thickness (Winistorfer and others 1996). Xu

and Winistorfer (1996a) fitted an equation to VDP data using Fourier analysis. This was achieved first by performing the Fourier transform of the density profile data and then by synthesizing the mathematical equation in the form of cosines based on the transform output. Two sets of density profile data were used in this analysis, and a good fit of the VDP was obtained for each case. This technique and the mathematical expression of VDP are recommended for studies investigating the VDP–property relationship.

The actual density profiles are not smooth lines, especially in the case of OSB. Recent studies on the commercial OSB (Gu and others 2003; Wang and others 2003) showed that VDP varied from one OSB manufacture to another, especially for the thicker aspen made panels (Fig. 2).

Other Physical Properties

Xu and Winistorfer (1995a,b) developed two techniques to determine thickness swell (TS) characteristics of individual layers within a wood composite panel. They developed an intact specimen algorithm to determine TS distribution across the board thickness based on vertical density distribution changes measured before and after the water exposure treatment. The procedure uses a linear relationship between adjacent density data points in the VDP and assumes a constant weight of an individual horizontal layer after swell. An algorithm was developed to make the estimation. A thin, horizontal layer within a sample has a known volume and mass from radiation measurement. After water exposure, the same known volume expands some unknown amount. As the thin layer expands due to swelling stresses, the mass of the original volume decreases as material moves out of the original volume (expands) due to swelling pressures. For TS, the algorithm uses the original mass of the known layer thickness and solves for the new unknown volume of the expanded layer. For water absorption, the algorithm uses radiation absorption principles involving two elements to separate the wood mass from the water mass. The second technique is a layer slicing procedure in which thin horizontal layers are sectioned from composite samples and subsequently tested for TS after a 24-h water soak. Both techniques show that discrete layer TS is positively correlated to the layer density and suggest that efforts to improve TS should focus on treatments or processes that impact the more dense surface layers of composite panels.

Both techniques have some limitations that may restrict their widespread use as a standard protocol. The intact algorithm method requires the nondestructive measurement of layer density through the sample thickness. The commercial densitometers for the panelboard industry utilize the standard 50- by 50-mm internal bond (IB) sample for density profile measurement. The same limitation applies to the layer slicing technique in that only 50- by 50-mm samples can be prepared with the technique, and the standard TS sample is 150 by 150 mm. Other limitations to the layer slicing technique

include the removal of saw kerf material as an additional source of measurement error, and that individual layers once removed from the intact specimen more easily absorb water and swell more or less than the intact, whole sample without the influence of internal stress.

Wang and Winistorfer (2002a, 2003a) developed a nondestructive optical technique to determine TS of discrete layers within intact samples of wood composites. They considered the nondestructive optical technique an improvement over the first two techniques. Based on this technique, strong correlations between the actual TS and layer density were built for lab-made MDF (Wang and others 2001b), lab-made OSB (Wang and Winistorfer 2000a), and commercial OSB (Gu and others 2004; Wang and others 2003).

Wang and Winistorfer (2001) conducted research to evaluate compression and swelling characteristics of individual furnish elements sampled through the thickness of lab panels pressed without resin. The results of this work showed that flakes from surface layers exhibited compression of 25% to 37%, about double that of flakes in core layers. As expected, flakes from surface layers showed much greater TS than core flakes and the response was accentuated with higher equilibrium moisture content (EMC) conditions. The correlation between the flake TS and compression ratio was at the 1% significance level, except for the correlation between the flake TS and compression ratio for relative humidity (RH) 35% to 65%, which was at the 10% significance level. The individual layer TS of the pine panel through the panel thickness direction is very similar to flake TS. Face layers swelled much more than core layers due to high face flake compression. The layer sawing technique was also employed to obtain specimens for water absorption (WA) tests (Xu and Winistorfer 1996b). These tests revealed that WA was positively correlated to layer density and layer TS.

Mechanical Properties

There has been a large number of research reports published that describe the correlation between VDP and panel mechanical properties. Some of the mechanical properties that are influenced by density include torsion shear strength of particleboard (Shen and Carroll 1970), tensile strength of particleboard (Plath and Schnitzler 1974), tensile and compression strength through OSB thickness (Steidl and others 2003), modulus of elasticity (MOE) and modulus of rupture (MOR) (Rice and Carey 1978; Hse 1975; Wong and others 1998), IB (Schulte and Frühwald 1996a,b), and shear modulus (Schulte and Frühwald 1996a).

Xu and Winistorfer (1995a) sawed an OSB specimen into nine layers, and measured the IB of each layer. Although there was a positive correlation between IB and density, the degree of correlation was small (r^2 between 0.20 and 0.25). The lowest IB did not always occur in the low-density core

layer, and the highest IB did not necessarily occur in the high-density face layers.

To determine the variation in strength and stiffness through the thickness of the panel, Steidl and others (2003) sawed a commercial OSB into 15 layers to obtain thin layer specimens for tension and compression testing. Specimens were obtained both parallel and perpendicular to the length of the panel. The specimens were tested in tension using straight-sided specimens and unbonded tabs. For specimens parallel to the length of the panel, the face layers had a tensile strength approximately an order of magnitude greater than the core. Greater face tensile strength was due to a combination of strand orientation and density. An apparatus was designed to test the thin specimens in compression. The average compression strength was significantly higher than average tension strength. However, the average compression MOE was significantly lower than average tension MOE. These layer tension and compression properties were related to the VDP with high r^2 values (>0.75), thus indicating a strong linear relationship exists. The layer properties were used to predict the panel properties.

A study completed by Andrews (1998) examined the relationship of the formation of the VDP in OSB as influenced by furnish moisture content (MC) and press closure rate. Results showed that there was a negative correlation ($r = -0.65$) between the location of maximum density in the tension face layer and the bending MOE of the panel. As the maximum density location moved closer to the panel surface, the stiffness of the panel increased. The location of the maximum density influenced the MOE more than the density value itself. The same relationship was true for MOR, but the correlation was lower ($r = -0.33$).

Geimer and others (1975) examined the effects of layer characteristics on three-layer particleboards. In one series of tests, face and core layers were separated and tested for stiffness in tension parallel to the board surface. They suggested that there was a nonlinear relationship between the MOE of the face layer and the density of the face layer, while there was a linear relationship between MOE of the core and density of the core layer. Laminate theory was used to predict board properties from layer properties. The predicted stiffness averaged 78% of the measured stiffness in two-point loading tests and 87% of the measured stiffness in single-point loading tests. Using the density gradient in successive 0.8-mm (1/32-in.) increments along with the developed nonlinear modulus–density relationships resulted in improved predictions, 92% for the two-point loading and 100% for the single-point loading test.

Geimer (1979) measured tension, compression, and bending MOE and failure stress of full thickness flakeboards made with uniform densities throughout their thickness and different degrees of flake alignment. Logarithmic relationships between stiffness (or strength) and specific gravity and wave

speed were developed. Several important behavioral aspects were determined from this work. The failure stress (or MOR) was highly correlated with the stiffness. The stiffness of boards with a density gradient could be predicted to within $\pm 20\%$ using the stiffness–density relationship from uniform density boards. The bending MOR was almost double that of the tension failure stress for the same level of stiffness.

Carll and Link (1988) studied the layer behavior of 12.7-mm- (0.5-in.-) thick aspen, and Douglas-fir flakeboard panels. 3.2-mm- (1/8-in.-) thick face layers and 6.35-mm- (1/4-in.-) thick core layers were tested in tension and compression. A logarithmic relationship was developed between the tensile or compressive MOE and the specific gravity and wave speed. These relationships were used with the density measured in six layers through the thickness (10%, 15%, 25%, 25%, 15%, and 10% of the thickness) to predict the bending MOE. The predicted MOE was consistently 10% to 15% higher than the measured MOE.

Xu (1999) used laminate theory and simulated linear layer MOE–layer density relationships to examine the effect of different VDPs on the panel MOE. The analysis showed that the MOE benefits from the high-density surface layer and increases linearly with an increase in peak density, but the maximum MOE does not occur when the peak density is located at the extreme board surface.

After measuring shear modulus, IB, and density profile for five different types of commercial MDF, a correlation between the failure position and parameters derived from the VDP could not be established (Schulte and Frühwald 1996a). Sixty-nine percent of the failures were found in the outer layers of the specimens (15%–35% and 56%–85% of thickness, respectively), even if the lowest density was found in the core layer. Only if the minimum density is more than 30% lower than the mean density is the failure position near the point of minimum density. There is a high correlation between minimum density and IB. There are high correlations between interlaminar shear modulus, shear strength, and IB as well as between mean density and IB, shear modulus, and shear strength.

Schulte and Frühwald (1996b) also determined the relation between IB, parameters derived from the density profile, and the respective failure position for five different thicknesses of furniture grade particleboard. Independent of panel thickness, the failure position was found to be in a range of the 25% to 75% of panel thickness. A correlation between the failure position and parameters derived from the density profile could not be found. There appears to be three predetermined failure lines (35%, 50%, and 65% of panel thickness). The correlation between mean density and IB is high for the total sample ($r = 0.81$). The correlation between minimum density and IB is lower, especially with regard to results relating to a single panel thickness. Humphrey (1991)

predicted the variation of inter-particle bond strength across the thickness of a single-layer spruce particleboard. Based on his simulation model, he indicated that bond strengths seem to be at their lowest at some distance away from the core layer of the panel. This may help to explain the tendency of boards to delaminate at this location upon premature press opening.

Wang and Winistorfer (2000b) report on the nature of the unsteady contacting phase that exists during hot-pressing and explains some phenomena relating to manufacturing processes of wood composites and end-product panel properties. The process of bonding wood is a complex interaction of physical and chemical variables. The bonding of wood elements in a hot-pressed composite panel is a recognized complex phenomenon that includes polymerization of the resin, chemical reaction, and mechanical interlocking of the resin with the wood substrate. The bonding phenomena in hot-pressed composites occur under varying environmental conditions that include dynamic temperature, RH, MC, pressing pressure, and steam pressure. During pressing, the wood furnish elements are not in a steady state of contact, due to significant consolidation changes that occur throughout the mat during the entire press cycle, even after the press reaches final position. Another study (Wang and Winistorfer 2000d) showed that the VDP of wood composites is formed from a combination of actions that occurs both during consolidation and also after the press has reached final position. Recognition of the consolidation changes during pressing implies that there is not a steady state for resin bonding during pressing. The more severe the unsteady phase during hot-pressing, the poorer the quality of the bond formation. Any method that could reduce the unsteady contacting phase during pressing should result in better bond formation and consequently better end-product panel properties. Knowledge of the unsteady contacting phase during pressing enables an adequate explanation of the phenomena why most of the failures were found in the outer layers of the specimens, even if the lowest density was found in the core layer.

Horizontal Density Distribution

Density variations in the plane of the panel are referred to as the horizontal density distribution (HDD) while density variation through the thickness of a panel is described by the VDP. The HDD is mainly dependent on furnish geometry and forming. As strands are formed into a mat, some areas in the panel will have more strands overlapping than other areas. As the mat is pressed to a constant thickness, these areas are densified to a greater degree than the areas with fewer overlapping strands. On the other hand, void (Sugimori and Lam 1999) or low-density areas may also exist in the panel. Suchsland (1962, 1973) described the nonuniform HDD as undesirable because differential thickness swelling between areas of varying density could cause damaging stresses in a panel. Suchsland and Xu (1989, 1991)

simulated the HDD in flakeboard by crossing narrow strips of veneer in perpendicular layers to form a mat. Variations in the HDD could be controlled by the number of strips in each layer. This density variation has a direct effect on both the IB and the TS of the model and an indirect effect as damaging swelling stresses develop during water exposure.

Xu (1993) measured the HDD by removing finite specimens and showed that apparent HDD in wood composites is dependent on the size of the specimens used to measure the density variations. Smaller specimen sizes will have more variability in density than larger specimen sizes. The results showed that MOR, MOE, IB, and TS of particleboard were shown to be greatly controlled by nonuniformity of board structure. All these properties were improved as structure uniformity improved.

Lu and Lam (1999) determined the overlaps and HDD in a robot-formed wood flakeboard mat using x-ray scanning. The HDD for a full 1.2- by 2.4-m (4- by 8-ft) panel can be determined using x-ray scanning equipment developed by the Alberta Research Council (Linville and Wolcott 2001). The equipment has a resolution of 4 pixels per inch and can calculate discrete horizontal density variations based on a grid size as small as 12.7 mm (0.5 in.). Linville (2000) developed a model to predict failure in an OSB panel due to the HDD. The model predicts that increases in average panel density or horizontal density variations will increase damage in the panel due to differential swelling. Dai and Steiner (1997) developed a mathematical model for characterizing horizontal density variation of a short-fiber wood composite panel by point density variance, point-to-point autocorrelation function, and variance of local average. Oudjehane and Lam (1998) showed that during the manufacture of wood composite panels, the random layout of flakes has a strong influence on the density variation within the panel. Van Houts and others (2003) analyzed mat structure made from industrially manufactured strands using simulation modeling. Information provided by the model includes the number and geometrical details of voids and strand overlap.

Winistorfer and others (1998) procured commercial OSB and plywood products for comparison of whole panel (1.2 by 2.4 m (4 by 8 ft)) water absorption, TS, and MC. The results showed that a significant nonuniform distribution of water absorption, TS, and MC existed across the panel. The nonuniform water absorption has also been found in small samples (van Houts and others 2003, unpublished data). Figure 3 is a nuclear magnetic resonance (NMR) image after 12 h of water soak in the XY plane through the center of a sample with industrial sealant applied on the upper and right edge (van Houts and others, unpublished data). The effectiveness of the industrial sealant in preventing water from entering the edges is quite apparent. However, in one location, a significant amount of water has entered the right edge even though there is sealant present. This location corresponds to a low-density zone with a large number of voids.

This example shows how a low-density zone, even when the edge is sealed with industrial sealant, is susceptible to rapid water penetration. This would also affect the TS of the sample.

Macro-voids exist in strand-based wood composites (Sugimori and Lam 1999; van Houts and others 2003). The voids contribute to the rate and directional characteristics of moisture movement through a panel. Macro-voids, low-density spots, and high-density spots should be considered as defects in strand-based wood composites. These defects will cause potentially damaging internal stresses to develop in the wood panel.

In a study on the density and property relationship of wood strand composites, Dai and others (2002) analyzed the strand overlaps and the influence of horizontal density variation. Increasing density can increase strand to strand contact which can lead to better bonding. However, internal stresses increase with densification and even wood cell wall damage may occur at excessive densification. These contradicting effects suggest the existence of optimum densification for bonding. The optimum IB strength can be clearly detected in elements with no or little horizontal density variation. With horizontal density variation, the density and IB relationships of strand boards become monotonically linear. Density variation also causes a constraining effect on TS, which may lead to lower overall TS. While it does not appear to have an effect on MOE, horizontal density variation causes a negative effect on MOR. Further tests on real strand boards indicate that the density property relationship is also governed by pressing conditions, which may be linked to internal stress development and resin cure. The information generated from this study is useful for developing models for predicting board properties and low-density strand products.

There is little literature regarding influence of hot-pressing on HDD formation. Significant in-plane mass flow is not expected to exist in a strand mat during hot-pressing because the size of the large strands does not allow the strand to move. However, in-plane mass flow could exist to some extent in a fiber mat during pressing. Wang and Winistorfer (2000c) used a high-resolution x-ray computed tomography (CT) system to generate spatial density variation of MDF panels. The CT scanner was set at 420 kV, 3 mA, 0.5-mm slice thickness, and 0.166-mm pixel size. The images included the in-plane images taken at the midplane of each sample, and the transverse images taken at three heights. The CT in-plane images (Fig. 4) showed the horizontal density variation in MDF panels. The enlargement of a small region of the slice of MDF panel showed there is a ± 45 degree weave of fibers as well.

Control Strategies for Hot-Pressing

In pressing, a number of factors are involved, including the resin type and level, wax type and level, pressing temperature, wood species and furnish geometry, mat density and distribution, mat moisture level and distribution, press closure rate, and pressure. As is usual in the board manufacturing process, all of these factors interact.

In the previous section, we have discussed that there are different panel property requirements for different applications, and panel properties are strongly influenced by density distribution. In this section, control strategies for hot-pressing are discussed.

Key Criteria and Methods of Press Control

Hot-pressing is a process of pressing a mat between hot platens or hot rollers of a press to compact and set the mat structure by simultaneous application of heat and pressure. The major goal of hot-pressing is to achieve a designed panel physical and mechanical properties within a limited pressing cycle. There are two basic requirements that must be met and considered when making wood-based, particulate composites: (1) the properties must be optimized to impart the designed properties to the panel mainly through sufficient resin cure and correct vertical density distribution, and (2) the process must be optimized to achieve minimum pressing time without blows and blisters.

Degree of Resin Cure

Most wood-based composites processing done today is controlled by a fixed “time and temperature schedule” based on empirical observation of the process variables and resin chemistry. The thermal-setting adhesives in commercial uses require temperatures in excess of 100°C to accelerate their polymerization. Measurements of temperature inside wood-based panels during hot-pressing are commonly done with thermocouples and used to estimate pressing cycle in all kinds of hot-presses. The minimum pressing cycle is commonly estimated based on the time for core temperature to reach 100°C and the time for resin to cure above 100°C. The internal temperature hardly exceeds 110°C at the end of the pressing process for a thick panel. However, internal temperatures easily exceed 130°C to 140°C for a thin panel.

The processing of wood-based composites is further complicated by lot-to-lot variations associated with adhesive systems, variations in wood species, moisture content, pH, and seasonal plant environmental conditions. In the panel industry, trial-and-error methods are now used to determine the appropriate press cycle for a particular condition. Because there is no real-time feedback of panel property information for the press operator, pressing control is generally not

optimized (Wang and Winistorfer 2002b). There is a need for an on-line sensor system that can determine the state of adhesive cure within the composite panel during pressing, without compromising the integrity of the finished products due to invasive methods. To provide real-time monitoring and intelligent control for the curing of wood composites during hot-pressing, several techniques are currently being developed. Wang and Winistorfer (2002b) recommended the in-process measurement and control of hot pressing through monitoring the internal density change during press opening. Chen and Beall (2000) investigated bond strength development in particleboard during pressing using acousto-ultrasonics.

For control purposes, dielectric analysis (DEA) appears to be the most promising and popular method for monitoring the resin state in composites (Kim and Lee 1993; Maffezzoli and others 1994; Magill and van Doren 2000; Rubitshun 1981; Wang and Winistorfer 2000b, 2003b; Wolcott and Rials 1995). DEA has been used to provide large amounts of data about basic phenomena in resin-based systems.

Vertical Density Profile

To impart the designed properties to the panel, the targeted vertical density distribution should be achieved at the same time sufficient resin cure is being achieved. A density gradient through the panel thickness is typically reflected by the presence of high-density face layers and low-density core layers within the panel but may take on many forms depending on manufacturing conditions and desired end-product attributes. The density gradient has been referred to by many names including vertical density gradient, vertical density profile, density profile, and vertical density distribution. The density profile will commonly be nearly symmetrical in shape when viewed about a midpoint that is the centerline representing total panel thickness (Fig. 1).

A superior MDF panel for laminating, gluing, and finishing should have a deep density profile, in which the face density is considerably higher than the core density (Fig. 1). Painting, grain printing, and overlaying the new generation of lightweight papers is also enhanced by a high-density panel surface. The homogeneous core of MDF makes it especially suitable for embossing, molding, and general machining. Most MDF panels are usually sanded to remove precured surfaces.

Recent research on commercial OSB (Gu and others 2004; Wang and others 2003) showed that VDP varied from one OSB manufacturer to another, especially for the thicker aspen panel. The 11-mm (7/16-in.) pine OSB panels had smooth profiles with a wide face density, which is located far from the panel surface. The highest peak density is located on the top surface for most of the panels (Wang and others 2003). Density profiles of three aspen panels (Fig. 2) demonstrated three significantly different processing

techniques when making the panels (Gu and others 2004). Panels 19 and 21 had steep density profiles and wide low-density core regions. The difference between the two profiles was that panel 21 had two relative flat shoulders at the surface areas instead of two narrow peak densities as panel 19. Panel 20 had a less steep density profile with high core density. Two peak densities near the surfaces were pushed inside. The mechanical and TS performance of the three aspen OSB panels were expected to be affected by their different density profiles. It should be noticed that 11-mm- (7/16-in.-) thick sheathing OSB are usually not sanded and 18.3-mm- (23/32-in.-) thick flooring products are usually sanded before entering the market. Panel 21 was sanded.

Medium-density fiberboard is one of the most rapidly growing composite products available in the marketplace. MDF is seeing increased application in many product areas such as furniture, kitchen cabinets, and ready-to-assemble furniture. Thin MDF is mainly used for laminating flooring substrate, door skins, and furniture parts. Traditional press schedules for MDF manufacture include a creep closing until the press reaches final board thickness or position. It is easy for heat to transfer from the face to the core while thin MDF is pressed. Consequently, there is a smaller temperature gradient in the thin panel than in thick MDF. As a result, there is a more uniform VDP in thin panels than in thick panels. A uniform VDP will result in better IB but lower bending strength and bending stiffness.

To improve surface quality of thin MDF, Dieffenbacher has developed a few techniques used in their thin MDF lines, including decompression joint, surface preheating, and water spraying. Decompression joint in the continuous press (CP) helps quick reduction of the specific pressure which permits production of MDF boards with a big density difference between the surface layer and the core layer on very short presses. The spraying of the formed mat with a water-chemical mix enhances heat transfer through the mat during pressing and results in surface hardening by increased density. This provides optimal precondition for subsequent lacquering of the board which minimizes paint consumption (Jager 2002). An over-pressing technique was developed to modify the vertical density profile by Wang and others. (2001a). With the over-pressing schedule, the mat is first compressed thinner than the final panel thickness and then press position is relaxed to the final position. The over-pressing schedules significantly changed the traditional shape of the VDP of the laboratory-made thin MDF panels. The over-pressing schedules resulted in a deep VDPs with a low core density.

Blow and Blister Control

From the process control point of view, the pressing process should be accomplished without blows or blisters using a minimum press time. Blows are caused by excessive internal gas pressure, which is stronger than the IB of the panel at the

moment the press opens. Excessive MC, high press temperature, high density, high face density, or incorrect press decompression are common reasons to lead to high internal gas or steam pressures in the mat and consequently to cause blows. If the internal vapor pressure in the OSB mat is higher than 20.7 to 34.5 kPa (3 to 5 lb/in²) at the time the press opens when there is no mat contact, the panel will normally blow if the IB is approximately 275.8 kPa (40 lb/in²) or less (Alexopoulos 1999a,b).

When blows resulted from process variation, plant personnel initiated a number of changes to eliminate the blows. These include changing the closing strategy, increasing the decompression time, and possibly press temperature reduction. Gunnells (1999) studied the effect of closing strategy changes and press temperatures on the gas pressure. The closing strategy changes, which were the removal of one or more C-pumps from a particular close sequence, had very little effect on the gas pressure. Changes in press temperature were more effective at reducing the gas pressure.

Delaminations or blisters are a result of high MC furnish, which sometimes can lead to under cured resin. Pressing time, mat MC, press temperature, or any other factors that influence resin cure, are potential causes of delaminations. Press mechanical problems, for example, bent platens, simultaneous closing alignment, across the width alignment, and steam flow problems can cause blow or delamination as well.

Very recently, presses have been built with a special cooling zone in approximately the last third of the length of the press. Experience with the Kusters press at the MDF Hallein factory shows that with press cooling, the gas pressure in the board at the press outlet is reduced as the cooling temperature decreases (Barbu and others 2002). Without increased production capacity, the IB of the boards will be 5% to 10% higher and production will become more reliable concerning variations of production parameters (lower risk of blisters and delamination and wider operational window). The initial MC of the fiber mat can be increased; this accelerates the heat transfer into the fiber mat during hot-pressing and increases the MC of the finished boards. In combination with the higher initial mat MC, the production capacity of the press can be increased by 10% to 20%.

Typical Pressing Procedures

Oriented Strandboard

Different pressing strategies are being used to manipulate the VDP of wood composites and consequently improve product performance. Figure 5 shows schematic diagrams of platen position during hot-pressing. Schedule B in the Figure 5 represents a typical pressing schedule used by many researchers. Schedule B is an ideal hot-pressing schedule, which is typically reflected by a continual closing period under a constant closing speed followed by a period of the

final press position. However, industrial pressing schedules are more complicated than schedule B. The position of the moving platen is generally determined by the computer-based position-control system or pressure-control system. The pressure-control system is commonly used in plywood production. Schedule C in Figure 5 is a typical pressing schedule used in OSB production. Industrial pressing using the position-control system does not always mimic laboratory press closing due to hydraulic system limitation. The press quickly closes to a position near final panel thickness and then closing speed slows as the press reaches maximum pressure. While the press maintains maximum pressure, press platen movement is dependent on wood plasticization and further densification. To manipulate the end-product density profile attributes, other pressing schedules have been or will be used in the panel industry. For instance, schedule A includes a creep closing for MDF pressing (Park and others 1999), and schedule D is a step-closing schedule for particleboard, OSB, and MDF pressing (Wang and others 2000, 2001b,c).

Research results showed that the step closure schedules significantly changed the traditional shape of the VDP of the laboratory-made OSB panels (Wang and others 2000). The step schedules resulted in density profiles with multiple surface densification peaks, flat core density, and main density peaks with good symmetry about the panel central axis (Fig. 6). Step pressing schedules are one processing method that can be used to alter the densification process in the panel and subsequently influence panel physical properties.

Medium-Density Fiberboard

Medium-density fiberboard is one of the most rapidly growing composite board products available in the marketplace. MDF is experiencing increased application in many product areas such as furniture, kitchen cabinets, and ready-to-assemble furniture. A key product attribute of MDF is the density profile through the panel thickness. A superior MDF panel for laminating, gluing, and finishing should have a deep density profile, in which the face density is considerably higher than the core density. Painting, grain printing, and overlaying the new generation of lightweight papers is also enhanced by a high-density panel surface. The homogeneous core of MDF makes it especially suitable for embossing, molding, and general machining. A uniform density through the panel thickness results in better fastening properties.

Fiber mats are easy to compress, consequently resulting in steep M shape VDP if a similar pressing strategy as OSB pressing is used. Wang and others (2001b) compared differences in the VDP of OSB and MDF pressed under the same step-closure schedules. Figure 7 shows the VDP of MDF panels pressed under similar OSB step-closure schedules. A 20-s closing rate in schedule A produced the control panel with a steep density profile consisting of a high face density and low core density. The 80-s closing rate in schedule B

resulted in a higher core density and lower face density than the control panel. There were two shoulders in the density profile of panel B, which obviously resulted from the second closing step. The highest core density was in panel F, which was pressed under a total 135-s closing rate. The overall shape of the VDPs of the above three panels were very similar.

Figure 8 shows the VDPs of OSB panels pressed under the same MDF step-closure schedules. Step-closure schedules C, I, and Control used in OSB (Wang and others 2000) were similar to MDF schedules B, F, and A, respectively. The 80-s two-step closure schedule for panel C resulted in two internal minor peaks. The 140-s closing rate (three-step) produced panel I with a flat core density.

There were larger differences between the face and core density in the MDF samples than in the OSB samples. For instance, a 20-s closing rate produced MDF with 1.13 g/cm³ maximum face density and 0.633 g/cm³ minimum core density. Surface density was 78.6% higher than core density. The maximum and minimum densities of OSB were 0.885 and 0.662 g/cm³, respectively. The surface density was 33.6% higher than the core density.

For the MDF and OSB panels described, it should be mentioned that there were some differences in the pressing parameters. The pressing temperature of the OSB mats was 200°C (Wang and others 2000), which was much higher than the 160°C MDF pressing temperature. Target thickness of the MDF was 15.9 mm, which was slightly thicker than the 12.7-mm OSB. Target average density of the MDF was 0.760 g/cm³, which also was higher than the 0.672 g/cm³ for OSB. However, pressing pressure data recorded showed that compression resistance of the MDF mat was significantly less than pressure for the OSB mat. MDF mats composed of fibers were more homogeneous and compacted more easily than heterogeneous OSB mats composed of large size flakes.

Maloney (1993) stated that the contribution of Owen Haylock at Canterbury Timber Products in Canterbury, New Zealand, should be noted in the development of the MDF industry. Haylock and his colleagues developed a pressing technique in their multiple-opening press resulting in MDF boards with relatively high surface densities and uniform core densities. The pressing strategy uses a step system, rapidly bringing the mat after insertion into the press to a thickness about 30% greater than the final targeted panel thickness. This produces a panel with a high-density surface. Subsequent steps are then taken to bring the panel to final caliper. This technique eliminates much of the soft-surface face found in the early production lines using platen heating only for pressing. Most of the earliest MDF plants used a combination of platen heating and high-frequency curing. This pressing strategy, often referred as creep closure technique, is widely used in MDF production now. For a typical 15.9-mm- (5/8-in.-) thick MDF pressing schedule using creep closure, the total press closure time for the 15.9-mm-

(5/8-in.-) thick MDF is about 120 s, which is much longer than OSB production. Cooking time is only 15 s.

Wang and others (2001b) investigated step-closure schedules and their impact on the formation of the VDP of lab-made MDF panels. Results showed that the effect of step-closure pressing schedules on the density profile formation occurred as a function of the intermediate step position (percentage of final panel thickness), time at intermediate position, and rate of closing speed. An intermediate position of 120% or greater significantly changed the shape of laboratory MDF pressed with a conventional single closing step. Coreline temperature was also clearly affected by the intermediate position, subsequently influencing compaction pressure and resulting density profile shape. A longer intermediate position resulted in a minor density peak near the panel center. A fast closing speed in the first closing step influenced the location of the surface peak density. A fast closure speed during the second and third closing periods resulted in significant internal density peaks. A slow closure speed during the second and third closing period minimized or eliminated internal density peaks. The results of MDF research also showed that step-closure schedules resulted in improved IB strength of the tested specimens (Wang and others 2001c).

Minimizing Pressing Time and Preheating Methods

Shortening Closure Time and Short Initial Closing Time

The research conducted by Heebink and Lehmann (1972) showed that increasing platen temperature and rate of press closure shortens the warm-up period by increasing the rate of heat transfer. Both of these variables, however, are limited by other desired board characteristics such as the extent of surface layer resin precure, wood damage, and the panel VDP. The platen temperature can be up to 238°C for OSB production.

Press closing time is mainly adjusted based on the VDP requirement. Alexopoulos (1999a) investigated 11-mm- (7/16-in.-) thick strandboard panels produced in the lab with liquid, powder, and powder-liquid combination resin, using a gradual consistent closing and an exaggerated fast initial closing with creep closing to thickness. The fast closing reached 105% of the target thickness in 10 s from the start of mat pressure build-up, and the slower close took approximately 30 s to reach the same thickness. Total closing time to thickness was approximately 42 s for all conditions. The results showed that the faster closing resulted in faster heat transfer to the core and in higher temperature at thickness. The faster initial closing also resulted in IB values as much as 35% higher with the powder-liquid system. It appears that the higher temperature at thickness during high compaction allows the powder to soften and flow for greater bonding.

Radio Frequency or Microwave

Most of the earliest MDF plants used a combination of platen heating and high-frequency curing. Radio frequency (RF) or high-frequency preheating units are placed at the entry of continuous presses making thicker panels instead of directly heating mats inside a press. This reduces press times up to 40%. A uniform density through the panel thickness is another advantage of using preheating units. The high-frequency preheating units have been used in thin fiberboard line as well.

Testa (2002) recently made a good overview on application of microwave and RF in the engineered wood industry. The first use of RF in the wood products industry was for plywood, immediately following World War II. Now, major applications of RF are LVL, glulam, and I-joist manufacture primarily for preheating. Microwave is much newer than RF. MacMillan Bloedel (Vancouver, BC, Canada) began experimenting with the technology in the 1970s and began using it commercially for its trademarked parallel strand lumber product and Parallam[®] in the 1980s. Both RF and microwave ensure a direct and rapid curing of glue, despite their very different methods of application. Microwave preheating is also being used for LVL manufacture. They both have particular application to the thicker, longer products in today's market, especially since most raw stock is too small to create these products and must be laminated or fingerjointed to do so.

Steam Shock and Steam Injection

Heat is transferred from the heated platens to the mat surfaces and toward the interior. Heat transfer mechanisms can be summarized as conduction, convection, and the diffusion of water vapor and air. Heat conduction is generally considered as a major heat transfer mode during hot-pressing. The warming up of the core layers is based on the evaporation of water in the face layer and the transportation of the heat via the steam shock; in the cold core layer of the mat, the vapor condenses and warms up the core layer. The higher the amount of vapor and the steeper the vapor pressure gradient, the quicker the warming up of the core layer, enabling shorter press times. Using high MC of face furnishes has become a standard process for particleboard and OSB productions that require separate drying and blending lines for the face and core furnish. The water spraying technique was mainly developed for MDF and high-density fiberboard having uniform mat structure. To eliminate mold, press fouling, and formation of deposits on the product, release agent needs to be added in the spray water (Godber and others 2002). Other spray additives can be used to improve panel surface properties. For example, reactive surface sealer is used to reduce paint consumption for doorskin manufacture.

Alternatives to limited steam shock process include direct injection of steam and preheating. The steam-injection

pressing is a relatively new technology, which utilizes perforated platens to inject steam directly into the board and permits the transfer of heat into the core of a board much faster than in conventional pressing. The reduction of press time using steam-injection pressing is the major goal. Steam-injection pressing reduced laminated veneer lumber and 7-ply plywood pressing time by 30% (Troughton and Lum 2000). In addition to reduced press time, an additional advantage of steam-injection pressing is adjustment of VDP. The density of the steam-injection pressing boards appeared to be uniform throughout the panel (Kwon and Geimer 1998).

Preheating

A system was developed to preheat the strand mat before it enters the press to further reduce pressing times and condition the mat (Wöstheinrich and Meier 2001). A controlled mixture of steam and air is injected into the mat, thus the entire mat is heated quickly and homogeneously to the desired temperature. In the preheating system, steam-air flow is directed symmetrically from the top and the bottom face into the mat with the surplus escaping through the mat edges. Through condensation of the steam, high specific energy is released and transferred to the strand mat. As long as the temperature of the mat is below the dew point, the steam condenses. The dew point and final mat temperature depend on the steam volume contained in the air-steam mix. It is not possible to exceed the set mat temperature because steam does not continue to condense beyond its dew point. Through heating by steam condensation, the MC of the mat is raised by 0.7% per 10°C temperature rise. Preheating can offer the following advantages: (1) reduced pressing time by 25% when preheating the mat to 85°C to 90°C, (2) reduced specific pressure required in the press with increasing moisture and temperature, (3) improved swelling properties. This particular preheating system was developed for use with continuous press process and is not suitable for multi-daylight presses because of the different mat retention times in the loader between preheating and press closure. Additionally, the resin is likely to pre-cure differently before the mats enter the press.

Metso Panelboard (Helsinki, Finland) introduced a preheating unit to MDF industry called Coreheater. As the fiber mat approaches the hot press on the conveyor belt, it is sawn in half laterally by an integrated beltsaw. The lower part of the mat remains on the conveyor belt, while the upper section flows over the wedge-shaped steam bar. Steam is injected into the fiber mat through nozzles arranged crosswise on the upper and lower sides of the steam bar, heating the core to approximately 40°C to 60°C. The company claims that production increases of up to 20% can be achieved for board thicknesses between 12 and 38 mm.

Other Pressing Method Developments

Investigations were conducted at a few laboratories to extend the technology of steam injection pressing to the injection of other gases. Geimer and others (1994) investigated the introduction of three different gases into wood composites. The gases were methyl borate (MeB) as a fire retardant, methyl formate (MeF) as a resin catalyst, and carbon dioxide (CO₂) as an accelerator for cement-bonded wood composites. Results indicate that the introduction of MeB can improve the fire resistance of phenolic- and isocyanate-bonded panels but only at the expense of lowering strength properties. Experiments with MeF indicated that this gas has the potential to decrease press times for wood composites bonded with phenolic resin. Ho and others (1992) tested the efficiency of injecting ammonia into strandboards at the final stage of the steam pressing operation, with the intention of reducing formaldehyde emission from the boards.

Chowdhury (1999) designed a cylindrical sealed pressing system in which preformed wood fiber networks were consolidated under a controlled thermodynamic and chemical environment. His work emphasized the selection of treatment chemicals. Kim (2002) consolidated beams in a specially developed rectangular gas injection pressing system using ammonia as a softening agent and an ester as a low-temperature adhesive catalyst. Structural beams were made from oriented hemp and random wood fiber networks with phenol formaldehyde adhesive. It was found that density gradients could be created within beams by injecting ammonia from one platen. Methyl formate was found to hasten the rate of strength development and final network strength by 51% and 22%, respectively.

To increase OSB properties, OSB can be overlaid with other thin materials, such as wood veneer and perforated aluminum foil, during OSB pressing. These materials will affect heat and mass transfer and consequently make a vertical density formation contribution, especially with relatively thick wood veneers (Wang 1987).

Summary

The hot-press is a key piece of equipment in composite panel production. It determines the performance of products and the processing efficiency of the whole production line. Based on furnish geometry and preparation methods, wood-based particulate composites can be divided into three categories: fiber-based products including medium- and high-density fiberboard; particle-based products including chipboard, particleboard, and flakeboard; and strand-based products including OSB, rim board, and laminated strand lumber. Each type of panel is manufactured in a variety of sizes, average densities, and density profiles to provide the end product with the specific properties needed.

Through-the-thickness properties of wood composite include the VDP, layer TS, IB, tension, compression strength, and other mechanical properties. There have been a large number of research reports published that describe the correlation between VDP and panel physical and mechanical properties.

The major goal of hot-pressing is to achieve designed panel physical and mechanical properties within a limited pressing cycle. To impart the designed properties to the panel, correct vertical density distribution should be achieved at the same time sufficient resin cure is being achieved. Different pressing strategies are being used to manipulate the VDP of wood composites and consequently improve product performance. There have been significant technology improvements in minimizing pressing time and developing new pressing methods during the past decade. There is still a need for process control and new pressing technology developments.

Literature Cited

- Alexopoulos, J.** 1999a. OSB pressing optimization and problem solving using monitoring of temperature and gas pressure. In: Proceedings 3d European panel products symposium. Llandudno, Wales: 190–208.
- Alexopoulos, J.** 1999b. Troubleshooting and baseline a manufacturing facility using temperature and gas pressure. Pt. 1. OSB manufacturing. The Pre-Symposium Technical Workshop. 33d international particleboard and composite materials symposium; 1999 April 12; Washington State University, Pullman, WA.
- Andrews, C.K.** 1998. The influence of furnish moisture content and press closure rate on the formation of the vertical density profile in oriented strandboard: relating the vertical density profile to bending properties, dimensional stability and bond performance. Master's thesis. The University of Tennessee, Knoxville, TN.
- Barbu, M.; Martin, C.; Hoepner, D. [and others].** 2002. European experiences with in-press cooling and continuous pressing of MDF. 36th international particleboard and composite materials symposium; 2002 April 9–11; Washington State University, Pullman, WA: 109–116.
- Carll, C.G.; Link, C.L.** 1988. Tensile and compressive MOE of flakeboard. *Forest Products Journal*. 38(1):8–14.
- Chen, L.; Beall, F.C.** 2000. Monitoring bond strength development in particleboard during pressing, using acousto-ultrasonics. *Wood and Fiber Science*. 32(4): 466–477.
- Chowdhury, M.J.A.** 1999. Sealed consolidation of natural fiber composites with chemical reactant injection and removal. Corvallis, OR: Oregon State University. Ph.D. dissertation.

- Dai, C.; Steiner, P.R.** 1997. On horizontal density variation in randomly-formed short-fibre wood composite boards. *Composites Pt. A* 28A: 57–64.
- Dai, C.; Mei, C.; Korai, H.** 2002 Density and property relationships of wood strand composites. In: Proceedings, 6th Pacific Rim bio-based composites symposium; 2002 November 10–13; Portland, OR: 458–466.
- Dueholm, S.** 1996. Determination of density profiles of wood-based panels: from traditional off-line laboratory techniques to continuous, in-line, real-time monitoring. In: Maloney, T.M., ed. Proceedings, 30th international particleboard/composites materials symposium; 1996 April 15–18; Washington State University, Pullman, WA: 45–57.
- Geimer, R.L.** 1979. Data basic to the engineering design of reconstituted flakeboard. Proceedings, 13th international particleboard/composite materials symposium; 1997 June 17–20; Washington State University, Pullman, WA: 105–125.
- Geimer, R.L., Montrey, H.M.; Lehmann, W.F.** 1975. Effects of layer characteristics on the properties of three-layer particleboards. *Forest Products Journal*. 25(3): 19–29.
- Geimer, R.L.; Ledo, A.; Armbruster, D.; Pablo, A.** 1994. Property enhancement of wood composites using gas injection. In: Proceedings, 28th international particleboard/composite materials symposium. Washington State University, Pullman, WA: 243–259.
- Godber, K.; Würtz, J.; Kjeld, A.** 2002. Product and process improvements through mat spray application. In: Proceedings, 6th panel products symposium. Liandudno, Wales, UK: 198–205.
- Gu, H.; Neimsuwan, T.; Wang, S.; Wang, S.G. [in press].** 2004. Comparison study of commercial OSB flooring products in thickness swell and mechanical performance. *Forest Products Journal*.
- Gunnells, D.** 1999. Troubleshooting and baseline a manufacturing facility using temperature and gas pressure, Pt. 2. Particleboard and MDF manufacturing. In: The pre-symposium technical workshop. 33d international particleboard and composite materials symposium; 1999 April 12; Washington State University, Pullman, WA.
- Haag, W.** 1992. Gluing, blending, spreading, and testing-trends as to machinery and process control developments. In: Maloney T.M., ed. Proceedings, 26th particleboard/composite materials symposium; 1992 April; Washington State University, Pullman, WA.
- Heebink, B.A.; Lehmann, W.F.** 1972. Reducing particleboard pressing time: Exploratory study. Res. Pap. FPL–RP–180. Madison, WI: U.S. Department of Agriculture, Forest Service, Forest Products Laboratory, Madison, WI.
- Ho, S.K.; Anderson, C.R.; Croucher, M.** 1992. Ammonia treatment of strandboard during pressing. In: Pacific Rim bio-based composites symposium; 1992 November 9–13; Rotorua, New Zealand.
- Hse, C.** 1975. Properties of flakeboards from hardwoods growing on southern pine sites. *Forest Products Journal*. 25(3): 48–53.
- Humphrey, P.E.** 1991. Pressing issues in panel manufacture: internal properties, and profit. In: Proceedings, 25th particleboard/composite materials symposium; 1991 April 9–11; Washington State University, Pullman, WA: 99–108.
- Jager, R.** 2002. A new generation thin high-density fiberboard plant. In Proceedings, 36th particleboard/composite materials symposium; 2002 April 9–11; Washington State University, Pullman, Washington: 99–104.
- Kim, J.W.** 2002. Gas injection consolidation of miniature natural fiber beams. Corvallis, OR. Oregon State University. Ph.D. dissertation.
- Kim, J.S.; Lee, D.G.** 1993. On-line cure monitoring and viscosity measurement of carbon fiber composite materials. *Journal of Materials Processing Technology*. 37: 405–416.
- Kwon, J.H.; Geimer, R.L.** 1998. Impact of steam pressing variables on the dimensional stabilization of flakeboard. *Forest Products Journal*. 48(4):55–61.
- Lemaster, R.; Green, A.** 1992. The use of air-coupled AE sensors to measure density profiles in wood-based producers. In: Proceedings, National Particleboard Association Pressline Technology Seminars; 1992 December 2–3; Charlotte, NC: 59–68.
- Lin, F.S.** 1996. Meeting OSB customer requirements. In: Maloney T.M., ed. Proceedings, 30th particleboard/composite materials symposium. Washington State University, Pullman, WA: 163–170.
- Linville, J.D.** 2000. The influence of a horizontal density distribution on moisture-related mechanical degradation of oriented strand composites. Washington State University, Pullman, WA. 121 p. M.S. Thesis.
- Linville, J.D.; Wolcott, M.P.** 2001. Controlling thickness swell in oriented strand composites. In: Proceedings, 35th international particleboard/composite materials symposium; 2001 April 2–5; Pullman, WA: 91–101.
- Lu, C.; Lam, F.** 1999. Study on the X-ray calibration and overlap measurements in robot formed flakeboard mats. *Wood Science and Technology*. 33: 85–95.
- Maffezzoli, A.; Trivisano, A.; Opalicki, M. [and others].** 1994. Correlation between dielectric and chemorheological properties during cure of epoxy-based composites. *Journal of Materials Science*. 29: 800–808.

- Magill, R.; van Doren, J.** 2000. Intelligent monitoring and control wood panel press curing in-situ impedance sensors. In: Proceedings, 34th international particleboard/composites materials symposium; 2000 April 4–6; Pullman, WA: 89–95.
- Maloney, T.M.** 1993. Modern particleboard & dry-process fiberboard manufacturing (Updated Edition). San Francisco, CA: Miller Freeman, Inc. 681 p.
- Oudjehane, A.; Lam, F.** 1998. On the density profile within random and oriented wood-based composite panels: horizontal distribution. *Composites Pt. B* 29B: 687–694.
- Park, B.-D.; Riedl, B.; Hsu, E.W.; Shields, J.** 1999. Hot-pressing process optimization by response surface methodology. *Forest Products Journal*. 49(5):62–68.
- Plath, E.; Schnitzler, E.** 1974. The density profile, a criterion for evaluating particleboard. *Holz als Roh-und Werkstoff*. 32: 443–449.
- Quintek Measurement Systems, Inc.** 1999. Product Literature. Model QDP-01X Density Profiler. Quintek Measurement Systems, Inc., Knoxville, TN.
- Rice, J.T.; Carey, R.H.** 1978. Wood density and board composition effects on phenolic resin-bonded flakeboard. *Forest Products Journal*. 28(4): 21–28.
- Rubitshun, R.A.** 1981. Measuring adhesive cure by dielectric analysis. Oregon State University, OR. M.S. Thesis.
- Schulte, M.; Frühwald, A.** 1996a. Shear modulus, internal bond and density profile of medium density fiber board (MDF). *Holz als Roh-und Werkstoff*. 54: 49–55.
- Schulte, M.; Frühwald, A.** 1996b. Some investigations concerning density profile, internal bond and relating failure position of particleboard. *Holz als Roh-und Werkstoff*. 54: 289–294.
- Shen, K.C.; Carroll, M.N.** 1970. Measurement of layer strength distribution in particleboard. *Forest Products Journal*. 20(6):53–55.
- Steidl, C.M.; Wang, S.; Bennett, R.M.; Winistorfer, P.M.** 2003. Tensile and compression properties through the thickness of oriented strandboard. *Forest Products Journal*. 53(6): 72–85.
- Strickler, M.D.** 1959. The effect of press cycles and moisture content on Douglas-fir flakeboard. *Forest Products Journal*. 9(7): 203–215.
- Suchsland, O.** 1962. The density distribution of flakeboards. Michigan Agriculture Experiment Station Quarterly Bulletin. 45(1): 104–121.
- Suchsland, O.** 1973. Hygroscopic thickness swelling and related properties of selected commercial particleboards. *Forest Products Journal*. 23(7): 26–30.
- Suchsland, O.; Xu, H.** 1989. A simulation of the horizontal density distribution in a flakeboard. *Forest Products Journal*. 39(5): 29–33.
- Suchsland, O.; Xu, H.** 1991. Model analysis of flakeboard variables. *Forest Products Journal*. 41(11/12): 55–60.
- Sugimori, M.; Lam, F.** 1999. Macro-void distribution analysis in strand-based wood composites using an X-ray computer tomography technique. *Journal of Wood Science*. 45: 254–257.
- Testa, B.M.** 2002. Zap! Engineering wood with microwave and radio frequencies. *Engineering Wood Journal*. Fall, 22–25.
- Troughton, G.E.; Lum, C.** 2000. Pilot plant evaluation of steam-injection pressing for LVL and plywood products. *Forest Products Journal*. 50(1): 25–28.
- Van Houts, J.; Winistorfer, P.M.; Wang, S.** 2003. Analysis of mat structure made from industrially manufactured strands using simulation modeling. *Wood and Fiber Science*. 37(3): 351–362.
- Wang, S.** 1986. A study and application of density gradient of wood-based panel. Science Report of Postgraduate. 1(1): 3–6 (in Chinese).
- Wang, S.** 1987. A study of single-step hot pressing technology of oriented strand composite plywood. *Journal of Nanjing Forestry University*. (2): 74–84 (in Chinese, with English abstract).
- Wang, S.; Winistorfer, P.M.** 2000a. Effect of species and its distribution on the layer characteristics of OSB. *Forest Products Journal*. 50(4): 37–44.
- Wang, S.; Winistorfer, P.M.** 2000b. Unsteady contacting phase during hot pressing and its influence on resin cure and bond formation. In: Proceedings of Wood Adhesives 2000; 2000 June 22–23; South Lake Tahoe, NV: 155–161.
- Wang, S.; Winistorfer, P.M.** 2000c. Effect of spatial density distribution on the layer thickness swell of MDF. Abstract. In: Proceedings, 34th international particleboard and composite materials symposium; 2000 April 3–6; Washington State University, Pullman, WA: 181.
- Wang, S.; Winistorfer, P.M.** 2000d. Fundamentals of vertical density profile formation in wood composites. Pt. 2. Methodology of vertical density formation under dynamic condition. *Wood and Fiber Science*. 32(2): 220–238.
- Wang, S.; Winistorfer, P.M.** 2001. Flake compression behavior in a resinless mat as related to dimensional stability. *Wood Science and Technology*. 35(5): 379–393.
- Wang, S.; Winistorfer, P.M.** 2002a. Process and system for determination of layer thickness swell of wood composites. U.S. patent No. 6,396,590.

- Wang, S.; Winistorfer, P.M.** 2002b. Monitoring *in-situ* density change for in-process measurement and control of hot pressing. *Forest Products Journal*. 52(7/8): 77–82.
- Wang, S.; Winistorfer, P.M.** 2003a. An optical technique for determination of layer thickness swell of MDF and OSB. *Forest Products Journal*. 53(9): 64–71.
- Wang, S.; Winistorfer, P.M.** 2003b. Monitoring resin cure during particleboard manufacture using a dielectric system. *Wood and Fiber Science*. 37(4): 532–539.
- Wang, S.; Gu, H.; Neimsuwan, T.; Wang, S.G.** 2003. Layer thickness swell and related properties of commercial OSB products: A comparative study. In: Proceedings, 37th international particleboard and composite materials symposium; 2003 April 7–10; Washington State University, Pullman, WA: 65–76.
- Wang, S.; Winistorfer, P.M.; Moschler, W.W.; Helton, C.** 2000. Hot pressing of oriented strandboard by step-closure. *Forest Products Journal*. 50(3):28-34.
- Wang, S.; Winistorfer, P.M.; Young, T.M.** 2001a. An over-pressing technique for modification of the vertical density profile of thin MDF panels. Abstract In: Biographies and Abstracts. Proceedings, Forest Products Society 55th annual meeting; 2001 June 24–27; Baltimore, MD: 56 p.
- Wang, S.; Winistorfer, P.M.; Young T.M.; Helton, C.** 2001b. Step-closing pressing of medium density fiberboard. Pt. 1: Influence on the vertical density profile. *Holz als Roh-und Werkstoff*. 59(1/2): 19–26.
- Wang, S.; Winistorfer, P.M.; Young, T.M.; Helton, C.** 2001c. Step-closing pressing of medium density fiberboard. Pt. 2: Influences on the panel performance and layer characteristics. *Holz als Roh-und Werkstoff*. 59(5): 311–318.
- Winistorfer, P.M.; Xu, W.; Wimmer, R.** 1995. Application of a drill resistance technique for density profile measurement in wood composite panels. *Forest Products Journal*. 45(6): 90–93.
- Winistorfer, P.M.; Young, T.M.; Walker, E.** 1996. Modeling and comparing vertical density profiles. *Wood and Fiber Science*. 28(1): 133–141.
- Winistorfer, P.M.; Moschler, W.W.; Helton, C. [and others].** 1998. Water soak and high humidity exposure effects on properties of whole-panel OSB and plywood. In: Engineered systems using structural panels, Proceedings No. 7272. Proceedings, 50th anniversary meeting of the Forest Products Society; 1997, June 22–26; Vancouver, CA: 43–51.
- Wolcott, M.P.; Rials, T.G.** 1995. In-situ monitoring of adhesives for wood-based composite. In: Proceedings, 29th international particleboard/composites materials symposium; Pullman, WA: 185–193.
- Wong, E.D.; Zhang, M.; Wang, Q.; Kawai, S.** 1998. Effects of mat moisture content and press closing speed on the formation of density profile and properties of particleboard. *Journal of Wood Science and Technology*. 44: 287–295.
- Wöstheinrich, A.; Meier, J.** 2001. Operating experiences—producing OSB with continuous presses. In: Proceedings, 35th international particleboard/composites materials symposium; 2001 April 3–5; Pullman, WA: 103–107.
- Xu, W.** 1993. Horizontal density distribution of particleboard: origin and implications. Vancouver, BC: University of British Columbia. 166 p. Ph.D. dissertation.
- Xu, W.** 1999. Influence of vertical density distribution on bending modulus of elasticity of wood composite panels: a theoretical consideration *Wood and Fiber Science*. 31(3): 277–282.
- Xu, W.; Winistorfer, P.M.** 1995a. A procedure to determine thickness swell distribution in wood composite panels. *Wood and Fiber Science*. 27(2): 119–125.
- Xu, W.; Winistorfer, P.M.** 1995b. Layer thickness swell and layer internal bond of medium density fiberboard and oriented strandboard. *Forest Products Journal*. 45(10): 67–71.
- Xu, W.; Winistorfer, P.W.** 1996a. Fitting an equation to vertical density profile data using Fourier analysis. *Holz als Roh-und Werkstoff*. 54: 57–59.
- Xu, W.; Winistorfer, P.M.** 1996b. A procedure to determine water absorption in wood composites. *Wood and Fiber Science*. 27(2):119-125

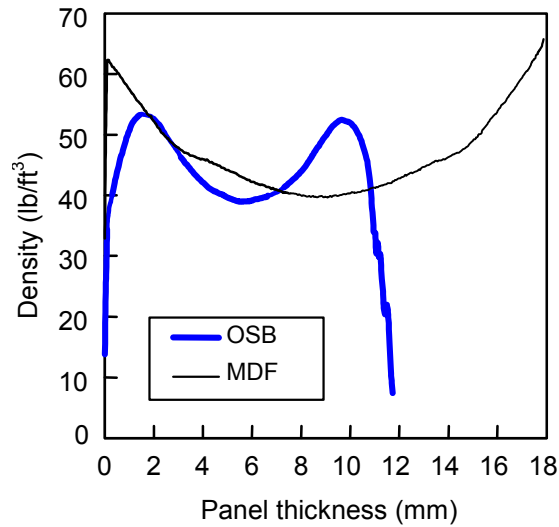

Figure 1—Typical vertical density profiles of oriented strandboard (OSB) and medium-density fiberboard (MDF) (Wang and Winistorfer 2003a) (1 lb/ft³ = 16 kg/m³).

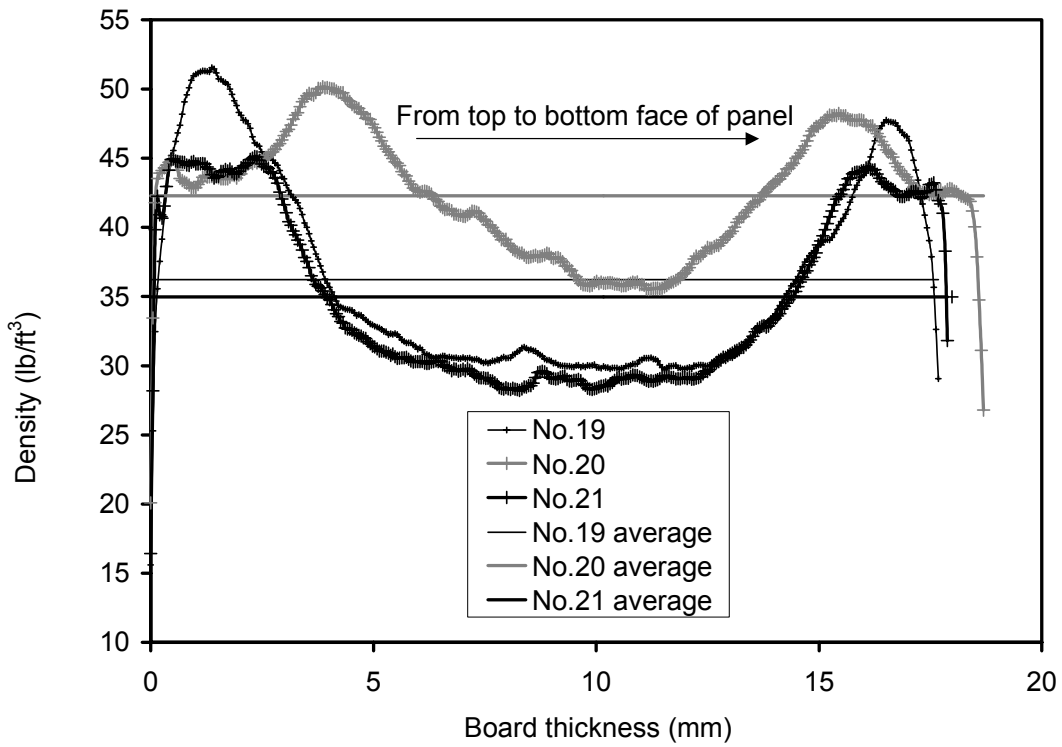

Figure 2—Vertical density profiles for three aspen oriented strandboard 18.3-mm- (23/32-in.-) thick panels (Gu and others 2004) (1 lb/ft³ = 16 kg/m³).

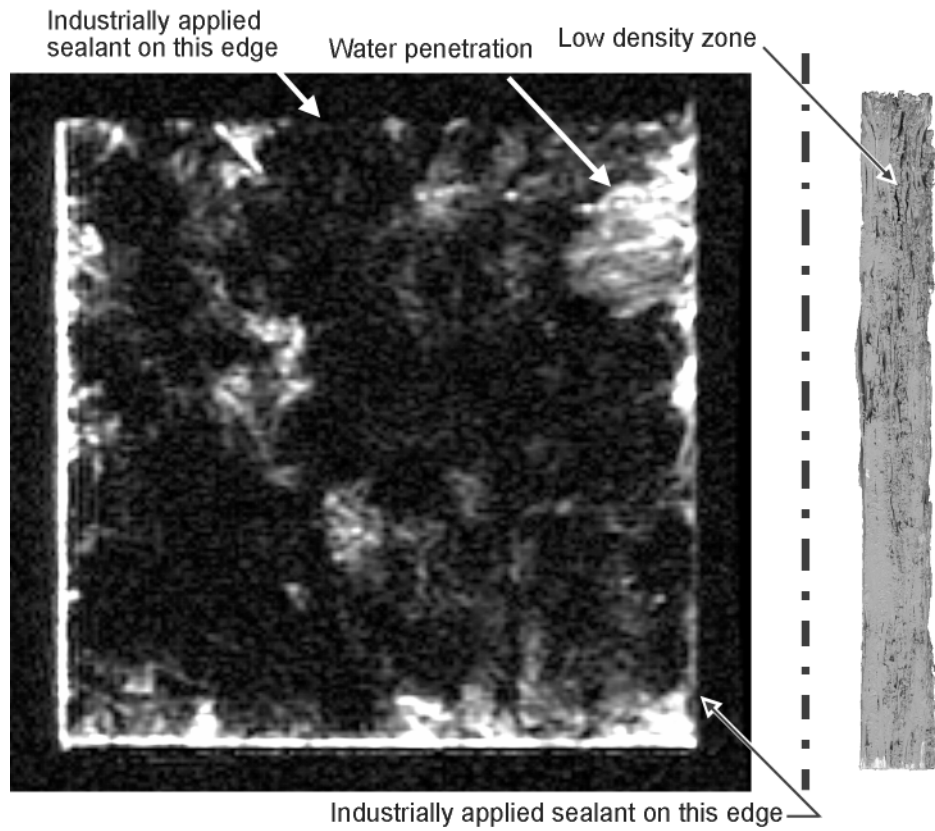

Figure 3—Nuclear magnetic resonance image of OSB taken through the XZ plane after a total of 12 h of watersoak of a specimen with industrially applied sealant on two edges. Also shown is a photograph of one of the sealed edges (YZ plane) with a low-density zone indicated (van Houts and others 2003b).

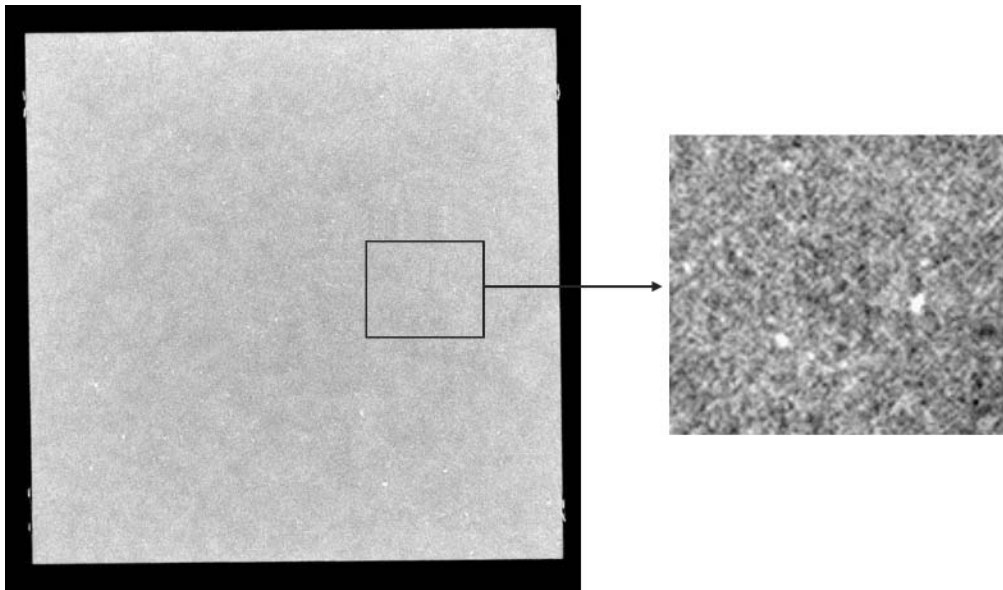

Figure 4—X-ray computed tomography (CAT) of MDF, 228.6 by 228.6 mm (9 by 9 in.), 0.5-mm slice thickness, and 0.16-mm pixel size

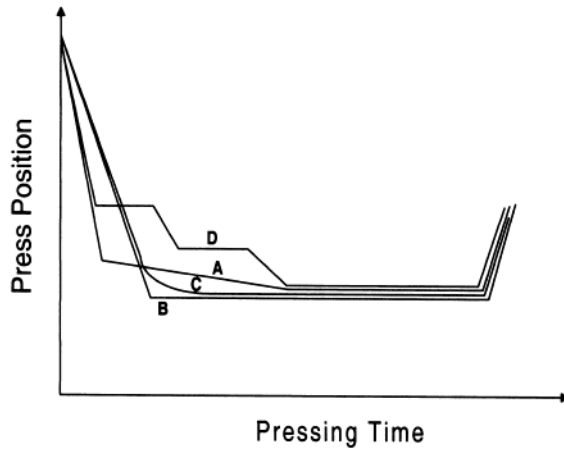

Figure 5—Platen position during hot-pressing using different pressing schedules. Schedules shown are (A) creep closing schedule for medium-density fiber-board pressing, (B) theoretical one-step pressing schedule, (C) typical oriented strandboard industrial pressing schedule, and (D) three-step closing schedule.

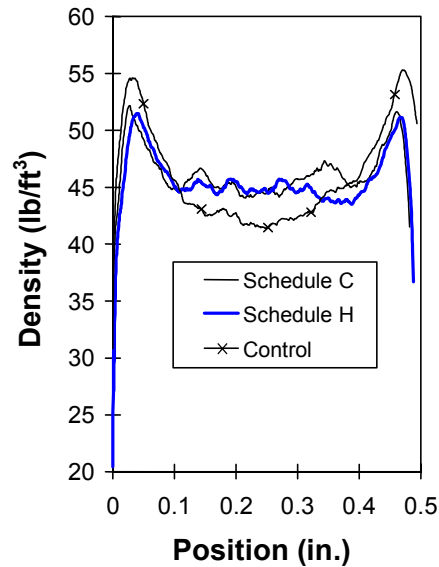

Figure 6—Vertical density profiles of schedule C (two-step closing, 80-s closure time), H (three-step closing, 140-s closure time), and control (one-step closing, 20-s closure time) boards (Wang and others 2000) (1 lb/ft³ = 16 kg/m³; 1 in. = 25.4 mm).

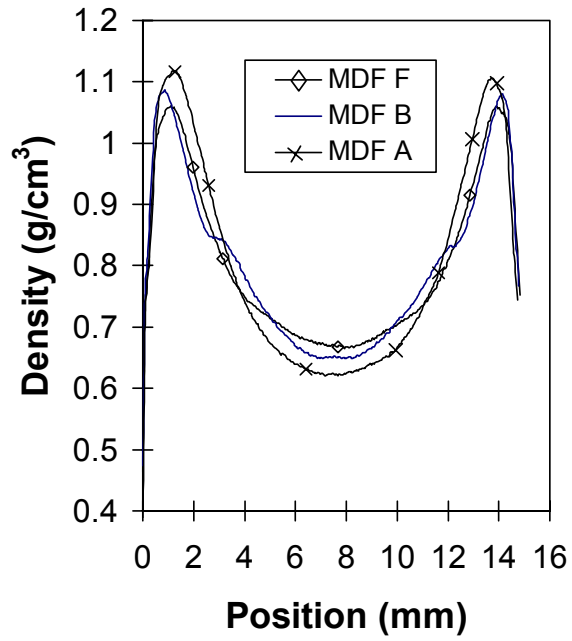

Figure 7—Vertical density profiles of medium-density fiberboard (MDF) (Wang and others 2001a).

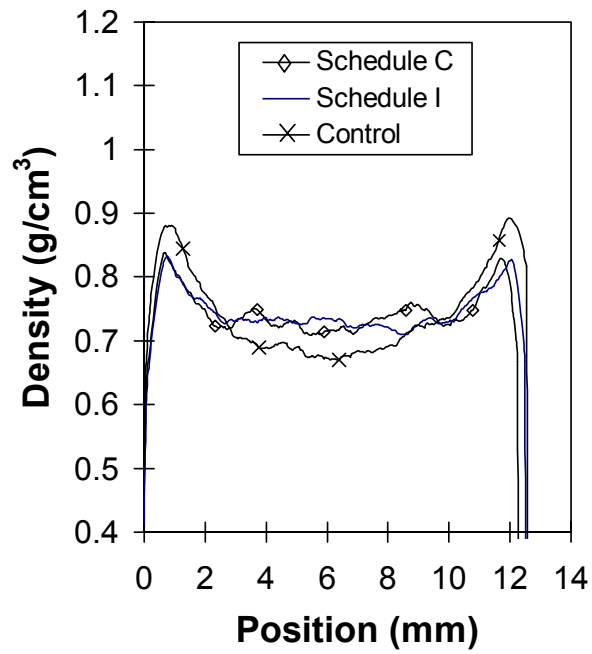

Figure 8—Vertical density profiles of oriented strandboard (OSB) (Wang and others 2000).

Discussion—Press Control for Optimized Wood Composite Processing and Properties

Siqun Wang and Chunping Dai

Winandy: Once again, I would like to apologize to both speakers. I wish I could have had an hour for each one of the talks. They were exactly what we asked for, but we just tried to cram a whole bunch of critical information into too short a time period. Heiko Thomen is going to be prepared to do his talk at 11:05 so that gives us about a 1 hr and 5 min to do 1-1/2 h of discussion. Thus, we want to keep on pace with this cramming as much into as little bit of time as possible. We will have both of the speakers standing here, ready and able to answer your questions, I would again suggest that if you have a particular slide that you want to see or you want to bring up and re-discuss, lets try to do that in the first few minutes of the conversation and then we will get back and get the conversation flowing. Once again, I remind you that the conversation should be from table to table, rather than from table to the speakers. It should go back and forth; this is a roundtable, not a lecture at this point. So if the speakers are ready, I guess that I would like to start off with a question.

We had a discussion over coffee during the break. We talked about vertical density profile and how controlling it could give you different kinds of properties and that optimizing one property affected another. I was wondering if you could just review what might be known in that area. For example, we talked about nail holding, is it better to have a big vertical density profile at the same average density or is it better to have a uniform density in the product for nail holding?

Wang: The correlation between vertical density profile and board property in some part is quite clear. For example, to optimize for MOE we create a steep density profile to get better bending strength and stiffness. But at same time in doing this, we produce a steep density profile and may achieve lower internal bond. I showed a slide in my talk that in an internal bond test the board may not break in the lowest density area, but there still is a strong correlation between lower internal bond strength and lower density. For example, the screw holding strength is based on how we test. If we know it is MDF and particleboard we test in two directions. One is perpendicular to the panel plane and the other is on edge. I cannot recall which kind of correlation when tested normal to panel plane because either you have a very steep density profile that means that you have high screw holding on the surface area, or you have less screw holding in the core. Either way I am not sure which way is better. I can't recall but I recall that somebody did that research. When we test screw holding on the edge, which means that the screw holding stress occurs in a lower density area, which means

that when we have lower core density, we have lower screw holding properties.

Dai: On the vertical density profile optimization, remember the industry really tries to minimize the average density. Let's say we try to optimize the bending strength by densifying the surface, but we have only so much to give. At a given average density, we might run into problems of meeting the IB standard and I guess IB for OSB is low compared to other products and I guess the other thing about IB is that it affects the degas and pressing time. If we don't have enough IB, we can't pull the panel out without blows and so I think it is pretty much a balance for OSB mills, when they try to reduce the overall density of the product. And as far as nail holding, I don't know. I agree with Siqun, you sort of increase the surface holding by densifying the surface, but then the core is suspect. ARC has done some work and I don't really know if they are looking at density profile as a parameter.

Jong Lee: Well I guess about nail withholding strengths you have to have overall high density board rather than vertical density profile or the uniform density because density is the key factor controlling the withholding strengths of the nail. So if you have aspen OSB or the southern pine OSB, I guess southern pine OSB performs better with withholding strengths. But if you deal with the screw holding strengths it is a little bit different, if you deal with nail withholding strength you have got to have a high surface area and a high density surface area to provide surface hardness. We are getting more low density wood from the low density hardwood species so if you think about the nail withholding strengths and some other structure performance rather than just a simple bending or a shear, you got to have some other strategies to control the final properties.

Jim Wescott: As far as the vertical density profiles goes and how that affects the thickness swell, I think that you showed an excellent slide on how obviously the higher density surfaces do swell substantially more than the lower density core. I guess I have a couple questions on that. Does the overall total thickness of the board increase as a result of an extreme vertical density profile and second of all, I guess it is kind of a similar question, has anyone looked at normalizing that data for like a swell per gram of dry wood and trying to compare different resins and perhaps even comparing a 24 h swell to boil, just to try to get a better feel for how the resin is actually either contributing or impeding thickness swell?

Wang: Yes, thickness swell is a very difficult topic because we know the thickness swell is affected by many things. Density profile is one of them. If we say we want to have lowest thickness swell and in my mind I am still not very clear which kind of density profile would be best because we still have a good question related to the bonding and the durability and especially when we are talking about water

soak and boiling at the test that that would be a different situation. I remember that last year I tested a very thin fiberboard. The fiberboard had a coating surface on top because we wanted to have a good surface exposed to the outside. Thus, we used a special chemical treatment on that top surface. When we tested layer thickness swell, under water soaking at room temperature, the top surface layer swelled more than the bottom surface layer. But when we boiled the specimen, the swelling was the opposite. So that means that when we boil a sample we cannot merely look at the thickness swell. It's also effects of the durability on the bonding.

Dai: On that I would like to also add that when we talked about the thickness swell, it really depends on what sort of test we use. If we are looking at the maximum potential, the thickness swell should be tested in boiled water. But for most OSB the normal exposure is more like a temporary test. The Japanese standard calls for a 72-h water shower test, but for most of the tests it is really a 24-h water soak under room temperature conditions. If we densify the product we usually achieve lower thickness swell. But then the opposite can happen if we do a boil test because there are two things happening there. If we densify the board the moisture doesn't get in. So if I am in a mill and I want to try something, I would try to densify the surface to suppress the moisture from getting in. But I am cheating a bit in that I am just delaying the swell. Somebody who is familiar with construction can tell us whether we need a boil test for OSB, but it is a different story as far as the density effect goes.

Fred Kamke: I want to make a brief comment first about the nail holding resistance of OSB and refer you to Alex Salenikovich, now a professor at University of Laval. Alex, when he was at Virginia Tech as a graduate student, was working on this very topic with OSB and its nail holding capabilities in regards to the rigidity of wall structures particularly in earthquake situations and he has got quite a bit of data on that. Alex then went to Mississippi State where he continued some of that research.

My other question had to do with I think it was Siquin's slide number 34. It was labeled "Typical Pressing Procedures for OSB." It had to do with the influence of the two step closing process on the development of the vertical density profile. It is easier to see the vertical density profiles on the printout than it is on your slide. However, you do have quite distinct differences in the peak density and then you show a result of what I think was a 24 h thickness swell test. Visually they look dramatically different, the one on the right with conventional pressing looks much worse than the one on the left, why is that?

Wang: Maybe we need to explain that two closing strategies. In our conventional pressing, I used just constant speed closing so that the press starts at the beginning position and it goes to the final position in 60 s. Because they were slow to close, there is more time for the surface to heat up and the

resin on the surface to cure. So after a 24-h water soak, you can see that flakes peeled off from the surface. That performance issue is probably related to press procedures. After 60 s the resin may not be fully cured and that results in some kind of effect. Did that answer your question?

Kamke: Maybe I misunderstood the press schedule here. So the conventional schedule was just a constant rate closure over a period of 60 s and the two step closing had a more rapid press closing rate initially and then it slowed down for a total closing time of 60 s. Is that correct?

Wang: Yes, total closing time is the same; it is a 60-s close to final position. In the other pressing method, the step closing strategy, initially we very quickly closed to 110% of final thickness and held there for a while, then closed to target thickness over the final few seconds. The quick close results in a denser surface. By holding there, we let the core warm up and when we close from 110% of target thickness to the final thickness, we now densify the warmer core.

Cloutier: I would just like to point out that when we are talking about optimizing the density profile we must not forget about dimensional stability of the panel in service. I have been working with Stefan Ganev from Forintek East over the last two three years on those problems of warping and it is clear that the linear extension is the driving force for warping of panel in service. We have also found working with CPA that a steeper density profile produced a panel that is more prone to warping due to the earlier expansion in the plane, this parameter increases with wood density so I think that this is quite important and should be considered. For those interested in that, there is a report available from CPA (Ganev and Cloutier 2003) on those results that we obtained. But the density profile clearly has an impact on that.

Wang: I think that is a good point. Another thing I want to explain is how that applies when running an OSB mill, where we may want good quality with a limited density range. So the challenge for the OSB mill usually is maximize bending properties, such as MOE, when using low density species like aspen. So usually what they do is try to first achieve adequate bending properties, then consider other issues, such as density, and then adjust accordingly. If after such adjustments, everything meets the base standard they stay there. If they are much higher, they just try to retain the benefit while they decrease overall the density.

Ted Frick: One of the things that you will see in practice in a mill of course is fluctuating moisture content in your surface and core layer. Have you done any studies within the normal range where moisture content can fluctuate how that affects vertical density profile when you stick to one standard press schedule?

Wang: No, I have not done anything specifically looking at the influence of different moisture distributions.

Al Christiansen: Is it possible that as we are releasing pressure we are breaking bonds that have been formed already and is it a problem related to the differences between the faces and the cores? I mean if you get your resin cure too soon before it is relaxed you are going to be breaking a number of bonds.

Wang: Yes, I think that is what happened. Otherwise we cannot explain why the high-density area on the outer layer might have lower shear stress or internal bond strengths compared to the lower-density core area. So that is the reason why the resin companies now supply different face resins and core resins. They want to slow down the face cure and speed up the core cure. This use of two different resins changes the cure history. That means that as we build up the surface we need to make sure resin is not completely cured. Otherwise, if we already have resin cure and we try to further build up the density profile, we break down the bonding.

Dai: Like I was saying Al, in a mill where they have low IB, normally what they see is more blister or blows. So they use IB as a control on the blow too. And the other factor relating to what Siqun was saying about the weakest link not being at the very center has to do with the fact that sometimes in pressing the intermediate layer accumulates higher moisture than the core layer. Phil Humphrey has done some work showing that in some pressing strategies we can have a situation like that, especially when we create a high humidity in intermediate layers due to fast closing or a fast pressing schedule. The curing won't be as good because there is so much moisture there in those layers. Then the intermediate layers can become the weak link.

Katherine Friedrich: I believe that one of you had a slide in which you showed cure temperatures for different types of curing. It was a chart on which you had a table and I was wondering, how do you determine and what type of test did you do to determine whether it had cured or not.

Dai: Yes, that is my slide. What type of test did we do? Well, for bonding, we usually test for IB just to check whether it's cured. The rule of thumb is such that we need to keep certain temperature and to hold it for a certain period of time, and for different thickness or different resin, the holding time might be different, particularly for MDI, because the target temperature can be a little bit lower. Now the holding time is very much depending on the thickness of the panel we press. I mean if we press a thicker panel, we have a bigger heat sink so the core temperature can be lower than when pressing a thinner panel. Also, the residual heat there helps cure to continue after pressing. Looking at the table, the plywood and the LVL actually don't list the holding time, the main target is just to achieve a certain core temperature because in plywood or LVL pressing it takes awhile for it to decompress, usually stepwise decompress helps provide enough time to cure the resin and also in LVL plywood situations

the compression force is so much lower compared to OSB and other particle composites. We talked about this compression issue yesterday. We had to densify as much as 50%–60% to achieve a certain intimate contact. But the byproduct of that is residual stress. In plywood and LVL we don't have that and so we are able to press lower and use less time.

Friedrich: So it was a specific level of strength that you were looking for in the internal bond test then, to determine whether it had cured?

Dai: Yes, it's the curing but resin companies they do a lot of instrumental analyses, I mean like what degree resins start to cure and accelerate. Maybe Chip and the adhesive guys can add on that. I mean each resin has a temperature in which curing starts to accelerate and then you still need a little bit more time to achieve full cure. But then when we are applying the conditions to real wood samples, we have to deal with them situation by situation. One rule of thumb is that we try to achieve, let's say over 100°C for a certain period of time and then at the end we try to reach a maximum temperature, say 150°C, but in that process I have achieved the 100°C core temperature for say 3 min or 2 min or even 1 min, so that is the sort of criteria to apply to determine the curing conditions.

Pablo Garcia: Something I know that I have seen in use that panel MSR system where they flex the panel online after the hot press. Do you know how well they are doing or whether they have seen an increase of popularity in that use for process control?

Dai: When I put these slides together about the testing methods and stuff like that I realized I missed the end panel MSR and there are two types, one is developed by ARC. CAE is the commercial arm for that. Then there is another type out there by TECO, there is some moderate success, I wouldn't call it an even success by either product, the ARC system is good and it is a beautiful machine, they have two units installed, one in BC and the other is in a LP mill, which I think it is in Dawson Creek. So they have two units sold and its basic concept is to shoot a panel through a set of rolls depending on the deflection, oh no, it is the same deflection but it depends on the load cell and it can measure the stiffness of the panel. And it is very fast, it's online so it can monitor the strengths of the product being made, panel by panel. But I think there are two things that are causing, it not going further. First thing is this can cost over a half million dollars for hardware, and then plus installation it is a million dollar equipment. The second thing is that it is very useful but they haven't been able to teach or work with the mill to come up with some sort of a process control, methodology that can be used to mills profit. You know, they just can't link that to the profit, I mean it is good data but mills say so what, I can't use it, and what do I adjust? So then it becomes a question of knowing what sort of products they are making now, what should they be adjusting. Is it

density, is it resin content, is there anything else, closing rate? And that has to be established, the software side hasn't been well established and I think those are the two reasons that that is not taking off as well as it should be. And I think it is still a good technique and as far as the TECO unit, I hear that, no mill has actually used it so I don't want to comment further on that.

Karl Englund: One question I wanted to ask, we talked about determining our MOE and MOR, has anybody looked at changing the span to depth ratio on these things? As far as if we are developing this large gradient in the vertical density profile, if we change our span to depth ratio in testing, we would get a different type of failure. I would think if we have a very low core density we would start to see a little bit more shear failure in our bending. It goes along the lines with online processing control, do they change the span to depth in those rollers at all and take into account those things?

Dai: There has been some work done by Forintek and ARC looking at shear failure and even looking at the effect of fines on shear failure and that kind of stuff. As far as changing the load and depth ratio, I haven't seen any mill try to test it differently, they follow the standard right? I mean are you talking about changing the codes or standard when changing the span ratio for different products?

Englund: No, I am not talking about changing the codes; I wouldn't want to do that. With these increased press run times on the presses, we are starting to see these density profiles really kind of affecting properties, thickness swell, etc. I think not everything out in the world is a 16 to 1 span ratio. There are going to be scenarios where you are going to have a shorter span where you might start seeing shear failures. I was just wondering if anybody has taken it into consideration.

Dai: I haven't seen much work done, I think that will be a question put to the codes and standards people actually because whatever the mills do, they follow the standard, they try the minimum test to pass the standard and then you know to generate the maximum profit. Ted you want to add anything?

Ted Laufenberg: The panel performance codes embody a separate test for that type of function for shear capability and concentrated load testing is that, whereas the flexural test is strictly for that long span bending assuming we don't have shear failure. I wanted to make a comment earlier though and this is a good time to do that. Having to do with thickness swell and what we see is not always just a function of vertical density profile, it is also a function of horizontal density profile. You have got a lot of variability in your panel, in your forming; your constituents perhaps may cause some of that. If you have only got 30 constituents per thickness versus 3000 as you have with MDF versus OSB, then you are going to have a lot more horizontal density variation

and that results in property changes and thickness swell is one of those. If we could talk more about fasteners and the variability there, but there is also an opportunity, if we have a horizontal density profile that we have control of, one situation might be racking strength, where you are looking for enhanced fastener capability at the edges. Somebody smart enough could make their panel denser at the edges to make that a marketable product and really benefit the industry. I don't know where else to go with that but shear capacity is highly influenced by density yes, but we have separate testing in the codes.

Dai: I think I can sort of comment on that Ted. It is true that vertical density profile is always there everybody knows, horizontal density profile sort of like I mentioned in the presentation, Otto Suchsland sort of started, you know he is the one who first mentioned it and then we actually did quite a bit of work in modeling that. The relationship between the horizontal density variation and the strand geometry and even species and the fines content, and also based on that. ARC has established a laboratory testing scanner, it's a x-ray scanner you can run the panels through you will know the density and variation and I know that some of that is already being used by Truss Joist, looking at their timber strand and I know it is very important. Yes, there are two things as far as I am concerned about the horizontal density variation, the effect of that on property. One thing is, we all know, horizontal density variation contributing to the graphing or uneven thickness swell the other thing is, I didn't have time to mention in my presentation, I'd like to make this analogy, I don't know if it is correct, if you look at a plywood and compare to OSB, their properties are comparable but then if you look at plywood average density which is 0.4 or 0.45 okay so what I am saying is the densification of that product might be like 5% to 10% right? Then if you look at OSB, we talked about it yesterday, it is 50% or 60%. Because of this inherent density variation, in order to create intimate contact between strands, you have to densify the product that much, the byproduct of using discrete elements or constituents like strands. In the case of LVL/plywood you have more uniform and continuous veneer sheets and you have less variation so you can just press a little bit and its done, OSB, no, you can't do that. But that is just the inherent part of it that is governed by the geometry of the strand, the fines content and species. However, there is a move in the industry right now, people are more looking at the forming issue, like how well the forming machines do? I mean like you have the inherent variation but the machine can also induce variation so that is why it is important to monitor what sort of a variation you have with your OSB mat, so once you see it exceeds your target limit and you have to do something about it, especially for a commercial product where the width of line is expanding, what is the widest production now, is it 16 ft or 24 ft? And so over that span, I mean your mass variation, it's very difficult to control so it is becoming very critical and talking about the importance of making low

density product, unless you have a good control on your density variation you can't go too far with lowering your overall density of the board.

Wang: Yes, I agree that the horizontal density distribution is definitely a big player for thickness swell and Mike Wolcott had a student who researched this a couple years ago. They had a publication on their Pullman proceeding. The point is here, we know the horizontal density distribution is very important but manufacturers don't want to do a lot about it. For example, a typical OSB strand right now is around 28-thousandth-in. thickness. If we use the thinner flakes making the same product, the horizontal density distribution will be less than when we use the thick flakes and the property will be increased. The problem is if we use the thinner furnish that means we have more surface to bond so we have to use more resin. Maybe resin companies will be happy about that, but if you are making a 3/8-in. thick panel and we use the 28-thousandth-in. flakes, there are not many flakes on that layer. I mean whole thickness probably includes only 10 to 20 layers of furnish creating tremendous internal stress over that thickness.

Dai: And on the strand geometry, I would like to add to Wang's comments about the thickness effect, yes, we found that the thickness has the biggest effect on horizontal density variation followed by width and fines content has a huge effect too. But if you try to manipulate thickness and there is another factor in the production, that is, you try to make it thinner, you have more bulk volume to deal with and for some of the forming and you know the production it is designed for certain volume so you have more volume and you can't handle that and so that is one thing. Another thing is about thickness effect which is really intriguing, if you use too thin strands, I don't know if it is much to do with the overall consumption of the resin, thinner strands create less micro voids, especially on the surface, you will have a hard time to vent, you will have blow. So there are a lot of factors to consider when it comes to pressing.

Lee: You can find some articles on the linear expansion and the thickness swell in OSB, done by Quinglin Wn at LSU as an extended work of Otto Suchland and we did some modeling to predict the thickness swelling through the thickness of OSB and we found that there is a higher relationship between density and the thickness swelling but here the density, the localized density, so if you have averaging, I mean two specimens with the same average density you cannot predict that they would have the same thickness swelling. In case you have a vertical density profile, the highest density creates problems, so uniform density profile will make you less thickness swelling overall. In the same concept, if you have a very high horizontal density variation, any spot with very high density will cause the problem so in order to reduce the horizontal density variation, you have got to have a low density strand rather than thinner strand because there is a certain limitation that you can make the same strand

because strand properties determine the OSB properties. If we have lower density strands you can control much easier the overall horizontal density distribution.

Garcia: I was really interested about the aspect of densifying the edges of the mat; I think there are sort of several advantages in that. I know, well yesterday it was pointed out that some mills will densify their edges, I also heard that some mills will somehow drop more furnish in the middle and that has the advantage for racking strength because your mat is cut down the middle and you cut into 4x8 sheets and that is where you are sticking the nails through. But from a heat and mass transfer side, yesterday we heard the lateral permeability has a very important effect and so I started looking at densifying the edges in the heat and mass transfer model and what I seem to get is, well what you are essentially doing is sealing the gas pressure in the mat, you are sealing the moisture in, there is less moisture escaping out the edges, less heat escapes out the edges, so you move from essentially getting toward the edges, you move from a more rounded distribution, more dryer edges, more cooler edges, to a more table-top distribution with very uniform internal conditions and towards core. You would expect that gas pressures instead of sealing everything in, you are probably more at risk of blows and stuff because now you have not got high gas pressures inside, but I didn't test this on big mats, this is pure modeling, but since the mat is so big now, 24 ft by 12 ft master panels, in the middle of the mat where you expect your highest gas pressures, the increase is barely noticeable because you are so far away from the edge anyway. So all these effects are going to undoubtedly have an effect on vertical density profile and uniformity of vertical density profile from the middle of the mat towards the edges. If uniformity is a sign of quality, densifying the edges could be a way of getting more uniformity in your mat from that side.

Kamke: Something dawned on me, Chunping, when you were talking about the amount of hydraulic pressure required to close the press and you showed a slide where the hydraulic pressure reached a maximum and then was held constant for some period of time prior to reaching the target thickness of the mat. You had to rely on creep strain to achieve your final target thickness. I guess my first question is, is that maximum in hydraulic pressure, because of the maximum pressure available in the press or was that actually intentional to use the maximum and allow it to reach the target thickness just based on creep?

Dai: Basically, you are talking about pressure reaching to the max some sort of a plateau there and there being held more or less let the thickness to creep to the target.

Kamke: Yes.

Dai: Yes, it is very common in OSB pressing and yes, it pretty much depends on the maximum pressure of the press. It is something limited by the equipment and you know the higher the pressure you get, the more you have to pay I guess. So in a way it is limited by the maximum pressure you can apply in practice. I know in a lab it can go higher than that.

Kamke: Well, what dawned on me is I wonder if this might be an advantage, maybe not intentional but an advantage in regards to the final strength of this product. My point is that if you don't have such a high mat compaction pressure, perhaps you do not cause compression failures in the wood strands. Particularly if you think about the horizontal density distribution in some of those areas within the mat you are going to have extremely high density. Your probability of causing some compression failure in those strands might be quite high. In fact it is probably guaranteed that you cause compression failures and the cell walls fracture. Well, if that happens then I would expect that you are not going to have very good strength properties and it is not due to a poor adhesive bond. It is due to the fact that you have got wood that has been fractured and it has virtually no resistance to bending stresses and shear forces.

Dai: Fred, that is a very good observation and I would completely agree with that and we actually did some tests in the lab where we just looked at a solid wood, we compressed it into different compression ratios, let's say 5%–10% representing plywood and then 25% even to 60%. After that we wanted to see what was the internal bond strength after pressing. We found that the IB was reduced. If IB is the test of the integrity of the product or the bonding or whatever, in the wood, then these results indicate that the wood is ruptured due to pressing. And of course high densification helped to create more intimate contact for bonding for OSB if you just keep the compression relatively low and you don't have much high pressure built in. So in this case, yes, it could be an advantage. I believe this sort of pressing strategy is going to be used for OSB as they try to reduce the overall density. You want to create a minimum density with maximum bonding. How do you do that? You do it by achieving minimum wood failure and minimal stress.

Heiko Thomen: I would like to introduce another aspect. We basically are just talking about batch presses here. My own estimation is that in Northern America approximately 80% of the wood based panels are produced on batch presses so that is the reason why continuous presses are not of much interest here. In Europe, it is the other way around. About 80% of the wood based panels are produced on continuous presses so there was a development in the last ten years. There are definitely differences between batch and continuous presses. Chunping, you mentioned that there is not much underlying money to run control and probably that is right for batch presses. But I think for continuous presses there is a lot of underlying money for process control already. So my

question is, where is North America heading? Will North American companies move toward continuous pressing within the next ten or twenty years or will they stay with batch presses?

Dai: Okay, my first comment is that I guess continuous presses are very good and nice, but the initial capital investment is large. I think probably the trend, like in your new European mills now, is that they are moving towards the continuous press because it gives you so much production. The total volume production and also the potential for manipulating the process to achieve real-time control, instead of the programmed control is vast. So I think that is where the future of North America pressing is going. But then again, it is cost driven. Anybody from the industry can add on that?

Wang: In a continuous press, what we are gaining is more flexibility to control it when compared to multiple opening or single opening presses. For example, in continuous pressing we often try to use different temperatures at different stages. We might add in a cooling stage before the mat enters into the continuous press or they might have a pre-heating unit to heat up the mat first. I think that in the future, the trend in industry will be to use the continuous press rather than the multiple opening or single opening. But it depends on the application. I think we agree that when we press thin panels using a continual press will have a lot of advantages. Often they don't even need to sand the surface. They are ready for finish and painting. Often, a batch press will not achieve this same surface quality.

Kamke: I have a follow up question directed at the Press-MAN monitoring and control systems. This question goes to both of the speakers. How are these companies using this data on the internal mat conditions? Is it just a curiosity or is it actually being implemented and improving the process?

Dai: Some mills use the data offline. Whenever they have some problems, they study and use it to check out and correct things. But, steam pressure and temperature probes are also sometimes used in mills. They are used as a tool for looking at internal mat condition, and then they use that data to modify their process.

Kamke: I have used the gas pressure probes and temperature probes a lot in a lab press and witnessed their use in commercial presses. In the lab press where we have a much smaller mat to work with and a lot more time to insert probes, it is still quite a challenge to get it positioned where we want it to be. If you want to have a center core measurement, it is difficult to find that center core measurement particularly with a strand mat. I wonder about an industrial process, where you have got things moving down a line and you don't have much opportunity to stop things and get things aligned, how can they really use that data if they don't know exactly where that probe is located?

Dai: They sort of look at, it is not just one board though, they have to look at a bunch of boards and develop some understanding on their conditions and they use more than one sensor usually for one board, too, so you can look at the average and remind you it's the temperature that is causing most of the problem if there is variation, the gas pressure as you and I know, has little variation between the surface and the core as the pressure is built up. So the positioning of the probe isn't going to cause any big problem to monitoring the gas pressure. Yes, I agree with you about the temperature measurement. I have seen they use just thermocouples and stuff like that to monitor temperature.

Kamke: So, if I understand you correctly, do you believe that the industry, at least that you are familiar with, in their applications of the PressMAN monitoring system, that they are interpreting that data in a reasonable way and being able to use it to their benefit?

Dai: I think they have benefit, yes. Otherwise how can you measure mat conditions? PressMan is a valuable tool for measuring gas pressure.

Kamke: I know that GP Resins has been distributing a system that they call "Press Monitor." I thought there was somebody else too that had put together their own little system. PressMAN might be the only one that is actually being marketed and sold. But the concern I've had since that technology has been adopted is that there is a lot of data collected and the people in the mills are overwhelmed with data and don't necessarily know what to do with it other than in its very simple form.

Dai: Oh, I agree, it is like this thing about the MSR and once you get all this data collected in the mill, you have got to make it easy for them to use. And there is no easy way, no established way, that they can follow like A, B, C stepwise to develop their recipe. They still have to interpret it themselves and the other challenge like I said, if you stick a probe in the mat and if you don't know what kind of a moisture and species or fines content you have, your measurement is only very general because it varies with the kind of material you are dealing with and so that is another challenge in the mills.

Wang: Another thing that we can use is the core temperature signal. We know we need to get to a certain temperature above the boiling point and for resin cure. But how long should we stay there after reaching 100 degrees? Thinner panels require a shorter time after close to final position to get the core temperature up to 100 degrees. But when we press a very thick panel, we take a few minutes, maybe even 10 min longer to get to that point. My point here is that the resin on the thick panel is starting to cure even before we reach the 100 degrees. Based on a typical core temperature curve, we can look at how much energy is being transferred into the mat and how long it is above 100 degrees.

Winandy: I would like to thank our two session moderators here. Please give them a round of applause.

Simulation of the Pressing Process

Heiko Thoemen

Department of Wood Science, University of Hamburg, Hamburg, Germany

Abstract

There has been a rapid growth of computer simulation techniques in almost all engineering disciplines for the last two decades. Correspondingly, an increasing number of research groups are working on hot-pressing simulation models, and such models are already used for a wide range of applications. An overview of some of the existing models is given in this paper, and typical applications are described. While all modeling approaches for heat and mass transfer are relatively similar, different approaches for rheology and adhesion are used. Main challenges for the modeling community are the reduction of execution time and, even more important, the improvement of the quality of model predictions. Both the refinement of existing modeling approaches and the determination of material property data are critical for improving the model predictions. Although some repetitions are fruitful, redundancies should be reduced to improve the efficiency of research in modeling the hot-pressing process.

Introduction

Simulation techniques have entered almost all disciplines of science and technology. One of the most prominent examples is the flight simulator. And the design of modern cars would not be thinkable without simulating and optimizing the air flow patterns in a wind tunnel (Figure 1). The advantages of using simulation techniques are evident. Compared with trial and error procedures conducted in the real system, simulations are relatively inexpensive, they can be executed with hardly any risks, and they are fast, because usually only little equipment setup is necessary. Furthermore, simulations can help us understand events that are not measurable, such as events in history (e.g., continental drift), in future (e.g., ecological systems), or processes that are inaccessible (e.g., in space).

On the other hand, there is the danger of oversimplification when applying simulation techniques. When the German car manufacturer Mercedes-Benz developed the A-Class (so-called Baby-Benz) during the 1990s, simulations were used to secure the curve stability of the car. However, it turned out in real tests that the vehicle had the tendency to overturn when going too fast through a narrow curve. To solve this problem, each A-Class Mercedes was provided with an electronic stabilization system (ESS) for about 900 US\$. The improper usage of simulation can have costly consequences, as demonstrated in this example.

Nevertheless, usually the advantages prevail, and consequently, there has been a boom of simulation in recent years. A large number of software packages have been developed as simulation tools, entire companies have specialized in numerical simulations, and there is a huge and still growing scientific community dealing with numerical simulation.

When simulating the pressing process of wood furnish mats, the subject of heat and mass transfer through a porous hygroscopic material has to be addressed. The same subject is of importance in numerous other disciplines, as well. Examples include food drying, paper manufacture, convective and diffusive transport processes in textiles, and heat and mass transfer phenomena investigated in geoscience. In the future, the different disciplines working on similar topics may profit from each other much more than has been the case in the past.

Simulation may be defined as a research or teaching technique in industry, science, or education that reproduces actual events and processes under test conditions (Encyclopedia Britannica 2003). This is a very general definition and includes computer simulations, the subject of this paper.

The typical sequence of computer simulation is displayed in Figure 2. The real system to be simulated is described by a model that typically consists of a set of equations. Once the model has been implemented into a programming code, the program can be executed to compute the model predictions. The model predictions have to be validated by comparing them with the real system, and a new iteration may be necessary if predictions do not match the real world data.

To do the execution of the computer program, the use of appropriate material property data is of essence (e.g., thermal conductivity or permeability of the mat). In simulating the pressing process of wood-furnish mats, these data are highly dependent on the local mat conditions, such as mat temperature, moisture content, or density. Knowing these dependencies is critical to achieve accurate model predictions. Because the mat conditions vary considerably within the mat and throughout the process (e.g., local densities may vary between 50 and 1,200 kg/m³ for medium-density fiberboard (MDF)), determining material property data for the entire range of material conditions is time consuming and may require elaborate testing equipment. The lack of appropriate material property data is still one of the limits in simulating the pressing process of wood-furnish mats. Some references

of material property data presented in the scientific literature are included in this paper.

State of the Art

An overview of those physical mechanisms most relevant during hot-pressing is given in Figure 3. The mechanisms may be allocated to three different groups of mechanisms, which are heat and moisture transfer (or heat and mass transfer, respectively, if air flow through the void system is included), rheology, and adhesion.

The individual mechanisms listed in Figure 3 are highly dependent on each other and, therefore, cannot be looked at in isolation. Consequently, for modeling the process, an integrated approach is required that accounts for the interdependencies of the mechanisms. However, for this state-of-the-art report, a separation of the groups of mechanisms is helpful. The three groups will be described and discussed individually here, followed by a brief overview of numerical approaches used by different research groups and of the different press types simulated so far.

Heat and Mass Transfer

Contrary to the other two groups of mechanisms, all researchers working on modeling the pressing process use a similar approach to describe heat and mass transfer. This approach was introduced for the first time by Humphrey (1982) and Humphrey and Bolton (1989) for flake mats and has been adopted for MDF and oriented strandboard (OSB) mats, respectively. Since then, it has been adopted by Carvalho and Costa (1998), Hubert and Dai (1999), Thoemen (2000), Zombori (2001), and Garcia (2002). The following description is an enhancement of the approach presented by Humphrey and Bolton.

Even in its highly compacted stage, the wood furnish mat is a capillary porous material that consists of a matrix of wood material and a system of inter- and intra-particle voids. The voids are filled with a gas mixture consisting of air and water vapor as its main components.

Three different mass transfer mechanisms that may be relevant during hot-pressing are illustrated in Figure 4. While gas convection is the main mass transfer mechanism, it is generally agreed that gas diffusion and bound water diffusion only play a minor role. Gas convection is the bulk flow of the gas mixture along a total gas pressure gradient. Such gradients develop both perpendicular to the mat surface and within the mat plane. If the convective gas flow through a porous material is laminar, it can be described by Darcy's law.

Both heat conduction and heat convection are important mechanisms during hot-pressing (Figure 5). Heat conduction may be described by Fourier's first law; the flux is proportional to the temperature gradient. On a microscopic level,

the main flow path of conductive heat transfer is the wood material. Contrary, convective heat transfer is associated with convective gas flow through the void system of the mat, in combination with phase change of water. Radiation as a third heat transfer mechanism is believed to be insignificant in this type of process.

Two important equilibrium assumptions are made by all research groups that have published their models, so far. The first assumption is the assumption of instantaneous sorption equilibrium. It says that there is always local sorption equilibrium between the atmosphere in the voids and the moisture content in the adjacent wood material and that there are no moisture content gradients within single particles and no partial pressure gradients within single voids. Second, it is assumed that there are no temperature gradients on a microscopic scale. These two assumptions are more realistic the smaller the wood particles are. They may, however, be critical for strands or other types of large-size particles.

The most important material properties needed to describe heat and mass transfer are thermal conductivity, permeability, and hygroscopicity. A comprehensive literature review on data for these properties is given by Thoemen (2000). Only a brief excerpt from this review and some newer work is presented in this paper.

Thermal conductivity is a function of density, moisture content, flow direction, and to a lesser degree of temperature. Measurements of thermal conductivity have been conducted, among others, by Shao (1989) using unresinated fiber mats, and by von Haas (2000) using MDF, particleboard, and OSB panels, as well as unresinated mats. Both workers covered a wide range of material conditions. A different approach was used by Zombori (2001), who calculated the thermal conductivity of the mat, instead of measuring it, based on the thermal conductivity of solid wood, the thermal conductivity of air, and the structure of the mat.

Permeability of the wood furnish mat depends strongly on the mat density and the flow direction, while mat moisture content and temperature has only a little, if any, effect on this property. Unlike thermal conductivity, the direct derivation of the permeability from the mat structure appears to be difficult; so far, only measurements have been reported in the literature. The most comprehensive set of permeability data for MDF, particleboard, and OSB panels of different density levels has been presented by von Haas and others (1998). A method designed for a quick data acquisition has been introduced by Haselein (1998). The wood furnish material samples are densified step by step during a single sequence of measurements, so that permeability data for a given material type can be attained without having to manufacture several panels of different densities.

Hygroscopicity, i.e., the affinity of the wood material towards water, is independent of the mat structure but is a function of relative humidity in the pore spaces and of

temperature. So far, only few data are available for high temperatures, and there are considerable discrepancies between those data, particularly for high relative humidities. Both theoretical models and measurements have been presented in the past.

The most frequently used theoretical model is the two-hydrate Hailwood and Horrobin (1946) model. However, for temperatures above 150°C, the model gives somewhat erratic values that deviate considerably from experimental results at all relative humidity levels. Another set of hygroscopicity data often used is that presented by Kauman (1956) for temperatures up to 180°C and high relative humidities; they are extrapolations from measurements done at atmospheric pressure.

Among the most comprehensive hygroscopicity data for elevated temperatures and relative humidities available today are those presented in the Wood Handbook's (FPL 1999) for temperatures up to 130°C and those measured by Engelhardt (1979) for temperatures up to 170°C (Fig. 6).

Those heat and mass transfer models developed in recent years typically predict the development of mat temperature, moisture content, water vapor pressure, and air pressure, among others, over space and time. Examples of predictions obtained with three different models are displayed in Figures 7 and 8.

Rheology

Taking the term rheology in its narrower sense, it describes only phenomena such as viscous or delayed-elastic deformation. Stress relaxation and creep processes are consequences of such types of material behavior. However, in this paper, the term rheology will be used in a broader sense, following the convention facilitated by Ren (1991). According to this definition, the rheological behavior of a material includes time-dependent as well as instantaneous deformation processes. Such usage of the term rheology reflects the fact that both aspects of the material behavior are interactive with each other.

As already stated above, some of the material properties needed to compute heat and mass transfer phenomena are highly dependent on the local density of the material. Consequently, a heat and mass transfer model will only provide reliable model predictions if the density distribution in the mat is accounted for; a procedure to compute the densification of the material is required.

Two different approaches to model the rheological material behavior during hot-pressing are summarized here. The first one goes back on work done by Ren (1991) working together with Humphrey; it uses a rheological model, consisting of three springs and two dashpots (Figure 9a). Each of the five rheological coefficients is a function of temperature, moisture content, and density. Before the model can be

applied for a specific material type, the coefficients have to be determined experimentally for the entire range of conditions. A set of rheological coefficients for MDF have been presented by Thoemen (2000), covering the entire range of internal mat conditions relevant during hot-pressing. These data have been derived from experimental work done by von Haas (1998), who also included two different flake furnish materials and one OSB material in his study.

The second approach has been applied by Dai and Steiner (1993), Lang and Wolcott (1996), and Lenth and Kamke (1996). The models of these three research groups have in common that the compaction behavior of the mat is assumed to be governed by two independent factors: the geometry of mat and wood constituents and the properties of solid cell wall substance. If the influence of environmental variables such as temperature and moisture content is restricted to the cell wall substance, as proposed by Wolcott (1989), this approach provides a technique to compute the stress-strain relationship under different environmental conditions relatively easily, once the relevant geometrical parameters are known. So far, research based on probabilistic and geometrical theory to model mat consolidation has been restricted to mats made of strands or small pieces of veneer.

By combining a rheological model with a heat and mass transfer model, the development of the cross-sectional density profile, as well as the horizontal density distribution, can be simulated. Figure 9b displays the cross-sectional density profile development simulated by Thoemen (2000) for an MDF mat.

Adhesion

Adhesive cure has an impact on the thermodynamics of the system on the one hand and on the bond strength development on the other hand. The first of these two effects is due to the exothermal cure reaction of the adhesive, which generates heat, and to the condensation reaction, which adds water to the system.

Clearly, the localized bond strength development has a direct impact on the final panel properties but also on the rheological behavior of the mat inside the press. Particularly, modeling the impact on the panel properties is of high economical significance and can, therefore, be expected to be one of the great challenges of the next decades. Important work towards this goal has been done by Humphrey (1994), who developed the Automated Bonding and Evaluation System (ABES, Figure 10a), and by Heinemann (2003), who presented, only lately, the Integrated Pressing and Testing System (IPATES, Figure 10b). While the ABES can be used to test the bond strength development on small veneer strips in shear mode, the build-up of the internal bond strength perpendicular to the plane of fiber or flake samples can be observed with the IPATES. By using the data obtained by IPATES, in combination with a heat and mass transfer

model and a rheological model, the development of the internal bond strength can be simulated (Figure 11).

Numerical Approaches

It is not intended at this point to give a full description of the different numerical approaches used for simulating the hot-pressing process. However, it seems to be worthwhile to mention the large variety of numerical methods used by different research groups. Hubert and Dai (1999) use the finite-element method, Humphrey (1982) and Thoemen (2000) describe an algebraic approach, Zombori (2001) and Carvalho and Costa (1998) apply the finite-difference method, and finally Garcia (2002) describes his approach as a finite-volume method. Obviously, all the approaches mentioned here are appropriate to solve the set of equations describing the hot-pressing process.

Different grid schemes have been used in the past. Humphrey and Bolton (1989) started with a cylindrical coordinate system. Today, two-dimensional (Zombori 2001) or three-dimensional (Thoemen 2000) grids are used. Hubert and Dai (1999) describe their grid scheme as a one-dimensional grid, but they account for vapor escape through the edges of the mat by an approximation of the in-plane vapor flow.

Simulation of different press types

The press most frequently simulated is the conventional batch press of either one- or multi-opening type. A model to simulate the processes inside a steam injection press has been presented by Hata and others (1990). Simulation models of the pressing process have also been extended to include pre-heating of the wood-furnish material (Pereira and others 2001).

Because the continuous pressing technology has gained considerable importance during the last two decades and because the number of continuous presses will certainly continue to grow, Thoemen and Humphrey (2003) presented a model that can be used to simulate both batch and continuous presses. Important differences between these two press types are the gas flow patterns at the press entry and outlet and the fact that the boundary conditions vary along the length of the press in production direction. Figure 12 displays the total gas pressure distribution and the horizontal gas flow pattern within the mat while passing through the in-feed section of a continuous press.

Applications, Potential, and Limits

Typical applications of existing hot-press models are education and training, process optimization, equipment development, product design and development, and research. Some examples of such applications are discussed here.

When using a model as a tool for education and training, the learning goals may vary considerably, according to the target group addressed. While clarifying and visualizing the interactions between the different process parameters and mechanisms may be more applicable for students on the college or university level, the technologist and plant operator is probably more interested in the specific effects of the pressing parameters on the panel properties. In any case, statements should be presented as clearly and straightforward as possible. Particularly for training operators, the user interface of the model should resemble the input variables and logic known from the control screens of the real process as close as possible.

A typical process optimization problem can be described by means of the following example. Differences in the vertical density profile across the width of the panel are a well known phenomenon. When addressing such problem, important questions are, what are the reasons for this phenomenon, and what can be done about it? A hot-pressing model that is able to predict the development of the vertical density profile is certainly a helpful tool to investigate these questions. In case the model predictions are rather qualitative than quantitative in nature, vital insights valuable for solving the problem can still be expected from simulations.

Hot-pressing models already play an important role in equipment development. A good example for this is the design of a pre-heating system. Typical questions that have been addressed are how does the design of the system affect the efficiency of pre-heating and how does the pre-heating affect the density profile and the pressing time. Expensive and time consuming experiments cannot be completely substituted by using a simulation model, but experience shows that they can be significantly reduced.

To stimulate the use of simulation models by the wood-based composites industry, the modeling community has to understand the demands of the industry. First, models have to be easy to use. Second, the industry has to become familiar with the potential of simulations. In other words, appropriate promotion is required. And third, the limits of the models have to be stated clearly.

These are important prerequisites for widening the use of models. Above, of course, great challenges are the reduction of the execution time of the models and the improvement of the quality of model predictions. To meet the first of these challenges, it may be necessary to further optimize the numerical solution schemes or to use parallel computing techniques or super computers. However, it is reasonable to assume that the hardware industry will continue to rapidly improve the power of personal computers. Therefore, working out concepts to reduce the execution time of the model is not necessarily the highest priority for the model developers.

The improvement of the quality of model predictions clearly is the greater challenge for the modeling community.

Although some of the existing models have reached a stage where they can be used for a wide range of applications, a further enhancement of the simulation results is still desired. Such objective requires work on material property data, as well as significant model refinements itself.

Reducing the execution time and improving the quality of model predictions are also prerequisites for applications that may become important in the future, such as solving optimization problems or online process control. An example of an optimization problem is to specify a desired density profile and to approach this profile by an iterative procedure. Such iterations are typically very time consuming. An online process control application could be a situation where a sensor detects a change in moisture content of the mat. The model then evaluates the new situation and decides to adjust the pressing time. Neither work on optimization problems nor online process control applications have been reported for hot-pressing models so far.

One important feature of a model that has not been mentioned yet is its availability to the potential user. Unfortunately, not all hot-pressing models that have been developed are available to the industry.

The simulation software MatPress (Hubert and Dai 1999, Dai and others 2000) of Forintek Canada Corporation is accessible only to Forintek members. The hot-pressing model developed by Zombori (2001) is part of a larger simulation environment, the WBC Simulator (Figure 13). The software cannot be purchased, but it runs on the server of the WBC Center (Virginia Tech, Blacksburg, Virginia) and can be accessed by the internet.

The simulation software Virtual Hot Press (VHP) can be purchased from the University of Hamburg (Germany) and installed on a standard PC. It uses the model developed by Thoemen and Humphrey (2003) as a core module. Batch as well as continuous presses can be simulated, and material property data are available for MDF, particleboard, and OSB. The VHP output platform (Figure 14) visualizes the simulation results for mat thickness, pressing pressure, internal gas pressure, temperature, moisture content, and density profile. Above, additional output variables are stored in data files.

Conclusions

For several years, an increasing number of research groups have been working on hot-pressing simulation models, and such models are already used for a wide range of applications. However, the potential of today's models are by far not exploited yet. The reasons are many fold, and the situation is comparable with other engineering disciplines, as pointed out by Gibson and others (2003): "Growth in the use of simulation technology has been less than expected. Today there are still many applications that could benefit from simulation, but that do not use it."

Challenges for the next years are the reduction of execution time and, more important, the improvement of the quality of model predictions. Both appropriate model refinements and the determination of material property data are critical for elevating the predictive power of the models. Concerning the material property data, in the long term, it is not enough to characterize only few material types. The material properties of the wood-furnish material strongly depend on the wood species mix, as well as on the size distribution and shape of the wood particles. Both the species mix and the geometry of the particles vary considerably between materials from different manufacturers, and new material types will be added in the future. Consequently, methods should be developed to easily determine the characteristics of any new material.

Although some repetitions are fruitful, the modeling community should avoid excessive repetitions to gain maximum benefits from research done in the field of modeling and computer simulation. It is a waste of resources if everybody who wants to contribute to the improvement of today's models starts from scratch. Bilateral cooperations between researchers could be a first step towards a reduction of redundancies. To stimulate the information exchange within the modeling community, and also between the modeling community and other researchers or industry, a web-based database would be helpful. Such a database could include descriptions as well as material property data and would contribute to transparency and stimulate communication among the parties.

Literature Cited

- Carvalho, L.M.H.; Costa, C.A.V.** 1998. Modeling and simulation of the hot-pressing process in the production of medium density fiberboard (MDF). Gordon & Breach Science Publishing Inc. Chemical Engineering Communications, 170. 1–21.
- Dai, C.; Steiner, P.R.** 1993. Compression behavior of randomly formed wood flake mats. Wood and Fiber Science. 25(4): 349–358.
- Dai C.; Yu, C.; Hubert, P.** 2000. Modeling vertical density profile in wood composites during hot pressing. In: Proceedings, 5th Pacific Rim bio-based composites symposium; 2000 December 10-14; Canberra, Australia. 220–226.
- Encyclopedia Britannica.** 2003. Web-based encyclopedia. www.britannica.com.
- Engelhardt, F.** 1979. Untersuchungen über die Wasserdampfsorption durch Buchenholz im Temperaturbereich von 110°C bis 170°C. Holz als Roh-und Werkstoff. 37: 99-112.

- FPL.** 1999. Wood handbook—wood as an engineering material. Gen. Tech. Rep. FPL–GTR–113. Madison, WI: U.S. Department of Agriculture, Forest Service, Forest Products Laboratory. 463 p.
- Garcia, P.J.** 2002. Three-dimensional heat and mass transfer oriented strandboard hot-pressing. University of British Columbia, CA. 254 p. Ph.D. Thesis.
- Gibson, R.; Medeiros, D.J.; Sudar, A. [and others].** 2003. Determining the return on investment from simulation. 2003 winter simulation conference, New Orleans, LA.
- Hailwood, A.J.; Horrobin, S.** 1946. Absorption of water by polymers: analysis in terms of a simple model. *Trans. Faraday Society.* 42B: 84–92.
- Haselein, C.R.** 1998. Numerical simulation of pressing wood-fiber composites. Corvallis, OR: Oregon State University. 244 p. Ph.D. Thesis.
- Hata, T.; Kawai, S.; Sasaki, H.** 1990. Production of particleboard with steam-injection. Pt. II. Computer simulation of temperature behavior in particle mat during hot pressing and steam-injection pressing. *Wood Science Technology.* 24: 65–78.
- Heinemann, C.** 2003. Charakterisierung der Aushärtung von Aminoharzen in einer Holzpartikelmatrix durch Evaluierung von Festigkeiten und Reaktionskinetik. University of Hamburg. 236 p. Ph.D. Thesis.
- Hubert, P.; Dai, C.** 1999. An object-oriented finite element processing model for oriented strand board wood composites. In: *Proceedings, 12th international conference on composite materials; 1999 July; Paris, France.*
- Humphrey, P.E.** 1982. Physical aspects of wood particle-board manufacture. University of Wales, UK. Ph.D. Thesis.
- Humphrey, P.E.** 1994. Engineering composites from oriented natural fibres: A strategy. In *Proceedings, 2d Pacific Rim bio-based composites symposium, Vancouver, Canada:* 2–8.
- Humphrey, P.E.; Bolton, A.J.** 1989. The hot pressing of dry-formed wood-based composites. Pt. II. A simulation model for heat and moisture transfer. *Holzforschung* 43(3): 199–206.
- Kauman, W.G.** 1956. Equilibrium moisture content relations and drying control in super-heated steam drying. *Forest Products Journal.* 6(9): 328–332.
- Lang, E.M.; Wolcott, M.P.** 1996. A model for viscoelastic consolidation of wood-strand mats. Pt. II. Static stress-strain behavior of the mat. *Wood and Fiber Science.* 28(3):369–379.
- Lenth, C.A.; Kamke, F.A.** 1996. Investigations of flake-board mat consolidation. Pt. II. Modeling mat consolidation using theories of cellular materials. *Wood and Fiber Science.* 28(3): 309–319.
- Pereira, C.M.C.; Blanchard, C.; Carvalho, L.M.H.; Costa, C.A.V.** 2001. Modelling and simulation of HF pre-heating of medium density fiberboard (MDF). In: *Proceedings, 5th panel products symposium. Llandudno, Wales, UK:* 27–37.
- Ren, S.** 1991. Thermo-hygro rheological behavior of materials used in the manufacture of wood-based composites. Corvallis, OR: Oregon State University. 226 p. Ph.D. Thesis.
- Shao, M.** 1989. Thermal properties of wood fiber networks. Corvallis, OR: Oregon State University. 95 p. M.S. Thesis.
- Thoemen, H.** 2000. Modeling the physical processes in natural fiber composites during batch and continuous pressing. Corvallis, OR: Oregon State University. 187 p. Ph.D. Thesis.
- Thoemen, H.; Humphrey, P.E.** 2003. Modeling the continuous pressing process for wood-based composites. *Wood and Fiber Science.* 35(3): 456–468.
- von Haas, G.** 1998. Untersuchungen zur Heißpressung von Holzwerkstoffmatten unter besonderer Berücksichtigung des Verdichtungsverhaltens, der Permeabilität, der Temperaturleitfähigkeit und der Sorptionsgeschwindigkeit. Dissertation, Hamburg, Germany: University of Hamburg. 264 p.
- von Haas, G.** 2000. Untersuchungen zur Wärmeleitfähigkeit von Faser- und Spanmatten und Platten. *Holzforschung und Holzverwertung.* 52(5): 102–104.
- von Haas, G.; Steffen, A.; Frühwald, A.** 1998. Untersuchungen zur Permeabilität von Faser-, Span- und OSB-Matten für Gase. *Holz als Roh- und Werkstoff.* 56(6): 386–392.
- Wolcott, M.P.** 1989. Modeling viscoelastic cellular materials for the pressing of wood composites. Petersburg, VA: Virginia State University. Ph.D. Thesis.
- Zombori, B.G.** 2001. Modeling the transient effects during the hot-compression of wood-based composites. Petersburg, VA: Virginia State University. Ph.D. Thesis.



Figure 1—Simulation examples: (a) flight simulator. (b) wind tunnel.

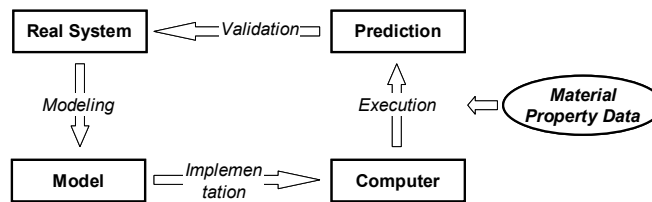

Figure 2—Typical sequence of computer simulation.

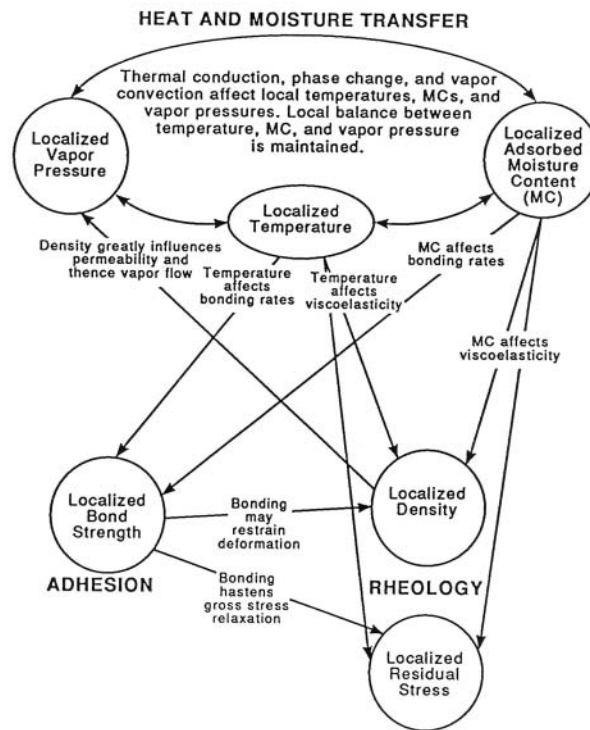

Figure 3—Mechanisms relevant during hot-pressing of wood-furnish mats (Humphrey 1994).

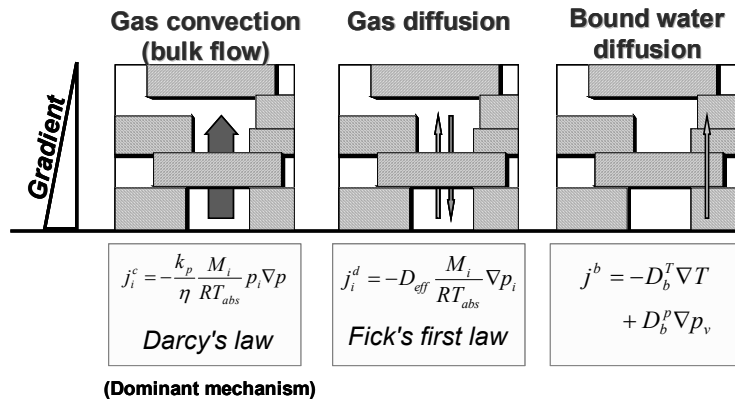

Figure 4—Mass transfer mechanisms.

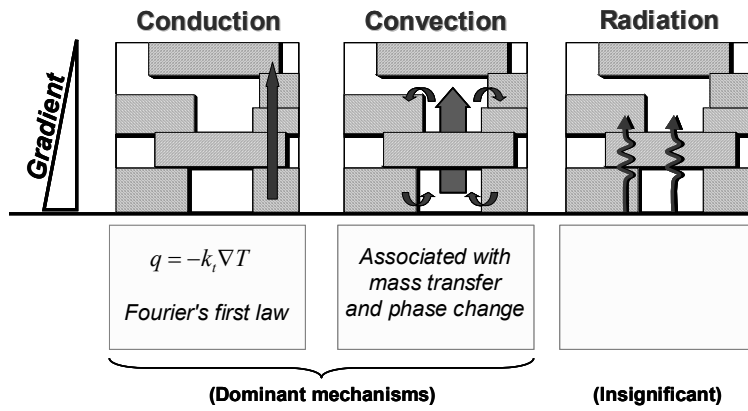

Figure 5—Heat transfer mechanisms.

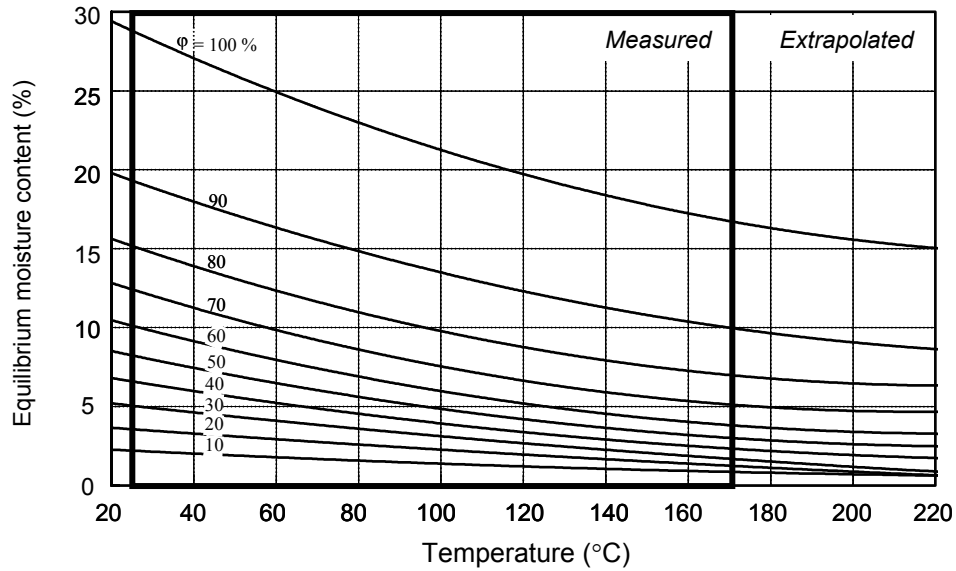
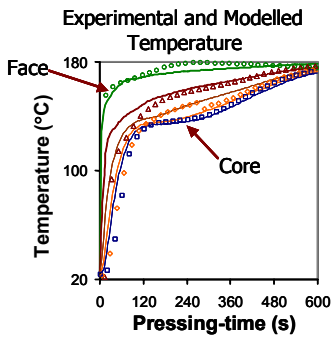
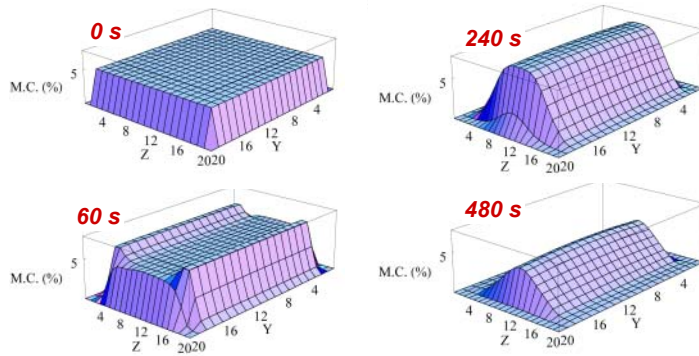

Figure 6—Sorption isopsychrens for beech (Thoemen 2000, refined after Engelhardt 1979).



(a)



(b)

Figure 7—Simulation results presented by Garcia (2002) for mat temperature (a) and Zombori (2001) for mat moisture content (b). Both simulations refer to OSB mats.

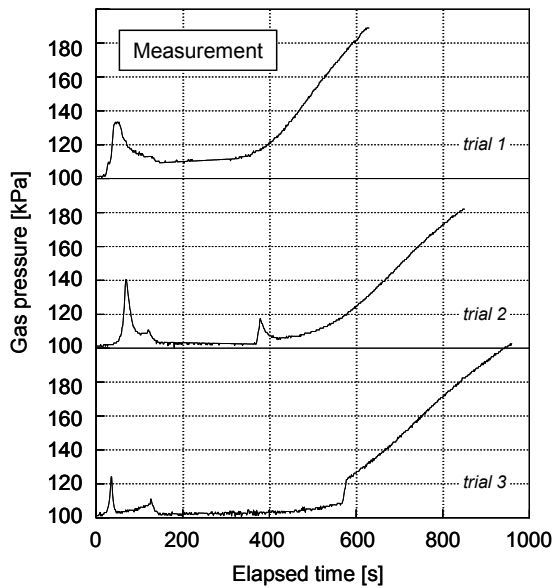

(a)

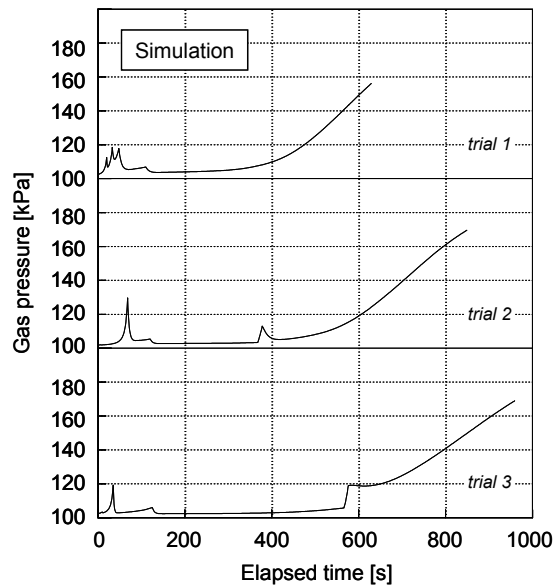

(b)

Figure 8—Comparison of measured (a) and simulated (b) total gas pressure in the center of an MDF mat (Thoemen 2000).

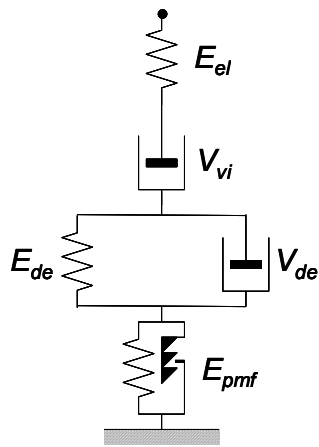

(a)

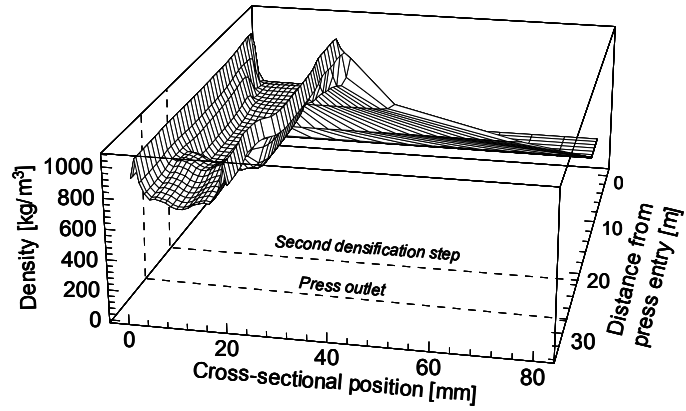

(b)

Figure 9—(a) Burgers–Humphrey model (refined after Ren 1991). (b) Simulated density profile development in a continuous MDF press (Thoemen 2000).



(a)



(b)

1. Pressing



2. Testing



Figure 10—(a) Automated Bonding and Evaluation System (ABES, Humphrey 1994). (b) Integrated Pressing and Testing System (IPATES, Heinemann 2003).

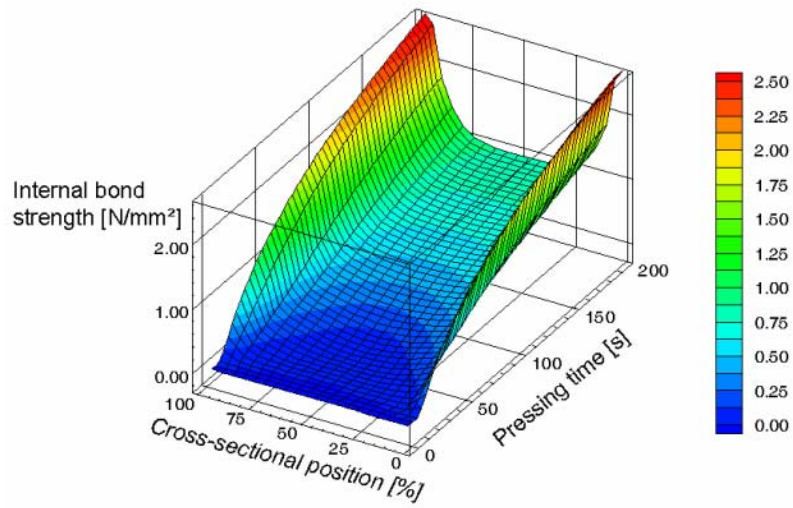

Figure 11—Simulated development of the local internal bond strength in an MDF mat. Internal bond model input data from Heinemann (2003).

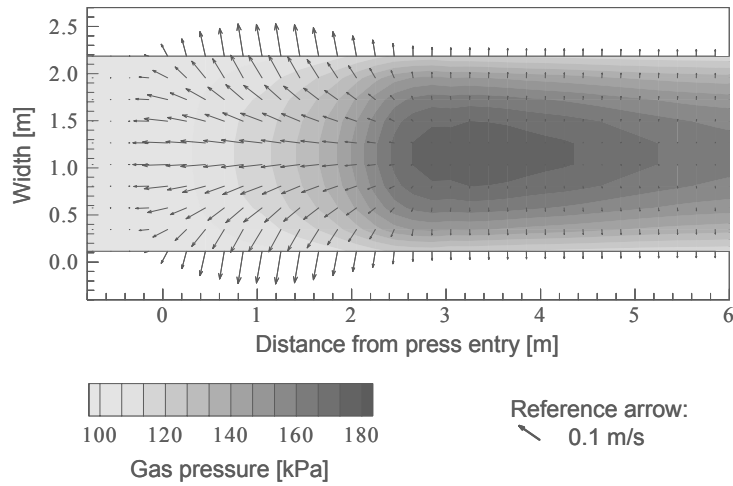

Figure 12—Simulated total gas pressure distribution and gas velocities (arrows) for the first 6 m within the central layer of the mat (Thoemen and Humphrey 2003).

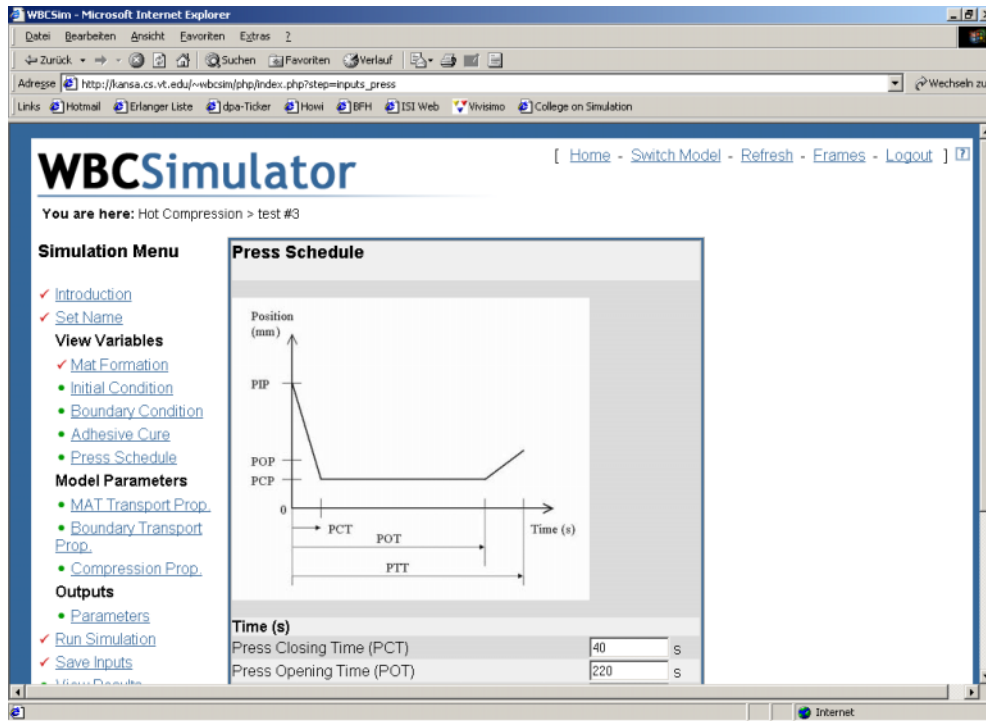

Figure 13—Web-based WBC simulator of Virginia Tech.

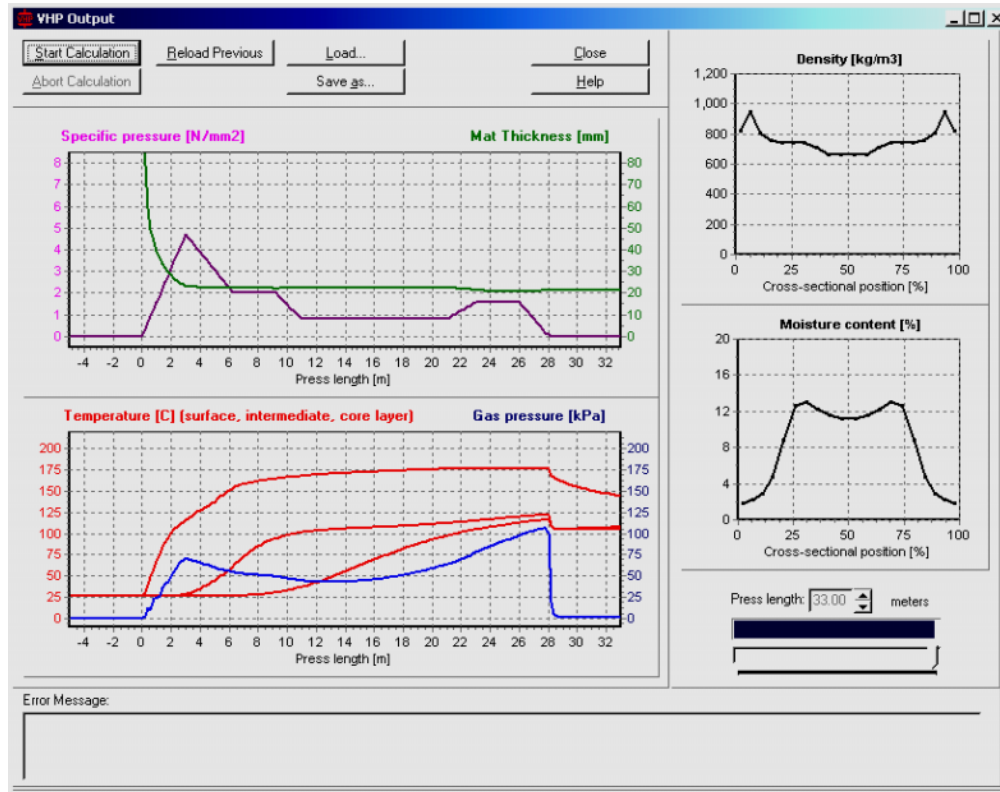

Figure 14—Output platform of the simulation software VHP (University of Hamburg).

Discussion—Simulation of the Pressing Process

Heiko Thoemen

Fred Kamke: Actually, I just want to make a comment about the WBCSIM website. You gave us an old URL that has been now updated. It was correct on your other slide. If anyone wants the correct URL, just call Jong or I.

Thoemen: Okay, it is <http://kansa.cs.vt.edu/~wbcsim/>

Kamke: I have a question. I wanted to refer to the information you had about the ABES system and the other system you are developing at Hamburg. In the graphs you showed the ABES system, for the shear strength versus time, the regression equations were straight lines. For the IBs versus time, from the EPOTIS system the lines were nonlinear and neither one goes to the origin. I wanted to ask why, first of all, this one is a straight line and the other one is nonlinear and then why neither one of them goes through the origin.

Thoemen: Okay, maybe I start with the second question, why it doesn't go through the origin. There are basically two reasons, one reason is it takes some time to get the temperature to the glue bond. There is probably a second reason and Professor Frazier might better comment on it, because there is no immediate start of the reaction. That is what I suppose. What was the first part of your question?

Kamke: This relationship from ABES is a straight line and the MDF-IB strength is a nonlinear relationship?

Thoemen: Okay, probably this data from the ABES they would get similar curves so they would deviate from this straight line if you would continue the measurement for higher strength values, but what I was told that at high strength values you get kind of a deviation from the plane so you get other effects so that is one of the reasons why it makes sense to stop the lines here and we didn't have this type of problem here so that is one of the reasons. The other reason was the way Phil Humphrey was using his data. He was looking for a straight line (i.e., the slope) so he could estimate the bonding rate and the rate of bond strength development at any one specific temperature. With this MDF data, we used a different modeling approach where we didn't need a constant rate for one temperature. So does it answer your question?

Kamke: It answers my question as far as why you did it that way; I am trying to think of how I would apply this data to a modeling situation?

Thoemen: Okay, the easier way is to use this type of data, for any temperature you have a defined bond strength development rate and so you can calculate it step by step so for any time for any position, you know the rate and you can calculate the gain in bond strength.

Jerry Winandy: So if I understand what you are saying, you are basically just going to use that and develop a kinetic rate constant and then you can do it over a whole continuum of temperatures once you develop that kinetic rate constant.

Thoemen: Yes, that is right. So the concept behind it is that the bond strength development rate at any given temperature is a constant, so whether it is early during the process or late in the process, that is the assumption that is made here. Probably this assumption is debatable but it is the first try to get some simulations of the bond strength development.

Kamke: I guess the problem I have with this data is trying to understand how I would implement it in a model. This is a bond strength or this is a shear strength you are showing us and I am thinking in terms of a reaction, a polymerization. The reaction rate to that polymerization would follow a much different type of relationship mathematically, compared to what you are showing right here.

Thoemen: Okay, one point is that, we already had this discussion I think, adhesive cure is the chemical reaction to something different to the strength development, so there are two different paths that I followed and I agree that this data probably you have to start like here at zero and then it goes up and then it reaches an end level at sometime, that would be probably what you are referring to. But the method is not exact enough so that there would be speculation to anything to fit these curves to any data down here so that is why I do not start at the zero.

Chuck Frihart: On your previous data, were those tested at those temperatures? On the other slide, the shear strength, those measured values were at that temperature?

Thoemen: Yes, that is correct.

Frihart: So, there is certainly a rheological factor in there in that at the lower temperature your material is going to be much more viscous and is going to have a certain shear resistance. You are probably not going to see that in an internal bond strength because you are already starting with some type of polymer chain when you put the adhesive on. As the water disappears you have a base strength value which exists even with no reaction. At the higher temperature because your material naturally thins out, it is going to have less strength.

Thoemen: Probably you are right, I personally did not go into this adhesive strength development too much and I am not a chemist. I am aware that there are many mechanisms happening that affect this strength development and probably it is more complex to talk about these first regions. Basically what we did here was we just ignored all the chemical development. I don't know whether that makes sense so we just looked at the strength development, we did not care so much about what are the chemical effects.

Frihart: I would think though that if you're concerned about blowout resistance that your IB values are much more indicative of resistance to that force than your shear strength. I know it doesn't model as well but you might want to look at really putting your IB values in there as being resistance to blowout because I think that more relates to that.

Felisa Chan: I think there is a difference between that graph and the other one because one is on shear strength, probably plywood, while the other is maybe MDF and or something?

Thoemen: Okay, the difference is this one is determined on smaller strengths, some smaller veneer strips, so you have kind of two strips, you glue them together inside this apparatus, you press them, you have a defined pressure and a defined temperature and then after a defined time you pull the two strips apart and then you measure the shear strength of this bond and if you go to this machine, it is a completely different setting. Here we have fiber or flake materials, particles that could be particles or fibers.

Chan: And another one is do you consider like the first graph can you use that for different types of resin, for example formaldehyde or phenol formaldehyde?

Thoemen: You can use both approaches to investigate the different resins and I don't want to talk about the ABES too much. Phil (Humphrey) should do that. The concept is that if you want to develop a method where you can measure the strength development as a function of temperature and as a function of the different resin type. Phil wanted a method where he used both components, the wood and the adhesive. I think that is the charming thing about this approach that you have a way to measure the strength development, you have not just the adhesive as it is in many other methods but you have the combination of wood and adhesive.

Winandy: On the ABES system, if I understand it, you basically take two flakes so you have a very thin profile which is not going to retain latent heat very long so it cools and that might explain why that is relatively linear. With the EPOTIS system you have a thicker profile and so it is going to generate more latent heat and it is going to have more post heating curing involved which would then give you that second order effect?

Thoemen: That is one possibility, but I think that the main thing at the moment if we wanted we could fit linear lines through this curve and if we would cut this graph let's say here, then it would be easier to fit linear curves to it as an approximation so probably this is the more realistic curve. Now if you look here, if you would continue your measurements towards higher shear strength values then you would probably get something like a leveling off as well. The problem is, as I mentioned before, we don't get this leveling off because before we get there, we get kind of a

buckling of our sample so that is the reason we stopped here and we don't continue our measurements.

Alain Cloutier: I want to change the subject a little bit, first I would like to thank you for this excellent presentation. I totally agree with you when you mention that the physical parameters are key in the modeling processes. You mentioned the thermal conductivity, permeability, and the absorption isotherm as key parameters. I also think that you are right, this is what we've seen, so that those parameters are very important. But I would like to concentrate on this absorption isotherm. You showed us a slide where you extrapolated the data from Englehardt. My questions are how comfortable are you with the curves you extrapolate in there and do you think that there should be more investigation in that part of the absorption isotherm?

Thoemen: That is a very good question, how confident are we with this data in this range here. I did not see any data for this range here. I am not sure whether Chris (Lenth) went to that range, so I totally agree that it would be helpful if we have measurements. Whenever we extrapolate anything, the better way would be to measure it. Just from what I read and I think Chris had the same experience, it is extremely difficult to obtain this data and that is probably the reason why there is so little data available so far.

Kamke: You are referring to Chris Lenth (Lenth 1999, Lenth and Kamke 2001), who worked on this as a graduate student as part of his Ph.D. work about 3 or 4 years ago. He did measure equilibrium moisture contents of a couple of different species up to 180°C. It did require some very specialized equipment to do that, and he had to account for thermal decomposition and loss of other materials from the wood in addition to the water. As a consequence, he was only able to do that for a few temperatures. I do want to make one comment however, and it is something that Chris saw in his data and then was able to collaborate it with some work that was done by Strickler. Strickler (1968) also collected some data at high temperatures. He observed this phenomena and made a comment without going into it in any more detail, which he thought that something was happening in the wood cell wall that disrupted this behavior and caused some stepwise change in absorption characteristics. What Chris believes happens is that when you pass through the glass transition temperature, the wood cell wall changes in its ability to absorb moisture and you actually would get higher equilibrium moisture contents than you would expect by simple extrapolation of low temperature data.

David Harper: I am going to switch gears again and pose this question to all of the modelers here. Why did you choose not to release your source code? It seems like what essentially you have done is provide a framework for inputting separate models into different parts of your program. There are a lot of different institutions working on specific

problems associated with the hot press, maybe not the holistic view that this model is taking, but it would be nice to have the code (i.e. framework). Then users would be able to insert their research into that framework and see how it affects the overall process which you have put together.

Thoemen: It is a question about the open source approach, I agree with you that I see the advantage of having such an open source approach in which anybody who wants to can make improvements. But there are some restrictions to it, which I mentioned. There are reasons why we don't see an open source approach at the moment in our field, but I want to mention some other problems. If anybody would use my code and would try to implement aspects or change aspects, it would probably take them several weeks to step into it and really understand my program. So it is probably the easier way to contact me or whomever and talk about it and try to do it together. And actually about the open source approach, the concept is that you put the source code into the internet, there are hundreds of people interested in the subject that like to sit down to work on it to find a bug and to improve the program and that may be true in other disciplines or in other fields. But I don't really see these hundreds of people in our field to sit down and look at the source code and come up with suggestions.

Harper: Well, you have at least identified seven different groups or so that are interested in this type so there is an interest here, that is why we are here. And there are as far as making commercially available another way to go about licensing it, you are not just limited to an open source type model, you are thinking about the GPL or something like that, you could go to a Berkeley type model which is you release the source code, anybody can take it, and commercialize it but they don't necessarily have to release it which is how Windows NT got started.

Thoemen: I think part of it, just say it again.

Harper: Well, there are different approaches you can take as far as this but I am personally of the opinion, especially as public institutions, putting up this research, that you should submit it and let the community look at it and try to improve upon it. Yes, the first place to start would be to contact those who made the model in the first place and then start working on it together. But I think that it would be advantageous for us all to be able to see the code. Transparency will foster innovation.

Thoemen: I agree partly, if there is the big interest in the source code it is possible to approach Fred or me or Chun-ping. I am sure there will be ways that you can look at the source code and improve it. I just don't see that if I put my source code into the net, that there would be such a big group of people that look at it, I just see the danger if I do this, then at the moment there would be no commercial value of the model anymore. And I just can speak for myself, I am

interested in the other opinion at the moment. It is just not feasible to do that.

Kamke: This question of distribution of the software for these models and making it available to anybody is something that we have done at Virginia Tech for a long time. One name that wasn't discussed up here in addition to Balazs Zombori and I, is Layne Watson. Layne Watson is a computer scientist at Virginia Tech, he has absolutely no interest in wood or wood composites, but is very much interested in modeling, he is also very much interested in getting sophisticated simulation models out to people who need to use them and that is the reason why we went in the direction of having a web-based simulation model. We came to the conclusion that this is not a money maker. The source code is not a money maker; the program is not a money maker. However, if we want to continue to make it available to people and to improve upon it, we have to have some way of financing those things, particularly web-based. You can't put something on the web and leave it there, without maintaining it. And so what we are struggling with is where we can find a way to make this really available to people and yet still be able to cover our expenses of maintaining a high end computing system as the host for this model and how we can continue to make changes to it as new information comes available. That is our big challenge. How do we do that? What is the market for these types of software codes if you were to sell it? Well, very limited, not very many people are going to want to buy it. So what are you going to charge, \$10,000? Well that is a drop in the bucket in what it cost to develop it. Of course, most of that money came from the Federal government; the rest of it came from the state government. In your case I think there was some private industry funds involved with it as well, Heiko. But that is money already spent, it's gone, you are not going to recover that. No one is going to get rich off these software codes. I like the idea of an open source code approach and I think some value is still there in regards to the interface. You have the source code but the interface really makes it usable and that is basically our conclusion now with the WBCSim website. Perhaps we should just make the code available to others, how much we could support that is a different question. I don't know about you Heiko, but I am not a programmer by training. Balazs Zombori was certainly not a programmer by training. We have all learned this by the seat of our pants as we went along and the end result is a code that is perhaps not the most efficient in the world, but it does work.

Harper: That gets back to my point. Most of us here are not programmers. That is why I feel it is important that we make source code available. So if someone has a model, and the code is available, they can work with their own computer scientist/programmer and improve it.

Pablo Garcia: Heiko, I have a question about your modeling. In that simulation that you showed, you have a very

interesting, and maybe you can explain theoretically, because it is a theoretical model, why we've got a kink. I noticed that for the certain time when you were tracking three time through the pressing time, you have got a change in an inflection point in your vertical density profile. Yes, that one.

Thoemen: Okay, so which point were you talking about?

Garcia: There, you see at about 15/16 or something and through the thickness you have got the slide formation, you have got the first peak in the vertical density. Yes. That one.

Thoemen: Okay the question is where do these bumps come from? Okay we can just go further back with our simulation and if you look at this moment so it is like after 8 meters, there is quite a high pressure on the mat and that is the moment where these layers get the temperature and the moisture condition, so they are softened and so that this model load is enough to further densify it so it is basically far after the main pressure had been applied.

Gracia: What's your wood rheology model based upon at that point? Is it a function of temperature or moisture content?

Thoemen: Which rheology model is the function of moisture content, temperature and density? No, okay, maybe we can go back. Okay, as I said we have to know the coefficients and to determine these coefficients it was very time consuming work that was done by Funhaus. He utilized a miniature press, where he could inject steam or climatized air so he could adjust the moisture content and the temperature within this little press. Then he did all kinds of different pressing schedules so he determined these different coefficients. He determined elastic response of the mat to pressure, he determined viscous behavior and so on. And he did this for the whole range of temperature and moisture contents. And this data is the basis for our simulations.

Chunping Dai: I guess I am one of the three modelers in this room and maybe I should comment a little bit about the open source or closed source issue. My answer to that I don't know. But for those of you who are familiar with Forintek, we are sort of a membership based company jointly sponsored by the government and also by our industry. So we are obliged to keep some projects only available to members. But on the general subject though, I believe that some of the models created, such as the hot pressing model, are so complex. You make it open source or you make it available to any company and you still have to, like Heiko was saying, train them to be able to run it, understand it, and use it more efficiently. In that sense, I don't know if open source is the best idea or the best way to go. In Forintek, we agree that it is not going to be a money maker, but we try to use it as a tool for us to provide our service for our members. For example, if someone has a question regarding pressing or doing a new product and we actually use it for ourselves so

that we educate ourselves. Therefore, we are becoming more efficient in delivering our service to our members and so it is something that, it is a program that we developed ourselves, we are very familiar with, and we find that is the most efficient way for that to be utilized. But anyway, I do have a question about the other, go back to that tester, not the ABES, the other one, and yes the IB one. Can you sort of explain in more detail to us, how do you prepare a sample? Is it a closed system or is it open because it is so small, as people talk about? Can you contain the steam, you know, or all that kind of stuff. Can you elaborate on that? And for me, I am particularly interested in OSB, and did you do any work on OSB? Or the person who has developed this, has any work been done on OSB?

Thoemen: Okay, good question. Last question first, we have a diameter of 10 centimeters, 100 millimeters, so it is designed for MDF and flakes, it is not designed for OSB, and we knew this from the beginning on. The way the system is operated is you first form your mat in this big tube with this diameter and you precompress it so that it fits into this press. Then you put the cylinder into the press and position the platen exactly to fit into the cylinder. Originally it was intended that this whole system would be sealed so that you could create higher gas pressures in there for the beginning. We ignored this option and we just used different moisture contents (i.e. mat MC) and different temperatures of our mat and of course different heating platen temperatures. The idea would be if we would have an instantaneous temperature rise in the core so what we actually have is kind of a slower increase of the temperature but what we like to have is one defined temperature. That is the reason we make it relatively thin, so it is like 4 millimeters thick so have relatively little time delay. My assistant, Christian, did this work some weeks ago to test whether he could use it as a sealed system. At this moment, we still have some problems due to wear from extensive use of our equipment. It is not sealed anymore so we have to replace the cover and the inside of it. So that would be the next step but so far we just will get atmospheric pressure. Does that kind of give you an idea of how this apparatus is operated?

Dai: Did he try to measure the gas pressure?

Thoemen: Yes, Christian did and he told me just two weeks ago that at the moment he does not get an increase in gas pressure.

Siqun Wang: Can you go back to visual hot press slide, the simulation, the interface, yes that one? You use the pressure control for simulation and I wonder how do you control the thickness of the final product or maybe you can give me more background about continuous press. What is the general way to control.

Thoemen: Okay, it is good question. The question is whether it is realistic to assume a pressure control or load control and the answer is actually in the in-feed section you

kind of have thickness control because the in-feed rate dictates the thickness of your mat. So early on, it is not pressure controlled but thickness controlled. Then usually in industry you have a period where the load is controlled and you don't care about the thickness; you just care about the load. Then, at the later stage, where you kind of calibrate the thickness of your panel, you again have thickness control. So far, we can switch between 100% load control and 100% thickness control but it is already implemented. That is one of the next steps that we are doing here, it is already implemented, that we can switch between these two so that we can specify a minimum thickness and a load so if the mat touches the minimum thickness, then it is not further compressed so we just have to change the user interface to incorporate that but it's already incorporated in the model.

Frihart: In your models, do you assume that all the flakes are oriented the same direction or do you do it like in OSB where you have a middle section that is cross oriented?

Thoemen: Okay, the main differences between the different orientations is the permeability so the permeability is dependent on the direction and that is incorporated. If you look here you can choose, let's say we want to simulate a three layered OSB mat and you can click on the three layered and you can specify the core layer, let's say that across OSB strands with perpendicular alignment and you have to specify the surface layers with parallel OSB strands and then the permeability data they are available for both directions.

Frihart: Do you consider that there's different adhesives in the middle layer and therefore has different properties as far as cure rates?

Thoemen: Okay, good question. In this version of our model we don't have the adhesion included so that's the next step, that is what Christian and I are working on and that is the next step to incorporate it into the model. So to answer your question, no, so far we cannot consider different resins. We just don't have the data for different adhesives at least for OSB, we have this data for UF and PF resin for flakes but not for OSB. I like to refer to talking about the heat and mass transfer, that work started more than 20 years ago; talking about rheology, that worked out for us about 8 years ago; and talking about the adhesion, that started like 3 years ago and that's just in a preliminary stage. So cure is not in our version of our virtual hot press. That is not incorporated.

Garcia: I was thinking about David's question. I developed a heat and transfer mass model for my Ph.D. I have no interest in commercializing. I suppose it's open source code, it's ugly looking because I am not a programmer, but when making my program, it was most useful to me. I would have liked to simplify the code, but what was more interesting was algorithms, mathematical equations, and stuff. I developed mine off wood drying models because it is similar drying of hygroscopic materials, which more specifically I

developed it off of a drying model by Patrick Perry and Ian Tuner. I took their equations and modified them a little bit. I think scientifically that it might be a little more valuable to just sort of share that stuff because Balaz Zombori had a really good derivation in the thesis and all of us, last time we met, were talking about that absorption isotherm history. That is one of the brick walls that we all came across and we all worked our different models in slightly different ways and there is where you can increase your efficiency by just changing your algorithm a little bit. For example, Chuck's question there, the way it would work my algorithms in terms of resin cure and stuff like that, I didn't dabble too much into it but I have made allowances for it in the equation system basically as its some black box in the function of time. What links from there out of resin cure is that you have got mass source, if it's a condensation reaction where all of a sudden got a source of vapor, that will vary with time depending on the kinetics. To me that is the black box, so I just leave that as another arbitrary function of science that can be thought of in the future. Different resin distributions would mean different initial conditions and different functions that would now be a function of time as well as space because what you are talking about is that the core would have different resin curing kinetics so this function now becomes some arbitrary function that you could take it or someone real cleared up on adhesives could take this stuff and see it as a function of x, y and z and time and those are the ways that I think algorithm could be very useful.

Cloutier: I would just like to come back to the open source point that we have. At Lavel we do have a research center on numerical methods called and this group, Marcell and myself, we are members of that group. We had an analyzed discussion on the open source, should we go open source or should we keep the code in house and so on. The code we use is still in house made and the policy we came up with is that the code is made available to anybody who wants to use it for research purposes and this way we know who it is distributed to and the condition to use it is to send back the developments that people make with that code to the center and that is the way that works fine for us so far. To put the code in open source, I see some difficulties, first the support that you must give to the users that want to use it as you mentioned, they want to use it, you can have a lot of questions to answer. We don't have time to do that and we don't have resources to do that. Also for users to download such a code there is a lot of work to do to understand the code and I don't think it would be so useful for someone outside so my suggestion or my point is that I think it could be interesting to have such a group interested in that topic to share and this way it's a common code and you can download on your computer, do your own development with it and maybe send it back for the comment of the community of the people who are working with it. Although I was very interested by the parameters, the idea you mentioned about the common database, I think would be very helpful also.

Thoemen: Maybe just one example that comes into my mind talking about open source, I think all of our works are based on the work of Phil Humprey. He put his source code at the end in the appendix to his Ph.D. thesis. So it is available to everybody and I am almost sure that nobody used this code. You did? Okay, then I was wrong. I can say from my own perspective that when I started to work with Phil, I decided to start from scratch, I got the concepts in endless discussion with him but his source code was written in Fortran. I wanted to do it in C++, so his source code was not a help for me, it was much more the discussions and talking about the concepts and so I agree with Pablo that exchanging algorithms or black boxes was more helpful probably.

Jong Lee: In case you need the webpage address, I have one here so I am going to pass around later and the presentation you made on the rheology, so far I have been dealing with the rheology and the simulation of vertical density profile about six months and I have kind of a problem to deal with determining the questions involving the rheology because if we use the single layer mat, which has less variation in the properties in the mat, we don't have any problem running the three layer hot pressing simulation model but in case you deal with the three layer mat structure we come with more variation at the different positions of the mat then we end up crashing the simulation model, so I cannot run the model again completely so somehow I just need the equations for the rheology model so if you can translate some technology in your Van Haas German dissertation they would really appreciate it.

Thoemen: Okay, the rheology model is no secret, we are on the way to publish it and it is written in my Ph.D. thesis as well. I think that there are two different things you are talking about, one is the numerical stability and the other one is the rheological model. I am pretty much aware of these nasty crashes of the program and that you have to work some weeks to find a way to get around it, but probably in this case it doesn't have too much to do with the rheological model itself.

Lee: Well, I have been running with the old equations that you provided in your dissertation at the end in the appendix, all different moisture contents and temperature conditions and you determined equations but that didn't work with the OSB mat. When you deal with you know quite a high variation of the mat structure.

Thoemen: Okay, in my Ph.D. thesis, I just provided the data for MDF so there are no OSB data in there so far.

Lee: Right, so it didn't work for the OSB mat.

Thoemen: So which data are you talking about?

Lee: You mentioned on the presentation that material MDF, particleboard and OSB rheology data is available? So, I want to see if I can get some OSB values.

Thoemen: Okay, I derived this data from the data from Van Haas. I sense that is one of the big problems that his publications are mainly in German. I think there is one in English but most of them are in German, and his Ph.D. is in German as well. So that is one of the problems, we can talk afterwards and of course I can give you the data.

John Hunt: I would like to talk about your modeling as it goes. We expressed the difference of the U.S., which is primarily a batch system, solid platens, you know, constant heat, you know, steam heat or oil heat, whereas your continuous press is able to have different sections and zones of heating and pressure and the cooling, it seems, at the end. I have a question in regard to when you go in the laboratory to model this process, what kind of press do you use? You have this small sample, are there any batch wise systems that simulate the continuous process?

Thoemen: Okay, that is a good question whether we can simulate a continuous press on a small batch lab press. In a way you can change, you can edit the pressing schedule from a continuous press so that the pressure profile or the thickness profile, what you cannot do is you cannot change the temperatures. From what I know is, for example the cooling, it is difficult to simulate a continued cooling press in a small batch press. I think that Metsu has one lab press in Sweden where they are relatively flexible but it really doesn't match the real situation and then of course the other problem is the size of the press so you have much higher gas pressures due to the bigger size of your mat in a continuous press but I don't consider this as a big problem because if we simulate it and we realize our simulation matches the situation in the batch press then we can run the model for a continuous press or for a bigger press and we can kind of be somewhat confident that we get the right predictions for the continuous press.

Hunt: You mentioned the one that goes, in Sweden you said, where was the one that you said has a batch small one?

Thoemen: It is Metso I am talking about, it's in Sweden. Actually I haven't been there but I just heard about that and they have a little continuous press. I am not really sure whether they use the little continuous press for their modeling or whether they also have a batch press where they can just insert let's say cold water through the platens to cool it on.

Hunt: How do they cool? I am curious, in the continuous press do they cool it with water in this thin belt?

Thoemen: You're talking about the real press.

Hunt: The real press, the continuous press, is that water cooled?

Thoemen: There was a nice picture in, was it Chunping's or Siqu'n's presentation, basically what they do is they have the steel bed running through the whole press but they have the

roller carpets and that does not run through the whole press but it runs through lets say 2/3 of your press and then it takes off and there is a separated circuit for the cooling zone. So you have your steel bed going through but the roller carpets that are much heavier so you couldn't cool it down so fast so that is they reason they separate it, and so then in the end of the press in the last say 1/3 of the press they have separated heating or cooling systems so they can heat it or cool it and they can do it either with water or with oil. Maybe one last thing, if we talk about cooling we don't really talk about temperatures like in a refrigerator, we talk about heating circuit temperatures of about 80–85 degrees.

Hongmei Gu: I have a question about modeling, I guess we have been talking the whole day today about the theoretical modeling. In mathematical and analytical modeling, there are two ways to go. One is regression (i.e., statistical) modeling from the experimental data where, for example, you perform regression analysis. The data is usually from the real tests or from industry. The other way to go is mathematical modeling. So I would like to hear you comment on how these two approaches right now in the wood composite area go and I am more curious about how the mathematical model predicts the results.

Thoemen: Okay, that is a very good question about different modeling approaches. We just talked so far about analytical or theoretical model and what you refer to are statistical models. I am not sure whether you actually talk about like SPOC that is a system from Sympocom from ATR, that statistical model for process control and Metso has a similar approach. Actually, I had two slides about it in my presentation and I removed them last night to avoid over-running my time because I was scared of Jerry and his 5 min warnings. Briefly, these are two completely different approaches, so what a statistical process control model does, it takes the input parameters, it takes the output parameters, and it kind of treats the process itself as a kind of black box. Input parameters could be temperatures, pressing conditions, mat moisture content, material and pressing conditions. Output parameters could be the IB or any property of the panel. They use statistical methods to get a link between the input parameters and the output parameters. And they have established such a model or such a link and then they can run their model, they can input the input conditions and then they can predict lets say the IB, the bending strength. If you look at our approach, an analytical model, it is completely the other way around. We focus on the process itself and we use input parameters later, we don't need the input parameters for our model development but we need them if we want to make simulations so it is kind of a completely different way of doing it. And you are asking about the reliability of your predictions or the quality of your predictions. Of course there are discrepancies between what you simulate and what you measure, actually I think I showed some of the graphs, they are not too bad. Like for the temperature development you can get relatively good estimates of the real temperature

situation in your press. If you come towards simulating lets say the IB of course we are still relatively off, okay talking about the statistical modeling of course they match much better, the situations so if they have a good model then it should be possible to match the IB for example within what they say within some percent.

Karl Englund: I was wondering has anybody done a sensitivity analysis on either the statistical model or the analytical model to see which variables are most important for your response variables?

Thoemen: Okay, maybe someone else wants to answer this?

Ted Laufenberg: I guess earlier I was eluding to that. I had used Phil Humphrey's fortran model in conjunction with Phil, he didn't have it up at OSU yet, but we ran a sensitivity analysis of all the parameter, vertical permeability, horizontal permeability, looking at really mundane data, and wondering whether the assumptions he made, whether we could improve on them by developing better data, better parametric data for these physical constants. We found some that were really in need of improvement, we based a proposal to the USDA on that analysis. The sensitivity analysis showed that horizontal permeability was the one we were most in need of. Prediction of the density profile, I am pragmatic about this, I stuck in the final density profile on a number of cases to see whether or not going immediately to the final density profile and just squishing the entire mat made a difference in the behavior and it didn't. I guess some of that could be derived from the vertical permeability not being a factor and thermal conductivity was not highly influenced by that density profile either. We did do the sensitivity analysis in conclusion and found that the curves were most needed. The permeability data was lacking and the change in thermal conductivity as a function of relative humidity and of pressure. Moisture content was also needed to be supplemented, but we never produced the results from that because I was moved to a different project right after it got funded and I handed it off to another researcher.

Thoemen: What you are asking is would anybody change the material properties and how much does it affect the outcome. I think all of us of course did it, some of us published it. I think Balaz did write some of his findings in his thesis, I know that Alain talked about it already, that you did tests and I completely agree about the permeability that horizontal permeability is important and that vertical permeability is not important. What I found was that thermal conductivity is very important so if you change the thermal conductivity by a factor of 0.1 then you get a strong impact on your results and maybe just one small thing here we have one button advance and you can do exactly as that what you are saying so you can shift up the thermal conductivity by 10% or 30%, whatever you want, and so any of the material properties you can change by a certain number and look how does it affect the simulations.

Kamke: Just to follow up on that comment, Balazs Zombori did include a sensitivity analysis in his dissertation. That is also going to be included in a publication and I am told it is going to be out in the April 2004 issue of Wood and Fiber Science.

David Marr: A question for Fred I have wanted to ask. Does the Virginia Tech program allow you to shift between force and displacement control?

Kamke: The program that we have is only a position control program at this time.

Chip Frazier: I would like to talk more and learn more about the rheological modeling and ask what types of viscoelastic functions or viscoelastic models that you have used or other folks are using?

Thoemen: Okay, I can answer for my part and maybe Chunping or Fred can answer for their approach. What we basically use is Burger's model, that is this part of the rheological model and we added this one component to it so basically we account for elastic deformation so its instantaneously recoverable, we account for viscous deformation that is not instantaneous, not recoverable, we account for delayed elastic deformation that is recoverable not instantaneous and by adding this last element we also account for instantaneous but not recoverable deformation.

Frazier: Now I understand. At first I didn't, but once you mentioned that, I remembered. So no one is using more models such as Kaulare-Williams-Watts equation approach or the other common viscoelastic examples. You are just using these simple spring and dashpot models not the phenomenological approach where folks make the measurements and just fit them to various equations.

Thoemen: I am not sure about the second approach but we just use this relatively simple model. It is complex enough for us at the moment but maybe if we move on towards more reliable predictions maybe we need some more elements. Maybe we need another approach, that is another option of course.

Frazier: Another question along this line, I just have kind of a new interest in rheology of the wood cell wall and one of the big issues is whether or not you are working in a linear region or in a nonlinear region and I guess where a nonlinear response is that a big issue or does that not matter in how you have to model your material?

Thoemen: Of course we are in the nonlinear region and it's probably our approach that helps us get along with it so we model the response of our material for each or we calculate the response of our material for each time, so step by step. Maybe Fred can comment on it, probably if you first derive a differential equation, then solve this differential equation, it's much more complex to account for a nonlinear material.

Hunt: In your model or any of the other models we talked about the industry concerns, they have 20 different varieties and flavors and flakes that they put in their board. You know from oak to aspen. When you put your model here do you tweak something when going from a fast grown low density aspen compared to a slow growth suppressed something or other? Do you go into your model and tweak it that way or how do you change your parameters based on your furnish?

Thoemen: Okay, it's a question about the effect of the problem that you have different material and the material has different properties and basically as I mentioned toward the end of my presentation that the ideal solution would be that we would have a range of a set of different measurement techniques that we can relatively easily determine these material properties so that if you come with a new material, just give it to me and it is measured within a short period of time. We don't have that at the moment so we have to live with it. Basically we assume a standard material. At the moment we have a standard MDF, standard core layer flake material, surface layer material, and OSB material. If we know, for example, that the stiffness of the material that we have is higher then we can adjust the coefficients but that is a very rough way of doing it at the moment. It works, it is not the optimum so maybe the approach that was proposed by Steiner and Chunping, that could help so from, if I understand that approach correctly, then you don't have to care too much about the structure you just have to determine the property of your cellular wall material for the temperature and moisture content range and that is probably much easier than to determine these five coefficients for the whole temperature, density, and moisture range.

Gu: In one of your slides for the future research on the optimization problems, you mentioned how to achieve a specified density profile, you talked about the other way around, to model the problem which is a known specified density profile which is good for properties or performance of the product and then you go back the way to see how to simulate this processing order to achieve this profile. Can you comment a little bit more on this thought? How do you do that?

Thoemen: Okay, so far we cannot go this way around. I think Chunping mentioned the independent and the dependent variables and so far we can use independent variables as input parameters and we simulate the dependent variable. It would be nice if we could do it the other way around so if we could input the dependent variables like the density profile and could simulate the independent variables but that requires an iterative procedure and that requires a lot of calculations you have to run your model again and again. One difficulty is also that you have such a wide range of different possibilities so you have to tell your models somehow in which direction to go so at the moment it is not possible to simulate that way around in order to solve the optimization problems.

Kamke: A question about optimization, the program that Balazs Zambori developed for hot pressing process was not designed to optimize but simply to take a collection of inputs, run it through the code and then come up with the collection of outputs. However, there is software publicly available optimization routines that will work with independent codes. At this website, WBCSSim, we have an optimization program, a public domain optimization program, that we have linked with some other simulation models. We have a rotary drying model, for example, that was never designed to be an optimizing code, but it is when it is linked with this other optimizing code called DOT. We simply linked them together. The way DOT works is it is an iterative approach, but it's an intelligent interactive approach. It runs your simulation over the range of conditions that your simulation is defined for and then based on that it makes intelligent decisions as to what should be the next guess that it makes. It still takes a long time, but you don't use that much time in trying to come up with the optimum solution. We haven't yet tried to link it with the hot pressing model simply because the hot pressing model does require a lot of computation time and would probably tie up our workstation for hours, if not days if you try to run the optimization on it.

Gu: Right, I'm really interested in that. I know that for process control techniques, there is another technique called Expert system. You probably heard about it and that is similar to what you are talking about the optimization software. If you have a set of simulations run in a range of condition, and then next time the system will give you the prediction of what to do next step through this Expert system, like an expert predicts. That is what I am curious about. Before I am giving up, I have a question for you maybe also for Chunping and Heiko about this modeling. You guys have been doing this modeling for quite a long time. I know there are some limits, you have mentioned a couple of, one is that Heiko mentioned about the computer limits that we really can't do anything about that. We will leave that up to the computer person, but in our field, wood science field, what do you think about the future for the modeling and somebody mentioned about the properties which I really think that is a big issue, material properties. But other than that what do you think the limits right now for our modeling?

Kamke: I agree with Heiko in the limitations that he mentioned to modeling, I do think that the very important limitation is our knowledge about some of the physical properties, and we just don't have enough data for that. That is an area that we are concentrating our efforts on at Virginia Tech right now. We are not going to be able to do it all. There is just too much to do. We are concentrating on strand products right now and that is not going to be very helpful for people that want to work with particles and fibers. The limitations based on hardware as Heiko says, will take care of themselves and really it may not be a limitation in certain cases right now depending on how sophisticated you want your model to be. If you don't try to simulate everything under

the sun, all possibilities, all these mechanisms, if you are willing to accept some simplifying assumptions so you don't have to make so many computations, then we have plenty of computing power right now. If you don't think you need a 3-dimensional simulation, you cut your computing time down by a power of ten. Heiko gave us a demonstration right here on a laptop computer. It depends on how much you are willing to limit your model and what assumptions you are trying to make. That is not such an important limitation in my mind. I think the more difficult limitation is our lack of data on physical properties.

Thoemen: I agree that the computing time, in the long term, will not be the limitation. The lack of property data will be. There are actually two ways we have to go. One way is we have to measure those data if they are not available. But the first way should be to assemble those data that are available. I realize that in the German literature, there is some data available that are just not recognized. I am almost certain that in the Russian literature there is a lot of that none of us is aware just because of the language problem. So measuring this property data is one thing, finding them is the other thing, finding the existing one. And if I think about the heat and mass transfer, I am relatively confident with our model predictions. Talking about density profile development and talking about development of the mechanical properties, I think we definitely need a lot of work regarding the model development itself.

Hunt: I'd like to just make a comment about this, optimization problems. As we try to go towards a performance based and in this statement here, I know it is an example, but in the statement it says that density drives all performance and I guess I would like to see that we say that density may be a function to get you there but it is really a performance based and what is it that I need, you know percent of glue, density is just one component of my performance you know it would relate to percent, all the variables that would be necessary to describe the performance parameters that you're looking for and that would be the optimization that you are really looking for and not just the density profile. Although right now we use it because it's the best predictor of properties.

Thoemen: So what you are saying is that basically we want one performance. Let's say we want one specific bending strength of our panel and we can achieve it through the density profile or through choosing the right adhesion content. Maybe there is some other parameters and if we think about that then these optimization problems really become difficult.

Hunt: Right, it expands it but I realize this is just an example and we use density as a predictor but the next step would be, at least I would propose it, how do we define performance based on things other than just density and try to see how that drives our process.

Thoemen: I am sure that the mechanical properties will be an issue or a challenge within the next years concerning modeling.

Kamke: This question of John's about what do we really need to predict here with these simulation models, I agree with you 100%, we haven't taken these far enough yet. I mean we are still working on these and we don't quite have these right yet. All that we are able to do up to this point is predict density profiles and maybe predict some degree of cure or degree of bond strength development. But what does that mean in terms of the actual engineering properties of the final composite? I believe that is as big a challenge as it has been just getting to this point. We are about three years into a project just with strand composites to try to do a small part of that. Elena Kultikova (Ph.D. student at Virginia Tech) is trying to predict some mechanical properties, some bending properties and some shear properties. A lot of that is empirical based and that means that when she is done it's still going to be somewhat limited to that range of conditions she was able to include in her experimental work. I would like to see some effort done that could be more fundamental based. In other words, if you know the physical and mechanical properties of the raw materials going in and then know something about how those properties may change as a result of the manufacturing process, you should be able to predict the mechanical properties of the final composite. But that is a huge task.

Dai: If nobody talks, I'll talk. Fred and I have been fighting for the microphone, but can I have a little bit of time now, thank you. Haha. Just kidding. But yes, about this whole issue of dealing with the property side you know looking into the effect of species and the strand geometry other than density and also Chip you are talking about the rheological side of things, like you are doing tests on glue and ideally you would like to play that with two strands or you don't want to play with a bunch of strands, you want two strands so you can isolate the problem because it's easier to observe things and eliminate a variation of other unpredictables. That has sort of been the driving force for at least my approach in a way that we are studying. The program was developing a model for mat structure so it's a model where you can actually monitor each strand as it is being laid up, I mean their positioning, the orientation, and you can define the property of each strand and then you can input you know with a percentage of dimensions or species and then you can observe how that's deformed and how that structure changes and you know effect your permeability and rheology and that kind of stuff. So we have achieved some success with that and I presented some of that this morning and Heiko mentioned that. The first thing that we were able to achieve that yes, we have such a structure, sort of a geometric computer simulation program now and we can link that to the compression behavior overall mat to individual strands, if you just test individual strands like Fred (Kamke) and Wolcott did, compression tests of individual strands, you give

me the property and I can plug into the mat formation model and I can tell you what kind of a deformation and strand stress relationship for mat. Then also because the mat is not being uniform I can also tell to what extent localized stress varies within a mat and there was some mention about the horizontal density variation, the effect of that on dimensional stability. I know it is a long way to go to predict that but I think my idea is that we have got to start with trying to understand the structure of the material first and you are talking about strands, basically, that define the length, width and thickness and how they might vary, and that's it. Computer might take a long time to calculate but I think the idea is there. We are able to also link the viscoelastic property of a mat to the viscoelasticity of single strands and also we are working on how the mat structure changes, how that relates to permeability and we have achieved some of that already and we are going to publish some of that pretty soon. From my standpoint I find it is really useful to start with modeling structure of a mat but it is going to take a longer time but it's really starting to sort of link everything together now, the sort of global approach and the structure approach and then link that to various other individual tests on strands, on glowing and that kind of stuff so anyway I found that would be sort of a direction that I would be pursuing to understand the structure of the material.

Thoemen: If I can just comment on it, it's just a discussion at the moment about the two different approaches, a more fundamental approach and a more empirical approach and I think probably we have to go both directions. It just depends on what we want. The more fundamental approach I agree that is in the long term what we need to understand the structure and maybe we also need it so that we can easily account for changes in the raw material so that we don't have to do this whole range of measurements but the drawback of this more fundamental approach is that you are kind of at one level of uncertainty in your predictions and we have to be aware of that and so if you, for example, want to run your model as a process control to it, maybe that the more empirical approach in the shorter term is the more realistic approach to it.

Dai: We have a similar type of a model like yours and now we are also working on the structure model. One benefit I found is that understanding the structure you are able to predict the average response of the mat or average let's say permeability of a mat because you have to understand the local structure and then you can predict the voids and that kind of stuff.

Gu: I just want to keep comment on that structure model and, I feel like I completely agree with that, because I am interested in structure models. Start with the fundamental structure of wood to build up the model and Fred probably knows that I did a little bit for my Ph.D., and I am still doing that here. We are right now dealing with the solid wood, not into the composite yet but I really found promising to start with the fundamental structure of wood but I am not sure

about the structure of wood start from this point of the solid wood compared to the, you were talking about, the structure of the composite. Do you think we should start from the basic fundamental structure of the wood itself or the structure of the composite, the fiber or strand?

Dai: Yes, going back when I did my Ph.D. and studied in the early 90s with Paul Steiner, we sort of studied with modeling the formation of a mat, you know the structure model of a mat so in a way it is structure of the composite before it's been densified. The structure aspect you talk about is the structure of a wood, I mean what's good about understanding the structure of the composite is that you can sort of break it down. Let's take example of OSB. You can look a localized structure it's really you are dealing with two overlapping strands and then you can isolate that, you can do tests on just the two strands, overlapping strands. And if you magnify that, you can look at compression or the property of the solid wood itself and there has been a lot of work done by the wood physics, just look at solid wood itself and then you look at the bonding and that so that is the unique thing about that is that you are able, if you understand the structure, you are able to link all these things together. And if I am wood physics I would start with wood structure, that would be information not only useful for understanding wood itself but useful as an input for the model or for wood composite products.

Winandy: Well, I think that we reached that time where we need to take a break for about 8 to 10 min and try to come back just after 3:00 with some more questions and answers and a summary and we will try to end. Many of you are probably ready to leave.

Summary and Wrap-up

Jerry Winandy: Alright, are we ready to rock and roll? I want everyone to stand up; we are going to do the chicken dance. Haha. First of all, while I am thinking about it, I want to ask everybody that was here that referred to published or unpublished work that either you yourself did or that you knew of from a co-worker or a collaborator, if you mentioned a report, please send me the citation or if you can, the whole paper so I can get it right.

Fred Kamke: Can you wait to do that until after we receive the transcripts?

Winandy: I am sure there will be plenty of cases for that. Also feel free to, in the proceedings, when you see the written transcript, if a stroke of genius hits you, oh I remember Smith did this in 1903, you know, you can refer to that and that makes you look really smart in the proceedings so I give you the authority to improve on that. I would like to go over some of my notes on what I saw and heard. Maybe that will spur some questions. I was scribbling like crazy when I heard someone in their presentations or in their conversations that went on that identified what I thought were real research needs. Something that anyone of us might have the possibility of going back to our shops and working on either individually or collaboratively and if we could just answer one or two questions in a collaborative type environment this conference I think would be major success and I know we will get there. They are in no particular order and I apologize if I cannot read my own writing.

Research needs identified at workshop:

Basic questions remain on vertical density profile, whether it occurs at closure or after closure, and some of the fundamental characteristics that drive it need to be defined.

Need to determine the effects of fiber versus strands on vertical density profile formation.

Need to define the recovery and the rate of that recovery of the mat after press opening.

Need to define wood based composite properties as a function of location in the press and correlating lab presses to industrial presses.

Need to define vertical density profile as a function of location in the press and correlating lab presses to industrial presses.

Need to define how elastic recovery, i.e., relaxation is a function of compaction ratio and wood density.

Need to identify how fines interact with mat consolidation and mat permeability, which seems to be unknown but seems to be a general assumption on the part of most folks

that the more fines, the more permeability. But do we have specific documentation on that?

From the session on adhesives and resins, we need to define what the relationship is between resin cure and mechanical property development.

Need to develop better understanding of how and how much resin cure is a function of time, temperature, and distribution on the flakes, chips, or fibers.

Need to address how we monitor and measure the development of that resin cure?

Need to address questions on how creep is influenced by resin type, different types of resin (PF, pMDI, etc.).

Agreed that fundamental work is needed to define creep at identical process times, temperatures and times, rather than at traditional press schedules for one resin or another resin where we say this creep is more than that, what happens at identical process conditions.

Need to define the effect of controlling resin flexibility on the eventual bond strength and how that affects the properties of the board.

Need a definition of which properties are best evaluated by one test methodology versus some other test methodology, for example, is creep more a function of flexural MOE and not a function of IB, that was said as a statement that we know that, but do we know that.

Need to identify how environmental factors interact with that property evaluation as a function of test method. Maybe creep is more influenced in one environment by one property and in a different environment by some other property. Do we know that?

When we are dealing with press strategies, we need to learn how to control the press to optimize resin cure and strength rather than using some predetermined recipe.

Need to develop alternatives to pressing, or at least the fundamental science to know if they have any real applicability.

Need fundamental data on how strand size through the thickness of the mat affect permeability and the problems it might create with blows.

Need to define resin cure as a function of heat energy as opposed to defining it as a function of temperature.

On the session on simulation, simulation of mechanical properties will proceed over the next decade as has simulation of temperature and pressure. Can we work together to accomplish that in a more efficient manner?

Main challenges are improvements in quality of model predictions and the reduction in processing execution time.

There is an on-going concern about the benefits and the drawbacks of open source code versus prioritized based codes. This concern should be discussed in an open forum; consideration should be given to intellectual property rights, both individual and corporate versus the potentials for improvements in simulation efficiencies through open source codes.

A series of simulation methods have been developed, each model has many very reliable prediction capabilities, and each may have some less reliable functions. Either as a group of developers or a group of users or a combination of the two, we probably need to define what works in each one of the systems and what doesn't work so that we can improve the efficiency and reliability of those modeling simulations.

Need to learn how to reverse engineer simulation models to allow process optimization in the future, especially as computer tools become more available to us and processing enables that.

Simulation models are limited by our lack of understanding of fundamental physical properties maybe it's the time to develop a consensus across the whole industry that we need to return to a certain amount of basic fundamental research on wood physics.

Now I guess I would like to open it up, if anybody had any comments.

Al Christiansen: One of the things that we were talking about before, there seems to be a lot of work being written up in foreign languages. Maybe we have to work at trying to find way of translating that material and getting it into general circulation somehow, we could save ourselves a lot of time.

Winandy: I have one comment on that. We had a conversation among a small group of us yesterday in that for example, the laboratory has a whole storehouse of Russian literature that was translated by a man who worked here for 20 years who did a great job and its all in our library. But I would almost contend that very few people know it exists, that the availability of that knowledge exists. We have a policy at the laboratory of putting everything we do, since about probably 1995 or 1996, on our Internet, on our webpage. And we are trying to put the critical papers from the past on the webpage too but we only have one or two people doing this and they can only do so much so we need to prioritize what needs to be on the web. One thing I will say to you, if any of you ever know of an old FPL report that you think is critical to your work, let us know. We do have a policy that priority in putting old papers on the web is given to people who ask. So if you need Stamm's paper from

1938, we will put it on the web or at least it will be a higher priority paper.

Kamke: Those Russian articles you are talking about, is that searchable in a database somewhere or how do we know what is contained in those articles?

Winandy: My understanding is that most of those articles are in our bibliography and we have our FPL library catalog available on the internet at <http://www.cybertoolsforlibraries.com/asp/usdafs.html>. Then click on "Search the catalog." The FPL library catalog is under construction and not everything is there yet, so ask for assistance. Our librarian might be able to identify what else we have. If you just call our main FPL switchboard (608-231-9200) and ask for the library, they will help you get the answer. Anybody else have any questions?

Ted Laufenberg: There are a lot of ideas for new projects to undertake and I am afraid that you all have brought in way too many ideas so we all need to get ready for homework.

Winandy: I think 60 h a week of our working will be plenty. If no one has anything else then I would like to move to closing. First of all, I would like to thank Professor Fred Kamke, pioneer of the Wood Based Composites Center at Virginia Tech for helping us organize this workshop. It has been terribly informative for me; I hope it has been informative for you. I want to thank the presenters whose hard work in their research and in preparing their talks, it sets the stage for the success of this workshop. As Ted just alluded to, we have got dozens and I mean dozens of ideas that we can each take back and work on. I think that it shows that if we get together and we freely throw out ideas, these ideas grow into something that is really viable. I am sure that in reading the literature in 5 or 6 years, there are going to be a number of things that come out of this workshop. I think that many of us will point our finger at something and say "I remember when we talked about that." But for now, thank you to the presenters, but now for the hook. I have one paper, I am expecting six, so please get your papers to me as soon as possible. That gives me time to prepare the audio transcriptions and try to turn this thing around before next spring and you are all out fishing or something. Number two, I would like to thank Steve Schmeiding, the FPL AV specialist for all his efforts in AV recording and all the general technical assistance in getting all these talks transferred from Virginia Tech, the University of Tennessee, Forintek, and the University of Hamburg. You know as they were coming in, one person said "your FTP site works wonderfully." That was exciting to hear and it is all because of Steve. So thank you Steve. I would also like to thank Viththal Talati who in the back there has been instrumental in keeping our audio online so that you can hear it. Special thanks to Dave Marr and Katherine Freidrich for running the hand microphones during the discussions. Thanks to Sue Paulson, Nancy Keen, Sandy Morgan and George Couch for running the

registration desk, organizing the lunches, breakfasts, and Wednesday's social event at Captain Bill's. Especially want to thank them for how well they enabled us to keep modifying the schedule on the fly. They were just wonderful to work with in that way. Thanks also to Linda Caudill at Virginia Tech for all her preliminary work in inviting each of us and for just organizing this meeting and helping with the hotel arrangements and all that. And finally, and I think most importantly, thanks to each of you for attending this and helping us synthesize what I think will become a state of the art, that I think that many of us will show to our students or to the junior engineers that work for you or scientists that work for you and say go forth and do this good work. So thanks to each of you, have a safe trip home, thanks for coming to Madison.

Kamke: One more comment, I think you forgot to mention yourself. We all should give Jerry a hand for coming up with the idea of having such a conference and doing such a great job in leading us the last few days and keeping us all on course. That was a big help, it wouldn't have happened without you Jerry, thanks a lot.

Winandy: Class dismissed. Thank you all, and now go forth and do great things related to the fundamentals of composite processing.

Literature Cited

- Ballerini, A.A.** 1994. Cure of aqueous phenol-formaldehyde resin at elevated water vapor pressures. Ph.D. thesis. Blacksburg, VA: Virginia Tech.
- Ebewele, R.O.; River, B.H.; Myers, G.E.** 1994. Behavior of amine-modified urea-formaldehyde-bonded wood joints at low formaldehyde/urea molar ratios. *Journal of Applied Polymer Science*. 52: 689–700.
- Ganev, S., Cloutier, A.** 2003. Determination of the diffusion coefficients and modeling of the hygro-mechanical warping of particleboard. Final Rep. Gaithersburg, MD: Composite Panel Association.
- Geimer, R.L., Christiansen, A.W.** 1996. Critical variables in the rapid cure and bonding of phenolic resins. *Forest Products Journal*. 46(11/12):67–72 (see page 70).
- Irle, M.A.; Bolton, A.J.** 1988. Physical aspects of wood adhesive bond formation with formaldehyde based adhesives, Part 2: Binder physical properties and particleboard durability. *Holzforschung* 42: 53–58.
- Laborie, M.** 2001. Investigation of the wood/phenol-formaldehyde adhesive interphase morphology. Ph.D. thesis. Blacksburg, VA: Virginia Tech.
- Lenth, C.A.** 1999. Wood material behavior on severe environments. Ph.D. thesis. Blacksburg, VA: Virginia Tech.
- Lenth, C.A.; Kamke, F.A.** 2001. Equilibrium moisture content of wood in high-temperature pressurized environments. *Wood and Fiber Science* 33(1): 104–118).
- Rasthauser, J.W.; Haider, K.W.; Hunt, R.N.; Gustavich, W.S.** 1997. Chemistry of PMDE wood binders: Model studies. In: M. Wolcott (ed.) *Proceedings of the 31st International Particleboard/Composite Materials Symposium*. Pullman, WA: Washinton State University Press. p. 161–176.
- Stamm, A.** 1964. *Wood and cellulose science*. New York, NY: Roland Press Company.
- Strickler, M.D.** 1968. High temperature relations of grand fir. *Forest Products Journal*. 18(4): 69–75).

Appendix—Participant List

Bill Augustine
Research Project Leader
Trus Joist—A Weyerhaeuser Business
TJ Technology Center
P.O. Box 8449
Boise, ID 83707-2449
Phone: (208) 332-4211
Fax: (208) 332-4220
Email: augustb@trusjoist.com

Marcia Vidal Bastias
Ph.D. Candidate
Laval University
Department of Wood and Forest Sciences
Ste-Foy, Quebec
G1K 7P4 CANADA
Phone: (418) 656-5851
Fax: (418) 656-5262
Email: mavib2@agora.ulaval.ca

Felisa Chan
Research Scientist
University of New Brunswick
Fsc of Forestry & Environmental Management
P. O. Box 44555
Fredericton, NB
E3B 6C2 CANADA
Phone (506) 452-6156
Fax (506) 453-3538
Email: fchan@unb.ca

Al Christiansen
Chemical Engineer
USDA Forest Products Laboratory
One Gifford Pinchot Drive
Madison, WI 53705-2398
Phone: (608) 231-9289
Fax: (608) 231-9592
Email: achristiansen@fs.fed.us

Craig Clemons
Research General Engineer
USDA Forest Products Laboratory
One Gifford Pinchot Drive
Madison, WI 53705-2398
Phone: (608) 231-9396
Fax: (608) 231-9852
Email: cclemons@fs.fed.us

Alain Cloutier
Professor
Laval University
Department of Wood and Forest Sciences
Ste-Foy, Quebec
G1K 7P4 CANADA
Phone: (418) 656-5851
Fax: (418) 656-5262
Email: alain.cloutier@sbf.ulaval.ca

Chunping Dai (Presenter)
Senior Scientist-Wood Composites
Forintek Canada Corporation
2665 East Mall
Vancouver, BC
V6T 1W5 CANADA
Phone: (604) 222-5736
Fax: (604) 222-5690
Email: dai@van.forintek.ca

Karl Englund
Research Engineer
Wood Materials and Engineering Lab
P.O. Box 1806
Washington State University
Pullman, WA 99164-1806
Phone: (509) 335-6259
Email: englundk@wsu.edu

Ted Frick, Technical Manager
Bayer Polyurethanes
Wood and Foundry Products
100 Bayer Road, Bldg. 1
Pittsburgh, PA 15205
Phone: (412) 777-2944
Fax: (412) 777-7864
Email: ted.frick.b@bayer.com

Katherine Friedrich
General Engineer
USDA Forest Products Laboratory
One Gifford Pinchot Drive
Madison, WI 53705-2398
Phone: (608) 231-9398
Fax: (608) 231-9852
Email: kfriedrich@fs.fed.us

Charles Frihart (Presenter)
Project Leader
USDA Forest Products Laboratory
One Gifford Pinchot Drive
Madison, WI 53705-2398
Phone: (608) 231-9208
Fax: (608) 231-9592
Email: cfrihart@fs.fed.us

Pablo Garcia
Post-Doctoral Research Associate
University of Tennessee
Forest Products Center
2506 Jacob Drive
Knoxville, TN 37996-4570
Phone: (865) 946-1878
Fax: (865) 946-1109
Email: pgarcia@utk.edu

Hongmei Gu
Post-Doctoral Fellow
USDA Forest Products Laboratory
One Gifford Pinchot Drive
Madison, WI 53705-2398
Phone: (608) 231-9574
Fax: (608) 231-9852
Email: hgu@fs.fed.us

David Harper
Post-Doctoral Fellow
USDA Forest Products Laboratory
One Gifford Pinchot Drive
Madison, WI 53705-2398
Phone: (608) 231-9398
Fax: (608) 231-9852
Email: dpharper@fs.fed.us

Shane Hartzke
Research Technician
Grant Forest Products, Inc.
P.O. Box 160, Hwy 11N
Earlton, Ontario P0J 1E0
CANADA
Phone: (705) 563-2460
Fax: (705) 563-3213
Email: shartzke@gfp-inc.com

John Hunt
Research General Engineer
USDA Forest Products Laboratory
One Gifford Pinchot Drive
Madison, WI 53705-2398
Phone: (608) 231-9433
Fax: (608) 231-9852
Email: jfhunt@fs.fed.us

Fred Kamke (Presenter)
Professor and Director
Wood-Based Composites Center
Sustainable Engineered Materials Institute
Virginia Tech
Brooks Center (0503)
1650 Ramble Road
Blacksburg, VA 24061
Phone: (540) 231-7100
Fax: (540) 231-8868
Email: kamkefa@vt.edu

Ted Laufenberg
Research General Engineer
USDA Forest Products Laboratory
One Gifford Pinchot Drive
Madison, WI 53705-2398
Phone: (608) 231-9433
Fax: (608) 231-9852
Email: tlaufenberg@fs.fed.us

Jong Lee
Research Scientist
Sustainable Engineered Materials Institute
Virginia Tech
1650 Ramble Road
Blacksburg, VA 24061
(540) 231-5219
Email: jolee6@vt.edu

Zipporah Magee
Technical Service Representative
National Casein Company
601 W. 80th Street
Chicago, IL 60620
Phone: (773) 846-7300
Email: cgolab@nationalcasein.com

David Marr
General Engineer
USDA Forest Products Laboratory
One Gifford Pinchot Drive
Madison, WI 53705-2398
Phone: (608) 231-9586
Fax: (608) 231-9852
Email: dmarr@fs.fed.us

John Noffsinger
Technical Manager
Weyerhaeuser Company
P. O. Box 487
Sutton, WV 26601
Phone: (304) 765-4220
Fax: (304) 765-4285
Email: john.noffsinger@weyerhaeuser.com

Nian Ou
R&D Manager
J. M. Huber Corporation
P.O. Box 670
Commerce, GA 30529
Phone: (706) 336-3123
Fax: (706) 336-3164
Email: wpnho@huber.com

Rick Rammon
R&D Manager, Wood Adhesives
Georgia-Pacific Resins, Inc.
2883 Miller Road
Decatur, GA 30035-4088
Phone: (770) 593-5921
Fax: (770) 322-9973
Email: rmmrammon@gapac.com

David Ruth
Product Development Specialist
Boise Cascade Corporation
P.O. Box 2400
White City, OR 97503
Phone: (541) 826-0225
Fax: (541) 826-0219
Email: DaveRuth@boisebuilding.com

Nicole Stark
Chemical Engineer
USDA Forest Products Laboratory
One Gifford Pinchot Drive
Madison, WI 53705-2398
Phone: (608) 231-9392
Fax: (608) 231-9852
Email: nstark@fs.fed.us

Heiko Thoemen (Presenter)
Federal Research Center for Forestry and Forest Products
University of Hamburg
Leuschnerstr. 91
21031 Hamburg
GERMANY
+49-40-73962-603
Email: thoemen@holz.uni-hamburg.de

Siqun Wang (Presenter)
Assistant Professor
University of Tennessee
Department of Forestry, Wildlife, and Fisheries
Knoxville, TN 37901-1071
Phone: (865) 946-1120
Fax: (865) 946-1109
Email: swang@utk.edu

Jim Wescott
Director of Research
Heartland Resource Technology
c/o USDA Forest Products Laboratory
One Gifford Pinchot Drive
Madison, WI 53705-2398
Phone: (608) 469-0256
Fax: (608) 231-9592
Email: jmwme@aol.com

Jerry Winandy (Host, General Chair)
Project Leader – Performance Engineered Composites
USDA Forest Products Laboratory
One Gifford Pinchot Drive
Madison, WI 53705-2398
Phone: (608) 231-9316
Fax: (608) 231-9852
Email: jwinandy@fs.fed.us