



United States  
Department of  
Agriculture

**Forest Service**

Forest  
Products  
Laboratory

General  
Technical  
Report  
FPL-GTR-118



# Drying Hardwood Lumber

**Joseph Denig  
Eugene M. Wengert  
William T. Simpson**



## Abstract

*Drying Hardwood Lumber* focuses on common methods for drying lumber of different thickness, with minimal drying defects, for high quality applications. This manual also includes predrying treatments that, when part of an overall quality-oriented drying system, reduce defects and improve drying quality, especially of oak lumber. Special attention is given to drying white wood, such as hard maple and ash, without sticker shadow or other discoloration. Several special drying methods, such as solar drying, are described, and proper techniques for storing dried lumber are discussed. Suggestions are provided for ways to economize on drying costs by reducing drying time and energy demands when feasible. Each chapter is accompanied by a list of references. Some references are cited in the chapter; others are listed as additional sources of information.

Keywords: drying, hardwood, lumber, warp, kiln

September 2000

Denig, Joseph; Wengert, Eugene M.; Simpson, William T. 2000. Drying hardwood lumber. Gen. Tech. Rep. FPL–GTR–118. Madison, WI: U.S. Department of Agriculture, Forest Service, Forest Products Laboratory. 138 p.

A limited number of free copies of this publication are available to the public from the Forest Products Laboratory, One Gifford Pinchot Drive, Madison, WI 53705–2398. Laboratory publications are sent to hundreds of libraries in the United States and elsewhere.

The Forest Products Laboratory is maintained in cooperation with the University of Wisconsin.

The use of trade or firm names is for information only and does not imply endorsement by the U.S. Department of Agriculture of any product or service.

The United States Department of Agriculture (USDA) prohibits discrimination in all its programs and activities on the basis of race, color, national origin, sex, religion, age, disability, political beliefs, sexual orientation, or marital or familial status. (Not all prohibited bases apply to all programs.) Persons with disabilities who require alternative means for communication of program information (Braille, large print, audiotape, etc.) should contact the USDA's TARGET Center at (202) 720–2600 (voice and TDD). To file a complaint of discrimination, write USDA, Director, Office of Civil Rights, Room 326-W, Whitten Building, 1400 Independence Avenue, SW, Washington, DC 20250–9410, or call (202) 720–5964 (voice and TDD). USDA is an equal opportunity provider and employer.

## Units of Measurement

In this manual, measurements are expressed in both English (inch–pound) and SI units. The following provides SI equivalents for lumber thickness sizes, dimension lumber, board foot volume, and other units.

### SI equivalents for lumber thickness sizes

3/4	19 mm
4/4	25 mm
5/4	32 mm
6/4	38 mm
8/4	51 mm
10/4	64 mm
12/4	76 mm
14/4	89 mm
16/4	102 mm

### SI equivalents for dimension lumber

Nominal (in.)	Standard (mm)
2 by 4	38 by 89
2 by 6	38 by 102
2 by 10	38 by 165

### SI equivalents for other units

board foot <sup>a</sup>	$2.36 \times 10^{-3} \text{ m}^3$
ft <sup>3</sup>	$0.0283 \text{ m}^3$
ft/s	0.305 m/s
ft/min	0.005 m/s
lb	0.454 kg
lb/in <sup>2</sup>	6.895 kPa
lb/ft <sup>3</sup>	$16.0 \text{ kg/m}^3$
°F	0.56°C
temperature	$T_C = [T_F - 32]/1.8$

<sup>a</sup>The conversion factor for board foot is used to convert gross volumes of lumber. It does not take into account any variation between actual and nominal sizes but rather is based on the volumetric ratio between 1 cubic meter (1 m × 1 m × 1 m) and 1 board foot (1 in. × 12 in. × 1 ft).

# Drying Hardwood Lumber

**Joseph Denig**

Associate Professor

North Carolina State University, Raleigh, North Carolina

**Eugene M. Wengert**

Professor Emeritus

University of Wisconsin, Madison, Wisconsin

**William T. Simpson**

Research Forest Products Technologist

Forest Products Laboratory, Madison, Wisconsin



## Preface

For hardwood lumber producers, drying is an opportunity to add value to products and to enter new, previously inaccessible markets. For most hardwood users, such as furniture manufacturers, lumber drying is an essential procedure in the manufacturing process. As with any part of the manufacturing process, costs must be controlled. Costs can be magnified by improper drying techniques that cause degrade, resulting in quality losses; mistakes can be made that cause problems in subsequent manufacturing processes; and considerable amounts of energy can be wasted. As hardwood lumber prices escalate, ensuring that the highest yield is obtained from the hardwood resource becomes critical in controlling overall costs. Fortunately, drying techniques and systems are available that can produce a quality hardwood lumber product at minimum cost.

*Drying Hardwood Lumber* is an update of a previous Forest Service publication, *Drying Eastern Hardwood Lumber* by John M. McMillen and Eugene M. Wengert. Both publications contain information published by many public laboratories, universities, and associations, as well as that developed at the Forest Products Laboratory and other Forest Service units. The updated version includes much basic information from the original publication and new information relevant to new technology and the changing wood resource.

# Contents

	<i>Page</i>		<i>Page</i>
<b>Chapter 1 Overview.....</b>	<b>1</b>	Tropical Hardwoods.....	78
Quality Requirements and Cost of Degrade .....	1	Kiln Start-Up Procedures .....	79
Basic Drying Concepts.....	1	Equalizing and Conditioning .....	86
Drying Methods.....	3	Sterilization .....	88
Moisture Content.....	5	Drying Time .....	88
References .....	6	Operational Considerations .....	90
<b>Chapter 2 Drying Mechanisms of Wood.....</b>	<b>7</b>	References .....	91
Wood Characteristics That Affect Drying .....	7	<b>Chapter 8 Advanced Kiln Drying Procedures.....</b>	<b>93</b>
Environmental Factors.....	12	Modifications to General Hardwood Schedules .....	93
Rate of Drying.....	18	Special Hardwood Schedules .....	94
Stages of Drying.....	21	Adjustment of Moisture Content of Kiln-Dried Wood...95	
References .....	24	Alternative Schedules for Some Species .....	96
<b>Chapter 3 Stock Preparation and Stacking.....</b>	<b>25</b>	Kiln Operational Techniques.....	97
Protection of Logs .....	25	References .....	102
Sawing Procedures .....	25	<b>Chapter 9 Drying Defects.....</b>	<b>103</b>
Protection of Green Lumber.....	26	Checking.....	103
Prevention of Surface Checks.....	27	Shake.....	105
Prevention of End Checks .....	27	Collapse.....	106
Color Enhancement Through Steaming.....	28	Warp.....	106
Other Lumber Pretreatments .....	28	Discoloration.....	107
Sorting.....	29	Problems Caused by Incorrect Lumber	
Stacking.....	30	Moisture Content.....	109
Additional Ways to Control Warp.....	33	Residual Tension set (Casehardening).....	110
References .....	33	Machining and Gluing Problems .....	110
<b>Chapter 4 Air Drying .....</b>	<b>35</b>	Insect Damage .....	111
Advantages and Limitations .....	36	Statistical Process Control.....	112
Utilization of Air Movement .....	36	References .....	114
Other Factors That Affect Drying Rate and Degrade .....	37	<b>Chapter 10 Special Drying Methods .....</b>	<b>115</b>
Drying Time and Final Moisture Content.....	40	Heated-Room Drying .....	115
Air Drying and Shed Drying Operating Costs .....	43	Press Drying .....	115
Quick Guide for Improving Air Drying.....	43	High-Frequency and Microwave Heating.....	115
References .....	44	Solvent Seasoning .....	116
<b>Chapter 5 Drying Sheds .....</b>	<b>45</b>	Lesser-Used Drying Methods .....	116
Open Sheds.....	45	Solar Drying .....	116
Fan Sheds .....	46	References .....	118
References .....	47	<b>Chapter 11 Storage of Dried Lumber .....</b>	<b>119</b>
<b>Chapter 6 Accelerated Air Drying and Predrying.....</b>	<b>49</b>	Air-Dried Lumber.....	119
Accelerated Air Drying .....	49	Kiln-Dried Lumber .....	119
Warehouse Predrying .....	50	Storage Facilities .....	119
References .....	56	References .....	120
<b>Chapter 7 Conventional Kiln Drying.....</b>	<b>57</b>	<b>Chapter 12 Economics and Energy .....</b>	<b>121</b>
Dry Kiln Designs.....	57	Economics .....	121
Dehumidification Drying.....	58	Energy Considerations.....	122
Basic Kiln Operating Philosophy .....	60	References .....	125
Kiln Samples .....	60	<b>Appendix A—Lumber, Tree, and Botanical Names</b>	
Recording of Drying Date .....	71	<b>of Commercial North American Hardwoods.....</b>	<b>126</b>
Basic Hardwood Kiln Schedules .....	72	<b>Appendix B—Portable Electric Moisture Meters.....</b>	<b>128</b>
		<b>Glossary .....</b>	<b>131</b>

# Chapter 1—Overview

The fundamental reason for drying lumber is to enhance the properties of the wood and thereby make the lumber more valuable. In short, the primary objective when drying hardwood is to produce a useful product, minimizing any quality losses, thereby conserving natural resources and at the same time making a profit. Stated another way, hardwood lumber drying is, or should be, a conservation-oriented, profitable process.

Some advantages of dried lumber over undried or partially dried lumber are as follows:

- Lumber with less than 20% maximum moisture content (MC) has no risk of developing stain, decay, or mold as a result of fungal activity.
- Dry lumber is typically more than twice as strong and nearly twice as stiff as wet lumber.
- Fasteners driven into dry lumber, including nails and screws, will perform much better than do fasteners in wet lumber, especially if the wet lumber dries after fastening.
- Dry lumber weighs 40% to 50% less than wet, undried lumber. For example, an 18-wheel, flatbed truck can haul about 7,500 board feet of wet lumber, 10,500 board feet of partially dried lumber, and 12,500 board feet of kiln-dried lumber.
- Products made from properly dried lumber will shrink very little or none at all while in service; products made from wet lumber often shrink substantially as the wood dries.
- Gluing, machining, and finishing are much easier to accomplish with dry wood.
- Wood that will be treated with fire retardants or preservatives (such as copper chromium arsenate, CCA) after drying must be at least partially dried to allow for quick penetration of the treating chemicals.

## Quality Requirements and Cost of Degrade

Proper drying, aimed at achieving the highest possible quality of the wood, seems to have assumed new importance and gained appreciation in the past decade. For example, the rules of the National Hardwood Lumber Association allows

ordinary surface checking in clear cuttings only if the checks surface out at the standard thickness. Furthermore, end splits must be very large before they reduce the grade of lumber. However, an increasing number of companies are insisting on higher quality standards. Customers have become aware of the factors that influence costs. Because the wood raw material often constitutes 75% of total costs, customers now insist on exceptional quality of dried lumber. Furniture and cabinet industries, for example, have found that a 1% increase in yield through better drying can reduce the cost of parts by more than \$40/thousand board feet, based on estimates using 1998 cost and values. The importance of correct final MC in reducing rejects in machining and gluing, and even the importance of proper MC in the final product, is now well accepted by the industry, especially with the advent of the affordable, in-line moisture meter that checks the MC of every piece of lumber. In short, lumber drying has entered a new era, one of high quality drying. In a poor drying operation, the costs incurred by loss in quality (perhaps as high as \$100/thousand board feet) can easily exceed all other drying costs combined. In a high quality operation, the costs incurred by loss in quality can be considerably lower (\$15/thousand board feet), and most of this loss is the result of the inherent quality of the wood and not the drying procedures.

When drying lumber, the key question is “What level of quality does the customer require?” This question, which determines the quality that must be achieved, must be answered before analyzing the correct drying method. Specifically, the major quality factors for dried lumber (Table 1.1) must be considered. Although this is a long list, in most cases the customer is concerned about only a few of these items.

In addition to knowing the level of quality required, the trained kiln operator needs to have the right equipment; to assure that the equipment is operated and maintained properly; to receive properly stacked, good quality lumber; and to have adequate time to do the job correctly.

## Basic Drying Concepts

Understanding the fundamental concepts that underlie lumber drying can guide the selection of economical and efficient drying methods that result in high quality products. This knowledge will allow kiln operators, drying practitioners, and drying managers to apply general drying concepts and information to specific situations.

**Table 1.1—Quality factors for dried lumber**

---

Correct MC—average and spread within individual piece (shell-core; end to end)
Correct MC—average and spread for entire load
No checking on surfaces
No checking in interior
No checking and splits on ends
No warp (cup, bow, side bend (crook), twist)
No casehardening
Good color
Good strength
No or minimal fungal stain
No or minimal chemical stain
Good machinability
Good glueability

---

To dry wood, three basic requirements must be met:

1. Energy (heat) must be supplied to evaporate moisture throughout the drying process. Two types of water can be found in wood: free water and bound water. Free water fills the wood cell cavity and is easily evaporated from the wood. Drying green wood with large amounts of free water requires 1,045 Btu/lb (2.4 MJ/kg) of water evaporated (Fig. 1.1). Bound water refers to the water in a wood cell when MC is less than approximately 30%. Bound water is chemically attached to the cell wall; an increasing amount of energy is required to remove a given amount of water as MC decreases. In practical terms, however, lumber drying must be considered on a larger scale, such as a piece of lumber, rather than on the small scale of a cell.

Because a piece of lumber consists of many wood cells, during drying some cells located on the lumber surface have low MC while cells located in the center of the piece have high MC. As a result, the amount of energy required to remove a given amount of water varies only slightly with a change in the average MC of the lumber—approximately 1,100 Btu/lb (2.6 MJ/kg) are required to evaporate water from lumber during drying. Additional energy is required for heat losses (conduction and ventilation) in the dryer.

Proper control of temperature during drying is essential for quality drying. In short, as the temperature increases, drying is more rapid; wood becomes weaker (in the short term), thereby increasing the risk of checking, cracking, honeycomb, collapse, and warp; drying is more uniform throughout the load; wood darkens in color; and insects, insect eggs, and fungi become less active and are killed when the temperature is above 130°F (54°C).

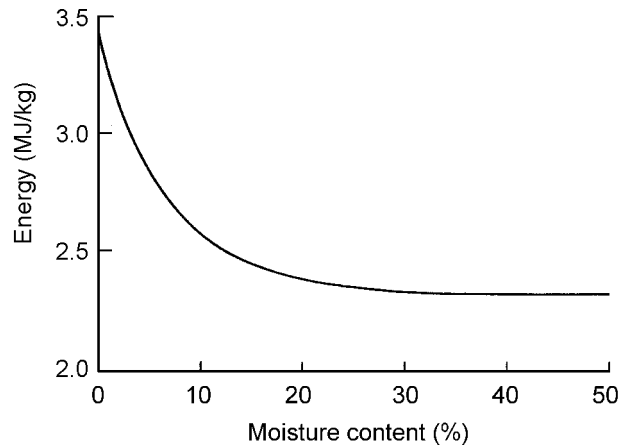

**Figure 1.1—Energy required in drying of wood cell as wood MC changes (after Skaar and Simpson 1968).**

2. The environment surrounding the lumber must be capable of receiving moisture from the wood surface. That is, the relative humidity of the air surrounding the lumber must be below 100%.

Proper control of humidity during drying is also essential for quality drying. The lower the relative humidity (RH), the faster the drying, resulting in flatter, brighter colored lumber. On the other hand, low RH values at the beginning of the drying process can result in excessively fast drying that may cause cracks, splits, and honeycomb in some species and lumber thicknesses.

3. During drying, air movement through a stack of lumber must be adequate to bring energy into the stack, to remove evaporated moisture, and to maintain the desired RH.

Proper control of the air velocity during drying at high and intermediate MCs is essential for quality drying. Inadequate velocity, especially at high lumber MCs, can result in excessively high humidity and slow drying within a stack of lumber, leading to warp and to poor color and staining in some species. Higher velocity at high MCs can result in excessive drying rates, which in turn can lead to checking, cracking, and honeycomb. At low MCs, velocity is not a critical factor in controlling lumber quality or limiting the drying rate.

The combination of these three factors—temperature, RH, and air velocity—determines the rate at which lumber dries. These factors can be manipulated to control the drying process, minimizing defects while drying the lumber as rapidly as possible. For more detailed information on the theory and details of the drying process, wood properties, and causes and cures of specific drying defects, refer to the *Dry Kiln*



*Operator's Manual* (Simpson 1991), *Air Drying of Lumber* (FPL 1999a), *Lumber Drying Sourcebook* (Wengert and Toennisson 1998), and *Drying Oak Lumber* (Wengert 1990). Highly technical information is provided in other references (McMillen 1969, Panshin and De Zeeuw 1980, and Stamm 1964).

## Drying Methods

A number of methods are in widespread commercial use for drying hardwood lumber:

- Air drying
- Shed air drying
- Forced-air shed drying
- Warehouse predrying
- Low temperature kiln drying
- Conventional electric dehumidification kiln drying
- Conventional steam-heated kiln drying

Combinations of two of these methods are often used in commercial hardwood drying operations to produce a low cost, high quality product (Table 1.2). A typical example is warehouse predrying of lumber followed by conventional drying.

The most popular drying combination for hardwood lumber prior to the 1990s was air drying, which often took up to 6 months, followed by kiln drying. Recently, four factors have necessitated an aggressive search for drying systems that produce a higher quality dried product in, if possible, a shorter amount of time:

- Increasing lumber prices

- Pressure by firms to cut manufacturing inventory, driven by high interest rates and/or operating cash shortages
- The use of lower grade lumber for kiln-dried products
- The use of more variable lumber in terms of drying characteristics, partially as a result of changes in tree diameter, straightness, and growth rates

Thus, air drying sheds and warehouse predryers have increased in popularity for the initial drying of moderate and hard-to-dry hardwood species, such as the oaks. On the other hand, for species such as yellow-poplar and hard maple that can be dried quickly with a small risk of degrade and where color control of the final product is important, the wood is often dried most successfully if placed directly into a kiln—that is, dried green-from-the-saw. Some species, especially thinner lumber of easy-to-dry species, are dried in fan shed dryers, followed by conventional kiln drying.

As the lumber drying industry has begun to recognize that the true cost of drying includes degrade costs as well as operating costs, the industry has moved from systems with poor control of the drying process, such as air drying, to those systems that have sufficient control to avoid damaging the lumber. As an illustration, current typical stacking costs are approximately \$20/thousand board feet. Drying costs, excluding degrade, profit, and overhead, are about \$50 to \$75/thousand board feet. The cost of degrade in air drying can exceed \$75/thousand board feet, while degrade costs using controlled methods such as shed or warehouse predryers can be as little as \$10/thousand board feet. In short, in most cases air drying is no longer a preferred system for quality, profitable drying of hardwood lumber.

Over the past several years, the market for kiln-dried lumber has become highly competitive. Drying costs are extremely sensitive to the amount of production run through a drying

**Table 1.2—Suitability of various systems for drying hardwood lumber based on quality**

Drying system	Suitability of system for various species and lumber thicknesses <sup>a</sup>					
	Hard-to-dry species		Moderately hard-to-dry species		Easy-to-dry species	
	4/4	8/4	4/4	8/4	4/4	8/4
Air dry and kiln dry	Fair–Poor	Poor	OK	Poor	OK	OK
Shed dry and kiln dry	Excel.	Excel.	Very good	Good	Good	Good
Fan shed dry and kiln dry	Good	Fair	Excel.	Excel.	Excel.	Excel.
Predry and kiln dry	Excel.	Fair	OK	Fair	Poor	Poor
Kiln dry	Excel.	Excel.	Excel.	Excel.	Excel.	Excel.

<sup>a</sup>Examples of hard-to-dry species are oak and beech; moderately hard-to-dry, hickory and hard maple; and easy-to-dry, ash, basswood, yellow-poplar, and soft maple.

system. Thus, besides the push for quality, throughput is a major issue with many hardwood lumber manufacturers. The ideal drying system is usually a combination of drying methods that consistently produces a quality product at a high production level.

A detailed review of drying systems, with operating costs and drying times, is provided in *Drying Oak Lumber* (Wengert 1990) and *Opportunities for Dehumidification Drying of Hardwood Lumber* (Wengert and others 1988). Only a brief review is provided here. Other techniques used rarely in hardwood drying in North America include vacuum drying, platen or press drying, radiofrequency drying, and solar heated drying. These techniques are discussed in Chapters 4 through 9.

## **Air Drying**

### **Open Yard**

As the lumber industry has become more quality-conscious, air drying lumber in the open yard has lost favor because of the high risk of substantial degrade. Degrade in sensitive species can be reduced by some procedures, such as placing the lumber pile under a large roof and covering the pile with open-weave plastic cloth. Moreover, air drying can provide the desired quality characteristics and is the most economical method for some products, such as upholstery frame stock. Air drying is also the best method in terms of energy conservation. However, the drying quality and speed of air drying are unpredictable because the process is controlled by the weather. In addition, inventory costs are high when large volumes of lumber are held in the air drying yard.

### **Shed**

Air drying lumber under a roof protects the lumber from rain and sun, reducing the amount of degrade. Capital, operating, and other costs for air drying lumber in a shed are very low. Drying times are very close to those in open yard air drying; in rainy weather, lumber in sheds may dry faster and to lower MC than lumber dried in an open yard. Sheds also offer the opportunity to restrict air flow when drying conditions are too harsh, by using burlap or plastic mesh curtains on the outside opening of the shed. The cloth can be hung so that it can be opened or closed as dictated by the drying conditions. This system of drying is often used successfully for refractory lumber, including all thicknesses of oak.

### **Forced-Air Shed**

For species that can be dried quickly without degrade, the addition of fans to quicken the drying of lumber in air drying sheds can be an effective method of improving the rate and quality of drying. The cost of electricity for operating the fans, which may be as high as \$15/thousand board feet, is offset by the benefit of faster drying, which often produces whiter and flatter lumber than lumber dried by other

air drying methods. Thus, the forced-air drying shed is an attractive method of drying from the green condition to around 20% MC. The cost of forced-air shed drying is one-third that of kiln drying for the same MC loss and can reduce the size of the boiler required for the kiln if the kiln is not required to dry lumber from green to 20% MC.

## **Warehouse Predrying**

Predryers are extremely popular for drying 4/4 through 6/4 oak lumber, providing nearly perfect drying conditions 24 hours per day, without the risk of damage from rain or sun. Although initially developed for colder climates, where good air drying conditions prevail only 6 months or less per year, predryers are now used throughout the East, South, and North. Predryers have a lower capital cost than that of dry kilns with similar capacity, yet they can provide nearly equal drying rates above 30% MC. Compared to air drying, predryers reduce inventory and degrade costs; however, these savings are partially offset by energy and capital costs.

## **Kiln Drying**

### **Low Temperature Drying**

The low temperature kiln, operating below 130°F (54°C), is often designed to be loaded with lumber of mixed MC, much like a predryer. The wide main alleys also resemble a predryer, whereas the air flow and heating systems are similar to those of a conventional kiln.

### **Conventional Electric Dehumidification Drying**

A conventional, steam-heated dry kiln loses nearly 75% of the energy used in drying through the vents—both the sensible heat required to heat the vent make-up air (25%) and the latent energy required to evaporate the water (50%). The remainder of the energy lost as heat through the structure. The electric dehumidifier, also called a heat pump, is in essence a heat recovery system for the 75% energy that is vented. The electric dehumidification (DH) kiln uses electricity as its primary energy source; however, by recapturing the vent energy that would normally be exhausted, the DH system is able to operate at a very high energy efficiency. Although electricity is an expensive form of energy, the efficiency of the DH system makes these dryers quite economically competitive, especially for those plants that produce less than 2 million board feet per year. The modern DH kiln differs operationally from conventional steam-heated kilns only in terms of the energy source and in the ability to operate efficiently at lower temperatures. Performance and degrade are similar to those associated with modern steam kilns (Wengert and others 1988); these factors primarily depend on the operator and control system and not the basic drying equipment. A small steam system is required for stress relief when using a DH kiln, although the use of a fine water mist system has met success.

## Conventional Steam-Heated Drying

Modern dry kilns can dry most species and most thicknesses with little, if any, degrade. Computer controls carefully regulate temperature, humidity, and air velocity to achieve the best drying possible. Although the capital cost of steam kilns is high, their versatility, drying quality, and productivity offset this cost. Steam kilns are also very efficient in equalizing MC both within a piece of lumber and from piece to piece. Normal drying stresses (and even some growth stresses) are also easily relieved in a steam system. The high kiln temperatures (typically up to 180°F (82°C) and low MC values are easy to achieve.

## Vacuum Drying

Although developed almost a century ago, vacuum drying has not been a very popular drying method until recently. Much of its appeal today is that it can be used in a small scale operation. Drying is rapid—4/4 red oak can be dried in less than a week, and many other species can be dried in 3 days—and quality can be very good, as good as conventional systems if the vacuum system is well designed and operated.

## Moisture Content

### Measurement

Moisture content (MC) is a measure, usually expressed as a percentage, of the weight of water in wood compared to the oven-dry weight of the same piece of wood. Mathematically,

$$MC(\%) = \frac{(\text{wet weight} - \text{oven-dry weight})}{\text{oven-dry weight}} \times 100\%$$

The primary guiding factor in operating a dryer is MC of the lumber. The primary measure of the success of hardwood lumber drying is the final MC. Moisture can be measured with an oven and scales, where the wet piece is weighed, oven-dried, and then reweighed, or it can be measured with electronic moisture meters, which measure an electrical property of wood that is then correlated to MC.

The final MC of kiln-dried lumber is usually measured with an electronic moisture meter rather than with the oven-drying tests used for obtaining MCs during the drying process. Comparisons of MC values measured by meters with oven-drying MCs for many hardwoods have shown that meter-derived values are within 1% of the true oven-dry values. The oven-drying technique is discussed in more detail in Chapter 7; the electrical moisture meter technique is discussed in Appendix A.

### Appropriate Moisture Levels

How dry is dry enough? In decades of studying the use of wood, the authors have noted that problems in processing

dry lumber into cabinets, furniture, millwork, and other value-added products arise when the wood is not dried to the difficulties in many processes (examples in parentheses): in gluing (end splits in glued panels during heating season), machining (fuzzy grain), and shrinkage (warp after manufacturing). Conversely, lumber that is too dry may exhibit gluing problems (precurring problems), machining problems (grain tear-out and breakage), and swelling problems (tight drawers). Non-uniformly dried lumber combines the problems of both too much and too little moisture. As a result of tighter building construction, central heating, and year-round climate control, the MC of hardwood products eventually equalizes at a low level.

To avoid manufacturing problems with the finished product, especially warping, splitting, and checking, lumber must be dried to a final (post-conditioning) MC that is close to the middle of the range of expected in-use MC values. (Because swelling problems from dry wood are often less troublesome than shrinking problems from wetter wood, MC may be slightly below the middle of the range.) The in-use MC for various regions of the United States can be estimated (Table 1.3). The importance of obtaining the correct MC when kiln drying cannot be overemphasized. A clear understanding by management and the kiln operator of the final target MC for a kiln charge is essential. Also critical is determining the final MC prior to unloading a kiln charge using proper kiln sampling procedures; such procedures include obtaining kiln samples that represent both the wettest and driest lumber in the load.

The MC may be higher for special uses other than furniture, cabinets, and millwork, such as lumber used for bending or destined to be exported. Typical desired final MC values for these kinds of products are listed in Table 1.4.

Once lumber is properly dried, it must be stored, manufactured, and warehoused at humidity conditions that are at or slightly below the expected in-use humidity conditions. Failure to adhere to these basic principles will result in serious economic losses for the manufacturing firm.

**Table 1.3—Expected average interior RH and recommended MC values for most wood items for interior use in United States and Canada<sup>a</sup>**

Area	RH (%)		Wood MC (%)	
	Avg.	Range	Avg.	Range
Much of United States and Canada	40	15 to 55	8	4 to 10
Dry Southwest <sup>b</sup>	30	15 to 50	6	4 to 9
Damp, warm coastal	60	40 to 70	11	8 to 13

<sup>a</sup>Lower values are typical “heating season” values.

<sup>b</sup>Also applies to areas where interior environment is dry year around. Adapted from Forest Products Laboratory data (FPL 1999b).

**Table 1.4—Typical final MC for special hardwood lumber products**

Product	Final MC
Pallet stock	18% to green
Bending stock, severe bends	25% to 28%
Bending stock, mild bends	15% to 18%
Lumber to be pressure treated	20% to 30%
Lumber for framing in construction	10% to 19%
Lumber for export to Europe	10% to 13%
Lumber for export to Eastern Asia and tropical areas	12% to 16%

## References

**FPL.** 1999a. Air drying of lumber: a guide to industry practices. Gen. Tech. Rep. FPL–GTR–117. Madison, WI: U.S. Department of Agriculture, Forest Service, Forest Products Laboratory. 143 p.

**FPL.** 1999b. Wood handbook—Wood as an engineering material. Gen. Tech Rep. FPL–GTR–113. Madison, WI: U.S. Department of Agriculture, Forest Service, Forest Products Laboratory. 463 p.

**McMillen, J.M.** 1969. Accelerated kiln drying of presurfaced 1-inch northern red oak. Res. Pap. FPL–RP–122. Madison, WI: U.S. Department of Agriculture, Forest Service, Forest Products Laboratory. 31 p.

**Panshin, A.J.; De Zeeuw, C.** 1980. Textbook of wood technology. New York, NY: McGraw–Hill. 722 p.

**Simpson, W.T., ed.** 1991. Dry kiln operator’s manual. Agric. Handb. 188. Washington, DC: U.S. Department of Agriculture. Forest Service. 247 p.

**Skaar, C.; Simpson, W.T.** 1968. Thermodynamics of water sorption by wood. Forest Products Journal.18(7): 49–58.

**Stamm, A.J.** 1964. Wood and cellulose science. New York, NY: Ronald Press. 549 p.

**Wengert, E. M.** 1990. Drying oak lumber. Madison, WI: University of Wisconsin–Madison, Department of Forestry. 167 p.

**Wengert, E.M.; Toennisson, R., eds.** 1998. Lumber drying sourcebook: 40 years of practical experience. Pub. 7274. Madison, WI: Forest Products Society. 371 p.

**Wengert, E.M.; Grimm, P.; Lamb, F.M.; Muench, J.** 1988. Opportunities for dehumidification drying of hardwood lumber in Virginia. Unnumb. Pub. Sandston, VA: Virginia Forest Products Association. 34 p.

# Chapter 2—Drying Mechanisms of Wood

The following section provides definitions and explanations of terms that describe the structure of wood. In addition, the importance or impact of various features on drying is mentioned. These features are important when selecting moisture samples for dryer operation, when measuring final moisture content (MC), and when seeking to “explain” and understand the causes of drying degrade (such as splits, checks, and warp). A more complete description of the terms is available in wood technology texts, such as the *Textbook of Wood Technology* (Panshin and de Zeeuw 1980) and *Forest Products and Wood Science* (Haygreen and Boyer 1982). Wood characteristics and properties, such as grain orientation and density, and environmental factors affect the drying mechanisms of wood. The rate of drying is determined and controlled by the effects of air velocity. The drying process is described in four stages, which correspond to the moisture content of the lumber.

## Wood Characteristics That Affect Drying

The drying mechanisms of wood are affected by wood characteristics and properties and environmental factors. This section describes the effects of cell morphology, grain orientation, density and specific gravity, wood shrinkage, and bacterial infection.

### Cells

The basic building block of wood is the cell. A stem of a tree grows in diameter every year by the addition of cells in layers just beneath the bark; these layers, which may be several cells thick, are called the cambium. Once a cell is formed, it is generally full size; it does not grow larger in diameter or length. It also does not change its location in the stem; in fact, unless the tree moves or falls over, the cell remains at the same height above the ground as well. Growth occurs by an increase in length only at the tips of the branches and the stem. The increase in girth each year is evidenced by annual growth rings.

The thickness of the cell wall and the size of the cell lumen may vary within the same tree from the cells formed early in the growing season to those formed later. The cells formed early in the year in some species, such as oak, generally have thin walls and large openings (lumens); these cells form what is called earlywood. Cells formed later in the growing season have thicker walls and smaller lumens and form what is called latewood. Earlywood and latewood are sometimes called springwood and summerwood, respectively. It is the

contrast between earlywood and latewood that makes the annual rings distinct. Some species, such as aspen and basswood, have very little contrast between earlywood and latewood cells, so the annual growth rings are indistinct. Cell size varies from tree to tree and from species to species.

The living cells in the cambium are few in number and just several cells thick. There are also living parenchyma cells that store starches and sugars throughout the sapwood. The freshly formed, living cambium cells, the parenchyma cells, and the nonliving cells formed in previous years that still conduct fluids between the leaves and the roots are called sapwood cells. Sapwood is light (white) in color and very permeable to liquids. For this reason, the sapwood dries faster than does the heartwood. Another important characteristic of sapwood is that it is typically, but not always, much wider in trees grown in the South than in trees grown in the North, which is due in part to the longer growing season in the South. Sapstain (discoloration of sapwood) is therefore more problematic in the South than the North because sapwood is more likely to be included in pieces of lumber and because the warmer temperatures in the South encourage staining.

As the sapwood cells become older, they eventually become less permeable as various chemicals are deposited within the cell. These dark-colored cells provide resistance to decay and insect infestation in species like white oak and walnut. These older cells, and the darker area that they form, are called heartwood. Because of the deposits in the heartwood cell pores, fluid conduction in the heartwood is greatly slowed, compared to that in sapwood.

The white oaks (except chestnut oak), black locust, and several other species have chemical deposits that occlude (block) the cell lumens. These deposits, called tyloses, greatly reduce the permeability and the drying rates of the wood.

When the stem at a given location is first formed (that is, the first cells form at the center of the stem at a given height), the cells in this location are very soft, weak, bendable, and dark in color. This region is called the pith and is about the diameter of a small pencil. For perhaps the next 15 years of growth at that location, the wood cells formed each year are somewhat shorter and weaker, and they shrink differently than does more mature wood, which is formed in later years. The wood formed in the early life of the stem, excluding the pith, is called juvenile wood. Even a 100-year-old tree still forms juvenile wood in the smaller diameter, younger stems and branches. The shift from juvenile wood to mature wood is

gradual—where one ends and the other begins is impossible to determine precisely. Juvenile wood shrinks more along the grain and less across the grain than does mature wood. Juvenile wood may also have a higher likelihood of developing tension wood.

Tension wood is formed in response to stress. A growing hardwood tree is occasionally influenced by external forces, such as another tree leaning against it, persistently strong wind from one direction, or competition for sunlight. To counteract or offset these forces, the tree develops, in its new growth, special cells that form what is called tension wood. Tension wood cells often have thinner walls than do “normal” mature wood cells; or they may have typical walls with a very thick additional layer on the inside of the cell. In either case, tension wood is weaker for its weight than is normal, mature wood. This weakness primarily affects machining (fuzzy grain), but the weakness can also affect structural uses such as for chair legs. Tension wood also shrinks along the grain more than does normal, mature wood.

## Grain Orientation

The behavior and characteristics of wood (such as strength, stiffness, and physical properties like shrinkage) varies, depending how the cells are aligned. That is, wood is anisotropic. The cells are aligned in three directions: longitudinal, radial, and tangential.

**Longitudinal**—direction running up and down the tree. Approximately 85% to 95% of cells are aligned in this direction. Most mature wood cells and therefore most lumber shrinks very little (<0.5%) in the longitudinal direction as MC changes from green to oven-dry. Further, because the long hollow lumens of the cells are oriented in this direction, water can move in the tree and in lumber much faster in the longitudinal direction than in the other directions.

**Radial**—direction running from the bark inward to the pith, like the spokes of a wheel. When the end of a log is viewed, the radial direction is on a radius. The few cells (5% to 15%) that are not longitudinally oriented are oriented radially, and can thereby help conduct fluids from the bark toward the pith in the sapwood. These radially oriented cells are called ray cells. The ray cell orientation assists in drying in the radial direction. That is, drying in the radial direction is faster than in the tangential direction, but not as fast as in the longitudinal direction. The ray parenchyma cells contain a large amount of sugars and starches. These chemicals oxidize to form sticker stain, interior gray stain, and several other chemical, non-fungal stains in wood.

**Tangential**—direction tangent to the annual rings when viewing the end of a log. Moisture movement is slowest in the tangential direction compared to the other directions.

When tangential and radial directions are combined, they are called “across the grain,” as contrasted with the longitudinal direction or “along the grain.”

When the wide face of lumber is primarily a tangential surface, the lumber is called flatsawn (also called plainsawn). Most oak lumber produced for North American markets is flatsawn because the grain pattern is quite pleasing and desirable in today’s markets. When the wide face of lumber is primarily a radial surface, the lumber is called quartersawn; the rings are typically at a 0° to 15° angle to the surface. Lumber with rings at between 15° and 45° to the surface is called riftsawn. Quartersawn and riftsawn lumber produce a very striking pattern in many species because the sides of the ray cells are exposed. These exposed rays appear as short ribbons and are called ray flecks.

Flatsawn lumber dries faster than does quartersawn lumber; thus, flatsawn lumber is at much greater risk of developing surface checking and internal checking (honeycomb). Flatsawn lumber also has a higher tendency to cup during drying, or after drying if the moisture changes, especially when the lumber is from an area close to the pith. Quartersawn lumber is quite stable, shrinking in width about half as much as does flatsawn lumber, and has little tendency to cup. However, because much of the moisture movement from the core to the surface is in the tangential direction, quartersawn lumber dries more slowly than does flatsawn.

The MC of the living tree is called the green MC. “Green from the saw” refers to lumber that did not experience any drying from the time the tree was cut to the time of sawing. Green MC values vary with species (Table 2.1). When the wood has been infected by bacteria, its green MC can exceed that of uninfected wood.

Cross grain is a deviation in grain pattern caused by knots. In a tree with a branch at approximately 90° to the stem, the orientation of wood cells around the branch changes from the longitudinal direction in the tree to the longitudinal direction in the branch. When lumber is sawn from this intersection of the stem and the branch, the intersection appears as a knot, with a surrounding deviation in grain pattern called cross grain. That is, when flatsawn or quartersawn lumber has a knot, or the wood is close to a knot, the local grain pattern or cell orientation changes to predominantly longitudinal or end grain in that area. With end grain, the knots and the surrounding cross-grain dry faster than does the rest of the lumber. Because of the shrinkage differences in the three grain directions, knots and their surrounding cross-grain shrink more along the length of the lumber than does the rest of the wood. Faster drying and more shrinkage often lead to cracking and distortion in and around the knots and warping of the lumber.

## Density and Specific Gravity

If an individual cell in a piece of wood were compressed to eliminate all the air spaces in the lumens, the remaining wood

**Table 2.1—Green moisture content of selected North American hardwoods**

Species	Moisture content (%)	
	Sapwood	Heartwood
Alder, red	—	97
Apple	81	74
Ash		
Black	95	—
Green	—	58
White	95	113
Aspen	95	113
Basswood	81	133
Beech, American	55	72
Birch		
Paper	89	72
Sweet	75	70
Yellow	74	72
Cherry, black	58	—
Cottonwood, black	162	146
Elm		
American	95	92
Cedar	66	61
Rock	44	57
Hackberry	61	65
Hickory, true		
Mockernut	70	52
Pignut	71	49
Red	69	52
Sand	68	50
Magnolia	80	104
Maple		
Silver	58	97
Sugar	65	72
Oak		
California black	76	75
Northern red	80	69
Southern red	83	75
Water	81	81
White	64	78
Willow	82	74
Sweetgum	79	137
Sycamore, American	114	130
Tupelo		
Black	87	115
Swamp	101	108
Water	150	116
Walnut, black	90	73

would be all cell walls, would be quite dense (1½ times heavier than water), and would not float. However, the air space in the lumens, even in the living tree, provides buoyancy, making a wood like oak or hickory about 2/3 as heavy as water.

The density of wood provides an estimate of the amount of cell wall material; the amount of cell wall material, and therefore the density, influences drying rates, shrinkage, strength, and many other properties and characteristics. Often, the density of wood is not expressed in pounds per cubic foot (kilograms per cubic meter), but rather as a ratio of the density of wood to the density of an equal volume of water. This ratio is called specific gravity.

A quick method to measure specific gravity, and thereby determine if the wood is abnormally dense and as such will dry differently than normal, is to cut a piece of wood of uniform cross-section (about ½- by ½-in. (13- by 13-mm) and about 10 in. (254 mm) long). This piece is then slowly lowered into a narrow cylinder or pipe filled with water (Fig. 2.1). The specific gravity is the ratio of the length of the submerged portion of the stick to total length.

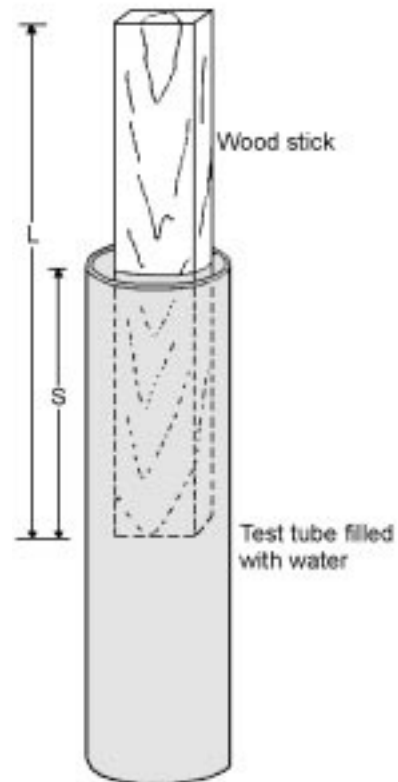

**Figure 2.1—Simple test to estimate specific gravity of a sample of uniform cross-sectional area. S is length of submerged part of stick; L, total length.**

## Shrinkage

When the drying of a green cell begins, first the free water from the cell evaporates. As the free water is removed, the MC of the wood is decreased from green to approximately 30%. At this MC level, all the free water has been removed but the cell wall is still fully saturated. The point at which all free water is gone but no bound water has been removed is called the fiber saturation point (FSP). The FSP of 30% MC refers to the MC of a cell and not to the average MC of a larger piece of wood. No shrinkage has occurred up to this point (that is, in drying a cell from green to FSP), unless there is collapse, which is rare in most hardwood lumber species (except cottonwood, aspen, and some foreign species). However, any drying below 30% MC results in removal of the bound water from the cell wall and consequent shrinkage.

As drying continues below FSP, more and more water is removed from the cell wall. If drying were to continue until no appreciable amount of water remains in the wall (which cannot be achieved in conventional kilns), this is called 0% MC; if the wood is dried at 215°F (102°C) so that no appreciable amount of water remains in the wall, the wood is referred to as oven-dry. Shrinkage continues from FSP to 0% MC in approximately a direct, linear proportion to the MC.

The cell wall always has an affinity for water. This characteristic, called hygroscopicity, means that dry wood will not stay dry if the wood is exposed to a higher RH. Therefore, if the cell wall has lost moisture and is then exposed to high RHs, the wall will absorb water until equilibrium between the air and the wall is obtained. Therefore, wood not only dries and shrinks when exposed to low humidity; it also regains moisture and swells when exposed to higher humidity.

Temperature does not make the cell shrink or swell appreciably. The only factor of importance that causes shrinkage is moisture loss, and the only factor that causes swelling is moisture gain. In turn, the only major factor that causes MC to change is the RH of the environment. So, changes in RH cause shrinkage or swelling.

In general, the denser the wood, the more it will shrink and swell. Because the amount of shrinkage is directly related to checking, denser woods are harder to dry. Therefore, density (or specific gravity) is a good predictor of drying behavior.

Wood shrinks the greatest amount in the tangential direction. Radial shrinkage is about half that of tangential (Table 2.2). Longitudinal shrinkage is usually negligible. However, there can be appreciable longitudinal shrinkage in wood in the juvenile core or in tension wood, which can cause bow and crook (or side bend) and may contribute to twist. As an example of why longitudinal shrinkage causes warp, consider a quartersawn piece of lumber with one edge having juvenile wood and the remainder of the piece having mature wood. The juvenile wood edge will shrink lengthwise, while the rest

of the piece will shrink very little lengthwise. This difference results in crook toward the pith. The same scenario, but with shrinkage differences occurring between faces rather than edges, is a major reason for bowing of lumber.

Figure 2.2 illustrates expected shrinkage as wood dries from green to 7% MC. This behavior can be explained as follows:

- The round piece in the cross section changes to oval because of greater tangential shrinkage compared to radial.
- The square piece toward the periphery changes to diamond-shaped because of greater tangential shrinkage compared to radial. The square piece nearer the center becomes rectangular; the tangential dimension is slightly smaller than the radial direction as a result of difference in shrinkage.
- The quartersawn pieces (rectangles) remain flat; width changes less than does thickness (on a percentage basis). When used where MC fluctuates, quartersawn lumber holds paint, varnish, and other finishes better with less cracking of the finish than does flatsawn lumber because a quartersawn surface does not move as much as a flatsawn surface. Careful examination of the quartersawn piece with pith shows that it is a little thicker in the center than at the edges. This is because thickness shrinkage near the pith is radial and that near the edge is tangential.
- The flatsawn piece (center of cross section, near periphery) has cupped toward the bark. This is a natural tendency because the bark face of lumber is more tangential than is the pith side. As a result, the bark side shrinks more than does the pith side. The difference in shrinkage will be greater if the lumber is sawn from an area closer to the pith. Consequently, small-diameter wood, which constitutes the bulk of the lumber resource, has a greater tendency to cup than did the larger wood harvested in the past. Furthermore, because most lower grade lumber is taken from the central section of a tree (near the pith), there is a tendency for lower grade lumber to cup more than do the higher grades.
- The piece with mixed grain (upper left of cross section) exhibits the same tendency to cup as does flatsawn lumber, for the same reasons. However, mixed grain lumber experiences less cup.

## Bacterial Infection

The presence of bacteria in the living tree can affect lumber processing. These bacteria, identified and studied by James Ward at the Forest Products Laboratory, USDA Forest Service, are anaerobic—that is, they grow in the absence of air. Although not everything is known about these bacteria, they apparently prefer wet soils and older (75+ years) trees. Once in the tree, probably through a break in the roots, the bacteria move slowly upward, perhaps only a few inches per year (1 in. = 25.4 mm). The bacteria are confined to the lower section of the butt log; it is rare to find them more than 8 ft



**Table 2.2—Average shrinkage values for North American hardwoods**

Species	Shrinkage (%)		Species	Shrinkage (%)	
	Radial	Tangential		Radial	Tangential
Alder, red	4.4	7.3	Locust, black	4.6	7.2
Ash			Magnolia		
Black	5.0	7.8	Southern	5.4	6.6
Green	4.6	7.1	Sweetbay	4.7	8.3
White	4.9	7.8	Maple		
Aspen			Bigleaf	3.7	7.1
Bigtooth	3.3	7.9	Black	4.8	9.3
Quaking	3.5	6.7	Red	4.0	8.2
Basswood	6.6	9.3	Silver	3.0	7.2
Beech, American	5.5	11.9	Sugar	4.8	9.9
Birch			Oak, red		
Paper	6.3	8.6	Black	4.4	11.1
Sweet	6.5	9.0	Laurel	4.0	9.9
Yellow	7.3	9.5	Northern red	4.0	8.6
Buckeye	3.6	8.1	Pin	4.3	9.5
Butternut	3.4	6.4	Southern red	4.7	11.3
Cherry, black	3.7	7.1	Water	4.4	9.8
Cottonwood			Willow	5.0	9.6
Black	3.6	8.6	Oak, white		
Eastern	3.9	9.2	Bur	4.4	8.8
Elm			Chestnut	5.3	10.8
American	4.2	9.5	Live	6.6	9.5
Cedar	4.7	10.2	Overcup	5.3	12.7
Rock	4.8	8.1	Post	5.4	9.8
Slippery	4.9	8.9	Swamp chestnut	5.2	10.8
Hackberry	4.8	8.9	White	5.6	10.5
Hickory and pecan	4.9	8.9	Sassafras	4.0	6.2
Hickory			Sweetgum	5.3	10.2
Mockernut	7.7	11.0	Sycamore	5.0	8.4
Pignut	7.2	11.5	Tanoak	4.9	11.7
Shagbark	7.0	10.5	Tupelo, black	5.1	8.7
Shellbark	7.6	12.6	Walnut, black	5.5	7.8
Holly, American	4.8	9.9	Willow, black	3.3	8.7
Honeylocust	4.2	6.6	Yellow-poplar	4.6	8.2

(2.4 m) above the ground. Even then, the entire cross section is not typically infected. Only some of the wood will be infected, especially near the heartwood/sapwood zone or in the outer heartwood.

In any case, these bacteria do not kill the tree. Furthermore, there are no grading rules that consider bacterial infection to be a negative factor. In fact, it is sometimes difficult to detect bacterial presence or damage in lumber. Nevertheless, the bacteria do cause some drying problems.

As the bacteria live and grow in the tree, they secrete enzymes that slowly destroy part of the wood, making the wood weaker. Because the wood is weakened, when the wind blows these infected trees are apt to develop wind shake (also called shake). In addition, the weakened wood has a high risk of developing checks, splits, and honeycomb during drying. When processing the wood after drying, machining and finishing problems are likely to occur as well.

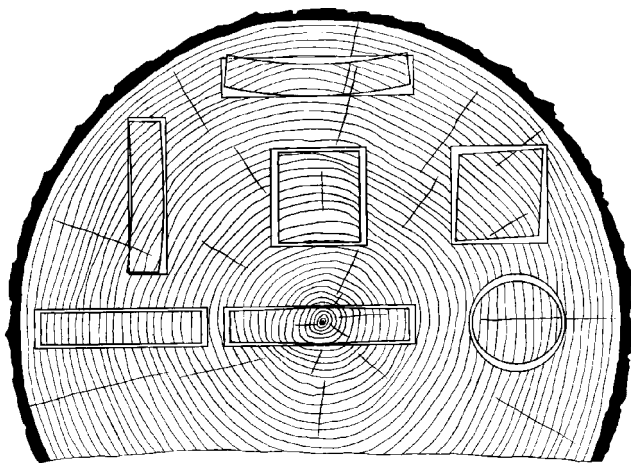

**Figure 2.2—Generalized shrinkage across the grain as wood dries.**

The bacteria create low molecular weight, basic fatty acids that have a characteristic unpleasant odor. This odor is most noticeable when the wood is green. However, if dry wood is subjected to humid conditions, then the odor can return. A strong vinegary smell and a stinging vapor often accompany this odor. Apparently, these chemicals in the wood may interfere with finishing the wood product, especially when lacquer is used.

Bacteria are frequently associated with much higher than normal green MC values. For example, with red oak, green MC can be as high as 110%, compared to the normal 75% to 80%. The bacteria create a coating on the inside of the cell wall, which retards moisture movement.

When an infected log is sawn into lumber, at most 20% of the lumber is likely to be infected. Even then, many pieces may be infected only at one end (the butt end). After the lumber is sawn and stacked, the infection will not spread; that is, the bacteria do not move from piece to piece.

Bacterial infection in oak trees killed by gypsy moths is seemingly more widespread than bacterial infection in healthy trees. Discoloration also seems more pronounced in trees killed by gypsy moths.

In summary, bacterial infection of the living tree can have the following effects:

- Wood that is moderately or heavily infected with bacteria has a bad odor and may have wind shake; both the odor and shake are good indicators of bacterial presence.
- Wood that is moderately or heavily infected with bacteria is weaker than uninfected wood, so it is subject to surface checks and honeycomb when standard drying schedules are used.

- Bacterially infected wood with high green MC require considerably longer drying time.

It is best to avoid drying bacterially infected lumber. If the lumber must be dried and processed, avoid 6/4 and thicker lumber. If possible, the lumber should be dried in a shed rather than dried green-from-the-saw in a kiln. The 8/4 schedule should be used for 4/4 and 5/4 lumber; during the first week, the fans should be run only 12 h/day. If possible, the kiln temperature should be lowered 10°F (6°C) from the schedule values. However, when the infection is advanced, successful drying of the infected area is probably impossible using commercial drying equipment, even under a careful operation. Again, note that infection seldom occurs throughout the entire piece of lumber and usually affects only a small portion of a load.

## Summary

The following wood characteristics, species, and features affect the rate of drying:

Slower drying	Faster drying
Heartwood	Sapwood
Quartersawn	Flatsawn
Face or edge grain	End grain
Flat grain	Knots
High density wood	Low density wood
White oak	Red oak
Bacterially infected	Not infected

These criteria must be considered when selecting sample boards and analyzing any problems in drying, such as a wide spread of final MC or checking. Although many drying problems are a result of environmental factors, the importance of wood-related factors must not be overlooked.

## Environmental Factors

The three environmental variables that control the rate and quality of lumber drying are the (1) temperature of the air, (2) relative humidity (RH) of the air (can also be expressed as wet-bulb depression or equilibrium moisture content, EMC), and (3) velocity of the air. Whenever the wood dries too slowly or too rapidly, these variables must be manipulated to achieve the desired drying rate.

## Temperature

The temperature of air in drying is frequently called the dry-bulb temperature because the temperature is measured with a sensor (usually an electronic thermometer) that is dry. When drying hardwood lumber, the temperature (dry-bulb) is always the temperature of the air just before it enters the load

of lumber. This is the hottest temperature in drying and therefore the most critical in terms of possible quality loss.

As the wood temperature increases, water moves faster within the wood, the wood dries more rapidly, and drying is more uniform. In addition, in general, the higher the temperature, the greater the amount of warp. Also, the higher the temperature, the weaker the wood becomes, which is especially important at high MCs when checking is likely. These last two characteristics force kiln operators to use a low temperature when drying oak, beech, and other check-prone species. Research has suggested that a fairly low temperature, below 110°F (43°C), be used whenever warping may be a problem.

Staining and insect damage are also affected by drying temperature. Generally, the best conditions for staining and insect damage are between 80°F and 100°F (27°C and 43°C). Therefore, when low temperatures are used to prevent checking or warp, the RH must be low to prevent staining. If insects pose a problem for drying at low temperatures, the lumber may need to be treated with chemicals before drying or it can be heated briefly (approximately 24 h) to 130°F (54°C) or higher, which will kill insects, insect eggs, and fungi.

If the temperature is exceptionally high (over 160°F (71°C)) for any length of time when the lumber is still quite wet (more than 40% MC), then permanent strength loss can be expected. Because of this concern for strength loss, steaming of green or partially dried wood (including the use of steam spray during heat up) is not recommended, except in a few cases such as color enhancement for walnut and cherry. Steaming for stress relief is acceptable when the wood is fully dry. Steaming can also be used when the RH in the dryer must be increased, but the wood must already be warm and the steaming duration must be short (several minutes maximum).

When drying a load of lumber, note that as the air moves through the load, the air gives up energy so that water can be evaporated. As this energy is lost from the air, the air cools. The amount of cooling, called the temperature drop across the load (TDAL), varies with the species, load width, lumber MC, velocity, and sticker thickness. The TDAL is widely used in softwood drying. In hardwood drying, as the air moves through the pile of lumber the TDAL is usually only a few degrees. Consequently, it would be difficult to use the TDAL in a standardized manner for controlling a hardwood dryer. Nevertheless, because a difference in dry-bulb temperature of a few degrees can make a large difference in RH and EMC, the cooling effect or TDAL must be understood and incorporated in managing the performance of a dryer.

From a technical viewpoint, the heat capacity of air is 0.016 Btu/ft<sup>3</sup> of air per °F (1,100 J/m<sup>3</sup>/°C). If the TDAL is 10°F (5.6°C) and the airflow is 10,000 ft<sup>3</sup> (283 m<sup>3</sup>) of air, the energy loss would be 1,600 Btu (1.69 MJ); this would

evaporate approximately 1.5 lb (700 g) of water, which is equivalent to approximately 0.05% MC loss per thousand board feet.

## Relative Humidity

The relative humidity (RH) of air is the ratio of the amount of water in air compared to the maximum amount of water that the air can hold at the same temperature. RH is usually expressed as a percentage.

In most operations, RH is measured by using a standard temperature sensor covered with a wet, muslin wick. The water used for wetting must be pure and the velocity across the wick should be about 600 ft/min (3 m/s). This sensor is called the wet bulb. The wet-bulb temperature is always cooler than the dry-bulb, except at 100% RH where they will be equal. The difference between the dry-bulb and wet-bulb temperatures is the wet-bulb depression or just the depression. Given the dry-bulb temperature and the depression, the RH can be found by consulting a table or graph.

As mentioned, the airflow should be about 600 ft/min (3 m/s) across the wet bulb. However, slightly lower airflow will not greatly affect the wet-bulb temperature. In practical terms, because many dryers do not have 600-ft/min (3-m/s) airflow, the wet-bulb sensor should be located in the area with the highest airflow. If airflow is much lower than 500 ft/min (2.5 m/s), then a small auxiliary fan should probably be used to increase the velocity across the bulb.

Because of occasional problems in supplying clean, constant water to the wet bulb, in supplying adequate airflow, and in keeping the wick clean, some drying control systems use a cellulose wafer as the humidity sensor. The cellulose gains and loses water in response to changes in RH. The electrical resistance of the wafer is related to RH of the air.

As the RH is lowered during drying, water moves faster; that is, the wood dries faster. At any given MC, the drying rate of the wood can be expressed as

$$\text{Rate} = \text{coefficient} \times (100 - \text{RH})$$

This expression means that if the RH is initially 80% but then lowered to 60%, the lumber will dry twice as fast. That is, at 80% RH, the drying rate is coefficient  $\times$  20; at 60% RH, the rate is coefficient  $\times$  40. The coefficient in this equation is a constant at a given MC, temperature, and velocity. As the wood dries, the coefficient gets smaller (that is, drying rate slows); as the temperature increases the coefficient increases; and as the velocity increases, the coefficient increases. The coefficient is also dependent on species, grain direction, specific gravity, and thickness of the lumber.

As the RH is lowered, drying is more uniform, less warp occurs, and the risk of initiating discoloration (especially chemical discoloration) is reduced. If the RH is too low and

therefore drying is too fast, checks, splits, and honeycomb can be expected to form and/or increase in severity.

The RH also controls the final MC. Although warp will usually be decreased when lower RHs are used during drying especially under 40% MC, if the RH is too low at the end of drying the low final MC that results in the wood will increase shrinkage. With increased shrinkage, more warp is likely.

Whenever the temperature of air changes, so does the RH. For example, if the temperature of the air in a room is initially 80°F (27°C) with 70% RH and the air is cooled to 70°F (21°C), the new RH is 97%. Likewise, if the air is heated to 90°F (32°C), the new RH is 50%. (In these examples, no moisture is added to or withdrawn from the air during cooling or heating.)

During drying, as the air moves through the lumber pile, the air will cool. As a result of this cooling, the RH of the air will increase as the air moves through the pile. (In contrast, the wet-bulb temperature is uniform throughout the pile. Although this may seem strange, it is indeed true for an air path that does not go across heating coils or does not have outside air introduced in the airstream.) In addition, the RH will increase as a result of the moisture picked up by the air from the drying lumber. This RH rise across the load (HRAL) or EMC rise (ERAL) can be used in controlling drying—increasing airflow when HRAL is too large and slowing velocity when HRAL is small. When conventional equipment is used to monitor and control drying conditions, the RH measured is the condition of the air entering, which is the lowest RH condition. Precise control procedures when the HRAL or ERAL is measured have not yet been established.

## Air Velocity

Air velocity is as important as temperature and RH for controlling the drying process. The velocity of air when the wood is above 40% MC (approximately) affects the rate of drying. Higher velocities result in faster drying (Fig. 2.3), more uniform RH within the pile, and more uniform drying within the pile. Of course, faster drying can increase the risk of checking, but conversely it can decrease the amount of warp. (The curves in Figure 2.3 vary with lumber thickness, species, specific gravity, and other variables. The intent of presenting this information is to illustrate the general affect of velocity on drying rates.)

Below 20% MC, velocity has very little effect on the rate or quality of drying. That is, the relationship between velocity and drying rate is nearly a horizontal line at 20% MC (Fig. 2.3). Velocity has an insignificant effect because at low MCs, the drying speed is controlled by the rate at which water can move within the wood rather than the rate at which the air can carry the moisture away from the surface. Between 40% and 20% MC, the effect of velocity decreases proportionally (Fig. 2.3).

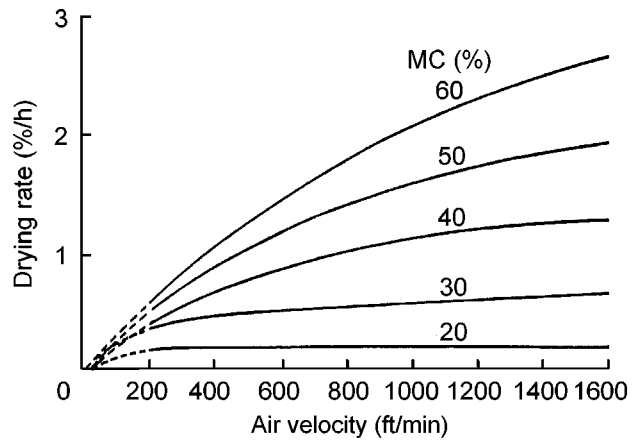

**Figure 2.3—Effect of velocity on drying rate of lumber based on green hard maple at 65% RH and indicated MC values. 1 ft/min  $\cong$   $5 \times 10^{-3}$  m/s.**

An important concept in airflow is that the volume of air going into the load equals the amount coming out. There cannot be a buildup of air within the pile. Therefore, air velocity is usually measured on the exit side of the pile because it is very easy to do so; it is hard to measure velocity accurately on the entering air side. However, one problem that must be considered in measuring airflow in this manner is the tendency for the air to move upward as it moves horizontally through the piles. Hence, the exit air side may show higher velocities near the roof than near the floor, but this pattern may not exist on the entering air side of the load. Nevertheless, this upward trend indicates the need for horizontal baffles in the space between adjacent packs, especially in track kilns, when drying green lumber. (Recall that green lumber is more influenced by velocity than is partly dried lumber.)

This reduced importance of velocity at low MCs can be used to save substantial energy for fan operation. Specifically, fan speeds can be reduced at low MCs without affecting the drying rate or drying time. Reducing fan speed by 50% can save from 40% to 70% in electrical costs, depending on the electrical rate structure and demand charges.

There is a direct relationship at high MCs between air velocity and RH. That is, if the velocity is decreased, which will slow drying, then the RH can be decreased, which will increase the rate of drying. In other words, many combinations of velocity and RH can provide the desired drying rate.

Because velocity is so important when drying lumber with high MCs (>30%), it is critical to locate the sample boards within the lumber pile (that is, in sample pockets), rather than in the bolster space, on the edge of the pile, or in other locations where the velocity is not typical. Conversely, for lumber with <20% MC, there is more freedom in the sample board location, because velocity exerts less influence.

## Energy Required for Airflow

Drying always requires energy; about 1,100 Btu (1.16 MJ) of energy is needed to evaporate a pound (0.454 kg) of water from wood. Therefore, drying of 1,000 board foot of oak lumber, which typically contains about 2,500 lb (1,135 kg) of water that needs to be evaporated, will require  $2.75 \times 10^6$  Btu (2.90 GJ) of energy from the air. If a cubic foot of air blowing through a load of lumber changes temperature by 2.5°F (1.4°C), the air will have supplied only 0.05 Btu (53 J) of heat to the wood. Therefore, at this typical temperature drop of 2.5°F (1.4°C),  $50 \times 10^6$  ft<sup>3</sup> ( $1.4 \times 10^6$  m<sup>3</sup>) of air per thousand board feet must be blown through the lumber to dry the load.

The volume of air required to carry the moisture away from the lumber can be calculated. A cubic foot of air can carry less than 0.001 lb (454 mg) of water at low temperatures, but can carry up to 0.01 lb/ft<sup>3</sup> (0.2 g/m<sup>3</sup>) at higher temperatures. To carry 2,500 lb (1,135 g) of water at low temperatures will require over  $2.5 \times 10^6$  ft<sup>3</sup> ( $71 \times 10^3$  m<sup>3</sup>) of air circulating through the load.

The airflow through a load of lumber begins as laminar flow, which is several times less effective in transferring heat and removing moisture than is turbulent flow. Airflow becomes turbulent after about 4 ft (1.2 m) of travel into the pile. This distance varies depending on what the velocity is and whether the pieces of lumber in the layer are the same thickness and have the same surface smoothness. Turbulence develops faster if there are gaps, edge to edge, between each piece. Trying to encourage turbulent flow could result in faster drying at high MC, but lowering humidity and increasing velocity accomplish the same thing much more easily and uniformly. Variations in lumber texture (for example, band- or roughsawn) do not result in major variations in drying rates.

## Other Factors

Other factors that affect how wood dries are the dew point, equilibrium moisture content (EMC), and absolute humidity.

### Dew Point

The dew point is defined as the temperature of the air at which vapor in the air begins to condense into liquid water as the air is cooled. The more the air is cooled below its dew point, the more moisture will be condensed.

### Equilibrium Moisture Content

When wood is exposed to air at a constant temperature and RH, the wood will lose (or gain) moisture until it reaches moisture equilibrium with the air. The MC at equilibrium is defined as being numerically equal to the EMC of the air. Several variables can change the MC of a piece of wood when in equilibrium with a given temperature and humidity.

These variables include the natural variability of wood and external factors, such as stress or heat. The natural variability of oaks is so small that it is ignored in lumber drying. To address this variability, even though it is small, a standard set of EMC values (Table 2.3) has been adopted and is applied to all wood species. These data are presented graphically in Figures 2.4 and 2.5. In both of these figures, the point of interest is where the lines for the known conditions intersect. Where conditions lie between the lines, then an imaginary line (in proportion to the given lines) is used.

These standard EMC data, which were collected more than 50 years ago, are primarily based on the drying of small shavings of Sitka spruce in a dryer with a small oscillation in RH. In spite of the potential shortcomings of the data, they serve very well for drying hardwood lumber.

The following tabulation shows key values of EMC and RH for drying. These values are very important because they can be used to obtain high quality dried lumber. When the RH is kept constant, the EMC of air varies only slightly with changes in temperature below 120°F (49°C). The following RH and EMC values are valid from 32°F to 120°F (0°C to 49°C). As the temperature rises at constant RH, the EMC values drop slightly—at 212°F (100°C), the EMC at 100% RH is 22%; EMC values at higher temperatures show less change.

RH (%)	EMC (%)
0	0
30	6
50	9
65	12
80	16
100	28

The EMC can be related directly to shrinkage, which in turn is closely related to stresses; likewise, stresses are related to several types of degrade, including checks, splits, and warp. Hence, EMC can be a useful expression for indicating the MC of the air in a dryer.

### Absolute Humidity

The absolute humidity is a measure of the mass (or weight) of water per volume of air. The historically used weight measurement unit in hardwood lumber drying is grains per cubic foot (1 grain = 1/7000 lb = 0.065 g). The cubic foot measurement is made at the dew point temperature (100% RH). The absolute humidity does not change when air is heated or cooled, unless moisture is added or condensation occurs when the air is cooled below the dew point.

**Table 2.3—Relative humidity and equilibrium moisture content for given temperatures and wet-bulb depressions<sup>a</sup>**

Dry-bulb temperature (°F (°C))	Wet-bulb depression																																						
	1	2	3	4	5	6	7	8	9	10	11	12	13	14	15	16	17	18	19	20	21	22	23	24	25	26	27	28	29	30	32	34	36	38	49	45	50 °F		
30 (-1.1)	89	78	67	57	46	36	27	17	6	—	—	—	—	—	—	—	—	—	—	—	—	—	—	—	—	—	—	—	—	—	—	—	—	—	—	—	—	—	
—	15.9	12.9	10.8	9.0	7.4	5.7	3.9	1.6	—	—	—	—	—	—	—	—	—	—	—	—	—	—	—	—	—	—	—	—	—	—	—	—	—	—	—	—	—	—	
35 (1.7)	90	81	72	63	54	45	37	28	19	11	3	—	—	—	—	—	—	—	—	—	—	—	—	—	—	—	—	—	—	—	—	—	—	—	—	—	—	—	
—	16.8	13.9	11.9	10.3	8.8	7.4	6.0	4.5	2.9	0.8	—	—	—	—	—	—	—	—	—	—	—	—	—	—	—	—	—	—	—	—	—	—	—	—	—	—	—	—	
40 (4.4)	92	83	75	68	60	52	45	37	29	22	15	8	—	—	—	—	—	—	—	—	—	—	—	—	—	—	—	—	—	—	—	—	—	—	—	—	—	—	
—	17.6	14.8	12.9	11.2	9.9	8.6	7.4	6.2	5.0	3.5	1.9	—	—	—	—	—	—	—	—	—	—	—	—	—	—	—	—	—	—	—	—	—	—	—	—	—	—	—	
45 (7.2)	93	85	78	72	64	58	51	44	37	31	25	19	12	6	—	—	—	—	—	—	—	—	—	—	—	—	—	—	—	—	—	—	—	—	—	—	—	—	
—	18.3	15.6	13.7	12.0	10.7	9.5	8.5	7.5	6.5	5.3	4.2	2.9	1.5	—	—	—	—	—	—	—	—	—	—	—	—	—	—	—	—	—	—	—	—	—	—	—	—	—	
50 (10.0)	93	86	80	74	68	62	56	50	44	38	32	27	21	16	10	5	—	—	—	—	—	—	—	—	—	—	—	—	—	—	—	—	—	—	—	—	—	—	—
—	19.0	16.3	14.4	12.7	11.5	10.3	9.4	8.5	7.6	6.7	5.7	4.8	3.9	2.8	1.5	—	—	—	—	—	—	—	—	—	—	—	—	—	—	—	—	—	—	—	—	—	—	—	—
55 (12.8)	94	88	82	76	70	65	60	54	49	44	39	34	28	24	19	14	9	5	—	—	—	—	—	—	—	—	—	—	—	—	—	—	—	—	—	—	—	—	—
—	19.5	16.9	15.1	13.4	12.2	11.0	10.1	9.3	8.4	7.6	6.8	6.0	5.3	4.5	3.6	2.5	1.3	—	—	—	—	—	—	—	—	—	—	—	—	—	—	—	—	—	—	—	—	—	—
60 (21.2)	94	89	83	78	73	68	63	58	53	48	43	39	34	30	26	21	17	13	9	5	1	—	—	—	—	—	—	—	—	—	—	—	—	—	—	—	—	—	—
—	19.9	17.4	15.6	13.9	12.7	11.6	10.7	9.9	9.1	8.3	7.6	6.9	6.3	5.6	4.9	4.1	3.2	2.3	1.3	0.2	—	—	—	—	—	—	—	—	—	—	—	—	—	—	—	—	—	—	—
65 (18.3)	95	90	84	80	75	70	66	61	56	52	48	44	39	36	32	27	24	20	16	13	8	6	2	—	—	—	—	—	—	—	—	—	—	—	—	—	—	—	—
—	20.3	17.8	16.1	14.4	13.3	12.1	11.2	10.4	9.7	8.9	8.3	7.7	7.1	6.5	5.8	5.2	4.5	3.8	3.0	2.3	1.4	0.4	—	—	—	—	—	—	—	—	—	—	—	—	—	—	—	—	—
70 (21.1)	95	90	86	81	77	72	68	64	59	55	51	48	44	40	36	33	29	25	22	19	15	12	9	6	3	—	—	—	—	—	—	—	—	—	—	—	—	—	—
—	20.6	18.2	16.5	14.9	13.7	12.5	11.6	10.9	10.1	9.4	8.8	8.3	7.7	7.2	6.6	6.0	5.5	4.9	4.3	3.7	2.9	2.3	1.5	0.7	—	—	—	—	—	—	—	—	—	—	—	—	—	—	—
75 (25.9)	95	91	86	82	78	74	70	66	62	58	54	51	47	44	41	37	34	31	28	24	21	18	15	12	10	7	4	1	—	—	—	—	—	—	—	—	—	—	
—	20.9	18.5	16.8	15.2	14.0	12.9	12.0	11.2	10.5	9.8	9.3	8.7	8.2	7.7	7.2	6.7	6.2	5.6	5.1	4.7	4.1	3.5	2.9	2.3	1.7	0.9	0.2	—	—	—	—	—	—	—	—	—	—	—	
80 (26.7)	96	91	87	83	79	75	72	68	64	61	57	54	50	47	44	41	38	35	32	29	26	23	20	18	15	12	10	7	5	3	—	—	—	—	—	—	—	—	
—	21.0	18.7	17.0	15.5	14.3	13.2	12.3	11.5	10.9	10.1	9.7	9.1	8.6	8.1	7.7	7.2	6.8	6.3	5.8	5.4	5.0	4.5	4.0	3.5	3.0	2.4	1.8	1.1	0.3	—	—	—	—	—	—	—	—	—	
85 (29.9)	96	92	88	84	80	76	73	70	66	63	59	56	53	50	47	44	41	38	36	33	30	28	25	23	20	18	15	13	11	9	4	—	—	—	—	—	—	—	
—	21.2	18.8	17.2	15.7	14.5	13.5	12.5	11.8	11.2	10.5	10.0	9.5	9.0	8.5	8.1	7.6	7.2	6.7	6.3	6.0	5.6	5.2	4.8	4.3	3.9	3.4	3.0	2.4	1.7	0.9	—	—	—	—	—	—	—	—	
90 (32.2)	96	92	89	85	81	78	74	71	68	65	61	58	55	52	49	47	44	41	39	36	34	31	29	26	24	22	19	17	15	13	9	5	1	—	—	—	—	—	
—	21.3	18.9	17.3	15.9	14.7	13.7	12.8	12.0	11.4	10.7	10.2	9.7	9.3	8.8	8.4	8.0	7.6	7.2	6.8	6.5	6.1	5.7	5.3	4.9	4.6	4.2	3.8	3.3	2.8	2.1	1.3	0.4	—	—	—	—	—	—	
95 (35.0)	96	92	89	85	82	79	75	72	69	66	63	60	57	55	52	49	46	44	42	39	37	34	32	30	28	26	23	22	20	17	14	10	6	2	—	—	—	—	
—	21.3	19.0	17.4	16.1	14.9	13.9	12.9	12.2	11.6	11.0	10.5	10.0	9.5	9.1	8.7	8.2	7.9	7.5	7.1	6.8	6.4	6.1	5.7	5.3	5.1	4.8	4.4	4.0	3.6	3.0	2.3	1.5	0.6	—	—	—	—	—	
100 (37.8)	96	93	89	86	83	80	77	73	70	68	65	62	59	56	54	51	49	46	44	41	39	37	35	33	30	28	26	24	22	21	17	13	10	7	4	—	—	—	
—	21.3	19.0	17.5	16.1	15.0	13.9	13.1	12.4	11.8	11.2	10.6	10.1	9.6	9.2	8.9	8.5	8.1	7.8	7.4	7.0	6.7	6.4	6.1	5.7	5.4	5.2	4.9	4.6	4.2	3.6	3.1	2.4	1.6	0.7	—	—	—	—	

**Table 2.3—Relative humidity and equilibrium moisture content for given temperatures and wet-bulb depressions<sup>a</sup>—con.**

Dry-bulb temperature (°F (°C))	Wet-bulb depression																																				
	1	2	3	4	5	6	7	8	9	10	11	12	13	14	15	16	17	18	19	20	21	22	23	24	25	26	27	28	29	30	32	34	36	38	49	45	50 °F
105 (40.6)	96	93	90	87	83	80	77	74	71	69	66	63	60	58	55	53	50	48	46	44	42	40	37	35	34	31	29	28	26	24	20	17	14	11	8	—	—
	—	21.4	19.0	17.5	16.2	15.1	14.0	13.3	12.6	11.9	11.3	10.8	10.3	9.8	9.4	9.0	8.7	8.3	7.9	7.6	7.3	6.9	6.7	6.4	6.1	5.7	5.4	5.2	4.8	4.6	4.2	3.6	3.1	2.4	1.8	—	—
110 (43.3)	97	93	90	87	84	81	78	75	73	70	67	65	62	60	57	55	52	50	48	46	44	42	40	38	36	34	32	30	28	26	23	20	17	14	11	4	—
	—	21.4	19.0	17.5	16.2	15.1	14.1	13.3	12.6	12.0	11.4	10.8	10.4	9.9	9.5	9.2	8.8	8.4	8.1	7.7	7.5	7.2	6.8	6.6	6.3	6.0	5.7	5.4	5.2	4.8	4.5	4.0	3.5	3.0	2.5	1.1	—
115 (46.1)	97	93	90	88	85	82	79	76	74	71	68	66	63	61	58	56	54	52	50	48	45	43	41	40	38	36	34	32	31	29	26	23	20	17	14	8	2
	—	21.4	19.0	17.5	16.2	15.1	14.1	13.4	12.7	12.1	11.5	0.9	10.4	10.0	9.6	9.3	8.9	8.6	8.2	7.8	7.6	7.3	7.0	6.7	6.5	6.2	5.9	5.6	5.4	5.2	4.7	4.3	3.9	3.4	2.9	1.7	0.4
120 (48.9)	97	94	91	88	85	82	80	77	74	72	69	67	65	62	60	58	55	53	51	49	47	45	43	41	40	38	36	34	33	31	28	25	22	19	17	10	5
	—	21.3	19.0	17.4	16.2	15.1	14.1	13.4	12.7	12.1	11.5	11.0	10.5	10.0	9.7	9.4	9.0	8.7	8.3	7.9	7.7	7.4	7.2	6.8	6.6	6.3	6.1	5.8	5.6	5.4	5.0	4.6	4.2	3.7	3.3	2.3	1.1
125	97	94	91	88	86	83	80	77	75	73	70	68	65	63	61	59	57	55	53	51	48	47	45	43	41	39	38	36	35	33	30	27	24	22	19	13	8
	—	21.2	18.9	17.3	16.1	15.0	14.0	13.4	12.7	12.1	11.5	11.0	10.5	10.0	9.7	9.4	9.0	8.7	8.3	8.0	7.7	7.5	7.2	7.0	6.7	6.5	6.2	6.0	5.8	5.5	5.2	4.8	4.4	4.0	3.6	2.7	1.6
130	97	94	91	89	86	83	81	78	76	73	71	69	67	64	62	60	58	56	54	52	50	48	47	45	43	41	40	38	37	35	32	29	26	24	21	15	10
	—	21.0	18.8	17.2	16.0	14.9	14.0	13.4	12.7	12.1	11.5	11.0	10.5	10.0	9.7	9.4	9.0	8.7	8.3	8.0	7.8	7.6	7.3	7.0	6.8	6.6	6.4	6.1	5.9	5.6	5.3	4.9	4.6	4.2	3.8	3.0	2.0
140	97	95	92	89	87	84	82	79	77	75	73	70	68	66	64	62	60	58	56	54	53	51	49	47	46	44	43	41	40	38	35	32	30	27	25	19	14
	—	20.7	18.6	16.9	15.8	14.8	13.8	13.2	12.5	11.9	11.4	10.9	10.4	10.0	9.6	9.4	9.0	8.7	8.4	8.0	7.8	7.6	7.3	7.1	6.9	6.6	6.4	6.2	6.0	5.8	5.4	5.1	4.8	4.4	4.1	3.4	2.6
150	98	95	92	90	87	85	82	80	78	76	74	72	70	68	66	64	62	60	58	57	55	53	51	49	48	46	45	43	42	41	38	36	33	30	28	23	18
	—	20.2	18.4	16.6	15.4	14.5	13.7	13.0	12.4	11.8	11.2	10.8	10.3	9.9	9.5	9.2	8.9	8.6	8.3	8.0	7.8	7.5	7.3	7.1	6.9	6.7	6.4	6.2	6.0	5.8	5.4	5.2	4.9	4.5	4.2	3.6	2.9
160	98	95	93	90	88	86	83	81	79	77	75	73	71	69	67	65	64	62	60	58	57	55	53	52	50	49	47	46	44	43	41	38	35	33	31	25	21
	—	19.8	18.11	16.2	15.2	14.2	13.4	12.7	12.1	11.5	11.0	11.6	10.1	9.7	9.4	9.1	8.8	8.5	8.2	7.9	7.7	7.4	7.2	7.0	6.8	6.7	6.4	6.2	6.0	5.8	5.5	5.2	4.9	4.6	4.3	3.7	3.2
170	98	95	93	91	89	86	84	82	80	78	76	74	72	70	69	67	65	63	62	60	59	57	55	53	52	51	49	48	47	45	43	40	38	35	33	28	24
	—	19.4	17.7	15.8	14.8	13.9	13.2	12.4	11.8	11.3	10.8	10.4	9.9	9.6	9.2	9.0	8.6	8.4	8.0	7.8	7.6	7.3	7.2	6.9	6.7	6.6	6.4	6.2	6.0	5.7	5.5	5.2	4.9	4.6	4.4	3.7	3.2
180	98	96	94	91	89	87	85	83	81	79	77	75	73	72	70	68	67	65	63	62	60	58	57	55	54	52	51	50	48	47	45	42	40	38	35	30	26
	—	18.9	17.3	15.5	14.5	13.7	12.9	12.2	11.6	11.1	10.6	10.1	9.7	9.4	9.0	8.8	8.4	8.1	7.8	7.6	7.4	7.2	7.0	6.8	6.5	6.4	6.2	6.0	5.8	5.7	5.4	5.2	4.8	4.6	4.4	3.8	3.3
190	98	96	94	92	90	88	85	84	82	80	78	76	75	73	71	69	68	66	65	63	62	60	58	57	56	54	53	51	50	49	46	44	42	39	37	32	28
	—	18.5	16.9	15.2	14.2	13.4	12.7	12.0	11.4	10.9	10.5	10.0	9.6	9.2	8.9	8.6	8.2	7.9	7.7	7.4	7.2	7.0	6.8	6.6	6.4	6.2	6.0	5.9	5.7	5.5	5.3	5.0	4.8	4.6	4.4	3.8	3.3
200	98	96	94	92	90	88	86	84	82	80	79	77	75	74	72	70	69	67	66	64	63	61	60	58	57	55	54	53	52	51	48	46	43	41	39	34	30
	—	18.1	16.4	14.9	14.0	13.2	12.4	11.8	11.2	10.8	10.3	9.8	9.4	9.1	8.8	8.4	8.1	7.7	7.5	7.2	7.0	6.9	6.6	6.4	6.2	6.0	5.9	5.7	5.6	5.4	5.2	4.9	4.7	4.5	4.3	3.8	3.3
210	98	96	94	92	90	88	86	85	83	81	79	78	76	75	73	71	70	68	67	65	64	63	61	60	59	57	56	55	53	52	50	47	45	43	41	36	32
	—	17.7	16.0	14.6	13.8	13.0	12.2	11.7	11.1	10.6	10.0	9.7	9.2	9.0	8.7	8.3	8.0	7.6	7.4	7.1	6.9	6.8	6.5	6.3	6.1	5.9	5.8	5.5	5.4	5.3	5.1	4.8	4.6	4.4	4.2	3.7	3.2

<sup>a</sup>For each dry-bulb temperature, data in 1<sup>st</sup> row are RH values (%) and data in 2<sup>nd</sup> row are EMC values (in italic; %).

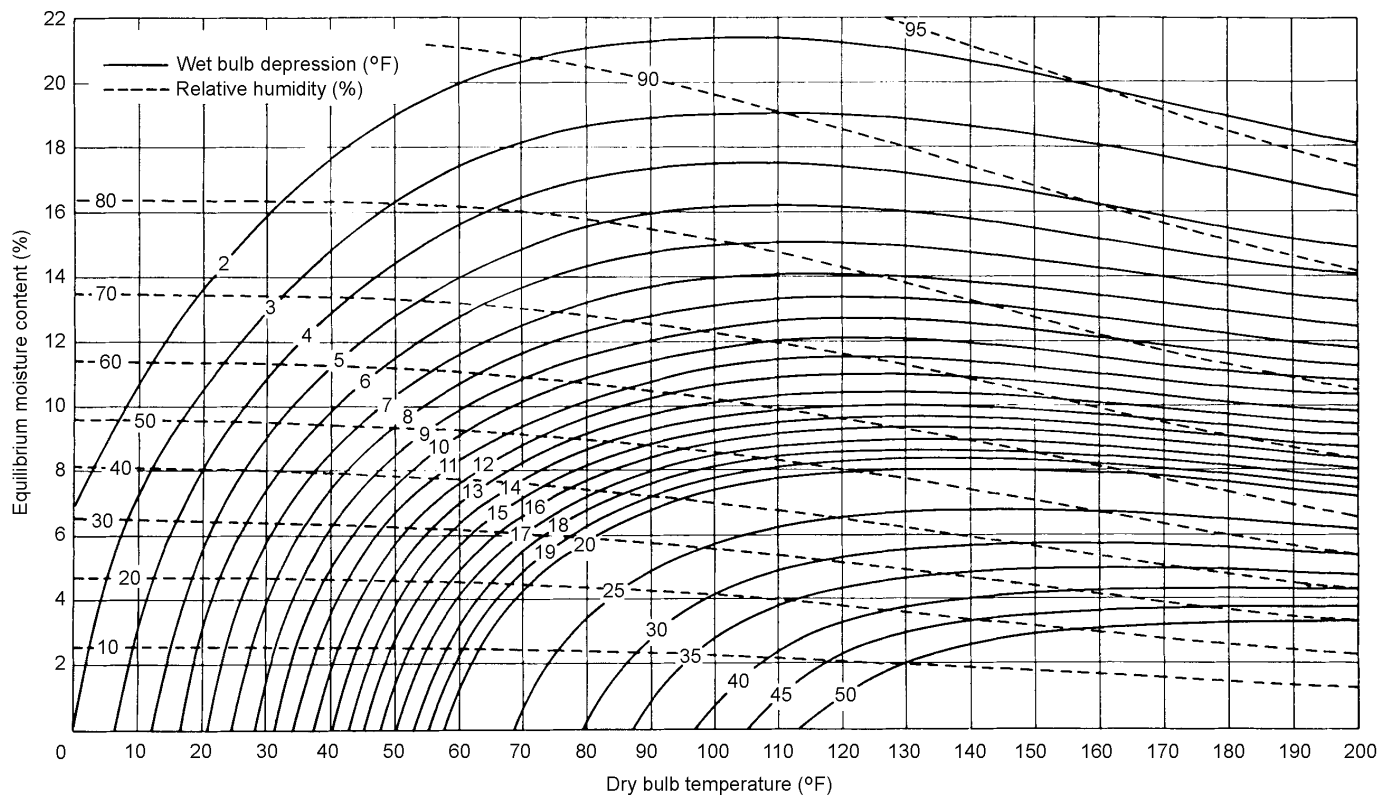

**Figure 2.4—Humidity graph for standard set of EMC values showing relationships with dry- and wet-bulb temperatures and relative humidity.  $T_c = [T_f - 32]/1.8$ ;  $1^\circ F = 0.56^\circ C$ .**

At 80°F (27°C) and 70% RH, the absolute humidity is 8 grains/ft<sup>3</sup> (18.29 g/m<sup>3</sup>). If the air is cooled to 70°F (21°C) or heated to 90°F (32°C), the RH will vary, but the absolute humidity will remain constant at 8 grains/ft<sup>3</sup> (18.29 g/m<sup>3</sup>). The following tabulation shows absolute humidity values for various air temperatures.

Temperature (°F (°C))	Absolute humidity at 100% RH (grains/ft <sup>3</sup> (g/m <sup>3</sup> ))
70 (21)	8 (18.29)
100 (38)	20 (45.77)
150 (66)	72 (164.78)
200 (93)	220 (503.49)

The maximum absolute humidity, or the amount of water that air can hold at 100% RH, increases substantially as the dry-bulb temperature increases. Those who operate a warehouse pre-dryer or other low temperature dryer must understand and be able to use absolute humidity to operate the dryer efficiently. This knowledge and skill are especially critical in the South where warm, humid weather can make proper pre-dryer operation extremely difficult.

## Rate of Drying

The controlling effect of airflow in lumber drying is to remove moisture from the surface of the lumber while providing energy to the wood so that evaporation can take place. Recall that at high MCs, the drying rate increases with increasing velocity; at low MCs, velocity has little effect on the drying rate.

The rate of drying is the key variable in determining drying quality. Because velocity determines and controls the rate of drying, it is therefore a major factor in determining drying quality. If velocity is too high, the wood will dry too quickly and checking will result. Conversely, if velocity is too low, staining may result. At high MCs, velocity and RH work together to control the drying rate. It is therefore essential to consider both the RH and velocity when determining the correct values of each.

## Integral Effect

As air passes through a load of lumber, its temperature drops and RH increases (Fig. 2.6). As might be expected, the drop in temperature and increase in RH depends on the volume flow of air. The volume flow, in turn, is dependent on the velocity and the sticker thickness. This effect of velocity on lumber drying is termed the integral effect.



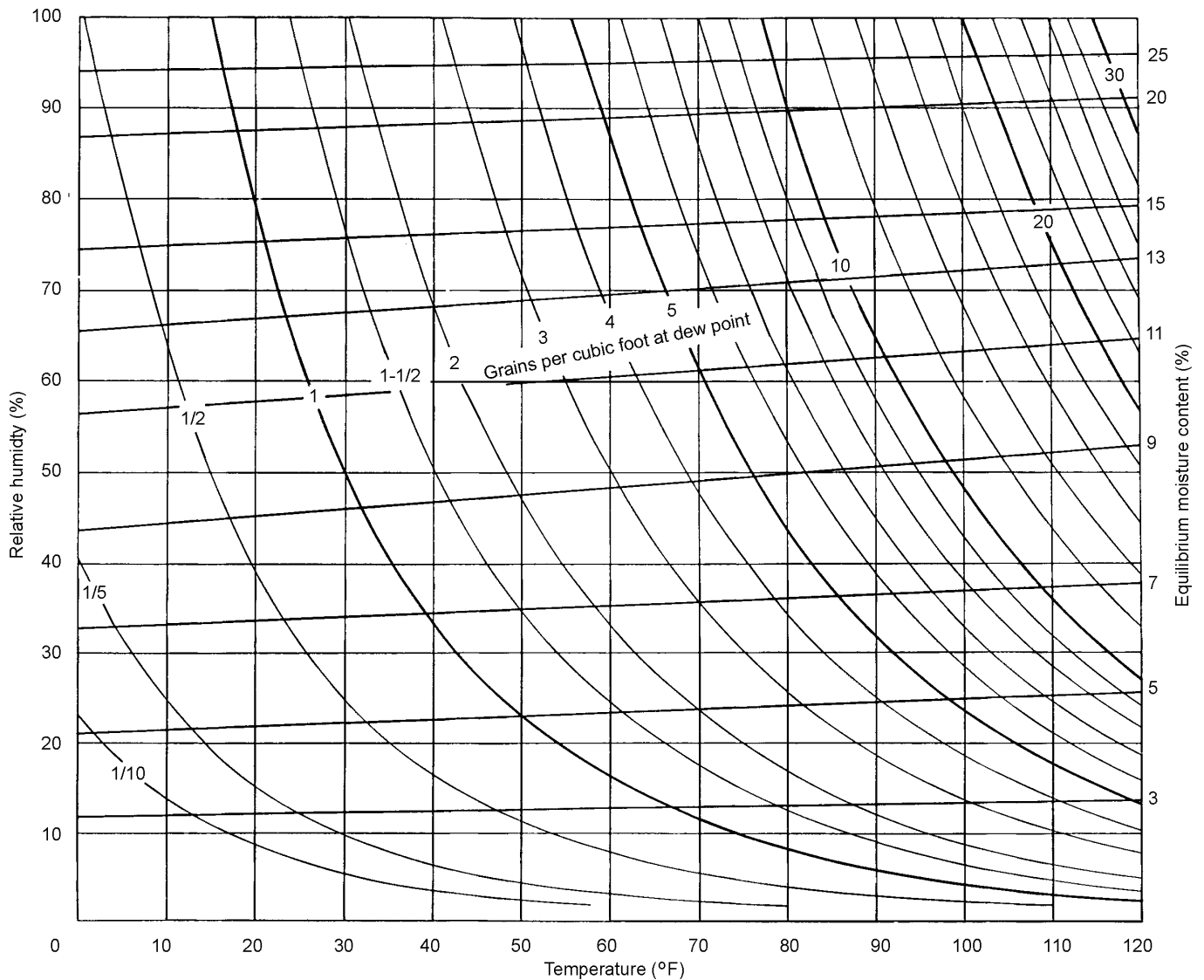

Figure 2.5—Humidity graph for standard set of EMC values showing relationships with RH and dry-bulb temperature, and absolute humidity.  $1 \text{ ft}^3 = 0.028 \text{ m}^3$ .  $T_C = [T_F - 32]/1.8$ .

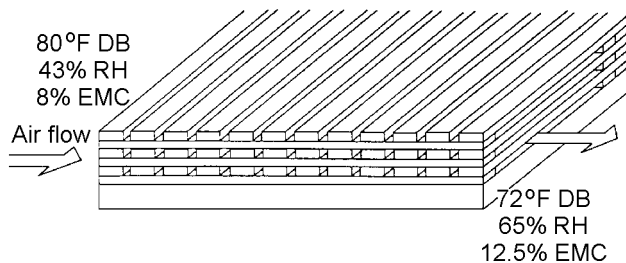

Figure 2.6—Changes in dry-bulb (DB) temperature, RH, and EMC as air passes through lumber load.

As velocity increases, there is an increase of volume flow of air through the sticker spaces or channels. This means that as the air moves through the load, if there is more air volume, the conditions of the air (temperature and RH) will change more slowly as the air passes through the lumber pile. Drying conditions through the load will be more uniform and therefore the rate of drying will be more uniform with higher volumes of air. However, because higher velocities result in faster drying (which, for oak, could be too fast), from a practical standpoint the best way to increase through the load is to increase sticker thickness.

For green oak, if volume flow is very low, the air will give up its heat and become saturated soon after it enters the load of

lumber. With low volume, only the edge of the pile will dry as fast as desired; the rest of the load will be subjected to more humid air and will dry slower. (Staining and cupping are also likely with slow drying.) Thus, the higher the volume flow rate (in practice, the higher the velocity and the thicker the sticker), then the more uniform drying will be from the entering edge of the pile to the exit edge. In addition to the use of high volume, the velocity direction is reversed periodically (every 2 h for green oak) to help keep drying uniform from side to side.

Again, air volume is related to both velocity and sticker thickness. The benefit of thicker stickers is illustrated by the following example. A dryer is loaded with 50 thousand board feet of 4/4 green oak lumber stacked on 3/4-in.- (1.9-cm-) thick stickers; velocity is 300 ft/min (1.5 m/s) through the load. If the sticker size is increased to 1-in. (2.5-cm) thickness, the dryer capacity would be decreased by 12% to 44 thousand board feet. There would also be 12% fewer sticker openings, but the area of each sticker opening would increase by 3%. Assuming that the volume of air delivered by the fans would remain constant, the average velocity in each opening would drop from 300 ft/min (1.5 m/s) to approximately 250 ft/min (1.3 m/s) because the stickers openings are larger. The net result of thicker stickers at high MCs would be slower drying because of the drop in velocity, but more uniform drying throughout the pile is caused by the increase in volume flow. Lower RH could be used to offset the slower velocity, if needed. Thus, thicker stickers can be advantageous when drying green lumber, although the gain is partially offset by decreased dryer capacity and therefore potentially higher operating costs. (In air drying, especially with low air movement, thicker stickers result in significantly faster drying at high MCs.) At low MCs, sticker size would have little effect on drying rate and uniformity of drying through the pile.

For the example described in the previous paragraph, if the dryer is loaded with only 44 thousand board feet, the heating and venting systems are often better matched to the load, providing better performance—that is, faster heating and venting and better control of conditions.

To further understand the effects of velocity and sticker thickness, consider a load of 4/4 green red oak stacked with 3/4-in. (1.9-cm) stickers and dried using a standard oak schedule. The load is four 6-ft (1.8-m) bundles wide (24 ft (7.3 m)). The difference in drying rate between the edge and the center of the load, using 2-h reversals of the fans, is shown in Figure 2.7 for two velocities, 200 and 400 ft/min (1 to 2 m/s). The difference between the center and edge drying rate is greater with the slower velocity. The maximum difference of 12% MC occurred on the 10th day of drying. If the load were narrower, however, the difference between the center and the edges would be reduced proportionately.

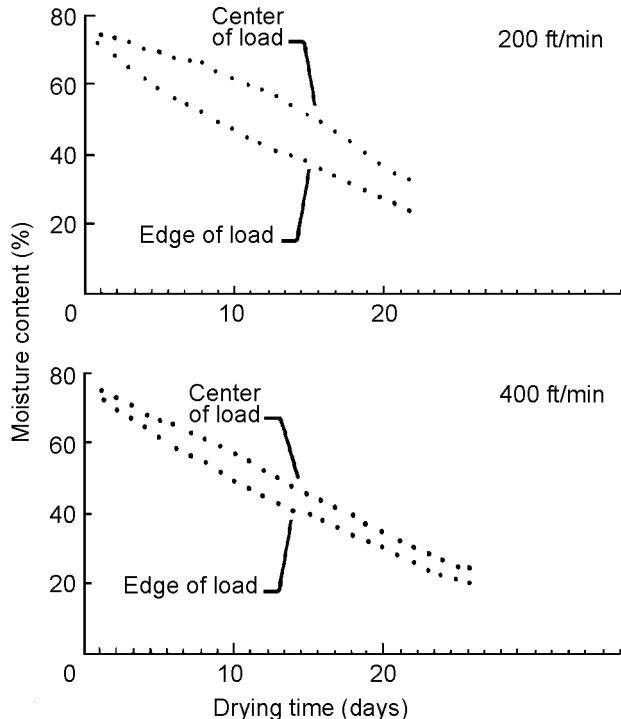

**Figure 2.7—Effect of air velocity at 200 and 400 ft/min (1 and 2 m/s) on MC within lumber pile during drying.**

### Venting Effect

The same fans that circulate the air through the load of lumber in conventional kilns are also responsible for venting. Conventional dryers use venting to remove moisture from inside the dryer; humid air is exhausted and drier outside air is brought into the dryer. (This venting effect does not occur in dehumidifier dryers because they do not have vents.) Typically, the vents have covers or lids that open only when venting is required. That is, if the vents are properly operating, they open whenever the conditions in the dryer are too humid and close when the RH is at or below the desired level.

Because the same fans are used for circulation and venting, any increase in circulation will increase venting. Therefore, although changes in fan velocity will not affect the overall or net amount of air vented (that amount is determined on the basis of the difference between inside and outside absolute humidity), velocity changes will result in changes in the rate of venting. The venting rate affects the ability to achieve the desired conditions in the dryer rapidly.

With fast-drying woods that release moisture quickly to the air, high venting rates are required to keep the air from becoming too humid. High venting rates can be achieved by using large vents, high temperatures, and high air velocities. Oak, beech, and other refractory species usually do not require high venting rates.

## Secondary Effects of Velocity

### Heat Effect

Velocity also affects the rate of heat transfer from the heat fin pipes, coils, or other heating system to the air. The higher the velocity through the coils, the greater the heating rate. This effect is most important when energy demands for drying are highest; wet lumber requires the greatest amount of energy for drying. As the lumber dries, the energy demand per hour decreases, even though the dry-bulb temperature increases. Therefore, somewhat lower velocities across the coils at lower lumber MCs are generally acceptable. This supports the idea of lowering dryer velocity to save energy at lower MCs.

Poor velocity across the heat coils can be offset by increasing the fin size, increasing the amount of fin pipe, or increasing the steam pressure.

### Electrical Consumption

As fan speed (r/min) is decreased, velocity decreases. Accompanying this decrease is a very large decrease in electrical consumption. A reduction in fan velocity of 20% (all else equal) will reduce energy consumption by approximately 50%. As mentioned in the previous sections, when wood MC is below 20%, velocity can be decreased, thereby reducing energy consumption, without a decrease in quality and drying time.

The monthly electrical bill for drying will probably be reduced by only 25% if energy usage is reduced by 50% during most of the month. The reason for this smaller savings is that most electric utilities have a demand charge that is based on the maximum usage rate over a 15-min period for the month. The demand charge does not change if the peak usage remains unchanged, which would happen if fan speed were reduced for only part of the month. The demand charge is often one-half of the bill; hence, the predicted savings is at most 25% if fan speed is reduced when wood MC is below 30%.

### Optimal Air Velocity

Current standard kiln schedules for hardwood lumber are based on 300- to 375-ft/min (1.5- to 1.9-m/s) airflow through the sticker openings. Because of the connection between air velocity and RH, any change in airflow from these values would need to be accompanied by a change in the RH schedule. For example, in an experimental kiln for hardwoods with 1,000-ft/min (5-m/s) airflow, the drying rate was so high at the standard 87% RH that the wet-bulb temperature had to be raised to bring the RH over 95% in order to slow drying to a safe level. This slowed the drying rate to more acceptable levels, but it increased the risk of staining. However, the control of such high humidity values in industrial drying equipment is difficult; conditions vary considerably from

time to time and from location to location. In this case, surface checking was still excessive in oak.

What rate of airflow is best? The answer is that for a given RH and temperature, the best airflow is the velocity that results in drying the wood at a rate close to (but not exceeding) its safe drying rate. The safe rates for various species are discussed in Chapter 8. Computer simulations can often provide some guidance as to the best velocity under different drying conditions. In general, for hardwood lumber, the kiln schedules used and recommended throughout the United States for hard-to-dry species and most thick hardwood lumber are based on experience with drying at 250 to 350 ft/min (1.3 to 1.8 m/s). Therefore, this should be the general target for most hardwood lumber drying operations. For the white woods, velocity is often 500 to 600 ft/min (2.5 to 3.1 m/s). For drying green hardwoods in a warehouse predryer, most work on developing schedules has been conducted at 75 to 150 ft/min (0.3 to 0.7 m/s). (For most easy-to-dry hardwoods, velocity is often more than 500 ft/min (2.5 m/s) to ensure uniform drying as much as to produce fast drying.) In any dryer, once wood MC is under 30%, the best airflow rate is the velocity that provides good control of dryer conditions with a change across the load of less than 2% EMC. Computer controls can provide such information on drops in EMC.

## Stages of Drying

To understand the drying process more clearly, the drying of lumber is divided into four stages (Bois 1998), based on MC and expected defects (Table 2.4). The following subsections, which present a classical description of how thick oak dries based on the drying stages in Table 2.4, apply to all species of hardwoods, although the time references will vary. Both the environmental conditions and anatomical variations must be factored into these descriptions when considering how a “real” piece of wood dries. Nevertheless, the following description is sufficiently accurate to be of great practical

**Table 2.4—Stages of drying**

Stage	Wood moisture content <sup>a</sup>	Major defect risk
I	Green to 2/3 green	Formation of surface and end checks, stain, warp
II	2/3 green to 30% MC	Aggravation of surface and end checks
III	30% MC to final	Conversion of checks to honeycomb, cupping, overdrying
IV	Final	Unequal final MC, casehardening

<sup>a</sup>Green denotes moisture content (MC) in the living tree, not when the lumber is received.

value. This description should be studied thoroughly until it is well understood. It explains why and when degrade occurs and what environmental or schedule changes can be safely made and which should be avoided.

*Note:* The following text may make an unexperienced operator afraid to dry oak and other refractory hardwoods. However, serious degrade (especially checking) is not likely to occur when good practices are followed and when wood quality is high.

## Stage I

Stage I is called the surface checking stage. It begins the moment the lumber is first sawn (green MC) and ends when one-third of the moisture has evaporated. Surface checks and end checks are formed during this stage. Surface checks that appear later in drying were previously formed in Stage I. Such checks may be aggravated later in the drying process, but they are created only in Stage I.

At the beginning of Stage I, the cells on the outside of the piece begin to dry. Within a few hours, these outer cells are dried below 30% MC (fiber saturation point) and therefore will begin to shrink. However, the cells on the inside of the lumber are still fully green and therefore are not shrinking. As drying continues, an increasing number of cells near the surface begin to dry, and therefore, an increasing number of cells begin to shrink. This shrinkage of the outer cells (the shell) begins to squeeze or compress the cells in the center region of the lumber (the core). If the core is being compressed, then the shell must be in tension. The tension forces in the shell increase as drying continues. For 8/4 oak lumber being dried with a standard schedule, the tension forces reach a maximum after approximately 5 days of drying.

As the tension forces in the shell increase as a result of restrained shrinkage, the forces are likely to exceed the proportional limit. If they do, the outer cells will eventually dry to a larger size than they would have if they had been free to shrink without restraint. This process is similar to stretching a rubber band. With a small force, the rubber band can be stretched slightly, and when the force is removed the band will return to its original size. However, if the band is stretched beyond its proportional limit or is stretched and then held stretched for some time, it becomes enlarged. When the force is released, the band returns to a size somewhat larger than its original size. This change in size is called “set” because it occurs with a tension force, but a more accurate term is “tension set.” Another word for tension set is casehardening.

If the tension forces continue to increase (which happens when drying is too fast or RH is too low), they may exceed the strength of the wood and result in an opening called a check. This is similar to stretching a rubber band until it breaks. Because the junction between the rays and vertical cells is fairly weak in many species (especially oak)

compared to other cell junctions, checking will usually occur at this point. When an opening occurs on a flatsawn (tangential) surface of lumber, it is called a surface check. Because weak junctions are most prevalent on a flatsawn surface and because the shrinkage forces are greatest in the tangential direction, checking is most apt to occur on a flatsawn surface.

Wood has very low cleavage strength. Once a check, even a small one, has formed, its size (length and depth) can easily increase, even if the tension forces continue at moderate levels. To understand this process, try pulling a sheet of paper apart by pulling only from the top and bottom edges. Much force is needed to tear the paper. However, if you make a small tear on each (top and bottom) edge, then the paper tears easily when pulled. The fact that it is easy to worsen existing checks has important consequences. First, milder schedules must be used on checked wood (see Stage II discussion). Second, because almost all internal checks (honeycomb) are surface or end checks that penetrate inward, preventing surface checks prevents almost all honeycomb.

While tension is building in the shell, compression on the core is also increasing. If compression exceeds the strength of the core cells, some of the core will be damaged, weakening the cells and increasing the risk of failures during Stage III.

It must be understood and appreciated that two components are involved in the risk of checking: the magnitude of the force and the strength of the wood. These components jointly determine whether failures (checks) will result. The magnitude of the tension forces depends on how much shrinkage occurs; this in turn means that the magnitude of the tension forces depends primarily on the RH (or EMC). Furthermore, the magnitude of the tension forces also depends on how fast the wood is dried; the rate of drying depends on the RH (or EMC) and the velocity.

The strength of the wood depends on natural and manufacturing factors, which include

- wood species,
- width or size of rays—lumber with wider and longer rays more apt to check,
- site where grown—upland and lowland more likely to check,
- location of wood in tree—stronger wood usually located further from center and lower in tree,
- presence of bacteria,
- use of dull or sharp saw, and
- temperature and MC—the hotter and wetter, the weaker the wood.

The sharpness of the saw affects the strength of the wood surface. A dull saw apparently tears the wood to such an extent that the lumber produced is much more likely to check than is lumber produced with a sharp saw. In one experiment (McMillen 1969), red oak lumber that was planed before drying had 18 times less checking than did roughsawn lumber. Planing before drying is called presurfacing and is discussed in the Accelerated Air Drying and Predrying section.

Thus, in Stage I the temperature must be kept quite low to maximize the wood strength, the RH (or EMC) must be quite high to prevent excessive shrinkage and rapid drying, and the velocity must be modest to prevent rapid drying. The maximum temperature recommended for check-prone species, such as northern, upland red oak is 110°F (343°C), but cooler temperatures (down to 80°F (27°C)) would be beneficial when the wood strength is lower than normally expected or when an extra safety margin is required. At 375 ft/min (1.9 m/s) velocity and 110°F (43°C), the recommended RH for quality drying of 4/4 upland oak is 87%. For species less prone to checking, RH can be as low as 60%. At 125 ft/min (0.6 m/s) velocity and 80°F (27°C), an acceptable RH for upland red oak can be as low as 65%. There are no precise, universal, “cookbook” values of temperature, RH, and velocity for drying any species. Drying procedures must consider all the critical elements, including species, lumber thickness, lumber history, type of dryer, and equipment condition.

Close examination of flatsawn kiln samples for checking in Stage I can help the kiln operator minimize damage to the lumber. If surface checks continue to elongate and deepen, the drying conditions are too severe. The temperature should be lowered, RH increased slightly, and/or velocity decreased to achieve more desirable conditions.

## Stage II

Stage II begins when one-third of the moisture has evaporated and ends at 30% MC.<sup>1</sup> This MC range refers to the average MC of the lumber, not just shell or core MC. In Stage II, the tension level in the shell decreases. This means that the risk of new surface checks will quickly drop to zero. Therefore, with the decreased risk of checking, it is possible to begin to slowly lower the RH in Stage II. The RH can be safely lowered *if and only if very little or no surface checking has occurred in Stage I*. Recall that if checking has occurred, it will be easy to aggravate the existing checks even under moderate drying conditions. In other words, it is not safe to lower the RH if checking has occurred; very mild conditions must be maintained.

---

<sup>1</sup>These MC levels are chosen to facilitate understanding of the concept of the four stages of drying. Nothing dramatic happens at a particular MC level or in the change in drying from one stage to the next. The transition is gradual.

Because the MC of many cells has dropped below 30% at this point and the cells are therefore shrinking or on the verge of shrinking, compression on the wet core increases at the beginning of Stage II. Therefore, the temperature of the wood must be kept low during this stage to maximize wood strength.

Toward the end of Stage II, many cells in the core have begun to shrink. The shell has become quite dry and has, for practical purposes, nearly finished shrinking. The shell is also larger than if it had been free to shrink. Thus, when the core cells begin to shrink at the end of Stage II, they begin to create compression in the shell. In other words, shrinkage results in a reversal of stresses; the shell is now in compression while the core is in tension, the reverse of what happens in Stage I. The compression in the shell tightly closes any normal surface checks. However, because compression is confined to the shell, any deep surface checks will normally not close. Also, any checks that were subject to alternate drying, wetting, and drying will not close.

In practice, during Stage II the schedule for all hardwoods will maintain the same temperature as in Stage I. For example, the typical schedule for oak will continue to maintain a temperature of 110°F (43°C). However, in Stage II, the RH is lowered very slowly (from 87% to 60% ) in small steps for 4/4 upland red oak. Note that the standard kiln schedule assumes that little or no checking has occurred. If checking has occurred, the standard schedule, with the drop in RH at high MCs, is probably not appropriate; the schedule must be moderated. On the other hand, some small surface checks in 8/4 oak may occur with the standard schedule; prevention of such checks is almost impossible.

Because surface checking is often invisible during visual inspection of rough lumber, especially in Stages II and III, samples with surface checks should always be prepared if the history of the lumber is not known, if the lumber has been air dried, or if the lumber is not green (MC) at the start of the run.

At the end of Stage II, the MC of the middle of the lumber is still above 30%, while that of much of the shell is below 30%. It is incorrect to say that the lumber is at the fiber saturation point (FSP) at the end of this stage. Only a few cells are at FSP; most cells in the shell are below FSP and many cells in the core are above FSP.

## Stage III

Stage III begins at 30% MC and continues to the final MC. During this stage, tension in the core is increasing as the core cells dry below 30% MC, but the level of tension is not high as that in Stage I. The RH can be safely lowered and the dry-bulb temperature can be safely increased at this time. However, if surface checks had developed in Stage I and then worsened in Stage II (perhaps as a result of improper dryer operation), they will likely develop into internal checks

(honeycomb) in Stage III. In fact, when deep checking has occurred, even if the conditions are relatively mild, it may be too late to effectively prevent honeycomb.

Overdrying must also be avoided in Stage III and therefore extremely low RHs are not recommended; the limit is a 40°F to 45°F (22°C to 25°C) depression (25% to 31% RH or 3.7% to 4.3% EMC). Because high temperatures can increase lumber discoloration and may contribute to subsequent machining problems, a maximum dry-bulb temperature of 160°F (71°C) is suggested to achieve top quality dried lumber; some operations use 140°F to 150°F (60°C to 66°C) maximum.

## Stage IV

Stage IV involves equalizing and conditioning the lumber. Equalizing is the process of developing uniform MC within and between the individual pieces of lumber in a load. Conditioning is the process of relieving drying stresses (tension set). Detailed procedures for equalizing and conditioning are given in Chapters 7 and 8.

## References

- Bois, P.J.** 1998. The four stages of drying thick oak. In: Wengert, E.M.; Toennisson, R., eds. Lumber drying sourcebook: 40 years of practical experience. Pub. 7274. Madison, WI: Forest Products Society. 371 p.
- Haygreen, J.G.; Boyer, J.L.** 1982. Forest products and wood science. Ames, IA: Iowa State University Press. 500 p.
- McMillen, J.M.** 1969. Accelerated kiln drying of presurfaced 1-inch northern red oak. Res. Pap. FPL-RP-122. Madison, WI: U.S. Department of Agriculture, Forest Service, Forest Products Laboratory.
- Panshin, A.J.; de Zeeuw, C.** 1980. Textbook of wood technology. New York, NY: McGraw-Hill. 722 p.

# Chapter 3—Stock Preparation and Stacking

To a great extent, the quality of the lumber dried in a kiln is predetermined by the treatment the lumber receives during the manufacturing process prior to kiln drying. Before actual drying operations begin, several steps are important in reducing warp and preventing other seasoning defects. Unless great care is exercised in the early phases of the manufacturing process, subsequent drying steps may be ineffective in reducing degrade and costs. The precautions start with the logs.

## Protection of Logs

Logs should be taken from the forest and sawn into lumber as soon as possible, particularly during warm weather. The importance of this procedure and the impact of long log storage on drying quality cannot be overstated.

For a small sawmill where only a few logs are accumulated and good log inventory rotation practices are in place, no other precautions are needed. For larger sawmills that store a large supply of logs, some precautions should be taken to protect the logs against deterioration. Logs that have been piled without protection are at risk for end checking and attack by fungi and insects, especially during warm weather.

Even if good log protection practices are followed, such as continuously spraying the logs with water, good log inventory rotation practices are critical. Although continuous spraying does inhibit staining and decay by fungi, activity by anaerobic bacteria continues under the low oxygen conditions. Bacterial action weakens the wood, contributing to a substantially increased risk of splitting, surface checking, and honeycomb during drying. Furthermore, chemical changes in the wood lead to increased risks of producing dried lumber with so-called enzymatic oxidation stain, which includes gray stain, pinking, and sticker shadow.

Continuous spraying with water has proven to be an effective means of reducing end checking, splitting, fungal stain, and decay. Spraying must be continuous to be effective, so spray equipment should be as clog-free as possible. The spray must cover both the sides and ends of logs. Cold, fresh water is more effective than is warm, recycled water. Figure 3.1 shows one type of spraying system.

Veneer log buyers and veneer manufacturers have used wax end-coatings on logs to prevent the ends from drying. End coating of high grade sawlogs may be an economically sound practice because of the high cost of logs and the need to reduce waste. End coating prevents logs from splitting and

retards fungal stain. The wax coating should be applied to the log immediately after cutting (bucking) to be most effective.

The effectiveness of end coating of red oak and hard maple sawlogs was investigated in a 12-week study in Wisconsin during the summer (Linares–Hernandez and Wengert 1997). End coating reduced blue stain in hard maple logs by as much as 9 in. (30 cm) per log end, resulting in savings of more than \$54/thousand board feet. End coating reduced splitting in red oak by 6 in. (15 cm) per log end, resulting in savings of more than \$36/thousand board feet. The longer the logs were stored, the greater the benefit of coating (Table 3.1). Coating costs were below \$3/thousand board feet.

## Sawing Procedures

Certain sawing procedures increase the risk of warp during drying. Lumber that is sawn parallel to the bark is less likely to bow (lengthwise warp or curvature similar to a ski) and to twist than is lumber that is sawn at various angles to the bark. Flatsawn lumber is more prone to cupping (warp from edge to edge) than is quartersawn lumber. Lumber with the annual rings off-center when viewed from the end grain of the lumber is more prone to developing sidebend, or crook when drying, compared to lumber with rings that are centered (rings on edges of lumber are mirror images). Lumber sawn from near the center of the tree will often have high lengthwise shrinkage, especially the closer the wood is to the pith (exact center) of the tree.



**Figure 3.1—Water spraying equipment can often be used effectively on decked logs to prevent deterioration over short periods.**

**Table 3.1—Length of splits and economic benefit of end coating of red oak logs stored for 12 weeks during the summer in Wisconsin**

Time (week)	Length of splits in logs <sup>a</sup>		Savings (\$/thousand board feet)
	Uncoated end (in. (cm))	Coated end (in. (cm))	
2	0.44 (1.12)	0.11 (0.28)	1
3	0.64 (1.63)	0	4
4	0.87 (2.21)	0.16 (0.41)	4
5	1.37 (3.48)	0.02 (0.05)	8
7	2.87 (7.29)	0	17
9	3.98 (10.1)	0	24
12	6.14 (15.6)	0	37

<sup>a</sup>One end of the log was coated, the other end not coated.

Lumber that is manufactured to a uniform thickness will promote more uniform drying because thicker lumber dries slower than does thinner lumber; the thickness of the lumber determines the drying time. If excessively thick lumber could be reduced to an acceptable average thickness, drying times could be reduced by as much as 25% with an accompanying savings of 10% in energy usage (Wengert 1990). Also, less warp occurs in uniformly thick lumber because the stickers can separate the lumber effectively. Sawing variation of less than 1/32 in. (0.08 mm) is becoming common in hardwood mills. If accurately sawn lumber is not available, presurfacing lumber (planing both faces) or blanking (planing one face) to a uniform thickness before stacking for drying increases the usable volume of a unit package, increases drying speed, and reduces the amount of warp.

Wood from small logs and from species with high amounts of tension wood or growth stresses, such as aspen and yellow-poplar, can be sawn into wide, unedged lumber, dried, and edged or ripped after drying to reduce the effects of sidebend or crook. Sawing around the log, centering and boxing the heart, and rotating the log 180° from the first to the second face tend to minimize lengthwise warp (crook and bow) caused by differential shrinkage between normal and juvenile wood.

Sawing too long on one side of the log before turning the log to another face also increases the risk of warp in drying because the center thickness of some pieces is thicker than that of the ends. As a result, as the green lumber is piled, the upper layers will begin to bow. This is called pile bend or pile crown. The solution is to rotate the log more frequently, but proper saw maintenance and proper feed speeds are critical as well.

## Protection of Green Lumber

Lumber needs to be protected from the time it leaves the sawmill until it can be transported to the drying site. Unless the weather is cold, freshly sawn lumber may be attacked by fungi and insects, and it is susceptible to checking and splitting, especially if exposed to direct sunshine or high air speed. Most insecticides approved for treating green lumber are not effective because the insects live on the inside of the lumber while the insecticide provides only short-term protection of the outer fibers. Prompt drying and good sanitation practices are recommended for insect control. Commercial, licensed treating firms are usually required for safe and effective insect control in lumber handling areas.

The sooner that controlled drying can begin—using the appropriate temperature, humidity, and velocity—the better the quality of the dried lumber. Manufacturers of high quality, bright, white kiln-dried lumber ensure rapid air drying by using fan sheds or by starting kiln drying before any lumber discoloration appears.

## Fungal Stain

Active growth of fungi in lumber during the drying process requires the following conditions:

- Temperatures must be approximately 50°F to 120°F (10°C to 49°C).
- Moisture must be available; most blue stain and mold occur when moisture content > 40% or relative humidity > 95%.
- Oxygen must be available.
- Nutrients for the fungi must be available; blue stain fungi are nourished by sugar in the sap.

Dipping green lumber in an antifungal chemical solution poisons the thin outer layer of food for the fungi, thereby eliminating the risk of new fungal stain. Stain that has reached below the surface will not be affected by this treatment. In addition, treatment chemicals have a very short effective period. Often, they lose most of their effectiveness within 3 weeks after application. Environmental and health hazards also raise concerns about chemical treatments. Chemical treatment by dipping is usually considered only when immediate stacking is impossible.

A chemical should be used only in accordance with its label. To ensure that dipping provides good protection against stain, the strength of the dip solution should be monitored continuously. A general recommendation is to dip the lumber during any period of a week or so when the daily mean temperature is expected to be at least 60°F (16°C). For maximum effectiveness, the lumber should be dipped immediately after sawing. Lumber that is held for several days and then dipped can be bright on the surface and stained on the inside.



## Insect Damage

One of the best methods of lowering the risk of insect attack is through good yard sanitation. Piles of slabs, sawdust and bark, old lumber, and sticker debris serve as the breeding ground for many insects. If these sources of infestation are eliminated, so are most insect problems.

## Chemical Stain

Initial chemical reactions that eventually lead to sticker stain, interior graying, and other enzymatic oxidative discolorations can begin in the stored log or in stored lumber. Dipping lumber in a fungicide or insecticide does not protect it against oxidative discoloration; in fact, the excessive moisture left on the wood may promote discoloration under some circumstances. The best preventative for oxidative stain is to rapidly dry the surface moisture. Oxidation stain can sometimes be minimized (but may not be prevented) in unstickered hardwood lumber by keeping the wood in the green state and as cool as possible until rapid drying can be started; however, bulk storage should not be prolonged (McMillen 1976). If green or excessively wet sapwood lumber has been held for more than 2 weeks before stacking, the lumber surfaces should be fast-dried before regular air drying begins to minimize discoloration. Fast drying can be accomplished by 1 day of accelerated air drying or 3 days of openly spaced yard drying. If mixed loads of sapwood and heartwood are dried, or if the sapwood boards have heartwood on one face, the heartwood should be observed frequently so that drying can be slowed down as soon as minor checks appear. (See also Ch. 9.)

One mistake is to sticker green lumber and then hold it in closely spaced stacks in a temporary storage yard. Costly damage from chemical stain or discoloration can occur in just a few days of warm weather, even if the lumber has been dip-treated.

## Prevention of Surface Checks

Surface checks can start during exposure of 2-in. (51-mm) heartwood of any hardwood or 1-in. (25-mm) heartwood of oak, hickory, and beech to direct sunlight or strong winds during hot or dry weather. Basically, the surface of the material dries much faster than does the interior, which results in stresses on the surface that can exceed the strength of the wood. All lumber should be protected from direct sunlight. Protection should consist of a roof over the entire green chain including the lumber piles; a roof over the green lumber packages at all times; and a tarp or a layer of low grade lumber as a stack cover to protect high-grade lumber during transportation. As a rule, expensive lumber that checks easily should be protected by a roof if exposed 1 or more hours to the sun or strong winds. This rule also applies to the transport of lumber on open trucks.

Some firms purchase green lumber that has been inaccurately sawn and has rough surface characteristics. Research has shown that presurfacing lumber to remove all fine saw marks substantially reduces surface checking in oak (McMillen 1969, Rietz and Jenson 1966, Simpson and Baltes 1972, Wengert and Baltes 1971; field trials described in Cuppett and Craft 1972 and Rice 1971). Several furniture manufacturers have successfully used presurfacing to improve drying. As an added benefit, surfacing to a uniform thickness, when the lumber has not been precisely sawn, helps to control warp. The best way to address the problems of poor surface quality and sizing is to work directly with the sawmill rather than to modify drying practices.

## Prevention of End Checks

Another common form of drying degrade is end checks. In uncoated thick stock, end checks that appear as hairline cracks can extend inside the lumber 12 in. (305 mm) or more from the end of the piece. This emphasizes the importance of effective end-coating to prevent quality loss. Many hardwood manufacturing operations routinely trim 3 to 10 in. (76 to 254 mm) off the ends of every board to eliminate end checks. This practice results in a 6% to 20% loss of lumber for 100-in. (2.5-m) lengths and is not acceptable in terms of economics.

From the standpoint of both economics and quality, hardwood lumber of all thicknesses would benefit from end coating. When the ends of 5/4 red oak were coated with a wax emulsion coating, the end checks were 2-1/8 in. (54 mm) shorter than those of uncoated ends (Wengert 1990). Furthermore, the checks in 62% of the coated ends were  $\leq 1$  in. ( $\leq 25$  mm). The same test in a predryer indicated that the checks in more than 75% of the coated ends were  $\leq 1/8$  in. ( $\leq 3$  mm), whereas the checks in 50% of the uncoated ends were considerably longer.

End coating should be applied as soon as possible to freshly cut end surfaces; end coating applied after checking has begun usually does not prevent deepening of the checks. The importance of applying the coating immediately to freshly prepared ends was illustrated in a study of 5/4 red oak end-coated with wax (Wengert 1990) (Table 3.2). In this test, the lumber was air dried for 60 days and then evaluated for the extent of checking. When application of the coating was delayed by 3 days, the benefit of coating was one-third that of the benefit of applying the coating on freshly prepared ends.

End coatings may be divided into cold and hot coatings. Cold coatings are liquid at ordinary temperatures and can be applied without being heated; and hot coatings are solid at ordinary temperatures and must be applied hot.

Cold coatings can be readily applied to logs and lumber. Special end-coatings of the cold coating class are available

**Table 3.2—Effect of delay in application of end coating to air dried 5/4 red oak lumber<sup>a</sup>**

Time delay in applying end coating after sawing (days)	Pieces with $\leq 1$ in. ( $\leq 25$ mm) checks on coated ends (%)	Difference in length of checks in uncoated and coated ends (in. (cm))
0	62	2-1/8 (540)
3	22	1 (254)
6	17	1/2 (127)
10	16	5/8 (159)

<sup>a</sup>Air drying time was 60 days.

from manufacturers and dry kiln companies. Cold coatings are usually applied by brush, although they can be sprayed with proper equipment. Sprayable wax emulsions have proven effective in preventing end checks in oak lumber when applied immediately after the lumber is sawn. For small-scale use, heavy pastes such as roofing cement can be used. Cold coatings should be allowed to air dry a few hours before being subjected to kiln drying.

Hot coatings (pitch, asphalt, and paraffin) are well suited for small stock that can be easily handled. These coatings are inexpensive and have good water resistance when applied in a single coat. Hot coatings are generally applied by dipping, but they can also be applied by holding the end of the lumber against a roller that rotates while partially submerged in the coating. Paraffin, which has a low softening point, is only suitable for air drying or for temporary protection of the ends of squares that will be kiln dried; the kiln schedule must use high relative humidity during the initial stages of drying.

Some specialty items, such as walnut gunstock blanks, require a highly water-resistant coating with a high softening point. In the absence of a quality coating, end checks can extend through the length of the piece as honeycomb.

## Color Enhancement Through Steaming

Little research has been conducted on steaming of lumber. This lack of information makes it difficult to develop reliable guidelines for steaming. Therefore, the following comments must be taken and applied with caution.

The most common use of presteaming treatments is to modify the color of black walnut sapwood. Steaming darkens the sapwood, toning down the contrast between it and the rich brown heartwood, thereby facilitating the uniform finishing of the wood. Steaming also improves the color of the heartwood, making it more uniform. Steaming is occasionally used for “pinking” beech and maple, softening the color of cherry, and darkening oak.

The best steaming results are achieved by treating green, never-dried lumber with wet steam in as tight a structure as possible at temperatures close to 212°F (100°C). Steaming chambers are held at atmospheric pressure and not pressurized. The structure itself is insulated and is made of materials that will withstand wet heat and the corrosive acids of the wood. Lumber would generally not be steamed inside a conventional kiln because of the high risk of deterioration to the kiln. Furthermore, many conventional kilns cannot achieve saturated conditions close to 212°F (100°C). If conditions are not saturated, the lumber may dry and may develop serious drying defects, including checking and honeycomb. However, some color change is possible if lumber is heated and steamed in a conventional kiln.

In the typical steaming chamber, low temperature steam is injected into the chamber through a pipe with holes along its length. The pipe is submerged in a trough of water to assure that the steam is saturated. A cover over the trough may be required to prevent splashing of water directly onto the lumber. No fans are used. Steaming times are typically 24 to 96 h, depending on the color development required and the thickness of the lumber.

## Other Lumber Pretreatments

The objectives of pretreatments are to improve drying quality, shorten drying time, and lower operating costs. In addition to fungicides and end coatings, several other pretreatments are used occasionally.

### Presurfacing

Presurfacing is an often overlooked predrying technique that can reduce the occurrence of surface checking in oak and beech manifold, as well as decrease drying time and energy use and increase kiln capacity for all species. Presurfacing involves the planing of *both* faces of green lumber before initiation of drying. It is theorized that a roughsawn surface has a large number of minute tears from sawing. When planed, the surface becomes much stronger and better able to withstand the tension forces of drying. In one study, rough, unplaned lumber had 11 times more surface checks than did presurfaced lumber (McMillen and Wengert 1978). In addition to the reduction of surface check, presurfacing decreases the width of lumber up to 8%. Compared to lumber that has not been presurfaced, presurfaced lumber dries more than 12% faster, has 8% less water, requires 8% less energy for drying, and requires 8% less dryer capacity (increases kiln capacity by 8%).

To presurface lumber routinely, the rough green thickness may have to be increased slightly. The typical size of green presurfaced 4/4 lumber is 1.03 in. (26 mm). Because at least 0.09 in. (2 mm) would be required for planing allowance before presurfacing, rough lumber should be no thinner than 1.12 in. (28 mm). Approximately 8% of the volume of rough

lumber is removed in presurfacing. On the other hand, presurfaced lumber may be smooth enough after drying to eliminate initial dry planing.

Because an individual company can easily run its own test with a package or two of lumber, the generally positive outlook for presurfacing can be analyzed in a specific operation. Presurfacing is especially attractive if the lumber will be used by the same firm that dries it. Otherwise, because the National Hardwood Lumber Association (NHLA) grading rules are not easily applied to presurfaced lumber, grading after drying could potentially be difficult.

## Blanking

When blanking lumber, only one face is planed to achieve uniform thickness. Therefore, blanking does not realize the benefit of surface check reduction on both faces of the lumber that is achieved by presurfacing. However, all other benefits of presurfacing—thinner lumber that contains less water, uses less kiln capacity, requires less energy for drying, and dries slightly faster—will potentially be realized.

## Chemical Surface Treatment

Certain chemicals can be applied to the surface of lumber to retard checking by retarding moisture movement or altering the vapor pressure at the wood surface. Treatments to retard drying have included a thick emulsion of microcrystalline wax and sodium alginate, salt (a proprietary salt, with corrosion inhibitors), table salt paste (a salt solution mixed with cornstarch), polyvinyl acetate glue, and urea. When large timbers were required for sailing ships, the logs and hewn timbers were submerged in cold saltwater for several years to avoid serious checking during drying. Chemical surface treatment of wood may involve corrosion of metal fasteners and possible strength loss. The effectiveness of a treatment can be predicted by the diffusion properties and thickness of the coating.

## Polyethylene Glycol (PEG) Treatment

Soaking wood for several weeks in a solution of polyethylene glycol 1000, commonly known as PEG, greatly improves dimensional stability. Many shrinkage problems encountered while drying wood can be minimized or eliminated with a PEG pretreatment, although the cost of PEG prohibits its widespread use. The treatment will work with a porous wood like red oak; on the other hand, treatment of white oak is less effective because of the low permeability of this species. PEG treatment is essential for lumber used in special products that require a high level of dimensional stability to meet exacting performance requirements. Examples of such products include laminated stocks for precision rifles, straight edges, patterns, essential structural parts for large cameras, and mounting blocks for large metal engravings. PEG may interfere with application of some finishes.

## Precompression

Compressing green wood momentarily 7% to 8.5% in thickness has been shown to decrease collapse and honeycomb and permit more rapid drying in yellow birch and red oak. Increases in permeability have been noted, leading to speculation that precompression causes small ruptures or failures in cell walls that facilitate the movement of moisture.

## Prefreezing

Lumber of some species that is frozen and then thawed before drying has been shown in laboratory tests to dry more rapidly and with less drying quality losses and less shrinkage than does unfrozen lumber. Favorable results have been obtained with black walnut, black cherry, American elm, white oak, and black tupelo. Freezing temperatures are  $-10^{\circ}\text{F}$  ( $-23^{\circ}\text{C}$ ) or colder for 24 h for 4/4 lumber. Large-scale tests, however, have not always shown such benefits.

## Sorting

From the standpoint of drying quality, hardwood lumber must always be sorted by species (or species group, such as upland and lowland red oak) and nominal thickness. Sorting on the basis of species tends to increase the efficiency of the drying operation because species differ in their drying characteristics. Lumber is also frequently sorted by grade, with the higher grade material receiving special attention to prevent any drying losses. Sorting on the basis of heartwood and sapwood contributes to drying efficiency within some individual species because of different drying rates and different sensitivity to drying defects between heartwood and sapwood.

Thickness is also a basis for sorting because drying time depends on lumber thickness. As a general rule, 8/4 lumber (8/4-in.- (50.8-mm-) thick) requires about three times more drying time than does 4/4 lumber. Another reason for a thickness sort is stacking restraint, which helps control warp. If thick and thin boards are stacked in the same layer, the thin boards will not make contact with the stickers and therefore will not be restrained from warping. Sorting by length is strongly encouraged because it helps to decrease warp and sticker damage, simplifies stacking, and increases kiln capacity.

In a large drying operation for which quartersawn and flatsawn lumber have different markets, sorting for quartersawn and flatsawn lumber is feasible, although not often done. Quartersawn lumber dries more slowly and with less cup than does flatsawn, whereas flatsawn lumber is more prone to surface checking. A sort may also be based on the amount of sapwood and heartwood on one or both faces of the lumber.

Sorting for quality has long been practiced with some species on the basis of research findings on quality differences and

the causes of drying problems encountered with low quality material. When defects are present in large quantity, lumber should be sorted out according to type of defect so that special kiln schedules and moisture monitoring measures can be applied. For example, so-called mineral streak (mineral portions of sugar maple) is known to be a wound-induced discoloration (Shigo 1965). Material with mineral streak is very low in permeability and internal checking is common. Oaks, aspen, cottonwood, and several other hardwood species may have streaks of wood infected with bacteria (Sachs and others 1974, Ward and others 1972). Until a method of identifying bacterially infected wood is developed, sorting for this defect cannot be done reliably.

The idea of sorting to limit drying defects has been extended by several mills that produce large volumes of oak lumber. The log scaler identifies logs with the potential to produce heavy stock, such as 6/4 and 8/4 lumber. Excluded from these logs are logs that have the odor of bacterially infected wood or logs that have the wide, wavy growth rings characteristic of "lowland" type oak. In mills that have a high percentage of bacterially infected wood or southern lowland oak, limiting production to 4/4 and 5/4 lumber is the most prudent course of action. Sorting will not only enhance quality but also increase production.

Bacterially infected oak can be difficult to separate from uninfected oak. Mill workers become desensitized to the odor of infected oak and soon lose their ability to distinguish it from uninfected material. Infected and uninfected wood cannot be distinguished visually. If there were a fast and reliable way to sort out infected oak, it would be possible to dry each sort by optimum method. Research by Ross and others (1992) showed that the speed of sound waves differs in infected and uninfected red oak, thus potentially forming the basis for a fast, nondestructive method of sorting.

## Stacking

For almost all drying processes (the most notable exceptions are some vacuum drying processes), lumber must be stacked in horizontal layers, with each layer separated from the next by strips of wood called stickers (Fig. 3.2). The importance of proper stacking cannot be overemphasized. The major purposes of stacking lumber in a specified manner are to promote uniform air circulation, which in turn results in good drying; and to reduce or eliminate warp. During stacking, the lumber may also be graded and measured for volume. Quality assessment of the lumber can be (in fact, should be) made at this point.

## Piles

Stacking uniform lengths of lumber within one package is the best method for consistently minimizing warp, maximizing kiln productivity, and maximizing the ease and quality of stacking. When this cannot be done and random-length



Figure 3.2—Stacking of stickered package of lumber.

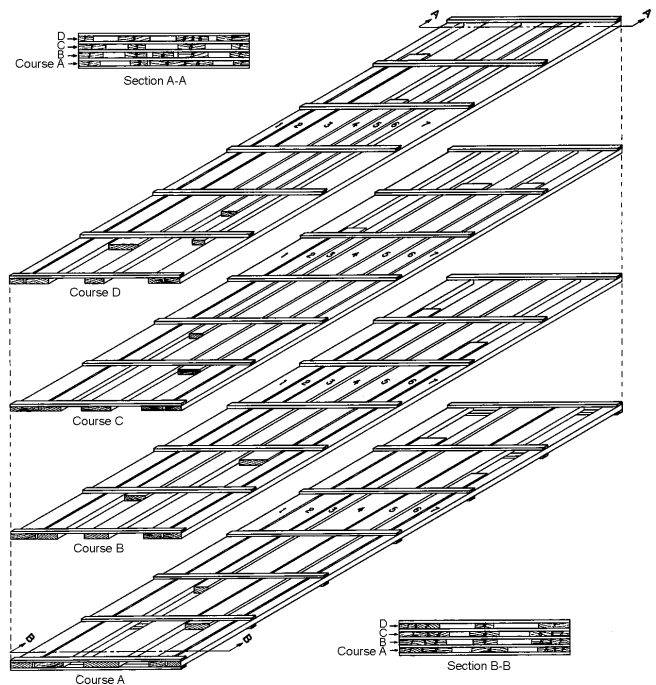

Figure 3.3—Box piling of random-length lumber.

pieces of lumber are stacked, the lumber is either boxed piled (preferred method) or even-end piled. For box piling, the longest pieces of lumber are placed on the outside edges of each layer and shorter pieces are staggered from one end to the other within the layer (Fig. 3.3). When possible, the short pieces from one layer should be placed over short pieces on another layer to provide good sticker support and weighting. These techniques produce unit packages with flat, smooth ends, and the ends of most pieces of lumber are supported well enough to retard warp. For even-end piling, all the lumber ends are even or flush at one end of the pile. Because the lumber lengths vary, the other end of the pile is ragged. This method of stacking usually leads to excessive warp and

end checking losses and therefore cannot be recommended for lumber of any value. Furthermore, even-end piling often lowers kiln production efficiency.

Typical package size for hardwoods is 4 to 8 ft (1.2 to 2.4 m) wide and 2 to 6 ft (0.6 to 1.8 m) high. Often the maximum forklift load capacity and kiln dimensions determine package width and height at an individual plant.

The pieces of lumber within a layer are usually stacked tightly edge to edge. Kiln drying is not appreciably affected by spacing or lack of spacing between pieces. However, for lumber that will be air dried in packages wider than 4 ft (1.2 m), drying will be more even and rapid if a small gap ( $\geq 1/4$ -in. ( $\geq 6$  mm)) is left between pieces.

In the past, air drying piles were hand built and occasionally were tilted or sloped to encourage rainwater to run off rather than into the piles. Hand-built piles occasionally had internal spaces, called flues, to assist in internal circulation. Today, most lumber is stacked with automatic or semiautomatic stackers without internal flues. The special stacking methods of the past are not required today because of the use of forced circulation dryers.

The correct stacking procedure will produce square, level, straight-sided piles with stickers and bolsters in alignment throughout. This kind of stacking will result in uniform drying and minimization of warp. Any variations in drying or any warp will be the result of problems with the drying environment, such as varying velocity or high relative humidity, or the result of natural characteristics within the wood itself, such as tension or juvenile wood.

The length of the lumber package is usually the same as that of the lumber. When several sizes of lumber are sawn, several different package lengths should be used. Most large sawmills sort by every even-length manufactured; odd lengths of lumber are stacked with the lumber that is 1 ft (0.3 m) longer. This is the best method in terms of minimizing warp and facilitating stacking. Smaller sawmills often mix lumber lengths. For example, 6- through 8-ft (1.8- through 2.4-m) lumber is considered one group, 9- through 12-ft (2.7- through 3.7-m) lumber another group, and 13- through 16-ft (4.0- through 4.8-m) lumber yet another.

## Stickers and Bolsters

Stickers (sticks, fillets, or strips) and bolsters (crossers) work together to control warp.<sup>1</sup> Good stacks require quality stickers. Stickers should be of the correct length for the pile width, of uniform thickness to reduce warp, and dry to prevent sticker stain. Most hardwood drying operations use

---

<sup>1</sup> In many operations with good stacking procedures, low relative humidity is often a more effective control measure than is the use of stickers and bolsters.

$3/4$ -in.- (19-mm-) thick stickers, spaced 24 in. (610 mm) on center. Any species can be used without risk of discoloration. However, dense species provide stronger, more durable stickers.

Sticker thickness is an important variable in drying, affecting drying speed and uniformity. Uniform thickness from sticker to sticker is also extremely important. Nonuniform thicknesses will increase warp. Typical sticker thickness for air drying is  $3/4$  in. (19 mm), although  $7/8$ - and 1-in. (22- and 25-mm) thicknesses are occasionally used. For predrying and kiln drying, sticker thickness is usually  $3/4$  in. (19 mm), but  $9/16$ - to  $7/8$ -in. (14- to 22-mm) thicknesses are also used. Poor air flow patterns caused by poor kiln designs, especially in some package kilns, have created interest in using 1-in. (25-mm) or thicker stickers to improve equipment operation. Thicker stickers greatly reduce kiln capacity. As a rule of thumb, each  $1/8$ -in. (3-mm) increase in sticker thickness reduces kiln capacity by 7%. A properly designed kiln will work very well with  $3/4$ -in. (19-mm) stickers.

For upper grades of  $4/4$  through  $6/4$  sizes of most hardwoods, stickers should be placed every 12 to 18 in. (30 to 46 cm) along the lumber length. This reflects the importance of laying upper grades of lumber as flat as possible. This close spacing is required for expensive material for which a small amount of warp can be very costly. If there is a considerable amount of uneven length lumber that results in unsupported ends, extra stickers may have to be added within 12 in. (30 cm) of the end of the pile. Likewise, if the forklift forks are not aligned directly under a sticker, extra stickers may have to be added in the bottom four or five layers at the lifting points to keep the pile intact. For hardwood lumber thicker than  $6/4$ , 24-in. (60-cm) sticker spacing is usually acceptable. However, lower grade lumber is usually more prone to warp than is upper grade; therefore, sticker spacing for  $4/4$  through  $6/4$  lower grade lumber should probably be 12 in. (30 cm) on center.

For warp-prone species such as red gum, stickers should be spaced 12 in. (30 cm) apart. For lumber of mixed lengths, when the normal sticker spacing is 24 in. (60 cm) on-center an extra set of stickers should be placed 12 in. (30 cm) from each end of the packs. This practice will provide better support to the ends of the pieces, thereby minimizing warp on the ends. To use this method for 12-ft (3.7-m) lumber, stickers are placed at marks 0, 12, 24, 48, . . . , 120, 132, and 144 in. (0, 30, 61, 122, . . . , 305, 335, and 366 cm).

Pile width is frequently governed by the requirements of the dry kiln or forced-air dryer or by those of the fork lift truck. In air drying and shed air drying, the narrower the pile the faster the wood dries. However, in forced air dryers with good airflow, pile width is less critical. The most common package widths are 48, 60, and 96 in. (122, 153, and 244 cm).

Stickers should be made of uniform, straight-grained wood and must be dry. They can be planed smooth or rough textured. The heartwood of any durable species is usually suggested for stickers, but all species have been used. Because stickers are an expensive investment, usually a strong species (such as oak) is used. Grooved stickers (stickers with ridges) have been used effectively to prevent staining.

Recently, stickers have been made with thin wood laminates, 1/8 in. thick (3 mm), glued together into a sticker of the required size; the sticker looks like a small laminated beam. The adhesive is very durable, not being affected by temperature or moisture. The many layers in the sticker assure that they will stay straight year after year. They also tend to be stronger than a solid sticker. Although they are expensive, their longevity and straightness more than pay for the extra cost. On the other hand, there have been numerous reports of increased stain of laminated pine stickers, especially during the first few uses; the exact cause is not known. Stickers are also being made from recycled plastic and wood. These stickers have proven to greatly reduce risk of staining.

Although sticker width is not critical for drying, very wide stickers may encourage staining. The usual width of stickers for drying hardwoods is 1-1/4 to 1-1/2 in. (32 to 38 cm). Stickers that are only slightly wider than they are thick are often inadvertently placed on edge, which results in uneven thickness of stickers and increases the risk of warp. Wide stickers are less likely to break in handling than are narrow ones. The strength of a sticker is a function of its width and its thickness squared. Therefore, a sticker twice as wide as another sticker is approximately twice as strong; a sticker twice as thick is four times as strong.

Stickers must be at least as long as the pile is wide, but stickers are often 1 to 2 in. (25 to 51 mm) longer. This extra length helps to keep stickers aligned when they are set in place manually; after the pile is completed, the extra length facilitates visual checking of the quality of stickering. It is false economy to use stickers that are shorter than the pile width. When stickers are only slightly longer than the width of the pile, care must be exercised when loading two piles edge to edge so that the ends projecting from one pile do not catch on the adjacent pile and break off.

Bolsters transfer the weight from one package to the package below it (or to the loading frame or floor); they also facilitate the ability of the forklift to lift the pile. Bolsters are usually made from nominal 4- by 4-in. (standard 89- by 89-mm) lumber. For efficient airflow, the thinner the bolster, the better. Bolsters are as long as the stickers. Bolsters near or in contact with the ground should be pressure treated with a wood preservative (fungicide and insecticide). For air drying, the bolster space should be as high as is convenient (18 in. (46 cm) minimum) to encourage good air circulation. To reduce lost kiln capacity and to minimize paths for air to short circuit, bolsters should be as low as possible. Some

firms use a nominal 3- by 6-in. (standard 64- by 140-cm) bolster; these firms use 6-in- (152-mm-) high spacing for air drying and 3-in. (76-mm) spacing for kiln drying.

The stacking of hardwood lumber should be aimed toward forming square, level, and straight-sided piles with stickers and bolsters in perfect alignment. To control warp, both stickers and bolsters must be aligned directly above and below the stickers in the layer above and below. Even a small amount (1 or 2 in. (25 or 51 mm)) of misalignment can greatly accentuate warp. Bolsters should be placed at every sticker, especially if warp control is important. That is, to obtain the flattest lumber, support from the top down to the foundation, floor, or ground level must be provided under *each column of sticks*. Nominal 4- by 4-in. (standard 89- by 89-mm) bolsters and the pile foundation should provide a solid column of support for the lumber.

## Special Stacking Methods

Certain products are stacked in special ways. For example, short squares (approximately 3 in. wide by 3 in. thick and up to 12 in. long (76 by 76 by 305 mm)) can be randomly placed into bins with no stickering or special arrangement. Longer squares and barrel staves can be stacked in layers, as is lumber, but typically the square or staves themselves act as stickers (are self-stickered). Ties and timbers are also self-stickered; only one sticker (a tie or timber) is placed at the end of each layer, alternating ends in every layer. Other stacking methods are illustrated in *Air Drying of Lumber* (FPL 1999).

## Quality Checks During Stacking

The stacking operation affords the opportunity to check the lumber for its conformity to various quality standards. Typically the grade and footage are verified, but other equally important factors should be checked:

- **Color**—Departure from “normal” color indicates that the wood may be bacterially infected, from trees killed by gypsy moths, of a different species than stated, or otherwise deteriorated.
- **Texture**—Wood texture, including coarseness and fuzziness, can be important in establishing whether the lumber has tension wood or other characteristics that will affect subsequent machining.
- **Growth rate**—The growth rate is important in distinguishing between upland and lowland oaks.
- **Odor**—The smell of the wood can indicate the presence of bacteria.
- **Moisture content**—Higher-than-normal moisture content can indicate the presence of bacteria; lower-than-normal moisture content can indicate that the lumber has already been partially dried and may have checks or other drying defects.

- **End checks**—End checks indicate that subsequent drying procedures must be moderated to avoid lengthening of checks.
- **Weight**—The difference in weight between various pieces of lumber of the same size can indicate moisture content or density differences. Higher density and high moisture content lengthen drying time.

All of these criteria for checking lumber quality are in addition to the National Hardwood Lumber Association grading criteria (NHLA 1994). The listed criteria have a strong relationship to the utilization potential of the lumber, but they will usually not change the grade of the lumber. This checklist has three purposes: (1) to indicate a problem with the lumber supply that should be addressed, because it will decrease the ultimate usefulness of the lumber; (2) to indicate the cause of defects or low yields, if they occur after drying; and (3) to indicate that drying procedures may need to be changed (usually moderated) to avoid aggravating preexisting damage to the lumber.

## Additional Ways to Control Warp

Most of the following procedures require additional funds for their implementation. However, as the value of high-quality lumber rises and as pressure to reduce waste increases, the cost to benefit ratio will justify the additional expense.

### Pile Covers and Weights

In air drying, the top layers of lumber are subjected to rapid drying from the sun and rewetting from rain, which can cause severe checking and warp. To protect the top layers, a water-tight roof is frequently placed over the lumber pile. The roof will help reduce moisture loss in the topmost layers, but it has little effect on the remaining layers in the stack. Therefore, when degrade control is important, the lumber should be placed in a roofed shed thereby protecting the entire pile from rain and sun effects.

Research and practical experience have shown the benefit of using heavy weights (often concrete, reinforced with wire or enclosed in a metal frame) on the top package of lumber for controlling warp during drying. The common loading level is in excess of 150 lb/ft<sup>2</sup> (7.2 kPa). Other methods of weighting the top—spring-loaded jigs and permanent strapping—have not been effective, probably because load levels are lower and the straps loosen when the lumber shrinks. However, using fabric strapping that is tightened daily (usually with a ratchet-type tightener) is effective.

Research showed that a load of 50 lb/ft<sup>2</sup> (2.4 kPa) is adequate for aspen nominal 2- by 4-in. (standard 38- by 89-mm) lumber dried at high temperatures. Denser woods might require more weight. Research on 4/4 blackgum, for instance, showed that 150 lb/ft<sup>2</sup> (7.2 kPa) was more effective than

90 lb/ft<sup>2</sup> (4.3 kPa) in reducing cupping. One example of an effective weight, which is used by some firms, are concrete blocks that are 10 in. (25 cm) thick and have been properly designed and reinforced for ease of handling.

Extensive care is needed when placing weights on lumber piles to avoid a safety hazard. Good vertical alignment of stickers and bolsters is also essential. With lower density species, stickers may protrude into the lumber when heavy weights are used.

### Other Methods

The foundation, kiln floor, and kiln trucks must provide a firm and flat bearing surface for the lumber pile. A crooked or uneven surface can cause twist, bow, or kink in the lumber during drying. Rapid natural air drying or equivalent accelerated air drying may be a necessary first step in drying warp-prone woods such as gum. Such methods tend to develop a large amount of tension set in the outer shell, which helps to hold the lumber flat in later stages of drying (McMillen 1963). When kiln drying lumber green from the saw, use schedule modifications that provide initial conditions of lower temperature and lower RH than those generally recommended. The lower temperature gives the lumber more strength during early drying, while the lower RH results in faster drying to a lower moisture content, which helps prevent warp in the later stages of drying.

## References

- Cuppett, D.G.; Craft, E.P.** 1972. Kiln drying of presurfaced 4/4 Appalachian oak. *Forest Products Journal*. 22(6): 86.
- FPL.** 1999. Air drying of lumber. Gen. Tech. Rep. FPL–GTR–117. Madison, WI: U.S. Department of Agriculture, Forest Service, Forest Products Laboratory. 62 p.
- Linares–Hernandez, A.; Wengert, E.M.** 1997. End coating logs to prevent stain and checking. *Forest Products Journal*. 47(4): 65–70.
- McMillen, J.M.** 1963. Stresses in wood during drying. Rep. 1652. Madison, WI: U.S. Department of Agriculture, Forest Service, Forest Products Laboratory.
- McMillen, J.M.** 1969. Accelerated kiln drying of presurfaced 1-inch northern red oak. Res. Pap. FPL–122 Madison, WI: U.S. Department of Agriculture, Forest Service, Forest Products Laboratory.
- McMillen, J.M.** 1976. Control of reddish brown coloration in drying maple sapwood. Res. Note FPL–0231. Madison, WI: U.S. Department of Agriculture, Forest Service, Forest Products Laboratory. 8 p.
- McMillen, J.M.; Wengert, E.M.** 1978. Drying eastern hardwood lumber. *Agric. Handb.* 528. Washington, DC: U.S. Department of Agriculture.

**National Hardwood Lumber Association.** 1994. Rules for the measurement and inspection of hardwood and cypress. Memphis, TN: National Hardwood Lumber Association.

**Rice, W.W.** 1971. Field test of a schedule for accelerated kiln drying of presurfaced 1-in. northern red oak. Res. Bull. 595. Amherst, MA: University of Massachusetts.

**Rietz, R.C.; Jenson, J.A.** 1966. Presurfacing green oak lumber to reduce surface checking. Res. Note FPL-0146. Madison, WI: U.S. Department of Agriculture, Forest Service, Forest Products Laboratory.

**Ross, R.J., Ward, J.C.; TenWolde, A.** 1992. Identifying bacterially infected oak by stress wave nondestructive evaluation. Res. Pap. FPL-RP-512. Madison, WI: U.S. Department of Agriculture, Forest Service, Forest Products Laboratory.

**Sachs, I.B.; Ward, J.C.; Kinney, R.E.** 1974. Scanning electron microscopy of bacterial wetwood and normal heartwood in poplar trees. In: Proceedings, 7<sup>th</sup> annual symposium, Scanning electron microscopy and the plant sciences; April 1974. Chicago, IL: IIT Research Institute: 453-460.

**Shigo, A.L.** 1965. The pattern of decays and discolorations in northern hardwoods. *Phytopathology* 55(6): 648-652.

**Simpson, W.T.; Baltes, R.C.** 1972. Accelerating oak air drying by presurfacing. Res. Note FPL-0223. Madison, WI: U.S. Department of Agriculture, Forest Service, Forest Products Laboratory.

**Ward, J.C.; Hann, R.A.; Baltes, R.C.; Bulgrin, E.H.** 1972. Honeycomb and ring failure in bacterially infected red oak lumber after kiln drying. Res. Pap. FPL-RP-165. Madison, WI: U.S. Department of Agriculture, Forest Service, Forest Products Laboratory.

**Wengert, E.M.** 1990. Drying oak lumber. Madison, WI: University of Wisconsin, Department of Forestry. 167 p.

**Wengert, E.M.; Baltes, R.C.** 1971. Accelerating oak drying by presurfacing, accelerated schedules, and kiln automation. Res. Note FPL-0214. Madison, WI: U.S. Department of Agriculture, Forest Service, Forest Products Laboratory.



# Chapter 4—Air Drying

For centuries the most popular drying method was air drying. By air drying wood for a year or more, moisture levels under 20% moisture content (MC) could be achieved, depending on the climate, species, and lumber thickness. Air drying achieved the major objective of reducing the chances of the wood developing mold, stain, or decay during transit, storage, or use. Because many uses did not require additional drying, air drying also provided the correct MC for many wood products. Until houses and offices were centrally heated, in-use moisture levels were seldom significantly below 12% MC, so only a little additional drying was required to achieve this MC level.

In the past, most lumber was obtained from large trees and the wood was thus clear and straight grained. Consequently, the risk of developing splits, cracks, checks, warp, and other degrade was low. The color of many species used for lumber was quite dark, so brightness and freedom from stain were not as important as they are today. In addition, wood was plentiful and inexpensive, interest rates were very low, and the cost of carrying an inventory for a year or more was low.

Today, open-yard air drying is no longer widely accepted as a quality drying method for hardwood lumber, especially in view of the conservation of natural resources. First, the quality of the wood resource is lower, but user demands for quality (especially bright color) have risen; consequently, more care must be taken during drying. Second, the availability of lumber has decreased and the value of many lumber species has increased. This means that losses in quality are more expensive than ever. Finally, as a result of moderate interest rates, inventory costs must be considered; air drying for a long time is expensive.

Where annual mean temperatures are not very low and space is not particularly limited, air drying of easy-to-dry, lower value hardwood lumber can still be an economical and energy-conserving method to withdraw most of the water from hardwood lumber prior to kiln drying. For hard-to-dry, higher value lumber, air drying degrade levels (quality losses) are often excessive—color may be poor, checks may be plentiful, and air drying quality is not consistent from month to month and year to year.

In a study by Gammon (1971) in which the lumber was graded before and after air drying, losses in air drying were substantial (Table 4.1).

Studies and experience have shown that adding moisture to the surface of lumber after it has been completely or partially air dried greatly increases the amount of checking that

remains open after drying (Hart and others 1992, Wengert 1990). The open checks greatly decrease the potential yield from the lumber in a furniture or cabinet rough mill. The amount of loss in check-prone species, such as oak, is likely to increase the longer the lumber remains in the yard. There are no substantial difficulties in kiln drying air dried stock at 25% to 30% MC. Therefore, it is best to stop air drying, especially of lumber that will be kiln dried, before the lumber reaches an average of 25% MC. Termination of air drying at 25% MC or slightly higher is a good compromise among the benefits of “free” air drying, the cost of kiln drying, and the cost of degrade.

Lumber to be bent to form, used for outdoor furniture, or used in constructing unheated structures such as barns and garages should be dried to 20% MC or slightly below. If lumber will be greatly bent in manufacturing, a better target is 25% MC. Wood that will be bent in a hot press or machined for trim and flooring in structures that are heated only occasionally should be dried to a lower MC (12% to 18%). These MC levels for bending stock can be obtained by prolonged air drying in a shed.

Air drying practices are discussed in detail in *Air Drying of Lumber* (FPL 1999). The proper application of the general principles of air drying can make this drying method more efficient and in some cases profitable. During good air drying weather, slight deviation from best practices is tolerable and will not result in serious degrade or retardation of drying rate. However, 3 or more days of very abnormal weather can be devastating. High humidity, heavy rain, and fog can cause discoloration, and strong winds in combination with low relative humidity (RH) can cause severe checking. Therefore, it is important to adhere to good drying practices year around, irrespective of weather conditions.

**Table 4.1—Approximate value loss for air dried 4/4 and 5/4 No. 1 Common lumber in typical open yards in Pennsylvania**

Species	Value loss (%)
Basswood	8
Yellow birch	6
Hard maple	14
Red oak	13
White oak	15

<sup>a</sup>Shrinkage losses not included.  
Source: Gammon 1971.

Although the lumber industry is moving away from traditional air drying as a predrying method for fine hardwoods because of the high cost of degrade, traditional air drying is discussed here to emphasize practices that produce quality results, conserve energy, increase kiln throughput and limit air drying inventory. In almost all cases, the following discussion and practices, when applied to lumber air dried under sheds, results in drying of reasonably good quality. Therefore, in the following text the term air drying is considered to include shed drying as well. Shed drying will be discussed in more detail in Chapter 5.

## Advantages and Limitations

One advantage of air drying is its apparently low initial cost. Although air drying involves substantial land, installation, and operating costs, the cost of kiln-drying dense, thick hardwoods to the MC levels achieved by air drying is often prohibitively high. However, as the value of the wood resource increases and/or interest rates increase, kiln drying of moderately easy-to-dry species like ash, beech, birch, and hard maple green-from-the-saw becomes more feasible than air drying. This is especially noteworthy in regions with fewer than 6 months of good air drying weather.

A second advantage of air drying is substantial energy savings. Each 1% of moisture content removed by air drying saves 50 to 85 Btu (53 to 90 kJ) per board foot in subsequent kiln drying. For a conventional kiln with a capacity of 50,000 board feet, this means that  $2.5$  to  $4.25 \times 10^6$  Btu (2.6 to 4.5 GJ) per kiln can be saved for each 1% moisture lost in air drying. At typical 1998 energy prices, this amounts to more than \$15/% moisture content/kiln.

The air drying process also offers the producer or large-scale user a means of carrying an inventory of various species, grades, and sizes of lumber. To meet shipping schedules during periods when the sawmill cannot be operated to capacity, the yard inventory is built up when sawing conditions are favorable and the lumber is air dried. However, using an air drying yard as a lumber storage facility is extremely expensive in view of value loss caused by stock degradation; that is, drying under 25% MC can result in considerable quality loss.

Air drying also reduces weight and shipping costs. Any degree of drying that can be achieved is helpful, even during short periods of lumber accumulation. However, there may be some danger of oxidative discoloration for white sapwood species that are partially dried and then bulk-piled for shipment.

In combination with properly applied anti-stain dip treatments, air drying decreases the chance that mold, fungal stain, and decay will cause degrade during storage and shipment. Rapid air drying at low RH levels produces a large amount of tension set, which contributes to the reduction of

warp. If the stock is properly stacked and protected in a well-designed yard, minimum degrade from checking will be apparent under reasonable climatic conditions, even for thick stock of dense woods and nominal 1-in. (standard 19-mm) heartwood of refractory woods.

Limitations of air drying are generally associated with the weather and the uncontrollable nature of the process. Production schedules are at the mercy of changing climatic conditions—temperature, RH, rainfall, sunshine, and winds. Drying is generally very slow during the winter in the North. But mean annual values for climatic variables are fairly consistent within any one region from year to year; therefore, general production schedules and plans can be implemented. Detailed planning requires both specific technical information and good judgment.

The lack of absolute control of drying conditions poses some hazards of excessive degrade. Unusually fast drying of the surface, caused by sun or wind and low RH, can cause surface checking of beech or oak within a day, even in the winter in the North. At other times and in other regions, brief periods of hot, dry winds may increase degrade and volume loss as a result of severe surface checking and end splitting. Warm, rainy, or sultry periods, with little air movement, encourage the growth of fungal blue stain and aggravate chemical oxidation stain, and such periods can cause excessive losses unless proper pile spacing and piling methods are used.

An excessively large inventory is very costly, especially when interest rates are high. Substantial deterioration of the lumber can occur if air drying is prolonged beyond the time needed to lower the MC to 25% or less.

## Utilization of Air Movement

Air circulation is so important that it is considered broadly here as well as in detail in later sections. Air circulation is the principal means of bringing the heat needed to evaporate water into the air drying yard or shed and into the lumber piles. Circulation is also involved in removing moisture-laden air from the pile and from the drying area.

Because air must move into and through the drying area, yard layout is very important. Adequate alleys and spaces must be provided between rows and piles. By custom in the United States, the “main” alleys for the transport of lumber to the piles are perpendicular to the prevailing wind direction. However, recent research has shown that for some types of yards, better circulation and therefore more uniform drying are obtained by constructing the main alleys parallel to the direction of the prevailing wind. Whatever such refinements, the air spaces must be adequately large and straight and continuous across the yard. If these principles are observed, airflow will be adequate through the yard whenever there is wind, regardless of which direction the piles face.

Except for those piles exposed directly to the wind (oriented perpendicular to the wind direction), little wind blows through most piles on an air drying yard. Rather, airflow is due to small differences in air pressure from wind eddies and aspiration effects and in air density. As the water evaporates, the air is cooled in and around all the piles. Cooling makes the air denser, and the air tends to flow downward. When the cool dense air is removed from beneath the pile, fresh air is brought to the top of the pile. This effect and the consequent drying go on continuously, regardless of wind, unless the air around all the boards is saturated with water vapor. This is why, from the viewpoint of fast, economical drying, high and open pile foundations are very important.

*Caution:* Thick or especially check-susceptible material should not be located on the windward side of the yard. Lower air velocities and increased RH levels in the central or leeward areas of the yard modify the severity of drying conditions and reduce the likelihood of checking. However, during severe weather, it would be bad practice to start refilling an empty yard from the leeward side toward the windward side because each pile in turn would be exposed directly to the wind.

## Other Factors That Affect Drying Rate and Degrade

The rate at which green lumber dries after it is placed in the air drying yard depends upon variables that involve the wood itself, the yard, the pile, and climatic conditions other than wind.

### Lumber Characteristics

Lumber characteristics that affect the rate of drying and degrade are wood species, grain pattern, and thickness.

#### Species

Some lightweight hardwoods (basswood, willow, yellow-poplar) dry rapidly under favorable air drying conditions. The heavier hardwoods require longer drying periods. Specific gravity is a physical property of wood that can guide estimations of drying rates or overall drying time. However, beech and sugar maple will dry faster in yards in the North than will northern red oak, even though all of these species have the same specific gravity. The difference between these species is related to the permeability of the wood; that is, difference in the proportion of sapwood and heartwood. Beech and maple consist of nearly all sapwood and oak of nearly all heartwood. These species differ in wood anatomy as well. The fibrous parts of the oak heartwood, which constitute most of its structure, are low in permeability and diffusivity.

Generalized estimates of air drying time by species are given later in this chapter. It must be recognized, however, that some woods are handled commercially in groups of species,

and differences occur between species in the groups. Pecan, for instance, usually consists of sweet pecan (*Carya illinoensis*), water hickory (*C. aquatica*, often called bitter pecan), and two minor *Carya* species (see Appendix D). The sapwood and heartwood of sweet pecan and the sapwood of bitter pecan dry very rapidly, but the heartwood of bitter pecan dries very slowly.

A similar situation exists with the tupelos and the oaks. The heartwood and sapwood of black tupelo, usually called blackgum (*Nyssa silvatica*) and the sapwood of swamp tupelo (*N. silvatica* var. *biflora*) and water tupelo (*N. aquatica*) dry rapidly, but the heartwood of water tupelo usually dries slowly. The heartwood of swamp tupelo is intermediate in drying characteristics. Red oak consists of several species of *Quercus* and white oak of another group of *Quercus* species. Southern lowland oaks, both white and red, have drying characteristics similar to each other but different from those of the upland oaks.

#### Grain Pattern

Rays aid the movement of moisture through the wood. The areas of contact between rays and adjacent wood cells are areas of weakness where checking occurs. Under severe drying conditions, flatsawn lumber, which has more exposed rays, is more likely to surface check than is quartersawn lumber. Likewise, the rays in flatsawn lumber run from face to face and allow faster drying compared to that of quartersawn lumber.

#### Thickness

Thick stock naturally takes longer to dry than does thin material. One theoretical approach suggests that drying time, under identical or similar drying conditions, is a function of the square of the thickness. Because thick stock often takes longer than one air drying season to reach 25% MC in the central and northern parts of the United States, actual air drying time for nominal 2-in. (standard 38-mm) stock is three to four times as long as that for 1-in. (19-mm) stock. Also, the greater the thickness the greater the tendency for hardwoods to surface check and end check.

### Yard Characteristics

The objective of good site selection and preparation, good yard layout, and good pile design is to enable the outside air to move into the pile to absorb moisture and then move out again. If the air does not move out, saturation occurs and drying stops.

#### Site

An efficient yard for rapid air drying should be situated on high, well-drained ground with no obstruction to prevailing winds. One southeastern furniture firm made considerable savings by building a new 12-acre (5-ha) yard on a hill 3 mi (5 km) from three old, overcrowded, and inefficient

yards (Minter 1961). The savings included 45% labor reduction, faster drying, and a decrease in total inventory of 2 million board feet.

## Layout

Alley orientation and size, row and pile spacing, and pile size for both hand-built pile and forklift yards are discussed extensively in *Air Drying of Lumber* (FPL 1999). The general function of alleys and pile spaces in removing moisture-laden air from the yard has been well known. The effect of wind-induced circulation within the piles, however, was not understood until pile studies were conducted on miniature models of forklift layouts using wind tunnels. White (1963) used two orientations of a single block of row-type model piles. Artificial smoke was used to indicate the relative amount and direction of air movement. When the piles were oriented perpendicular to the wind, much of the air was deflected over the top of the block. No wind blew directly through the piles except those right on the windward side. However, some air that flowed between the other piles entered them from the rear and left from their front, side, and top surfaces. Double eddies at the rear of each pile moved air up into the turbulent area above the piles. When the piles were oriented parallel with the wind, more air moved through the spaces between the piles and through the piles compared to airflow of perpendicularly oriented piles.

Finighan and Liversidge (1972) studied eight yard layouts. Two layouts were single large blocks of row-type yards; the others were line-type yard variations. The evaporation rate of a solid plug of moth crystals (paradichlorobenzene) located in each model pile simulated the rate of drying. Drying rates in all the line-type layouts were 20% to 40% greater than those in the row-type layouts. These differences would probably have been lower if a greater amount of "open space" had been used in the row-type layouts. The greatest amount of "drying" took place in the line-type layouts with the greatest amount of open space—double lines of piles with 25-ft (7.6-m) alleys. The best combination of good average drying rate and good uniformity throughout the layout occurred when the model piles and the main alleys were oriented parallel to the wind.

For those species and sizes that may be dried as rapidly as possible without danger of loss from splitting and checking, the line-type layout parallel to the prevailing wind appears to be best. For species such as oak that are subject to checking, the row-type layout may be required. The length and number of rows should be limited, however. If the row-type layout is used and if there are problems in drying the lumber of all piles uniformly prior to shipment or kiln drying in the shortest possible time, variable or nonuniform (using movable pile foundations) pile spacing in each row should be tried (McMillen 1964). Such nonuniform spacing has been widely used for redwood. In this method, the spacing between piles in the middle of the row is about double the spacing between

the piles near the alleys. Whichever yard layout style is used, the main and cross alleys and the spaces between piles should be perfectly aligned all the way across the yard and free of all obstructions.

## Condition of Surface

The drying efficiency of a yard depends to some extent on how well the surface is graded, paved, and drained. If water stands in a yard after a rain, it will substantially lower the drying rate. A yard can be surfaced to a depth of 6 in. (150 mm) with crushed rock. Blacktop paving can also be used. No matter what type of yard surfacing material is used, care should be taken that no pools of water can form underneath the lumber piles. The ground level underneath a pile should be even with or preferably slightly higher than the ground level adjacent to the pile. The yard should also be kept clean. Vegetation and debris, including broken stickers, boards, or pieces of timber from pile foundations, interfere with the movement of air over the ground surface and can be a source of insect infestation.

## Pile Characteristics

### Piling Methods

The drying rate of lumber is affected by the way the lumber is stacked. Lumber dries faster in air drying yards when air spaces are left between the boards of a unit package, especially in packages >5 ft (>1.5 m) wide, than when the boards are placed edge to edge. The air spaces permit greater downward flow of cooler moist air within the piles (that is, fresh air that initially enters the pile and then cools as it evaporates moisture). This internal circulation is important when the outside air is calm or nearly calm. Lumber packages ≤4 ft (≤1.2 m) wide are usually stacked tightly edge to edge. Downward flow occurs in the spaces between the piles. When random-length, random-width lumber is box-piled in ≥5-ft (≥1.5-m) piles, enough space develops within the piles (because of short lumber pieces) to make edge-to-edge spacing unnecessary. Proper sticker alignment, which is critically important for quality drying, is discussed in Chapter 3.

### Pile Foundation

A high, open pile foundation is necessary to allow cool, moist air to flow readily from beneath the pile. An open foundation is also a significant factor in obtaining uniform drying from the top to the bottom of each pile. Foundation height for hand-built piles should be at least 18 in. (46 cm) above the yard surface. In well-designed and -drained forklift yards, a 12-in. (30-cm) minimum opening (with open foundation construction) is satisfactory in many regions; in areas of high rainfall, the 18-in. (46-cm) minimum should be used with this type of stacking. Weeds and debris should not be allowed to block air passage. Minimum required pile spacing, edge-to-edge, is 2 ft (61 cm). End-to-end, piles can be as close as practical.

## Pile Roof

Clark and Headlee (1958) showed that pile roofs saved enough in degrade and drying time for 4/4 No. 1 Common and Better red oak to pay for the roofs in five uses. Also, faster drying rates and lower final MC values were achieved by the use of roofs in rainy spring weather. A report on similar air drying research in Australia, reviewed by McMillen (1964), showed outstanding differences in final MC of roofed and unroofed piles during rainy autumn and winter seasons—roofed piles were more than 5% drier than unroofed piles. This difference could easily result in kiln drying time savings of a day, which is potentially worth more than \$35/thousand board feet in production costs savings, not including the cost of degrade.

In regions of high rainfall, shed roofs provide some protection from rewetting. They can cut customary air drying times in half or greatly reduce the amount of water to be evaporated in a kiln after a “standard” air drying time.

## Climatic Conditions

The climate of the area or region in which the hardwood air drying yard is located greatly influences the air drying rate and yard output. The most influential factor is temperature, but RH and rainfall also play roles. In the northern United States and most of Canada, the drying rate is retarded during the winter months by low temperatures. In the southern United States, where the winter dry-bulb temperatures are higher, better drying conditions are expected. However, these higher temperatures may be offset in some localities by rain that wets the lumber and extends the drying time, unless the lumber is well protected. Research on beech, sugar maple, and red oak by Peck (1954, 1957, 1959) indicated that hardwoods air dry at a moderate rate when the daily mean temperature exceeds 45°F (7°C) and at a considerably faster rate when the temperature exceeds 60°F (16°C).

Figure 4.1 presents a map of different air drying weather regions in the eastern United States. The number of “good air drying months” is the same throughout each region. There is no precise definition of a “good air drying month.” Such a month may be roughly equivalent to a month with 22 or more days equivalent to the “effective air drying days” in the Upper Midwest defined by Rietz (1972) and discussed later in this chapter. The boundaries of the zones in the map are largely based on the average cumulative “growing degree days” from March 1 to mid-October for the years 1971 to 1975 (USDA 1975).<sup>1</sup> The northern extensions of the Central and Mid-South zones along the Atlantic Seaboard are located to coincide with the periods when mean temperatures are over 45°F (7°C) (USDC 1973).

<sup>1</sup>Growing degree days are computed to a 50°F (10°C) base with daily maximums listed to 86°F (30°C) and daily minimums to 50°F (10°C).

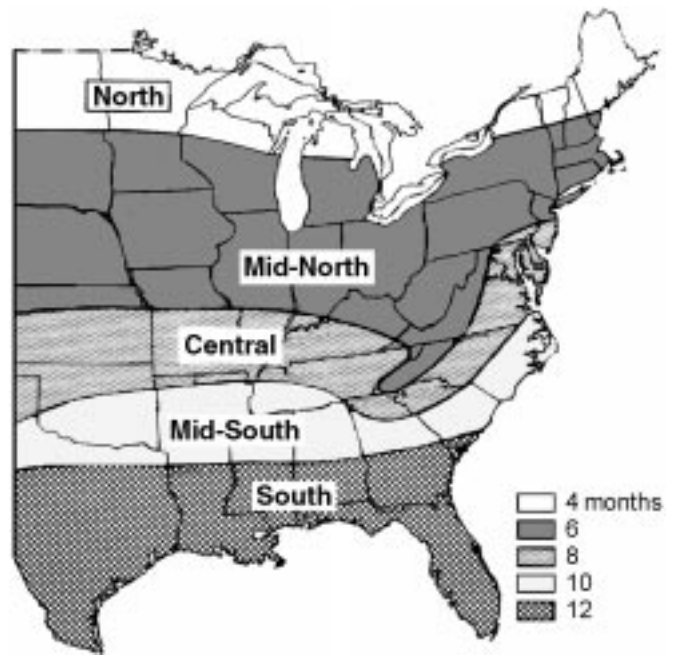

Figure 4.1—Airdrying map for eastern United States.

General confirmation of the map was obtained from a large number of commercial dryers throughout the Eastern United States. Within the Central, Mid-North, and North zones, a drying yard located on an exceptionally good site, with local temperature and wind velocity above the zone averages, could be expected to have an extra month per year of “good” weather.

Obviously, a “good” air drying day is not the best. To use the map in planning the most economical mix of air drying and kiln drying or of accelerated air drying and kiln drying, one should consider that “good” air drying weather is capable of bringing 4/4 oak and other slow-drying hardwoods to 25% MC in 90 days. The “best” weather will accomplish this in 60 days; during unusually cold winters in the South, it may take about 120 days.

Low RH, especially in company with high winds, can cause surface checking and end checking. This can happen at any time of the year. Danger periods often occur in late winter or early spring when rapid solar heating of air with a low absolute humidity causes the RH to drop precipitously. A good yard manager will learn from monthly weather records when such periods of low RH are likely to occur and will pile check-susceptible species in a manner that restricts air circulation to avoid checking.

Rain also influences the drying rate. In low sites, with poor yard surfaces and drainage, rain tends to raise the RH within the bottom of the piles and to interfere with downward air-flow and removal of moist air. Any lumber that is rewetted must be redried of course. Pile roofs prevent rain from

entering the lumber piles; the water along the sides of the pile is usually superficial, except for wind-driven rain. Where heavy rains are common, a shed with a wide overhang should be considered.

Sunshine indirectly affects drying rate. Solar radiation heats nearby land areas, exposed areas between the lumber piles, and surrounding buildings. Air moving over these warmed areas and structures is heated by convection, and its drying potential increases both by a rise in temperature and a fall in RH. Because dark-colored materials absorb more solar energy and become hotter than do light colored materials, blacktopping the roadways and sometimes the whole area can be used to accelerate drying.

In some instances, it may be desirable to arrange the main alleys of the yard north and south to take greatest advantage of solar heat. This orientation helps to melt snow quickly and to dry out the yard faster after heavy rains. In the South and Mid-South during the summer, the sun can cause the tops of piles to become too warm and dry too quickly, resulting in honeycomb and collapse in species like oak and willow. Pile roofs, close pile spacing, and plastic mesh fabric pile covers (Fig. 4.2) will reduce this form of degrade.

## Drying Time and Final Moisture Content

Air drying times published in *Air Drying of Lumber* (FPL 1999) have been limited to 4/4 lumber and generalized for the entire range over which each species grows. For the manager seeking to make the drying operation very efficient, especially in regard to energy conservation and inventory



**Figure 4.2—Good air drying yard: packages covered with plastic fabric to slow drying during dry and windy weather.**

expenses, estimates of drying time for both 4/4 and 8/4 material and for specific regions are desirable. Drying times for flatsawn lumber in unit package piles  $\leq 4$  ft ( $\leq 1.2$  m) wide have been estimated (Table 4.2).

The minimum times apply to lumber piled during the best drying weather, generally spring and early summer. If actual 1-in. (25.4-mm) lumber is piled too late in the best weather period in the expectation of reaching 20% MC by fall, or if lumber is piled during the fall or early winter, its MC will not reach 20% for a very long time. Thus, maximum drying times for 4/4 oak lumber in the Mid-North region are for reaching 25% MC (Table 4.2). In fact, none of times for drying 4/4 lumber to 20% MC assume absolute 20% MC, but MC as high as 23% in poor drying weather.

These time estimates are somewhat speculative because they are based on sketchy information. However, these times are thought to be the best base for calculating the feasibility of revising an old yard or building a new one with a good site, a good yard layout, the best piling practice with high, open pile foundations, and a roof on every pile.

An aid that should be very useful in estimating drying time in order to plan actual drying operations is the “effective air drying day calendar” developed by Rietz (1972) for the Upper Midwest. Each “best” month is considered to have 30 effective air drying days and other months to have few such days, as shown in Table 4.3.

As an example, green 4/4 northern red oak was dried to 20% MC in 60 days in a well-designed forklift yard with good air circulation, when stacked in June or early July. This is the best drying weather in the location considered. If the lumber were piled in early November, the effective air drying days would be November 10, December 5, January 5, February 5, March 10, and April 20, for a total of 55 days. Drying to 20% MC would probably be completed in early May, giving a total drying time of 180 days. Research by Peck (1959) indicated that 20 days would be saved by dismantling the piles at 25% MC. This MC level would be reached in 162 days.

Once such a calendar is set up, the minimum number of drying days (from drying time tables) for a certain item piled on specific days in the best months can be used in conjunction with the effective drying days of various months to predict when that item is likely to be dry. For yards located in the Tennessee Valley, and perhaps other parts of the Central zone, the Tennessee Valley Authority air drying guide should be helpful (TVA 1974). The charts in this guide show expected finishing dates for 4/4 and 8/4 hardwood lumber stacked on the 5<sup>th</sup>, 15<sup>th</sup>, or 25<sup>th</sup> of each month. No distinction is made for wood species.

An air-drying calendar for 4/4 red oak lumber was developed for the Roanoke, Virginia, region (Table 4.4) based on air drying data that were collected in the field and then

**Table 4.2—Estimated time to air dry green 4/4 eastern hardwood lumber<sup>a</sup>**

Species <sup>c</sup>	Size (in. (mm))	Estimated air drying time (days) by region <sup>b</sup>			
		South	Mid-South	Central	Mid-North <sup>d</sup>
Ash	1 (19)	45–70	45–75	45–80	60–165
	2 (38)	180–210	180–220	180–230	—
Aspen	1 (19)	—	—	—	50–120
	2 (38)	—	—	—	—
Basswood, American	1 (19)	40–65	40–70	40–75	40–120
	2 (38)	170–200	170–210	170–220	—
Beech, American	1 (19)	45–70	45–75	45–80	60–165
	2 (38)	180–210	180–220	180–230	—
Birch, paper	1 (19)	—	—	—	40–120
	2 (38)	—	—	—	170–220
Birch, sweet, yellow	1 (19)	—	50–85	50–90	70–165
	2 (38)	—	190–240	190–250	—
Butternut	1 (19)	—	40–70	40–75	60–165
	2 (38)	—	170–210	170–220	—
Cherry	1 (19)	45–70	45–75	45–80	60–165
	2 (38)	180–210	180–220	180–230	—
Cottonwood, eastern	1 (19)	40–65	40–70	40–75	50–120
	2 (38)	170–200	170–210	170–220	—
Elm, American, slippery	1 (19)	40–65	40–70	40–75	50–120
	2 (38)	170–200	170–210	170–220	—
Elm, rock, cedar, winged	1 (19)	50–80	50–85	50–90	80–150
	2 (38)	190–230	190–240	190–250	—
Hackberry, sugarberry	1 (19)	40–65	40–70	40–75	0–120
	2 (38)	170–200	170–210	170–220	—
Hickory	1 (19)	50–80	50–95	50–90	60–165
	2 (38)	190–230	190–240	190–250	—
Magnolia	1 (19)	40–75	—	—	—
	2 (38)	170–220	—	—	—
Maple, red, silver	1 (19)	40–65	40–70	40–75	0–120
	2 (38)	170–200	170–210	170–220	—
Maple, sugar, black	1 (19)	45–70	45–75	45–80	50–165
	2 (38)	180–210	180–220	180–230	—
Oak, lowland	1 (19)	100–280 <sup>d</sup>	—	—	—
	2 (38)	No data	—	—	—
Oak, red (upland)	1 (19)	60–120	55–100	50–90	60–165
	2 (38)	240–360	215–300	190–250	—
Oak, white (upland)	1 (19)	60–120	55–100	50–90	70–200
	2 (38)	240–360	215–300	190–250	—
Pecan	1 (19)	60–120	65–100	50–90	60–165
	2 (38)	240–360	215–300	190–250	—
Sweetgum, heartwood (red gum)	1 (19)	50–80	50–95	50–90	70–200
	2 (38)	190–230	180–240	190–250	—
Sweetgum, sapwood (sap gum)	1 (19)	40–65	40–70	40–75	60–165
	2 (38)	170–200	170–210	170–220	—
Sycamore	1 (19)	40–65	40–70	40–75	0–120
	2 (38)	170–200	170–210	170–220	—
Tupelo (and blackgum)	1 (19)	60–110	45–90	45–80	70–165
	2 (38)	210–300	180–220	180–230	—
Walnut, black	1 (19)	45–70	45–75	45–80	70–165
	2 (38)	180–210	180–220	180–230	—
Willow, black	1 (19)	30–65	35–70	40–75	0–120
	2 (38)	150–200	160–210	170–220	—
Yellow-poplar	1 (19)	40–65	40–70	40–75	40–120
	2 (38)	170–200	170–210	170–220	—

<sup>a</sup>The 4/4 lumber was dried to approximately 20% average MC and the 8/4 lumber to approximately 23% to 27% MC (McMillen and Wengert 1976). Lumber size is nominal (standard SI units).

<sup>b</sup>Regions of approximately equal number of months of “good” air drying weather.

<sup>c</sup>Forest Service official tree names; corresponding botanical names are listed in Appendix A.

<sup>d</sup>Lumber dried to an average MC of 25%.

**Table 4.3—Effective air drying day calendar for the Upper Midwest<sup>a</sup>**

Month	Effective air drying days (no.)
January	5
February	5
March	10
April	20
May	25
June	30
July	30
August	30
September	25
October	20
November	10
December	5

<sup>a</sup>Reitz 1972.

correlated to the historical meteorological data of the region (Denig and Wengert 1982). The air drying data were collected from three furniture plants with air drying yards located within a 55-mile (90-km) radius of the Roanoke weather station. The MC loss from the sample boards was highly dependent on the MC of the sample, the air temperature, and the RH.

The air drying data for 4/4 red oak lumber for the Roanoke, Virginia, region show that red oak lumber stacked from March through July dries rapidly and is ready for the kiln in 2 months. The MC of lumber that is stacked in the fall and winter months drops to about 30% to 40%. At this MC, air drying slows down until the spring. The time estimated by the air drying calendar to dry lumber to 20% MC is in line with the estimates shown in Table 4.2.

**Table 4.4—Moisture content of 4/4 red oak lumber in air drying yard in Roanoke, Virginia, by month and day<sup>a</sup>**

Month	Day	Moisture content (%)											
		Jan	Feb	Mar	Apr	May	Jun	Jul	Aug	Sep	Oct	Nov	Dec
January	1	80										33	39
	10	57										33	37
	20	45										32	35
February	1	39	80									32	33
	10	35	56									31	32
	20	33	44									30	30
March	1	31	38	80								29	30
	10	29	33	54								27	28
	20	27	30	42								26	26
April	1	25	27	34	80							25	25
	10	22	24	28	53							22	22
	20	20	21	24	38								
May	1			21	30	80							
	10				26	53							
	20				24	40							
June	1				21	31	80						
	10					27	53						
	20					23	39						
July	1					21	31	80					
	10						26	53					
	20						23	38					
August	1						20	29	80				
	10							26	53				
	20							24	40				
September	1							21	31	80			
	10								29	54			
	20								27	42			
October	1								26	34	80		
	10								25	31	55		
	20									29	43		
November	1									28	35	80	
	10										33	56	
	20										31	44	
December	1										30	37	80
	10											35	57
	20											34	56

<sup>a</sup>Moisture content values were developed from historical monthly meteorological data, using statistical regression analysis. For example, initial MC of lumber stacked on April 1 was 80%; on April 10, 53%; on April 20, 38%; and so on.



The practice of holding lumber 90 days (or even longer) in the air drying yard and then shipping it, under the assumption that this practice is very efficient and cost effective, is faulty on two counts. This air drying time is unnecessarily long and costly for some areas of the country during much of the year. Extra, unnecessary air drying usually increases degrade. On the other hand, when the weather is cold, 90 days may not be long enough to lower average MC to 25%.

There are advantages to keeping track of the moisture of the lumber as it air dries. Figure 4.3 provides a good estimate of air drying time for a given species, thickness, and month. The method of using samples, if modified slightly (described later in this text), is suitable for use in air drying. The major change is in construction of the sample pocket. The sample pocket is made two boards wide; the sample is placed in the inner space and a dummy board on the outer edge of the lumber stack. Alternatively, the sample is placed in the bolster space between the two lowest packages and some means is used to prevent excessive air circulation over the sample. This technique is not as effective as the ordinary sample pocket.

In the North, differences in drying time can occur depending on time of piling. The flatness of the curves (see Fig. 4.3) at low MC levels indicates the impracticality of waiting until the moisture content of the stock falls to 20% before moving it to the kiln. Safe methods for starting kiln drying at 25% to 30% lumber MC, regardless of kiln type, are described later.

## Air Drying and Shed Drying Operating Costs

Drying costs vary from one operation to another and from one lumber species and thickness to another. Calculation of

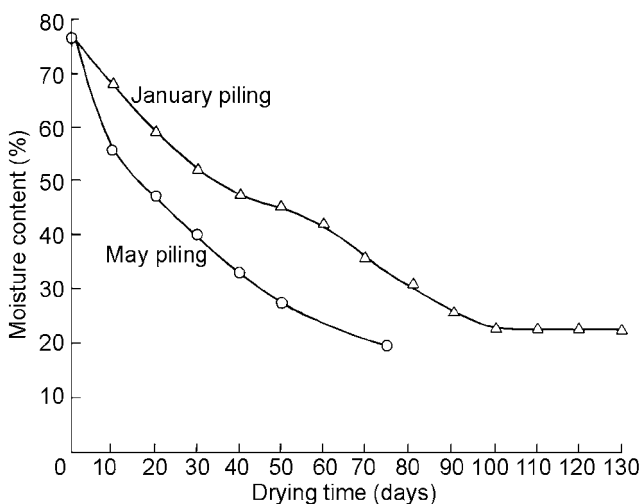

Figure 4.3—Estimated air drying time for 4/4 northern red oak piled at different times in southern Wisconsin.

drying costs is discussed in detail in Chapter 12. The operating costs presented in Table 4.5 are rough guidelines. Degrade must also be added to these figures to obtain the total cost. Typical degrade levels for 4/4 fine hardwoods are 8% to 13% of the lumber value for air drying, 4% for shed drying, and 3% for fan shed drying.

## Quick Guide for Improving Air Drying

The following guide summarizes procedures to reduce air drying time and increase efficiency for greatest energy savings. Note that many of these procedures may be risky for check-prone lumber.

1. When green lumber arrives or is first cut, immediately place the lumber on stickers. Even if the lumber will be kiln dried soon, store the lumber where it can air dry (that is, where the wind can blow through the pile). Drying is most rapid in the first 3 to 4 days: Do not miss this opportunity for effective early drying.

*Note:* If lumber will be placed into a warehouse predryer, better quality is achieved by placing the lumber directly into the predryer without prior air drying.

2. For species not prone to check, spread out lumber piles to increase their exposure to drying winds. The spacings published in *Air Drying of Lumber* (FPL 1999) are minimum values. Lumber piled too closely increases relative humidity in the surrounding area and slows drying as well as increases the chance for mold and stain. Place the driest and least check-prone lumber on the outside edges of the yard (especially on the edges facing into the wind) to increase the rate of drying.
3. Accelerating drying for species such as oak, beech, and hickory can increase the risk of checking and honeycomb. If dried too quickly, oak can develop honeycomb and check-prone species are subject to degrade even in the winter.

Table 4.5—Typical operating costs for average air drying of 4/4 hardwood in a yard<sup>a</sup>

Drying method	Air drying time (days)	Drying cost (\$/thousand board feet)	
		Cost/% MC loss	Cost/day
Air	90	0.50 to 0.99	0.30 to 0.55
Shed	30	0.20 to 0.25	0.30
Fan shed	20	0.20 to 0.30	0.25

<sup>a</sup>Moisture content of lumber green to 25%.

4. Consider using a sticker that is thicker than 3/4 in. (19 mm). Thicker stickers will permit increased airflow within the pile and therefore increase the rate of drying. As an alternative to thicker stickers, consider narrower piles for lumber to be air dried.
5. Keep the yard clear of weeds and debris so that the bottom layers of the pile will dry as fast as the top layers. Good sanitation of the yard also helps prevent infestation of wood-destroying insects.
6. Perfectly level and flat pile foundations and good stacking practices are two keys to successful air drying. Foundations that are of sturdy, open construction and support the lumber at least 12 in. (30 cm) above the ground promote good airflow and protect the bottom layers of the stack from warp.
7. Cover the tops of the piles to avoid exposure to rain and snow. Rain can cause checking and stain.
8. End coat the lumber as soon as possible after end trimming, or coat the log if the lumber is not trimmed.
9. Minimize exposure to sun.
10. For most species, avoid very slow airflow.
11. Cover the piles with open-weave plastic fabric if slower drying is needed.
12. Pave the yard to increase drying rates by as much as 3% to 4% MC/day.
13. Do not overdry; consider moving the lumber from the yard when MC > 30%.

## References

- Clark, W.P.; Headlee, T.M.** 1958. Roof your lumber and increase your profits. *Forest Products Journal*. 8(12): 19A–21A.
- Denig, J.; Wenger, E.M.** 1982. Estimating air-drying moisture content losses for red oak and yellow-poplar lumber. *Forest Products Journal*. 32(2): 26–31.
- Finighan, R; Liversidge, R.M.** 1972. An examination of some factors affecting the performance of air seasoning yards. Australia. *Timber Journal*. 38(3): 12–27.
- FPL.** 1999. Air drying of lumber: a guide to industry practices. Gen. Tech. Rep. FPL–GTR–117. Madison, WI: U.S. Department of Agriculture, Forest Service, Forest Products Laboratory. 143 p.
- Gammon, G.L.** 1971. Volume loss and grade change of hardwood lumber during air-drying. Res. Pap. NE–227. Broomall, PA: Northeast Forest Experiment Station. 17 p.
- Hart, C.A.; Gilmore, R.C.; Wyatt, W.C.** 1992. Prevention of open surface checks in dried lumber. *Forest Products Journal*. 42(4): 62–66.
- McMillen, J.M.** 1964. Wood drying—techniques and economics. *Southern Lumberman*. 208(2588): 25–26, 28, 32–34.
- McMillen, J.M.; Wenger, E.M.** 1976. *Drying News Digest*. Madison, WI: Forest Products Society.
- Minter, J.L.** 1961. One yard replaces three in model lumber storage, seasoning, and grading setup. *Wood and Wood Products*. 66(8): 23–24, 66, 70.
- Peck, E.C.** 1954. Effects of machine stacking on drying rate and degrade. *Southern Lumberman*. 189(2362): 62,64,66–67.
- Peck, E.C.** 1957. Air drying and sticker staining of 4/4 sugar maple flooring stock in Upper Michigan. Rep. 2086. Madison, WI: U.S. Department of Agriculture, Forest Service, Forest Products Laboratory.
- Peck, E.C.** 1959. Air drying of 4/4 red oak in southern Wisconsin. *Forest Products Journal*. 9(7): 236–242.
- Rietz, R.C.** 1972. A calendar for air drying lumber in the upper Midwest. Res. Note FPL–0224. Madison, WI: U.S. Department of Agriculture, Forest Service, Forest Products Laboratory.
- TVA.** 1974. An air drying guide for the Tennessee Valley. Pam. F74F3. Norris, TN: Tennessee Valley Authority, Division of Forest, Fish, and Wildlife Development.
- USDA.** 1975. Growing degree days. *Weekly Weather and Crop Bulletin*. 62(15): 10–12.
- USDC.** 1973. Monthly normals of temperature, precipitation, and heating and cooling degree days. 1941–70: New Jersey. *Climatology of the United States 81 (by state)*. Asheville, NC: National Ocean and Atmosphere Administration, Environmental Data Service.
- Wengert, E.M.** 1990. Drying oak timber. Madison, WI: University of Wisconsin–Madison, Department of Forestry. 167 p.
- White, J.F.** 1963. Air circulation within a lumber yard—an analysis by model techniques. M.S. thesis. Athens, GA: University of Georgia.

# Chapter 5—Drying Sheds

As explained in Chapter 4, the benefit of conventional open-yard air drying as a predrying method is low initial and operating costs, but there is also the risk of loss in quality. This quality loss reflects both grade loss and loss in usability. Increasing log and lumber prices as well as the potential high cost of degrade make it difficult to financially justify conventional air drying for predrying of most hardwood lumber today. The following text considers two improved air drying methods: (1) simple open sheds that protect lumber from rain and sun during air drying and (2) fan sheds that protect lumber from the elements during drying and increase the rate of drying through increased airflow.

## Open Sheds

### Economic Benefits

As mentioned in Chapter 4, using roofs to protect lumber from rain and sun during air drying can be very beneficial. Degrade can be measured by grading a stack of green lumber and then assigning a value to the stack. By regrading the stack during the stages of drying and plotting the data to show the loss of value over time, an operator can determine the most economical method for predrying the lumber. Figure 5.1 compares loss in lumber value for air drying and shed drying of 4/4 white oak lumber in eastern North Carolina; value loss for air drying was nearly twice that for shed drying.

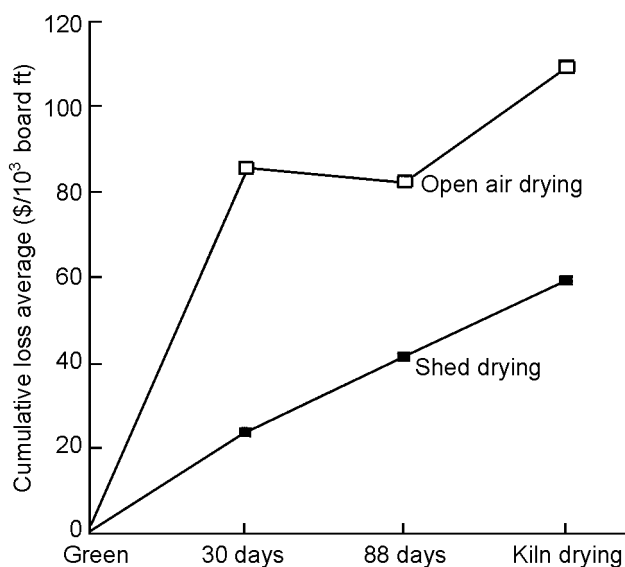

Figure 5.1—Value loss for air drying compared to shed drying in North Carolina.

This double-grading method of evaluating drying losses is conservative because it does not reflect the actual yield loss caused by drying defects that occurs during the manufacture of wood products. The double-grading method reflects only the losses recognized by the grade rules. Thus, the benefits of air drying may not be revealed by this method. A facility that includes secondary manufacturing of lumber, compared to a facility restricted to drying, may realize greater cost savings from good predrying practices through improved yield in the rough mill. The data in Figure 5.1 show a gain in the value of air dried lumber at 88 days as opposed to 30. This gain is due to the closure of checks during this stage in drying. Figure 5.1 illustrates how the grading rules do not recognize the true value loss in lumber because they do not recognize the checks as defects.

## Shed Designs

The main purpose of an air drying shed is to protect lumber from direct exposure to sun and rain. The two types of drying sheds commonly used are the T-shed and the pole shed.

The T-shed consists of a roof supported by columns in the center ridge; the trusses are cantilevered on both sides of the shed (Fig. 5.2). This type of shed can be used when air drying conditions are not severe. The T-shed protects lumber from direct exposure to the sun and rain, thereby reducing quality losses compared to those incurred during conventional air drying; red oak T-sheds in Virginia reduced quality loss from 13% to 3%. Another advantage of the T-shed is that it promotes rapid drying, especially when piles are



Figure 5.2—Air drying T-shed for hardwood.



**Figure 5.3—Air drying pole shed for hardwood.**

spaced 2 ft (0.6 m) apart, edge-to-edge, and the total width of the lumber piles is under 16 ft (5 m). The disadvantage of T-sheds is that they are expensive (they may cost more than pole sheds), the sides of the lumber packs may be exposed to blowing rain, and drying may be too rapid, causing checks in thick refractory woods.

The pole shed (Fig. 5.3) is usually wider than a T-shed; the pole shed may contain stacks that total  $\leq 24$  ft ( $\leq 27.3$  m) wide. Because the greater volume of lumber per area results in lower airflow, lumber in a pole shed initially dries more slowly than lumber dried in the air or in a T-shed. For example, in a sawmill in the Appalachian Mountains of North Carolina, after 5 months of pole-shed drying during the winter, the moisture content of 4/4 red oak lumber ranged from 31% to 71%, with an average of 52%. Slower drying can be an advantage for refractory lumber, protecting the lumber from severe checking. The disadvantages of a pole shed are that it can slow down the rate of drying, which compels the lumber yard to increase its inventory compared to that of yards that use T-sheds or conventional air drying, and it increases the risk of stain for some species.

The design of a shed should take into consideration the following:

1. Spacing between packs of lumber must be great enough to allow air circulation to prevent stain and mold from developing. However, if spacing is too wide, too much airflow occurs, which increases the risk of checking. The general recommendation is 24 in. (61 cm) of spacing between the packs, edge to edge. Packs can be as close as practical end to end.
2. Forklifts should be able to stack lumber packs safely and neatly. The most economical shed space is vertical. Height is limited by forklift reach, pile stability, and local

fire department or insurance company rules. A flat, smooth floor is required to stack the lumber packs correctly. A concrete floor is best.

3. The roof overhang of the shed should extend far enough to prevent rain or sun on the side of the exterior row of lumber. Typically, the overhang is  $\geq 4$  ft ( $\geq 1.2$  m).
4. The roof gutter and drain system should be designed to remove water from the roof and away from the drying shed during severe storms.
5. The road between the sheds should be designed for all-weather use. Muddy roads can keep the humidity high, thereby slowing drying, and can prevent the efficient operation of forklifts. Smooth roads are required to prevent sticker movement during transport. It is recommended that the roads between sheds be paved, since the shade from multiple sheds will slow the drying of dirt and gravel roads. A minimum of 40 ft (12 m) is suggested for spacing between adjacent sheds.
6. To reduce the rate of drying, the walls of the sheds may be partially closed. Some designs use solid walls with a  $\geq 12$ -in. ( $\geq 30$ -cm) gap at the floor and roofline. Some designs use plastic mesh curtains that can be closed during unfavorably rapid drying conditions. The curtains can also be closed to minimize the effects of blowing rain and snow.
7. The drying rate and drying quality of the lumber should be carefully and frequently monitored, especially in the initial drying stages, because the humidity can be too low at times, even for 4/4 lumber. Kiln sampling techniques can help to determine how well the lumber is drying (Ch. 7).

## Fan Sheds

A fan shed is a pole shed to which many fans have been added to one side. (In a few cases, fans are placed in a wall situated in the center of the shed.) The fans pull air through the lumber; air speeds are typically more than 600 ft/min (3 m/s). One rule of thumb is that 1 hp (750 W) of fan is used for every 6,000 board feet of lumber in the shed. This results in an electrical cost of about \$7/thousand board feet of lumber dried.

In the past, fan sheds were primarily used for rapid predrying of easy-to-dry-species such as cottonwood, yellow-poplar, soft maple, and sap gum. The data indicate that 1-in.- (25.4-mm-) thick elm, sap gum, hackberry, and yellow-poplar can be dried from green to  $<30\%$  MC in 6 to 7 warm summer days (Cobler 1963, Helmers 1959). Although fan sheds have been installed in a few places in the North, they are really effective in cold climates only from mid-April until mid-October.



**Figure 5.4—Typical fan shed used in a mill in Appalachia. Drying must be carefully monitored to prevent checking.**

Although many fan sheds have excessive velocity for refractory species, the use of low-velocity (approximately 200-ft/min (1-m/s)) fan sheds to predry 4/4 and 5/4 oak is increasing throughout the southeastern United States, especially where natural airflow is low. Likewise, lumber manufacturers in the Appalachian region have been experimenting with using low-velocity fan sheds to predry red and white oak. These fan sheds have greatly improved drying rates and uniformity of final MC compared to that obtained through conventional air drying and open-shed drying.

The fan shed shown in Figure 5.4, which is located at a mill in the Appalachians, is made from a 40- by 200-ft (12- by 60-m) metal building. The 96 1-hp (750-W) fans in the unit are 48 in. (1.2 m) in diameter. The fans are wired such that six sections of fans run along the length of the building, each section controlled by a different starter. The air travels through four 8-ft- (2.4-m-) wide packs with a measured air velocity of 400 to 500 ft/min (2 to 2.5 m/s). Typical drying rates for various species dried in this fan shed are shown in Table 5.1. The net effect of using a fan shed at this mill is much quicker turnover of the lumber with no adverse effects on quality. In addition, the use of a fan shed reduces the MC variability at the beginning of kiln drying, thereby increasing kiln production.

Like kiln samples, fan shed samples are used to track the progress of drying. The measured drying rate can indicate whether the lumber is drying too quickly. If so, the fans must be turned off for several hours or longer to achieve a more reasonable drying rate.

*Caution:* The lumber drying conditions—temperature and humidity—can be much more severe in a fan shed compared to kiln drying (initial drying steps) for oak, beech, and other refractory species. With the added

**Table 5.1—Typical drying rates for lumber dried in fan shed in the Appalachians**

Species and dimension	Time initially piled in shed	Drying time (days)	Change in MC (%)
4/4 red oak	End of January	56	80 to 28
4/4 white oak	Middle of January	38	60 to 35
5/4 red oak	Beginning of October	114	96 to 28
5/4 white oak	Beginning of October	40	52 to 31

effect of velocity, degrade can occur very quickly in the fan shed. When lumber is green from the saw, some operators start the drying process without the fans and keep the fans off for a week or so until the risk of creating surface checks is quite low (MC < 50% or so). This practice reduces checking. Another technique used to slow the drying rate and thereby prevent checking is to use air drying or open-shed drying until lumber MC is reduced to 50% or lower.

A useful addition to a fan shed is a humidistat that will shut off the fans when the humidity is too high (>92% RH). Although drying of wet lumber will occur at high humidity levels, drying will be slow and thus the cost per percentage of MC removed will be high. Blowing very humid air across drier lumber will result in moisture regain, which may increase degrade and drying time. Another useful addition to a fan shed is a rain sensor that will shut off the fans during rain.

The yard-fan dryer is similar in operation and applicability to the fan-shed dryer except that the fans are portable. The roof is also temporary and portable; it may be made of canvas, plywood, or sheet metal panels. With a yard-fan dryer, the fans and associated equipment are carried to the lumber piles, used until the lumber achieves the desired moisture content, and then moved to another lumber pile. However, such an arrangement is not practical in many modern air drying yards.

## References

- Cobler, W.E.** 1963. Fan air drying for the small mill operator. In: Wengert, E.M.; Toennisson, R, eds. Lumber drying sourcebook: 40 years of practical experience. Pub. 7274. Madison, WI: Forest Products Society: 123–124.
- Helmerts, R.A.** 1959. New way to speed air drying of hardwoods. Furniture Design and Manufacturing. (11): 30–31, 35.



# Chapter 6—Accelerated Air Drying and Predrying

In the past, the terms accelerated air drying and predrying referred to any drying system, except air drying, used prior to kiln drying. Usually such systems operated at temperatures under 130°F (54°C); the heat may or may not have been controlled. If the heat were controlled, the drying system was often called a low temperature drying system. These definitions were used throughout the industry prior to 1975. In the late 1970s, however, the meaning of predrying changed to a drying system that uses a warehouse-size dryer (capacity ≤1.5 million board feet) with air temperatures around 80°F to 90°F (27°C to 32°C), relative humidity (RH) between 50% and 80%, and relatively low air velocity (<250 ft/min (<1.3 m/s)).

Several accelerated air drying systems are briefly discussed in this chapter. The capital and operating costs of accelerated drying are usually higher than those of a warehouse predrying system, the drying times are longer, and the quality of the dried lumber is about the same. Therefore, warehouse predrying systems now take preference over accelerated air drying.

## Accelerated Air Drying

Accelerated air drying involves a specially designed drying enclosure, often appearing to be an inexpensive dry kiln. These dryers have fans for circulating the air through the lumber piles. Most of the air is recirculated, and only a small amount is ventilated to the outside to reduce humidity in the dryer. In addition, accelerated air dryers have heating systems; temperatures generally do not exceed 130°F (54°C). The use of heat results in shorter drying times compared to air drying times in northern climates during much of the year.

Solar drying can also be considered an accelerated air drying system (see Ch. 10).

## Research Basis

Accelerated air drying, often referred to as forced air drying in the literature, has been studied extensively in the United States and Canada. Accelerated air drying methods are technically sound and have many practical applications. Much of the research has been empirical. The Southeastern Forest Experiment Station of the USDA Forest Service established technical data to aid in the design and operation of forced-air dryers.

Data from an experiment by Vick (1965a) were used to derive the curves shown in Figure 6.1. This figure shows the

influence of temperature on drying time at a constant equilibrium moisture content (EMC) condition. The air velocity was 550 ft/min (2.8 m/s) and the load width 8 ft (2.4 m). The heartwood of yellow-poplar dried quickly, and as Figure 6.1 indicates, the sapwood dried even faster. At 10% EMC, the effect of temperature was significant. At 100°F (38°C), 4/4 sapwood dried to 20% moisture content (MC) in three-fifths the time required at 80°F (27°C). Vick (1965a) also showed the effect of different EMC levels. Degrade was very limited except at 120°F (49°C) and 6% EMC. Vick's report also shows the mathematical basis by which the actual results were found to agree with theoretical expectations. Similar data on 4/4 sweetgum lumber, tupelo rounds, and mixed hardwood rounds are available (Vick 1965b, 1968a,b).

Information on the economic prospects of accelerated air drying has been published by a number of authors (Catterick 1970, Cuppett and Craft 1971, Davenport and Wilson 1969, Gatslick 1962, Norton and Gatslick 1969, Wengert and Lamb 1982). In general, the data indicate that accelerated air drying has little or no advantage in drying rate compared with ideal summer air drying. An advantage for accelerated air drying rate could be anticipated during the 6 to 8 months of poor air drying weather. This advantage may also be operative where space for a well-laid-out air drying yard is limited, where rainfall is heavy for long periods, or where RH is unusually high. Means of comparing the economic advantage or disadvantage of accelerated air drying are described in Chapter 12.

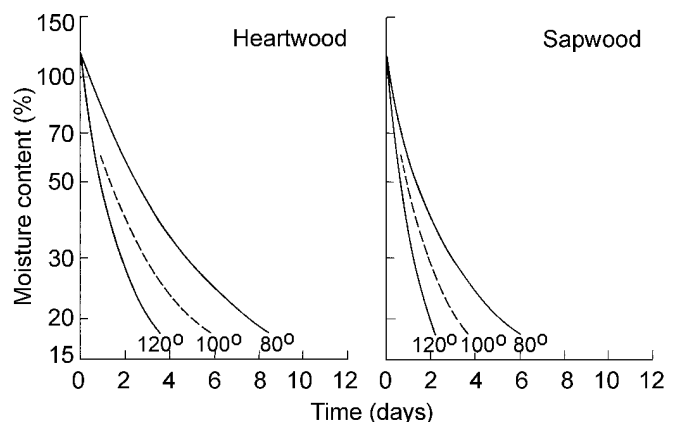

**Figure 6.1—Effect of temperature on drying of 4/4 yellow-poplar lumber in a low-temperature forced-air dryer under 10% EMC conditions (after Vick 1965b).**

The two basic types of dryers used in accelerated air drying are the forced-air dryer, which only partially controls RH through venting, and the low temperature kiln, which fully controls RH through venting and addition of moisture. Both the forced-air dryer and the low temperature kiln usually consist of an inexpensive structure plus the necessary heating and controlling equipment. Neither type of dryer is in widespread use today.

## Advantages and Disadvantages

The main advantage of accelerated air drying compared with yard drying is that the lumber is protected from the weather and the method provides air drying conditions that are closer to the ideal for longer periods. Accelerated air dryers have special advantages in northern areas where the weather is not optimal for air drying throughout the year. In northern areas, the drying rate for accelerated air drying is likely to be 2 to 4 times as fast as that for outdoor drying. The air velocity through the load in an accelerated dryer is 50 to 300 ft/min (0.3 to 1.5 m/s).

The advantages of accelerated air drying are as follows:

1. Drying is faster because of protection of lumber from rain and faster air circulation. Faster drying make it possible to reduce lumber inventory, resulting in considerable cost savings and lowered risk of degrade.
2. Lumber suppliers are able to respond more quickly to market changes because the drying period is shortened.
3. The operator has an opportunity to reduce shipping weight and thus reduce shipping charges.
4. The productivity of existent kilns used for drying green lumber is increased. The capital investment is potentially less than that required for the construction of standard kilns.
5. Accelerated air drying prevents lumber sticker stain and oxidative or chemical stain and protects the lumber from the weather, thereby preventing surface discoloration and resulting in brighter colored stock with greater marketability. Accelerated air drying also reduces surface checking and can reduce warp.

The potential disadvantages of accelerated air drying include the following:

1. Moisture content may not be uniform if the dryer is not designed and operated properly.
2. Sticker stain or other discoloration may occur in light-colored woods if RH is allowed to remain high (>90% RH).
3. Costs may be higher than those for air drying when suitable land is readily available with low rent or taxes and when the producer is willing to assume a large share of the risk.

4. Costs may be higher than those incurred in a typical warehouse predryer.
5. The availability of operating experience and operating guidelines is limited.

## Warehouse Predrying

The original warehouse-type predryer was designed by Jim Imrie more than 40 years ago. This predryer was designed to dry hard maple lumber in western Michigan, where high snow fall and short summers limit air drying. The original dryers, called Quality Controlled Air Drying (QCAD) dryers, were very popular in this geographical area. They operated at approximately 80°F (27°C) and 50% RH. Most of the dryers were small, holding less than 100 million board feet. They differed from conventional kilns, with respect to not only the operating temperatures but also the manner of loading. The QCAD dryers were loaded in small batches; thus, recently sawn lumber was sometimes placed alongside lumber that had been in the unit for several weeks. Because drying times were much shorter than those for air drying in this northern climate, lumber inventory was reduced.

Although QCAD dryers performed well in Michigan, in most parts of the country conventional air drying still provided adequate drying at a reasonable cost; that is, there was little impetus to improve drying quality or cost. However, in the late 1970s, interest rates and the price of logs and lumber began to rise sharply and industry began to adopt a conservation-oriented, “waste not, want not” attitude. Consequently, many furniture and cabinet companies began to look for ways to reduce air drying inventory costs, reduce losses and waste, and increase yields. The warehouse predryer concept seemed to be the answer to their problems.

Although maple was an important species to the hardwood industry, more than half the hardwood lumber dried was oak, primarily red oak. Limited information was available on the warehouse predrying requirements for oak, so many of the early predryers were designed on the basis of educated guesses. Their performance was evaluated and further design changes were made in the next manufacturing round of predryers. As a result, some early experiences were not very favorable. Nonetheless, by 1985 more than 40 warehouse predryers were installed in the eastern United States. Some with a capacity of as much as 1.5 million board feet of oak lumber. Inventory costs were reduced substantially; this savings alone, irrespective of any quality benefits, paid for the predryer within months.

## Predryer Designs

Today, warehouse predrying technology is well developed and provides an excellent quality method for drying lumber of many species and thicknesses from green to 25% MC.



The typical predryer operates at 85°F to 95°F (29°C to 35°C) with approximately 70% to 80% RH. Airflow through the lumber pile is about 125 ft/min (0.6 m/s). Air travel should be limited to 12 ft (3.7 m) of lumber before the air is reheated and reconditioned. By design, airflow direction is constant and it is not reversed in most conventional warehouse predryers.

The most common design for a predryer building is a large, insulated warehouse (Figs. 6.2 and 6.3). The building is about 100 ft (30 m) wide, which accommodates four 12-ft (3.7-m) rows of lumber (equivalent to eight 6-ft- (1.8-m-) wide packs) and adequate aisle space in the center to allow for loading and unloading. The length of the building varies, depending on the capacity desired. A typical predryer is 100 ft (30 m) long. The roof is gabled; the height at the wall is approximately 25 ft (7.6 m) and that at the center,  $\geq 35$  ft ( $\geq 10.7$  m). One or both ends of the building usually have roll-type doors that are opened to allow entrance and exit for the forklifts and lumber bundles; the doors should be kept closed except for entry or exit.

Heating coils are typically located along the walls. Fresh air intake vents are also on the walls; heating coils are usually located in front of the fresh air vents to allow rapid heating

of the incoming air. Exhaust vents are positioned along the roof ridge. Intake and exhaust vents are positioned every 20 ft (6 m) or so along the length of the predryer. The exhaust vents are powered with fans. The intake vents often have louvers that open automatically when the exhaust fans are operating, but the vents are otherwise closed to avoid drafts from wind.

The lumber packages are positioned near the sides of the building, with the lumber oriented parallel to the length. A 30-ft (9-m) wide aisle down the length of the building allows for forklift loading and unloading of the lumber. The lumber stacks are kept about 6 ft (1.8 m) from the walls; have a 4-in. (102-mm) space between the packages, edge to edge; and have a 4-ft- (1.2-m-) wide fan aisle halfway between the walls and main aisle.

The fans are located above the fan aisle and blow downward. This design is often called a downdraft predryer. To develop uniform velocity through the lumber piles, back pressure must be created at intermediate heights in the fan aisle. Flat baffles (Fig. 6.4) are very effective for this purpose. Uniform airflow is required to ensure uniform drying throughout the loads of lumber. In a few predryers, fans move the air horizontally, much like the fans in a conventional dry kiln.

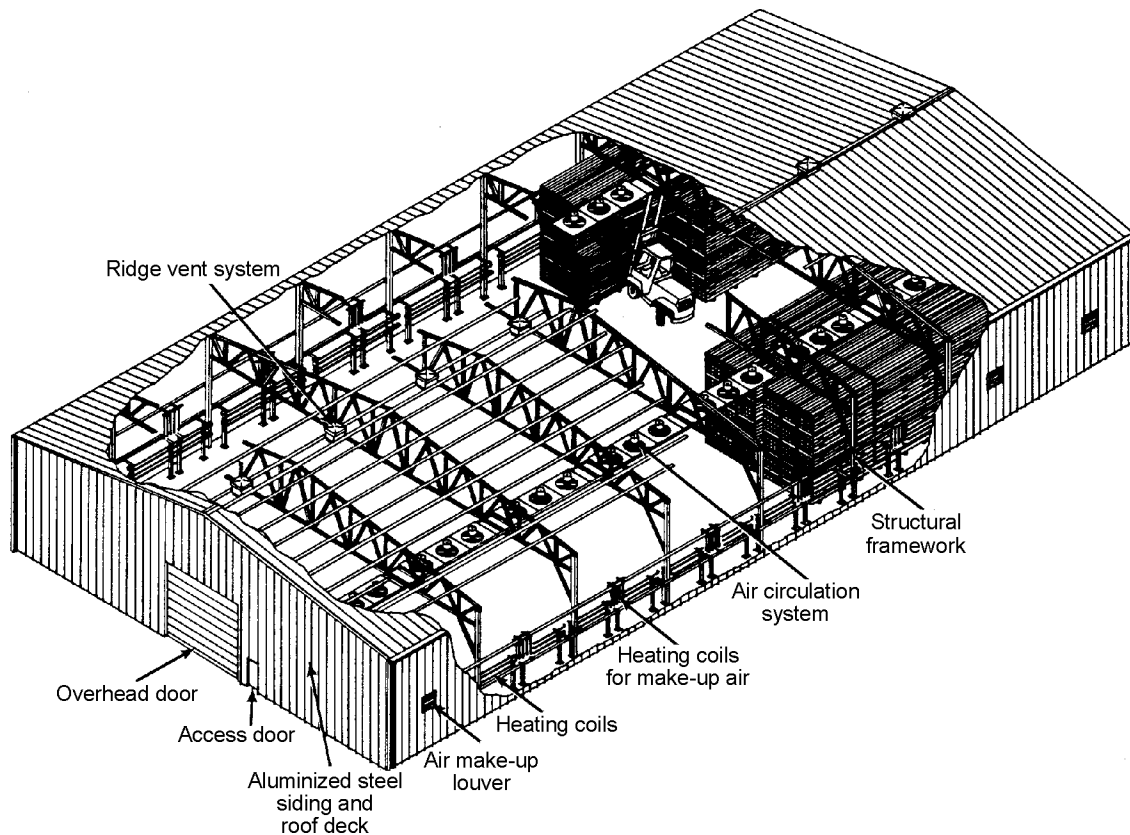
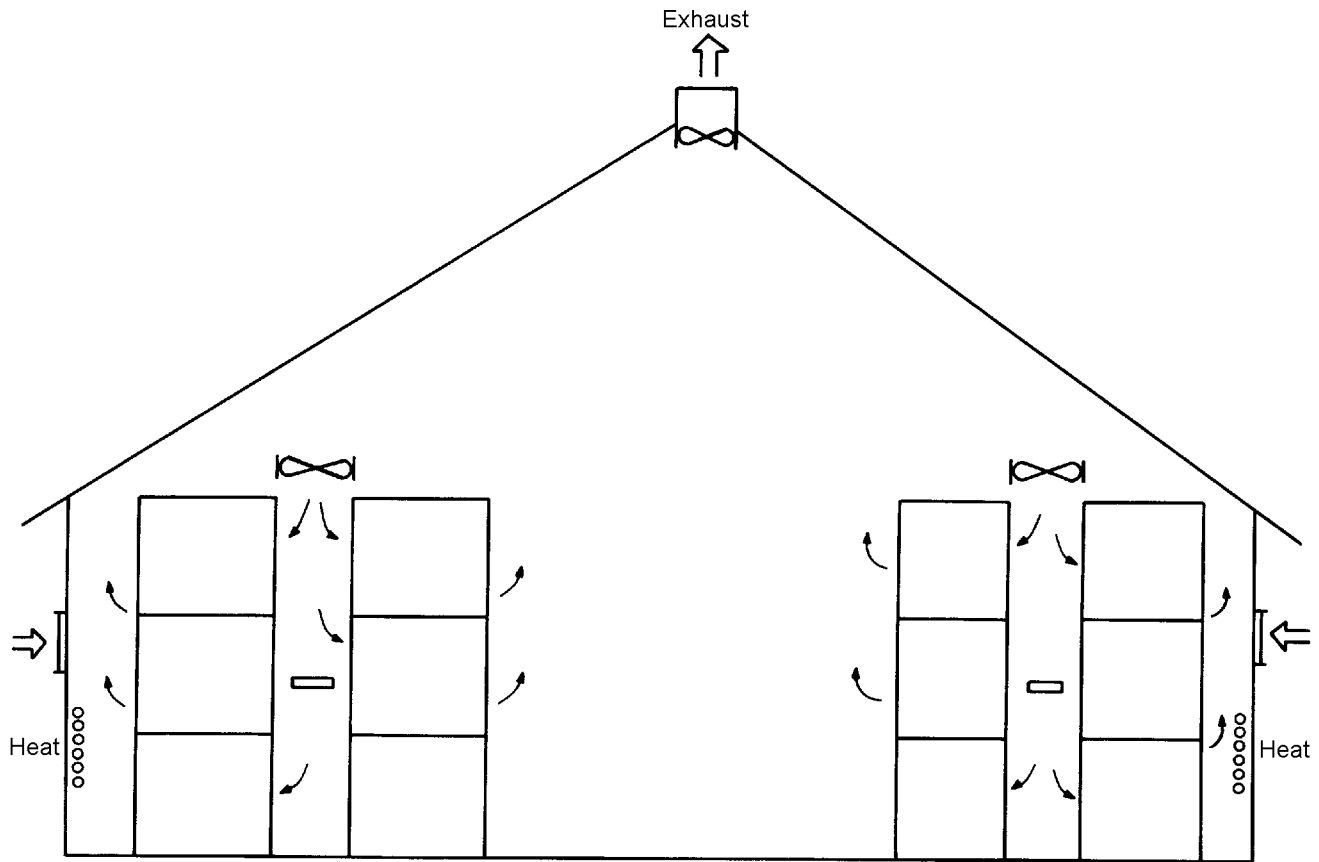

Figure 6.2—Schematic of a warehouse predryer.



**Figure 6.3—Schematic of the interior of a warehouse predryer. The exhaust vents are located near the lights in the roof peak.**

The temperature and humidity of the air being blown into the fan aisle is measured and controlled to within narrow limits for best quality drying. In many areas of the United States, the mildest conditions that can be developed in a predryer are 80°F (27°C) and 80% RH with 125 ft/min (0.6 m/s) velocity. These conditions can be too severe for initial drying of 8/4 and thicker oak and beech. In warm and humid regions, it may be difficult to achieve conditions under 65% RH because of the external conditions and the low operating temperature of the predryer. Such conditions may be too humid for rapid drying without stain, especially when coupled with air velocities under 200 ft/min (1 m/s). In fact, in most dryers the required conditions for maintaining whiteness in white woods like maple, ash, basswood, and hackberry cannot be obtained during the summer.

As a generalization, warehouse predryers are very effective for 4/4, 5/4, and 6/4 oak and beech as well as dark-colored species such as walnut and cherry. Other drying systems, such as fan sheds or kiln drying green from the saw, are most effective for the white woods. Drying in a predryer can result in as little degrade (that is, <2% loss) as any drying system for 4/4, 5/4, and 6/4 oak, beech, hickory, pecan, cherry, and walnut, if the predryer is operated properly.

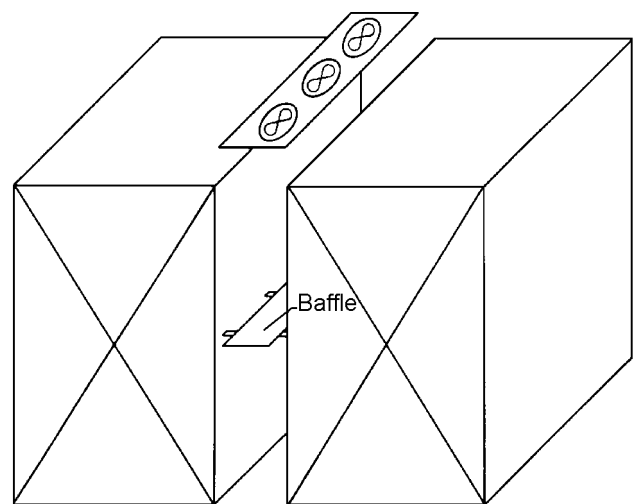

**Figure 6.4—Plenum baffles in a predryer help to develop even airflow and uniform drying of lumber, from top to bottom.**

There is a fundamental difference between a predryer and a kiln drying or air drying system. In the predryer, the lumber is exposed to a given, constant temperature, RH, and velocity 24 hours per day. As a result, the lumber is drying and is being stressed continuously. The fans do not reverse airflow direction. The situation is different in a kiln, especially in the early stages of drying when kiln humidity is high. In this case, the lumber may be exposed to the high humidity called for in the kiln schedule; but as the air travels through the packs of lumber, the humidity increases; the exit side of the load is exposed to very high humidity and little drying occurs. When the fans reverse, the humidity on the side that previously was the exit side is as designated by the schedule, but on the previous entering side (now the exit side), the very high humidity gives the lumber a “resting” period until the fans reverse airflow again. A similar situation occurs in air drying. Although RH can be quite low in the middle of the day, it will reach nearly 100% in the late evening through early morning, thereby giving the lumber a “resting” period. Thus, because lumber is continuously stressed, the predryer operation is very critical if high quality is required. Close, continual monitoring of drying conditions with accurate control systems and daily monitoring of drying quality are absolutely essential for the successful operation of a predryer.

Typical operating cost for a steam-heated warehouse predryer for oak lumber (excluding degrade, stacking, handling, and profit) is \$0.80/% MC loss/thousand board feet. These costs are equivalent to about \$1.50/day/thousand board feet. Total drying degrade is less than \$10/thousand board feet if the predryer is properly operated.

## Predryer Operations

Eckert and Little (1999) published an excellent overview of predryer operations. Manufacturers instructions need to be followed in all cases. A quality checklist for predryers was developed by Wengert and Boone (1993).

### Safety

Certainly the first concern for operating a predryer is safety. The predryer should be well lit, and the floor should be free from debris. Any condensation on the floor is apt to make the floor slippery. All fans and other equipment must have a lock-out system. Hard hats and safety glasses are essential because of the potential for falling lumber and blowing dust.

### Loading

The warehouse down-draft predryer lumber inventory should be managed so that approximately 25% is freshly stacked lumber that has been subjected to drying for less than a week, 25% is nearly dry and will be unloaded within a week, and the remaining lumber is at intermediate stages of drying. This system provides enough moisture from the drying lumber to obviate the need for a special humidifying system and

also ensures that the amount of green lumber will be low enough to prevent the accumulation of too much moisture in the predryer.

Lumber piles must be positioned so that they do not block the downward airflow from the fans and so that air can flow through the adjacent packages as evenly as possible. Bright lines are often painted on the floor to indicate to the lift driver where to place the bottom packs on the floor. Adjacent packs should be separated by 4 in. (10 cm) of space, edge-to-edge. To ensure uniformity of airflow when loading the predryer, it is best to fill the row from the wall to the center aisle.

Plenum baffles must be positioned after a section is loaded. Vertical end-baffles should be positioned on the end stacks to prevent short circuit air from going around the ends of the piles. Proper (tight) loading is absolutely essential in achieving proper airflow. In locations where lumber piles are not loaded tightly end to end, a temporary baffle should be used to fill in the gaps.

### Temperature, RH, and Air Velocity

The conditions of the air entering the predryer will vary with different predryers and with different lumber species and thicknesses. For 4/4 red oak, a typical predryer will operate at 85°F (29°C), 70% to 75% RH, and 125-ft/min (0.6-m/s) velocity.

It is important that the dryer conditions do not vary over time, especially when fresh lumber is loaded; that is, the heating and venting systems must be adequate to keep the temperature and humidity at the correct, desired level. The lumber should be loaded in small lots to avoid overloading the venting system. If the RH cannot be maintained at the desired level and is too high, then something should be done immediately to correct the situation. For example, some of the wettest lumber can be removed from the predryer. Another approach is to raise the air temperature in the predryer, thereby increasing the efficiency of the vents; raising the temperature by 10°F (6°C) will substantially increase vent capacity and efficiency. Consider the following example. The predryer is operating at 80°F (27°C) and 80% RH, which is equivalent to 9 grains of moisture per cubic foot of air (21 g/m<sup>3</sup> air) (see Ch. 2, Fig. 2.4). The air outside the predryer is 80°F (27°C) and 60% RH, equivalent to 7 grains moisture/ft<sup>3</sup> air (16 g/m<sup>3</sup> air). When the vents bring in a cubic foot (0.028 m<sup>3</sup>) of outside air, the air will gain 2 grains moisture/ft<sup>3</sup> air (5 g/m<sup>3</sup> air) before it is exhausted to the outside. Now, consider that the predryer is heated to 90°F (32°C), but the humidity is kept at 80% RH. Because warmer air carries more moisture, this new condition is equivalent to 11½ grains moisture/ft<sup>3</sup> air (26 g/m<sup>3</sup> air). Now, each cubic foot of outside air brought into the dryer will be able to absorb 4½ grains moisture/ft<sup>3</sup> (10 g/m<sup>3</sup> air) before it is exhausted to the outside, more than doubling the efficiency of the vents.

Velocity is especially important at lower temperatures because cooler air carries less water and therefore can become more humid rapidly. To provide for as uniform drying through the load as possible, velocity must be kept uniform and at a modest rate. The volume of air flowing in the sticker space is the key factor. Therefore, both velocity and sticker thickness are important. Table 6.1 shows how the MC gradient in the lumber stack changes with a change in air velocity. The examples in Table 6.1 illustrate the importance of achieving as uniform velocity in the predryer as possible to achieve uniform drying. Uniform velocity involves both the use of plenum baffles under the downdraft fans and proper loading.

### Schedules

Standard schedules are impossible for predryers because (1) velocity plays a major role in determining the drying rate, (2) at low velocity levels, small changes in velocity cause a large variation in drying rate, and (3) velocity varies by predryer. However, guidelines can be established that can be fine-tuned and customized for each predryer by measuring and noting the drying rate of the samples.

The dry-bulb temperature in a predryer should be between 80°F and 95°F (27°C and 35°C). The dry-bulb temperature

**Table 6.1—Effect of air velocity on moisture content of 4/4 red oak lumber stack after 1 week of drying<sup>a</sup>**

Velocity (ft/min (m/s))	Distance from top of stack <sup>b</sup> (ft (m))	MC (%)
125 (0.6)	0	59
	3 (0.9)	61
	6 (1.8)	63
	9 (2.7)	65
	12 (3.7)	66
40 (0.2)	0	59
	3 (0.9)	65
	6 (1.8)	69
	9 (2.7)	72
	12 (3.7)	73
250 (1.3) <sup>c</sup>	0	59
	3 (0.9)	60
	6 (1.8)	61
	9 (2.7)	62
	12 (3.7)	3.7

<sup>a</sup>Conditions: initial MC, 75%; ¾-in.- (1.9-cm-) thick stickers. Lumber was placed in predryer with two 6-ft- (1.8-m-) wide piles on each side of downdraft (airflow path 12 ft (3.7 m)).

<sup>b</sup>0 = top of stack.

<sup>c</sup>This small gradient is nearly the same gradient that would occur at 125 ft/min (0.6 m/s) velocity with 1-in.- (2.5-cm-) thick stickers, instead of ¾-in.- (1.9-cm-) thick stickers.

should be raised or lowered as necessary to achieve more uniform drying or to reduce checking when other techniques (changing RH or velocity) cannot be used.

The velocity in a warehouse predryer should generally be 125 ft/min (0.6 m/s) at all locations, especially when drying a refractory species like oak. If easy-to-dry species are dried in a predryer, then a higher velocity (400 ft/min (2 m/s)) is preferable. Velocity in a conventional predryer will frequently range between 400 ft/min (2 m/s) near the floor to 0 to 50 ft/min (0 to 0.2 m/s) at 10 ft (3 m) above the floor and to -50 to -100 ft/min (-0.2 to -0.5 m/s) near the top (the minus sign indicates flow in the reverse direction). It is essential to install baffles in the predryer plenum under the downdraft fans to achieve uniform flow (Fig. 6.4). If baffles are not used, then the 400-ft/min (2-m/s) velocity zone dictates that a high RH must be used with refractory species to prevent checking. However, this high RH is too high for efficient drying at velocities under 300 ft/min (1.5 m/s), and in fact it may result in staining and 50% longer drying time. For easy-to-dry species and varying velocity, staining will often result where velocity is too low.

The RH in a warehouse predryer is adjusted to provide an acceptable, safe drying rate. For drying 4/4 and 5/4 oak with an air velocity of 125 ft/min (0.6 m/s) and a dry-bulb temperature of 85°F (29°C), 70% to 75% RH is commonly used throughout drying. For easy-to-dry species such as hard maple, 50% to 55% RH is suggested. In any case, the drying rate on the entering-air side of the pile where the velocity is highest and RH is lowest is monitored to ensure that the drying rate is safe; the exit side can be monitored to ensure that the RH is not too high.

For 8/4 oak, RH will need to be about 85% (or even higher), which is difficult to maintain in most predryers. Furthermore, at such a high RH level, drying conditions will tend to be non-uniform throughout the pile of lumber and condensation on the building walls will occur, leading to rapid deterioration of the building. As a result, the predryer may not be the best drying method for thick oak. If thick oak must be dried in a predryer, it is often better to use mesh fabric on the entering-air side of the pile to reduce airflow further. It may also be wise to operate the fans only part of the time; that is, the fans are shut off for 8 to 12 h each day while lumber MC is higher than 40%. Excessive staining and mold growth will often occur during the drying of thick oak and other slow-drying species. Again, monitoring and controlling the drying rate is essential for efficient, safe drying.

### Kiln Samples

The previous discussion of MC gradients and the factors that affect the gradients indicate an important concept about kiln samples in the predryer. (As stated previously, “kiln” samples can and should be used in a predryer.) It is necessary to place kiln samples in two locations in the downdraft predryer: on the faster drying edge of the load, to monitor the

quality of the fastest drying lumber, and on the slower drying edge, to monitor the MC of the slower drying, wetter lumber. It is essential that all kiln samples be located in kiln pockets rather than in the spaces between nominal 4- by 4-in. (standard 89- by 89-mm) bolsters or other locations.

### Additional Operating Hints

- Double-check predryer conditions—The conditions in the predryer should be double-checked with portable temperature- and humidity-measuring devices every day. The damage that can result when an automatic sensor fails can be enormous.
- Use a physical barrier to separate zones in a single-stage predryer—If the conditions within a single-stage predryer will vary in different zones, then a physical barrier (perhaps canvas or plastic) can be useful in avoiding undesired conditions near the junction of the two zones. (See section on two-stage predrying.)
- Take care with thick lumber—If a few pieces of thick lumber must be loaded into the predryer but the predryer conditions (especially RH) are set for thinner lumber, consider wrapping the thicker lumber in burlap or plastic mesh fabric. The risk of this approach is that some stain may develop in the wrapped lumber. Another option is to operate the fans part-time; initially, operate the fans only 50% of the drying time to slow the drying rate for the thick material.
- Take care with green lumber—One option for handling green lumber is to store it temporarily in a shed. In designing a predryer, consider a substantial roof overhang at one end of the building, which would form a temporary storage shed. Another option is to remove partially predried lumber from the predryer into a kiln or open shed (avoid moisture regain at all costs) and move the green lumber into the predryer. This is the preferred option because the greenest lumber runs the highest risk of degrade. Placing this lumber under controlled drying conditions as soon as possible offers the best opportunity for quality control. Partially predried lumber runs a lower risk of quality loss, and therefore it can be removed from the predryer with little risk.
- Control RH by lowering predryer temperature—If the predryer is not fully loaded, or if the inventory becomes quite dry (little or no green lumber), RH typically cannot be maintained at the required level. To regain control of RH, lower the predryer temperature.
- Monitor humidity sensors—If predryer humidity is measured with electronic humidity sensors, check the accuracy of the sensors monthly. If wet-bulb thermometers are used, consider installing a small auxiliary fan at each thermometer to provide adequate air velocity. Change wet-bulb wicks or EMC wafers weekly. Use blocks or paper to even out velocity—blocking the 4 by 4 bolster

space makes velocity more uniform, but this method may not be cost effective. Kraft paper (4 in. (102 mm) wide) stapled to the ends of the bolsters has been used successfully for baffling.

- Control intake of fresh air through vents—Consider installing a hood over the exterior side of the fresh-air intake vents. This prevents snow and rain, and even some cold air, from entering the predryer when the vents are open. Some predryers have movable louvers on the intake vents. The louvers open and close in response to predryer RH; they open when RH is too high and close when RH is acceptable or too low.
- Check exhaust fans—Frequently, especially after maintenance, check the fan speed and direction of rotation for both circulating and exhaust fans. Also, with a new predryer or whenever fan blades are replaced, check the pitch of the blades; factory settings can vary.
- Capture condensation—Hang large pans well below the exhaust vents to catch condensation. The condensation will evaporate from the pans; no drain is needed.
- Keep predryer floor clean—Keep the predryer floor free of dust and dirt. Use a “riding” vacuum cleaner to clean the floor weekly. A clean floor means less food for mold and mildew and potentially brighter lumber. The floor in the bays where lumber piles are located should be cleaned whenever the lumber is removed and before fresh lumber is brought in. A clean floor is also a safe floor.
- Check the entire predryer operation—Any rating less than 4 should be carefully evaluated to determine if the situation is causing an undue risk or is actually causing losses in lumber quality, drying time, or energy required for drying.

### Removal of Lumber From Predryer

Although lumber can be removed from the predryer at any time, it is prudent to wait until average MC is below 30%. At this level, the lumber will not be damaged in storage as long as it does not regain moisture. Do not place predried lumber in an air drying yard. In general, it is most economical to remove lumber from the predryer at 25% MC. Although no harm is done to the lumber if its MC is below 25%, control of predryer RH may be difficult.

### Kiln Start-Up

When predried lumber is taken directly from the predryer into the kiln, the kiln can be started at the appropriate temperature (in a typical kiln schedule), as indicated by the MC of the incoming lumber. However, a conservative approach is to start the kiln at a dry-bulb temperature 10°F to 20°F (6°C to 11°C) cooler than the maximum temperature given in the standard kiln schedule. Once this temperature is reached, then the initial kiln EMC should be set at 1% lower than the predryer EMC; the initial kiln EMC should be set

predryer EMC; the initial kiln EMC should be set 2% lower than predryer EMC when the lumber does not have a high risk of developing degrade.

Cut new kiln samples for each kiln charge of predried lumber. Select most samples from the wettest portion of the predried lumber. For example, take the samples from the top of the stacks if airflow velocity is low at this location. In keeping with the standard procedure for operating a kiln, several samples representing the driest lumber should also be prepared.

## Quality Control

As stated previously, the highest risk of lumber degrade occurs in the first stage of drying, at the highest level of lumber MC. Therefore, it is critical that lumber be loaded into the predryer as soon as possible after sawing so that the drying rate can be controlled at a safe rate from the beginning of the drying process.

Air drying the lumber for a few days or weeks before bringing it into the predryer is not recommended. The increase in RH in the predryer, compared to the lower outside humidity, is likely to worsen any small air drying checks and splits.

Likewise, it is critical to monitor and control the drying rate of the greenest lumber because drying too quickly or too slowly too can quickly result in damage to the wood. The control points in the predryer—temperature and RH—are therefore in the zones with the wettest wood.

If there is any doubt about the quality of incoming lumber, various quality samples should be cut to document the initial quality (see Ch. 9). These tests are essential for custom drying, where the customer may doubt that the incoming lumber had any quality problems.

## Two-Stage Predrying

Predryers do not dry lumber as uniformly as do kilns, primarily because air velocity is not uniform. In general, the top of the load is wetter than the layers. In addition, predryer RH must be kept quite high to protect the wettest lumber from damage. The high humidity slows the drying rate of dryer lumber, as do the constant predryer conditions. One approach to dealing with the problem of non-uniform drying is to move the top layer of lumber to the bottom and the bottom layer to the top, at the mid point of the predrying cycle. This procedure costs perhaps \$3 to \$10/thousand board feet. If this reversal of layers causes the lumber to be drier when it enters the kiln and kiln time is reduced by more than 1 day, this effort is worthwhile.

An approach to deal with slow drying is to use two predryers or to partition one predryer into two separate chambers. One predryer or chamber is used exclusively for the greenest

lumber; the conditions in this Stage I predryer are kept cool and humid enough to dry the wet lumber perfectly. After 2 to 3 weeks, the lumber is moved into the second (Stage II) predryer. This predryer is kept a little warmer and a little less humid than the Stage I predryer. As a result, the lumber in the Stage II predryer dries faster and to a lower MC than it would in a conventional, single-stage predryer. Furthermore, when the lumber is moved, the bundles can be flipped, top to bottom and vice versa, to assure more uniform MC. Faster predrying, more uniform MC, and faster kiln drying make this technique worthwhile and economical.

## References

- Catterick, J.** 1970. Costs of low temperature drying—North. *Logger and Timber Proceedings*. 18(9): 18,50,60.
- Cuppert, D.G.; Craft, E.P.** 1971. Low temperature drying of 4/4 Appalachian red oak. *Forest Products Journal*. 21(1): 34–38.
- Davenport, K.L.; Wilson, L.E.** 1969. A cost analysis of yard drying and low temperature forced-air drying of lumber in Alabama. Circular, 1970. Auburn, AL: Auburn University Agricultural Experiment Station. 19 p.
- Eckert, K.; Little, R.** 1999. Effective predryer operations. Pub. 7264. Madison, WI: Forest Products Society. 52 p.
- Gatslick, H.B.** 1962. The potential of the forced-air drying of northern hardwoods. *Forest Products Journal*. 12(8): 385–388.
- Norton, K.; Gatslick, H.B.** 1969. Potential of low temperature drying of eastern spruce and eastern hemlock. *Forest Products Journal*. 19(10): 33–36.
- Vick, C.B.** 1965a. Drying-rate curves for 1-inch yellow-poplar lumber in low-temperature forced-air dryers. *Forest Products Journal*. 15(12): 500–504.
- Vick, C.B.** 1965b. Forced air drying sweetgum furniture billets in solid stacks. *Forest Products Journal*. 15(3): 121.
- Vick, C.B.** 1968a. Low-temperature drying of 1-in. sweetgum. *Forest Products Journal*. 18(4): 29–32.
- Vick, C.B.** 1968b. Forced-air drying of unstickered hardwood furniture rounds. *Forest Products Journal*. 18(7): 46–48.
- Wengert, E.M.; Boone, R.S.** 1993. Quality drying in a hardwood lumber predryer: guidebook–checklist. Gen. Tech. Rep. FPL–IMP–GTR–3. Madison, WI: U.S. Department of Agriculture, Forest Service, Forest Products Laboratory. 32 p.
- Wengert, E.M.; Lamb, F.M.** 1982. Predryer symposium for management. Sandston, VA: Virginia Forest Products Association. 26 p

# Chapter 7—Conventional Kiln Drying

Kiln drying of grade hardwood lumber is conducted in a closed chamber or building in which heated, humidity-controlled air is rapidly circulated over the surface of the wood being dried. For initial drying, conventional dry kilns commonly use temperatures of 100°F to 130°F (38°C to 54°C); final drying temperatures, when the MC of the lumber is less than 15%, ranges from 150°F to 200°F (66°C to 93°C). For hardwoods, air velocity through the load is generally between 200 and 650 ft/min (1 and 3 m/s); the lower velocity values are for refractory or difficult-to-dry species such as oak and beech, and the higher values are for the white species such as maple, ash, and basswood. The higher air temperatures and faster air velocities are the principal means of accelerating drying greatly beyond the rates of air drying and accelerated air drying. Control of relative humidity (RH) or equilibrium moisture content (EMC) during kiln drying is necessary to avoid shrinkage-associated defects, as well as to equalize and condition the wood with a high degree of precision. Temperature, RH, and sometimes fan speed are controlled in older kilns by semi-automatic dry- and wet-bulb temperature recorder–controllers; today, many kilns use computerized equipment. A typical electronic recorder–controller chart is shown in Figure 7.1.

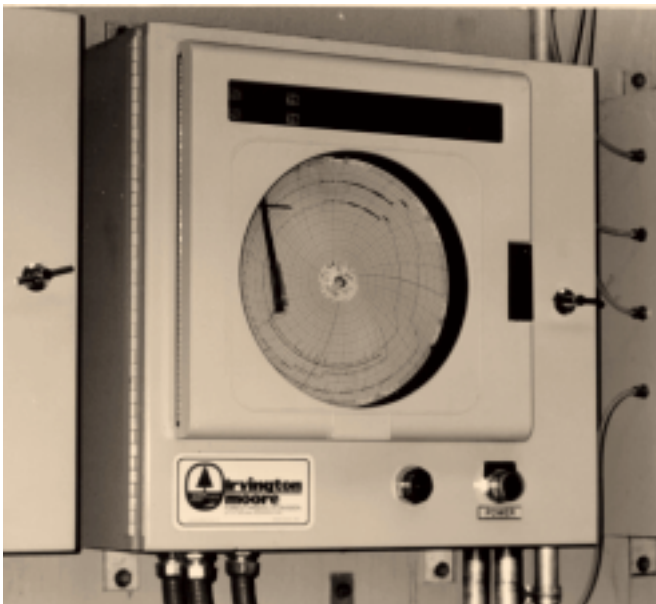

**Figure 7.1—Instrument chart of conditions used in kiln-drying a small load of air-dried black cherry. (The procedures used assumed that the lumber had undergone surface moisture regain.)**

## Dry Kiln Designs

Conventional kilns designed to dry hardwood lumber are of two types: package-loaded (Fig. 7.2) and track-loaded (Fig. 7.3). In general, package kilns have a lower capital cost/unit capacity compared with that of track kilns. Because of the length of airflow travel (24 ft (7.3 m)), most older package kilns are designed and function best when drying well air-dried or predried lumber; track kilns are better able to dry green lumber as well as air-dried or predried lumber. Many new package kilns incorporate shorter airflow and reheating in the center of the kiln to improve flexibility, especially in handling green material.

Many technical factors are involved in dry kiln design. Those who are considering the installation of kilns for moderate- to large-scale commercial production are advised to obtain current recommendations from experienced dry kiln manufacturers. However, the length of airflow travel through the load in package kilns and the reheating of air in track kilns play critical roles in drying green lumber. Kilns in which air travels much further than 8 ft (2.4 m) without reheating require undue lengthening of drying time to ensure that center packages are sufficiently dry before the dry-bulb temperature is raised. This delay is required to avoid collapse and honeycombing of the wood in the middle of the kiln load. Since drying cost is directly related to the length of time required to dry a charge, drying green lumber in kilns with long air travel through the lumber packs can be expensive. Long airflow travel also means that RH will change substantially as the air moves through the lumber stacks, potentially creating excessively high humidity that can lead to staining. Long air travel, and the associated differences in drying rates within the pile, can also result in the overdrying of pieces on the edges (entering and exit) of the load, compared to pieces in the center of the load.

Reheat or “booster” steam coils between packs of lumber at an intermediate point along the airflow travel (usually half-way) can overcome the problem of overdrying, but the coils must be correctly designed and operated to avoid surface checking of refractory woods during early drying stages. Surface checking is caused by an increase in the dry-bulb temperature, which results from too much direct radiation from the reheat coils. Thus, solving the problem of long airflow by reheating the air may create another problem, drying defects, which in turn can increase operation costs.

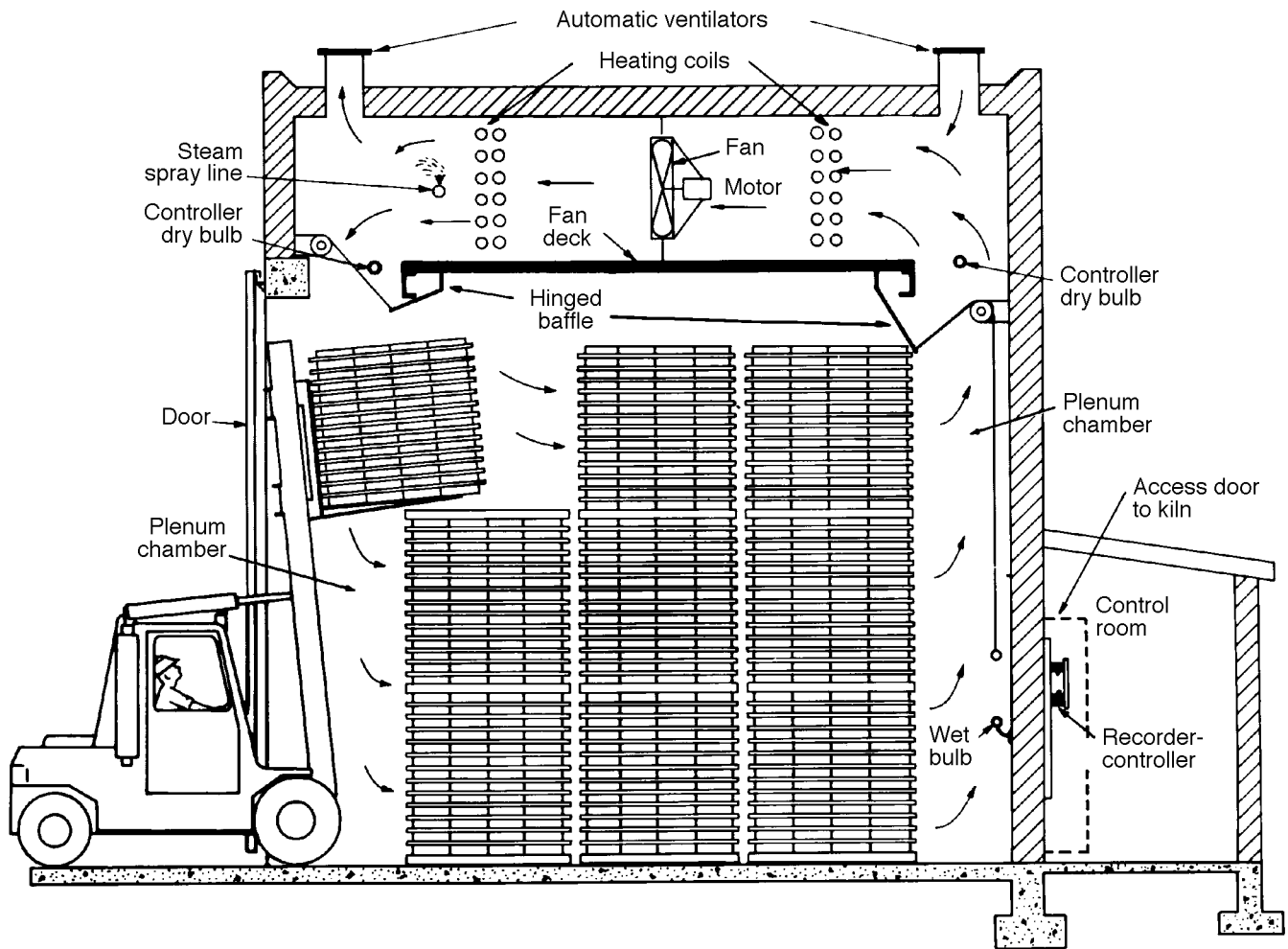

Figure 7.2—A typical package-type dry kiln for hardwood lumber.

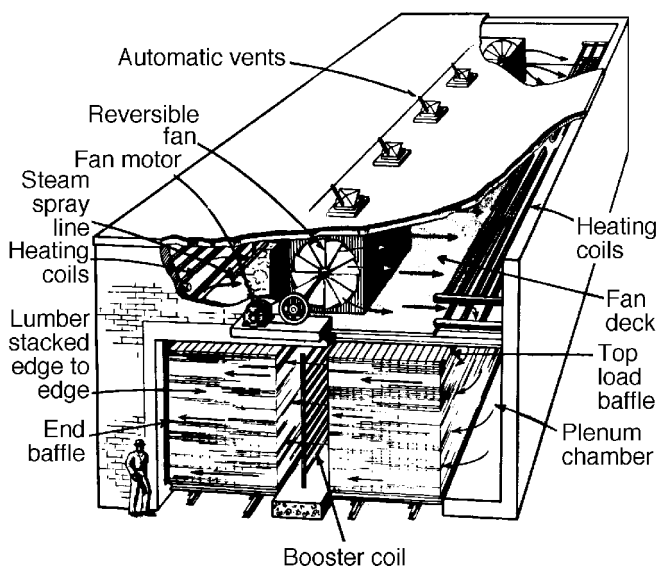

Figure 7.3—A typical track-type dry kiln for hardwood lumber.

## Dehumidification Drying

Although most hardwood dry kilns are steam heated, many kilns use electricity, especially dehumidifier-type kilns, and a few kilns are heated by hot water. Direct fired kilns, for which hot exhaust gases from the burner enter the kiln directly, and kilns that use a hot-air plenum chamber between the kiln and the burner are not popular in North America for quality hardwood lumber drying. (Direct fired systems are popular for drying Southern Pine construction lumber.) If modern kiln designs and construction techniques are used and if the equipment is working properly and achieves the required temperature, humidity, and velocity, drying quality will depend on the operating procedures and not the basic type of equipment. Lumber drying quality is determined by the temperature, RH, and velocity used during the drying process.

Dehumidification drying is an attractive method because it can produce very high quality drying with a small capital investment. Furthermore, drying times are similar to those used for steam kilns. For a small to medium operation



(<2 million board feet/year), the dehumidification kiln almost always proves to be the most economical method of drying. If electrical rates are low (under \$0.07/kWh), even larger operations can be economical. Typical internal rates of return, after taxes, exceed 12% when the value added to lumber by drying exceeds \$200/thousand board feet.

Electric dehumidifiers have become a good way to dry lumber at temperatures up to 150°F (66°C); final MC values can be as low as 6% if required. Electric dehumidifier temperatures kill insects and their eggs. The quality of lumber dried in a properly operated dehumidification kiln is as good as that dried in a properly operated steam kiln.

The dehumidifier kiln is essentially a closed structure in which water is removed from the atmosphere in the kiln by passing warm, moist air across cold coils. The moisture in this air is condensed into liquid. When vapor is condensed, it releases about 1,000 Btu/lb (2.3 kJ/g) of condensed water, which is then used to heat the dehumidified air before it passes back into the kiln. The energy in the dehumidified, heated air is then used to evaporate more water from the lumber, and the cycle continues. When oak is dried in a dehumidification kiln, the condensed water used to heat the dehumidified air has a pH of around 3.4. The characteristics of this condensed water are described in detail by Solliday and others (1999). For new dehumidification installations, check with State water control officials for up-to-date requirements for water disposal and treatment.

Because dehumidification represents only a difference in type of energy, not in type of hardware, the dehumidification drying process is identical to that used in a steam kiln. A dehumidification kiln uses approximately 300 to 500 kWh (1,100 to 1,800 MJ) per thousand board feet of electrical energy to remove moisture from the kiln atmosphere, whereas a steam kiln uses venting. A dehumidification kiln recycles the heat of evaporation, whereas a steam kiln vents this potential energy. In dehumidification drying, the lumber does develop normal “casehardening” stresses, which must be removed if the wood will be resawn, ripped, or heavily machined. Normal equalizing is also required. Efficient equalizing and conditioning can be accomplished with a small boiler. Water spray systems can also be very effective in some situations.

The dehumidification compressor must be properly sized for the job. As a rule of thumb, approximately 1 hp (735 W) compressor power is required for every thousand board feet to be dried. A smaller compressor can be used if the wood is a slow drying species or is thick. If the wood is a fast drying species, such as most softwoods and most low density hardwoods, then compressor power must be more than 2 hp (1,500 W) per thousand board feet. If the compressor is too small, drying times will be prolonged and the risk of staining will be high. If the compressor is too large, it will cycle on and off frequently, which will shorten its service life, but no lumber damage will be incurred if the controls are working properly. Most compressors require a kiln temperature of at

least 85°F (29°C) before they can be turned on. If the lumber is cold when it enters the kiln, it is wise to consider an auxiliary heating source for the initial start-up. Electric heaters can be used, but they are expensive.

Fans within the kiln should circulate the air through the load at about 350 ft/min (1.8 m/s). Higher velocities can be used for fast drying species, but the cost of increasing air speed is quite high and may not be justified. For slightly underpowered dehumidification units, it is advisable to load the kiln initially 50% full and operate it for a day before adding the rest of the load. This procedure provides for better color control and prevents the growth of mold. High quality kiln controls are essential. These controls both record and control kiln temperature and RH (or wet-bulb depression, wet-bulb temperature, or EMC). The controls also automatically reverse fan direction every several hours.

In nearly all cases, the kiln schedule used with a dehumidification kiln incorporates a lower initial dry-bulb temperature than that used in the standard steam schedule. The lower initial dry-bulb temperature, although not necessary if there is sufficient heat in the dehumidification dryer, results from the fact that the compressor can begin working at 85°F (29°C); steam kilns cannot work well under 105°F (41°C). However, cooler temperatures often enhance lumber quality. At the end of the drying cycle, most dehumidification kilns achieve 150°F (66°C) maximum temperature because of the limits imposed by operating temperatures of the compressor. The RH specified by the dehumidification kiln schedule is usually identical to that for the steam kiln schedule. In most cases, the velocity in the dehumidification kiln is a minimum of 350 ft/min (1.8 m/s) through the load, which is similar to that used in many steam kilns. Higher velocities are beneficial for fast drying species.

The building that houses the dehumidification kiln is similar to that used for a steam kiln. However, because heat losses are expensive when electric energy is used, good insulation is more critical for a dehumidification kiln building than for a steam kiln building. Many dehumidification buildings are wood frame (2 by 10) structures with ≥8 in. (≥203 mm) of insulation. The walls are covered with C-C grade exterior plywood. A conventional plastic vapor barrier is placed behind the interior plywood; the interior plywood may also be painted with a commercial kiln coating. The exterior wall must not be coated with anything that will inhibit moisture removal from inside the walls. Standard kiln safety features must be followed, including those that govern exit doors, lighting, electrical lock-outs, and so on.

The total energy used in dehumidification is 50% or less of that used in a conventional steam kiln. This benefit is partially offset by the higher cost of electricity compared with the cost of steam energy. However, with the support of various government and power company incentives, the cost of dehumidification drying is competitive with that of steam-heated drying.

## Basic Kiln Operating Philosophy

A kiln schedule, which indicates the desired temperature, humidity, and velocity for the dryer, is a carefully developed compromise between the need to dry lumber as fast as possible and the need to avoid severe drying conditions that cause drying defects. A series of dry- and wet-bulb temperatures establish the temperature and RH in the kiln; these temperatures are applied at various stages in the drying process. Temperatures are chosen to strike the compromise of achieving a satisfactory drying rate and preventing objectionable drying defects. Key defects are discoloration, checking, and cracking.

*Note:* Very few kiln schedules specify air velocity even though airflow is an important factor in drying rate and quality. The traditional schedules assume that airflow through the load of lumber is around 300 ft/min (1.5 m/s) and that airflow does not vary during the kiln cycle.

Kiln schedules can be classified as general or special. General schedules will result in satisfactory drying. Special schedules are those developed to attain certain drying objectives; for example, to produce brighter lumber or to maintain maximum strength of the lumber for special uses. Because of the many variables in the character of wood, the type and condition of the kiln, the quality of drying required, and the cost considerations, no schedule presented in this chapter can be considered ideal. The schedules are presented as guides for kiln operators in developing schedules best suited for their own particular operations. In general, the schedules presented are conservative, and often they can be accelerated with care. This chapter outlines procedures for systematically accelerating a schedule. The operator should not make the schedules more conservative unless there is some specific reason for doing so, such as abnormally low lumber quality or poor kiln performance.

Because both drying rate and susceptibility to drying defects are related to lumber MC, kiln schedules are usually based on MC. That is, the temperature and humidity in the kiln are altered as the MC of the lumber drops. The successful control of drying defects as well as the maintenance of the fastest possible drying rate for hardwood lumber depends on the proper selection and control of temperature and RH in the kiln. A quality checklist has been prepared by Boone and others (1991).

## Kiln Samples

Because lumber is dried by kiln schedules, which are combinations of temperature and RH applied at various MC levels during drying, some means of estimating lumber MC in the kiln during drying is necessary. These MC estimates are made with kiln sample boards.

Traditionally, MC estimates have been obtained by removing kiln samples from the kiln periodically and weighing them manually. This manual procedure is still used in the majority of hardwood operations, but automated methods are available. One such method utilizes probes that are inserted into sample boards; electrical resistance is measured as an estimate of MC. When corrected for initial MC measurement variations, this system is accurate to within 5% MC from 50% down to 6% MC. This electrical resistance signal can be fed into a computerized control system that makes scheduled changes in kiln conditions automatically. Another system uses miniature load cells that can continuously weigh individual sample boards; the measurements are fed into a computerized control system.

Whether kiln samples are monitored manually or automatically, the same principles of selection and placement apply. The main principle of selection is that the kiln samples be representative of the lumber in the kiln, including the extremes of expected drying behavior. It is impractical to monitor MC of every board in a kiln, so the samples chosen must represent the lumber and its variability. The main principles of placement are that the samples are spread throughout the kiln at various heights and distances from the ends of lumber stacks and that the samples are subject to the same airflow as is the lumber.

For some drying operations, it is difficult to justify proper kiln sampling. The handling of kiln samples requires additional operator time, and some lumber is lost when kiln samples are taken. These disadvantages are more than offset by several advantages. The selection, preparation, placement, and weighing of kiln samples, if properly done, provides information that enables a kiln operator to (1) reduce drying defects, (2) improve control of final MC of charge, (3) reduce drying time while maintaining lumber quality, (4) develop time schedules, and (5) locate kiln performance problems. All of these advantages add up to lower drying costs and lower secondary manufacturing costs because the dried lumber has consistent MC, is uniformly conditioned, and is free of drying defects.

The following sections cover the

- selection and preparation of kiln samples,
- number of samples required in a kiln charge,
- determination of MC and oven-dry weight of samples,
- methods for using samples during drying, methods for estimating intermediate MC levels,
- tests for residual drying stress, and
- recording and plotting of data.

## Selection and Preparation Criteria

To make full use of known drying techniques and equipment and to ensure good drying in the shortest time, each kiln charge should consist of lumber with similar drying characteristics. Differences between boards will invariably exist despite measures to minimize them, and kiln sample selection must include these differences. The following variables should be considered in selecting kiln samples:

- species
- thickness
- grain (flatsawn or quartersawn)
- moisture content
- heartwood and sapwood content
- wetwood or sinker stock

### Species

Both native and imported wood species have a wide range of physical properties that can influence the ease of drying. These properties include specific gravity, shrinkage, moisture diffusion and permeability, strength perpendicular to the grain, size, and anatomical elements (distribution and characteristics). It is usually advisable to dry only one species at a time in a kiln or, at most, a few species with similar drying characteristics. If different species are dried together, kiln samples should be taken from all the species.<sup>1</sup>

To a great extent, specific gravity determines how fast wood can be dried. In general, the lower the specific gravity, the faster the drying and the fewer problems. Specific gravity values for various commercially important hardwoods are listed in Table 7.1. Operators can also use specific gravity to determine which species can be dried together in a mixed load. Low specific gravity species, such as basswood, soft maple, and yellow-poplar, are relatively easy to dry, with few or no serious drying defects. Others, such as the oaks, black walnut, and beech, are more likely to check or honeycomb during kiln drying. Before drying a new species, kiln operators can use Table 7.2 to learn what defects may be encountered and how to prevent them.

### Thickness

When lumber dries, moisture evaporates from all surfaces but principally from the wide faces of the boards. Thickness is therefore the most critical dimension. The thicker the

lumber, the longer the drying time and the more difficult it is to dry without creating defects. Lumber of different thicknesses cannot be dried in the same kiln charge without prolonging the drying time of thin lumber or risking drying defects in thick lumber.

Kiln operators should recognize incorrectly cut (miscut) lumber and either dress the lumber to uniform thickness or choose kiln samples accordingly. Nominal 4/4 lumber can vary from 3/4-in.- to >1-1/4-in.- (19- to >32-mm-) thick, even in the same board. The thinner parts will dry faster than the thick parts, resulting in uneven final MC or drying defects.

### Grain

Quartersawn boards generally dry more slowly than do flatsawn boards, but they are less susceptible to surface checking. Thus, more severe drying conditions (such as lower humidity) can be used for green quartersawn lumber. However, because quartersawn lumber dries more slowly, care should be taken in raising the dry-bulb temperature before the center of the board is below fiber saturation (core MC <25%; average MC typically <18%). If the dry-bulb temperature is raised too rapidly, the chances of collapse and honeycombing are increased. Kiln samples should generally reflect the relative amount of each grain pattern in a charge. For lumber that has been air dried or predried, which contains a mix of flatsawn and quartersawn material, more samples should be taken of the quartersawn material. Chances are that the quartersawn samples will be wetter than the flatsawn samples and will therefore be the controlling samples of the kiln charge. It is sometimes advantageous to segregate quartersawn and flatsawn lumber and dry the boards separately.

### Moisture Content

The extent to which lumber has been air dried or predried (in addition to moisture variation in species mixtures) before it is put in a kiln must also be considered, because MC often governs the drying conditions that can be used. If all the free water has already been removed from the lumber, more severe drying conditions can be used in the initial stages of kiln drying with little or no danger of producing drying defects. Furthermore, uniform initial MC greatly accelerates drying to uniform final MC. If boards vary considerably in initial MC, the kiln samples should reflect this variation.

If the lumber has been air dried or predried prior to entering the kiln, the operator should select the majority of the samples from the wettest lumber entering the kiln. An aging inventory can be used to select lumber packs that have been air dried or predried the least. Yard location or location in the predryer may influence lumber MC. In individual lumber stacks, the wettest samples in air-dried lumber may be typically found towards the bottom in the center, while in lumber stacks from a warehouse predryer, the wettest samples are typically located close to the top of the stack in the center.

---

<sup>1</sup>Exceptions: The 20 species of red oak sold as Red Oak lumber and the species sold as White Oak lumber. The only important separator for these species is growth rate: fast-grown wood (>1/4-in. (>6 mm) spacing between growth rings) is called lowland and slower grown wood is called upland. Likewise, the eight species of the Hickory–Pecan lumber group are not separated for drying.

**Table 7.1—Average specific gravity of wood (green volume and oven-dry weight)<sup>a</sup>**

Species	Average specific gravity	Species	Average specific gravity
Alder, red	0.37	Locust, black	0.66
Apple	0.61	Madrone, Pacific	0.58
Ash		Maple, soft	
Black	0.45	Bigleaf	0.44
Green	0.53	Red	0.49
White	0.55	Silver	0.44
Aspen		Maple, hard	
Bigtooth	0.36	Black	0.52
Quaking	0.35	Sugar	0.56
Basswood, American	0.32	Oak, red	
Beech, American	0.56	Black	0.56
Birch		California black	0.51
Paper	0.48	Laurel	0.56
Sweet	0.60	Northern red	0.56
Yellow	0.55	Pin	0.58
Buckeye, yellow	0.33	Scarlet	0.60
Butternut	0.36	Southern	0.52
Cherry, black	0.47	Water	0.56
Chestnut, American	0.40	Willow	0.56
Cottonwood, black	0.31	Oak, white	
Dogwood, flowering	0.64	Bur	0.58
Elm		Live	0.80
American	0.46	Overcup	0.57
Rock	0.57	Post	0.60
Slippery	0.48	Swamp chestnut	0.60
Hackberry	0.49	White	0.60
Hickory, pecan		Persimmon, common	0.64
Bitternut	0.60	Sweetgum	0.46
Pecan	0.60	Sycamore, American	0.46
Hickory, true		Tanoak	0.58
Mockernut	0.64	Tupelo	
Pignut	0.66	Black	0.46
Shagbark	0.64	Water	0.46
Shellbark	0.62	Walnut, black	0.51
Holly, American	0.50	Willow, black	0.36
Hophornbeam, eastern	0.63	Yellow-poplar	0.40
Laurel, California	0.51		

<sup>a</sup>Sources: FPL 1999, Simpson 1991.

**Table 7.2—Common drying defects in U.S. hardwood lumber species**

Species	Drying defect	Contributing factor
Alder, red	Chemical oxidation stains (sticker marks)	Chemical wood extractives
Ash		
Black	Ring failure	Wetwood, drying temperatures
White	Gray-brown sapwood stain (sticker marks, stains)	Trees from wet sites, drying too slow, poor airflow
	Surface checks	6/4 and thicker stock
Aspen	Water pockets, honeycomb, collapse	Wetwood, drying temperatures
Basswood, American	Brownish chemical stain	Sapwood from certain sites, drying too slow
Beech, American	End and surface checks	Normal wood refractory, wetwood (occasional)
	Discoloration, honeycomb	
Birch		
Paper	Brownish chemical stain	Extractives in wood from certain sites
Yellow birch	End and surface checks	Refractory heartwood
	collapse, honeycomb	wetwood (heartwood), mineral streaks
Blackgum	Water pockets, collapse	Wetwood
Cherry, black	Ring shake, honeycomb	Wetwood (not common)
Chestnut	Iron stains	Extractives
Cottonwood	Water pockets, honeycomb, collapse	Wetwood
Cucumber tree	Sapwood discoloration	Poor air circulation
Dogwood		
Eastern and Pacific	Oxidative sapwood stains	Sapwood extractives, drying temperatures
Elm		
American	Ring failure	Wetwood
	Warp	Grain orientation
Slippery	Ring failure	Wetwood
Rock	Boxheart splits	Growth stresses
Hackberry and sugarberry	Sapwood discolorations	Slow drying with poor airflow
Hickory	Chemical sapwood stains, ring failure, honeycomb	Slow drying with poor airflow, wetwood
Holly	Sapwood stains	Extractives, poor airflow
Laurel, California	End checks	Refractory wood from old-growth trees
Locust		
Black, honey	End and surface checks	Refractory wood
Madrone	End and surface checks	Refractory wood
	Collapse	Wetwood
Maple		
Soft		
Red, silver	Sapwood discoloration, ring failure, honeycomb in heartwood	Wetwood, poor airflow
Hard		
Sugar, black	Sapwood discoloration	Extractives, poor airflow
	Collapse, honeycomb in heartwood	Mineral streaks, wetwood
Myrtle, Oregon (see California laurel)		
Oak, western		
California black	Honeycomb, collapse, ring shake	Wetwood
Oregon white	Honeycomb, collapse, ring shake	Wetwood

**Table 7.2—Common drying defects in U.S. hardwood lumber species—con.**

Species	Drying defect	Contributing factor
Oak		
Red upland	End and surface checks	Severe drying
	Iron stains	Extractives
	Ring failure	Severe wetwood
	Honeycomb	Severe drying of normal heartwood, mild drying of wetwood
Red lowland, "Southern oak"	Gray sapwood stains	Poor airflow
	End and surface checks	Severe drying
	Iron stains	Extractives
	Collapse, ring failure	Wetwood
White upland	Honeycomb	Severe drying of normal heartwood, mild drying of wetwood
	End and surface checks	Severe drying
	Iron stains	Extractives
	Collapse, ring failure	Wetwood
	Gray sapwood stains	Poor airflow
White lowland, "Southern oak"	Honeycomb	Severe drying of normal heartwood, mild drying of wetwood
	Gray sapwood stains	Poor airflow
	End and surface checks	Severe drying
	Iron stains	Extractives
	Collapse, ring failure	Wetwood, mild drying of wetwood
Pecan	Honeycomb	Wetwood, mild drying of wetwood
	Water	Wetwood
	Persimmon	Severe drying
	Sapwood discoloration	Slow drying at low temperature
Sap gum	Surface and end checks	Poor airflow
Sweet gum	Honeycomb, collapse, water pockets	Severe drying
	Wetwood	Wetwood
Sycamore (heartwood)	Honeycomb, ring failure, water pockets	Wetwood
	Wetwood	Wetwood
Tanoak	End and surface checks	Severe drying
	Honeycomb	Wetwood
Tupelo gum	End checks	Severe drying
	Honeycomb, collapse, water pockets	Wetwood
Walnut, black	End checks	Severe drying
	Iron stains	Extractives
	Honeycomb, collapse, ring failure	Wetwood
Willow, black	Honeycomb, collapse, water pockets, ring failure	Wetwood
	Wetwood	Wetwood
Yellow-poplar	Mold, sapwood stains	Slow and poor drying, moderate kiln schedule
	Honeycomb, water pockets (rare)	Wetwood

As a rule of thumb, it is often more advisable to mix lumber species and thicknesses than to mix MC levels. Losses in quality, especially for refractory species, can be high when the mild conditions required for the wetter MC lumber are used on drier pieces. The high humidity will cause the dry surface fibers to swell quickly, increasing the tension forces on the lumber core and thereby increasing the risk of internal checking, especially if the lumber has some surface checking.

### Heartwood and Sapwood

Sapwood usually dries considerably faster than does heartwood. Resin, tannin, oils, and other extractives retard the movement of moisture in the heartwood. Tyloses and other obstructions may be present in the pores of the heartwood of some species, principally white oak and the locusts. Sometimes, it is practical to segregate heartwood and sapwood lumber and dry them in separate loads. For many species with appreciable sapwood, however, the green MC of sapwood is considerably higher than the MC of heartwood. Table 7.3 lists the MC of sapwood and heartwood for various species. Choice of kiln samples should be guided by the relative proportions of heartwood and sapwood in a kiln charge. The green MC can also be used as a guide for establishing how wood will dry; in general, lumber with higher green MC will require longer drying.

### Wetwood or Sinker Stock

Wetwood or sinker stock (Ward and Pong 1980) is a condition caused by bacterial infection that develops in the living tree. When severe enough to affect lumber drying quality, wetwood is usually detected by a foul odor and by shake (a separation parallel to the rings); discoloration sometimes occurs. The bacterially infected wood often has a disagreeable odor after drying when the lumber is exposed to high humidity. Bacterially infected lumber or areas within a piece of lumber are higher in initial MC, dry more slowly, and are more likely to develop drying defects even when standard drying conditions are used. However, wetwood is not a grading defect in standard log and lumber grading rules, unless there is obvious shake. Although wetwood is thought to be found in every species, red oaks, willow, aspen, and cottonwood, as well as many tropical species, develop wetwood quite frequently. Ideally, wetwood lumber should be segregated from normal lumber and dried separately by a different drying schedule. In fact, if the bacterial infection is severe, it is probably impossible to dry the lumber without excessive drying defects. Some of the best success with drying bacterially infected red oak is to predry the material in a shed or fan shed at ambient temperatures to below 30% MC and then kiln dry it to the final MC. If bacterially infected oak is a big problem, the sawmill might consider adopting a strategy of avoiding the cutting of thick stock from infected logs. If wetwood is suspected, sample boards should be selected accordingly and observed carefully during drying to detect any drying defects.

**Table 7.3—Typical average moisture content for green wood**

Species	Moisture content (%)		
	Heartwood	Sapwood	Mixed heart- and sapwood
Alder, red	—	97	—
Apple	81	74	—
Ash	—	—	—
Black	95	—	—
Green	—	58	—
White	46	44	—
Aspen	95	113	—
Basswood, American	81	133	—
Beech, American	55	72	—
Birch	—	—	—
Paper	89	72	—
Sweet	75	70	—
Yellow	74	72	—
Buckeye, yellow	—	—	141
Butternut	—	—	104
Cherry, black	58	—	—
Chestnut, American	120	—	—
Cottonwood, black	162	146	—
Dogwood, flowering	—	—	62
Elm	—	—	—
American	95	92	—
Cedar	66	61	—
Rock	44	57	—
Hackberry	61	65	—
Hickory	—	—	—
Bitternut	80	54	—
Mockernut	70	52	—
Pignut	71	49	—
Red	69	52	—
Sand	68	50	—
Water	97	62	—
Holly, American	—	—	82
Hophornbeam, eastern	—	52	—
Laurel, California	—	65	—
Locust, black	—	40	—
Madrone, Pacific	—	81	—
Magnolia	80	104	—
Maple	—	—	—
Silver (soft)	58	97	—
Sugar (hard)	65	72	—
Oak	—	—	—
California black	76	75	—
Live	—	—	50
Northern red	80	69	—
Southern red	83	75	—
Southern swamp	79	66	—
Water	81	81	—
White	64	78	—
Willow	82	74	—
Osage-orange	—	—	31
Persimmon, common	—	—	58
Sweetgum	79	137	—
Sycamore, American	114	130	—
Tanoak	—	—	89
Tupelo	—	—	—
Black	87	115	—
Swamp	101	108	—
Water	150	116	—
Walnut, black	90	73	—
Willow, black	—	—	139
Yellow-poplar	83	106	—

## Number of Samples

The number of kiln samples needed for any kiln charge depends upon the condition and drying characteristics of the lumber, the performance of the dry kiln, and the final use of the lumber. There are several reasons behind using kiln samples, which dictate the number as well as placement of the samples.

Because many variables affect drying results, the specific number of kiln samples required when using MC schedules has not been firmly established. The requisite number is different for different species, initial MC levels, and kilns, and it is best determined through experience. The *Dry Kiln Operator's Manual* (Simpson 1991) suggests that an operator use at least four samples in charges  $\leq 20$  thousand board feet. For charges  $\geq 100$  thousand board feet, 10 to 12 kiln samples per charge usually suffice. However, today's narrower lumber, which leads to a higher piece count in the kiln, indicates that more samples should probably be used than was recommended in 1961. Moreover, as the variability of the charge increases in terms of the variables previously discussed, more samples should be added to the charges. More samples should also be used when (1) drying a charge of lumber of different species, thickness, MC, grain, or heartwood and sapwood content (minimum of four samples for each distinct grouping is suggested), (2) drying an unfamiliar species, (3) drying costly lumber, (4) obtaining drying data for modifying a drying schedule or developing a time schedule, and (5) using a dry kiln with unknown or erratic performance.

## Monitoring of Kiln Performance

Studies of kiln performance show that dry-bulb temperature and rate of air circulation may vary considerably throughout a kiln. Such variations may affect drying time and quality. Variations in temperature and air circulation can be determined with testing equipment. If such equipment is not available, kiln samples can be used instead. To monitor kiln performance, four or five samples should be cut from the same piece of lumber to minimize variation in drying characteristics between samples. These matched samples should be placed near the top and bottom of the stacks. Another matched set can be placed on both sides of the load and yet another set at intervals of 10 to 16 ft (3 to 4.9 m) along the length of the kiln.

Kiln samples that dry slowly indicate zones of low temperature, high humidity, or low air circulation; samples that dry rapidly indicate zones of high temperature, low humidity, or high air circulation. If the drying rates vary greatly, action should be taken to locate and eliminate the cause of such variation. Differences in drying rates between the samples on the entering-air and exiting-air sides of the stacks will assist the operator in determining how often to reverse air circulation—the greater the difference in drying rate between these sides, the more frequently the direction of air circulation

should be reversed. Two-hour reversal times are commonly used.

## Selection and Preparation Procedures

Ideally, lumber should be segregated based on all the factors that affect drying rate and quality, and it should be dried in uniform loads. Because these practices frequently are not possible or practical, a kiln operator must be guided in the selection of kiln samples primarily by the drying rate of the most critical, slowest drying material. The largest number of samples should be selected from the slowest drying material. Some samples should also be selected from the fastest drying material because these determine when the equalizing period should be started.

The best time to select boards from which kiln samples will be cut is during stacking. Some samples are selected to represent the heavier, wetter, wider, and thicker lumber in the load; these samples contain a relatively high percentage of heartwood. Only one kiln sample is usually cut from each selected piece of lumber (Fig. 7.4) to ensure a representative group of kiln samples. Some kiln samples are also cut from lumber that represents the drier and faster drying pieces. Such lumber is usually flatsawn, narrow, and thin, and it contains a high percentage of sapwood. Such pieces may also be drier than the rest of the lumber at the time of stacking or loading the kiln.

Kiln samples and moisture sections are prepared as shown in Figure 7.4. Ideally, kiln samples should be 30 in. (76 cm) long. Moisture sections for estimating initial MC, which are taken from each end of the kiln sample, should be cut about 1 in. (25 mm) in length along the grain. Knots, bark, pitch, and decay should not be included in kiln samples, except when drying lower grade lumber. Moisture sections must be cut from clear, sound wood. Any bark on the kiln sample or moisture sections should be removed before weighing the sample and sections because it causes error in the MC estimate and interferes with drying.

### Cutting

Mark kiln samples and moisture sections for identification before cutting them from the board. Usable lengths of lumber can usually be salvaged from each end of the board after the kiln samples and moisture sections are cut. Cut the samples  $\geq 20$  in. ( $\geq 51$  cm) from the ends of the boards to eliminate the effects of end drying.

With certain exceptions, moisture sections should be cut not less than 1 in. (25 mm) in length along the grain and across the full width of the board. Shorter moisture sections can be cut to obtain a quick, approximate estimate of MC. To minimize errors, take extra precaution in cutting, handling, and weighing short sections. In dimension stock  $\leq 1$ -in.- ( $\leq 25$ -mm-) square in cross section, moisture sections are cut 2 in. (51 mm) in length along the grain. A sharp, cool-running saw should be used and the sections should be



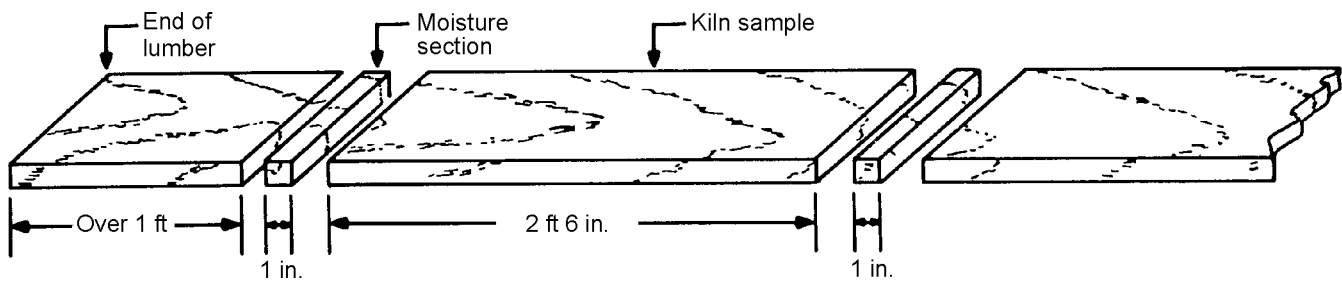

**Figure 7.4—Method of cutting and numbering kiln samples and MC sections. 1 in. = 25 mm; 1 ft = 0.3 m.**

weighed immediately. If it is necessary to cut a number of sections at a time before weighing them, place the sections in plastic bags or wrap them in plastic to avoid moisture loss between sawing and weighing.

### Weight Measurement

The oven-dry weight and the subsequent weights of the kiln sample obtained at intervals during drying, called current weights, are used to calculate the MC at those times.

After cutting the moisture sections, remove all bark, loose splinters, and sawdust. Weigh each section immediately on a balance with a precision of 0.05% of the weight of the section (typically 0.01 g). Electronic scales are preferred because they reduce labor and the likelihood of error, although triple-beam or top-loading-pan balances are also accurate. Balances with the precision to weigh moisture sections are somewhat delicate, and they require proper care and maintenance. Consult the manufacturer's recommendations and procedures to ensure accurate measurement.

To save weighing and calculating time, the two moisture sections cut from each kiln sample can sometimes be weighed together. This technique, however, does not distinguish the difference in MC usually present between the moisture sections. Therefore, it is preferable to weigh each section separately. Large differences in the weights of the sections may indicate an error in weighing or an abnormal sample, such as a sample that contains a wet pocket. After weighing the moisture sections, mark the weight on each section with an indelible pencil or a felt-tip pen with waterproof ink. Record the weights on a data form.

After cutting the kiln samples, remove all bark, loose splinters, and sawdust. Then, immediately apply end coating to the samples. The ends must be covered completely so that the coating adheres to wet wood, forms an effective moisture barrier, and does not melt during kiln drying. Many companies offer effective end-coating products for kiln samples. Note that this is not the same coating used on the ends of logs and lumber. Asphalt roofing compounds are effective for sample ends and are readily available.

Immediately after applying the end coating, weigh the kiln samples on a balance sensitive to 0.01 lb (approximately 5 g). For larger, heavy, and thick samples, the balance

capacity should be about 35 lb (15 kg). Weight should be expressed in either grams or pounds and decimals of pounds (not ounces). Mark the weight and date with a waterproof pencil or ink on the kiln sample and also on a data form. The weight of the end coating can usually be disregarded. If the kiln sample needs to be shorter than recommended and is cut from a low-density species, the weight of the end coating can result in a small error (less than 1% MC). However, if a final moisture section is prepared, then the weight of the coating is not important.

When placing a sample into a pocket in the kiln load, it may be helpful to number the lumber edge above or below the pocket to help in finding the correct pocket when returning the samples to the load after weighing and inspecting.

As drying progresses, conditions in the kiln are changed on the basis of MC of the samples at various times during the run. How frequently the samples must be weighed depends on the rate of moisture loss—the more rapid the loss, the more frequently the samples must be weighed. For maximum kiln productivity and quality, kiln samples should be checked at least once a day. The samples should be returned to their pockets immediately after weighing—within minutes, not hours.

### Ovendrying of Moisture Sections

After the moisture sections are weighed, they should be dried in an oven maintained at 214°F to 221°F (101°C to 105°C) until all water has been removed. This usually takes from 24 to 48 h in a forced convection oven (that is, an oven with fans to circulate the air). To test whether the sections are thoroughly dry, weigh a few sections, return them to the oven for another hour, and then reweigh them. If no additional weight has been lost, the entire group of sections can be considered oven-dry.

The moisture sections should be open stacked in the oven to permit air to circulate freely around each section. Avoid excessively high temperatures and prolonged drying because they will cause destructive distillation of the wood, resulting in incorrect MC values. If newly cut sections are placed in an oven with partly dried sections, the newly cut sections may cause the drier sections to absorb some moisture and unnecessarily prolong drying time. If sections are not fully dried

when removed from the oven and weighed, then the calculated MC will be lower than actual.

Microwave ovens can also be used for oven-drying moisture sections. Such ovens can be used to determine MC much faster than can a convection oven—moisture sections can generally be dried in less than 1 h. However, a microwave oven requires constant attention during this procedure. Care must be taken not to overdry or underdry the sections. In a convection oven, the drying time is not particularly critical. If a moisture section is left in the oven slightly longer than necessary, no great harm is done; the oven-dry weight of the section will not be affected significantly. However, if a moisture section is left in a microwave oven even slightly longer than necessary, considerable thermal degradation can occur. The indicated oven-dry weight of the moisture section will be less than it should be, and the calculated MC will be too high. This danger can be decreased by using a microwave oven with variable power settings. Through experience, the operator can establish the combinations of species, size, and initial MC of the moisture sections, oven-drying time, and oven power setting (usually a low setting of about 250 to 300 W) that give accurate oven-dry weights. Microwave drying time is about 30 min or longer for green sections and 10 to 15 min for dry sections. To determine if the sections are oven-dry, weigh several sections, microwave for an additional 1 or 2 min, and then reweigh. If the weights are constant, the sections are oven-dry. In any case, if the sections begin to smell smoky, they must be discarded because they will no longer give accurate oven-dry weights.

Oven-dried moisture sections are weighed by the same procedures used for freshly cut moisture sections. However, the sections must be weighed immediately after removing from the oven to prevent moisture adsorption.

### Calculation of Moisture Content and Oven-dry Weight

**Moisture content of moisture sections**—The MC of a kiln sample is determined from the moisture sections. The average MC of the two sections and the weight of the kiln sample at the time of cutting are used to calculate the oven-dry weight of the kiln sample.

The MC of a moisture section is calculated by dividing the weight of the removed water by the oven-dry weight of the section and multiplying the quotient by 100. Always use two decimals beyond the decimal point. Because the weight of the water equals the original weight of the section minus its oven-dry weight, the formula for this calculation is

$$MC (\%) = \left( \frac{\text{Original weight} - \text{Oven-dry weight}}{\text{Oven-dry weight}} \right) 100 \quad (1)$$

When using an electronic calculator, it is convenient to use an alternative formula:

$$MC (\%) = \left( \frac{\text{Original weight}}{\text{Oven-dry weight}} - 1 \right) 100 \quad (2)$$

Example: calculate the average MC of two moisture sections (Fig. 7.4) when

Green weight of moisture section A1 = 98.55 g

Oven-dry weight of moisture section A1 = 59.20 g

Green weight of moisture section B1 = 86.92 g

Oven-dry weight of moisture section B1 = 55.02 g

First, calculate the MC of A1 and B1:

$$MC \text{ of section A1} = \left( \frac{98.55}{59.20} - 1 \right) 100 = 66.47\%$$

$$MC \text{ of section B1} = \left( \frac{86.92}{55.02} - 1 \right) 100 = 57.98\%$$

Next, calculate the average MC of moisture sections A1 and B1:

$$\frac{66.47 + 57.98}{2} = 62.22$$

**Oven-dry weight of kiln samples**—The MC of a kiln sample at the time of cutting and weighing is assumed to be the same as the average of the MC of the two moisture sections cut from each end of the sample. Knowing this value and the weight of the sample at the time the sections were cut, the oven-dry weight of the sample can be calculated by the following formula:

Oven-dry weight of kiln sample =

$$\frac{\text{Original weight of kiln sample}}{1 + MC \text{ in decimal form}} \quad (3)$$

Example: Calculate the oven-dry weight of kiln sample S-1, which had an original weight of 2.03 kg, using the average MC calculated for moisture sections A1 and B1, 62.22% MC.

$$\text{Oven-dry weight of kiln sample} = \frac{2.03}{1 + 0.6222} = 1.25 \text{ kg}$$

### Placement of Samples in Kiln Charge

After kiln samples are cut, end coated, and weighed, they are placed in sample pockets as illustrated (Fig. 7.5). Sample pockets are usually placed at several locations along the length of the kiln on both sides of the load. Since the kiln samples are intended to be representative of the wettest and driest lumber being dried, they should at all times be exposed to the same drying conditions as the rest of the lumber in the

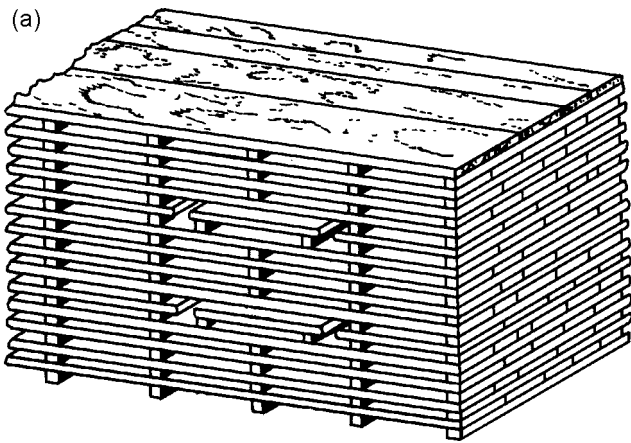

**Figure 7.5—Placement of kiln samples in pockets.** (a) Schematic of kiln samples placed in pockets built in the side of a load of lumber. Pockets should be deep enough so that the kiln samples do not project beyond the edge of the load. (b) Photograph of kiln sample in place.

kiln charge. Otherwise, the samples will likely give a false estimate of the MC of the kiln charge.

*Note:* If samples are cut and weighed several days before the lumber is loaded into the kiln, the samples should be prepared and inserted into the loads or packages during the time the lumber is outside the kiln.

If a mixed kiln charge is being dried, the samples representing each type of material should be placed in the truckloads or packages containing that lumber. For example, if 4/4 and 6/4 soft maple lumber are being dried in the same charge, the 4/4 samples should be with the 4/4 lumber and the 6/4 samples with the 6/4 lumber.

Some operators of poorly lit kilns place small colored-glass reflectors or reflective tape on the edges of the samples or the edges of boards above and below the sample pocket. These reflectors can be located with a flashlight. To guard against replacing samples in the wrong pocket after weighing, a number or letter corresponding to the sample should be written on the edge of the board immediately above or below the pocket.

## Procedures During Drying

### Calculation of Kiln Sample Moisture Content

Two weights are required to calculate the current MC of a sample: the current weight and the calculated oven-dry (OD) weight. The formula used is as follows:

$$\text{Current \% MC} = \frac{\text{Current weight}}{\text{Calculated OD weight}} \quad (4)$$

Thus, if the calculated OD weight of the sample is 2.75 lb and its current weight 4.14 lb, then

$$\begin{aligned} \text{Current \% MC} &= \left( \frac{4.14}{2.75} - 1 \right) 100 \\ &= (1.5054 - 1) 100 \\ &= 50.54 \end{aligned}$$

After another day of drying, this sample weighs 3.85 lb. The current MC of the sample will then be

$$\begin{aligned} &= \left( \frac{3.85}{2.75} - 1 \right) 100 \\ &= (1.400 - 1) 100 \\ &= 40.00 \end{aligned}$$

### Monitoring of Kiln Temperature and Humidity

Kiln schedules provide for changes in kiln conditions as drying progresses. With MC schedules, the temperature and RH are changed when the MC of the kiln samples reaches certain levels as defined by the particular schedule in use.

When using the standard hardwood kiln schedules presented later in this chapter, the basic recommendation is to change drying conditions when the average MC of the wettest half of the kiln samples equals a given MC in the schedule. A kiln operator may sometimes change drying conditions according to the wettest one-third of the samples or the average MC of a smaller group that may be distinctly wetter or more difficult to dry than the others. This approach is more conservative than the wettest-half recommendation. In any case, the samples used to obtain the MC for kiln schedule changes are called the controlling samples. The MC of the driest sample is used to monitor the controlling samples and to determine when equalizing should be started. The MC of the wettest sample determines when conditioning should be started.

### Automatic Moisture Control

The use of an automatic control system changes how kiln samples and moisture sections are used. The use of electronic probes that estimate MC from electrical resistance is growing. Such probes offer automatic control, but they currently have some limitations. The change in electrical resistance when MC is above 25% is small, so that the probes are limited in accuracy above this level. When MC is below 25%, the probe readings are usually accurate enough for kiln operation, until equalizing or conditioning takes place; kiln samples and moisture sections are not needed. However, if moisture section MC is above 25% when the sections are cut, then the section MC can be used to correct or adjust the electronically measured MC, thereby achieving accurate values up to 50% MC or higher (Chen and others 1994). When MC is below 6%, electrical resistance may be too high for accurate, reliable measurement.

When miniature load cells are used, kiln samples and moisture sections are still necessary. However, since the sample boards are weighed automatically and continuously, there is no need to enter the kiln to retrieve the samples for weighing. Computer interface and control do not require manual calculation of current MC. However, with automatic measurement, the samples, lumber, and inside of the kiln should still be visually inspected once a day to monitor and check for drying defects and kiln malfunctions. Daily inspections are particularly critical for lumber with >30% MC and for check-prone species.

The sample board selection criteria described previously in this chapter still apply with automatic sampling systems because the probes are inserted in sample boards. Likewise, the samples, especially those with >25% MC, need to be placed in pockets so that the samples are exposed to the correct temperature, humidity, and velocity.

With automated systems that use load cells or moisture probes, it is important that the kiln operator gain a clear understanding of the moisture content of the entire kiln charge as compared with the moisture content being measured by the control system. This information affects the

drying schedule. For example, consider a kiln charge of partially air-dried oak being dried in a package kiln that has relatively low airflow. When moisture content is controlled manually, experienced kiln operators have found that the interior of the charge dries slower than does the exterior. Thus, to protect the charge, operators delay raising the temperature to avoid honeycomb. Temperature is delayed by either selecting the wettest sample as the controlling sample or lagging a step behind in the schedule. When switching to an automated control system, the operator must decide how to accommodate this “experience factor” into the kiln operation.

### Intermediate Moisture Content Tests

If the MC of the moisture sections does not truly represent that of the kiln sample, the calculated oven-dry weight of the kiln sample will be wrong. This may mislead the operator into changing kiln conditions at the wrong time, with such serious consequences as prolonged drying time, excessive drying defects, and non-uniformly dried lumber. For example, if the moisture sections are wetter than the sample, the calculated oven-dry weight of the sample will be too low and therefore its calculated current MC will be too high. This will lead the kiln operator to believe that the MC is higher than it really is, and scheduled kiln condition changes will be delayed. The end result is an unnecessary extension of drying time. Conversely, if water pockets are present in the sample but not in the moisture sections, the calculated oven-dry weight of the sample will be too high and its current MC too low. This will lead the kiln operator to believe that the MC is lower than it really is, and scheduled kiln condition changes will be made too soon. A problem also occurs when the moisture section loses a little moisture before it is weighed—such moisture loss can be due to heating from the saw, short delays between cutting and weighing, or drying of the sample ends before the moisture sections are prepared. The result of incorrect (lower than actual) MC levels is an acceleration of the kiln schedule that will increase the risk of drying defects such as checks, cracks, and honeycomb. All the potential problems described here can be avoided or minimized by making intermediate MC estimates.

**Optimal time for testing**—The best time for making an intermediate estimate is when the average MC of the samples is about 20% to 25%. However, if the calculated MC of one or a few kiln samples is much higher than that of the other samples, or if the rate of drying of the samples appears to be much slower than the average rate, an intermediate moisture check should be made on these “different” samples as soon as possible to confirm or to obtain a better estimate of their calculated oven-dry weights.

**Test method**—Trim a section about 5 in. (130 mm) long from one end of the kiln sample. Then, cut a 1-in.- (25.4-mm-) wide moisture section from the newly exposed end of the sample, weigh the section immediately, and oven-dry it. Coat the freshly cut end of the shortened kiln sample

and weigh the sample immediately. The new weight is the “original” weight used in Equation (3). After weighing the sample, place it in its pocket in the kiln charge. As soon as the moisture section has been dried, weigh it and calculate MC. Substitute the new MC value, together with the new original weight of the sample in Equation (3), to obtain a new calculated oven-dry weight. Use this new value in Equation (2a) to obtain the current MC of the sample in all subsequent weight measurements.

Another MC check using new moisture sections may be desirable near the end of the kiln run when the final MC must be controlled to narrow limits. This check would also be valuable for obtaining a better estimate of when to start equalizing.

### Shell and Core Moisture Tests

Shell and core moisture tests allow a kiln operator to estimate the size of the moisture gradient in the lumber. These tests can be prepared when the kiln sample has about 20% MC or at the end of drying. When kiln sample MC is 20%, it is useful for the kiln operator to know the MC of the shell and core (outer and inner portions of lumber cross-section, respectively) to determine whether the kiln temperature can be raised safely. For example, in thick oak that is susceptible to drying defects such as honeycomb, it is important to delay raising the temperature in the kiln to  $\geq 140^{\circ}\text{F}$  ( $\geq 60^{\circ}\text{C}$ ) until the core MC is below 25%. However, when the core MC is 25%, the average MC for the whole piece will be below 25%.

At the end of drying, especially for lumber that will be re-sawn or heavily machined, it is important that the shell-to-core moisture difference be less than 1% MC to avoid shrinkage or swelling in use and inaccurate stress tests. For shell and core tests, a typical moisture section (1 in. (25.4 mm) along the grain) is cut and further cuts are then made into the shell and core portions (Ch. 9, Fig. 9.3). The shell, which usually represents the outer 50% of the wood in the moisture section, and the core, which represents the inner 50%, are weighed separately and then oven-dried so that the MC can be calculated according to Equation (1) or (2). For 8/4 and thicker lumber, the moisture section is cut into thirds: the shell (outer one-third of lumber cross-section), outer core (middle one-third), and inner core center one-third). The MC of each part is determined separately.

## Recording of Drying Data

Good recordkeeping of kiln run details can be useful to the kiln operator in several ways, such as for modifying drying schedules on subsequent charges to obtain faster drying without sacrificing quality and for checking kiln performance for causes of nonuniform drying or drying defects.

The data vary with the nature of the drying. More than the usual amount of drying data is required in the case of a test run in a new kiln, a new and unfamiliar type of lumber, or a

new or modified schedule. Also, good documentation of the kiln run may be useful when precise drying is required or high-value lumber is dried. The data include lumber properties, lumber characteristics, and drying and handling procedures. Important properties are origin of trees (geographical location) and resultant lumber (sawmill); lumber species, grade, grain, and thickness; percentage of sapwood; number of rings; moisture content; presence of bacteria, discoloration, or stain; and preexisting damage or defects. Procedures could include date of sawing, intermediate handling between sawing and drying, drying history, predryer and kiln schedules, drying time, processing defects, post-drying procedures (for example, lumber handling and storage), and shipping date. Any other information that the kiln operator considers relevant should be noted as well.

## Forms for Recording Data

Kiln sample data should be recorded on suitable forms such as those supplied by kiln manufacturers. A completed kiln sample record is shown in Figure 7.6. Many kiln operators develop their own forms to fit their specific needs; computer spreadsheets can also be used. Drying data should be recorded for each sample during the kiln run. Other data (such as kiln number; lumber volume, species, and thickness; and starting and ending dates for the run) can be entered as required. Data for the final moisture and drying stress tests should also be recorded. The amount of casehardening present should be noted. Photocopying the stress samples is an easy method of recording casehardening levels. The sample data, stress sample data, and kiln chart should be saved for further reference.

## Graphs of Drying Data

Graphs of drying data show at a glance the time required to reach certain MC levels. A plot of the MC of several kiln samples is shown for 4/4 northern red oak in the section Drying Time (Fig. 7.7). The curve illustrates the steady loss of moisture over the entire drying period. Curves plotted from data obtained from each sample are useful for checking kiln performance and reliability of kiln sample MC levels.

For example, if the moisture loss data from some samples in several charges in the same zones in a kiln consistently indicate a slower (or faster) drying rate than that of the other samples in the charges, this is evidence of a cold (or hot) zone or slower (or faster) air circulation in that location. The source of trouble should be identified and corrected. On the other hand, if it is known or if an investigation shows that the cause is not associated with heating or air circulation, the calculated oven-dry weight of the kiln sample may be inaccurate and an intermediate MC test should be made. If lumber of the same species, thickness, and grain is dried in the same kiln, then the drying curve will be the same from load to load. An historic curve can then be used to predict drying rates and MC levels in future loads.

### KILN SAMPLE RECORD

SPECIES RED OAK THICKNESS or SIZE 4/4 KILN NO. 3  
 Date Run Started MARCH 14 Hour 9am Ended \_\_\_\_\_

SAMPLE NO.	MOISTURE SECTIONS		GREEN WT. OF SAMPLE	CALC. O.D. WT.	DATE	3/14	3/15	3/16	3/17	REMARKS
	WT. (G.)	O.D. WT. (G.)			HOUR	9am	9am	9am	9am	
					TOTAL HRS # DAYS	0	1	2	3	
#11	WT. 257.32	201.64	2.462	1.910		2.462	2.396	2.345	2.302	
A	M.C. 27.6		28.9			28.9	25.4	22.8	20.5	
B	WT. 249.45	206.91								
M.C.	30.2									
WT.										
M.C.										
#12	WT. 375.82	275.97	1.450	1.052		1.450	1.402	1.376	1.340	
A	M.C. 36.2		37.8			37.8	33.3	30.8	27.4	
B	WT. 351.17	251.80								
M.C.	39.5									
WT.										
M.C.										
#13	WT. 277.66	211.66	1.832	1.392		1.832	1.802	1.758	1.720	
A	M.C. 31.2		31.6			31.6	29.5	26.3	23.6	
B	WT. 265.46	200.89								
M.C.	32.1									
WT.										
M.C.										
WT.										
M.C.										
WT.										
M.C.										
WT.										
M.C.										
WT.										
M.C.										
AV. M.C. OF ALL SAMPLES						32.8	29.4	26.6	23.8	
AV. M.C. OF <u>2</u> WETTEST SAMPLES						34.7	31.4	28.6	25.5	

Figure 7.6—Form used for recording kiln sample data in a dry kiln run of 4/4 air-dried red oak. Data for 3 of 10 kiln samples are shown.

## Basic Hardwood Kiln Schedules

### Drying Principles

Nine basic principles govern the kiln drying of hardwood. These principles must be understood before standard kiln schedules can be used successfully.

1. Changes in humidity and temperature are based on the average MC of the wettest half of the samples in the published and widely used kiln schedules for hardwood lumber. Since a kiln typically contains 10 or 12 samples, the wettest 5 or 6 samples are used for kiln schedule control. Any drying procedure that uses MC other than the average MC of the wettest samples needs to develop new schedules of temperature and depression, RH, or EMC. Using only the wettest sample is extremely conservative in most cases; however, using the average of all samples may be too severe.
2. The MC of the sample is the average MC for the entire piece, not just the core or shell MC.
3. Sample MC is also inspected to ascertain whether any degrade (checks, stain) is developing. This visual inspection is often the first indication that conditions in the dryer are not what they should be.
4. In drying green hardwood, the drying quality is monitored and predicted by measuring the rate of drying—that is, the percentage of MC loss per day. This is not the average rate, but rather the individual daily rate of each sample. For “normal” wood, each species and thickness has a published safe drying rate. Exceeding the drying rate of any piece of lumber greatly increases the risk of drying degrade such as splits, checks, and honeycomb. Operating substantially under this rate is expensive and may increase the risk of cupping and stain.

5. The rate of checking and subsequent honeycomb is accentuated by drying conditions that oscillate around the desired conditions. A dryer control system that is sluggish and slow to respond or that frequently has wide fluctuations in conditions (that is, overshoots or undershoots the desired values of temperature) is much more likely to develop short-term drying conditions that will damage the wood. With each out-of-control excursion, the damage accumulates and the final result is a serious loss of quality. The best guideline is to control kiln temperature to within 1°F (0.56°C) or better and to control RH to within 2%, especially at higher MC levels. Note that old control systems may no longer be adequate for quality drying of green hardwoods.

6. Published kiln schedules for almost all species are conservative. They must be successful under a wide range of conditions, for various designs of drying equipment, and for a wide range of resource quality. It is possible to accelerate kiln schedules and achieve faster drying times, especially when the control system and the resource are of high quality, by raising the temperature and/or lowering the RH. It must be understood that the control system itself rarely affects drying times; rather, the schedule (or more precisely, the actual temperature and humidity) affects drying time. However, the overall cost of drying must be considered. Saving a day of drying time will save about \$3/thousand board feet in total costs, but an increase in drying degrade in one or two pieces can easily offset this savings.

7. When drying hardwood for high value uses such as furniture, millwork, and cabinets, the final MC must be controlled to within narrow limits. The wood is typically dried to 7% ± 1% MC. Overdrying any piece must be avoided as this will increase shrinkage, cupping, machining defects (especially planer splits), and gluing problems. Because one piece of lumber may be cut into 8 or 10 parts for furniture, an overdried piece can cause problems in that many pieces of furniture. At the same time, underdrying must be avoided at all costs because these pieces will shrink and develop end checks and open glue joints. Again, the risk is extreme: one wet piece of lumber can end up in several different finished pieces. In other words, the effect of improper final MC is exponential.

The demand for stringent MC control for many products makes it imperative that any drying system, new or old, be responsive to not just the average final MC of the load of lumber but also the wettest and driest pieces. Because nonuniformity in final MC is a result of both resource and dryer variability, in practice uniformity is achieved by an equalization procedure. Thus, all kiln schedule for hardwoods intended for high-value uses must include this equalization procedure.

8. After kiln drying, MC of individual boards varies and an equalizing period is required to reduce variability to acceptable limits.

9. Drying stresses develop during kiln drying and must be relieved by a high humidity conditioning step to avoid board distortion after machining.

## Moisture-Content-Based Kiln Schedules

Pilot testing and considerable commercial experience over the past 50 years have demonstrated that the basic kiln schedules for steam heated kilns developed by the Forest Products Laboratory of the USDA Forest Service are satisfactory for drying 8/4 and thinner North American hardwood lumber. Schedules for all species throughout the world have been published by Boone and others (1988).

The basic kiln schedules change the temperature and humidity in the kiln based on the MC of the lumber during various stages of drying. The MC is established through the use of kiln samples. Therefore, the most important purpose of kiln samples by far is to enable a kiln operator to dry a kiln charge of lumber by a specific MC schedule.

The basic schedules form the base from which an operator can develop and fine-tune the schedules to optimize their performance for a specific species, lumber thickness, and type of kiln. This chapter presents the basic schedules; related information on application and modification of the schedules is presented in Chapter 8. Chapter 8 also provides suggestions for drying thick hardwoods.

Although the same schedule generally is prescribed for 4/4, 5/4, and 6/4 of each species, 6/4 lumber will take considerably longer to dry than will 4/4, and therefore the best practice is to dry each thickness separately. If 4/4 and 5/4 lumber must be dried together, most kiln samples should be taken from the 5/4 stock. If a very conservative schedule is needed, 6/4 refractory hardwoods can be dried on an 8/4 schedule.

## Time-Based Schedules

At drying operations in which certain easy-to-dry species and thicknesses of lumber from the same source are dried regularly, kiln operators can use kiln samples to develop time schedules for subsequent charges of the same material dried from and to the same MC. This may involve extra sampling work to measure the full range of variables. However, after sufficient information and experience are obtained, the necessity for daily weighing of kiln samples can be reduced for future charges, except if there are strict requirements for quality, including final MC. Time schedules still require the measurement of kiln sample MC to determine when to equalize and condition the lumber.

## Basis for Developing Kiln Schedules

At the start of drying, a fairly low temperature is required to maintain maximum strength in the fibers near the surface to help prevent surface checks. The RH should be kept high early in drying to minimize surface checking caused by

tension stresses that develop in the outer shell of the lumber. Even under these mild initial kiln conditions, the lumber loses moisture rapidly. The drying rate is monitored to ensure that drying does not occur too rapidly. This part of the drying process is called Stage I.

After the loss of the first one-third of lumber MC (based on green MC), the drying rate begins to slow down. The mild drying conditions are no longer necessary because the surface fibers have little or no risk of checking at this point. That is, the wood fibers become stronger as MC decreases and can safely withstand higher drying stresses. Therefore, to maintain an acceptable drying rate, the RH is lowered gradually, starting at the one-third loss point. This is Stage II drying.

When the wood reaches 30% average MC, in general the temperature can safely be raised gradually and the humidity can continually be lowered. These initial temperature changes must be gradual because of the danger of internal checking (often called honeycomb). This is Stage III drying.

As a rule of thumb, when the moisture in lumber at mid-thickness is below 25% to 30% (which means the average MC of 4/4 lumber is about 20%), it is generally safe to make large ( $\leq 10^{\circ}\text{F}$  ( $\leq 6^{\circ}\text{C}$ )) increases in dry-bulb temperature to maintain a fast drying rate. For thicker lumber of some dense species and for squares, it may be necessary to decrease average MC to 15% to lower the mid-thickness MC to 25%–30%.

An ample number of kiln samples should be used to make good estimates of these critical MC levels. The recommended operating procedure is to use the average MC of the wetter half of the kiln samples (called the controlling samples) as the factor that determines when to change drying conditions.

The basic schedules are for hardwood lumber that is to be dried from the green condition. The schedules are for the more difficult-to-dry types of lumber in a species—for example, flatsawn heartwood rather than quartersawn sapwood. Because of the difference in the MC of sapwood and heartwood in many species, most kiln samples should be taken from the wettest heartwood and their MC used in applying the kiln schedule. Modifications are described in the next chapter for lumber that is all or predominately sapwood. The basic schedules must be modified for application to air-dried lumber (Ch. 8).

## Modification of Kiln Schedules

Given the current wood resource quality and quality-conscious hardwood lumber customers, several changes are suggested for the basic schedules. These changes as they relate to specific species are discussed in more detail in Chapter 8.

Two important changes for all species are recommended:

1. The maximum temperature of the schedule prior to equalization and conditioning should be no higher than  $160^{\circ}\text{F}$  ( $71^{\circ}\text{C}$ ) to improve lumber color and machinability; for many species, the previous recommendation was a maximum of  $180^{\circ}\text{F}$  ( $82^{\circ}\text{C}$ ). In practice, some operators will raise the temperature no higher than that needed to achieve acceptable drying rates; in some cases, this means a maximum temperature of  $140^{\circ}\text{F}$  ( $60^{\circ}\text{C}$ ). Drying schedules for lower quality lumber can use  $180^{\circ}\text{F}$  ( $82^{\circ}\text{C}$ ) for faster drying.
2. All schedules should use a maximum wet-bulb depression of  $45^{\circ}\text{F}$  ( $25^{\circ}\text{C}$ ); the previous recommendation was  $50^{\circ}\text{F}$  ( $28^{\circ}\text{C}$ ) maximum. (Wet-bulb depression is the temperature difference between dry-bulb and wet-bulb temperatures.) Some operators will even use a  $40^{\circ}\text{F}$  ( $22^{\circ}\text{C}$ ) maximum depression. Avoiding high depression values improves lumber machinability and reduces cup.

These suggestions have been incorporated into the schedule recommendations (Tables 7.4 to 7.7).

## Kiln Schedule Codes

Each basic kiln schedule is a combination of temperature and humidity conditions for a specific MC range. An index of recommended schedules for 4/4 to 8/4 hardwood lumber and other products is presented in Table 7.4. For drying 6/4 lumber of refractory species such as oak, the 8/4 schedule is suggested. Historically, the schedule has given wet-bulb depression values rather than RH values. Each schedule is represented by a two-letter and two-number designation, such as T4–D2.

There are 14 temperature schedules (Table 7.5), ranging from the mildest to the most severe. In all cases, initial temperatures are maintained until the average MC of the controlling samples reaches 30%.

The six MC classes (Table 7.6) are related to the green MC of the species (Table 7.3). By selecting the correct MC class, the schedule will automatically maintain the initial mild RH during the loss of the first one-third of moisture from the green condition (Stage 1).

Of the eight numbered wet-bulb depression schedules (Table 7.7), schedule 1 is the mildest and 8, the most severe. Together, the dry-bulb temperature and the wet-bulb depression establish the wet-bulb temperature, RH, and EMC of the air.

There are 672 possible schedules, using all possible combinations of temperature, wet-bulb depression, and green MC. There is no demonstrated need for so many schedules, nor have they all been tested. The schedules merely represent a systematic way to develop the whole range of degrees of drying severity. The codes and schedules listed in Table 7.4 may be conservative for some types of dry kilns and for



**Table 7.4—Kiln schedule designations for 4/4 through 8/4 hardwood lumber**

Species	Thickness <sup>a</sup>		Comment
	4/4, 5/4, 6/4	8/4	
Alder, red	T9–D4 T5–D5 T11–D3	T8–D3	Standard “honey” color Lighter color Darker color
Apple	T5–C3	T3–C2	
Ash, black	T7–D4 T5–D5	T5–D3 T2–D4	Normal color; some darkening Light color
Ash, white, green, Oregon	T7–C3 T5–B5	T5–C2 T2–B4	Normal color; some darkening Light color
Aspen	T11–E7 T7–E7 T3–E5m	T9–E6 T5–E6	Low quality uses; some darkening Higher quality uses; lighter color Collapse-prone wood
Basswood	T11–E7 T9–E7	T9–E6 T7–E6	Some browning likely Lighter color
Beech	T7–C2	T5–C1	
Birch, yellow	T7–C4 T5–C5	T5–C3 T2–C4	Normal color Lighter color
Birch, paper and others	T9–C4	T7–C3	Low quality uses
Blackgum (see tupelo, black)			
Boxelder	T7–D4	T5–C3	
Buckeye	T9–F4	T7–F3	
Butternut	T9–E4	T7–E3	
Cherry, black	T8–B4	T5–B3	
Chinkapin, giant, golden	T4–B2	T3–B2	
Cottonwood	T9–F5 T5–D5	T7–F4 T5–C4	Normal wood without wet streaks Wet streak material; collapse likely <sup>b</sup>
Cucumber	T11–D4	T9–D3	Lower quality uses
Dogwood, Eastern	T5–C3	T3–C2	
Elm, American, red, slippery	T5–D4	T5–D3	
Elm, rock, winged	T5–B3	T3–B2	
Hackberry	T7–C4 T5–C5	T5–C3 T2–C4	Some stain likely Whiter color
Hickory and pecan	T7–D3 T5–D4	T5–D1 T3–D2	Normal color Whiter color
Holly	T5–D4	T3–C3	
Hophornbeam	T5–B3	T3–B1	
Ironwood (see hophornbeam)			
Laurel, California	T5–A4	T5–A3	
Locust, black	T5–A3	T3–A1	
Madrone	T3–B2	T3–B1	
Magnolia	T9–D4	T7–D3	
Maple, hard	T7–C3 T3–C5 T1–C5	T5–C2 T2–C4	Some darkening likely; some stain Whiter color; difficult to achieve in summer; some risk of cracking <sup>c</sup> Whitest color; difficult to achieve in summer
Maple, soft, Oregon	T7–D4 T5–D5	T5–C3 T3–C4	Some darkening possible Whiter color
Myrtle, Oregon (see laurel, California)			
Oak, California black, Oregon white, canyon live	T3–B1	T3–B1	
Oak, red, upland (Appalachian or Northern)	T3–D2 T3–C2m	T3–D1 T2–B1m	Use T3–D1 for 6/4 Lumber with preexisting checks
Oak, red, lowland (Southern)	T2–C1		Shed dry 6/4 and 8/4; then use T2–B1m
Oak, white, upland (Appalachian or Northern)	T3–C2 T3–B2m	T3–C1 T2–B1m	Use T3–C1 for 6/4 Lumber with preexisting checks
Oak, white, lowland (Southern)	T2–C1		Shed dry 6/4 and 8/4; then use T2–B1m
Osage-orange	T5–A2	T3–A1	
Pecan (see hickory)			
Persimmon	T5–C3	T3–C2	
Sassafras	T7–D4		
Sweetgum (red gum; heartwood)	T7–C4	T5–C3	
Sweetgum (sap gum; sapwood)	T7–F5	T7–D4	
Sycamore	T5–D2	T3–D1	
Tanoak	T3–B1	T3–B1	Shed dry
Tupelo, black	T7–E5	T7–D3	
swamp	T7–E3	T7–D2	
water	T5–H2		
Walnut, black	T5–D4	T3–D3	
Willow, black	T7–F4	T7–F3	
Yellow-poplar	T7–D5	T7–D4	

<sup>a</sup>A small “m” after the designation indicates that the wet-bulb temperatures should be adjusted to avoid temperatures below 90°F (32°C).

<sup>b</sup>Steam at end of drying to recover collapse; watch MC variability.

<sup>c</sup>Try T1–C4 to avoid cracking.

**Table 7.5—Dry-bulb temperatures for hardwood lumber kiln schedules**

Moisture content (%)	Dry-bulb temperature designations (°F) <sup>a</sup>													
	T1	T2	T3	T4	T5	T6	T7	T8	T9	T10	T11	T12	T13	T14
>30	100	100	110	110	120	120	130	130	140	140	150	160	170	180
25 to 30	105	110	120	120	130	130	140	140	150	150	160	170	180	190
20 to 25	105	120	130	130	140	140	150	150	160	160	160	170	180	190
15 to 20	115	130	140	140	150	150	160	160	160	170	170	180	190	200
<15	120	150	160	180	160	180	160	180	160	180	180	180	190	200

<sup>a</sup>T<sub>C</sub> = [T<sub>F</sub> - 32]/1.8.

**Table 7.6—Moisture content ranges for hardwood lumber kiln schedules**

Schedule step	MC class designations (%) for various kiln schedules					
	A	B	C	D	E	F
1	>30	>35	>40	>50	>60	>70
2	25 to 30	35 to 30	35 to 40	40 to 50	50 to 60	60 to 70
3	20 to 25	25 to 30	30 to 35	35 to 40	40 to 50	50 to 60
4	15 to 20	20 to 25	25 to 30	30 to 35	35 to 40	40 to 50
5	10 to 15	15 to 20	20 to 25	25 to 30	30 to 35	35 to 40
6	<10	<15	15 to 20	20 to 25	25 to 30	30 to 35
7			<15	15 to 20	20 to 25	25 to 30
8				<15	15 to 20	20 to 25
9					<15	15 to 20
10						<15

**Table 7.7—Wet-bulb depression values for hardwood lumber kiln schedules**

Schedule step	Wet-bulb depression designations (°F) for various steps							
	1	2	3	4	5	6	7	8
1	3	4	5	7	10	15	20	25
2	4	5	7	10	14	20	30	35
3	6	8	11	15	20	30	40	45
4	10	14	19	25	35	45	45	45
5	25	30	35	40	45	45	45	45
6	45	45	45	45	45	45	45	45
7	45	45	45	45	45	45	45	45
8	45	45	45	45	45	45	45	45
9	45	45	45	45	45	45	45	45
10	45	45	45	45	45	45	45	45

some drying requirements. A combination of experience and judgment allows a kiln operator to modify schedules to improve drying quality and increase efficiency.

## Assembly of Dry Kiln Schedule

The most-needed schedules have been formulated (Boone and others 1993). Any schedule can be assembled using the following procedure, which is illustrated by using an example of a schedule for 4/4 hard maple (Table 7.8).

1. From Table 7.4, find the schedule code for the lumber to be dried. The code for 4/4 hard maple is T7–C3. Write the code at the top of the form (Table 7.8).
2. Since the first change in drying conditions involves the wet-bulb depression, write the wet-bulb depression steps (steps 1–6) in column 2.
3. In column 3, write the MC values corresponding to the schedule and wet-bulb depression steps from the appropriate MC class (Table 7.6). In the example (Table 7.8), the MC class for 4/4 hard maple is C, so the values are >40% MC, 40% MC, 35% MC, and so on.
4. In column 5, write the wet-bulb depression values corresponding to the steps from the appropriate wet-bulb depression schedule number from Table 7.6. In the example (Table 7.8), the wet-bulb depression code is 3, so the wet-bulb depression values are 5°F (2.8°C) (step 1), 7°F (3.9°C) (step 2), 11°F (6.1°C) (step 3), and so on.
5. In column 1, write the dry-bulb temperature steps. Since changes in dry-bulb temperature are not made until the average MC of the controlling samples reaches 30%, repeat dry-bulb temperature step 1 as often as necessary. In filling out the schedule, it is sometimes necessary to add a step or two at the end to complete the temperature steps; then, repeat the wet-bulb depression in step 6 in all subsequent steps. In the example for maple (Table 7.8), the initial dry-bulb temperature, 130°F (54°C), is repeated three times (wet-bulb depression steps 1, 2, and 3).

The MC at the beginning of temperature step 5 is 15%. Therefore, the 45°F (25 °C), depression is repeated.

6. In column 4, write the dry-bulb temperature that corresponds to the dry-bulb temperature step (Table 7.5). When the dry-bulb temperature step is repeated, then the initial dry-bulb temperature must be repeated; in the example (Table 7.8), 130°F (54°C) is repeated three times.
7. Subtract the wet-bulb depression from the dry-bulb temperature in each step to obtain the corresponding wet-bulb temperature. These values are entered in column 6.

The RH and EMC, which are helpful in understanding drying, have been added in the final two columns of the example kiln schedule assembly (Table 7.8).

## Combined Schedules

When kiln drying hardwoods that are partly or fully air-dried or predried, it becomes feasible to group all eastern hardwood species into one of 11 pairs of schedules. A pair consists two temperature schedules: one for 4/4 through 6/4 lumber and the other for 8/4 lumber. These are called combined schedules. All species in each schedule group have identical or very similar intermediate and final dry-bulb temperatures in the basic schedule. Also, all species in each group have similar intermediate and final wet-bulb temperatures. The combined schedules are therefore essentially the same as the recommended basic schedules, in regard to air-dried and partly air-dried hardwoods.

There should be little or no increase in drying time for the combined schedules beyond that experienced with the recommended basic schedule. When drying green stock, the combined schedules may result in longer drying times compared with the times for the recommended schedules.

The combined schedules may also be slightly severe for green stock of a few species (see footnotes in the combined schedule tables). When drying large quantities of green

**Table 7.8—Example of kiln schedule assembly for 4/4 hard maple (T7–C3)**

Dry-bulb temperature step	Wet-bulb depression step	MC at start of step	Dry-bulb temperature (°F)	Wet-bulb depression (°F)	Wet-bulb temperature (°F)	RH (%)	EMC (%)
1	1	>40	130	5	125	86	16.0
1	2	40	130	7	123	81	14.0
1	3	35	130	11	119	71	11.5
2	4	30	140	19	121	56	8.4
3	5	25	150	35	115	35	5.1
4	6	20	160	45	115	25	3.7
5	6	15	160	45	115	25	3.7

stock, the kiln operator is encouraged to revert to the originally recommended basic schedule.

The suggested combined kiln schedules for various species are described by schedule and species in Tables 7.9 and 7.10, respectively. The combined schedules are given in Tables 7.11 through 7.21. The schedule codes used in the *Dry Kiln Operator's Manual* for each species are given at the bottom of some of these tables.

Each combined schedule shows specific temperature and wet-bulb depressions for the intermediate and final stages of drying. These temperatures and wet-bulb depressions are sometimes slightly different from the basic recommendations in the *Dry Kiln Operator's Manual* to avoid large temperature changes or temperatures in excess of 180°F (82°C). Specific temperature and wet-bulb depression values are also included for equalizing and conditioning for a final target MC of 7%.

The intermediate-stage wet-bulb temperatures are close to those that are naturally attained when the vents are kept closed and the steam spray is turned off. Operators who do not know how to achieve this mode of operation with their equipment should check with their kiln manufacturer. During the final drying stage the vents should remain closed and the steam spray kept off until the moisture given off by the lumber is no longer sufficient to maintain the desired wet-bulb depression. When the desired wet-bulb depression can no longer be maintained, the steam spray or humidification system should be turned on or activated.

## Tropical Hardwoods

Kiln operators in the United States are sometimes faced with drying tropical hardwoods, either in their kilns or in kilns of business associates overseas. Schedules for some common tropical hardwoods are given in Table 7.22. In addition to these woods, there are thousands of other tropical hardwoods that have not been widely used for finished wood products in the United States. As the preferred common species become less available, interest in using alternative species is growing. However, for many tropical species there are no recommended kiln schedules.

As previously mentioned, the sensitivity of hardwoods to drying defects increases with specific gravity. Thus, as specific gravity increases, kiln schedules should become less severe. Because many tropical hardwoods do not have a recommended schedule, a relationship between specific gravity and kiln schedule code has been established. It is therefore possible to estimate a kiln schedule for any hardwood with a known specific gravity. The kiln schedule code can be calculated from the following equations:

$$\text{Temperature code} = 13.7 - 13.6G$$

$$\text{MC code} = 4.51 - 1.56G$$

$$\text{Wet-bulb depression code} = 5.20 - 3.95G$$

where  $G$  is specific gravity.

**Table 7.9—Description of combined kiln schedules for air-dried or predried hardwoods**

Table <sup>a</sup>	Temperature schedule for		Severity of schedule	Species in group
	4/4 group	8/4 group		
7.11	T2	Irregular	Mild	Red and white oak, southern lowland
7.12	T4	T3	Mild	Red oak, northern or upland
7.13	T4	T3	Mild	White oak, northern or upland
7.14	T6	T3	Mild	Apple, dogwood, rock elm, hophorn-beam, black locust, Osage—orange, persimmon, sycamore
7.15	T6	T3	Moderate	American elm, slippery elm, holly, mahogany, black walnut
7.16	T8	T5	Mild	Beech, sugar maple, hickory, pecan
7.17	T8	T5	Moderate	Black ash, green ash, white ash, yellow birch, cherry, cottonwood (wet streak), hackberry, red maple, silver maple, sassafras, sweetgum heartwood (redgum)
7.18	T10	T8	Moderate	buckeye, butternut, chestnut, cottonwood (normal), magnolia, swamp tupelo (swamp blackgum), black willow
7.19	T11	T10	Moderate	Yellow-poplar, cucumbertree
7.20	T12	T11	Moderate	Black tupelo (blackgum), sweetgum sap wood (sapgum)
7.21	T12	T10	Severe	Aspen (sapwood or box), basswood

<sup>a</sup>Kiln schedules are given in Tables 7.11 through 7.21.

**Table 7.10—Key to kiln schedule (table) by species**

Species	Table no.
Apple	7.14
Ash, black, green, white	7.17
Aspen	7.21
Basswood (light brown)	7.21
Basswood (light color)	7.18
Beech	7.16
Birch, paper	7.18
Birch, yellow	7.17
Blackgum	(see tupelo)
Buckeye	7.18
Butternut	7.18
Cherry, black	7.17
Chestnut	7.18
Cottonwood, normal	7.18
Cottonwood, wet streak	7.17
Cucumbertree	7.19
Dogwood	7.14
Elm, American, slippery	7.15
Elm, rock	7.14
Gum	(see sweetgum)
Hackberry	7.17
Hickory	7.16
Holly, American	7.15
Hophornbeam (ironwood)	7.14
Locust, black	7.14
Magnolia	7.18
Mahogany	7.15
Maple, red, silver	7.17
Maple, sugar	7.16
Oak, red, northern (upland)	7.12
Oak, white, northern (upland)	7.13
Oak, red, white, southern lowland	7.11
Osage—orange	7.14
Pecan	7.16
Persimmon	7.14
Poplar	(see yellow-poplar)
Sassafras	7.17
Sweetbay	(see magnolia)
Sweetgum, heartwood (redgum)	7.17
Sweetgum, sapwood (sapgum)	7.20
Sycamore, American	7.14
Tupelo, black (blackgum)	7.20
Tupelo, swamp (swamp blackgum)	7.18
Tupelo, water (tupelo)	(see <i>Dry Kiln Operator's Manual</i> )
Walnut, black	7.15
Willow, black	7.18
Yellow-poplar	7.19

As an example, estimate the kiln schedule when the specific gravity is 0.62:

$$\text{Temperature code} = 13.7 - (13.6)(0.62) = 5.2$$

$$\text{MC code} = 4.51 - (1.56)(0.62) = 3.5$$

$$\text{Wet-bulb depression code} = 5.20 - (3.95)(0.62) = 2.8$$

Rounding off the results, the schedule is 5–4–3, or T5–D3. More details are given in Simpson and Verrill (1997).

## Kiln Start-Up Procedures

This section describes specific procedures for kiln start-up and the first 1 or 2 days of the run when drying predried, air-dried, or partly air-dried lumber. In all cases, the procedures are designed to avoid any regain of moisture by the surface of the lumber and to avoid development of excessive surface shrinkage. The average MC of air-dried stock should be 25% or lower; no material should have more than 30% MC. For partly air-dried stock, no material should have more than 50% MC. Specific procedures for starting kiln drying of green lumber are given in Chapter 10 of the *Dry Kiln Operator's Manual* (Simpson 1991).

### Partially Air-Dried Lumber

Partly air-dried lumber is defined as lumber with 40% to 50% MC.

#### 4/4, 5/4, and Most 6/4 Lumber

1. Bring dry-bulb temperature up to value prescribed by schedule for average MC of controlling kiln samples. Keep vents closed. Use steam spray only as needed to keep wet-bulb depression from exceeding 10°F (6°C). Do not allow depression to become lower than 5°F (3°C) or moisture will condense on the lumber.
2. After prescribed dry-bulb temperature has been reached, run first three wet-bulb depression steps for minimum of 12 h each, observing 5°F (3°C) minimum wet-bulb depression. Then, change to conditions prescribed for MC of controlling samples.

#### 8/4 (plus 6/4 Oak) Lumber

1. Bring dry-bulb temperature up to value prescribed by schedule for average MC of controlling kiln samples. Keep vents closed. Use steam spray only as needed to keep wet-bulb depression from exceeding 8°F (4°C). Do not allow depression to become less than 5°F (3°C).
2. After prescribed dry-bulb temperature has been reached, run first three wet-bulb depression steps for minimum of 18 h each, observing 5°F (3°C) minimum wet-bulb depression. When kiln conditions coincide with those prescribed by schedule based on average MC of controlling samples, change to MC basis of operation.

**Table 7.11—Kiln schedules for green, air-dried, or predried red and white oak—southern lowland<sup>a</sup>**

Initial MC <sup>b</sup> (%)	4/4 and 5/4 (T2–C1)			6/4 and 8/4 (irregular)		
	Dry-bulb temperature (°F)	Wet-bulb depression (°F)	Wet-bulb temperature (°F)	Dry-bulb temperature (°F)	Wet-bulb depression (°F)	Wet-bulb temperature (°F)
>40	100	3	97	— <sup>c</sup>	— <sup>c</sup>	— <sup>c</sup>
40	100	4	96	— <sup>c</sup>	— <sup>c</sup>	— <sup>c</sup>
35	100	6	94	— <sup>c</sup>	— <sup>c</sup>	— <sup>c</sup>
30	110	10	100	106	8	97
25	120	25	96	110	11	99
20	130	40	90	120	15	105
15	150	45	105	130	30	100
11	160	45	115	160	45	115
Equalize	170	43	127	170	43	127
Condition	180	10	170	180	10	170

<sup>a</sup>For all oak species, 6/4 stock is usually dried by the 8/4 schedule.

<sup>b</sup>Moisture content at beginning of step.

<sup>c</sup>Air dry to 25% MC.

**Table 7.12—Kiln schedules for green, air-dried, or predried red oak—northern, Appalachian, or upland<sup>a</sup>**

Initial MC (%)	4/4 and 5/4 (T3–D2)			6/4 and 8/4 (T3–D1)		
	Dry-bulb temperature (°F)	Wet-bulb depression (°F)	Wet-bulb temperature (°F)	Dry-bulb tem- perature (°F)	Wet-bulb depression (°F)	Wet-bulb temperature (°F)
>50	110	4	106	110	3	107
50	110	5	105	110	4	106
40	110	8	102	110	6	104
35	110	14	96	110	10	100
30	120	30	90	120	25	95
25	130	40	90	130	40	90
20	140	45	95	140	45	95
15	160	45	115	160	45	115
Equalize	170	43	127	170	43	127
Condition	180	10	170	180	10	170

<sup>a</sup>For all oak species, 6/4 stock is usually dried by the 8/4 schedule.

**Table 7.13—Kiln schedules for green, air-dried, or predried white oak—northern or upland<sup>a</sup>**

Initial MC (%)	4/4 and 5/4 (T3–C2)			6/4 and 8/4 (T3–C1)		
	Dry-bulb temperature (°F)	Wet-bulb depression (°F)	Wet-bulb temperature (°F)	Dry-bulb tem- perature (°F)	Wet-bulb depression (°F)	Wet-bulb temperature (°F)
>40	110	4	106	110	4	107
40	110	5	105	110	4	106
35	110	8	102	110	6	104
30	120	14	106	120	10	110
25	130	30	100	130	25	105
20	140	45	95	140	40	100
15	160	45	115	160	45	115
Equalize	170	43	127	170	43	127
Condition	180	10	170	180	10	170

<sup>a</sup>For all oak species, 6/4 stock is usually dried by the 8/4 schedule.

**Table 7.14—Kiln schedules and recommended green stock codes for air-dried or predried rock elm, dogwood, persimmon, and similar woods**

Initial MC (%)	4/4, 5/4, and 6/4 (T5–B3)			8/4 (T3–B2)		
	Dry-bulb temperature (°F)	Wet-bulb depression (°F)	Wet-bulb temperature (°F)	Dry-bulb temperature (°F)	Wet-bulb depression (°F)	Wet-bulb temperature (°F)
>35	120	5	115	110	4	106
35	120	7	113	110	5	105
30	130	11	119	120	8	112
25	140	19	121	130	14	116
20	150	35	115	140	30	110
15	160	45	115	160	50	110
Equalize	173	43	130	173	43	130
Condition	180	10	170	180	10	170

Recommended green stock code		
Species	4/4, 5/4, and 6/4	8/4
Apple	T5–C3	T3–C2
Dogwood	T5–C3	T3–C2
Elm, rock	T5–B3	T3–B2
Hophornbeam <sup>a</sup>	T5–B3	T3–B1
Locust, black <sup>a</sup>	T5–A3	T3–A1
Osage–orange <sup>a</sup>	T5–A2	T3–A1
Persimmon	T5–C3	T3–C2
Sycamore <sup>a</sup>	T5–D2	T3–D1

<sup>a</sup>Use basic kiln schedule for 4/4 and 8/4 locust and osage–orange and 8/4 hophornbeam (ironwood) and sycamore stock with >35% MC.

**Table 7.15—Kiln schedules and recommended green stock codes for air-dried or predried American and slippery elm, holly, mahogany, and black walnut**

Initial MC (%)	4/4, 5/4, and 6/4 (T5–C4)			8/4 (T3–C3)		
	Dry-bulb temperature (°F)	Wet-bulb depression (°F)	Wet-bulb temperature (°F)	Dry-bulb temperature (°F)	Wet-bulb depression (°F)	Wet-bulb temperature (°F)
>40	120	7	113	110	5	105
40	120	10	110	110	7	103
35	120	15	106	110	10	100
30	130	25	105	120	19	101
25	140	35	105	130	35	95
20	150	40	110	140	40	100
15	160	45	115	160	45	115
Equalize	170	43	127	170	43	127
Condition	180	10	170	180	10	170

Recommended green stock code		
Species	4/4, 5/4, and 6/4	8/4
Elm, American	T5–D4	T5–D3
Elm, slippery	T5–D4	T5–D3
Holly	T5–D4	T4–C3
Mahogany	T5–C4	T4–C3
Walnut, black	T5–D4	T3–D3

**Table 7.16—Kiln schedules and recommended green stock codes for air-dried or predried beech, hickory, sugar maple, and pecan<sup>a</sup>**

Initial MC (%)	4/4, 5/4, 6/4 (T7–C2)			8/4 (T5–C1)		
	Dry-bulb temperature (°F)	Wet-bulb depression (°F)	Wet-bulb temperature (°F)	Dry-bulb temperature (°F)	Wet-bulb depression (°F)	Wet-bulb temperature (°F)
>40	130	4	126	120	3	117
40	130	5	125	120	4	116
35	130	8	122	120	6	114
30	140	14	126	130	10	120
25	150	30	120	140	25	115
20	160	40	120	150	35	115
15	160	45	115	160	45	115
Equalize	170	43	127	173	43	127
Condition	180	10	170	180	10	170

Recommended green stock code		
Species	4/4, 5/4, and 6/4	8/4
Beech	T7–C2	T5–C1
Hickory	T7–D3	T6–D1
Maple, sugar	T7–C3	T5–C2
Pecan <sup>b</sup>	T7–D3	T6–D1

<sup>a</sup>Cooler dry-bulb temperatures will often give bright, whiter color.

<sup>b</sup>Bitter pecan (water hickory) heartwood is very difficult to kiln dry from green. Stock should be thoroughly air dried first.

**Table 7.17—Kiln schedules and recommended green stock codes for air-dried or predried white ash, yellow birch, cherry, sweetgum, and similar woods**

Initial MC (%)	4/4, 5/4, 6/4 (T7–C4)			8/4 (T5–C3)		
	Dry-bulb temperature (°F)	Wet-bulb depression (°F)	Wet-bulb temperature (°F)	Dry-bulb temperature (°F)	Wet-bulb depression (°F)	Wet-bulb temperature (°F)
>40	130	7	123	120	5	115
40	130	10	120	120	7	113
35	130	15	115	120	11	109
30	140	25	115	130	19	111
25	150	35	115	140	30	110
20	160	45	115	150	40	110
15	160	45	115	160	45	150
Equalize	170	43	127	170	43	127
Condition	180	10	170	180	10	170

Recommended green stock code		
Species	4/4, 5/4, and 6/4	8/4
Ash, black	T7–D4	T5–D3
Ash, green, white <sup>a</sup>	T7–B4	T5–B3
Birch, yellow	T7–C4	T5–C3
Cherry, black <sup>a</sup>	T7–B4	T5–B3
Cottonwood (wet-streak)	T7–D5	T6–C4
Hackberry	T7–C4	T6–C3
Maple, red, silver	T7–D4	T6–C3
Sassafras	T7–D4	T5–C3
Sweetgum (heartwood)	T7–C4	T5–C3

<sup>a</sup>For green or white ash and cherry stock with >35% MC, use the green stock schedules.



**Table 7.18—Kiln schedules and recommended green stock codes for air-dried or predried magnolia, paper birch, butternut, normal cottonwood, and similar woods**

Initial MC (%)	4/4, 5/4, 6/4 (T9–D4)			8/4 (T7–D3)		
	Dry-bulb temperature (°F)	Wet-bulb depression (°F)	Wet-bulb temperature (°F)	Dry-bulb temperature (°F)	Wet-bulb depression (°F)	Wet-bulb temperature (°F)
>50	140	7	133	130	5	125
50	140	10	130	130	7	123
40	140	15	125	130	11	119
35	140	25	115	130	19	111
30	150	35	115	140	35	105
25	160	40	120	150	40	110
20	160	45	115	160	45	115
15	160	45	115	160	45	115
Equalize	170	43	127	170	43	127
Condition	180	10	170	180	10	170

Species	Recommended green stock code	
	4/4, 5/4, and 6/4	8/4
Basswood (light color)	T9–E7	T7–E6
Birch, paper	T9–C4	T7–C3
Buckeye	T9–F4	T7–F3
Butternut	T9–E4	T7–E3
Chestnut	T9–E4	T7–E3
Cottonwood (normal)	T9–F5	T7–F4
Magnolia, sweetbay	T9–D4	T7–D3
Tupelo, swamp (swamp blackgum) <sup>a</sup>	T9–E3	T7–D2
Willow, black	T9–F4	T7–F3

<sup>a</sup>For swamp tupelo with >40% MC, use the green stock schedule. For water tupelo, see *Dry Kiln Operator's Manual* (Simpson 1991).

**Table 7.19—Kiln schedules for green, air-dried, or predried yellow-poplar and cucumbertree<sup>a</sup>**

Initial MC (%)	4/4, 5/4, 6/4 (T11–D4)			8/4 (T9–D3)		
	Dry-bulb temperature (°F)	Wet-bulb depression (°F)	Wet-bulb temperature (°F)	Dry-bulb temperature (°F)	Wet-bulb depression (°F)	Wet-bulb temperature (°F)
>50	150	7	143	140	5	135
50	150	10	140	140	7	133
40	150	15	135	140	11	129
35	150	25	125	140	19	121
30	160	35	125	150	35	115
25	160	40	120	160	40	120
20	160	45	115	160	45	115
15	160	45	115	160	45	115
Equalize	170	43	127	170	43	127
Condition	180	10	170	180	10	170

<sup>a</sup>Although a species of magnolia, cucumbertree is usually dried with yellow-poplar.

**Table 7. 20—Kiln schedules and recommended green stock codes for green, air-dried, or predried black tupelo (black gum) and sweetgum sapwood (sap gum)<sup>a,b</sup>**

Initial MC (%)	4/4, 5/4, 6/4 (T11–D4)			8/4 (T9–D3)		
	Dry-bulb temperature (°F)	Wet-bulb depression (°F)	Wet-bulb temperature (°F)	Dry-bulb temperature (°F)	Wet-bulb depression (°F)	Wet-bulb temperature (°F)
>60	160	10	150	150	5	145
60	160	14	146	150	5	145
50	160	20	140	150	7	143
40	160	30	130	150	11	139
35	160	40	120	150	19	131
30	160	45	115	160	35	125
25	160	45	115	160	40	120
20	160	45	115	160	45	115
15	160	45	115	160	45	115
Equalize	170	43	127	170	43	127
Condition	180	10	170	180	10	170

Species	Recommended green stock code	
	4/4, 5/4, and 6/4	8/4
Sweetgum sapwood (sap gum)	T11–F5	T11–D4
Black tupelo (black gum)	T11–E5	T11–D3

<sup>a</sup>Lower grade sweetgum heartwood (red gum) is often included with sap gum sorts. If more than 15% of stock is red gum, use schedules in Table 7.17.

<sup>b</sup>Cooler dry-bulb temperatures will often give bright, whiter color.

**Table 7.21—Kiln schedules and recommended green stock codes for green, air-dried, or predried basswood and aspen (sapwood or box lumber)<sup>a</sup>**

Initial MC (%)	4/4, 5/4, 6/4 (T11–E7)			8/4 (T9–E6)		
	Dry-bulb temperature (°F)	Wet-bulb depression (°F)	Wet-bulb temperature (°F)	Dry-bulb temperature (°F)	Wet-bulb depression (°F)	Wet-bulb temperature (°F)
>60	160	20	140	140	15	125
60	160	30	130	140	20	120
50	160	40	120	140	30	110
40	160	45	115	140	40	100
35	160	45	115	140	45	95
30	160	45	115	150	45	105
25	160	45	115	160	45	115
20	160	45	115	160	45	115
15	160	45	115	160	45	115
Equalize	170	43	127	170	43	127
Condition	180	10	170	180	10	170

Species	Recommended green stock code	
	4/4, 5/4, and 6/4	8/4
Aspen (some collapse) <sup>b</sup>	T11–E7	T9–E6
Basswood (slight browning)	T11–E7	T9–E6

<sup>a</sup>Cooler dry-bulb temperatures will often give bright, whiter color.

<sup>b</sup>See special schedules in Chapter 8.

**Table 7.22—Kiln schedules for tropical hardwoods**

Common lumber name	4/4 and 6/4	8/4
Afrormosia	T10–D5	T8–D4
Albarco	T3–D2	T3–D1
Andiroba	T3–C2	T3–C1
Angelique	T2–B2	—
Apitong	T3–D2	T3–D1
Avodire	T6–D2	T3–D1
Balata	T1–B1	—
Balsa	T10–D4	T8–D3
Banak	T3–C2	T3–C1
Benge	T3–C2	T3–C1
Bubinga	T2–C2	T2–C1
Cativo	T3–C2	T3–C1
Ceiba	T10–D5	T8–D4
Cocobolo	T2–C2	T2–C1
Courbaril	T3–C2	T3–C1
Cuangare	T5–C3	—
Degame	T2–C2	T2–C1
Determa	T6–D2	T3–D1
Ebony, East Indian	T3–C2	T3–C1
Ebony, African	T6–D2	T3–D1
Gmelina	T13–C4	T11–D3
Goncalo alves	T3–C2	—
Greenheart	T2–C2	T2–C1
Hura	T6–D2	T3–D1
Llomba	T3–C2	T3–C1
Imbuia	T6–D2	T3–D1
Ipe	T3–C1	—
Iroko	T6–D2	T3–D1
Jarrah	T3–C2	T3–C1
Jelutong	T10–D4	T8–D3
Kapur	T10–D4	T8–D3
Karri	T3–C2	T3–C1
Kempas	T6–D2	T3–D1
Keruing	T3–D2	T3–D1
Lauan, red, white	T6–D4	T3–D3
Lignumvitae	T2–C2	T2–C1
Limba	T10–D5	T8–D4
Mahogany, African <sup>a</sup>	T6–D4	T3–D3
Mahogany, true	T6–D4	T3–D3
Manni	T3–C2	T3–C1
Merbau	T3–C2	T3–C1
Mersawa	T6–D2	T3–D1
Mora	T2–C2	T2–C1
Obeche	T14–C5	T12–C5
Okoume	T6–D2	T3–D1
Opepe	T6–D2	T3–D1
Pau marfim	T6–C3	T5–C2
Peroba de campos	T3–D2	T3–D1
Peroba rosa	T6–D2	T3–D1
Primavera	T6–F3	—
Purpleheart	T6–D2	T3–D1
Ramin	T3–C2	T2–C1
Roble ( <i>Quercus</i> )	T2–C2	T2–C1
Roble ( <i>Tabebuia</i> )	T6–D2	T3–D1
Rosewood, Indian	T6–D2	T3–D1
Rosewood, Brazilian	T3–C2	T3–C1
Rubberwood	T6–D2	—
Sande	T5–C3	—
Santa Maria	T2–D4	T2–D3
Sapele	T2–D4	T2–D3
Sepetir	T8–B3	T5–B1
Sucupira ( <i>Bowdichia</i> )	T5–B2	—
Sucupira ( <i>Diplotropis</i> )	T7–B3	—
Teak	T10–D4	T8–D3
Wallaba	T2–C2	T2–C1

<sup>a</sup>Normal specific gravity.

## Air-Dried Lumber

Air-dried lumber is defined as lumber with less than 30% MC.

### 4/4, 5/4, and Most 6/4 Lumber

The following procedure applies to 4/4, 5/4, and 6/4 (except oak) lumber that has been dried to 20% to 30% MC.

1. Bring dry-bulb temperature up to value prescribed by schedule for average MC of controlling kiln samples, keeping vents closed and steam spray turned off.
2. After kiln has reached dry-bulb temperature, set wet-bulb temperature.
  - a. If the air-dried or predried lumber has not been wetted on the surface or exposed to a long period of high humidity just before entering the kiln, set wet-bulb temperature as specified by schedule.
  - b. If air-dried or predried lumber has been surface wetted or has regained moisture, set wet-bulb controller for a 10°F (6°C) wet-bulb depression and turn on steam spray only if necessary to achieve and maintain desired depression. Let kiln run for 12 to 18 h at this wet-bulb setting and then change to wet-bulb setting specified by schedule.

### 8/4 (plus 6/4 Oak) Lumber

The following procedure applies to 6/4 oak and 8/4 lumber that has been dried to 20% to 30% MC.

1. Bring dry-bulb temperature up to value prescribed by schedule for average MC of controlling kiln samples, keeping vents closed. Use steam spray (manually) only as needed to keep wet-bulb depression from exceeding 12°F (7°C).
2. After kiln has reached dry-bulb temperature, set wet-bulb temperature.
  - a. If there has been no surface moisture regain, set wet-bulb temperature at level specified by schedule.
  - b. If there has been surface moisture regain, set wet-bulb controller for 8°F (4°C) wet-bulb depression and turn on steam spray. Let kiln run for 18 to 24 h at this setting. Then, set 12°F (7°C) depression for 18 to 24 h before changing to conditions specified in schedule.

## Predried Lumber

When starting the kiln, follow step 1 for air-dried lumber. For step 2, set the EMC of the kiln to a value 1% to 2% lower than the average EMC in the predryer during the week before the lumber was removed for drying.

## Alternative Procedures

The procedures described for air-dried and partly air-dried lumber are general recommendations. More precise starting conditions can be used, as required for obtaining the highest quality of lumber. Follow step 1 for air-dried or partly air-dried lumber, as appropriate. In step 2, measure the lumber surface MC before the lumber is placed in the kiln, using an electric resistance type moisture meter and inserting the pins <math><1/16\text{-in.}</math> (<math><1\text{ mm}</math>) into the face of the lumber. Measure the surface MC of 20 pieces of lumber from throughout the load. If the readings vary by less than 5% MC, then set the kiln EMC 1 or 2 percentage points below the average surface MC. This will ensure that the lumber does not regain moisture during kiln start-up, but that the lumber does begin to dry. If the surface readings vary considerably, then use the drying procedures described in the preceding subsections.

## Equalizing and Conditioning

Equalizing and conditioning are usually necessary for hardwood lumber that will be dried to <math><11\%</math> MC and used in end products that will be resawn or ripped into narrow pieces. Measurement of final MC and final stress levels are discussed in Chapter 9. The following procedures are based on the use of kiln samples to monitor equalization and stress sections to monitor conditioning. These procedures will be satisfactory for lumber that has been dried to a final average 5% to 11% MC. Table 7.23 contains basic information on kiln sample MC and kiln EMC conditions for these treatments. Wet-bulb depression values required to obtain desired EMC conditions are also given.

Equalizing and conditioning (stress relief) are two quality-control measures necessary to complete the seasoning of high quality hardwoods. Producing lumber at the desired final MC with little variability and free of drying stresses is critical in today's manufacturing and supplier/purchaser environment. The methods presented here represent a balanced approach to obtaining maximum lumber quality at a reasonable cost.

## Equalizing

Lumber MC frequently varies near the end of the drying run. This is the result of natural variability in drying rate (the ends of the lumber compared to the center of the lumber, for example), initial MC, proportion of heartwood and sapwood, and bacterial wet pockets. Variability can also result from variability in drying conditions (temperature, humidity, or velocity) in various parts of the kiln. Variation in final MC can cause serious problems in the subsequent processing and use of the lumber. The purpose of equalizing is to reduce this variation in MC without overdrying.

Determining if the lumber must be equalized requires knowledge of the variability of MC throughout the charge. Furthermore, because some end uses require very precise MC levels, with little variation both between and within pieces, knowledge of the end-use requirements is essential. Finally, uniform and thorough conditioning requires proper equalization beforehand. Kiln samples serve as the basis for controlling and evaluating the equalizing treatment.

To equalize and condition lumber properly, a kiln operator needs a clear idea of the target MC. The target average MC is a single value, not a range. The procedure for equalizing a kiln charge of lumber, using the settings given in Table 7.23, is as follows:

1. Start equalizing when the MC of the *driest* kiln sample in the charge has reached an average value that is 2% below the desired final average MC. For example, if the desired final average MC is 7%, start equalizing when the driest kiln sample reaches 5% MC.
2. When step 1 is achieved, immediately establish an equalizing EMC in the kiln numerically equal to 2% EMC below the desired final average MC. In essence, this setting will stop the driest sample from drying any further and will allow wetter pieces to continue drying. In the example given in step 1, the equalizing setting would be 5% EMC. In most cases, use a dry-bulb temperature of 170°F (77°C) during equalizing (180°F (82°C) for lower density hardwoods). Cooler temperatures require extended equalization time.

**Table 7.23—Traditional wet-bulb temperatures for equalizing hardwoods**

Final MC <sup>a</sup> (%)	Equalizing EMC (%)	Wet-bulb temperature at various dry-bulb temperatures (°F)						
		140	150	160	170	180	190	200
5 (6)	3	92	101	110	120	130	140	150
6 (7)	4	99	108	118	127	137	147	157
7 (8)	5	105	115	125	135	145	156	167
8 (9)	6	111	121	131	141	152	163	174

<sup>a</sup>Final MC values in parentheses are for faster drying when the highest quality drying is not required.

3. Continue equalizing until the *wettest* sample reaches the desired final average MC. In the example given in step 1, the kiln load would be equalized until the MC of the wettest sample reached 7%. At this point, the samples would have 5% to 7% MC; this is also the MC range for all the lumber in the kiln if the samples were properly chosen. However, this level of MC is a little lower than the 7% MC target. During conditioning, the lumber and samples will gain an average of approximately 1% MC, making the final range 6% to 8% MC.

If the equalizing treatment is to be followed by a conditioning treatment, it is often helpful to use a dry-bulb temperature for equalizing 10°F (6°C) lower than the dry-bulb temperature that will be used for conditioning. This is due to the fact that typically as the wet-bulb is raised to achieve a high conditioning EMC, the dry-bulb will also rise, in effect keeping the EMC too low to condition the lumber properly and quickly. This problem of extra heat is primarily a result of superheat in the steam, as well as the latent heat of condensation within the wood. By lowering the equalization dry-bulb, the extra heat that results in conditioning will be used to achieve the hotter dry-bulb temperature required. Another method to compensate for dry-bulb temperature override during conditioning is to equalize normally, using the dry-bulb temperature that the schedule permits. Then, when equalization is complete, shut the kiln down for several hours to cool the kiln and the surface of the lumber. The wet-bulb is then turned on to achieve the desired wet-bulb for the conditioning EMC, but the dry-bulb heat is kept off. Once the wet-bulb temperature is achieved, the dry-bulb heat is operated normally.

## Conditioning

Residual drying stresses (often called casehardening although the surface does not actually harden) can cause warp when the lumber is machined, various gluing problems, and pinching of the saw blade during ripping or resawing. Drying stresses should be removed (that is, the lumber should be conditioned) from most hardwood lumber before it is cut. The purpose of conditioning is to relieve the residual compressive drying stresses in the shell by exposure to high

temperature and high RH. Conditioning can also have the beneficial effect of producing more uniform MC throughout the thickness of the boards. Effective equalizing is necessary before satisfactory conditioning can be accomplished because the effectiveness and length of the conditioning treatment depend on MC.

For conditioning to be uniform throughout the charge, the lumber must be of a uniform moisture prior to conditioning. Therefore, the conditioning treatment, which must always be preceded by an equalizing treatment (even when the average MC is within narrow limits, to assure that the ends of the lumber are not over-dried) should not be started until the average MC of the wettest sample reaches the desired final average MC. The temperature settings for conditioning are given in Table 7.24.

The procedure for conditioning is as follows:

1. The conditioning temperature is preferably 10°F (6°C) higher than the equalizing temperature; in older kilns, the conditioning temperature may have to be the highest temperature at which the conditioning EMC can be controlled. For hardwoods, the conditioning EMC is 4% EMC above the desired final average MC. Set the desired wet-bulb temperature for the proper depression but do not raise the dry-bulb temperature above the equalizing temperature (that is, keep the heat turned off) until after the proper wet-bulb temperature is attained.

Example: Assume a hardwood species with a desired final MC of 7% and a conditioning temperature of 180°F (82°C). The conditioning EMC is 11% (7% + 4%). At 170°F (77°C), a 10°F (6°C) wet-bulb depression will give 11.1% EMC (see Table 2.4).

*Caution:* The important factor in conditioning is to obtain the desired EMC. It is not enough merely to set the controls to the proper setting. In addition, the actual dry- and wet-bulb temperatures need to be monitored to determine whether they are actually achieving the desired EMC for conditioning. Dry-bulb temperatures higher than desired result in a lower EMC than desired, which lengthens conditioning time and leads to poor stress relief.

**Table 7.24—Traditional wet-bulb temperatures for conditioning hardwoods**

Final MC (%)	Conditioning EMC (%)	Wet-bulb temperature at various dry-bulb temperatures (°F)					
		140	150	160	170	180	190
6	10	126	136	147	157	168	178
7	11	128	138	149	159	170	180
8	12	130	140	151	161	172	182
9	13	132	142	152	163	173	183

2. Continue conditioning until satisfactory stress relief is attained. The time required for conditioning is determined by several variables:

- Species Denser species require more conditioning time.
- Lumber thickness Thicker lumber requires more time.
- Condition of kiln Leaky or poorly insulated kilns require more time.
- Steam pressure Higher pressure requires more time.
- Type of drying Air-dried lumber requires less time compared to predried or kiln dried green.

At a conditioning temperature of 160°F to 180°F (71°C to 82°C), low density 4/4 hardwoods may require as little as 4 h conditioning time. Denser 8/4 species may require up to 48 h. Much variation from kiln to kiln in conditioning time is related to how fast the desired EMC for conditioning can be reached—quickly achieving the desired EMC results in quick stress relief. If the conditioning temperature is lower than 180°F (82°C), conditioning time may be prolonged.

The most exact way to determine when conditioning is complete is the casehardening test (Ch. 8). Conditioning time should not be continued any longer than necessary because of excessive steam consumption and excessive moisture pickup, particularly for low-density species.

If tests for average MC are made immediately after the conditioning treatment, the MC obtained may be as much as 1.5% above the desired value because of surface moisture regain. Therefore, after conditioning, the lumber should be stored at room temperature for several days; this is often called a cooling period. The surface moisture will quickly evaporate into the drier air. The average MC should then be at the desired level if the kiln has been operated well and the samples were well chosen and prepared.

## Sterilization

Sterilization is a procedure to kill any noxious insects and their eggs (and perhaps any fungi) in the lumber. The procedure is especially directed toward insects that originated and lived in the standing tree. The objective of sterilization is to prevent forest pests from spreading from one geographic location to another. It is required for lumber being exported to certain countries. All research indicates that when wood is thoroughly heated to  $\geq 130^{\circ}\text{F}$  ( $\geq 54^{\circ}\text{C}$ ), this treatment will kill all existing insects, their eggs, and any fungi associated with wood. However, the sterilization procedure, as applied in Canada and the United States, typically requires the center of all the lumber in a kiln or sterilization chamber to be heated to  $133^{\circ}\text{F}$  ( $56^{\circ}\text{C}$ ) for at least 6 h, although shorter times are certainly quite effective.

To ascertain the exact sterilization time, a company must consider the lumber MC, lumber thickness, type of heat used, and kiln or chamber characteristics. Usually, temperature measurements are made within pieces of lumber (in the slowest, coolest part of the kiln) to develop a specific procedure and confirm that the required procedure is adequate. The dryer is then “certified.”

*Note:* The temperature of wet lumber is closer to the wet-bulb temperature than the dry-bulb temperature. As the lumber dries, its temperature becomes closer to the dry-bulb temperature.

The standard kiln schedules used in steam, hot air (direct fired), and dehumidifier kilns will always achieve adequate sterilization without the use of any special procedures. In some older dehumidifier kilns, however, special care must be used to ensure that the required temperatures are achieved and are held for the required time.

When lumber is to be shipped green but sterilization is required, heating must be done at very high humidity to avoid drying. This can be accomplished by direct steaming of the lumber. Because the steam temperature exceeds  $212^{\circ}\text{F}$  ( $100^{\circ}\text{C}$ ) and because steam condensation on cold lumber provides excellent heat transfer, steaming times seldom exceed 1 h for most products and species. Sterilization in hot-air kilns is difficult without drying the lumber because high humidity levels are difficult to maintain.

When the wood is taken from the kiln, it can be reinfected by insects. If the wood is not dried to  $<20\%$  MC, it can be infected by fungi. However, only a few insects will invade, inhabit, and damage dry ( $<10\%$  MC) wood. Three major dry-wood insects are carpenter bees, termites, and lyctid powderpost beetles. These insects are not the insects that are of concern because they can be transported through cut timber to forests in other geographical areas.

*Note:* Always check for special sterilization regulations when the lumber is to be shipped to another country to make sure that the procedures discussed here are considered adequate.

## Drying Time

### Kiln Drying Time

The time required to kiln dry a given species and thickness depends upon the character of the wood, type of kiln, and kiln schedule. The time estimates given in Table 7.25 are generally minimum times that can be obtained in well-maintained commercial kilns with relatively short air travel. These times are based on the assumption that the operator will take some steps to increase the drying rate. Kilns with longer air travel ( $<200$  ft/min ( $<1$  m/s)), with heating systems that cannot reach the suggested kiln temperatures, or in poor condition will take several days to a week longer to dry green stock. For air-dried or predried stock, such kilns may

require or 1 or 2 days longer than the times listed in Table 7.25. The drying times in this table are for precisely sawn rough green material 1-1/8 in. (28.6 mm) thick. Miscut lumber with greater thickness will take longer to dry.

## Prediction of Drying Time

Management is frequently faced with determining how long it will take to dry a load or when the next change in kiln conditions can be made.

The question “How long before the next change?” can be easily answered if the operator graphs the MC of the samples as they dry (Fig. 7.7). To make this job easy, special graph paper can be obtained that has horizontal markings in tenths of an inch (2.54 mm) and vertical markings in twelfths of an inch (2.12 mm). With such paper, it is easy to show drying time to days and hours. Graphing the MC of the samples as they are weighed results in a smooth drying curve.

Any portion of this curve can be extended 24 h ahead with a straight line to predict the approximate MC for the next day. In fact, when the same lumber species and thickness is dried repeatedly, the total drying time can be reasonably well estimated.

To develop basic drying curves, the operator should use sample data for green or nearly green stock of various species and thickness. After the first 1 to 2 days of drying, for any subsequent charge of lumber dried from a lower initial MC, the curve for the drier stock will approximate the curve for the green stock at the same MC. Ultimately, the kiln operator can develop one curve for each wood species, kiln type, and lumber thickness. A side benefit of such a drying graph is that any subsequent charge of normal stock with a slower drying rate will indicate that the kiln may not be operating properly. A comparison of graphs over some period should also show any slow loss of efficiency in the kiln.

**Table 7.25—Approximate minimum kiln-drying times for 4/4 hardwood lumber in conventional kilns<sup>a</sup>**

Species	Kiln drying time (days)		Species	Kiln drying time (days)	
	Air-dried <sup>b</sup> condition	Green condition		Air-dried <sup>b</sup> condition	Green condition
Apple	4	10	Hophornbeam, eastern	6	14
Ash, black	4	7	Locust, black	6	14
Ash: green, white	4	10	Magnolia	4	8
Aspen	3	9	Mahogany	4	10
Basswood (slight browning)	3	6	Maple, red, silver (soft)	4	7
Basswood (light color)	4	9	Maple, sugar (hard)	5	11
Beech	5	12	Oak, red, northern or upland	5	21
Birch, paper	2	4	Oak, white, northern or upland	5	23
Birch, yellow	5	12	Oak, red, white, southern lowland	6	( <sup>c</sup> )
Buckeye	3	6	Osage—orange	6	14
Butternut	5	10	Pecan	4	( <sup>c</sup> )
Cherry	5	10	Persimmon, common	5	12
Chestnut	4	8	Sweetgum, heartwood (red gum)	6	15
Cottonwood, normal	4	8	Sweetgum, sapwood (sap gum)	4	10
Cottonwood, wet streak	4	10	Sycamore	4	8
Dogwood	5	12	Tupelo, black (black gum)	4	8
Elm, American, slippery	4	9	Tupelo, swamp	5	10
Elm, cedar, rock	5	13	Tupelo, water	5	( <sup>c</sup> )
Hackberry	4	7	Walnut, black	5	11
Hickory	4	10	Willow	4	10
Holly	5	12	Yellow-poplar	3	6

<sup>a</sup>Approximate time to dry to 6% MC, prior to equalizing and conditioning, in kilns with air velocities through the load of 200 to 450 ft/min (1 to 2 m/s). In practice, drying times are at least 25% longer than table values.

<sup>b</sup>For most woods, 20% MC; for slow-drying woods like oak, pecan, and hickory, 25% MC.

<sup>c</sup>This lumber should be dried in a shed before kiln drying.

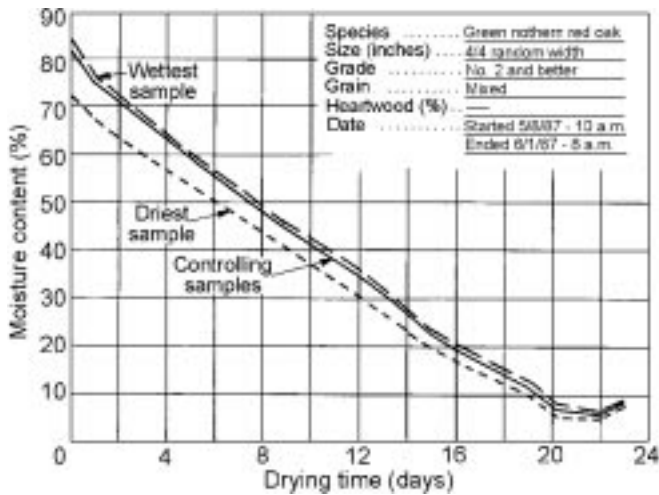

Figure 7.7—MC levels obtained during a drying run.

It is not practical to establish green stock drying curves for all species and thicknesses of lumber. Approximate curves can be estimated by using drying time factors for the most common thicknesses. One such set of factors was developed by Higgins (n.d.) to predict total drying time. Such factors have a theoretical base related to diffusion and other aspects of wood drying, but these factors were empirically developed after several years of experience in commercial drying of foreign and domestic woods. They are roughly corroborated by other commercial drying time data. In this manual, the drying time factor for 4/4 stock is set at 1.00 (Table 7.26).

The factors for 4/4 and 8/4 lumber indicate that 8/4 stock will require 2½ times as long as the time required to dry 4/4 stock. Actual drying times will vary, depending on actual thickness, width, percentage of heartwood, and quality of stock.

## Operational Considerations

### Inclusion of Small Amounts of Lumber in Large Loads

Small amounts of fully air-dried lumber ( $\leq 20\%$  MC) can be kiln dried with air-dried stock of species that take other basic kiln schedules, but final MC and stress relief may not be as satisfactory as when the lumber is dried with a species of its own group. If the only hardwood kiln available is used for drying green or partly air-dried stock, arrangements should be made to put the small amount of air-dried lumber in the kiln sometime after it is started, when the major stock and the small amount of air-dried material have about the same MC.

Another approach is to reduce the MC of small amounts of air-dried stock to the proper level by heated room drying, which is described later in this manual. However, such

Table 7.26—Drying factors for different thicknesses of lumber of the same species

Thickness	Drying time factor
3/4	0.62
4/4	1.00
5/4	1.38
6/4	1.75
8/4	2.50
10/4	3.38
12/4	4.38
14/4	5.62
16/4	7.12

drying may leave the wood with unrelieved drying stresses, which can cause warp when the lumber is machined.

### Heating, Humidification, Venting, and Air Circulation

Many older kilns were designed for drying air-dried hardwoods. These kilns usually cannot dry green hardwoods very efficiently—they have inadequate heating, humidification, and circulation systems. Many older kilns also have inadequate venting for the rapid drying of green stock of fast-drying species.

It is easy to determine if a kiln is short of heating capacity. If the heating system is inadequate, the kiln will require more than 4 h to reach the desired elevated temperature. If circulation and boiler capacity are adequate and if other equipment is functioning properly, a kiln manufacturer can often add more heating pipe or ducts.

In a kiln with inadequate humidification, the steam spray will run continuously but the required depression cannot be achieved; lumber cannot be conditioned adequately in such cases. If the required depression cannot be achieved even though little or no superheat is present, the vents are closed tightly, there are no leaks or cold spots (especially on the floor, doors, or roof), and the spray line and holes or nozzles are not plugged, a larger steam supply is needed. Increasing only the pressure will increase the superheat and may not solve the problem. Cold water misting may be the only reasonable solution.

If venting capacity is inadequate and moist air cannot be exhausted rapidly, the wet-bulb temperature will be higher than desired. The result is slow drying with a risk of stain development, especially in the light-colored species. Restricted use of steam spray during kiln warm-up and removal of snow from the lumber before the kiln is loaded can help reduce the amount of moisture that must be removed.



However, in most cases of inadequate venting, the size or number of vents must be increased, or power (that is, fans in the vents) can be installed. Power vents can be part of a vent energy recovery system as well as provide adequate venting.

The recommended kiln schedules are based on a velocity through the load of 200 to 400 ft/min (1 to 2 m/s); for some white non-refractory species, velocities up to 600 ft/min (3 m/s) are reasonable. Increasing the velocity in the early stages of drying for refractory species like oak and beech will accelerate drying, but it will also increase the risk of surface checking. In general, if the lumber MC exceeds 40%, higher airflow will increase drying and lower airflow will retard drying. However, if the lumber MC is below 20%, velocity will have little effect on drying rate.

Any increase in velocity will usually improve heating and venting; any decrease will reduce heating and venting. In summary, changes in airflow design and in fan speed usually require the advice of a kiln engineer.

## Humidity Control With High Pressure Steam

Some hardwood dry kilns are heated with  $>20 \text{ lb/in}^2$  ( $>14 \text{ kPa}$ ) steam. Such high pressure steam is very economical. The hotter coils mean that less finned heating pipes are required with smaller steam feed lines and heat control valves, compared to a low pressure system operating at  $<10 \text{ lb/in}^2$  ( $<70 \text{ kPa}$ ). Higher pressure steam can also be piped for longer distances more easily. However, the heat of high pressure steam makes it unsuitable for use in the humidity spray system. When the steam is injected into the kiln, the steam is so hot and so dry that it raises the dry-bulb temperature excessively when the wet-bulb temperature is raised; consequently, it is impossible to carry a  $4^\circ\text{F}$  or  $5^\circ\text{F}$  ( $2^\circ\text{C}$  to  $3^\circ\text{C}$ ) wet-bulb depression during the initial stages of some schedules or to obtain a  $10^\circ\text{F}$  ( $6^\circ\text{C}$ ) wet-bulb depression for conditioning and stress relief at the end of a charge. Modifying the conditioning procedure by using a conditioning temperature  $10^\circ\text{F}$  ( $6^\circ\text{C}$ ) hotter than equalizing or cooling the lumber before conditioning can both be helpful when steam pressures are not too high. For steam pressures  $>60 \text{ lb/in}^2$  ( $>413 \text{ kPa}$ ), a desuperheater or a combination of steam and water spray system is needed.

A desuperheater system reduces the pressure of the steam to just a few pounds/square inch ( $1 \text{ lb/in}^2 = 6.89 \text{ kPa}$ ) and then injects liquid water into the reduced pressure steam. The vaporization of the water uses the excess superheat, so that the output of the desuperheater is low-pressure, saturated steam—an ideal supply of steam for conditioning. Cold water misting is another effective solution.

## Part-Time Kiln Operation

Part-time drying (that is, running the kilns perhaps 5 days/week and shutting them off during the weekends) is

technically feasible for air-dried stock. It is not a recommended practice, however, for green or partly air-dried stock even when proper care is used in schedule application and operating procedures. The risk of stain with white woods is high. Rasmussen (1961) recommended full-time drying during the first stages of drying refractory hardwoods as well.

In summary, the technology of part-time drying has not been adequately established to include recommended procedures, recommended schedules, and predicted drying times in this publication. The potential savings in not running a power plant 7 days/week are offset by longer drying times, increased energy usage, and the risk of losing quality.

## References

- Boone, R.S.; Kozlik, C.J.; Bois, P.J.; Wengert, E.M.** 1993. Kiln schedules for commercial species of lumber. Madison, WI: Forest Products Society.
- Boone, R.S.; Milota, M.; Danielson, J.D.; Huber, D.W.** 1991. Quality drying of hardwood lumber: guidebook-checklist. Gen. Tech. Rep. FPL-IM-GTR-2. Madison, WI: U. S. Department of Agriculture, Forest Service, Forest Products Laboratory. 56 p.
- Chen, Z.; Wengert, E.M.; Lamb, F.M.** 1994. A technique to electrically measure the moisture content of wood above fiber saturation. *Forest Products Journal*. 44(9): 57-62.
- FPL.** 1999. Wood handbook: wood as an engineering material. Gen. Tech. Rep. FPL-GTR-113. Madison, WI. U.S. Department of Agriculture, Forest Service, Forest Products Laboratory. 463 p.
- Higgins, N.C.** n.d. A rule-of-thumb method for estimating drying time. Release 8,023. East Lansing, MI: Cooperative Extension Service, Department of Forest Products, Michigan State University.
- Rasmussen, E.F.** 1961. Dry kiln operator's manual. Agric. Handb. 188. Washington, DC: U.S. Department of Agriculture, Forest Service. 197 p.
- Simpson, W.T. ed.** 1991. Dry kiln operator's manual. Agric. Handb. 188. (Rev.) Washington, DC: U.S. Department of Agriculture, Forest Service. 274 p.
- Simpson, W.T.; Verrill, S.P.** 1997. Estimating kiln schedules for tropical and temperate hardwoods using specific gravity. *Forest Products Journal*. 47(7/8): 64-68.
- Solliday, D.S.; Armstrong, J.P.; Dawson-Andoh, B.E.** 1999. Dehumidification drying of red oak. Part 1. Chemical characterization of volatile organic compounds. *Forest Products Journal*. 49(7/8): 21-23.
- Ward, J.C.; Pong, W.Y.** 1980. Wetwood in trees: a timber resource problem. Gen. Tech. Rep. PNW-112. Portland, OR: U.S. Department of Agriculture, Forest Service, Pacific Northwest Forest and Range Experiment Station. 56 p.



# Chapter 8—Advanced Kiln Drying Procedures

## Modifications to General Hardwood Schedules

Once a kiln operator has dried a certain species and item by a general kiln schedule without causing defects or excessive degrade, modification of the schedule to reduce drying time should be considered. Perhaps the lumber can stand a more severe schedule without developing serious defects, or the dried product does not need to be free of defects. The operator should try to develop the fastest drying schedules consistent with acceptable amounts and types of defects. Schedules should be modified in a systematic way, for which good records are helpful. It must be recognized, however, that schedule modification satisfactory for lumber from one source and dried in one kiln may not be satisfactory for lumber from another source and dried in a different kiln.

To accelerate the drying process, the first move in systematic schedule modification is to shift from one wet-bulb depression class to another (for example, from class C to D), the second modification is to shift to the next higher wet-bulb depression schedule (for example, from schedule 4 to 5), and the third modification is to shift temperature schedules to obtain a higher starting temperature (for example, from schedule T3 to T5). After each modification, the new schedule needs to be thoroughly tested and evaluated for quality.

If a schedule is too severe it can be slowed down by reversing the modification procedure. The first step in slowing down a schedule is to shift the temperature schedule to obtain a lower starting temperature (for example, from schedule T3 to T2). The modification to smaller wet-bulb depressions (for example, from schedule 4 to 3) must be done carefully to avoid adding moisture back to the lumber. Changes in wet-bulb depressions can be delayed by shifting to a lower class (for example, from class C to B).

## Changes in Moisture Class and Wet-Bulb Depression Schedule

The moisture content (MC) classes (Ch. 7, Table 7.6) are set up so that a species of wood can be classified in accordance with the green MC of its heartwood. The MC limits of the classes were chosen on a conservative basis. Thus, the first modification that a kiln operator should consider is to shift to a higher moisture class, particularly if the green MC is near the upper end of the values in the class. For example,

4/4 northern red oak with 95% MC has been successfully dried in pilot tests using the E2 schedule instead of the D2 schedule, saving 4 or 5 days in drying time. By changing to the E2 schedule, the first increase in wet-bulb depression is made at 60% MC rather than 50% MC. This modification is especially useful when the lumber to be dried consists primarily of sapwood.

The next modification that should be considered is to shift to the next higher wet-bulb depression schedule number. This modification results in an increased wet-bulb depression at each MC level, which may cause minor surface and end checks. A drastic change in wet-bulb depression may cause severe surface and end checks.

## Changes in Temperature Schedules

Controlling temperature is critical in preventing collapse and honeycomb, two defects that may not appear until late stages in the drying process. Until the kiln operator has gained experience in drying a particular species and thickness, the recommended temperature schedule should be followed. The general temperature schedules will safely dry most lumber used in commercial drying. If the lumber being dried consists of almost all sapwood or is relatively free of natural characteristics that contribute to drying defects, increasing the temperature (T) number by 1 or 2 to obtain a 10°F (6°C) greater initial temperature is generally permissible. For example, a 9/4 all-sapwood sugar maple charge free of pathological heartwood and mineral streak is dried on a T7 temperature schedule instead of the recommended T5 schedule. The milder T5 schedule would be used for drying a charge of sugar maple that had a considerable amount of heartwood or mineral streak.

## Changes Within Schedule

The only significant change that can be made within a wet-bulb depression schedule is a more rapid reduction of the wet-bulb temperature during the intermediate stages of drying. The logical approach is to increase the wet-bulb depression in steps 3 and 4 of Table 7.6 (Ch. 7). This modification should be approached with caution, and several charges should be dried before the schedule is further modified. If any objectionable amount of checking occurs, slowly change the wet-bulb depression to the previously satisfactory schedule.

## Special Hardwood Schedules

Although the general hardwood schedules, with minor modifications, will do a good job of drying most species for most end uses, special purpose schedules are advantageous in some cases.

### Maximum Strength Schedules

Exposure of wood to temperatures above 150°F (66°C) can cause permanent strength reduction. At kiln temperatures of 200°F (93°C) or less, only prolonged exposure causes excessive strength reduction. Thus, the general drying schedules and proper operating procedures do not significantly reduce the strength of the lumber; lumber strength is sufficient for most end uses. However, when the wood is to be used for products requiring high strength per unit weight, such as aircraft, ladders, and sporting goods, somewhat lower temperatures should be used in drying. Table 8.1 lists temperature schedule codes for various hardwood species; Table 8.2 lists the actual maximum drying temperatures at various MC levels recommended for these schedules. For example, from Table 8.1, 4/4 white ash lumber has a temperature schedule number of 5. Then, from Table 8.2, the maximum drying temperature at 40% MC is 125°F (52°C). Any general schedule used should thus be modified to stay below these maximum temperatures. Wet-bulb depressions should remain the same as listed in the general schedules.

### Warp and Shrinkage Reduction

A number of measures for warp reduction are described in Chapter 2. A major method for reducing warp is to dry

**Table 8.1—Temperature codes for maximum strength retention for various species and lumber thicknesses**

Species	Temperature code by lumber thickness				
	4/4	6/4	8/4	12/4	>12/4
Ash, white	5	5			
Birch, yellow	5	5			
Cherry, black	5	5			
Mahogany, African	5	5			
Mahogany, true	5	5			
Maple, hard	3	3			
Maple, soft	3	3			
Oak, red	8	8			
Oak, white	8	8			
Sweetgum	6	6			
Yellow-poplar	3	4	5	6	7
Walnut, black	4	4			

lumber rapidly by natural air drying or by accelerated air drying (assuming that the lumber is piled properly). Research on red oak has shown that shrinkage is reduced by using lower temperatures and rapid reduction of relative humidity (RH) (McMillen 1963). The effect is uniform from 140°F to 95°F (60° to 35°C). From 95°F to 80°F (35°C to 27°C), the effect is greater because more of the wood is affected by tension set. Tension set tends to resist shrinkage of the board and thus reduces warp. This is a major part of the reason why air drying results in the least shrinkage and warp. Compression set in the interior of the wood is also important because it tends to increase board shrinkage and warp. Thus, the drying of green oak with an initial temperature above 110°F or 115°F (43°C or 46°C) would be expected to produce more than the normal amount of warp.

With 4/4 stock, the effects of uniform thickness, good stacking, and restraint may overcome the effects of temperature differences. No significant difference was detected in the warp of 4/4 green sugar maple with initial temperatures of 110°F to 160°F (50°C to 71°C) when the same EMC was used in all runs (Rietz 1969). For thicker stock, in which compression set probably has more influence, use of lower than customary initial temperature and RH is probably helpful.

No series of low-shrinkage, low-warp schedules has been developed. The kiln operator who is able to extend kiln-drying time slightly longer than required can experiment with lower RH schedules by using slightly higher initial wet-bulb depressions. The lower the wet-bulb temperature, the easier it is to achieve a lower dry-bulb temperature in the kiln. Changes from recommended or basic schedules should be slight at first, and the kiln operator needs to observe the stock in the kiln frequently to see whether any surface checking is developing. Any such experimentation, of course, should be done only with the consent of the management.

**Table 8.2—Maximum drying temperature for maximum strength retention by temperature schedule**

Moisture content (%)	Maximum temperature (°F) for various schedules <sup>a</sup>					
	3	4	5	6	7	8
>40	130	125	120	115	110	105
40 to 30	135	130	125	120	115	110
30 to 25	140	135	130	125	120	115
25 to 20	145	140	135	130	125	120
20 to 15	150	145	140	135	130	125
15 to 10	155	150	145	140	135	130
10 to final	160	155	150	145	140	135

<sup>a</sup>See Table 8.1.  $T_c = [T_F - 32]/1.8$ .

## Dehumidification Schedules

A dehumidification (DH) dryer uses basically the same schedule as does a steam kiln. The difference between the two drying methods is in the hardware, not the way in which the wood is dried. However, a DH compressor generally begins to function at 80°F to 85°F (27°C to 29°C). Therefore, the starting temperature for a DH schedule is lower than that for a steam schedule. Because the wood will be stronger at low temperatures, the lower temperature may permit the RH to be lowered as well. Dehumidification kilns often have superior control systems, which allow the RH to be safely lowered without increasing the degrade. As most DH units cannot easily exceed 150°F (66°C) (some can reach 160°F (71°C)), the final temperature is usually limited to 150°F (66°C).

To convert a steam schedule to a DH schedule (Table 8.3), use the highest dry-bulb temperature possible with the equipment being used, but not higher than the recommended steam schedule temperature. Then use the same RH as is specified for the steam schedule for the same MC ranges. It may be possible to lower the RH, but this will have to be evaluated for each DH unit and will depend on velocity through the load as well.

## Adjustment of Moisture Content of Kiln-Dried Wood

Once wood has been kiln dried to a MC suitable for interior purposes, it should be stored in a heated or dehumidified shed or room (see Ch. 9). However, some situations require a change in lumber MC: (1) when the MC is too low for use in steam bending, boat construction, or the like, or (2) when the wood has not been properly stored and must be redried.

## Raising Moisture Content

If the MC is too low, a two-step procedure is advised. The lumber must be stickered in properly built piles and the void spaces of the kiln baffled. The exact schedule will depend on the MC desired and the time available. Allow 2 days for each step for 4/4 stock, longer for thicker material or large moisture differences. For the first half of the time required, use a kiln EMC equal to the desired MC. For the second half, use an EMC 3% higher. If enough time is available, use a kiln temperature of 130°F or 140°F (54°C or 60°C). For quicker results, 160°F or 180°F (71°C or 77°C) can be used. In either case, the vents should be closed during kiln warm-up. Steam spray should be used intermittently to avoid EMC values lower than the present MC or higher than the desired MC during the warm-up period. Do not allow moisture to condense on the lumber. Use the kiln sample procedure to monitor the moisture pick-up. If the rate is too slow, use a higher temperature with the same EMC value. The moisture level to which hardwoods can be easily raised is limited to about 13% MC, for it is difficult to maintain higher than 16% EMC in most kilns.

## Lowering Moisture Content

Redrying kiln-dried lumber that has been kept in uncontrolled storage requires great care. Otherwise, surface checks that were tightly closed may become permanently opened or internal hairline checks can occur. If the storage period has been short, tightly bundled lumber can be redried in the bundles because most moisture pick-up will have been on the board ends and the surfaces of exposed boards. For longer storage or for lumber that has been kept outdoors on stickers, the lumber must be stickered for redrying.

**Table 8.3—Example of conversion of steam schedule to DH schedule using T3–D2 for 4/4 red oak<sup>a</sup>**

Steam schedule				DH schedule			
MC (%)	Dry-bulb (°F)	Wet-bulb (°F)	RH (%)	MC (%)	Dry-bulb (°F)	Wet-bulb (°F)	RH (%)
>50	110	106	87	>50	90	86	87
50 to 40	110	105	84	50 to 40	90	85	84
35 to 40	110	102	75	35 to 40	95	88	75
30 to 35	110	96	60	30 to 35	100	87	60
25 to 30	120	90	31	25 to 30	110	82	31
20 to 25	130	90	21	20 to 25	120	82	21
15 to 20	140	95	19	15 to 20	130	90	19
<15	160	115	26	<15	150	108	26

<sup>a</sup>Note that MC and RH values are identical in each schedule. The DH dry-bulb temperature is determined on the basis of experience with the equipment. The DH wet-bulb temperature is calculated using the dry-bulb temperature and RH. Because the dry-bulb temperature is lower in the DH schedule, it may be possible to lower RH slightly, taking advantage of the stronger wood and offsetting the slower drying that occurs at lower temperatures.  $T_c = [T_F - 32]/1.8$ .

Two temperature steps are suggested for the redrying operation. The first step should be about 1 day long at 130°F or 140°F (54°C or 60°C). The second step should be at the final temperature of the drying phase of the basic schedule (see Ch. 7), usually 160°F (71°C), for the species and size involved. The second temperature can be achieved by using several smaller steps, rather than making a 20°F (11°C) or greater immediate jump in temperature. Do not use steam spray during kiln warm-up. Surface checks already present may open, but they will close again as the wood dries. When the first kiln temperature is reached, set the wet-bulb controller to achieve a start-up EMC that is numerically halfway between the current MC of the lumber and the MC desired. For the final step, set the controller to give an EMC 2% below the desired MC. When the wettest kiln sample reaches the desired MC, stop the drying.

## Alternative Schedules for Some Species

Improvements in kiln schedules have always been sought to shorten drying time and decrease cost without sacrificing quality. This quest has been intensified with the increased competitiveness of the kiln-dried lumber market. However, this objective must be kept in perspective—the cost of running a kiln is about \$3/day/thousand board feet, and the profit is about \$30/day/thousand board feet. If shorter time results in quality loss, the potential profit disappears quickly.

When the recommended schedules were devised, dry kilns varied considerably in their performance, operation, and care. The schedules were therefore purposely conservative. In many cases, schedules can be accelerated and considerable savings will result. The extent to which the schedules can be sped up while maintaining a very low level of drying defects depends on

1. attention to detail of the fundamentals (for example, proper sample selection, good records),
2. the drying system involved (for example, extent and uniformity of predrying, kiln design), and
3. the specific characteristics of the wood (for example, fast grown or slow grown).

Some species have peculiar drying characteristics as well as some other reason for a special drying schedule; comments about these schedules are included in Chapter 7, Table 7.4.

### Aspen

Aspen trees sometimes develop a darkened (typically black or brown) area of wet-pocket wood in the center of the tree. This wood, usually considered to be bacterially infected, is slow drying and susceptible to collapse. This wood is more common in the lower grade boards sawn from near the heartwood–sapwood transition and from the center of the log.

The upper grades of lumber sawn from the outside of larger logs can still be dried by the recommended general schedule.

Now that aspen is being used for a wider array of products than crating and rough lumber, consideration must be given to minimizing collapse. This defect is a principal problem in drying aspen. The uppermost grades of lumber sawn from the outside of larger logs, as well as crating lumber, can still be dried by the schedules in Table 7.22 (Ch. 7).

### Hickory

Upper grades of hickory are sometimes used for high-quality specialty products, such as tool handle and ladder-rung stock, and require a slightly more conservative schedule to develop maximum strength than the basic schedule listed in Table 7.4. Improved color schedules, using cooler temperatures and lower initial RHs can also be used.

### Swamp and Water Tupelo

The heartwood and sapwood of swamp and water tupelo dry quite differently. When these species can be separated, it is advantageous to dry them separately by different schedules.

### Sugar Maple

Some end uses of sugar maple put a premium on the whitest sapwood; the special schedule given in Table 7.4 (Ch. 7) will accomplish this.

Sugar maple sometimes has mineral streaks that are impermeable and subject to collapse and honeycomb during drying. When drying 4/4 maple that contains mineral streak or other character marks, many kiln operators satisfactorily use T5–C3.

Fine internal hairline checks that do not appear in 8/4 and thicker maple until manufacture or use have sometimes been a costly problem. These checks are believed to be caused by stresses from surface moisture regain at 20% to 50% MC, as well as improper redrying of previously kiln-dried stock.

### Ash, Maple, and Other White Woods

It is well known that using low RH initially on green lumber results in brighter, whiter lumber. Also, lower kiln temperatures result in brighter and whiter material. Therefore, T5–C5, which specifies a lower initial temperature and humidity than does the basic schedule, is generally recommended for 4/4 through 6/4 thicknesses of white lumber, including ash, aspen, birch, basswood, hard and soft maple, hackberry, and yellow-poplar.

### Red Oak

Significant energy and cost savings can result from shortening the drying time. If the green MC is very high, the first acceleration is to change from schedule T4–D2 to T4–E2.

This will accelerate changes in the wet-bulb depression. Although the initial 4°F (2°C) depression is the same as in the basic schedule, the 5°F (3°C) depression of the second step is started at 60% MC instead of 50% MC. The depression then moves to 8°F (4°C) at 50% and so on. (Dry-bulb temperature values do not change.)

If T4–E2 works well for several charges, with no surface checking, the next change should be to schedule T4–E3 (Table 8.4). In this change from E2 to E3, the initial wet-bulb depression is increased. The starting depression is 5°F (3°C) rather than 4°F (2°C). Subsequent wet-bulb depressions are also increased. In a kiln with well-calibrated instruments and good construction, T4–E3 should work well, but a slight amount of surface checking could occur on the edges of the load where air enters.

The 45°F (25°C) depression prescribed in this handbook for the latter stages of drying is only a guide. In general, the kiln operator should manually turn off the steam spray and set the wet-bulb controller so that the vents stay closed during the latter half of the drying schedule. If the wet-bulb temperature does not come down to the value shown for each step in the basic schedules, the kiln operator may want to open the vents for short periods only. However, when a dry-bulb temperature of 160°F (71°C) or higher is reached, the vents should be kept closed.

## Presurfaced Northern Red Oak

Experimentally, some accelerated drying of oak has been obtained by presurfacing the lumber and then using an accelerated kiln schedule (Wengert and Baltes 1971). Pilot tests have been made on presurfacing and the accelerated kiln schedule it permits (Cuppett and Craft 1972, Rice 1971). Drying time savings were estimated to be 24% or higher and kiln capacity was increased 8% to 12%.

**Table 8.4—Accelerated kiln schedule for 4/4 and 5/4 northern or upland red oak with high initial moisture content<sup>a</sup>**

Moisture content (%)	Dry-bulb temperature (°F)	Wet-bulb temperature (°F)	Depression (°F)
>60	110	105	5
60–50	110	107	7
50–40	110	99	11
40–35	110	91	19
35–30	110	— <sup>a</sup>	30
30–25	120	— <sup>a</sup>	40
25–20	130	— <sup>a</sup>	45
20–18	140	— <sup>a</sup>	45
<18	160	— <sup>a</sup>	45

<sup>a</sup>Some risk of slight surface checking. Vents closed, steam spray shut off, accept whatever depression occurs, as long as it does not exceed the value prescribed.

## Bacterially Infected Oak

Oak lumber infected with heartwood anaerobic bacteria is highly susceptible to internal checking when dried by normal or accelerated oak schedules. Both honeycombing and ring separation occur (Ward 1972; Ward and others 1972). Research has shown that material in the advanced stage of infection is especially subject to surface checking and honeycombing. Infected oak logs should be sawed into 4/4 lumber, rather than thicker lumber. Good results were obtained when 4/4 infected lumber was forced air dried to 20% MC by an 8/4 oak procedure (Cuppett and Craft 1972). Almost as good results were obtained when kiln drying was started at 25% MC. Low air velocity was used, and the fans were run only half the time for the first 11 days of forced air drying.

## Other Species

Not all the recommended kiln schedules are so conservative that they can be modified as much as the oak schedule. See Table 7.4 in Chapter 7 for a listing of schedules and comments for each species.

## Thick Lumber

Kiln drying hardwoods thicker than 8/4 from the green condition is often impractical because of the long kiln time. A common practice is to air dry, shed dry, or use a predryer before kiln drying. Table 8.5 is an index of suggested schedules for 10/4 and thicker hardwood lumber. These schedules are not as well established as those for thinner lumber and should be used with caution.

## Kiln Operational Techniques

### Using a Kiln Schedule

There are three important aspects of using a kiln schedule:

1. Always make sure to “get what you set.” That is, if the schedule calls for 78% RH at 120°F (49°C), make sure that the kiln achieves these conditions within several hours after start-up and maintains these conditions until the settings change. If the kiln cannot achieve and maintain these conditions, then load the kiln partially full, rather than completely, at the start. With a partial load, the kiln can heat faster and vent excess moisture faster. After 1 or 2 days, load the remaining lumber.
2. When initially starting a schedule and once drying starts, the rule is “Don’t let lumber regain moisture.” Regain of moisture, especially at about 20% MC, will accentuate warp, cracks, and checks and may result in stain.
3. Inspect the lumber in the kiln daily to stop any problems before they become catastrophic. This inspection includes measuring the MC and evaluating the daily rate of moisture loss.

**Table 8.5—Kiln schedule designations for 10/4 through 16/4 hardwood lumber<sup>a</sup>**

Species	Thickness		
	10/4	12/4	16/4
Alder, red	T5–C3	T5–C3	
Ash, white	T5–B3	T3–B2	T3–A1
Aspen	T7–E5	T7–D5	T7–C4
Birch, yellow	T5–B3	T3–B2	T3–A1
Blackgum	T11–D3	T9–C2	T7–C2
Boxelder	T5–C2		
Cherry	T5–B2	T3–B2	T3–A1
Cottonwood	T5–E3	T5–D2	
Cottonwood (wet streak)	T3–D3	T3–C2	
Elm, American	T5–D2	T3–C2	
Elm, rock	T3–B2	T3–B1	T3–A1
Hackberry	T5–C3	T5–C2	T3–B1
Maple, soft	T5–C2	T3–B2	
Maple, hard	T3–B2	T3–A1	T3–A1
Oak, red, upland	T3–C1	T3–C1	
Oak, white, upland	T3–B1	T3–B1	
Sweetgum (red gum, heartwood)	T5–C2		T5–B2
Sweetgum (sap gum, sapwood)	T11–D3	T9–C3	
Sycamore	T3–D1	T3–C1	T3–B1
Tupelo, black	T11–D3	T9–C2	T7–C2
Walnut, black	T3–D3	T3–C2	
Yellow-poplar	T9–C3	T7–C2	T5–C2

<sup>a</sup>Source: USDA Forest Service, Forest Products Laboratory. All schedules changed to 160°F (71°C) maximum dry-bulb temperature. For hard maple, after 30% MC is reached, gradually shift to T3–B2.

In addition to these three basic rules, other guidelines involving equipment, lumber handling and sampling, start-up, and procedures during the run must be followed to minimize the risk of quality losses.

### Equipment

The first step in using a schedule is to ensure that the equipment is operating properly:

- Fans are all operating and all are running in the same direction.
- Steam traps are functioning.
- Steam spray line is correctly aligned, sloping either downward with a drain at the end and the holes on the upper half or upward with a drain or trap at the inlet end.
- Heating fin pipe is clean with minimal corrosion.

- Vents are operating properly.
- Gas pressures in a dehumidification (DH) unit are adequate.
- Control equipment is accurate, especially when drying lumber with high MC.

### Lumber Handling and Sampling

The next step is to ensure that the lumber is handled properly and the samples are taken correctly:

- Lumber is correctly stickered and bolsters are in proper position.
- Lumber is loaded correctly into the dryer without encroaching into the plenum area and with 4 in. (102 mm) between packs, edge to edge.
- Baffles are in position.
- Samples represent both the wettest and driest lumber in the dryer (use electric moisture meter when selecting samples).
- Special samples have been cut to assess any preexisting damage.
- Samples are properly located within lumber stacks in sample pockets, especially when MC > 25%.

### Start-Up

Next, the kiln must be started correctly:

- Fans should be started before the doors are fully closed to avoid risk of implosion.
- Conditions that add moisture back to the lumber should be avoided, especially during start-up; steam spray is never used initially on partly or fully dried lumber until the lumber has been fully warmed.
- Low temperatures can be used for an extra safety margin on wetter lumber.
- Vents are not opened until operating temperatures are reached.
- DH compressors are not operated until the correct operating temperature is achieved.

### Procedures During Run

Once drying has started, procedures must be followed to ensure high quality and correct final MC:

- Entrance doors to the kiln have required safety brackets; workers wear hard hats; tops of lumber piles are examined for lumber that might fall; equipment is “locked out” to avoid accidental starting; and another person is nearby to assist in the event of trouble.



- Fans reverse circulation frequently when lumber MC > 30%.
- Conditions in the dryer are those specified; otherwise, dryer must be shut down until proper conditions can be achieved or any problems are corrected.
- Samples are inspected daily, especially when MC > 30%.
- Intermediate moisture samples are cut whenever initial MC > 25%.
- Rate of MC loss is measured daily, especially when MC > 40% MC.
- Water condensation on floor when drying lumber at 4°F or 5°F (2°C or 3°C) depression should be minimal. Excessive condensation indicates either that conditions are more humid than indicated by controls or the floor is not well insulated and is therefore cool. In the latter case, the perimeter of the kiln foundation should be insulated. A floor drain is essential.
- The dryer should not oscillate between spraying and venting.
- DH compressor should not turn on and off frequently but should run for at least 30 min before shutting off and then not restart for at least another 15 min.
- New final MC samples should be prepared before the kiln is shut off.
- When drying is complete, evaluation samples should be prepared for such variables as stress, checks, and MC.
- Electric moisture meter is used to evaluate MC of lumber as various packs are being unloaded.

## Fine Tuning Schedule With Drying Rate

All the kiln schedules are intended as guidelines, with common sense used to fine tune them. The schedules act like highway speed limit signs. The signs indicate the maximum speed, but the driver should not go that fast when common sense indicates that it isn't safe. Experience is an important factor in drying hardwood lumber. Furthermore, knowing that many older kiln control instruments often have a 1°F to 2°F (1°C) error, it is easy to understand why a 4°F (2°C) depression indicated on the instrument can unintentionally result in too rapid or too slow drying.

To fine tune the drying process, the response of the lumber is monitored, especially in the critical stages of drying, Stages I and II. On a day-to-day, practical basis, one way to monitor lumber response is to visually inspect the samples, watching for staining or checking. Another way is to measure the drying rate of the samples and compare the actual rate to the safe rate. For every species and thickness, there is a safe rate of drying (percentage of MC loss per day) that will result in high quality dried lumber. Exceeding this rate greatly

**Table 8.6—Safe drying rates for 4/4 and 8/4 lumber**

Species	MC loss/day (%)	
	4/4	8/4
Ash, white	10.4	4.1
Beech	4.5	1.8
Birch, yellow	6.1	2.4
Cherry	5.8	2.3
Elm, American	10.4	4.1
Maple, hard	6.5	2.6
Maple, soft (sapwood)	13.8	5.5
Oak, red, upland	3.8	1.5
Oak, red, lowland	1.0–3.8	—
Oak, white, upland	2.5	1.0
Red gum	5.3	2.1
Tupelo	10.9	4.3
Walnut	8.2	3.3
Yellow-poplar	13.8	5.5

increases the risk of quality loss. Likewise, going considerably under the safe rate can increase the risk of staining and can be quite expensive. Safe drying rates for major hardwoods are given in Table 8.6. These are daily rates and not the average of several days of drying; that is, 8% MC loss today and 2% MC loss tomorrow does not average to 5% MC loss per day when considering the safe rate. As mentioned, the safe rate applies to the drying of wet lumber (Stages I and II) when drying defects, especially surface checking and internal checking, are most likely.

The safe rate applies to each sample individually, not the average of all or some samples. That is, the drying rate of no individual sample should exceed the safe rate. The one exception occurs when the lumber is freshly sawn and has some additional moisture from rain or snow or from an anti-stain dip treatment. It is possible that initial drying (day 1) can safely exceed the safe rate because of the rapid evaporation of surface moisture.

It has been suggested that stress levels on the lumber surface can be monitored, moderating conditions when stresses are too high or accelerating drying when stresses are too low. It has also been demonstrated that a sensitive microphone can monitor microchecking and therefore potentially indicate when drying conditions are too severe. However, both of these ideas are not yet commercially practical.

## Advanced Equalizing and Conditioning Techniques

Advanced equalizing and conditioning procedures include techniques for equalizing with steam, conditioning with steam, and measuring transverse and longitudinal stress.

## Equalizing With Steam

To achieve rapid equalization for those schedules that conclude at 160°F (71°C) or lower, the suggested dry-bulb temperature is 170°F (77°C). To achieve the correct EMC, the wet-bulb temperature needs to be increased by 10°F to 15°F (6°C to 8°C), which may require steam to be injected into the kiln. However, when the wet-bulb temperature is raised by adding steam, the dry-bulb temperature may also increase and reach a temperature higher than desired. To overcome this effect, it is suggested that the wet-bulb be increased first to the correct setting for a 170°F (77°C) dry-bulb; however, the desired dry-bulb is left at 160°F (71°C). Several hours later, heat is added, if necessary, to raise the dry-bulb temperature to the desired setting. Specifically, if the final schedule settings are 160°F (71°C) dry-bulb and 115°F (46°C) wet-bulb and the equalization setting is 5% EMC, the equalization conditions are 170°F (77°C) dry-bulb and 135°F (57°C) wet-bulb. The operational procedures are to increase the wet-bulb to 135°F (57°C), but not to change the dry-bulb. After the wet-bulb reaches 135°F (57°C), which should take approximately 1 h, then the dry-bulb is increased to 170°F (77°C). Because of the heat in the steam spray that is released while raising the wet-bulb temperature, usually little additional heat is required to raise the dry-bulb temperature.

As an energy savings procedure, the same wet-bulb temperature should be equalized as specified in the final step of the schedule (often 115°F (46°C)). To achieve the correct EMC, the dry-bulb temperature is lowered.

## Conditioning with Steam

The key for efficient stress relief or conditioning is to rapidly add moisture back to the surface of the lumber. This can be done by using a very high wet-bulb temperature—at or close to the dry-bulb temperature used for equalizing. Therefore, the conditioning dry-bulb temperature is usually 180°F to 190°F (82°C to 88°C). To achieve this dry-bulb temperature, the heat in the steam spray, rather than the heat in the heating coils, is used to increase the dry-bulb temperature.

Specifically, after equalizing at 170°F (77°C) dry-bulb, condition at 180°F (82°C) dry-bulb temperature. For a conditioning setting of 11% EMC (as required for a 7% final MC target), the wet-bulb would then be 170°F (77°C). To begin conditioning, first increase the wet-bulb temperature to 170°F (77°C), but turn off the heat, either by turning off a hand valve or an electric switch or by keeping the set point for the dry-bulb at 170°F (77°C). After several hours, the heat in the steam spray usually increases the dry-bulb temperature to 180°F (82°C). Add more heat at this time, if needed. Often, this procedure will shorten conditioning time by 4 h.

In some operations, the lumber is cooled after equalizing but before conditioning. Then, when the RH or wet-bulb temperature is increased for conditioning, very rapid moisture gain at the lumber surface is likely because the lumber is cool. This procedure is very attractive for DH operations where steaming capabilities are limited. Although conditioning time is very short with this cooling method, there is a risk that excessive compression set will be developed if conditioning is longer than necessary. Excessive compression set is called reverse casehardening. There is no cure for reverse casehardening, except heavy (and equal) planing of both faces to remove the compression set material mechanically.

## Measuring Transverse Stress

Two basic methods are used for preparing stress sections. The first technique indicates whether stress is present and how severe it is. The second technique provides a visual guide to the extent of moderate to severe stress. Both methods operate on the principle that stresses will become unbalanced when lumber is sawn.

The first method (Fig. 8.1) illustrates the reaction of sections that have residual drying stresses—the two outer prongs curve inward as a result of the release of tension set in the core, which occurs when the center is removed by the saw cut. (See discussion of stresses in Chapter 3.) In situations where drying stresses are moderate to severe, the prongs will touch and the contact may be quite tight. However, it is difficult to judge the extent of the stresses.

The second method visually distinguishes between moderate and severe drying stresses. As Figure 8.2 illustrates, the stress section is sawn to allow diagonally opposite prongs to bypass each other; the amount of bypass is related to the severity of drying stresses. After the section is cut from the sample board, the section is cut on lines P and Q but the section loosened by these cuts is not removed. Then, the section is cut along line R, which is approximately midway in the width of the section. The section is then sawn diagonally along S and its diagonally opposite counterpart. The diagonally opposite prongs and the loose center section are removed to allow the remaining diagonally opposite prongs to move freely.

Unfortunately, residual drying stresses and moisture gradients sometimes interact and can cause confusion. If the MC of the prong of a cut stress section is not the same as the MC of the shell, or if the prong MC is not approximately equal to the EMC of the air surrounding the prong, then the prong MC will change. Depending on the MC of the inner face of the prong, the inner face will either shrink and react as if casehardened, or it will swell and react as if reverse casehardened. The most accurate test for stress is done after the lumber has cooled and temporary moisture gradients have

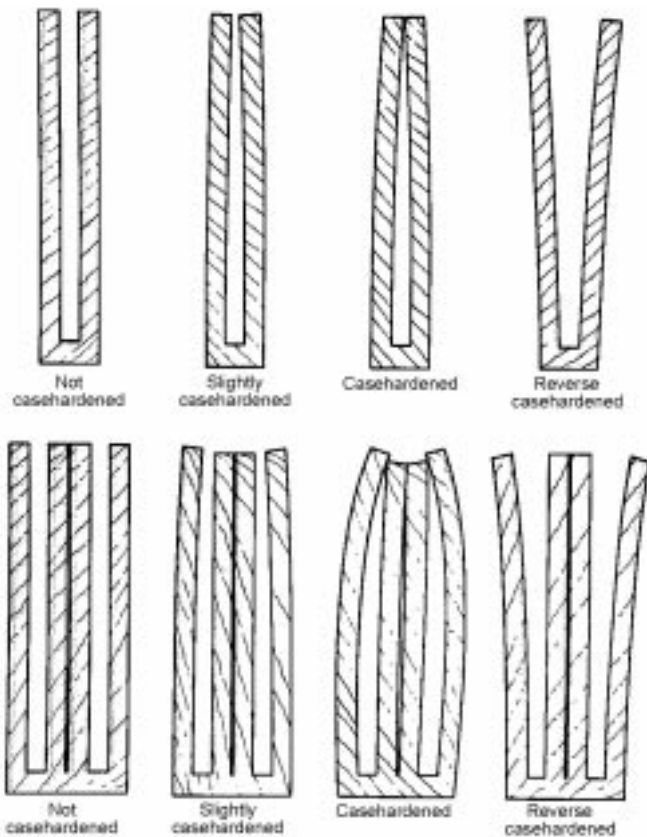

**Figure 8.1—Method of cutting stress sections for casehardening tests. Lumber <math><1-1/2\text{ in. (4 cm)}</math> thick is cut into three prongs and the middle prong is removed; lumber  $\geq 1-1/2\text{ in. (4 cm)}$  thick is cut into six prongs and the second and fifth prongs are removed.**

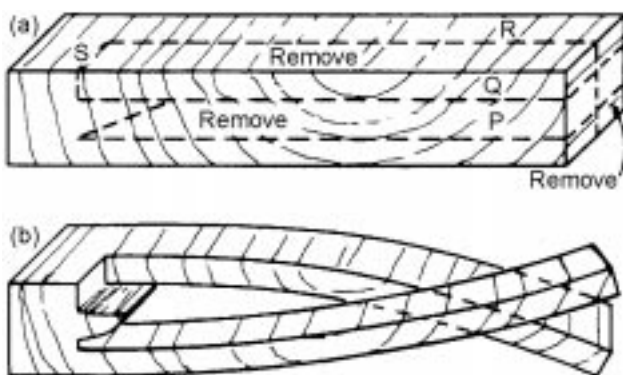

**Figure 8.2—Prongs for severe casehardening tests. (a) Method of cutting stress sections; (b) prongs offset so that they can cross and indicate severity of casehardening.**

dissipated, which may require 3 or more days after the kiln cycle is complete.

Immediately after drying and conditioning, the MC of the core is a little higher than that of the shell. When the prongs are cut, the moisture content of their inside surfaces is high enough so that these surfaces dry and shrink slightly when exposed to the surrounding air. The result is that the prongs, which might be straight when first cut (indicating no drying stress), will bend (pinch in) several hours later, indicating stress. If the prongs have a MC gradient when they are initially cut, the readings will not be accurate at this time; the correct readings will be the later ones, when no MC gradient is present. On the other hand, if there is no moisture gradient when the prongs are initially cut, then any drying stresses will cause immediate prong movement and the test results will be accurate at this time. Prong movement points to a situation that should be corrected to avoid warp upon resawing or machining: additional stress relief or equalization, or both procedures, is required.

In any case, the prong samples should always be allowed to sit in a warm room several hours before the final reading is obtained. The process of equalizing moisture in a prong test can be accelerated by heating the prongs at high power in a microwave oven for 15 s. After the prongs are cooled for several minutes at room temperature, the readings will be accurate.

### Measuring Longitudinal Stress

Occasionally, the transverse casehardening test shows no stress, but the lumber bows immediately when resawn or ripped. Bowing or curving is caused by longitudinal stress resulting from either longitudinal tension set in the surface zones (similar to transverse casehardening) or longitudinal shrinkage differentials caused by tension wood. These stresses are most likely to be unrelieved when conditioning temperature is under 160°F (71°C), when conditioning EMC is too low, or when conditioning time is too short. There are two tests for longitudinal stress: longitudinal stress sticks and ripped lumber.

Longitudinal stress sticks are sawn as shown in Figure 8.3. If the fingers of the stick warp immediately (when no moisture gradient is present), then longitudinal drying stresses or longitudinal growth stresses are present. Because the stick sawn with flatwise fingers (stick A) is sensitive to both growth and drying stress but the other stick (stick B) is only sensitive to growth stress, both types of sticks need to be sawn. Both stick A and stick B must be sawn from near the center of the lumber, not at the edge. If longitudinal stresses are a problem, ensure that the desired EMC is attained quickly in the kiln. Additionally, equalize the lumber properly and make sure that the recording instrument is calibrated. If longitudinal stresses are still a problem, the wet-bulb temperature can be raised 1°F (1°C) over the

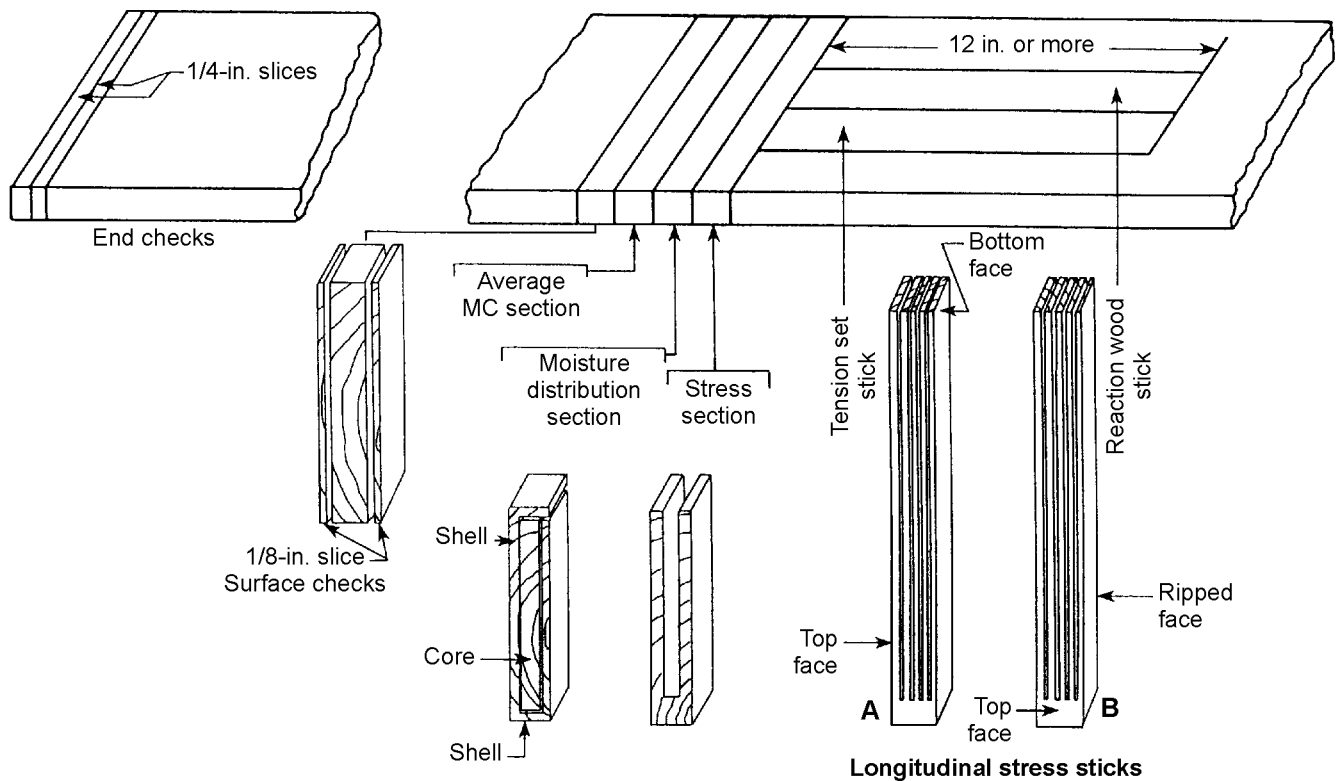

Figure 8.3—Method of cutting longitudinal stress sticks and other tests of drying quality. 1 in. = 25 mm.

recommended value. Also, the conditioning period can be extended about 4 h per inch (25 mm) of thickness. If tension wood stresses are very severe, they may not yield to any conditioning treatment.

An alternative longitudinal stress test is to cut a 24- to 30-in.- (61- to 76-cm-) long section from an approximately 8 in.- (20-cm-) wide piece of lumber, avoiding areas within 12 in. (30 cm) from the ends of the lumber. Rip this section into two 4-in.- (10-cm-) wide pieces. Put the two pieces back together in the same position they were before being ripped. Many users would consider that the lumber has longitudinal stress if there is a gap between the ripped pieces more than the thickness of a dollar bill.

## What To Do When Drying Apparently Stops

What can be done when drying seems to stop in the middle of the kiln run? Drying will never actually stop if the EMC of the kiln atmosphere is lower than the core MC of the lumber, but the drying rate is extremely slow. To correct this problem of “slow drying,” the dry-bulb temperature can be slightly increased (perhaps 5°F (2°C)) during the intermediate stages of drying. Higher increases are not recommended because of the risk of degrade. If a kiln operator decides to increase temperature above 30% MC, the operator should make sure that the kiln controller is properly calibrated.

## References

- Cuppert, D.G.; Craft, E.P. 1972. Kiln drying of presurfaced 4/4 Appalachian oak. *Forest Products Journal*. 22(6): 86.
- McMillen, J.M. 1963. Stresses in wood during drying. Forest Products Laboratory Rep. 1652. Madison, WI: U.S. Department of Agriculture, Forest Service, Forest Products Laboratory.
- Rice, W.W. 1971. Field test of a schedule for accelerated kiln drying of presurfaced 1-inch northern red oak. *Res. Bull.* 595. Amherst, MA: University of Massachusetts.
- Rietz, R.C. 1969. Influence of initial drying temperatures on development of warp in one-inch hard maple. *Forest Products Journal* 19(7):37–40.
- Ward, J.C. 1972. Anaerobic bacteria associated with honeycomb and ring failure in red and black oak lumber. *Phytopathology*. 62(7):796.
- Ward, J.C.; Hann, R.A.; Baltes, R.C.; Bulgrin, E.H. 1972. Honeycomb and ring failure in bacterially infected red oak lumber after kiln drying. *Res. Pap. FPL* 165. Madison, WI: U.S. Department of Agriculture, Forest Service, Forest Products Laboratory.
- Wengert, E.M.; Baltes, R.C. 1971. Accelerated oak drying by presurfacing, accelerated schedules, and kiln automation. *Res. Note FPL-0214*. Madison, WI: U.S. Department of Agriculture, Forest Service, Forest Products Laboratory.

# Chapter 9—Drying Defects

Drying defects are often the most costly item in drying hardwood lumber. Table 9.1 lists common defects by cause. Checklists for evaluating drying equipment have been prepared (Boone and others 1991, Wengert and Boone 1993). In the following text, each major area of drying degrade is discussed briefly. A thorough understanding of the four stages of drying (Ch. 3) and the use of samples (Ch. 7) is essential for preventing and controlling degrade. Without this information, control of degrade becomes a matter of chance.

**Table 9.1—Summary of drying defects by cause**

---

Drying too rapid
Surface checks
End checks
Internal checks (honeycomb)
Splits and cracks
Collapse
Drying too slow
Fungal stain
Mold
Mildew
Decay
Warp, especially cup
Chemical stains
Checking <sup>a</sup>
Poor stacking
Warp, especially bow
Uneven drying
Operational errors
Lumber is too wet <sup>b</sup>
Lumber is too dry <sup>b</sup>
Residual tension set
Miscellaneous defects <sup>c</sup>
Ring failure, shake
Checked or loosened knots
Heart split
Processing defects
Raised, chipped, fuzzy, or torn grain
Gluing problems, especially end splits and open joints
Planer splits
Warp during and after machining
Saw pinching (tension set defect)
Bad odors (related to bacteria)

---

<sup>a</sup>Especially if slow drying results in rewetting.

<sup>b</sup>Final MC should equal EMC  $\pm$  2%.

<sup>c</sup>Occur during drying but cannot be well controlled.

## Checking

If lumber is dried too quickly, checks appear on the surface, on the ends, and inside the wood. These defects are called surface checks, end checks, and honeycomb, respectively.

### Surface Checks

Surface checking is any crack in or near the surface of lumber that develops in drying (Fig. 9.1). In some cases, the checks may be visible after drying, but often they are invisible in the dry lumber. Checking becomes evident only after the lumber is planed or surfaced. The failure occurs along the junction of the ray tissue with the longitudinal cells. As a result, checking occurs on the tangential surface; that is, checks are seen on the flatsawn surface of lumber.

When checks are open during air drying, they often trap dirt particles. If the open check is exposed to water, staining often occurs inside the check. These two characteristics are



**Figure 9.1—Extensive surface checking in oak lumber.**



**Figure 9.2—Dirt and stain inside a check, a certain indicator that the check was open during air drying.**

very powerful diagnostic tools for determining at what point a surface check was formed. The occurrence of dirt or stain inside the check (Fig. 9.2) indicates that the check was open during air drying. Such a check is often called an air seasoning check.

The basic cause of surface checking is drying the lumber too fast; that is, relative humidity (RH) is too low, velocity is too high, or both low RH and high velocity are present. (See also the section on bacterial infections in Ch. 8.) Excessive temperatures can contribute to checking. The risk of surface checks is greatest during the first stage of drying, when the lumber loses one-third of its moisture. For red oak, this loss is typically from green to 50% moisture content (MC); for white oak, from green to 45% MC. It is virtually impossible for lumber to check at lower MC levels; the only exception is if the lumber is subjected to unusually extreme drying conditions. At lower MC levels, the shrinkage of the core exerts compression on the shell, so sufficiently large tension forces to create checking cannot develop. Surface checks may open at lower MC levels. However, the checks are not being created at low MC—they are already there and are merely re-opening.

If surface checks are exposed to alternate wetting and drying, they become quite deep and usually are open by the end of drying.

Surface checking is controlled by keeping the initial drying rate at a safe level for the wood being dried. This safe level can differ by species (lowland species require slower drying than upland, for example), temperature history, sharpness of the saw, and other minor factors. To maximize wood strength during Stage I of drying, the temperature is kept low.

Only a few hours of “too fast” drying conditions can cause surface checks. Once checks form, they remain, although they may be closed on the surface in later stages of drying.

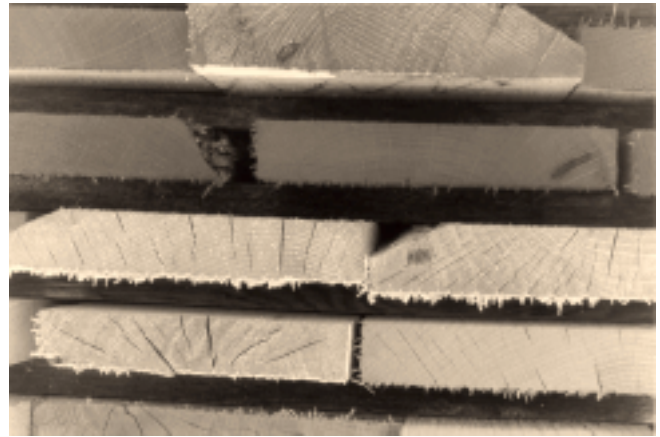

**Figure 9.3—End checks highlight the benefits of end coating, especially for expensive lumber.**

The following steps can be taken to prevent surface checking during drying:

- Avoid initial dry-bulb temperatures over 110°F (43°C) in the kiln; use lower temperatures, perhaps 100°F or 105°F (38°C or 41°C), with critical species or thicknesses.
- Avoid air velocities over 375 ft/min (1.9 m/s) during initial stages of drying.
- Avoid RH below 87% during Stage I of drying (when one-third of lumber moisture is lost), unless velocity has been reduced substantially below 375 f/min (1.9 m/s).

*Note:* Such conditions will often encourage mold.

- Monitor the daily drying rate; avoid rates over the limit (see Ch. 8) by using properly prepared kiln samples.
- When the drying rate cannot be controlled by raising the RH, run the fans only part-time (for example, 6 h on and 6 h off); turn off the heating, humidifying, and venting systems when the fans are off.
- Prepare the recommended number of samples per kiln load—usually no less than 10.
- Maintain very accurate records of kiln conditions and associated lumber handling procedures, especially handling prior to kiln drying, to prevent surface checking loss in the future.

## End Checks

End checks are cracks in the end grain of lumber (Fig. 9.3) caused by too rapid drying of the ends of the lumber. End checking often indicates that RH is too low or air velocity is too high in the dryer; these conditions result in surface checking and increase the risk of honeycomb as well.

When checking is severe (that is, when drying is too fast for a long time), the end checks can develop into end splits or honeycomb. The honeycomb can extend as much as 2 ft (0.6 m) inward from the ends of the lumber. Like surface checks, end checks can close during the second stage of drying and become invisible.

End checking is controlled by slowing the drying of the ends when lumber MC is very high. The most effective way to slow drying is to use a water-resistant end coating (see Ch. 3). However, recall that a delay of 3 days in applying end coating in an air drying experiment reduced the benefit of end coating by 50%. Currently, end coatings can be applied for \$2.50/thousand board feet or less; other methods of slowing end drying are not as cost effective.

Some end splits are preexisting checks or cracks caused by logging damage. Stresses within the tree can also cause end checks or splits, but they will be at least 1/4-in. (6.4-mm) wide after drying is completed and will often extend up the lumber for a considerable distance.

To control end checks, follow these procedures:

- Use end coating on the fresh ends of logs or on freshly trimmed lumber ends.
- When stacking, use box piling. Trim the ends of long pieces of lumber to obtain even ends. Checking may be reduced by keeping a row of stickers near or at the ends of the lumber, but the stickers may fall out of the pile when it is transported.
- When loading a dryer, try to stagger the ends of the piles so that the air cannot flow past the ends. Keep the piles as tight as possible, end to end.

## Internal Checks (Honeycomb)

Internal checking, also called honeycomb, deep surface checking, or bottleneck checking, is almost always related to surface checking that worsens over time. The exception occurs when the wood is weakened by exposure to high temperatures or possibly by bacterial degradation. In other words, if surface checking is severe, it is likely to develop into honeycomb; in older literature, honeycomb resulting from the penetration of a surface check is sometimes called bottleneck checking. Spontaneous internal checking (that is, internal checking not related to surface checking) is not common.

Internal checking is tension failure within the inside of the piece of lumber running across the rings. Only in rare cases is an internal check noticeable or detectable when examining the surface of dried lumber; usually internal checks are found only when the lumber is machined (crosscut, ripped, or heavily planed, carved, or routed).

Examination of the inside of a honeycomb check may reveal dirt, which confirms that the check was open during air drying. Internal checking is controlled by preventing surface and end checking, which in turn are controlled by the rate of drying and the temperature of the wood during drying. When surface or end checks exist, subsequent drying must be slowed to prevent their worsening. Special kiln schedules are available.

To prevent honeycomb, take the following steps:

- Prevent surface and end checks from forming. This is especially critical during Stage I drying, which is included in air drying, shed drying, and predrying.
- Once surface or end checks have occurred, control them through mild drying conditions, high RH, and low velocity at warm (not hot) temperatures.
- Avoid higher-than-recommended dry-bulb temperatures. Remember that samples on the edges of the load may be drier than pieces in the center, especially for long air travel (more than 20 ft (6 m)); delay changes in dry-bulb temperatures if lumber in the center is likely to be wetter.
- Be cautious in raising the dry-bulb temperature on thick stock if core (middle portion) MC is above 28%.
- Do not use less than the recommended minimum number of properly prepared kiln samples.
- Keep adequate records so that incorrect procedures can be identified and avoided in the future (Ch. 7).

## Shake

Shake is a separation of the annual rings (Fig. 9.4). Shake runs parallel to rather than across the rings, as do internal checks. Shake is almost always related to a weakening of the wood in the standing tree by bacterial action. Exceptionally strong wind may also result in shake. Drying stresses are seldom large enough to create such a failure. Therefore, little can be done in drying to control shake damage.

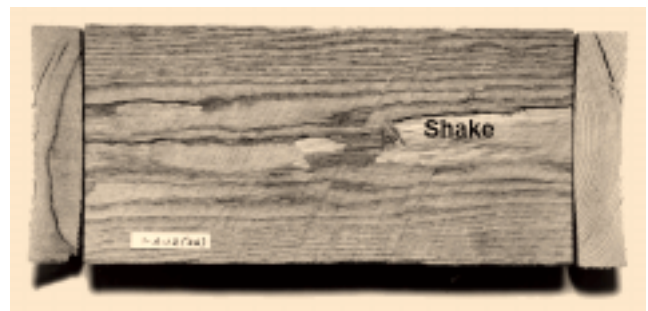

**Figure 9.4—Shake in lumber is associated with bacterial infection in the tree.**

# Collapse

In collapse, individual cells are reduced (collapsed) in diameter so that their opening (lumen) is much smaller than normal (or even nonexistent). Collapse occurs when lumber is dried rapidly at very high MC; high drying temperatures may also encourage collapse. Although the precise mechanism of collapse is not yet fully described, it is commonly believed that collapse is related to cells with very high MC and few, if any, naturally occurring air bubbles in the lumens and to cells with low permeability. Cottonwood is the most likely North American hardwood species subject to collapse, although other low density species (such as aspen) and bacterially infected wood may show this defect.

# Warp

The three types of warp—bow, crook (side bend), and twist (Fig. 9.5)—are caused by longitudinal shrinkage, which in turn is a result of the presence of tension wood (hardwoods only; evidenced most often by excessive fuzziness), spiral grain in the tree, diagonal grain caused by improper sawing, or growth stresses in the tree. Although aggressive drying and the avoidance of re-wetting of partially dried lumber will

provide a small amount of help in controlling warp, warp is basically a natural tendency of lumber.

Bow is often the result of not sawing parallel to the bark. When sawing is not parallel to the bark, one face of the lumber (often the bark side) will shrink more than the other side. Bow is also caused by poor stacking—stickers are not aligned and/or too far apart, bolsters have not been placed under every sticker, stickers or bolsters are not uniform in thickness, or foundations are uneven.

Crook or side bend is often a result of improper sawing patterns or crooked logs such that the rings, when viewed from the end of the piece of lumber, are off center edge-to-edge. Often the wood closer to the center of the tree shrinks more than does the wood closer to the bark; the off-center rings indicate that one edge of the lumber is shrinking more than the other.

Cup is a result of the difference in shrinkage between the two faces of a piece of lumber. The bark side will always shrink more than does the heart side; this difference is accentuated as the lumber is cut closer to the pith (smaller logs and lower grade lumber). In other words, cup is a natural tendency of flatsawn lumber.

Twist is the turning of the four corners of any face of a board so that they are no longer in the same plane. It occurs in wood containing spiral, wavy, diagonal, distorted, or interlocked grain. Lumber containing these grain characteristics can sometimes be dried reasonably flat by using proper stacking procedures.

In the lumber drying operation, several procedures, all related to increasing the surface moisture or rewetting the lumber, can accentuate warp. Ordinarily, the outer fibers of the lumber are dry and strong and assist in holding the lumber flat. With an increase in moisture, the strength of the outer fibers decreases, increasing warp. Re-wetting is not the basic cause of warp, but it does increase the amount of warp.

To prevent warp, pay attention to the following procedures:

- Do not mix lumber with different MC levels in the kiln. If MCs are mixed, the kiln will be operated on the mild conditions necessary for the wet lumber, which are too wet for, and will add water back to, the drier lumber.
- Do not use steam spray at start-up, because steam will condense on the cold lumber.
- Do not use long fan reversal cycles (over 2 h), which expose the lumber on the exiting-air side of the load to high humidity for a long time, thereby increasing MC.
- Do not use too conservative a schedule on partially dried lumber, because the humidity will be too high.
- Do not dry too slowly; that is, RH actually achieved in the dryer is higher than the schedule called for or air velocity is too slow.

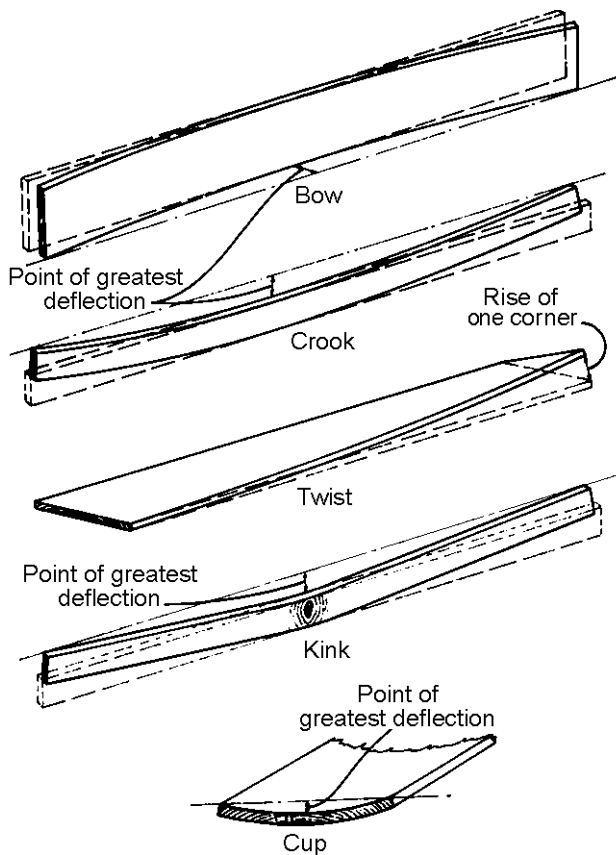

**Figure 9.5—Types of warp. Most warp is the result of characteristics in the lumber rather than errors in drying.**



The use of weights on the top of the pile is effective in controlling some warp. The suggested weight for a load is 150 lb/ft<sup>2</sup> (7 kPa), which is equivalent to about 10 in. (25 cm) of concrete over the entire top of the load. Weights are seldom used in hardwood lumber drying. When the warp-prone lumber can be accumulated in one package of lumber, place this package on the bottom of a load; place packages of non-warp-prone lumber on top.

## Discoloration

Lumber can become discolored through chemical reactions (iron tannate stain), fungal infection (blue stain, mildew and mold), and slow drying (sticker stain) and by chemicals.

### Iron Tannate Stain

Iron tannate stain is a result of a chemical reaction between wood tannins, water, and iron. These chemicals combine to form iron tannate, which is dark blue to black in color. Control is achieved by eliminating the source of iron. Typical iron sources are rusty metal fixtures in the kiln, such as roof vent framing or fan floors. Water condenses on these iron items and then drips on the lumber. Rusty iron steam pipes and steam spray systems with inadequate water drainage can also be the source of iron.

*Note:* Steam spray lines should be sloped so that all water can easily be drained or trapped away by gravity.

If the source of iron and water is constant, then the stain can penetrate more than 1/2 in. (13 mm) into the lumber.

Other sources of iron include metal forks on lift trucks, metal rollers or other conveying equipment in the mill or on stacking machines, steel strapping, and saw filing from saw blades. Stain from these latter sources seldom penetrates more than 1/64 in. (0.4 mm).

Iron tannate stain can be quickly and easily removed from green or dry lumber using various chemicals such as oxalic acid.

### Fungal Stain

Fungi thrive in wet environments. Wet lumber is subject to blue stain, mold, and mildew.

#### Blue Stain

When wet wood is dried very slowly or stored where it cannot dry, the sapwood is likely to become infected with a fungus, which results in discoloration of the lumber. The typical stain, which is blue, gray, or black, is called blue stain or sap stain. The color is actually due to the color of the fungus itself rather than a color change within the wood cells or chemicals. Blue stain fungus does not affect the wood structurally, but the discoloration can be a problem for wood that will be finished with light-colored or clear finishes.

Control of blue stain is achieved by eliminating one of the four essential elements that the fungi need for active growth—food, water, oxygen, and warm temperature. During drying, water can be eliminated if drying is rapid enough. Temperature may be used as a control element if temperatures exceed 130°F (54°C), but such temperatures can be too hot for many species with high MC. It is impossible to use oxygen as a control element during drying. If the wood cannot be dried fast enough, the only other alternative is to treat the wood with chemicals and thus poison it as a source of nutrients for the fungi (see Ch. 3).

#### Mold and Mildew

Mold and mildew are also the result of fungi, which may be various colors (red, green, white, blue, or black). As for blue stain fungi, control of mold and mildew fungi is achieved by eliminating one of the essential elements for active growth. However, the food supply of mold and mildew fungi consists of microorganisms and organic matter in dirt and dust, rather than wood fibers. Treating the wood with chemicals, as for blue stain control, usually does not control mold and mildew. The best control techniques are rapid drying and the use of clean drying equipment.

### Sticker Stain

A very common drying problem is a dark area or areas on dried, planed lumber. The discolored or stained area runs across the width of a piece of lumber and is located in the same place where a sticker was located during drying. Typically, the stain is not seen in the rough lumber and is only evident after planing. This defect is called sticker stain or sticker shadow. (Lumber graders prefer the term shadow because stain connotes the early evidence of decay, according to the National Hardwood Lumber Association (NHLA) definition. However, tradition has resulted in widespread use of the term sticker stain.) Seldom, if ever, are any fungi associated with sticker stain; the stained wood is nearly always (except in a few extreme cases) as strong and as solid as unstained wood.

Sticker stain seems to have been more severe and more common during the past decade compared with the 1970s and 1980s, although outbreaks of sticker stain were recorded from time to time in the 1950s and 1960s. Reasons for the recent high incidence of sticker stain include the increased use of light finishes, the elimination of bleaching (oxalic acid) from the finishing process, and the generally higher prices for white woods in the marketplace.

Researchers from the University of Minnesota and Mississippi State University found that sticker stain was almost inevitable in lumber sawn from old logs (Schmidt and Amburgey 1997), no matter how good the kiln operator. The researchers found that when the tree is first cut down, the wood cells do not die immediately. Cells continue to live for a while and create chemicals that eventually change color

during drying. This indicates that much sticker stain is a result of sawmill inventory practices and not caused by the kiln operator.

The lack of knowledge on drying maple lumber may sometimes be the major reason for stain. Many drying practitioners evidently have forgotten the basic principles that govern the drying of white woods; they know how to dry oak, but not other species. Furthermore, much of current drying equipment is geared toward oak drying (especially with respect to slow air speeds), not white wood drying.

### Cause of Sticker Stain

The basic cause of sticker stain is slow drying (probably <5% MC/day) at warm temperatures (50°F to 130°F (10°C to 54°C)) when MC lumber >40%. These conditions begin the chemical reaction within the wood that will eventually, as the lumber dries, lead to discoloration. In fact, the discoloration itself may not show up until much later in drying; that is, at much lower MC levels. The final oxidation and discoloration may actually occur below 15% MC. This final discoloration is accentuated by temperatures that exceed 150°F (66°C) during the final steps of the kiln schedule. However, it is the initial slow drying before discoloration occurs that is the fundamental cause of sticker stain. As mentioned previously, poor log storage can initiate the reaction. Some species of stickers may also slightly aggravate the stain, but the stickers do not cause the stain.

Sticker stain is not caused by fungi. However, the slow drying that causes sticker stain can also result in fungal stain if other conditions for fungal activity are favorable.

Because sticker stain is actually a result of the oxidation of naturally occurring chemicals within the wood (perhaps catalyzed by enzymes within the wood), little can be done to inhibit the reaction in freshly cut lumber in terms of chemical dips, including fungicidal dips for blue stain control, or chemical treatments. Some people have attempted to treat the lumber with oxidation-inhibiting chemicals, and others have tried enzyme-inhibiting chemicals. The problem with such treatments is the difficulty in getting the chemical to penetrate the wood deeply, not just the surface layers.

*Note:* The only practical method for preventing sticker stain in freshly sawn lumber is to dry the lumber under the stickers as quickly as possible.

### Prevention of Sticker Stain

The remedies for sticker stain involve drying the lumber under the stickers as quickly as possible by avoiding wet stickers, avoiding high kiln temperatures, maintaining good airflow, and using proper schedules and controls. Most of these procedures *are not necessary* for fresh logs when the lumber is stacked promptly and placed in the kiln immediately after stacking and required kiln conditions are achieved within 6 h; some of these procedures can be used as

inexpensive “just in case” insurance. When the lumber is at risk for developing stain, employing as many of the following procedures as possible should be considered.

*Note:* Asterisk indicates particularly effective methods.

### Before Sawing

- Use fresh logs that have been stored less than 2 weeks during warm weather.
- In warm weather, stack the lumber within 12 h after sawing.

### Stacking and Handling

- Use stickers with 8% to 10% MC; check MC with a moisture meter; obtain stickers directly from the unstacker rather than from storage.
- Use stickers 1¼ in. (3.2 cm) wide by ¾ or 7/8 in. (1.9 or 2.2 cm) thick.
- Use grooved stickers.
- Protect stacked lumber from rain, especially lumber with high MC and during warm weather.
- If stacked lumber is not loaded directly into the kiln, place it in fast-drying locations; fan sheds (or blow boxes) are ideal.
- After lumber has dried for several days, disassemble the stack and re-stack the lumber with dry stickers positioned (on the lumber) a short distance (several inches (centimeters)) away from original sticker positions.\*

### Kiln Equipment and Procedures

- Use a kiln load narrower than 16 ft (5 m); for white woods, use velocity over 500 ft/min (2.54 m/s).
- Do not use a “snow melting” or “thawing” kiln procedure.
- For white woods, within the first 6 h of drying develop kiln RH levels that are at least equivalent to a 10°F (6°C) depression. Greater depressions may be required, if recommended in the schedule. In humid weather, kiln temperatures may have to be raised slightly to achieve the low humidity required.
- Load the kiln with only two rows of lumber for the first 12 to 36 h to help achieve the required humidity immediately. After RH has been maintained for ≥12 h, load the remaining lumber; the required RH should be more easily achieved in this manner at all times.\*
- Use low kiln temperatures (110°F to 120°F (43°C to 49°C) initially) as recommended in the schedule; exceed 160°F (71°C) only during equalizing and conditioning.
- Reverse fans every 2 h.
- Use correct kiln sampling procedures.

- Do not over-condition lumber.
- If lumber has been air-dried or possibly mishandled, use a special kiln schedule that operates at very low temperatures.

## Chemical Stains

A variety of enzymatic oxidation chemical stains can occur in lumber before and during drying. These stains are often not noticed until the lumber is planed or machined. Sticker stain is one of these stains. Other stains of the type include the following:

- Interior graying, noted especially in southern oak, hackberry, maple, and ash; can occur in sapwood of all hardwood species
- Brown stain, often called coffee stain; occurs in hardwoods, primarily white oak
- Pinking and browning in interior of light-colored species such as hard maple and hickory

Chemical stains are controlled using the same techniques described for controlling sticker stain.

## Problems Caused by Incorrect Lumber Moisture Content

Probably 75% of the manufacturing problems in furniture or cabinet plants are related to incorrect MC of the lumber. In nearly all cases, the wood is too wet. The problem is often related to inadequate sampling in the dry kiln; not enough samples are used or the samples do not represent the entire load.

In package kiln drying of wet lumber, the MC of the samples, which are located on the edges of the pile for easy access, does not represent the MC of lumber within the piles, especially in the packs in the middle of the load. This situation requires better sampling, which may mean special effort to obtain samples from the center packs.

Occasionally, the MC of the lumber is incorrect because of improper storage or transportation. Moisture content can be monitored during lumber storage and transportation by keeping several kiln samples with the lumber.

Sometimes the lumber is at the wrong MC for its environment as a result of poor information from management on the proper average and spread of the final MC required by the kiln. Commonly, the operator is told to dry the lumber to “6% to 8% MC.” Does this mean that all pieces should have MC between 6% and 8%, or should the MC of most pieces be in this range? Should the core MC be below 8% or does the MC range pertain to average MC of a piece? Most

operators of drying equipment can achieve the desired MC levels if they are given adequate direction from management and adequate time to do the job correctly.

The question of determining the correct MC for lumber intended for interior uses, including furniture, millwork, and kitchen cabinets, centers on two issues:

1. What MC is required for efficient, quality manufacturing?
2. What MC is required for quality service performance of the product?

There is no standard within the hardwood manufacturing industry for the correct MC during manufacturing, the correct MC at the time of installation, and the expected average MC when the product is in use.

## MC Requirements for Manufacturing

In manufacturing, it is important for MC of the lumber to approach EMC of the air (Wengert 1988). If lumber MC and air EMC are *not* very close (within 2%), then significant shrinking, swelling (Table 9.2), and warping will occur during manufacturing as the wood loses or gains moisture in an effort to achieve MC equal to EMC. (See also following sections on machining and gluing.) In many wood manufacturing plants throughout the United States, average EMC is 7% to 9%.

## MC Requirements in Service

The interior conditions that wood products are subjected to vary considerably. In much of the United States, interior EMC is 6% to 8%. However, in coastal environments (for example, New Orleans, most of Florida, Seattle), interior EMC exceeds 9%. Coating the finished product with a vapor barrier finish reduces short-term moisture gain (that is, eliminates the extremes). However, over a long exposure to high (or low) humidity, coated wood will eventually pick up (or lose) substantial moisture as it reaches the average EMC in use.

**Table 9.2—Change in width of 3-in.- (8-cm-) wide northern red oak with change in MC<sup>a</sup>**

MC change (%)	Width change (in. (mm))	
	Radial	Tangential
1	0.05 (1.3)	0.11 (2.8)
3	0.14 (3.6)	0.33 (8.4)
5	0.24 (6.1)	0.55 (14.0)

<sup>a</sup>For some southern oaks, change in width will be as much as 50% greater than values shown; the width of most other species will be slightly less than values shown.

## Establishment of Correct MC

The first step in achieving a quality product is to design the product so that it can easily accommodate small changes in MC. The importance of good design cannot be overstated. For example, in a good design, a wood product, such as a cabinet door, can shrink a little without creating objectionable gaps. Moreover, in a good design, a little swelling can occur without causing the door to buckle or pushing the sides of the frame outward.

Likewise, it is important that the width and thickness of the lumber in a wood product not change significantly (by keeping any MC change to less than 2%) between the time of manufacturing and the time of installation. Change in product dimension could result in serious installation problems.

Generally, shrinking is a greater problem than is swelling in most wood products; that is, a crack from shrinking is more serious than high pressure created by a little swelling. Swelling causes the wood to compress slightly, absorbing some swelling pressure. However, shrinkage is almost always accompanied by the opening of a joint. Therefore, joints in wood products must be designed to open without creating a failure.

As a rule of thumb, most hardwoods should be dried to an average MC of 6.5% to 7.0%. With this average and with only a small variation in MC around the average, no major dimensional changes will occur.

Some specific suggestions for achieving the correct final MC are as follows:

- Obtain specific instructions on the exact final MC required. Does “6% to 8% MC” mean nothing wetter than 8% and nothing drier than 6% MC in the entire load? MC of samples is between 6% and 8%?
- Choose at least 10 kiln samples from lumber pieces throughout the kiln load and throughout the packages, not just from the edges of conveniently located packs. At least eight samples should represent the wettest lumber. With air-dried or predried lumber, use an electrical resistance probe that can reach inside a stickered pack of lumber for guidance in selecting the samples.
- Do not use low melting point, wax-based end coatings on sample boards. Use recommended products.
- Place kiln samples in pockets, not bolster spaces.
- Double-check final MC.
- Keep samples with the lumber in storage and shipment so any changes in MC during storage can be measured and documented.
- Keep storage conditions as dry as needed to maintain EMC equal to lumber MC.

- Use at least 12 h equalization for every load.
- Sample final MC levels within the load using a moisture meter; look for wet pieces and any trends with respect to location of pieces in the dryer.

## Residual Tension Set (Casehardening)

The procedures for relieving tension set are documented in Chapter 7. Problems with conditioning occur when high pressure steam or steam with too much heat is used.

Drying stress, also called tension set or casehardening, is a normal occurrence in drying and can easily be relieved at the end of drying. However, uniform and rapid stress relief requires uniform MC levels (or proper equalizing). Also, it is necessary to establish how exact the stress relief must be; the tougher the requirements, the more important equalizing is and the more the following operational items must be adhered to. Specifically, to obtain good stress relief, moisture must be added back to the lumber quickly and at a hot temperature.

Practical procedures for eliminating stress include the following:

- Use the recommended EMC (target MC + 4%); at a dry-bulb temperature of 180°F (82°C), this means a wet-bulb temperature of 170°F (77°C).
- Make sure that the desired EMC is achieved quickly. If the dry-bulb temperature overrides the setting and the EMC is too low, then initially use the heat in the spray, rather than the heat in the heating coils, to raise the dry-bulb temperature (see Ch. 8). Cold water spray systems can eliminate this problem.
- Use a dry-bulb temperature of 180°F (82°C).
- Allow moisture gradients to dissipate before evaluating stress samples by allowing lumber to cool for 1 or 2 days. Moisture gradients can confuse prong tests. Gradients can be removed from the prongs by heating them in a microwave oven for 15 s at high power. The heat will dissipate the gradients within several minutes after the prongs are removed from the oven.

## Machining and Gluing Problems

By the time lumber or cut-up parts are ready for machining and gluing, the wood has become quite valuable. Losses due to poor machining quality or poor gluing, including open joints, can be extremely expensive. This expense is needless—almost all (perhaps 90%) of machining and gluing defects can be eliminated by proper drying.

## Machining

When everything else is correct, incorrect MC can cause fuzzy, chipped, torn, or raised grain, planer or roller splits, planer skip, and lack of flatness when machining (Wengert 1988). These defects are discussed here, although other factors can also contribute to machining problems.

### Fuzzy Grain

Fuzz can consist of large fibrous pieces or fine material (“peach fuzz”). Because wet wood is relatively weak, the knife or saw pushes the fibers over, rather than cutting them cleanly. Dull knives can contribute to this problem. The wood fibers are sometimes weaker than normal as a result of tension wood. Some species, such as cottonwood and aspen, are inherently weak and prone to fuzz.

### Chipped or Torn Grain

As the wood becomes drier, its strength increases. The strong fibers do not cut easily, but rather tear out in large chunks. If cutting causes the grain of the surface to dive into the piece, the tear-out follows the grain, creating a depression in the surface. Small knife angles (very slender knives) contribute to this failure, but the major cause is low (<6%) MC.

### Raised Grain

Raised grain appears hours to months after machining. When lumber is machined, some fibers are pushed down hard enough (rather than cut cleanly) that the wood cells collapse; that is, the slender straw-like cells are compressed so that the hollow space between cells disappears. Although the wood surface appears smooth when first machined, the addition of moisture causes the collapsed cells to spring back to their original shape, creating a washboard or rippled surface. When the cells are severely damaged, permanent failures may occur, leading to loose grain. Loose grain refers to the apparent separation of annual rings (also called shelling).

### Planer or Roller Splits

When lumber is planed, an apparently high quality piece of lumber sometimes develops long splits or cracks. It is as if the lumber were extremely brittle. Dropping such a piece of lumber on the floor may also result in the development of splits. The basic cause of splits is stress in the wood (perhaps casehardening stress not removed by conditioning or growth stress from the tree), drying at high temperatures and/or overdrying, excessive cup (perhaps a result of overdrying), and possibly poor machine set-up (wood is pounded by knives). When wood is overdried, steaming it to increase the MC will not restore its machinability.

### Planer Skip

Planer skip is caused by excessively thin lumber or an incorrectly set machine. Although thin lumber can be a sawmill error, it is commonly a result of overdrying, which in turn

causes excessive shrinkage, decreasing the overall thickness slightly and increasing warp.

### Lack of Flatness

If the MC of lumber is not equal to the EMC of the air (or, from a practical standpoint, is not within 2 percentage points), then the wood can be expected to shrink or swell noticeably as it seeks to attain equilibrium with the air. The problem occurs most often in the winter when the EMC of the air in the manufacturing plant, especially in heated plants, is below 4%, but the MC of the dried lumber is  $\geq 7\%$ .

*Note:* Softwoods typically shrink less than do hardwoods, so they are more forgiving of slight MC to EMC imbalances. However, with increased customer demand for quality, changes in softwoods can create problems in service.

Lack of flatness also can result in poor gluing.

## Gluing

Incorrect MC at the time of gluing is responsible for open joints, panel end-splits, planking, telegraphing through veneer, warp of all sorts, and low strength joints (Wengert 1988). The rule of thumb is that lumber MC must be within 2% of the EMC of the air in the manufacturing plant and in use. Casehardening can also lead to poor gluing and lack of flatness. Starved joints most likely occur when lumber has been overdried.

A strong glue joint requires that the mating surfaces be very close—0.002 to 0.006 in. (0.05 to 0.15 mm) apart. Size changes between wood preparation and the application of glue can result in poor mating and, consequently, open joints and weak joints. Changes in size after gluing cause panel end-splits, planking, and warp. The only reason the size or shape of the wood changes is because the MC of the wood has changed, which indicates that the MC of the wood and the EMC of the air were not close enough to prevent meaningful shrinkage.

## Insect Damage

Most insects that affect wood prefer wet wood; only lyctid powderpost beetles and termites infect moderately dry wood. Insects and their eggs are killed when the wood is heated above 130°F (54°C), especially at high humidity; therefore, in most cases, newly dried wood is free of insects and eggs. Often, the insect holes in lumber are exit holes, rather than entry holes, and occurred before drying. When insect holes are accompanied by dust piles, the insect has probably left the wood and may be living in moist soil or other wet debris scattered around the drying plant. Good sanitation is essential for controlling insects. Chemicals should be used as a last resort because of the potential hazards involved (from chemical residues) in subsequent processing of the wood.

It is prudent to separate green storage and dry storage areas to prevent insects from infesting the dry lumber.

## Statistical Process Control

One of the best tools available for analyzing lumber drying is statistical process control (SPC). Statistical process control is a procedure that draws on a lot of common sense and some statistical methods. It can be used immediately when unloading a charge of lumber from the kiln to assess the average and spread of final MC, lumber flatness, and even checking and splitting. With the use of only a few carefully chosen samples, SPC provides instant feedback to kiln operators. The following section presents several examples of successful use of SPC. This information can benefit kiln operators, supervisors, quality control personnel, and managers.

### Definition of SPC

The term statistical process control, sometimes also called statistical quality control, is a new tool and concept in modern hardwood processing operations. This tool is often included under the broader concept of total quality management (TQM). Actually, SPC is an old technique that was developed in the 1940s and has recently been refined. The personal computer and pocket calculator have enabled the implementation of SPC in drying operations regardless of their size; it can be implemented in small, medium, and large operations. Perhaps the greatest impetus for the development and adoption of this technique has been the need for improved drying quality and therefore improved profitability and efficiency. In the past, drying inefficiency was passed on to the consumer as price increases. When wood supplies were plentiful, everyone was equally inefficient and the price of kiln-dried lumber assured adequate profits. There was little motivation to become efficient and quality conscious.

Today's customers are demanding higher quality in every piece of lumber. Moreover, competitive operations have already increased their efficiency and are passing resulting benefits to the consumer in terms of lower prices, higher profits, and better quality lumber. Timber is not as plentiful as it was in the past. To compete successfully, each mill must become highly efficient in processing. SPC is a very effective tool toward reaching that goal.

Statistical process control is probably best understood as an attitude, rather than a strict mathematical procedure. It involves not just an inspection of quality, but the detection of defects and assessment of the risk of defects at every step of the process—during green storage, during drying, and after drying, during storage and shipping.

### Effective Use of SPC

The definition of a defect or an unacceptable process is critical to the use of SPC. This definition is not constant; it may change (become more stringent) as the process becomes

better and better controlled, or it may change as customer requirements change. It is also critical that the significance or importance of the defect or unacceptable process be incorporated into the decision-making process. For example, a small amount of end splitting in lower grade lumber is not as important as the occurrence of light sticker stain in an appearance-grade board.

Another critical aspect of SPC is time. Because wood is an everchanging material and especially sensitive to humidity changes, a time frame for judging satisfactory performance must be defined. For example, if certain tolerances in the MC of kiln-dried lumber are required, the lumber should be inspected within 1 day after it leaves the kiln. Incorrect MC after 1 day could be due to poor storage conditions rather than incorrect kiln drying procedures.

In addition, the kiln operator must learn what the customer considers "quality" dried lumber. Can cabinet-grade lumber that has been dried to 10% MC and shipped to the manufacturing plant be expected to perform well when the EMC of the plant is 6%? Does the customer know the answer to this question, or does the customer expect the supplier to provide exactly what is needed? Often, the customer expects the supplier of kiln-dried lumber to know what is needed in terms of quality (MC, stress, and flatness, for example).

To use SPC successfully, it is also necessary to define the process variables most important for proper quality or performance. Why monitor temperature or humidity during manufacturing if the critical variable is lumber thickness? Why monitor lumber stain if the product is to be painted? An important step in SPC is to eliminate the unimportant variables but include the important ones. Furthermore, the important variables should be ranked according to their impact. Possible ranking criteria are as follows:

1. **Critical variable**—Defect or variable related to safety
2. **Major variable**—Defect or variable that results in major expense; cost or economics often determines significance
3. **Minor variable**—Defect or variable that results in minor expense
4. **Incidental variable**—Defect or variable that causes insignificant problems but affects the appearance of the product

Finally, an effective SPC program requires a reaction whenever the data indicate a problem; that is, the information must be put into use, which in turn requires management support and commitment.

In brief, for an SPC program to be effective, the following must be true:

- The performance criteria must be set; that is, the specifications and standards must be defined and redefined.

*Note:* Experience has shown that employee participation in setting these performance criteria (specifications and standards) makes achieving better quality and efficiency much more likely.

- A method for measuring the adherence to these criteria must be in place; for example, if MC is important, then MC meters must be available.
- There must be management support—training, proper equipment, and incentives for both management and employees)
- There must be a system to respond to those statistics that indicate a problem.

## Value of Statistics

Is it affordable to check every piece of wood that is handled to ensure that it conforms to the specification? Can this be done for every operation in the mill? Obviously, some mills cannot economically afford to do such a check. Every piece of lumber is checked when it is graded, which is probably the only time the lumber is inspected so thoroughly. One approach is for the grader to check lumber quality in the process of grading.

Statistical process control is a technique that helps the operator make conclusions (inferences) about the population, based on a small sample taken from that population. The population is the entire number of observations of a particular variable, such as MC, stress, flatness, grade, color, or size. The number of observations in the population is designated  $n$ . An individual observation in the population is designated  $X_i$ . The average value, or mean, of the observations in the population is designated  $\bar{x}$ . The maximum and minimum values can be used to express the variation within the population. A more useful number for expressing variation is the standard deviation, indicated by the lower-case Greek letter sigma,  $\sigma$ .

The usefulness of the standard deviation is that it is easy to estimate the range of any part of the population if the population is characterized by a normal distribution. Some typical values are shown in Table 9.3;  $\bar{x}$  represents the average, and

**Table 9.3—Percentage of population included in range of values (average  $\pm$  number of standard deviations) for a normally distributed population**

Population included (%)	Range of values
99.9	$\bar{x} \pm 3.00$ SD
95	$\bar{x} \pm 1.96$ SD
90	$\bar{x} \pm 1.64$ SD
75	$\bar{x} \pm 1.15$ SD
67	$\bar{x} \pm 1.00$ SD

the standard deviation (SD) multiplied by a factor is added to or subtracted from the mean to establish the range.

Sampling every member of the population, as stated, can be too large a task to be reasonable. However, by using a small random sample from the population, inferences concerning the characteristics of the population can be made. Only 30 to 40 observations are usually needed. The average of the samples ( $\bar{x}$ ) is an *estimate* of the population average. The standard deviation of the sample (SD) is used to obtain an estimate of the population variation.

## SPC Functions

As stated in the previous text, SPC is a mathematically based procedure. Computer programs can be purchased to perform most calculations. In fact, many calculations can be performed with an inexpensive calculator.

This section describes two functions of SPC: (1) description of the average values and variation of a population and (2) daily performance record on a control chart. Many texts, such as Pitt (1999), cover these and other SPC functions in detail. For example, the texts describe how to establish control limits to determine whether the drying process is out of control and how to determine whether to accept or reject a lot or load of lumber.

### Population Descriptions

**Example 1. Estimates of MC range**—A sample of 30 pieces of lumber is randomly chosen from an incoming shipment of 6,000 pieces and measured for MC using an electric moisture meter.

*Note:* Previous work indicated that the population of final MC for hardwood lumber is normally distributed. Therefore, a sample of 30 pieces is quite adequate.

From the measurements, the average of the 30 observations is calculated to be 7.2% MC. In addition, the spread of the data is calculated and expressed as the standard deviation. (Several commercial moisture meters have a built-in standard deviation calculation routine and display.) The standard deviation, calculated for the 30 readings, is 0.70. These two values—average and standard deviation—can be used to estimate the ranges of MC for the entire population (Table 9.4).

**Table 9.4—Estimated range of MC for average of 7.2% MC and standard deviation of 0.70**

Population included (%)	Calculation of range	MC range (%)
99.9	$7.2 \pm (3.00)(0.70)$	5.1–9.3
95	$7.2 \pm (1.96)(0.70)$	5.8–8.6
90	$7.2 \pm (1.64)(0.70)$	6.1–8.3
75	$7.2 \pm (1.15)(0.70)$	6.4–8.0

**Example 2. Estimates of Certain MC Values**—With the same conditions and readings as in Example 1, other calculations are possible. For example, the number of pieces in the population that have more than 7.4% MC is 43%. Similarly, the number of pieces in the population that have exactly 6.5% MC (that is, 6.45% to 6.55% MC) is 3%.

*Note:* The 10 or 12 kiln samples in the load (the usual number of samples) do not provide an accurate estimate of average MC or MC range for three reasons:

1. Kiln samples are not randomly chosen. (Nor should they be. Kiln samples should represent the wettest and driest pieces.)
2. There are too few pieces (<30) of lumber.
3. Samples are not taken from pieces inside the load, but from pieces on the edges of the load.

For these reasons, a separate final MC sampling should always be conducted if the customer requires good control of final MC.

### Control Charts

A very dramatic method for presenting the results of an SPC program is to plot the average values of a variable, such as MC, and the standard deviation. This graph is called a control chart. Figure 9.6 is an actual control chart of average MC measured every day in a rough mill operation. Note the slight trend toward higher moisture over time.

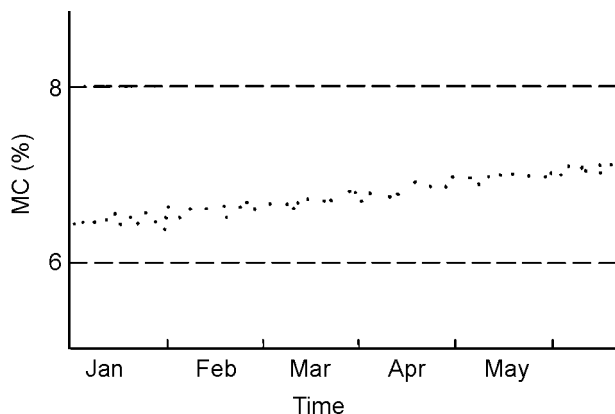

**Figure 9.6—Control chart showing daily MC of rough lumber entering a furniture plant (Wengert 1990).**

A control chart often shows limits (dashed lines on Fig. 9.6), which are called the upper control limit (above the average) and lower control limit (below the average). These limits are very useful. For example, if average MC values exceed the limits, then the drying process (equalization or sampling) is probably out of control and needs immediate attention. Control limits are discussed in more detail in SPC texts (for example, Pitt 1994).

### References

- Boone, R.S.; Milota, M.; Danielson, J.D.; Huber, D.W.** 1991. Quality drying of hardwood lumber: guidebook-checklist. Gen. Tech. Rep. FPL-IMP-GTR-2. Madison, WI: U.S. Department of Agriculture, Forest Service, Forest Products Laboratory. 56 p.
- Pitt, H.** 1999. SPC for the rest of us. Reading, MA: Addison-Wesley. 429 p.
- Schmidt, E.L.; Amburgey, T.L.** 1997. Prevention of non-microbial enzymatic sapstain by log fumigation. In: Prevention of discolorations in hardwood and softwood logs and lumber. Forest Products Society Proceedings No. 7283. Madison, WI: Forest Products Society: 28-30.
- Wengert, E.M.** 1988. The wood doctor's Rx. Blacksburg, VA: Virginia Tech. 378 p.
- Wengert, E.M.** 1990. Drying oak lumber. Madison, WI: University of Wisconsin-Madison, Department of Forestry. 162 p.
- Wengert, E.M.; Boone, R.S.** 1993. Quality drying in a hardwood lumber predryer: guidebook-checklist. Gen. Tech. Rep. FPL-IMP-GTR-3. Madison, WI: U.S. Department of Agriculture, Forest Service, Forest Products Laboratory. 32 p.



# Chapter 10—Special Drying Methods

This chapter describes additional methods for drying lumber: heated-room drying, press drying, high-frequency and microwave heating, solvent seasoning, and solar drying.

## Heated-Room Drying

In heated-room drying, a small amount of heat is used to lower the relative humidity (RH). This method is suitable only for wood that has been air dried initially. Green lumber may check and split by this method. Heated-room drying does not dry lumber rapidly, but it is suitable for small amounts of lumber.

Before air drying is started, the lumber should be cut as close as possible to the size needed for the product. Allowance must be made for some shrinkage and warp during drying and for a small amount of wood to be removed during planing and machining. If it is necessary to shorten some long pieces of air-dried lumber before heated-room drying is started, the freshly cut ends should be end coated to prevent end checks, splits, and honeycomb.

For reasonably fast heated-room drying, the lumber should be exposed to an equilibrium moisture content (EMC) about 2% below the final desired moisture content (MC). The lumber is left in the drying room just long enough to reach the desired average MC. It is then removed from the room and stored in a solid pile until use. The storage area should have the same EMC as that in the area in which the wood will be used.

The amount that the temperature must be raised above the average outdoor temperature depends on the average outdoor RH. Typical values range from 20°F to 30°F (11°C to 17°C). An accurate hygrometer should be used to monitor actual RH conditions. Raise the temperature if the conditions are too humid and lower it if the conditions are too dry. If the increase in temperature exceeds 30°F (17°C) and the conditions remain too humid, then air will need to be vented to the outside.

Any ordinary room or shed can be used for heated-room drying, and any safe means of heating should be satisfactory. A slight amount of air circulation is desirable to achieve uniformity in temperature. If the size of the lumber is relatively small, the lumber can be stacked in small, stickered piles on a strong floor. It could also be sticker-piled on moveable carts. Long lumber should be box-piled on strong, raised supports, as discussed in Chapter 3.

The lumber should be marked or records should be kept on when the wood enters the drying room and when it is removed from the room. The heating system should be large enough so that it can accommodate the entry or removal of any amount of lumber without upsetting conditions. The doors should be kept closed as much as possible so that the average temperature can be kept close to the desired level. Variations of the average outdoor temperature from night to day and small variations from day to day do not affect the drying process.

## Press Drying

Press drying (Hittmeier and others 1968, Simpson 1985) is defined as the application of heat to opposite faces of lumber by heated platens to evaporate moisture from the lumber. Temperatures range from 250°F to 450°F (120°C to 230°C). Thermal contact between the heated platens and the lumber face is maintained by platen pressure of 25 to 75 lb/in<sup>2</sup> (170 to 520 kPa).

During drying, heat is transferred from the platens to the wood, causing air and vapor in the wood to expand and water to vaporize. A mixture of vapor and liquid then moves to the surface of the lumber where it escapes. The process is particularly suited for ½-in.- (13-mm-) thick lumber of species that are very permeable. Ventilated cauls located above and below the lumber have been used to help the vapor escape. The platens also hold the lumber flat and reduce width shrinkage; however, platen pressure and high temperatures generally lead to greater-than-normal thickness shrinkage. The heartwood of some species of wood tends to darken and develop checks and honeycomb during press drying. For many applications, these defects may not adversely affect the lumber. In fact, the darker color is often more appealing than the original color.

## High-Frequency and Microwave Heating

High-frequency heating involves placing the lumber in a radiofrequency field oscillating at more than 1 MHz. If the wood is wet, it is quickly heated to the boiling point of water; if the wood is dry, temperatures quickly exceed the boiling point. Dry wood can begin to char rapidly and burn. If there were no resistance to the movement of free water or vapor through a piece of wood, it would dry rapidly. In general, however, wood is not very permeable; most species have fairly permeable sapwood, but the heartwood of many

species is not permeable, especially around knots. The movement of moisture may be so impeded that high internal pressures and temperatures well above the boiling point of water occur, even with wet wood. Internal explosions or ruptures may occur. In permeable woods, temperature levels off slightly above the boiling point as long as free water is present and internal pressures are only slightly above atmospheric.

Apart from technical difficulties, high-frequency heating is often quite expensive, compared to conventional drying techniques. The main costs are for high-frequency generators and electricity. As a result, high-frequency drying is economically limited to specialty products that are either very expensive and can easily accommodate the higher drying cost, or to products that cannot be dried efficiently in conventional equipment.

To avoid the high temperatures of radiofrequency drying at atmospheric pressures, several dryers have been produced that combine vacuum drying with radiofrequency drying. When oak is dried with such dryers, many quality factors were improved, because the system has many of the advantages of vacuum drying. However, final MC varies considerably as a result of the uneven radiofrequency energy distribution in the chamber, variable electric properties of the lumber, and permeability of the lumber, especially in thicker stock. Capital costs and energy costs are also high.

## Solvent Seasoning

The solvent seasoning process involves subjecting the wood to a spray or continuous immersion in either hot acetone or a similar solvent miscible with water for a number of hours until most of the water is extracted from the wood. The solvent is removed by steaming or with a vacuum. Additional water is removed at the same time.

Although solvent seasoning has not been applied to eastern U. S. hardwoods, extensive research has been done in California on using this method to dry tanoak sapwood. For 4/4 lumber, drying time is as short as 30 h. A few pieces of lumber have suffered streaks of collapse, probably because of the presence of heartwood or bacterial infection.

## Lesser-Used Drying Methods

Infrequently used methods for drying lumber include azeotropic, vapor, and infrared drying.

### Azeotropic Drying

Wood can be rapidly dried in an oily liquid maintained at a temperature high enough to boil off the water. A complicated variation of this procedure is called azeotropic drying. Research (Eckelman and Galezewski 1970, Huffman and others 1972) has demonstrated that the process does not have good prospects for drying hardwoods unless a considerably

reduced pressure (partial vacuum) is used. Although this simple boiling-in-oil process is not suitable for hardwoods because of checking, those interested in azeotropic drying can find valuable information in a report by McMillen (1961a).

### Vapor Drying

Vapor drying exposes the wood to the vapors of a boiling organic chemical, such as vapors produced in a pressure-treating cylinder and removed in combination with the chemical (McMillen 1961b). This method has been used to a considerable extent to dry oak, hickory, and other hardwood railroad crossties before preservative treatment. Vapor drying is also suitable for crossing plank and car decking, but it is not suitable for hardwoods to be used at low MC levels for fine work.

### Infrared Drying

In the past, infrared radiation was proposed as a method for drying wood. However, the depth of ray penetration is slight and the method is not suitable for drying hardwood lumber.

## Solar Drying

The hobbyist or small business owner can save a great deal of money and realize a greater sense of achievement if the lumber is sawn and dried "in house" rather than purchased already sawn and dried. Research in small experimental and semi-commercial solar dryers has shown that most 4/4 hardwoods can be satisfactorily dried from green to 6% MC in about 6 weeks of good weather. The most popular design is called a semi-greenhouse design (the walls are insulated and solid). The roof, which incorporates the solar collector, faces south and is elevated to an angle equal to the latitude where the kiln is located.

A solar heated dry kiln is satisfactory for any operation where drying time is not critical. However, for operations requiring more than 50,000 board feet of kiln-dried lumber annually, other drying options, such as the electric dehumidification dryer, would probably be better investments because such drying operations can provide lumber year round on a predictable, lower cost basis.

### Construction of Solar Kiln

Constructing a solar kiln is relatively straightforward and inexpensive. The procedure given here has been used to construct more than 300 kilns nationwide. The success of this design is in its simplicity and adaptability to any size. The dimensions given are only a suggestion; the kiln can be built to suit individual drying needs. A kiln constructed to the specifications shown in Figure 10.1 will dry 450 board feet of 4/4 hardwood lumber in 6 weeks or less of good weather or 600 board feet of 8/4 lumber in 15 weeks. Drying time varies with sun intensity, lumber MC, and relative humidity.

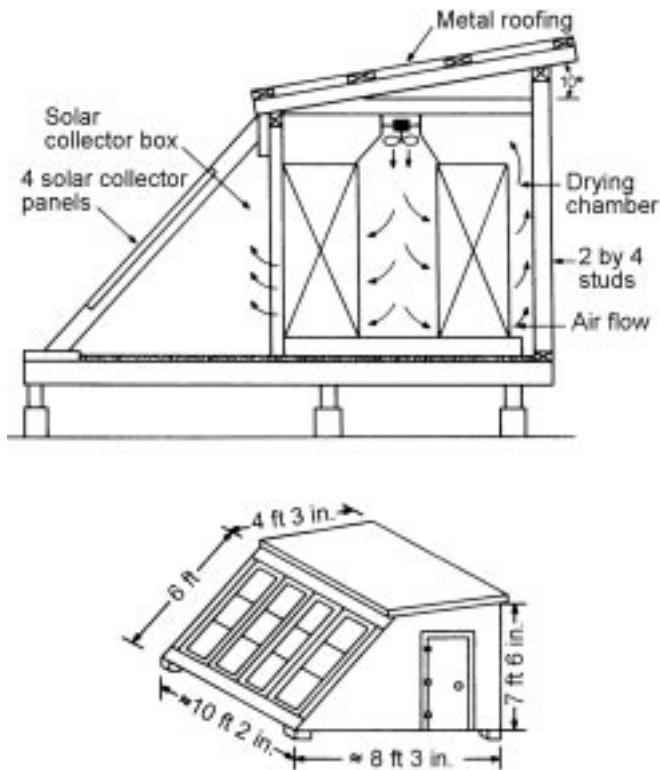
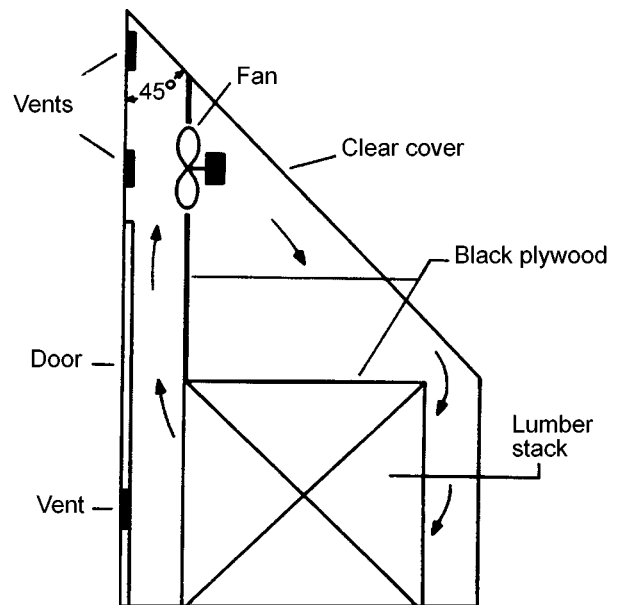

**Figure 10.1—Design for semi-greenhouse solar kiln (Wengert and Meyer 1992). (1 in. = 25.4 mm; 1 ft = 0.3 m)**

When deciding what size to build the kiln, consider the maximum capacity of the kiln in board feet to be 10 times the roof area (measured perpendicular to the sun at noon) in square feet. For maximum year-round performance, the roof angle of the kiln should be equal to its latitude in degrees north of the equator. For example, a roof angle of 45° is ideal in Wisconsin because its latitude ranges from 42.5° to 47°. Increasing the roof angle to 55° would improve winter performance of the kiln.

Frame the kiln floor with 2 by 6 joists; cover the framing (top and bottom) with 5/8-in. (16 mm) plywood. For durability, use pressure-treated lumber and “exterior”-rated plywood. Space floor joists 16 to 24 in. (40 to 60 cm) apart and mount with joist hangers. Insulate the floor with blanket-type or solid foam insulation. Avoid insulations with a foil vapor barrier because they may trap moisture inside the floor. Do not use poured-in or blown-in insulation. Apply two coats of aluminum- or oil-based paint to the top sheet of the plywood (kiln floor) to prevent moisture from seeping into the floor. Cover the floor with flat black paint for maximum solar absorption.

Construct the walls of 2 by 4 or 2 by 6 studs and 3/4-in. (19-mm) plywood. Be sure the studs on the side walls frame openings for doors at least as large as the end dimensions of the wood pile. The back wall studs should frame four 1-ft-



**Figure 10.2—Baffle of semi-greenhouse solar kiln. The baffle, situated above lumber pile, forces air through pile. Some air also exits the dryer (bottom vent) and is replaced by drier outside air (top vents). Wengert and Meyer (1992).**

(0.3-m-) square vent openings, two on top and two on bottom. Paint the interior walls in the same manner as the floor. Cover vents with screen, to keep birds and rodents out, and use simple doors.

Fasten a 3/4-in. (19-mm) plywood fan baffle to the side walls. The fan baffle ensures that air flows through the wood pile rather than over the top of the pile (Fig. 10.2). Cut holes for mounting two electric fans as close to the roof as possible to eliminate dead hot air pockets in the upper corner. The baffle should extend from the roof to within 6 in. (150 mm) of the lumber pile. A sheet of plastic or canvas can be used to close the gap between the baffle and the lumber pile.

Mount electric fans to the baffle. Temperature can exceed 150°F (66°C) inside the kiln, so avoid fans with plastic parts that could melt; typically, multi-speed, metal window fans are used. Fans should blow towards the front of the kiln (away from top vents).

Raise the kiln off the ground with cinder blocks or railroad ties, or construct a cement foundation. The wooden kiln floor structure will deteriorate rapidly if it rests directly on the ground. Align the kiln so that the angled roof faces south. Stain the exterior of the kiln with a dark-colored stain. Do not use any covering that is impervious to water and may trap moisture in the insulation, such as oil-based paints.

Cover the kiln roof with one or two layers of translucent fiberglass, plastic film, or glass. Two layers will shorten

drying times. Fiberglass is inexpensive, resistant to breaking, and the easiest to work with. Apply a nonhardening silicone caulk to the outer surface of the frame to provide a seal between the plastic and the wood. Secure the fiberglass to the frame with 1 by 4 treated wood strips.

## Preparation of Lumber

For optimum lumber quality, load the dry kiln according to the following suggestions.

Place stickers on the kiln floor, perpendicular to the lengthwise direction of the lumber pile. Never place lumber directly on the floor. Fill the kiln to its designed capacity. A smaller load than the designed size will dry more rapidly, perhaps leading to checking and honeycomb. The top of the lumber should be within 6 in. (152 mm) of the bottom edge of the baffle. There should be 1 ft (0.3 m) spacing between the edge of the pile and the wall, front and back.

After stacking the lumber, end coat any uncoated, exposed ends. Cover the stack with a black-painted sheet of plywood or scrap lumber (separated by stickers from top layer of lumber) to protect the top layer from repeated exposure to direct sunlight. Place rocks, scrap iron, or other heavy weights on top of the cover to help prevent warp in the top layers of lumber.

## Drying Process

Lumber can be air dried before loading into the kiln or kiln dried green-from-the-saw. Air-dried lumber will often develop quality losses as a result of unfavorable weather. On the other hand, kiln drying green-from-the-saw lumber allows control of the drying conditions throughout the drying cycle, thereby assuring excellent quality. Drying time for air-dried, 4/4 lumber is 4 to 5 weeks in good weather.

At night, as the dryer cools and the humidity rises, water may condense on the walls of the kiln. This is an essential part of the drying process; it relieves stresses in the wood that develop during the day as the wood dries. For this reason, do not run the fans at night. Furthermore, do not use auxiliary heat and do not store solar heat during the day to be used at night unless a water spray or steam system is available for relieving stresses.

In the semi-greenhouse solar dryer presented here, the roof area and capacity are designed so that even on hot, sunny days, the dryer cannot dry 4/4 red oak lumber too rapidly. That is, the maximum drying rate will not exceed 3.8% MC loss/day for red oak. However, for thicker lumber with slower maximum drying rates, samples must be used to carefully monitor the drying rate. For 8/4, heavy, green hardwoods, covering half the roof area to reduce the amount of solar radiation will slow drying.

## References

### Special Drying Methods

- Eckelman, C.A.; Galezewski, J.A.** 1970. Azeotropic drying of hardwoods under vacuum. *Forest Products Journal*. 20(6): 33.
- Hittmeier, M.E.; Comstock, G.L.; Hann, R.A.** 1968. Press drying nine species of wood. *Forest Products Journal*. 18(9): 91–96.
- Huffman, D.R.; Pfaff, F.; Shah, S.M.** 1972. Azeotropic drying of yellow birch and hard maple lumber. *Forest Products Journal*. 22(8): 53–56.
- Johnson, C.L.** 1961. Wind-powered solar-heated lumber dryer. *Southern Lumberman*. 203(2532): 41–44.
- McMillen, J.M.** 1961a. Special methods of seasoning wood. Boiling in oily liquids. Rep. 1665 (rev.). Madison, WI: U.S. Department of Agriculture, Forest Service, Forest Products Laboratory.
- McMillen, J.M.** 1961b. Special methods of seasoning wood. Vapor drying. Rep. 1665–3 (rev.). Madison, WI: U.S. Department of Agriculture, Forest Service, Forest Products Laboratory.
- Simpson, W.T.** 1985. Process for rapid conversion of red oak logs to lumber. *Forest Products Journal*. 35(1): 51–56.

### Solar Drying

- Bois, P.J.** 1977. Constructing and operating a small solar-heated lumber dryer. Tech. Rep. No. 7. Madison, WI: U.S. Department of Agriculture, Forest Service, State and Private Forest, Forest Products Utilities.
- Chudnoff, M.; Maldonado, E.D.; Goytia, E.** 1966. Solar drying of tropical woods. Res. Pap. ITF 2. Rio Piedras, PR: U.S. Department of Agriculture, Forest Service, International Institute of Tropical Forestry.
- Crowther, R.I.** [and others]. 1976. Sun, earth: How to use solar and climatic energies today. Denver, CO: A. B. Hershfeld Press.
- Johnson, C.L.** 1961. Wind-powered solar-heated lumber dryer. *Southern Lumberman*. 203(2532): 41–44.
- Peck, E.C.** 1962. Drying 4/4 red oak by solar heat. *Forest Products Journal*. 12(3): 1037.
- Plumtre, R.A.** 1973. Solar kilns: Their suitability for developing countries. Rep. ID/WG 151/4. Vienna, Austria: U.N. Industrial Development Organization.
- Read, W.R.; Choda, A.; Cooper, P.I.** 1974. A solar timber kiln. *Solar Energy*. 15(4): 309–316.
- Sauter, G.R.** 1971. Timber drying by dehumidification. Annual Special Issue, Sawmilling and Woodwork. Sect. S/23–28. *Timber Trade Journal*.
- Wengert, E.M.** 1971. Improvements in solar dry kiln design. Res. Note FPL–0212. Madison, WI: U.S. Department of Agriculture, Forest Service, Forest Products Laboratory.
- Wengert, E.M.; Meyer, D.A.** 1992. Processing trees to lumber for the hobbyist and small business. *Forestry Facts* 60. Madison, WI: University of Wisconsin–Madison, Department of Forestry. 4 p.
- Wengert, E.M.; Oliveira, L.C.** 1980. Solar-heated, lumber dry kiln designs. Blacksburg, VA: Department of Forest Products, Virginia Polytechnic Institute and State University. 72 p.

# Chapter 11—Storage of Dried Lumber

Lumber dried to 12% or less moisture content (MC), and items manufactured from it, will regain moisture if stored for extended periods under conditions of high relative humidity (RH). Excessive regain of moisture frequently results in (1) swelling of whole pieces or certain parts, such as ends of pieces; (2) warping of items, glued-up panels for example; and (3) wood or glue-line failures in piled items where moisture regain is confined to lumber ends. A more complete discussion of moisture effects on machining and gluing is given in Chapter 9 and in work by Wengert (1988, 1998). A thorough discussion of lumber storage is provided by Rietz (1978). In short, improper storage can negate many achievements of proper drying.

Another major risk during storage is insect damage. Insects are controlled by keeping the storage area for kiln-dried lumber isolated from the storage areas for green and partially dried lumber and by keeping all storage areas free of debris and waste. Because kiln drying at temperatures higher than 130°F (54°C) kills all insects and their eggs, lumber that leaves the kiln is sterilized. Eliminating the source of reinfestation (that is, keeping the area free of debris) will control the risk of insect damage.

## Air-Dried Lumber

Storage of air-dried and predried hardwood lumber is generally not a good practice because of the risk of insect damage and the cost of storing the inventory. However, storage is sometimes required. Because MC over 20% is high enough to support fungal damage and insect activities, stored air-dried and predried lumber should be inspected frequently for insect or fungal damage; if damage is discovered, the lumber should be kiln dried as soon as possible.

When lumber in the air-drying yard is as dry as can be expected (that is, below 20% MC in most climates), the deteriorating effect of weathering continues as long as the lumber remains outdoors. Lumber should therefore be stored where it is no longer exposed to sun and rain. In fact, removing lumber from the air-drying yard at 30% MC may be advisable to avoid quality loss from rewetting. The best storage facility for both air-dried and predried lumber is an unheated, open shed.

## Kiln-Dried Lumber

Kiln dried lumber is placed in an unheated storage shed, heated storage area, or EMC-controlled room until ready for

use. These storage options are discussed in the following text. The best storage for furniture and cabinet lumber is in a heated, EMC-controlled shed or building. In all cases, if the storage EMC is not equal to the lumber MC, the ends of the boards, if not end coated, will start to gain or lose moisture immediately. Likewise, MC of boards on the outside of the pack will change rapidly.

Little shrinking and swelling occur during storage, as shown in Table 11.1 which shows dimensional changes in 3-in.- (76-mm-) wide red oak and yellow-poplar at different MC levels. However, given that gaps or unevenness of more than 0.006 in. (0.15 mm) affect glue joint strength, even seemingly minor MC changes need to be taken into consideration. In some cases, small changes in MC can cause warp in lumber and dimensional cuttings.

## Storage Facilities

### Open Shed

A roofed shed that is open on one or more sides can serve as a dry storage shed for air-dried lumber that is awaiting sale, kiln drying, or use in the air-dried condition. However, if kiln-dried lumber destined for furniture or other high-grade uses is stored in such a shed, MC will affect the quality of the lumber.

The shed roof should have a substantial overhang and be well maintained to prevent rain (except in very windy conditions) from hitting the lumber. Gutters should be installed to assure good rainwater drainage. The bottom surface of the shed (floor, dirt, gravel, or paved) should be dry.

**Table 11.1—Dimensional change in 3-in.- (76-mm-) wide red oak and yellow poplar with change in MC**

MC change (%)	Change in width (in. (mm))			
	Red oak		Yellow-poplar	
	Radial	Tangential	Radial	Tangential
1	0.005 (0.13)	0.011 (0.28)	0.005 (0.13)	0.009 (0.23)
2	0.014 (0.36)	0.033 (0.84)	0.014 (0.36)	0.017 (0.43)
3	0.024 (0.61)	0.055 (1.40)	0.024 (0.61)	0.026 (0.66)

## Unheated Closed Shed

If storage periods are short (up to 1 month) and the storage building is kept closed most of the time, little change in MC will occur because in most cases, the EMC (due to solar heating of the building) will be only slightly above the MC of the lumber. However, if dry lumber is stored for several months or longer in unheated buildings not designed to maintain a fixed low EMC condition, substantial moisture regain will occur—perhaps several percentage points of MC per month. In any case, the rule of thumb for lumber intended for furniture, cabinets, and the like is “If the lumber is stored in an unheated building, use the lumber promptly.” Unheated storage sheds are being successfully used for lumber intended for less demanding end uses.

An unheated shed should be located on a dry, well-drained site and have a concrete or asphalt floor. The shed should have adjustable vents in the roof and walls. Never use an earthen floor if the shed is situated in a low, damp place. Shed doors should be closed at night and as much as possible on rainy or foggy days. The roof should be well maintained; gutters and appropriate drainage systems should be used to direct rainwater away from the building.

## Heated Shed

The efficiency of a closed shed in maintaining low lumber MC is enhanced if the air can be heated to maintain the desired EMC. Only a small amount of heat is needed to raise the temperature sufficiently above the average outdoor temperature (average of daily high and low temperatures) to maintain 6% to 10% EMC (Table 11.2).

Heat can be supplied to a closed storage shed by steam coils, radiator, or unit heater. The system need not have a large capacity, but it should be arranged so that the temperature throughout the shed is reasonably uniform. A minimum temperature of 35°F (2°C) is suggested for a steam-heated storage area, to prevent the return lines and traps from freezing. The heat supply may be controlled by an ordinary thermostat or by a more precise automatic device.

**Table 11.2—Heat required to maintain 6% to 10% EMC in heated shed**

Desired EMC (%)	Approximate heating above average outside temperature (°F (°C))
6	25 (13.9)
7	20 (11.1)
8	15 (8.3)
9	12 (6.7)
10	8 (4.4)

To use a thermostat, obtain local weather forecasts for the expected average outdoor temperature for 4 to 7 days. Set the thermostat the number of degrees higher than the average temperature needed to maintain the desired EMC (see Table 11.2). Good air circulation is needed to maintain temperature and EMC uniformity.

A humidistat or a differential (inside to outside) thermostat may be used to control heat automatically. A humidistat maintains a given EMC by turning the heat on when conditions are too humid and off when conditions are too dry. Differential thermostats can be preset to maintain temperature in the shed at a specific level above the outside temperature. The differential thermostat is very dependable, economical, and easily installed, and the cost of maintenance is low.

## Dehumidified Room

An electric dehumidifier can be used in a small, well-enclosed space. Dehumidifiers need some heat (up to 80°F (27°C)) so that they do not freeze. Dehumidifiers can be turned on and off by a properly calibrated humidistat. These machines are very effective, but they are not as economical as heated storage sheds for large quantities of lumber.

## References

- Rietz, R.C.** 1978. Storage of lumber. Agric. Handb. 531. Washington, DC: U.S. Department of Agriculture. 63 p.
- Wengert, E.M.** 1988. The wood doctor's Rx. Blacksburg, VA: Virginia Tech, Department of Forest Products. 378 p.
- Wengert, E.M.** 1998. Moisture and wood. Video tape (38 min). Madison, WI: University of Wisconsin Extension. Marietta, GA: Wood Component Manufacturers Association.

# Chapter 12—Economics and Energy

The cost of air drying, predrying, or kiln drying hardwoods normally includes the costs of stacking, handling, and operating. Degrade cost should be assigned to each drying stage, but these costs are often overlooked.

Because wood drying involves the evaporation of large quantities of water, energy can be a very important element of total cost. If fuel is to be conserved, drying procedures have other implications besides cost. Traditionally, the lowest operating cost and the lowest energy usage in hardwood lumber production (not including degrade) have been achieved by combining air drying and kiln drying. Often, the least expensive system in terms of total cost is a combination of shed drying and warehouse predrying, provided that degrade costs are included.

The information in this chapter cannot serve as a complete analysis of all costs and energy use involved in drying

lumber. It is intended to provide guidance for those who wish to analyze their own operation. Professional advisors are available for thorough analyses.

## Economics

The economics of drying lumber is discussed in terms of typical costs and costs associated with degrade.

### Typical Costs for Various Drying Methods

Drying costs are difficult to obtain because most companies hesitate to share such information with their competitors. Moreover, each company uses different accounting procedures and has different quality requirements. Therefore, the data presented in Tables 12.1 and 12.2 are intended as guidelines only.

**Table 12.1—General cost of drying 4/4 red oak lumber by various methods in average large drying operation<sup>a</sup>**

Drying method	MC (%)	Time	Cost (\$/10 <sup>3</sup> board feet)					
			MC basis (per % MC loss)			Time basis (per day)		
			Operating	Degrade	Total	Operating	Degrade	Total
Air drying	Green to 22	6 months	0.99	1.00	1.99	0.30	0.30	0.60
Shed drying	Green to 20	6 months	1.10	0.25	1.35	0.30	0.08	0.38
Predrying	Green to 25	30 days	0.80	0.20	1.00	1.50	0.33	1.83
Dehumidification	Green to 6	36 days	0.96	0.14	1.10	2.00	0.28	2.28
Conventional	Green to 6	35 days	1.29	0.17	1.46	2.30	0.34	2.64

<sup>a</sup>Capacity of drying operation >5 million board feet/year. Source: Wengert 1990.

**Table 12.2—Typical total cost comparison of methods for drying 4/4 red oak lumber from green to 6% MC<sup>a</sup>**

Drying method	Operating cost (\$/10 <sup>3</sup> BF)	Degrade cost (\$/10 <sup>3</sup> BF)	Drying time (weeks)	Total cost (\$/10 <sup>3</sup> BF)
Air drying followed by conventional kiln drying <sup>b</sup>	77	65 <sup>c</sup>	25	145
Shed drying followed by conventional kiln drying <sup>b</sup>	87	20	28	110
Predrying followed by conventional kiln drying <sup>b</sup>	60	10	6	73
Dehumidification kiln	66	10	5	76
Conventional kiln	79	13	5	92

<sup>a</sup>Based on data in Table 12.1. BF is board feet.

<sup>b</sup>\$3/10<sup>3</sup> BF added for lumber moving costs.

<sup>c</sup>A well operated yard could have substantially lower degrade costs.

## Degrade Costs

The greatest costs can result from degrade, especially in air drying. In a study of degrade in Appalachian air-drying yards, Cuppett (1966) reported an average loss, adjusted to 1999, of more than \$64/thousand board feet, although at some mills the losses were controlled to less than \$10/thousand board feet. Estimates by Hanks and Peirsol (1975) of air-drying-degrade losses for 10 hardwoods dried under good conditions ranged from 0% to 15% of the lumber value. However, with proper air-drying procedures and acceptable weather, degrade can be controlled and degrade costs can be greatly reduced. Beall and Spoerke (1973) showed that, under careful air-drying procedures and by terminating drying when lumber MC was at 20%, degrade of 4/4 oak was 1% to 2% of lumber value and degrade of 8/4 oak, 3% to 4%. By using proper procedures and paying attention to the drying process, degrade can be controlled and almost eliminated.

## Energy Considerations

Understanding how energy is used in drying will reduce costs by conserving energy. Energy is used in drying in five major areas:

1. Initial heating of lumber and water in the wood when the dryer is started and heating of lumber and water whenever dryer temperature is changed
2. Evaporation of water from lumber
3. Heating of incoming vent air
4. Heat loss (conduction) through walls, doors, floor, and roof
5. Electrical energy input to air-circulating fans

## Evaporation

Typically, half the energy used for drying wood is used for evaporating water. This energy includes both the heat necessary to evaporate water and that necessary to break the hygroscopic bonds between water and wood molecules. The total amount of energy needed for evaporation depends on the initial and final MC and density of the wood. Consequently, it is impossible to reduce the energy required for evaporation in predrying or kiln drying unless the lumber is partially dried before it enters the kiln.

Note that because the basis for the calculations is board feet, additional energy is required for oversized lumber. For example, if every piece of 4/4 lumber is 1/32 in. (0.8 mm) thicker than required, the amount of energy required for evaporation will increase 3%. If every piece has 3 in. (80 mm) over-length on one end, the energy needed will increase 2% to 3%. Planing lumber before drying (presurfacing or blanking) will reduce the average thickness of typical lumber by 1/16 in. (2 mm), thereby giving an

energy savings of 6%. (Other benefits of presurfacing, such as faster drying and reduced checking, are discussed in Chapter 8.)

Once the water has evaporated, the vapor carries the energy of evaporation. In a conventional kiln, this energy is carried out the vents. However, if this vapor can be condensed to a liquid, the energy of evaporation will be recovered. This, in fact, is how a dehumidification compressor works and why a dehumidification dryer is so energy efficient. In addition, a condenser can be placed on top of the vents to recover the energy of evaporation from the vent air. The recaptured energy will be at a low temperature and will seldom be supplied at a rate higher than 3,000 Btu/h (878 W) per thousand board feet. This is a savings rate of approximately 2½ cents/h/thousand board feet. For a kiln with a load capacity of 36 thousand board feet/month, the savings could potentially be \$8,000/year, if there is a use for all the recaptured heat and if the unit is fairly efficient.

## Ventilation

In the conventional steam-heated kiln or predryer, the moisture from the lumber is exhausted through vents and fresh outside air is brought into the dryer. Heat is required to bring this air up to the operating temperature of the kiln. The amount of energy required for ventilation depends on the temperature difference between the inside and outside (the greater the difference, the more heat required) and the difference between the inside and outside absolute humidity. The greater the outside humidity, the lower the wet-bulb temperature of the dryer (or the lower the relative humidity (RH) at low dry-bulb temperature, the greater the energy usage). Venting is also more efficient at higher dry-bulb temperatures than at low temperatures; that is, the warmer the dryer, the less venting required.

Vent energy usage can be minimized by avoiding conditions where the absolute humidity in the dryer is within 4 grains/ft<sup>3</sup> (9 g/m<sup>3</sup>) of the absolute humidity outside the dryer. When the difference is less than 4 grains, the dry-bulb temperature should be increased if possible.

*Note:* the suggested schedules in this text do not use a wet-bulb temperature of 80°F (27°C), which would be very energy inefficient.

Vent losses can also be minimized by maintaining the dryer so that it is free of leaks. In a steam kiln, the vents and spray should not operate together. That is, during any given hour, the kiln should either vent or inject steam spray, not both. If the dryer oscillates between venting and spraying over an hour, equipment problems will need to be corrected to conserve energy. For example, the control instrument may require repair, the vents may need to be adjusted so that they do not vent too rapidly, or the spray line control valve may need to be turned off manually.



*Note:* When drying oak from green to 7% MC, more than 2,000 lb (900 kg) of water/thousand board feet is released, requiring more than 1,000,000 ft<sup>3</sup> (28,000 m<sup>3</sup>) of vent air. In most cases, the moisture added to the air in the dryer by evaporation is sufficient to maintain the required humidity. Condensation does occur inside the kiln when there are leaks or when the walls, doors, roof (including the vent covers), or floor are poorly insulated resulting.

Ventilation losses can be reduced by using a dehumidification compressor, rather than the vents, to reduce RH in the dryer. In addition to the standard electric dehumidification unit, cold water pipes in the kiln have been used as condensers. It should be obvious that vent losses can also be reduced by plugging any leaks and by using a well insulated building.

## Conduction

Heat flows from warm to cold areas. The amount of heat depends on the insulating properties of the material and the temperature difference between outside and inside. To reduce conduction losses, the insulation in the walls must be kept as dry as possible. Lowering the temperature of the dryer also reduces conduction losses, but this gain will be offset by longer drying times and thus increased heat losses during the run; in other words, lowering the dry-bulb temperature is not effective.

Conduction losses can be reduced by increasing the amount of insulation in the walls. For example, doubling the insulation in the walls and roof reduces heat loss in these areas by 50%. However, heat loss through the doors, framing members and panel joints, and floor would still be large. Therefore, doubling the insulation would save perhaps 35% of conduction losses. In kiln drying green oak, the savings would be about 350,000 Btu (400 MJ) per thousand board feet or \$3/thousand board feet. In a kiln with a capacity of 36 thousand board feet that dries 12 charges/year, annual savings would be less than \$1,300, which might not be enough to pay for the cost of the extra insulation.

Energy required to kiln dry hardwood lumber at various moisture content levels in modern kilns compared with older kilns is shown in Table 12.3.

**Table 12.3—Energy consumption required to kiln dry hardwood lumber at various moisture content levels**

Lumber moisture content	Total energy used/10 <sup>3</sup> BF lumber (×10 <sup>6</sup> Btu) <sup>a</sup>	
	Good	Intermediate
Air-dried to 22% MC	1.3	2.6
Partly air-dried to 37% MC	2.6	5.2
Green at 47% MC	3.4	6.9

<sup>a</sup>Good efficiency, modern kilns; intermediate, older kilns.

## Example of Energy Use

As an example of the magnitude of energy used to kiln dry hardwood lumber, consider the following situation:

Species	red oak
Lumber thickness	nominal 4/4
Initial MC	80%;
Final MC	7%
Kiln size	26 ft wide by 28 ft deep by 24 ft high (7.9 by 8.5 by 7.3 m)
Kiln capacity	36 thousand board feet
Drying time	30 days
Schedule	T4-D2
Outside conditions	55°F (13°C), 65% RH

No equalizing and conditioning

Energy usage for a kiln with these conditions is summarized in Table 12.4. Note that 53% of the energy is used for water evaporation, 24% for ventilation loss, and 19% for heat loss through the structure.

As another example, assume that the outside RH in the previous example is increased from 65% to 75% and the average temperature is increased to 80°F (27°C) (Table 12.5). Note that when the exterior humidity is high, there is large increase in ventilation losses and a slight reduction in conduction losses.

## Suggestions for Conserving Energy

The following suggestions (Wengert 1974, Wengert and Meyer 1992) should be helpful in increasing the efficient use of energy during kiln drying:

**Table 12.4—Energy profile for drying oak lumber with standard schedule and outside conditions of 55°F (13°C) and 65% RH**

Use of energy	Energy consumption		
	Per kiln (×10 <sup>6</sup> Btu/kiln)	Per volume (×10 <sup>6</sup> Btu/10 <sup>3</sup> BF)	Proportion of total (%)
Heating wood and water	7.3	0.2	4
Evaporation	91.8	2.6	53
Ventilation	41.4	1.2	24
Heat loss	33.2	0.9	19
Total	173.8	4.8	—

**Table 12.5—Energy profile for drying oak lumber with standard schedule and outside conditions of 80°F (27°C) and 75% RH**

Use of energy	Energy consumption		
	Per kiln ( $\times 10^6$ Btu/kiln)	Per volume ( $\times 10^6$ Btu/ $10^3$ BF)	Proportion of total (%)
Heating wood and water	5.1	0.1	3
Evaporation	91.8	2.6	55
Ventilation	46.1	1.3	27
Heat loss	25.2	0.7	15
Total	173.8	4.8	—

1. Use as much air drying or forced-air drying as possible to reduce amount of water that must be evaporated in kiln. Three days of good air drying can reduce evaporation energy required by 20%. During air drying, cover lumber pile to prevent wetting by rain, which can increase lumber MC and therefore increase energy required for drying.
2. Do not use steam or water spray in kiln except during conditioning. Let moisture from the wood build up humidity to the desired level; a modern kiln will not have enough moisture leaks or cold spots to make steam spray necessary during most of the schedule. Steam may have to be used when very low wet-bulb depression temperatures are required.
3. Double insulation in walls, floor, and roof in new kilns; retrofit older kilns with additional insulation.
4. Repair and caulk all leaks, cracks, and holes in doors and kiln structure (especially where walls join roof) to prevent unnecessary venting and loss of heat. Make sure doors close tightly, especially at the top. Temporarily plug any leaks around doors with rags and order new gaskets, shimming strips, or hangers if necessary. In a track kiln, use sawdust-filled burlap bags to plug leaks around tracks.
5. For brick or cinder block kilns, maintain moisture-vapor-resistant kiln coating in the best possible condition. This will prevent walls and roof from absorbing water. Check that weep holes are not plugged.
6. For aluminum kiln walls only, paint exterior walls and roof a dark color to increase wall temperatures through solar absorption, thereby reducing heat conduction loss. Never paint exterior of masonry walls; the paint coating will trap moisture in the wall.
7. To reduce heat loss, consider installing a new roof or repairing an old one. Add additional insulation if

necessary. Make sure interior vapor barrier or coating is intact.

8. Install or repair baffling to obtain high, uniform air velocity through lumber and prevent short circuiting air travel.
9. Arrange to adjust fan speeds, if possible, during a run. A 20% reduction in fan speed results in 50% energy saving.
10. Adjust (and repair as needed) valves and vents to close tightly.
11. Keep steam system in proper working order. Fix leaks. Maintain traps, check valves, and return pumps. Traps should primarily eject hot water and little steam, if any.
12. Clean heating coils of debris and corrosion. Corroded pipes usually indicate that operating temperature is too low; look for water-logged or blocked coils.
13. Have the recorder-controller calibrated and checked for efficient operation. Kiln should not oscillate between periods of venting and steam spraying and should not vent and steam at the same time.
14. Determine wood moisture content accurately. If samples do not represent load, do not waste energy by over-drying or too lengthy drying. Try to plan loads so that when they are sufficiently dry, someone will be available to shut off the kiln and, if possible, to unload, reload, and restart. Do not leave load of dry lumber in the kiln overnight or through a weekend.
15. Use accelerated schedules where possible. Check the chapter on Conventional Kiln Drying for accelerating schedules with minimum risk. The higher the temperature for drying, the more efficiently energy is used.
16. Avoid low wet-bulb temperatures on warm, humid days, especially when absolute humidity is high outside.
17. If possible, reduce length of time for conditioning; some low-density hardwoods can be conditioned in 6 h.
18. Unload and reload kiln as fast as possible to avoid cooling kiln unnecessarily.
19. In a battery of kilns, avoid loading or unloading a kiln while temperature of adjacent kiln  $\geq 180^\circ\text{F}$  ( $\geq 82^\circ\text{C}$ ).
20. Load kiln to rated capacity. When purchasing new kilns, several smaller kilns may be more efficient than a large one.
21. During periods when kiln is not operating, close all valves tightly and keep kiln doors closed. Use a small amount of heat, if necessary, to prevent freezing of steam and water lines.

22. Install heat exchanger on vents to capture and recycle some sensible and latent heat.
23. Check with manufacturers of dryers and boilers to determine whether steam pressures or gas or oil flow rates can be lowered during periods of constant dry-bulb temperature. Have manufacturer check burner for optimal efficiency.

## References

**Cuppett, D.G.** 1965. How to determine seasoning degrade losses in sawmill lumberyards. Res. Note NE-32. Upper Darby, PA: U.S. Department of Agriculture, Northeast Forest Experiment Station. 7 p.

**Hanks, L.F.; Peirsol, M.K.** 1975. Value loss of hardwood lumber during air drying. Res. Pap. NE-309. Upper Darby, PA: U.S. Department of Agriculture, Northeast Forest Experiment Station. 10 p.

**Wengert, E.M.** 1974. How to reduce energy consumption in kiln drying lumber. Res. Note FPL-0228. Madison, WI: U.S. Department of Agriculture, Forest Service, Forest Products Laboratory. 4 p.

**Wengert, E.M.** 1990. Drying oak lumber. Madison, WI: University of Wisconsin-Madison, Department of Forestry. 167 p.

**Wengert, E.M; Meyer, DA.** 1992. Energy at the furniture, millwork and cabinet plant: Conservation and cost reduction. Forestry Facts. 62. Madison, WI: University of Wisconsin-Madison, Department of Forestry. 8 p.

# Appendix A—Lumber, Tree, and Botanical Names of Commercial North American Hardwoods

Commercial name for lumber	Official common tree name	Botanical name
Apple	Apple	<i>Malus</i> spp.
Ash		
Black	Black ash	<i>Fraxinus nigra</i>
White	White ash	<i>F. americana</i>
	Blue ash	<i>F. quadrangulata</i>
	Green ash	<i>F. pennsylvanica</i>
Aspen (popple)	Bigtooth aspen	<i>Populus grandidentata</i>
	Quaking aspen	<i>P. tremuloides</i>
Basswood	American basswood	<i>Tilia americana</i>
	White basswood	<i>T. heterophylla</i>
Beech	Beech	<i>Fagus grandifolia</i>
Birch		
Soft (white)	Gray birch	<i>Betula populifolia</i>
	Paper birch	<i>B. papyrifera</i>
	River birch	<i>B. nigra</i>
Yellow	Sweet birch	<i>B. lenta</i>
	Yellow birch	<i>B. alleghaniensis</i>
Blackgum (see tupelo)		
Buckeye	Ohio buckeye	<i>Aesculus glabra</i>
	Yellow buckeye	<i>A. octandra</i>
Butternut	Butternut	<i>Juglans cinerea</i>
Cherry	Black cherry	<i>Prunus serotina</i>
Chestnut	Chestnut	<i>Castanea dentata</i>
Cottonwood		
Normal	Balsam poplar	<i>Populus balsamifera</i>
Wet streak	Eastern cottonwood	<i>P. deltoides</i>
	Swamp cottonwood	<i>P. heterophylla</i>
Cucumber	Cucumbertree	<i>Magnolia acuminata</i>
Dogwood	Flowering dogwood	<i>Cornus florida</i>
Elm		
Rock	Cedar elm	<i>Ulmus crassifolia</i>
	Rock elm	<i>U. thomasii</i>
	September elm	<i>U. serotina</i>
	Winged elm	<i>U. alata</i>
Soft (American)		
Hard type	American elm	<i>U. americana</i>
Soft type (gray)	Slippery elm	<i>U. rubra</i>
Gum (see sweetgum)		
Hackberry	Hackberry	<i>Celtis occidentalis</i>
	Sugarberry	<i>C. laevigata</i>
Hickory	Mockernut hickory	<i>Carya tomentosa</i>
	Pignut hickory	<i>C. glabra</i>
	Shagbark hickory	<i>C. ovata</i>
	Shellbark hickory	<i>C. laciniosa</i>
Holly	American holly	<i>Ilex opaca</i>
Ironwood (hophornbeam)	Eastern hophornbeam	<i>Ostrya virginiana</i>

Commercial name for lumber	Official common tree name	Botanical name
Locust	Black locust	<i>Robinia pseudoacacia</i>
	Honey locust	<i>Gleditsia triacanthos</i>
Magnolia	Southern magnolia	<i>Magnolia grandiflora</i>
	Sweetbay	<i>M. virginiana</i>
	(also see cucumbertree)	
Maple		
Hard	Black maple	<i>Acer nigrum</i>
	Sugar maple	<i>A. saccharum</i>
Soft	Red maple	<i>A. rubrum</i>
	Silver maple	<i>A. saccharinum</i>
Oak		
Red		
Northern or upland	Black oak	<i>Quercus velutina</i>
	Blackjack oak	<i>Q. marilandica</i>
	Cherrybark oak	<i>Q. falcata</i> var. <i>pagodaefolia</i>
	Northern pin oak	<i>Q. ellipsoidalis</i>
	Northern red oak	<i>Q. rubra</i>
	Pin oak	<i>Q. palustris</i>
	Scarlet oak	<i>Q. coccinea</i>
	Shumard oak	<i>Q. shumardii</i>
	Southern red oak	<i>Q. falcata</i> var. <i>falcata</i>
Southern lowland	Cherrybark oak	<i>Q. falcata</i> var. <i>pagodaefolia</i>
	Laurel oak	<i>Q. laurifolia</i>
	Nuttall oak	<i>Q. nuttallii</i>
	Shumard oak,	<i>Q. shumardii</i>
	Water oak	<i>Q. nigra</i>
	Willow oak	<i>Q. phellos</i>
White		
Northern or upland	Bur oak	<i>Q. macrocarpa</i>
	Chestnut oak	<i>Q. prinus</i>
	Chinkapin oak	<i>Q. muehlenbergii</i>
	Post oak	<i>Q. stellata</i>
	Swamp white oak	<i>Q. bicolor</i>
	White oak	<i>Q. alba</i>
Southern lowland	Overcup oak	<i>Q. lyrata</i>
	Swamp chestnut oak	<i>Q. michauxii</i>
Osage-orange	Osage-orange	<i>Maclura pomifera</i>
Pecan		
Sweet	Pecan	<i>Carya illinoensis</i>
	Nutmeg hickory	<i>C. myristicaeformis</i>
Bitter	Water hickory	<i>C. aquatica</i>
Persimmon	Common persimmon	<i>Diospyros virginiana</i>
Poplar (see yellow-poplar)		
Sassafras	Sassafras	<i>Sassafras albidum</i>
Sweetbay	Sweetbay	<i>Magnolia virginiana</i>
Sweetgum		
Redgum	Sweetgum (heartwood)	<i>Liquidambar styraciflua</i>
Sapgum	Sweetgum (sapwood)	<i>L. styraciflua</i>
Sycamore	American sycamore	<i>Platanus occidentalis</i>
Tupelo, black (blackgum)	Black tupelo	<i>Nyssa sylvatica</i>
	Swamp tupelo	<i>N. sylvatica</i> var. <i>biflora</i>
	Water tupelo	<i>N. aquatica</i>
Tupelo		
Walnut	Black walnut	<i>Juglans nigra</i>
Willow	Black willow	<i>Salix nigra</i>
Yellow-poplar	Yellow-poplar	<i>Liriodendron tulipifera</i>

# Appendix B—Portable Electric Moisture Meters

Electric moisture meters are so-named because they measure an electrical property of a piece of wood and convert that measurement to a corresponding moisture content (MC) value, usually read directly on the meter. Depending on the type and manufacturer of the meter, the electrical property measured may be resistance, conductance, dielectric constant, or power-loss factor.

Electric moisture meters, if used properly, provide a rapid, convenient, and, for most purposes, sufficiently accurate means of determining wood MC when it is lower than 30%. When wood is treated with certain wood-preserving or fire-retardant salts, electric moisture meter readings are reliable only in a narrow range (see section on special situations).

Producers and users of dry lumber have gained better awareness of the importance of correct MC during manufacturing and in the eventual performance of a quality product. Both producers and users use portable electric moisture meters to monitor MC and to provide data for statistical process control programs. The MC values obtained from electric moisture meter readings are becoming an important factor in the acceptance or rejection of lumber loads at secondary wood products manufacturing plants.

The information in this appendix was obtained from Sidney Boone and Paul Bois, former employees of the Forest Products Laboratory, USDA Forest Service.

## Types of Meters

Two types of portable electric meters are currently in widespread use: pin and non-pin. Because both types of meters measure an electrical property rather than MC directly, some natural variation occurs in the readings. This means that two meters measuring MC on the same piece of wood may have slightly different readings from time to time. If the meter readings will be one basis for accepting or rejecting lumber, it is prudent to indicate the brand and model number of the meter that will be used for such testing.

### Pin Meters

With pin meters (also called resistance meters), pin or needlelike electrodes are driven into the wood. The electrical resistance or conductance between the pins (electrodes) is measured and converted to a MC reading.

When the pins are mounted in the meter case, they are usually not insulated and measure about 3/8 in. (9.5 mm) long. In another style of pin meter, the pins are mounted in some type of hammer or device for driving the pins into the wood, and this hammer is connected to the meter by a cable. These designs usually use 1-in.- (25-mm-) long pins that are insulated except at the tips. Pin or resistance meters read the MC of the wettest area that contacts the uninsulated part of the pin. The effective measurement range of resistance for pin meters is from 7% to 30% MC. These meters are specialized ohm meters; below 7% MC, the electrical resistance is too high for reliable readings. For example, at 7% MC, the resistance for red oak is about 15,000 megohms and for hard maple, 72,000 megohms. Above 30% MC, electrical resistance has too much variability and shows too little change for reliable readings. At 30% MC, the resistance for red oak is about 0.50 megohms and for hard maple, about 0.60 megohms.

### Non-Pin Meters

The non-pin (dielectric) meter uses a sensor plate that does not physically penetrate the wood. Instead, the sensor plate is held in intimate contact with the wood surface and an electric field is projected into the wood. An electrical property such as the dielectric constant or power-loss factor is measured and converted to a MC reading. Effective range of non-pin or dielectric meters is about 5% to 30% MC. Note that the lower limit of the range is about 2% MC lower than that of the pin (resistance) meter; both meters have the same upper limit of 30% MC.

## Preferred Procedures for Using Meters

### Pin Meters

1. Turn the meter on and check that the battery has ample power. Check calibration, if required.

All meters have a button or switch to check the condition of the battery. If the indicator shows low power, replace the battery with a new one. If the meter has an adjustment knob or screw, turn it to bring the needle or digital readout to the position recommended by the meter manufacturer.

2. Select a location on the lumber for MC measurement.

For unpiled lumber, this location should be at least 2 ft (0.6 m) from the end of piece, approximately in the middle of the wide face of the board. If measuring pieces of molding, turnings, or other products less than 4 ft (1.2 m) in length, select a location approximately in the middle of the piece. For piled lumber, readings may be taken on the edge or narrow face of the board. However, remember that the MC of edge pieces may not represent the MC of interior pieces. Readings taken from the end grain of boards will not usually represent the average MC of the piece.

3. Position the pins on the wood surface with the needles parallel to the grain. (A few meters require the pins to be across the grain; check the instruction book.)

Orienting the pins parallel to the grain is important when MC exceeds 15%. For readings below 15% MC, pin alignment is not critical.

4. Force the pins into the wood to the required depth.

When using meters with pins mounted in a meter case (usually uninsulated pins 3/8 in. (1 cm) long), *do not hammer or pound on the case*. Apply hand pressure only. Try to push pins to their full length into the wood. For oak, hickory, and other dense woods, force pins as deep as possible without striking the meter. Meters with electrodes (pins) attached by cables typically have some type of hammer to drive longer pins (usually 1 in. long, insulated except at tip) to desired depth in wood.

To determine average MC of the wood, drive insulated pins 1/5 to 1/4 of the thickness of the piece. Example: for 4/4 lumber, drive pins 1/4 in. (6 mm) deep; for 8/4 lumber, drive 1/2 in. (13 mm) deep. To determine whether moisture gradients exist, take readings at different depths, from surface to core. A shell that is wetter than the core indicates moisture regain after kiln drying. To determine core MC of the wood, drive pin tips to the center of the piece.

5. Read current MC values and record.

If meter readings drift, use the reading taken immediately after the electrode reaches the desired depth in the piece.

6. Take MC readings at more than one location per piece.

Several readings will give an indication of MC variation, if any, along the length or width of the piece. Several readings will help locate wet pockets in the piece, if any.

7. Make temperature corrections if lumber temperature is below 60°F (16°C) or above 90°F (32°C).

Meters are usually calibrated for 70°F to 80°F (21°C to 27°C). If lumber is above or below this temperature by 20°F (11°C) or more, corrections should be made. Correction tables are available from the meter manufacturer and many general wood drying reference books. Readings

taken at room temperature are usually best. Some meters have provisions for presetting temperature correction. Use this feature if it is available. The meter, including the electrode pins, should be at room temperature if at all possible.

8. Make species correction as needed.

Some meters have provisions for presetting species or species groups. Use this feature if it is available. Species corrections are usually very slight (1% MC) for most North American hardwoods; corrections may be greater for some tropical woods. Correction tables are available from the meter manufacturer and many general wood drying reference books. Most meters sold in the United States are factory calibrated for Douglas Fir or Southern Pine, so no correction is needed when measuring MC of these species.

9. Turn off the meter when finished with measurements.

## Non-Pin Meters

1. Turn the meter on and check that the battery has ample power. Also check meter calibration, if required. All meters have a button or switch to check the condition of the battery. If the indicator shows low power, replace or recharge the battery.

2. Select the proper location for MC measurement.

For lumber, the location should be at least 2 ft (0.6 m) from the end of piece and about midwidth. Position the meter so that no metal rollers or supports are on the back side of the board opposite the meter location. It is best to position the back side of the board so that it is exposed to air. For molding, turnings, or other products less than 4 ft (1.2 m) in length, select a location in approximately in the middle of the piece. *Use the meter on the edge or narrow face of piled lumber only if sensor plate does not overlap adjacent boards*. A minimum contact area is often required for a reliable reading on a particular board. In other words, the sensor plate must be entirely covered.

3. Press the sensor plate of the meter firmly against the wood surface.

Non-pin meters are designed to give readings of average MC of the cross section of lumber up to about 2 in. (51 mm) thick. Consult manufacturer's literature for precise limits.

4. Read current MC values and record.

5. Take MC readings at more than one location per piece.

Since non-pin meters do not make holes are made in the wood, many readings can be made along the length of the board without marring the surface. Taking several readings per board gives an indication of MC variation along the length and easily locates wet spots in species prone to this drying problem.

6. Make allowances or adjustments for specific gravity and/or species of the wood.

Non-pin meters can be greatly influenced by the specific gravity or density of the wood. Some meters have built-in species adjustments. Check the meter instruction sheet and use this feature if it is available.

7. Turn off the meter when finished with measurements.

## Situations That May Affect Meter Reliability

The following situations may affect the accuracy of readings from electric moisture meters.

1. Wet wood surfaces as a result of rain, snow, or ice.

Liquid moisture on the wood surface can enter the lumber when the probe of a pin meter is inserted. This may result in incorrect (too high) readings even when insulated pins are used. Do not use non-pin meters when surface moisture is present because readings will not be accurate.

2. Transfer of a meter from room temperature to a hot humid kiln or a very cold outdoor environment.

If a meter or probe is brought from a cold into a warm environment and the equipment is colder than the dew point temperature of the warm air, moisture will condense on the cold equipment. This condensation may cause an extremely high reading or may limit the reading to 10% MC. Low MC cannot be measured until the moisture is evaporated from the equipment, which may take several hours. Therefore, do not take an electric moisture meter into a hot kiln unless the meter is warmed to approximately the temperature of the kiln. Optimally, use the meter and pins at room temperature.

3. Use of pin meters in very low humidity conditions.

In a very dry environment (below approximately 30% RH) or when very dry lumber is planed, a static charge can develop on the lumber or the meter cable that can cause erroneous meter readings. The meter may also begin to indicate a MC value before the pins even touch the lumber. In extreme cases, it may be necessary to take MC readings on a grounded metal table to dissipate the static charge.

4. Wood treated with certain wood preservatives or fire retardants.

Treatment of wood with oilborne preservatives generally does not affect moisture meter readings. The meter readings of wood treated with waterborne salt solutions of wood preservatives or fire retardants will generally be too high when wood MC is higher than approximately 10%. Wood treated with waterborne oxide solutions of wood preservatives such as chromated copper arsenate, type C

(CCA-C) will give fairly accurate readings up to about 25% MC.

## Accuracy of Moisture Meters for Kiln-Dried Lumber

The secondary wood products manufacturing industry has grown increasingly aware of the importance of correct wood MC during manufacturing and in the eventual performance of the product. As a result, electric moisture meters are being used more often to monitor MC and provide data for quality control programs. The accuracy of these meters for kiln-dried lumber (6% to 8% MC) is therefore of great concern.

A test was conducted to establish the accuracy of portable electric moisture meters, both pin and non-pin types, using more than 250 samples of northern hardwood kiln-dried lumber. Moisture measurements were compared to those from oven-dried wood. Measurements were taken at the same locations on the test and comparison specimens.

For the test specimens, the pin (resistance) meters measured MC at a point and the non-pin (dielectric) meter measured MC within a small area. However, MC of the entire cross-section of the oven-dried specimens was measured, from edge to edge. Therefore, some variability was expected because the basis of measurement was not the same. However, the meters were used in a manner similar to that used by most companies in daily practice.

Overall, all three meters performed very well (Table B1); no one meter outperformed the others. For most species, the difference between the meter reading and the oven-dry MC was under 1% MC. For all the meters, 95% of the readings were within  $\pm 2\%$  MC. The resistance meter readings under 6.5% MC were not used in this evaluation; however, the dielectric meter was able to measure low MC accurately.

**Table B1—Average difference (Ovendry MC–Meter MC) for three electric moisture meters**

Species	Average difference (%) by meter type and manufacturer		
	Delmhorst resistance	Lignomat resistance	Wagner dielectric
Ash	0.8	0.9	-1.2
Aspen	0.6	0.3	2.5
Basswood	0.4	0.1	-1.9
Yellow birch	0.8	1.0	—
Cherry	0.4	—	-1.2
Hard maple	0.5	0.7	0.1
Soft maple	0.5	-0.9	1.4
Red oak	0.6	0.5	1.2
Walnut	0.3	0.9	-0.1



# Glossary

**Accelerated Air Drying.** The use of equipment and procedures to accelerate air drying. In this handbook, accelerated air drying includes yard fan drying, shed fan drying, forced air drying, low temperature kiln drying, and controlled air drying.

**Active Drying Period.** In air drying, the period or season of the year when conditions are most favorable for drying wood at the highest rate.

**Air-Dried.** (See **Moisture Content Classes.**)

**Air Drying.** The process of drying green lumber or other wood products by exposure to prevailing natural atmospheric conditions outdoors or in an unheated shed.

**Air Drying Calendar.** A table that shows the number of effective air drying days in each month of the year in a specific area.

**Air Travel.** The distance air has to move from the entering-air side to the leaving-air side of the load.

**Air Velocity.** The velocity of air as it leaves the sticker spaces on the leaving-air side of the load.

**Alley.** In air drying, the passageway between rows or lines of piles of lumber or other wood products in a yard.

**Cross**—The passageways that connect main alleys and lie at right angles to the piled lumber.

**Main**—The roads in a yard for the transport of lumber and other wood products.

**Baffle.** A canvas, metal, or wood barrier used for deflecting, checking, or otherwise directing the flow of air.

**Board.** Lumber that is less than 2 in. (51 mm) thick and at least 2 in. (51 mm) wide; a term usually applied to 4/4 through 6/4 stock of all widths and lengths.

**Boiling in Oil.** A special process for drying wood; the rough green wood products are submerged in an open hot bath of a water-repelling liquid such as petroleum oil, creosote, or molten wax, or perchloroethylene in azeotropic drying, all of which have a boiling point considerably above that of water.

**Bolster.** A piece of wood, generally a nominal 4 in. (standard 89 mm) in cross section, placed between stickered packages of lumber or other wood products to provide space for the entry and exit of the forks of a lift truck. The bolster should be placed in alignment with a tier of stickers and a supporting foundation member.

**Bound Water.** In wood technology, moisture that is intimately associated with the finer wood elements of the cell wall by adsorption and held with sufficient force to reduce the vapor pressure.

**Bow.** A form of warp in which lumber deviates from flatness lengthwise but not across the faces.

**Box Piling.** A method of flat stacking random-length lumber for air or kiln drying. Full-length lumber is placed in the outer edges of each layer and shorter pieces in-between are alternated lengthwise, end-to-end, to produce square-end piles, unit packages, or kiln truckloads.

**British Thermal Unit.** The amount of heat required to raise the temperature of 1 lb of water at its maximum density, 1°F. The metric equivalent is a joule (J), which is the amount of heat required to raise 1 cm<sup>3</sup> of water at its maximum density by 1°C.

**Bulk Piling.** In handling lumber and other wood items, the stacking onto dollies or pallets, into unit packages, or into bins without vertical spaces or stickers between the layers for air circulation.

**Casehardening.** A condition of stress and set in dry wood in which the outer fibers are under compressive stress and the inner fibers are under tensile stress, and the stresses persist when the wood is uniformly dry.

**Cell.** In wood anatomy, a general term for the minute units of wood structure that have distinct walls and cavities, including wood fibers, vessel segments, and other elements of diverse structure and function. In dense woods, the cell fibers are thick walled and make up the major part of whole zones of wood. These fibrous zones dry slowly.

**Cellulose.** The carbohydrate that is the principal constituent of wood and forms the framework of wood cells.

**Check.** A separation of the wood fibers within or on the surface of a log, timber, lumber, or other wood product resulting from tension stresses set up during drying (usually in the early stages).

**Surface**—Checks that occur on the flat faces of lumber.

**End**—Checks that occur on the ends of logs, lumber, or dimension parts.

**Chemical Seasoning.** The application of a hygroscopic chemical (sodium chloride, for example) to green wood for the purpose of reducing defects, mainly surface checks, during drying. The chemical may be applied by soaking, dipping, spraying with an aqueous solution, or spreading with the dry chemical and bulk piling.

**Collapse.** Buckling or flattening of the wood cells during drying, resulting in excessive or uneven shrinkage and a corrugated surface.

**Conditioning.** In kiln drying, a process for relieving the stresses present in the wood at the end of drying. While still in the kiln, the stock is subjected to a fairly high dry-bulb temperature and 4% equilibrium moisture content above the desired average moisture content for the stock. The process should be long enough to eliminate casehardening through reducing compression and tension sets.

**Course.** A single layer of lumber or other wood products of the same thickness in a stickered pile, package, or kiln truck-load.

**Crook.** A form of warp in which lumber deviates edgewise from a straight line from end to end.

**Cup.** A form of warp in which lumber deviates from a straight line across the width of the wood.

**Decay.** The softening, weakening, or total decomposition of wood substance by fungi.

**Defect.** Any irregularity or imperfection in a tree, log, bolt, lumber, or other wood product that reduces the volume of useable wood or lowers its durability, strength, or utility value. Defects may result from knots and other growth conditions and abnormalities, insect or fungus attack, and saw-milling, drying, machining, or other processes.

**Degrade.** Generally, in lumber and other forest products, the result of any process that lowers the value of the wood.

**Density.** The weight of wood per unit volume, usually expressed in pounds per cubic foot or grams per cubic centimeter. Because changes in moisture content affect wood weight and volume, it is necessary to specify the conditions of wood at the time density is determined.

**Depression** (also called **Wet-Bulb Depression**). Difference between dry- and wet-bulb temperatures.

**Desuperheater.** A device for removing from steam the heat beyond that required for saturation at a given pressure.

**Diamonding.** A form of warp: the change of a cross section of a square-sawn wood item to diamond-shaped during drying. Diamonding occurs where the growth rings pass through diagonal corners and is caused by the difference between tangential and radial shrinkage.

**Diffusion.** Movement of water through wood from points of high concentration to points of low concentration.

**Diffusivity.** Measurement of the rate of moisture movement through wood as a result of differences in moisture content.

**Dimension (Dimension stock).** Small pieces of hardwood cut from lumber and intended for cabinet and furniture parts.

**Dimensional Stabilization.** Reduction in the normal swelling and shrinking of wood as a result of special treatment.

**Discoloration.** Change in the color of wood caused by fungal or chemical stains, weathering, or heat treatment.

**Dry Kiln.** A room, chamber, or tunnel in which the temperature and relative humidity of air circulated through parcels of lumber, veneer, and other wood products can be controlled to govern drying conditions.

**Dryer.** Air-moving and air-directing equipment used to accelerate the air drying of wood. (See **Kiln**.)

**Forced-Air**—An old, little-used term referring to an inexpensive building with reversible fans, tight baffling, and a source of heat that provides high air velocity through the lumber piles, thermostatically controlled temperature in the range of 70°F to 120°F (21°C to 49°C), and partial control of relative humidity by limited venting.

**Low-Temperature (low temperature kiln)**—A dryer similar to a forced-air dryer, with sources of heat and humidity that provide high air velocity through the piles; dry- and wet-bulb temperatures are controlled through a recorder or controller.

**Shed-Fan**—A shed with a permanent roof, permanent or temporary end walls, and a permanent side wall, with enough fans to draw yard air through the lumber piles at high velocity.

**Solar (Solar Kiln)**—A forced-air dryer or low temperature kiln in which only solar energy is used for heat.

**Warehouse Predryer**—A warehouse-like building with overhead fans and layout designed for gentle recirculation of air through the lumber piles; controlled vents and unit heaters maintain desired temperature and relative humidity.

**Yard-Fan**—Similar in operation to a shed-fan dryer, except that the roof and end walls are temporary and made of canvas, plywood, or sheet metal. Some yard-fan dryers use portable fans to exhaust air from an enclosed central plenum space between two yard piles.

**Drying.** The process of removing moisture from wood to improve its serviceability in use.

**Drying Degrade.** A reduction in lumber grade and volume as a result of drying defects.

**Drying Rate.** The loss of moisture from lumber or other wood products per unit of time. Drying rate is generally expressed in percentage of moisture content lost per hour or day.

**Drying Record.** A daily or weekly tabulation of dryer or kiln operation, which includes sample weight, moisture content, and temperature readings or recorder–controller charts.

**Drying Shed.** In air drying, an unheated building for drying lumber and other wood products. The building may be open on all sides or closed.

**Drying Stress.** The force per unit area that occurs in some zones of drying wood as a result of uneven shrinkage in response to normal moisture gradients and to set that develops in wood.

**End Coating.** (1) A coating of moisture-resistant material applied to end-grain surfaces of green wood, such as logs, timbers, lumber, and squares, to retard end drying and consequent checking and splitting or to prevent moisture loss from the ends of the wood. (2) A coating applied to the end of kiln samples to prevent moisture loss.

**End Pile.** In air drying, stacking of green lumber on end and inclined in a long, fairly narrow row; layers separated by stickers. In lumber storage, placement of wood items on end in suitable bins, a practice at mills and retail yards. In kiln drying, placing of lumber on kiln trucks with their length parallel to the length of the kiln.

**Entering Side of Load.** The side of a lumber pile where the air enters the pile when the fans are turning in a specific direction. The air on the entering side of the load must be controlled in accordance with the drying schedule to prevent drying defects. (See also **Exit Side of Load.**)

**Equalization (Equalizing).** In kiln drying, the process of increasing equilibrium moisture content in the final stages of drying lumber and other mill products to reduce the moisture content range between pieces of lumber and the moisture gradient within pieces of lumber.

**Equilibrium Moisture Content.** The condition of air at which wood at a specified moisture content neither gains nor loses moisture when surrounded by air at a given relative humidity and temperature. Equilibrium moisture content is numerically equal to the moisture content of the wood at this equilibrium condition. Equilibrium moisture content is frequently used to indicate potential of an atmosphere to bring wood to a specific moisture content during drying.

**Even-End Piled.** A method of flat stacking random-length lumber for drying. Full-length lumber is placed on the outer edges of each layer and shorter pieces of lumber are placed between the layers. Shorter pieces are pulled to one end of the layers, so that one end of the pile is squared off and the other is ragged. (See also **Box-Piled.**)

**Exit Side of Load.** The side of a lumber pile where the air exits the pile when the fans are turning in a specific direction. The air on this side of the load is cooler and more humid than the air on the entering side. (See also **Entering Side of Load.**)

**Extractives.** Substances in wood that are not an integral part of the cellular structure and can be removed by solution in hot or cold water, ether, benzene, or other solvents that do not react chemically with wood substances.

**Dimensional Change.** The alternate swelling and shrinkage that occurs in dried wood as a result of moisture content changes caused by variations in the surrounding atmospheric conditions.

**Fiber Saturation Point.** The point in the drying or wetting of wood at which the cell walls are saturated with water (bound water) and the cell cavities are free of water. The fiber saturation point usually occurs at 28% to 30% wood moisture content.

**Foundation.** Structural supports for an air-drying pile, designed to prevent warping and facilitate air circulation under the pile.

**Free Water.** In wood technology, water that is held in the lumens or the grosser capillary structure of the wood.

**Fungus (fungi).** A plant that feeds on wood fiber. Fungi primarily consist of microscopic threads (hyphae) that traverse wood in all directions, dissolving materials out of the cell walls.

**Grain.** The direction, size, arrangement, appearance, or quality of fibers in lumber or other wood products.

**Across the Grain**—The direction (or plane) at right angles to the length of the fibers and other longitudinal elements of the wood.

**Along the Grain**—The direction (or plane) parallel to the length of the fibers and other longitudinal elements in the wood.

**Cross Grain**—Wood in which the fibers deviate from a line parallel to the sides of the piece. Cross grain may be either diagonal or spiral grain or a combination of these.

**Edge Grain**—Wood that has been sawn or split so that the wide surfaces extend approximately at right angles to the annual growth rings. Lumber is considered edge-grained when the rings form an angle of 45° to 90° with the wide surface of the piece. Quartersawn usually refers to angles of 75° to 90°, riftsawn to 45° to 75° angles.

**End Grain**—Wood grain as seen on a cut made at a right angle to the direction of the fibers (such as on a cross section of a tree).

**Flat Grain**—Lumber or other wood products sawn or split in a plane approximately perpendicular to the radius of the log. Lumber is considered flat grained when the annual growth rings form an angle of less than 45° with the surface of the piece.

**Interlocked Grain**—Lumber or other wood products in which fibers are inclined in one direction in a number of rings of annual growth, then gradually reverse and are inclined in an opposite direction in succeeding growth rings. This pattern is reversed repeatedly.

**Raised Grain**—Roughened surface of lumber and other wood products, particularly softwood, after planing, caused by the projection of earlywood or latewood above the surface.

**Slope of Grain**—In lumber and other wood products, the degree of cross grain computed as the ratio of a 1-in. (25-mm) deviation of the grain from the long axis of a piece to the distance along the edge within which this deviation occurs.

**Straight Grain**—Wood in which the fibers and other longitudinal elements run parallel to the axis of a piece.

**Green.** Freshly sawn or undried wood. (See also **Moisture Content.**)

**Green Volume.** Cubic content of green wood.

**Growth Ring.** The layer of wood growth put on a tree during a single growing season.

**Hardwood.** One of the botanical groups of trees that have vessels or pores and broad leaves, in contrast to the conifers or softwoods. The term has no reference to the actual hardness of the wood.

**Heartwood.** The wood extending from the pith to the sapwood, the cells of which no longer participate in the life processes of the tree. Heartwood is frequently more decay resistant than is sapwood and more difficult to dry.

**Heated Room Drying.** Air drying of wood in a room or small building by using just enough heat to raise the temperature slightly above outdoor air temperature and to provide an equilibrium moisture content 2% below the desired final moisture content. Mild air circulation promotes temperature uniformity.

**High-Frequency Dielectric Heating.** The use of an electric field oscillating at frequencies of 1 to 30 million Hz to heat wood. The electric energy is applied to wood between metal plates as electrodes.

**High-Temperature Drying.** In kiln drying wood, the use of dry-bulb temperatures of 212°F (100°C) or higher.

**Honeycomb.** In lumber and other wood products, a drying-related defect in which checks occur in the interior of a piece of wood, usually along the wood rays and perpendicular to the growth rings. Often, the checks are not visible on the wood surface. Most honeycomb is the extension of surface or end checks.

**Humidistat.** A device for automatically regulating the relative humidity of air.

**Humidity.** The moisture content of air.

**Relative**—Under ordinary temperatures and pressures, the ratio of the amount of water vapor present in the air to that which the air would hold at saturation at the same temperature.

**Absolute**—The mass of water vapor per volume of air.

**Hygroscopicity.** The property of a substance, such as wood, that permits it to absorb and lose moisture readily.

**Hygrostat.** A device for automatically regulating the equilibrium moisture content of the air. (See also **Humidistat.**)

**Hysteresis.** The tendency of dried wood exposed to any specified temperature and relative humidity to reach equilibrium at a lower moisture content when absorbing moisture from a drier condition than when losing moisture from a wetter condition.

**Infrared Drying.** A special process for drying wood by direct radiation from high intensity sources such as heat lamps and radiant gas burners.

**Kiln.** A chamber or tunnel used for drying and conditioning lumber, veneer, and other wood products in which the temperature and relative humidity of the circulated air can be varied.

**Conventional**—A kiln that uses an initial temperature from 100°F to 130°F (38°C to 54°C) and a final temperature from 150°F to 200°F (66°C to 93°C). Control of equilibrium moisture content is necessary to avoid shrinkage-associated defects and to equalize and condition the wood at the end of drying. Air velocities are generally between 200 and 450 ft/min (100 to 230 cm/s).

**High-Temperature**—A kiln that operates at dry-bulb temperatures above 212°F (100°C).

**Low-Temperature**—A kiln that operates below 130°F (54°C).

**Package-Loaded**—A trackless compartment kiln for drying packages of stickered lumber or other wood products. The dryer usually has large doors that can be opened so that the kiln charge can be placed in or removed from the dryer by forklifts.

**Progressive**—A dry kiln in which the total charge of lumber is not dried as a single unit but as several units, such as kiln-truck loads, that move progressively through the dryer from the entering (wet) end to the exit (dry) end. The kiln is designed and operated so that the temperature is lower and the humidity higher at the entering end than at the exit end.

**Track-Loaded**—A kiln with doors at one or both ends. Loads are assembled outside the kiln and are then moved into and out of the kiln on tracks.

**Kiln Charge.** In kiln drying, the total amount of lumber or wood items to be dried in the kiln at one time.

**Kiln Dried.** Lumber or other wood items that have been dried in a closed chamber in which the temperature and relative humidity of the circulated air can be controlled. (See also **Moisture Content**).

**Kiln Leakage.** The undesirable loss of heat and vapor from a kiln through and around doors and ventilators or through cracks in the walls and roof.

**Kiln Operator.** In kiln drying, the supervisor or person responsible for the performance of dry kilns and related equipment.

**Kiln Run.** The term applied to the drying of a single charge of lumber or other wood product.

**Kiln Sample.** A length cut from a piece of lumber and placed in the kiln charge so that it may be removed for examination, weighing, or testing.

**Kiln Schedule.** The prescribed schedule of dry-bulb and wet-bulb temperatures (and rarely velocity) used in drying a load of lumber. The humidity aspect is sometimes expressed in terms of wet-bulb depression, relative humidity, or equilibrium moisture content.

**Knot.** That portion of a branch or limb that has been surrounded by subsequent growth of the stem. The knot that appears on the sawn surface is merely a section of the entire knot.

**Latent Heat.** In lumber drying, the energy required to convert liquid water to vapor, or vice versa, usually at 212°F (100°C).

**Layout.** On an air-drying yard, layout refers to the arrangement and orientation of alleys, row and line spacings, pile sizes and spacings, and foundation placement.

**Losses, Drying.** In drying lumber and other wood products, the reduction in volume and grade quality that can be attributed to the drying process. (See also **Degrade**.)

**Low-Temperature Kiln.** A relatively tight structure for forced air drying that is equipped to produce air movement through the lumber loads and recirculate the air over heat and/or humidity sources. Dry- and wet-bulb controls are used to maintain small to moderate wet-bulb depression between 85°F and 120° F (30°C and 50°C).

**Lumber.** The product of the sawmill and planing mill for which manufacturing is limited to sawing, resawing, passing lengthwise through a standard planing machine, crosscutting to length, and matching.

**Lumen.** In wood anatomy, the cell cavity.

**Microwave Heating.** Heating of a material by electromagnetic energy alternating at a frequency from 915 to 22,125 MHz.

**Mildew.** A fungal growth, usually black tiny spots that cover the lumber surface, which does not cause deep discoloration of the wood; usually associated with mold.

**Mineral Streak.** An olive to greenish-black or brown discoloration in hardwoods, particularly hard maples, resulting from wound-induced bacterial, chemical, or fungal action. Narrow mineral streaks often contain mineral matter.

**Moisture Content.** The amount of water contained in the wood, usually expressed as a percentage of the weight of the oven-dry wood.

**Average**—Moisture content of a single section representative of a larger piece of wood, the average of all measurements taken from lumber or other wood products, or the average of measurements taken from a lot of lumber or other wood products.

**Core**—Average moisture content of the center or middle half (thickness-wise) of a piece of lumber or moisture section. (See **Shell** moisture content.)

**Final**—Average moisture content of lumber or other wood product at the end of the drying process.

**Initial**—The moisture content of the wood at the beginning of the drying process.

**In-use**—The moisture content that wood items reach in the environmental conditions where they are used.

**Shell**—Average moisture content of the outer half (one-quarter of the thickness from each face) of a piece of lumber or moisture section. (See **Core** moisture content.)

**Moisture Content Class.** Classification of lumber by moisture content.

**Air Dried**—Lumber that has been air- or shed-dried to an average of 25% moisture content or lower, with no material having more than 30% moisture content.

**Green (Green-From-the-Saw)**—Freshly sawn lumber or lumber that has received essentially no formal drying.

**Kiln Dried**—Lumber dried in a kiln, or by some other refined method, to an average specified moisture content (typically 6% to 8%) or to a moisture content understood to be suitable for a certain use. Kiln-dried lumber is usually considered to be free of drying stresses.

**Partially Air-Dried**—Lumber with an average of 25% and 45% moisture content, with no material having more than 50% moisture content.

**Predried**—Lumber that has been dried in a predryer to an average of 20% to 25% moisture content.

**Shipping Dry**—Lumber partially dried to prevent stain or mold in brief periods of transit, preferably with the outer 1/8 in. (3 mm) dried to 25% moisture content or below.

**Moisture Content Range.** Difference in moisture content between driest and wettest lumber in a shipment, lot, or kiln charge or between representative samples of the lot.

**Moisture Gradient.** In lumber drying, the distribution of moisture content within the wood. During drying, distribution varies from the low moisture content of the relatively dry surface layers and the higher moisture content at the center of the piece.

**Moisture Meter.** An instrument used for rapid determination of the moisture content of wood by electrical means.

**Moisture Movement.** The transfer of moisture from one point to another within wood or other materials.

**Mold.** A fungal growth on lumber or other wood products at or near the surface and, therefore, not typically resulting in deep discoloration. Mold is usually ash green to deep green, although black and yellow are also common.

(See also **Mildew**.)

**Overhang.** The end of lumber that is unsupported by stickers and extends beyond the ends of most pieces in an air drying pile, kiln truckload, or unit handling package.

**Ovendry.** Wood that has been dried in a ventilated oven at 215°F to 221°F (102°C to 105°C) until no further significant loss in weight occurs.

**Ovendry Weight.** The weight of wood when all the water has been driven off by heating the wood in an oven at 215°F to 221°F (102°C to 105°C).

**Part-Time Drying.** In kiln drying, discontinuous operation of the kilns, usually necessitated by an interrupted steam, fuel, or power supply.

**Permeability.** The ease with which a fluid flows through a porous material (wood) in response to pressure.

**Pile.** In air drying, a stack of lumber layers, separated by stickers or self-stickered, on a supporting foundation (hand stacked). Also, a stickered unit package of lumber, stacked by lift truck or crane, placed on a foundation and separated by bolsters.

**Pile Roof.** A cover on top of a lumber pile to protect the upper layers from exposure to sun, rain, and snow. The sides and ends of the roof may project beyond the pile to provide added protection.

**Pile Spacing.** The distance between individual piles in a row.

**Predryer.** (1) A warehouse-like building with overhead fans, designed for gentle circulation of air through the lumber piles. The desired temperature and relative humidity are

maintained with exterior vents and heaters. (2) (Rarely used) Any drying system that precedes kiln drying.

**Predrying.** A wood drying process carried out in a predryer before kiln drying.

**Predrying Treatment.** Special measure taken before drying or early in the drying process to accelerate drying rate, modify color, or prevent checks and other drying defects.

**Blanking**—Surfacing of one face of roughsawn lumber to achieve uniform thickness and reduce warping.

**Polyethylene Glycol**—Deep impregnation of green lumber with polyethylene glycol 1000 to retain the green dimension during drying and indefinitely thereafter, minimizing shrinkage, swelling, and warp.

**Precompression**—Momentary transverse compression of green lumber about 7% to permit drying by a severe schedule and improve drying performance.

**Prefreezing**—Freezing and thawing of green wood before drying to increase the drying rate and decrease shrinkage and seasoning defects.

**Presurfacing**—Surfacing of both broad faces of green roughsawn lumber to permit drying by a schedule more severe than the prescribed schedule for roughsawn lumber, achieving faster drying and fewer drying defects.

**Steaming**—Subjecting of green wood to saturated steam at or close to 212°F (100°C) to accelerate drying, achieve a desired color, or both.

**Surface Treatment**—Application of a salt or sodium alginate paste to the surface of green wood to help prevent checking as the wood is dried.

**Press Drying.** The application of heat to opposite faces of lumber by heated platens to evaporate moisture from the lumber, using temperatures between 250°F and 450°F (120°C and 230°C) and platen pressures between 25 and 75 lb/in<sup>2</sup> (1.8 and 5.3 kPa).

**Radial Surface.** A surface or plane extending wholly or in part from the pith to the bark and longitudinally.

**Radiofrequency Drying.** (See **High-Frequency Dielectric Heating**.)

**Random-Length Pile.** (See **Even-End Piled**.)

**Reaction Wood.** Wood with more or less distinctive anatomical characteristics, formed typically in parts of leaning or crooked stems and branches. In hardwoods, reaction wood is called tension wood. (See **Tension Wood**.)

**Recorder–Controller.** An instrument that continuously records dry- and wet-bulb temperatures of circulated air in a dryer or kiln and regulates these temperatures by activating automatic heat and steam spray valves.

**Redry.** In kiln or veneer drying, a process whereby dried material found to have a moisture content level higher than desired is returned to the dryer for additional drying.

**Refractory.** A term that implies difficulty in processing or manufacturing by ordinary methods, resistance to the penetration of preservatives, difficulty in drying, or difficulty in working.

**Ring Failure.** Separation of wood along the grain and parallel to the annual rings, either within or between the rings.

**Rot.** Synonymous with decay. (See **Decay**.)

**Brown**—In wood, any decay caused by fungi that attack cellulose rather than lignin, producing a light to dark brown friable residue.

**Dry**—A term loosely applied to any dry, crumbly rot but especially to rot that, when in an advanced stage, permits the wood to be crushed easily to a dry powder. The term is actually a misnomer for any decay, since all fungi require considerable moisture for growth.

**White**—In wood, any decay caused by fungi that attack both cellulose and lignin, producing a generally whitish residue that may be spongy or stringy or occur in pockets.

**Rounds.** Pieces of green wood dried in the form of cylinders. For example, ash baseball bat stock is often kiln dried as rough turned rounds rather than squares.

**Sap.** The fluid in green wood that contains nutrients and other chemicals in solution.

**Sapwood.** In wood anatomy, the outer layers of the stem that contain living cells and reserve materials such as starch. The sapwood is generally lighter in color than the heartwood.

**Season.** To dry lumber and other wood items to the desired final moisture content and stress condition for the intended use.

**Self-Stickered Pile.** Stacking in which the stock itself is used as stickers to separate the layers of the pile.

**Set.** A semipermanent deformation in wood caused by tensile and compressive stresses during drying.

**Compression set**—Set that occurs during compression, which tends to give the wood a smaller than normal dimension after drying. Compression set is usually found in the inner layers of wood during the later stages of drying, but sometimes occurs in the outer layers after extended conditioning or rewetting. Compression set is also caused by external restraint during rewetting of dried wood.

**Tension set**—Set that occurs during tension, which tends to increase the dimensions of the wood after drying. Tension set usually occurs in the outer layers of wood during the early stages of drying. (See **Casehardening**.)

**Shrinkage.** The contraction of wood fibers caused by drying below the fiber saturation point. Shrinkage is usually expressed as a percentage of the dimension of the wood when green.

**Longitudinal**—Shrinkage along the grain.

**Radial**—Shrinkage across the grain, in a radial–transverse direction.

**Tangential**—Shrinkage across the grain, in a tangential–transverse direction.

**Volumetric**—Shrinkage in volume.

**Sinker.** A log that sinks in water.

**Sinker Stock.** Lumber or other sawmill products sawn from sinker logs. Green moisture content is very high and the drying rate can be low.

**Softwood.** In general, one of the botanical groups of trees that, in most cases, have needle- or scale-like leaves; the conifers; also, the wood produced by such trees. The term softwood has no reference to the actual hardness of the wood.

**Solar Dryer (Solar Kiln).** A forced-air dryer or low-temperature kiln in which only solar energy is used for heat.

**Species.** A group of individual plants of a particular kind; that is, a group of individuals that share many characteristics. Species is a category of classification lower than genus but higher than variety.

**Specific Gravity.** In wood technology, the ratio of the oven-dry weight of a piece of wood to the weight of a volume of water at 4°C (39°F), equal to the volume of the wood sample. Specific gravity of wood is usually based on green volume and oven-dry weight.

**Stain.** A discoloration in wood that may be caused by microorganisms, metal, or chemicals. The term also applies to materials used to impart colors to wood.

**Blue**—A bluish or grayish discoloration in sapwood caused by the growth of certain dark-colored fungi.

**Chemical**—A general term including all stains that result from color changes of the chemicals normally present in wood.

**Iron Tannate**—A bluish-black surface stain on oak and other tannin-bearing woods following contact of the wet wood with iron or water in which iron is dissolved.

**Sticker.** A strip made from wood or another material that is placed between courses of lumber or other wood products in a pile, unit package, or kiln truckload. Stickers are placed at right angles to the long axis of the stock, to permit air to circulate between the layers.

**Sticker Alignment.** The placement of stickers in a pile, unit package, or kiln truckload of lumber or other wood products so that they form vertical tiers.

**Sticker Marking.** Indentation or compression of the lumber or other wood product by the sticker when the superimposed load is too great for the sticker bearing area. Sticker marking also refers to light areas under the sticker that form as the rest of the lumber darkens.

**Sticker Spacing.** The distance between adjacent stickers in a pile, kiln truckload, or unit package of lumber.

**Stickering.** The construction of packages, piles, or kiln truckloads of lumber whose courses or layers are separated by stickers to facilitate wood drying.

**Storage.** Bulk or stickered piling of air- or kiln-dried wood products with protection from the weather in accordance with the level of moisture content desired. Protection is provided by tarpaulins or sheds (open, closed–unheated, or closed–heated).

**Sun Shield.** In air drying, plywood panels, lumber, or another type of shield used to protect the ends of piles from direct sun. The purpose of the sun shield is to retard end drying, thus minimize checking and splitting of lumber ends.

**Super Heat.** The heat in steam in excess of the amount of heat in saturated steam at a given pressure.

**Swelling.** An increase in the dimensions of wood resulting from an increase in moisture content. Swelling occurs tangentially, radially, and, to a lesser extent, longitudinally.

**Tangential Surface.** The wood surface tangent to the growth rings; a tangential section is a longitudinal section through a log perpendicular to a radius. Flat-grained lumber is sawn tangentially.

**Temperature.** The condition of a body that determines the transfer of heat to or from other bodies; a measure of the thermal potential of a body.

**Dry-Bulb**—Temperature of air indicated by any temperature-measuring device with an uncovered sensitive element or bulb.

**Wet-Bulb**—Temperature indicated by any temperature-measuring device with a sensitive element that is covered by a water-saturated cloth (wick).

**Tension Failure.** The pulling apart or rupturing of wood fibers as a result of tensile stresses.

**Tension Wood.** Abnormal wood (reaction wood) found in leaning trees of some hardwood species and characterized by the presence of gelatinous fibers and excessive longitudinal shrinkage. The machined surface tends to be fibrous or woolly, especially when green.

**Transverse.** The direction at right angles to the wood fibers or across the grain. A transverse section is a section taken through a tree or timber at right angles to the pith.

**Unit Package.** Lumber or other wood products that have been assembled into a parcel for handling by a crane, carrier, or forklift truck.

**Vapor Barrier.** In kiln drying, a material with high resistance to vapor movement that is applied to the surfaces of a dry kiln to prevent moisture migration.

**Vapor Drying.** Drying of wood by subjecting it to the hot vapors produced by boiling an organic chemical such as xylene.

**Vent.** In kiln drying, an opening in the kiln roof or wall that can be opened and closed to control the wet-bulb temperature within the kiln.

**Volume, green.** The volume of wood determined from measurements made while the entire piece of wood is above the fiber saturation point (that is, above 30% moisture content, the green condition).

**Wane.** Bark or the lack of wood from any cause on the edges of a piece of square-edged lumber.

**Warp.** The distortion in lumber and other wood products that causes the material to depart from its original plane, which usually develops during drying. Warp includes cup, bow, crook, twist, out-of-round, kinks, and diamonding, or any combination thereof.

**Warp Restraint.** In drying lumber and other wood products, the application of external loads to a pile, package, or kiln truckload of products to prevent or reduce warp.

**Weight of Wood.** The weight of wood includes that of the oven-dry wood and its moisture content. The weight of lumber is expressed as pounds per cubic foot (kilograms per cubic meter) at a certain moisture content or weight per thousand board feet at a specified moisture content. The weight of wood depends on specific gravity and moisture content.

**Wetwood.** Wood with abnormally high water content and a translucent or water-soaked appearance. Wetwood develops in living trees and is believed to be related to bacterial activity within the wood.