

**BRIDGE MAINTENANCE, REHABILITATION, AND REPLACEMENT:
CASE HISTORIES**

Over time, bridges may become structurally or functionally deficient. Structurally, the deficiency can result from deterioration, damage, or increased load requirements in excess of the design capacity.

Hydraulically, the original waterway opening under the bridge may become inadequate as a result of changing drainage patterns in the watershed or because the hydraulic parameters on which the original design was based are inadequate. Bridges may also become functionally deficient when the roadway width, vertical clearance, or geometry are inadequate for current traffic requirements.

In most cases, structural deficiencies that develop are corrected by preventative or routine maintenance. If such maintenance is continually neglected, major maintenance may be required to restore the bridge to its original capacity. When hydraulic or geometric deficiencies are encountered, bridge rehabilitation can improve the conditions. If the bridge is severely deficient structurally, hydraulically, or geometrically, complete replacement may be the only option.

Previous chapters discuss the methods of timber bridge design, maintenance, and rehabilitation. In this chapter, case histories illustrate how these methods have been applied. These case histories include the following:

Case History 15.1 - In-Place Preservative Treatment of Deteriorating Timber Bridges

Case History 15.2 - Extending Bridge Life: In-Place Treatment of a Timber Bridge

Case History 15.3 - Pepin County Bridge Widening

Case History 15.4 - Union County Covered Bridge Rehabilitation

Case History 15.5 - Rehabilitation of Nail-Laminated Timber Decks by Transverse Stressing

Case History 15.6 - Sauk County Bridge Redecking

Case History 15.7 - Bruneau River Bridge Rehabilitation

Case History 15.8 - Uinta Canyon Canal Bridge Replacement

Case History 15.9 - Cook County Bridge Replacement

CASE HISTORY 15.1- IN-PLACE PRESERVATIVE TREATMENT OF DETERIORATING TIMBER BRIDGES

Contributed by Edgar E. Hedgecock, Civil Engineer, USDA Forest Service, Francis Marion and Sumter National Forests

In 1982, the decision was made to arrest internal deterioration and surface decay by undertaking in-place preservative treatment of the existing 391-foot-long Bay Creek Bridge located on the Apalachicola National Forest in Florida. The in-place treatment also included the replacement of deteriorated sections of structurally deficient timber piling.

The National Forests in Florida contracted with Osmose Wood Preserving, Inc., to treat the Bay Creek Bridge. The work was completed over a 9-day period in the fall of 1982. The cost for the in-place treatment was slightly more than \$28,000 (\$72/lin ft). Replacing the bridge would have cost approximately \$450,000.

All chemicals used in treating the Bay Creek Bridge were formulated to eradicate existing decay fungi. In addition, the treatment is intended to retard any new fungus infection for 12 to 15 years. The following wood-preserving chemicals, produced by Osmose Wood Preserving, Inc., of Buffalo, New York, were used in treating the bridge:

Tie-Gard. Tie-Gard cartridges were placed in predrilled holes at the groundline or waterline of all the bridge piles. The cartridges are solidified preservatives consisting of 37.5-percent sodium fluoride, 37.5-percent potassium bifluoride, 19-percent sodium dichromate, 5-percent 2,4 dinitrophenol, and 1-percent inert material. The ingredients of the cartridges become active when exposed to moisture.

Timber Fume. Vials of Timber Fume were placed in holes between the Tie-Gard cartridges and the tops of the piles. This chemical is a highly poisonous liquid-fumigant solution that volatilizes and diffuses into the wood to arrest internal wood decay. The solution consists of 99-percent chloropicrin and 1-percent inert ingredients.

Osmose 24-12 Solution. Osmose 24-12 solution was injected under pressure into the pile caps and into the top area of piles. This liquid wood-preservative solution prevents wood mold and decay fungi. The solution is composed of 4.48-percent pentachlorophenol, 0.52-percent other chlorophenols, 5.16-percent aromatic petroleum solvent, 46.52-percent aliphatic petroleum solvent, and 43.32-percent inert ingredients.

Osmoplastic-F. Osmoplastic-F was injected into predrilled holes in all bridge stringers. This chemical is a paste wood preservative that kills existing decay fungi and inhibits new fungi growth. The preservative is

20-percent sodium fluoride, 8.9-percent pentachlorophenol, 1.1-percent other chlorophenols, 15-percent creosote, and 55-percent inert ingredients. The contractor had years of experience in treating wood railroad bridges and utility poles but had not treated a bridge like the Bay Creek unit. Their standard operating plan, with only a few minor changes, followed this sequence:

1. Drill inspection holes
2. Inspect for internal decay
3. Establish a treatment pattern for piles, caps, and stringers
4. Develop environmental protection measures
5. Replace sections (“posting”) of piles
6. Treat piling
7. Treat caps
8. Treat stringers
9. Remove and dispose of all protective material and waste

Each of the procedures involved specific steps to ensure maximum efficiency in the treatment. Brief summaries of each step follow:

1. Drill inspection holes. The contractor made a preliminary inspection of the bridge to assess requirements for treating and component repair. All members were sounded with a hammer, and borings were made at locations of suspected decay in piles, caps, and stringers. The results of this inspection were used to develop a cost estimate on which the contract price was based.

As part of the contract, the contractor drilled a predetermined pattern of 3/8-inch diameter inspection holes into piles, caps, and stringers (Figure 15-1). The patterned holes permitted inspection of critical areas near the groundline and at the pile-cap-stringer connections. The contractor modified a standard railroad bridge inspection pattern to better fit the condition and configuration of the Bay Creek Bridge.



Figure 15-1. - Typical investigative borehole pattern.

2. Inspect for internal decay. The condition of each bridge member was determined using the inspection holes and a special metal probe. The contractor estimated the location and extent of sound wood and deteriorated wood in each member, and the figures for shell and void were marked beside each inspection hole.

3. Establish treatment pattern. A treatment pattern was established based on the inspection data and surface-water conditions at the site. A variety of chemicals were selected because of the high water table and the variation in size of the structural members.

4. Develop environmental protection measures. A special effort was made to prevent any pollution or contamination of water. Highly toxic chemicals were used, and extra care was required during treatment near the water. Plastic draping was placed around and under pile caps to contain any spillage or leakage. In addition, a metal funnel-shaped collar was attached to the base of each pile to collect any chemicals that might run down the pile.

A two-person crew performed all treatment operations. One crew member applied the chemical treatment, while the other acted as a guard to locate and control spills or leakage.

5. Post rejected piles. The contractor has methods and equipment to completely replace deteriorated piling, matching the replacement pile to the alignment and batter of the original pile. Further, the contractor can replace only a section of deteriorated piling above the water- or groundline using pile posting techniques. On the Bay Creek Bridge, two piles were rejected because of decay, and sections of each were replaced by posting from just above the groundline to the pile cap (Figures 15-2 and 15-3). The creosote-treated replacement sections were connected to the existing piles with eight fluted-steel pins, 3/8 inch in diameter by 16 inches long, and were welded in place with epoxy resin (Figure 15-4).



Figure 15-2. - Section of deteriorated pile removed from the structure.

Normally, the contractor has a separate crew do the pile posting; however, because this bridge was a relatively small project the treatment crew performed the piling repairs.

6. Treat piling. In-place treatment of the piling was complicated by the high, fluctuating water level of Bay Creek. To achieve maximum effectiveness in the treatment, the contractor used a combination of three products: Osmose 24-12, Timber-Fume, and Tie-Gard. The following procedure allowed optimum treatment of wood with the least risk of chemical spillage or leakage:



Figure 15-3. - Cutting a replacement pile section using a specially designed pile cutter.



Figure 15-4. - Completed pile posting with protective plastic in place.

- a. In addition to the inspection borings, extra holes were drilled in the piling at the groundline. Tie-Gard preservative cartridges were inserted into the holes, which were then plugged with treated wood dowels (Figures 15-5 and 15-6). The cartridges dissolve over a period of time and the preservative diffuses into the pile by capillary action.



Figure 15-5. - Drilling holes for solid preservative cartridges.



Figure 15-6 - Insertion of solid preservative cartridges into a timber pile. Note the use of rubber safety gloves.

- b. Vials of Timber-Fume fumigant were inserted into holes drilled in the midsection of all piles (Figure 15-7). This chemical becomes a gas and diffuses into the pile. Timber-Fume is not effective when water is present. It is a highly toxic substance so extra care was used in preparing and placing the vials (Figure 15-8).

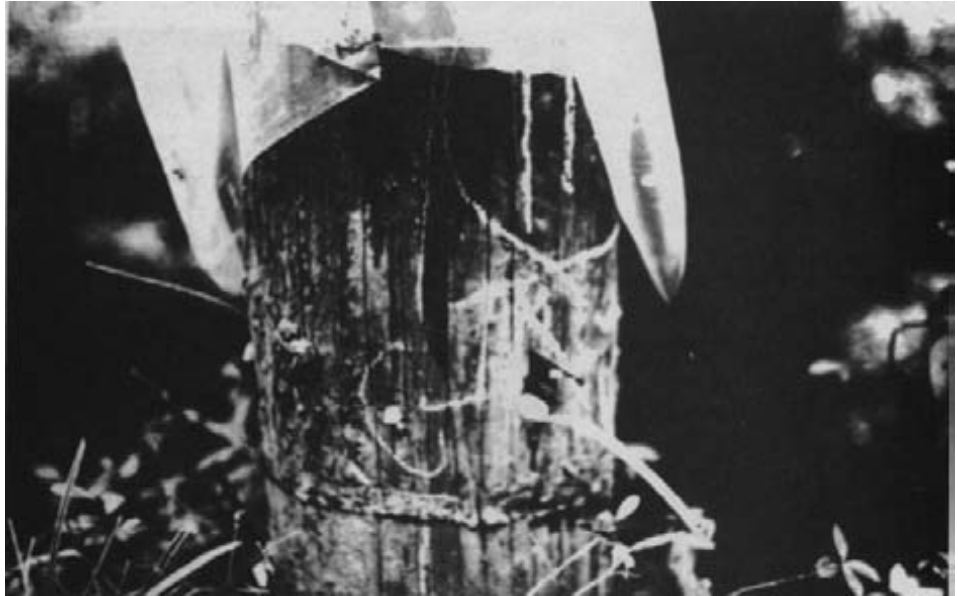

Figure 15-7. - Fumigant vial in wood-plugged hole, with location tab visible.



Figure 15-8. - Preparing fumigant vials. Note the required safety mask and gloves.

- c. For extra protection against decay, Osmose 24-12 preservative was injected into the inspection holes at the top area of each pile (Figure 15-9).

7. Treat caps. Osmose 24-12 preservative was injected under pressure into all inspection holes in the pile caps. A treated wood plug was driven into each hole to seal the chemical in the wood after injection. Plastic draping was used to catch any chemical that seeped out of cracks during injection (Figures 15-10 and 15-11).

In the injection process, a relief valve and catch bucket were used to suppress back-pressure spills. The two-person crew worked well in preventing spills (Figure 15-12).

8. Treat stringers. Stringer treatment caused the contractor some problems. The narrow 3-inch stringer width, and the high water condition at the site, prevented use of liquid wood preservatives. The contractor chose to use Osmoplastic paste preservative, which was injected into the stringers with a grease gun. However, the high sodium fluoride content of Osmoplastic caused the rubber seals in the grease gun to disintegrate, and forced the contractor to switch to Osmoplastic-F, which contains ingredients that are less active. With this compound, the contractor was able to maintain pressure and properly inject the compound into the inspection holes.



Figure 15-9. - Injection of liquid preservative solution into a timber pile.



Figure 15-10. - Typical individual cap and pile draping and funnel for protection against leakage of the liquid preservative.



Figure 15-11. - Bridge draping for spillage protection, in place and ready for preservative injection.



Figure 15-12. - Two-person crew injects liquid wood preservative solution into piles and caps. Note the safety backflow valve on the worker's belt.

9. Cleanup. The contractor waited 2 to 3 hours after treatment before removing protective plastic draping. All plastic, waste rags, and containers were carefully rolled and placed in plastic trash bags for removal from the site.

Throughout the project, the Forest Service monitored water quality at the Bay Creek site. Water samples were taken before treatment commenced to establish a typical quality level. During the project, samples were taken upstream and downstream from the bridge and were sent to the Florida Department of Environmental Regulation for testing. Analysis of the samples indicated no detectable levels of the treatment chemicals. Further, there was no noticeable variation in water quality between the samples taken before treatment and those taken after treatment.

This was the first contract awarded by the Forest Service in the Southern Region for this particular service. If the Forest Service's experience with this method is as satisfactory as that of the railroads, we will be able to save considerable maintenance and reconstruction funding in the future.

CASE HISTORY 15.2- EXTENDING BRIDGE LIFE: IN-PLACE TREATMENT OF A TIMBER BRIDGE

Contributed by Bill Grabner, Regional Bridge Engineer, USDA Forest Service, Pacific Northwest Region

The Sullivan Lake Outlet Bridge, located on the Colville National Forest in northeastern Washington, is a single-lane, 10-span timber trestle that is 191 feet long. Originally constructed in 1935, the bridge consists of a series of sawn lumber stringer spans supported on timber pile bents. Inspections of the structure completed in 1979 and 1981 indicated that extensive decay was present in several of the timber piles and pile caps. Because the bridge was not located on a heavily used road and was subjected primarily to light administrative and recreation traffic, no funds were available for bridge replacement or for major bridge rehabilitation work within the foreseeable future.

In the summer of 1981, it was learned that a Midwest-based company had been engaged in the in-place treatment of utility poles and timber railroad structures for a number of years. This company had not previously done any in-place timber bridge treatment for public agencies; however, negotiations were held between the Forest Service and this company, and a contract was awarded. The bridge rehabilitation work subsequently took place in November 1981.

To begin the work, a thorough inspection of the entire 191-foot-structure was made by an experienced bridge inspection crew employed by the contractor. The inspection procedure consisted of drilling 2,126 holes, each 3/8 inch in diameter, in areas where decay was most likely to occur. When decay was located, its extent was determined by the use of a wire probe and additional drilling, as needed. This allowed the inspector to completely define the void or deteriorated region in each pile and cap. The results of the inspection were noted in a detailed report for each of the eleven pile bents and ten stringer spans. Based on the inspection report and the recommendations of the contractor, the decision as to which members were to be treated and which were to be replaced was made by the Forest Service.

Four piles were repaired by removing badly deteriorated pile sections, varying in length from 5 to 15 feet, and replacing them with new sections of treated pile (pile posting). The replacement sections were secured into position using 16-inch steel pins and epoxy resin. One cap was replaced by the contractor using a unique jacking method to lift and support the superstructure while installing a new treated-timber cap. This work was accomplished with little traffic interruption.

The result of the work was to restore the structure to full capacity and extend the usable life by an estimated 10 to 15 years. This was achieved by replacing piles and caps that were inadequate to support loads, and by destroying all fungi and preventing their reintroduction into the timber by the continuing presence of fumigant. This in-place treatment work can be repeated once the fumigant level has reached nontoxic levels, with a further increase in structure life. Fumigant toxicity level can be determined by assay methods.

Total cost of the treatment, including replacement of piles and cap, was \$31,140. Comparing this to an estimated bridge replacement cost of \$250,000 indicates that this pilot project proved to be very cost effective. Further use of in-place treatment for timber structures is contemplated in the Pacific Northwest Region of the Forest Service as a method of reducing replacement costs by extending timber bridge life. Various phases of this project are depicted in Figures 15-13 through 15-17.



Figure 15-13. - View of the Sullivan Lake Outlet Bridge as in-place treatment was commencing. Note the canvas slings placed under the bridge to prevent water contamination should accidental spillage of treatment chemicals occur.



Figure 15-14. - Liquid fumigants being applied to the timber abutment.



Figure 15-15 - Underside view of an intermediate bent cap after treatment was completed. Holes drilled for treatment application have been plugged with treated-wood dowels.



Figure 15-16. - Timber pile after treatment of the soil contact area. The treated portion of the pile was wrapped in waterproof paper to prevent potential soil contamination.



Figure 15-17. - Pile bents after replacement of deteriorated sections by pile posting.

CASE HISTORY 15.3- PEPIN COUNTY BRIDGE WIDENING

Contributed by Ken Johnson, Civil Engineer, Wheeler Consolidated, Inc.

Pepin County is a small rural county in western Wisconsin. Many miles of rural highways with a large number of bridges were built in the county between 1950 and 1970. These facilities were constructed according to the standards existing at that time. The factor used to project average daily traffic for determining the level of design underestimated the actual growth in traffic. The growth in traffic above projected levels made many bridges functionally deficient by current standards.

This condition adversely affected the Pepin County Highway Department in two ways. First, the bridges posed a continuing hazard to the traveling public because they were too narrow to adequately handle the traffic volume. Second, the sections of highway with functionally deficient bridges did not qualify for Federal or State funding for resurfacing work.

This case study covers three bridges, all located on the same section of a county highway. The three bridges were similar in construction, crossed the same river, and had been constructed at the same time. The bridges were single, simple-span concrete structures. The span for each was a cast-in-place concrete slab. The curb and railing were also concrete but were not monolithic with the deck slab. Abutments were concrete, with load-bearing piles in the back walls and wing walls. The back wall extended from the outside edges of the deck about 2 feet on each side. The wing walls flared from the back wall at a 45 degree angle. The bridges were structurally and hydraulically adequate but were deficient in roadway width. The vertical alignment of the bridges and highway was less than desirable, as each bridge was placed at the low point of a very short sag vertical curve. Horizontal alignment was satisfactory.

The county explored all the options that could be applied. The “do nothing” option was immediately ruled out, as any continuation of the present conditions was unacceptable. Complete replacement of the structures, the most costly solution, was considered. The two replacement alternatives, building a culvert or a bridge at each location, would require the construction of a temporary bypass at two of the locations. The third option, widening the existing structures, offered the best solution.

The most economical method of widening the bridges was then addressed by the county. The proposal to match the original type of construction, cast-in-place concrete, was analyzed from both engineering and cost of construction perspectives. A concrete deck supported on steel stringers was considered. Another option investigated was the use of a prefabricated

treated-timber deck. This option was less costly than any of the others considered and was selected by Pepin County.

The first step was to measure the existing bridges to produce accurate as-built plans. These plans were then used by the County Engineer to design the rehabilitation project. The deck was designed as a longitudinal lumber deck, mechanically laminated with dowel-like spikes. The basic concept for this type of widening is to make use of the extra width of the abutment back wall, including a portion of the wing walls, to support the additional deck width.

After the plans and proposals were completed, a contract was awarded for the actual construction work. This was a furnish and install type of contract.

The contractor began the project by removing the concrete curbs and railings. A construction joint between the curb and the deck slab facilitated removal (most bridges of this type have a construction joint that facilitates this type of rehabilitation).

A bearing area for the new panels was constructed on the portions of the abutments and wing walls that were cut down. The elevation of the bearing areas was established so that the top elevation of the timber deck panels would be the same as the top of the concrete slab. The wing walls were raised to retain the additional fill needed to widen the grade.

Holes for anchor bolts were drilled into the outside edge of the existing concrete bridge deck. Cinch-type anchors and galvanized machine bolts were used to attach the first timber plank, measuring 4 inches thick by 14 inches wide, to the existing bridge. A splice plank was next attached to the this first plank. The splice plank was one-half the depth of the deck panels to create a ship-lap joint between the first deck lamination and the remainder of the additional new deck section.

A sequence of photos describing the project is presented in Figures 15-18 through 15-26.



Figure 15-18. - Typical concrete bridge on Pepin County Trunk Highway Z before rehabilitation. The bridges were adequate hydraulically and structurally, but did not meet minimum standards for roadway width.



Figure 15-19. - The first step in the rehabilitation was removal of the concrete curb and railing. Next, a concrete seat was poured on the wing walls to support the additional deck width. This bridge also had 2 feet of overburden removed as part of the contract.

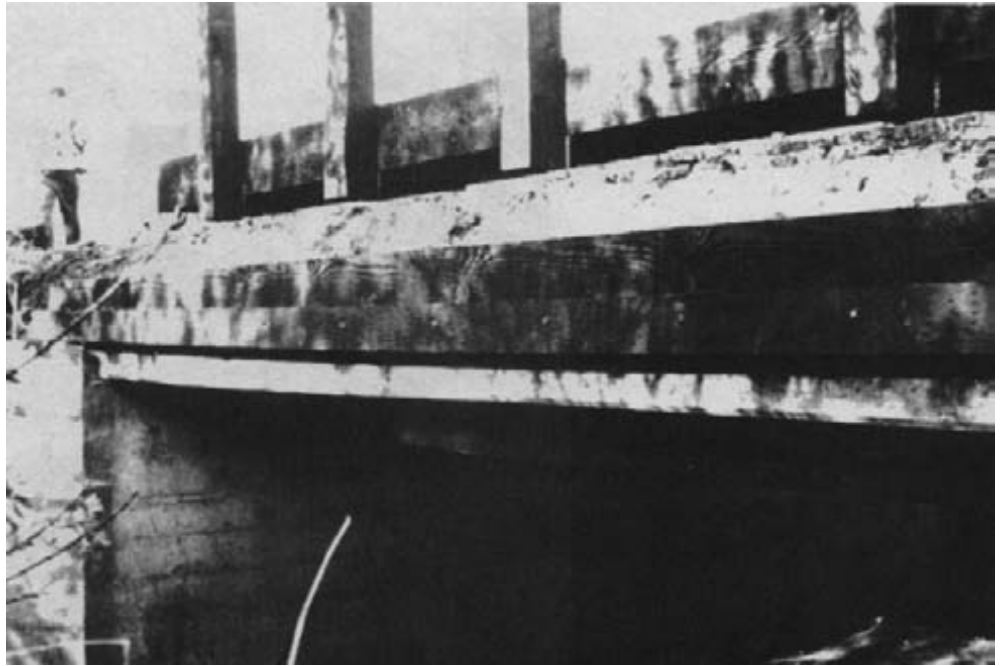

Figure 15-20. - A 4-inch-thick by 14-inch-wide creosote-treated Douglas-fir plank was attached to the edge of the existing concrete deck with galvanized machine bolts and cinch type anchors. The ends of this plank rest on the concrete placed on the wing walls. A 4-inch-thick by 7-inch-wide splice plank was spiked to the bottom half of the plank to form a ship-lap-type joint with the timber deck panel.



Figure 15-21. - Anchor bolts are placed in the concrete wingwalls that match predrilled holes in the timber deck panels.

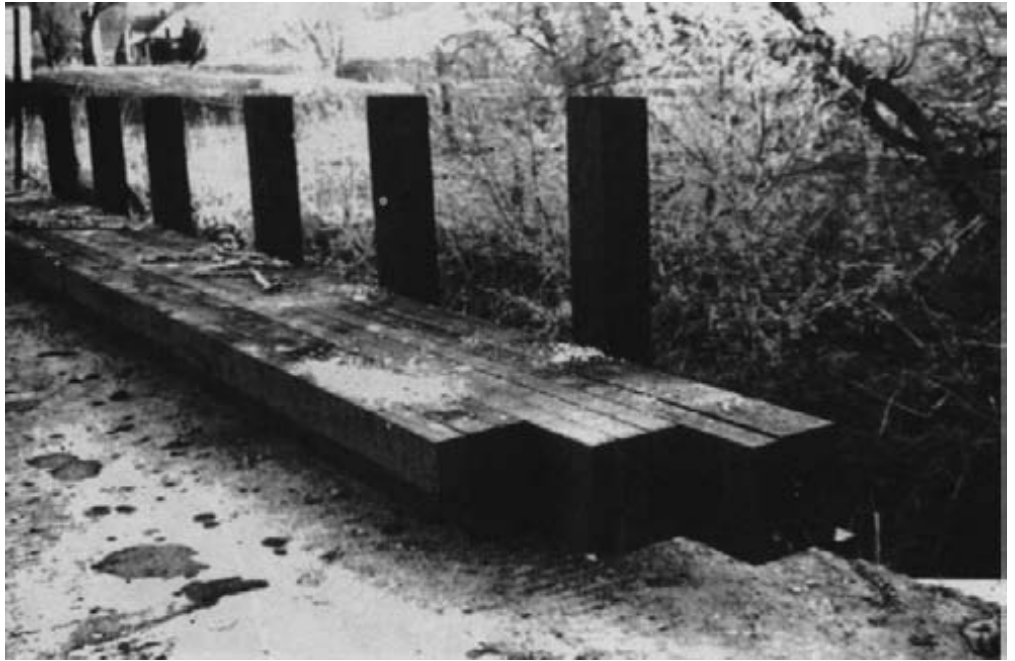

Figure 15-22. - Rail posts are attached to the deck panels before the panels are placed on the abutments.



Figure 15-23. - A prefabricated deck panel is lifted onto the abutments. Each panel was prefabricated to fit each bridge.



Figure 15-24. - A panel is lowered over the anchor bolts.



Figure 15-25. - A panel in final position. The ship-lap joint between the deck panel and first plank are interconnected with 5/8-inch-diameter by 13-inch-long drive spikes placed vertically through the joint.



Figure 15-26. - The completed project with widened roadway, ready for paving.

CASE HISTORY 15.4- UNION COUNTY COVERED BRIDGE REHABILITATION

Contributed by Jeff Stauch, Civil Engineer, Union County, Ohio

During the 1800's, more than 3,500 wooden covered bridges were built in Ohio. Many different types and designs made up the once-abundant population of Ohio's covered bridges, of which only about 145 remain. Some of the remaining structures must be completely replaced, others are being moved to local fairgrounds or parks to be used as pedestrian crossings, and in some cases new bridges are being built alongside the old to divert all traffic away from the existing structures. But the ideal preservation practice involves rehabilitation of the existing bridge, leaving it in place with the ability to carry modern loads, to remain a part of the local transportation system.

In Union County, Ohio, located in the central part of the State, five covered bridges remain, four of which are an integral part of the county road system. The County Engineer and Commissioners have recognized the importance of preserving these structures. The decision was made to upgrade each of these four bridges, rehabilitating one every year with Union County forces.

The first candidate was chosen based on its low traffic volume (dead-end road) and generally poor condition throughout the bridge. This truss, spanning 95 feet, had a noticeable twist caused primarily by nearly broken

lower chords at opposite corners. The ends of some diagonals and lower chords were decayed and crushed from years of termite attack and general deterioration. Two steel piers were placed under the bridge in the 1950's, along with other various supports added in attempts to keep the bridge standing. An accurate analysis of the bridge was nearly impossible because of the unique design, the poor condition of the truss, and all the supports installed over the years. The bridge had a posted load limit of only 3 tons.

Various design options were considered, many of which would have worked well. Most centered around a bridge-within-a-bridge concept, where the existing floor system would be removed and replaced by a system that would remain independent of the wooden truss. This concept was especially attractive to us because of the uncertainty of the live-load capabilities of the old truss. Armed with this central idea, other more specific design parameters were formulated, including the following:

1. The waterway adequacy must not be constricted by the improvement.
2. Bridge capacity must be increased to handle a two-axle, 18-ton fire truck.
3. Timber will be used in the improvement for aesthetic compatibility.
4. The new system will help support the truss against further sag and twist, and straighten the truss.
5. All construction will be performed by Union County crews.
6. One of the piers cannot be relied on because of possible foundation problems.
7. Original appearance must be maintained as much as possible.
8. The project must meet economic criteria; 50 other structures in the county are load reduced, and also need attention.

A final design solution was selected based on a great deal of discussion, preliminary design calculations and sketches, and help from Ashtabula County (Ohio) Engineer John Smolen, whose covered bridge rehabilitation and construction programs are known nationwide.

Two large glulam girders (10-3/4 inches wide by 42 inches deep) were set inside the bridge at roadway elevation, and transverse glulam floorbeams (5-1/8 inches wide by 14-1/4 inches deep) were hung from the girders with steel rods. The glulam members, fabricated from Southern Pine, were pressure treated with pentachlorophenol in a heavy oil. A longitudinal, nail-laminated lumber floor was then placed on the floorbeams. Because only one existing pier could be used, two unequal simple spans were necessary; one 60 feet long and the other 34 feet long. The steel hanger assembly for floorbeams consisted of 3/4-inch-diameter threaded steel rods (ASTM A108) and 3-1/2-inch by 3/8-inch steel angles (ASTM A36). The floorbeams were placed 30 inches on-center and were extended

beyond the girders underneath the lower truss chords to help straighten the chords by drawing up the beams with the threaded rods. This configuration did not help the trusses as much as expected because their condition was worse than originally thought. However, it was expected that the floorbeams would lend a great deal of support.

Eventually, the decision was made to repair all four truss corners, especially the lower chords, with new poplar timbers. Once this was done the truss squared up nicely.

The design for loading, in excess of AASHTO H 15-44 loading, was based on the current AASHTO, NDS, and AITC specifications. The floorbeam spacing (30 inches on-center) was a result of the AASHTO wheel-load distribution guidelines.

In retrospect, the project was a success. A covered bridge was saved and left in service. Some historians and covered bridge purists may argue the methods used, or question the authenticity or aesthetic value that remains, but there is probably no perfect or absolutely correct way to improve these bridges' deficiencies and still preserve them. Too many factors are involved to ideally address each problem area of the bridge. It tends to become a give-and-take exercise. Various phases of this project are depicted in Figures 15-27 through 15-37.



Figure 15-27. - Covered bridge on Winget Road before rehabilitation work began. Note the excessive rack and twist of the truss.



Figure 15-28. - Another view of the bridge before rehabilitation. One objective of the project was to maintain the bridge's appearance.



Figure 15-29. - Support for the roadway was obtained by installing two pressure-treated glulam girders inside the existing bridge, one along each side of the roadway.



Figure 15-30. - Transverse glulam floorbeams were suspended from the tops of the girders by steel-rod hangers.

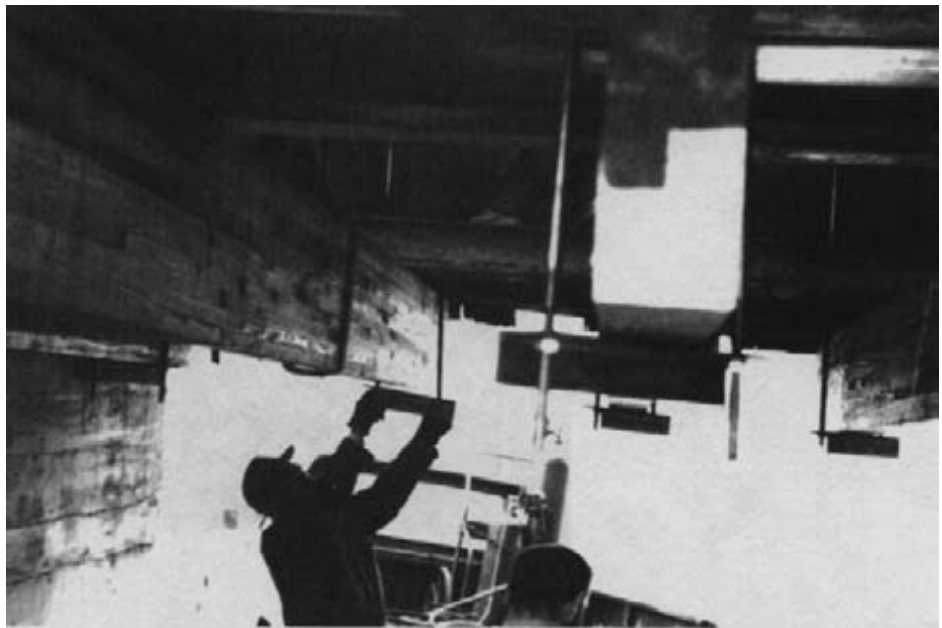

Figure 15-31. - Floorbeams are installed on the hangers from the bridge underside.



Figure 15-32. - Severe deterioration at each corner of the bridge was one cause of the poor truss alignment. New floorbeams were extended beyond the girders to help support each truss.



Figure 15-33. - Broken lower chords at two of the four corners prompted the replacement of some existing truss members.

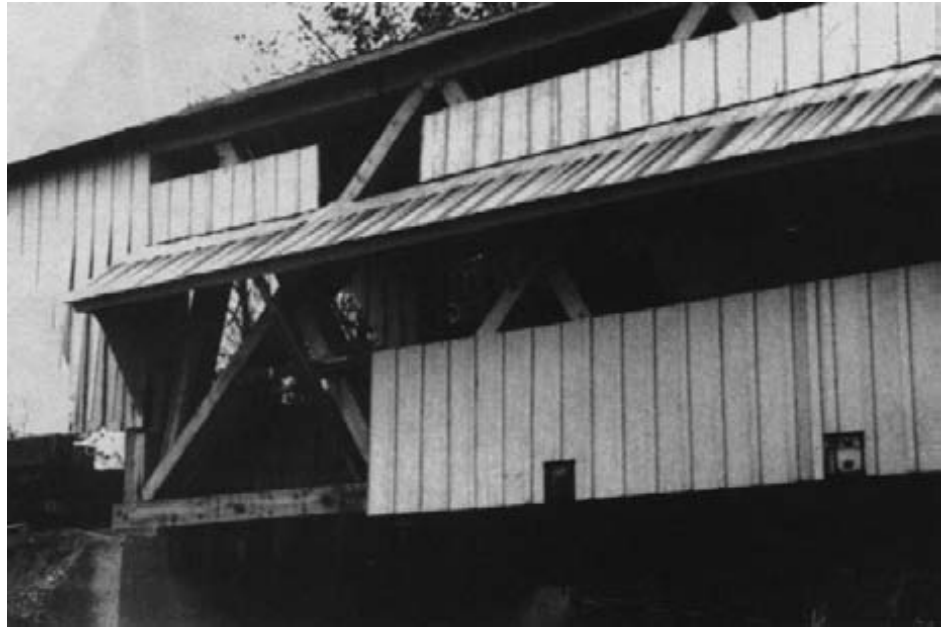

Figure 15-34. - Completed repair of one corner of the bridge, using poplar timbers. Note the closer spacing of the endmost floorbeams to account for the reduced floorbeam load distribution adjacent to the abutment.



Figure 15-35. - A view inside the bridge showing the glulam girders, floorbeams, and longitudinal nail-laminated lumber floor. The existing floor, still in place at the far end of the roadway, was removed in sections to facilitate construction.



Figure 15-36. - The final result of the bridge-within-a-bridge concept. Four kneebraces to the roof system, which had been removed over the years, were reinstalled for stability and appearance. Note the improved truss alignment.



Figure 15-37. - The completed rehabilitation results in a significantly increased load capacity (18 tons), while maintaining the historic bridge's aesthetic appeal.

Planning for a second restoration is under way for a shorter (63-foot span) structure. Several improvements have been incorporated into the design, both aesthetic and structural. The hanger system will be totally hidden, connecting the floor system with the girders through holes bored along the centerline of the girders. In addition, a panelized transverse glulam deck with a plank wearing surface will replace the floorbeam and nail-laminated lumber floor system used before. The combination of 10-3/4-inch wide by 48-inch deep glulam girders (single span) and an 8-3/4-inch-thick glulam deck will permit AASHTO H 15-44 loadings. Use of the glulam deck will also increase the vertical clearance within the structure, without decreasing the waterway opening.

CASE HISTORY 15.5- REHABILITATION OF NAIL-LAMINATED TIMBER DECKS BY TRANSVERSE STRESSING

Contributed by Raymond J. Taylor, Associate Research Engineer, Ministry of Transportation, Ontario, Canada

The concept of transverse prestressing was developed in 1976 as a method of rehabilitating deteriorated nailed-laminated wood bridge decks. Since that time, it has been developed as a totally new form of wood bridge deck design through considerable research and development. The current design specifications in the Ontario Highway Bridge Design Code (OHBDC) cover both the rehabilitation of old nail-laminated decks and the design of new ones. Since the first bridge was rehabilitated in 1976, this method of repair has been applied nearly a dozen times. This brief summary describes the field operations involved in the rehabilitation of nailed-laminated timber decks in Ontario.

Figure 15-38 displays the common problem associated with the delamination of nailed-laminated timber bridge decks. Their inability to maintain an unbroken asphalt wearing surface makes them a constant maintenance problem. To correct the problem, the deck is squeezed back together by applying pressure perpendicular to the laminations. This creates adequate friction between the lamination surfaces to reinstate load sharing and prevent breakup of the wearing surface.



Figure 15-38. - Breakup of asphalt pavement because of delamination of the nail-laminated timber deck.

The typical detail of the prestressing system as specified in the OHBDC is shown in Figure 15-39. The arrangement consists of a pair of high-strength bars attached to steel anchorage plates. This acts like a large flexible clamping system. The anchorage plates bear against steel channel bulkheads, which run the full length of the deck, and help to distribute the high prestressing forces, preventing local crushing of the wood.

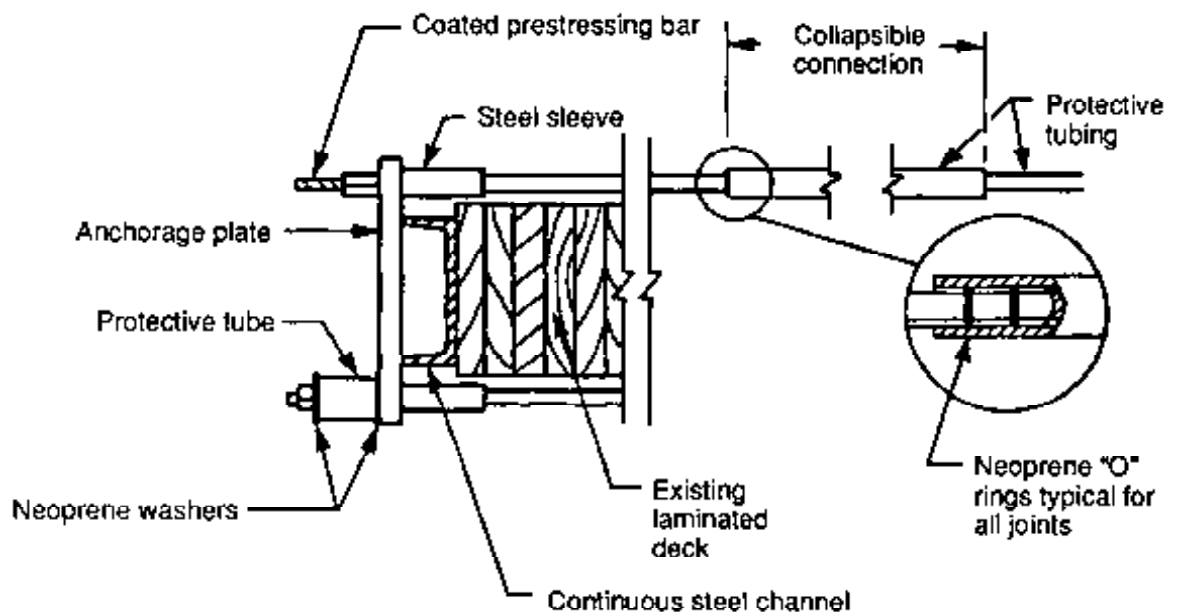

Figure 15-39. - Prestressing detail for rehabilitation of existing decks.

Figure 15-40 displays the anchorage detail used at the Pickerel River Bridge near Thunder Bay, Ontario. The bars were galvanized and enclosed in protective polyvinyl chloride (PVC) tubing to guard against deterioration. Several new wood laminations were added to offset the narrowing of

the deck as it was squeezed transversely. Generally, about 1 to 2 percent of the initial bridge width is added depending on the extent of separation that has occurred in the existing deck.



Figure 15-40. - Prestressing anchorage used at the Pickerel River Bridge.

The joint between the PVC pipe and the steel sleeve that extends from the steel anchorage plate (Figure 15-40) is sealed with neoprene O-rings. The same O-ring joint is used at the collapsible connection shown in Figure 15-39. Figure 15-41 displays these O-rings, before assembly, as applied at the Pickerel River Bridge.



Figure 15-41. - PVC sleeve connection with neoprene O-rings.

The installation of the prestressing system is usually facilitated by the complete removal of the asphalt surface. However, in several bridge rehabilitation projects, the top bars were placed in transverse grooves cut in the asphalt surface (Figure 15-42). This was done to maintain traffic but was not considered to be successful because the asphalt cutting took considerable time and the final asphalt surface was badly deteriorated by traffic. To date, the best method of maintaining traffic during the stressing

operation has been the installation of a temporary plank surface (Figure 15-43). The two-way plank system includes a bottom layer parallel to the bars spaced so that the bars can be installed beneath the running planks. Maintenance of the plank surface has not been a problem.



Figure 15-42. - Top prestressing bars installed in grooves cut in the asphalt wearing surface of the North Pagwachuan River Bridge near Terrace Bay, Ontario.



Figure 15-43. - Temporary plank surface placed over prestressing bars during construction at the Pickerel River Bridge.



Figure 15-44. - Multijack hydraulic system used at the North Pagwachuan River Bridge.

The actual stressing of the bars was originally performed using only a pair of hydraulic jacks so that only the two bars at one location could be stressed simultaneously. This did not prove to be efficient, as the initial stressings at each position had only local effects and the stressing of one pair of bars (station) would loosen the adjacent station. On the Hebert Creek Bridge in 1976, twelve passes along the bridge were required to reach an acceptable level of stress in all bars. Today, the stressing is performed using a multijack hydraulic system (Figure 15-44). This 24-jack system uses 530-kN (60-ton) capacity jacks with steel back-up plates that allow each jack to stress one pair of bars at the same time. These jacks are of hollow cylinder design, so they can also be used for single-bar construction as used in new decks.

Stressing an existing deck has not resulted in any visible distress at the bearing support of the laminations. The original toenailing of the laminations may have deteriorated or may simply provide little resistance to the transverse movement of the laminates. In any case, no repairs have been necessary other than tying down the final deck to the supports. Simple

steel rods and plates are used to clamp the deck to the supporting member (Figure 15-45).



Figure 15-45. - Tie-down of the deck to supports at the Kabaigon River Bridge.

A number of bridges rehabilitated by transverse prestressing have been load tested. Typical test results are displayed in Figure 15-46, which compares midspan deflections on the Hebert Creek Bridge before and after transverse prestressing. These results demonstrate the benefits of rehabilitating old nail-laminated decks by this method; load distribution is improved, making the bridge stronger than its original design.



HEBERT CREEK, HWY 539

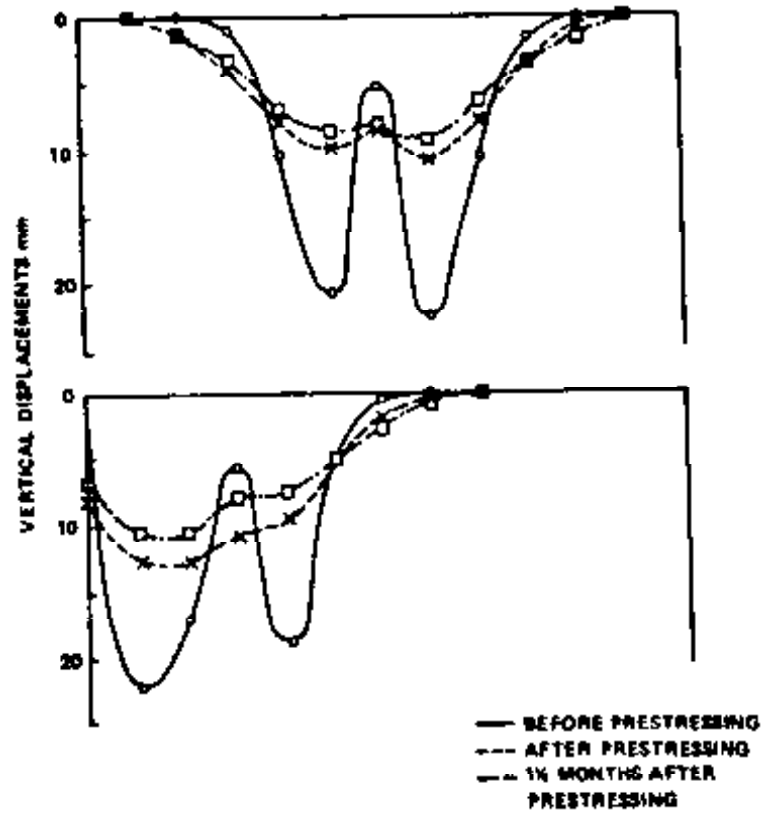

Figure 15-46. - Load test results at the Hebert Creek Bridge, before and after transverse prestressing was applied.

CASE HISTORY 15.6- SAUK COUNTY BRIDGE REDECKING

Contributed by Ken Johnson, Civil Engineer, Wheeler Consolidated, Inc.

Sauk County, a rural county in south-central Wisconsin, contains a portion of the prime recreation area around the Wisconsin Dells. This is one of the major tourist attractions in the upper Midwest. The major arterial route serving this area is County Trunk Highway A, which has the highest average daily traffic of all county trunks in Sauk County. The route is carried over the narrows of Mirror Lake on an overhead steel truss bridge. The 96-foot structure was originally constructed with a cast-in-place concrete deck.

Annual inspections of the structure revealed serious deterioration of the deck, which had been overlaid with a bituminous wearing course. The use of de-icing chemicals and the freeze-thaw cycles accelerated the rate of deterioration. The bridge was posted for restricted loads because of the condition of the deck and the additional dead load from the bituminous overlay. Sauk County was faced with the problem of eliminating this hazard. Their options were to replace the entire structure; replace the existing concrete deck, in kind; or replace the existing deck with some other type of construction.

Selection of the best option was easy for the county once each option was fully evaluated. Replacement of the entire structure, the most costly option, was not selected because the main structural components of the existing bridge were still adequate. The main truss, the floor beams, and the steel stringers were in excellent condition. The structure was hydraulically adequate and had sufficient roadway width. The choice narrowed to replacement of the deck.

The choice of replacing the concrete deck with one constructed of treated timber was made based on cost, ease of construction, time required for construction, weather restraints for construction, and deck weight. The estimated cost for the treated timber deck was considerably less than the estimated cost for replacement with a concrete deck. The treated timber deck could be placed by Sauk County's highway crew using existing county equipment and could proceed during wet or freezing weather (the highway could not be closed during the summer). The entire project could be completed within 1 week, which was an important consideration because there was no reasonable detour. In addition, the dead load of the timber deck would be only one-third that of concrete, which would substantially increase the bridge live load capacity. All factors indicated that replacement of the concrete deck with one constructed of treated timber was the most prudent decision for Sauk County.

The county provided the timber vendor with an as-built plan of the structure. The vendor provided detailed construction plans as part of the material purchase price. A transverse laminated lumber deck was pre-fabricated into panels that were matched to the lifting capacity of the county equipment.

Work on the project was started on Monday, November 15, 1982, and the bridge was completed and open for traffic on Friday, November 19, 1982. The concrete deck was removed in sections approximately 5-feet square. Once a portion of the old deck was removed, the new timber deck panels were placed. The panels were prefabricated so as to be placed without removing any of the bridge railing. The transverse panels were attached to the steel stringers using a 5/8-inch-diameter domehead bolt with an offset shoe that gripped the flange of the stringer. A compression spring was placed between the nut and the offset shoe. This type of hardware compensates for changes in deck thickness from moisture changes. The uncompressed length of the compression spring is 1-1/2 inches and the compressed length is 7/8 inch.

The completed timber deck was surfaced with a bituminous wearing course. The entire project was completed in 5 working days and the total cost to Sauk County was \$31,184.44, which is \$12.49/ft² of deck. The following is a breakdown of the total project cost:

Material delivered to jobsite	\$21,621.37
Labor	4,396.29
Equipment	2,942.26
Labor overhead costs	<u>2,224.52</u>
TOTAL PROJECT COST	\$31,184.44

Figures 15-47 through 15-54 present a sequence of photos describing the project.



Figure 15-47. - The existing bridge was a steel truss, 96 feet long, with a 26-foot roadway width. The noncomposite concrete deck was supported by steel stringers (WF16 x 50) spaced 4 feet 6 inches on center. The stringers were supported by steel floor beams (WF30 x 116).



Figure 15-48. - The concrete deck was removed in approximately 5-foot-square sections by the Sauk County Highway maintenance crew. The concrete was broken using jackhammers, and reinforcing bars were flame cut. The sections were lifted and loaded on the trucks with a hydraulic excavator.

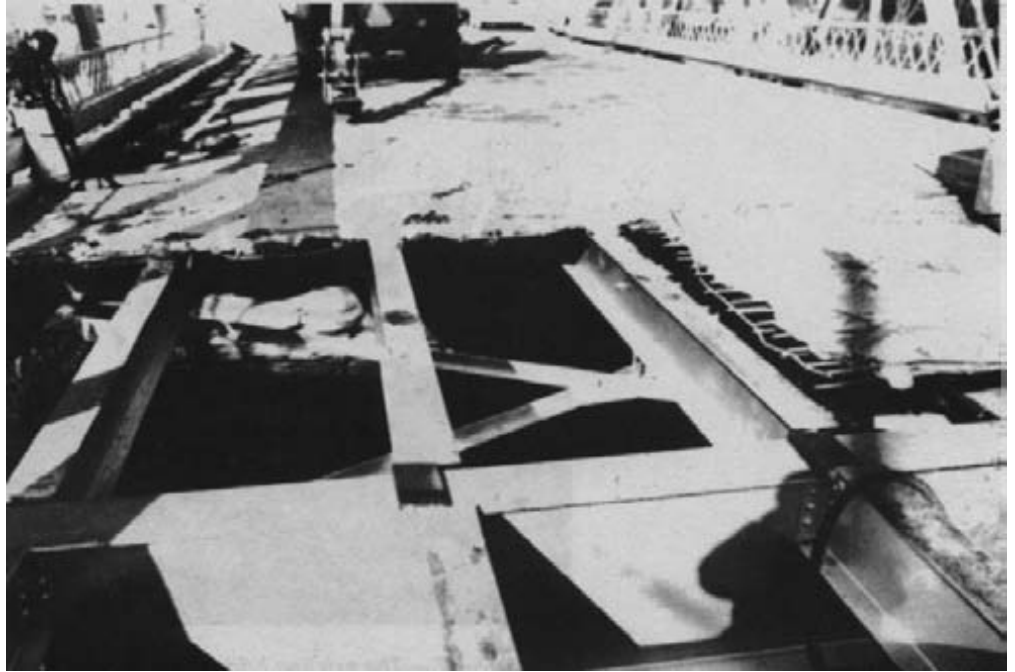

Figure 15-49. - Exposed steel floorbeams and stringers as deck removal proceeds.



Figure 15-50. - New, prefabricated treated-timber deck panels were placed with a hydraulic excavator. The panels were designed to fit transversely on the stringers and were placed without removing the existing railing.

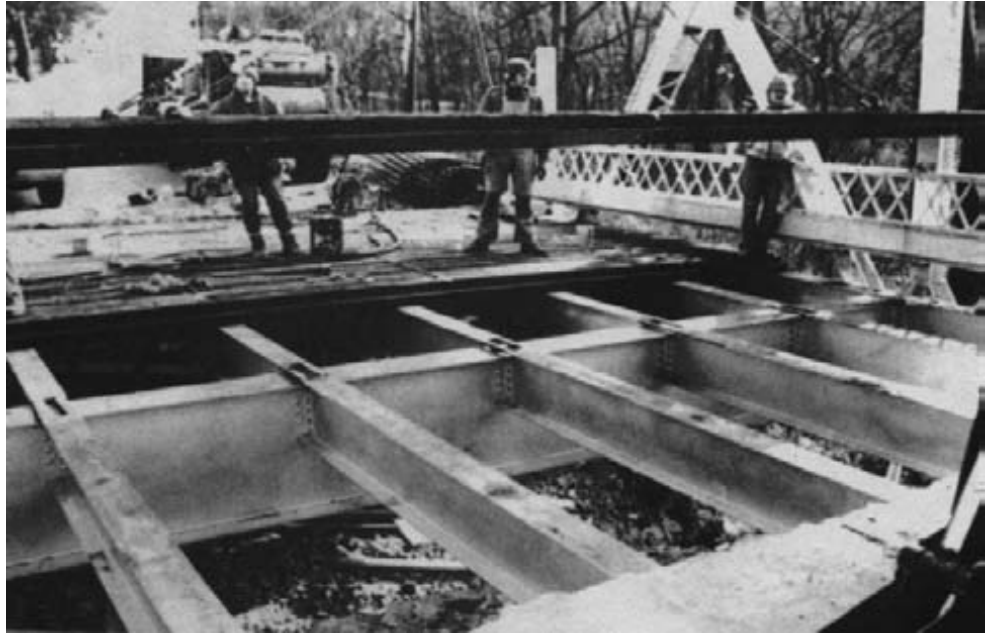

Figure 15-51. - Deck replacement proceeded in stages along the bridge length. After a portion of the concrete was removed, timber deck sections were placed. Steel straps were welded to the ends of the stringers (across floorbeams) to provide continuous support for the timber deck panels.



Figure 15-52. - Timber deck panels were provided with four eye-bolts and were banded with straps to facilitate shipping and handling. Panels were fabricated from 3-inch-thick, 6-inch-wide (S1S) creosote-treated Douglas-fir lumber, and were 6 feet 3 inches wide. The individual lumber laminations were laminated together with 5/16-inch-diameter, 8-inch-long ring-shank spikes. Ship-lap-type joints were used between panels, with 1/2-inch-diameter by 5-inch-long drive spikes placed vertically through the joints.

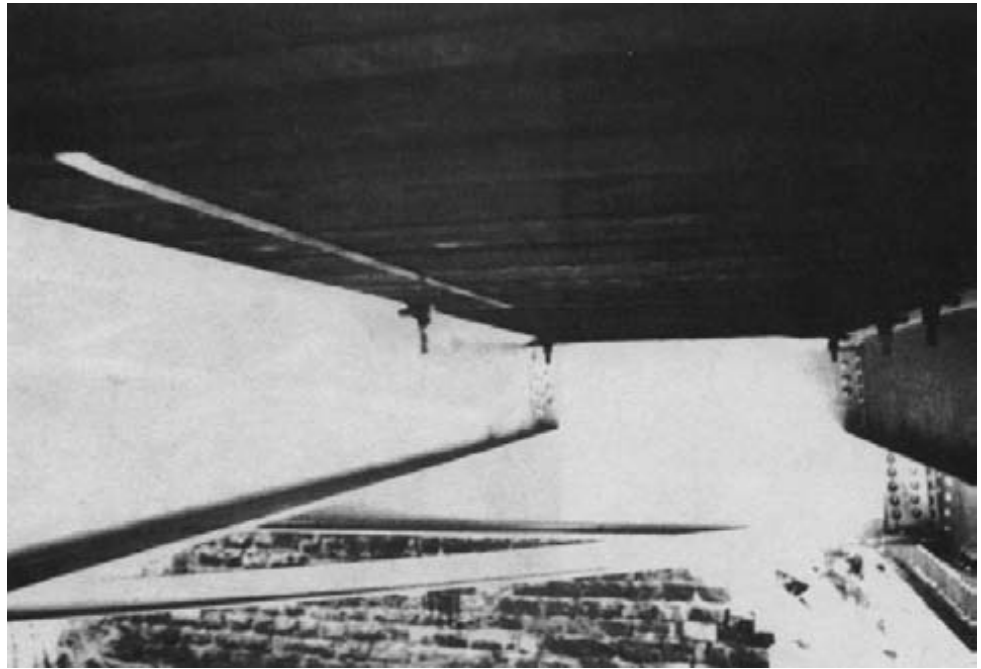

Figure 15-53. - Panels were attached to the stringers with 3/4-inch-diameter by 9-inch-long machine bolts, using a 3/4-inch offset shoe and spring. The offset shoe grips the flange of the stringer, and the compression spring compensates for changes in deck thickness from moisture changes in the timber.



Figure 15-54. - The completed treated-timber deck, before placement of an asphalt-pavement wearing surface.

CASE HISTORY 15.7- BRUNEAU RIVER BRIDGE REHABILITATION

Contributed by Steve Bunnell, Regional Bridge Engineer, USDA Forest Service, Intermountain Region

The Bruneau River Bridge is located in north-central Nevada. Although located in a remote area, it is a vital link in the back-country traffic patterns in northern Nevada. The bridge, constructed in 1953, was originally 74 feet long and consisted of two 14-foot side spans of longitudinal nail-laminated lumber decking and a 46-foot steel-beam center span with a transverse nail-laminated lumber deck. The abutments were timber cap and bulkhead-type, and the piers were reinforced concrete contained by corrugated metal pipe on spread footings.

During the spring of 1984, flooding occurred throughout northern Nevada because of a record snowfall the previous winter. A small stream, Meadow Creek, has its confluence with the Bruneau River just upstream from the bridge site. Extreme high flow in Meadow Creek forced the main flow in the Bruneau River against the north abutment, breaching the north approaches and the abutment-supporting foundation material, and the north approach span fell into the stream. No other damage to the bridge occurred from this incident. However, previous technical inspections of this bridge identified that the transverse nail-laminated lumber decking was reaching the end of its expected life, and that there were some structural problems with the south bulkhead abutment.

Immediate temporary repair measures consisted of replacing the approach embankment and raising the existing span back in place to restore traffic on the bridge. Analysis in preparation for a permanent repair to the bridge determined that the existing river piers and the steel portions of the superstructure were structurally adequate and had sufficient life remaining for all alternatives considered. Hence, a decision was made to rehabilitate the bridge rather than replace it.

The rehabilitation proposal consisted of replacing the south approach span with four longitudinal glulam deck panels, 8-3/4 inches thick by 3 feet 10-1/2 inches wide by 18 feet 8 inches long, and lengthening the span from 14 feet to 19 feet. The longitudinal panel interfaces were doweled with 1-1/8-inch-diameter steel dowels. The north approach span was lengthened from 14 feet to 50 feet by using two steel beams (and bracing) salvaged from another dismantled bridge and secured by the contractor as government-furnished material. The two new steel beams were connected to the existing steel beams by a field-pinned connection because there was not sufficient room on the existing cap for an additional bearing. The existing bearing assembly was adequate to carry the additional reaction. The existing nail-laminated lumber deck on the steel girder span was

removed, and 24 new treated-timber transverse glulam deck panels, 6-3/4 inches thick by 4 feet wide by 15 feet 6 inches long, were placed on the remaining portion of the bridge, including the new steel girder span. Each panel interface was doweled with fifteen 1-1/4-inch-diameter steel dowels. Both abutments were replaced with treated-timber bearing caps and bulkhead-type abutments. This new design resulted in an increase in traveled-way width from 12 feet to 14 feet 4 inches. Treated-timber glulam curb/wheel guards and a bituminous wearing surface were included in the contract proposal.

In September 1985, a contract was awarded to Thorton Construction of Burley, Idaho, for \$65,103.80, which included the cleaning and painting of the steel work. The contract was completed on schedule in August 1986. The new facility provides an additional hydraulic opening of 36 feet on the north side, which may preclude damage from incidents similar to the 1984 flooding; it also provides an additional 2 feet 4 inches of traveled way on the deck. Photos of the project are shown in Figures 15-55 through 15-65.



Figure 15-56. - Collapsed span and breached approaches of the existing bridge.



Figure 15-57. - Close-up of the collapsed longitudinal nail-laminated lumber approach span.



Figure 15-58. - The temporary repair made to the bridge consisted of replacing the approach embankment and lifting the nail-laminated approach span back into position.

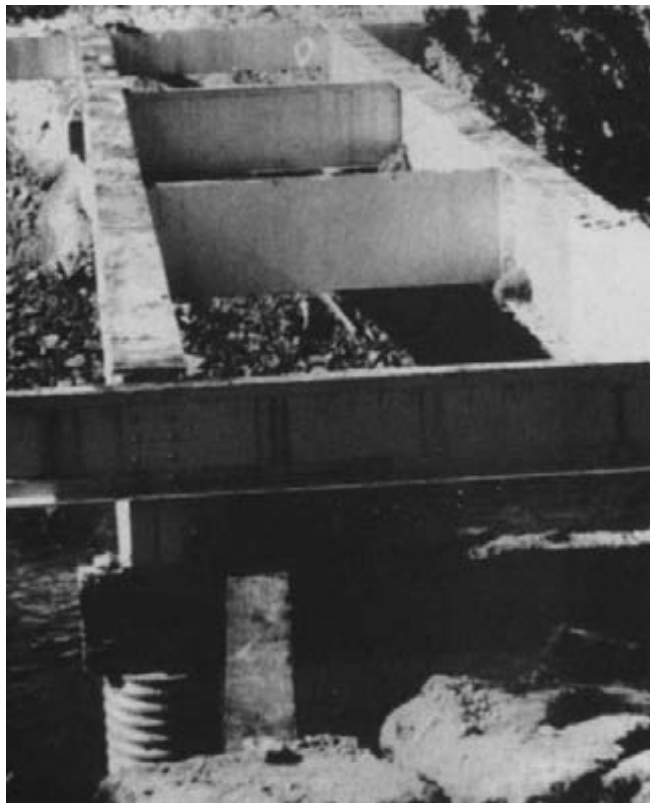

Figure 15-59. - A view of the bridge as rehabilitation began, with the deck, curbs, and timber abutments removed.

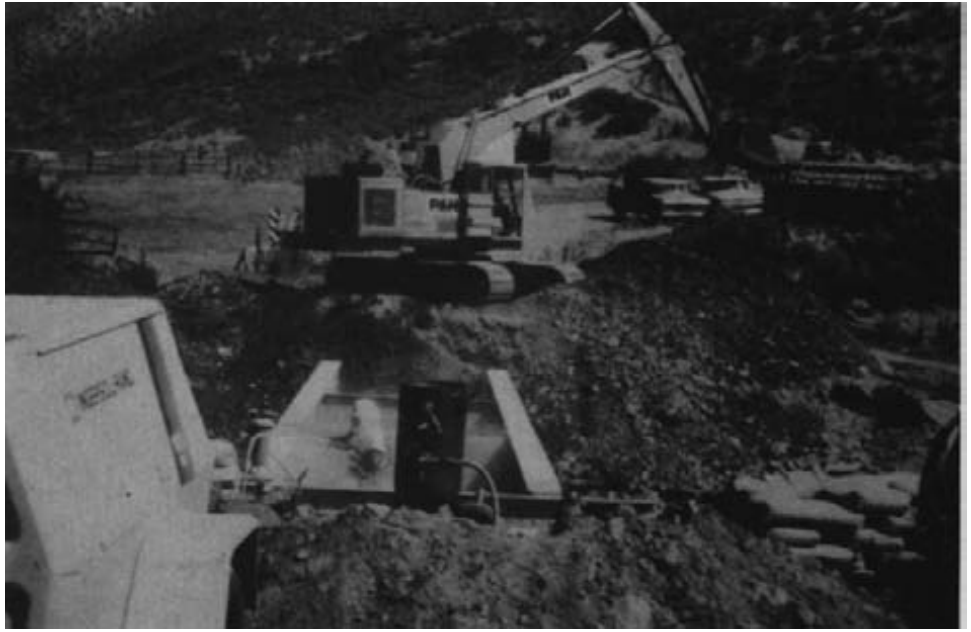

Figure 15-60. - Blast cleaning of the existing steel work in preparation for painting, while a backhoe removes material that was placed for the temporary repair.



Figure 15-61. - Steel beam extensions in place and pinned to the existing beams.

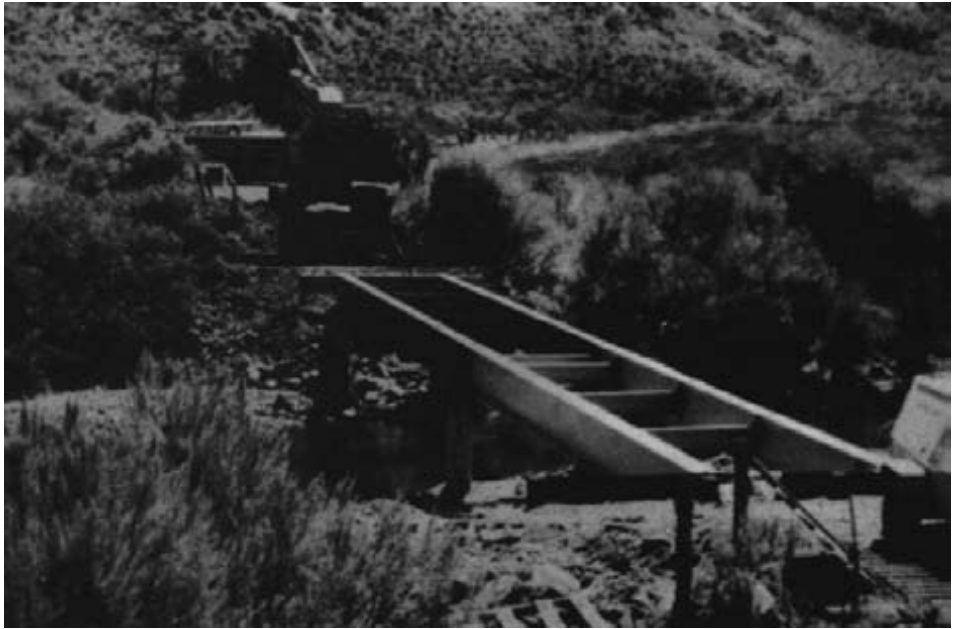

Figure 15-62. - A portion of the final paint coat has been applied to the steel and the new treated-timber abutments are in-place. The backhoe is positioned to lift the longitudinal glulam panels for the far side approach span.



Figure 15-63. - Transverse glulam deck panels are lifted into place.



Figure 15-64. - Backhoe pushes panels together after dowels have been aligned. A large timber block was placed across the panel edge to prevent damage from the backhoe bucket.



Figure 15-65. - The completed bridge with glulam curb/wheel guards and asphalt wearing surface in place.

CASE HISTORY 15.8- UINTA CANYON CANAL BRIDGE REPLACEMENT

Contributed by Steve Bunnell, Regional Bridge Engineer, USDA Forest Service, Intermountain Region

The Uinta Canyon Canal Bridge is located on the Ashley National Forest near Roosevelt, Utah. It serves mostly recreational traffic on the south slope of the Uinta Mountains. A recent timber sale necessitated an increase in the load capacity of the Uinta Canyon Canal Bridge.

The existing bridge consisted of a single-lane longitudinal nail-laminated lumber deck bridge, 26 feet long with a 27-degree skew, on treated timber abutments. The existing deck was severely delaminated, with openings of 1 to 2 inches between laminations. Previous technical inspection reports documented the delaminating condition, but revealed that the treated timber abutments had remaining life and were structurally adequate to support the timber-sale loads. Hence, a decision was made to replace just the deck and curb portions of the bridge as a measure to rehabilitate the bridge for the heavier loads.

The contract proposal was to replace the deck with longitudinal glulam deck panels and wheel guard/curbs. Design requirements showed that depths of single laminates normally used (10-3/4 inches, 8-3/4 inches, 6-3/4 inches, etc.) were not adequate for the existing 26-foot span. A check with a glulam supplier revealed that using edge-glued laminations consisting of two pieces, a 2 by 6 and a 2 by 8 (surfaced), placed alternately top and bottom to build up 14-inch-deep panel laminations (surfaced to 12-1/4 inches), would provide adequate structure depth to span the 26 feet.

Four pressure-treated glulam deck panels, measuring 12-1/4 inches deep, 4 feet wide and 26 feet long, were proposed, with glulam curbs measuring 6-3/4 inches by 12 inches. Panel interfaces were connected with 1-1/2-inch-diameter dowels. In September 1986, a contract was awarded to Niedermeyer-Martin Company of Portland, Oregon, for \$9,430 to supply the treated-timber members. The bridge construction was performed by Ashley National Forest maintenance crews. Because of the skew and the interference of the existing abutment backwalls, the panels could not be jacked together in place because the dowels were to be placed normal to panel interfaces. The four deck panels were assembled together on two well casings in a staging area adjacent to the bridge and the entire deck unit was jacked together. The assembled deck was erected as one complete unit, 16 feet wide and 26 feet long. Sling connections were attached to the well casings and used to erect the unit with a crane. The new deck fit perfectly on the old abutments. The panels were then connected to the existing caps, the wheel guard/curbs were installed, and a temporary surface was placed on the deck.

The timber members were delivered to the site on Monday, November 24. All the construction was completed and traffic was restored across the bridge at 5 p.m. on Tuesday, November 25. When moderate weather permits, the temporary aggregate wearing surface will be removed and replaced with a permanent bituminous wearing surface.

The use of the glulam panels allowed salvaging the existing abutments and increasing the load capacity of the bridge. In addition, the traveled way was increased from 12 feet to 14 feet 4 inches. The new deck is free from any fasteners that penetrate the treated wood, which ensures improved protection against decay and increased life over nail-laminated construction. Assembly was made quick by simple, efficient, state-of-the-art equipment.

The project sequence is presented in Figures 15-66 through 15-75.

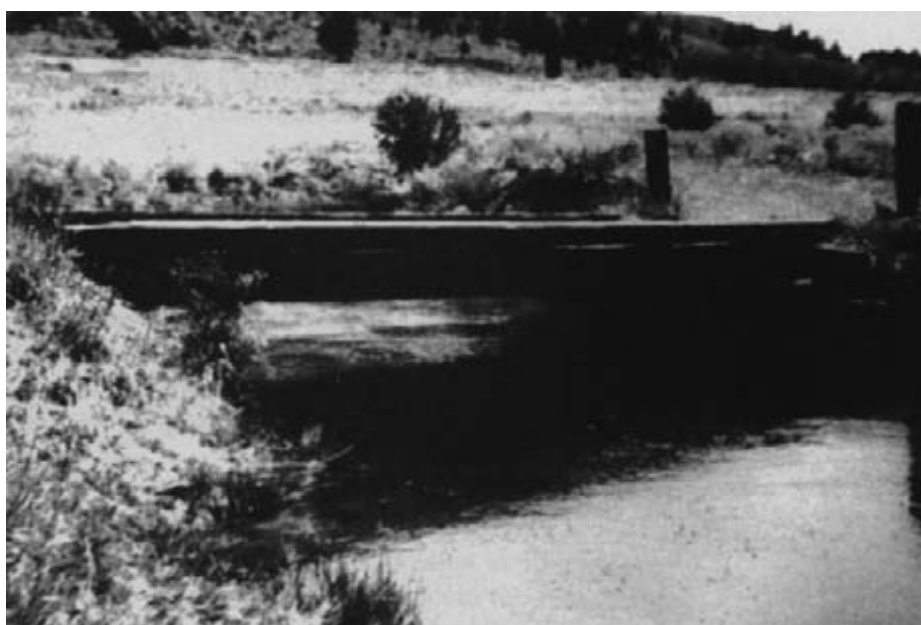

Figure 15-66. - The longitudinal nail-laminated lumber-deck bridge before replacement. The bridge was 26 feet long with a 27-degree skew.



Figure 15-67. - The existing deck was carefully removed in sections to avoid damage to the treated-timber abutment caps.



Figure 15-68. - A view of the abutments after the bridge was removed.



Figure 15-69. - The first two panels of the new bridge are interconnected with steel dowels and pulled together with a come-a-long. Because the crossing was skewed, the doweled panels could not be assembled on the abutments. Assembly was completed adjacent to the site on two well casings to facilitate assembly and lifting.



Figure 15-70. - Another view of the first two panels being pulled together. Note the corner protectors under the come-a-long chains and the can of roofing cement on the deck. All panel joints were sealed with the roofing cement before being pulled together.



Figure 15-71. - Steel dowels are aligned before joining the fourth panel. The dowels are 1-1/2 inches in diameter, 19-1/2 inches long, and are spaced 12 inches on center.



Figure 15-72. - The completed deck, resting on the well casings, is lifted into place on the abutments. Note that the curbs have been preassembled adjacent to site.



Figure 15-73. - The replacement deck in place.



Figure 15-74. - Curbs are attached to the deck.



Figure 15-75. - The completed structure with a temporary aggregate wearing surface. The deck was later provided with an asphalt pavement wearing surface.

CASE HISTORY 15.9- COOK COUNTY BRIDGE REPLACEMENT

Contributed by Michael G. Oliva, Associate Professor of Structural Engineering, University of Wisconsin, Madison

The Gunflint Trail is a historic route used by early fur traders to transport their goods from the northwestern territories to the shores of Lake Superior. It is currently a paved county road in Cook County, Minnesota, and is used primarily for access to the Boundary Waters Canoe Area and the Superior National Forest. A bridge located over the Cross River on a gravel-surfaced Gunflint Trail access road consisted of a two-span timber beam superstructure supported by timber cribbing constructed of logs. The superstructure consisted of sawn lumber beams that were judged to be untreated with preservatives, and a transverse plank deck spiked to the beams (Figure 15-76). The wearing surface was provided by lumber running planks. The bridge was structurally and functionally deficient and lacked curbs and railing (Figure 15-77). The increased recreational traffic and existing deficiencies required full replacement of both the abutments and superstructure.



Figure 15-76. - The existing single-lane bridge was a simply supported, two-span, untreated-timber beam bridge supported by log cribbing (photo courtesy of Wheeler Consolidated, Inc.).



Figure 15-77. - The existing bridge was structurally deficient and load-posted. In addition, it was too narrow and lacked curbs and railing (photo courtesy of Wheeler Consolidated, Inc.).

The bridge was located on the sole access route to a series of recreational and sporting locations on Gunflint Lake and was being used for fishing in the Cross River. Cook County's primary concern in planning a replacement bridge was economy, accompanied by a desire to increase load capacity and to widen the roadway to accommodate fishing activities. Wheeler Consolidated, Inc., a Midwest timber bridge supplier, used the opportunity to attempt construction of one of the first longitudinal stress-laminated lumber bridges in this country and provided cost incentives to Cook County for erection of this prototype structure.

The new bridge design consisted of a single-span longitudinal stress-laminated lumber deck measuring 44 feet long, 18 feet wide, and 16 inches thick. The deck was fabricated of nominal 4-inch wide by 16-inch deep Douglas Fir-Larch lumber laminations, visually graded No. 1 or better. The laminations were pressure treated with creosote and were 4 feet to 20 feet in length. Butt jointing of the laminations was achieved through the stress-laminating process, using 1-inch-diameter high-strength steel prestressing rods placed transversely through the center of the laminations at 4-foot intervals. The replacement bridge was supported on two new creosote-treated timber crib abutments. The bridge was still intended for one lane of traffic, but was widened to accommodate pedestrians, and included curbs and railing. The hydraulic configuration was unchanged although the center crib was no longer needed.

The entire replacement project was completed by the Cook County road crew of seven men, along with a hired crane and loader with operators. The timber cribbing materials for the abutments were precut and treated (with markings to indicate location of each piece) and were shipped to the Cook County shop. The county started work on March 11 during a lull in normal snow-removal activities. The old superstructure was removed using two backhoes and incinerated at the site. Explosives were used to remove the old cribbing abutments from the frozen ground, but the center support could not be removed because it was frozen in the lake. The new cribs were constructed in place using the precut treated Douglas Fir-Larch (Figure 15-78). Each of the cribs was backfilled with rock, granular material, and soil.



Figure 15-78.-The new crib abutment under construction using precut and creosote-treated Douglas-fir timbers. The only field fabrication involved drilling holes in the timbers for drive spikes used for connections. Such penetration of the protective envelope should have been avoided by drilling before pressure treatment (photo courtesy of Wheeler Consolidated, Inc.).

The county had arranged delivery of the replacement bridge to occur at the start of construction. The deck was prefabricated and prestressed in two stress-laminated panels, each 9 feet wide and 44 feet long with 2 inches of upward camber. The two panels were placed in adjacent positions over the span after the cribbing was completed (Figure 15-79). The two separate panels had to be connected to achieve the desired longitudinal deck action. A special coupling process was used to stress-laminate the panels together using the existing stressing hardware in the separate panels.

Since previous research at the University of Wisconsin had shown that little stiffness loss would occur if the stress in a stress-laminated deck was reduced to one-half the design value, every other rod in either panel could be released without losing the integrity of the panel. Alternate rods were released in each panel, with a released rod in one panel being opposite to the unreleased rod in the other panel. The released rods were attached to the unreleased rods in the adjacent panel using special high-strength couplers (Figure 15-80). After all rods were coupled, the released rods were restressed and the two panels were pulled and laminated together by the prestress. Two separate stressing passes along the rods, restressing each individually, had to be completed to obtain relatively uniform forces in all the rods. The two prefabricated panels then formed a single integral bridge deck (Figure 15-81).



Figure 15-79. - One of the prefabricated, prestressed, bridge deck panels is lifted into position on the treated-timber crib abutments.



Figure 15-80. - Prestressing rods protruding from the two prefabricated deck panels before connection. The rod opposite each coupler was released and threaded into the coupler. After all couplings were made, the released rods were restressed, causing the deck panels to be stress-laminated together as an integral bridge deck.



Figure 15-81. - The completed longitudinal stress-laminated deck bridge replaced the existing two-span structure with a single span. The new deck increased load capacity to AASHTO HS 20-44 and included curbs and railing. Remains of the old center support are visible below the replacement structure (photo courtesy of Wheeler Consolidated, Inc.).

The entire sequence of cribbing erection, superstructure placement, and stressing was accomplished by the Cook County crew in 13 hours over a 2-day period. The roadway was then reopened for traffic, although curb and rail installation was not completed until the third day. The connection between the prefabricated panels would have been much easier if the alignment of the rods in each of the panels had been more carefully monitored during the plant fabrication. Misalignment in some of the bars resulted in difficulty during coupling. One bar that was not sufficiently threaded into the coupler pulled out during the restressing. Sufficient insertion into couplers, and locking bars in position in couplers, could have been achieved by placing lock nuts on the bars at correct locations before threading into the coupler. In addition, the exterior laminations had large natural defects such as splits and knots. These defects usually induced further splitting of the exterior laminations during the prestressing operation because of the concentrated compression forces transferred into the wood. The splitting did not detract from the structural performance but the aesthetic appearance would have been improved if better-quality lumber without defects had been used for exterior laminations. One of the exterior laminations at the end of the deck was only 4 feet long with a single prestressing rod inserted through its face and the lamination rotated slightly during the restressing. The minimum length of laminations should be such that each lamination has at least two rods through its face.

The erection of this prototype bridge proved that the longitudinal stress-laminated bridge could be prefabricated in panels and connected at the site to form an integral deck. The erection of such a bridge can proceed very rapidly, in this case in less than two full days. The bridge was covered with a gravel wearing surface after completion of the superstructure erection and attachment of curbs and rails. Observation of the behavior of the bridge during the 2 years since it was erected has shown that the original camber was insufficient to balance the dead-load deflections and time-related creep deflection has resulted in a permanent sag of the deck. The deflections indicate that the span was probably longer than should normally be used with decks of 16-inch thickness.