

LOADS AND FORCES ON TIMBER BRIDGES**6.1 INTRODUCTION**

A bridge must be designed to safely resist all loads and forces that may reasonably occur during its life. These loads include not only the weight of the structure and passing vehicles, but also loads from natural causes, such as wind and earthquakes. The loads may act individually but more commonly occur as a combination of two or more loads applied simultaneously. Design requirements for bridge loads and loading combinations are given in *AASHTO Standard Specifications for Highway Bridges* (AASHTO).³ AASHTO loads are based on many years of experience and are the minimum loads required for design; however, the designer must determine which loads are likely to occur and the magnitudes and combinations of loads that produce maximum stress.

This chapter discusses AASHTO load fundamentals as they relate to timber bridges. Methods and requirements for determining the magnitude and application of individual loads are presented first, followed by discussions on loading combinations and group loads. Additional information on load application and distribution related to specific bridge types is given in succeeding chapters on design.

6.2 DEAD LOAD

Dead load is the permanent weight of all structural and nonstructural components of a bridge, including the roadway, sidewalks, railing, utility lines, and other attached equipment. It also includes the weight of components that will be added in the future, such as wearing surface overlays. Dead loads are of constant magnitude and are based on material unit weights given by AASHTO (Table 6-1). Note that the minimum design dead load for timber is 50 lb/ft³ for treated or untreated material.

Dead loads are commonly assumed to be uniformly distributed along the length of a structural element (beam, deck panel, and so forth). The load sustained by any member includes its own weight and the weight of the components it supports. In the initial stages of bridge design, dead load is unknown and must be estimated by the designer. Reasonable estimates may be obtained by referring to similar types of structures or by using empirical formulas. As design progresses, members are proportioned and dead loads are revised. When these revised loads differ significantly from estimated values, the analysis must be repeated. Several revision cycles

Table 6-1. - Material dead load unit weights.

Material	Dead load (lb/ft ³)
Timber (treated or untreated)	50
Steel of cast steel	490
Cast iron	450
Aluminum alloys	175
Concrete (plain or reinforced)	150
Pavement, other than wood block	150
Macadam or rolled gravel	140
Compacted sand, earth, gravel, or ballast	120
Loose sand, earth, and gravel	00
Cinder filling	60
Stone masonry	70

From AASHTO³ 3.3.6; © 1983. Used by permission.

may be required before arriving at a final design. It is often best to compute the final dead load of one portion of the structure before designing its supporting members.

6.3 VEHICLE LIVE LOAD

Vehicle live load is the weight of the vehicles that cross the bridge. Each of these vehicles consists of a series of moving concentrated loads that vary in magnitude and spacing. As the loads move, they generate changing moments, shears, and reactions in the structural members. The extent of these forces depends on the number, weight, spacing, and position of the loads on the span. The designer must position vehicle live loads to produce the maximum effect for each stress. Once the locations for maximum stress are found, other positions result in lower stress and are no longer considered.

TERMINOLOGY

Vehicle live loads are generally depicted in diagrams that resemble trucks or other specialized vehicles. The terms used to describe these loads are defined below and shown in Figure 6-1.

Gross vehicle weight (GVW) is the maximum total weight of a vehicle.

Axle load is the total weight transferred through one axle.

Axle spacing is the center-to-center distance between vehicle axles. Axle spacing may be fixed or variable.

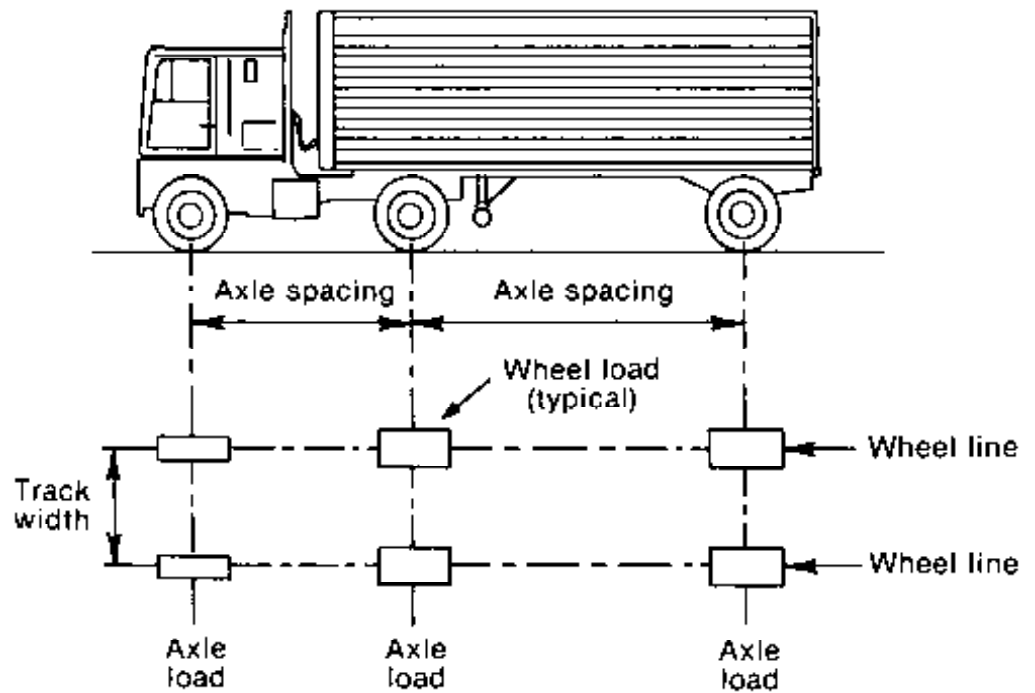

Figure 6-1. - Typical diagrams and terms for describing vehicle live loads used for bridge design.

Wheel load is one-half the axle load. Wheel loads for dual wheels are given as the combined weight of both wheels.

Wheel line is the series of wheel loads measured along the vehicle length. The total weight of one wheel line is equal to one-half the GVW.

Track width is the center-to-center distance between wheel lines.

STANDARD VEHICLE LOADS

AASHTO specifications provide two systems of standard vehicle loads, H loads and HS loads. Each system consists of individual truck loads and lane loads. Lane loads are intended to be equivalent in weight to a series of vehicles (discussed in the following paragraphs). The type of loading used for design, whether truck load or lane load, is that producing the highest stress. It should be noted that bridges are designed for the stresses and deflection produced by a standard highway loading, not necessarily the individual vehicles. The design loads are hypothetical and are intended to resemble a type of loading rather than a specific vehicle. Actual stresses produced by vehicles crossing the structure should not exceed those produced by the hypothetical design vehicles.

Truck Loads

There are currently two classes of truck loads for each standard loading system (Figure 6-2). The H system consists of loading H 15-44 and loading H 20-44. These loads represent a two-axle truck and are designated by the letter H followed by a number indicating the GVW in tons.

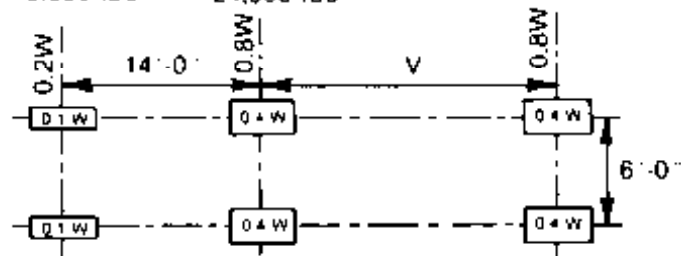
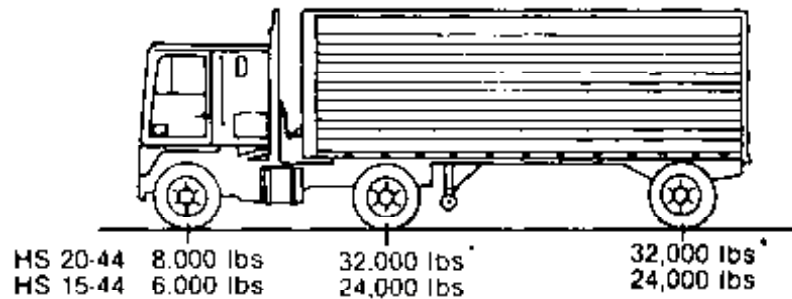
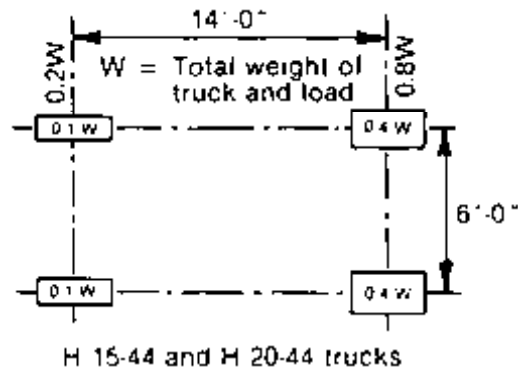
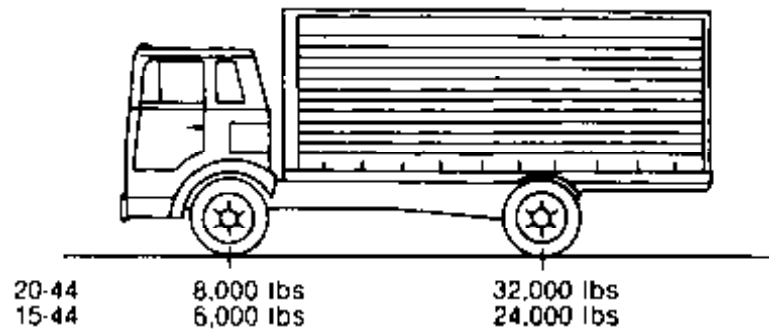

W = Combined weight on the first two axles which is the same as for the corresponding H (M) truck.
V = Variable spacing—14 feet to 30 feet inclusive. Spacing to be used is that which produces maximum stresses.

HS 15-44 and HS 20-44 trucks

*In the design of timber floors and orthotropic steel decks (excluding transverse beams) for H 20 and HS 20 loading, one axle load of 24,000 pounds or two axle loads of 16,000 pounds each spaced 4 feet apart may be used, whichever produces the greater stress, instead of the 32,000 pound axle shown.

Figure 6-2. - Standard AASHTO truck loads (from AASHTO³ Figures 3.7.6A and 3.7.7A; © 1983. Used by permission).

The load designations also include a “-44” suffix to indicate the year that the load was adopted by AASHTO (1944). The weight of an H truck is assumed to be distributed two-tenths to the front axle and eight-tenths to the rear axle. Axle spacing is fixed at 14 feet and track width at 6 feet.

Truck loads for the HS system consist of loadings HS 15-44 and HS 20-44. These loads represent a two-axle tractor truck with a one-axle semitrailer and are designated by the letters HS, followed by a number indicating the gross weight in tons of the tractor truck. The configuration and weight of the HS tractor truck is identical to the corresponding H load. The additional semitrailer axle is equal in weight to the rear tractor truck axle and is spaced at a variable distance of 14 to 30 feet. The axle spacing used for design is that producing the maximum stress.

When H 20-44 and HS 20-44 loads are used for timber deck (floor) design, a modified form of standard loading is permitted by AASHTO. Instead of the 32,000-pound axle load specified for the standard trucks, one-axle loads of 24,000 pounds or two-axle loads of 16,000 pounds each, spaced 4 feet apart, may be used (AASHTO³ Figures 3.7.6A and 3.7.7A). Of the two options, the loading that produces the maximum stress is used design. These modified loads apply to the design of most timber decks, but do not apply to transverse beams, such as floorbeams (Chapter 8).

Lane Loads

Lane loads were adopted by AASHTO in 1944 to provide a simpler method of calculating moments and shears. These loads are intended to represent a line of medium-weight traffic with a heavy truck positioned somewhere in the line. Lane loads consist of a uniform load per linear foot of lane combined with a single moving concentrated load, positioned to produce the maximum stress (for continuous spans, two concentrated loads -- one placed in each of two adjoining spans -- are used to determine maximum negative moment). Both the uniform load and the concentrated loads are assumed to be transversely distributed over a 10-foot width.

AASHTO specifications currently include two classes of lane loads: one for H 20-44 and HS 20-44 loadings and one for H 15-44 and HS 15-44 loadings (Figure 6-3). The uniform load per linear foot of lane is equal to 0.016 times the GWV for H trucks or 0.016 times the weight of the tractor truck for HS trucks. The magnitude of the concentrated loads for shear and moment are 0.65 and 0.45 times those loads, respectively.

Modification to Standard Loads

There may be instances when the standard vehicle loads do not accurately represent the design loading required for a bridge. In such cases, AASHTO permits deviation from the standard loads provided they are obtained by proportionately changing the weights for both the standard truck and corresponding lane loads (AASHTO 3.7.2). The weights of the standard loads are increased or decreased, but the configuration and other requirements remain unchanged.

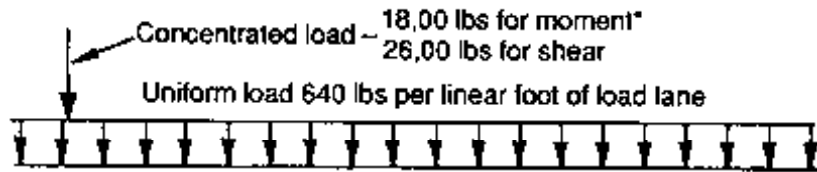

H 20-44 and HS 20-44 loading

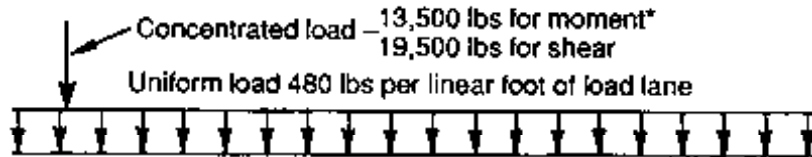

H 15-44 and HS 15-44 loading

*For computing maximum negative moment on continuous spans, two concentrated loads are used; one in each of two adjoining spans

Figure 6-3. - Standard AASHTO lane loads (from AASHTO³ Figure 3.7.6B; © 1983. Used by permission).

Example 6-1 - Modified loading for standard AASHTO loads

Determine the AASHTO truck and lane loads for H 10-44 and HS 25-44 loadings.

Solution

H 10-44 Loading

The GVW of an H 10-44 truck load is 10 tons, or 20,000 pounds. From Figure 6-2, the GVW is distributed 20 percent to the front axle and 80 percent to the rear axle:

$$\text{Front axle load} = 0.20(\text{GVW}) = 0.20(20,000) = 4,000 \text{ lb}$$

$$\text{Rear axle load} = 0.80(\text{GVW}) = \mathbf{0.80(20,000) = 16,000 \text{ lb}}$$

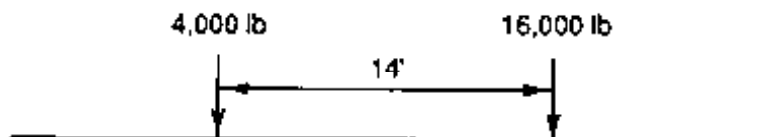

For lane loading, the uniform load is 0.016 times the GVW:

$$\text{Uniform lane load} = 0.016(\text{GVW}) = 0.016(20,000) = 320 \text{ lb/ft}$$

Concentrated loads for moment and shear are 0.45 and 0.65 times the GVW, respectively:

$$\text{Concentrated load for moment} = 0.45(\text{GVW}) = 0.45(20,000) = 9,000 \text{ lb}$$

$$\text{Concentrated load for shear} = 0.65(\text{GVW}) = 0.65(20,000) = 13,000 \text{ lb}$$

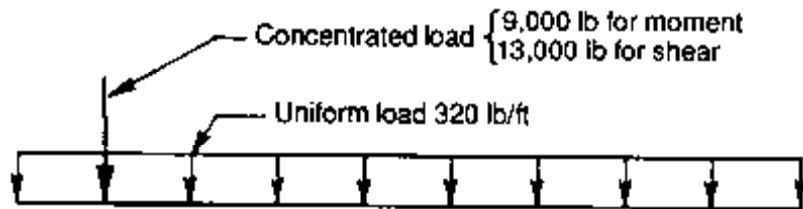

HS 25-44 Loading

For an HS 25-44 truck load, the weight of the tractor truck is 25 tons, or 50,000 pounds. From Figure 6-2, the weight is distributed 20 percent to the front axle and 80 percent each to the rear tractor truck axle and semi-trailer axle:

$$\text{Front axle load} = 0.20(50,000) = 10,000 \text{ lb}$$

$$\text{Rear tractor and semitrailer axle loads} = 0.80(50,000) = 40,000 \text{ lb}$$

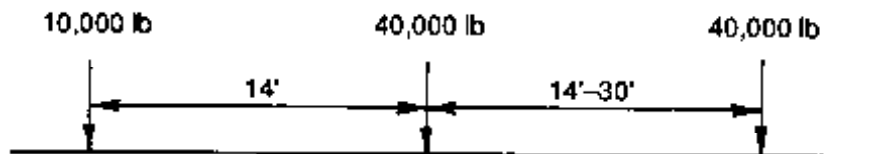

For lane loading, the uniform load is 0.016 times the weight of the tractor truck:

$$\text{Uniform lane load} = 0.016(50,000) = 800 \text{ lb/ft}$$

Concentrated loads for moment and shear are 0.45 and 0.65 times the weight of the tractor truck:

Concentrated load for moment = $0.45(50,000) = 22,500$ lb

Concentrated load for shear = $0.65(50,000) = 32,500$ lb

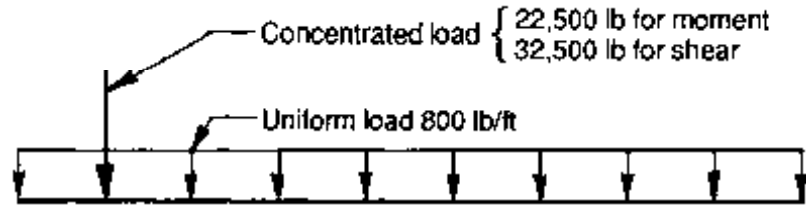

Alternate Military Loading

In addition to the standard loading systems, AASHTO also specifies an alternate military loading (AASHTO 3.7.4) that is used in some design applications discussed later in this section. This hypothetical loading consists of two 24,000-pound axles spaced 4 feet apart (Figure 6-4). There is no lane load for the alternate military loading.

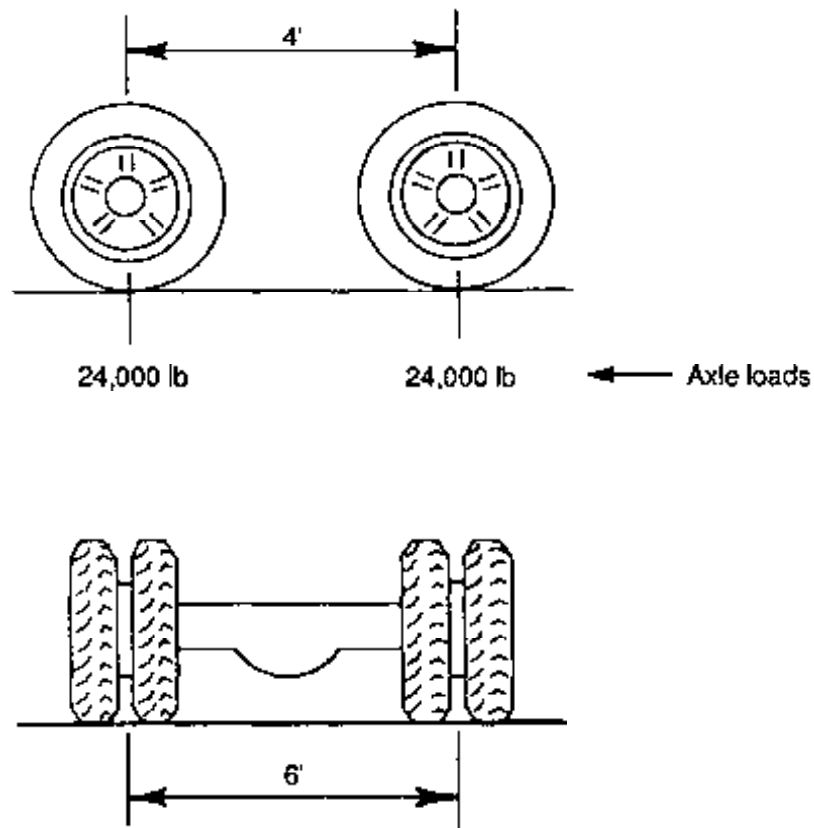
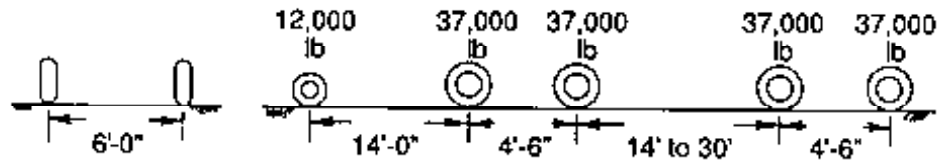

Figure 6-4. - AASHTO alternate military loading.

Overloads

An overload or permit load is a design vehicle that represents the maximum load a structure can safely support. It is generally a specialized vehicle that is not part of the normal traffic mix but must occasionally cross the structure. Although there are no standardized AASHTO overloads, many States and agencies have adopted standard vehicle overloads to meet the use requirements of their jurisdictions. Three of the overloads commonly used by the Forest Service are shown in Figure 6-5. In most cases, overloads are controlled or restricted from crossing bridges without a special permit.

U80 truck – GVW = 80 tons (Axle loads are shown)



U102 truck – GVW = 102.5 tons (Axle loads are shown)

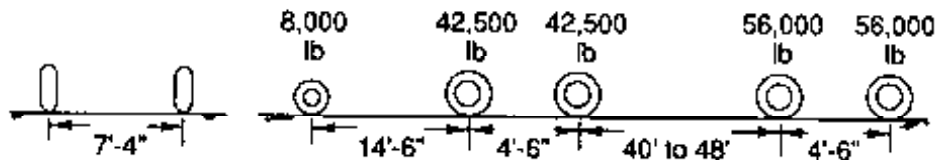

L90 tracked loader – GVW = 90 tons

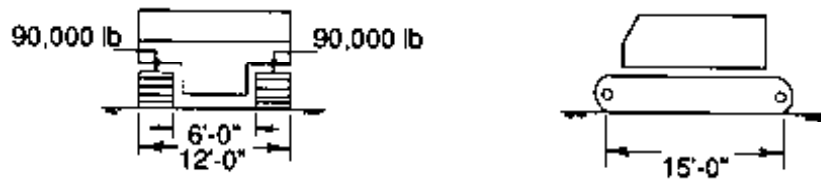

Figure 6-5. - Overload vehicles used by the USDA Forest Service.

APPLICATION OF VEHICLE LIVE LOAD

Vehicle live loads are applied to bridges to produce the maximum stress in structural components. The designer must determine the type of design loading and overload (when required), compute the absolute maximum vehicle forces (moment, shear, reactions, and so forth), and distribute those forces to the individual structural components. The first two topics are discussed in the remainder of this section. Load distribution to specific components depends on the configuration and type of structure; it is addressed in subsequent chapters on design.

Design Loading

Vehicle live loads used for design vary for different locations and are established by the agency having jurisdiction for traffic regulation and

control. Bridges that support highway traffic are designed for heavy truck loads (HS 20-44 or HS 25-44). On secondary and local roads, a lesser loading may be appropriate. To provide a minimum level of safety, AASHTO specifications give the following minimum requirements for bridge loading:

1. Bridges that support interstate highways or other highways that carry or may carry heavy truck traffic are designed for HS 20-44 loading or the alternate military loading, whichever produces the maximum stress (AASHTO 3.7.4).
2. Bridges designed for less than H 20-44 loading also must be designed to support an infrequent heavy overload equal to twice the weight of the design vehicle. This increased load is applied in one lane, without concurrent loading in any other lane. The overload applies to the design of all affected components of the structure, except the deck (AASHTO 3.5.1). When an increased loading of this type is used, it is applied in AASHTO Load Group IA, and a 50-percent increase in design stress permitted by AASHTO (see discussions on load groups in Section 6.19).

Traffic Lanes

Vehicle live loads are applied in design traffic lanes that are 12 feet wide, measured normal to the bridge centerline (AASHTO 3.6). The number of traffic lanes depends on the width of the bridge roadway measured between curbs, or between rails when curbs are not used (AASHTO 2.1.2). Fractional parts of design lanes are not permitted; however, for roadway widths from 20 to 24 feet, AASHTO requires two design lanes, each equal to one-half the roadway width (this requirement generally does not apply for single-lane, low-volume bridges that require additional width for curve widening). For all other widths, the number of traffic lanes is equal to the number of full 12-foot lanes that will fit the roadway width.

Each traffic lane is loaded with one standard truck or one lane load, regardless of the bridge length or number of spans. The standard loads occupy a 10-foot width within the lane and are considered as a unit (Figure 6-6). Fractional parts of either type of load are not allowed. Traffic lanes and the vehicle loads within the lanes are positioned laterally on the bridge to produce the maximum stress in the member being designed, but traffic lanes cannot overlap. In the outside lanes, the load position in relation to the nearest face of the rail or curb depends on the type of component being designed. For deck design, the center of the wheel line is placed 1 foot from the railing or curb. For the design of supporting beams and other components, the center of the wheel line is placed 2 feet from the rail or curb. Vehicle positioning in traffic lanes is discussed in more detail in subsequent chapters on bridge design.

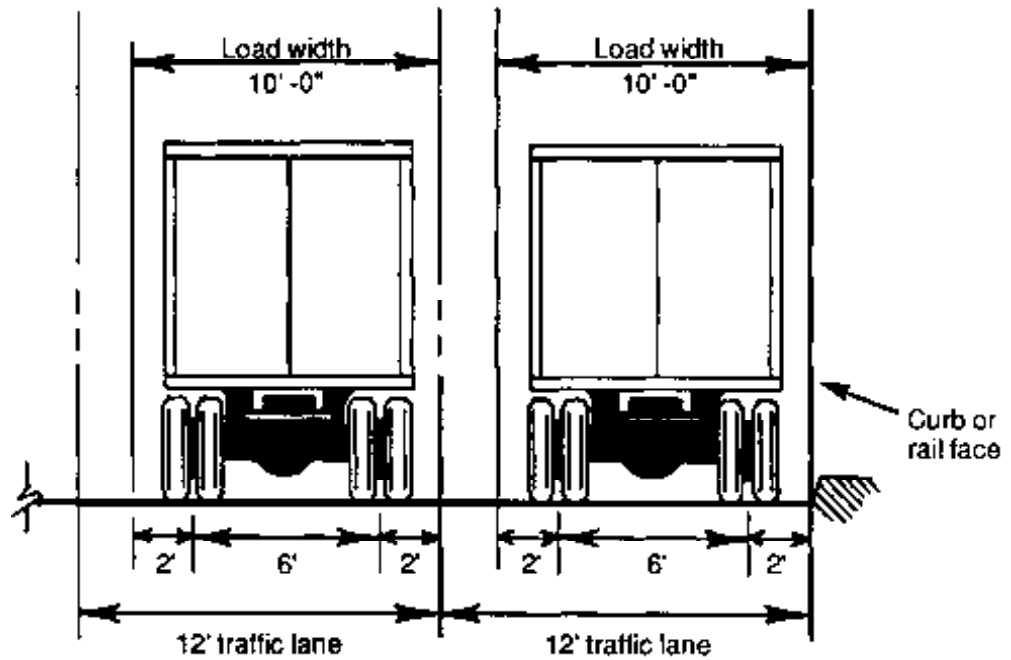

For deck design, the center of the wheel line is assumed to be positioned 1 foot from the nearest face of the curb or rail

Figure 6-6. - AASHTO traffic lanes. The 10-foot truck width is positioned laterally within the 12-foot traffic lane to produce the maximum stress in the component being designed.

Maximum Forces on Simple Spans

Maximum forces from vehicle live loads on simple spans depend on the position of the loads on the span. For lane loads, these positions are well defined and apply to all span lengths. For truck loads, general load positions are defined; however, the specific combination of wheel loads that produces the maximum forces may vary for different span lengths. When the span is less than or equal to the vehicle length (in some cases slightly greater than the vehicle length), the group of wheel loads that produces the maximum force must be determined by the designer. Some trial and error may be required when short spans are loaded with long vehicles with many axles. For truck loads with variable axle spacing, for example, the HS 15-44 and HS 20-44 loads, the minimum axle spacing always produces the maximum forces on simple spans.

General procedures for determining maximum vehicle live load forces on simple spans are discussed below and shown in Examples 6-2 and 6-3. Tables for computing maximum moment, vertical shear, and end reactions for standard truck and lane loads and selected overloads are given in Chapter 16. For additional information, refer to references listed at the end of this chapter.^{18,24}

Maximum Moment

In most cases, the maximum moment on a simple span from a series of moving wheel loads occurs under the wheel load nearest the resultant (R)

of all loads when the resultant is the same distance on one side of the span centerline as the wheel load nearest the resultant is on the other side.

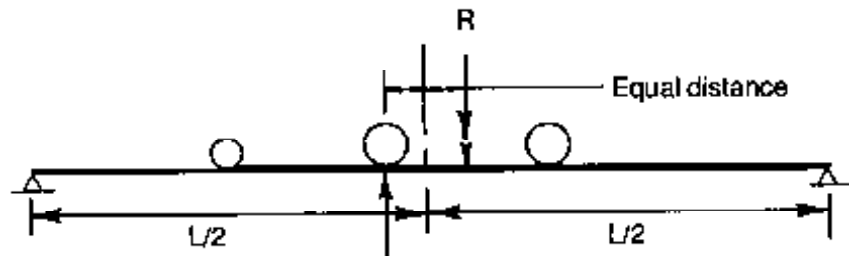

For lane loads, the maximum moment on a simple span occurs at the span centerline when the uniform load (w) is continuous over the span length and the concentrated load for moment (P_M) is positioned at the span centerline.

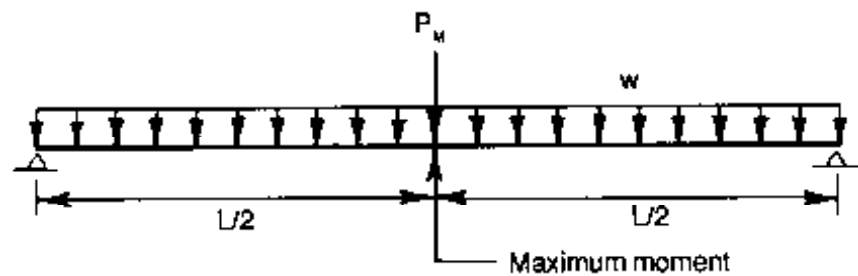

Maximum simple span moments for AASHTO vehicle loads are shown graphically in Figure 6-7. Truck loads control for simple spans less than 56.7 feet for H loads and 144.8 feet for HS loads (the alternate military loading controls over the HS 20-44 load on spans less than 41.3 feet). On longer spans, lane loads control.

Maximum Vertical Shear and End Reactions

The maximum vertical shear and end reactions for wheel loads on a simple span occur under the wheel over the support when the heaviest wheel (generally the rear wheel) is positioned at the support, with the remaining wheel loads on the span.

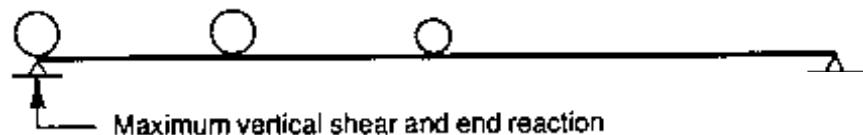

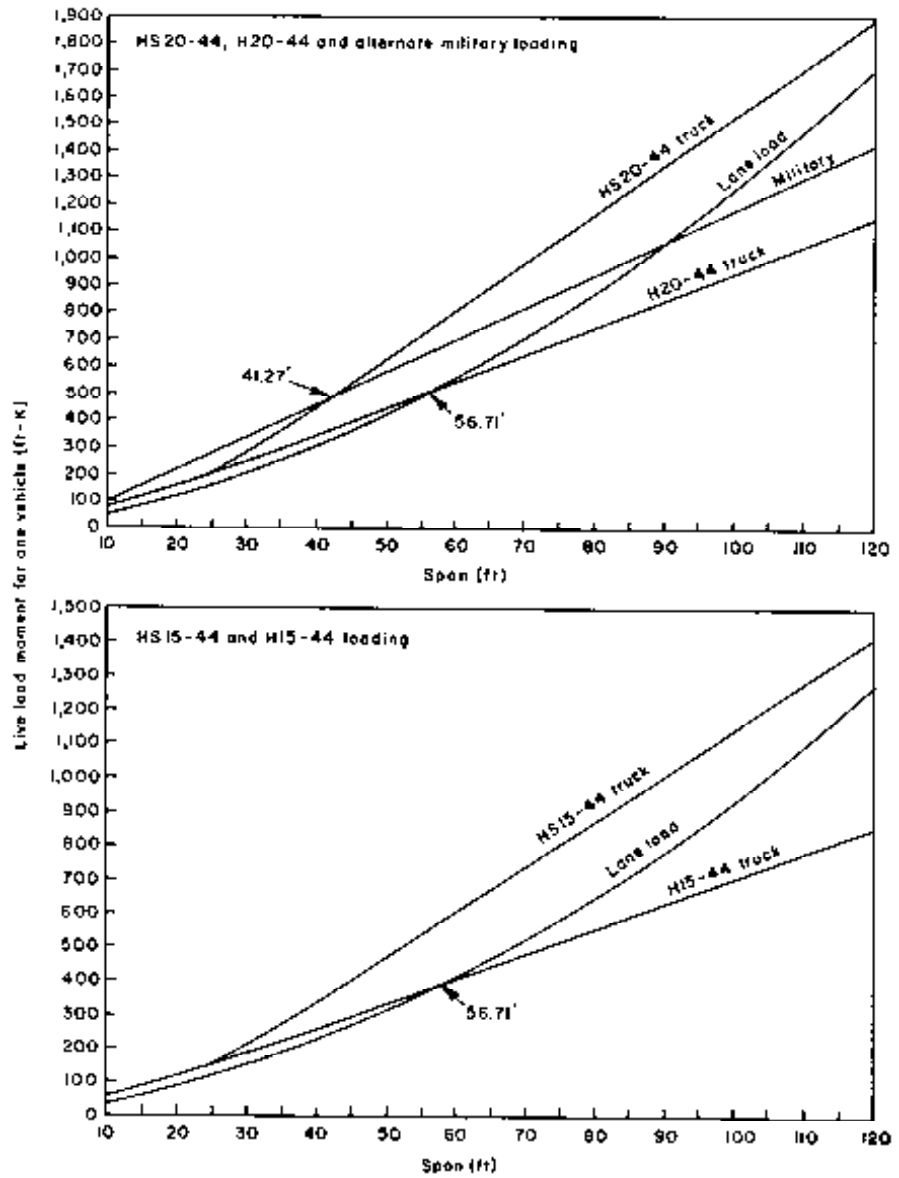
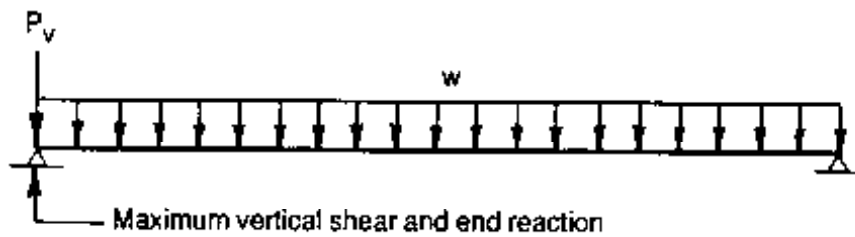

Figure 6-7. - Maximum moment on a simple span from one traffic lane of standard AASHTO vehicle loading.

The absolute maximum vertical shear and end reaction for lane loads occur when the uniform load is continuous and the concentrated load for shear (P_v) is positioned over the support.



Maximum end reactions computed by these procedures are based on the bridge span measured center to center of bearings and are commonly tabulated in bridge design specifications and handbooks. Although they are technically correct for point bearing at span ends only, they do provide a very close approximation of the actual reaction for short bearing lengths. For very long bearing lengths, reactions should be computed based on the out-to-out span length with loads placed at the span end.

Maximum vertical shear and end reactions produced by AASHTO loads are shown graphically in Figure 6-8. Truck loads control maximum vertical shear and end reactions for simple spans less than 33.2 feet for H loads and 127.3 feet for HS loads (alternate military loading controls over HS 20-44 loading on spans less than 22 feet). On longer spans, lane loads control.

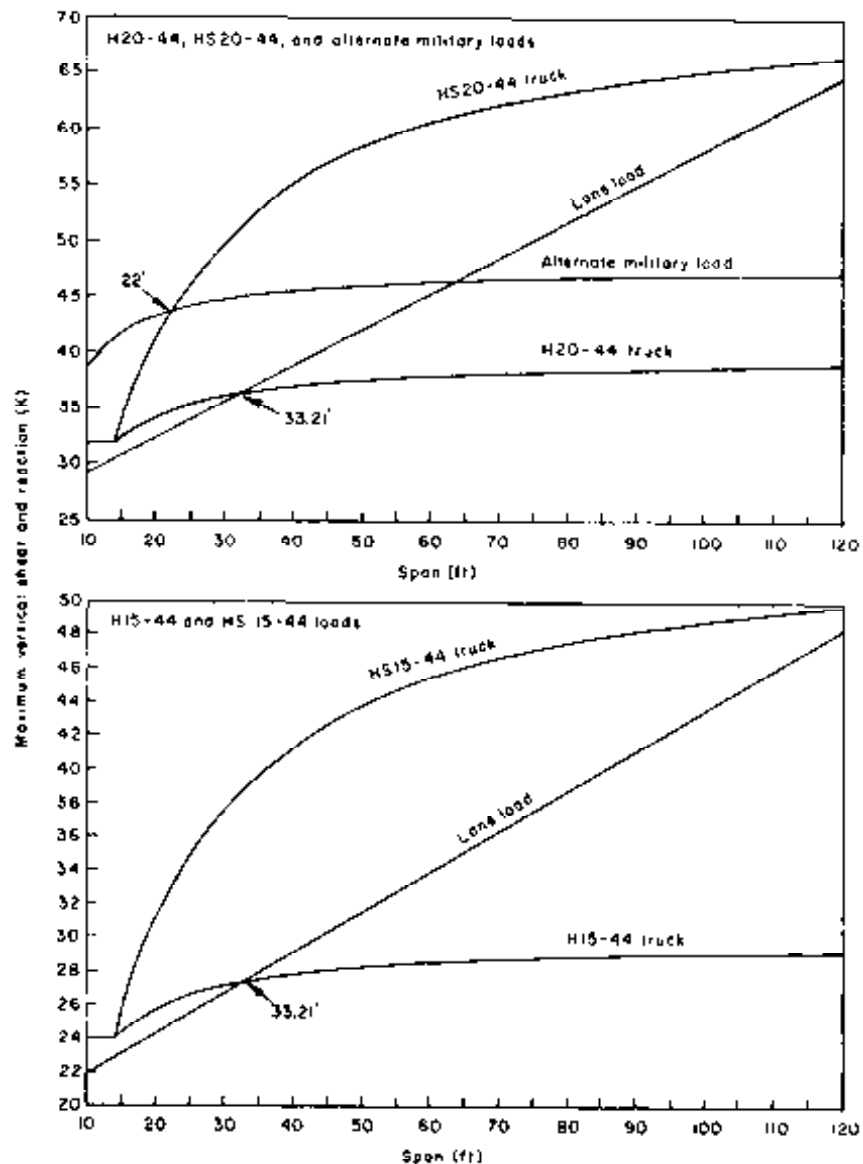
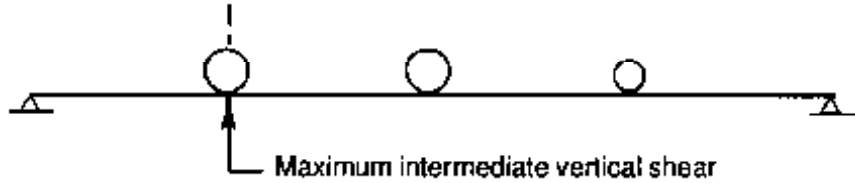

Figure 6-8. —Maximum vertical shear and end reactions on a simple span from one traffic lane of standard AASHTO vehicle loading.

Maximum Intermediate Vertical Shear

The maximum vertical shear at an intermediate point on a simple span is computed by positioning the loads to produce the maximum reaction at the support nearest the point. For truck loads, this generally occurs when the heaviest (rear) wheel load is placed over the point and no wheel loads occur on the shortest span segment between the point and the support.



The maximum intermediate vertical shear for lane loads is produced by using a discontinuous uniform load with the concentrated load for shear (P_v) positioned at the point where shear is computed.

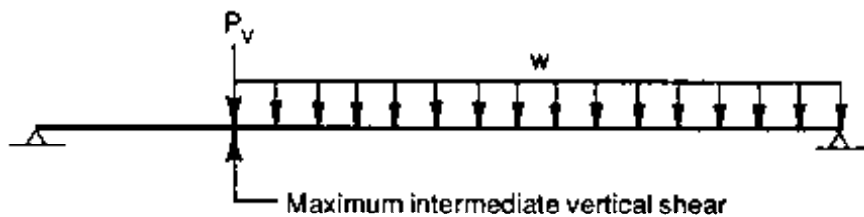

Example 6-2 - Maximum vehicle forces on a simple span; H 15-44 loading

For one lane of H 15-44 loading on a 62-foot simple span, determine the (1) maximum moment, (2) maximum reactions, and (3) maximum vertical shear at a distance 10 feet from the supports.

Solution

From Figure 6-2, the H 15-44 truck load consists of one 6,000-pound axle and one 24,000-pound axle with an axle spacing of 14 feet:

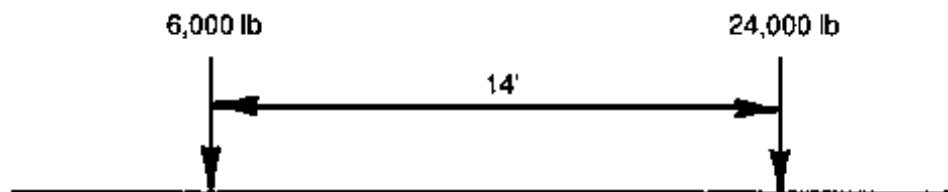

From Figure 6-3, H 15-44 lane loading consists of a uniform load of 480 lb/ft and a concentrated load of 13,500 pounds for moment and 19,500 pounds for shear.

Maximum Moment

Maximum moment from truck loading will be computed first. The distance (x) of the load resultant from the 24,000-pound axle is determined

by summing moments about the 24,000-pound axle and dividing by the gross vehicle weight:

$$x = \frac{(14 \text{ ft})(6,000 \text{ lb})}{(6,000 \text{ lb} + 24,000 \text{ lb})} = 2.8 \text{ ft}$$

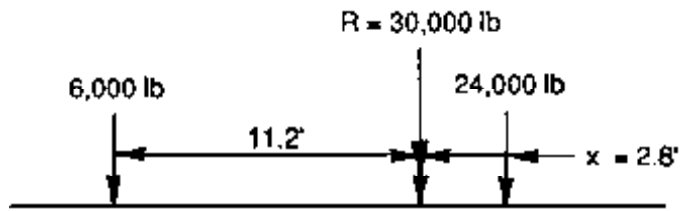

Maximum moment occurs under the 24,000-pound axle when the span centerline bisects the distance between the load resultant and the axle load:

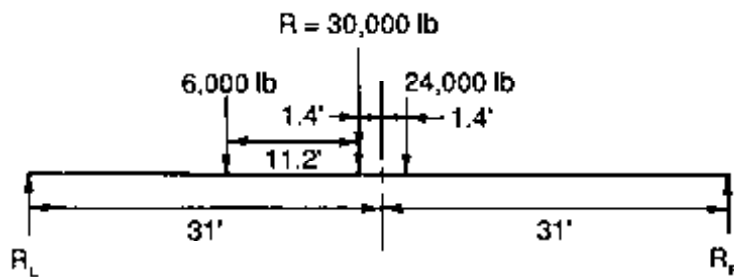

$$R_R = \frac{(30,000 \text{ lb})(31 \text{ ft} - 1.4 \text{ ft})}{62 \text{ ft}} = 14,322 \text{ lb}$$

$$M_{MAX} = (14,322 \text{ lb})(31 \text{ ft} - 1.4 \text{ ft}) = 423,931 \text{ ft-lb}$$

For lane loading, the concentrated load for moment is positioned at the span centerline:

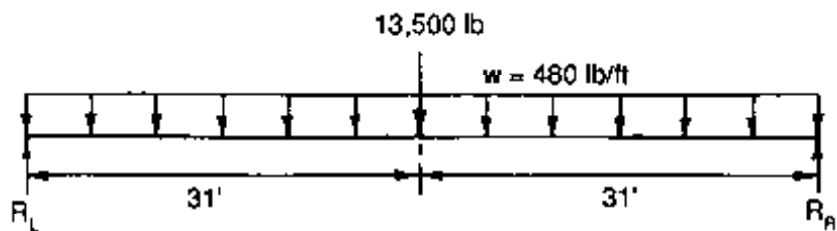

$$M_{MAX} = \frac{wL^2}{8} + \frac{PL}{4} = \frac{480(62)^2}{8} + \frac{13,500(62)}{4} = 439,890 \text{ ft-lb}$$

439,890 ft-lb > 423,931 ft-lb, so lane loading produces maximum moment.

Maximum Reactions

For truck loading, the maximum reaction is obtained by positioning the 24,000-pound axle over the support:

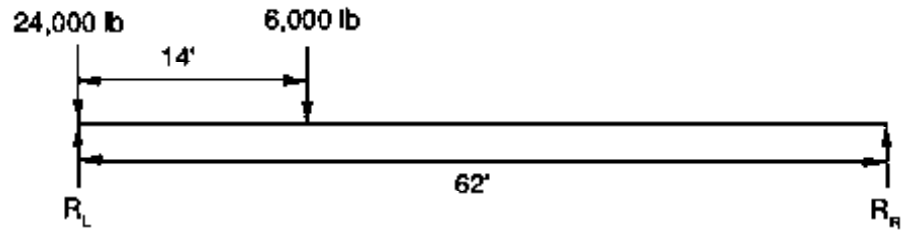

$$R_{MAX} = R_L = \frac{(6,000 \text{ lb})(62 \text{ ft} - 14 \text{ ft}) + (24,000 \text{ lb})(62 \text{ ft})}{62 \text{ ft}} = 28,645 \text{ lb}$$

For lane loading, the maximum reaction is obtained by placing the concentrated load for shear over the support:

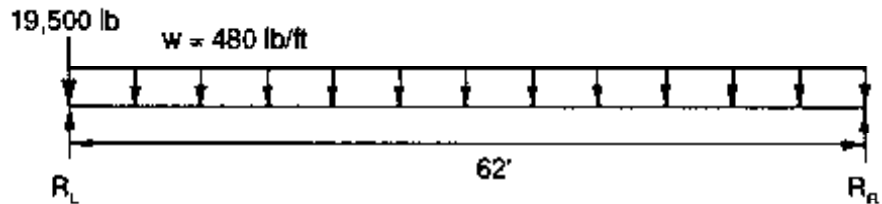

$$R_{MAX} = R_L = \frac{(480 \text{ lb/ft})(62 \text{ ft})}{2 \text{ ft}} + 19,500 \text{ lb} = 34,380 \text{ lb}$$

34,380 lb > 28,645 lb, so lane loading also produces the maximum reaction.

Maximum Vertical Shear 10 feet from the Support

For truck loading, the maximum vertical shear 10 feet from the support is obtained by positioning the 24,000-pound axle 10 feet from the support:

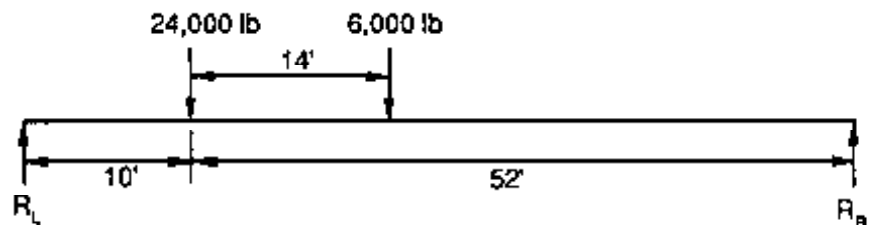

$$V_{MAX} = R_L = \frac{(6,000 \text{ lb})(52 \text{ ft} - 14 \text{ ft}) + (24,000 \text{ lb})(52 \text{ ft})}{62 \text{ ft}} = 23,806 \text{ lb}$$

For lane loading, maximum vertical shear is obtained using a partial uniform load with the concentrated load for shear positioned 10 feet from the support:

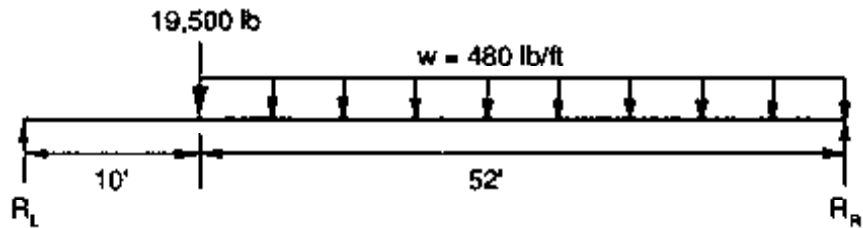

$$V_{MAX} = R_L = \frac{(480 \text{ lb/ft})(52 \text{ ft})(52 \text{ ft}/2) + (19,500 \text{ lb})(52 \text{ ft})}{62} = 26,822 \text{ lb}$$

26,822 lb > 23,806 lb and lane loading again controls maximum loading.

Example 6-3 - Maximum vehicle forces on a simple span; HS 20-44 loading

Determine the absolute maximum moment and reactions for one lane of HS 20-44 loading on a 23-foot simple span.

Solution

From Figure 6-2, the HS 20-44 truck load consists of one 8,000-pound axle and two 32,000-pound axles with a variable axle spacing of 14 to 30 feet. For this simple span application, the minimum axle spacing of 14 feet produces maximum forces:

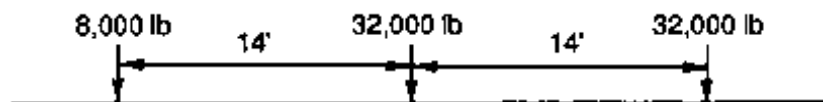

From Figure 6-3, HS 20-44 lane loading consists of a uniform load of 640 lb/ft and a concentrated load of 18,000 pounds for moment and 26,000 pounds for shear.

Maximum Moment

The span length of 23 feet is less than the vehicle length, so the maximum moment from truck loading will be produced by a partial vehicle configuration. For the two 32,000-pound axles,

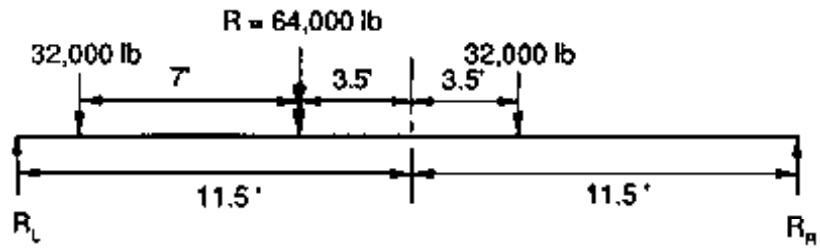

$$R_R = \frac{(64,000 \text{ lb})(11.5 \text{ ft} - 3.5 \text{ ft})}{23 \text{ ft}} = 22,261 \text{ lb}$$

$$M_{MAX} = (22,261 \text{ lb})(11.5 \text{ ft} - 3.5 \text{ ft}) = 178,088 \text{ ft}\cdot\text{lb}$$

For a single 32,000-pound axle at the span centerline,

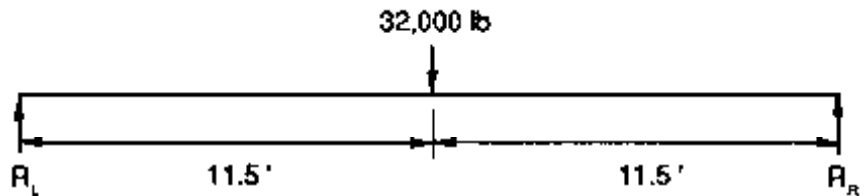

$$R_R = \frac{32,000 \text{ lb}}{2} = 16,000 \text{ lb}$$

$$M_{MAX} = (11.5 \text{ ft})(16,000 \text{ lb}) = 184,000 \text{ ft}\cdot\text{lb}$$

In this case, maximum moment is controlled by a single axle at the span centerline, rather than by both axles positioned for maximum moment. This usually occurs when one axle is located close to a support. For HS truck loads, the single axle configuration will control maximum moment for spans up to approximately 23.9 feet.

For lane loading, maximum moment is produced when the concentrated load for moment is positioned at the span centerline:

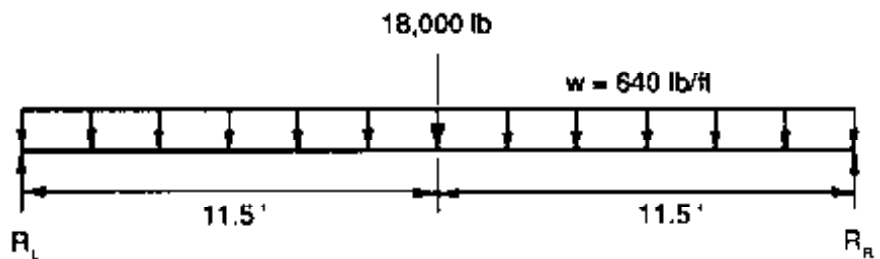

$$M_{MAX} = \frac{wL^2}{8} + \frac{PL}{4} = \frac{640(23)^2}{8} + \frac{18,000(23)}{4} = 145,820 \text{ ft-lb}$$

The maximum moment of 184,000 ft-lb is produced by truck loading with a single 32,000-pound axle positioned at the span centerline.

Maximum Reaction

For truck loading, the maximum reaction is obtained by positioning the rear 32,000-pound axle over the support (the front axle is off the span):

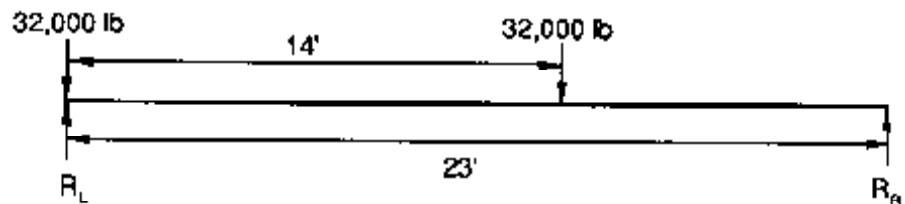

$$R_{MAX} = R_L = \frac{(32,000 \text{ lb})(23 \text{ ft} - 14 \text{ ft}) + (32,000 \text{ lb})(23 \text{ ft})}{23 \text{ ft}} = 44,522 \text{ lb}$$

For lane loading, the concentrated load for shear is placed over the support:

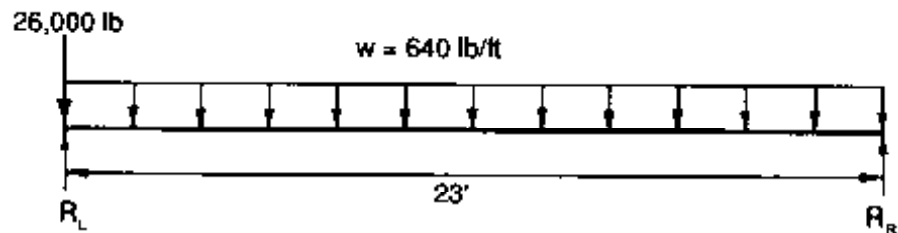

$$R_{MAX} = R_L = \frac{(640 \text{ lb/ft})(23 \text{ ft})}{2} + 26,000 \text{ lb} = 33,360 \text{ lb}$$

44,522 lb > 33,360 lb, so truck loading also produces the maximum reaction.

Maximum Forces on Continuous Spans

Maximum vehicle live load forces on continuous spans depend on the number, length, and stiffness of individual spans. In contrast to the case of simple spans, for continuous spans the designer must consider both positive and negative moments, as well as shear and reactions at several locations. Load positions are not well defined, and it is not always obvious how the loads should be placed. Historically, load positions have been determined by using influence diagrams or through trial and error. In recent years, inexpensive microcomputer programs have become the primary tool for determining maximum force envelopes. A detailed dis-

ussion of influence diagrams and other methods is beyond the scope of this chapter. For additional information, refer to references at the end of this chapter or other structural analysis publications.

Reduction in Load Intensity

The probability of the maximum vehicle live load occurring simultaneously in all traffic lanes of a multiple-lane structure decreases as the number of lanes increases. This is recognized in AASHTO specifications, and a reduction in vehicle live load is allowed in some cases (AASHTO 3.12.1). When the maximum stresses are produced in any member by loading a number of traffic lanes simultaneously, the percentages of the live loads given in Table 6-2 are used for design.

Table 6-2. - Reduction in load intensity for simultaneous lane loading.

Number of traffic lanes loaded simultaneously	Percent of vehicle live load used for design
One or two lanes	100
Three lanes	90
Four or more lanes	75

From AASHTO³ 3.12.1; © 1983. Used by permission.

6.4 DYNAMIC EFFECT (IMPACT)

A moving vehicle produces stresses in bridge members that are greater than those produced by the same loads applied statically. This increase in stress is from dynamic effects resulting from (1) the force of the vehicle striking imperfections in the roadway, (2) the effects of sudden loading, and (3) the vibrations of the vehicle or bridge-vehicle system. In bridge design, the word *impact* is used to denote the incremental stress increase from moving vehicle loads. In most contexts, impact denotes one body striking another. However, in bridge design, it refers to the total dynamic effect of moving loads.

AASHTO specifications require that an allowance for impact be included in the design of some structures. This allowance is expressed as an impact factor and is computed as a percentage increase in vehicle live load stress. Because of timber's ability to absorb shock and loads of short duration, AASHTO does not require an impact factor for timber bridges (AASHTO 3.8.1). However, when main components are made of steel or concrete, the impact factor may apply to the design of that member. Refer to AASHTO specifications for requirements related to application of the impact factor for materials other than timber.

6.5 LONGITUDINAL FORCE

Longitudinal forces develop in bridges when crossing vehicles accelerate or brake. These forces are caused by the change in vehicle momentum and are transmitted by the tires to the bridge deck. The magnitude of the longitudinal force depends on the vehicle weight, the rate of acceleration or deceleration, and the coefficient of friction between the tires and the deck surface. The most severe loading is produced by a braking truck and is computed, using physics, by

$$F_L = \mu \left(\frac{W}{g} \frac{dV}{dT} \right) \quad (6-1)$$

where F_L = the longitudinal force transferred to the bridge (lb),

W = the weight of the vehicle (lb),

g = the acceleration due to gravity (32.2 ft/sec²),

dV = the change in vehicle velocity (ft/sec),

dT = the time required for velocity change (sec), and

μ = the friction factor of the tires on the bridge deck.

The magnitude of the longitudinal force given by Equation 6.1 can vary substantially, depending on the physical condition of the vehicle and deck surface. The friction factor, μ , is a function of vehicle velocity and varies from 0.01 to 0.90, depending on the air pressure and type of tires, amount of tire tread, and roadway conditions. Additionally, and perhaps of more significance, is the rate of vehicle deceleration, dV/dT . In stops from high speeds, vehicle deceleration depends more on the condition of the braking system than on the friction between the tires and the roadway.

In view of the variables affecting the actual longitudinal force F_L , AASHTO specifies an approximate longitudinal force LF based on vehicle loads (AASHTO 3.9.1). A longitudinal force equal to 5 percent of the live load is applied in all lanes carrying traffic in the same direction. When a bridge is likely to become one directional in the future, all lanes are loaded. The live load used to compute longitudinal force is the uniform lane load plus the concentrated load for moment. Values of the longitudinal force for one traffic lane are shown in Figure 6-9.

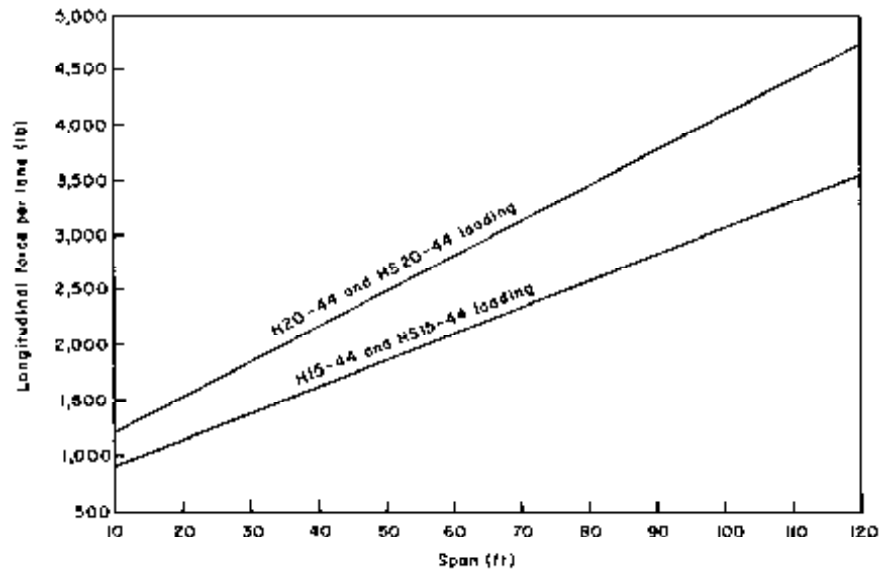

Figure 6-9. - Longitudinal force for one traffic lane of standard AASHTO vehicle loading.

The longitudinal force is applied in the center of the traffic lane at an elevation 6 feet above the bridge deck (Figure 6-10). The force acts horizontally in the direction of traffic and is positioned longitudinally on the span to produce maximum stress. When the maximum stress in any member is produced by loading a number of traffic lanes simultaneously, the longitudinal forces may be reduced for multiple-lane loading as permitted for vehicle live load (Table 6-2).

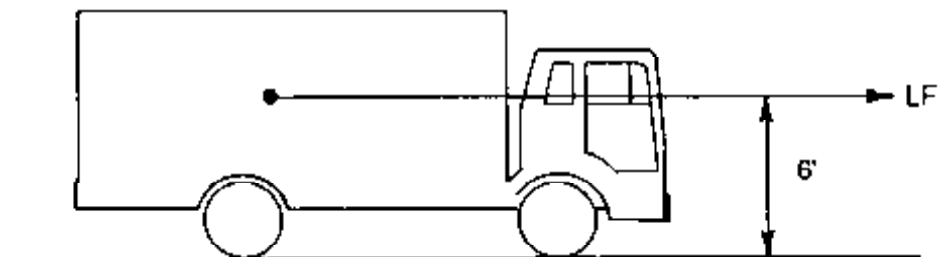

Figure 6-10. - Application of the vehicle longitudinal force.

Longitudinal forces are distributed to the structural elements of a bridge through the deck. For superstructure design, the forces generate shear at the deck interface and produce moments and axial forces in longitudinal beams. Application of the force 6 feet above the deck also produces a longitudinal overturning effect resulting in vertical reactions at bearings. In most cases, longitudinal forces have little effect on timber superstructures, but they may have a substantial effect on the substructure. When substructures consist of bents or piers, the forces produce shear and

moment in supporting members. These forces are most critical at the base of high substructures when longitudinal movement of the superstructure can occur at expansion bearings or joints. Bearings on timber bridges are generally fixed, and members are restrained against longitudinal sidesway. In this case, forces on bents or piers are reduced by load transfer through the superstructure to the abutments.

6.6 CENTRIFUGAL FORCE

When a vehicle moves in a curvilinear path, it produces a centrifugal force that acts perpendicular to the tangent of the path (Figure 6-11). In bridge design, this force must be considered when the bridge is horizontally curved, when a horizontally curved deck is supported by straight beams, or when a straight bridge is used on a curved roadway. Situations of this type are not common for timber bridges, but may occur in some applications (Figure 6-12).

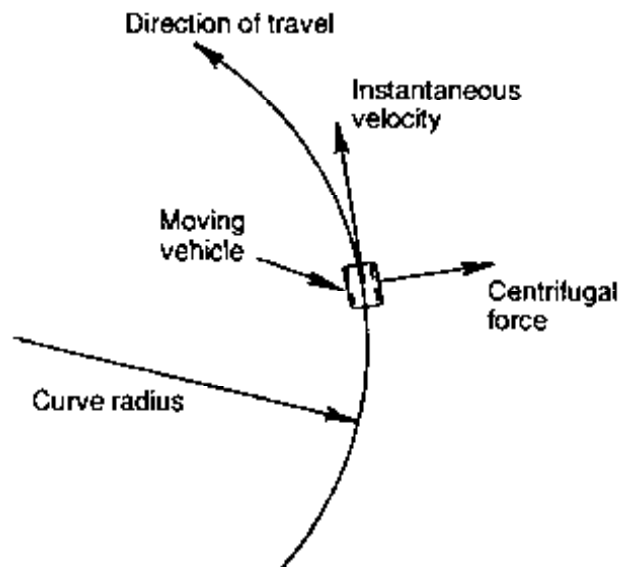

Figure 6-11. - Centrifugal force produced by a vehicle moving on a curved path.

Centrifugal force depends on vehicle weight and velocity as well as the curve radius. Magnitude of the force is given in AASHTO as a percentage of vehicle live load applied in each traffic lane (AASHTO 3.10.1), as given by

$$C = 0.00117S^2 D = \frac{6.68S^2}{R} \quad (6-2)$$

where C = the centrifugal force in percent of live load,

S = the design speed (mph),



Figure 6-12. - A timber bridge with sharply curved approach roadways. Trucks crossing the bridge can produce centrifugal forces that affect the bridge superstructure and substructure.

D = the degree of curve, and

R = the radius of the curve (ft).

The live load used to compute centrifugal force is the vehicle truck load (lane loads are not used). Traffic lanes in both directions are loaded with one truck in each lane, placed in a position to produce the maximum force. The force is applied 6 feet above the centerline of the roadway surface and acts horizontally, away from the curve (Figure 6-13). When roadway superelevation is provided, the centrifugal force is resolved into horizontal and vertical components.

Centrifugal forces are most significant for bridges that have high design speeds and small radii curves, or are supported by substructures with tall columns. For substructure design, centrifugal forces can produce large moments and shears in supporting members, particularly tall piers or columns. Additionally, they generate a transverse overturning effect on the superstructure that results in vertical forces at the reactions. For superstructure design, centrifugal forces produce transverse shear at the deck interface. For longitudinally rigid decks that are adequately attached to supporting beams, these forces are resisted in the plane of the deck and transferred to bearings by transverse bracing. When timber decks are considered, many configurations are not longitudinally rigid, and transverse loads can generate torsion in beams between points of transverse bracing.

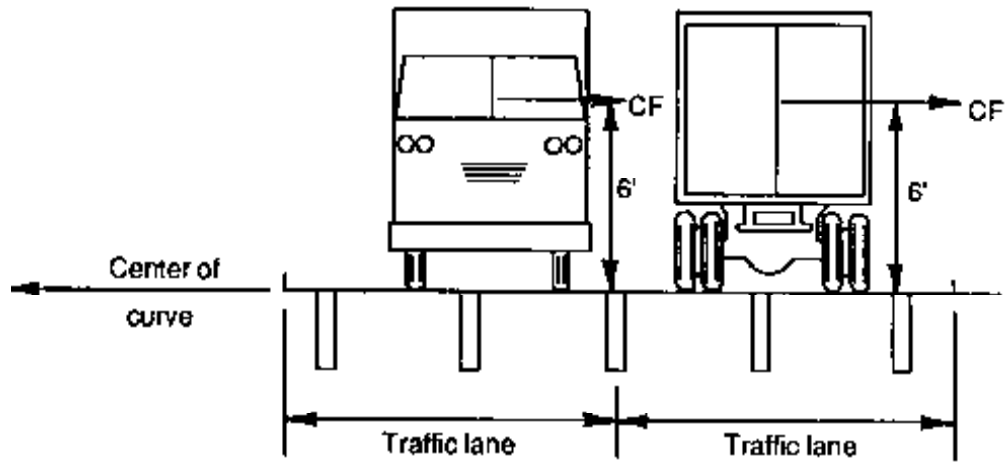

Figure 6-13. - Application of the vehicle centrifugal force.

6.7 WIND LOAD

Wind loads are caused by the pressure of wind acting on the bridge members. They are dynamic loads that depend on such factors as the size and shape of the structure, the velocity and angle of the wind, and the shielding effects of the terrain. For design purposes, AASHTO specifications give wind loads as uniformly distributed static loads. This simplified loading is intended for rigid structures that are not dynamically sensitive to wind; that is, structural design is not controlled by wind loads. With very few exceptions, timber bridges are included in this category. For structures that are highly sensitive to dynamic effects (bridges with long flexible members or suspension bridges), a more detailed analysis is required. Wind-tunnel tests may be appropriate when significant uncertainties about structural behavior exist.

Wind loads are applied to bridges as horizontal loads acting on the superstructure and substructure and as vertical loads acting upward on the deck underside. The magnitude of the loads depends on the component of the structure and the base wind velocity used for design. Wind loads given in AASHTO are based on an assumed base wind velocity of 100 miles per hour (mph) (AASHTO 3.15). In some cases, a lower or higher velocity is permitted when precise local records or permanent terrain features indicate that the 100-mph velocity should be modified. When the base wind velocity is modified, the specified loads are changed in the ratio of the square of the design wind velocity to the square of the 100-mph wind velocity.

SUPERSTRUCTURE LOADS Superstructures are designed for wind loads that are applied directly to the superstructure (W) and/or those that act on the moving vehicle live load (WL). The magnitude of these loads varies for different loading combinations (AASHTO 3.15.1). In general, the full wind load acts directly on the structure when vehicle live loads are not present. When live loads are

present, the wind load on the structure is reduced 70 percent, and an additional wind load acting on the moving vehicle live load is applied simultaneously (see Section 6.19).

Loads Applied Directly to the Superstructure

Wind loads acting directly on the bridge superstructure (W) are applied as uniformly distributed loads over the exposed area of the structure (Figure 6-14). The exposed area is the sum of areas of all members, including the deck, curbs, and railing, as viewed in elevation at 90 degrees to the longitudinal bridge axis. The magnitude of the uniform load for beam (girder) superstructures is 50 lb/ft^2 of exposed area, but not less than 300 lb/lin ft (AASHTO 3.15.1.1.1). For trusses and arches, the wind load is 75 lb/ft^2 of exposed area, but only for trusses not less than 300 lb/lin ft in the plane of the windward chord and 150 lb/lin ft in the plane of the leeward chord. The wind loads for all superstructure types are applied horizontally, at right angles to the longitudinal bridge axis.

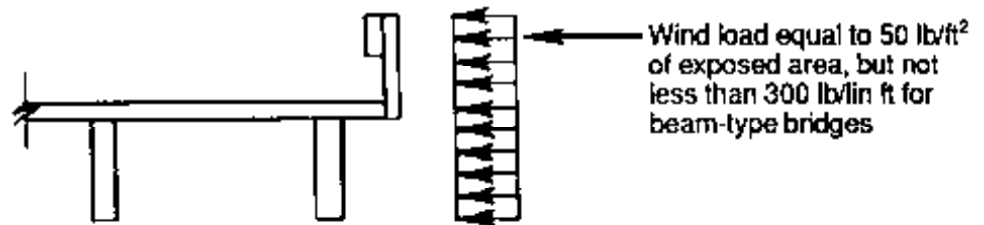

Figure 6-14. - Wind load applied to the bridge superstructure.

Loads Applied to the Vehicle Live Load

Wind loads acting on the moving vehicle live load (WL) are applied along the span length as a horizontal line load of 100 lb/lin ft . The loads are applied horizontally at right angles to the longitudinal bridge axis, 6 feet above the roadway surface (Figure 6-15).

Wind loads on the superstructure are laterally distributed to structural members and the bearings by the deck and transverse bracing. The loads produce transverse forces that develop shear at the deck interface and bearings, axial forces in the bracing, and small moments in beams or other supporting members. Wind loads generally have little or no effect on main superstructure components, but are considered in the design of transverse bracing and bearings.

SUBSTRUCTURE LOADS

Substructures are designed for wind loads transmitted to the substructure by the superstructure, and those applied directly to the exposed area of the substructure (AASHTO 3.15.2). Both loads act in a horizontal plane, but are applied at various skew angles to the structure. The skew angle is measured from the perpendicular to the longitudinal bridge axis (Figure 6-16). The angle used for design is that which produces the greatest stress in the substructure.

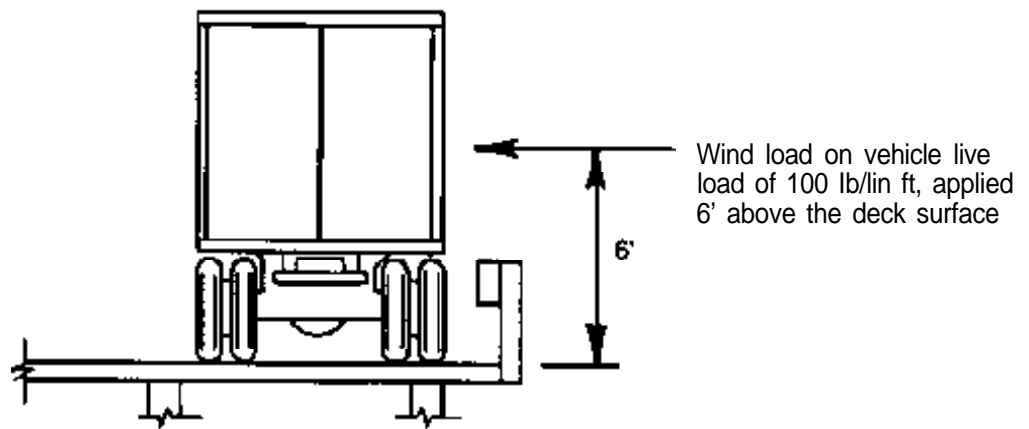

Figure 6-15. - Application of wind load acting on the vehicle live load.

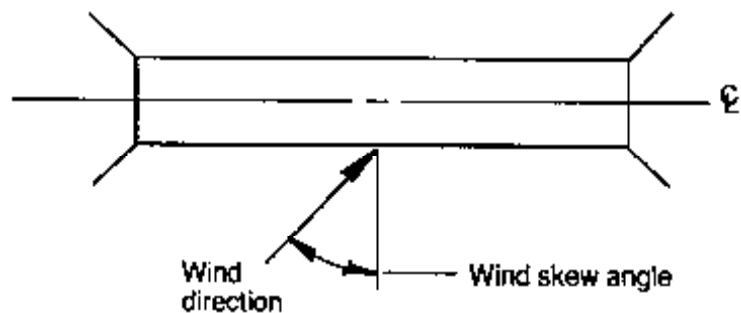

Figure 6-16. - Wind skew angle for substructure design.

Loads Transmitted to the Substructure by the Superstructure

Wind loads transmitted to the substructure by the superstructure include the loads acting directly on the superstructure (W) and those acting on the moving vehicle live load (WL). Both loads are applied simultaneously in the lateral and longitudinal directions (Table 6-3). Wind loads acting directly on the superstructure are applied at the center of gravity of the exposed superstructure area. Loads acting on the moving live load are applied 6 feet above the deck.

For beam and deck bridges with a maximum span length of 125 feet or less, which includes most timber bridges, AASHTO contains special provisions for superstructure wind loads transmitted to the substructure (AASHTO 3.15.2.1.3). Instead of the more precise loading given above, these structures may be designed for the following loads without further consideration for skew angles:

Wind load on structure (W): 50 lb/ft², transverse, and 12 lb/ft², longitudinal, both applied simultaneously

Wind load on live load (WL): 100 lb/lin ft, transverse, and 40 lb/lin ft, longitudinal, both applied simultaneously

Table 6-3. - Wind loads transmitted to the substructure by the superstructure.

Skew angle of wind (deg)	Wind load on the superstructure (lb/ft ²)				Wind load on the moving vehicle live load (lb/ft)	
	Trusses		Beams (girders)		Lateral load	Longitudinal load
	Lateral load	Longitudinal load	Lateral load	Longitudinal load		
0	75	0	50	0	100	0
15	70	12	44	6	88	12
30	65	28	41	12	82	24
45	47	41	33	16	66	32
60	24	50	17	19	34	38

From AASHTO³ 15.2.1.3; © 1983. Used by permission.

Loads Applied Directly to the Substructure

Wind loads applied directly to the substructure are 40 lb/ft² of exposed substructure area (AASHTO 3.15.2.2). The force for skewed wind directions is resolved into components perpendicular to the end and front elevations of the substructure. The component acting perpendicular to the end elevation acts on the exposed area seen in the end elevation. The component acting perpendicular to the front elevation acts on the exposed area seen in the front elevation and is applied simultaneously with the wind loads from the superstructure.

Wind loads acting on the substructure generate lateral and longitudinal forces that produce the same effects previously discussed for centrifugal and longitudinal forces. They are most significant for continuous or multiple-span structures supported by high piers or bents.

OVERTURNING FORCE

AASHTO specifications (AASHTO 3.15.3) require that the wind forces tending to overturn a bridge be computed in some loading combinations (Load Groups II, III, V, and VI discussed in Section 6.19). When overturning is considered, the wind loads applied to the superstructure and substructure are assumed to act perpendicular to the longitudinal bridge centerline. In addition, a vertical wind load is applied upward at the windward quarter point of the transverse superstructure width (Figure 6-17). This vertical wind load (W) is equal to 20 lb/ft² of deck and sidewalk area as seen in the plan view. When applied in load combinations where vehicle live loads are present (Load Groups III and IV), the vertical force is reduced to 6 lb/ft² of deck and sidewalk area.

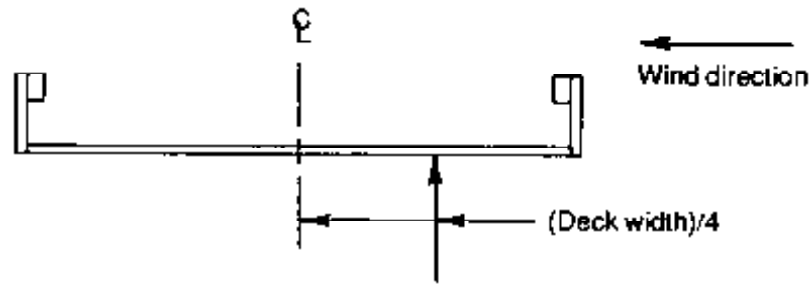

Upward wind force equal to 20 lb/ft² of deck and sidewalk area, applied at the windward 1/4 point of the deck width

Figure 6-17. - Wind load overturning force.

6.8 EARTHQUAKE FORCES

When earthquakes occur, bridges can be subject to large lateral displacements from the ground movement at the base of the structure. In many areas of the United States, the risk of earthquakes is low, while in others, it is high. Large earthquakes, such as those that occurred in San Francisco in 1906 and Alaska in 1964, induce strong structure motions that can last up to 1 minute or more. Smaller earthquakes also can produce significant motion, although the duration of movement is shorter. Bridge failures in earthquakes generally occur by shaking that causes the superstructure to fall off the bearings, displacement or yielding of tall supporting columns, or settlement of the substructure caused by a strength loss in the soil from ground vibrations (Figure 6-18). Earthquake or seismic analysis is concerned primarily with ensuring that the bearings and substructure are capable of resisting the lateral forces generated by movement of the superstructure. The objective of seismic analysis is not to design the structure to resist all potential loads with no damage, but to minimize damage to a level below that associated with failure.

Bridge earthquake loads depend on a number of factors, including the earthquake magnitude, the seismic response of soil at the site, and the dynamic response characteristics (stiffness and weight distribution) of the structure. An exact analysis is complex and requires specific seismic data for the site. For timber bridges, the most appropriate method of analysis is generally the equivalent static force method given in AASHTO 3.21.1. Using this simplified procedure, which is intended for structures with supporting members of approximately equal stiffness, the earthquake force (EQ) applied as an equivalent static force at the structure's center of mass, is computed as

$$EQ = (C)(F)(W) \quad (6-3)$$

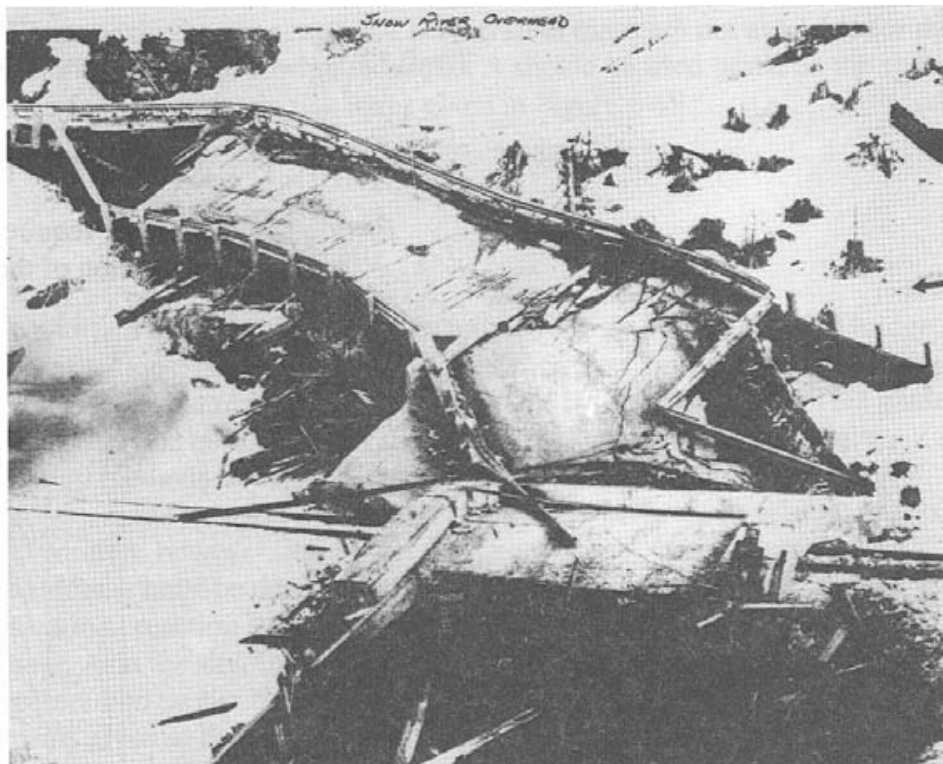

Figure 6-18. - Earthquake damage to a timber trestle highway bridge that occurred during the Alaska earthquake of 1964 (photo courtesy of the Alaska Department of Transportation and Public Facilities).

where EQ = equivalent static horizontal force applied at the center of gravity of the structure (lb),

C = combined response coefficient,

F = framing factor (1.0 for structures where single columns or piers resist the horizontal forces, 0.80 for structures where continuous frames resist horizontal forces applied along the frame), and

W = total dead load weight of the structure (lb).

The combined response coefficient C in Equation 6-3 can be computed directly from equations given in AASHTO when seismic data are available for the site. In many cases, such data are not available, and C is determined from graphs based on the natural period of vibration (T) of the structure, the expected rock acceleration (A), and the depth of alluvium to rocklike material at the site. Graphs for determining C for depths of alluvium to rocklike material of 0 to 10 feet and 11 to 80 feet are shown in Figure 6-19 (see AASHTO 3.21.2 for greater depths). To use the graphs, the designer must determine the applicable values of T and A :

$$T = 0.32 \sqrt{\frac{W}{P}} \tag{6-4}$$

where T = period of vibration of the structure (sec), and

P = total uniform force required to cause a 1-inch maximum horizontal deflection of the structure (lb).

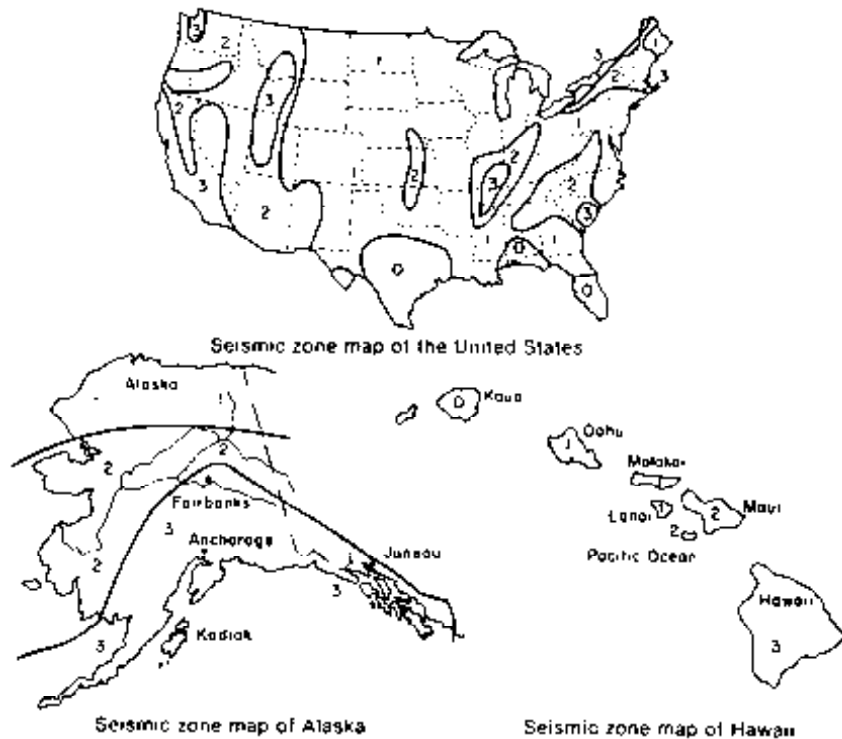
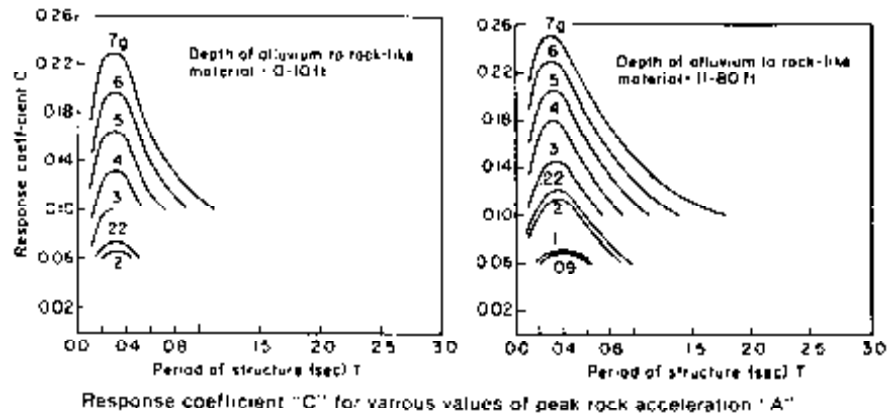

Figure 6-19. - Combined response coefficients and seismic zones used for computing earthquake loads by the equivalent static force method (from AASHTO³ 3.21.1; © 1983. Used by permission).

When maximum expected rock acceleration maps are not available for the specific site, the following values for A should be used based on the site zone from the seismic risk maps given in Figure 6-19:

Zone 1	$A = 0.09g$
Zone 2	$A = 0.22g$
Zone 3	$A = 0.50g$

In addition to the equivalent static method given in the AASHTO bridge specifications, AASHTO has also published a much more comprehensive *Guide Specifications for Seismic Design of Highway Bridges*.⁴ This guide, which may be used in lieu of the equivalent static force method, gives several methods of analysis based on a number of factors related to the location and type of structure. For single-span bridges, no seismic analysis is required; however, the connections between the bridge span and the abutments must be designed to longitudinally and transversely resist the dead load reaction at the abutment multiplied by the acceleration coefficient, A , at the site. In addition, expansion ends (which are generally not required on timber bridges) must meet minimum bearing length requirements given in the specifications. The AASHTO guide specifications present a good approach to seismic analysis and include commentary and design examples. Their use is currently optional but highly recommended.

6.9 SNOW LOAD

Snow loads should be considered when a bridge is located in an area of potentially heavy snowfall. This can occur at high elevations in mountainous areas with large seasonal accumulations. Snow loads are normally negligible in areas of the United States that are below 2,000 feet elevation and east of longitude 105°W , or below 1,000 feet elevation and west of longitude 105°W . In other areas of the country, snow loads as large as 700 lb/ft^2 may be encountered in mountainous locations.

AASHTO specifications do not require consideration of snow loads except under special conditions (AASHTO 3.3.2). The effects of snow are assumed to be offset by an accompanying decrease in vehicle live load. This assumption is valid for most structures, but is not realistic in areas where snowfall is significant. When prolonged winter closure of a road makes snow removal impossible, the magnitude of snow loads may exceed those from vehicle live loads (Figure 6-20). Loads also may be notable when plowed snow is stockpiled or otherwise allowed to accumulate. The applicability and magnitude of snow loads are left to designer judgment.

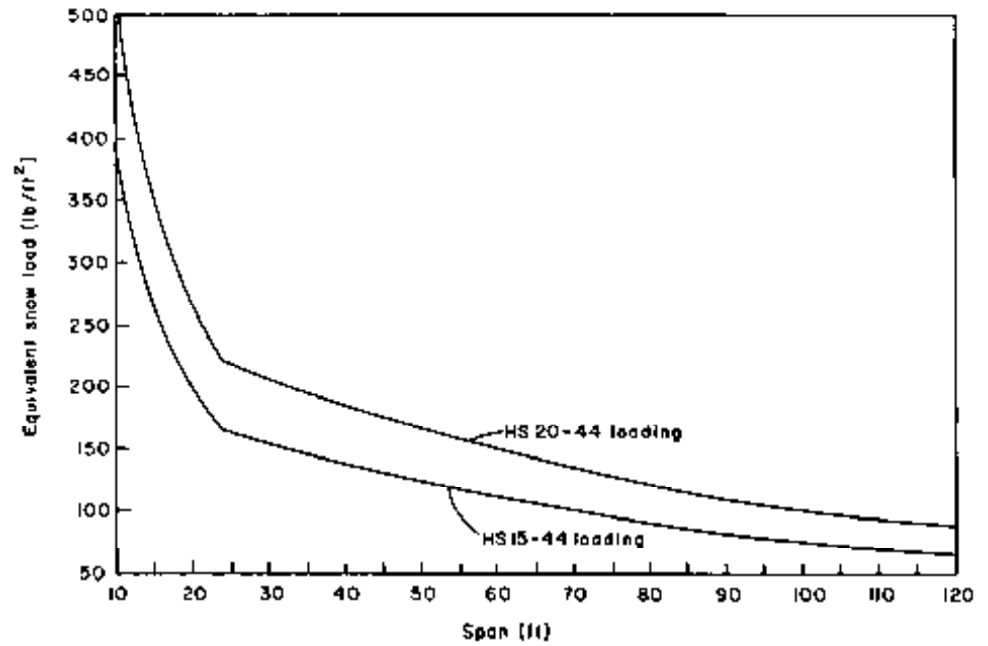

Figure 6-20. - Equivalent snow load required to produce the same moment as one truck load.

Snow loads vary from year to year and depend on the depth and density of snow pack. The depth used for design should be based on a mean recurrence interval or the maximum recorded depth. Density is based on the degree of compaction. The lightest accumulation is produced by fresh snow falling at cold temperatures. Density increases when the snow pack is subjected to freeze-thaw cycles or rain. Probable densities for several snow pack conditions are as follows:⁹

Condition of snow pack	Probable density (lb/ft ³)
Freshly fallen	6
Accumulated	19
Compacted	31
Rain on snow	31

Estimated snow load can be determined from historical records or other reliable data. General information on ground snow loads is available from the National Weather Service, from State and local agencies, and in ANSI A58.1.⁷ Snow loads in mountainous areas are subject to extreme variations, and determining the extent of these loads should be based on local experience or records, rather than generalized information.

The effect of snow loads on a bridge structure is influenced by the pattern of snow accumulation. Windblown snow drifts may produce unbalanced loads considerably greater than those from uniformly distributed loads. Drifting is influenced by the terrain, structure shape, and other features that cause changes in the general wind flow. Bridge components, such as railing, can serve to contain drifting snow and cause large accumulations to develop.

6.10 THERMAL FORCE

Thermal forces develop in bridge members that are restrained from movement and are subjected to temperature change. The magnitude of the thermal force depends on the member length, the degree of temperature change, and the coefficient of thermal expansion for the material. Like other solid materials, timber expands when heated and contracts when cooled; however, the thermal expansion for timber is only one-tenth to one-third that for other common construction materials (Chapter 3). As a result, thermal forces can be induced at connections or other locations where timber is used in conjunction with other materials that are more sensitive to temperature. In most bridge applications, thermal forces in timber members are insignificant and are commonly ignored. When members are very long, are subjected to extreme temperature changes, or are used in conjunction with other materials, consideration of thermal forces and/or provisions for expansion and contraction are left to the judgment of the designer.

6.11 UPLIFT

Uplift is an upward vertical reaction produced at the supports of continuous-span superstructures. It develops under certain combinations of bridge configuration and loading that generate forces acting to lift the superstructure from the substructure. Uplift forces may develop in continuous-span timber bridges where short spans are adjacent to longer spans (Figure 6-21).

Uplift forces are transmitted from the superstructure to the substructure by anchor bolts or tension ties at the bearings. The strength of the connections and the mass or anchorage of the substructure must be sufficient to resist these forces. AASHTO specifications require that the calculated uplift at any support be resisted by members designed for the largest force obtained under the following two conditions (AASHTO 3.17.1):

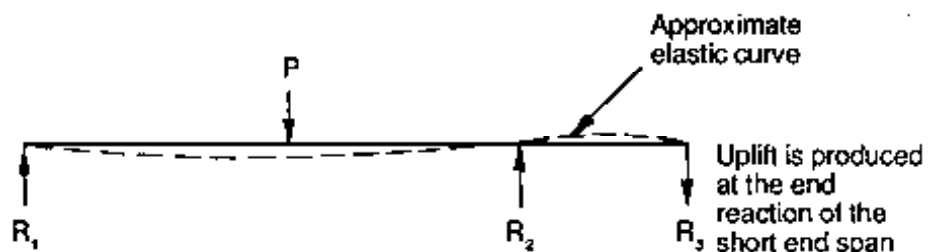

Figure 6-21. - Uplift force on a continuous-span superstructure.

1. 100 percent of the calculated uplift caused by any loading or loading combination in which the vehicle live load (including impact, when applicable) is increased by 100 percent
2. 150 percent of the computed uplift at working load level from any applicable loading combination

The allowable stress in anchor bolts in tension or other elements of the structure stressed under these conditions may be increased by 150 percent.

6.12 EARTH PRESSURE

Earth pressure is the lateral pressure generated by fill material acting on a retaining structure. In bridge design, it is most applicable in the design of substructures, primarily abutments and retaining walls (Figure 6-22). Earth pressures also may be transmitted to the superstructure when backwalls or endwalls are directly supported by superstructure ends; however, in most design applications, earth pressure is significant in substructure design only.

The magnitude of earth pressure depends on the physical properties of the soil, the interaction at the soil-structure interface, and the deformations in the soil-structure system. For routine bridge design, active earth pressures are generally computed using Rankine's formula, a somewhat simplified procedure employing an equivalent fluid pressure. The fill material is assumed to act as a fluid of known weight, and the forces acting on the structure are computed from the triangular distribution of fluid pressure (Figure 6-23 A). AASHTO specifications require that a minimum equivalent fluid weight of 30 lb/ft³ be used for retaining structures (AASHTO 3.20.1). In practice, an equivalent fluid weight of 35 or 36 lb/ft³ is more commonly used (sandy backfill with a unit weight of approximately 120 lb/ft³). These fluid weights assume that fill material is free draining and that no significant hydrostatic forces exist. When hydrostatic forces may be generated, the equivalent fluid weight must be increased.

The earth pressure acting on a retaining structure is increased when vehicle live loads occur in the vicinity of the structure. When vehicle traffic can come within a horizontal distance from the top of a retaining structure equal to one-half its height, a live load surcharge of 2 feet of fill is added to compensate for vehicle loads (AASHTO 3.20.3). The resulting load distribution on the structure is trapezoidal (Figure 6-23 B). This additional load is not required when a reinforced concrete approach slab supported at one end by the bridge is provided.

Earth pressures can vary significantly, based on soil conditions at the site and the type and complexity of the structure. In some cases, a more



Figure 6-22. - Bulging in an abutment retaining wall caused by earth pressure.

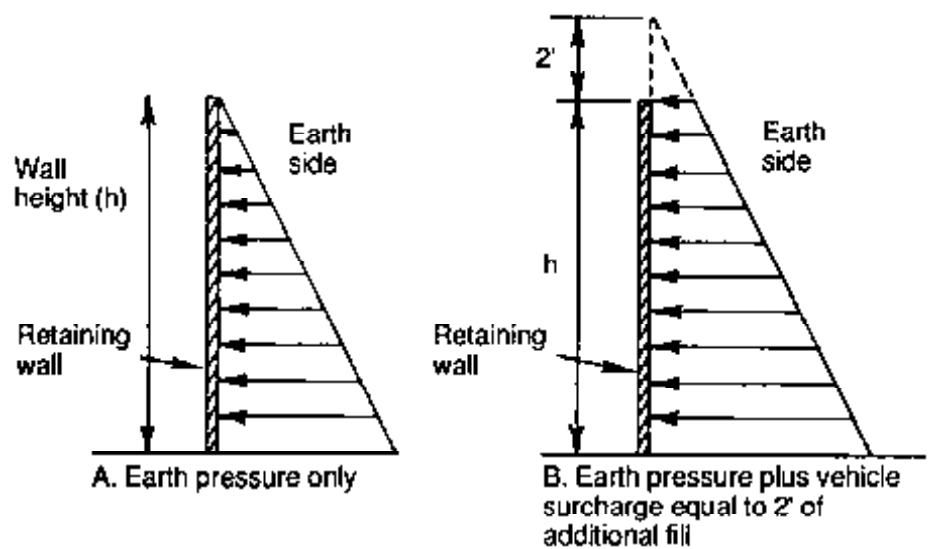
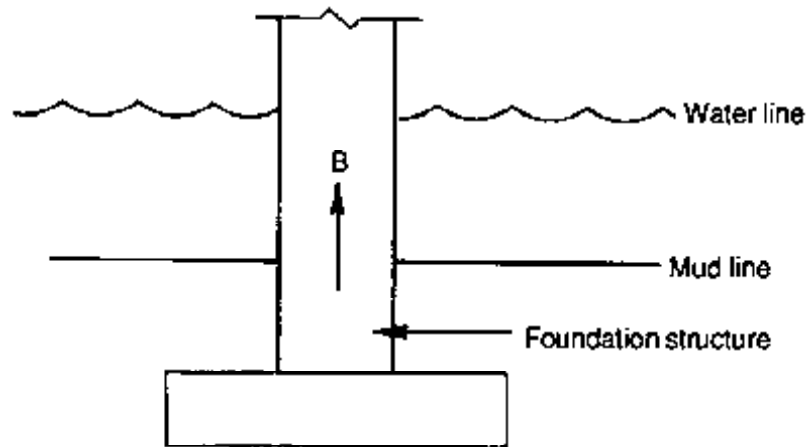

Figure 6-23. - Distribution of earth pressure on retaining structures.

sophisticated analysis than that required in AASHTO is warranted. References listed at the end of this chapter provide more detailed information on the application of soil mechanics to the design of abutments and retaining walls.^{12,28}

6.13 BUOYANCY

Buoyancy is the resultant of the upward surface forces acting on a submerged body (Figure 6-24). It is considered in bridge design when a portion of the structure is submerged or is located below the water table. Buoyancy is equal in magnitude to the weight of fluid displaced, or 62.4 lb/ft³ for water. Its effect is to reduce the weight of the substructure, which may result in smaller footing or pier sizes and a more economical design; however, buoyancy also reduces the ability of the substructure to resist uplift from vertical or lateral (overturning) loads. When combined with significant longitudinal or transverse moments, the effects of buoyancy could result in a larger footing. In either case, buoyancy is most significant in the design of massive footings or piers where dead load is a considerable percentage of the total load. In most timber bridge applications, the ratio of dead load to live load is small, and the effects of buoyancy are generally of little or no significance.



The buoyancy force (B) is an upward vertical force equal in magnitude to the volume of the structure below the water line times the unit weight of water (62.4 lb/ft³)

Figure 6-24. - Buoyancy forces on a submerged substructure.

6.14 STREAM CURRENT

Stream currents produce forces acting on piers, bents, and other portions of the structure located in moving water. These forces produce pressure against the submerged structure and are computed as a function of stream velocity (AASHTO 3.18.1) as

$$P = K V^2 \quad (6-5)$$

where P = stream flow pressure (lb/ft²),

V = water velocity (ft /sec), and

K = a constant for the shape of the pier (1-3/8 for square ends, 1/2 for angle ends where the angle is 30° or less, 2/3 for round ends).

The stream flow pressure computed by Equation 6-5 is applied to the area of the substructure over the estimated stream depth (Figure 6-25). Although stream velocity varies with depth, a constant velocity for the full depth provides sufficiently accurate results. The pressures act to slide or overturn the structure and are most significant on large piers or bents located in deep, fast-moving streams or rivers.

Forces associated with streams depend on a number of factors that must be thoroughly investigated for each site. In general, hydraulic parameters for flow velocity and depth are based on the 50- or 100-year occurrence interval. For many streams, flow records and other data have been established to provide this information. When such data are not available, estimated flow should be based on local experience or the best judgment of the designer.

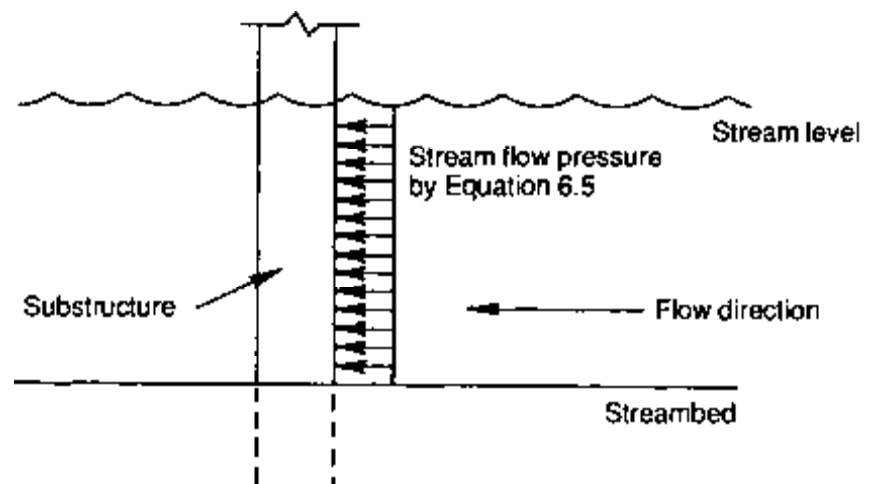

Figure 6-25. - Application of stream flow pressure on a submerged substructure.

6.15 ICE FORCE

In areas of cold climate, substructures located in streams or other bodies of water may be subjected to ice forces. These forces result from (1) the dynamic force of floating ice sheets and floes striking the structure; (2) the static ice pressure from thermal movement of continuous ice sheets on large bodies of water; (3) the static pressure produced by ice jams forming against the structure; and (4) the static vertical forces caused by fluctuating water levels when piers are frozen into ice sheets.

Ice forces are difficult to predict and depend on a number of factors including the thickness, strength, and movement of ice, as well as the configuration of the structure. AASHTO specifications give guidelines for computing dynamic ice forces on piers (AASHTO 3.18.2); however, definitive recommendations for static forces are not practical because of variations in local conditions. When ice formation is possible, potential forces should be determined by specialists using field investigations, published records, past experience, and other appropriate means. Consideration should be given to the probability of extreme rather than average conditions. Additional information on ice forces is given in AASHTO and references listed at the end of this chapter.^{9,15}

6.16 SIDEWALK LIVE LOAD

Sidewalks are provided on vehicle bridges to allow concurrent use of the structure by pedestrians, bicycles, and other nonhighway traffic. Sidewalks are subjected to moving live loads that vary in magnitude and position, just as do vehicle live loads. For design purposes, AASHTO gives sidewalk live loads as uniformly distributed static loads that are applied vertically to the sidewalk area (Figure 6-26). The magnitude of the load depends on the component of the structure and the length of sidewalk it supports. When a member supports a long section of sidewalk, the probability of maximum loading along the entire length is reduced. As a result, loads vary and are based on the type of member and sidewalk span (AASHTO 3.14.1).

Sidewalk floors, floorbeams (longitudinal or transverse), and their immediate supports are designed for a live load of 85 lb/ft² of sidewalk area. Loads on longitudinal beams, arches, and other main members supporting the sidewalk are based on the sidewalk span:

Span length	Sidewalk load
Up to 25 ft	85 lb/ft ²
25 ft to 100 ft	60 lb/ft ²

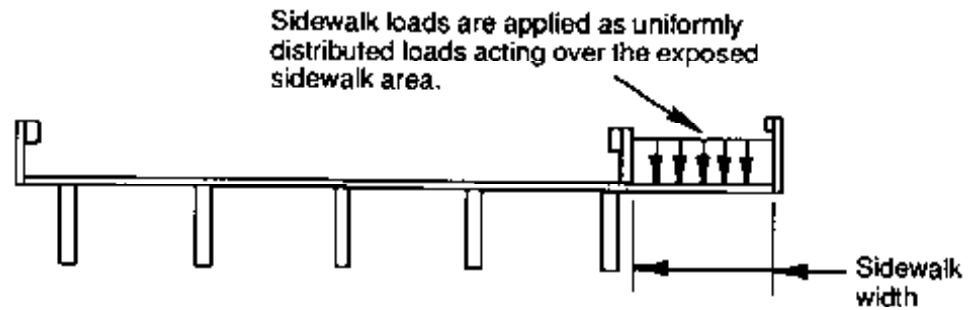

Figure 6-26. - Application of side walk loads.

When the span length exceeds 100 feet, the design live load is determined as

$$P = \left(30 + \frac{3,000}{L} \right) \left(\frac{55 - W}{50} \right) \leq 60 \text{ lb/ft}^2 \quad (6-6)$$

where P = load per square foot of sidewalk area (lb/ft²),

L = loaded length of sidewalk (ft), and

W = sidewalk width (ft).

It should be noted that sidewalk loads given in AASHTO are intended for conditions where loading is primarily pedestrian and bicycle traffic. If sidewalks will be used by maintenance vehicles, horses, or other heavier loads, the designer should increase the design loading accordingly.

Sidewalk loads are distributed to structural components in a manner similar to dead load. The load supported by any member is computed from the tributary area of sidewalk it supports. If bridges have cantilevered sidewalks on both sides, one or both sides should be fully loaded, whichever produces the maximum stress. In cases where the maximum design load in an outside longitudinal beam results from a combination of dead load, sidewalk live load, and vehicle live load, AASHTO allows a 25-percent increase in allowable design stresses, provided the beam is of no less carrying capacity than would be required if there were no sidewalks (AASHTO Table 3.22.1A).

6.17 CURB LOADS

Curbs are provided on bridges to guide the movement of vehicle wheels and protect elements of the structure from wheel impact. When traffic railing is provided, curbs may be included as a part of the rail system and are frequently used to connect rail posts to the deck. On low-volume roads

with relatively slow design speeds, barrier curbs are sometimes used instead of traffic railing to delineate the roadway edge and inhibit slow-moving vehicles from leaving the structure (Figure 6-27). In both cases, curb loading is from vehicle impact applied either directly to the curb or through the rail system.

AASHTO specifications give curb loading requirements based on the interaction of the curb and traffic railing (AASHTO 3.14.2). When curbs are used without railing, or are not an integral part of a traffic railing system, the minimum design load consists of a transverse line load of 500 lb/lin ft of curb applied at the top of the curb, or at an elevation 10 inches above the floor if the curb is higher than 10 inches (Figure 6-28). When curbs are connected with traffic railing to form an integral system, the design loads applied to the curb are those produced by the railing loads (see Chapter 10).

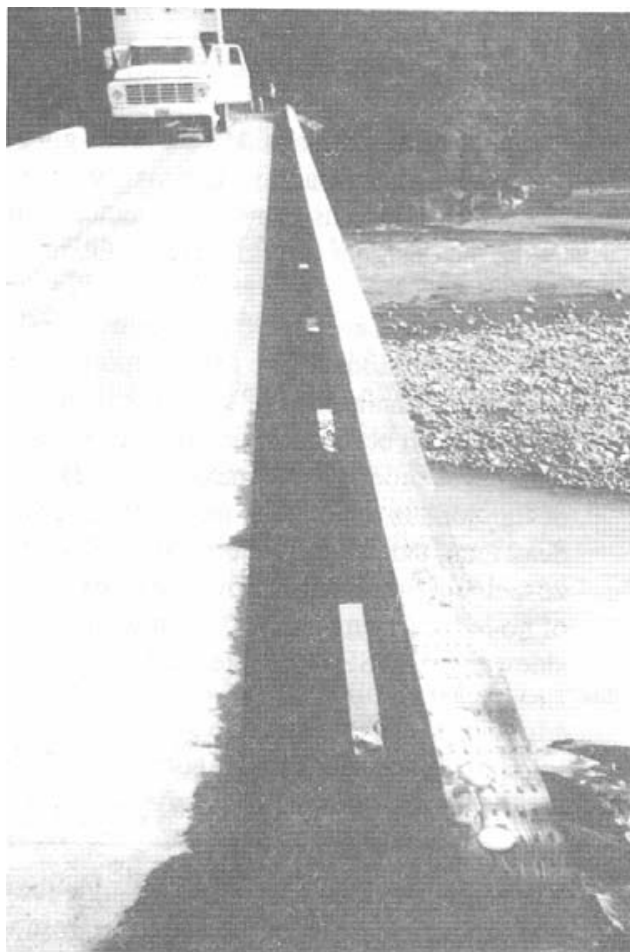

Figure 6-27—Barrier curbs on a timber bridge. Such curbs are sometimes used instead of railing on single-lane, low-volume bridges.

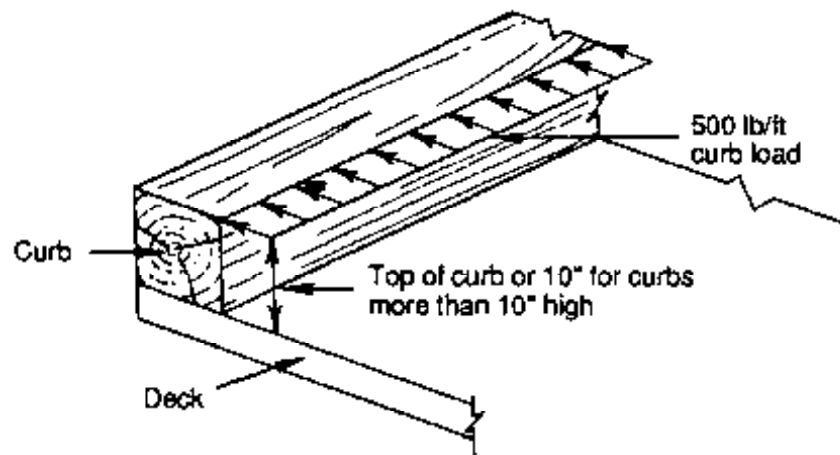

Figure 6-28 - Application of curb loads when the curb is not integral with the vehicular railing system.

6.18 OTHER LOADS

In addition to the minimum AASHTO load requirements discussed in this chapter, timber bridges may be subjected to other loads during construction and in service. Consideration should be given to loads resulting from transportation, handling, and erection, especially when long, slender beams or columns are considered. Because these loads are difficult to quantify, they are left to the judgment of the designer and must be based on specific information for each project.

6.19 LOAD COMBINATIONS

Timber bridges may be subjected to any of the loads and forces previously discussed. In practice, these loads seldom act individually, but normally occur as a combination of loads acting simultaneously. The designer must determine which loads are applicable to the design of a structure and the combination of loads that produce the maximum stress in each bridge component.

Load combinations for bridge design are based on load groups given in AASHTO (AASHTO 3.22) for service-load design (load-factor design is currently not applicable for timber). These load groups consist of a number of individual loads that are assumed to act simultaneously on a particular bridge component. Each load group is computed using the following equation and the load group numbers and factors given in Table 6-4:

$$GROUP(N) = \gamma[\beta_D(D) + \beta_L(L + I) + \beta_C(CF) + \beta_E(E) + \beta_B(B) + \beta_S(SF) + \beta_W(W) + \beta_{WL}(WL) + \beta_L(LF) + \beta_R(R + S + T) + \beta_{EQ}(EQ) + \beta_{ICE}(ICE)] \quad (6-7)$$

- where
- N = load group number,
 - γ = load factor from Table 6-4,
 - β = load coefficient from Table 6-4,
 - D = dead load,
 - L = vehicle live load,
 - I = vehicle live load impact (not applicable to timber),
 - E = earth pressure,
 - B = buoyancy,
 - W = wind load on the structure,
 - WL = wind load acting on the vehicle live load,
 - LF = longitudinal force from vehicle live load,
 - CF = centrifugal force,
 - R = rib shortening,
 - S = shrinkage,
 - T = temperature,
 - EQ = earthquake force,
 - SF = stream flow pressure, and
 - ICE = ice pressure.

Table 6-4. - AASHTO load group coefficients for service load design of timber bridges.

Group (N)	γ	β factors														% ^a	
		D	(L + I) _n	(L + I) _p	CF	E	B	SF	W	WL	LF	R + S + T	EQ	ICE			
I	1.0	1	1	0	1	β_E	1	1	0	0	0	0	0	0	0	100	
IA	1.0	1	2	0	0	0 ^b	0	0	0	0	0	0	0	0	0	150	
IB	1.0	1	0	1	1	β_E	1	1	0	0	0	0	0	0	0	100 ^b	
II	1.0	1	0	0	0	1	1	1	1	0	0	0	0	0	0	125	
III	1.0	1	1	0	1	β_E	1	1	0.3	1	1	0	0	0	0	125	
IV	1.0	1	1	0	1	β_E	1	1	0	0	0	1	0	0	0	125	
V	1.0	1	0	0	0	1	1	1	1	0	0	1	0	0	0	140	
VI	1.0	1	1	0	1	β_E	1	1	0.3	1	1	1	0	0	0	140	
VII	1.0	1	0	0	0	1	1	1	0	0	0	0	1	0	0	133	
VIII	1.0	1	1	0	1	1	1	1	0	0	0	0	0	0	1	140	
IX	1.0	1	0	0	0	1	1	1	1	0	0	0	0	0	1	150	
X	1.0	1	1	0	0	β_E	0	0	0	0	0	0	0	0	0	100	Cutvert

^a Percentage of allowable unit stress used for design. No increase is permitted for members or connections carrying wind loads only.

^b Percentage = $\frac{\text{Maximum unit stress (operating rating)}}{\text{Allowable unit stress}} \times 100 = 133\%$ for timber bridges.

Allowable unit stress

(L + I)_n = Live load plus impact for AASHTO H or HS loading.

(L + I)_p = Live load plus impact consistent with the overload criteria of the operating agency.

$\beta_E = 1.0$ and 0.5 for lateral loads on rigid frames (check both to see which governs).

$\beta_E = 1.0$ for vertical and lateral loads on all other structures.

From AASHTO³ Table 3.22.1A. © 1983. Used by permission.

For service load design, the load factor for all load groups is 1.0 and the requirements of Equation 6-7 can be read directly from values specified in Table 6-4. The relative magnitude of each load within a group is determined by the β factor in columns 2 through 13. When the β factor for an individual load is zero, that load is not considered in the load group. For example, Load Group III consists of the dead load, vehicle live load, centrifugal force, earth pressure (factored by the applicable beta factor), buoyancy, stream force, 30 percent of the wind load on the structure, wind load on the vehicle live load, and the longitudinal force. Although each of these loads is assumed to act simultaneously in the load group, the applicability of any load for a specific structure is left to the judgment of the designer. If an individual load is not applicable, the β factor for that load is zero, regardless of the β factor given in Table 6-4.

The concept of load groups is based on the assumption that a number of loads will occur simultaneously on the structure. To compensate for the small probability that all loads will act together at their maximum intensities, an increase in allowable design stresses is permitted for most groups. These increases are based on the premise that the possibility of all loads acting at the same time is small enough to justify a reduction in the factor of safety. Percentages of allowable stresses for each load group are given in column 14 of Table 6-4, with the following two exceptions:

1. When a member loaded in any load group is subjected to wind load only, no increase in allowable stress is permitted.
2. For overloads considered in Load Group IB, the design stresses are a percentage of allowable stresses computed as the ratio of the maximum unit stress allowed at the operating rating level given in the *AASHTO Manual for Maintenance Inspection of Bridges*² and the allowable unit stress. For timber components, this ratio is 133 percent.

For timber bridges, increases in allowable stresses for load groups are cumulative, with modifiers for duration of load. Because duration of load adjustments reflect the material properties of timber, they should not be confused with increases based on load probability. The total increase in allowable unit stress for timber components is that given for the load group plus the applicable factor for duration of load discussed in Chapter 5.

Each component of a bridge superstructure and substructure must be proportioned to safely withstand all load group combinations that are applicable to the structure. Different load groups will control the design of different parts of the structure. Load Groups I, II, and III are most applicable for bridge superstructures and substructures; Load Groups IV, V, and VI are for arches and frames; and Load Groups VII, VIII, and IX are for substructures. Load Group X is for culvert design only and is not used

for bridges. To determine the controlling load groups, the designer must determine which individual loads are applicable and compute magnitudes and effects of these loads; however, it is not necessary to investigate all group loads for all bridges. In most cases, it is evident by inspection that only a few loadings are likely to control the design of any single type of structure or component. In general, the following three load groups are most applicable for timber bridges:

Superstructures: Load Group I; Load Group IB when overloads are considered

Abutments: Load Groups I and III; Load Group IB when overloads are considered; Load Group VII when earthquake loads are applicable

Piers: Load Groups I, II, and III; Load Group IB when overloads are considered; Load Group VIII when ice loads are applicable

6.20 SELECTED REFERENCES

1. American Association of State Highway and Transportation Officials. 1976. AASHTO manual for bridge maintenance. Washington, DC: American Association of State Highway and Transportation Officials. 251 p.
2. American Association of State Highway and Transportation Officials. 1983. Manual for maintenance inspection of bridges. Washington, DC: American Association of State Highway and Transportation Officials. 50 p.
3. American Association of State Highway and Transportation Officials. 1983. Standard specifications for highway bridges. 13th ed. Washington, DC: American Association of State Highway and Transportation Officials. 394 p.
4. American Association of State Highway and Transportation Officials. 1984. A policy on geometric design of highways and streets. Washington, DC: American Association of State Highway and Transportation Officials. 1,087 p.
5. American Association of State Highway and Transportation Officials. 1984. Guide specifications for seismic design of highway bridges.- Washington, DC: American Association of State Highway and Transportation Officials. 107 p.
6. American Institute of Timber Construction. 1985. Timber construction manual. 3d ed. New York: John Wiley and Sons, Inc. 836 p.
7. American National Standards Institute. 1982. Minimum design loads for buildings and other structures. ANSI A58.1. New York: American National Standards Institute. 100 p.

8. American Society of Civil Engineers. 1982. Evaluation, maintenance, and upgrading of wood structures. Freas, A., ed. New York: American Society of Civil Engineers. 428 p.
9. American Society of Civil Engineers. 1980. Loads and forces on bridges. Preprint 80-173, 1980 American Society of Civil Engineers national convention; 1980 April 14-18; Portland, OR. New York: American Society of Civil Engineers. 73 p.
10. American Society of Civil Engineers. 1961. Wind forces on structures. Final report of the task committee on wind forces. Pap. 3269. American Society of Civil Engineers Transactions 126(2): 1124-1198.
11. Bell, L.C.; Yoo, C.H. 1984. Seminar on fundamentals of timber bridge construction. Course notes; 1984 May 22-25; Auburn University, AL. Auburn University. [150 p.].
12. Bruner, R.F.; Coyle, H.M.; Bartoskewitz, R.E. 1983. Cantilever retaining wall design. Res. Rep. 236-2F. College Station, TX: Texas Transportation Institute. 179 p.
13. Grubb, M.A. 1984. Horizontally curved I-girder bridge analysis: V-load method. In: Bridges and foundations. Trans. Res. Rec. 982. Washington, DC: National Academy of Sciences, National Research Council, Transportation Research Board: 26-36.
14. Gurfinkel, G. 1981. Wood engineering. 2d ed. Dubuque, IA: Kendall/Hunt Publishing Co. 552 p.
15. Haynes, F.D. 1983. Ice forces on bridge piers. Hanover, NH: U.S. Army CRREL. 16 p.
16. Heins, C.P.; Lawrie, R.A. 1984. Design of modern concrete highway bridges. New York: John Wiley and Sons. 635 p.
17. Kozak, J.J.; Leppmann, J.F. 1976. Bridge engineering. In: Merritt, F.S., ed. Standard handbook for civil engineers. New York: McGraw-Hill Co. Chapter 17.
18. McCormac, J.C. 1975. Structural analysis. 3d ed. New York: Intext Educational Publishers. 603 p.
19. Milbradt, K.P. 1968. Timber structures. In: Gaylord, E.H., Jr.; Gaylord, C.N., eds. Structural engineering handbook. New York: McGraw Hill. Chapter 16.
20. Ministry of Transportation and Communications. 1983. Ontario highway bridge design code. Downsview, ON, Can.: Ministry of Transportation and Communications. 357 p.
21. Ministry of Transportation and Communications. 1983. Ontario highway bridge design code commentary. Downsview, ON, Can.: Ministry of Transportation and Communications. 279 p.
22. Ministry of Transportation and Communications. 1986. Ontario highway bridge design code updates. Downsview, ON, Can.: Ministry of Transportation and Communications. 28 p.
23. State of California, Department of Transportation. 1986. Bridge design specifications manual. Sacramento, CA: State of California, Department of Transportation. 379 p.

24. State of California, Department of Transportation. 1983. Bridge design practice-load factor. Sacramento, CA: State of California, Department of Transportation. 619 p.
25. State of California, Department of Transportation. 1985. Revisions of the standard specifications for highway bridges relating to seismic design. Sacramento, CA: State of California, Department of Transportation. 85 p.
26. State of Wisconsin, Department of Transportation. 1979. Bridge manual. Madison, WI: State of Wisconsin, Department of Transportation. [350 p.]
27. U.S. Department of Agriculture, Forest Service, Northern Region. 1985. Bridge design manual. Missoula, MT: U.S. Department of Agriculture, Forest Service, Northern Region. 299 p.
28. U.S. Department of Agriculture, Forest Service, Pacific Northwest Region. 1979. Retaining wall design guide. Portland, OR: U.S. Department of Agriculture, Forest Service, Pacific Northwest Region. [300 p.]
29. United States Steel Corp. 1965. Highway structures design handbook. Pittsburgh, PA: United States Steel Corp. Vol. 2. 597 p.