

**AIR QUALITY AND SHELTERBELTS:
ODOR MITIGATION AND LIVESTOCK PRODUCTION
A LITERATURE REVIEW**

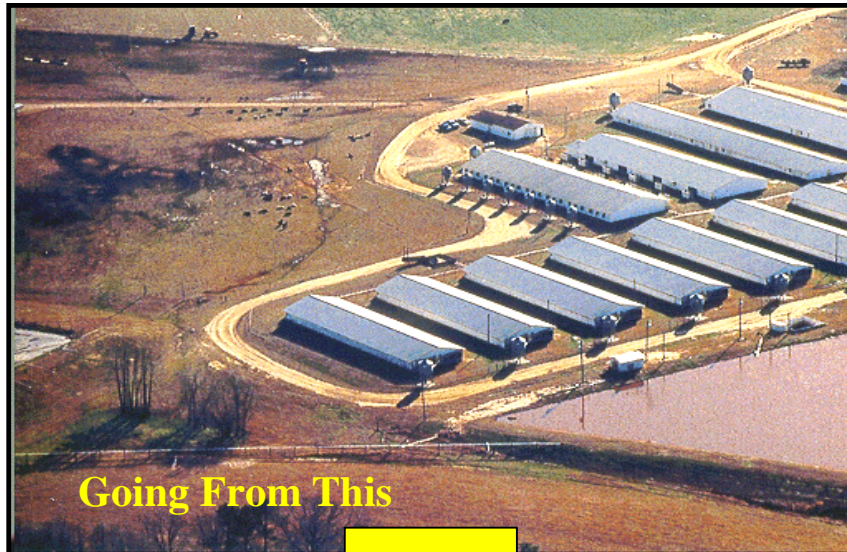

**USDA NATIONAL AGROFORESTRY CENTER SPONSORED RESEARCH
PROJECT**

John Tyndall and Joe Colletti,
Forestry Department, Iowa State University

AIR QUALITY AND SHELTERBELTS: ODOR MITIGATION AND LIVESTOCK PRODUCTION A LITERATURE REVIEW

**Final Project Report
March 27, 2000**

Written by John Tyndall and Joe Colletti, Forestry Department, Iowa State University,
Ames, Iowa.

Assistance provided by: Chuck Rodrigues, Department of Forestry, Iowa State
University, Ames, Iowa.

Special Thanks to Dr. Gwyn Beattie, Department of Microbiology and Plant Pathology,
Iowa State University for sharing literature resources and for providing literature
synthesis and personal notes.

**Project Funded by The United States Department of Agriculture,
National Agroforestry Center, Lincoln, Nebraska**

Project Number: 4124-4521-48-3209

Cover photos: Top photo, photographer unknown; bottom photo, photographer Ann
Holtz, Forestry Department, Iowa State University, 1999.

Acknowledgement

The authors would like to gratefully acknowledge that this research was made possible through the support of The United States Department of Agriculture National Agroforestry Center in Lincoln, Nebraska. Special thanks goes to Bruce Wight, NRCS Lead Agroforester for his assistance and feedback. And special thanks to the Leopold Center for Sustainable Agriculture in Ames, Iowa for their continued long-term support of Iowa State University's Agroecology Issue Team.

Any and all errors or omissions found within the text are the author's responsibility alone. The views expressed and format of this document are those of the authors and do not necessarily represent the views of either the National Agroforestry Center or The Leopold Center for Sustainable Agriculture.



National Agroforestry Center

USDA National Agroforestry Center
East Campus – University of Nebraska- Lincoln
Lincoln, NE 68583-0822



LEOPOLD CENTER

Leopold Center for Sustainable Agriculture
209 Curtiss Hall
Iowa State University
Ames, Iowa 50011-1050

Table of Contents

LIST OF FIGURES	VI
LIST OF TABLES	VII
EXECUTIVE SUMMARY	1
Shelterbelts and Livestock Odor Amelioration	3
Dilution of gas concentrations of odor into the lower atmosphere	4
Encouraging dust and other aerosol deposition by reducing wind speeds.....	4
Physical interception of dust and other aerosols	4
By way of acting as a sink for the chemical constituents of the odorous pollution	4
Economics.....	5
Barriers to Adoption of Shelterbelts for Livestock Odor Control.....	5
INTRODUCTION.....	7
The U.S. Swine Industry	8
Manure.....	10
MAJOR EXTERNALITIES OF CONFINED ANIMAL PRODUCTION	11
Water Quality.....	11
Odor	11
Livestock Odor and Socio-Economic and Environmental Concerns.....	13
Legal Considerations and Livestock Odor	13
LIVESTOCK ODOR AND ODOR CONTROL.....	15
SHELTERBELTS DEFINED	16
SHELTERBELTS AND ODOR	18
IMPORTANT ASPECTS OF LIVESTOCK ODOR.....	19

Land Application of Livestock Manure.....	19
Constituents of Livestock Odor	21
Particulate Matter and Aerosol Transport of Livestock Odor	22
SHELTERBELTS AND ODOR CONTROL.....	24
Potential Roles of Shelterbelts	24
Dilution of gas concentrations of odor into the lower atmosphere	25
Encouraging dust and other aerosol deposition to the windward and lee sides of a shelterbelt by reducing wind speeds.....	27
Physical interception of dust and other aerosols	30
Acting as a sink for the chemical constituents of the odorous pollution.....	31
General Shelterbelt Design Considerations.....	35
General Considerations for each above mentioned Shelterbelt Effect.....	36
ADDITIONAL DESIGN CONSIDERATIONS FOR SHELTERBELTS USED TO MITIGATE LIVESTOCK ODOR AS REGARDING VARIOUS SOURCES OF LIVESTOCK ODOR.....	41
Shelterbelts and Land Application of Manure	42
Hogs.....	42
Dairy.....	42
Shelterbelt Design Considerations as Regarding Livestock Manure Application	43
Shelterbelts and Manure Storage.....	44
General Livestock Odor Facts Regarding Manure Storage	44
Hogs.....	44
Dairy.....	44
Shelterbelt Design Consideration as Regarding Manure Storage	45
Shelterbelts and Production Buildings	45
General Livestock Odor Facts Regarding Production Buildings.....	45
Shelterbelt Design Considerations with Production Buildings	46
ECONOMICS OF USING SHELTERBELTS FOR LIVESTOCK ODOR CONTROL	47
SUMMARY OF SHELTERBELTS AND LIVESTOCK ODOR AMELIORATION	50

Dilution of gas concentrations of odor into the lower atmosphere	51
Encouraging dust and other aerosol deposition by reducing wind speeds.....	51
Physical interception of dust and other aerosols	51
By way of acting as a sink for the chemical constituents of the odorous pollution	51
Economics	52
Barriers to Adoption of Shelterbelts for Livestock Odor Control.....	52
BIBLIOGRAPHY.....	54

LIST OF FIGURES

Figure 1: Industry Consolidation of Cattle, Dairy, Hog, Layer, Broiler and Turkey Animal Feeding Operations in 1978 and 1992.	7
Figure 2. Distance from annual survey respondent's residence to closest neighbor's livestock facility	12
Figure 3. Schematic representation of turbulence and zone of potential odor dilution ...	26
Figure 4. This 20-foot single row Amur maple (<i>Acer ginnala</i>) shelterbelt is being used to reduce the effects of unwanted pollen drift from a conventional farming system onto an organic farm in central Iowa.....	30
Figure 5 . Diagram of possible shelterbelt benefits in mitigating odor from field application of livestock manure.	39
Figure 6. Example wedge shape planting that has been suggested by some researchers to get higher air-flow over the shelterbelt.	39
Figure 7. A hypothetical shelterbelt system design for a typical swine production facility.	40
Figure 8. Planted in April 1999, this five row mixed conifer and hardwood species shelterbelt is located on the northwest corner of a swine confinement facility in central Iowa. This shelterbelt was planted specifically for odor control and improved aesthetics.	41
Figure 9. Newly planted (April 1999) two row, mixed conifer/hardwood species shelterbelt located along the east side of a manure lagoon in the northeast corner of a swine production facility in central Iowa.....	45
Figure 10. Six year old, three row shelterbelt composed of one row of poplar (<i>Populus spp.</i>), one row of silver maple (<i>Acer saccharinum</i>) and a third row of assorted small shrubs (ninebark, nanking cherry, and high bush cranberry).....	47
Figure 11. Drawing of shelterbelt planting design at a 3,000 head sow facility in central Iowa used in economic analysis discussed below. Approximately 900 trees were part of the analysis. The name of the facility is being kept confidential. North is to the left of the drawing.	48
Figure 12. Beef production facility showing typical openness to surrounding areas. Many such facilities have suitable land available for shelterbelt plantings.	49

LIST OF TABLES

Table 1. Increase in the Average Number of Animal Units (AUs) per Operation from 1978 to 1992	8
Table 2. Average manure production for various livestock animals.....	10
Table 3. Estimated annual U.S. manure production (1997).....	10
Table 4. Average separation distances of U.S. hog manure storage facilities and manure lagoons from the nearest occupied house.....	13
Table 5. Economic data from economic benefits analysis of a two-row windbreak system on a 160 acre winter wheat field.	18
Table 6. Farm type, animal units (AU), and cropland, by confined animal facility size, in 1992.....	20
Table 7. Average dust deposition results on the windward side of 21 shelterbelts in Indio, California. (Note that the relatively high value at 20 H was attributed to some localized soil disturbances that were not observed during sampling).....	27
Table 8. Data displaying different levels of down wind dust reduction associated with different wind parameters.....	29
Table 9. Chemicals removed from sealed chamber by household plants in 24 hours.	34
Table 10. General spacing guidelines for windbreak based on windbreak position and component (density and species type).....	38

Executive Summary

This literature review is focused on the potential for innovative use of trees and other vegetation to reduce the odor associated with livestock production. The goal is to examine available evidence to assess if trees and shelterbelts may: 1) be able to help control odor through physical and biological means, and 2) be an economically feasible technology for livestock producers as well as surrounding communities.

The current stage in the evolution of livestock agriculture in the United States is toward increased industrialization and involves the infusion of multiple technologies, the concentration of production and processing facilities and the integration of inputs to production, processing, and marketing. This evolution is most easily identified by changes in the overall size of the facilities and in increases in the average number of animals per farm system. The increases in size is primarily due to perceptions that large operations benefit from economies of scale, particularly in terms of expenditures for labor, feed, and facilities, which have caused producers to try to capture those potential benefits (SOTF, 1995).

In terms of overall animal production in the U.S., the total number of animal units per farm operation increased considerably. For example, from 1978-1992 the average number of animal units per U.S. cattle operation increased by 56%, dairy by 93%, hogs by 134%, and layer poultry 176% (US EPA, 1999). However, during this same time period the overall number of livestock operations decreased considerably as well. The number of cattle operations dropped by over 40%; dairy, hogs, and layer poultry by over 50% (US EPA, 1999). All of this indicating significant consolidation within the industries and greater production from fewer, larger production facilities, which are based on animal confinement systems.

With the greater number of livestock and increased size of production facilities have come larger amounts of animal waste, concentrated into relatively small geographic areas.

- In the US, about 130 times more animal waste is produced annually than human waste (US Senate Committee ANF, 1997).
- Over 1.4 billion tons of manure is produced annually by US livestock (US Senate Committee ANF, 1997).

This consolidation of animals and associated manure has exacerbated common farm externalities, in this examination odor, to the point where it is causing significant social problems. The sheer quantity of manure produced per farm has elevated the intensity, duration, and timing of odor events. Geographic migration of production sites within the US and urban expansion has also put more people into closer proximity to these confinement facilities (Williams, 1996).

- A 1998 survey of Iowa farmers found that 46% of 2,312 survey respondents live ½ mile or less from a livestock facility (Lasley, 1998).
- This finding is consistent with national averages (USDA, 1996).

The term "odor" actually refers to the complex combination of gases, vapors, and dust that result from both the feed method, animal living arrangements and the anaerobic decomposition of manure. There are three primary sources of livestock odor (NPPC, 1995):

- Animal confinement buildings, manure storage facilities, and land application
- Studies have shown that the majority of odor complaints are associated with pig facilities and land application followed by poultry (Hardwick, 1996).
- Swine excretions are the most liquid of all livestock excretions which quickly leads to anaerobic decomposition and producing stronger and more toxic odors than dry manure (Ritter, 1989).

All of these factors, (increased manure concentration, changes in geographic location, urban expansion, limited separation distances) have caused the issue of odor control to become of paramount concern for the public and for livestock producers. There are some very serious social ramifications involved with the issue of livestock odor (Palmquist, 1997; Schiffman et al., 1998; Donham, 1998; Thu, 1998):

- Mental and physical health concerns for both human and animals.
- Decreased real estate values as well as negative effects on tourism and recreation.
- Stressed relationships between families, neighbors and entire communities.
- Civil rights concerns.

Because there are no Federal laws and very few state and local laws that regulate livestock odor directly, effected citizens may resort to common-law nuisance litigation (Hamilton, 1992).

Due to the high costs associated with this type of litigation, every state has "Right-to-Farm" laws that grant protection against nuisance complaints as long as the producer complies with related Federal, state, and local mandates regarding manure management (Hamilton, 1992). In 1998, the Iowa Supreme Court ruled that the Iowa "Right-to-Farm" law was unconstitutional and amounted to a taking of the petitioners rights (Lucht, 1998). This decision set a precedent that calls into question all the states "Right-to-Farm" laws.

Thus for social and legal reasons, livestock producers should deal with the odors emanating from their facilities.

- In a 1998 survey of Iowa farmers, 63 % (n=2,312) agreed that the frequency of odor related problems in Iowa was increasing (Lasley, 1998).
- And, 25% of the respondents feel as though the quality of their lives has been negatively affected by livestock odor (Lasley, 1998).

There are three main strategic methods for controlling livestock odor (Chapin et al., 1998a):

- 1) Prevention of odor (i.e. food & manure additives); 2) capture and destruction of odorous chemicals (chemical scrubbers and biofilters); and 3) collection, dispersion and dilution of odorous chemicals (shelterbelts)
- Use of multiple control devices improves effectiveness of odor control (Lorimor, 1998).

Shelterbelts and Livestock Odor Amelioration

Shelterbelts have the potential to be an effective and inexpensive odor control device particularly when used in combination with other control methods for added effectiveness. The potential of shelterbelts is really defined by the characteristics of livestock odors. These characteristics (Smith, 1993) are:

- Odor source at or very near ground level;
- Limited plume rise, due to certain weather conditions (i.e. temperature inversions);
- Plume shows spatial and temporal variability;
- Plume may be of large areal extent;
- Close proximity to critical receptors of odor (i.e. people);
- Odors generated in animal facilities that are intense and detectable at appreciable distances all travel as aerosols (Hammond et al., 1981).

There is compelling evidence that shelterbelts will work very well within an agricultural landscape to provide odor control by affecting these characteristics. Because the odor source is near the ground and the tendency of the plume is to travel along the ground (Takle, 1983). Shelterbelts of even modest heights (i.e. 20-30 ft) may be ideal for plume interception and disruption (Heisler and DeWalle, 1988; Laird, 1997; Thernelius, 1997). Shelterbelts can easily be designed as to fit the production situation and expected/experienced odor plume shapes. Also, depending on the shelterbelt design and species used, they can deal with the temporal characteristics and provide year round plume/aerosol interception.

There are be four primary ways that shelterbelts can ameliorate livestock odors:

- Dilution of gas concentrations of odor into the lower atmosphere
- Encouraging dust and other aerosol deposition by reducing wind speeds
- Physical interception of dust and other aerosols
- By way of acting as a sink for the chemical constituents of odor

Dilution of gas concentrations of odor into the lower atmosphere

- Shelterbelts create turbulence at the surface of the terrain that intercept and disrupt odor plumes traveling in laminar flow helping to push the plume into the lower atmosphere facilitating dilution (OCTF, 1998; SOTF, 1995; Takle, undated).
- Lowering wind speeds over storage lagoons can reduce convection of odorous compounds from the surface and allow for slower release of the odor plume which also facilitates dilution (Bottcher et al., 1999)

Encouraging dust and other aerosol deposition by reducing wind speeds

- Pesticide drift mitigation research suggests that due to reduced wind speeds drift pesticide will drop from the air stream. In broadleaf species, downwind drift reductions of 70% (no leaves present) to 90% (with leaves present) have been recorded (Porskamp et al., 1994)
- Numerical simulation of the effects of tall barriers around manure lagoons predicted reductions in downwind malodorous lagoon emissions of 26% to 92% (Liu et al., 1996)
- Wind tunnel modeling of a three-row shelterbelt system has quantified reductions of 35% to 56% in the downwind mass transport of odorous particulates (dust and aerosols) (Laird, 1997; Thernelius, 1997)

Physical interception of dust and other aerosols

- Meister et al. (1984) suggests that a forest cleans the air of microparticles of all sizes by combing out twentyfold better than barren land.
- Leaves with complex shapes and large circumference to area ratios collect particles most efficiently, indicating that conifers may be more effective particle traps than deciduous species (Smith, 1994) as well as having an “in leaf” temporal advantage.

By way of acting as a sink for the chemical constituents of the odorous pollution

- Volatile Organic Compounds (VOC's) have a distinct affinity to the lipophilic membrane (the cuticle) that covers plant leaves and needles. Research on this affinity is currently underway (Beattie et al., undated)
- Researchers have quantified measurable quantities of anthropogenic VOC's that have accumulated at the surface of plants (adsorption) and within the plants tissues (absorption) (Reischl et al., 1989; Reischl et al., 1987; Gaggi et al., 1985)
- Micro-organisms dominate the surface of plants (Preece and Dickenson, 1977). These organisms also adsorb and absorb VOC's and provide additional surface area for pollution collection. These organisms also have the ability to metabolize and breakdown VOC's (Screiber and Schonherr, 1992; Muller, 1992; Beattie et al, undated)

Economics

- Economic analysis of a new shelterbelt planted around a 3000 head hog facility, using scenarios of “high” cost (10\$/ Tree and shrub) and “higher” cost (\$25/ Tree and shrub), showed the following costs:
 - for the “high” scenario: \$0.30/pig for one year, capitalized over 20 years at 5% it comes to just \$0.06/pig
 - for the “higher” scenario: \$0.68/pig for one year, capitalized over 20 years at 5% it comes to just \$0.09/pig
 - These costs include maintenance costs
- The relatively low cost of a shelterbelt system would allow most producers to economically utilize other odor control techniques (Hoff, 1998). Using multiple control strategies increases the effectiveness of odor reduction (NPPC, 1995; Lorimor, 1998).

Increased production costs are often the main barrier to reasonable odor control. However, studies have shown that consumers may be willing to pay for socially responsible animal production.

- Using contingent valuation methods researchers have determined significant numbers of people who would be willing to pay a premium for meat products produced in an “environmentally friendly” manner, including odor control (Kliebenstein et al, 1998).
- The Swine Odor Task Force out of North Carolina has recommended a certification process for producers who control air and water pollution.

Through the ways identified above shelterbelts should aid producers in achieving the cost effective, realistic goals of livestock odor mitigation which are as follows:

- Reductions in: Odor concentrations reaching populated areas, the number of people affected, the time duration of exposure to odors, and the number of occurrences of odor events (Penkala, 1977; Smith and Watts, 1994; SOTF, 1995)

Barriers to Adoption of Shelterbelts for Livestock Odor Control

The use of shelterbelts for odor mitigation, and the diffusion of this technology to livestock producers as well as communities affected by odor issues, faces several barriers to fruition. The most pervasive barriers are as follows:

- Lack of technical information regarding shelterbelts: species composition, site preparation, planting techniques, maintenance needs, and effective planting designs in and around animal facilities.
- Lack of benefit – cost analysis at farm level as well as community level.
- Lack of information regarding cost share possibilities.
- Lack of acceptance and promotion as an odor control technology.
- Further quantification of effectiveness as odor control device needed. Current studies are underway (Bottcher et al, 1999; Beattie et al, undated; Iverson et al., undated).
- There often exist cultural barriers to erecting “non-agricultural” structures within an agricultural setting. The following are some common concerns: removing crops from production, branches and roots may be troublesome, may impede the use of common farm equipment, may be habitat for pests.

Introduction

This literature review is focused on the potential for innovative use of trees and other vegetation to reduce livestock manure odor. The goal is to examine available evidence and assess if trees and shelterbelts may: 1) be able to help control odor through physical and biological means, and 2) be an economically feasible technology.

The current stage in the evolution of livestock agriculture in the United States is toward increased industrialization and involves the infusion of multiple technologies, the concentration of production and processing facilities and the integration of inputs to production, processing, and marketing. This evolution is most easily identified by increases in the overall size of the facilities and in the average number of animals per farm system as well as the advanced use of animal confinement systems. These changes in size are primarily due to perceptions that large operations benefit from economies of scale, particularly in terms of expenditures for labor, feed, and facilities, which have caused producers to try to capture those potential benefits (SOTF, 1995).

The industrialization, consolidation, and concentration of animal production in the U.S. is not unique to any one single livestock group. This is and has been a trend in all the major livestock types: that is the cattle, dairy, swine and poultry industries (for the purpose of this study poultry is considered “livestock” where as much literature will separate poultry into its own category). Examples of this trend in the U.S. are numerous.

In terms of overall animal production in the U.S., the total number of animal units (AU's) increased about 4.5 million (about a 3% increase) between 1987 and 1992. An animal unit is an index that sums the number of animals, across species, based on average liveweights per species. According to U.S. Environmental Protection Agency (EPA) specifications one AU equals one beef head, 0.7 dairy cows, 2.5 hogs, 55 turkeys, and 100 chickens. However, during this same period, the number of livestock farms decreased, indicating a consolidation within the industries overall and greater production from fewer, larger production facilities (EPA, 1999).

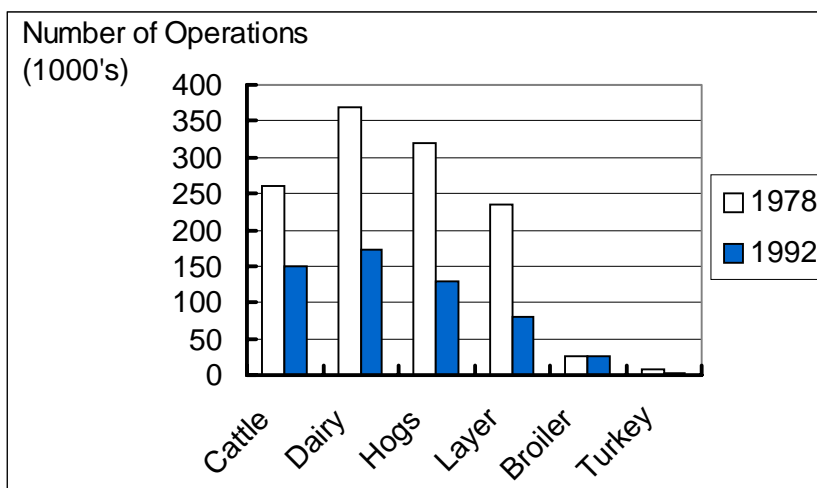

^a Source US EPA, 1999

Figure 1: US Industry Consolidation of Cattle, Dairy, Hog, Layer, Broiler and Turkey Animal Feeding Operations in 1978 and 1992. ^a

Table 1. Increase in the Average Number of US Animal Units (AUs) per Operation from 1978 to 1992. ^a

Operation Type	Increase in AU's
Cattle	56 %
Dairy	93 %
Hog	134 %
Layer	176 %
Broiler	148 %
Turkey	129 %

^a Source US EPA, 1999

Above in Figure 1, a comparison of 1978 and 1992 shows this consolidation within the industries; likewise, Table 1 displays the increase in the average number of AU's per operation from 1987 – 1992.

Through the use of confinement systems, often a large number of animals are concentrated into relatively small geographic areas. To get a brief idea of how many large-scale confinement systems there are, in the cattle industry, only 2 percent of feed operations accounted for 40 percent of all the cattle sold in 1997 (US Senate Committee on Agriculture, Nutrition, & Forestry, 1997). In 1984, 50% of beef cattle that were fattened in lots with greater than 16,000 head capacity (Eghball and Power, 1994a). In 1998, there were about 9,400 U.S. cattle and calve operations with over 1000 head, with 46% of the inventory in Nebraska, 19% in Missouri, and 12% in Iowa (USDA, 1999a). In the U.S. milk cow industry there were 7,455 operations in 1997 that had over 200 head, with 24% of the operations located in California and 9% in Texas (USDA, 1999b). The poultry industry, between 1969 and 1992, saw the number of broiler house chicken farms decrease by 35 percent while production during that same time nearly tripled (US Senate Committee on Agriculture, Nutrition, & Forestry, 1997). The number of U.S. hog operations whose inventory was over 5,000 head was 1,915 operations and accounted for 42% of the total inventory (USDA, 1998). And to look at a livestock industry generally not considered major, such as sheep, consolidation of production also occurs. In terms of breeding sheep in 1999, 39% of the total sheep inventories were on operations of between 500-4,999 head and 15% were on farms of over 5000 head, with most of the production in Texas and California (USDA, 1999c).

The U.S. Swine Industry

In the 1990's there were such remarkable changes in the pig production process as well as geographic migration of production sites that this subject is worthy of additional examination. From the 1950's to 1990, the industrialization of the U.S. swine industry lagged behind the industrialization of other U.S. livestock and poultry industries. For example, in the 1950's the poultry industry made structural changes while becoming fully industrialized. The industrialization of the swine industry was thought to be following right behind. It has occurred just forty years later (Hurt, 1994). The industrialization of the swine industry, like all the other modern animal production industries, is linked to structural change caused in part by specialization and intensification of production. Again the increased size of a swine production facility is an integral part of the

substitution of capital for labor that characterize a developing economy and occurs in varying degrees, in all parts of agriculture (Rhodes, 1995).

The evidence of swine production intensification in the U.S. is 1) that the number of hog farms in the US decreased from the high of about 1.1 million in 1965 to about 114,380 in 1998 (USEPA, 1999) and 2) that from 1991-1997 the number of US hog operations declined 8.9% annually, yet the number of hogs marketed during that period increased by 14% (Parcell and Dhuyvetter, 1997). The average hogs per farm in Iowa (the nation's number one producer) were 579 in 1995, a 58% increase from the 1989 average. The average for North Carolina (the number two producer) was over 1,200, a 511% change (Benjamin, 1995).

Productivity within the swine industry has increased over the past 15 years with rapid technological advances in disease control, genetics, and management practices (Benjamin, 1995). This has led to increased pigs per litter and market weights and the rapid improvements on meat quality as well as an increase in the ratio of annual pork production per head of breeding stock (Dhuyvetter and Parcell, 1997). As a result of these productivity gains, U.S. swine producers today can produce the same amount of pork as in 1980 which was the peak year for per capita pork production, using less labor, less feed, and an inventory of 20 % fewer hogs (Benjamin, 1985).

Demand for pork products has increased as well. The pork producers and processors have responded to consumer tastes and preferences to improve meat quality, consistency and leanness, causing domestic and international demand to increase dramatically. Between 1987 and 1997, pork exports increased 700% by volume (Reifschneider, 1999). The U.S. average consumption of pork increased by 5 pounds in 1998, the only meat protein source with any significant increase in consumption (Reifschneider, 1999). The relatively high rate of return on capital invested in pork production has been noted as another factor leading to increased industrialization of the pork industry (Hurt, 1994). Indeed, swine farms who are part of the Iowa State University records program achieved > 25 % annual average rate of return on capital from 1980 to 1994 (Hurt, 1994). Interesting to note that from 1994 to 1999 the swine industry as a whole has seen its financial situation change considerably with periods of very depressed market prices, it appears to be the larger farms as a whole have largely been able to remain in business.

Another major factor influencing the changes in the swine industry is the economic importance the industry has on regional economies. In Iowa, pork production generated receipts of \$3.0 billion in 1996 (Scanes, 1998). In North Carolina, pork production has overtaken tobacco and poultry to become the primary agriculture product, with gross farm income of about \$1.6 billion in 1996 (SOTF, 1995).

The regional importance of the swine industry is not unique to just the United States but applies to any agricultural region producing hogs. For example, an economic impact analysis for Alberta, Canada reported that as a result of production expenditures, each hog operation with 1,000 sow equivalents are estimated to contribute between \$3.5 and \$3.8 million annually to the local economy, and an additional \$100,000 to \$500,000 regionally (Alberta AFRD, 1998).

Though this evidence about contributions to regional economics is compelling, there is growing dissent regarding the total socio-economic and environmental benefits to

local and regional communities stemming from large-scale animal production (Thu, 1998).

Manure

With the greater number of livestock and increased size of production facilities, has come larger, more concentrated quantities of animal waste. In the U.S., about 130 times more animal waste is produced annually than human waste. To get an idea of manure produced per typical livestock animal, Table 2 lists average pounds of manure eliminated per day by animal. Estimated annual solid manure production is about 1.37 billion tons in the U.S. (US Senate Committee on Agriculture, Nutrition, & Forestry, 1997). Table 3 below displays estimated annual U.S. manure production for cattle, hogs, chickens, and turkeys.

Table 2. Average manure production for various livestock animals.^a

Animal	Manure (Pounds per day)
Dairy Cow (1000 pounds)	86
Beef Cow (1000 pounds)	60
Finishing Pig (150 pounds)	10
Sow and Litter	23
One Chicken	0.21

^aSource Mid West Plan Service, 1985

Table 3. Estimated annual U.S. manure production (1997).^a

Animal	Solid Manure (Millions of Tons/year)
Cattle	1229.2
Hogs	116.7
Chickens	14.4
Turkeys	5.4
Total	1365.7

^a Source US Senate Committee on Agriculture, Nutrition, & Forestry, 1997

In addition to the major livestock species discussed thus far, several other types of livestock are also often produced in confinement systems. Power and Eghball (1994b) examined manure management for such species as sheep, goats, horses, veal, calves, and mink. It was estimated that from these five classes of livestock, about 130- 143 thousand tons of nitrogen and 28 thousand tons of phosphorus from manure are produced annually under confined conditions, with about 60% coming from horses and 30% from sheep. Almost all of this manure produced in confinement is applied to land. It had been noted that though this manure production is small in comparison with that produced by the major livestock and poultry groups, many of these other animals (horses and mink in particular) are raised within fringe boundaries of urban areas and near urban populations where odor and waste utilization concerns often become acute. The agronomic and environmental effects of manure produced by these animals do not differ significantly

from those of the major livestock and poultry groups therefore these animals do contribute to odor causing conditions (Power and Eghball, 1994b).

Major Externalities of Confined Animal Production

Water Quality

The U.S. livestock and poultry industry has responded to the concentrated quantities of manure with waste management technologies to reduce or prevent environmental effects. Of particular concern, are odor and water quality pollution. Wastewater can leak from lagoons into ground water resources or can be released into surface waters from run-off or spills (Okun, 1997). For instance, one study from North Carolina examined seepage rates from manure lagoons across a range of soil types and found that about 55% of the lagoons surveyed experienced “moderate to severe” rates of seepage (Huffman and Westerman, 1995). Another recent report that was commissioned by the Iowa State legislature determined that 72 percent of 40 manure lagoons surveyed from five different regions in Iowa were seeping faster than state pollution laws allowed (Glover, 1999).

Manure spills are a severe and recurring problem in many swine producing states. In 1995, 35 million gallons of spilled animal waste killed an estimated 10 million fish in North Carolina (Source US Senate Committee on Agriculture, Nutrition, & Forestry, 1997). In Iowa, fish and other organisms were killed along a ten-mile stretch of the Iowa River after 1.5 million gallons of manure were spilled in 1996 (Jackson, 1998).

When manure is present in surface waters, microorganisms in the water facilitate the decomposition and/or oxidation of organic matter in the manure, thus the oxygen level decreases and fish suffocate (Chastain, undated). Chastain (undated) indicated that the pollution strength of raw livestock manure is about 160 times greater than raw municipal sewage. Diluted manure such as from runoff from outside cattle lots has a pollution strength that is two to four times greater than raw municipal sewage. Also noted in the literature, excess nutrients in water can either result in or contribute to: eutrophication, anoxia (the lowering of dissolved oxygen), toxic algal blooms, and outbreaks of microbes such as *Pfiesteria piscicida* and pathogens such as *Cryptosporidium* (US EPA, 1999).

Odor

Odor is a serious nuisance problem. It has been noted by odor researchers that perceptions of odor differ from individual to individual and are characterized by personal preferences, opinions, experiences, and variability in our olfactory systems (Williams, 1996). There are also specific conditions that can govern our perceptions of livestock odor (Williams, 1996; SOTF, 1995):

- Control – People often are better able to cope with objectionable odor if it is believed that they have some control over the situation.
- Understanding – In many cases, people can tolerate a problem better if they understand its source. Being accustomed to the odor causing situation.

- Context – People react as much to the context of an odor as they do the odor itself. Preferences, imagination, cultural associations, and visual images often all play a role in odor perception, i.e. if someone perceives swine to be filthy animals, that person would be more likely to find swine odors quite objectionable.

The trend in U.S. livestock industry has affected all of these conditions as production has expanded from the typical mid-western swine/animal belt states to areas west and the southeast, often where environmental laws are more lax. This brings livestock production into contact with people who are less experienced with and often less understanding of farming. Urban expansion has caused co-mingling of rural and urban communities, putting homes in closer proximity to livestock producers. For example, a 1998 survey of Iowa farmers conducted by Iowa State University found that 46% of the 2,312 survey respondents live ½ mile or less from a livestock facility (see Figure 2) (Lasley, 1998). This finding is consistent with average separation distances nationwide. Table 4 lists the average separation distances of U.S. pork producers by operation size, showing that the majority of sizable hog odor sources are less than one-half mile from the nearest occupied home (USDA, 1996). As discussed in detail later, under certain weather conditions, odor can travel much further than one half mile (NPPC, 1995).

All of these factors (changes in geographic location, urban expansion, limited separation distances) have caused the issue of odor control to become of paramount concern for the public and for livestock producers.

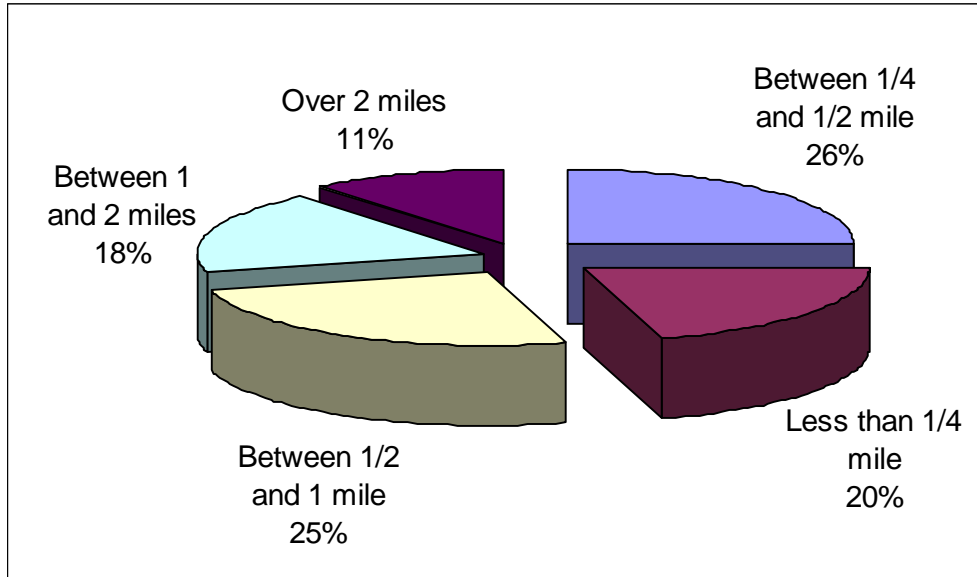

Figure 2. Distance from annual survey respondent's residence to closest neighbor's livestock facility. Source, Lasley, 1998

Table 4. Average separation distances of U.S. hog manure storage facilities and manure lagoons from the nearest occupied house. ^a

Capacity of Hog Facilities	500-999 (# Head)	1,000-2,499 (# Head)	+2,500 (# Head)
Storage Facility to Nearest Occupied House (ft)	755	770	1,200
Manure Lagoon to Nearest Occupied House (ft)	1,386	1,344	3,191

^a Source USDA, 1996

Livestock Odor and Socio-Economic and Environmental Concerns

There are serious social ramifications involved with the issue of livestock odor and odor management. Much research supports the concern that livestock generated dust and gas concentrations can affect human and animal mental and physical health (Schiffman et al., 1998; Cunnick, 1995; Donham, 1998a; Donham, 1998b). Also, there is increased concern that bio-aerosols and airborne endotoxins within the odor plume could cause humans and animals health problems (Homes, 1995). Research points to decreased real estate values (Hudson, 1998; Colindres, 1998; Palmquist, 1997) and negative effects on recreation and tourism (Okun, 1997; Hatfield, 1997). Neighbors and communities are being strained by the livestock odor issue (Chapin, 1998; Thu, 1998; Thu, 1997; Person et al., 1995). Legal and civil rights battles have been cited in the national media including a Pulitzer Prize winning news article from the News & Observer, Raleigh, NC and a “60 Minutes” piece about large-scale hog farms and African-American communities (Thu, 1998; News & Observer, 1995).

Legal Considerations and Livestock Odor

To date, odor and air quality issues involving industrialized animal production in the U.S. have received relatively little regulatory attention. Unlike many European livestock producing countries, there are no U.S. federal laws and that regulate livestock odor directly (Chapin et al., 1998a; Hamilton, 1992), some countries with strict livestock odor control laws include Great Britain, the Netherlands, Germany, Denmark, Sweden, and Greece. There are also very few state laws regulating odor directly, for example, Minnesota has a hydrogen sulfide reduction program which is currently the most extensive livestock air pollution program in the United States (Chapin et al., 1998a). Oklahoma signed Senate Bill 1175 in June of 1998 which includes a provision requiring an Odor Abatement Plan (OAP) for new and expanding swine facilities. The OAP must include preventative, site-specific methods for reducing odor from: 1) animal maintenance sources, 2) waste storage, 3) land application, and 4) carcass disposal (Chapin et al., 1998b). However, there are no provisions regarding success of abatement and /or monitoring. Also, Colorado just recently declared that owners of factory hog farms would have to cover waste lagoons and control odors emanating from their operations under rules adopted by the Colorado Air Quality Control Commission (Eddy, 1999).

Most other state regulation involving odor is ancillary to other concerns such as water quality issues. For example, odor controls typically include enforced separation distances from occupied dwellings, wells, and surface water, although such regulation occurs mostly to protect surface and belowground water quality (Heber, undated).

Federal interpretation of odor issues can be summed up in the EPA administrators' office stating that odors are a local problem amenable to local controls rather than a national problem requiring national controls (Sweeten and Levi, 1996). In short, the U.S. EPA also offers no odor control assistance. This statement may be the result of the assumption that almost all malodorous substances are thought to be non-toxic, organic or highly reactive inorganic compounds, that do not cause physical damage or pollute anything (at least in a legal sense) (Sweeten and Levi, 1996).

Until recently, there was not much information regarding any chronic or acute medical conditions caused by repeated or prolonged exposure to odor concentrations. This topic is being studied to a higher degree now (Schiffman et al., 1998; Donham, 1998; Cunick, 1995; Donham, 1990) and it may play a more significant role in future odor control regulation.

This lack of regulation in the U.S. has forced neighbors of animal production facilities to resort to traditional common-law nuisance suits instead of depending upon agency intervention (Chapin, 1998; Hamilton, 1992). State "right-to-farm" laws typically have extended animal producers some protection against nuisance suits, however, recent changes in some states have left many producers vulnerable to litigation and indeed some odor related lawsuits have recently gone to trial (Chapin, 1998; Gault, 1998; News and Observer, 1995). A 1999 Animal Confinement Policy Task Force survey, of the 35 participating states, 17 indicated that currently there was active court action involving confined livestock operations, much of it odor related (Edelman, 1999).

The high costs that are often associated with defending nuisance suits, even when successful, make them a very serious issue to all livestock producers in the U.S. and worldwide (Hamilton, 1992). The cost and risk of litigation are, perhaps, the major reasons why all 50 states have created right-to-farm laws protecting, to an extent, the rights of food producers to produce the nation's most important commodity without fear of litigation over common farm externalities (Hamilton, 1992). These laws are designed to protect existing agricultural operations by giving farms that meet state (and Federal) mandated legal requirements a defense against nuisance suits (Chapin et al., 1998a; Hamilton, 1992). North Carolina's right-to-farm law is typical. It declares that an agricultural operation, which has existed for a year without being a nuisance, is presumed not to be a nuisance even when new neighbors move adjacent to it. This applies to any rural neighbors as well as urban and suburban expansion (Nolo Press, undated).

Several states list specific annoyances that are not considered a legal nuisance to neighbors. The lists include odor, noise, dust and the use of pesticides, the very conditions that, without the right-to-farm laws, could lead to a lawsuit by a neighbor. Right-to-farm laws do not give farmers complete freedom to manage their operations with disregard. Farmers must operate in a legal and reasonable manner to be eligible for the law's protection. Some states, New York and Florida for example, do not allow a protected farming operation to undergo a large increase in size (Hamilton, 1992). Many right-to-farm laws do not allow farmers to substantially change their operations, if they are to remain protected under the law. Also no right-to-farm laws protect operations that

do not follow normal waste management procedures and regulations or who deliberately annoys neighbors (Nolo Press, undated).

Of considerable importance to this issue the Iowa Supreme Court made a decision on September 23, 1998 that effectively struck down the Iowa right-to-farm law, Iowa Code, Chapter 352.11. (Borman v. Board of Supervisors, No. 192/96-2276, Iowa, September 23, 1998). The court unanimously ruled that the nuisance protection such as odor from livestock production, offered to Iowa farms operating in designated agricultural areas, amounted to an easement and was fragrantly unconstitutional (Lucht, 1998). The Justices concluded that “the challenged statutory scheme amounts to a commandeering of valuable property rights without compensating the owners, and sacrificing those rights for the economic advantages of a few...(and) is plainly we think flagrantly unconstitutional.” (NRDC, 1998).

When the United States Supreme Court refused to rehear the Iowa case and let the ruling stand, it opened up the possibility for national ramifications, putting into question all the 50 states right-to-farm laws. In Iowa, opinions relating to the court decision are varied. The Iowa Center for Rural Affairs (1998) hoped the decision will “open up the door for debate on policies relating to pork production in Iowa and other states and allow the state to promote responsible pork production on independent, family farms”. The Iowa Pork Producers Association, however, was very much concerned that the ruling would open the door to removing other nuisance protection clauses and damage the attractiveness of investing in agriculture (Lucht, 1998). The Iowa Farm Bureau considered the ruling a serious threat to livestock production across the country. However, the words of a Springville, Iowa family farmer may be the most salient: “(Animals) smell. Where are we going to raise them?” (Cedar Rapids Gazette, 1999).

Livestock Odor and Odor Control

Regardless of how odors may cause air and water pollution and perhaps human and animal health problem, odors need to be dealt with by livestock producers. Lasley (1998) in an annual survey of Iowa farmers indicated that 85% of the surveyed farmers (n = 2,312) believed that people who live in the country must accept the presence of livestock. While most (71%) of Iowa farmers also feel that most livestock producers are doing a reasonable job in controlling negative externalities (i.e. odor and noise), 63 percent agreed that the frequency of livestock odor is increasing in Iowa. Lasley also reported that while 83 percent of the farmer respondents indicated that they were not opposed to neighbors raising livestock just as long as it did not affect their quality of life. Nearly one-fourth of the respondents, however, perceive that neighboring livestock production is diminishing their quality of life. Odors from livestock and poultry production and manure storage and land application were listed as the major detractors to their quality of life (Lasley, 1998).

Many odor control management technologies are available. They generally fall into one of three strategic categories: the first deals with the prevention of odor and involves technologies such as manure and feed additives; the second technology attempts to capture and destroy odors before they are released into the atmosphere and involve techniques such as chemical scrubbers and biofilters; and the third technique uses innovations that attempt to disperse and/or dilute odors before they can accumulate and become a nuisance and involve manipulating air movement using barriers made of living

trees and shrubs (Schmidt and Jacobson, 1995). It is this last strategy that is the particular focus of this review.

Shelterbelts Defined

In simple terms, shelterbelts are vegetation systems that typically use trees and shrubs to redirect wind and reduce wind speeds, thereby modifying environmental conditions within the upwind and downwind sheltered zones. In early research the concepts of shelterbelts and windbreaks were differentiated. Shelterbelts were defined as tree plantings designed to protect fields from soil erosion and to improve crop yield, whereas windbreaks were defined as tree plantings designed to provide wind protection for a farmstead or a feedlot (Baer, 1989). More recent literature, however, often uses these terms interchangeably and has expanded the type of vegetation considered effective for shelterbelt purposes.

The effects from a shelterbelt depend on several physical and management characteristics. The internal and external structures of a shelterbelt are very important. In terms of the internal structure, porosity (also often referred to as density) is the most commonly used descriptor, porosity being a simple ratio of perforated area to total area (Heisler and DeWalle, 1988). Shelterbelts with a porosity/density of 40 to 60% provide the greatest reduction in wind speed over the greatest distance (Brandle and Finch, 1991). External structure can be described as the height, width, number of rows, species composition, length, orientation, continuity, and design of the vegetation used. Management characteristics can include: the goals of the shelterbelt; species selection, planting technique and planting design; manipulation of porosity; and maintenance (Brandle, 1998).

The basic wind dynamics involved with a shelterbelt are that when wind approaches a windbreak, some of it will pass through the vegetation, some will pass around it, with the remaining wind being lifted up and over the belt of vegetation. The lifting aspect will begin at some distance on the windward side, typically a distance equal to 2 to 5 times the height (referred to as $2-5 H$) of the shelterbelt. Measured reductions in wind speed to the lee (downwind) of a shelterbelt have been varied, with some being recorded as far as $50H$ of the shelterbelt (Heisler and DeWalle, 1988). Wind speed reductions to about $30H$ are more typical.

As a result of these reductions in wind speed and changes in the turbulent transfer between stratified air layers, a site can experience beneficial microclimate changes. These beneficial changes include: solar radiation transfers (the amount of energy per unit surface area per unit time), improved temperature conditions, more efficient moisture relations, and increased CO_2 fluxes. The magnitude of microclimate changes will vary within and between shelterbelt systems depending upon the internal, external, and managerial characteristics of the system.

Microclimate modification has been linked to increased yields of forage and field crops. Crops that seem to benefit most from shelter are corn, sugar beets, winter wheat, rye, barley, millet, alfalfa, hay (Schroeder and Kort, 1989; Kort, 1988). Because of enhanced efficiency in moisture use, yield increases due to shelterbelts are often more prominent in drier climates and during drier years. These yield increases can provide improved economics to marginal lands (Norton, 1988).

Changes in wind dynamics can benefit farm systems by reducing soil erosion (Tibke, 1988). Lower wind speeds can reduce damage to tomatoes, peppers, leaf lettuce, peas, beans, and other garden vegetables (Wight et al., 1991). Sheltering animals from summer and winter winds is a major benefit to outdoor livestock production as there is often a reduction in animal stress, improved animal health and birthrates, and increased feeding efficiency (Quam and Johnson, 1994). Areas that have frequent dust storms benefit from control of blowing dust (CDC, 1988). Fruits and vegetables that require insect pollination also greatly benefit from wind protection (Naeve, 1995; Wight et al., 1992; Kort, 1988). Reduced windspeed can improve the effectiveness of pesticide application, through reduced drift and evaporation so that more of the chemical reaches the target plants (Ronneberg, 1992). Another potential benefit is in the control of drifting pollen from a non-organic farm into an organic farm. The organic certification process precludes organic foods that may have been pollinated by genetically altered organisms. Also, reduced wind speeds can also improve working and living conditions for humans.

Possible market products and conservation benefits from the shelterbelts include: wood products, forage crops, nuts, berries, and flowers. Shelterbelts can be used within a riparian (stream) buffer system to help control runoff from agriculture fields. Shelterbelt systems have been used for years to help control noise, such as that coming from airports and highways (Vanhaverbeck and Cook, 1972). These systems are now being investigated for their potential as carbon sinks to offset atmospheric carbon emissions (Kort and Turnock, 1996). Shelterbelts also provide wildlife habitat for many mammal and bird species (Ronneberg, 1992; Johnson et al., 1991).

Improved aesthetics is also a major benefit as noted in Ronneberg (1992), "Visual diversity...(is) preferred to open landscape". It is generally accepted that a well-landscaped livestock operation, which is visually pleasing (or even hidden from view by landscaping) is much more accepting to the public than one which is not (Lorimor, 1998; NPPC, 1995; Melvin, 1996). If it is made known to neighbors and local communities that a shelterbelt is being used as a pollution (air or water) control tool, it can serve as very visible proof that a livestock producer is making an effort to control some of their externalities. Such a thing may prove valuable in terms of public relations.

There are few economic analyses of shelterbelts where the results can be generalized to many regions and situations. One primary reason for this is that each farm situation involving shelterbelts has unique management goals and uses different planting designs, making analytical results site specific. For those studies that are available the results are favorable. In one study, an attempt was made to determine if yield increases due to the use of shelterbelts is sufficient to offset the costs associated with the cropland removed from production. Brandle et al. (1992) calculated the economic profitability of shelterbelt investments for several hypothetical farm situations based on the benefits and costs over time. Using a capital investment, net present value (NPV) approach, Brandle et al. determined that investment in an shelterbelt that occupies 5% of a farm field is economically sound over a range of economic and crop production parameters. It was further concluded that long-term crop yield for soybeans, corn, and wheat of just 6%, more than compensate for the cost of establishing the shelterbelt and the loss of crop output from acres taken out of production (Brandle et al., 1992). Ronneberg (1992) summarized another Brandle led study (Brandle et al., 1984) that investigated the economic benefits of a two-row windbreak system on a 160-acre winter wheat field that

at its largest, the windbreak occupied 6.25 % of the field. Below in Table 5 are some of the key facts and figures of that study as documented by Ronneberg.

Table 5. Economic data from economic benefits analysis of a two-row windbreak system on a 160 acre winter wheat field. ^a

• Total cost of establishing shelterbelt system over three years: \$5, 320
• Number of years until the increased yields fully compensate for acreage occupied by shelterbelt: 8
• Number of years until shelterbelt is fully matured: 12
• Yield increase with mature shelterbelt: 15 percent
• Annual economic benefit of mature shelterbelt (due to increased yield, lower production costs): \$2, 555
• Present value of cash flow due to shelterbelt was:
- \$22, 184 at 5 percent real interest rate
- \$5, 450 at 10 percent real interest rate
- \$589 at 15 percent real interest rate

^a Data from Brandle, 1986 and Brandle et al., 1984, summarized by Ronneberg, 1992

It is important to point out that only the economic benefits from increased crop yields were considered in these studies. If some of the other above-mentioned benefits (i.e., pollution buffering, product diversification, recreation potential, CO₂ sequestration) from shelterbelts were considered the net return would most likely be even more favorable.

Shelterbelts and Odor

Several factors need to be considered to assess the ability of shelterbelt vegetation to ameliorate odors emanating from livestock facilities. Key information includes the animal type and management system being utilized, and the physical source of odor. Others are the chemical makeup of odor and the odor emission type - dust or gaseous emission. Four primary ways that a shelterbelt system may cause reduction in malodorous compounds associated with livestock production have been identified:

- 1) Dilution of gases into the lower atmosphere;
- 2) Reduction of surface winds allowing for dust and aerosol deposition;
- 3) Physical interception of dust borne odor particles; and the
- 4) Chemical adsorption and absorption onto/into the vegetation and the micro fauna and flora residing upon the vegetation.

The potential of shelterbelts for agricultural odor mitigation is really defined by the characteristics of livestock odors. Agricultural odor sources are unique compared to other large-scale odor sources such as industrial sources in that the odor source is at or very near ground level, there is limited plume rise due to the vertical momentum or lower density of a mass flow of warm gas, the odor source may be of relatively large areal extent, the spatial and temporal variability in emission rates, and of particular import, the critical receptor zone (people encountering the odor) may be relatively close to the source of emissions (Smith, 1993). For these reasons, shelterbelts may work very well within an

agricultural landscape to provide assistance in odor control. Because the odor source is near the ground and the tendency of the plume is to travel along the ground (Takle, 1983), shelterbelts of even modest heights (i.e. 20-30 ft) may be ideal for plume interception (Laird, 1997; Thernelius, 1997; Heisler and Dewalle, 1988). Shelterbelts can easily be designed as to fit the production situation and expected odor plume. Also, depending on the shelterbelt design and species used, they can deal with some of the temporal characteristics and provide year round plume interception.

It is important to keep in mind that the use of shelterbelts to help ameliorate the effects of odor is not limited to livestock producers. Rural residents, people living in expanding urban areas close to agriculture fields, and recreational sites can also plant shelterbelts in and around their homes, neighborhoods, and communities. The public can take a proactive role in current and future protection against odor problems emanating from existing, new, or expanding livestock operations.

Important Aspects of Livestock Odor

When dealing with odor, the location of where the odor develops is a very important consideration. There are three primary sources of odor in confined animal production: the animal confinement buildings, manure storage facilities, and land application (Swine Odor Task Force, 1995). Hardwick (1986) counted the number of agricultural premises in the United Kingdom that were causing justifiable odor complaints and found that among 1,820 pig, cattle, and poultry farms, 46% of the complaints were associated with slurry spreading, 25% regarding building odors, 19% were in regards to manure storage. Most complaints were associated with pigs (56%) followed by poultry (24%), and cattle (20%) (Hardwick, 1986). In another UK based study, it was found that of the 2200 odor complaints in the year 1984, over 50% were associated with pig farms and almost 50% of the total was associated with the spreading of slurry or manure on the land (Pain et al., 1988). Swine odors typically are associated with most odor complaints because of characteristics specific to swine manure. Swine excretions are the most liquid of all livestock excretions, which quickly leads to anaerobic decomposition and producing stronger and more toxic odors than dry manure (Ritter, 1989). Another characteristic of swine manure is that it has very high biological oxygen demand (BOD) and will start to anaerobically decompose within 24 hours of elimination (Barrington, 1997).

Land Application of Livestock Manure

The manure of livestock is very nutrient rich and is often utilized as fertilizers for pastures, crops, and even woodlands (Chapin et al., 1998a). Farms that integrate crop and livestock production often use manure to reduce the need for chemical fertilizers and can reduce farm operation costs significantly. A study that examined the economics of various application rates of liquid manure in Iowa, noted that the highest economic return (\$379) was from lands treated with manure applied at 2000 gallons per hectare compared to commercial fertilizers (\$337) at the recommended rate for that region and crop (Chase et al., 1991). Chase et al. concluded that with increasing cost of chemical fertilizers, the profitability of using manure as a nutrient source will increase. A major problem associated with this is that most confined animal producers do not integrate livestock and crop enterprises. Letson and Gollehon (1996) reported that the number of animal units

per available acre for land application of manure differed considerably with facility size. Large-scale producers have the smallest area of cropland. As an example Letson and Gollehon noted that 1 percent of beef feedlots (the largest producers) produce 71 percent of fed beef, but have only 2 percent of the cropland on feedlot beef farms. Below in Table 6, data from 1992 illustrates this disparity between the size of operation and available cropland. Because of this condition livestock producers are often forced to transport solid and liquid manure significant distances for fertilization purposes. Transporting liquid manure comes with high cost, thus limiting the distance that most producers are willing to haul liquid manure to about a maximum of 1 mile.

Table 6. Farm type, animal units (AU), and cropland, by confined animal facility size, in the US, 1992.

Animal Type	Small (<50 AU) Acres of cropland (1,000 acres)	Medium (51-999 AU) Acres of cropland (1,000 acres)	Large (>1,000 AU) Acres of cropland (1,000 acres)
Fed Beef farms	34, 199	10,160	1,117
Dairy farms	6,097	32,542	515
Swine	17,029	37,121	1,795
Turkeys	848	535	33
Layers	8,848	881	149
Broilers	2,207	1,371	211

^a Data from Letson and Gollehon, 1996

Manure from cattle in a feedlot is usually solid and considered an economical chemical substitute for fertilizer. Studies in Alberta, Canada found the economical hauling distance for manure from large scale beef feedlots (hailed in single axle trucks) to be about 9.4 miles (Freeze and Sommerfelt, 1985). In the US where most beef production occurs, has considerable crop acres, so a nearby land base exists for utilization of the manure (Eghball and Power, 1994a). Acceptable soil loading rates for livestock manure have not been adequately defined, however.

The high cost for manure hauling combined with the lack of information regarding acceptable rates of manure application often encourages over-application on fields located as close to the animal production sites as possible. Over-application, particularly repeated over-application, can lead to many different environmental and economic problems. Problems of particular concern include: run-off pollution (Letson and Gollehon, 1996), ground water contamination (particularly from nitrate leaching) (Jackson, 1998; Bailey and Buckley, 1998), nutrient loss and air pollution concerns (particularly ammonia volatilization) (Bailey and Buckley, 1998; Berglund and Hall, 1988), possible crop damage from excessive nutrients (particularly phosphorus which can build up in the soil), and of course, odor.

Vegetation can be useful to control odors emanating from these fields (this aspect is discussed in detail in later sections) and to provide an additional sink for manure, in some small scale cases limiting hauling distances and reducing, to some degree, potential over-application on agricultural fields. A study from Iowa of land application of treated municipal biosolids to a system of tree rows and alley crops has shown that trees within a shelterbelt system can effectively utilize nitrogen. With 150 to 300 pounds per acre of

nitrogen applied to the hybrid poplar trees, tree biomass was enhanced by 30 to 40 percent compared with no nitrogen application and that no off-site negative impacts occur on soil and water resources (Thompson et al., 1996).

Constituents of Livestock Odor

When discussing odor, the distinction should be made between odors and gases. The term "odor" actually refers to the complex combination of gases, vapors, and dust that result from both the feed method, animal living arrangements and the anaerobic decomposition of manure (Chapin et al, 1998, NPPC, 1995). Anaerobic decomposition of animal manure involves a complex series of digestive reactions by diverse populations of bacteria that metabolize the nutrients contained within the manure and subsequently converts these chemicals to various odorous compounds (Williams, 1996). Aerobic manure management does exist and odors emitted from such systems are considerably less noticeable than anaerobic systems. However, anaerobic manure management is more cost effective and thus more prevalent. For example, in the United States, more than 75 percent of the swine production systems process waste anaerobically (Zahn et al., 1997). Gases refer solely to the specific gaseous compounds that are produced and emitted from a source.

Researchers have identified 60 to 168 specific odorous components in animal manure odor that are end products and intermediates of the anaerobic decomposition process (Zahn et al. 1997; Hartung and Phillips, 1994; Koelsch, 1995; Yasuhara et al., 1984; Hammond and Smith, 1981, Melvin, 1996). The familiar manure odor is a product of a complex interaction and intermingling of individual odorous and non-odorous components (Melvin, 1996). Some of the identified volatile substances include fatty acids, organic acids, alcohols, aldehydes, carbonyls, sulfides, esters, mercaptans, amines, nitrogenous compounds, fixed gases, phenols, indoles, and methylamines (Chapin et al., 1998a, Zahn et al. 1997, Hartung and Phillips, 1994, Hammond and Smith, 1981, Hammond et al, 1979, Melvin, 1996). The primary gases produced are ammonia (NH₃), hydrogen sulfide (H₂S), methane (CH₄), and carbon dioxide (CO₂) (Chapin et al., 1998a; Hartung and Phillips, 1994). These gases can add to the overall odor plum and when air borne, they can pose serious threats to human, animal, environmental, and community health. These dangers have been documented and researched extensively (Lorimor, 1994; Chapin et al, 1998; SOTF, 1995; Thu, 1998; Donham and Thu, 1993).

For odor control purposes it is important to know some of the physical characteristics of each of these gases. Methane and carbon dioxide are odorless, but are considered major greenhouse gasses. Ammonia is lighter than air and is often quickly dissipated, but it is considered a major constituent of air pollution and can cause significant environmental damage (for an extensive treatment of ammonia dynamics and environmental concerns see Asman et al., 1997). Hydrogen sulfide is 20 percent heavier than air, has an extremely powerful "rotten egg" smell, and can be detected in concentrations of about 5 ppm (Farm Safety Association, 1985). Because of the density of hydrogen sulfide it disperses slowly and due to its high toxicity this makes hydrogen sulfide an extremely dangerous gas in terms of human and animal health.

The emission process of these odors can be divided into two paths, gaseous emissions and aerosol (dust) emissions, though both are typically combined within an overall odor plume. The effects of aerosol emissions once they reach a smell receptor (humans) are instantaneous. Gas emissions from livestock systems, particularly highly

volatile compounds like ammonia, have much more subtle effects (Jacobson, 1995). Gas effects typically manifest themselves in the form of long-term environmental degradation rather than short-term odor effects.

The dynamics of odor movement are very complex and still not fully understood. To measure offsite odor movement, atmospheric dispersion models are often used. Understanding the dynamics of an odor plume in general and in specific situations is integral to the examination of odor nuisance situations and to optimization of design and siting of livestock operations and odor management technologies (Heber, 1997; Gassman, 1995; SOTF, 1995; Person et al., 1995).

There are many different ways to model odor emissions and air quality, in general there are four typical methods: Gaussian, numerical, statistical, and physical models (Gaussian models are used with the most frequency due to its relative mathematical simplicity) (Li et al., 1995). In a review of odor transport modeling methodologies Gassman (1995?) discusses in detail some of the current techniques and difficulties. The Gaussian plume dispersion equation, which has dominated the methods used in the attempt to quantify pollutant transport, is discussed at length. The Gaussian plume dispersion equation is a mathematical model that examines the concentration of odor over spatial and temporal paths using variables such as: odor units average over time, distance traveled downwind, crosswind distance, plume height above ground, emission source height, emission rate. Modifications to the Gaussian equation to better represent the variables involved with agricultural sources of odor are often utilized (Gassman, 1995; Keddie, 1980). The most important variables that essentially drive the equation are the coefficients that represent the plume crosswind and vertical spread as functions of downwind distance, time, and wind speed (Gassman, 1995, Gassman, 1992).

According to Gassman, air flows over the planetary boundary layer, however, do have turbulence patterns that fall out of the range of the Gaussian models typical parameters. Turbulent flows such as flow over irregular or rugged terrain and those in the lee of flow obstacles are considered exceptional and non-Gaussian. Therefore many researchers have developed modified Gaussian models. Krause (1994) and Cha and Jann (1990) are two notable sources that discuss odor dispersion using non-Gaussian dispersion simulation. For a more in depth discussion of odor transport from ground level agricultural sources see Smith (1993).

Particulate Matter and Aerosol Transport of Livestock Odor

Particulate matter is a component of odor plumes and closely related to odor from cattle, swine and poultry (housing) facilities and the outdoor lots for swine, cattle, and sheep. The majority of the odorous compounds listed above are easily absorbed onto and carried by animal dust and other particulates (Laird, 1997, SOTF, 1995). Dust can carry many times more molecules of some odorous compounds than the same volume of air, thus concentrating odors (OCTF, 1998). As reported in Hoff (undated), it has been hypothesized by Hammond and Smith (1981) that dust particles holding absorbed odors more readily adhere to human olfactory tissues within the nasal cavity than do odorants molecularly dispersed in the gas phase. The importance of dust in the transportation of odor from livestock buildings has been well documented (OCTF, 1998; Thernilius, 1997; Laird, 1997; SOTF, 1995; Carpenter and Mouldsley, 1986; Hartung, 1986; Hammond et al., 1981; Hammond and Smith, 1981).

It has been noted that the odors generated in animal facilities, such as animal houses, feedlots and storage lagoons, that are intense and detectable at appreciable distances are all aerosols (Hammond et al., 1981). An aerosol being a suspension of solid or liquid particles in a gas with particle size ranging from 0.002 to more than 100 μ m (this includes such things as dust, clouds, fumes, mist, fog, smog, smoke and sprays) (Hinds, 1999).

Researchers have identified the important dust-borne odorants in swine confinement facilities as being various long chain fatty acids, phenols, and carbonyl compounds (Hammond and Smith, 1981; Hammond et al., 1979). A survey of molecularly dispersed odorous chemical constituents performed by Hammond and Smith (1981) reported that butyric, phenylacetic, hydrocinamic, and 2-phenylpropionic acids; p-cresol and ethylphenol; and several carbonyl compounds as the chief odorous compounds adsorbed on the dust. Hartung (1986) discovered that 1.0 m³ of the exhaust air from a 500 head pig fattening unit can contain dust borne 6.27 μ g volatile fatty acids and 2.76 μ g phenolic/indolic compounds. It has been concluded by some (Thernilius, 1997; Laird, 1997, SOTF, 1995; Hammond and Smith, 1981; Hammond et al., 1979; Hoff et al, undated), that removing these dust particles, may cause animal houses, lagoons, and feedlots to become almost odorless. Eby and Willson (1969) report that most of the odor from poultry houses can be eliminated by removal of air borne dust. Hartung (1989) stated that filtering the dust from exhaust air could reduce odor emission from animal houses up to 65%.

There is often a fairly large quantity of air borne dust found in and around animal confinement buildings. Hoff (undated) cited a study by Stroik and Heber (1986) who monitored 11 commercial swine houses and found dust concentrations up to 33 mg/m³ with a mean for all houses of 7.5 mg/m³. This dust, depending on the animal, comes from dried manure, feed stuff, animal dander, dead skin, feathers, molds, and pollen that is agitated by the feeding method and the general movement of the animals (Laird, 1997; SOTF, 1995).

This dust is then swept from the buildings by way of open air or mechanical ventilation. It is important to distinguish between natural and mechanical ventilation because of its relationship to odors and dust in the buildings, which directly relates to odor emission and the types of odor control methods that can be used (OCTF, 1998). To get an idea of differences in dust emissions due to ventilation strategies, one study compared total dust in the air of buildings that were naturally ventilated and those mechanically ventilated. The study indicated that the dust content in naturally ventilated buildings ranged from 1.55 - 4.48 mg/m³ and the mechanically ventilated buildings ranged from 0.60 --2.08 mg/m³ (Meyer and Manbeck, 1986).

Dust concentrations in the ambient air outside of the animal buildings are to a large degree determined by building ventilation rates. In a survey of mechanical ventilation rates in Northern Europe, winter and summer ventilation rates were recorded. On the basis of 500kg animal liveweight, the mean ventilation rate for pig houses were 428 m³/hour in the summer and 241 m³/hour in the winter. Cattle house ventilation rates were 404 m³/hour and 341 m³/hour, respectively, and poultry houses had the highest ventilation rates, recorded at 965 and 451, respectively (Seedorf et al., 1998b). Takai et al. (1998) conducted field surveys of dust concentrations within and dust emissions from 329 cattle, pig, and poultry buildings throughout Northern Europe.

Dust concentrations and emissions were found to be strongly affected by animal, feeding system, and by housing type. Emission rates of inhalable and respirable dust were found to be highest in poultry houses at 3165 mg/h and 505 mg/h respectively, pig houses had rates of 765 mg/h and 85 mg/h respectively, and cattle houses were found to have concentrations of 145 mg/h and 24 mg/h (Takai et al., 1998). Dust concentrations tend to increase as the fattening process progressed in pig and poultry buildings (Hinz and Linke, 1998). Takai et al. (1998) also noted that the floor type (litter and slatted) influenced dust concentrations. Dust concentrations in cattle houses tended to be higher where bedding (litter) was used. The opposite tended to occur in pig houses where slatted floors produced higher dust concentrations. In poultry houses, percherics had much higher dust concentrations than caged units.

Feeding methods also plays a role in dust concentrations, as there are higher dust levels for self-fed animal systems than for controlled feeding systems (Stroik and Heber, 1986). Researchers have also found notable seasonal effects on concentrations and emissions in pig and poultry houses, with higher dust concentrations in the winter than summer but higher emissions of inhalable dust in summer than winter (primarily due to higher ventilation rates during the summer). Seasonal variations in cattle houses were weak (Hinz and Linke, 1998; Takai et al., 1998).

The dust emission characteristics of different farm systems need to be taken into account when odor control management is considered as they have different consequences for each farming situation, (that is farm size, waste management techniques, odor control, ect.). An example, from Takai et al. (1998), assumes that the inhalable dust emission rate per cow in a cubical is 120 mg/h (500kg liveweight), 973 mg/h (500kg) for a fatterner pig, and 3570 mg/h (500kg) for a broiler chicken, then 8 fatterner pigs and 30 broiler chickens are equivalent to one cow in terms of emissions. Therefore, differing herd sizes will have very different emission patterns. So a typical dairy farm with 50 cows emits only 6 g/h. Contrast this with emissions of 88 g/h for a medium-sized hog farm with 500 pig fatterners, and 286 g/h from a broiler unit of 20, 000 birds. These types of variables play vital roles in the selection and use of odor management systems including shelterbelt systems. Dawson (1990) provides an in-depth literature review of various techniques to minimize and control dust in and around livestock buildings.

Shelterbelts and Odor Control

Potential Roles of Shelterbelts

There are four primary ways that shelterbelts can ameliorate livestock odors:

- 1) Dilution of gas concentrations of odor into the lower atmosphere
- 2) Encouraging dust and other aerosol deposition to the windward and lee sides of the break by reducing wind speeds
- 3) Physical interception of dust and other aerosols
- 4) By way of acting as a sink for the chemical constituents of the odorous pollution

Several sources (Koelsch, 1999; WED, 1999; NPPC, 1999; Lorimer et al., 1998; OCTF, 1998; Jacobson et al., 1998) list shelterbelts as odor control devices, but provide

little physical, biological, or economic quantification as to effectiveness. Gassman (1995) concluded in a review of available literature that shelterbelt and other vegetation impacts on odor movement and abatement have yet to be studied in detail.

The following sections present examples of scientific evidence that supports each of the four hypothesized ways that shelterbelts may deal with odor. The cited literature is selective rather than comprehensive.

Dilution of gas concentrations of odor into the lower atmosphere

Animal confinement buildings are ventilated in one of two primary ways: ventilation by way of natural, open-air methods and by way of mechanical ventilation. Regardless of the ventilation process utilized, it is this ventilated air that contains odorous gases and odor containing dust particles. This air is in most cases exhausted without prior treatment. Once outside the confinement, depending on the current climatic conditions, these odorous aerosols and gases can travel significant distances.

The conditions leading to pollutant trapping by the atmosphere are well known (Takle, 1983; Takle et al, 1976). Temperature inversions can create this situation as the inversion can restrict air mixing into the lower atmosphere. Atmospheric inversions, where the normal temperature structure of the atmosphere is reversed, that is temperature increases with height rather than decreases, result in stable atmospheric layers which play significant roles in the extent and effects of odor plumes (Australian EPA, 1997). High concentrations of pollution can occur at ground level as a result of ground-based inversions preventing or limiting vertical mixing or atmospheric layers (Australian EPA, 1997). Low wind velocity and lack of physical landscape features that create turbulence can also contribute to pollutants being trapped in the atmosphere (Takle et al, 1976). As wind speeds decrease, there is less turbulence, and therefore less dilution of escaping odors. The odor problem has a tendency to be most severe during stable, night-time conditions with low to moderate wind speeds, at which times odors emitted near the surface will not diffuse upward but remain near the surface and travel by way of near laminar flow that will meander over the terrain (OCTF, 1998; SOTF, 1995; Takle, undated).

Air temperature is also a major factor. At higher temperatures, the conditions for anaerobic decomposition can improve, and greater volatility of odorous compounds may occur (NPPC, 1995; SOTF, 1995). When these weather conditions occur singly or simultaneously, odor has been noted to be transported to distances greater than two miles (NPPC, 1995). Shelterbelt systems may be of value in dealing with these situations.

Shelterbelts have the ability to lift some of the plume constituents into the lower atmosphere aiding in the dilution and dispersion process. As studies in the distribution of windblown pollution indicate, the properties of the underlying surface (terrain) is important in deflecting the airstream or in modifying the rate of mixing and consequent dilution of the material carried with it (Pasquill, 1974). As discussed in McNaughton (1988) near shelterbelts, heat, vapors, CO₂ and other scalar quantities (including odor plumes) are transported along streamlines by the prevailing winds and subsequently across streamlines by turbulence. Shelterbelts present an obstacle to the wind, deflecting air streams upward. McNaughton (1988) further notes that as the air streams top the obstacle, the stream is redirected, compressed and air speeds increase. This effected zone above the shelterbelts has been noted at heights of 1.5 H (that is 1.5 times the height of

the barrier) to $1.7 H$. This zone then widens and follows the air stream downwind and acts as a source of turbulent kinetic energy. In studies that have modeled the dynamics behind artificial windbreak fences, a “quiet” zone that extends from the top of the barrier down to a distance of about $8 H$ from the barrier exists. Outside this quiet zone the longitudinal turbulent fluctuations are more energetic and larger in scale (McNaughton, 1988). It is in this zone, depending upon the height of the shelterbelt, that much of the dilution of the odor plume may take place, see Figure 3 below for a schematic of these processes. Porosity is of particular importance, in terms of turbulence, as shelterbelt porosities of $< 40\%$ are associated with the greatest amount of turbulent energy transfer.

Recent studies from North Carolina State University indicates that artificial wind break walls can deflect ventilated air so that air flows higher above the ground or the surface of downwind lagoons improving potential dilution of odors to the point of noticeable positive odor reduction downwind (OCTF, 1998; Bottcher et al, 1999). Dilution is important to reduce odorous gas concentration (which is the concentration of the odorous gas relative to the concentration at the threshold of detection as determined by olfactometry). Dilution to the point where it will not be considered, to some degree an on-site nuisance, and to a large degree an off-site, downwind nuisance is critical (Smith and Watts, 1994).

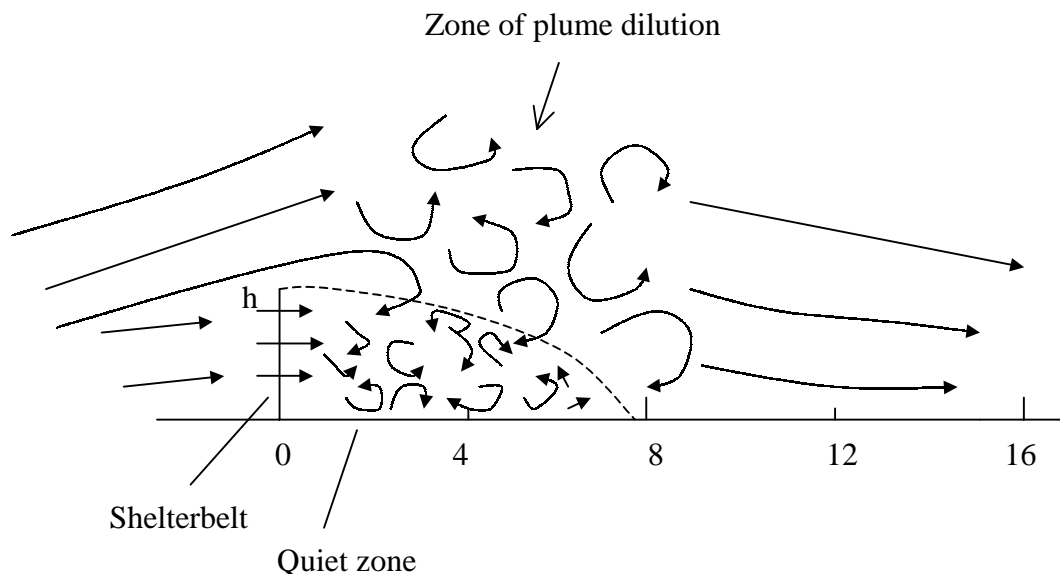

Figure 3. Schematic representation of turbulence and zone of potential odor dilution. Adapted from Raine (1974) as used in McNaughton (1988).

Dispersion as a control strategy involves using the natural turbulent mixing of the lower atmosphere to reduce concentrations emitted by an odor source to acceptable levels before the emissions reach a critical receptor such as humans capable of sensing an objectionable odor (SOTF, 1995; Penkala, 1977).

Encouraging dust and other aerosol deposition to the windward and lee sides of a shelterbelt by reducing wind speeds

A full understanding of the aerodynamics of shelterbelt systems is not available. However, there has been progress made in understanding turbulent transport of air over, around, and through windbreak structures as well as quantifying wind speed alterations (Wang and Takle, 1995; Zhang et al, 1993; McNauton, 1988; Heisler and DeWalle, 1988; Kort, 1988). The air turbulence and wind speed reduction creates situations where wind borne particles can be deposited at much shorter downwind distances than would occur without the break. Shelterbelt research has been carried out in both the field and by way of wind tunnel modeling. In the field, a barrier effect has been noted in the hedgerow systems in Britain as downwind spatial deposition patterns of various propagules have been identified (Burel, 1996). Ucar and Hall (1998), investigating windbreaks and agrochemical drift mitigation, discussed the exponential trends of drifted spray deposits. They determined that evidence from recent windbreak research indicate that even a simple vegetative barrier such as a single row of trees would reduce potential chemical drift significantly due to reduced wind speed (though they pointed out that that does not mean reduction to significant levels in all cases). Further, Ucar and Hall (1998) touched on a study by Porskamp et al. (1994) that suggests that windbreaks (made of alders in this case) can be utilized to reduce drift up to 70% when they are absent of leaves and up to 90% when in leaf. Deposition patterns have been noted in snow distribution studies. Kort (1988) listed several snow distribution studies in a literature review examining the benefits of windbreaks. Greb and Black (1971), in a comparison of differing windbreak fence densities, found that lower densities (37 and 58%) produced deep and narrow snow drifts, while the higher density fences (79 and 85%), resulted in shallow and wide drifts (Kort, 1988).

Related research has been conducted in regard to the use of shelterbelts and other wind barriers to control fugitive dust emissions in arid regions. Studies have concluded that physical wind barriers such as sand fences can absorb wind energy and reduce its velocity near the surface, thereby reducing fugitive particulate emissions (Grantz et al., 1998; Bilbro and Fryrear, 1995). Even topographical barriers as discrete as sparse shrub vegetation have been noted to effectively suppress dust emissions (Buckley, 1987).

Table 7. Average dust deposition results on the windward side of 21 shelterbelts in Indio, California. (Note that the relatively high value at 20 H was attributed to some localized soil disturbances that were not observed during sampling)^a

Distance to the Shelterbelt	Average Dust Deposition (mg)
0 H	.297
1 H	.181
5 H	.109
10 H	.096
15 H	.165
20 H	.268
30 H	.191

^a Data from CDC, 1988

Dust deposition in the windward side of a windbreak has been investigated. One study (CDC, 1988) tested 21 shelterbelts in California, for their ability to control fugitive dust. They examined patterns of dust deposition on the windward side of the shelterbelts.

Wind speeds involved in this study averaged from 2 to 7 mph with gusts of over 10 mph. There were measurable differences in deposited dust the closer the samples were to the shelterbelt, indicating that wind speeds were lowered below the threshold speeds needed to initiate dust movement (CDC, 1988). The results of this study are displayed in Table 7 above.

Windbreak walls are currently being used to reduce forward movement of ventilated air, causing odorous dust to settle and additionally to push air upward to aid in the dilution process, however, any records in the effectiveness of such use remains unpublished (Koelsch, 1999a; Koelsch, 1999b). Windbreak walls are an odor reduction technology used quite frequently, with observed success, in Taiwan where more than 200 farms have walls made of plastics, tarps, and plant residues erected downwind from tunnel ventilated poultry houses (Bottcher et al., 1999; Koelsch, 1999a; Koelsch, 1999b; OCTF, 1998).

Current research from North Carolina State University hopes to quantify both downwind dust reductions and any related reduction in detectable odor (Bottcher et al., 1999). Research assumptions were based on Liu et al. (1996) who numerically simulated the effects of tall barriers around manure lagoons and predicted reductions in downwind malodorous lagoon emissions of 26% to 92% for a range barrier distance to height ratio from 8 to 0.6. Coupling that information with what is known about dust/odor relationships (Hammond et al., 1981) and dust collection and deposition, a full-scale windbreak wall system was erected downwind of building exhaust fans at a swine-finishing farm in eastern North Carolina.

Preliminary results have shown less dust particle numbers downwind of the wind walls as compared to a wall-less control site. Data from the study also indicates that odors were stronger downwind of the building without the windbreak wall and inside the windbreak wall enclosure, than odors on the far side of the lagoon or 3 meters downwind of the windbreak wall (Bottcher et al., 1999). Despite these preliminary results, the mechanism for the odor reduction (increased dust deposition or increased atmospheric dilution) remains to be identified and fully quantified.

The difficulty in determining the effectiveness of windbreak walls or shelterbelts on odor control has been noted by several researchers. This difficulty is due to three notable factors. The first factor being the inherent difficulty in measuring complete wind directions in the field (Wang and Takle, 1995) and in ventilated air (OCTF, 1998). The second factor is in separating the source of odor, for example odors emitted from lagoons often complicate measurements in downwind odor reduction. The third factor involves the difficulty in measuring boundary layer/ turbulence effects from porous objects (Wang and Takle, 1995; Wang and Takle, 1994).

Field data does not exist yet that quantifies ability of a shelterbelt to reduce, through dust deposition, dust borne odor. Those effects, however, have been modeled by use of wind tunnels. Using wind tunnels to study particle motion in the atmosphere is a common technique. Scientists have used wind tunnel testing to model atmospheric boundary layers, study the effects of erosion, model snow drifts, track pollen dispersion,

study desert growth, examine mining residues, and to model pollution, and most importantly how to prevent these effects (Laird, 1997; Iversen and Jensen, 1981).

Laird (1997) and Thernelius (1997) both modeled the potential of windbreaks to deal with odor carrying dust. Using an open circuit wind tunnel at the Iowa State University Environmental wind tunnel facility and a small-scale model of an open air ventilated hog confinement building and a shelterbelt system in the form of strips of simulated vegetation; Laird and Thernelius were able to simulate the dynamics of dust particle transport. The hog house dust was simulated with highly ground walnut shells positioned within the model hog house. Digital imaging was used to examine the brightness of the wind tunnel floor as a measure of dust deposition behavior such as distance from model structure and depth of deposition over time. Multiple scenarios were tested using model variables such as number of parallel placed shelterbelts of various scaled heights and thickness as well as different wind velocity and wind angles. The objective was to minimize the particle/dust mass lost down stream in percent of the total mass leaving the model, the percent mass lost, and then to quantify the statistical relationship between the above variables and the percent mass lost. Polynomial regression techniques were utilized. Table 8 below displays the modeled effectiveness of downwind dust reduction due to shelterbelts. The last column on the right displays the percent of dust reduction. In the table the term “lost” refers to the amount of dust lost offsite (the farm area) and carried further downwind. Both researchers, however, noted that in order for the information they gathered to be useful in full-scale applications, it remains necessary to perform field testing. Based on the results, wind velocity,

Table 8. Downwind dust reduction associated with different wind parameters as modeled by way of wind tunnel examination using 3 rows of simulated shelterbelts.

Wind Speed (m/s)	Angle of Wind (°)	Height of shelterbelts (translated from 1:50 scale)	% Lost Without Shelterbelt	Best Case % Lost with Shelterbelt	% Reduction of % lost
4	0	16.4 feet	57.4	29.1	49.3
4	30	16.4 feet	75.3	32.8	56.4
5	15	12.3 feet	80.0	51.7	35.4
6	0	16.4 feet	81.9	49.3	39.8
6	30	16.4 feet	96.4	63.0	34.6

Source Laird, 1997 and Thernelius, 1997

number of shelterbelts, and the height of the shelterbelts are the most important variables with wind velocity being the most important. Successful reduction in mass transport far down stream, ranged from 35% to 56%, with the conclusion that this reduction would provide a substantial reduction in the effects of offensive odors in surrounding areas (Laird, 1997).

Vegetation type was not a variable nor was windbreak porosity, which has been noted as possibly the most influential factor in reducing wind speed (Ucar and Hall, 1998; Brandle and Finch, 1991; Heisler and Dewalle, 1988). Dust interception by the vegetative barriers was considered only with regard to the total dust mass that was prevented from leaving the test farm model. These studies are, however, the precursors

to more shelterbelt modeling research currently being conducted at Iowa State University (Iverson et al., undated), thus furthering quantification of shelterbelts and odor amelioration.

Physical interception of dust and other aerosols

As air moves across vegetative surfaces, leaves and other aerial plant surfaces remove some of the dust, gas, and microbial burden normally carried by the wind. This removal is carried out mostly by way of a dry wind borne route, in raindrops, or in rain splash droplets (Barth and Klockow, 1988; Gregory, 1971). The total surface area of leafy plants is very large, often exceeding the surface area of the soil containing those plants by as much as 20-fold (Schultze, 1982), which positively favors the interception of dust and other aerosols (Jaenicke, 1988; Schultze, 1982). It has been noted that trees and shrubs are very efficient at filtering road dust. Farmer (1992) reviewed literature regarding the effects of dust on vegetation and reported on several studies that quantified the ability of trees and shrubs to act as dust interceptors. Among the studies discussed were Steubing and Klee (1970), who measured the filtering capacity of *Pinus mugo* along the roadsides in Frankfurt, Germany and found that *P.mugo* has a filtering effect with up to 0.18 mg cm² of dust on the leaf surface (Farmer, 1992). A comparison of broadleaved and conifer species occurred in an experimental study of dust application to *Carpinus betulus* and *Picea abies*, and uncovered differential dust deposition patterns. Dust was deposited primarily in the upper branches in the broadleaf species but to the middle and lower branches on the conifer. Pyatt (1973), however, noted different deposition patterns in a field comparison and found greater deposition onto the lower branches of three broadleaved species (Farmer, 1992).



Figure 4. This 20-foot single row Amur maple (*Acer ginnala*) shelterbelt is being used to reduce the effects of unwanted pollen drift from a conventional farming system onto an organic farm in central Iowa. Photograph by J. Tyndall, Iowa State University, 1999

Shelterbelts specifically have been used to intercept pesticide drift (as well as reduce airborne drift by way of reduced wind speeds, see above section) and pollen drift (see Figure 4 above), though effectiveness of the latter use has yet to be quantified. According to Smith (1994) it is generally accepted that as leaf surface roughness increases so does capture efficiency for particles with diameters of 5 μ m (and less). The reason for this being that increased surface roughness (i.e. leaf hairs, leaf veins, relatively small leaf size) decreases the stability of the boundary layer of the leaf, which in turn can increase particle impaction. Also suggested was that leaves with complex shapes and large circumference to area ratios collect particles most efficiently, indicating that conifers may be more effective particle traps than deciduous species (Smith, 1994) (since conifers are “in leaf” year round they may also be more effective temporally).

Because of the dust interception capacity of vegetation, the use of tree screens has been suggested to prevent dust from traveling significant distances from its source or to protect sensitive areas (Farmer, 1992; Wight et al, 1991; Eggesman, 1981; Rao, 1971). Dust control issues are also of major concern in beef cattle feedlots. A USDA (1994) study stated that 80% of the 498 examined feedlots with over 1,000 head capacity used at least one of three dust control techniques. Vegetative screening was not one of the listed methods.

Acting as a sink for the chemical constituents of the odorous pollution

Not much is known about the ability of trees and other plants to ameliorate odor by way of intake or absorption of odorous chemicals or the managerial use of vegetation for this purpose. There is, however, compelling indirect evidence that this is possible.

In the last few decades there has been tremendous interest in the ability of plants to remove pollutants from the air, and several reviews have addressed the capability of plants to act as a sink for air contaminants (Kwiecien, 1997; Smith, 1994; Bennett and Hill, 1993; Hill, 1971). Meister et al. (1984) suggests that a forest cleans the air of microparticles of all sizes by way of interception at least twenty times better than barren land. Because of this, forests have often been referred to as pollutant air filters.

This filter activity occurs because of the ways in which plants come into contact with atmospheric aerosols and chemicals. There are three major ways in which plants interact with atmospheric aerosols and chemicals: 1) in precipitation, 2) through dry deposition, and 3) through deposition of water vapor and associated chemicals onto canopy surfaces from clouds or fog (Perry, 1994). The first two paths of interaction are of particular importance for this topic. Chemical cycling research on chemical washout from rain and subsequent vegetative interception has quantified different levels of nutrient input via precipitation indicating that depending upon the source and level of emissions of atmospheric chemicals, nutrient inputs via this route can be significant (Perry, 1992; Bruijnzeel, 1991; Kimmins, 1996, Smith, 1984). Dry deposition of chemicals occur by way of diffusion of the aerosol or gas toward a leaf and plant body because of the high mobility of aerosols. Impaction and interception on plant surfaces (as discussed above) occurs because of inertia and high flow velocities. Sedimentation will happen because of gravity (Jaenicke, 1989). Atmospheric pollution in the form of gases also interact with vegetation and chemical input via gaseous intake has been intensively studied (Kimmins, 1996; Smith, 1984; Bennett and Hill, 1975; Bennett and Hill, 1973; Hill, 1971).

When pollutants (particles, chemicals, and gases) come in contact with plants three things can typically occur. The first of which is that the particles and chemicals can simply bounce off or be knocked off the plant and returned to the atmosphere or settle onto the soil; secondly, gases can simply pass through the vegetation; or thirdly, the chemicals become fixed to plant surfaces and can enter the plant.

Chemicals can enter the plant in three ways: 1) gaseous diffusion through open stomata, 2) if chemicals are soluble, they can enter through the stomata in dissolved form, and 3) chemicals can be absorbed and adsorbed into plant tissues (Landolt and Keller, 1985; Smith, 1984). The rate of pollutant transfer is regulated by a series of resistances (Saxe, 1990; Smith, 1984). It has been emphasized that other than pollutant concentration and exposure time, stomatal resistance is the most important factor determining the uptake of pollutants by the plants (Landolt and Keller, 1985). Diffusion through open stomata is considered the route of least resistance. This is regulated first by the plant surface boundary layer (the perfectly still layer of air surrounding all surfaces) and then by the concentration gradient between the ambient air and the sorptive surfaces of a plants interior (Kimmins, 1997; Treshow and Anderson, 1989). Diffusability and solubility of pollutants are the main factors that affect the rate of boundary layer penetration. Once the boundary layer is penetrated and contact is made with the leaf surface, a pollutant may enter by two routes: absorbed by way of passive diffusion through the stomates (if soluble, pollutants will often enter in solution) or adsorbed through the tissues (Saxe, 1990). One study of interest examined different sorption rates of sulfur dioxide and ozone between conifers and deciduous trees during a fumigation study and determined that sorption rates were higher in conifers (Elkiey et al., 1982). In that same study, when absorption could be separated from adsorption, absorption rates were higher in most cases. Absorption depends upon stomatal openings whereas adsorption depends upon the plant surface (Elkiey et al., 1982).

A waxy, lipophilic cuticle resists adsorption of pollutants into plant tissues. The cuticle does offer significant resistance to the movement of water and solutes but it is not impermeable, as evidenced by the fact that most agricultural chemicals are applied as foliar sprays and many of those chemicals, such as herbicides and systematic insecticides, must penetrate the cuticle to be effective (Schonherr and Riederer, 1989). Interestingly, lipophilic substances (i.e. organic compounds) accumulate in lipids on plant surfaces (the cuticle is composed of cutin which is a lipid based polymer (Taiz and Zeiger, 1991). The leaves of higher plants are highly lipophilic and due to lipophilic affinity, they are excellent accumulators of lipophilic foreign substances (Reischl et al., 1989; Reischl et al., 1987). For example, dry deposition rates of ammonia as measured in field experiments have indicated that ammonia has high affinity for leaf cuticles and other plant surfaces (Asman et al., 1997).

Of particular interest to this review, in terms of atmospheric nitrogenic pollution (NH_x compounds), the amount of ammonia adsorbed onto leaf cuticles increases with increased relative humidity and decreased vapor pressures (Asman et al., 1997). Both typically occur within the shelter of a shelterbelt. Depending on the porosity of the shelterbelt, relative humidity is typically 2 to 4 percent higher in sheltered areas than in open areas (Brandle and Finch, 1991). Asman et al. (1997) suggested that reductions in NH_x may be achieved indirectly by modifying local scale atmospheric transport. Asman noted that while little work has been done in developing indirect nitrogen abatement

methods, due to the fact that a relatively large percentage of the emission is dry deposited close to the source, benefits might be achieved by planting a managed farm woodland system around known sources to increase dry deposition and reduce deposition to more critical areas.

Smith (1994) listed some generalizations regarding pollutant interception and/or uptake into plants that can be made based on controlled experiments and with seedlings. Among the more important were:

- Plant uptake rates increase as solubility of the pollutant in water increases.
- When the plant surfaces are wet, the pollutant removal rate may increase up to 10-fold. Interestingly, when conditions are damp, the entire aerial plant surface is available for uptake. (Horn and Vedt (1980) while using wind tunnels, determined that trees with wet leaves accumulated 100 times more aerosol sulfur than dry trees and also determined that conifers were better aerosol collectors than deciduous trees).
- Moisture stress and limitations on solar radiation act to limit stomatal openings and can hinder pollutant uptake significantly.
- Pollutants are absorbed most efficiently by plant foliage near the canopy surface, where light mediated metabolic and pollutant diffusivity rates are greatest.
- Though some pollutants (e.g., nitrogen dioxide and sulfur) can be taken up during nighttime respiration, uptake rates are significantly reduced during the night.
- Because numerous forces and conditions regulate the rate of pollutant uptake, the rate of removal under field conditions will be highly variable.
- However, the rate of pollutant removal can increase linearly as the concentration of the pollutant increases.

Other forms of indirect evidence come from studies that have investigated the accumulation of various organic compounds (much of it anthropogenic) on plants and in their tissues. Some research suggests that plants (mosses, lichens, and higher plants) can be used as bio-indicators for pollution emission location and prediction (Reischl et al., 1989; Reischl et al., 1987; Gaggi et al., 1985). Reischl et al. (1989), using gas chromatography tests recorded accumulations of chlorinated hydrocarbons in the foliage of 15-year-old spruce trees (*Picea abies*). Foliage samples were taken at different locations in the proximity of different pollution emitters such as an industrial area, an urban area, and a hazardous waste landfill and were then compared to samples from a “clean air” site (an area of considerable distance from a pollution source). The study found much higher concentrations of pollutants from the samples located in the polluted areas as compared to the low levels recorded for the clean area. In similar studies, Gaggi et al (1985) and Gaggi and Bacci, (1985) also found measurable levels (1 to 50 ng/g) of chlorinated hydrocarbons in the leaf litter of various conifer and deciduous species as well as different lichen species (Beattie, 1999).

Other indirect evidence supporting the intake of aerial pollutants into plants are from studies that have examined pathways of intake by comparing chemical translocation through soil and intake of volatilized chemicals from the soil. Nash and Beall (1970) while examining DDT found that sorption of residues vaporized from surface treated soil was 6.8 times greater than that obtained through root uptake and translocation. This finding has since been further substantiated with examinations of chlorinated insecticide accumulations in azalea (*Azalea indica*) (Bacci and Gaggi, 1987). In tests examining

levels of polychlorinated biphenyls (PCB's) in plant tissues, Bacci and Gaggi, (1985) suggested that the lack of correlation of PCB levels in soil compared to PCB levels in the foliage indicated that during the study, PCB intake was through vapors rather than soil translocation (Beattie, 1999).

In addition to the research regarding plants and outdoor pollution, there has been experimentation on green plants and indoor pollution control. Scientists from the National Aeronautics and Space Administration have conducted sealed chamber experiments to test the ability of green plants to reduce common indoor aerial pollutants (Hoogasian, 1990). By using sealed chambers researchers were able to control the level of ambient chemicals and quantify levels of reduction over time, below in Table 9, is a list of chemicals that were removed by houseplants from sealed chambers after 24 hour exposure. Also noted was that the longer a plant remained in a polluted environment the more proficient it becomes at reducing pollution, though the mechanism for that remains unclear (Hoogasian, 1990).

Table 9. Chemicals removed from sealed chamber by household plants in 24 hours. ^a

Plant	Percent of Chemical Removed		
	Formaldehyde	Benzene	Trichloroethylene
Mass cane	70	21.4	12.5
Pot mum	61	53	41.2
Gerbera daisy	50	67.7	35
Warneckii	50	52	10

^a Source Hoogasian, 1990

Complete understanding of the sorption and uptake process does not yet exist, however there are numerous publications that attempt to identify and quantify different pathways and to model the process (Welke et al., 1998; Schonherr and Baur, 1994; Schreiber and Schonherr, 1993; Schreiber and Schonherr, 1992; Sabljic et al., 1990; Trapp et al., 1990; Riederer, 1990; Lenzian, 1984).

Though quantification of plant intake of odorous chemicals originating from livestock production does not yet exist, the above evidence points out that pathways of chemical intake clearly exist. A study currently being conducted at Iowa State University is exploring the ability of plants to absorb odors, by gaseous diffusion as well as impaction and sedimentation of particles, and the ability of plant-associated microorganisms to degrade those odors as they become available on the surface of the plant (Beattie et al., undated). The study will evaluate the adsorption capacity of lipophilic plant cuticles as well as attempt to identify microorganisms that can both degrade odorous chemicals and continue growth and survival on the plant surface. This study is a unique attempt to determine if it may be possible to use plants (including trees), in a managerial context, to accumulate volatile organic chemicals and thus ameliorate livestock odors.

Another potential air pollution sink exists on and within the microorganisms that coexist on plant surfaces. The surfaces of plants, depending on such factors as plant species, humidity, season, leaf age and health are usually covered with micro-organisms of all kinds, various forms of fungi, bacteria, and yeasts dominate (Schreiber and Schonherr, 1993; Dickson and Preece, 1976; Preece and Dickson, 1971). Schreiber and

Schonherr (1992, 1993) determined that microorganisms often influence and effect the quantification of foliage uptake of chemicals to the point where care must be made to separate the mechanism during related research.

In an early review, Smith (1976) hypothesized that since epiphytic organisms have been exposed to many compounds now considered as pollutants for millennia and that this exposure occurs at the atmospheric: plant interface, that these microbes may behave as sinks for certain particulates and gaseous pollutants. As evidence Smith (1976), reiterated the conclusions of several studies such as Rassmussen and Hutton (1972) who noted that tropical, phylloplane microbes are a major sink for naturally occurring organic volatiles in the air below the canopy of tropical forests and Gonzalez and Hutton (1969) who presented evidence that tropical forest leaf litter microbes were capable of utilizing automobile exhaust hydrocarbons.

It is known that many different microorganisms are capable of metabolizing and/or breaking down chemical pollutants such as anthropogenic VOC's (Baker and Herson, 1994; Muller, 1992; Fry et al, 1992) and this process is used in many different types of bioremediation techniques (Baker and Herson, 1994). It is also known that microorganisms are capable of metabolizing odorous VOC's as this is the process by which biofilters are effective at mitigating odors from livestock buildings (Nicolai and Janni, 1997; Li et al., 1996). It is not, however, currently known how effective epiphytic microorganisms are at metabolizing and/or degrading odorous VOC's or if such a process could be effective in mitigating ambient and downwind odorous conditions. Beattie et al. (undated), as mentioned above, are currently studying this very process and are identifying the microorganisms involved as well as quantifying the livestock odor VOC sink activity. To do this they have obtained leaf-surface bacteria from plants downwind from several hog waste lagoons in Iowa. Then by enriching the organisms capable of odor-degradation they will identify the resulting strains that exhibit these degradation abilities. Future studies (Beattie et al, undated) will involve the evaluation of differences among plant species in their ability to adsorb odorous VOC's and the extent to which these adsorbed chemicals will be available for microbial metabolism as well as potential for inoculation of plant material to enhance odor adsorption.

Shelterbelt Impact on Odor Perception

Penkala (1977) suggests the primary goal of odor mitigation is to minimize or eliminate perceived odors. Achievement of this goal can be measured by reductions in: 1) odor concentrations reaching populated areas, 2) number of people affected by objectionable odors, 3) time duration of exposure to odors, and 4) number of occurrences of odor events. The relationship between odor perception and concentration of odorous chemicals is logarithmic. This means that the concentration of odorous chemicals within a parcel of air needs to be reduced significantly (i.e. sometimes > 99%) before there is a noticeable change in perceived offensiveness. For example, in laboratory studies, Misselbrook et al. (1993) determined that the average concentration of odorous chemical emission following application of pig slurry would need to be reduced between 94 % and 97.8% before the perceived intensity (as determined by a human smell panel) went from a level 6 intensity on a six level scale (6 = extremely strong odor) to a level 2 (2 = faint odor). A typical concentration of odor from a poultry house ventilation system would

need to be reduced between 99.1% and 99.7% to get from perception level 6 to level 2. As discussed earlier, legally defined separation distances aid in the dispersion of odors. In Iowa, for example this distance is between 1250 and 2500 feet depending on the size of the facility and number of head of animals (Lorimor, 1999). Since most of these distances are determined based on protection of water sources, the distance is often not enough to reduce odor concentrations to levels that eliminate odor nuisance. Shelterbelts have the ability to reduce odor concentrations significantly (estimated at > 56% (Thernelius , 1997; Laird, 1997) at or very near the source, which greatly enhances the effectiveness of the separation distance. The 56% reduction estimate above was achieved in a wind tunnel experiment modeling a natural ventilated production building with minimal shelterbelt design considerations. Proper shelterbelt and shelterbelt systems designs should be able to decrease the concentration levels of odor plumes leaving production sites even more and combined with legal separation distances effectively reduce the odor perception levels reaching populated areas, reduce the number of people affected, reduce the time duration of exposure to odors, and allow for reductions in the number of occurrences of odor events.

However, both laboratory and field work on the quantification of the effectiveness of shelterbelts to mitigate odor is currently underway (Iverson, J., James, W., and B. Munson, 1999-present; Beattie et al., 1999-present; Bottcher et al, 1999). There are also currently 10 Iowa livestock producers who are participating in Iowa State University's Odor Control Demonstration Project using landscaping that was planted in 1997. At least two other Iowa livestock producers (both swine) have independently installed shelterbelt systems for odor control within the last few years and one large scale beef lot has made serious inquiries.

General Shelterbelt Design Considerations

Since field quantification of a shelterbelts ability to mitigate livestock odor is currently underway, it is not possible to recommend the best mix of tree and shrub species for this task. But generalizations can be made based on what the trees are expected to do in terms of interacting with odor. It is recommended that species selection should be based on specific site characteristics, including species range, soil type, wind, and precipitation. The advice of local experts should be sought. Sources of such information include: local USDA Natural Resource Conservation Service, State Department of Natural Resources, the USDA National Agroforestry Center, local University Extension, and the USDA Forest Service.

General Considerations for each above mentioned Shelterbelt Effect

- **Dilution of gas concentrations of odor into the lower atmosphere**

Shelterbelts present an obstacle to the wind, deflecting and lifting air streams (odor plumes) upward into the lower atmosphere. The lifting aspect will begin at some distance on the windward side, typically a distance equal to 2 to 5 times the height (referred to as 2 –5 H) of the shelterbelt.

McNaughton (1988) further notes that as the air streams top the obstacle (the shelterbelt), the stream is redirected, compressed and air speeds increase. This effected zone above the shelterbelts has been noted at vertical heights of 1.5 H (that is 1.5 times the height of the barrier) to 1.7 H. This zone then widens and follows the air stream downwind and acts as a source of turbulent kinetic energy. In studies that have modeled the dynamics behind artificial windbreak fences, a “quiet” zone that extends from the top of the barrier down to a distance of about 8 H from the barrier exists. Outside this quiet zone the longitudinal turbulent fluctuations are more energetic and larger in scale (McNaughten, 1988).

It is important to note that as porosity of the shelterbelt decreases (<50%) the greater the turbulence created in the turbulent zone. It is in this zone, depending upon the height of the shelterbelt, that much of the dilution of the odor plume can take place.

At a minimum two rows of trees/shrubs should be utilized. Wedge shaped shelterbelts facing the prevailing winds are often considered to create more turbulence as well as push air streams higher into the lower atmosphere.

Because height is of particular importance, fast growing species should be utilized. Depending on space available a simple three-row shelterbelt could be utilized with a fast growing deciduous species such as a poplar variety (*Populus spp.*) planted on the outside. A slower growing species in the middle and a shrub species to the inside facing the oncoming wind would create a wedge shape. Faster growing species, though they have a tendency to be somewhat short lived (often 30-40 years) they have the advantage of serving as nurse trees for the other rows which could be made up of slower, longer lived species.

- **Encouraging dust and other aerosol deposition by reducing wind speeds**

In general, the horizontal extent of wind protection is proportional to the shelterbelts height. Shelterbelt porosity is perhaps the most important variable as maximum wind reductions can be experienced by manipulating this factor. Shelterbelts with a porosity/density of 40 to 60% provide the greatest reduction in wind speed over the greatest distance (Brandle and Finch, 1991).

Measured reductions in wind speed on the windward side of shelterbelts have been recorded at 2 to 5 H of the shelterbelt. Measured reductions in wind speed to the lee (downwind) of a shelterbelt have been varied, with some being recorded as far as 50H of the shelterbelt (Heisler and DeWalle, 1988). Wind speed reductions to about 30H are more typical. At about 8H wind speeds can be about 25-50% of open field wind velocity. From about 10H to 20H wind speed can range from 50-80% that of open field wind velocity (Wray, 1997).

Porosity can be manipulated by way of spacing as well as species used in the shelterbelt. Shelterbelts of deciduous trees have a tendency to be more open close to the ground whereas conifer belts typically have branch cover close to the ground. Table 10, presents a general spacing guide as used by the Cooperative Extension Office at the University of Nebraska.

Table 10. General spacing guidelines for windbreak based on windbreak position and component (density and species type).

Windbreak Position	Windbreak Component	Spacing(ft.) Between Trees	Spacing(ft.) Between
Windward Rows (Rows 1 or 2)	Dense Conifer	6-12	12-20
Leeward Rows (Rows 3+)	Dense Conifer	8-12	14-20
Leeward Rows (Rows 3+) Broadleaf/Conifer	Medium Ht. Trees	10-18	14-20
Leeward Rows (Rows 3+)	Tall Trees	12-20	20-25
Windward	Shrubs	4-6	8-10

Source Wilson, 1996

- **Physical interception of dust and other aerosols**

Important considerations involve information such as that accorded by Smith (1994). It is generally accepted that as leaf surface roughness increases so does capture efficiency for particles with diameters of 5µm and less. The reason for this being that increased surface roughness (i.e. leaf hairs, leaf veins, relatively small leaf size) decreases the stability of the boundary layer of the leaf, which in turn can increase particle impaction. Smith (1994) also suggested was that leaves with complex shapes and large circumference to area ratios collect particles most efficiently, indicating that conifers may be more effective particle traps than deciduous species (Smith, 1994). Since conifers are “in leaf” throughout the year, they may be more effective.

- **By way of acting as a sink for the chemical constituents of odor**

Species selection for this particular shelterbelt effect has the least amount of known information available to allow for suggestions. Perhaps all that can be suggested is to utilize species that are adept at retaining surface moisture following precipitation events. When the plant surfaces are wet, the pollutant removal rate may increase up to 10-fold. Interestingly, when conditions are damp, the entire aerial plant surface is available for uptake. Horn and Vedt (1980), while using wind tunnels, determined that trees with wet leaves accumulated 100 times more aerosol sulfur than “dry” trees. They also determined that conifers were better aerosol collectors than deciduous trees. There also have been several studies that quantified the chemical adsorption and absorption of

various types of anthropogenic (human made) air pollutants onto/into the plant tissues of conifer species such as spruce trees (*Picea abies*).

Below are very general schematics of some design considerations discussed in the above tables. Figure 7 shows in greater detail possible shelterbelt layouts within a hypothetical swine confinement system. A similar schematic, Figure 11 can be found on page 47 (landscape drawing of an actual planting in Central Iowa).

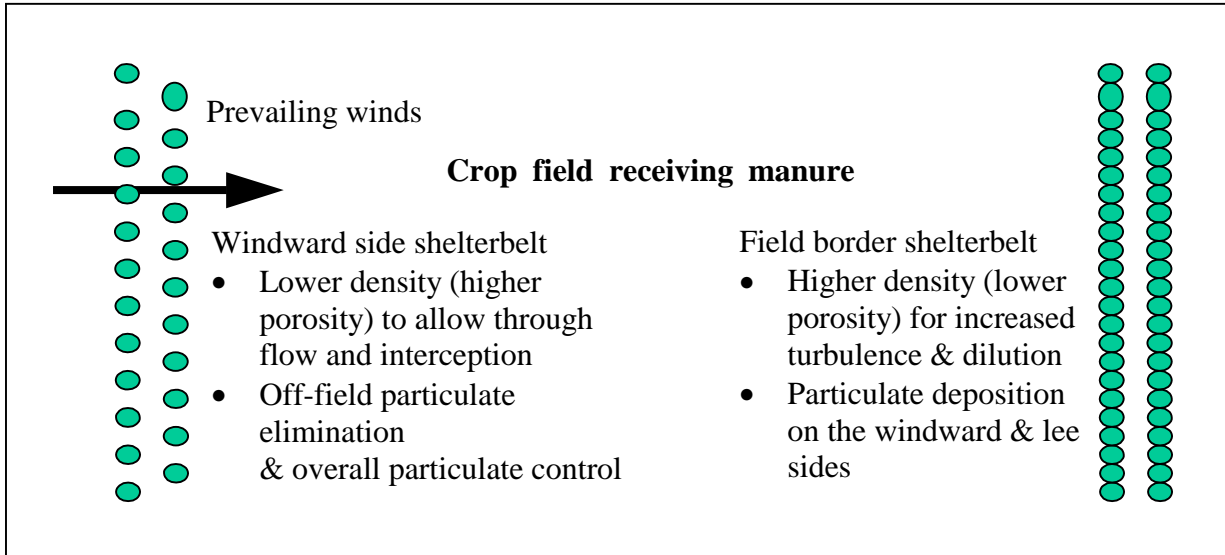

Figure 5 . Diagram of possible shelterbelt benefits in mitigating odor from field application of livestock manure.

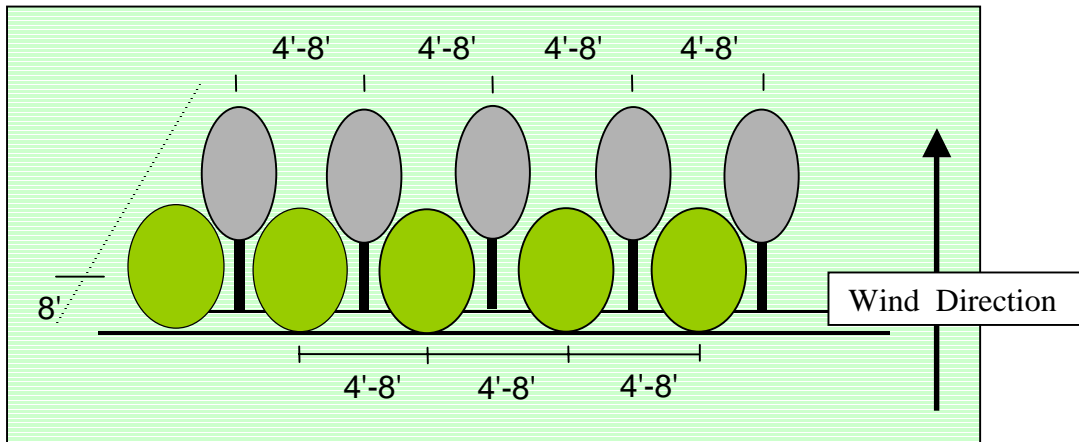

Figure 6. Wedge shape planting suggested to generate higher air-flow over the shelterbelt.

Below is basic diagram of a shelterbelt design associated with a swine production facility. The shelterbelt design shown is very generic. The exact number of rows, species, and total number of trees are important considerations not displayed. This generic design provides “buffering” around the major sources of livestock odor. The design can easily be adapted to fit other livestock confinement and /or feedlot systems. The wind in Iowa primarily comes from the south and west during the summer months and the north and west during the winter. The orientation of shelterbelts below reflects this.

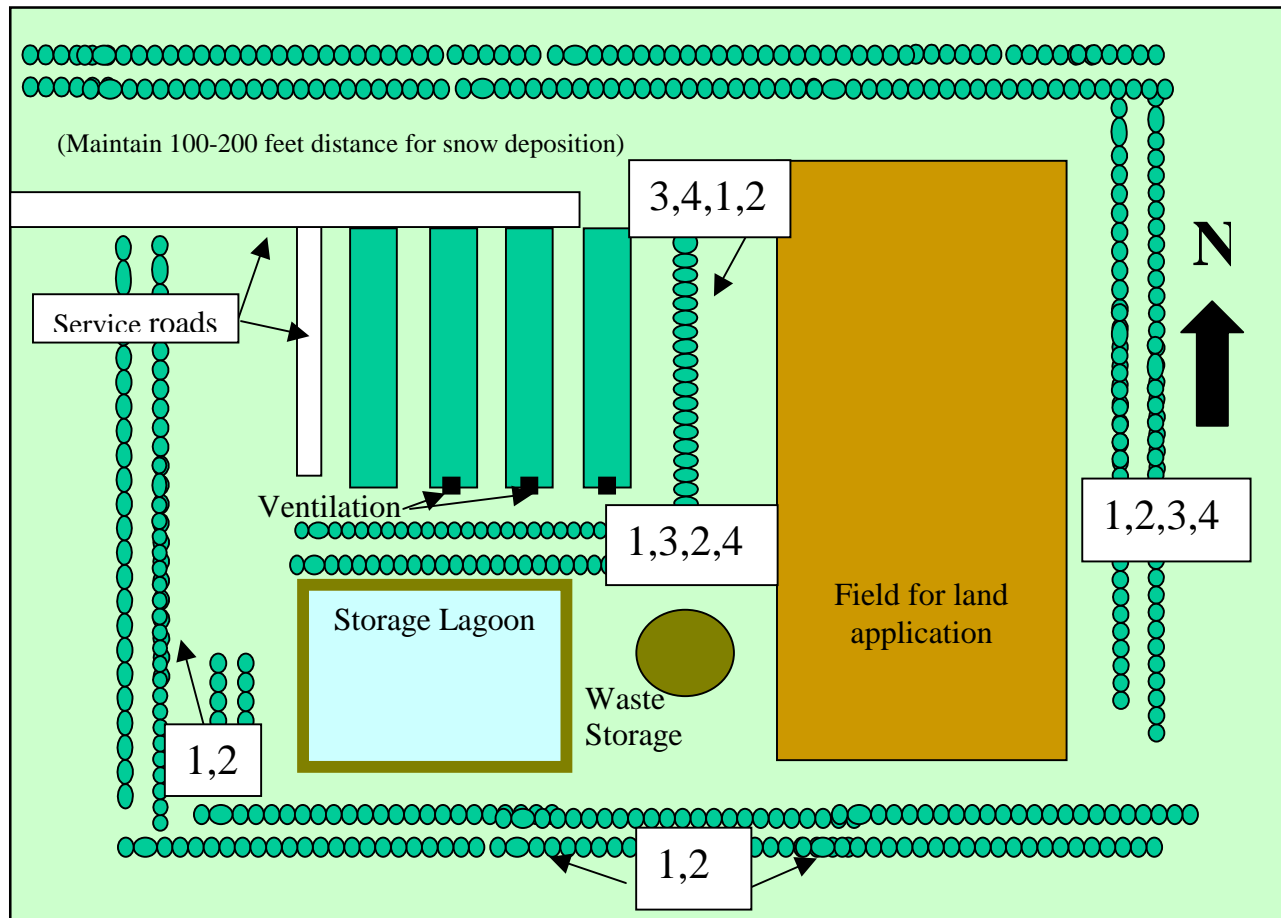

Figure 7. A hypothetical shelterbelt system design for a typical swine production facility. The numbers refer to the functional interaction and means by which the shelterbelt will mitigate livestock odor. The number 1 refers to creation of air mixing turbulence, the number 2 refers to dust deposition, the number 3 refers to particulate interception, and the number 4 refers to sites of air pollution sinks. Other important design considerations include: livestock type, odor sources, air/wind patterns, the species of trees/shrubs used. Another concern is the location of access openings and roadways. Openings should, as much as possible, be located so as not to breach the shelterbelts interception of prevailing winds. Another very important factor to be understood is typical snow deposition patterns. It is undesirable to place any vegetation in a way that cause snow deposition to become troublesome, in fact vegetative placement can help to ameliorate snow problems and cut down on snow removal labor and costs (For more information see Wray et al, 1997 and Quam et al, 1996.)

The numbers (1,2,3,4) next to the example shelterbelts on the diagram correspond to the potential shelterbelt functions as listed below; the numbers are in order of probable functional importance. Thus, a “3,4” would mean that the shelterbelt location and design would facilitate the interception of the particulates, bio-aerosols, and gasses from an odor plume as well as provide a sink for those chemicals to be incorporated on or within or otherwise broken-down by the shelterbelt vegetation. The shelterbelt and odor interactions are summarized again below:

- 1) Turbulence -
 - Dilution into lower atmosphere
- 2) Dust deposition
 - Off-field particulate elimination & overall particulate control
 - Particulate deposition on the windward & lees sides
- 3) Interception
 - Dust, bio-aerosols, gasses
- 4) Pollutant sink
 - Adsorption and absorption of odorous chemicals onto/into plants
 - Microbial sink as well



Figure 8. Planted in April 1999, this five row mixed conifer and hardwood species shelterbelt is located on the northwest corner of a swine confinement facility in central Iowa. This shelterbelt was planted specifically for odor control and improved aesthetics. Photograph by A. Holtz, Iowa State University, 1999.

Additional Design Considerations for Shelterbelts Used to Mitigate Livestock Odor as Regarding Various Sources of Livestock Odor

The following lists summarize some characteristics of livestock odor associated with the many different livestock species. Some general shelterbelt design considerations

are also listed. This information is separated by that relating to shelterbelts and land application of manure, shelterbelts and manure storage, and shelterbelts and production facilities.

Shelterbelts and Land Application of Manure

General Livestock Odor Facts Regarding Land Application

- Liquid manure is associated with high emissions of odorous VOC's.
- Due to higher costs of odor controlling techniques such as soil injection and/or incorporation, most application is simply surface applied (Heber and Jones, 1999).
- Over application of manure is common (Leetson and Gollehon, 1996).
- Odor nuisance is highest immediately after application and typically lasts no more than 1-2 days (Pain et al, 1988).
- Odor decreases as field surface dries.
- Use of solid manure may increase particulate load in the airstream.

Hogs

- Most nuisance complaints related to land application of liquid hog manure (Hardwick, 1986; Pain et al., 1988).
- The majority of swine manure is applied as a liquid. In 1992, 64% as compared to 31% spread as solid (USDA, 1992).

Poultry

- Most poultry manure that is land applied is in solid form typically with a box or flail spreader.
- May have higher dust concentrations due to dryness of applied manure.

Cattle - Beef

- Beef cattle manure is spread mostly as a solid (Eghball and Power, 1994).
- Although some states the finishing stage is done in confinement, so liquid application may be more prevalent (Meyer and Graves, 1996)

Dairy

- Land application of dairy manure is typically a combination of solid and liquid.

Other – Horses, Sheep, Goats, Mink

- For all these animals, most manure is handled and spread as a solid. Horse manure is typically composted rather than spread, as most horse owners have limited

access to crops and because of disease and parasite problems exist for horses if spread without proper composting (Hudson, 1994)

Shelterbelt Design Considerations as Regarding Livestock Manure Application

Liquid Application

- Depending on the dimensions of the field, multiple shelterbelts could be used on both sides of the field, orientated perpendicular to prevailing winds, for a diversity of effects.
- A shelterbelt on the windward side of the field could be used to capture off-field particulates that would otherwise pass over the field surface and pick up VOC's being emitted. This would also encourage particulate deposition.
- A shelterbelt on the far side should create turbulence and enhance odor dilution as well interception and encourage deposition of some particulates. Shelterbelt density should be increased for maximum turbulence (< 60% porosity).
- To maximize turbulence wind speed needs to be at its prevailing rate, so if a two belt system is used, the field should be wide enough to allow for the wind speed to regain its prevailing velocity as it approaches the turbulence creating belt.
- Shelterbelt height is also an important variable for dilution. Taller species of trees would be recommended
- Some research has indicated that a wedge-shaped belt, facing wedge first into prevailing wind can push airstreams higher into the atmosphere (Brandle, 1999).

Solid Application

- Design may need to maximize particulate interception and deposition.
- To maximize particulate interception, some wind should be allowed to pass through the belt so as to allow for plant: particulate interactions. The use of lower density belts (~50% porosity or >) should facilitate this (Brandle and Finch, 1991).
- Maximizing surface area of plant material is of considerable importance. Conifers may be of particular use for interception purposes (Smith, 1994).

Other Considerations

- Keep in mind other shelterbelt dynamics in relation to effects on crops as well as snow deposition (Kort, 1988) so as to prevent potential negative interaction.

Shelterbelts and Manure Storage

General Livestock Odor Facts Regarding Manure Storage

- Manure storage has been listed as the third most important source of odor nuisance (Hardwick, 1986).
- For liquid storage, odor emissions are highest during agitation prior to use as land fertilizer. Basically there are two types of liquid storage, pits and lagoons (Lorimor, 1995).
- Open lot management systems usually handle manure as a solid using a holding pond to control runoff (Dickey et al., 1981).

Hogs

- As hog capacity increases, producers tend to handle manure as a liquid and use lagoons. Smaller farm systems tended to handle manure as a solid and use storage pits (USDA, 1992).
- Again, swine manure is associated with high VOC creation and the majority of nuisance complaints.

Poultry

- Poultry manure has a higher total solids content than most other livestock manure.
- Most cage laying units store manure in deep pits located within the building, whereas broiler and turkey manure is diluted with litter material (OSU, undated).

Cattle - Beef

- Solid storage includes the use of concrete and/or metal tanks and concrete basins.

Dairy

- Dairy housing and feeding areas usually handle and store manure as a solid and the manure from milking areas is typically handled as a liquid (Davie et al., 1998)

Other – Horses, Sheep, Goats, Mink

- Horse manure is typically composted; sheep manure is typically handled the same way as beef manure, where feedlots would be scraped and manure stored in some type of basin for later field application; mink manure is littered much like poultry and stored in pits (Power and Eghball, 1994). Goat manure storage depends on the animal management process, many goat herds are pastured and manure

quantity is not much of a problem. When animal populations are large the manure management is much the same as for sheep and cattle (Graves, 1996).

Shelterbelt Design Consideration as Regarding Manure Storage

- Some studies have indicated that placing shelterbelts around lagoon or storage structure perimeters can reduce wind flow at the liquid level and therefore reducing convection of VOC's from the storage surface may prove effective in odor reduction (Bottcher et al., 1999). Numerical simulation of the effects of tall barriers around manure lagoons predicted reductions in downwind malodorous lagoon emissions of 26% to 92% (Liu et al., 1996).



Figure 9. Newly planted (April 1999) two row, mixed conifer/hardwood species shelterbelt located along the east side of a manure lagoon in the northeast corner of a swine production facility in central Iowa. Photograph by A. Holtz, Iowa State University, 1999.

Shelterbelts and Production Buildings

General Livestock Odor Facts Regarding Production Buildings

- There is often a fairly large quantity of air borne dust found in and around animal confinement buildings.
- It has been concluded by some researchers that the majority if not all the odor that is transported and considered objectionable downwind fro a production site is carried on particulates (Hammond and Smith, 1981; Hammond et al., 1979; Hoff et al, undated).
- Dust concentrations in the ambient air outside of the animal buildings are to a large degree determined by building ventilation rates

- Dust concentrations tend to increase as the fattening process progressed in pig and poultry buildings (Hinz and Linke, 1998).
- Hartung (1989) stated that filtering the dust from exhaust air can reduce odor emission from animal houses up to 65%. It has been concluded by some (Thernilius, 1997; Laird, 1997, SOTF, 1995; Hammond and Smith, 1981; Hammond et al., 1979; Hoff et al, undated), that removing these dust particles, may cause animal houses and feedlots to become almost odorless.

Shelterbelt Design Considerations with Production Buildings

- A shelterbelt orientated perpendicular to the primary ventilation location of the production building would serve to intercept any particulates being expelled from the building as well as encourage dust deposition around the break system. One study that utilized wind-break walls in this capacity placed the breaks at a distance of between 3 meters and 6 meters from the exhaust fan cones (4M and 7M from the building walls respectively) of a swine house (Bottcher et al., 1999). Bottcher et al. (1999) by way of airflow visualization using smoke, observed that some air issuing from the ventilation systems was contained within the windbreak system for longer periods of time in the 6m system than the 3m system (perhaps increasing dust deposition). Consultation with an agricultural engineer about location would avoid any negative airflow interactions between the shelterbelt and the ventilation system.

One question that remains unanswered at this time, and that is at what point after a shelterbelt is established will it begin to help mitigate odor. In terms of wind dynamics, depending on the size of the planted stock, effects may be apparent immediately after planting. For a general idea of growth characteristics of a Midwestern shelterbelt that could be used for odor mitigation, below are the growth details (provided by Carl Mize, Iowa State University, 1999) of a six year-old shelterbelt in central Iowa, associated with a livestock (pig) and grain farm (see Figure 10).



Figure 10. Six year old, three row shelterbelt composed of one row of poplar (*Populus spp.*), one row of silver maple (*Acer saccharinum*) and a third row of assorted small shrubs (ninebark, nanking cherry, and high bush cranberry). Photograph by G. Horvath, Iowa State University, 1999.

The above shelterbelt is planted in an “L” shape with its long axis running in an east-west direction for 2,450 feet and the shorter north-south axis for 100 feet. The design has the shrubs on the windward side, then the silver maples and the poplars on the leeward side (wedge shaped). Spacing is 11 feet between rows and 5 feet between trees. Management has consisted of pesticide weed control and mowing during the first three years after planting.

Overall, tree growth has been described as “good” by the shelterbelt managers, with survival in the maples in excess of 95%, shrubs around 50%, and the poplars around 75%. In 1999, the height growth was 30 feet for the poplars, 25 feet for the maples, and 5 feet for the shrubs.

As far as odor mitigation is concerned some of the shelterbelt effects, particularly the interception of particulates outside of the ventilation systems, may begin to take place shortly after the trees (and shrubs) are firmly established and growing freely.

Economics of Using Shelterbelts for Livestock Odor Control

In order to assess the economic feasibility of using shelterbelts to help mitigate livestock odors, a simple economic analysis was used to calculate potential costs of an actual shelterbelt system planted around a 3000 head sow facility in central Iowa. See Figure 11 for a schematic of the facility and the planting design. For comparison, two scenarios based on costs of vegetative materials were developed. One scenario used a relatively high price of \$10 per tree and shrub and the other scenario used an even higher price of \$25 per tree and shrub, both prices being much higher than most shelterbelt plantings would be. By using a spreadsheet program, annual costs for each scenario, which include cost of materials (~ 871 trees and shrubs were planted in this case) as well as site prep and maintenance costs, were calculated and applied to the number of sows produced over a production year (about 78,000 sows). This was done so as to put the cost on a per animal basis. For the “high” scenario (\$10/tree and shrub) it was determined that the one-year cost was \$0.30/pig. If this cost, however, is capitalized at 5% over 20 years, a reasonable life span for a shelterbelt (Brandle, 1998), the cost becomes just \$0.06/pig. Looking at the “higher” scenario (\$25/tree and shrub), the one-year cost is \$0.68/pig. Again capitalized at 5% over twenty years the cost becomes \$0.09/pig.

The relatively low costs involved with using shelterbelts are of significant importance in this regard. As the comparatively low cost and time commitments associated with planting and maintenance of shelterbelts should be within the production budgets of many producers and perhaps even leave room for the use of other odor control technologies to further enhance mitigation. Multiple odor control techniques can be reasonably affective (Lorimor,1998; Miner,1997; Miner, 1995), but many of the methods come with considerable costs and are often economically prohibitive. Techniques such as using manure and feed additives, building exhaust air scrubbers, placing bio-covers on manure storage tanks, and soil injection of manure when land applying have all been shown to reduce odor emissions (CETAC-WEST, 1999; Jacobson et al., 1998; OCTF, 1998; Barrington, 1997). Costs associated with these various strategies, in various

part of the analysis. The name of the facility is being kept confidential. North is to the left of the drawing. Drawing courtesy of Roger Hunt, Trees Forever, 1998.

Most producers are concerned about the odor generated by their facilities as well as being concerned about being a good neighbor. Unfortunately, the economics of livestock production are often not conducive to doing all that could be done in that regard. Many engineering odor control technologies simply may add too many extra costs to production. A 1992 USDA survey of US pork producers indicated that only 6% of the producers incurred extra costs associated with odor control (beyond standard manure storage methods), perhaps indicating the limits caused by these extra production costs.



Figure 12. Beef production facility showing typical openness to surrounding areas. Many such facilities have suitable land available for shelterbelt plantings. Photographer unknown.

There is also the potential fear of passing this excess cost to consumers thereby negatively effecting demand for livestock products. There is evidence, however, that suggests this concern maybe somewhat unfounded as some economists feel that the environment creates a basis for competition in pork production and that the consumer may be willing to take on some environmental responsibility when it come to purchasing products which are associated with negative externalities.

It has been recognized that a region's competitive position in the industry may be shaped by its collective ability to improve environmental impact technologies (Kliebenstein, 1998). Economists (Kliebenstein and Hurley, 1999; Hudson, 1998; SOTF, 1995) have also suggested that despite higher producer costs related to controlling odor and improved environmental conditions such as water quality, consumers may be willing to pay extra for those producers' costs and the expected public benefits. The Swine Odor Task Force assembled by the North Carolina General Legislative Assembly has recommended incentive-based approaches to dealing with livestock odor. Indicating that

a certification process might offer marketing advantage if products were packaged with “green labeling” attesting to the producer’s environmentally appropriate methods of production (SOTF, 1995). According to the Federal Reserve Bank of Chicago, a recent national level survey “indicates that over half of America’s consumers are willing to pay some premium for food produced in a socially and environmentally responsible manner” (Hudson, 1998).

In another recent study, an experimental economic method called Vickery auctions was used to determine consumer willingness to pay for environmental sustainability and improvements in air, surface, and ground water quality as affected by pork production (Kliebenstein and Hurley, 1999). The Vickery auction design used in the study was a series of sealed bid auctions for pork loin chops. In the first series of auctions the participants (from six cities in five different states, n = 329) use only physical attributes of the meat as the information to determine bids. In subsequent rounds information as to how the meat was produced in terms of different levels of environmental improvements was provided to the participants allowing them more information to determine offered bids. Those consumers who would pay a premium for “environmentally friendly” pork production were those who increased their bids from the “no environmental information” round to the “information” round. Sixty-two percent of the participants were willing to pay a premium for environmentally friendly pork production.

Summary of Shelterbelts and Livestock Odor Amelioration

Shelterbelts have the potential to be an effective and inexpensive odor control device particularly when used in combination with other control methods for added effectiveness. The potential of shelterbelts is really defined by the characteristics of livestock odors. These characteristics (Smith, 1993) are:

- Odor source at or very near ground level;
- Limited plume rise, due to certain weather conditions (i.e. temperature inversions);
- Plume shows spatial and temporal variability;
- Plume may be of large areal extent;
- Close proximity to critical receptors of odor (i.e. people);
- Odors generated in animal facilities that are intense and detectable at appreciable distances all travel as aerosols (Hammond et al., 1981).

Shelterbelts may work very well within an agricultural landscape to provide odor control by affecting these characteristics. Because the odor source is near the ground and the tendency of the plume is to travel along the ground (Takle, 1983). Shelterbelts of even modest heights (i.e. 20-30 ft) may be ideal for plume interception and disruption (Heisler and DeWalle, 1988; Laird, 1997; Thernelius, 1997). Shelterbelts can easily be designed as to fit the production situation and expected/experienced odor plume shapes. Also, depending on the shelterbelt design and species used, they can deal with the temporal characteristics and provide year round plume/aerosol interception.

There are four primary ways that shelterbelts can ameliorate livestock odors:

- Dilution of gas concentrations of odor into the lower atmosphere
- Encouraging dust and other aerosol deposition by reducing wind speeds
- Physical interception of dust and other aerosols
- By way of acting as a sink for the chemical constituents of odor

Dilution of gas concentrations of odor into the lower atmosphere

- Shelterbelts create turbulence at the surface of the terrain that intercept and disrupt odor plumes traveling in laminar flow helping to push the plume into the lower atmosphere facilitating dilution (OCTF, 1998; SOTF, 1995; Takle, undated).
- Lowering wind speeds over storage lagoons can reduce convection of odorous compounds from the surface and allow for slower release of the odor plume which also facilitates dilution (Bottcher et al., 1999)

Encouraging dust and other aerosol deposition by reducing wind speeds

- Pesticide drift mitigation research suggests that due to reduced wind speeds drift pesticide will drop from the air stream. In broadleaf species, downwind drift reductions of 70% (no leaves) to 90% (in leaf) have been recorded (Porskamp et al., 1994)
- Numerical simulation of the effects of tall barriers around manure lagoons predicted reductions in downwind malodorous lagoon emissions of 26% to 92% (Liu et al., 1996)
- Wind tunnel modeling of a three-row shelterbelt system has quantified reductions of 35% to 56% in the downwind mass transport of odorous particulates (dust and aerosols) (Laird, 1997; Thernelius, 1997)

Physical interception of dust and other aerosols

- Meister et al. (1984) suggests that a forest cleans the air of microparticles of all sizes by combing out twentyfold better than barren land.
- Leaves with complex shapes and large circumference to area ratios collect particles most efficiently, indicating that conifers may be more effective particle traps than deciduous species (Smith, 1994) as well as having an “in leaf” temporal advantage.

By way of acting as a sink for the chemical constituents of the odorous pollution

- Volatile Organic Compounds (VOC's) have a distinct affinity to the lipophilic membrane (the cuticle) that covers plant leaves and needles. Relevant studies currently underway (Beattie et al., undated)
- Researchers have quantified measurable quantities of anthropogenic VOC's that have accumulated at the surface of plants (adsorption) and within the plants tissues (absorption) (Reischl et al., 1989; Reischl et al., 1987; Gaggi et al., 1985)

- Micro-organisms dominate the surface of plants (Preece and Dickenson, 1977). These organisms also adsorb and absorb VOC's and provide additional surface area for pollution collection. These organisms also have the ability to metabolize and breakdown VOC's (Screiber and Schonherr, 1992; Muller, 1992; Beattie et al, undated)

Economics

- Economic analysis of a new shelterbelt planted around a 3000 head hog facility, using scenarios of “high” cost (10\$/ Tree and shrub) and “higher” cost (\$25/ Tree and shrub), showed the following costs:
 - for the “high” scenario: \$0.30/pig for one year, capitalized over 20 years at 5% it comes to just \$0.06/pig
 - for the “higher” scenario: \$0.68/pig for one year, capitalized over 20 years at 5% it comes to just \$0.09/pig
 - These costs include maintenance costs
- The relatively low cost of a shelterbelt system would allow most producers to economically utilize other odor control techniques (Hoff, 1998). Using multiple controls increases the effectiveness of odor reduction (NPPC, 1995; Lorimor, 1998).

Increased production costs are often the main barrier to reasonable odor control. However studies have shown that consumers may be willing to pay for socially responsible animal production.

- Using contingent valuation methods researchers have determined significant numbers of people who would be willing to pay a premium for meat products produced in an “environmentally friendly” manner, including odor control.
- The Swine Odor Task Force out of North Carolina has recommended a certification process for producers who control air and water pollution.

Through the ways identified above shelterbelts should aid producers in achieving the cost effective, realistic goals of livestock odor mitigation which are as follows:

- Reductions in: Odor concentrations reaching populated areas, the number of people affected, the time duration of exposure to odors, and the number of occurrences of odor events (Penkala, 1977; Smith and Watts, 1994; SOTF, 1995)

Barriers to Adoption of Shelterbelts for Livestock Odor Control

- Lack of technical information regarding shelterbelts: species composition, site preparation, planting techniques, maintenance needs, and effective planting designs in and around animal facilities.
- Lack of benefit – cost analysis at farm level as well as community level.
- Lack of information regarding cost share possibilities.

- Lack of acceptance and promotion as an odor control technology.
- Further quantification of effectiveness as odor control device needed. Current studies are underway (Bottcher et al, 1999; Beattie et al, undated; Iverson et al., undated).
- There often exist cultural barriers to erecting “non-agricultural” structures within an agricultural setting. The following are some common concerns: removing crops from production, branches and roots may be troublesome, may impede the use of common farm equipment, may be habitat for pests.

BIBLIOGRAPHY

1. Alberta (AFA) Agriculture, Food, and Rural Development. 1998. Reference guide – The economic and social impact of hog operations in Alberta. http://www.agric.gov.ab.ca/livestock/exp_dev/reference_guide.html (3/17/99)
2. Asman, W. A. H., M. A. Sutton, and J. K. Schjorring. 1997. Ammonia: emission, atmospheric transport and deposition. *New-phytol.* Cambridge : Cambridge University Press. May 1998. v. 139 (1) p. 27-48.
3. Australian Environmental Protection Agency. 1997. Atmosphere: Case study – air quality in the Illawarra – Dust and particles. State of the Environment Report 1997. http://www.epa.nsw.gov.au/soe/97/ch1/12_3.htm (7/23/99)
4. Bacci, E., and C. Gaggi. 1985. Polychlorinated biphenyls in plant foliage: Translocation of volatilization from contaminated soils. *Bull. Environ. Contam. Toxicol.* 35:673:681. New York: Springer- Verlag
5. Bacci, E., and C. Gaggi. 1986. Chlorinated pesticides and plant foliage: Translocation experiments. *Bull. Environ. Contam. Toxicol.* (1986) 37:850-857. New York: Springer-Verlag.
6. Bacci, E., and C. Gaggi. 1987. Chlorinated hydrocarbon vapours and plant foliage: Kinetics and applications. *Chemosphere*, Vol.16, Nos.10-21:2515-2522.
7. Baer, N.W. 1989. Shelterbelts and windbreaks in the Great Plains. *Journal of Forestry.* Bethesda, Md. : Society of American Foresters. Apr 1989. v. 87 (4) p. 32-36. ill.
8. Bailey, L., and K. Buckley. 1998. Land application of hog manure: Agronomic and environmental considerations the Canada perspective. <http://res.agr.ca/manurenet/en/hems/bailey.html> (5/16/99)
9. Baker K.H. and D.S Herson. 1994. *Bioremediation.* McGraw-Hill Inc., New York. 375 p.
10. Barrington, S. F. 1997. Odour control: What works and what does not work. <http://www.gov.on.ca/OMAFRA/english/livestock/swine/facts/odour/htm> (4/19/99)
11. Barth, S. and D. Klockow. 1988. A contribution to the experimental quantification of dry deposition to the canopy of coniferous trees. pp 87-96. In: Georgii, H.W. (Ed.). 1988. *Mechanisms and Effects of Pollutant-Transfer into Forests.* Proceedings of the Meeting on Mechanisms and Effects of

Pollutant – transfer into Forests, held in Oberursel/Taunus, F.G.R., November 24-25, 1988. Kluwer Academic Publishers. London.

12. Beattie, G.A. 1999. Personal communication, literature collection and synthesis, personal notes. Assistant Professor, Department of Microbiology and Plant Pathology, Iowa State University.
13. Beattie, G., A. Disperito, and L. Halverson. Undated. Use of Plants and Plant-Associated Microbes to Reduce Odor Emission from Livestock Production Facilities. Research Report. Hog Odor and Waste Management Issues Production Research Program.
<http://extension.agronn.iastate.edu/immag/ISUrep1.html> (5/16/99)
14. Benjamin, G. L. 1997. Industrialization in hog production: Implications for Midwest agriculture. *Economic Perspectives* (January/February 1997): 2-13.
15. Bennett, J.H. and A.C. Hill. 1973. Absorption of gaseous air pollutants by a standardized canopy. *Journal of Air Pollution Control Association*. 23:203-206.
16. Bennett, J.H. and A.C. Hill. 1975. Interactions of air pollutants with canopies of vegetation. In: Mudd, J.B. and T.T. Kozlowski. 1976. *Responses of Plants to Air Pollution*. Academic Press, New York. pps 273-304.
17. Berglund, S. and J.E. Hall. 1987. Sludge and slurry disposal techniques and environmental problems - A review. pp. 60-75. In: *Odour Prevention and Control of Organic Sludge and Livestock Farming*. Ed. V.C. Nielsen, J.H. Voorburg, and P. L'Hermite. Elsevier Applied Science Publishers, New York.
18. Bilbro, J.D. and D.W. Fryrear. 1995. Techniques for controlling fugitive emissions generated of cultivated land by wind. In: 88th Annual Meeting and Exhibition of the Air and Waste Management Association, San Antonio, Tx. June 1995. Pap. No. 95-MP12.01. AWMA, Pittsburgh, Pa.
19. Boersma, L., C. McFarlane, and F. T. Lindstrom. 1991. Mathematical model of plant uptake and translocations of organic chemicals: Application to experiments. *J. Environ. Qual.* 20:137-146.
20. Borman v. Board of Supervisors, No. 192/96-2276 (Iowa, September 23, 1998).
21. Botcher, R.E., R.D. Munilla, and G.R. Baughman. 1999. Controlling dust and odor from buildings using windbreak walls. *Proceedings: 1999 Animal Waste Management Symposium*. Raleigh, North Carolina. January 27-28, 1999.

22. Brandle, J. 1986. Response of winter wheat to shelter in eastern Nebraska. Great-Plains-Agric-Agric-Counc-Publ. Bozeman, Mont. : Montana State University, Cooperative Extension Service. 1986. (117) p. 107-108
23. Brandle, J.R. 1990. Management of microclimate with windbreaks. Proceedings from Plant Growth Regulation Society of America. Lake Alfred, Fl. The Society. 1990. (17th) 61-769.
24. Brandle, J.R. 1999. Personal Communication. Professor, University of Nebraska.
25. Brandle, J.R. and S. Finch. 1991. How windbreaks work. University of Nebraska Extension EC 91-1763-B.
26. Brandle, J.R., B.B. Johnson, and D.D Dearmont. 1984. Windbreak economics: The case of winter wheat production in eastern Nebraska. Journal of Soil and Water Conservation. Ankeny, Iowa : Soil Conservation Society of America. Sept/Oct 1984. v. 39 (5) p. 339-343.
27. Brandle, J.R., B.B. Johnson, and T. Akeson. 1992. Field windbreaks: Are they economical? J. Prod. Agric. 5:393-398.
28. Bruinzeel, L.A. 1990. Nutrient input-output budgets of tropical ecosystems: a review. Journal of Tropical Ecology. 7:1-24.
29. Buckley, R. 1987. The effect of sparse vegetation on the transport of dune sand by wind. Nature. London. 325:426-429.
30. Burel, F. 1996. Hedgerows and their role in agricultural landscapes. Critical Reviews in Plant Sciences 15(2):169-190. CRC Press, Inc.
31. California Department of Conservation (CDC). 1988. Windbreaks Demonstration Program. Final Report. Office of Land Conservation. December 1988. Chapter V. Fugitive Dust Experiment.
32. Carpenter, G.A. and L.J. Mousley. 1986. Dust concentrations in pig buildings. pp.333-335. In: Odour Prevention and Control of Organic Sludge and Livestock farming. Elsevier Applied Science Publishers, New York, NY.
33. Cedar Rapids Gazette, 1999, Supreme Court Refuses Hearing on 'Right -to-Farm': Iowa Farmers Fear Nuisance Law Suits, Gazette wire and staff reports, Posted February 23, 1999. <http://www.gazetteonline.com/agri/ag612.htm>.
34. Center For Rural Affairs, 1998, Corporate Farming Notes for November 1998, http://www.cfra.org/corporate_farming_notes.htm

35. Chapin, A., C. Boulind, A. Moore. 1998a. Controlling odor and gaseous emission problems from industrial Swine facilities. Yale Environmental Protection Clinic Handbook.
36. Chapin, A., C. Boulind, A. Moore. 1998b. Controlling odor and gaseous emission problems from industrial Swine facilities: Recent Laws and New Ideas. Yale Environmental Protection Clinic Handbook.
37. Chase, C., M. Duffy, W. Lotz. 1991. Economic impact of varying swine manure application rates on continuous corn. Journal of Soil and Water Conservation. Nov/Dec 1991. V. 46 (6) 460-464.
38. Chastain, J.P. Pollution Potential of Livestock Manure.
<http://gaia.agengumn.edu/extens/ennotes/enwin95/manure.html>
39. Colindres, A. 1998. Board smells lower land values near hog farm: Dewitt county officials grant lower assessments. Peoria: Journal Star, May 6, 1998, page A1.
40. Comfort, S. 1997. Manure application: Odor and related nuisances. Manure Matters vol.3, no.6. http://www.ianr.unl.edu/manure/v3n6_97.html
41. Cook, D.I. and D.F. VanHaverbeke. 1976. Residential traffic noise control using tree-shrub barrier combinations (windbreaks). Proceedings Great Plains Agriculture Council. 78:112-116.
42. Cunnick, J.E. 1995. Implications of environmental odor on psychological status and health. International Livestock Odor Conference, October 16-17, 1995, Iowa State university.
43. Dhuyvetter, K.C and J.L. Parcell, 1997, Trends in the Swine Industry: Productivity Measures, Swine Day 1997, Dept. of Agricultural Economics, Kansas State University.
44. Dickinson, C.H. 1976. Fungi on aerial surfaces of higher plants. pp. 293-324. In: Dickinson, C.H. and T.F. Preece. 1976. Microbiology of Aerial Plant Surfaces. Academic Press, London and New York. 669 p.
45. Dickinson, C.H. and T.F. Preece. 1976. Microbiology of Aerial Plant Surfaces. Academic Press, London and New York. 669 p.
46. Donham, K. 1990. Health effects from work in swine confinement buildings and dairy barns. American Journal of Industrial Medicine. 4:17-26.

47. Donham, K. 1998. Occupational Health Risks For Swine Producers: Inferences for Public Health Risks for People Living in the Vicinity of Swine Production Units, Manure Management Conference, Iowa State University 1998.
48. Donham, K. 1998. The impact of industrial swine production on human health. pp. 73-83. In: Thu, K.M. and E.P. Durrenberger, editors. 1998. Pigs, Profits, and Rural Communities. New York: State University of New York Press.
49. Donham, K. and K. Thu. 1993. Relationships of agriculture and economic policy to the health of farm families, livestock, and the environment. *Journal of the American Veterinary Medicine Society*. 202 (7):1084-1091.
50. Donham, K.J., J. Yeggy, and R. R. Dague. 1985. Chemical and physical parameters of liquid manure from swine confinement facilities: Health implications for workers, swine and the environment. *Agricultural Wastes* 14:97-113.
51. Eddy, M. 1999. Press Release, Denver Post, February 20.
<http://www.denverpost.com/news/news0220h.htm> (2/20/99)
52. Edelman, M.A., 1999, Animal Confinement Policy National Task Force Preliminary State Policy Survey Results, National ACP Task Force, Iowa State University. <http://cherokee.agecon.clemson.edu/confine.htm> (7/8/99)
53. Eggelsman, R. 1981. Hydrologic aspects of peatland utilization and conservation on northwest Germany. *Proceedings 6th International Peat Congress*. Duluth. pp 28-30. Listed in: Farmer, A. 1993. The effects of dust on vegetation- A review. *Environmental Pollution*. (79) 63-75
54. Eghball, B. and J. F. Power. 1994. Beef cattle feedlot manure management. *Journal of Soil and Water Conservation*. Soil Conservation Society of America March-April. V. 49. p. 113-122.
55. Elkies, T., D.P. Ormrod, and B. Marie. 1982. Foliar sorption of sulfur dioxide, nitrogen dioxide, and ozone by ornamental plants atmospheric pollutants. *Horticulture Science*. June 1982. V. 17(3) 358-360.
56. Ercolani, G.L. 1991. Distribution of Epiphytic bacteria on olive leaves and the influence of leaf age and sampling time. *Microb. Ecol.* (1991) 21:35-48.
57. Evans, M. R., R. Hissett, M. P. W. Smith, F. E. Thacker, and A. G. Williams. 1980. Aerobic treatment of beef cattle and poultry waste compared with the treatment of piggery waste. *Agricultural Wastes* 2:93-101.

58. Farm Safety Association. 1985. Manure gas—Hydrogen Sulphide. Fact sheet No.F-006, Sept. 1985. Guelph, Ontario http://www.fsai.on.ca/CC01_006.HTM (5/16/99)
59. Farmer, A. 1993. The effects of dust on vegetation- A review. *Environmental Pollution*. (79) 63-75.
60. Freeze, B.S. and T.G. Sommerfeldt. 1985. Breakeven hauling distances for beef feedlot manure in southern Alberta. *Canadian Journal Soil-Science*. Ottawa : Agricultural Institute of Canada. Nov 1985. v. 65 (4) p. 687-693.
61. Fry, J.C., G.M. Gadd, R.A. Herbert, C.W. Jones, and I.A. Watson-Craik (Editors). 1992. *Microbial Control of Pollution*. 48th Symposium of the Society for General Microbiology held at the University of Cardiff.
62. Gaggi, C., and E. Bacci. 1985. Accumulation of chlorinated hydrocarbon vapours. *Chemosphere*, Vol.14, No.5:451-456.
63. Gaggi, C., E. Bacci, D. Calamari, and R. Fanelli. 1985. Chlorinated hydrocarbons on plant foliage: An indication of the tropospheric contamination level. *Chemosphere*, Vol.14, Nos.11/12:1673-1686.
64. Gassman, P. W. 1992. Simulation of odor transport: A review. ASAE meeting presentation. Paper No. 92-4517 Michigan.
65. Gault, C, 1998. Livestock Environmental regulations in Iowa, Iowa Farm Bureau Federation, <http://www.ctic.purdue.edu/FRM/ManureMgmt/Paper23.html>
66. Glover, M. 1999. Study: Earthen lagoons a danger. January, 29, 1999. <http://www.dmregister.com/news/stories/c5903220/6705593.html>
67. Grantz, D.A., Vaughn, D.L., Farber, R.J., Ashbaugh, L., VanCuren, T., and R. Campbell. 1998. Wind barriers suppress fugitive dust and soil-derived particles in arid regions. *Journal of Environmental Quality*. July/August, 1998. V. 27 (4) 946-952.
68. Greb, B.W. and Black, A.L. 1971. Vegetative barriers and artificial fences for managing snow in the central and northern plains. In: A.O. Haugen (Ed.), *Snow and Ice Relations to Wildlife and Recreation*. Proc, Symp., Iowa State University, Ames, IA. 96-111.
69. Gregory, P.H. 1971. The leaf as a spore trap. pp. 239-244. In: Preece, T.F. and C.H. Dickinson. 1971. *Ecology of Leaf Surface Micro-Organisms*. Proceedings of an International Symposium held at the University of Newcastle Upon the Tyne. September 1970. Academic Press, London.

70. Groot Koerkamp, P. W. G., J. H. M. Metz, G. H. Uenk, V. R. Phillips, M. R. Holden, R. W. Sneath, J. L. Short, R. P. White, J. Hartung, J. Seedorf, M. Schroder, K. H. Linkert, S. Pedersen, H. Takai, J. O. Johnsen, C. M. Wathes. 1998. Concentrations and emissions of ammonia in livestock buildings in Northern Europe. *J. Agric. Eng. Res.* 70:79-95.
71. Hagen, L. J., and D. V. Armbrust. 1994. Plant canopy effects on wind erosion saltation. *Transactions of the ASAE. American Society of Agric. Engineers* 37(2):461-465.
72. Hamilton, N. D. 1992. *A Livestock Producer's Legal Guide to Nuisance, Land Use Control, and Environmental Law.* (Des Moines: Drake University Agricultural Law Center).
73. Hammond, E. G. and R. J. Smith. 1981. Survey of some molecularly dispersed odorous constituents in Swine house air. *Iowa State Journal of Research* 55(4):393-399.
74. Hammond, E. G., C. Fedler, and G. Junk. 1979. Identification of dust-borne odors in swine confinement facilities. *Transactions of the ASAE* 22(5):1186-1189, 1192.
75. Hammond, E. G., C. Fedler, and R.J. Smith. 1981. Analysis of particle borne swine house odors. *Agriculture and Environment.* (6) 395-401.
76. Hardwick, D.C. 1985. Agricultural Problems related to odour prevention and control. pp. 21-26. In: *Odour prevention and Control of Organic Sludge and Livestock Farming.* Ed. V.C. Nielsen, J.H. Voorburg, and P. L'Hermitte. Elsevier Applied Science Publishers, New York.
77. Hartung, J. 1985. Dust in livestock buildings as a carrier of odours. pp.321-332. In: *Odour Prevention and Control of Organic Sludge and Livestock farming.* Elsevier Applied Science Publishers, New York.
78. Hartung, J. and V.R. Phillips. 1994. Control of gaseous emissions from livestock buildings and manure stores. *Journal of Agricultural Engineering Research.* 57, 173-189.
79. Heber, A. Unknown Date. Setbacks for sufficient swine odor dispersion and dilution. <http://pasture.ecn.purdue.edu/~heber/setba.htm>
80. Heisler, G. M., and D.R. Dewalle. 1988. Effects of windbreak structure on wind flow. Elsevier Science Publishers B.V., Amsterdam. *Agriculture, Ecosystems and Environment*,22/23 (1988) 41-69.
81. Hill, A.C. 1971. Vegetation: a sink for atmospheric pollutants. *Journal of Air Pollution Control Association.* 21: 341-346.

82. Hinds, W. C. 1999. Aerosol technology: Properties, behavior, and measurement of airborne particles. 2nd edition. John Wiley and Sons, New York, NY. p.483.
83. Hinz, T., and S. Linke. 1998. A comprehensive experimental study of aerial pollutants in and emissions from livestock buildings. Part 1: Methods. J. agric. Engng. 70:111-118.
84. Hinz, T., and S. Linke. 1998. A comprehensive experimental study of aerial pollutants in and emissions from livestock buildings. Part 2: Results. J. Agric. Engng. Res. 70:119-129.
85. Hoff, S.J. and D.S. Bundy. 1998. Data presented to the Iowa State Legislature. January-February, 1998.
86. Hoff, S.J. and D.S. Bundy. 1996. Comparison of contaminant dispersion modeling approaches for swine housing. Transactions of the ASAE Vol.39(3):1151-1157.
87. Hoff, S.J. 1998. Personal Communication. Professor, Agricultural Biosystems and Engineering. Iowa State University. Ames, Ia.
88. Hoff, S.J., D.S. Bundy, and X.W. Li. 1997. Dust effects on odor and odor compounds. In: Proceedings of the International Symposium on Ammonia and Odour Control from Animal Production Facilities, Vinkeloord, The Netherlands, October 6-10, 1997
89. Hoff, S.J., Harmon, J.D., Xin, H, and L. Dong. Unknown Date. Treating Ventilation Exhaust Air for Odor Control, Department of Agricultural and Biosystems Engineering, Iowa State University. ASL-R1393
90. Holland, P. T., W. May, A. J. Boyd, and J. Maber. 1995. Drift from spraying of kiwifruit orchards. HortResearch Client Report 95/227 to NZ Kiwifruit Marketing Board on Project 1994/08.
91. Homes, M. J., A. J. Heber, C. C. Wu, L. K. Clark, R. H. Grant, N. J. Zimmerman, M. A. Hill, B. R. Strobel, M. W. Peugh, and D. D. Jones. 1995. Viability of Bioaerosols produced from a swine facility.
<http://www.anr.ces.purdue.edu/anr/anr/swine/house/conf.htm>
92. Hoogasian, C. 1990. Plants purge pollution. Florist. Feb. 1990, 61-64&100.
93. Hudson, K, 1998, The Social Impacts of Livestock Factories, Animal Production Systems and the Environment Conference, July 19-22, 1998, Convention Center, Des Moines, Iowa.

94. Huffman, R.L. and P.W. Westerman. 1995. Estimated seepage losses from established swine waste lagoons in the lower coastal plain of North Carolina. *Transactions of the ASAE* 2: 449-453.
95. Hurt, C. 1994. Industrialization in the pork industry. *Choices* 9, 4 (4Q/94): 9-13.
96. Iverson, J., James, W., and B. Munson. Unknown Date. Wind Tunnel Testing of Dust and Gaseous Emissions from Swine Production Facilities. Research Report. Hog Odor and Waste Management Issues Production Research Program. <http://extension.agronn.iastate.edu/immag/ISUrep1.html> (5/16/99)
97. Jackson, L.L. 1998. Large-scale swine production and water quality. pp. 103-120. In: Thu, K.M. and E.P. Durrenberger, editors. 1998. *Pigs, Profits, and Rural Communities*. New York: State University of New York Press.
98. Jacobson, L. D. 1997. Monitoring Odor and Air Quality. Presented at the 13th Minnesota Poultry Service Workshop (Sept 23, 1997) St. Paul, MN. pages 1520.
99. Jacobson, L., D. Schmidt, R. Nicolai, and J. Bicudo. 1998. Odor control for animal agriculture. BAEU-17. University of Minnesota Extension Service, Department of Biosystems and Agricultural engineering. <http://www.bae.umn.edu/extens/aeu/baue17.html>
100. Jaenicke, R. 1988. The deposition of aerosol particles in a forest using an atmospheric residence time model. pp 143-150. In: Georgii, H.W. (Ed.). 1988. *Mechanisms and Effects of Pollutant-Transfer into Forests*. Proceedings of the Meeting on Mechanisms and Effects of Pollutant – transfer into Forests, held in Oberursel/Taunus, F.G.R., November 24-25, 1988. Kluwer Academic Publishers. London
101. Johnson, D. 1996. Iowa Supreme Court Rules Hog Odor a Nuisance. *Spokesman* November 2, 1996, Iowa farm Bureau.
102. Johnson, R.J., Beck, M.M., and J. Brandle. 1991. *Windbreaks and Wildlife*. University of Nebraska Extension, EC91-1771-B.
103. Keddie, A.W.C. 1980. Dispersion of odors. In: *Odour Control: A Concise Guide*. Valentine, F.H.H and A.A. North (Eds.). Warren Springs Laboratory, Department of Industry, Stevenage, Hertfordshire, UK.
104. Kimmins, J.P. 1997. [Forest Ecology : A Foundation for Sustainable Management. 2nd ed.](#) Upper Saddle River, N.J. : Prentice Hall, c1997. xii, 596 p.

105. Kliebenstein, J.B. 1998. Economic and associated social and environmental issues with large-scale livestock production systems. Concept Paper for the World Bank Workshop on Sustainable Intensification of Agricultural Systems: Linking Policy, Institutions and Technology. July 5-10, 1998. Iowa State University, Ames, Ia.
106. Kliebenstein, J.B. and S.P. Hurley. 1999. Determining the benefits of environmental improvements in pork production and their sustainability: a community-based study of Iowa's pork industry. Leopold Center Progress Report. Volume 8, March 1999.
107. Koelsch, R. 1995. The causes of livestock odors. Manure Matters. Vol 1, Number 7. University of Nebraska Livestock Environmental Issues Committee. http://ianrwww.unl.edu/manure/v5n1_99.html
108. Koelsch, R. 1999. Animal housing odor control options. Manure Matters. Vol.5, Number 1. University of Nebraska Livestock Environmental Issues Committee. http://ianrwww.unl.edu/manure/v5n1_99.html
109. Kort, J. 1988. Benefits of windbreaks to field and forage crops. Agriculture, Ecosystems and Environment, 22/23:165-190.
110. Kort, J., and B. Turnock. 1997. Biomass production and carbon fixation by prairie shelterbelts: Green Plan Project. PRFA Shelterbelt Centre, Supplementary Report 96-5. Indian Head, Saskatchewan. <http://aceis.agr.ca/pfra/shbpub/shbpub63.htm>
111. Kuroda, K., T. Osada, M. Yonaga, A. Kanematu, T. Nitta, S. Mouri, and T. Kojima. 1996. Emissions of Malodorous Compounds and Greenhouse Gases From Composting Swine Feces. Bioresource Technology 56 (1996) 265-271.
112. Kwiecien, M. 1997. Deposition of inorganic particulate aerosols to vegetation – A new method of estimating. Environmental Monitoring and Assessment 46:191-207, 1997.
113. Laird, D.J. 1997. Wind tunnel testing of shelterbelt effects on dust emissions from swine production facilities. Thesis (M.S.)--Iowa State University.
114. Landolt, W., and T. Keller. 1985. Uptake and effects of air pollutants on woody plants. Experientia 41, Birkhauser Verlag, CH-4010. p.301-310.
115. Lasley, P., and K. Larson. 1998. Iowa farm and rural life poll—1998 Summary Report. Iowa State University Extension, Pm-1764 | July 1998.

116. Lenzian, K.J. 1984. Permeability of plant cuticles to gaseous air pollutants. In: Koziol, M.J. and F.R. Whatley. Gaseous Air Pollutants and Plant Metabolism. Butterworth, London.
117. Letson, D. and N. Gollehon. 1996. Confined animal production and the manure problem. Choices. Third Quarter, 1996. 18-24.
118. Li, J., D. S. Bundy, S. J. Hoff, and Q. Liu. 1995. Calculating odor emission rates from field measurements.
<http://www.nppc.org/Research/%2795reports/%2795Li-Emission.html>
119. Li, X. W., S. J. Hoff, D. S. Bundy, J. Harmon, H. Xin, and J. Zhu. 1996. Biofilter – A malodor control technology for livestock industry. J. Environ. Sci. Health, A31(9), 2275-2285.
120. Liu, Q., D. S. Bundy, and S. J. Hoff. 1995. A study on the air flow and odor emission rate from a simplified open manure storage tank. Transactions of the ASAE vol.38(6):1881-1886.
121. Liu, Q., D.S.Bundy, and S.J. Hoff. 1996. The effectiveness of using tall barriers to reduce odor emission. Proceedings of the International Conference on Air Pollution from Agricultural Operations, Midwest Plan Service, Ames, Ia. pp. 403-407.
122. Lorimor, J. 1999. A Short Summary of 1998 Manure Law Amendments. ISU Ag & Biosystems Engineering. July 7, 1999.
<http://www.ae.iastate.edu/manurelaw1998.pdf>
123. Lorimor, J. 1998. Iowa Odor Control Demonstration Project: Landscaping. Cooperative Extension Service. Iowa State University Extension. Pm-1754h.
124. Lorimor, J., C.V. Schwab, and L. Miller. 1993. Manure storage poses invisible risks. Cooperative Extension Service. Iowa State University. Ames, Iowa. Nov 1993. (1518K) 2 p.
125. Lucht, G. 1998. Farmers, Lawmakers Sort Out Court's Ag Law Ruling, Iowa Farmer Today Online,
<http://www.iowafarmer.com/98news/1009agarea.htm>.
126. Mackie, R. Unknown Date. Physiological aspects of the production of pollutants and malodorous compounds by pigs.
<http://www.aces.uiuc.edu/~pork/conferences/mackie.html> (5/16/99)
127. May, W. A., J. F. Maber, and J. P. Praat. 1994. The influences of sprayer type and live shelter on off-site Spray drift. Lincoln Technology, AEI Science Report 303:56pp. Hamilton, New Zealand.

128. McNaughton, K. G. 1988. Effects of windbreaks on turbulent transport and microclimate. *Agriculture, Ecosystems and Environment*, 22/23:17-40.
129. McPherson, E. G. 1994. Benefits and costs of tree planting and care in Chicago. USDA Forest Service Gen. Tech. Rep. NE-186.
130. Melvin, S.W. 1996. Swine odor measurement and control issues reviewed. *Feedstuffs*. May 27, 1996. V. 68 (22) 12-14.
131. Meyer, D. J. and H. B. Manbeck. 1986. Dust levels in mechanically ventilated swine barns. ASAE paper 86-4042. 6 p.
132. Miner, J.R. 1997. Nuisance concerns and odor control. *Journal of Dairy Science*. 80:2667-2672.
133. Misselbrook, T. H., C. R. Clarkson, B. F. Pain. 1993. Relationship between concentration and intensity of Odours for pig slurry and broiler houses. *Journal of Agricultural Engineering*. 55:163-169.
134. Muller, R. 1992. Bacterial degradation of xenobiotics. pp 35-58. In: (Eds.) Fry, J.C., G.M. Gadd, R.A. Herbert, C.W. Jones, and I.A. Watson-Craik. 1992. *Microbial Control of Pollution*. 48th Symposium of the Society for General Microbiology held at the University of Cardiff.
135. Midwest Plan Service (MWPS). 1993. *Midwest Plan Service: Livestock Waste Facilities Handbook*. Publication MWPS-8. Davidson Hall. Ames, Ia.
136. Naeve, L. 1995. *Tree fruit Pollination*. Cooperative Extension Service. Iowa State University, Extension handout Pm-1052.
137. Nash, R. G., and M. L. Beall, Jr. 1970. Chlorinated hydrocarbon insecticides: Root uptake versus vapor contamination of soybean foliage. *Science*. May 1970. 1109-1111.
138. National Pork Producers Council. 1995. *An Executive Summary: A Review of Literature on Nature and Control of Odors from Pork Production Facilities*. A report prepared by J.R. Miner, Bioresource Engineering Dept. Oregon State University for the subcommittee of the National Pork Producers Council.
139. Natural Resource Defense Council. 1998. *America's Animal Factories: How States Fail to Prevent Pollution from Livestock Waste*. NRDC Online report. <http://www.nrdc.org/nrdcpro/nrdcpro/factor/stiow.html>
140. News & Observer. 1995. *Boss Hog: North Carolina's pork revolution*. The News & Observer, Raleigh, North Carolina. February 19 - 26, 1995.

141. Nicolai, R. E. 1996. Managing odors from swine waste AEU-8.
<http://www.bae.umn.edu/extens/aeu/aeu8.html> (4/24/98)
142. Nicolai, R.E. and K. Janni. 1997. A biofilter for swine production facilities. Minnesota/Wisconsin Engineering Notes, Fall 1997.
<http://www.bae.umn.edu/extens/ennotes/enfall97/biofilter.html> (4/24/98)
143. Nielsen, V.C., J.H. Voorburg, P. L'Hermite. 1988. Volatile Emissions from Livestock Farming and Sewage Operations. Elsevier Applied Science. London and New York. 245 p.
144. Nolo Press, undated, Rural Neighbors and the Right to Farm, Nolo News,
<http://www.nolo.com>
145. Norton, R.L. 1988. Windbreaks: benefits to orchard and vineyard crops. Agriculture, Ecosystems, and Environment. 22/23: 205-213.
146. O'Neill, D. H. and I. W. Stewart. 1985. The control of odour nuisance from intensive livestock buildings. National Institute of Agricultural Engineering, Silsoe, UK.
147. O'Neill, D. H., I. W. Stewart, and V. R. Phillips. 1992. A review of the control of odour nuisance from livestock buildings: Part 2, The costs of odour abatement systems as predicted from ventilation requirements. J. agric. Engng. Res. 51:157-165.
148. Odor Control Task Force (OCTF). 1998. Board of Governors of the University of North Carolina. Control of odor emissions from animal Operations.
http://www.cals.ncsu.edu/waste_mgt/control.htm (3/31/99)
149. Okun, M. 1997. What's that smell in the air? CHECC: Hog Population Report Environmental Resource Program, School of Public Health, University of North Carolina, Chapel Hill.
<http://checc.sph.unc.edu/rooms/library/docs/Hogs/hogcase.html> (12/21/98)
150. Pain, B.F., Y.J. Rees and D.R. Lockyer. 1988. Odour and ammonia emission following the application of pig or cattle slurry to land. Pp 2- 11. In: Nielsen, V.C., J.H. Voorburg, P. L'Hermite. 1988. Volatile Emissions from Livestock Farming and Sewage Operations. Elsevier Applied Science. London and New York.
151. Palmquist, R. B., M. R. Fritz, and T. Vukina. 1997. Hog operations, environmental effects, and residential property values. Land Economics. V. 73. Feb. 1997. 114-124.

152. Parcell, J.L. and K.C. Dhuyvetter. 1997. Trends in the swine industry: Operations and Marketings. Swine Day 1997. Dept. of Agricultural Economics, Kansas State University.
153. Pasquill, F. 1974. Atmospheric Diffusion: The Dispersion of Windborne Material from Industrial and Other Sources. 2nd Edition. John Wiley & Sons, New York. 429 p.
154. Patterson, C. 1995. The Litigation Aspects of Livestock Odor Control, International Livestock Odor Conference, October 16-17, 1995, Iowa State university.
155. Perry, D.A. 1994. Forest Ecosystems. The Johns Hopkins University Press. 649 p.
156. Person, H., M. Aronoff, E. Alocilja, and K. Vigmostad. 1995. Recommended human relation management practice within a technological and social system involving livestock odor issues. International Livestock Odor Conference, October 16-17, 1995, Iowa State university.
157. Phillips, V. R., M. R. Holden, R.W. Sneath, J. L. Short, R. P. White, J. Hartung, J. Seedorf, M. Schroeder, K. H. Linkert, S. Pedersen, H. Takai, J. O. Johnsen, P.W.G. Groot Koerkamp, G. H. Uenk, R. Scholtens, J.H.M. Metz, and C. M. Wathes. 1998. The development of robust methods for measuring concentrations and emission rates of gaseous and particulate air pollutants in livestock buildings. *J. agric. Engng. Res.* 70:11-24.
158. Picot, J. J. C. and D. D. Kristmanson. 1997. Forestry pesticide aerial spraying; Spray droplet generation, Dispersion, and deposition. *Environmental Sci. and Technology Library*, 12:213pp. Netherlands: Kluwer Academic Publishers.
159. Porskamp, H.A.J., J.M.P.G. Michielsen, and Ir. J.F.M. Huijmans. 1994. The reduction of the drift of Pesticides in fruit growing by a wind-break. *Dienst Landbouwkundig Onderzoek, Instituut voor Milieu-en Agritechniek, Rapport 94-29.* Wageningen, 27pp.
160. Power, J. F. and B. Eghball. 1994. Manure management for minor classes of livestock in the United States. *Journal of Soil and Water Conservation.* Soil Conservation Society of America March-April. V. 49. p. 123-125.
161. Preece, T.F. and C.H. Dickinson. 1971. Ecology of Leaf Surface Micro-Organisms. Proceedings of an International Symposium held at the University of Newcastle Upon the Tyne. September 1970. Academic Press, London.

162. Pyatt, F.B. 1973. Some aspects of plant contamination by airborne particulate pollutants. *International Journal of Environmental Studies*. 5: 215-220. Listed in: Farmer, A. 1993. The effects of dust on vegetation- A review. *Environmental Pollution*. (79) 63-75
163. Quam, V. C., J. Gardner, J. Brandle, and T. Boes. 1991. Windbreaks in sustainable agricultural systems. Cooperative Extension Service, University of Nebraska, College of Agriculture and Home Economics. EC 91-1772-X.
164. Quam, V.C., L. Johnson, B. Wight, and J.R. Brandle. 1994. Windbreaks for Livestock operations. Cooperative Extension Service, University of Nebraska, College of Agriculture and Home Economics. EC 94-1766-X.
165. Quam, V.C., B. Wight, and H. Hirning. 1996. Farmstead Windbreak. North Dakota State University Extension Service. F-1055, May 1993 (Revised and reprinted April 1996).
166. Rao, D.N. 1971. A study of the air pollution problem due to coal unloading in Varansi, India. pp 273-276. In *Proceedings of the Second International Clean Air Congress*, Englung, H.M., and W.T. Beery. Academic Press, New York. Listed in: Farmer, A. 1993. The effects of dust on vegetation- A review. *Environmental Pollution*. (79) 63-75.
167. Reifschneider, D. 1999. Congressional Testimony on Behalf of the National Pork Producers Council Before the US Senate Committee on Agriculture, Nutrition, and Forestry, January 26, 1999, Washington, D.C.
168. Reischl, A., M. Reissinger, and O. Hutzinger. 1987. Occurrence and distribution of atmospheric organic micropollutants in conifer needles. *Chemosphere*, Vol.16, Nos.10-12:2647-2652.
169. Reischl, A., M. Reissinger, H. Thoma, and O. Hutzinger. 1989. Accumulation of organic air constituents by plant surfaces. *Chemosphere*, Vol.18, Nos.1-6:561-568.
170. Rhodes, V. J. 1995. The industrialization of hog production. *Review of Agricultural Economics*. 17, 2 (May 1995): 107-118.
171. Riederer, M. 1990. Estimating Partitioning and transport of organic chemicals in the foliage/atmosphere system: Discussion of a Fugacity-based model. *Environ. Sci. Technol.* 24:829-837.
172. Riederer, M. and J. Schonherr. 1988. Covalent Binding of chemicals to plant cuticles: Quantitative determination of epoxide contents of cutins. *Arch. Environ. Toxicol.* 17:21-25.

173. Ritter, J. 1989. Odour control of livestock wastes: State of the art. *North American Journal of Agricultural Engineering*. 42:51-62.
174. Ronneberg, E. 1992. *The Hedgerow Project: A Review of Literature*. Chicago: Hedgerow Foundation, i, 43 p. : ill. ; 28 cm.
175. Sabijic, A., H. Gusten, J. Schonherr, and M. Riederer. 1990. Modeling plant uptake of airborne organic chemicals. 1. Plant cuticle/water partitioning and molecular connectivity. *Environ. Sci. Technol.* 24:1321-1326.
176. Saxe, H. 1990. *Air Pollution, Primary Plant Physiological Responses, and Diagnostic Tools*. Other title: Luftforurening, primaere plantefysiologiske reaktioner og diagnostiske metoder. Thesis (doctoral)--Royal Veterinary- & Agricultural University, Frederiksberg C, Denmark, 1989. Includes bibliographical references.
177. Scanes, C. 1998. Iowa's animal production system-technology, history, and sustainability. Concept Paper for the World Bank Workshop on Sustainable Intensification of Agricultural Systems: Linking Policy, Institutions and Technology. July 5-10, 1998. Iowa State University, Ames, Ia.
178. Schiffman, Susan S. et al. The Effect of Environmental Odors Emanating From Commercial Swine Operations on the Mood of Nearby Residents, *Brain Research Bulletin*. 37, 4 (1995): 369-375.
179. Schmidt, D., and L. Jacobson. 1995. Odor and odor policy criteria. University of Minnesota Extension Service—Dept. of Biosystems and Agricultural Engineering. AEU-11 <http://www.bae.umn.edu/extens/aeu/aeu11.html> (3/15/99)
180. Schonherr, J., and M. Riederer. 1989. Foliar penetration and accumulation of organic chemicals in plant cuticles. *Reviews of Environmental Contamination and Toxicology*, Vol.108. New York: Springer-Verlag.
181. Schonherr, J., and P. Baur. 1994. Modeling penetration of plant cuticles by crop protection agents and effects of adjuvants on their rates of penetration. *Pestic. Sci.* 42:185-208. Great Britain.
182. Schreiber, L. 1996. Wetting of the upper needle surface of *Abies grandis*: influence of pH, wax chemistry and epiphyllic microflora on contact angles. *Plant, Cell, and Environment* 19:455-463.

183. Schreiber, L., and J. Schonherr. 1992. Uptake of organic chemicals in conifer needles: Surface adsorption and permeability of cuticles. *Environ. Sci. Technol.* 26:153-159.
184. Schreiber, L., and J. Schonherr. 1992. Leaf surface microflora may significantly affect studies on foliar uptake of chemicals. *Botanical Acta.* 105: 345-347.
185. Schreiber, L., and J. Schonherr. 1993. Contact areas between waxy leaf surfaces and aqueous solutions: Quantitative determination of specific leaf surface contact areas. *Journal of Experimental Botany*, Vol.44, No.268:1653-1661.
186. Schreiber, L., and J. Schonherr. 1993. Determination of foliar uptake of chemicals: influence of leaf surface microflora. *Plant, Cell, and Environment.* 16: 743-748.
187. Schroeder, W.R., and J. Kort. 1989. Shelterbelts in the Soviet Union. *Journal of Soil and Water Conservation* 44: 130-134.
188. Schulze, E.D. 1982. In: O.L. Lange, C.B. Osmund, H. Ziegler (Eds.), *Encyclopedia of Plant Physiology*. Vol. 12 B. Springer-Verlag, Berlin. pp. 615-676.
189. Seedorf, J., J. Hartung, M. Schroder, K. H. Linkert, S. Pedersen, H. Takai, J. O. Johnsen, J. H. M. Metz, P. W. G. Groot Koerkamp, G. H. Uenk, V. R. Phillips, M. R. Holden, R. W. Sneath, J. L. Short, R. P. White, C. M. Wathes. 1998. A survey of ventilation rates in livestock buildings in Northern Europe. *J. agric. Engng. Res.* 70:39-47.
190. Smith, R. J. 1993. Dispersion of odours from ground level agricultural sources. *J. agric. Engng. Res.* 54:187-200.
191. Smith, R. J., and P. J. Watts. 1994. Determination of odour emission rates from cattle feedlots: Part 1, A review. *J. agric. Engng. Res.* 57:145-155.
192. Smith, R. J., and P. J. Watts. 1994. Determination of odour emission rates from cattle feedlots: Part 2, Evaluation of two wind tunnels of different size. *J. agric. Engng. Res.* 58:231-240.
193. Smith, W.H. 1976. Air pollution-effects on the structure and function of plant: surface microbial ecosystems. pp. 75-106. In: Dickinson, C.H. and T.F. Preece. 1976. *Microbiology of Aerial Plant Surfaces*. Academic Press, London and New York.
194. Smith, W.H. 1984. Pollutant uptake by plants. pp 417-450. In: Treshow, M. (Ed.). 1984. *Air Pollution and Plant Life*. Wiley & Sons, New York.

195. Steubing, L., and R. Klee. 1970. Comparative investigations into the dust filtering effects of broad leaved and coniferous woody vegetation. *Agnew Botany*. 4: 73-85. Listed in: Farmer, A. 1993. The effects of dust on vegetation- A review. *Environmental Pollution*. (79) 63-75
196. Stroik, M. and A. H. Heber. 1986. Characteristics of aerial dust in swine finishing houses. ASAE paper 86-4027. American Society of Agricultural Engineers, St. Joseph, MI. 17 p.
197. Sweeten, J. M. and D. Levi. 1996. Odor Controls as Affected by Nuisance laws, University of Nebraska Extension Office, File G378, A-1, Laws & Regulations, <http://ianrwww.unl.edu>
198. Swine Odor Task Force (SOTF). 1995. Options for Managing Odor. North Carolina University, <http://www.ces.ncsu.edu/whpaper/SwineOdor.html>
199. Taiz, L. and E. Zeiger. 1991. *Plant Physiology*. Benjamin/Cummings series in the life series. Benjamin/Cummings Publishing Co. xxxii, 559p.
200. Takai, H., S. Pedersen, J. O. Johnsen, J. H. M. Metz, P. W. G. Groot Koerkamp, G. H. Uenk, V. R. Phillips, M. R. Holden, R. W. Sneath, J. L. Short, R. P. White, J. Hartung, J. Seedorf, M. Schroder, K. H. Linkert, C. M. Wathes. 1998. Concentrations and emissions of airborne dust in livestock buildings in Northern Europe. *J. agric. Engng. Res.* 70:59-77.
201. Takle, E.S. 1983. Climatology of superadiabatic conditions for a rural area. *Journal of Climate and Applied Meteorology*. 22:1129-1132.
202. Takle, E.S. Unknown Date. A numerical model feasibility study of managing swine odor by manipulation of atmospheric flow. A research proposal. Department of Agronomy, Iowa State University.
203. Takle, E.S., R.H. Shaw, and H.C. Vaughan. 1976. Low-level stability and pollutant trapping potential for a rural area. *Journal of Applied Meteorology*. 15:36-42.
204. Thernelius, S.M. 1997. Wind tunnel testing of odor transportation from swine production facilities. Thesis (M.S.)--Iowa State University, 1997
205. Thompson, M.L., J.P. Colletti, C.W. Mize, R.C. Schultz, I.C. Anderson, D.R. Buxton, and P.W. Wray. Demonstration of agroforestry system to minimize pollution hazards from land application of treated municipal sludge. A progress Report for the Leopold Center for Sustainable Agriculture, Ames, IA.

206. Thompson, Nancy, 1997. Are large hog operations good for rural communities?, Center for Rural Affairs Home Page: http://www.cfra.org/op_ed.htm
207. Thu, K.M. and E.P. Durrenberger, editors. 1998. Pigs, Profits, and Rural Communities. New York: State University of New York Press.
208. Thu, K.M., K. Donham, R. Ziegenhorn, et al. 1997. A control study of the physical and mental health of residents living near a large-scale swine operation. *Journal of Agricultural Safety and Health*. 3(1):13-16.
209. Thu, K.M. 1996. Understanding the Impacts of Large-Scale Swine Production. Iowa City: The university of Iowa.
210. Tibke, G. 1988. Basic principles of wind erosion control. *Agriculture, Ecosystems, and the Environment*. 22/23: 103-122.
211. Trapp, S., M. Matthies, I. Scheunert, and E. M. Topp. 1990. Modeling the bioconcentration of organic chemicals in plants. *Environmental Science and Technology*. 24, 1246-1252.
212. Ucar, T. and F. Hall. 1998. Windbreak technology for agrochemical drift mitigation. Progress Report 1 for the Laboratory for Pest Control Application Technology and the USDA-NRCS.
213. United States Department of Agriculture (USDA). 1996. Economic Research Service, Natural Resources and Environment Division. Manure Management by U.S. Pork Producers in 1992. AREI UPDATES, no. 7, Aug. 1996.
214. United States Department of Agriculture (USDA). 1998. National Agricultural Statistics Service. Hogs and Pigs. Data Release December 29, 1998. Mt An 4 (12-98).
215. United States Department of Agriculture (USDA). 1999a. National Agricultural Statistics Service. January Cattle and Calves. January 29, 1999 Data Release Iowa Agricultural Statistics, Des Moines, IA.
216. United States Department of Agriculture (USDA). 1999b. National Agricultural Statistics Service. Milk Cows and Production: Final Estimates 1993-1997. Statistical Bulletin Number 952.
217. United States Department of Agriculture (USDA). 1999c. National Agricultural Statistics Service. Sheep and Goats. January 1999.

218. United States Environmental Protection Agency (US EPA) and United States Department of Agriculture. 1999. Unified National Strategy for Animal Feeding Operations, March 9, 1999.
<http://www.epa.gov/owm/finafost.htm> (4/8/99)
219. United States Senate Committee on Agriculture, Nutrition, & Forestry. 1997. Animal Waste Pollution in America: An Emerging National Problem. Environmental Risks of Livestock & Poultry Production.
<http://www.senate.gov/~agriculture/animalw.htm> (2/11/98)
220. University of Nebraska-Lincoln/Cooperative Extension. 1996. Swine manure management Systems, G80-531-A.
<http://ianrwww.unl.edu/pubs/wastemgt/g531.htm>
221. Van-Haverbeke, D.F. and D.I. Cook. Green Mufflers. *American Forests*. Nov 1972, 78 (11): 28-31.
222. Wang, H. and E.S. Takle. 1994. Mesoscale and boundary layer flows over inhomogeneous surfaces consisting of porous obstacles. Reprints from, 6th Conference on Mesoscale Processes, Portland, American Meteorological Society. pp. 262-265.
223. Wang, H., and E. S. Takle. 1995. Boundary-layer flow and turbulence near porous obstacles. *Boundary-Layer Meteorology* 74:73-88.
224. Wang, H., and E. S. Takle. 1995. Numerical simulations of shelterbelt effects on wind direction. *Journal of Applied Meteorology* 34(13):2206-2219.
225. Wathes, C. M., V. R. Phillips, M. R. Holden, R. W. Sneath, J. L. Short, R. P. White, J. Hartung, J. Seedorf, M. Schroder, K. H. Linkert, S. Pedersen, H. Takai, J. O. Johnsen, P. W. G. Groot Koerkamp, G. H. Uenk, J. H. M. Metz, T. Hinz, V. Caspary, S. Linke. 1998. Emissions of aerial pollutants in livestock buildings in Northern Europe: Overview of a multinational Project. *J. agric. Engng. Res.* 70:3-9.
226. WED Western Economic Diversification. 1999. Hog Manure Management Strategic Initiative: New Technology Demonstration sites for Hog Manure Management. Western Canada Initiative. <http://www.cetac-west.ca/hmm/hmm-content.html> (3/17/99)
227. Welke, B., K. Ettliger, and M. Riederer. 1998. Sorption of volatile organic chemicals in plant surfaces. *Environ. Sci. Technol.* 32:1099-1104.
228. Wight, B, T.K. Boes, and J.R. Brandle. 1991. Windbreaks for rural living. Cooperative Extension Service, University of Nebraska, College of Agriculture and Home Economics. 1991. (91-1767-X) 12 p.

229. Williams, C.M. 1996. Nuisance Concerns with Animal Agriculture- The Case of Odors. Animal and Poultry Waste Management Center. North Carolina State University. Raleigh, NC.
230. Wray, P., L. Sternweis, and J. Lenahan. 1997. Farmstead Windbreaks: Planning. Iowa State University Extension Service, Ames, Iowa. Pm- 1716. August 1997.
231. Yasuhara, A., K. Fuwa, and M. Jimba. 1984. Identification of odorous compounds in fresh and rotten swine manure. *Agricultural Biology and Chemistry*. 48: (12) 3001-3010.
232. Zahn, J.A., J.L. Hatfield, Y.S. Do, A.A. DiSpirito, D.A. Laird, and R.L. Pfeiffer. 1997. Characterization of volatile organic emissions and wastes from a swine production facility. *Journal of Environmental Quality*. 26:1687-1696.
233. Zhang, H., J. R. Brandle, and G. E. Meyer. 1993. A model to evaluate windbreak protection efficiency. *Proc. Third North American Agroforestry Conf.*, 16-18 Aug. 1993. Pp. 145-151.
234. Zhu, J., D. S. Bundy, X. Li, and N. Rashid. 1997. Controlling odor and volatile substances in liquid hog manure by amendment. *J. Environ. Qual.* 26:740-743.