

The Natural and Man-made Noise Environment in Personal Communications Services Bands

A.D. Spaulding



U.S. DEPARTMENT OF COMMERCE
William M. Daley, Secretary

Larry Irving, Assistant Secretary
for Communications and Information

May 1997

CONTENTS

	Page
1. INTRODUCTION AND BACKGROUND	1
2. GENERAL BACKGROUND AND INDIVIDUAL NOISE SOURCES	8
3. SUMMARY AND CONCLUSIONS.....	21
4. REFERENCES.....	23

THE NATURAL AND MAN-MADE NOISE ENVIRONMENT IN PERSONAL COMMUNICATIONS SERVICES BANDS

A.D. Spaulding*

This report presents a summary of the available measurement information on the level and statistical characteristics of the background noise environment in the frequency range of 1-3 GHz. The frequency range covers the proposed frequencies for the new personal communications services. Natural and man-made unintentional radiations are covered, both the general overall background noise and noise from individual sources. The urban noise environment in this frequency range is due primarily to automotive ignition systems. The noise is non-Gaussian in character, but not highly impulsive.

Key words: noise; personal communications services (PCS); non-Gaussian interference; background noise levels.

1. INTRODUCTION AND BACKGROUND

Natural and man-made noise and interference determine the limiting performance of radio systems. This has become more and more significant as the radio spectrum becomes increasingly crowded, and noise-producing devices proliferate. In addition, the nature of the interference being, in many cases, highly non-Gaussian, seriously degrades most conventional systems designed for optimal or near-optimal performance against white-Gaussian noise. Therefore, it is important that the realworld electromagnetic environment be appropriately modeled so that correct system design and analysis can be carried out [1]. Prasad et al., [2] suggest that Middleton's physical-statistical models [3,4,5] are appropriate models for microcellular mobile radio systems and use these models in some theoretical digital system performance analyses.

It is the purpose of this short report to present the natural and man-made background noise levels likely in urban locations in the 1- to 3-GHz range and to give some indication as to the noise environment's statistical character. This environment then must be combined with co-channel interference (not treated here) to obtain the overall interference process.

This introduction continues with a background discussion and noise parameter definitions. This is followed by an overall look at the natural noise background. The next section then gives the general

* The author was formerly with the U.S. Department of Commerce, National Telecommunications and Information Administration, Institute for Telecommunication Sciences, Boulder, Colorado 80303.

man-made background noise level and characteristics in the frequency range of interest and also looks at the trend of the man-made noise level with time. Individual noise sources, including local lightning, are also included.

As noted above, this report addresses the background noise environment from natural and man-made sources, sometimes termed incidental radiation devices, but does not cover interference from intentionally radiated signals. A review of the nature of the interference environment due to these intentional signals can be obtained from [6,7,8].

It has been widely recognized since about 1945 that an effective study of communications systems and devices cannot be carried out in terms of an individual message or signal alone, nor can the inhibiting effects of the background noise or other interference on performance be neglected. Rather, one must consider the set, or ensemble, of possible signals for which the system is designed, the ensemble appropriate to the accompanying noise, and the manner in which they combine in the communications process itself. It is these that are ultimately significant in analysis, design, and performance. Thus, the methods of probability and random processes provide the required approach. Advances in communications technology rest on the foundation of Statistical Communications Theory. Indeed, this rigor tells what is *required knowledge* about noise and signal processes.

Environmental noise (man-made noise, atmospheric noise, interfering signals, etc.) is a random process. This is true for noise from a single source, like an automobile, as well as the more general case in which the interfering noise is from a collection of many individual sources. The fact that environmental noise is a random process means that the noise can be described only in probabilistic or statistical terms and cannot be represented by a deterministic waveform or any collection of deterministic waveforms. In addition, environmental noise is basically nonstationary and, therefore, great care must be exercised in planning, measuring, and interpreting the results. One must measure long enough to obtain a good estimate of the required parameter, but be certain that the noise remains "stationary enough" during this period. This is no small point and is frequently overlooked in the design of measurement experiments. It is assumed that the random noise process is stationary enough over some required time period to obtain the required statistics. How these statistics change with time, as from day to day, as well as with location, now becomes important.

The basic description of *any* random process is its probability density function (pdf) or distribution function. The first-order pdf of the received interference process is always required to determine system performance (but sometimes is not sufficient).

Although a random process, $X(t)$, is said to be completely described if its hierarchy of distributions is known, there are other important statistical properties (important to communications systems) that are not immediately implied by this hierarchy. Moments and distributions of level crossings of $X(t)$ within a time interval, moments and distributions of the time interval between successive crossings, distribution of extremes in the interval, and so on, are typical examples.

For analysis or design of a communications system, the noise process of interest is the one seen by that part of the receiving system in which information is extracted from the desired signal. In communications theory terms, the projection of the noise on the "signal space" of the receiver is required. Narrowband noise processes are almost always those of interest. Here "narrowband" means "characterized by an envelope and phase." A narrowband process results whenever the bandwidth of the system is a small fraction of the center frequency. The noise process, $n(t)$, at the output of a narrowband filter is given by

$$n(t) = v(t) \cos [\omega_c t + \Phi(t)], \quad (1)$$

where $v(t)$ is the envelope process and $\Phi(t)$ is the phase process. In the absence of discrete signals, Φ is generally uniformly distributed; that is

$$p(\Phi) = \frac{1}{2\pi}, -\pi \leq \Phi < \pi. \quad (2)$$

Therefore, the statistics of the envelope process, $v(t)$, are of primary interest. In general, for system analysis and design, the required statistics that determine performance are either the envelope statistics directly or are obtainable from the envelope and phase statistics. For noise from some discrete sources, or for general background noise plus interfering signals, $\Phi(t)$ may not be uniformly distributed, and the statistics of the Φ process must also be known. The envelope probability function is normally given as an exceedence distribution. The envelope exceedence distribution is defined as follows.

The *amplitude probability distribution* (APD) is the fraction of the total measurement time, T , for which the envelope voltage was above level v ;

$$D(v) = \text{Prob} [\text{Envelope voltage} \geq v] = 1 - P(v), \quad (3)$$

where $P(v)$ is the cumulative distribution function. The pdf of v is given by the derivative of $P(v)$. The appropriate envelope statistics are computed from the APD. (A measurement example at 2.335 GHz is shown in Section 2.)

The *average envelope voltage* is termed the expected value of v , $E[v]$;

$$v_{av} = E[v] = \frac{1}{T} \int_0^T v(t) dt = - \int_0^{\infty} v dD(v) \quad (4)$$

where

$$-dD(v) = p(v) dv.$$

The *rms voltage squared*, (proportional to energy, or power) $E[v^2]$, is

$$v_{rms}^2 = E[v^2] = \frac{1}{T} \int_0^T v^2(t) dt = - \int_0^\infty v^2 dD(v). \quad (5)$$

The rms voltage squared is the main single parameter of importance, giving the mean noise power, and with proper calibration determines the mean field strength impinging on the receiver antenna. It is important to note that most commercial field strength meters specify the field strength correctly only for a CW signal (or white Gaussian noise if used in the "noise" mode), although true rms measurement devices are available.

The noise power, while needed in determining the signal-to-noise ratio, for example, is seldom sufficient by itself to determine system performance. Quite often, the external noise is expressed as an antenna noise factor, so that it can be combined with the noise generated within the receiving system to give an overall operating noise factor. The overall operating noise factor, f , for a receiving system is composed of a number of noise sources at the receiving terminal of the system. Both internal and external noise must be considered. As derived in CCIR Report 413 [9], the only appropriate reference point for the overall operating noise factor for a radio-receiving system is the input of an equivalent loss-free receiving antenna. (The terminals of this lossless antenna do not exist physically.) The rms voltage squared can be referred by calibration to the terminals of an equivalent lossless antenna to give the available noise power, P_n .

For receivers free from spurious responses, the system noise factor is given by:

$$f = f_a + (f_c - 1) + \ell_c (f_t - 1) + \ell_c \ell_t (f_r - 1) \quad (6)$$

where

f_a = the external noise factor defined as

$$f_a = \frac{P_n}{k t_o b} \quad (7)$$

(F_a is the external noise figure defined as $F_a = 10 \log_{10} f_a$,

- P_n = the available noise power from an equivalent lossless antenna,
 k = Boltzmann's constant = 1.38×10^{-23} J/K,
 t_o = the reference temperature in K, taken as 290 K,
 b = the noise power bandwidth of the receiving system in Hz,
 l_c = the antenna circuit loss
 (power available from lossless antenna/power available from actual antenna),
 l_t = the transmission line loss (available input power/available output power),
 f_r = the noise factor of the receiver
 (F_r is the receiver noise figure defined as $F_r = 10 \log_{10} f_r$),
 f_c = the noise factor associated with the antenna circuit losses,

$$f_c = 1 + (l_c - 1) \left(\frac{t_c}{t_o} \right), \text{ and} \quad (8)$$

- f_t = the noise factor associated with the transmission line losses,

$$f_t = 1 + (l_t - 1) \left(\frac{t_t}{t_o} \right), \quad (9)$$

where

- t_c = the actual temperature, in K, of the antenna and nearby ground, and
 t_t = the actual temperature, in K, of the transmission line.

If $t_c = t_t = t_o$, (6) becomes

$$f = f_a - 1 + f_c f_t f_r. \quad (10)$$

Figure 1 shows the receiving system and how the noise factors can be combined. Equation (6) or (10) provides the means to determine an appropriate receiver noise figure, F_r , for an external noise level, f_a .

Equation (7) can be written

$$P_n = F_a + B - 204dBW \quad (11)$$

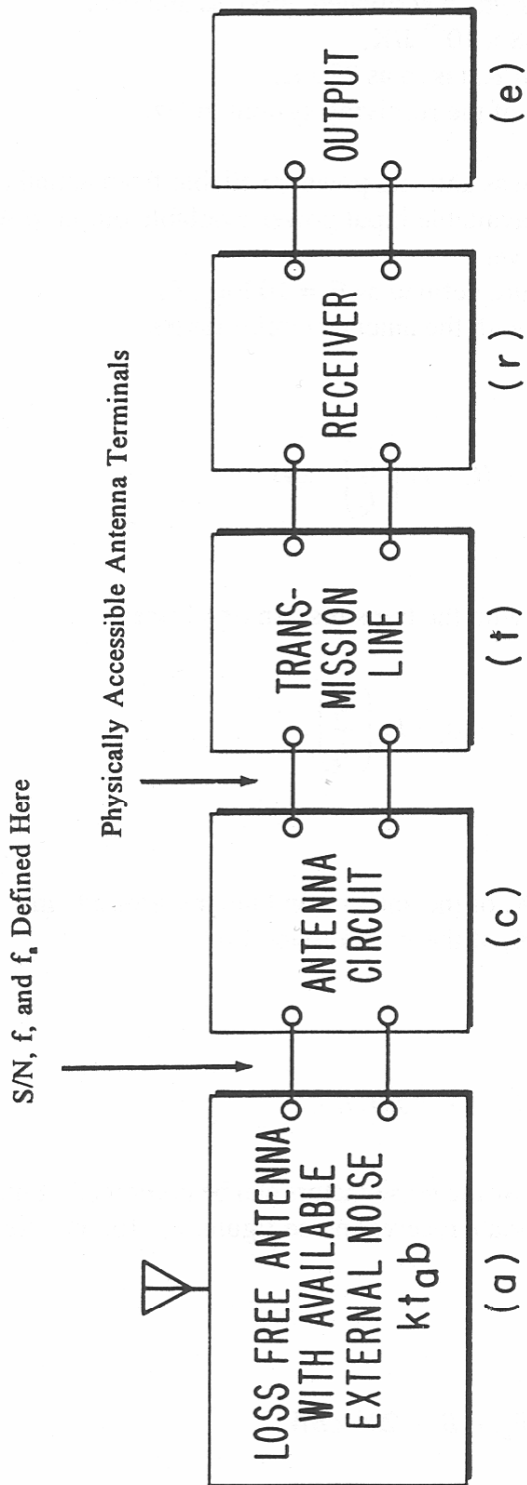

$$L_a = 1, t_a$$

$$L_c, t_c \quad L_t, t_t$$

$$f_a = t_a / t_o \quad f_c = 1 + (L_c - 1)(t_c / t_o) \quad f_t = 1 + (L_t - 1)(t_t / t_o) \quad f_r$$

$$f = f_a + (L_c - 1)(t_c / t_o) + L_c(L_t - 1)(t_t / t_o) + L_c L_t(f_r - 1)$$

Figure 1. The receiving system and its operating noise factor, f [9].

where

$$\begin{aligned} P_n &= 10 \log_{10} p_n, \quad p_n = \text{available power in watts,} \\ B &= 10 \log_{10} b, \text{ and } -204 = 10 \log_{10} kt_0. \end{aligned}$$

In general, since different antennas have different effective length-to-radiation resistance ratios, they can have different f_a 's for a given field strength [10]. One converts the specified f_a data (particular to the reference antenna) to the corresponding field strength. This field strength is then applied to the antenna of interest to obtain its f_a . Equation (7) or (11) relates available power and f_a . The available power is given, in general, for an antenna by

$$P_n = \frac{(\bar{e} \cdot \bar{\ell}_{eff})^2}{4R_{rad}}, \quad (12)$$

where \bar{e} is the field strength (in a bandwidth b), $\bar{\ell}_{eff}$ is the vector effective length of the antenna, and R_{rad} is the radiation resistance of the antenna.

For a short ($\ll \lambda$), grounded, vertical monopole, from (7) and (12), the vertical component of the rms field strength is given by

$$E_n = F_a + 20 \log_{10} f_{MHz} + B - 95.5 dB(\mu V / m), \quad (13)$$

where E_n is the field strength in bandwidth b , and f_{MHz} is the center frequency in MHz.

Similarly, for a half-wave dipole in free space,

$$E_n = F_a + 20 \log_{10} f_{MHz} + B - 99.0 dB(\mu V / m), \quad (14)$$

The external noise factor, especially at higher frequencies, is also commonly expressed as a temperature, t_a , where, by definition of f_a ,

$$f_a = \frac{t_a}{t_0}, \quad (15)$$

and t_a is the effective antenna temperature due to external noise.

Noise from individual sources such as the sun, atmospheric gases, and the Earth's surface, are usually given in terms of a brightness temperature, t_b . For the purposes of this report, the brightness temperature, t_b , and the effective antenna temperature, t_a , are completely equivalent.

Measurement data are given in terms of F_a (usually as distributions of F_a values for various time periods). Measurement data are also often given directly in field strength. It often is not known if this "field strength" is the actual field strength based on proper rms measurements.

The above discussion shows the relationship between F_a and field strength so that various diverse measurements can be interrelated. It also defines a receiving system's overall operating noise factor. This is especially useful to determine an appropriate receiver noise figure. It makes no sense to use a receiver with more sensitivity than that dictated by the external noise. It is also desirable to know the effect of the receiving system's internal noise on the overall interfering noise process.

For impulsive noise processes at higher frequencies (i.e., > about 1 GHz), F_a values can be quite low and only the higher-magnitude pulses appear above the measurement receiver's noise threshold. Description here can take the form of peak values for a given time period, exceedence probabilities at these higher levels, pulse counts at these higher levels, etc.

Before proceeding to the section that reviews the noise level (F_a , E_n , etc.) background measurements and the noise levels from particular sources in the frequency range of interest, the general overall background noise from natural sources is reviewed.

Figure 2 shows this background noise in the frequency range of 1 Hz to 1 THz. Notice that in the frequency range of interest (1-3 GHz), the natural noise background is extremely low. This is especially true for PCS systems since curves L_D , L_Q , F, H, and M all refer to very narrow beam antennas pointing directly at the source (e.g., galactic center or the sun) and PCS systems use much wider beamwidth antennas. In fact, in this frequency range, the background level can be as low as the cosmic background ($t_a = 2.7$ K). Figure 3 (a corrected figure from CCIR Report 670 [11]) shows much of the same information as Figure 2, but over the frequency range of 100 MHz to 100 GHz. Figure 3 also has curve A which is the man-made noise background in a business (urban) area. Extending curve A a bit, the background noise at 2 GHz (say) is around $F_a = 5$ dB. Detailed measurements in the next section show that this is a reasonable estimate. The next section also shows that the background noise (due primarily to automotive ignition systems) is not particularly impulsive in this frequency range.

2. GENERAL BACKGROUND AND INDIVIDUAL NOISE SOURCES

In this section, the general noise background level in urban areas in the 1- to 3-GHz range is reviewed in more detail. The interference from nearby individual sources is also presented. Most of the available information is from measurements prior to about 1975, and generally at frequencies below 1 GHz, although there have been reports of serious interference from man-made noise above 1 GHz (usually in special locations or situations only). An example was given by Clarke, et al., [12] in 1975. His study of electromagnetic noise on ships in the 1535- to 1660-MHz band concluded that a serious interference problem existed in 1975 for the MARSAT system while ships were in port, due to impulsive noise from dock equipment and automotive ignition systems. Other examples are

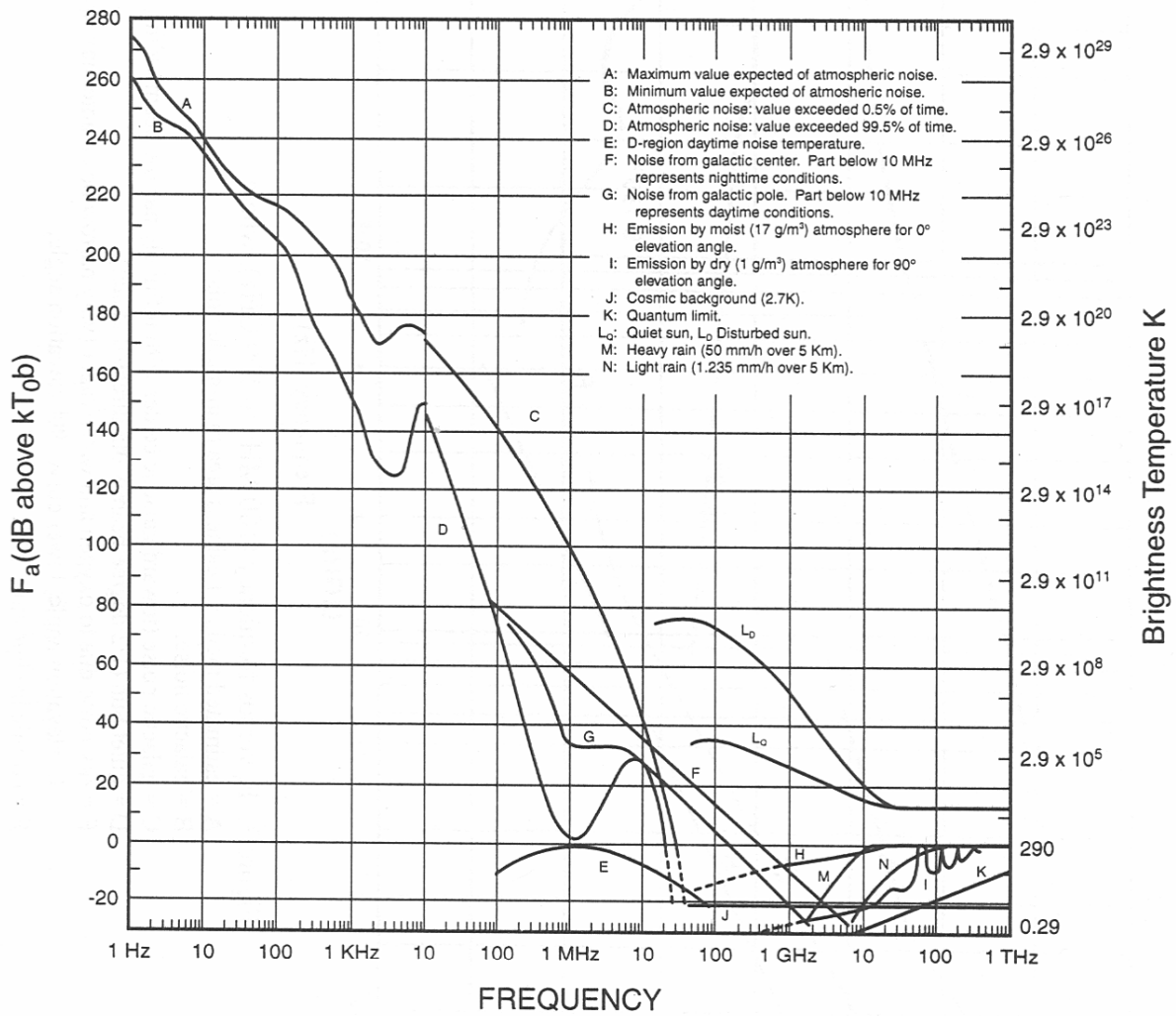

Figure 2. Natural radio noise (1Hz-1THz).

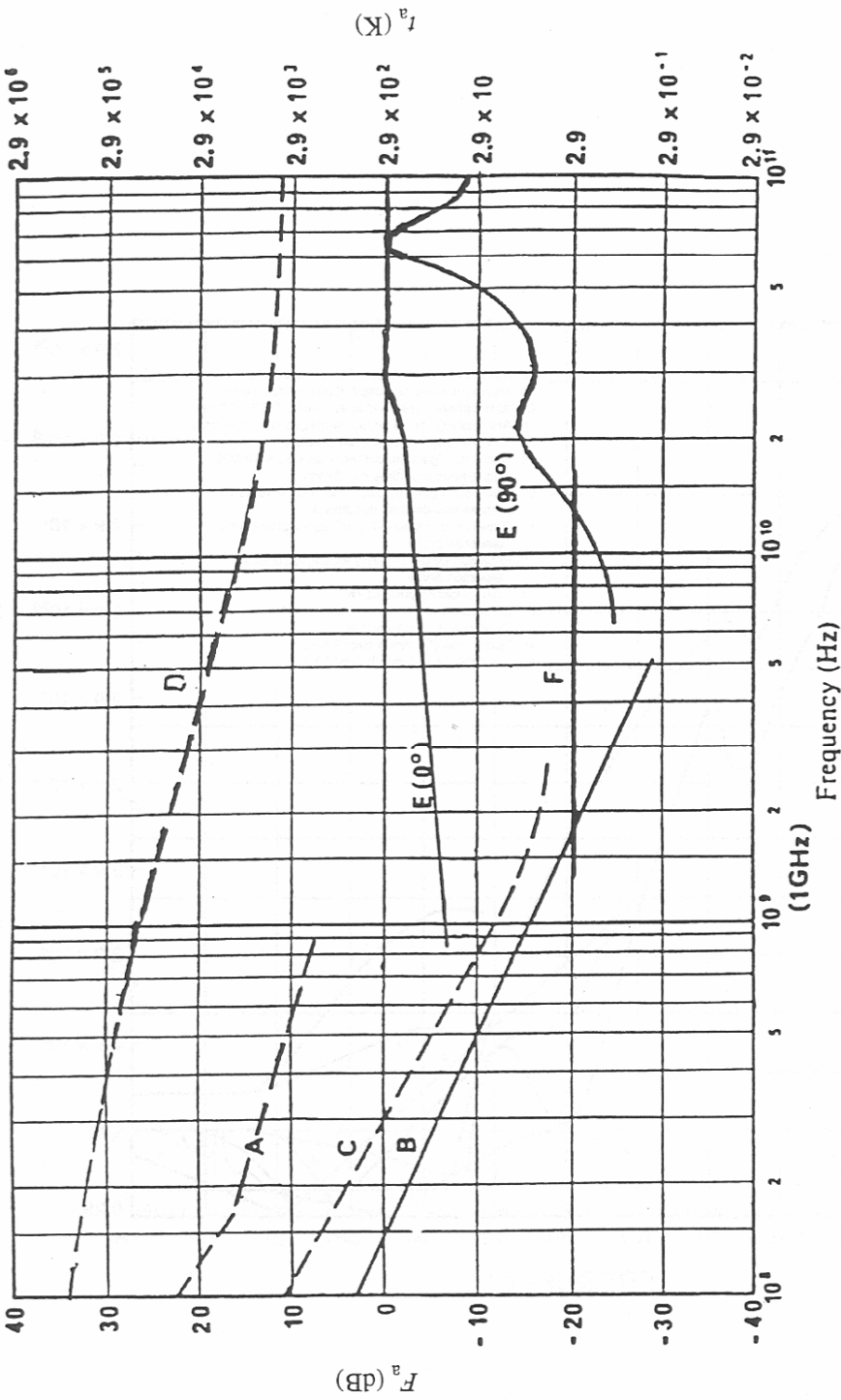

Figure 3. F_a versus frequency (100 MHz to 100 GHz), where

- A = estimated median business area man-made noise,
- B = galactic noise,
- C = galactic noise (toward galactic center with infinitely narrow beamwidth),
- D = quiet Sun (1/2 degree beamwidth directed at sun),
- E = sky noise due to oxygen and water vapor (very narrow beam antenna; upper curve 0° elevation angle, lower curve 90° elevation angle,
- F = cosmic background, 2.7K.

contained in Spaulding [13]. The major sources of radio noise in the frequency band of interest are, by rank,

1. automotive ignitions,
2. transportation and generation facilities,
3. industrial equipment,
4. consumer products,
5. lighting systems, and
6. medical equipment.

The effects of some of these sources are reviewed later.

In 1973, Skomal [14] performed a detailed analysis of the available noise measurements up to that time. This analysis, along with some further analysis, appears in Skomal's noted book on man-made noise [15]. Three figures from [15] that summarize the analysis for urban areas are reproduced here. The highest measurement frequency was about 1 GHz. Figure 4 [15] shows the results of one group of measurement data. If the trend line (slope = -12.3 dB/decade) is extended, the estimated value of F_a at 1 GHz is 7.7 dB, and at 2 GHz is 4.0 dB. Figure 5 shows the results of the analysis of another grouping of data. Here the 1-GHz F_a is 14 dB and the 2-GHz F_a estimate is 10 dB. Figure 6 [15] attempts to combine all urban measurements (defined as within 5.0 miles from an urban center). This figure gives an F_a estimate of 17 dB at 1 GHz and 13 dB at 2 GHz. Skomal's analysis was made difficult by the fact that many of the measurements were not of F_a directly, but of other parameters, and made with diverse equipment. Interrelating these measurements was a difficult (and approximate) task. The measurements were also widely separated in time.

In 1992, Freeman [16] attempted to develop a trend with time for urban man-made noise in the frequency range of 200-950 MHz using measurements made over the last 40 years. Many of the measurements (prior to about 1975) were those used by Skomal. He developed a linear trend with time (years) for P_n (power in dBm/kHz) using frequency and population as contributing variables. Reproduced results are shown in Figure 7, which uses the measurement data given in Table 1 and the references [17-26]. Note, from (11) and Figure 6, that an available power of -130 dBm/kHz (say) corresponds to an F_a of 14 dB. The results above from Skomal correspond to Freeman's trend for about the year 1970 or so. Since, in this frequency range, the background urban noise is due primarily to automotive ignition systems which have changed over the years in type and suppression, it is reasonable to expect the noise level due to ignition systems to have decreased. Freeman's trend analysis indicates that the noise level now (1996) should be given by an F_a of about 20 dB less than in 1970, on the order of -6 dB.

Yamanaka and Sugiura [27] presented an extensive set of noise measurements in urban areas (general streets and metropolitan expressways in Tokyo) in the 1- to 3-GHz range. Table 2 summarizes some of their measurements made at 1.48, 2.34, and 2.68 GHz. APD measurements were made, and Table 2 shows field strengths in a 100-kHz bandwidth exceeded .01 % and .001 % of the time (probabilities of 10^{-4} and 10^{-5}). Figure 8 shows an APD measurement from [27] at 2.335 GHz. The measurement system noise is also shown in Figure 8. Note that the background

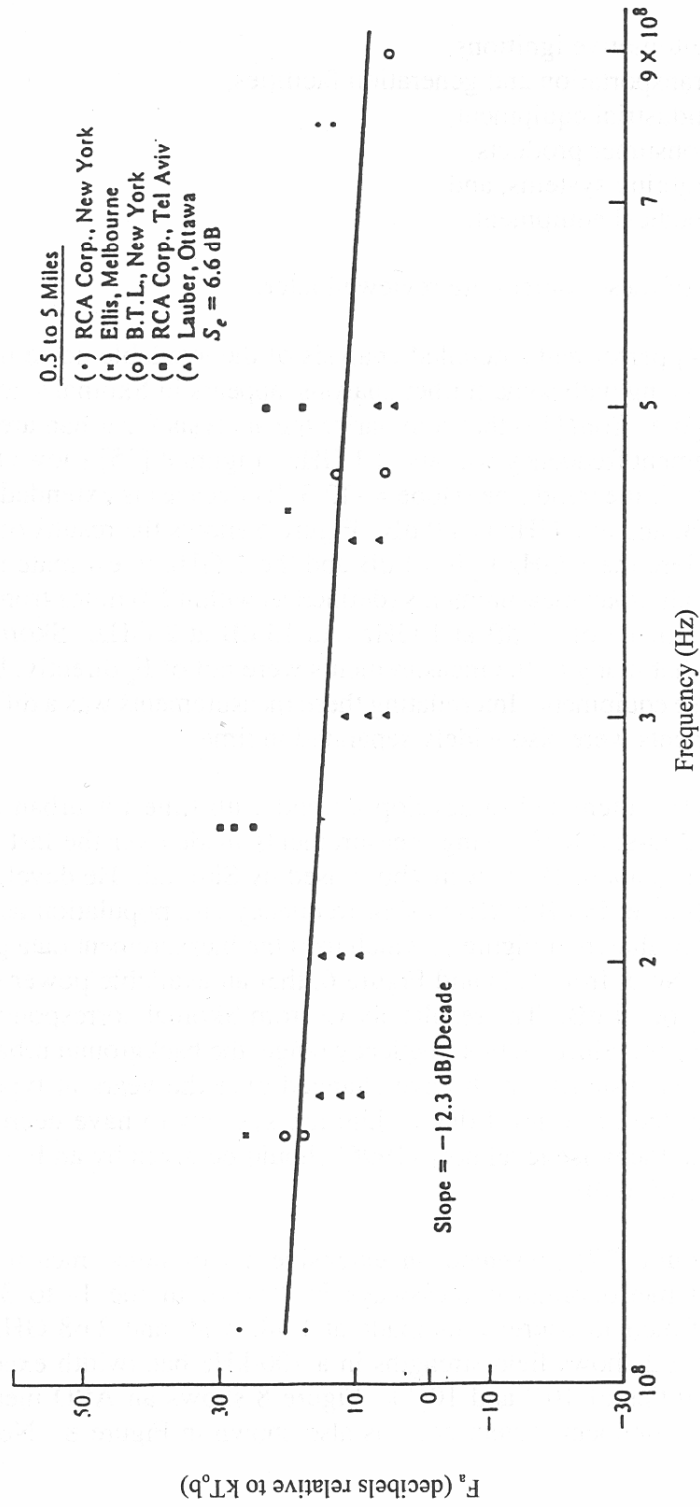

Figure 4. F_a versus frequency for data Group III.
 (Reprinted from p. 248 of [15], by permission,
 from Van Nostrand Reinhold © 1973)

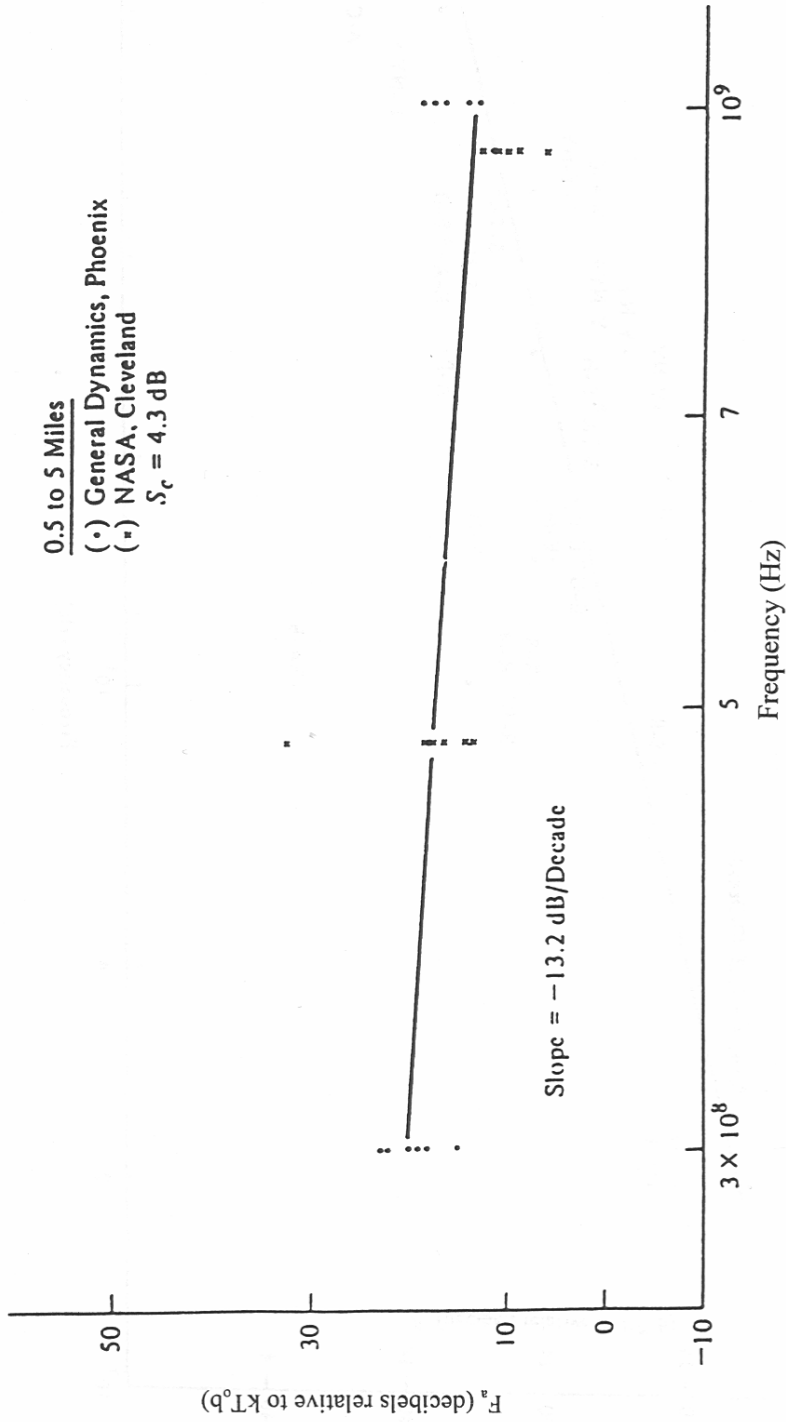

Figure 5. F_a versus frequency for data Group IVA.
(Reprinted from p. 249 of [15], by permission,
from Van Nostrand Reinhold © 1973)

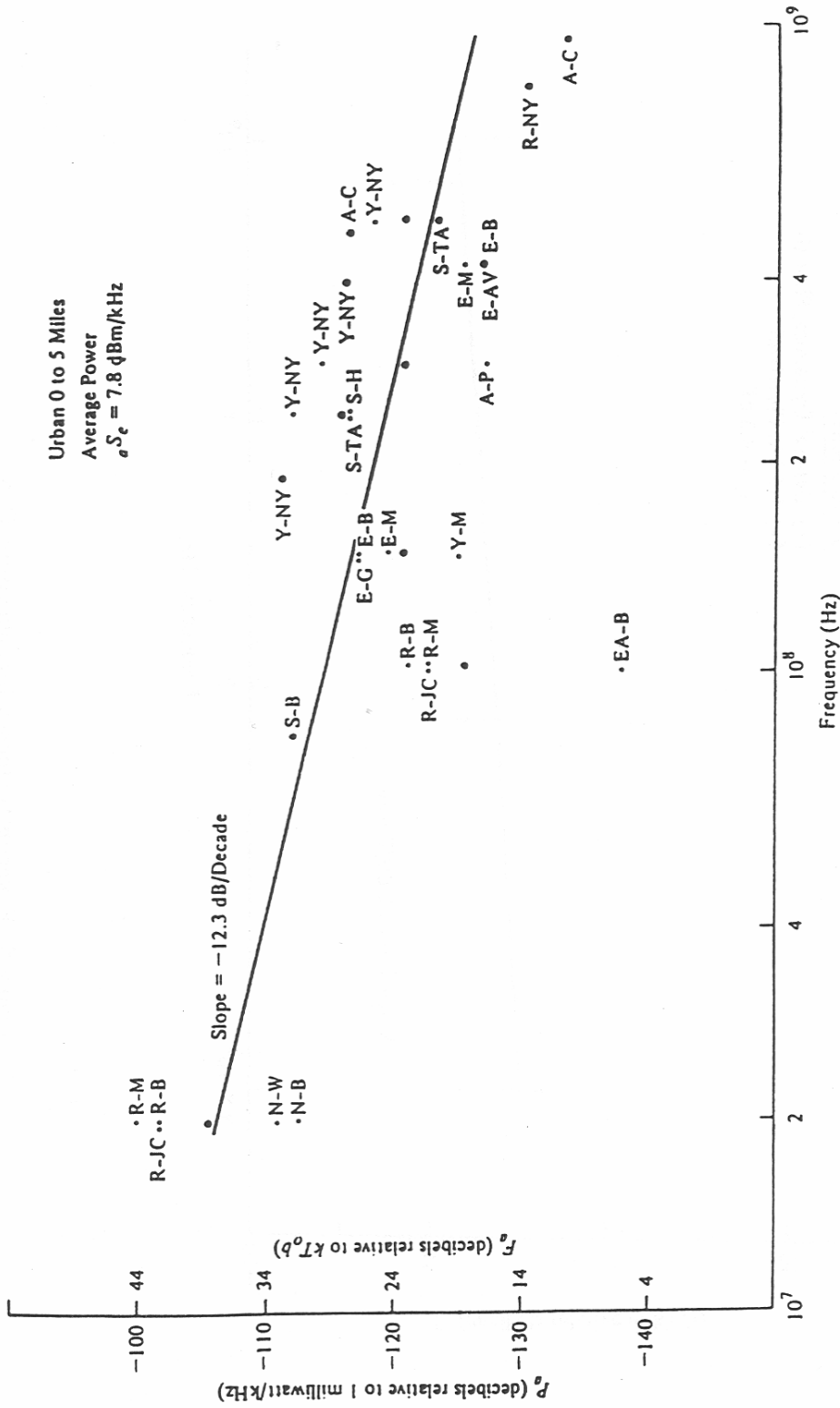

Figure 6. Average composite man-made noise power for the urban zone, 0 to 5 miles.
(Reprinted from p. 259 of [15], by permission,
from Van Nostrand Reinhold © 1973)

Table 1. Data Used in Regression Analysis
 (Reprinted from [16], by permission,
 from author and Commsphere '91 conference chairman)

City	Source	Frequency (MHz)	Year	Population (Millions)	Average Noise (dBm/kHz)		Difference (dB)
					Meas.	Calc.	
New York, NY	Young	300	1951	7.891957	-114	-119.3	5.3
New York, NY	Young	400	1951	7.891957	-116	-119.6	3.6
New York, NY	Young	200	1951	7.891957	-111	-119.0	8.0
New York, NY	Young	500	1951	7.891957	-118	-119.9	1.9
New York, NY	Young	250	1951	7.891957	-112	-119.2	7.2
Haifa	Simpson	250	1952	0.140000	-116	-117.8	1.8
Jerusalem	Simpson	250	1952	0.123000	-119	-117.8	1.2
Tel Aviv	Simpson	500	1952	0.335000	-123	-118.6	4.4
Tel Aviv	Simpson	250	1952	0.335000	-116	-117.9	1.9
Melbourne	Ellis	424	1962	1.956400	-125	-125.7	0.7
Bendigo, Aust.	Ellis	424	1962	0.040980	-126	-125.2	0.8
Ascot Vale, Aust.	Ellis	424	1962	1.956400	-126	-125.7	0.3
Manhattan, NY	RCA	800	1968	7.891957	-130	-132.5	2.5
Phoenix, AZ	Anzic	300	1969	0.584303	-127	-129.8	2.8
Cleveland, OH	Anzic	480	1969	0.750879	-116	-130.4	14.4
Cleveland, OH	Anzic	950	1969	0.750879	-133	-131.7	1.3
Ottawa, Can	Lauber	400	1976	0.693288	-136	-135.0	1.0
Ottawa, Can	Lauber	500	1976	0.693288	-138	-135.3	2.7
Ottawa, Can	Lauber	300	1976	0.693288	-136	-134.7	1.3
Ottawa, Can	Lauber	200	1976	0.693288	-132	-134.4	2.4
Los Angeles, CA	Flath	510	1977	2.966850	-140	-136.6	3.4
Montreal, Can	Angers	200	1978	2.818300	-136	-136.4	0.4
Montreal, Can	Angers	500	1978	2.818300	-139.5	-137.2	2.3
Montreal, Can	Angers	300	1978	2.818300	-137	-136.6	0.4
Montreal, Can	Angers	400	1978	2.818300	-138.5	-136.9	1.6
Ottawa, Can	Lauber	700	1983	0.743821	-142.3	-140.7	1.6
Ottawa, Can	Lauber	900	1983	0.743821	-143.7	-141.2	2.5
Ottawa, Can	Lauber	950	1983	0.743821	-143.6	-141.4	2.2
Ottawa, Can	Lauber	600	1983	0.743821	-141.9	-140.4	1.5
Ottawa, Can	Lauber	800	1983	0.743821	-143.5	-141.0	2.5
Turin, Italy	Cost 207	914	1989	1.190688	-127	-145.6	18.6

Table 2. Radio Noise Measurements
 (Reprinted from p. 355 of [27],
 by permission, from IEEE @ 1989 IEEE)

Frequency (GHz)	Average Field Strength Exceeded, dB μ V/m, 100-kHz Bandwidth		Standard Deviation		Measurement Place
	Probability of 10^{-4}	Probability of 10^{-5}	Probability of 10^{-4}	Probability of 10^{-5}	
1.48	39.7	47.0	3.7	3.0	Street
1.48	30.6	36.3	3.4	3.8	Expressway
2.34	32.7	39.4	3.6	3.7	Street
2.34	33.5	37.4	4.5	4.6	Street
2.34	30.3	33.4	3.3	4.5	Expressway
2.68	30.4	36.6	2.6	4.0	Street
2.68	32.8	36.4	1.5	3.5	Expressway

noise showed above the system noise only about 10% of the time. Even so, a reasonably good estimate of the rms level can be obtained from this APD using (5) since most of the energy is in the portion exceeding the system's noise. In [27], the E_{rms} for this APD is found [using (5)] to be 20 dB μ V/m (100-kHz bandwidth). This corresponds to an F_a of -1.9 dB, which corresponds reasonably well with Freeman's trend analysis.

In Figure 8, the Rayleigh distribution (envelope of the Gaussian distribution) plots as a straight line of slope -1/2, as seen in the system noise measurement. If "peak value" is defined as the value exceeded .001% of the time, then the difference between "peak" and rms (which occurs at a probability of .36) for Gaussian noise is 11 dB. This difference for the background noise in Figure 8 is on the order of 23 dB. The difference between "peak" and rms could be used as a measure of impulsiveness (although the difference between average and rms is normally used). This difference is, of course, a function of bandwidth (except for Gaussian noise). The background noise given by the measured APD of Figure 8 is not very impulsive. It has a peak-to-rms difference of 23 dB in a 100-kHz bandwidth.

As noted earlier, using Skomal's results [15] at 1 GHz, the noise level is around $F_a = 14$ or 17 dB. This (17 dB) converts to an rms field strength of 41.5dB μ V/m/MHz. Skomal [15] also gives results for peak measurements of automotive ignition noise in urban areas (high traffic density). At 1 GHz,

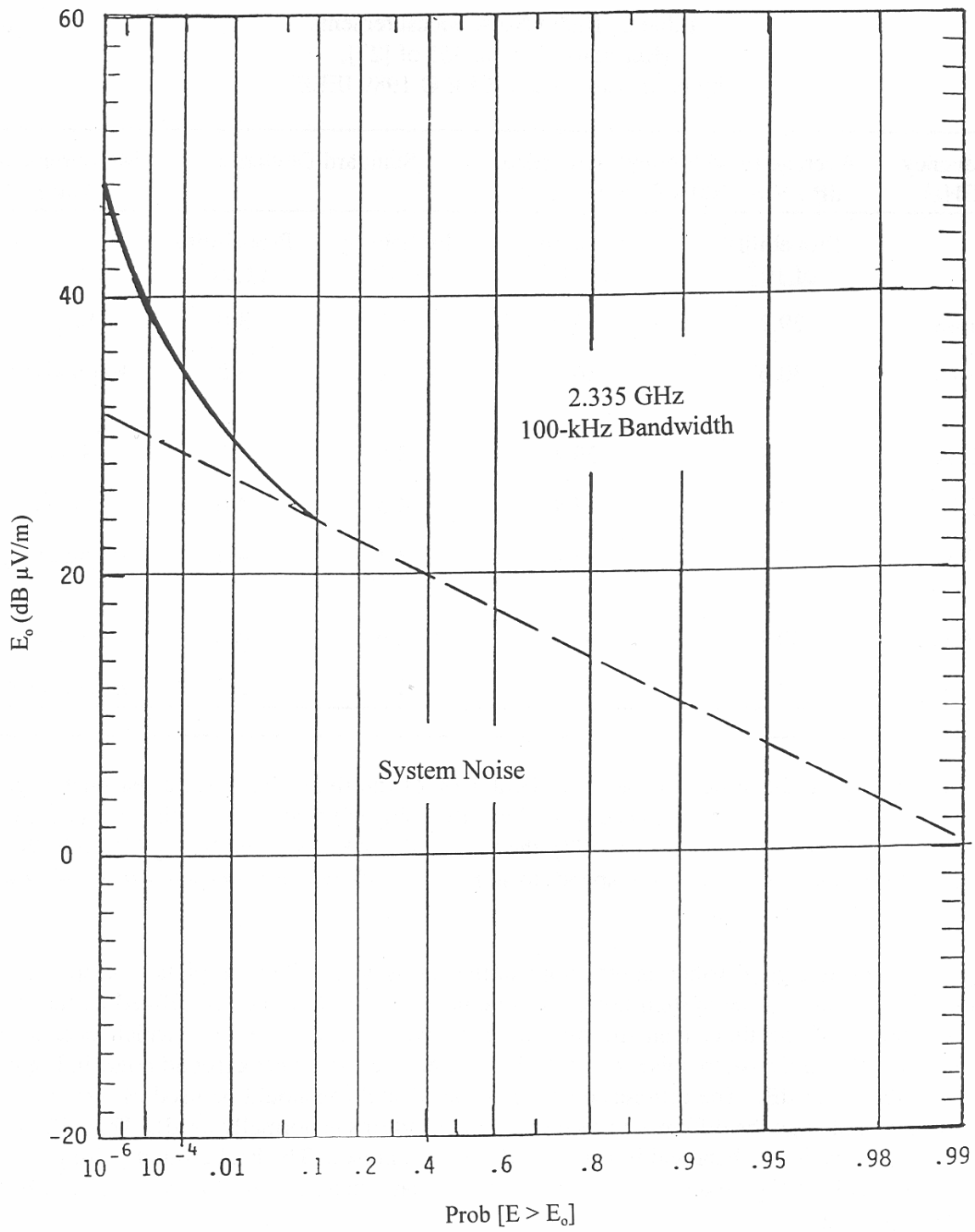

Figure 8. Amplitude probability distribution (APD) of system noise and ignition noise. (Reprinted from p. 355 of [27], by permission, from IEEE © 1989 IEEE)

these peak measurements are about 65-70 dB $\mu\text{V}/\text{m}/\text{MHz}$. These results (65-70 versus 41.5 in a 1-MHz bandwidth) also indicate that the noise is not particularly impulsive.

The above discussions have concerned the general urban noise background level. This broadband, slightly impulsive noise is due primarily to automotive ignition systems. Also of concern are individual high noise sources that may be close to communication systems. Accordingly, these individual sources will be reviewed briefly. For comparison purposes, for the general background, the 1-GHz results of a peak field strength of 65 dB $\mu\text{V}/\text{m}/\text{MHz}$ and a corresponding rms field strength of 41.5 dB $\mu\text{V}/\text{m}/\text{MHz}$ could be used. It should be noted, however, that these figures are for automotive noise around 1975 and now the noise level is approximately 20 dB less. Therefore, 20 dB $\mu\text{V}/\text{m}/\text{MHz}$ is chosen for the background rms field strength ($F_a = -4.5$ dB) and 40 dB $\mu\text{V}/\text{m}/\text{MHz}$ is chosen for the background peak field strength at 1 GHz. This is a somewhat arbitrary choice but should give a reasonable comparison for various individual sources with the current background level. The following is a review of individual sources in no particular order.

Nearby Lightning: Figure 9 from [28] shows a summary of lightning peak field strength measurements. The lightning is at a distance of 1 mile. At 1 GHz, the peak field strength is (from Figure 9) 35 dB $\mu\text{V}/\text{m}/\text{MHz}$, 5 dB below the background.

High-voltage Transmission Lines: An extensive power line noise measurement program was conducted in 1967 by Pakala et al., [29]. Some of these measurement results are also given in [15]. Typical results are given in Table 3.

Spaulding and Disney [30] also presented power line measurement results. For a 115-kV line directly under the power line, an F_a of approximately 0 dB is obtained (by extending the trend line since the

Table 3. High-voltage Transmission Line Noise at 1 GHz

Line (k V)	Lateral Distance from Line (ft)	Peak Field Strength (dB $\mu\text{V}/\text{m}/\text{MHz}$)	Type of Noise
4.16	50	30	Gap Discharge
69.00	200	40	Gap Discharge
244.00	200	10 (Fair Weather)	Corona
244.00	200	40 (Sleet)	Corona
525.00	50	20	Corona
735.00	50	30	Corona

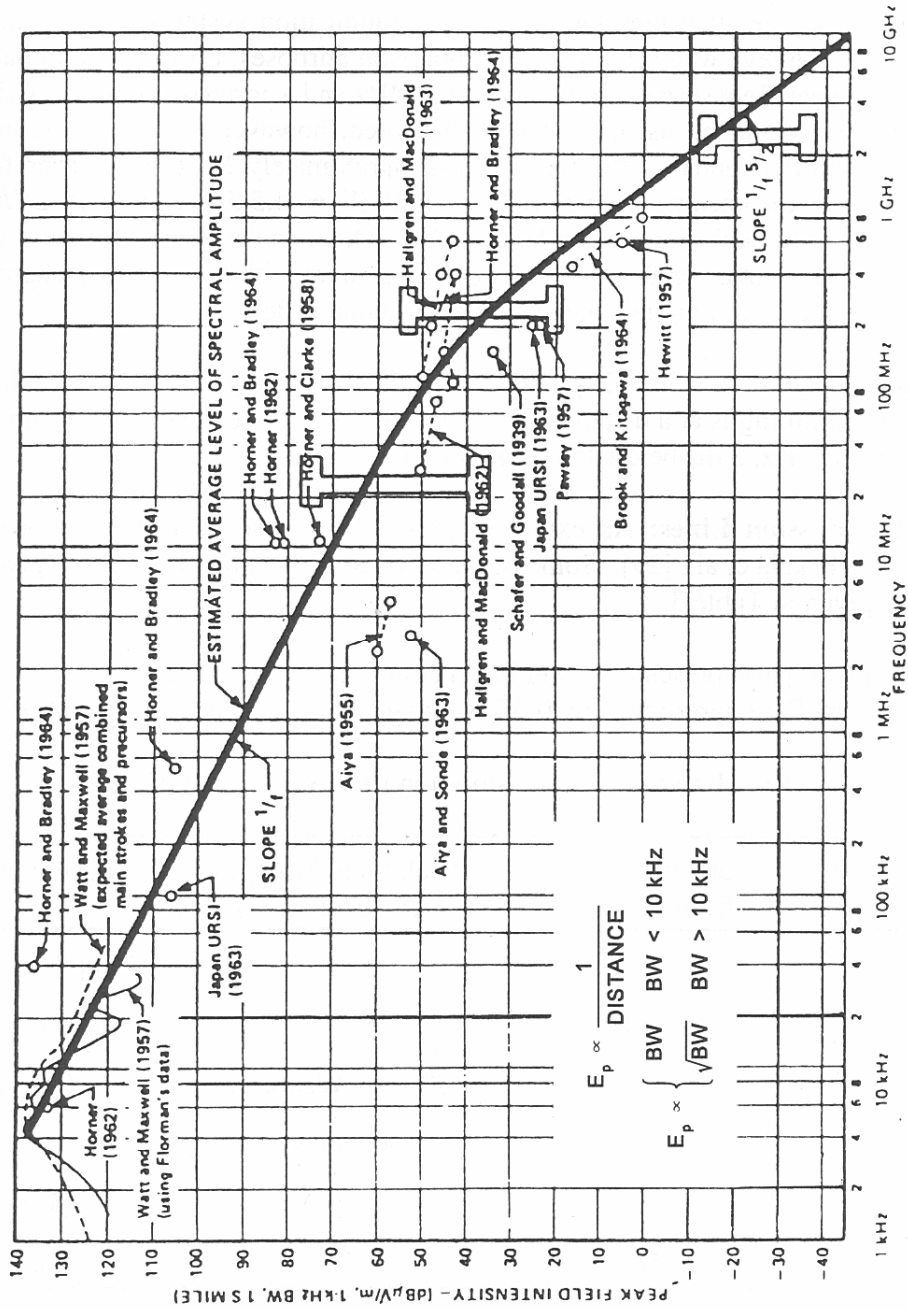

Figure 9. Lightning emission peak field strength, 1 mile distant.
 (Reprinted from p. 369 of [28], by permission,
 from IEEE © 1982 IEEE)

highest frequency of measurement was 250 kHz). Herak and Kirk [31] give results of power line measurements for a number of transmission lines ranging from 24-230 kV. In all cases, the measurements are similar in results to those above and indicate F_a values below zero at 1 GHz.

Transformer Substations: Pakala [29] shows a peak field strength of 62 dB $\mu\text{V}/\text{m}/\text{MHz}$ at 1 GHz, 60 ft from a 765-kV substation.

Welders: Skomal [15] gives results from various references for measurements of radiated spectra from welders. Typical results are a peak field strength at 1 GHz of 75 $\mu\text{V}/\text{m}/\text{MHz}$, 100 ft from an RF-stabilized arc welder.

Electromechanical Solenoid-type Relay: Joffe [32] presents measurements of the field emanating from electromechanical solenoid relays. His general result, for both making contact and breaking contact, is that the field strength at 1 GHz is approximately 5 $\mu\text{V}/\text{m}$ in a 1-kHz bandwidth. This converts to an F_a value of 19 dB.

Diesel Engine Generators: Parker [33] gives measurement results for diesel generator sets for 75-, 175-, 400-, and 940-kW generators. For all these generator sets, the emitted broadband noise was on the order of 80 $\mu\text{V}/\text{m}/\text{MHz}$ peak at 1 GHz.

Industrial, Scientific and Medical Equipment (ISM): These equipments operate in the ISM bands and apparently do not have any significant harmonics in the frequency range of interest. Industrial heating equipment, however, is permitted to function throughout most of the radio spectrum. Skomal [15] shows the example of a 7.5-kW preheater that has a harmonic at around 1 GHz with a field strength of 42 dB $\mu\text{V}/\text{m}$ at 25 ft.

Additional information on noise levels is given by Blackard et al., [34] at 918 MHz, 2.44 GHz, and 4.0 GHz to develop models for indoor wireless communications. They report " F_a values" between 24 and 50 dB at 918 MHz for various sites and around 30 dB at 2.44 GHz for a "typical case." The various sites represent "common workplace environments." These measurements primarily are in terms of "dB above mean thermal noise." It is not clear that proper F_a measurements (i.e., rms with correct antenna calibration) were made, however.

3. SUMMARY AND CONCLUSIONS

This report began by taking an overall look at the natural noise background and noted that in the 1- to 3-GHz range, the natural background noise is quite low; for systems using wide beamwidth antennas such as PCS, on the order of $F_a = -10$ dB or less. The man-made noise background in urban areas is due primarily to automotive ignition systems (in the 1- to 3-GHz range) and now (1996) is probably also quite low. (An approximate value of $F_a = -4.5$ dB, or rms field strength of 20 dB $\mu\text{V}/\text{m}/\text{MHz}$ was obtained). This background noise is impulsive in nature but not with a wide dynamic range, that is, not "very" impulsive. A peak field strength of about 40 dB $\mu\text{V}/\text{m}/\text{MHz}$ was

obtained. Other possible sources of noise, nearby lightning (1-mile distant) and nearby high-voltage transmission lines, produce noise at levels at or below the background.

This report showed that nearby individual "devices" can produce noise at levels well above the overall background and gave results for transformer substations, welders, and electromechanical solenoid-type relays. Industrial, scientific and medical equipment generally does not affect the frequency range of interest.

Finally, some recent measurements were cited that indicate the background noise in "common workplace environments" (inside, around office equipment) can also be well above that specified earlier. The exact nature of these measurements is not particularly clear, however. As noted, the background noise must be combined with interfering cochannel signals to obtain the overall interference environment. As given in [2], Middleton's Class A model should be a good model to use to model the overall environment. This short survey makes it clear that additional proper measurements are required to adequately characterize the background noise environment for PCS communications.

4. REFERENCES

- [1] A.D. Spaulding and D. Middleton, "Optimum reception in an impulsive interference environment - part I: coherent detection," *IEEE Trans. Comm. COM-25*, pp. 910-923, Sep. 1977.
- [2] R. Prasad, A. Kegel and A. deVos, "Performance of microcellular mobile radio in a cochannel interference, natural, and man-made noise environment," *IEEE Trans. Vehic. Tech.*, Vol. 42, No.1, pp. 33-40, Feb. 1993.
- [3] D. Middleton, "Statistical-physical models for urban radio noise environments -part I: foundations," *IEEE Trans. Electromagn. Compat. EMC-14*, pp. 38-56, May 1972. .
- [4] D. Middleton, "Canonical non-Gaussian noise models: their implications for measurement and for prediction of receiver performance," *IEEE Trans. Electromagn. Compat. EMC-21*, pp. 209-220, Aug. 1979.
- [5] D. Middleton, "Statistical-physical models for electromagnetic interference," *IEEE Trans. Electromagn. Compat. EMC-19*, pp. 106-127, Aug. 1977.
- [6] N.N. Hankin, "The radio frequency radiation environment: environmental exposure levels and RF emitting sources," Office of Radiation Programs, U.S. Environmental Protection Agency, Washington, D.C. 20460, EPA 520111-85-014, Jul. 1986.
- [7] R.E. Taylor and J.S. Hill, "Analysis of airbourne RF measurements from U.S.A. urban areas," in *Proc. IEEE Internat. Symp. Electromagn. Compat.*, Baltimore, Maryland, USA, 80CHI538-8, Oct. 1980, pp. 30-38.
- [8] R.E. Taylor and J.S. Hill, "Airbourne microwave measurements of western U.S.A., urban areas," in *Proc. IEEE Internat. Symp. Electromagn. Compat.*, Boulder, CO, 81CH1678, Aug. 18-21, 1981, pp. 387-391.
- [9] CCIR (International Radio Consultative Committee), "Operating noise-threshold of a radio receiving system," CCIR Report 413, International Telecommunications Union, Geneva, Switzerland, 1966.
- [10] G.H. Hagn, "Selected radio noise topics," SRI International Final Report, Project 5002, Contract No. NT83RA6-36001, Jun. 1984.
- [11] CCIR (International Radio Consultative Committee), "Worldwide minimum external noise levels, 0.1 Hz to 100 GHz," CCIR Report 670, International Telecommunications Union, Geneva, Switzerland, 1990.

- [12] J.M. Clarke, S.R. Cantor, J.I. Winchus and A.L. Caporale, "Measurement and analysis of L-band (1535 - 1660 MHz) electromagnetic (EM) noise on ships," U.S. Department of Transportation, U.S. Coast Guard Report No. CG-D-50-75, Jul. 1975.
- [13] A.D. Spaulding, "Man-made noise: the problem and recommended steps toward solution," U. S. Department of Commerce, Office of Telecommunications Report, OT 76-85, Apr. 1976.
- [14] E.N. Skomal, "An analysis of metropolitan incidental radio noise data," *IEEE Trans. Electromagn. Compat. EMC-16*, No.2, pp. 45-57, May 1973.
- [15] E.N. Skomal, *Man-Made Radio Noise*, New York, NY: Van Nostrand Reinhold Company, 1973.
- [16] E.R. Freeman, "Trends in urban noise in the 200 to 950 MHz band over the past 40 years," in *Proc. COMMSPPHERE '91 Symp.*, Dec. 16-18, 1991, pp. 6.3.1-6.3.6.
- [17] W.R. Young, "Comparison of mobile radio transmission at 150,450,900 and 3700 Me/sec," *Bell Sys. Tech. J.*, pp. 1068-1085, Nov. 1952.
- [18] L.C. Simpson, "Israel intercity VHF telecommunication system," *RCA Review*, pp. 100-124, Mar. 1953.
- [19] A.G. Ellis, "Site noise and its correlation with vehicular traffic density," *Proc. IRE (Australia)*, pp. 45-52, Jan. 1963.
- [20] G. Anzic, "Results and analysis of a combined aerial and ground UHF noise survey in an urban area," NASA Tech. Memo, NASA-TM-X-2244, Apr. 1971.
- [21] G. Anzic, "Radio frequency noise measurements in urban areas at 480 and 950 MHz," NASA Tech Memo, NASA-TM-X-1972, Mar. 1970.
- [22] W.R. Lauber and J.M. Bertrand, "Preliminary urban VHF/UHF radio noise intensity measurements in Ottawa, Canada," in *Proc. Second Symp. Electromagn. Compat.*, Montreux, Switzerland, Jul. 1977.
- [23] E.H. Flath, "Noise report," E-Systems Inc., PCN-ESY 5B1002, Nov. 1, 1978.
- [24] D. Angers, G.Y. Delisle and N. Cyr, "Etudes des problemes associes a la mesure du Bruit Radio et a l'utilisation des Donnes pour predire la performance des systems de communications," Final Report, L T -79-8231, Universite Laval, Montreal, Canada, Mar. 1979.

- [25] W.R Lauber and J.M. Bertrand, "Man-made noise level measurements of the UHF radio environment," in *Proc. 1984 IEEE National Symp. Electromagn. Compat.*, Apr. 24-26, 1984, pp. 185-192.
- [26] Commission of the European Communities, Cost 207, Digital Land Mobile Radio Communications, 1989.
- [27] Y. Yamanaka and A. Sugiura, "Measurements of automotive radio noise in lower frequency microwave bands (1-3 GHz)," in *Proc. Internat. Symp. Electromagn. Compat.*, Nagoya 464, Japan, Sep. 8-10, 1989, pp.352-357.
- [28] T.H. Shumpert, M.A. Honnell, and G.K. Lott, Jr., "Measured spectral amplitude of lightning sferics in the HF, VHF and UHF Bands," *IEEE Trans. Electromagn. Compat. EMC-24*, No. 3, pp. 368-369, Aug. 1982.
- [29] W.E. Pakala, E.R Taylor, and RT. Harrold, "High voltage power line siting criteria, vol 1: high voltage power line test results analysis and appendices," RADC-JR-66-606, Mar. 1967.
- [30] A.D. Spaulding and RT. Disney, "Man-made radio noise, part 1: estimates for business, residential and rural areas," U.S. Dept. of Commerce, Office of Telecommunications Report OT 74-38, Jun. 1974.
- [31] V. Herak and A. Kirk, "Power line noise, Winnipeg, 185 kHz to 950 MHz," Summer Job Corps Project No 88D-001, Canada Dept. of Communications, Central Region, Aug. 1977.
- [32] E.B. Joffe, "Some expected EMI effects due to switching of electromechanical relays," in *Proc. 8th Internat. Zurich Symp. EMC*, Mar. 7-9,1989, pp. 131-136.
- [33] E.W.H. Parker, "Diesel engine generators as a source of EM I," in *Proc. 1981IEEE Internat. Symp. EMC*, Aug. 18-20, 1981, pp. 379-386.
- [34] K.L. Blackard, T.S. Rappaport and B. Tuch, "Radio frequency noise measurements and models for indoor wireless communications at 918 MHz, 2.44 GHz, and 4.0 GHz," *EMC Test and Design*, pp. 25-33, Jul./Aug. 1991.

BIBLIOGRAPHIC DATA SHEET

1. PUBLICATION NO. 96-330 revised	2. Government Accession No.	3. Recipient's Accession No.
4. TITLE AND SUBTITLE The Natural and Man-Made Noise Environment in Personal Communications Services Bands		5. Publication Date May 1997
		6. Performing Organization Code
7. AUTHOR(S) A.D. Spaulding		9. Project/Task/Work Unit No.
8. PERFORMING ORGANIZATION NAME AND ADDRESS National Telecommunications & Information Admin. Institute for Telecommunication Sciences 325 Broadway Boulder, CO 80303		10. Contract/Grant No.
		11. Sponsoring Organization Name and Address NTIA HCHB, 14 th & Constitution Ave, NW Washington, DC 20230
14. SUPPLEMENTARY NOTES		12. Type of Report and Period Covered
<p>15. ABSTRACT (A 200-word or less factual summary of most significant information. If document includes a significant bibliography or literature survey, mention it here.)</p> <p style="text-align: center;">This report presents a summary of the available measurement information on the level and statistical characteristics of the background noise environment in the frequency range of 1-3 GHz. The frequency range covers the proposed frequencies for the new personal communications services. Natural and man-made unintentional radiations are covered, both the general overall background noise and noise from individual sources. The urban noise environment in this frequency range is due primarily to automotive ignition systems. The noise is non-Gaussian in character, but not highly impulsive.</p>		
<p>16. Key Words (Alphabetical order, separated by semicolons)</p> <p>Key Words: Noise, personal communication services (PCS), non-Gaussian interference, background noise levels</p>		
17. AVAILABILITY STATEMENT UNLIMITED.	18. Security Class. (This report)	20. Number of pages 32
	19. Security Class. (This page)	21. Price: