

March 2005

PREVENTING
NUCLEAR
SMUGGLING

DOE Has Made
Limited Progress in
Installing Radiation
Detection Equipment
at Highest Priority
Foreign Seaports



G A O

Accountability * Integrity * Reliability

GAO
Accountability · Integrity · Reliability

Highlights

Highlights of [GAO-05-375](#), a report to congressional requesters

Why GAO Did This Study

Since September 11, 2001, concern has increased that terrorists could smuggle nuclear weapons or materials into this country in the approximately 7 million containers that arrive annually at U.S. seaports. Nuclear materials can be smuggled across borders by being placed inside containers aboard cargo ships. In response to this concern, since 2003, the Department of Energy (DOE) has deployed radiation detection equipment to key foreign seaports through its Megaports Initiative (Initiative). GAO examined the (1) progress DOE has made in implementing the Initiative, (2) current and expected costs of the Initiative, and (3) challenges DOE faces in installing radiation detection equipment at foreign ports.

What GAO Recommends

GAO recommends that DOE (1) develop a comprehensive long-term plan for the Initiative that identifies, among other things, criteria for deciding how many and which lower priority ports to complete if DOE continues to have difficulties initiating work at its highest priority ports and (2) reevaluate the current per port cost estimate and adjust long-term cost projections as necessary. DOE concurred with our recommendations. DOE is working on a plan for the Initiative and will reevaluate its cost estimate at the end of fiscal year 2005.

www.gao.gov/cgi-bin/getrpt?GAO-05-375.

To view the full product, including the scope and methodology, click on the link above. For more information, contact Gene Aloise at (202) 512-3841 or aloise@gao.gov.

PREVENTING NUCLEAR SMUGGLING

DOE Has Made Limited Progress in Installing Radiation Detection Equipment at Highest Priority Foreign Seaports

What GAO Found

DOE's Megaports Initiative has had limited success in initiating work at seaports identified as high priority by DOE's Maritime Prioritization Model, which ranks ports in terms of their relative attractiveness to potential nuclear smugglers. Gaining the cooperation of foreign governments has been difficult in part because some countries have concerns that screening large volumes of containers will create delays that could inhibit the flow of commerce at their ports. DOE has completed work at 2 ports and signed agreements to initiate work at 5 other ports. Additionally, DOE is negotiating agreements with the governments of 18 additional countries and DOE officials told us they are close to signing agreements with 5 of these countries. However, DOE does not have a comprehensive long-term plan to guide the Initiative's efforts. Developing such a plan would lead DOE to, among other things, determine criteria for deciding how many and which lower priority ports to complete if it continues to have difficulties working at higher volume and higher threat ports of interest.

Through the end of fiscal year 2004, DOE had spent about \$43 million on Megaports Initiative activities. Of this amount, about \$14 million was spent on completing installations at 2 ports. Although DOE currently plans to install equipment at a total of 20 ports by 2010, at an estimated cost of \$337 million, this cost projection is uncertain for several reasons. For example, the projection is based in part on DOE's \$15 million estimate for the average cost per port, which may not be accurate because it was based primarily on DOE's work at Russian land borders, airports, and seaports. Additionally, DOE is currently assessing whether the Initiative's scope should increase beyond 20 ports; if this occurs, total costs and time frames will also increase.

DOE faces several operational and technical challenges in installing radiation detection equipment at foreign ports. For example, DOE is currently devising ways to overcome technical challenges posed by the physical layouts and cargo stacking configurations at some ports. Additionally, environmental conditions, such as high winds and sea spray, can affect radiation detection equipment's performance and sustainability.

DOE-Funded Radiation Detection Equipment at a Foreign Port



Source: GAO.

Contents

Letter

Results in Brief	1
Background	3
DOE's Megaports Initiative Has Had Limited Success Initiating Work at High Priority Foreign Seaports and Lacks a Comprehensive Long-Term Plan to Guide Its Efforts	6
Through the End of Fiscal Year 2004, DOE Had Spent About \$43 Million on Megaports Initiative Activities, but Total Program Costs Are Uncertain	10
DOE Faces Several Operational and Technical Challenges in Preventing Nuclear Smuggling at Foreign Seaports	19
Conclusions	22
Recommendations for Executive Action	26
Agency Comments and Our Evaluation	27
	28

Appendixes

Appendix I: Scope and Methodology	31
Appendix II: National Laboratory and Contractor Roles	34
Appendix III: Profiles of Ports Where DOE Has Completed or Initiated Work	37
Appendix IV: Additional DOE Efforts to Secure Sites in Greece Prior to the 2004 Olympic Games	40
Appendix V: Comments from the Department of Energy	46

Related GAO Products

50

Figures

Figure 1: Ports Where DOE Has Completed Installations and Those Where It Plans to Begin Work or Complete Installations in Fiscal Year 2005	13
Figure 2: Truck Passing through a Radiation Portal Monitor in Rotterdam, the Netherlands	15
Figure 3: Truck Passing through a Radiation Portal Monitor in Piraeus, Greece	17
Figure 4: Megaports Initiative Expenditures through the End of Fiscal Year 2004 (dollars in millions)	19
Figure 5: Design of Modified Straddle Carrier Fitted with Radiation Detection Equipment	25

Figure 6: Radiation Portal Monitors at a Northern Greek Border Crossing	41
Figure 7: A Handheld Gamma Radiation Detector and a Radioactive Isotope Identification Device	42
Figure 8: Radiation Detection Pager	43
Figure 9: Teletherapy Unit Containing Radioactive Source, Prior to Receiving Physical Security Upgrades	44

Abbreviations

CSI	Container Security Initiative
DHS	Department of Homeland Security
DOE	Department of Energy
IAEA	International Atomic Energy Agency
MOU	memorandum of understanding
PNNL	Pacific Northwest National Laboratory
SLD-Core	Second Line of Defense-Core program
TEU	twenty-foot equivalent unit

This is a work of the U.S. government and is not subject to copyright protection in the United States. It may be reproduced and distributed in its entirety without further permission from GAO. However, because this work may contain copyrighted images or other material, permission from the copyright holder may be necessary if you wish to reproduce this material separately.



March 31, 2005

Congressional Requesters

Over the past decade, as terrorist activities have spread throughout the world, the United States has become increasingly concerned about the threat posed by unsecured weapons-usable nuclear material.¹ Such material could be stolen and fall into the hands of terrorists or countries seeking weapons of mass destruction. According to the International Atomic Energy Agency (IAEA), between 1993 and 2003, there were 540 confirmed cases of illicit trafficking of nuclear and radiological materials. A significant number of the cases reported by IAEA involved material that could be used to produce a nuclear weapon or a device that uses conventional explosives with radioactive material (known as a “dirty bomb”). Even small amounts of nuclear and radiological materials are worrisome because as little as 25 kilograms of highly enriched uranium or 8 kilograms of plutonium could be used to build a nuclear weapon, and small amounts can be smuggled across borders in cars, carried in personal luggage on aircraft, or placed inside containers aboard cargo ships.

Seaports are critical gateways for international commerce, and maritime shipping containers play a vital role in the movement of cargo between global trading partners. In 2002, approximately 7 million shipping containers arrived at U.S. ports carrying more than 95 percent of U.S. imports by weight from outside North America. Responding to heightened concern about national security since September 11, 2001, several U.S. government agencies have acted to prevent terrorists from smuggling weapons of mass destruction in cargo containers from overseas locations. In 2003, the Department of Energy’s (DOE) National Nuclear Security Administration² initiated its Megaports Initiative (Initiative), the goal of which is to enable foreign government personnel at key seaports to use radiation detection equipment to screen shipping containers entering and leaving these ports, regardless of the containers’ destination, for nuclear

¹Weapons-usable nuclear material is uranium enriched to 20 percent or greater in uranium-235 or uranium-233 isotopes and any plutonium containing less than 80 percent of the isotope plutonium-238 and less than 10 percent of the isotopes plutonium-241 and plutonium-242. These types of material are of the quality used to make nuclear weapons.

²The National Nuclear Security Administration is a separately organized agency within DOE that was created by the National Defense Authorization Act for fiscal year 2000 with responsibility for the nation’s nuclear weapons, nonproliferation, and naval reactors programs.

and other radioactive material that could be used against the United States or its allies. Through the Initiative, DOE installs radiation detection equipment at foreign seaports that is then operated by foreign government officials and port personnel working at these ports.³

DOE's Megaports Initiative coordinates with and complements the Department of Homeland Security's Container Security Initiative (CSI). Under CSI, which began operating in January 2002, U.S. Customs officials stationed in foreign ports review the cargo manifests of containers bound directly for the United States and attempt to identify containers with potentially dangerous cargo, such as explosives or weapons of mass destruction.⁴ U.S. Customs officials then request that the host country's customs officials inspect these containers before they are loaded on vessels destined for the United States. CSI and the Megaports Initiative differ in several important ways. For example, while CSI stations U.S. personnel in foreign ports, the Megaports Initiative does not. Instead it installs radiation detection equipment that enables foreign customs officials to improve the level of sophistication of their inspections by screening cargo for nuclear and radioactive materials. Also, under CSI, the United States bears the financial burden for posting its own inspectors at foreign ports, while participating in the Megaports Initiative requires a significant financial commitment from a host country because it may need to hire additional customs agents to operate the radiation detection equipment DOE provides.

To help decisionmakers identify and prioritize foreign seaports for participation in the Megaports Initiative, DOE uses a complex model that ranks foreign ports according to their relative attractiveness to potential nuclear smugglers. The Maritime Prioritization Model incorporates information, such as port security conditions, volume of container traffic passing through ports, the proximity of the ports to sources of nuclear

³DOE's Second Line of Defense-Core (SLD-Core) program, which installs radiation detection equipment at international land border crossings, airports, and seaports in Russia and other countries, has also installed equipment at some Russian ports. These ports are considered part of the SLD-Core program, not the Megaports Initiative. As a result, for the purposes of this report, we have not included discussions of work DOE performed at these ports in Russia.

⁴For additional information about CSI, see GAO, *Container Security: Expansion of Key Customs Programs Will Require Greater Attention to Critical Success Factors*, [GAO-03-770](#) (Washington, D.C.: July 25, 2003) and related GAO products cited at the end of this report.

material, and the proximity of the ports to the United States and is updated regularly to incorporate new information. When selecting ports for equipment installations, DOE also considers other factors, including the likelihood that a potential host country will agree to participate in the Initiative and the location of significant world events, such as the Olympic Games. Once DOE selects a port and the host country shows interest in participating in the Initiative, program officials may conduct a visit to the port to familiarize themselves with its operations and layout. Prior to implementation activities at a selected port, DOE and the host country's government negotiate an agreement, or memorandum of understanding (MOU), that outlines the expectations, roles, and responsibilities of both parties for work at the selected port as well as the long-term use of the equipment to be installed.⁵

As agreed with your offices, we examined (1) DOE's progress in implementing its Megaports Initiative, (2) the current and expected costs of the Initiative, and (3) the challenges DOE faces in installing radiation detection equipment at foreign ports. To address these objectives, we analyzed documentation on the Megaports Initiative from DOE and its contractors, both at DOE's national laboratories and in the private sector, and conducted interviews with key program officials. We also visited completed Megaports Initiative installations at Rotterdam, the Netherlands, and Piraeus, Greece, to observe U.S.-funded radiation detection equipment and to discuss the implementation of the program with foreign officials. In addition, we analyzed cost and budgetary information, performed a data reliability assessment of the data we received, and interviewed knowledgeable program officials on the reliability of the data. We determined these data were sufficiently reliable for the purposes of this report. More details on our scope and methodology can be found in appendix I. We conducted our review from June 2004 to March 2005 in accordance with generally accepted government auditing standards.

Results in Brief

DOE's Megaports Initiative has had limited success in initiating work at ports identified as high priority by its Maritime Prioritization Model because DOE has been unable to reach agreement with key countries, such as China. DOE has completed work at only 2 foreign seaports, signed

⁵No installation of equipment may take place before DOE and the host country have signed an agreement or memorandum of understanding, which is typically a non-binding political document.

agreements to begin work at 5 others, and is negotiating agreements with the governments of 18 additional countries. According to DOE officials, the Initiative's limited success in initiating work at key ports is largely due to difficulties negotiating agreements with countries that have ports ranked as high priority by DOE's model. Gaining the cooperation of foreign governments has been difficult because some countries have concerns that screening large volumes of containers will create delays that could inhibit the flow of commerce at their ports. In addition, some foreign governments are reluctant to hire the additional customs officials needed to operate the radiation detection equipment DOE provides under the Initiative. In fiscal year 2005, DOE plans to begin work in Antwerp, Belgium, and to complete installations in Colombo, Sri Lanka, Algeciras, Spain, and Freeport, Bahamas. DOE currently plans to complete installations at a total of 20 ports by 2010. The two ports where DOE has completed installations include a pilot project in Rotterdam, the Netherlands, and a full installation in Piraeus, Greece. Both of these ports were ranked lower in priority than other foreign seaports by DOE's model. However, DOE officials believe their work at these two ports has been beneficial for a number of reasons. For example, the success of DOE's pilot project at one port terminal in Rotterdam led to a decision by the Dutch government to fund the deployment of radiation detection equipment at the port's three remaining terminals. Similarly, installing equipment at Piraeus contributed to the increased security in Greece for the 2004 Olympic Games.

Currently, DOE does not have a comprehensive long-term plan for its Megaports Initiative, although with limited progress installing radiation detection equipment at its highest priority ports, a well thought out plan can be an important guide for its efforts to further implement the Initiative. DOE uses an annual work plan to guide the Initiative's efforts and document the scope of work to be accomplished in the current fiscal year. Additionally, DOE uses its Future Years Nuclear Security Program, a five-year financial projection, to provide the Initiative with a long-term cost projection and annual performance measures of a certain number of ports completed per year. While using the number of ports completed annually provides a broad measure of the Initiative's progress, this measure does not take into account whether the ports where equipment is being installed are of highest priority. DOE's Maritime Prioritization Model provides a tool to help DOE officials identify important ports to include in the Initiative. Developing a comprehensive long-term plan for the Megaports Initiative would require DOE to, among other things, develop criteria for deciding how many and which lower priority ports to complete if it continues to have difficulties gaining agreements to install radiation detection

equipment at the highest priority ports. DOE officials told us that they will be developing such a plan for the Initiative in the near future. We believe that a comprehensive long-term plan that includes better criteria for measuring program success is needed and, as a result, we are making a recommendation to the Secretary of Energy that DOE develop such a plan for its Megaports Initiative.

Through the end of fiscal year 2004, DOE had spent about \$43 million on Megaports Initiative activities, but uncertainties may affect the Initiative's projected costs, scope, and time frames. DOE spent about \$14 million, or 32 percent of program expenditures, on the pilot project at Rotterdam and completing installations at Piraeus. Additionally, DOE spent about \$29 million on program integration activities, which are costs not directly associated with installing equipment at a specific port. Of this amount, about \$14 million was spent on advanced equipment procurement activities, which includes the purchase and storage of radiation portal monitors for future installations. The remaining \$15 million was spent on such other activities as the development and maintenance of DOE's Maritime Prioritization Model, the process of negotiating agreements with foreign governments, and the testing of radiation detection equipment. Although DOE currently plans to install equipment at a total of 20 ports by 2010, at an estimated total cost of \$337 million, this cost projection is uncertain for several reasons. For example, the Initiative's long-term cost projection is based in part on DOE's \$15 million average cost per port estimate, which may not be accurate. According to DOE officials, this estimate was derived primarily from DOE's prior experience in deploying radiation detection equipment at Russian land borders, airports, and seaports. DOE officials acknowledged that the cost of doing business in Russia may not be an accurate basis on which to estimate the cost of installing radiation detection equipment in other parts of the world. DOE has not yet reevaluated this estimate in light of experience gained from its installations at seaports. By the end of fiscal year 2005, however, DOE expects to have completed installations at a total of 5 ports and will have more information with which to assess the accuracy of its per port cost estimate. Additionally, DOE is currently assessing whether the Initiative's scope should increase beyond 20 ports; if this occurs, total costs and time frames will increase. To ensure the most accurate cost projections possible, we are recommending that DOE reevaluate the accuracy of the Initiative's average cost per port estimate and adjust its long-term cost projection, if necessary.

As DOE continues to implement its Megaports Initiative, it faces several operational and technical challenges specific to installing radiation detection equipment at foreign ports. Certain factors can affect the general capability of radiation detection equipment to detect nuclear material. For example, some nuclear materials can be shielded with lead or other materials to prevent radiation from being detected. In addition, one of the materials of greatest proliferation concern, highly enriched uranium, is difficult to detect because of its relatively low level of radioactivity. In its effort to screen cargo containers at foreign ports for radioactive and nuclear materials, DOE faces technical challenges related to these ports' physical layouts and cargo stacking configurations. To address a part of these challenges at some ports, DOE plans to outfit a device used to transport cargo containers between port locations—known as a straddle carrier—with radiation detection equipment. However, this approach may not work at all ports, so DOE is pursuing other solutions as well. Additionally, environmental conditions specific to ports, such as the existence of high winds and sea spray, can affect the radiation detection equipment's performance and long-term sustainability. To minimize the effects of these conditions, DOE has used steel plates to stabilize radiation portal monitors placed in areas with high winds, such as in Rotterdam, and is currently evaluating approaches to combat the corrosive effects of sea spray on radiation detection equipment. We provided a draft of this report to DOE for its review and comment. DOE generally agreed with our recommendations. DOE is currently working to produce a long-term plan for the Initiative and plans to reevaluate its per port cost estimate at the end of fiscal year 2005.

Background

The Megaports Initiative is part of DOE's Office of the Second Line of Defense, whose aim is to strengthen the overall capability to detect and deter illicit trafficking of nuclear and other radioactive materials across international borders. DOE, with the assistance of several DOE national laboratories and private contractors,⁶ generally implements its Megaports Initiative at foreign seaports in six phases: (1) port prioritization; (2) government-to-government negotiations and port familiarization; (3) technical site surveys, site design, and training; (4) final design, construction, and equipment installation; (5) equipment calibration and testing; and (6) maintenance and sustainability.

⁶For more information about the roles of each of the DOE national laboratories and private contractors that participate in the Megaports Initiative, see app. II.

The Maritime Prioritization Model, which is maintained by Sandia National Laboratories (Sandia), uses unclassified information to rank foreign seaports for their attractiveness to a potential nuclear material smuggler. This information is maintained within the model in several categories that are individually weighted and scored and then combined to provide each port with an overall score.⁷ Ports receiving higher scores are considered more attractive to a nuclear material smuggler and therefore of potentially higher interest for inclusion in the Initiative. In May 2004, DOE directed Sandia to conduct a peer review of the model to determine the validity of its modeling approach, the appropriateness of the factors used in the model, and the suitability of the data for selecting and prioritizing foreign ports for the Initiative.⁸ The peer review panel concluded in August 2004, that the approach used in the design and execution of the model is conceptually sound and provides a relevant, defensible baseline from which to pursue bilateral engagements for installing radiation detection equipment at foreign ports. The panelists noted that the primary strengths of the model are the ease with which new sources of information relevant to prioritizing potential nuclear material smuggling routes can be added and the transparency of the data and calculations used in the model. Currently, the model ranks about 120 seaports worldwide, and DOE plans to add an additional 80 ports to the model in fiscal year 2005. DOE officials noted that the model will continue to evolve to more clearly consider both volume and threat. DOE also considers other factors when deciding which specific ports to engage, such as a potential host country's level of interest in the Initiative and the location of significant world events, such as the Olympic Games.

Once DOE selects a port for inclusion in the Initiative, DOE officials and host country representatives begin to negotiate an agreement or memorandum of understanding that defines the scope of work and level of cooperation between DOE and the host country for work at the selected port or ports. Concurrently, a team of experts from DOE's national laboratories visits the selected port to familiarize themselves with the port's operations and layout. Discussions are also conducted, as appropriate, with major port and terminal operators. In many cases the

⁷There are three primary categories within the Maritime Prioritization Model: (1) country score, (2) port security score, and (3) shipping lane score.

⁸The Maritime Prioritization Model peer review panel consisted of members from academia, industry, and federal agencies with experience in maritime commerce operation, intelligence, and counterterrorism.

port-operating companies, along with terminal operators, have an economic interest in cooperating with the Initiative, since they have the most to lose in the event terrorists are successful in exploiting weaknesses of the maritime shipping network to launch an attack using weapons-usable nuclear or other radioactive material.

After an MOU has been signed, the technical site survey, design, and training phase begins.⁹ Initially, one or more site visits are conducted to gather technical information to determine the degree to which cargo can be effectively screened in a port, to assess the vulnerabilities of the port to illicit trafficking in nuclear and other radioactive materials, and to estimate equipment needs. These visits help DOE determine port security information, port traffic patterns, shipping volume, training needs, and any other relevant information. Program officials then develop a port security report that analyzes the flow of container traffic for all port entry and exit gates, as well as for cargo that arrives at a port on one ship, is offloaded onto a dock, and then leaves aboard another ship—known as transshipped cargo. DOE also performs a cost benefit analysis of the proposed equipment installations at specific entry and exit gates. On the basis of the results of these assessments, DOE develops a design requirements package that includes the port's layout, proposed equipment needs, and installation requirements. This information is used to conduct more detailed engineering surveys to develop the final design. During this phase, DOE also begins to provide training to foreign customs officials, including training at the DOE Hazardous Materials Management and Emergency Response center located at Pacific Northwest National Laboratory (PNNL). The training focuses on radiation safety, the use of radiation detection equipment, and alarm response procedures. The training generally consists of a 1-week course with both classroom learning and simulated field operations. Training is tailored to each port, and materials are provided in the working language of the host country.

During the final design, construction, and equipment installation phase, DOE determines the equipment needs of the port, the specific placement of the equipment, and any site preparation or construction work to be done at the port. The equipment that DOE provides through the Initiative is commercially available, off-the-shelf technology. DOE provides radiation detection portal monitors, which are stationary pieces of equipment

⁹To expedite implementation of the Initiative, DOE may choose on a case-by-case basis to conduct technical site visits prior to the negotiation and signature of an MOU.

designed to detect radioactive materials being carried by vehicles or pedestrians. These portal monitors can detect both gamma and neutron radiation, which is important for detecting the presence of highly enriched uranium and plutonium, respectively. In addition, DOE provides portable radiation detection devices, including handheld devices that can help assist foreign customs officials conduct secondary inspections to pinpoint the source of an alarm and to determine the type of radioactive material present. DOE also provides radiation detection pagers, which are small detectors that can be worn on a belt to continuously monitor radiation levels in the immediate area of the customs officials wearing the pagers. DOE installs the portal monitors at specific locations within the port, such as terminal entry and exit gates, and integrates the portal monitors with a central alarm station through the use of fiber optic cable or other methods.

Once installation is complete, the equipment is calibrated and tested before being turned over to the host country's government. DOE officials calibrate the equipment to optimal specifications for the detection of weapons-usable nuclear material. The settings, which determine the equipment's sensitivity, are based on a number of factors, including the level of background radiation of the location, the type of cargo handled at a specific port, and the potential use of shielding. Once the equipment is calibrated and tested, the host country's customs officials can begin to screen cargo containers for radiation. When a container is scanned, an alarm will sound if the equipment detects radiation. A monitoring system logs which monitor set off the alarm, the date and time of the alarm, the alarm type, the gamma and neutron count for the alarm, any indications of tampering, an average reading of the background radiation of the area, and takes a photograph of the container's identification number. If determined necessary, the customs official then conducts a secondary inspection with a handheld radiation detection device to identify the source and location of the radiation. If the radiation profile of a scanned container's contents matches the profile of consumer goods that are known to contain natural sources of radiation,¹⁰ foreign customs officers may opt not to conduct a secondary inspection. However, the profile of consumer goods can appear different from the typical profile if the container is not uniformly packed with this item or if the container is filled with a combination of consumer goods. If the customs officials cannot determine the content of the container after the screening with a handheld radiation device, they may

¹⁰Natural sources of radiation, which are usually relatively harmless, occur in a wide variety of common items and consumer goods, such as bananas, fertilizer, and ceramic tiles.

manually inspect the container or request assistance from other agencies within their government. Concurrent with the calibration and testing phase, DOE national laboratory experts travel to the host country to provide specific in-country training to foreign customs officials in the proper use of the radiation portal monitors as well as portable radiation detection equipment.¹¹

Once DOE fully turns the equipment over to the host government, the project moves to the maintenance and sustainability phase. Typically, DOE plans to fund 3 years of sustainability activities at each port. These activities include providing refresher training for foreign customs officials; general maintenance of the radiation detection equipment; spare parts; and, as negotiated with the host country, periodic evaluation of alarm data and port procedures to ensure that the equipment is being operated properly. DOE wants the U.S. government to be informed of any incidents or seizures that occur as a result of using equipment provided by the Initiative. Additionally, other technical data may be exchanged to assist technical experts from both DOE and the host country in their ongoing analysis of the operational effectiveness of the systems. To date, data sharing provisions have been incorporated into the agreements signed by DOE and host country governments.

DOE's Megaports Initiative Has Had Limited Success Initiating Work at High Priority Foreign Seaports and Lacks a Comprehensive Long-Term Plan to Guide Its Efforts

DOE's Megaports Initiative has made limited progress in beginning to install radiation detection equipment at seaports identified as high priority by its Maritime Prioritization Model. According to DOE officials, the Initiative's limited success in initiating work at certain ports is largely due to difficulties negotiating agreements with foreign governments, in particular with countries that have ports ranked as high priority by DOE's model, such as China. Further, DOE has completed work at only two ports, both of which were ranked lower in priority than other ports by DOE's model. Given DOE's limited success in installing radiation detection equipment at most high priority ports, it is particularly noteworthy that the Initiative does not have a comprehensive long-term plan that describes how DOE plans to measure program success, overcome obstacles it faces, and achieve the goals of the Initiative.

¹¹Training provided through the Megaports Initiative is an ongoing process that begins once agreements are reached with the host country and continues through the maintenance and sustainability phase for each port.

DOE Has Signed Agreements to Begin Work at Only 2 of the 20 Highest Priority Ports Identified by an Earlier Version of Its Prioritization Model

DOE has had difficulty reaching agreement with some countries where high-priority ports are located, such as China, due to a variety of political factors often outside of DOE's control. DOE has completed work at two ports and signed agreements to initiate work at five others, two of which were ranked in the 20 highest priority ports by DOE's model.¹² According to DOE officials, some foreign governments have been hesitant to participate in the Megaports Initiative for two main reasons: possible interruptions to the flow of commerce at their ports and reluctance to hire the additional customs agents necessary to operate and maintain the radiation detection equipment DOE provides.

First, some foreign governments have concerns that the flow of commerce at their ports could be disrupted by participating in the Initiative in both the short- and long-term. For the short-term, some foreign governments have expressed concern that the flow of commerce at their ports could be disrupted during the installation of radiation detection equipment. A related long-term concern is that, by agreeing to participate in the Initiative, the host country's customs officials will be screening large volumes of cargo containers, which could lead to delays or disruptions to the flow of commerce at the port. To address these concerns, DOE provides prospective Initiative participants with information on how the radiation detection equipment would be installed and operated in the country, including information on the design, construction, training, and implementation processes. To alleviate concerns about construction issues, such as the placement of radiation portal monitors, DOE analyzes the natural choke points that occur in a port and seeks to install equipment at these locations to avoid the interruption of commerce. According to a DOE official, to avoid delays in port operations during installation of

¹²At a February 14, 2005, meeting to discuss an early draft of this report, DOE officials informed us that revisions had been made to DOE's Maritime Prioritization Model and port prioritization process, but they did not provide us with a revised prioritization list. We met with officials from DOE and Sandia National Laboratories on February 22, 2005, to discuss these changes. These officials informed us that the revised prioritization model and process, among other things, placed a greater emphasis on ports with a high volume of cargo containers that enter and exit the port by land, rather than cargo that is transferred from one ship to the port's dock and then onto another ship (known as transshipment). At this meeting, DOE provided us with a new prioritization list showing its 35 highest priority ports listed alphabetically, rather than ranked from highest to lowest priority. The revisions to DOE's model and prioritization process resulted in a higher prioritization for some ports where DOE had completed or initiated work. A more detailed discussion about our work to better understand DOE's Maritime Prioritization Model and port prioritization process can be found in appendix I.

equipment, construction work is often performed at night so that normal port operations are not impeded. To further demonstrate how the radiation detection equipment is installed and operated, DOE officials show prospective Initiative participants a video or arrange site visits to the port of Rotterdam, where DOE has completed equipment installations in a pilot project at one port terminal, so that they can witness port operations and have an example of how the equipment will be operated in their country.

A second impediment to negotiating agreements with foreign governments is their reluctance to hire additional officials (generally customs agents) to operate and maintain the equipment DOE provides through the Initiative. Although some foreign governments have large numbers of personnel at their ports to regulate imports and exports, others lack the staff necessary to both perform other port functions and operate and monitor the radiation detection equipment DOE provides. For example, the Dutch government expressed this reservation before it agreed to participate in the Initiative, and Dutch officials told us that they will need to hire and train an additional 40-60 customs agents when radiation detection equipment is installed at all port terminals in Rotterdam. The need for additional workers, combined with limited financial resources, may prevent some countries from participating in the Megaports Initiative. However, DOE officials told us that they do not believe that this impediment would prevent a foreign government's participation in the Initiative.

DOE officials told us that they are in the process of negotiating with the governments of 18 countries to gauge their interest in participating in the Initiative. According to DOE officials, the Initiative has primarily focused on engaging countries that have ports ranked in the top 50 by DOE's model, but it also pursues ports of special interest that may be ranked lower than 50. DOE plans to begin work at Antwerp and to complete the installations in Colombo, Sri Lanka, Freeport, Bahamas, and Algeciras, Spain by the end of fiscal year 2005,¹³ but complications may prohibit DOE from meeting this goal. For example, a DOE official told us that program officials are currently in the process of determining the impact of the December 2004 tsunami disaster on DOE's planned work at the port of Colombo, Sri Lanka. According to a DOE official, resources for project construction and materials may be affected. If so, DOE may not be able to complete installation of radiation detection equipment at this port in fiscal year 2005.

¹³See appendix III for profiles of each of the ports where DOE has completed installation of equipment or is currently initiating work.

Additionally, on March 10, 2005, DOE and the government of Singapore signed an agreement to include the port of Singapore in the Megaports Initiative. DOE officials also told us that they are close to signing agreements to initiate work in five additional countries. Figure 1 shows the location of the ports DOE completed in fiscal year 2004 and those it plans to complete in fiscal year 2005.

Figure 1: Ports Where DOE Has Completed Installations and Those Where It Plans to Begin Work or Complete Installations in Fiscal Year 2005

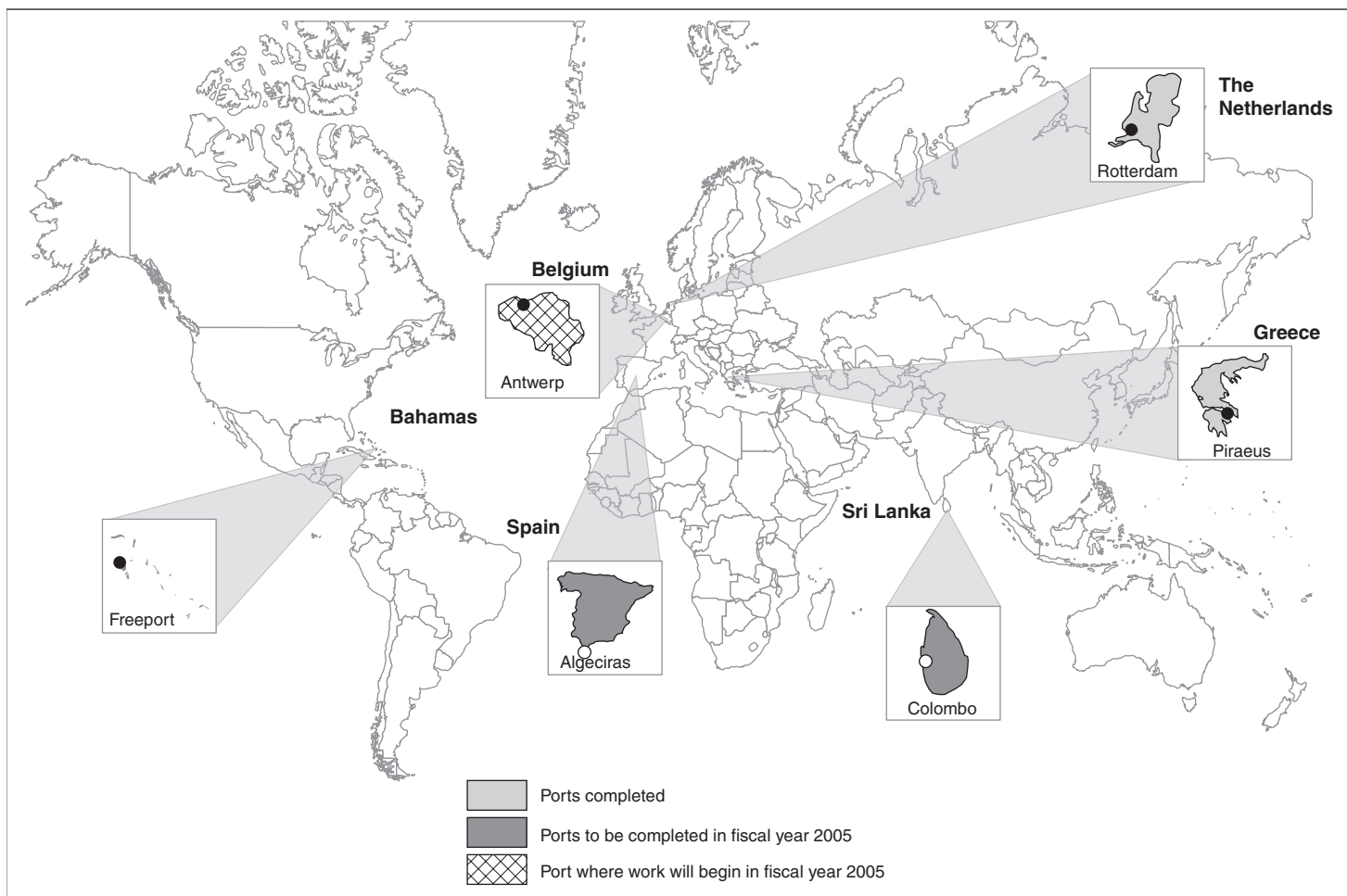

Source: GAO.

DOE Has Completed Installations at 2 Ports That Were Ranked Lower in Priority Than Other Foreign Seaports by DOE's Model

DOE has completed work at only two ports: Rotterdam, the Netherlands, and Piraeus, Greece, both of which were ranked lower in priority than other foreign seaports by DOE's model. The port of Rotterdam, which is the largest in Europe and handles an estimated 40 percent of all European shipments bound for the United States, became part of the Initiative on August 13, 2003, when DOE signed an MOU with the Dutch government. DOE installed a limited number of vehicle radiation detection portal monitors at the largest of Rotterdam's four terminals, which ships an estimated 87 percent of all of Rotterdam's cargo destined for the United States (see figure 2). Initially, DOE planned to install monitors at all four terminals at Rotterdam. However, as discussions with Dutch officials progressed, the Dutch government decided to limit its level of involvement in the Initiative by permitting DOE to install monitors at only one of Rotterdam's four terminals. Additionally, DOE trained 43 Dutch customs officials at its training center at PNNL and conducted additional onsite training for other Dutch customs officials. DOE also provided over 20 pieces of handheld radiation detection equipment for use in conducting secondary inspections.

Figure 2: Truck Passing through a Radiation Portal Monitor in Rotterdam, the Netherlands



Source: GAO.

DOE officials told us that they consider the installation at Rotterdam a pilot project and believe it to be a success because, as a result of their experience with it, the Dutch government agreed to pay for the installation of radiation detection equipment throughout the rest of the port. Dutch government officials told us that they plan to complete the full installation of radiation detection equipment at all four Rotterdam terminals by 2006. Although this type of cost-sharing arrangement is not an established objective of the Initiative, DOE officials believe that they may pursue other such pilot projects when a host government requests limited assistance from DOE. DOE completed the pilot project and the radiation detection equipment was fully turned over to the Dutch government in April 2004. During fiscal year 2005, DOE plans to conduct additional training on secondary inspection methods at Rotterdam for between 20 and 30 Dutch customs officials and will continue to provide equipment support and maintenance. Beyond fiscal year 2005, DOE's involvement at the port will likely be limited to training and technical consultations on future equipment installations made by the Dutch government.

While the port of Piraeus, Greece, is not one of the largest container ports in the world and was not ranked as a high priority by DOE's model, security concerns at the port increased prior to the 2004 Olympic Games in Greece. The heightened importance of Piraeus, which is about 6 miles from the center of Athens, led DOE to include the port in the Megaports Initiative as part of its efforts to secure Greece prior to the Olympic Games.¹⁴ Initially, the Greek Atomic Energy Commission requested assistance from IAEA in identifying ways to mitigate radiological and nuclear threats during the Olympics. IAEA then approached DOE to consider including the port of Piraeus in the Initiative. On October 30, 2003, DOE, the Greek Atomic Energy Commission, and the Greek Customs Service signed a tripartite agreement to include Piraeus in the Initiative. Because the design, construction, installation, training, and equipment testing needed to be complete before the Olympic Games, DOE executed the project on an accelerated schedule and, as a result, completed all equipment installations in July 2004. DOE installed a limited number of vehicle portal monitors at the cargo terminal in Piraeus (see figure 3), and some portal monitors (for both vehicles and pedestrians) at the passenger terminal of the port of Piraeus. Piraeus has one of Europe's largest ferry terminals, and the Greek government anticipated an increased volume of passenger traffic associated with the Olympic Games. DOE officials told us that providing radiation detection equipment to passenger terminals is normally outside the scope of the Megaports Initiative, but the potential security issues surrounding Greece's hosting of the Olympic Games led DOE to provide radiation detection equipment to the Piraeus passenger terminal. DOE also trained 10 Greek customs officials from Piraeus at its training center and provided additional in-country training to 50 Greek customs officials who work at the port. In fiscal year 2005, DOE plans to provide additional onsite training to Greek officials, determine whether any additional equipment installations are necessary, and evaluate any equipment problems that arise.

¹⁴DOE also performed other related work in Greece prior to the Olympic Games. See app. IV for additional information on this work.

Figure 3: Truck Passing through a Radiation Portal Monitor in Piraeus, Greece



Source: GAO.

DOE's Megaports Initiative Lacks a Comprehensive Long-Term Plan to Guide Its Efforts to Prevent Nuclear Smuggling at Foreign Ports

DOE's Megaports Initiative does not have a comprehensive long-term plan to guide the Initiative as it moves forward, which is particularly important given DOE's recent proposal to expand the Initiative's scope to include additional foreign seaports. To set the direction for the Megaports Initiative, DOE currently uses three planning documents: the Megaports Initiative Fiscal Year 2005 Program Work Plan, the DOE Future Years Nuclear Security Program, and the Megaports Initiative Strategy Paper. The Fiscal Year 2005 Program Work Plan is an evolving planning document that incorporates day-to-day changes in program activities and documents the scope of work to be conducted in this fiscal year. This plan also includes a detailed activity-based budget for the current fiscal year to guide the work of national laboratories and contractors involved in the Initiative. The Future Years Nuclear Security Program includes a 5-year financial-based projection of the number of ports to be completed. Additionally, at a February 22, 2005, meeting to discuss an early draft of this report, DOE officials provided us with a copy of the Megaports Initiative Strategy Paper. This two and one half-page document provides a broad vision for the Initiative, and describes some factors that may affect program success, but

it contains few details about how DOE plans to achieve the goals of the Initiative.

These three documents provide some elements that are needed in a long-term plan for the Initiative. Specifically, the DOE Future Years Nuclear Security Program establishes that the long-term goal for the program is to install radiation detection equipment at 20 ports by 2010 and provides cost estimates for the Initiative.¹⁵ In addition, the Megaports Initiative Strategy Paper describes DOE's approach for determining which ports to target for inclusion in the Initiative and states that the Initiative's mission is to diminish the probability of illicit trafficking of nuclear materials and other radioactive material in the global maritime system that could be used against the United States, its key allies, and international partners. However, DOE's goal of completing 20 ports may not be an adequate measure toward sufficiently addressing the overall threat of nuclear smuggling in the international maritime system. As previously stated, DOE uses its Maritime Prioritization Model to rank foreign ports on their relative attractiveness to nuclear smugglers and as a tool to help program officials decide which ports to pursue for inclusion in the Initiative. DOE has annual performance measures to install radiation detection equipment at a given number of ports to show progress towards its long-term goal of completing installations at 20 ports by 2010. While using the number of ports completed annually provides a broad measure of the Initiative's progress, this measure does not take into account whether the ports where equipment is being installed are of highest priority. That is, DOE has not tied its annual performance measures of completing a certain number of ports to the model it uses to determine which ports are of highest priority.

In addition, DOE did not meet its fiscal year 2004 performance measure of completing three ports through the Megaports Initiative. DOE officials stated that the Initiative did not meet this measure because of their inability to sign agreements with foreign governments to install radiation detection equipment. DOE's lack of progress in gaining agreements with countries that contain high-priority ports has led it to initiate work at ports that were not ranked as highest priority by DOE's model. Developing a comprehensive long-term plan for the Megaports Initiative would require DOE to, among other things, develop criteria for deciding how many and

¹⁵In its fiscal year 2006 budget proposal, DOE proposed expanding the scope of the Megaports Initiative to 24 ports. However, because this is a budget proposal and is subject to congressional approval, the official scope of the program currently remains at 20 ports.

which lower priority ports to complete, or what other actions may be warranted, if it continues to have difficulties gaining agreements to install radiation detection equipment at the highest priority ports. DOE officials told us that they intend to develop such a plan for the Initiative in the near future.

Through the End of Fiscal Year 2004, DOE Had Spent About \$43 Million on Megaports Initiative Activities, but Total Program Costs Are Uncertain

Since the inception of the Megaports Initiative in fiscal year 2003 through the end of fiscal year 2004, DOE had spent about \$43 million on Megaports Initiative activities. DOE spent these funds on such activities as the completion of a pilot project at Rotterdam, the Netherlands; equipment installations at Piraeus, Greece; the advanced purchase of equipment for use at future ports; program oversight; and the development and maintenance of DOE's Maritime Prioritization Model (see figure 4).

Figure 4: Megaports Initiative Expenditures through the End of Fiscal Year 2004 (dollars in millions)

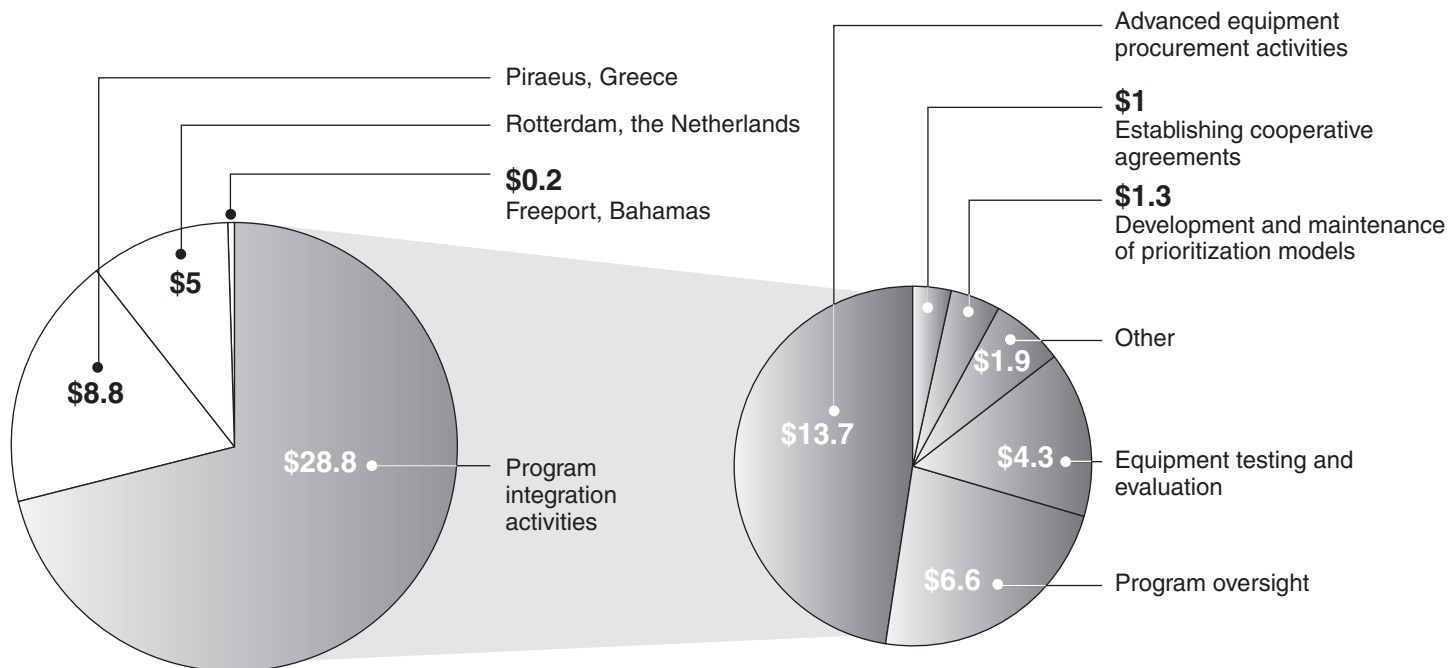

Source: GAO analysis of DOE data.
 Note: Figures have been rounded.

As figure 4 shows, DOE spent \$13.8 million, or 32 percent of program expenditures, to complete installations at Rotterdam, the Netherlands, and Piraeus, Greece. DOE also spent an additional \$238,000 on activities related to future equipment installations in Freeport, Bahamas. DOE spent \$28.8 million on program integration activities, which are costs not directly associated with installing equipment at a specific port. Of this amount, \$13.7 million was spent on advanced equipment procurement activities, which include the purchase and storage of approximately 408 portal monitors and associated spare parts for use at future installations. DOE also spent \$6.6 million on program oversight activities, such as program cost and schedule estimating, technical assistance provided by participating national laboratories, contractor reviews of project work plans, travel coordination, and translation services. In addition, \$1.9 million was spent on other program integration activities, such as the development of materials and curricula for training foreign customs agents on the use of radiation detection equipment.¹⁶

DOE's current plan is to install radiation detection equipment at a total of 20 ports by 2010 at an estimated cost of \$337 million, but several uncertainties may affect the Initiative's scope, cost, and time frames for completion. First, DOE uses \$15 million as its estimate for what an average port should cost to complete, but this estimate may not be accurate. Second, DOE is currently assessing whether the Initiative's scope should increase beyond 20 ports. Regarding the first uncertainty, DOE officials told us that the primary basis for their \$15 million per port cost estimate was DOE's prior experience deploying radiation detection equipment at Russian land border crossings, airports, and seaports. However, DOE acknowledged that the cost of doing business in Russia may not be an accurate basis for developing their per port cost estimate, and DOE has yet to reevaluate this estimate in light of work it has performed installing radiation detection equipment at ports. Furthermore, the costs of installing equipment at individual ports vary and are influenced by factors such as a port's size, its physical layout, existing infrastructure, and the level of the host country's cooperation with DOE. For example, the port of Antwerp, Belgium, which is the second largest port in Europe, will be a much larger, more expensive and complex project than DOE's two previously completed

¹⁶Once an agreement or memorandum of understanding is reached with a foreign government to include a port in the Initiative, all past and present program integration expenditures that can be directly associated with that port are transferred to an expenditure category for that specific port.

installations. According to DOE officials, because of the large physical size of the port, an estimated 60 radiation detection portal monitors will be required to complete the installation. The age of the port and the geographic location of some of the terminals will also create challenges in integrating information generated from the radiation detection monitors to the central alarm station where the alarm information will be processed and evaluated.

Additionally, another factor that may affect DOE's installation costs at a particular port is that, as a result of negotiating agreements with foreign governments, DOE's level of involvement at specific ports may vary, affecting the amount of radiation detection equipment DOE installs and, thereby, its installation costs. For example, although the port of Rotterdam is the largest port in Europe, the Dutch government chose to limit the scope of DOE's involvement at the port to installing equipment at only one of the port's four terminals. This resulted in DOE's costs at Rotterdam being significantly reduced compared to what it would have cost to install equipment all four terminals. DOE officials stated that as future agreements are reached with foreign governments and more port installations are completed, additional data will be gathered, which could assist them in refining the average per port cost estimate. By the end of fiscal year 2005, DOE plans to have completed installations at a total of five ports and should have additional information with which to reevaluate the accuracy of its current per port cost estimate. DOE officials told us that they plan to reevaluate the cost estimate once these ports are completed. A reevaluation of this estimate would allow DOE to better project individual port costs, as well as the total future costs of the Initiative. However, if DOE does not reevaluate its average per port cost estimate it will be difficult to accurately determine the total future costs of the Initiative and future annual funding needs.

DOE also is currently assessing whether the Initiative's scope should increase beyond 20 ports. DOE officials told us that DOE did not intend for the Initiative's initial goal to be static and they believe the scope of the Initiative will likely increase in the future. Additionally, these officials stated that if they determine that installing radiation detection equipment at a total of 20 ports does not sufficiently reduce the risk of illicit trafficking of nuclear and other radioactive materials, they plan to expand the scope of the Initiative to include a greater number of ports. In its fiscal year 2006 budget proposal, DOE proposed expanding the scope of the Initiative to 24 ports, but this scope expansion is subject to congressional approval. If the

scope of the Initiative increases, the total costs and time frames for completion will also increase.

DOE Faces Several Operational and Technical Challenges in Preventing Nuclear Smuggling at Foreign Seaports

In its effort to install radiation detection equipment at foreign seaports, DOE faces several operational and technical challenges. First, the capability of radiation detection equipment to detect nuclear material depends on such factors as how fast containers pass through the radiation portal monitors and how near the containers are to the detection equipment. Additionally, some nuclear materials can be shielded with lead or other materials to prevent radiation from being detected. Compounding these challenges, DOE faces technical challenges related to ports' physical layouts and cargo stacking configurations in its effort to screen cargo containers for radioactive and nuclear materials. Further, environmental conditions specific to ports, such as the existence of high winds and sea spray, can affect the radiation detection equipment's performance and long-term sustainability.

Several Factors Can Affect the Capability of Radiation Detection Equipment to Detect Nuclear Material

Three factors have an impact on the effectiveness of radiation detection equipment: time, distance, and shielding. The time factor refers to the amount of time that a radiation detector has to perform the process of detecting radiological material. For example, trucks carrying cargo containers are supposed to drive through a vehicle radiation detector at a uniform controlled speed. Variation from this program requirement can impact the radiation detection equipment's performance. The distance between the radiation detection equipment and the material being scanned also affects the effectiveness of the equipment. As a general rule, the closer the nuclear material is to the detector, the better the radiation detection equipment will perform.

Nuclear materials are more difficult to detect if lead or other metal is used to shield them. For example, in July 2004, a container that housed a small amount of radioactive material¹⁷ passed through radiation detection equipment that DOE had installed at one of the ports it has completed without being detected due to the presence of the large amounts of scrap

¹⁷This particular radioactive isotope is commonly used for medical practices as cancer treatment and commercially for the sterilization of food products. Sufficient amounts of this material could be used by a terrorist to construct a "dirty bomb."

metal in the same container. The host country's government later received information about the container, which led to the discovery of the radioactive source. The host country's government raised concerns that the radiation detection equipment did not register an alarm during a scan of the container and asked DOE to investigate the incident. DOE national laboratory experts determined that the radiation detection equipment had been set to program requirements. As a result, DOE national laboratory officials and the host country's government decided not to alter the settings of the radiation detection equipment.

A technical challenge is to detect and identify low-level radiation sources in the presence of high background radiation levels. Detecting actual cases of illicit trafficking in weapons-usable nuclear material is complicated because one of the materials of greatest concern in terms of proliferation—highly enriched uranium—is amongst the most difficult materials to detect due to its relatively low level of radioactivity. Uranium emits only gamma radiation so the radiation detection equipment, which contains gamma and neutron detectors, will only detect uranium from the gamma detector. Plutonium emits both gamma and neutron radiation. However, shielding of nuclear material does not prevent the detection of neutron radiation and, as a result, plutonium can be detected by neutron detectors regardless of the amount of shielding. According to DOE officials, a neutron alarm can be caused by only a few materials,¹⁸ while a gamma alarm can be caused by a variety of sources including commercial goods such as bananas, ceramic tiles and fertilizer and nuclear materials, such as plutonium and uranium.

Once DOE finishes installing radiation detection equipment at a port and hands control of the equipment over to the host government, the United States no longer has control over the specific settings used by the equipment or how the equipment is used by foreign government customs officials. Settings can be changed to decrease the number of nuisance alarms, which may also decrease the probability that the equipment will detect nuclear material. Additionally, foreign customs officials may decide not to perform secondary inspections when alarms sound in order to increase the flow of traffic through a port. Therefore, the level of effective use of the equipment is unclear. According to DOE officials, the periodic

¹⁸According to DOE, cosmic radiation can also activate a neutron alarm. At Rotterdam, DOE had difficulty identifying the cause of many nuisance neutron alarms from the radiation detection equipment. After testing, DOE and national laboratory officials determined that cosmic radiation was interfering with the calibration of the radiation detection equipment. DOE national laboratory officials installed a software program to solve this problem.

maintenance DOE national laboratory official perform on the radiation detection equipment helps them to ensure that the equipment is set to the optimal calibrations and operated appropriately. If the equipment settings have been altered, the DOE officials can inquire about these discrepancies to the foreign government and work to resolve any problems.

DOE Is Developing Methods to Overcome Technical Challenges Posed by Ports' Physical Layouts and Cargo Stacking Configurations

When implementing its Megaports Initiative at foreign ports, DOE has the specific challenge of trying to screen all cargo passing through a port. Currently, DOE usually installs radiation detection equipment at locations within a port where natural choke points occur. These locations slow down the transport of containers, making them optimal locations for the installation of radiation detection equipment. At some ports, however, a high percentage of cargo containers do not leave the port but are gathered together in the shipyard and then shipped to another location. DOE is addressing this problem in two ways: (1) by placing radiation detection equipment within ports to be able to screen cargo that moves between port terminals and (2) working with Los Alamos National Laboratory (Los Alamos) to develop a mobile radiation detection system for screening of this type of cargo. At some ports, DOE plans to place radiation detection equipment at the exits of each port terminal so that inter-terminal transport of cargo can be monitored, despite the fact that the cargo does not leaving the port itself. Additionally, Los Alamos officials are working to fit radiation detection equipment onto a straddle carrier¹⁹ so that containers that are awaiting transshipment can be scanned for the presence of radiation. This carrier would be able to scan containers stacked three containers high within the shipyard before they are loaded onto the next ship. The straddle carrier would scan the stacked containers with its radiation detection equipment to determine if radiological materials are present and follow-up inspections would then occur if necessary. See figure 5 for a diagram of the proposed straddle carrier design modified to carry radiation detection equipment.

¹⁹A straddle carrier is a piece of equipment used at ports to transport cargo containers from various port locations.

Figure 5: Design of Modified Straddle Carrier Fitted with Radiation Detection Equipment

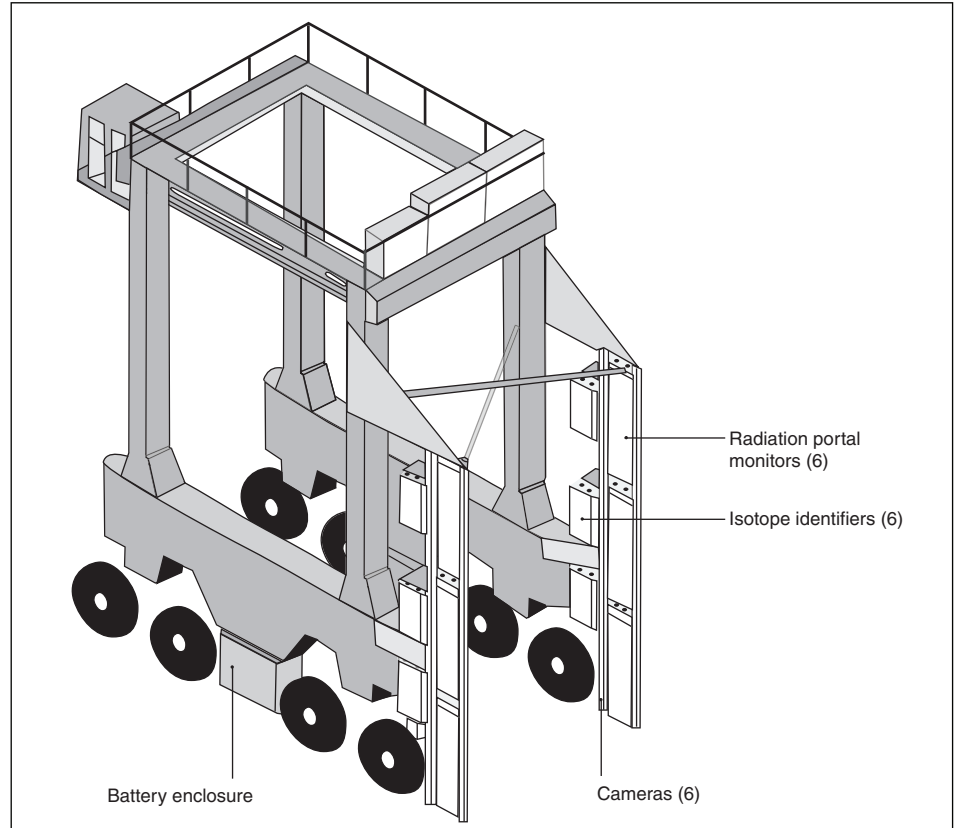

Source: Los Alamos National Laboratory.

According to Los Alamos officials, the modified straddle carrier will be more effective than a vehicle radiation detection portal monitor because the distance from the monitor to the container is greatly reduced, which increases the overall detection capabilities of the system. Los Alamos officials stated that they plan to test the design in a foreign seaport in summer 2005. If this testing is successful, DOE plans to implement this design in other ports that have similar cargo stacking arrangements and that utilize straddle carriers. However, this technology cannot remedy the entire problem DOE faces because many ports stack greater than three containers on top of each other in their shipyards and not all ports have straddle carriers because they move their containers with other types of

equipment and stack them in different configurations. According to a DOE official, because the straddle carrier solution will not work at all ports, DOE will continue to seek additional solutions to this problem.

Environmental Conditions Can Affect Radiation Detection Equipment's Performance and Sustainability

Another technical challenge specific to ports is coping with environmental conditions, particularly high winds and sea spray, which can cause problems for radiation detection equipment. Wind disturbances can vibrate the equipment and interfere with its ability to detect radiation. For example, after the pilot project at Rotterdam was completed, the bases of the radiation detection portal monitors DOE installed had to be reinforced with steel plates to stabilize them because high winds were causing them to vibrate and reducing their capability to detect nuclear material. Sea spray may also affect radiation detection equipment by corroding the equipment and its components. The corrosive nature of sea spray combined with other conditions such as coral in the water can accelerate the degradation of equipment. If the equipment casing becomes corroded, moisture can get into the equipment and affect its performance and long-term sustainability. Corrosion and moisture can cause radiation detection alarms to go off when they should not and not when they should. DOE and national laboratory officials told us that they are analyzing the problem to identify methods to alleviate sea spray's adverse effects on the equipment. At one port where DOE plans to complete installations in fiscal year 2005, sea spray is a potentially large problem. In December 2004, DOE convened a workshop of U.S. government officials and contractors to discuss possible solutions to the sea spray problem. At this workshop, several options for addressing the issue were discussed, such as installing special stainless steel casings, installing bolts and other hardware with protective coatings, and using nitrogen-filled housings to protect the video cameras. DOE officials are considering the recommendations from the workshop and how they should be implemented in this port and at other ports where DOE plans to install equipment.

Conclusions

DOE uses a threat- and volume-based analysis to determine which foreign seaports are of highest priority, and we believe that this is a sound basis for targeting the expenditure of U.S. funds. While DOE has completed work at two ports, Rotterdam, the Netherlands, and Piraeus, Greece, both were ranked lower in priority than other foreign seaports by DOE's Maritime Prioritization Model. In addition, DOE has been unable to reach agreement with many key countries that have ports ranked as high priority by its

model. If DOE continues to have difficulty gaining agreements to install radiation detection equipment at its highest priority ports, then this could raise questions about the Initiative's effectiveness and about how many lower priority ports to include. Currently, however, the Initiative's long-term goal is to install radiation detection equipment at 20 foreign seaports regardless of their priority. This goal is inconsistent with DOE's approach for selecting high-priority ports and does not provide a reasonable measure of long-term program success. Considering its limited progress at the highest priority ports, a well thought out plan can be an important guide for DOE's efforts in the further implementation of its Megaports Initiative. However, to date, DOE has not developed such a plan for the Initiative. Without a comprehensive long-term plan for the Initiative, Congress may not be able to judge whether DOE is making progress towards achieving the Initiative's long-term goals or how best to assist DOE in working toward its goals. DOE officials told us that they will be developing a plan for the Initiative in the near future, and we agree that such a plan is needed.

While the cost of installing radiation detection equipment at a port is dependent on a number of variables, such as the port's size, physical layout, and existing infrastructure, the costs of installing equipment at the two ports DOE has completed to date were significantly less than the \$15 million per port cost estimate that DOE used to develop its long-term cost projection for the Initiative. DOE's \$15 million estimate for the average cost of installing equipment at a port was based on the department's prior experience installing radiation detection equipment at Russian land borders, airports, and seaports. DOE officials acknowledged that the cost of doing business in Russia may not be an accurate basis on which to estimate the costs of installing such equipment at other foreign ports. Because DOE has not yet reevaluated its per port cost estimate to reflect its recent experience installing radiation detection equipment at ports, the accuracy of DOE's long-term cost projection for the Initiative is questionable. By the end of fiscal year 2005, DOE plans to have completed installations at a total of 5 ports, and will have additional information about the costs of these installations that could assist it in refining its per port cost estimate and long-term cost projection for the Initiative.

Recommendations for Executive Action

We recommend that the Secretary of Energy, working with the Administrator of the National Nuclear Security Administration, take the following two actions:

-
- Develop a comprehensive long-term plan to guide the future efforts of the Initiative that includes, at a minimum, (1) performance measures that are consistent with DOE's desire to install radiation detection equipment at the highest priority foreign seaports, (2) strategies DOE will employ to determine how many and which lower priority ports it will include in the Initiative if it continues to have difficulty installing equipment at the highest priority ports as identified by its model, (3) projections of the anticipated funds required to meet the Initiative's objectives, and (4) specific time frames for effectively spending program funds.
 - Evaluate the accuracy of the current per port cost estimate of \$15 million, make any necessary adjustments to the Initiative's long-term cost projection, and inform Congress of any changes to the long-term cost projection for the Initiative.

Agency Comments and Our Evaluation

We provided the Department of Energy with a draft of this report for its review and comment. DOE's written comments are presented as appendix V. DOE generally agreed with our recommendations. In its written comments, DOE also provided further clarification on the evolution of its Maritime Prioritization Model. Specifically, DOE noted that in the early stages of the Megaports Initiative, it focused on the 20 highest-volume-to-U.S. seaports, which was consistent with the approach taken by the Department of Homeland Security's Container Security Initiative. However, when DOE initially briefed us on its model in July 2004, DOE had changed its prioritization approach and was focusing almost entirely on a threat-based model. As DOE notes in its comments, it did not present us with information on modifications to its model until February 22, 2005, which was after DOE received an early draft of this report for a factual review. DOE's new port prioritization approach represents a combination of ports that ship large volumes of containers to the United States and ports that lie in regions of interest. DOE also provided technical comments, which we incorporated as appropriate.

As agreed with your offices, unless you publicly release the contents of this report earlier, we plan no further distribution until 30 days from the report date. We will then send copies of this report to the Secretary of Energy; the Administrator, the National Nuclear Security Administration; the Secretary of Homeland Security; the Director, Office of Management and Budget; and

interested congressional committees. We will also make copies available to others upon request. In addition, this report will be available at no charge on the GAO Web site at <http://www.gao.gov>.

If you or your staff have any questions concerning this report, I can be reached at 202-512-3841 or aloise@gao.gov. Key contributors to this report include R. Stockton Butler, Julie Chamberlain, Nancy Crothers, Chris Ferencik, and F. James Shafer, Jr.

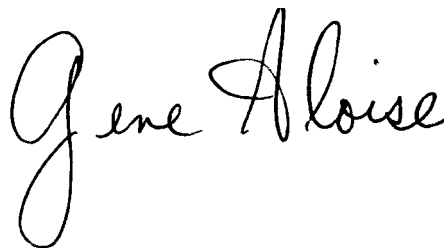
A handwritten signature in black ink that reads "Gene Aloise". The signature is written in a cursive style with a large, looped initial "G".

Gene Aloise
Director, Natural Resources and Environment

List of Congressional Requesters

The Honorable Susan M. Collins
Chairman
Committee on Homeland Security and Governmental Affairs
United States Senate

The Honorable Norm Coleman
Chairman
Permanent Subcommittee on Investigations
Committee on Homeland Security and Governmental Affairs
United States Senate

The Honorable Carl Levin
Ranking Minority Member
Permanent Subcommittee on Investigations
Committee on Homeland Security and Governmental Affairs
United States Senate

The Honorable John D. Dingell
Ranking Minority Member
Energy and Commerce Committee
House of Representatives

Scope and Methodology

We performed our review of the Department of Energy's (DOE) Megaports Initiative at DOE's offices in Washington, D.C.; the Department of Homeland Security (DHS) in Washington, D.C.; the Department of State in Washington, D.C.; Los Alamos National Laboratory (Los Alamos) in Los Alamos, New Mexico; Sandia National Laboratories (Sandia) in Albuquerque, New Mexico; and the National Nuclear Security Administration's Service Center in Albuquerque, New Mexico. Additionally, we visited completed Megaports Initiative installations in Rotterdam, the Netherlands, and Piraeus, Greece.

To assess the progress DOE has made in implementing its Megaports Initiative, we reviewed documents and had discussions with officials from DOE; DHS; Los Alamos; Sandia; DOE's private sector contractors—SI International and Tetra Tech/Foster Wheeler; and a number of nongovernmental entities, including nonproliferation and port security experts. In addition, in October 2004, we visited the Netherlands and Greece to interview Dutch and Greek officials and to see the completed Megaports Initiative installations at the ports of Rotterdam and Piraeus, respectively. While in Rotterdam, we spoke with officials from the Dutch Ministry of Finance, the Dutch Customs authority, the U.S. Embassy in The Hague, and a U.S. official from Container Security Initiative for the port of Rotterdam. We toured the Megaports Initiative installations in Rotterdam and observed the radiation detection equipment DOE installed. When we visited Piraeus, we interviewed officials from the Greek Atomic Energy Commission; the Port Authority of Piraeus; the Greek Ministry of Economy and Finance, Customs Directorate General (Greek Customs Service); DOE's contractors—Los Alamos, SI International, and Tetra Tech/Foster Wheeler; and officials from the Container Security Initiative in Piraeus. We toured the Megaports Initiative installations at both the passenger and cargo terminals at the port of Piraeus and observed the radiation detection equipment DOE had installed. Additionally, while we were in Greece, we toured (1) two border crossings where DOE had installed radiation detection equipment through its Second Line of Defense-Core program (SLD-Core), (2) the SLD-Core installations at the passenger arrival area of Athens International Airport, and (3) a small research reactor in Athens that received physical security upgrades from DOE prior to the 2004 Olympic Games.

To better understand DOE's Maritime Prioritization Model and port prioritization process, we met with officials from DOE and Sandia National Laboratories in August 2004 to discuss the components of the model, the types of data the model uses to rank foreign seaports, as well as the port

prioritization list DOE provided us in July 2004. DOE and Sandia officials told us that the model was threat-based and that the overall volume of containers shipped from a given port to the United States accounted for only 20 percent of the port's overall prioritization score. In addition, we reviewed a briefing packet on the model developed by Sandia as well as the report of the Maritime Prioritization Model Peer Review¹ that was conducted in August 2004 by members of academia, the intelligence community, and industry experts. We also visited Sandia National Laboratories in November 2004 and discussed the model and the results of the peer review report with a Sandia official in charge of the development and maintenance of the model. While we did not conduct an assessment of the model, it is worth noting that we were informed by the DOE project manager for the Megaports Initiative on January 24, 2005, that the port prioritization list we were using was still the current operational model that DOE was using for the Initiative. However, when we met with DOE officials 2 weeks later on February 14, 2005, to discuss their comments on a review of an early draft of this report they informed us that, because they had made recent changes to the model, the prioritization list we had been using was now outdated and no longer accurate. At a February 22, 2005, meeting, DOE and Sandia officials informed us that the revised model and port prioritization process, among other things, (1) reduced the emphasis on the threat of nuclear smuggling at individual ports and placed a greater emphasis on ports with a high volume of cargo containers that enter and exit the port by land, rather than cargo that is transshipped and (2) deemphasized the risk from spent (used) nuclear fuel in a target country. DOE also provided us with a new prioritization list that showed its 35 highest priority ports listed alphabetically, rather than ranked from highest to lowest priority.

We also spoke with DOE officials about strategic planning and reviewed DOE documentation, such as the Megaports Program Work Plan for Fiscal Year 2005 and DOE's Future Years Nuclear Security Program. We reviewed the Government Performance and Results Act of 1993, the President's Management Agenda from fiscal year 2002, and several of our previous reports on strategic planning and related topics.

To assess the current and expected costs of the Initiative, we reviewed DOE documents detailing program expenditures, projected costs, and

¹The Maritime Prioritization Model Peer Review took place from August 17-18, 2004 at the U.S. Merchant Marine Academy in Kings Point, NY.

schedule estimates. We reviewed contract data for expenditures through the end of fiscal year 2004 and met numerous times with DOE agency officials to discuss the data. We obtained responses from key database officials to a number of questions focused on data reliability covering issues such as data entry access, internal control procedures, and the accuracy and completeness of the data. Follow-up questions were added whenever necessary. We also reviewed DOE's 2004 Performance and Accountability Report. A caveat worth noting is that although DOE gathers and maintains expenditure data reported by contractors assisting in implementing the Megaports Initiative, rather than conducting routine follow-up checks to corroborate the data reported by the contractors, DOE officials noted that periodic follow-up checks will be conducted, if necessary. In addition, during the course of our review we found that for fiscal year 2004, approximately \$5.45 million in program expenditures had been inappropriately costed to the Megaports Initiative, which should have been costed to the SLD-Core program. As a result, total expenditures for the Megaports Initiative are \$5.45 million less than what is reflected in DOE's fiscal year 2004 financial reports. DOE officials told us that this mistake will be corrected and reflected in DOE's fiscal year 2005 financial reports. We determined that the data were sufficiently reliable for the purposes of this report based on work we performed.

To identify challenges DOE faces in installing radiation detection equipment at foreign ports, we examined documents and spoke with officials from DOE, Los Alamos, Sandia, Pacific Northwest National Laboratory, and nongovernmental entities, including nonproliferation and port security experts. We also attended a National Academies of Science conference on non-intrusive technologies for improving the security of containerized maritime cargo. Additionally, we attended the National Cargo Security Council conference on Radiation Detection and Screening.

We conducted our review between June 2004 and March 2005 in accordance with generally accepted government auditing standards.

National Laboratory and Contractor Roles

DOE National Laboratories

Sandia National Laboratories (Sandia)

In addition to developing and maintaining the Maritime Prioritization Model, Sandia also conducts research related to international threat information, which is used to maintain the Megaports Design Basis Threat document. This document contains information on both known maritime smuggling activities and plans by terrorist organizations seeking to acquire nuclear and other commodities that have parallels to nuclear smuggling patterns. Related to this, Sandia maintains a seaport information database and develops port specific background papers to assist DOE in evaluating ports for engagement. Furthermore, Sandia officials conduct port familiarization visits and technical site visits in order to gain a general understanding of port operations as well as to determine specific information on the physical layout of the port, security, port traffic, shipping volume, the host country's commitment level to implementing the Initiative, training needs, and other relevant information. This information is used to develop vulnerability assessments, which help DOE determine the most cost-effective locations at a seaport in which to install the equipment.

Pacific Northwest National Laboratory (PNNL)

PNNL provides specific in-country training to foreign customs officials, as well as training at DOE's Hazardous Materials Management and Emergency Response facility. Training includes hands-on instruction in the use of the radiation detection equipment and systems provided under the Initiative and covers operation, maintenance, and appropriate response protocols. To do this training, PNNL purchases presentation equipment and handheld radiation detection equipment and develops and maintains training props and related documentation. Training is tailored to each port and developed and delivered by technical experts in the form of presentations, manuals, hands-on practical exercises, field training, videos, and interactive games. In addition, PNNL provides the Initiative with a certified project manager at each port who assists the federal project manager in overseeing the implementation of the Initiative at a given port and is the primary point of contact responsible for integrating all the work conducted by the participating national laboratories and contractors.

Los Alamos National Laboratory (Los Alamos)

Los Alamos provides expertise in radiation detection technologies and is the lead national laboratory for testing and evaluating the performance of radiation detection equipment. Los Alamos tests the deployed radiation detection equipment and supports Sandia in performing site surveys and preparing design requirements documents. In addition, Los Alamos

technical experts analyze portal detection performance data to ensure the deployed equipment is meeting current detection requirements. Los Alamos has also conducted equipment testing in order to overcome challenges associated with scanning transshipped cargo.

Oak Ridge National Laboratory
(Oak Ridge)

Oak Ridge provides technical assistance at DOE headquarters on the communications infrastructure associated with the installation of radiation detection equipment at foreign ports and assists with the testing and evaluation of radiation detection equipment. Oak Ridge officials told us that a trainer from Oak Ridge will be provided to assist in each of the classes conducted for foreign customs officials at PNNL's Hazardous Materials Management and Emergency Response training facility during fiscal year 2005.

Private Contractors

TSA Systems

TSA Systems is a private contractor that manufactures the radiation portal monitors that DOE installs at foreign ports and also provides technical support to DOE on the equipment. According to TSA officials, each site is visited yearly to check the monitors for damage and to perform routine maintenance. In addition, TSA has modified radiation portal monitors to address challenges specific to particular ports. For example, TSA installed stabilization plates on portal monitors at Rotterdam to deal with high winds at the port.

Tetra Tech/Foster Wheeler

Tetra Tech/Foster Wheeler is an engineering and construction company who was the primary contractor in charge installing equipment at Rotterdam and Piraeus. Tetra Tech/Foster Wheeler also led the construction of the associated infrastructure to support the radiation detection equipment at these ports.

Ahtna Government Services
Corporation (Ahtna)

Ahtna will be the primary contractor for the design and construction of future Megaports Initiative installations. Ahtna was not involved in the installation of equipment in Rotterdam or Piraeus. Ahtna has entered into a subcontract with the former design build contractor, Tetra Tech/Foster Wheeler, to support design and construction activities at future installations.

Appendix II
National Laboratory and Contractor Roles

Technology Ventures Incorporated	Technology Ventures Incorporated provides logistical support to DOE's Megaports Initiative by storing and shipping radiation portal monitors that DOE procures in advance for installation at future ports.
SI International	SI International provides DOE with technical support related to the development and installation of the communications infrastructure associated with radiation detection equipment installed under the Initiative. SI International staff provide onsite training to foreign customs officials in operating and maintaining the communications systems.
Miratek	Miratek helps DOE manage and maintain budget and expenditure data for the Megaports Initiative.

Profiles of Ports Where DOE Has Completed or Initiated Work

Rotterdam, the Netherlands

The Ministry of Finance of the Netherlands signed a memorandum of understanding (MOU) with the Department of Energy (DOE) on August 13, 2003, to include the port of Rotterdam in the Megaports Initiative. The Netherlands was the first European Union country to join the Initiative. Rotterdam is Europe's largest port. The volume of containers passing through Rotterdam is roughly 7 million twenty-foot equivalent units (TEU) annually, about 6 percent of which is shipped to the United States.¹ Approximately 20 percent of cargo passing through Rotterdam is transshipped, meaning it does not pass through any natural choke points, such as vehicle or rail entry and exit gates. Containers at the port are handled primarily in four container terminals. In addition, the Department of Homeland Security began conducting Container Security Initiative (CSI) activities at Rotterdam in June 2002.

Piraeus, Greece

The Directorate General of Customs and Excise of the Ministry of Economy and Finance of the Hellenic Republic, the Greek Atomic Energy Commission, and DOE signed a tripartite agreement on October 30, 2003 to include the port of Piraeus in the Megaports Initiative. The port is located in the southwestern Aegean Sea on the innermost point of the Saronikas Gulf. The port received increased attention because of security concerns associated with the 2004 Olympic Games. Piraeus was also considered a significant port for inclusion in the Initiative because it not only serves as a major seaport for Greece, but also is the third largest passenger port in the world. The volume of containers passing through Piraeus is about 1.6 million TEUs annually. In addition, roughly 11,000 TEUs were shipped from Piraeus directly to the United States during 2003. Greece was the second European Union country to join the Initiative and become fully operational. CSI also began operations at Piraeus in June 2004.

Colombo, Sri Lanka

The Ministry of Ports and Aviation of the Democratic Socialist Republic of Sri Lanka and DOE signed an MOU on July 20, 2004 to include the port of Colombo in the Megaports Initiative. The port is located on the southwest coast of the country. The port of Colombo has a high level of container traffic—over 1.9 million TEUs annually. The port uses cranes to move containers within and out of the terminals. DOE anticipates using vehicle

¹Twenty-foot equivalent units are a standard unit of measurement for cargo capacity. One TEU equals a standard container measuring approximately 20 ft long and 8 ft wide.

monitors to screen all containers imported to Sri Lanka, all export containers originating in Sri Lanka, and all inter-terminal transshipment containers as they exit the terminals. CSI became operational at Colombo in June 2003.

Antwerp, Belgium

The Federal Public Service of Finance of the Kingdom of Belgium signed an MOU with DOE on November 24, 2004 to include the port of Antwerp in the Megaports Initiative. Antwerp is the 4th largest seaport in the world and the largest port in Belgium. Container traffic through the port is over 5 million TEUs annually, while traffic to the United States accounts for nearly 5 percent of the total annual container traffic through Antwerp. In 2003, Antwerp ranked 9th in the world for total volume of container traffic shipped to the United States. Additionally, there are direct cargo routes from Antwerp to many major U.S. seaports. The port is geographically split into a right and a left bank. While the right bank is fully operational, the left bank has two operational terminals with another two large terminals currently under construction. When the terminals are completed, the volume of cargo passing through the port will double. In addition, CSI began operations at Antwerp in June 2002.

Algeciras, Spain

The Central Agency for Tax Administration of the Kingdom of Spain signed an MOU with DOE on December 21, 2004 to include the port of Algeciras in the Megaports Initiative. The port is located on the southernmost tip of Spain adjacent to Gibraltar. It is the 25th largest container port in the world with container traffic through the port being over 2.5 million TEUs annually. The port is strategically important in its location because, in addition to being a through route from the Atlantic Ocean to the Mediterranean, and on to the Far East, the port lies on the crossroads of the busiest sea-lanes that use the Suez Canal. Spain's cooperation with DOE currently includes only the port of Algeciras, the Spanish port DOE was most interested in. However, the Spanish government wants DOE to consider installing equipment at the ports of Valencia and Barcelona as well. Currently, DOE is considering this request, including the possibility of using a cost-sharing arrangement similar to the one used in Rotterdam. In addition, CSI became operational at the port in January 2003.

Freeport, Bahamas

The Ministry of Finance of the Commonwealth of the Bahamas and DOE signed an MOU on December 30, 2004 to include the port of Freeport in the

**Appendix III
Profiles of Ports Where DOE Has Completed
or Initiated Work**

Megaports Initiative. Freeport has a high level of container traffic moving through the port. In particular, container traffic to the United States accounts for over 16 percent of the total annual container traffic through the port. Additionally, container traffic being shipped from Freeport accounts for a total of approximately 1.2 percent of all container traffic to the United States. In addition, CSI is not scheduled to be operational at Freeport.

Additional DOE Efforts to Secure Sites in Greece Prior to the 2004 Olympic Games

In addition to the work done by the Megaports Initiative at the port of Piraeus, Greece, DOE conducted three other efforts to increase security in Greece prior to the 2004 Summer Olympics. First, the Second Line of Defense-Core program installed radiation detection equipment at three land border crossings and at the Athens International Airport to assist Greek authorities in preventing nuclear smuggling. Second, the International Radiological Threat Reduction program helped secure 21 sites around Greece that contain radiological sources that could be used to make a radiological dispersion device (also known as a “dirty bomb”). Finally, the International Nuclear Materials Security program upgraded the physical security around Greece’s only nuclear reactor—a small research reactor used for research and training—located in Athens.

Second Line of Defense-Core Program

The Second Line of Defense-Core program (SLD-Core) installed radiation portal monitors in four locations throughout Greece: three land border crossing and a large airport. According to DOE officials, the total cost of these projects was about \$15 million. The projects began in October 2003 and were completed in July 2004. DOE and national laboratory officials also provided technical assistance and training to Greek customs officials during the period of the Olympic Games. Figure 6 shows an example of the radiation portal monitors DOE supplied through the SLD-Core program.

Figure 6: Radiation Portal Monitors at a Northern Greek Border Crossing



Source: GAO.

In addition to the training provided through the Megaports Initiative to Greek customs officials working at the port of Piraeus, DOE provided detailed training to 20 Greek customs officials who work at land border crossings at the Hazardous Materials Management and Emergency Response center at Pacific Northwest National Laboratory. Additionally, about 400 Greek customs agents were trained at various sites around Greece. In fiscal year 2005, DOE plans to conduct sustainability work and additional training at these sites.

Finally, DOE supplied over 450 pieces of handheld radiation detection equipment some of which were intended for use at Olympic venues. This equipment included handheld gamma radiation detectors, radioactive isotope identification devices, and radiation detection pagers (see figures 7 and 8). According to an agreement between the Greek Atomic Energy Commission and DOE, after the Olympic Games, these handheld devices

**Appendix IV
Additional DOE Efforts to Secure Sites in
Greece Prior to the 2004 Olympic Games**

were to be distributed to border locations throughout Greece that did not receive other DOE assistance.

Figure 7: A Handheld Gamma Radiation Detector and a Radioactive Isotope Identification Device



Source: GAO.

Figure 8: Radiation Detection Pager



Source: GAO.

International Radiological Threat Reduction Program

Through its International Radiological Threat Reduction program, DOE spent \$780,000 to increase security at 21 sites throughout Greece that contained radiological sources of a type and size that could be used for a dirty bomb and to provide additional handheld radiation detection equipment for first responders in Greece. DOE secured sites that included facilities with blood irradiator units containing cesium chloride sources, a large industrial sterilization facility, and oncology clinics that had medical isotopes used in cancer therapy. Figure 9 shows a teletherapy unit containing a radiological source, which is used to treat cancer.

Figure 9: Teletherapy Unit Containing Radioactive Source, Prior to Receiving Physical Security Upgrades

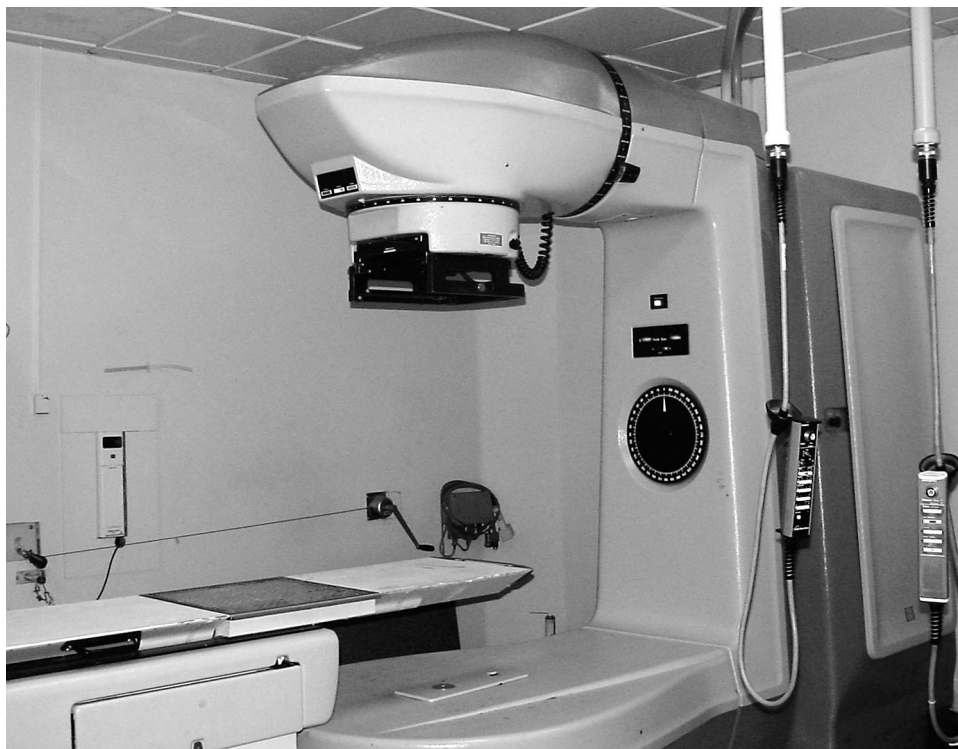

Source: DOE.

Additionally, DOE provided handheld radiation detection equipment to Greece through the Cooperative Radiological Instrument Transfer project. Through this project, DOE donated 110 handheld radiological detection devices that DOE national laboratories had previously deemed surplus. DOE officials said that Greece was not high on the list of target countries for assistance through the International Radiological Threat Reduction program, but because of the increased security needs for the Olympic Games, DOE expedited assistance to Greece. DOE began this project in October 2003 and completed the upgrades in May 2004.

Appendix IV
Additional DOE Efforts to Secure Sites in
Greece Prior to the 2004 Olympic Games

Atomic Energy Commission believed that it was important to upgrade the physical security of this reactor primarily because the reactor is fueled with a mix of highly enriched uranium and low enriched uranium. This site is the only location in Greece with weapons-usable nuclear material. The Greek Atomic Energy Commission is in the process of converting the reactor to use only low enriched uranium fuel.¹

To upgrade the physical security of the reactor, DOE installed a new perimeter detection system that included closed-circuit television, hardened windows and doors on the reactor building, a new central alarm station, and enhanced lighting of the building's perimeter. As an additional security measure, the Greek Atomic Energy Commission shut down the research reactor during the period of the Olympics Games.

¹We recently reported on research reactors, see GAO, *Nuclear Nonproliferation: DOE Needs to Consider Options to Accelerate the Return of Weapons-Usable Uranium from Other Countries to the United States and Russia*, [GAO-05-57](#) (Washington, D.C.: November 19, 2004) and *Nuclear Nonproliferation: DOE Needs to Take Action to Further Reduce the Use of Weapons-Usable Uranium in Civilian Research Reactors*, [GAO-04-807](#) (Washington, D.C.: July 30, 2004).

Comments from the Department of Energy



Department of Energy
National Nuclear Security Administration
Washington, DC 20585



March 18, 2005

Mr. Gene Aloise
Director
Natural Resources and Environment
Government Accountability Office
Washington, DC 20548

Dear Mr. Aloise:

The National Nuclear Security Administration (NNSA) appreciates the opportunity to have reviewed the Government Accountability Office's draft report, GAO-05-375, "PREVENTING NUCLEAR SMUGGLING: DOE Has Made Limited Progress in Installing Radiation Detection Equipment at Highest Priority Foreign Seaports." We understand that this audit was conducted to determine the progress, costs, and challenges of the subject initiative.

We acknowledge and appreciate that GAO, after discussions with our program element, has incorporated changes to the original draft report that adds clarity to the report. It is important to note that NNSA is focusing a significant amount of its resources on negotiations with foreign governments. We have had teams visit over 20 countries to discuss cooperation and negotiate agreements. In fact, we have completed agreements and are implementing installations at five additional ports and expect to sign up to five more agreements in the next few months as noted in the revised draft report.

Regarding the evolution of the Maritime Prioritization Model, we note that the model is only a tool to aid program officials in decision-making and it does provide valuable information to program officials. The data output obtained from the model, combined with other factors, such as the willingness of a host country to engage in cooperation with the U.S., our ability to effectively implement in a given port, the host country's ability and commitment to effectively operate and maintain the systems for the long term, and other political factors significantly influence programmatic priorities. In the early stages of the Mega-ports Initiative, the top 20 highest-volume-to-U.S. seaports were the primary focus, consistent with the approach of the U.S. Customs and Border Protection's Container Security Initiative (CSI). At that time we clearly placed high priority on sheer container volume and therefore focused our efforts on screening as many U.S.-bound containers as possible. Over time we came to more thoroughly understand the diversity and complexity of port operations and configurations and the technical challenges that this presents. As a result, major adjustments to the

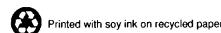

model were initiated in the summer 2004. While the relative ranking of some of the ports on our priority list changed, the total pool of ports of interest remained largely the same. On February 22, 2005, DOE presented information to the GAO on modifications and enhancements that had been made to the Maritime Prioritization Model, including a revised pool of priority ports. The most recent pool of ports represents a combination of ports that ship large volumes of containers to the U.S. and ports that lie in regions of interest (i.e., threat). We are focusing our efforts on the ports on this list and are at some level of engagement with over 20 of the included countries. Given the dynamic nature of maritime shipping, NNSA expects the priority list will change over time. Port capacities may increase, the threat could change, and other factors may arise that make a port a priority for implementation.

NNSA generally agrees with the report's recommendations. We have attached our specific comments to the report's recommendations. Should you have any questions related to this response, please contact Richard Speidel, Director, Policy and Internal Controls Management at 202-586-5009.

Sincerely,

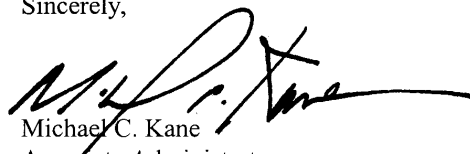

Michael C. Kane
Associate Administrator
for Management and Administration

Enclosure

cc: Paul Longworth, Deputy Administrator
for Defense Nuclear Nonproliferation
Robert Braden, Senior Procurement Executive
Karen Boardman, Director, Service Center

Comments to
GAO's Draft Report, GAO-05-375
"PREVENTING NUCLEAR SMUGGLING: DOE Has Made
Limited Progress in Installing Radiation Detection Equipment at
Highest Priority Foreign Seaports"

Comment:

NNSA agrees with the recommendations for Executive Action and will take the appropriate actions to meet the intent expressed in GAO's report.

Recommendations for Executive Action

"We recommend that the Secretary of Energy, working with the Administrator of the National Nuclear Security Administration, take the following actions:"

Recommendation 1

Develop a comprehensive long-term plan to guide the future efforts of the Initiative that includes, at a minimum, (1) performance measures that are consistent with DOE's desire to install radiation detection equipment at the highest priority foreign seaports, (2) strategies DOE will employ to determine how many and which lower priority ports it will include in the Initiative if it continues to have difficulty installing equipment at the highest priority ports as identified by its model, (3) projections of the anticipated funds required to meet the Initiative's objectives, and (4) specific time frames for effectively spending program funds.

Management Comment

Concur

While NNSA does not have a single document that portrays the comprehensive long-term plan for its Megaports Initiative, we do have the elements needed to develop the long-term plan in three separate planning documents. We agree that a comprehensive long-term plan is appropriate and we are currently working to produce this unified document.

Recommendation 2

Evaluate the accuracy of the current per port cost estimate of \$15 million, make any necessary adjustments to the Initiative's long-term cost projection, and inform Congress of any changes to the long-term cost projection for the Initiative.

Management Comment

Concur

By the end of Fiscal Year 2005, NNSA anticipates that the Initiative will have completed installations at five ports. It is at that point that NNSA will conduct a comprehensive cost analysis to assess the accuracy of the per port estimate for the Initiative. It is at that point that NNSA will adjust our long-term cost projections and inform Congress of same.

Related GAO Products

Weapons of Mass Destruction: Nonproliferation Programs Need Better Integration. [GAO-05-157](#). Washington, D.C.: January 28, 2005.

Nuclear Nonproliferation: DOE Needs to Consider Options to Accelerate the Return of Weapons-Usable Uranium from Other Countries to the United States and Russia. [GAO-05-57](#). Washington, D.C.: November 19, 2004.

Nuclear Nonproliferation: DOE Needs to Take Action to Further Reduce the Use of Weapons-Usable Uranium in Civilian Research Reactors. [GAO-04-807](#). Washington, D.C.: July 30, 2004.

Homeland Security: Summary of Challenges Faced in Targeting Oceangoing Cargo Containers for Inspection. [GAO-04-557T](#). Washington, D.C.: March 31, 2004.

Homeland Security: Preliminary Observations on Efforts to Target Security Inspections of Cargo Containers. [GAO-04-325T](#). Washington, D.C.: December 16, 2003.

Container Security: Expansion of Key Customs Programs Will Require Greater Attention to Critical Success Factors. [GAO-03-770](#). Washington, D.C.: July 25, 2003.

Container Security: Current Efforts to Detect Nuclear Material, New Initiatives, and Challenges. [GAO-03-297T](#). Washington, D.C.: November 18, 2002.

Customs Service: Acquisition and Deployment of Radiation Detection Equipment. [GAO-03-235T](#). Washington, D.C.: October 17, 2002.

Nuclear Nonproliferation: U.S. Efforts to Help Other Countries Combat Nuclear Smuggling Need Strengthened Coordination and Planning. [GAO-02-426](#). Washington, D.C.: May 16, 2002.

GAO's Mission

The Government Accountability Office, the audit, evaluation and investigative arm of Congress, exists to support Congress in meeting its constitutional responsibilities and to help improve the performance and accountability of the federal government for the American people. GAO examines the use of public funds; evaluates federal programs and policies; and provides analyses, recommendations, and other assistance to help Congress make informed oversight, policy, and funding decisions. GAO's commitment to good government is reflected in its core values of accountability, integrity, and reliability.

Obtaining Copies of GAO Reports and Testimony

The fastest and easiest way to obtain copies of GAO documents at no cost is through GAO's Web site (www.gao.gov). Each weekday, GAO posts newly released reports, testimony, and correspondence on its Web site. To have GAO e-mail you a list of newly posted products every afternoon, go to www.gao.gov and select "Subscribe to Updates."

Order by Mail or Phone

The first copy of each printed report is free. Additional copies are \$2 each. A check or money order should be made out to the Superintendent of Documents. GAO also accepts VISA and Mastercard. Orders for 100 or more copies mailed to a single address are discounted 25 percent. Orders should be sent to:

U.S. Government Accountability Office
441 G Street NW, Room LM
Washington, D.C. 20548

To order by Phone: Voice: (202) 512-6000
TDD: (202) 512-2537
Fax: (202) 512-6061

To Report Fraud, Waste, and Abuse in Federal Programs

Contact:

Web site: www.gao.gov/fraudnet/fraudnet.htm

E-mail: fraudnet@gao.gov

Automated answering system: (800) 424-5454 or (202) 512-7470

Congressional Relations

Gloria Jarmon, Managing Director, JarmonG@gao.gov (202) 512-4400
U.S. Government Accountability Office, 441 G Street NW, Room 7125
Washington, D.C. 20548

Public Affairs

Paul Anderson, Managing Director, AndersonP1@gao.gov (202) 512-4800
U.S. Government Accountability Office, 441 G Street NW, Room 7149
Washington, D.C. 20548