

PowerLight Corporation Lean Manufacturing, PV Manufacturing R&D Phase I Report

6 December 2001 — 31 March 2003

L. Hargis and J. Botkin
PowerLight Corporation
Berkeley, California

Subcontract Report
NREL/SR-520-35881
June 2005

NREL is operated by Midwest Research Institute • Battelle Contract No. DE-AC36-99-GO10337



PowerLight Corporation Lean Manufacturing, PV Manufacturing R&D Phase I Report

6 December 2001 — 31 March 2003

L. Hargis and J. Botkin
PowerLight Corporation
Berkeley, California

NREL Technical Monitor: David Mooney
Prepared under Subcontract No. NDO-1-30628-04

Subcontract Report
NREL/SR-520-35581
June 2005

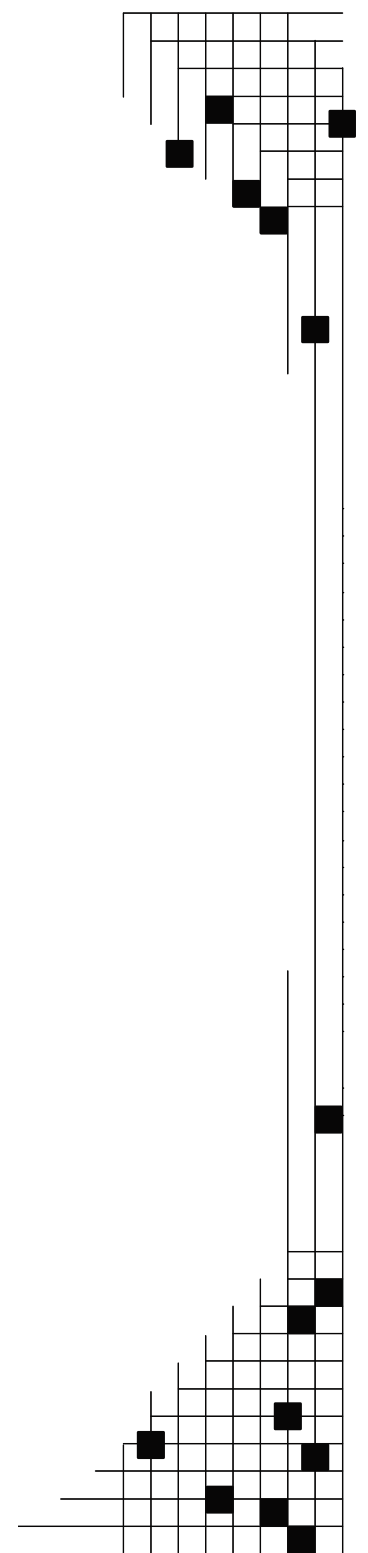

National Renewable Energy Laboratory
1617 Cole Boulevard, Golden, Colorado 80401-3393
303-275-3000 • www.nrel.gov

Operated for the U.S. Department of Energy
Office of Energy Efficiency and Renewable Energy
by Midwest Research Institute • Battelle

Contract No. DE-AC36-99-GO10337

**This publication was reproduced from the best available copy
Submitted by the subcontractor and received no editorial review at NREL**

NOTICE

This report was prepared as an account of work sponsored by an agency of the United States government. Neither the United States government nor any agency thereof, nor any of their employees, makes any warranty, express or implied, or assumes any legal liability or responsibility for the accuracy, completeness, or usefulness of any information, apparatus, product, or process disclosed, or represents that its use would not infringe privately owned rights. Reference herein to any specific commercial product, process, or service by trade name, trademark, manufacturer, or otherwise does not necessarily constitute or imply its endorsement, recommendation, or favoring by the United States government or any agency thereof. The views and opinions of authors expressed herein do not necessarily state or reflect those of the United States government or any agency thereof.

Available electronically at <http://www.osti.gov/bridge>

Available for a processing fee to U.S. Department of Energy
and its contractors, in paper, from:

U.S. Department of Energy
Office of Scientific and Technical Information
P.O. Box 62
Oak Ridge, TN 37831-0062
phone: 865.576.8401
fax: 865.576.5728
email: <mailto:reports@adonis.osti.gov>

Available for sale to the public, in paper, from:

U.S. Department of Commerce
National Technical Information Service
5285 Port Royal Road
Springfield, VA 22161
phone: 800.553.6847
fax: 703.605.6900
email: orders@ntis.fedworld.gov
online ordering: <http://www.ntis.gov/ordering.htm>



Table of Contents

Abstract	iv
Executive Summary	iv
1.0 Introduction.....	1
1.1 Background.....	1
2.0 Conclusions and Recommendations.....	3
2.1 Task 3.1: Model for PowerGuard Optimized Turn-key Plant Design	3
2.2 Task 3.2: Product Lead Time Improvements.....	6
2.3 Task 3.3: Yield Improvements	10
2.4 Task 3.4: Plant Operations Improvements	13
2.5 Task 3.8 Improved Manufacturing Capabilities for PowerGuard Generation II.....	15
2.6 Task 3.9 Enhanced Design for Manufacturability	18
2.7 Task 3.10 Advanced Quality System Implementation	24
2.8 Summary of Accomplishments	26

Abstract

PowerLight Corporation (PowerLight) has completed Phase I of its PV Manufacturing R&D subcontract, "PowerGuard^{®1} Lean Manufacturing," Subcontract No. NDO-1-30628-04. The overall technical goal of this project was to reduce the cost of PowerGuard manufacturing while simultaneously improving product quality. This will enable PowerLight to scale up production capacity as the market for PowerGuard continues to grow.

Through the introduction of world-class lean manufacturing techniques, PowerLight was to cut out waste in the manufacturing process of PowerGuard. The manufacturing process was to be overhauled with an objective of removing as much as possible those steps that do not add value to the product. Quality of finished goods was also to be improved through the use of statistical process control and error-proofing in the manufacturing process. Factory operations were also to be addressed in order to streamline those factory activities that support the manufacturing process.

This report details the progress made toward the above listed goals during the first phase of this subcontract.

Executive Summary

During the first phase of this PV Manufacturing R&D contract, PowerLight has implemented significant improvements that will yield a lower cost and more easily manufactured product. The process started with the creation of an analytical model in Task 3.1, which showed the major bottlenecks in the current production process and also demonstrated the benefits of some of the proposed improvements. Major bottlenecks have been mitigated and the basic requirements for the design of a new factory have been identified. Short-term improvements were identified to improve the flow of materials through the current factory. Long-term improvements were identified in the form of product changes to make PowerGuard more easily manufactured.

In Task 3.2, changes were implemented as identified in the model created in Task 3.1 above. A new router was added to the production line to augment the capacity of the existing router. This removed a significant bottleneck in the production process. Other changes were investigated to reduce curing time as much as possible in the existing process. The most significant changes were accomplished by changing the design of the PowerGuard product and drastically reducing the curing time requirement. A new replacement for the coating on the top of the polystyrene boards reduced the curing time from days to minutes. A new manufacturing line was set up for the new product and overall product lead time was reduced to 25% of its original value, far surpassing the

1 "PowerGuard" is a registered trademark of the PowerLight Corporation. Reference in the SOW or Subcontract Deliverable to any specific commercial product, process, or service by trade name, trademark, logo, manufacturer, or otherwise, does not constitute or imply its endorsement, recommendation, or favoring by the United States Government, the National Renewable Energy Laboratory or the Midwest Research Institute. The views and opinions of any author or authors expressed in any Deliverable report or referenced in any Deliverable do not necessarily state or reflect those of the United States Government, the National Renewable Energy Laboratory or the Midwest Research Institute.

goal of a 30% reduction. Furthermore, for PowerGuard tiles with sloped PV, the lead time is reduced to less than 10% of its original value.

Task 3.3 was focused on improvements to the yield of the PowerGuard manufacturing process. Error-proofing was implemented in several areas, most notably in the mixing of the liquids for the coating process. Short-term efforts focused on the existing PowerGuard production line while long-term efforts were focused on the new PowerGuard line. For the existing line, the reject rate was brought down to 0.6%, just short of the goal of 0.5%, but we anticipate significant improvements with the start of production of the new PowerGuard design. Statistical process control (SPC) was implemented for PowerGuard production and initial results have shown the process to be working well. SPC will be expanded to more of the production process over the course of the second phase of this project. Additionally, a new non-conformance reporting procedure was implemented which will lead to better tracking of yield problems and more expedient corrective action.

In Task 3.4, a new Quality Assurance/Quality Control system was put in place. Progress was made toward a Kanban style pull manufacturing system that will become fully implemented with the new PowerGuard production line. Work was done to reduce the cost of operating the PowerLight factory by improving the dust collection system, reducing noise and cleanup time, and improving the organization of the factory space. These improvements have helped to reduce the inventory of work-in-process (WIP) by 17% and reduced the required floor space per unit produced by 24%. The new production process will reduce WIP inventory by 94% and floor space by 74%.

In Task 3.8, improvements were designed for the new production line to reduce labor, maintain quality, and improve tool ergonomics in preparation for scaling up of production capacity. With the start of production on the new line, daily output quickly ramped up to the anticipated level. Improvements were designed which will decrease labor by 9%.

In Task 3.9, improvements were made to the design of the PowerGuard tile to enhance manufacturability and reduce cost. All improvements were tested to ensure that there was no impact on performance or longevity. The design improvements were incorporated into the product, and the first 2,000 units were produced from February through April, 2003.

Task 3.10 was concerned with the further advancement of PowerLight's quality assurance program. PowerLight developed a closed loop corrective and preventive action system. This is being tied to a quality assurance tracking system, which will allow the tracking of performance metrics for this system. PowerLight also improved testing of incoming PV modules by developing a new test station using dark I-V measurements to check the expected open circuit voltage, series resistance, and the status of the bypass diodes. This has significantly improved PowerLight's ability to detect module problems before they are installed in the field.

PowerLight is proud of the progress that has been achieved during the first phase of this contract. These improvements are helping to reduce the cost of installed PV systems, opening new markets for clean energy power plants. We look forward to continuing this work in the second phase of the contract.

1.0 Introduction

Objective

During Phase I, PowerLight was to conduct parallel efforts addressing the following advancements:

- Produce an analytical model of factory operations to perform a quantitative analysis of factory layout to minimize product lead time and manufacturing waste;
- Implement World Class Lean Manufacturing techniques to reduce product lead time by at least 30% and reduce manufacturing waste by at least 20%;
- Improve quality control techniques to achieve a maximum of 0.5% reject rate;
- Implement Statistical Process Control;
- Initiate ISO 9000 policies and procedures;
- Implement Error-Proofing to the PowerGuard manufacturing process;
- Improve factory operations to reduce inventory levels by at least 30% and required floor space by at least 25%;
- Improved manufacturing capabilities for PowerGuard Generation II design;
- Improved design-for-manufacturability of PowerGuard;
- Implementation of Advanced Quality Systems.

Achieving these objectives required the design of new equipment and procedures, installation and testing of new equipment, and the comparison of changes in the manufacturing process to the baseline created at the beginning of this contract.

1.1 Background

PowerGuard building-integrated photovoltaic roofing tiles generate electricity from solar energy. With the assistance of PV Manufacturing R&D, PowerLight has improved the PowerGuard manufacturing process to lower costs, improve product quality, and increase production capacity.



Figure 1

A PowerGuard tile consists of a flat plate PV laminate mounted onto a flat, rigid, extruded polystyrene (XPS) board. Historically, the XPS boards have all been covered with a cementitious coating. In the new version of PowerGuard developed as part of this contract, the XPS board is covered instead by a layer of sheet metal. Two edges of the XPS board are routed into a tongue profile and the other two edges are given a groove profile, allowing PowerGuard tiles to be assembled adjacent to each other in an interlocking fashion as shown in Figure 1 above. Adjacent tiles are tied together electrically through connectors supplied on each PV module, thus creating an electrical string of PV modules. One or more strings are then electrically connected in parallel at a remote location creating a solar electric array (PowerGuard system). The resulting DC current from the array is passed through a DC/AC inverter and isolation transformer before being tied into the building's electric distribution panel.

PowerGuard tiles provide benefits in addition to the electricity produced in the form of added insulation and protection of the roof membrane from ultraviolet light. Figure 2 shows how a PowerGuard system can reduce the heat transfer into a building and reduce operating costs.

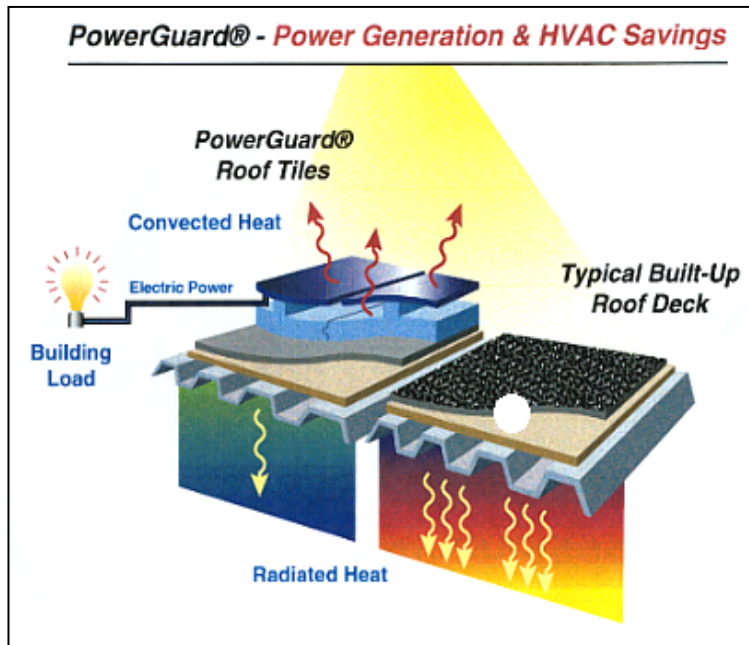

Figure 2

2.0 Conclusions and Recommendations

2.1 Task 3.1: Model for PowerGuard Optimized Turn-key Plant Design

Objectives

Under this task, PowerLight and its contractor were to perform a quantitative analysis of two or more scenarios for a turnkey factory layout, and to measure reductions in product lead time and manufacturing waste for each scenario. These are both key elements to minimize production costs.

PowerLight and its subcontractor were to develop an analytical model of the PowerLight factory and use it as a predictive tool to quantitatively evaluate performance improvements to the PowerGuard manufacturing process. The model would allow comparisons of different scenarios of factory design and would quantitatively indicate the effects of various changes. PowerLight was to use this model to help prioritize various potential upgrades to the existing production line.

The result of this task was to be the quantitative analysis of turnkey factory layouts, a turnkey factory layout model of an optimized production line, and specifications for improvements to meet cost reduction and increased capacity goals.

Results

PowerLight, in conjunction with Professor Hyun-soo Ahn of the University of California, Berkeley department of Industrial Engineering and Operations Research (IEOR), has developed an analytical model of factory operations. Initially, this model was used to identify the main imbalances and inefficiencies in the operation of the current factory. During the second phase of this project, the results of the model will be used in the process of designing the next generation PowerGuard factory.

The model was used to generate data based on the current production process as well as the new production process that has been set up to produce the new PowerGuard tile design. The new PowerGuard design allows most of the curing time to be eliminated as described in Task 3.2 below. The model shows the advantages that will be realized when we implement the new optimized production line. The most dramatic improvement shown is the drastic reduction of the amount of work-in-process (WIP), which is reduced to less than 10% of the current levels.

Some improvements were also identified for the existing production line that will help reduce cost until the optimized production line replaces the existing one. By making changes to the existing line so that the backerboard coating portion of the line runs at a 45-second takt time for one shift while the tile assembly portion runs at a 30-second takt time for two shifts, we will optimize the use of factory curing space.

Discussion

The model was designed to give the user a visual representation of the pre-existing layout of the factory as shown in Figure 3. Each operation is identified with a picture of the equipment used to process the material. The position of each operation and the distance between operations can be changed to experiment with different scenarios. The operating parameters of each production step can be adjusted to produce specifications for an optimized process. Figure 3 shows a forklift that is used to move raw material to the first operation and a truck that is used to move finished goods out of

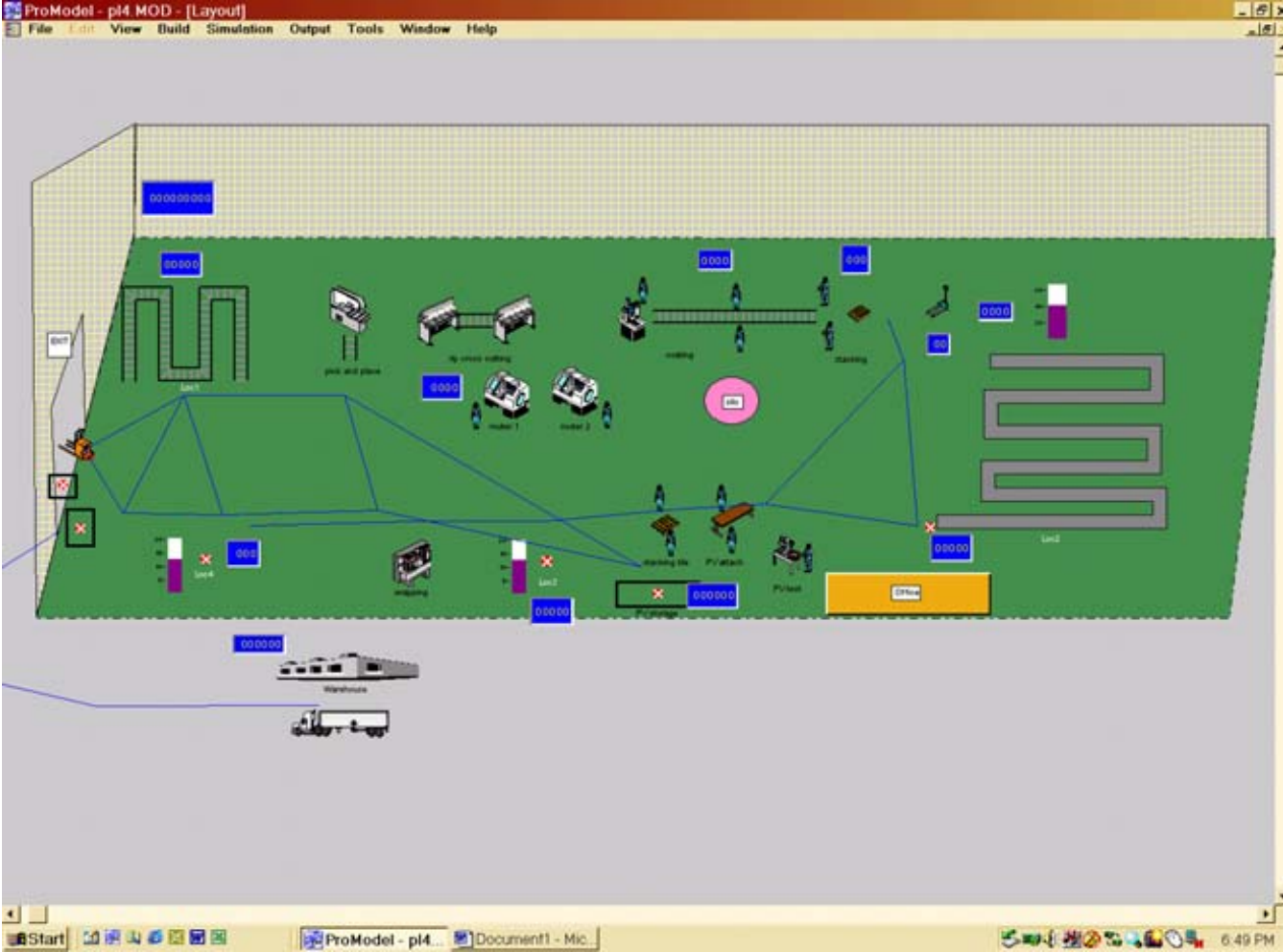

Figure 3: Pro Model Visual Representation of Pre-Existing Factory Operation

the facility. Product moves from one operation to the next after programmed batch sizes have been processed. The user can view all operations working simultaneously.

The model details the material movement between operations and collects data used to calculate WIP levels, cycle time and numerous other indices.

The current production process can be divided into two sections: the coating of backerboards and the assembly of the complete PowerGuard tiles. Each of these two processes has a cure time associated with it. The scenarios evaluated first used the current cure times for coating of the backerboards and for assembly of the tiles. The model was loaded with takt times of 15, 30, 45 and 60 seconds. The number of backerboards existing as WIP at the different production rates is shown in Table 1 for single-shift, two-shift, and three-shift operation. As can be seen, the amount of WIP increases as throughput increases and as the number of shifts increases.

	Production rate (seconds per unit)			
	15 seconds	30 seconds	45 seconds	60 seconds
1 shift	1168	910	742	679
2 shifts	2387	1890	1561	1339
3 shifts	4002	3165	2624	2248

Table 1: Work-In-Process (Backerboards) (old PowerGuard process)

Table 2 shows the maximum and average number of units stored for curing. Product is stacked 12 pieces to a pallet. This can be compared to actual space in the PowerLight factory. The total space allotted in the current PowerLight factory for curing backerboards and tiles is 42 pallets (504 units) per day. Thus it would not be possible to run continuously in the current factory at the rates simulated.

		Production rate (seconds per unit)							
		15 seconds		30 seconds		45 seconds		60 seconds	
		Maximum	Average	Maximum	Average	Maximum	Average	Maximum	Average
1 shift	Backerboard	840	768	660	600	540	492	456	408
	Tile	420	312	324	240	276	192	228	168
2 shifts	Backerboard	1896	1656	1488	1296	1224	1068	1044	900
	Tile	960	660	744	516	612	420	528	360
3 shifts	Backerboard	3204	2796	2520	2208	2076	1452	1776	1548
	Tile	1608	1116	1260	876	1044	720	888	612

Table 2: Number of Units of Curing Material (old PowerGuard process)

Tables 1 and 2 indicate that running the backerboard coating portion of the line at a 45 second takt time for less than 1 shift produces the maximum amount of material that can be stored in the factory. As described in Task 3.2 below, a second router has been added to the PowerGuard production line to support this production rate. Since each router has a capacity of one backerboard every 90 seconds, two routers can produce a backerboard every 45 seconds.

The tile assembly portion of the line yields the maximum number of pallets at 2 shifts with a 30-second takt time. However, if the tile assembly is run at the same rate as the coating line, then the entire production line will be balanced, and the daily schedule will be consistent.

As detailed in Task 3.2 below, PowerLight has worked on improvements to the PowerGuard design that will help reduce cost by improving the manufacturability of the product. One of the improvements will be a drastic reduction in the required curing time. To simulate this, the model was loaded with expected new cure times. Additionally, a new optimized layout was designed for the new manufacturing process. The model was adjusted to accurately represent the new layout. Table 3 shows the WIP generated with the new layout and the new design's reduced cure time for the backerboard coating and tile assembly.

	Production rate (seconds per unit)			
	15 seconds	30 seconds	45 seconds	60 seconds
1 shift	130	114	88	140
2 shifts	120	138	123	134
3 shifts	144	139	136	133

Table 3: Work-In-Process (Backerboards) with New Layout and Reduced Cure Times

The result shows there is no significant accumulation of WIP regardless of the takt time or number of shifts operated. The takt time is set based on the short initial cure time and the amount of space allotted for the new production line in the current factory. When the new factory is designed, sufficient space will be allotted to allow a significant increase in throughput.

During the process of designing the new factory in Phase 2 of this project, the model output will be iterated with different scenarios to identify the optimum throughput and layout for the space available. The model will also be used to identify areas for improvement as part of PowerLight's commitment to continuous improvement and the continued effort to drive down cost.

2.2 Task 3.2: Product Lead Time Improvements

Objectives

Under this task, PowerLight was to identify and upgrade stations of the existing manufacturing line as needed to reduce product lead times by at least 30% and reduce manufacturing waste by at least 20%, while at the same time maintaining product quality and worker safety.

PowerLight was to undertake steps to implement world-class lean manufacturing techniques and redesign equipment based upon the results identified from the model developed in Task 1. The primary focus of this task was to reduce waste in the manufacturing process, which would lead to a reduction in the product lead time. This would provide a direct path to cutting cost in the manufacturing of PowerGuard.

We have defined product lead time as the amount of time between the arrival of raw materials and the completion of finished goods. The activities which are performed in the process of going from raw materials to installed product can be divided into two categories: value-added and non value-added. Value-added activities are those that add something for which the customer is willing to pay. In the ideal case, all non value-added activities are eliminated, thus optimizing the use of resources and the responsiveness of the company to customers' needs. In reality, there will probably

always be some non value-added activity required. The objective is to reduce the non value-added portion of product lead time to a practical minimum.

In order to minimize non value-added activity, PowerLight was to make an assessment of the true product lead time for PowerGuard at the beginning of this task. Efforts would then be focused on modifying the various steps in the manufacturing process to eliminate non value-added activity wherever possible.

The result of this task was to be a modified PowerGuard production line that reduces product lead times by 30% and minimizes waste by 20% while maintaining product quality and worker safety.

Results

The initial lead time assessment showed that the current PowerGuard manufacturing process has a minimum lead time of 98 hours and 28 minutes. At the time of the assessment, much of the product was stored for significant amounts of time as raw material or as finished goods. As a result, approximately 80% of the PowerGuard product had an actual lead time of over 1270 hours.

Some new equipment was installed to help balance the production process and minimize the batch processes. With the development of a replacement for the cementitious coating on PowerGuard tiles and the implementation of a new production line, PowerLight was able to reduce the product lead time significantly. When manufacturing tiles with sloped PV modules, the product lead time is less than 10% of the original lead time. With a horizontal PV module as in the current PowerGuard design, the product lead time on the new production line will be reduced to 25% of the original lead time.

Discussion

As stated above, the existing PowerGuard production process had a minimum lead time of 98 hours and 28 minutes. PowerLight worked to reduce product lead time in two ways. First, steps in the production process that were creating bottlenecks were identified and assessed for possible improvements. Second, changes in the product design were investigated which would reduce cure time requirements. Near term improvements were made by removing bottlenecks, and drastic improvements were made for the long term by finding an alternative to the cementitious coating of the PowerGuard backerboards.

The primary bottleneck in production was the process of routing the tongue and groove profile on the backerboards. PowerLight has used a single CNC router for the previous three years. Because the process of routing backerboards is much slower than the coating process, routed backerboards were fabricated in large batches. When enough boards were finished, a coating run was started and continued until all the backerboards were coated. To increase the throughput of the routing process, the old router was augmented by a second router with the same specifications. The new router was installed and the old router was moved into a new position next to the new one as shown in Figure 4. The two routers are now positioned to feed the coating process directly. With the new router commissioned, coating runs are performed with routed boards coming off the routers and going straight into the coating process. This reduces some of the non-value added time in the product lead time. It also drastically reduces the amount of preparation time and floor space required for each coating run.



Figure 4: Old and New Router

A second large bottleneck has been floor space due to the curing requirements at the different stages of manufacturing. At the beginning of this contract, it was the standard practice to coat as many backerboards as possible during a coating run. This filled the factory with curing material. A large number of backerboards had to be routed to get ready for the next coating run, but since the floor space was filled with curing material, there was not much space for the stacks of routed backerboards. During this contract, PowerLight has worked towards using smaller coating batches and doing them more often. This way the capacity of the factory can be maximized, and the daily operation can be consistent. Also the storage of material can be consistent. These improvements help reduce wasted labor involved with moving materials more than necessary.

Other smaller bottlenecks have been addressed as well. Painting of XPS boards to make into spacers for the PV modules has been a time consuming process, and the paint must cure before the cutting operation can be done. PowerLight investigated several alternate methods of painting the spacers. It was especially desirable to paint the spacers either during the attachment of the spacers to the backerboard or during the PV attachment process. This would allow the paint to cure at the same time as the coating or the PV adhesive. Painting during the PV attachment process appeared to have the most promise of success. PowerLight purchased a pressurized paint roller system to try out, which was evaluated, but found to be inadequate for complete coverage. Other alternatives will be investigated.

To achieve drastic reductions in product lead time, PowerLight focused on changing the PowerGuard product to improve its manufacturability. The primary focus of this change has been to reduce curing times as much as possible. Since most of the curing time required is for the coating, PowerLight began investigating alternatives to the current coating. An alternative to the coating was developed which cuts the curing time from 72 hours to six minutes. Additionally, in the PowerGuard tiles with sloped PV modules, the adhesive for the PV module was replaced with mechanical fasteners, completely eliminating a curing step. Manufacturing of the new product design lends itself very readily to a continuous flow operation. When manufacturing the sloped PV tiles, the product lead time is 13 minutes, which is less than 10% of the original lead time. With a horizontal PV module, the product lead time on the new production line will be reduced to just over 24 hours or 25% of the original lead time.

A small assembly line was set up at the back of the PowerLight factory to produce the new PowerGuard design. Due to space limitations, it was set up for a fairly low

throughput. This throughput can be increased when additional space becomes available by increasing the length of the conveyor line and by improving the assembly tools for the workers. The major pieces of equipment were sized for the higher throughput level anticipated in the future.

Manufacturing waste has been reduced in many ways. The older manufacturing process produces physical waste in a few different forms. The routing process produces foam dust. Foam stock is trimmed to the appropriate size to feed the router, and this leaves small blocks of wasted foam. Excess coating formula is trimmed from the edges of the backerboards. A small amount of coating formula is wasted during startup and shutdown of the coating line. There is also waste in the form of non-value added activity in the manufacturing process and wasted labor when material has to be moved or reworked. The bulk of the waste in the existing manufacturing process is in the non-value added activity. In going to the new PowerGuard manufacturing process many of the non-value added activities have been eliminated.

Stacking of material represents a lot of wasted labor. At the beginning of this project, the existing manufacturing process involved three stacking operations. Routed foam boards were stacked to get ready for coating. Coated boards were stacked for curing. Complete tiles were stacked after final assembly. With the addition of a second router, the first of the three stacking operations can be eliminated, and with the transfer to the new production process, the tiles are only stacked once at the end of the entire process.

The various curing steps in manufacturing the older PowerGuard design also require a lot of labor to move the material around the factory. After the stacks of material are made at each step, the stacks must be moved for storage, and then moved to the beginning of the next step for processing. By creating a continuous flow process for the new PowerGuard manufacturing line, the parts move along a conveyor line until they are finished. All excess handling is eliminated.

With the older PowerGuard design, the coating edges slump as they come out of the coating process. Once the coating has taken an initial set, the edges must then be trimmed to remove the slumped material. This results in wasted material and wasted labor. The slumped material is dropped onto the floor, which must then be cleaned afterward. The trimming process requires two workers during the coating process and for two hours afterward for the cleaning. All of this is non value-added activity. By replacing the coating in the new PowerGuard design, this trimming process is entirely eliminated.

To minimize wasted foam, PowerLight has worked with its foam supplier to make custom size foam boards. This results in foam stock that yields exactly two routed boards without any leftover blocks. This reduces wasted material and also reduces wasted labor that was required to pick up the leftover blocks and package them to send to the recycler.

By eliminating the various steps described above, approximately 27% of the labor involved with assembling PowerGuard tiles is eliminated. Since all of this was wasted labor, this change results in a drastic reduction in waste. While the routing process still generates waste foam dust in the new process, the amount of material is reduced due to a modified tongue and groove profile. Most other manufacturing waste is eliminated in the new process.

Once the major components of the new assembly line were in place, PowerLight ran several small pilot runs to test out the process and the new parts. Factory workers were trained in the new assembly process, and production began in February 2003.

2.3 Task 3.3: Yield Improvements

Objectives

Under this task, PowerLight and its contractor were to improve quality control to achieve a maximum of 0.5% for parts that are rejected or require rework (from current level of 1% requiring rejection, 2-3% requiring rework).

PowerLight was to study and evaluate system behavior to identify causes of variability of product quality and all causes of parts requiring rejection or reworking. PowerLight was to begin by evaluating variations in the coating mixture and coating edging methods and would also investigate other elements of the line that lead to product quality variability. Based on this evaluation, upgrades were to be made that would achieve a limit of 0.5% of parts to be rejected or which require rework.

PowerLight was to incorporate error-proofing into the manufacturing process either by mechanical or electronic means as required in each step. This would start with performing a Failure Modes and Effects Analysis (FMEA) to determine the consequences of possible failure at each step of the manufacturing process. PowerLight was also to look at product changes that could be done to error-proof the PowerGuard manufacturing process.

After performing the FMEA, PowerLight was to implement appropriate detection methods at each step of the process based on the severity and likelihood of failure at that step. After the error-proofing steps were implemented, PowerLight was to use statistical process control during manufacturing. Attribute data or variable data would be used to predict special cause variation within normal random variation. PowerLight was to measure key product characteristic (KPC) variables during manufacturing. KPC are defined as those characteristics that affect fit, form, or function related to product safety. The result of this task was to be achievement of a limit of 0.5% of manufactured parts that are rejected or require rework.

Results

Some new tools were created to error-proof various parts of the production process. Long term yield optimization efforts focused on the new PowerGuard design. The incorporation of error-proofing and statistical techniques resulted in an improvement in product quality. The original rejection rate of 1% or 10,000 parts rejected per million produced was improved to 0.6% or 6,000 parts rejected per million produced (PPM). The original target of 0.5% or 5,000 PPM was closed in to within 0.1% or 1,000 PPM. It is anticipated that we will achieve or exceed our goal after we fully implement the new quality system for PowerLight Corporation. The completion of the FMEA set the tone for developing an error-proofing system for spacer placement and photovoltaic testing which is still progressing. Error-proofing of the liquid mixing process has also reduced variability of the coating process. In addition PowerLight has identified Key Process Characteristics and is implementing protocols to control them and reduce variability.

Discussion

At the beginning of this contract, PowerLight was focusing yield improvement efforts on the existing PowerGuard design. In an effort to error-proof the process of trimming the coating edges of PowerGuard backerboards, PowerLight designed and tested a new lightweight tool. The tool was designed to accomplish the work of trimming each tile edge, but with only half the stroke of the existing tools. It was found, however, that while the edges were trimmed consistently with the new tools, the tongue profile usually got coating residue smeared unevenly along its length. When compared to the work done by a skillful worker with a hand trowel, the result was judged inadequate for production. As a result, the focus shifted to choosing workers with attention to detail to trim the coating edges.

PowerLight has implemented a new design for the spacer placement station on the coating line that error-proofs both the set-up and the placement of spacers on the coated backerboards. With the previous station, the set-up was time consuming and required adjusting the position of the placement guide each time the set-up was changed. With the new station, each PowerGuard tile has a guide that is mounted to a frame. The frame is positioned with dowel pins so that it is positioned consistently. Once the position is adjusted the first time it is used, it can then be taken off and re-installed without requiring further adjustment.

It was decided early in the design process that the only spacer which needs true error-proofing is the one that will be next to the junction box of the PV module. The new spacer placement station incorporates a bar that prevents that spacer from being placed too close to the edge of the tile. This prevents fit problems when the PV module is attached later. The new spacer placement station was installed near the end of 2002.

PowerLight designed and implemented a new fluid mixing system for the liquid ingredients of the coating as shown in Figure 5. The previous system had no capacity to detect errors in the fluid mixing process. Errors would only be detected if the operator of the coating hopper remembered to look at the fluid flow meters while the system was pumping fluid to the mixing barrel. The new system incorporated a programmable logic controller (PLC) and flow meters on all three fluid lines. The PLC monitors the flow of one line and then drives pumps on the other two lines at speeds that create the correct proportions in the mixture. The PLC monitors the flow rate on all three lines, and if it detects any flow outside of the acceptable tolerance range, it shuts down the system and activates an audible and visible alarm. The system also stores a variety of error codes to allow the operator to quickly determine the cause of the problem. The PLC stores historic flow data for a period of time so that it is possible to monitor the accuracy of the mixing system.



Figure 5: Error-proof Liquid Mixing System

A nonconformance reporting process has been developed to establish metrics on supplier, in-process, and field performance. This data is being compiled into a closed-loop corrective action system that will provide a basis for reducing process variability and rejections. This system is designed to document nonconformances and provide a closed-loop corrective/preventive action process to eliminate those nonconformances. The procedure requires that any employee of PowerLight has the authority to initiate a nonconformance report whenever product or processes are not to specified requirements. The quality function operates as a facilitator to obtain effective corrective action and to identify trends in the data for management review. All of these efforts are being loaded into cost of quality models that identify waste, loss, and other inefficiencies. The long-term goal is to achieve a six-sigma quality operation.

As part of the efforts in Task 3.2 to improve the product lead time, PowerLight started investigating a variety of product changes that would improve the manufacturability of PowerGuard. Efforts continued to improve the yield of the existing PowerGuard product, but the long-term focus shifted to the yield of the new PowerGuard design.

SPC has been applied to the new PowerGuard manufacturing process. PowerLight is measuring the capability of the process by using SPC on the critical design features. A process is considered capable when the variation in critical design features is below the required threshold. Once a process is shown to be capable, it will reliably produce parts within the required tolerance. The information is fed back into the manufacturing process to reduce variability and material rejections. The initial efforts were focused on spacer placement and photovoltaic electrical integrity. In addition, valuable process control and capability studies have been performed on all of the metal parts. This has resulted in adjustments to the process, specification, or design to improve yield. PowerLight will continue to develop this process to reduce variability.

2.4 Task 3.4: Plant Operations Improvements

Objectives

Under this task, PowerLight and its contractor were to minimize wasted labor and optimize the flow of materials through the factory. This would lead to a reduction in inventory levels by at least 30% and a reduction in required floor space by at least 25%.

PowerLight was to approach optimizing labor by incorporating ISO9000 policies and procedures to adapt efficient manufacturing techniques. This would entail applying industry quality standards to factory operating procedures to achieve generally accepted quality practices.

PowerLight was to begin the implementation of an MRP or Kanban system. The benefits of these systems include streamlining product flow, reducing excess inventory, minimizing required supervision, reducing required floor space, meeting tight customer deadlines, and dealing with product proliferation, all of which contribute to the reduction of the cost of PowerGuard manufacturing.

The expected result of this task was the implementation of an MRP or Kanban system and implementation of a QA/QC program resulting in the targeted improvements listed above.

Results

PowerLight achieved a 17% reduction in work-in-process inventory levels by moving toward a continuous flow system that reduced the batch sizes of material produced. This resulted in a 17% reduction in the floor space required and a 24% reduction in labor. The new production line for the new PowerGuard design has been installed, and this will reduce inventory of work-in-process by 94% and floor space required by approximately 74%.

A quality system was created using ISO standards. This has resulted in the creation of an ISO9001 series quality manual, quality procedures, quality instructions and forms to standardize the entire company's operations and reduce process variability.

Discussion

PowerLight worked to reduce the cost of factory operations in several different ways. A new quality assurance system was created. The production process was changed to become more of a pull system to minimize inventory levels. Changes were made to help with factory organization and cleanliness to minimize the amount of labor spent maintaining the factory workspace. Additionally, improvements were put in place to increase the safety of the workers.

During the first year of this contract, PowerLight has worked to change the factory operation from a series of batch operations to a continuous flow. The ultimate goal is to have a system where each operation has a staging position that is used to signal the process immediately upstream when a new part is needed for processing. This creates what is known as a pull system. Each station produces a new part only when the station immediately downstream needs one. With the production launch of the new PowerGuard design on the new assembly line, PowerGuard production became a true pull system. Meanwhile, steps have been made in that direction with the older PowerGuard production line. The amount of improvement that can be made with the

existing production line is limited, however, due to the amount of curing time required. Some batch processing is necessary.

By decreasing the batch size and running each part of the manufacturing process more frequently, PowerLight has been able to reduce work-in-process (WIP) inventory, labor required per unit produced, and floor space required. At the beginning of this contract, the existing operating mode was to produce a week's worth of material at the beginning operation and store it in preparation for the next step. This batch of material was then processed through the next operation and so on until the process was complete. Currently, the system builds a one-day supply of material that can be consumed by the subsequent process in equal time. This has led to a 17% reduction in inventory levels. Additionally, this reduced the amount of material that had to be physically moved and repositioned for storage, then to be moved again for further processing. This represents a 24% reduction in labor required per tile produced. The storage space needed for curing accounts for the majority of the space in the factory. By limiting the amount of curing product on a daily basis, rather than building large batch sizes a few times a week, the total amount of square footage required has been reduced by 17%.

With the production launch of the new PowerGuard sloped PV tiles, most of the WIP is eliminated in that process due to the drastic reduction in cure time. The level of WIP inventory is reduced by 94%. Similarly floor space required is reduced by approximately 78%. The older PowerGuard production line will continue to produce tiles for some time in parallel with the new one. During this time, there will still be a large amount of WIP in the factory from the old process. This WIP will be eliminated when production is transferred completely to the new production line.

As part of the effort to create a continuous flow for the current production line, a second router was added as discussed in Task 3.2, and both routers were positioned side by side so that the movement required to bring material to and from the routers would be minimized. After the new router was commissioned, the coating line was operated simultaneously with the routing operation, with backerboards coming off the routers and going directly into the coating process.

The layout of the PV attachment process was also changed to facilitate easy movement of materials and to minimize wasted motion on the part of the workers. This has allowed the PV attachment process to run simultaneously with the coating process. In November 2002, the processes of routing backerboards, coating backerboards, and adhering PV modules were all being done simultaneously. The ability to perform all these functions simultaneously aids in the efficient use of floor space. Additionally, this allows the factory to produce the same volume with two shifts per day rather than three, offering additional cost savings.

PowerLight installed a new dust collection system that will help to reduce cost. By more efficiently collecting XPS waste, the new system will minimize labor spent to clean up the equipment and the work area. Through better containment of the XPS dust, the maintenance requirements of the equipment will be reduced, and the equipment will be less prone to failure.

PowerLight commissioned an investigation into the noise and dust exposure of the factory workers. It was determined that particles of the size generated in the factory do not pose any health risks, though they can affect the comfort level of the workers. As a result, all workers who work in the vicinity of the XPS processing equipment were

provided with dust masks. It was also determined that the noise level due to the routers was too high for long-term exposure. The workers were provided with suitable hearing protection based on their proximity to the routers as a temporary measure. For a permanent solution, a noise attenuation enclosure was purchased and installed around the two routers. Once the enclosure was installed, the noise exposure was measured again. The noise exposure test showed that with the new enclosure, none of the workers in the factory need to wear hearing protection.

A new Quality Assurance program has been created to provide quality assurance in receiving, in-process and final inspection activities. The following ISO9001 elements have been detailed in quality procedures:

1. Management Responsibility
2. Quality System
3. Contract Review
4. Design Control
5. Document and Data Control
6. Purchasing
7. Control of Customer Supplied Product
8. Product Identification and Traceability
9. Process Control
10. Inspection and Testing
11. Control of Inspection, Measuring and Test Equipment
12. Inspection and Test Status
13. Control of Nonconforming Product
14. Corrective and Preventive Action
15. Handling, Storage, Packaging, Preservation and Delivery
16. Control of Quality Records
17. Internal Quality Audits
18. Training
19. Servicing
20. Statistical Techniques

The collection of quality data has begun as described in Task 3.3. A non-conformance procedure has been implemented to formalize the reporting and tracking of quality issues.

2.5 Task 3.8 Improved Manufacturing Capabilities for PowerGuard Generation II

Objectives

Under this task, PowerLight was to improve the tools and processes used for manufacturing the new PowerGuard design. As discussed above, PowerLight made modifications to the design of PowerGuard tiles in Task 3.2 of this contract in order to reduce the product lead time. Additionally, PowerLight began the implementation of a new production line in PowerLight's Berkeley, California facility. In order to increase the

production rate to ramp up capacity, it was necessary to improve the tools and methods used to manufacture the tiles.

The initial production setup was to be used for pilot production and the first full production run at a rate of two minutes per tile. Based on the experience gained in using this setup, PowerLight was to identify changes necessary to reduce labor, increase production rate, and reduce waste in the production process. Improved tooling would aid in accurate alignment of parts and in error-proofing the assembly process.

The result of this task was to be the design of improvements to the PowerGuard Generation II production line that reduce the labor requirement per tile by 10%.

Results

Production started in February 2003. During the first day of production, throughput was approximately 6 minutes per tile since the workers were unfamiliar with the new process. During the course of the next few days of production, the rate quickly went to 4 minutes per tile, then 3 minutes, and then to 2.3 minutes. By the third week of production, the workers were meeting their daily goal of 180 tiles.

The production line was initially designed for a two-minute throughput. There were eleven workers required for this rate. The stations for each worker are described below:

1. Router operation
2. Roll coater operation
3. Sheet metal handling
4. Sheet metal handling
5. Sealant application
6. Front spacer install
7. Deflector assembly
8. PV module test and prep
9. PV/deflector assembly
10. PV attach
11. Material handling

During the first production runs several improvements were implemented. The screwdrivers used to install the spacers were found to be inadequate, and several different versions were tried. Most of the production was done with pneumatic torque-limiting screwdrivers. An improved system has been specified and quoted, but has not yet been installed. The new system consists of a pneumatic, push-to-start, in-line screwdriver attached to a support mechanism that keeps the screwdriver aligned vertically and also absorbs the torque applied to the screw so that the worker does not get tired. Figure 6 shows an example of this type of support mechanism.



Figure 6: Proposed Pneumatic Screwdriver and Support

The attachment of the sheet metal cover is the trickiest part of the assembly process. With the current setup, two workers support the sheet metal. The roll coater operator positions the foam backerboard, and the sheet metal is then lowered into position. The alignment must be done precisely and quickly. To improve this station, an alignment fixture has been designed, and a support mechanism for the sheet metal covers has been specified. This will allow one worker to handle the sheet metal covers instead of two. Figure 7 shows the alignment fixture with a foam backerboard in position. Figure 8 shows the proposed support mechanism for the sheet metal.

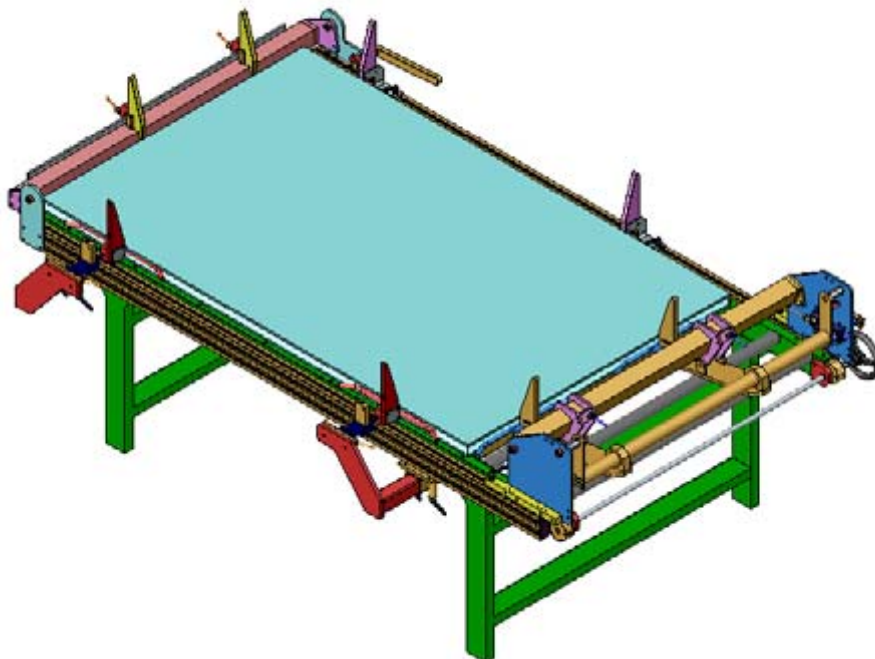

Figure 7: Sheet Metal Cover Alignment Fixture

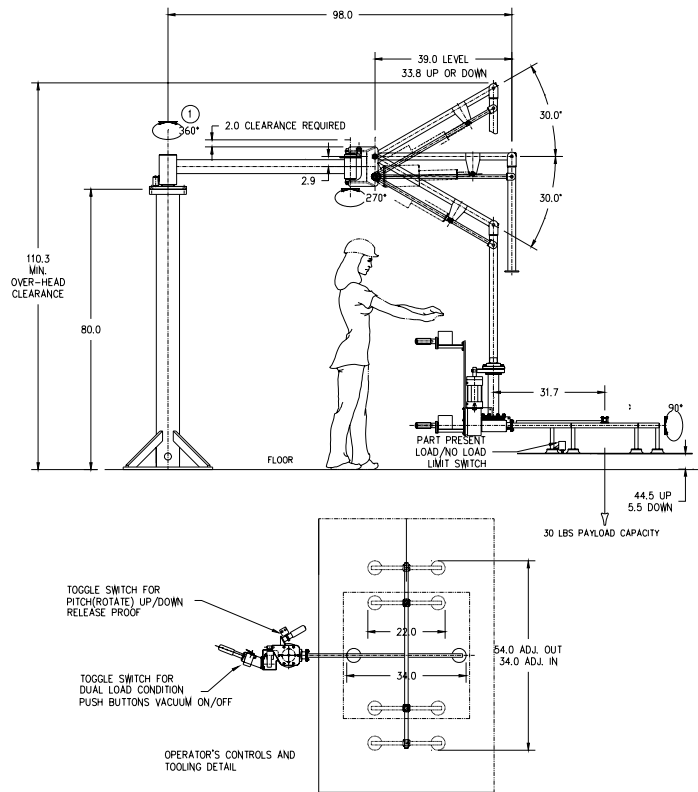

Figure 8: Proposed Sheet Metal Support Mechanism

Other improvements were made during the first production runs. An improved drill fixture was fabricated to catch the chips created when mounting holes are drilled in the frame of the PV module. An indicator light was added to the stacking fixture to signal the material handler that the pallet is full and must be replaced with an empty pallet.

Most of the improvements that have been made to date have been related to quality or ergonomics. The sheet metal alignment fixture and support will reduce the labor requirement by one person. This will yield a reduction of 9% instead of the expected 10%. As production continues during the second phase of this project, further improvements will be made to reduce the labor requirement per tile.

2.6 Task 3.9 Enhanced Design for Manufacturability

Objectives

Under this task, PowerLight was to expand upon the work started in Task 3.2. The focus was the continued improvement of PowerGuard design-for-manufacturability (DFM). These improvements were targeted toward reductions in cost, part count, and lead time. Design modifications were to be validated through testing.

Design improvements under this task were to incorporate new features in the advanced tile coating as well as an enhanced tile-to-tile connection in order to reduce manufacturing costs. Tile securement details were to be developed for high volume production in order to lower the overall cost of an installed system. An initial production design incorporating the replacement for the cementitious coating and enhanced tile-to-tile connection was to be developed and implemented on a production line as well as through shipping and installation on a roof.

Design modifications developed under this task were to be evaluated through testing and/or analysis. A preliminary evaluation of the long-term effects of moisture and freeze thaw cycling on the tile components was to be completed. In addition, the ability of the new design to adequately drain heavy rainfall was to be evaluated.

The result of this task was to be a completed production design of the PG tile that incorporates manufacturability improvements.

Results

Under this task, PowerLight has successfully created an improved PowerGuard tile product, Gen II, shown in Figure 9. Production of Gen II PowerGuard started in February 2003. The new Gen II product features sheet metal as an advanced tile coating that replaces the cementitious coating in the Gen I product. This design enhancement allows for significant improvements in the manufacturing of the PowerGuard tile.



Figure 9: Gen II Production Tile Design

As part of the development of the Gen II PowerGuard tile, all design changes were tested to ensure that the integrity of the PowerGuard design was not compromised. Moisture diffusion into the foam and freeze-thaw cycling endurance were tested with favorable results. Drainage testing was done at various simulated roof pitches. Wind tunnel testing was done with the new tile design. Results for these tests were favorable. Details are discussed below.

Discussion

Tile Design

By replacing the cementitious PowerGuard coating with sheet metal, the quality of the tiles is greatly improved due to the increase in product consistency, and the reduction of messy materials in the manufacturing process. Additionally, as discussed in section 2.2 above, the processing time for each board is greatly reduced from 3 days to cure the cement to 6 minutes to cure the adhesive on the board. Figure 10 and Figure 11 show Gen II PowerGuard tiles being assembled.

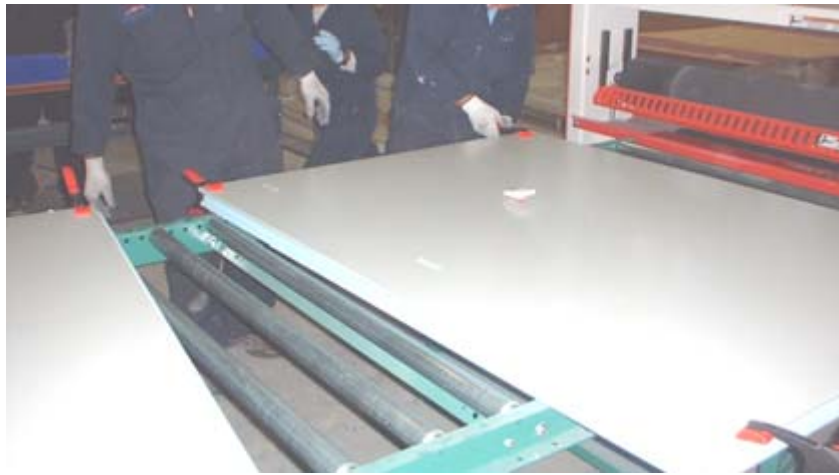

Figure 10: Continuous Backerboard Assembly Process

An additional design improvement, which has resulted in reduced lead time, involves using screws and other mechanical fastening hardware instead of an adhesive with a long cure time to attach the spacers to the PV and the backerboard.

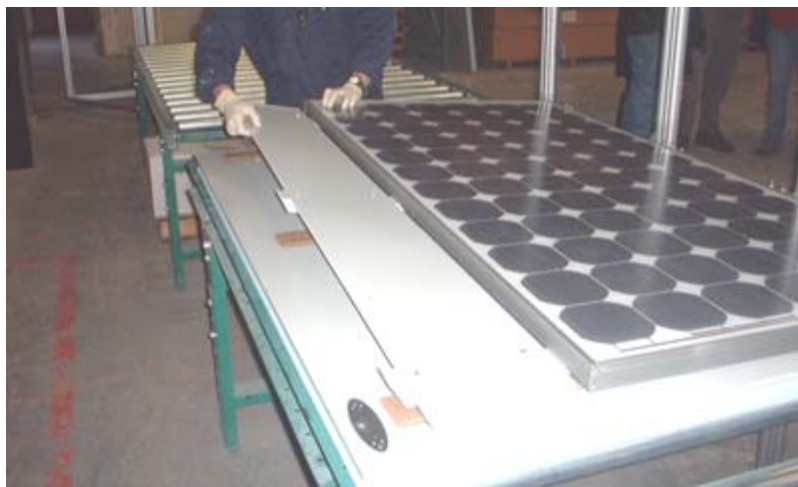

Figure 11: Completed Tile Assembly on the PL Factory Line

Other design improvements have increased the overall functionality of the PowerGuard product. A significant improvement in the design of the tile includes the use of sheet metal spacers to replace the polystyrene foam spacers. The use of sheet metal increases the overall structural integrity of the tile. Additionally the sheet metal allows for a greater flexibility in the design features that can be incorporated into the spacer. The first Gen II product is a sloped tile that ships flat and is tilted and secured in place during installation. This feature reduces the cost to ship the tile to the installation site. The sloped tile configuration increases the amount of energy generated annually by the PV module. Future work will involve the development of flat tile spacers that integrate with the backerboard sheet metal. Also, this spacer design, which includes the use of brackets and fastener hardware, allows for the easy maintenance and replacement of a PV installed in the array. This design feature will reduce service and maintenance costs of PowerLight photovoltaic systems.

Moving from a cementitious coating to a sheet metal coating has also facilitated the creation of a more full-featured tile-to-tile interconnector. Interconnection in the Gen I product relies on the tongue and groove profiles which are cut into the foam of the backerboard. In the Gen II product, an interconnector was designed which serves as a mechanical fastening and electrical grounding interconnection. The Gen II interconnector (Figure 12) creates a positive mechanical connection between the tiles, which resists lateral and uplift loads from wind, seismic, and gravity forces that could potentially distort an array and compromise the integrity of the system. Additionally, this interconnector is designed to serve as the grounding bond between the tiles to satisfy national electrical codes and safety practices. This design has been integrated with the backerboard sheet metal design to promote ease of manufacturing and ease of installation on the roof.



Figure 12: Tile Interconnect

In February 2003, over 1,100 Gen II tiles were fabricated at PowerLight's factory. By the beginning of April over 2,000 Gen II tiles had been produced.

In February and March, PowerLight installed over 1,100 Gen II tiles on the GSA Building in Downtown Los Angeles. This represented the first commercial installation of the new Gen II tile. Engineers were on hand to assist with the installation and gain valuable insight into design and manufacturing improvements that could both lower costs and increase installation ease. Figure 13 and Figure 14 show the Gen II PowerGuard tiles being installed.



Figure 13: First Commercial Gen II Tile Lift



Figure 14: First Gen II Commercial Installation, February 2003

By the end of April, PowerLight installed over 2,000 Gen II tiles on the GSA Building in Downtown Los Angeles.

PowerLight will continue to develop the Gen II tile design by building on the successes discussed above. Future Gen II tile improvements will continue to target reductions in cost, part count, and product lead time. Product redesign will focus on further cost improvements while reducing assembly operations. Additionally, PowerLight will continue to expand the family of new PowerGuard products as well as reduce overall cost sensitivity to component availability through continued development of our design for flexible manufacturing. A final production design incorporating lessons learned on initial production runs and initial installations will be developed and implemented on the factory production line.

Testing

Diffusion Testing

Although the foam used in PowerGuard is closed cell, and therefore does not absorb water, water can diffuse into the polymer. PowerLight wanted to ensure that subsequent freezing and thawing would not damage the foam's insulating properties, and possibly its structural properties as well. Diffusion and freeze-thaw testing is intended to simulate the weathering experienced by insulating panels which sit on a warm, moist roof membrane while being exposed to cold air and repeated freezing and thawing in diurnal cycles. This testing is accelerated by making the temperatures more extreme and the cycling more frequent than would be encountered in reality.

Samples are subjected to European Normative Standard (EN) 12088. This procedure first saturates the foam with water. Samples are then conditioned following EN 12091 for freeze-thaw. All samples are then tensile tested to failure to determine foam yield strength. Tensile test results are also compared to results from samples retrieved from the field.

Different types of foam and different tile constructions were tested. One type of foam that was tested clearly out-performed the other. All of the samples of the Gen II PowerGuard design passed the acceptance criteria. Further, several types of facings were tested as possible future designs. Of these, some performed better than others. The manner in which facings were attached to the foam was expected to have a significant impact on results, however in these standard tests, it did not. It is speculated that in "real-life" conditions, the attachment mechanism would play a larger role than in these standard tests.

All specimens, including those removed from the field, met the criteria of maintaining at least 20 psi tensile strength after the testing. The results of this test will be used by the PowerLight engineering group when considering future PowerGuard design changes.

Drainage Testing

Roofing systems are designed to drain rainfall from the roof as quickly as possible to avoid roof and/or structural damage. PowerGuard systems installed over an existing roof have been designed to allow rainfall to flow to roof drains. Testing has been done to ensure that the design changes that resulted in the Gen II PowerGuard tile will not impair the drainage of heavy rain.

Over an averaging period of one hour, the maximum rainfall ever recorded is on the order of 5"/hour. However, over a shorter averaging period such as 1-5 minutes, rainfall rates of 30"/hour can be expected. For this reason, PowerLight has opted to investigate drainage performance of roof-mounted products at a rainfall rate of 30"/hour.

A test set-up was constructed that simulates up to 30"/hour of rainfall over a 4' x 20' area. The test set up is shown in Figure 15 below. The reservoir on the left side of the photo stores water that is pumped through PVC piping to an area above the platform. The platform is used to model a roof, and can be sloped at any angle between 0° and 18°. Full-scale PowerGuard tiles can be installed on top of the platform to observe performance in heavy rain.



Figure 15: Drainage Test Setup

Several test iterations were conducted on PowerGuard tiles. Data collected included water flow rate into and out of the system, and water level measurements within the array. From these data, PowerLight determined the rate of drainage through the array at maximum rainfall conditions. Tests are continuing at other rainfall rates to completely characterize the system.

Tests were conducted with and without the perimeter curbing detail, and on slopes of 0:12 and 1:12 (0° and 5°). Test results indicated that simple modifications to the PowerGuard geometry might significantly improve drainage of the system. Fortunately, the design modifications are in-line with proposed modifications to improve manufacturability of the product.

Further testing is planned on several other design alternatives and various roof slopes.

2.7 Task 3.10 Advanced Quality System Implementation

Objectives

Under this task, PowerLight was to improve the quality system as first step towards ISO-9001 compliance. PowerLight was to define the corporate quality policy, vision, mission and core values and measure performance to those defined objectives. The quality management system was to be documented so that this performance could be measured. The implementation of a closed-loop corrective action program was to be implemented. This would include process measurements in manufacturing as well as from the field.

The result of this task was to be the complete documentation of the quality system. Performance indicators were to be established for the activities of design, manufacturing, installation and servicing. These enhancements in the quality management system would allow for performance metrics to be obtained and analyzed for positive corrective and preventive action. Once established, there would be specific performance indicators measured in the areas of scrap, rework, and first pass yield.

Results

PowerLight has developed a closed-loop corrective and preventive action system. An interdepartmental team developed a corporate policy for corrective and preventive action in January 2003, which became section 4.14 of the quality assurance manual. This policy established the requirement for the development of procedures and training in this critical area of quality assurance. PowerLight then developed document QP9190 Rev A, "Corrective and Preventive Action" as the quality procedure for conducting closed-loop corrective and preventive action. Two forms were developed to document internal and external corrective action responses to issues affecting the quality of our products and services. Currently PowerLight is automating this system by implementing a Quality Assurance Tracking System, which will allow us to accomplish performance metrics on those corrective and preventive action plans. Once fully implemented, we will have a fully optimized system for documenting, tracking and measuring the performance of corrective and preventive actions taken by Powerlight and its suppliers.

To improve the efficacy of incoming inspection, PowerLight designed a system to utilize Dark I-V testing of PV laminates. This testing measures PV parameters by forcing current (I) through the module in forward and reverse bias, and measures the voltage drop (V) created. The data are analyzed at 3 points, giving an estimate of open circuit voltage, series resistance, and the status of the bypass diodes. Test results are logged with the module serial number for quality tracking.

This system improves on the previous test setup because it is more accurate and precise, uses less energy, and reduces transcription errors in the quality tracking process by employing a bar code scanner. In addition, the new tester is able to diagnose missing bypass diodes, whereas the old system could only diagnose a shorted diode. The new test station is shown in Figure 16.



Figure 16: Dark I-V Module Test Station

2.8 Summary of Accomplishments

Over the course of this phase of the contract, many improvements have been made in the production of PowerGuard tiles. Most significantly, the development of a new design of PowerGuard tiles has greatly improved the manufacturability of PowerGuard creating the potential for drastic reductions in cost. The significant improvements made possible through this PV Manufacturing R&D contract are as follows:

- The creation of an analytical model of the PowerGuard production process
- Reduction of product lead time of over 90% for the sloped PV PowerGuard tiles and 75% for flat PV PowerGuard tiles
- Error-proofing of various parts of the PowerGuard production process
- Reduction of reject rate for current PowerGuard production to 0.6%
- Implementation of a Quality Assurance/Quality Control program
- Implementation of a non-conformance and corrective action program
- Implementation of a new production line for the manufacture of the new PowerGuard tile design
- 17% reduction of WIP inventory
- 17% reduction of floor space required per unit produced
- Improvements to the design of PowerGuard tiles to improve manufacturability
- Testing of design changes to ensure that the improvements to manufacturability did not compromise performance or endurance of the product
- Improvements to the working conditions in the factory through reduced noise level and improved dust collection
- Implementation of a new Dark I-V test station for PV modules.

PowerLight is committed to continuous improvement in manufacturing. We are proud of the progress we have been able to make due to the funding from the PV Manufacturing R&D program. With the help of this program we are making significant progress in reducing the cost of photovoltaic systems.

REPORT DOCUMENTATION PAGE

Form Approved
OMB No. 0704-0188

The public reporting burden for this collection of information is estimated to average 1 hour per response, including the time for reviewing instructions, searching existing data sources, gathering and maintaining the data needed, and completing and reviewing the collection of information. Send comments regarding this burden estimate or any other aspect of this collection of information, including suggestions for reducing the burden, to Department of Defense, Executive Services and Communications Directorate (0704-0188). Respondents should be aware that notwithstanding any other provision of law, no person shall be subject to any penalty for failing to comply with a collection of information if it does not display a currently valid OMB control number.

PLEASE DO NOT RETURN YOUR FORM TO THE ABOVE ORGANIZATION.

1. REPORT DATE (DD-MM-YYYY) June 2005		2. REPORT TYPE Subcontract Report		3. DATES COVERED (From - To) 6 December 2001–31 March 2003		
4. TITLE AND SUBTITLE\ PowerLight Corporation Lean Manufacturing, PV Manufacturing R&D Phase I Report: 6 December 2001–31 March 2003			5a. CONTRACT NUMBER DE-AC36-99-GO10337			
			5b. GRANT NUMBER			
			5c. PROGRAM ELEMENT NUMBER			
6. AUTHOR(S) L. Hargis and J. Botkin			5d. PROJECT NUMBER NREL/SR-520-35881			
			5e. TASK NUMBER PVB56101			
			5f. WORK UNIT NUMBER			
7. PERFORMING ORGANIZATION NAME(S) AND ADDRESS(ES) PowerLight Corporation 2954 San Pablo Avenue Berkeley, California 94702				8. PERFORMING ORGANIZATION REPORT NUMBER NDO-1-30628-04		
9. SPONSORING/MONITORING AGENCY NAME(S) AND ADDRESS(ES) National Renewable Energy Laboratory 1617 Cole Blvd. Golden, CO 80401-3393				10. SPONSOR/MONITOR'S ACRONYM(S) NREL		
				11. SPONSORING/MONITORING AGENCY REPORT NUMBER NREL/SR-520-35881		
12. DISTRIBUTION AVAILABILITY STATEMENT National Technical Information Service U.S. Department of Commerce 5285 Port Royal Road Springfield, VA 22161						
13. SUPPLEMENTARY NOTES NREL Technical Monitor: D. Mooney						
14. ABSTRACT (Maximum 200 Words) PowerLight Corporation (PowerLight) has completed Phase I of its PV Manufacturing R&D subcontract, "PowerGuard Lean Manufacturing," Subcontract No. NDO-1-30628-04. The overall technical goal of this project was to reduce the cost of PowerGuard manufacturing while simultaneously improving product quality. This will enable PowerLight to scale up production capacity as the market for PowerGuard continues to grow. Through the introduction of world-class lean manufacturing techniques, PowerLight was to cut out waste in the manufacturing process of PowerGuard. The manufacturing process was to be overhauled with an objective of removing as much as possible those steps that do not add value to the product. Quality of finished goods was also to be improved through the use of statistical process control and error-proofing in the manufacturing process. Factory operations were also to be addressed to streamline those factory activities that support the manufacturing process. This report details the progress made toward the above listed goals during the first phase of this subcontract.						
15. SUBJECT TERMS PV; manufacturer; coating process; module; extruded polystyrene (XPS); lean manufacturing; cost; quality; statistical process control;						
16. SECURITY CLASSIFICATION OF:			17. LIMITATION OF ABSTRACT UL	18. NUMBER OF PAGES	19a. NAME OF RESPONSIBLE PERSON	
a. REPORT Unclassified	b. ABSTRACT Unclassified	c. THIS PAGE Unclassified			19b. TELEPHONE NUMBER (Include area code)	

Standard Form 298 (Rev. 8/98)
Prescribed by ANSI Std. Z39.18