



U.S. General Services Administration

Federal Acquisition Service GSA Networx Program Update

Lieutenant General Charles E. Croom
Director
Defense Information Systems Agency

Fred Schobert
Networx Program Manager
FAS Integrated Technology Services

January 3, 2007



Federal Acquisition Service

Agenda

- Program History/Program Schedule
- Developing the Network Program Architecture
- Network Universal and Enterprise
- Network SLAs and Critical Levels of Service
- Network Services
- Network Pricing Structure
- Summary



Networx – Program History

- Networx is the third in a series of major competitive telecommunications programs
- FTS 2001 provides eight-year pricing that has saved over \$3 billion to date
- Networx projected revenue - \$20 billion over 10 years

Federal Acquisition Service

Networx – The Acquisition Cycle

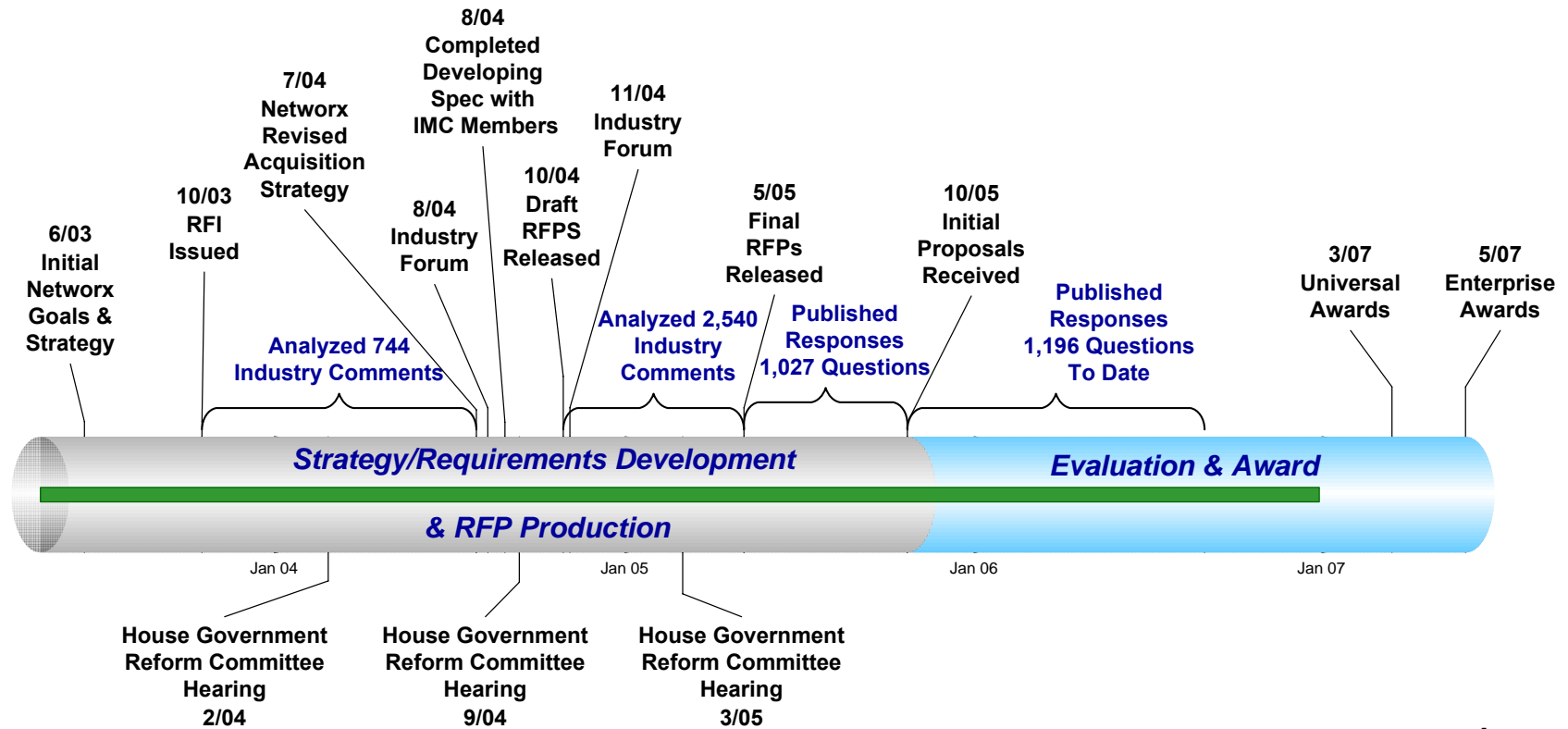

Federal Acquisition Service

Networx – The Program Plan After Award

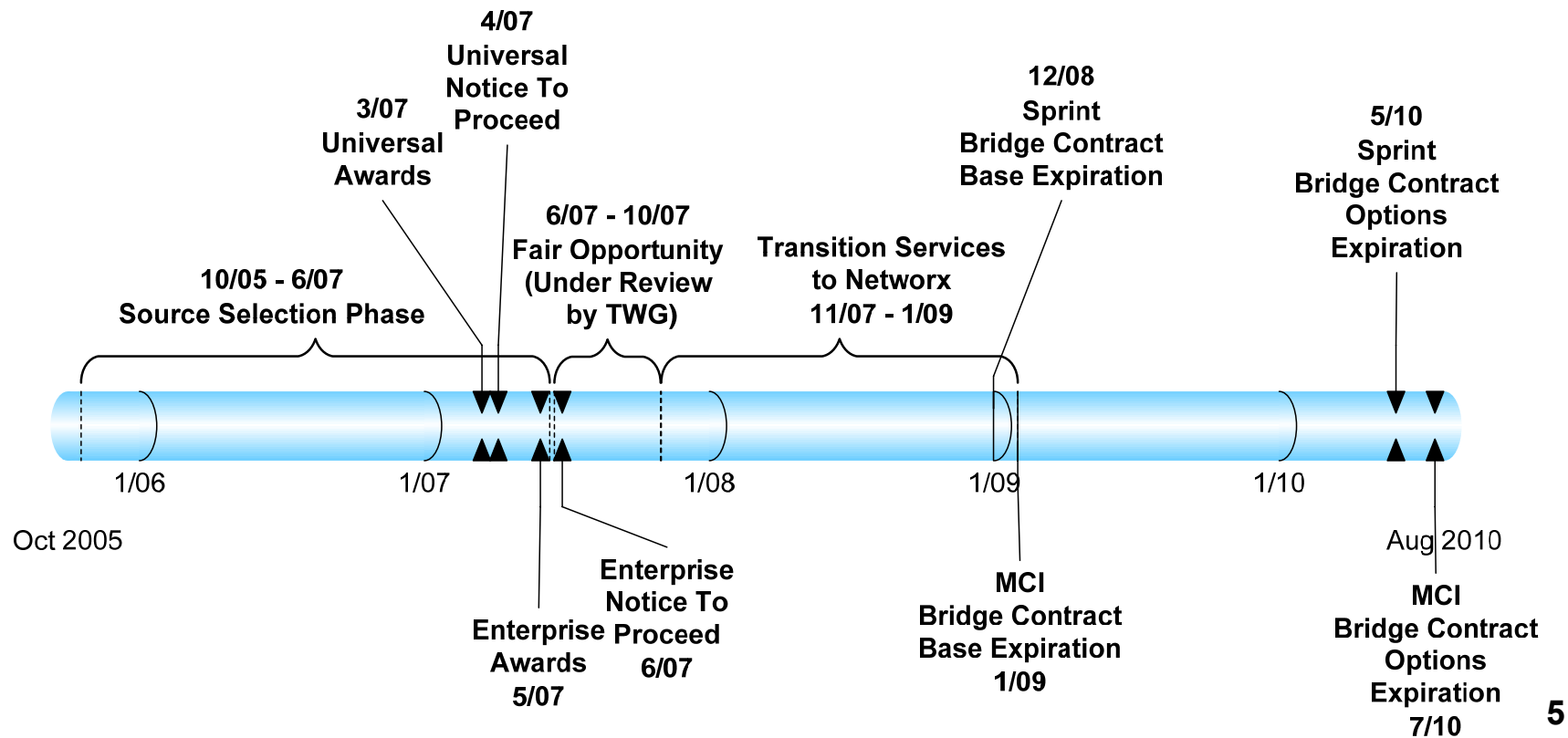



Federal Acquisition Service

Networx – Supporting the Transformation of Government

- Voice, IP, wireless, satellite, optical connectivity services
- IP-centric application services (hosting, content management, teleworking, etc.)
- Embedded security with flexibility to meet range of needs
- Built-in compliance with policy mandates
- Performance-based services and operations
- Built in technology refreshment

Seamless, Secure, Interoperable

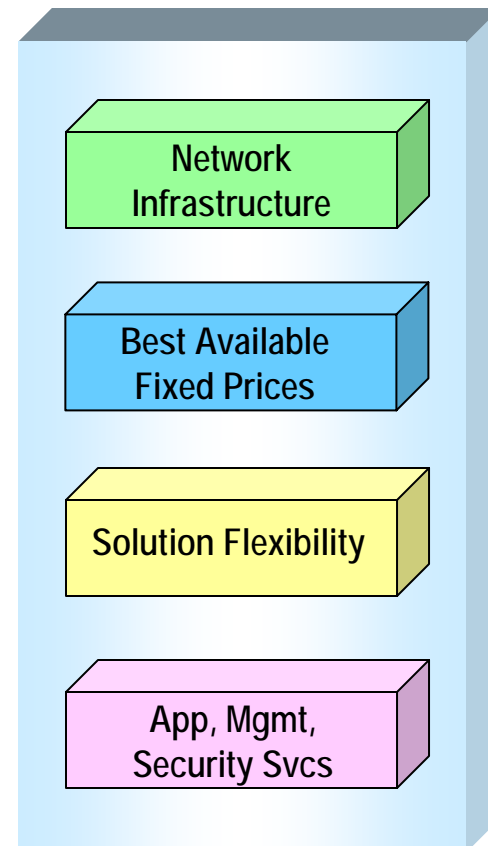



Federal Acquisition Service

Network – Program Architecture

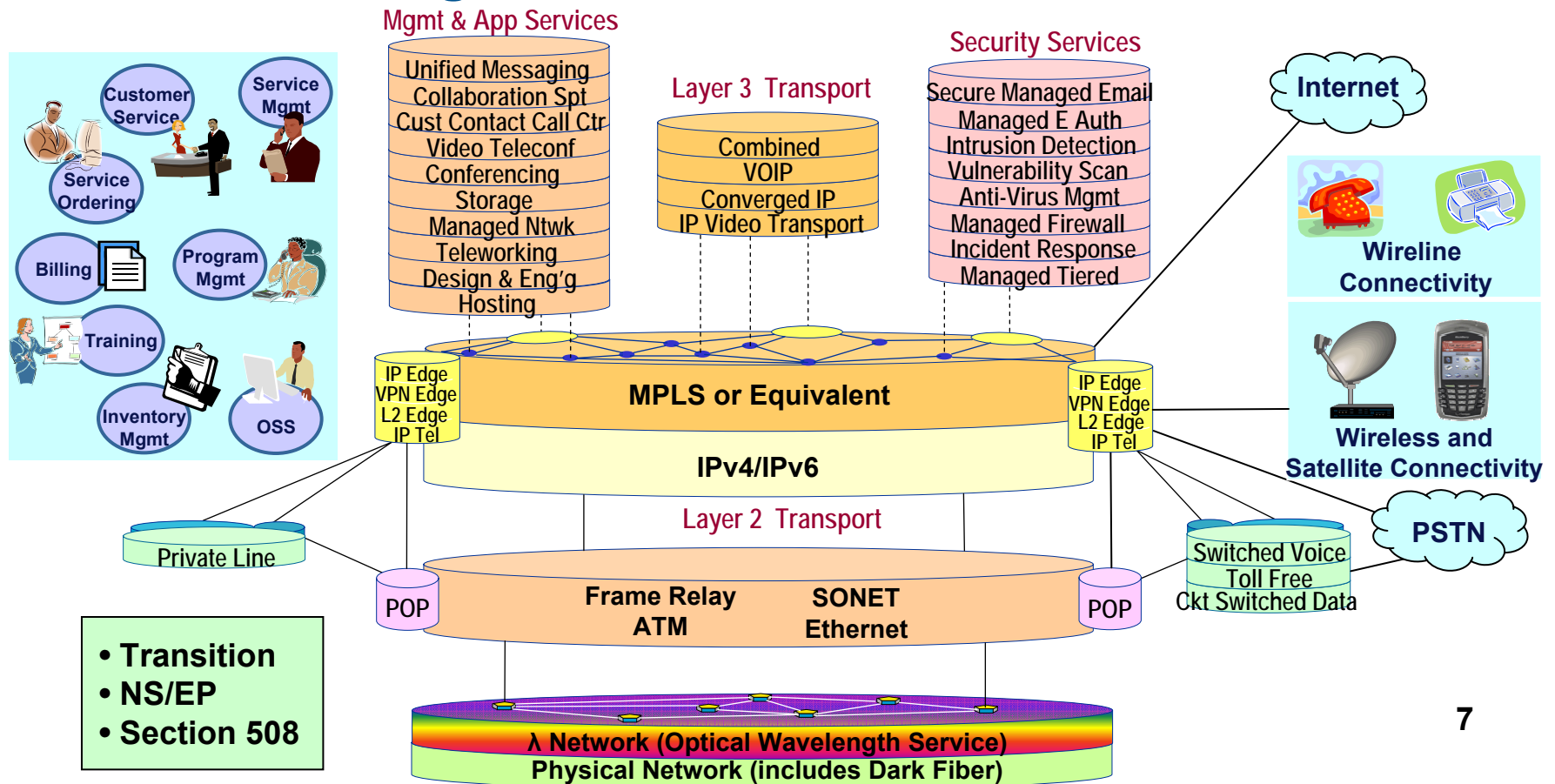



Federal Acquisition Service

Networx – Universal

Telecommunications Services

Communications Transport

- Voice
- Circuit Switched Data
- Toll-Free
- Combined
- Private Line
- Frame Relay
- Asynchronous Transfer Mode

- Ethernet

IP-Based

- Premises-Based IP VPN
- Network-Based IP VPN
- Voice over IP Transport
- Content Delivery Network
- Converged IP
- IP Telephony
- Internet Protocol

- Layer 2 VPN

- IP Video Transport

Optical

- Synchronous Optical Network
- Optical Wavelength
- Dark Fiber

Management & Application Services

- Video Teleconferencing
- Managed Network
- Audio Conferencing
- Teleworking Solutions
- Call Center/Customer Contact Center
- Web Conferencing
- Dedicated Hosting
- Collocated Hosting
- Storage
- Customer Specific Design and Engineering
- Unified Messaging
- Collaboration Support
- Internet Facsimile

Access Services

- None

Security Services

- Managed Firewall
- Intrusion Detection and Prevention
- Managed E-Authentication
- Vulnerability Scanning
- Anti-Virus Management
- Incident Response
- Secure Managed Email
- Managed Tiered Security

Special Services

- Land Mobile Radio
- Mobile Satellite
- Fixed Satellite

Wireless Services

- Cellular/PCS
- Multimode Wireless
- Cellular Digital Packet Data
- Paging

Note: Services in green are optional.

- Full range of services
- National and international coverage
- Strong competition for best prices
- Ensures continuity of current service
- Length: 4-year base with 3ea 2-year options
- Multiple awards
- MRG - \$525M



Federal Acquisition Service

Networx – Enterprise (IP-Based)

<p><u>Telecommunications Services</u></p> <p>Communications Transport</p> <ul style="list-style-type: none">- Voice- Circuit Switched Data- Toll-Free- Combined- Private Line- Frame Relay- Asynchronous Transfer Mode- Ethernet <p>IP-Based</p> <ul style="list-style-type: none">- Network-Based IP VPN- Voice over IP Transport- Internet Protocol- Premises-Based IP VPN- Content Delivery Network- Converged IP- IP Telephony- IP Video Transport- Layer 2 VPN <p>Optical</p> <ul style="list-style-type: none">- Synchronous Optical Network- Optical Wavelength- Dark Fiber	<p><u>Management & Application Services</u></p> <ul style="list-style-type: none">- Customer Specific Design and Engineering- Managed Network- Audio Conferencing- Teleworking Solutions- Call Center/Customer Contact Center- Web Conferencing- Dedicated Hosting- Collocated Hosting- Storage- Video Teleconferencing- Unified Messaging- Collaboration Support- Internet Facsimile <p><u>Access Services</u></p> <ul style="list-style-type: none">- Wireline Access- Broadband Access- Wireless Access- Satellite Access	<p><u>Security Services</u></p> <ul style="list-style-type: none">- Managed Firewall- Intrusion Detection and Prevention- Managed Tiered Security- Anti-Virus Management- Managed E-Authentication- Vulnerability Scanning- Incident Response- Secure Managed Email <p><u>Special Services</u></p> <ul style="list-style-type: none">- Land Mobile Radio <p><u>Wireless Services</u></p> <ul style="list-style-type: none">- Cellular/PCS- Multimode Wireless- Cellular Digital Packet Data- Paging
---	---	---

Note: Services in green are optional.

- **Minimum requirement: must offer either 9 mandatory services for secure, IP, and managed network solutions**
- **May offer wide range of optional services**
- **National coverage required; international coverage optional**
- **Length: 4-year base with 3ea 2-year options**
- **Multiple awards**
- **MRG - \$50M**



Federal Acquisition Service

Networkx – Universal and Enterprise SLAs

Telecommunications Services

Communications Transport

- Voice
- Circuit Switched Data
- Toll-Free
- Combined
- Private Line
- Frame Relay
- Asynchronous Transfer Mode
- Ethernet

IP-Based

- Premises-Based IP VPN
- Network-Based IP VPN
- Voice over IP Transport
- IP Telephony
- Internet Protocol

Optical

- Synchronous Optical Network
- Optical Wavelength

KPIs
Av (SDP-to-SDP)
Av (POP-to-POP)
TTR

KPIs
Av (VPN)
Latency (CONUS)
Latency (OCONUS)
TTR

Credits
Av (SDP-to-SDP)
TTR
Service Outage
On-Time Provisioning
Billing Accuracy

Credits
Av (VPN)
Latency (CONUS)
TTR
Service Outage
On-Time Provisioning
Billing Accuracy

Management & Applications Services – Dedicated Hosting

Access Services – Wireline Access (Enterprise Only)

Federal Acquisition Service

Network – Critical Service Levels

Telecommunications Services

Communications Transport

- Voice
- Circuit Switched Data
- Toll-Free
- Combined
- Private Line
- Frame Relay
- Asynchronous Transfer Mode
- Ethernet

KPIs
Av (SDP-to-SDP)
Acceptable Quality Level
 Routine: >99.5%

IP-Based

- Premises-Based IP VPN
- Network-Based IP VPN
- Voice over IP Transport
- IP Telephony
- Internet Protocol

KPIs
Av (SDP-to-SDP)
Acceptable Quality Level
 Critical: >99.95%

Optical

- Synchronous Optical Network
- Optical Wavelength

Management & Applications Services

- Call Center
- Storage Services

Configuration to Support Critical Availability

- Primary working waves will supply routine availability (99.5%).
- Redundant waves SDP-to-SDP provide Agency with critical availability (99.95%).

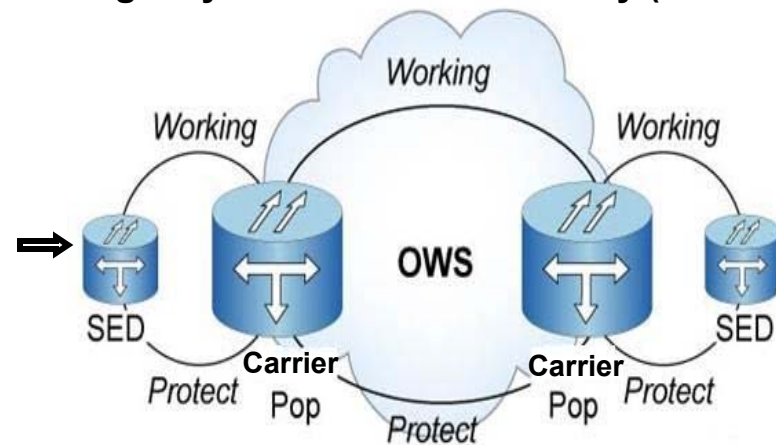

Federal Acquisition Service

Network – Managed Network Services**➤ Comprehensive network management solutions****• Design and Engineering Services**

- Network architecture design
- Network design validation
- Simulation and testing
- Engineering Support
- Evaluation of network technology alternative

• Implementation, Management and Maintenance

- Real-time proactive network monitoring
- Troubleshooting and Service Restoration
- Configuration changes and Backups

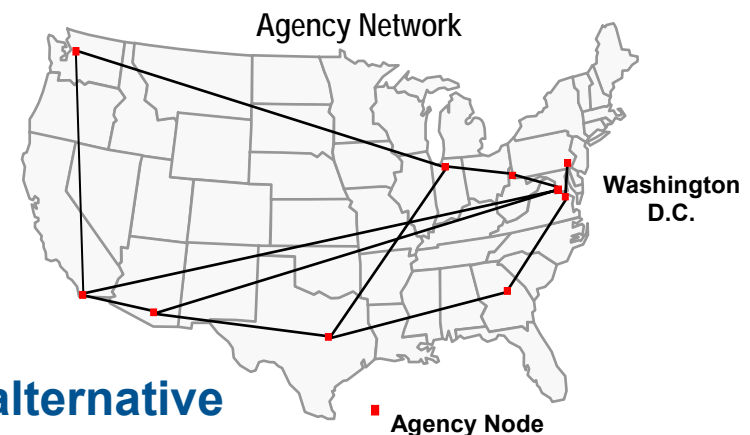



Federal Acquisition Service

Networkx – Security: Services for Defense in Depth

Network Protection Requirements

- Boundary Protection
- Authentication
- Authorization
- Confidentiality/Encryption
- Message Integrity
- Access Control
- Availability
- Nonrepudiation
- Malicious Code Filtering
- Audit & Monitoring
- Config Mgmt & Assurance
- Access diversity

Requirements

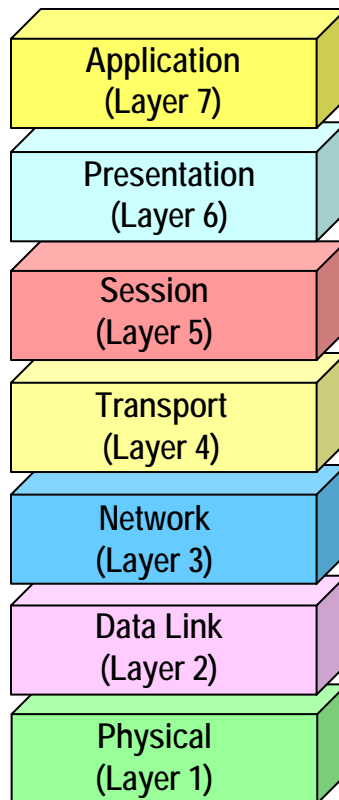

ISO/IEC 7498

Solutions

Networkx Services

- Managed Tiered Security Service
- Managed E-Authentication
- Vulnerability Scanning
- Incident Response
- Secure Managed Email
- Intrusion Detection and Prevention
- Managed Firewall
- Anti-Virus Management
- Network-Based IP VPN
- Premises-Based IP VPN
- Layer 2 VPN

VPN Cluster



Federal Acquisition Service

Networx – Security Services Meet ISO/DoD Guidelines

← *Spanning ISO Security Dimensions* →

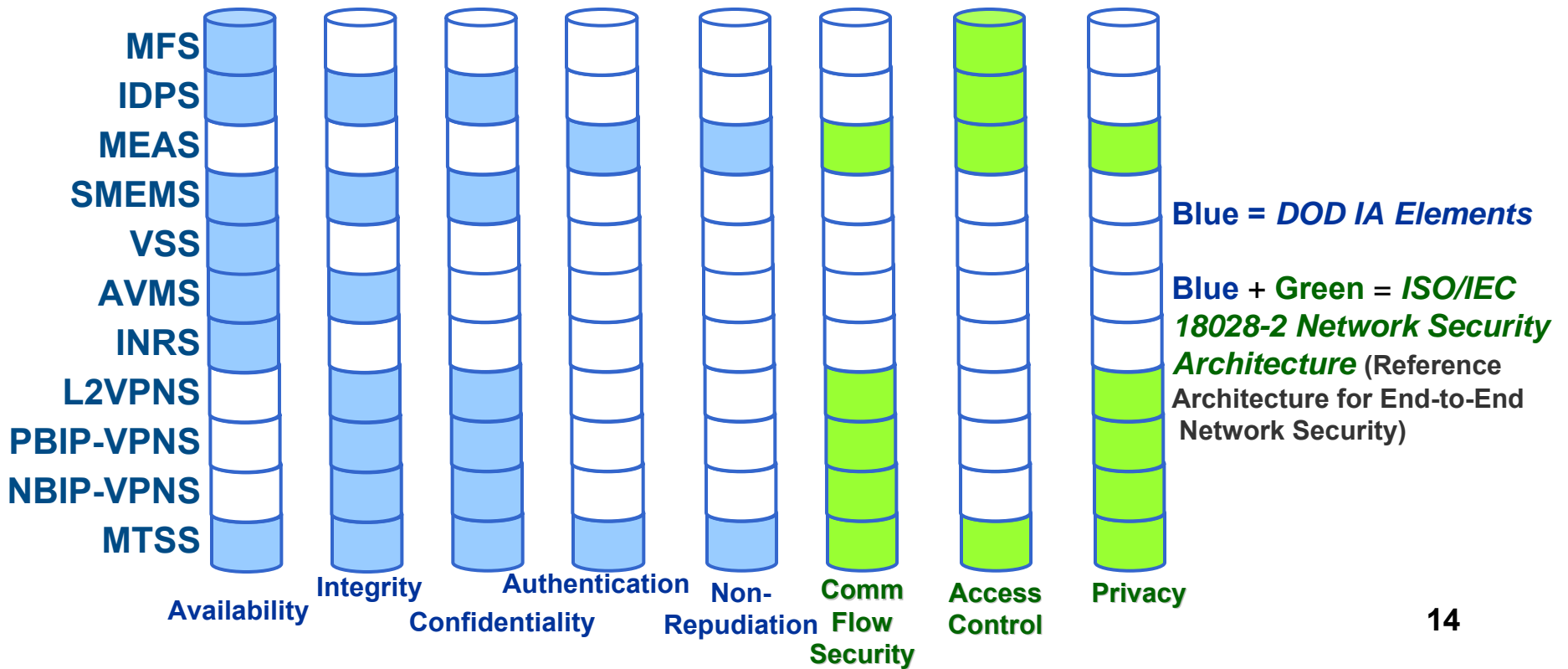



Federal Acquisition Service

Networx – A Toolbox for Agency Network Security that complies with FISMA

Networx Security:

13 Required Steps for Each Offeror (RFP Section C.3.3.2)

- Security Plan
- Risk Analysis
- Risk Mitigation
- Information Security
- Information Assurance
- Security Breach Notification
- Alarms and Audit Trails
- Personnel Security
- Physical Security
- Procedural Security
- Ongoing Security Refreshment
- Non Domestic Services
- Fraud Prevention Management



Federal Acquisition Service

Networx – Managed Tiered Security Service

<i>Security Enhancement Services</i>	<i>MTSP Service Tiers</i>			
	Standard	Protected	High Assurance	Network High
Agency Dedicated Help Desk	✓	✓	✓	✓
Anti-virus		✓	✓	✓
Firewall		✓	✓	✓
Intrusion Detection/Prevention		✓	✓	✓
Incident Response		✓	✓	✓
Packet Filtering		✓	✓	✓
Premises-based VPN		✓	✓	✓
Secure Managed Email		✓	✓	✓
Security Certification Support		✓	✓	✓
Security Maintenance		✓	✓	✓
Vulnerability Scanning		✓	✓	✓
Proxy Server		✓	✓	
Agency Sponsored Type 1 Encryption			✓	✓
NSA Approved Multilevel Security Solution			✓	✓
Network Isolation (Air Gap)				✓



Networx – Network Service Monitoring and Management

- NMM provides real-time performance information related to the health of Agency services.
- NMM includes real-time updates on the status of Trouble Resolution efforts.
- Contractor can provide KPI information for Agency services or provide Agencies with the capability to conduct own KPI measurements.
- Contractor shall provide additional hardware/software or other means of access to provide this capability.

Federal Acquisition Service

Networkx – SEDs Enable Optimum Service Delivery

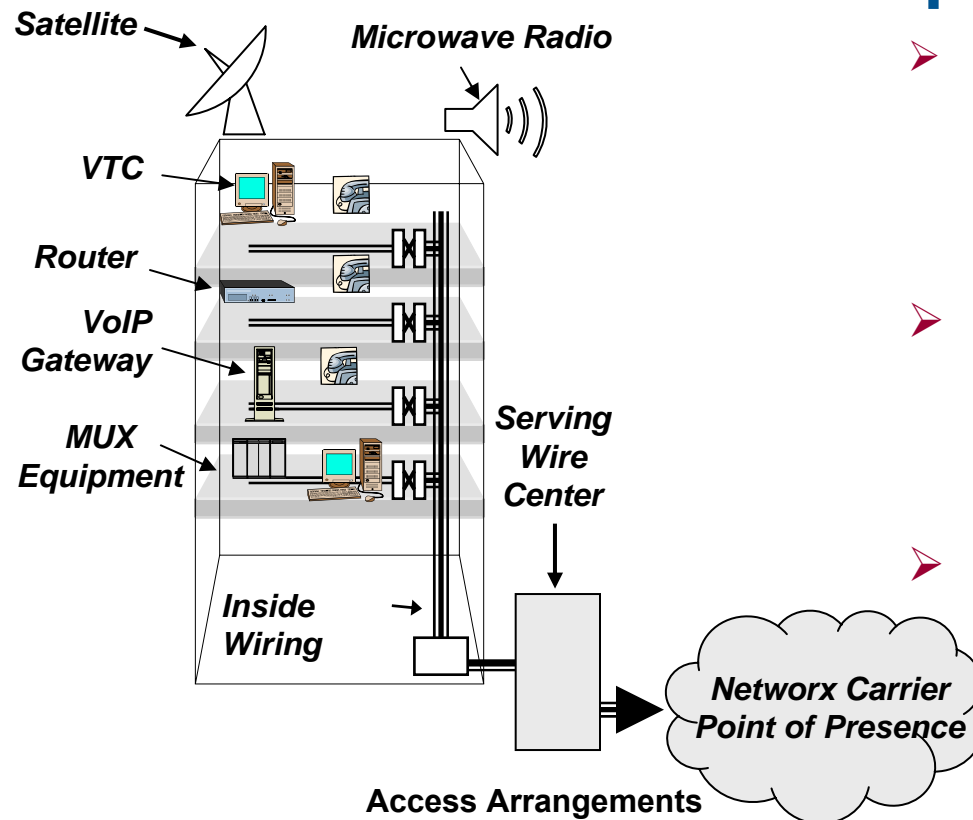

- **Clear visibility into prices and costs**
 - Separate device, installation, and maintenance prices
 - Device prices are fixed, based on discounts from MSRP
- **Broad and flexible scope**
 - Includes routers, mux, cellphones, IP phones, security devices, applications, i.e., devices needed for service delivery (hardware & software)
- **Flexible options for agency customers**
 - One-time rental charge or fixed term monthly payments
 - Mechanism for users to assume ownership and continue contract maintenance

Federal Acquisition Service

Network – General RFP Structure for Price

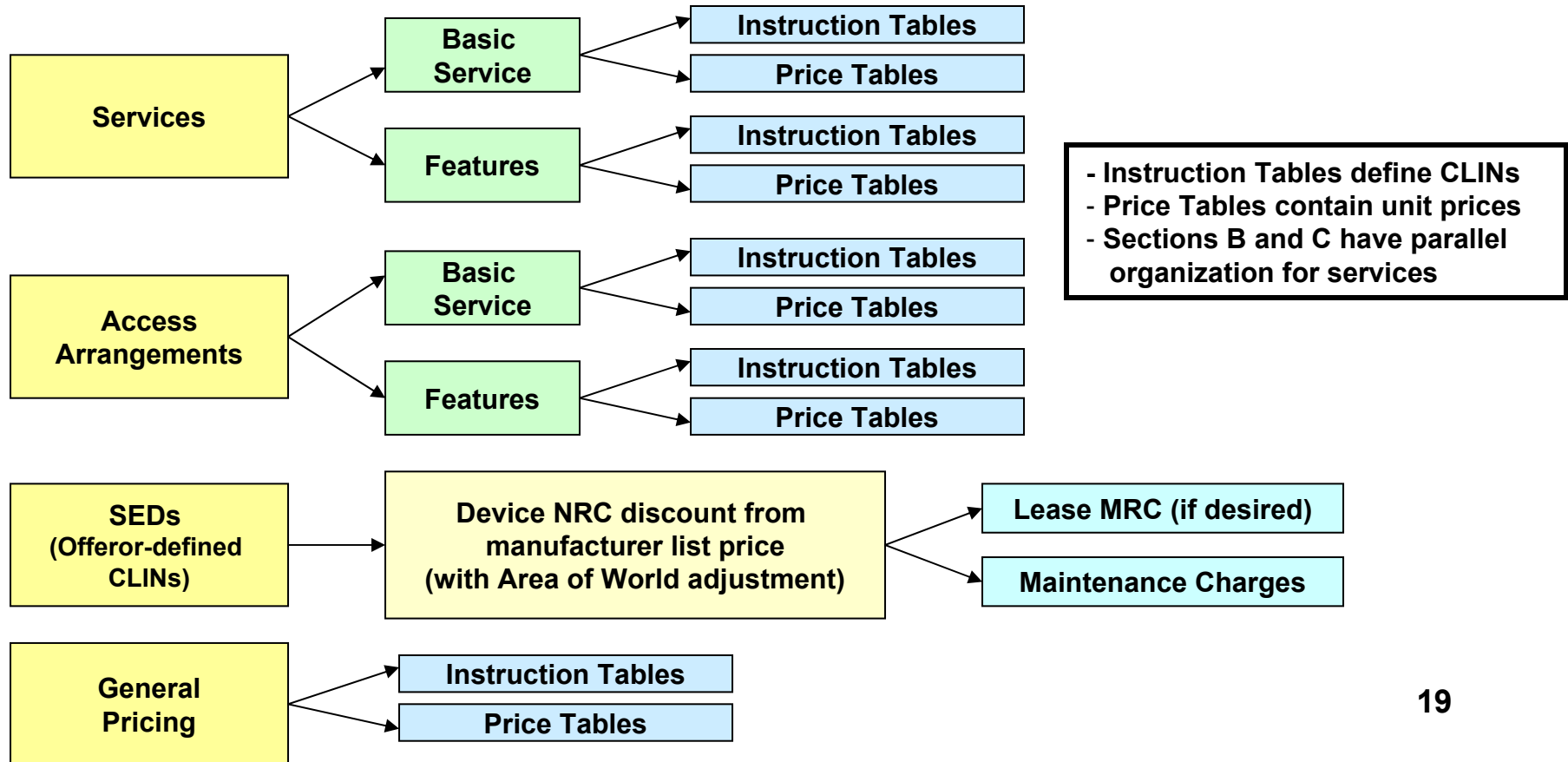

Federal Acquisition Service

Networx – Web Based

➤ State of practice web based, fixed price evaluation

- Evaluate over 1.3 million price records worldwide using projected agency traffic
- Documented requirements compliance
- Database foundation for post award support

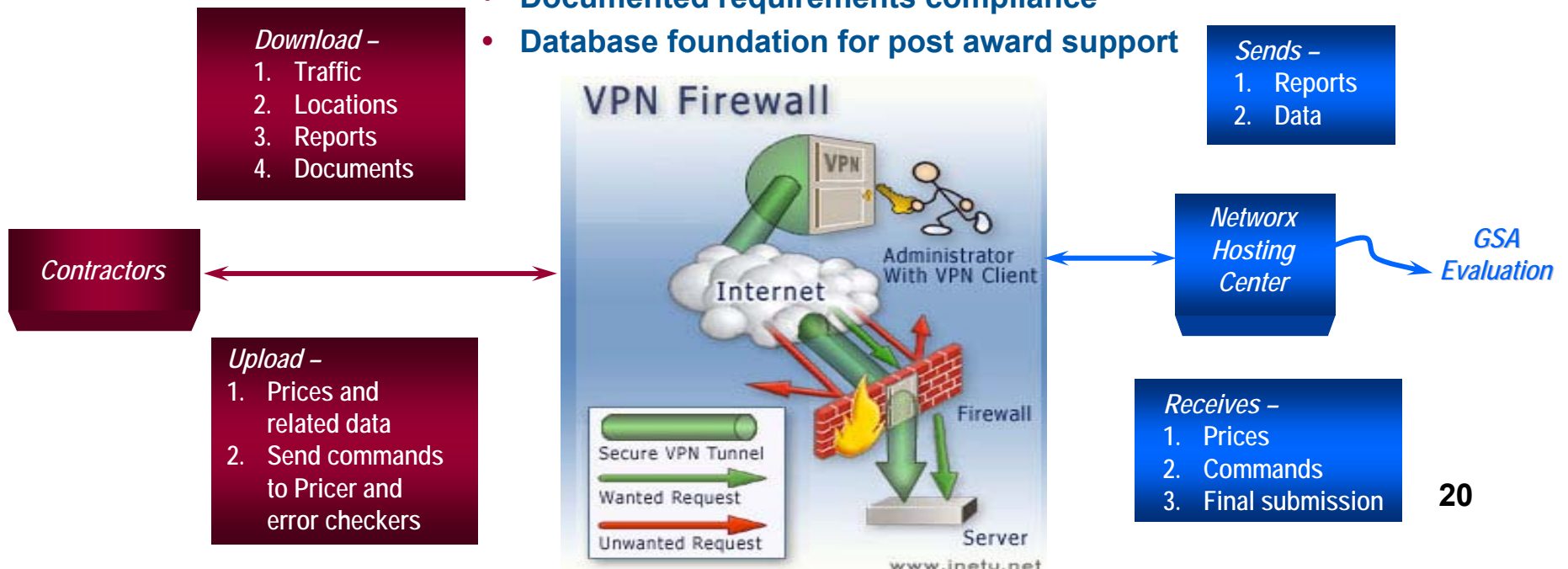

Federal Acquisition Service

Networkx – RFP Online Availability

- The Networkx RFPs as amended are accessible online at: www.gsa.gov/networkx
- Additional data may be obtained, to include:
 - Networkx FAQ
 - Amendments
 - Networkx Hosting Center
 - RFP Question and Answers
 - Networkx Document Library

Access GSA Networkx website: www.gsa.gov/networkx ①

Select Networkx RFPs & Amendments ②

Doc ID	Name	Format	Size	Publish Date
FTS	Networkx Universal RFP	Other	985K	
FTS	Networkx Universal RFP Amendment 0011	PDF	219K	6/22/2005
FTS	Networkx Universal RFP Amendment 0012	Other	817K	
FTS	Networkx Enterprise RFP	Other		
FTS	Networkx Enterprise RFP Amendment 0011	Other		
FTS	Networkx Enterprise RFP Amendment 0012	Other		
FTS	Networkx Enterprise RFP Amendment 0013	Other		
FTS	Networkx Enterprise RFP Amendment 0014	Other		
FTS	Networkx Enterprise RFP Amendment 0015	Other		
FTS	Networkx Enterprise RFP Amendment 0016	Other		
FTS	Networkx Enterprise RFP Amendment 0017	Other		
FTS	Networkx Enterprise RFP Amendment 0018	Other		
FTS	Networkx Enterprise RFP Amendment 0019	Other		
FTS	Networkx Enterprise RFP Amendment 0020	Other		
FTS	Networkx Enterprise RFP Amendment 0021	Other		
FTS	Networkx Enterprise RFP Amendment 0022	Other		
FTS	Networkx Enterprise RFP Amendment 0023	Other		
FTS	Networkx Enterprise RFP Amendment 0024	Other		
FTS	Networkx Enterprise RFP Amendment 0025	Other		
FTS	Networkx Enterprise RFP Amendment 0026	Other		
FTS	Networkx Enterprise RFP Amendment 0027	Other		
FTS	Networkx Enterprise RFP Amendment 0028	Other		
FTS	Networkx Enterprise RFP Amendment 0029	Other		
FTS	Networkx Enterprise RFP Amendment 0030	Other		

Select appropriate document ③ (i.e., RFP, section, amendment, etc.)

Federal Acquisition Service

Networkx – Summary

