

# Wetland Trail Design and Construction

2007 EDITION

**Robert T. Steinholtz**  
*Bristlecone Trails, Lakewood, CO*

**Brian Vachowski**  
*Project Leader*

**USDA Forest Service**  
**Technology and Development Program**  
**Missoula, MT**

**8E82A3—Trail Treatment for Wet Areas**

**January 2007**

The Forest Service, United States Department of Agriculture (USDA), has developed this information for the guidance of its employees, its contractors, and its cooperating Federal and State agencies, and is not responsible for the interpretation or use of this information by anyone except its own employees. The use of trade, firm, or corporation names in this document is for the information and convenience of the reader, and does not constitute an endorsement by the Department of any product or service to the exclusion of others that may be suitable.

The U.S. Department of Agriculture (USDA) prohibits discrimination in all its programs and activities on the basis of race, color, national origin, age, disability, and where applicable, sex, marital status, familial status, parental status, religion, sexual orientation, genetic information, political beliefs, reprisal, or because all or part of an individual's income is derived from any public assistance program. (Not all prohibited bases apply to all programs.) Persons with disabilities who require alternative means for communication of program information (Braille, large print, audiotape, etc.) should contact USDA's TARGET Center at (202) 720-2600 (voice and TDD). To file a complaint of discrimination, write to USDA, Director, Office of Civil Rights, 1400 Independence Avenue, S.W., Washington, D.C. 20250-9410, or call (800) 795-3272 (voice) or (202) 720-6382 (TDD). USDA is an equal opportunity provider and employer.



## Acknowledgments

**A**ny document concerning trail construction must recognize the men and women who do the field work—whether they are professionals or volunteers. Some of the most unforgettable and fun-loving people we have known have worked on trail crews.

None of the construction techniques in this document are new. Most have been used for decades. Fortunately, trail crews took the time to explain and demonstrate the construction techniques to us. The techniques described in this manual have occasionally been modified slightly to make it easier to work with contemporary materials.

Christy Fischer was responsible for the initial editing of this manual. Thanks also to the staff at the USDA Forest Service Missoula Technology and Development Center (MTDC), who obtained additional photographs, scanned figures, provided review and additional content, and edited, laid out, and printed this document. In this revised edition, the work involved Bert Lindler, Sunni Bradshaw, James “Scott” Groenier, and Jerry Taylor Wolf. Bob Steinholtz drew the illustrations used throughout this manual. Thanks also to the U.S. Department of Transportation’s Recreational Trails Program for funding the revision and additional distribution of this manual.





# Contents

<b>Acknowledgments</b>	<b>ii</b>
<b>Introduction</b>	<b>1</b>
<b>Types of Wetlands</b>	<b>2</b>
Wetlands Formed by Glacial Action	2
Wetlands With Organic Silt and Clay Soils	2
Silt and Clay Soils With Some Water	2
Silt and Clay Soils With Considerable Water	2
River Deposits and Deltas	3
Floating Wetlands—Trembling Earth or Quaking Bog	3
Wetlands on Mountains	4
Carrs	4
Seepage	4
Spruce Bogs	5
Muskeg	5
Wetlands With Wildlife That Bite Back	5
<b>Environmental and Accessibility Compliance</b>	<b>7</b>
National Environmental Policy Act and Other Federal Laws	7
The U.S. Army Corps of Engineers	7
State and Local Agencies	7
Accessible Trails	7
<b>Field Work</b>	<b>8</b>
Turned Around	8
Trail Layout	8
Reconnaissance	8
Preliminary Route—P-Line	8
Coordination	9
Blue Line	9
Final Layout	9
Drawings, Specifications, and Cost Estimates	10
<b>Wetland Trail Structures</b>	<b>14</b>
Sustainable Design	14
Corduroy	14
Turnpikes	15
Causeways	17
Improving Drainage	17
Dips or Ditches	17
Culverts	18
<b>Structures Requiring Foundations</b>	<b>21</b>
Sleepers (Sills)	21
Cribbing	22
Wooden Piles	22
End-Bearing Piles	23
Friction Piles	23
Bent Construction	24
Helical Piles (Screw Piles)	26
Helical Pile Assembly	27
Special Site Considerations	28
Puncheon	29

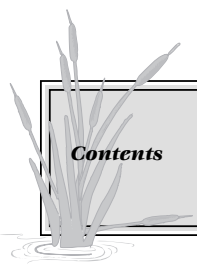

## Contents

Type 1 Puncheon	29
Type 2 Puncheon	30
Type 3 Puncheon	30
Puncheon Summary	31
Gadbury	31
Bog Bridge	32
Bog Bridge on Sleepers	33
Bog Bridge on Cribbing	33
Bog Bridge on Piles	33
Bog Bridge Summary	33
Boardwalk	33
Stringers	33
Boardwalk Summary	34
<b>Finishing Details</b>	<b>35</b>
Decks	35
Posts	35
Pedestrian Railing Types	36
Railing Installation	37
Curbs (Bull Rails)	38
Bulkheads (Backwalls, End Dams, Faceplates)	39
<b>Floating Trails</b>	<b>40</b>
<b>Construction Materials</b>	<b>41</b>
Choosing Materials	41
Logs	41
Lumber and Timber	41
Decay-Resistant Wood	42
Naturally Decay-Resistant Wood	42
Preservative-Treated Wood	42
Recycled Plastic	43
Hardware	43
Connectors	43
Nails	44
Bolts	44
Lag Bolts (Lag Screws)	44
Washers	44
Nuts	45
Wood Screws (Deck Screws)	45
Steel Reinforcing Bars	45
Staples	45
Hardware Cloth	45
Geosynthetics	46
Nonslip Gratings and Grit-Treated Mats	47

Roughened Wood Surface _____	47
Mineral Paper _____	47
Fishing Net _____	48
Cleats _____	48

**Construction Tools \_\_\_\_\_ 49**

Measuring Tapes _____	49
Framing Squares _____	49
Plumb Bob _____	49
Levels _____	49
String or Line Levels _____	50
Stringlines _____	50
Chalklines _____	50
Carpenter's and Mason's Levels _____	50
Torpedo Levels _____	51
Post Levels _____	51
Surveyor's Transits and Electronic Instruments _____	51
Surveyor's Levels or Transits _____	51
Electronic Distance Measuring Instruments _____	51
Saws _____	52
Handsaws _____	52
Chain Saws _____	52
Hand-Held Pruning Saws _____	52
Axes _____	53
Adzes _____	53
Planes _____	53
Draw Knives _____	53
Bark Spuds _____	54
Tools for Drilling Holes in Wood _____	54
Bits _____	54
Braces _____	55
Battery-Powered Drills _____	55
Gasoline-Powered Drills _____	55
Clamps _____	56
Wrenches _____	56
Chisels _____	56
Mallets _____	56
Hammers _____	56
Claw Hammers _____	56
Sledge Hammers _____	57
Crowbars _____	57
Tools for Digging Holes _____	57
Shovels and Posthole Diggers _____	57
Augers _____	57
Gasoline-Powered Augers _____	57

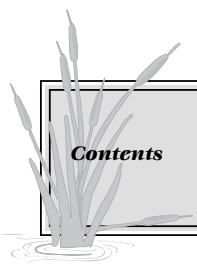

## Contents

Wheelbarrows _____	57
Compactors _____	58
<b>Practicing the Craft _____</b>	<b>59</b>
Working With Logs _____	59
Felling _____	59
Bucking and Seasoning _____	59
Moving Logs _____	59
Peeling _____	60
Squaring a Log _____	60
Cutting Planks With Chain Saw Mills _____	62
Working With Timbers _____	62
Working With Treated Wood _____	63
Pinning Logs and Timbers _____	63
Tread Surface _____	63
Slippery Wood Treads _____	63
Trail Grade _____	64
Cross Slope _____	64
Soil Conditions _____	64
Surface Treatments _____	64
Latex Paint _____	64
Walnut Chips _____	65
Mineral Products _____	65
Nonslip Gratings and Grit-Treated Mats _____	65
Working With Rock, Stone, and Gravel _____	65
Rock _____	65
Stone _____	65
Gravel _____	65
Uses of Stone and Gravel _____	65
<b>Appendix A—Field Note Sheets _____</b>	<b>66</b>
<b>Appendix B—Slope Conversion Table _____</b>	<b>68</b>
<b>Appendix C—Comparison of Round and   Rectangular Culverts _____</b>	<b>69</b>
<b>Appendix D—Sizes of Hot-Dipped Galvanized Nails _____</b>	<b>70</b>
<b>Appendix E—Table of Board Feet _____</b>	<b>71</b>
<b>Appendix F—Metric Conversions _____</b>	<b>72</b>
<b>Glossary _____</b>	<b>73</b>
<b>References _____</b>	<b>81</b>



# Introduction

Most experienced trail crews try to avoid wetlands because of the construction and maintenance problems they pose. Little has been published on wetland trail construction, and materials that are available are often outmoded or are too regionally focused. By pulling this information together from our experiences, we hope to answer questions you didn't even know you had.

In this manual we have described the common techniques for building a wetland trail. We have also included information on some of the more unusual materials and tools.

Some of the techniques and tools we describe are suitable for wilderness situations where mechanized equipment cannot be used. Others are suitable for urban greenbelts where

a wider range of techniques, material, and equipment can be used. Somewhere in between are the back-country sites where machines are permitted, but access and logistics are challenges. Although this book is written for wetland trails, the techniques described can also be used for correcting other poorly drained low areas in existing trails.

The manual is written for those who are untrained and inexperienced in wetland trail construction, but those with experience may learn a few things, too.

The 2007 edition incorporates minor changes to this report, first published in 2001 (0123-2833-MTDC). The changes primarily involve wood preservative treatments and construction details. The list of references has been updated.

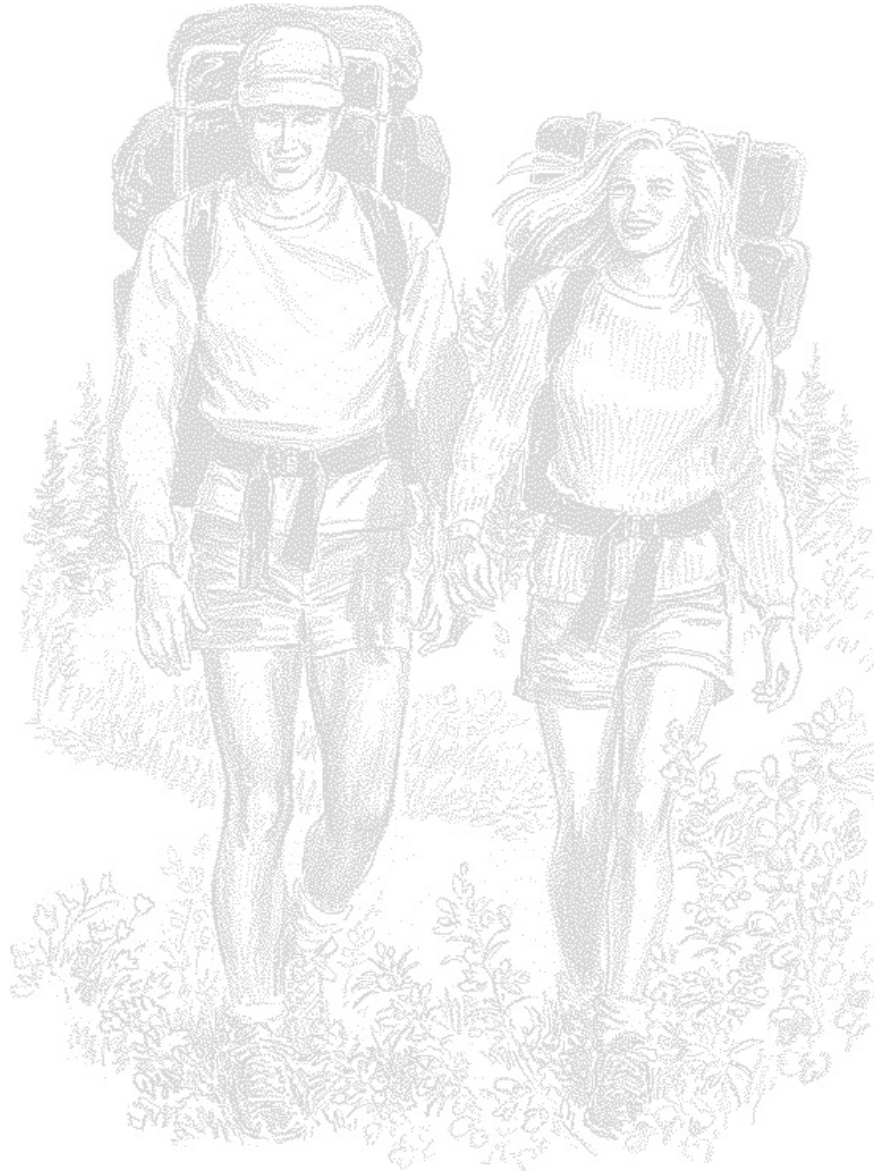

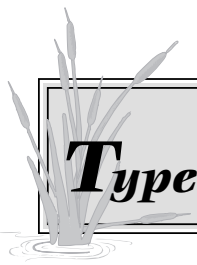

## Types of Wetlands

**W**etland managers and specialists recognize 30 or more different types of wetlands. From a trail construction viewpoint, there are only six types of wetlands, perhaps seven. The basic differences in construction techniques for wetland trails depend greatly on the geologic, hydrologic, and vegetative factors influencing the site and, to a degree, on the wildlife species that live there.

Local indicator plants can help identify whether a site may be a wetland. Test holes and rod soundings can help determine the capability of the soil to support a trail. By studying the soil, the wildlife, and the subsurface water at the site, you can select the appropriate trail layout and construction techniques.

### ***Wetlands Formed by Glacial Action***

Generally, trails are easiest to construct in wetlands formed by glacial action. As a glacier melts, sand, gravel, boulders, and occasional blocks of ice are deposited in a narrow area in a mountain valley. The melting glacier creates a large creek or river that drains the valley. During spring runoff, adjacent wetlands may be underwater, but the ground will still be solid. Although you may be working in standing water, you will not sink in the soil. As the wetland dries out, the surface may be dry and solid. However, water will be just a few inches to a few feet below the surface. During the dry season, the level of the groundwater will normally drop, but it will fluctuate depending on upstream runoff.

Look for this site condition in northern areas that were glaciated during the Ice Age, or in U-shaped mountain valleys. Such valleys indicate previous glaciation (figure 1). To avoid being misled, dig a 4-foot-deep test hole to see whether characteristic sand and gravel are present.

Occasionally, small deep pockets of organic silt and clay are found within wetlands of glacial origin. When these occur near a river or creek, the soil mixture becomes saturated with groundwater and is extremely fluid. These pockets are rare, usually easily visible, and should be avoided. They can be extremely treacherous, especially if covered with a thin layer of ice or snow. One such pocket encountered on a trail project in the Rocky Mountains was 10 feet long, 8 feet wide, and more than 4 feet deep.

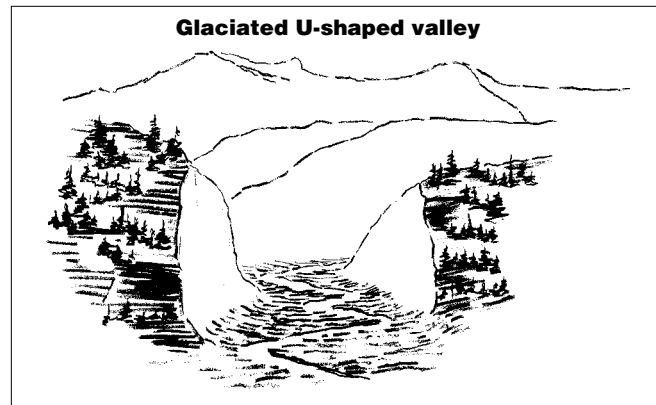

Figure 1—Glacial soils can be expected in U-shaped valleys typical of areas shaped by glaciers.

### ***Wetlands With Organic Silt and Clay Soils***

This type of wetland may be the most common. A test hole will indicate that the soil is not sand or gravel, but silt or clay—soils with fine particles. The silt and clay in most wetlands of this type are from organic materials such as leaves, bark, and wood. The terrain traps runoff and the soil particles hold this water, making the area soft underfoot.

#### ***Silt and Clay Soils With Some Water***

Anyone building a trail through this type of wetland will find that footprints quickly fill with water. Hikers may sink up to their ankles in the unstable soil.

#### ***Silt and Clay Soils With Considerable Water***

This type of wetland is similar to the one described above. A test hole will indicate that the soil consists of the same silt or clay material; however, it has considerably more water mixed with it. Work is difficult when you immediately sink to your knees or even to your waist.



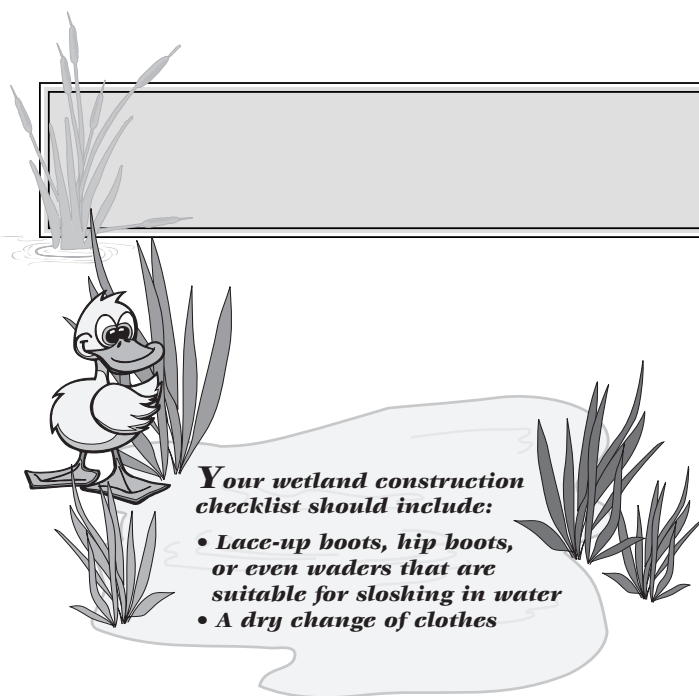

A test hole should be as deep as possible. Due to the excessively wet soil, the sides of the hole will continually slough off. It may be impossible to dig deeper than 12 to 18 inches. In that case, rod soundings can help determine subsurface conditions.

Rod soundings are not too difficult to perform or to interpret. A 6- to 8-foot-long steel rod is driven into the ground with a sledge hammer. If the rod hits something solid, it will stop, or slow considerably. The rod may have reached a strata of rock or firm soil that will support construction, or it may have struck a root or an isolated boulder, a misleading indication of overall conditions. Take additional soundings nearby to determine the overall conditions.

An inexpensive and easily portable rod can be made from 2-foot lengths of galvanized, ½-inch diameter pipe. Screw a cap onto one end of one pipe section and screw a coupling onto the other end. Continue with 2-foot sections until at least 6 feet of pipe is assembled. Screw a T connection onto the upper end of the rod so that a ½-inch-diameter steel bar can be passed through the T for leverage in case the rod gets stuck in the ground. Tap the T with a hammer (figure 2).

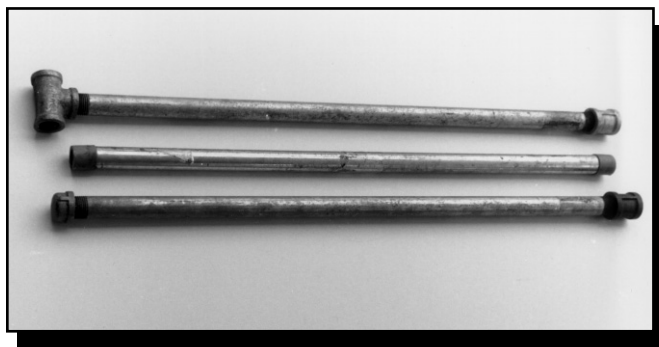

Figure 2—This sounding rod is inexpensive and easy to carry.

The rod can be made as long as necessary. Usually 6 or 8 feet of rod is enough to determine whether a soil problem exists.

## ***River Deposits and Deltas***

Soil deposited along rivers and in their deltas may include inorganic clay and an extremely high percentage of water. Walking in this type of wetland is almost impossible. This type of wetland is found along the Missouri River and in the Mississippi River delta, and should be expected along other large rivers.

## ***Floating Wetlands—Trembling Earth or Quaking Bog***

Another type of wetland is the result of water-tolerant sedge and sphagnum moss invading lakes. Basically, these wetlands are areas of land floating on water or water-saturated peat. Over the years leaves, needles, twigs, and seeds are carried into a wetland or lake by wind and runoff, eventually forming a layer of organic soil. In areas where the soil and water are extremely acidic, the high volume and acidity of the water keeps organic matter from rotting. As this soil layer builds, the seeds of less water-tolerant plants will begin to grow. After many years a miniature forest of slow-growing, stunted trees will be found on the site. Expect plants such as sedges, sphagnum moss, pitcher plant, cranberry, blueberry, and Labrador tea. Tree species that will tolerate this site condition are alders, balsam fir, black spruce, tamarack, willows, and baldcypress.

This soil will support little foot traffic. Often the ground will compress with weight and quake slightly underfoot. At the extreme, the ground will undulate as it would if someone was walking on a mattress. In the Okefenokee Swamp, this type of wetland is referred to as “trembling earth.” In the Adirondack Mountains and Canada, a similar site is called a “quaking bog.” A test hole may show a thin layer of organic soil, perhaps 1 foot thick. Below it will be a layer of sphagnum moss and peat. Rod soundings in these layers will meet little resistance. When the rod is hit with a 4-pound sledge hammer, people standing 2 to 5 feet away may feel the shock through the ground.

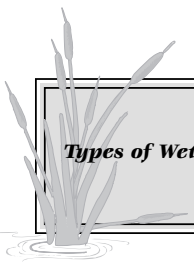

## Wetlands on Mountains Carrs

In mountainous areas, wet trail problems sometimes show up only after the trail has experienced heavy use. The terrain may slope, perhaps by as much as 10 to 20 percent. Problems become evident only when trail traffic wears through a thin layer of soil and exposes a wet, fluid soil that may be 1 to 3 feet thick. Trail crews often refer to these sites as carrs.

If test holes and rod soundings had been taken before construction, they would have revealed this thin layer of soil on top of fluid soil. The fluid layer may be so wet that it would have been impossible to dig a test hole without the hole's side walls continually caving in. Once the fluid layer is reached, the weight of the rod can cause it to sink 1 to 2 feet without being hit by a hammer. Leaning on the rod might cause it to sink 2 to 3 feet. The rod should be hammered until firm soil is reached or the rod has penetrated 8 feet of soil.

Carrs can often be identified by indicator plants. River birch, shrubby willows, and alders growing on what appears to be solid ground should alert a trail designer to the potential problem (figure 3) and the need for soil testing.

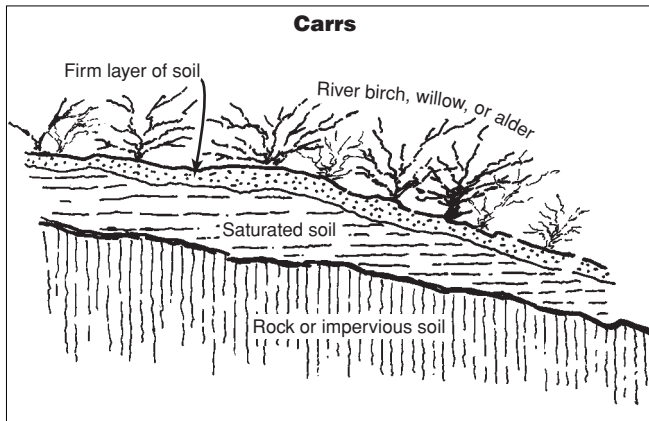

Figure 3—Carrs are characterized by a captive layer of saturated soil just under the surface that is sandwiched between two impervious layers.

## Seepage

Some mountain wetlands are caused by subsurface water that seeps to the surface from a perched water table. A perched water table occurs where dense rock or an impervious soil layer is within inches to a few feet below the ground. Precipitation that would normally percolate deep into the ground is trapped near the surface and follows the slope of the

impervious material downhill. This condition is common during the spring in high mountainous areas. In the dry season, the surface of the ground may be dry, but water will be only a short distance below. A trail designed and built in the dry season may be unsuitable during the wet season (figure 4).

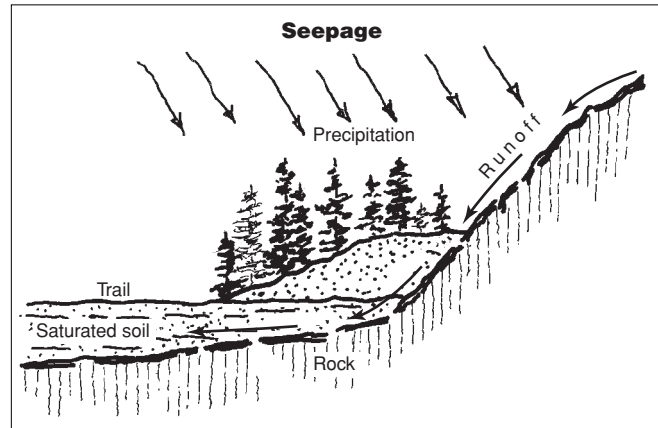

Figure 4—Seepage is sometimes caused by precipitation held in perched water tables.

Another more obvious condition occurs near limestone cliffs. Limestone covers millions of square miles of the Earth's surface, and some limestones are extremely porous. Water will percolate deeply through certain types of limestone. Other types of limestone may be highly fractured, permitting water to penetrate. Water will seep out of the exposed faces (figure 5). This condition also occurs in sandstone formations.

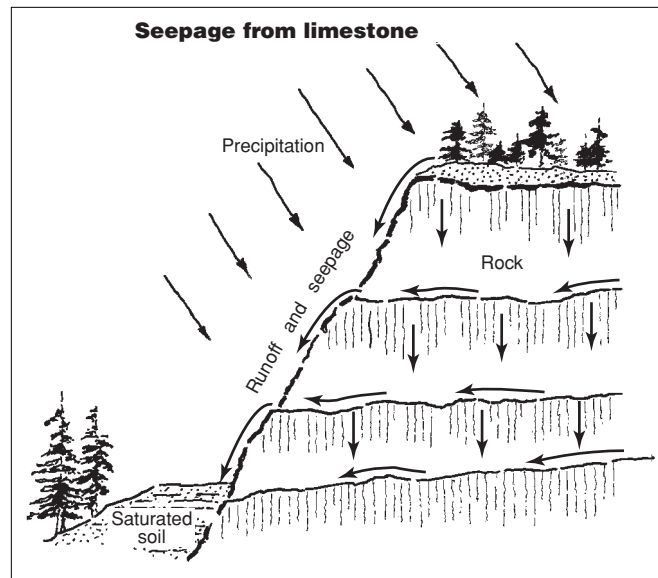
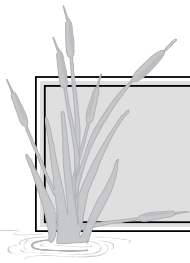

Figure 5—Limestone formations are very porous. Water will percolate through the limestone and seep out of exposed faces and cutslopes.



## **Spruce Bogs**

The spruce bog is a forest type found in the northern United States and throughout Canada and Alaska. The forest often consists of pure stands of black spruce, a slow-growing tree that survives in dense shade where the water table is high. Walking through a mature stand of these trees is a unique experience. The trees may be 6 to 12 inches in diameter, 25 to 40 feet tall, 15 to 40 feet apart, and 200 years old. Because they can withstand shade, the trees are often densely branched to the ground.

In spruce bogs, roots spread on the surface, presenting a problem for trail construction. The roots may be 15 to 20 feet long and as big around as the tree. Large tree roots on one side of the trail spread out and cross into the root system of trees on the opposite side of the trail. Cutting the roots for normal trail construction would leave roots on either side of the trail and unbalance the trees' support. Hikers may trip over the roots if they are left in place. The surface soil is organic and breaks down quickly into ruts and mudholes. Hikers detour around these spots, creating a braided trail with two, three, or four alternative routes.

## **Muskeg**

Muskeg refers to an area covered with sphagnum mosses and tufts of sedges. Muskeg is very common in Southeast Alaska, where all relatively open peat bogs with sphagnum mosses or sedges are called muskeg. The following information about muskeg is from the *Alaska Region Trails Construction and Maintenance Guide* (USDA Forest Service 1991).

Soils in Southeast Alaska maintain a thick, living, organic surface mat, a high percentage of iron oxides, and are often saturated with water. The soil structure breaks down readily under stress or disturbance.

Once the protective mantle and root layer are destroyed, the soil readily turns into water-muck. In some disturbed muskeg soils, there seems to be no limit to how far a person could sink. A site can go from solid footing to knee-deep muck after the trail crew makes just a few trips back and forth.

The volume of traffic these highly organic soils can support is directly related to the network of roots that exist in the soil. This network of roots strengthens the soil just as reinforcing bars strengthen concrete.

## **Wetlands With Wildlife That Bite Back**

The last type of wetland has more to do with hydrology, climate, and wildlife than geology. Sites in the southeastern United States and tropical regions support species of wildlife that look upon man as prey. Building a normal wetland trail in these areas may be hazardous to the crew building the trail and to hikers unfamiliar with the potential dangers posed by local wildlife.

Alligators are often found in wetlands in the southern United States. Normally, alligators are not a problem to adult humans, but they may take an interest in a visitor's dog or small child. Little can be done to permanently keep them off the trail. Alligators may find a way through sturdy barrier fences that are improperly maintained, but may have a harder time finding their way off the fenced trail.

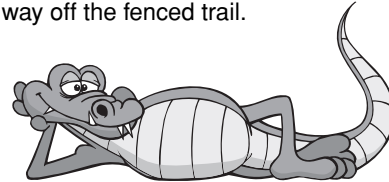

A loop trail should be considered in such areas. The loop trail provides the visitor with a route for hightailing it back to the trailhead, no matter where the alligator is encountered.

If alligators are the primary attraction for an interpretive trail, consider constructing an overlook. An overlook separates visitors from alligators and is an alternative to building a trail into the alligators' territory. In open areas, an overlook may be an effective way to see alligators. In areas with trees or dense brush, an overlook may not be worth the effort or expense. Guided boat trips might be another option for heavily-used locations.

Wetland trails in northern regions have their own potential wildlife challenges. Moose have a fondness for wetlands. Although usually docile, moose can be dangerous during some seasons. In the spring a cow moose is protective of her young. In the fall rutting season, a bull moose can be cantankerous and unpredictable. Moose have been known to attack people with no provocation and to follow wetland trails, including those with a wooden surface. Wetland trails in these areas might be designed with few abrupt curves and sight distances of at least 75 to 100 feet.

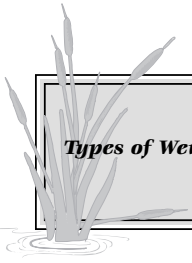

## Types of Wetlands

In the fall bull moose will demolish typical interpretive signs. One way to reduce sign damage is to use a vertical format for signs and place each sign on a single wide post (figure 6).

Wetlands with beaver, or where there is a possibility of beaver activity, pose different potential problems. Beavers are a natural draw for interpretive trails, but they might chew through wooden piles used to support the wooden deck of a trail. More importantly, they may change the water level of a wetland. A dam built upstream may reduce the flow of water into the wetland and reduce visitor enjoyment. A dam built downstream may raise the water level above the trail. Beavers may also plug culverts, weirs, and overflow structures. The level of the trail should be set higher to allow for higher water. A wetland trail that has been submerged because of beaver activity will require maintenance or reconstruction.

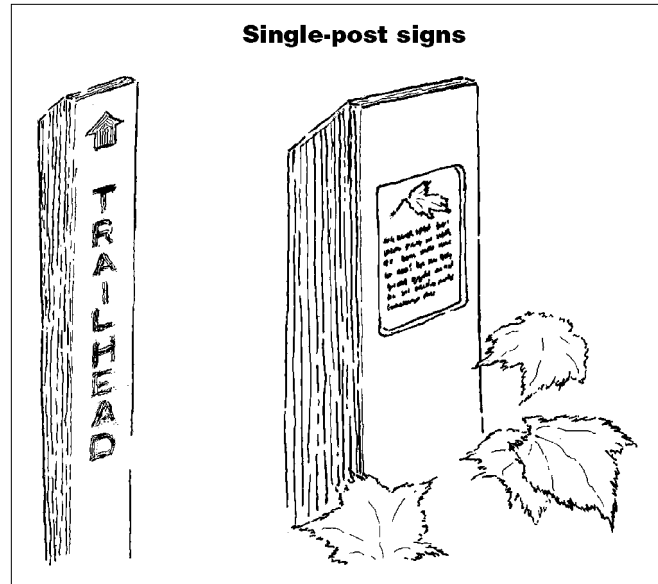
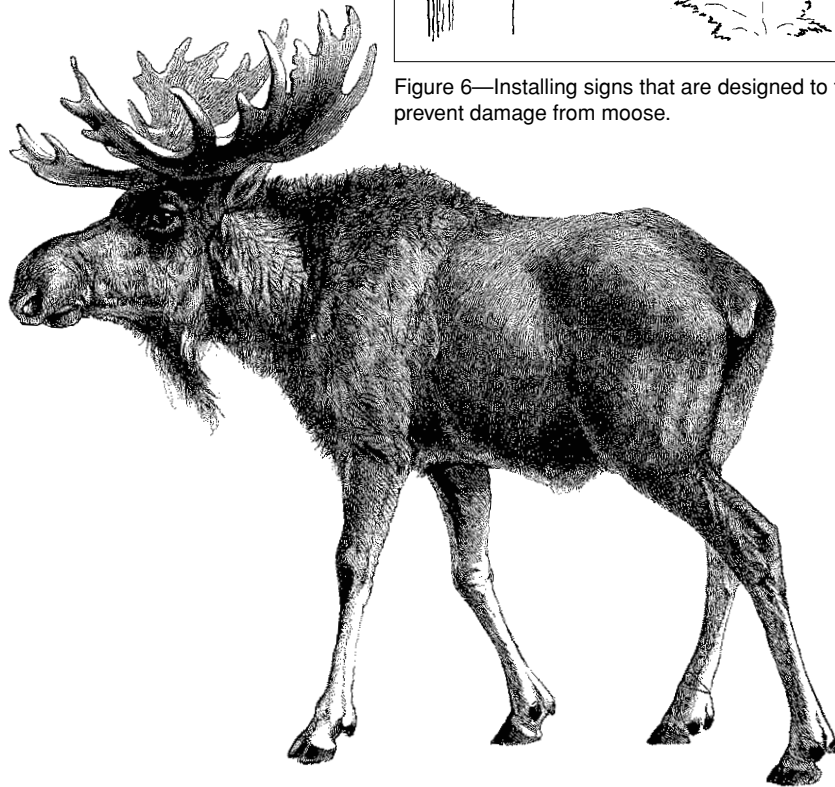

Figure 6—Installing signs that are designed to fit a single post helps prevent damage from moose.





# ***Environmental and Accessibility Compliance***

## ***National Environmental Policy Act and Other Federal Laws***

Laws, regulations, and management practices affect trail construction activities. Congress passed the National Environmental Policy Act (NEPA) in 1969. The purpose of this act is to ensure that Federal agencies consider the potential adverse effects their activities may have on the environment. The preservation of natural resources is the primary intent of this act, although the act covers cultural resources as well. The National Historic Preservation Act (NHPA) covers cultural resources. The Endangered Species Act (ESA) protects rare, threatened, and endangered plants and animals.

Trail construction on Federal lands, or lands where Federal funds are involved, must conform to these and other laws. Proposed trail routes should be walked by specialists knowledgeable about rare and endangered species of plants and animals. To avoid disturbing important cultural sites, archeologists and historians should be invited to participate. At some locations, cave specialists or fossil specialists will also be important. Trail planning needs to be coordinated with the land management agency that has jurisdiction over the trail.

Each U.S. Department of Agriculture, Forest Service jurisdiction must complete a formal environmental analysis before trail construction or major reconstruction. The process may be simple or complex, depending on the nature of the project and its affected environment. Checking with the District NEPA coordinator is a good first step. Other agencies will have similar review processes. Early in the planning stage, determine the regulations that govern development in the area being considered for construction. Where many agencies have jurisdiction, the agency with the most stringent regulations usually governs.

When Federal funds are not involved, professional ethics on the part of trail personnel suggests voluntary compliance with the intent of the NEPA and NHPA regulations.

## ***The U.S. Army Corps of Engineers***

The U.S. Army Corps of Engineers governs construction in navigable waterways and wetland areas of the United States. The agency's primary concern in wetland areas is to limit the volume of fill and avoid filling that would interfere with normal runoff entering the wetland. For a wetland trail the procedure generally involves a letter to the local district headquarters, perhaps a site visit by a Corps representative, and the issuance

of a Corps 402 or 404 permit. Generally, complying with Corps requirements also results in construction that needs minimal maintenance.

## ***State and Local Agencies***

Many States have enacted regulations controlling wetland development, including trails. More States can be expected to do the same. Some counties and municipalities have their own wetland regulations. More and more trail projects cross agency and property boundaries, so Federal project managers need to be aware of other laws and regulations that might apply.

Occasionally, large areas have been established with uniform regulations applying to many towns and counties. The Adirondack Park Agency is a good example. This agency's regulations apply to 6 million acres of New York State's Adirondack Mountains. Included are all or parts of 12 counties and more than 100 towns and villages. Roughly 45 percent of the land is owned by the State; the rest is privately owned.

## ***Accessible Trails***

Trails need to be accessible to people with differing physical abilities. All trails do not have to be accessible to all people, but accessibility is to be considered for new trail construction and major reconstruction. It is a legal requirement to do so.

In May 2006, the Forest Service Outdoor Recreation Accessibility Guidelines (FSORAG) and Forest Service Trail Accessibility Guidelines (FSTAG) became official direction for the USDA Forest Service on National Forest System lands. These detailed guidelines are based on the draft accessibility guidelines for outdoor developed areas created by the Architectural and Transportation Barriers Compliance Board.

To help field practitioners understand the FSORAG and FSTAG, the Forest Service produced the *Accessibility Guidebook for Outdoor Recreation and Trails* (Zeller and others 2006). This new guidebook is easy to use and is full of photos, illustrations, design tips, hotlinks, and valuable sidebars. Readers will have an easier time integrating accessibility into the outdoor recreation environment. The guidebook is available at:

<http://www.fs.fed.us/recreation/programs/accessibility/>



# Field Work

## Turned Around

A legendary Maine guide, so the story goes, insisted that he had never been lost, but he admitted to having been “turned around real good once—for 3 days.”

A wetland on an overcast day can easily provide an opportunity to get “turned around real good.” Wetland terrain is often featureless. There are no hills, ridges, or rock outcrops, and no obvious slopes. Vegetation is often uniform. If the vegetation is dense and at least 6 feet high, everything looks the same. The problem worsens with fog, rain, or falling snow. Maps and even aerial photographs are useless. There may be no real danger of getting lost. However, it is frustrating and time consuming to lay out a route in the wrong direction or to learn that you are not where you thought you were.

In this situation, a compass is essential. Start using the compass **before** entering the wetland and **before** getting turned around. Bring vinyl flagging ribbon and a good sighting compass to the wetland on the first day. Hand-held global positioning systems (GPS) are another way you can keep track of your location (figure 7).



Figure 7—Knowing how to use a compass or GPS unit will help you locate the trail.

Sometimes the terrain and vegetation are so uniform you have to mark the general area that the trail will traverse. Using the compass and the vinyl ribbon, flag a straight line route on one particular compass bearing or azimuth. Tie the ribbon at shoulder to eye level. When standing at one ribbon, you should be able to see the next one (figure 8).

Flagging ribbons

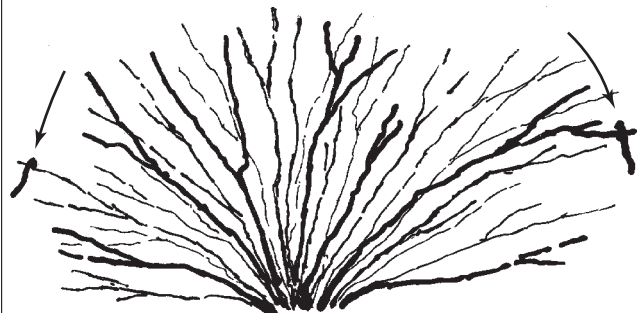

Figure 8—Dense, spreading shrubby plants such as willow and alder may require two flagging ribbons, one on each side of the plant.

Flag the outer perimeters of the general area wherever they are not obvious. Use different-colored ribbons as needed to help you find your vehicle at the end of the day. Not that *you* are likely to get turned around, of course.

## Trail Layout Reconnaissance

Reconnaissance (recon) involves walking over the area the trail will traverse and finding the places where the trail must go and the places you would like it to go. For example, there may be only one location where the trail can enter the wetland with minimal construction. This becomes a construction control point. There may be just one or two places where it is feasible to cross a small stream. These become construction control points. One of these points will probably be incorporated in the final route.

What about a location that provides a distant view? This becomes an esthetic control point. A small island in the wetland supports a variety of plant life that is of interpretive value. The island becomes another control point. A view of a sewer plant on the other side of the wetland is something to avoid. That location becomes a negative control point.

## Preliminary Route (P-Line)

The trail must be laid out on the ground. The objective is to tie the control points together in a reasonable route, somewhat like connecting the dots, but on a much larger scale. This is normally done with vinyl flagging ribbon.

Few people use striped ribbon, so consider using it to mark the preliminary route. Carry at least two different combinations of colors (red and white stripes and orange and black stripes or other combinations) (figure 9).

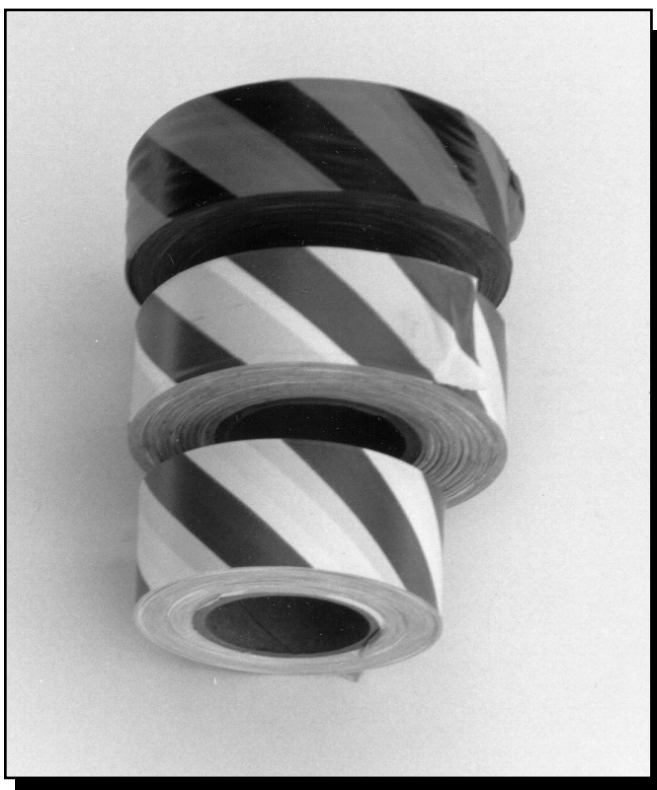

Figure 9—Vinyl flagging ribbon comes in many colors. Striped ribbon is good for marking the preliminary route.

If a portion of the route has to be changed, use the second color of ribbon. Do not tear down the ribbon for the first route that appears to be undesirable; it may prove to be better than the alternative route. Tie the new color of ribbon next to the piece of the first color where you want to depart from the first route. The outcome will be a preliminary route or P-line.

### **Coordination**

The layout of an interpretive wetland trail should be a collaborative effort between people experienced in trail construction and those who will be responsible for the interpretation of the completed trail. All parties need to be brought in at the planning and layout stage. The interpretive staff is in the best position to identify interpretive points.

On an interpretive trail, the interpretive points will be among the control points. Routing any trail through all possible control points would result in a long, zigzag trail that would be expensive to build and would look ridiculous. Usually there must be a compromise between alignment, the length of the trail, construction cost, maintenance problems, and the number of esthetic and interpretive control points along the route. One 600-foot length of trail was built near a beaver dam for its interpretive value. Soon, that length of trail was under almost 2 feet of water and had to be rerouted. That location turned out to be a poor compromise.

After agreement on the P-line, the various compliance specialists should be contacted and, if necessary, brought in to walk the route. These may include specialists from your own agency, perhaps others from the U.S. Army Corps of Engineers and the U.S. Fish and Wildlife Service, and cultural resource specialists such as historians and archeologists.

### **Blue Line**

It helps to go back over the P-line and refine it with an eye toward reducing construction problems, views of the trail by other trail users, and views of constructed structures from the trail. Refine the alignment to avoid sharp turns and long straight sections.

Blue ribbon is often a good choice for this more precise line. Blue has proven to be the most visible color in areas of dense vegetation. Spending time flagging the blue line will make the final layout work easier and faster. In some agencies, specific colors of ribbon denote specific purposes. Be sure your blue flagged line isn't going to be confused with a logging unit boundary, for example. Sometimes, because of vandalism and removal of the ribbon, the proposed route should not be too obvious. Solid green or black-and-yellow striped ribbon are usually the most difficult to see against vegetation and less likely to be removed. Sometimes cattle and wildlife chew on the ends of the ribbon. You may be able to locate the flag line by looking for the remaining knots of ribbon.

### **Final Layout**

The designer and one or two assistants measure the route and keep notes (appendix A) on distances and locations and on the lengths of items that will be needed during construction. This information is extremely important for preparing accurate cost estimates, ordering materials, tools and equipment, and determining the size of the construction crew.

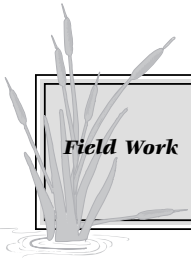

## Field Work

Distances are usually recorded by station, an engineering measuring system used for roads, railroads, and utility lines. Traditionally, in this system 100 feet is written as 1+00; 1,254 feet is 12+54. The distances are measured with either a 100-foot or 50-foot measuring tape and are “slope measured” (measured along the slope). Wire flags are marked with the station distance and stuck in the ground at the approximate location that has been measured. Using metric measurements, 100 meters is written as 1+00; 1,254 meters as 12+54.

The trail grade (the slope of the trail route) is measured on the ground between stations and between obvious changes in slope. At most sites a clinometer or Abney hand level is sufficiently accurate for this work. Precision is not as critical for a trail as it is for a road.

Measure the slope as a percentage of grade (the vertical rise or fall in feet per 100 feet of horizontal distance, or meters per 100 meters of horizontal distance) and record it in the notes. Where the route rises, it is shown as a positive or plus grade. Where the route drops, it is a negative or minus grade. Appendix B has slope conversion information.

A crew of three is more efficient than a crew of two for doing final layout. A crew of three is almost essential in areas of dense vegetation.

The field notes can be kept on Rite-in-the-Rain waterproof paper and stored in a 4- by 6-inch ring binder (figure 10). A blank form that you can copy is included in appendix A.



Figure 10—This field notebook is a tried and true technology that works.

The form shown (figure 11) is 4¼- by 5½-inches or a half sheet of paper. After the workday, remove the notes from the ring binder and leave them in the office or at camp. Normal surveyor’s notebooks are awkward for trail field notes—they keep trying to close up and they are difficult to copy.

The field notes should include important basic information: location, project, date, weather, first and last names of the crewmembers, job assignments, color of the flagging ribbons, and the location of the 0+00 station referenced to fixed objects on the ground. Clear and consistent handwriting and language skills are important. Standard abbreviations should be used and the abbreviations must be explained to others on the crew. Provide a legend for unusual abbreviations. Sketches and maps are also valuable sources of information. Eventually, the field notes will get to the office where someone else may have to interpret them.

What a waste of time it would be to go through all this work and end up with notes that are unusable. Paper is inexpensive compared to the time required to gather this information. Do not write notes too close to each other. When you make an error, put a single line through the mistake. Do not try to write over or erase it. Go to the next line and write in the correct information.

It is critically important to note the colors of ribbon that you used. Trail construction workers will need to know the color of ribbon they will be looking for. Six months after the field layout, even the workers who laid out the trail will not remember what colors were used.

## ***Drawings, Specifications, and Cost Estimates***

Regardless of who builds the trail, the field notes must be converted to drawings and specifications that can be used in the office for estimating costs and ordering materials, and in the field for construction.



Station & distance	Tread width	Sideslope (percent)	Gradient (percent)	Notes
				Pingree Park—Accessible wetland trail.
				9/10/97—Sunny, warm.
				Bob Pilk, Terri Urbanowski, Bob Steinholtz. Red ribbon/red flags.
				0+00-35' east of flag pole/north curb.
0+00				
	4'	25	5	
0+50				
	4'	30	5	
0+75				Enter willow brush
	4'	30	5	Heavy brush clearing
1+00				
		35	5	
1+76				Intersection with wetland
		10	4	loop—rt (south route)
				end willow brush clearing.
1+81				Begin bog bridge/piles
		0	4	
2+04				End piles, begin B.B. on
		0	-2	sleepers

Figure 11—Sample field notes are legible and have the information needed to locate the trail and plan for materials.

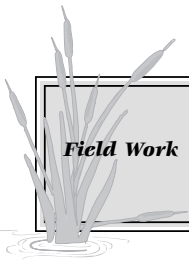

**Field Work**

Station & distance	Tread width	Sideslope (percent)	Gradient (percent)	Notes
2+38				End B.B./begin turnpike.
		0	+2	
2+74				End turnpike/begin B.B. on
		0	+2	sleepers—medium willow
				brush clearing.
3+06				
		±10	0	Hummocky/begin B.B. with
				cribbing, some cribbing
				one side only.
3+58				Timber culvert: 8' span by
	4'	0	0	4' height
3+66				
		0	0	
3+86				River on rt. Suggest 20 lf
		10	-1	of Geoweb in turnpike.
4+19				End turnpike. Begin trail
				on
	4'	0	+2	solid ground.
4+97				Sta. 4+97 = 1+76

Figure 11—(continued).

The drawings should include the approximate layout of the route, indicating landmarks and major items of construction. A second drawing at a larger scale should indicate by station or distance where these items begin and end. These distances are subject to field adjustment. Several large-scale drawings may be needed to show the whole trail route.

Drawings with construction details will also be needed for cost estimates and construction. These large-scale drawings show the construction materials, their dimensions, how they are put together, and how they are attached.

A specification defining the quality of the materials and craftsmanship must also be written. For a simple project, this information can be included on the drawings. The specification is also needed by the cost estimator, the individual ordering the materials, the crew chief, and the project inspector.

Preparing drawings and a specification may sound like a lot of work, but preparation reduces the questions of the construction crew and the time spent by the designer in the field during construction. Such work also reduces the possibility that the wrong materials could be delivered to the worksite. Written drawings and specifications are essential for contracts. Forest Service employees should follow the format of *Standard Specifications for Construction and Maintenance of Trails* (USDA Forest Service 1996) and *Standard Drawings for Construction and Maintenance of Trails* (USDA Forest Service 1996).

If the work is to be done in-house with an experienced crew, sometimes the procedures can be simplified. It is still a good idea to have drawings and written specifications, because they can prevent misunderstandings.





# Wetland Trail Structures

**A**t least eight types of trail structures are commonly built in wetlands. Some of these are built with no foundation. Others have sleepers (sills), cribbing, or piles as foundations. Most of these structures are built of wood.

The oldest methods for building a wetland trail were corduroy and turnpike, which require no foundation. Turnpike may require constructing timber culverts, which involves building two small timber walls. The walls must rest on a buried timber sill. Planks span the space between the walls.

The various types of puncheon, gadbury, and the simplest form of bog bridge construction may be built on a foundation of sleepers, or on log or timber cribbing. Cribbing is more difficult to construct and is used occasionally where the terrain is hummocky (having small mounds of vegetation interspersed with depressions that hold water).

Bog bridges and boardwalks are often supported on pile foundations. Three types of pile foundations have been used for bog bridges and boardwalks: end-bearing piles, friction piles, and helical piles. Piles are the most labor-intensive foundation. Helical piles and some friction piles require specialized machinery for installation.

Floating trails are another, less common, technique. Where they are used, you need some form of anchorage.

In this manual we describe the structures more or less in historical order. The oldest are early in the list, and the newest or most difficult to construct appear toward the end. The older structures can be built without machines, although machines make the work go faster. The newer structures are easier to build if machinery is available.

## Sustainable Design

Sustainable design essentially asks the trail designer or builder:

- Can we use the proposed construction technique and expect the materials and the various processes to be available years from now if we need to replace part of the trail?
- When the item is no longer usable, can any of the materials be recycled?

- Can recycled materials be used in the construction?
- Are recycled materials appropriate for the proposed use?

These criteria should be considered by all agencies, especially conservation agencies.

## Corduroy

Corduroy was originally used to provide access through wetlands to areas being logged or mined. Essentially, the technique involved laying a bridge on the ground where the soil would not support a road. Two log stringers or beams were placed on the ground about 8 feet apart. Small-diameter logs or half logs were placed on the stringers, spanning them. The logs became the tread or surface of the road. They were spiked or pinned to the stringers (figure 12).

A variation of corduroy construction was to place the tread logs directly on the ground. No stringers were used, and the logs were not pinned or spiked to the ground or each other. Some excavation was required to ensure the tread logs were level. The tread logs eventually heaved up or sank, creating severe cross slopes in the tread.

Corduroy construction was often used in areas with deep shade and considerable rainfall. The combination of sloping, wet tread resulted in a slippery, hazardous surface. The stringers and tread logs soon rotted. With no support, the cross slope on the tread logs became worse and more hazardous.

When corduroy was laid directly on the ground, it interfered with the normal flow of runoff. Runoff was blocked in some areas and concentrated elsewhere. Erosion and relocation of minor streams resulted. No plants grew underneath the corduroy, further damaging the wetland resource. Many trees needed to be cut to provide the logs for the corduroy. In many cases, these impacts would be unacceptable today. The useful life of corduroy today is only 7 to 10 years. Corduroy is rarely replaced because suitable trees are even farther from where they are needed for the reconstruction job.

Corduroy did not represent sustainable design and required considerable maintenance. Corduroy is rarely used today. We do not recommend it.

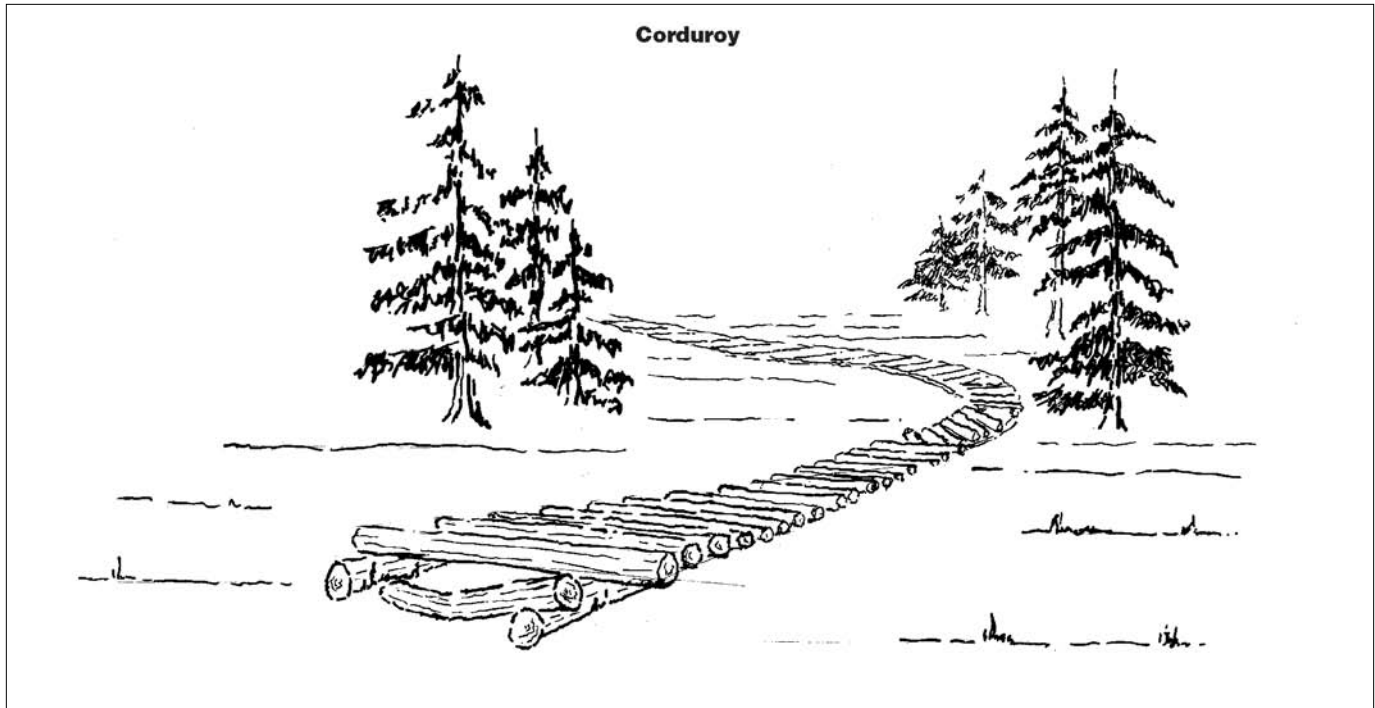

Figure 12—Corduroy requires a lot of native material, rots quickly to an unsafe condition, and is no longer recommended for new construction.

## Turnpikes

Turnpikes are used to elevate the trail above wet ground. The technique uses fill material from parallel side ditches and other areas to build the trail base higher than the surrounding water table. Turnpike construction is used to provide a stable trail base in areas with a high water table and fair- to well-drained soils (figure 13).

A turnpike should be used primarily in flat areas of wet or boggy ground with a 0- to 20-percent sideslope. The most important consideration is to lower the water level below the trail base and to carry the water under and away from the trail at frequent intervals. Turnpikes require some degree of drainage. When the ground is so wet that grading work cannot be accomplished and drainage is not possible, use puncheon or some other technique. A turnpike is easier and cheaper to build than puncheon and may last longer. A causeway is another alternative where groundwater saturation is not a problem and a hardened tread is needed.

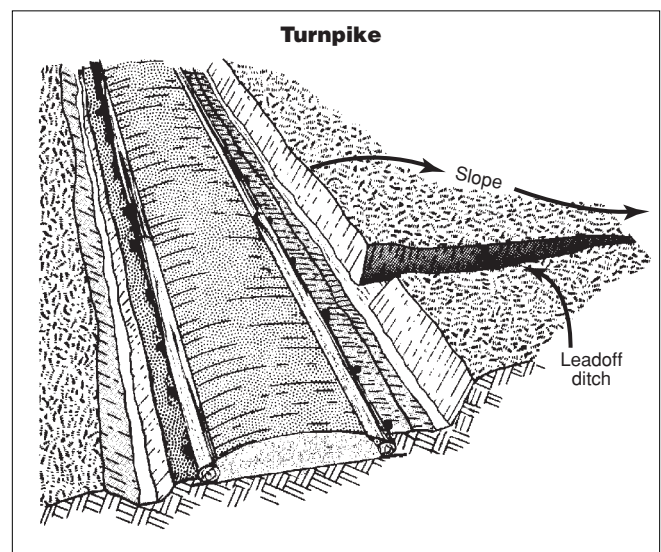

Figure 13—Trail turnpikes usually cost less than other techniques for crossing seasonally wet areas. Occasional culverts are needed for cross drainage under the turnpike.



## Wetland Trail Structures

Begin the turnpike by clearing a site wide enough for the trail tread and a ditch and retainer log or rocks on either side of the trail tread. Rocks, stumps, and roots that would protrude above the turnpike tread or rip geotextiles should be removed or at least cut flush below the final base grade.

Ditch both sides of the trail to lower the water table. Install geotextile or other geosynthetic materials and retainer rocks or logs. Geotextile and geogrid should go under any retainer rocks or logs (figure 14). Lay the geotextile over the ground surface with no excavation, then apply high-quality fill. An alternative method, one that not only provides separation between good fill and clay, but also keeps a layer of soil drier than the muck beneath, is called encapsulation (the sausage technique). Excavate 10 to 12 inches of muck from the middle of the turnpike. Lay a roll of geotextile the length of the turnpike, wide enough to fold back over the top with a 1-foot overlap (figure 15). Place 6 inches of crushed stone, gravel, or broken stone on top of the single layer of geotextile, then fold the geotextile back over the top and continue to fill with tread material.

Rocks or logs can be used for retainers. Rocks last longer. If you use logs, they should be at least 6 inches in diameter, peeled, and preferably treated or naturally decay-resistant. Lay retainer logs in a continuous row along each edge of the trail tread.

Anchor the logs with stakes or, better yet, with large rocks along the outside. The fill and trail surface keep the retainer logs from rolling to the inside.

The practices described above work best on turnpikes in mountain bogs or other areas that are not subject to periodic river flooding. In flood-prone wetlands, different techniques work better. One turnpike was flooded to a depth of 6 to 8 feet on two occasions in 1 month. Stones up to 1 cubic foot in an adjacent area of riprap were lost in the flood. The edges of that turnpike were logs pinned to the ground with diagonally driven driftpins that helped to keep the logs from floating up and away. The logs were still in place after the flood, but the fill material between the logs had been swept away. Geotextile fabric that had been installed between the fill and the ground was still in place. In retrospect, if geocell or geogrid had been placed on the geotextile fabric and stapled, nailed, or placed underneath the logs, most of the fill material would probably have remained in place (figure 16).

Wood used in turnpike construction should be either a naturally decay-resistant species or treated poles. Pinned as described, the logs or poles should survive some floods.

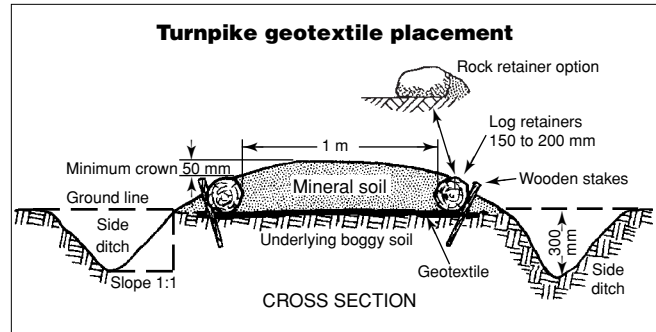

Figure 14—Place the geotextile under the retainer logs or rocks before staking it.

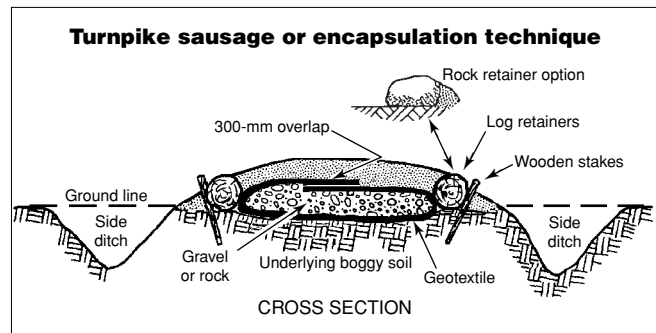

Figure 15—Sausage or encapsulation method.

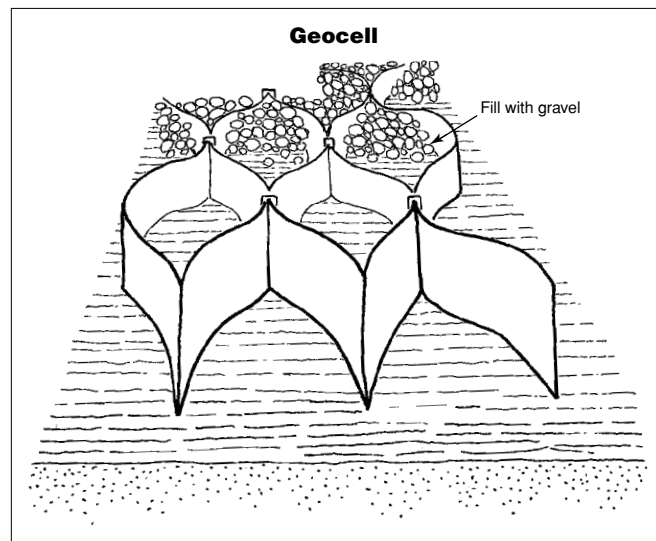
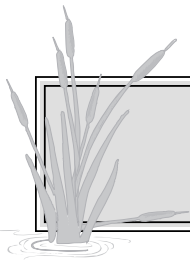

Figure 16—Geocell may help keep fill in place in areas prone to flooding.



Firm mineral soil, coarse-grained soils or granular material, or small, well-graded angular rock are needed for fill. Often, gravel or other well-drained material must be hauled in to surface the trail tread. If good soil is excavated from the ditch, it can be used as fill. Fill should not include organic material and should have minimal silt and clay components. Fill the trail until the crown of the trail tread is 2 inches above the retainer or outsloped a minimum of 2 percent. It doesn't hurt to overfill initially, because the fill will settle (figure 17). Compacting the fill—wet it first—with a vibratory plate compactor will help reduce settling.



Figure 17—A new turnpike will need additional fill as it settles, especially during the first year. This turnpike has a timber culvert.

Fill material imported from outside sources may contain seeds of invasive weeds. Instead, it is standard procedure to dig a borrow pit near the site. The pit and routes to it should be carefully located to avoid resource damage and a construction scar that will be seen for many years. The borrow pit should be dug into a slope so that the floor of the pit can slope out and carry runoff water out of the pit. After the trail has been completed, grade back the sides of the pit and revegetate the disturbed area with native plant material.

Keep water from flowing onto the turnpike by constructing a dip, waterbar, or a drainage structure at each end of the turnpike where necessary. Keep the approaches as straight as possible or widen any curves coming onto a turnpike to minimize the chance that packstock or motorbike users will cut the corners and end up in the ditches.

Turnpike maintenance, especially recrowning, is particularly important the year after construction; the soil settles the most during the first year.

## ***Causeways***

A more environmentally friendly relative of the turnpike is the causeway, essentially a turnpike without side ditches (figure 18). Causeways filled with broken rock have been successfully used throughout the Sierra Nevada and elsewhere to create an elevated, hardened tread across seasonally wet alpine meadows. Often, multiple parallel paths are restored and replaced with a single causeway. Causeways create less environmental impact than turnpikes because they do not require ditches that lower the water table. In highly saturated soils the causeway could sink into the ground, a problem that geotextiles can help prevent.

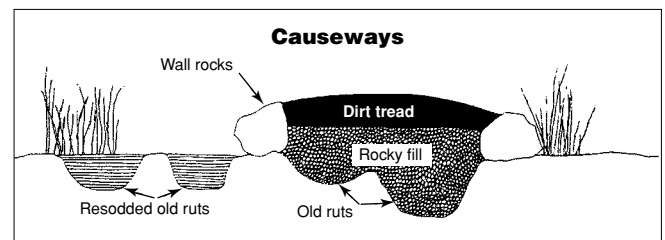

Figure 18—Causeways create an elevated, hardened tread across seasonally wet areas. Geotextiles may be added to help prevent the trail from sinking into the ground.

## ***Improving Drainage Dips or Ditches***

Turnpikes and causeways interrupt the flow of water along and across the trail. You need to take measures to ensure that water flows away from turnpikes instead of saturating them. The tools to ensure that water flows away from turnpikes include: dips (or ditches), open drains, French drains or underdrains, and culverts.



## Wetland Trail Structures

Generally, dips are at least 12 inches deep, have flat bottoms, and sideslope ratios of 1:1. In many cases, the dip can be extended beyond the wet area to capture water that might flow onto the trail.

The simplest way to get water across a trail is to cut a trench across it. These open-top cross drains, or dips, can be reinforced with rocks or treated timbers to prevent cave-ins. These structures are not usually a good alternative because people and packstock stumble on them. One way to reduce this risk is to make the dip wide enough (at least 2 feet) so that packstock will step into the drain rather than over it (figure 19).

An open drain can be filled with gravel. Such a drain is called a French drain. Start with larger pieces of rock and gravel at the bottom, topping the drain off with smaller aggregate (figure 20). French drains are often used to drain a seep or spring underneath a trail bed. A perforated or slotted pipe in

the bottom of the drain reduces the amount of fill material needed and drains the area more effectively.

## Culverts

Culverts provide better and safer drainage across turnpikes than open drainage gaps or ditches.

Historically, culverts were built as small bridges, using stone or logs. Stone culverts require large stones and a skilled mason. Finding large stones is difficult. Today, dry stone masonry is almost a lost art. Well-built stone culverts can be extremely durable. Some stone culverts that are at least 100 years old are still in use.

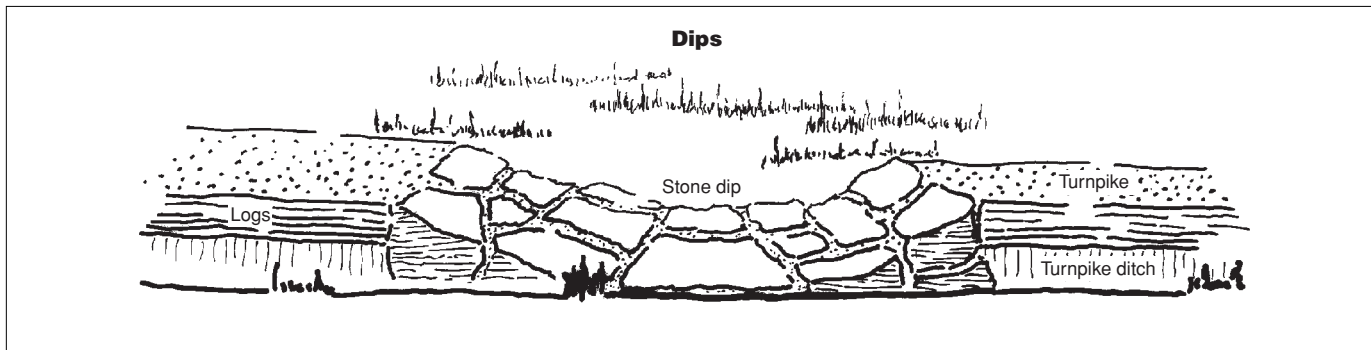

Figure 19—Dips and ditches are a simple and effective way to drain wet areas. The slope angle and depth vary with soil and water conditions. Stones help reinforce the dip. Geotextile may be installed under the stone dip to prevent fine materials from washing out.

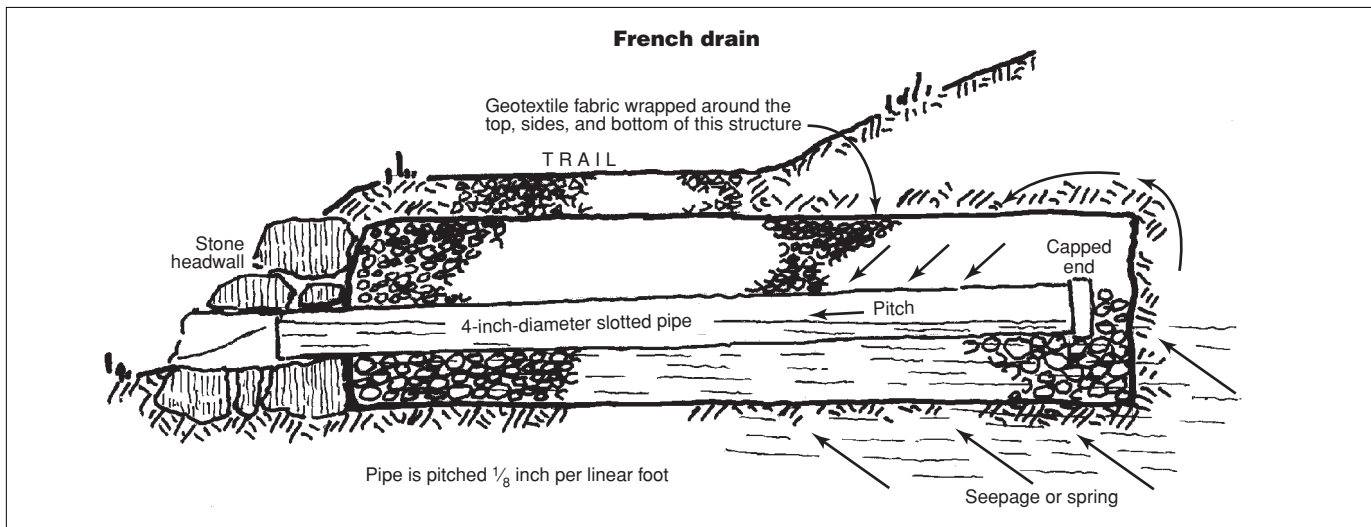
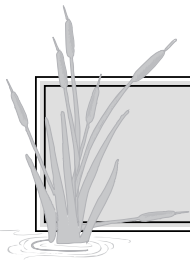

Figure 20—Wrapping French drains with geotextile helps prevent clogging. French drains or underdrains are used to drain springs and seeps that have a low flow.





Log culverts were used where stone (and stone masons) were not as readily available as logs. Construction crews may also have been more familiar with log construction. Log and timber culverts require less skill to build than stone culverts, but need maintenance. Expect to replace log culverts in 20 to 40 years, although they can last much longer.

Building a timber culvert is simple. We typically use 6 by 6 and 4 by 6 timbers, cutting them to any length suitable for the site and trail condition. Although old railroad culverts sloped the invert of their culverts, it may be difficult to do so in a wetland. In fact, it may be wise to build the invert level. This way the rising water from a creek or river can easily flow through the culvert as the water rises and recedes during a flood.

To build a timber culvert, two timber sleepers are placed in a shallow trench on each side of the trail, parallel to the trail centerline. The sleepers are pinned to the ground with at least two driftpins (figure 21). A timber wall is constructed on each side of the invert, resting on both sleepers. These walls can be as high or low as is suitable for the site condition. Notched 4 by 6 timbers are placed on the top of the walls to become the trail tread. The 4 by 6 timbers are spiked or pinned to the walls. Depending on materials available, the invert may be lined with stone or with planks resting on the sleepers. The invert should be flush with the bottom of the creek or wetland to allow aquatic organisms to move freely.

Normally, timber walls require deadmen going back perpendicular from the face of the wall into the earth behind the wall. The deadmen help keep the wall from collapsing. Because the walls for a timber culvert are only 6 to 8 feet long, installing deadmen is impractical. However, some bracing is

needed to keep the walls from collapsing. For timber culverts with walls retaining 12 to 24 inches of earth, 4 by 6 timbers can be used for each side of the tread surface. The bottom of each 4 by 6 can be notched 1 inch deep at each end to fit over the two timber walls, forming a brace to support the walls. The area between these two 4 by 6s can be filled with 3-inch-wide planks (figure 22). Timber walls retaining more than 24 inches of earth should have notched 4 by 6s the full width of the tread surface.

Most lumberyards carry 4 by 6s only in 8-foot lengths. For efficient use of the wood, the 4 by 6s should be used to span distances of 8 feet, 4 feet, or 2 feet, 8 inches. The 2-foot, 8-inch length would provide a 20-inch-wide open area and is the minimum width recommended for timber culverts. The minimum clear height of the culvert should be 7 inches. Rough sawn 2-inch-wide lumber is adequate for the entire tread surface of the 2-foot, 8-inch culvert (figure 23).

The trail tread can be the surface of the top timbers of the culvert, or a curb can be added on each side and the space between the curbs can be filled with earth. The height and width of a timber culvert can be adjusted to fit site conditions and the expected volume of water. The spacing and number of culverts can also be adjusted to reduce the concentration of runoff and potential erosion problems. Timber culverts have an advantage over round pipe because the top timbers can be quite low and still provide the cross-sectional area of a large round pipe. Round pipe also concentrates runoff, while timber culverts spread the same volume of water over a wider area. Timber culverts work well with turnpike construction. Round pipe requires taller structures, a disadvantage.

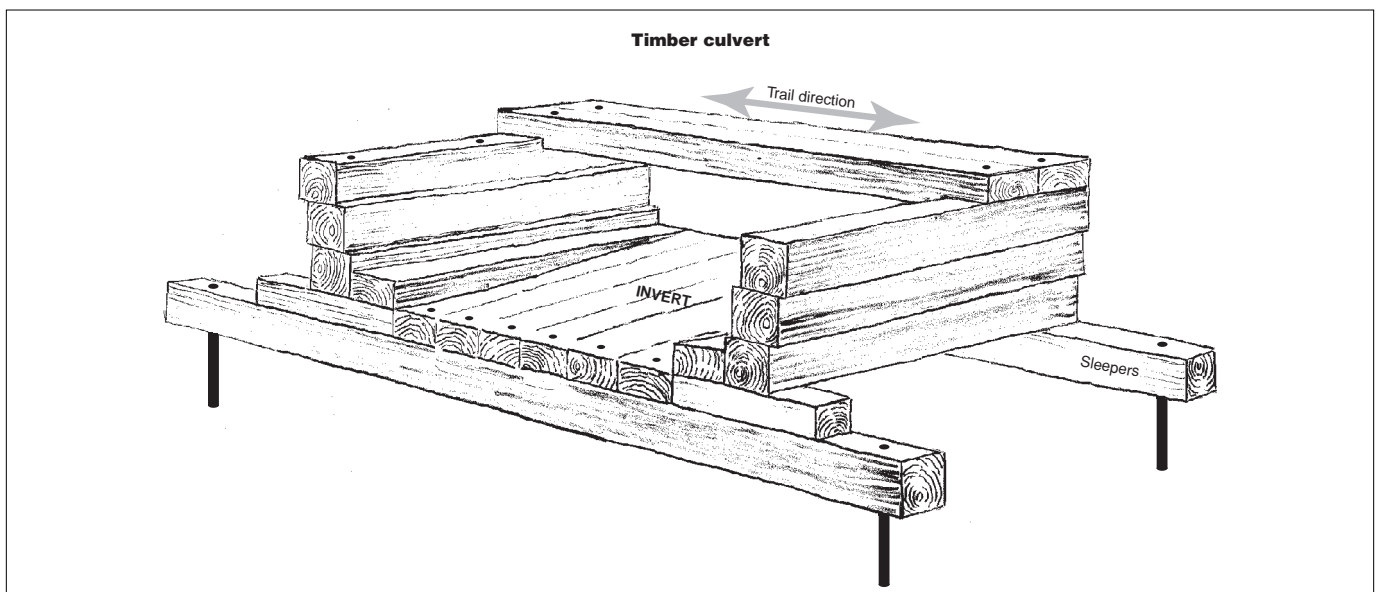

Figure 21—Timber culvert. The invert (bottom of the culvert) is often built level in wetlands because it is less likely to wash away in floods.

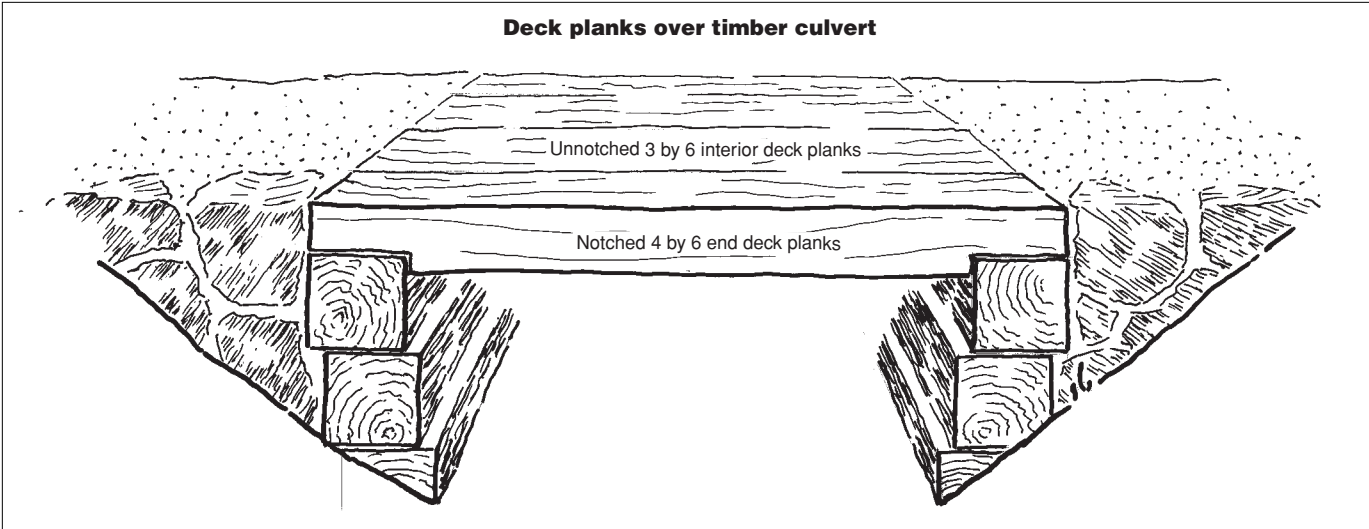

Figure 22—Notching the deck planks on both ends of the culvert (two planks with notches are adequate for a wall up to 24 inches high) helps to brace the walls.

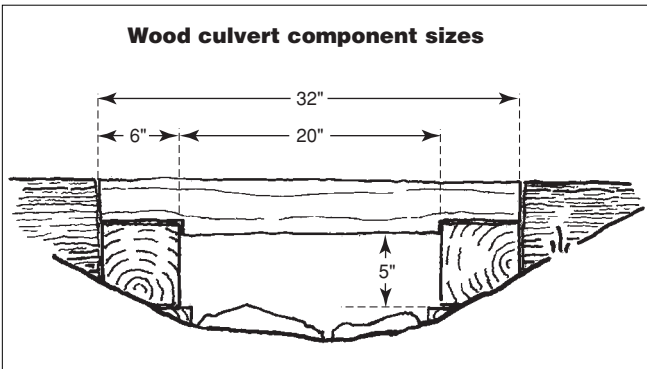

Figure 23—Minimum size recommendations for a wooden culvert designed to use standard timber sizes efficiently. Often larger culverts may be needed. This culvert has no constructed invert.

Pipe is not a traditional or visually compatible material for some backcountry trail culverts. Also, it is difficult to clean a small-diameter pipe with a shovel. A typical shovel blade is 9 inches wide and requires many passes to clean out a 12-inch-diameter pipe. You can do the job more easily with the smaller-diameter combi (combination tool). Make the rectangular opening of a timber culvert 20 inches wide and it will be

much easier to clean than a round pipe. Pipes as small as 2 inches in diameter have been used to carry surface runoff beneath turnpike (appendix C compares round and rectangular culverts). Such pipes plug up within weeks and are impossible to clean. They should never have been installed.

Corrugated plastic culverts are sturdy, lightweight, and easy to cut. Although the culverts are not natural, the colors usually blend in with their surroundings better than steel. High-density polyethylene (HDPE) plastic culverts have become quite popular for trail work. However, some trail designers feel corrugated plastic culverts look out of place and they may not meet Recreational Opportunity Spectrum guidelines in remote sites. The ends can be framed by rock so they look natural, and plastic does not decay.

Timbers or logs used in culvert construction should be naturally decay-resistant or treated wood to help meet sustainability criteria. Treated wood should meet best management practices for aquatic environments.

Another culvert design that can be effective is an open-bottom culvert, essentially half of a round culvert. Open-bottom culverts need to be adequately supported under both edges.

# Structures Requiring Foundations

Corduroy, turnpikes, causeways, and improved drainage are all constructed directly on the ground and do not require a foundation. The remaining techniques—puncheon, bog bridges, gadbury, and boardwalks—all require some sort of constructed foundation to raise the structure off the ground.

The type of foundation needed varies with the structure being constructed, materials available, and the site-specific soil and water conditions. More than one type of foundation may be appropriate for each structure, so we will discuss foundations first. These foundations include sleepers, cribbing, end-bearing piles, friction piles, and helical piles.

## Sleepers (Sills)

The simplest foundation is to rest the tread plank or stringers on sleepers, also called sills, or mud sills. A log of a naturally decay-resistant wood or a large-diameter treated

pole or post is used for the sleepers. Sleepers are used to support puncheon, gadbury, and bog bridge construction. The notching for each type of structure is different and will be discussed later in this chapter.

A sleeper (figure 24) is placed in a shallow trench at a right angle to the trail centerline. A second sleeper is placed in another trench parallel with the first sleeper. The distance between the two sleepers is the span. The span is determined with the help of someone with carpentry or structural engineering experience.

Pinning the sleepers to the ground with 24- to 30-inch driftpins is extra work, but it may reduce future maintenance in wetlands subject to flooding. Pinning is most important near streams or rivers where high water velocities may occur during flooding. Pinning may also reduce maintenance in areas of frequent slack-water flooding. The outer driftpins should be driven in holes drilled at opposing angles. Driftpins installed at these angles will resist flotation and uplift from frost and will also deter vandalism. If rebar is used for pinning, the hole can be  $\frac{1}{16}$ -inch smaller diameter than the rebar. Otherwise, the hole should be the diameter of the pin.

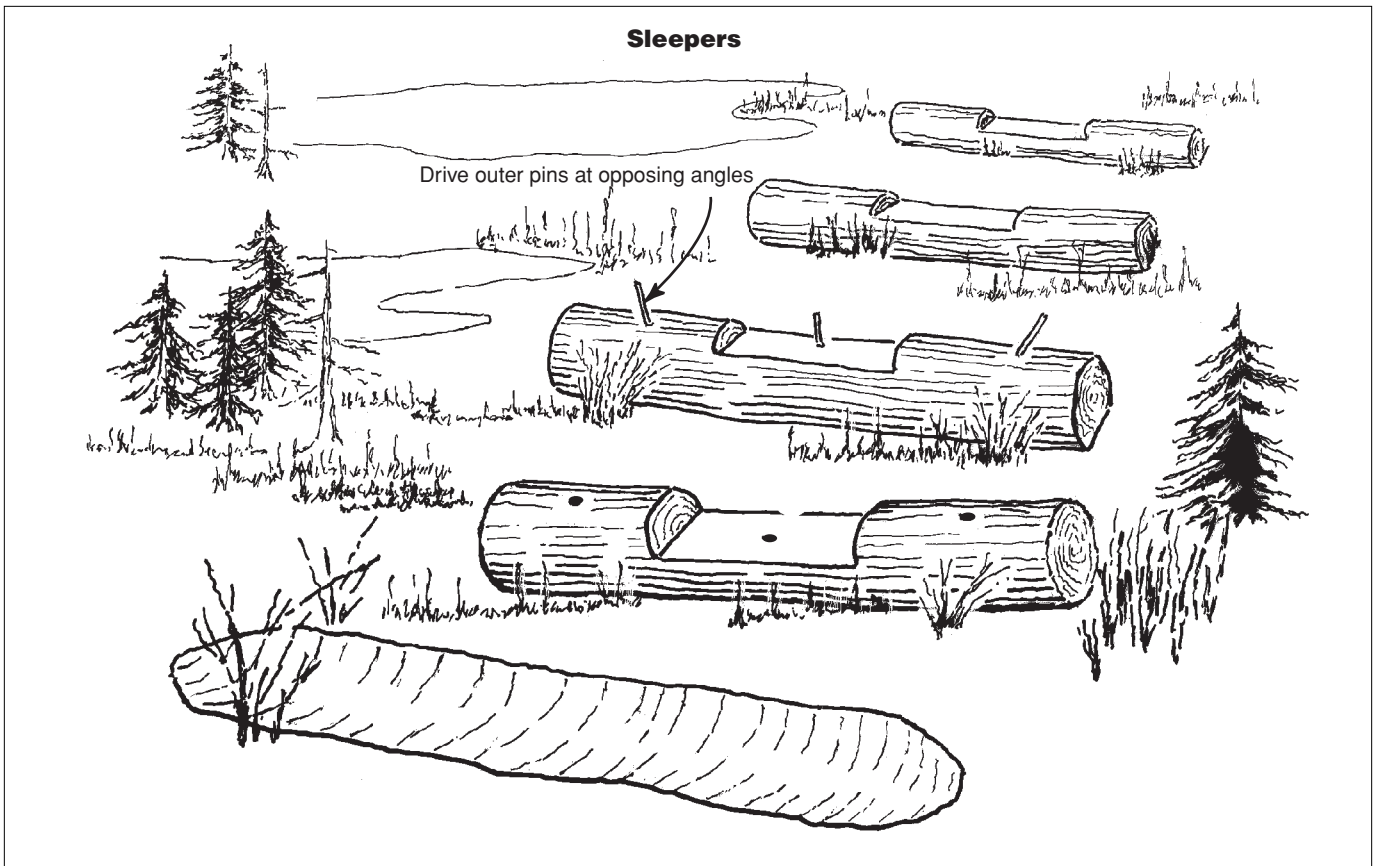
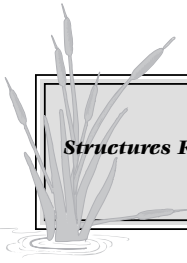

Figure 24—Place sleepers in a shallow trench and pin them at opposing angles so they won't float away during seasonal flooding.



## Structures Requiring Foundations

Timbers are sometimes used instead of logs for sleepers. Timbers are easier to work with because they do not require notching. However, timbers do not have the same rustic quality as logs. Precast concrete parking bumpers and other precast concrete units have been used for sleepers, but they are far from rustic. Concrete bumpers weighing 150 pounds per cubic foot are difficult to bring to the site. In most wetland soils, they will eventually sink into the ground.

Sometimes the base for the sleeper can be strengthened by excavating deeper, wider, and longer; laying down geotextile; adding several inches of gravel on top of the geotextile; and folding the geotextile back over the top of the gravel to encapsulate it. Lay the sleeper on top of this foundation.

### Cribbing

In hummocky terrain or when crossing a wide, low area, log or timber cribbing can be used to support a trail. Usually logs are used to construct cribbing (figure 25). Dig two parallel

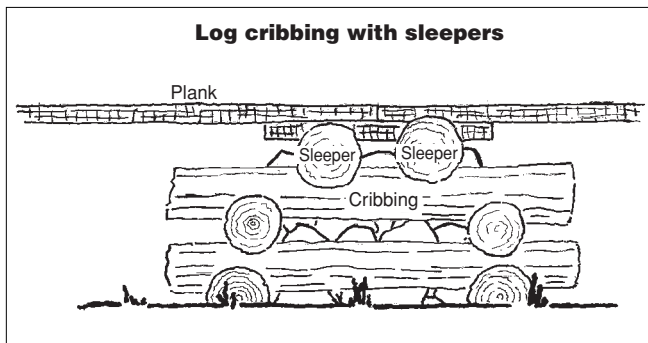

Figure 25—Log cribbing with two sleepers.

shallow trenches a few feet apart. Place a sleeper in each trench and diagonally pin it to the ground with three 30-inch driftpins. Drive the outer two pins at opposing angles. Depending on the width of the completed trail, the first layer (or course) may be 3- to 5-foot-long logs. A second course of two more logs is placed on the first course of logs, near their ends. Each course of logs is placed at right angles to the course below and spiked or pinned to it. The cribbing is built up until the proper height is reached. Lay the top course perpendicular to the centerline of the trail. Stringers or plank can either be nailed to each of the top logs or timbers, or a single, large-diameter log can be notched and pinned to the top logs (similar to the sleepers described earlier).

If you use logs, saddle notches may be used in the bottom of all but the sleepers. This will result in a solid wall of logs. A simpler technique is to use a square notch at the ends of each log that contacts another. This technique will leave a 3- to 6-inch gap between the logs (figure 26).

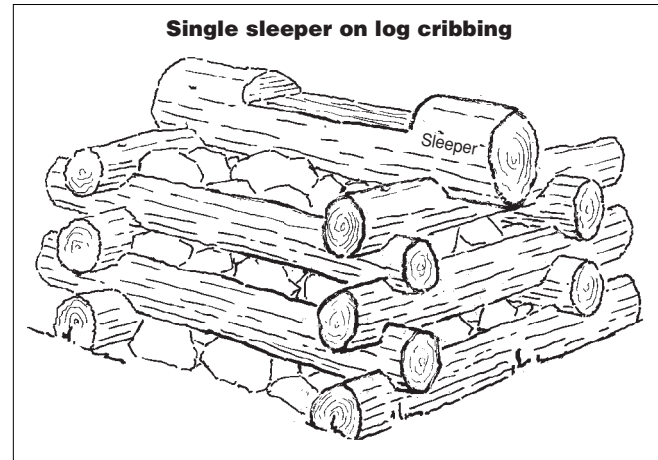

Figure 26—Log cribbing with a single sleeper. Do not notch logs that contact the ground.

Drive spikes or 12-inch-long driftpins into predrilled holes at the corners of the cribbing to hold it together. Avoid stacking the joints on top of each other. The joints must be offset or the driftpins from each course will hit the driftpins in the logs of the course below.

Timbers are easier to use than logs because they do not have to be notched. For greater stability and to prevent the cribbing from being washed away in floods, you can fill the open space in the core of the cribbing with stone.

Wire gabion baskets filled with rock also can be used for crib structures. Sleepers are placed on top.

### Wooden Piles

Piles are another foundation technique. Three types of piles have been used for wetland trails. Structural engineers refer to these piles as end-bearing piles, friction piles, and helical piles (figure 27). Geotechnical engineers use a hand-operated relative density probe to help determine soil conditions. The probe is driven into the ground with a fixed force, allowing resistance to be calculated.

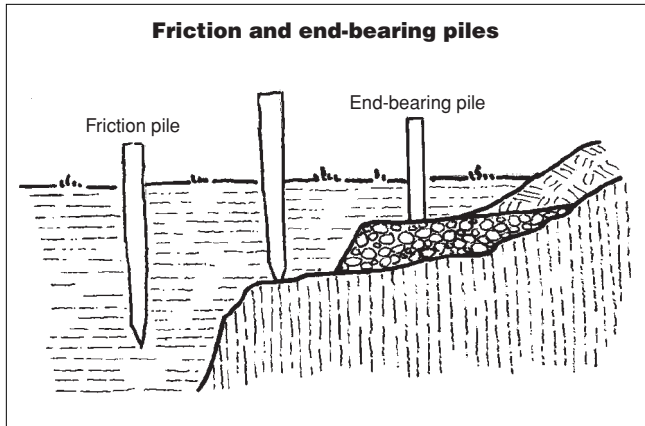
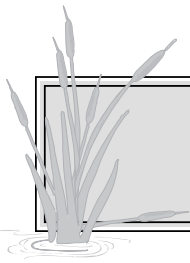

Figure 27—Friction and end-bearing piles. The pile in the middle began as a friction pile but became an end-bearing pile because it met solid resistance before fetching up.

### **End-Bearing Piles**

End-bearing piles are used at locations where firm earth or solid rock is found 2 to 10 feet below the ground. Although the soil at these sites may support sleepers, piles can be used to support the tread at abrupt changes in grade when the tread must be 1 to 5 feet above the ground or water. Piles can also support handrails.

To place an end-bearing pile, excavate a hole a little wider than the pile to a point below the frostline. If you encounter solid rock in the bottom of the hole before reaching the frostline, the pile can rest on the rock. Power augers help make digging easier and faster. In wilderness areas or where only a few holes are needed, a posthole digger, manually operated auger, or shovel will do the job.

Place the pile upright and plumb in the hole. Place the excavated earth (or imported coarse sand or gravel) in the hole in 6- to 8-inch layers, equally on all sides of the pile, and compact it by tamping. A tamping bar is the best tool for compacting earth (figure 28).

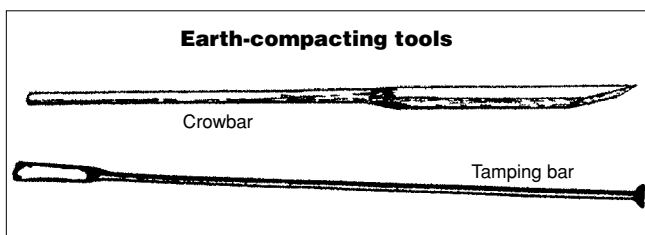

Figure 28—A crowbar (rock bar) and a tamping bar. The tamping bar is lighter than the crowbar and is best suited for loosening soil in holes and for tamping around posts.

End-bearing piles can be made from naturally decay-resistant or pressure-treated wood, steel, or concrete cast in sonotubes (disposable cylindrical forms). Wood is typically used because it is readily available and easier to use than steel or concrete. Connections to a wood pile are also much easier to make, and the tools needed for the job are lighter and more readily available. Timbers are the first choice for end-bearing piles because their flat, squared sides are easier to connect to than the round surface of logs. Usually, rough-sawn, pressure-treated 6 by 6s are adequate for this work (figure 29).

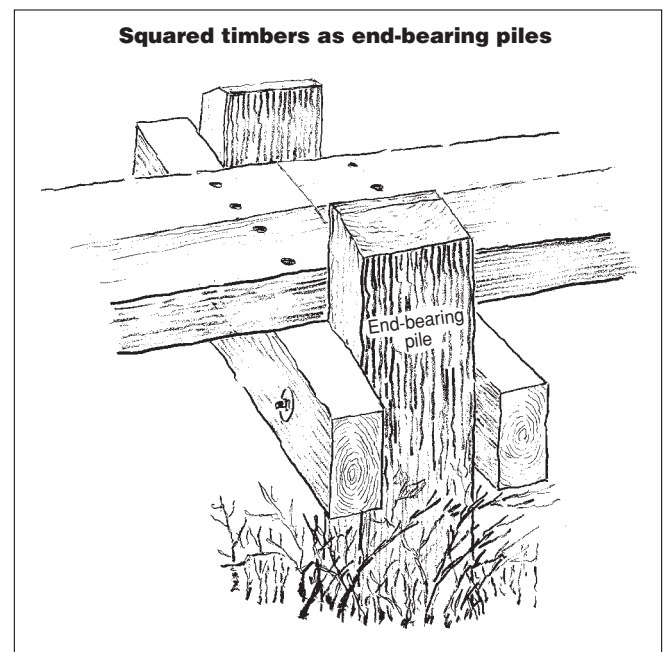

Figure 29—Using squared timbers for end-bearing piles makes connections easier than when round piles are used. Cut the tops at an angle so they will shed water.

### **Friction Piles**

Friction piles are normally used when the ground is wet and sloppy—areas where you need logs or some kind of a deck to stand on while you work. Friction piles for trail work are usually at least 12 feet long and 10 to 12 inches in diameter. Friction piles are considerably heavier, more awkward to transport, and more difficult to install than end-bearing piles.

A friction pile should be a naturally decay-resistant log or a pressure-treated log or pole. Cut a point on the narrow end and dig a shallow hole where the pile is to go. The pile must be driven with the wide butt end up and the narrow end down. The pile should stand as plumb as possible.

For backcountry wetland trail construction, friction piles are driven by hand. Pile driving is done with a “hammer”—a 2½-foot piece of 12-inch-diameter steel pipe (figure 30). A cap is welded at the top and two ½-inch-diameter holes are cut in the cap to let air out. Two steel handles of ½-inch-diameter reinforcing bars are welded to the sides of the pipe. At one area where friction pile construction was common, two of these hammers were used to drive the piles by hand. One hammer weighed 90 pounds and the other 135 pounds. Using these tools builds strong bodies. Usually two persons work together when operating these manual pile drivers.

The theory of the friction pile is that the surface of the pile develops friction against the sloppy soil. The deeper the pile is driven, the more friction develops, until finally the pile “fetches up” and can be driven only fractions of an inch with each blow of the hammer. When that point is reached, pile driving stops, normally at depths of 6 to 10 feet. Sometimes firm soil or rock will be reached before the pile fetches up. At this point the driving stops and the pile becomes an end-bearing pile.

If the trail is being built progressively, 12- to 16-foot piles can be driven by a small, lightweight machine with a pile driver attachment. Building a wetland trail strong enough to support the pile driver may be worthwhile in coastal areas that are subject to hurricanes, northeasters, or typhoons. If the wetland trail can support the machine, it will probably withstand some severe storms. If longer piles are needed, a much heavier pile driver can be brought to some sites on a barge.

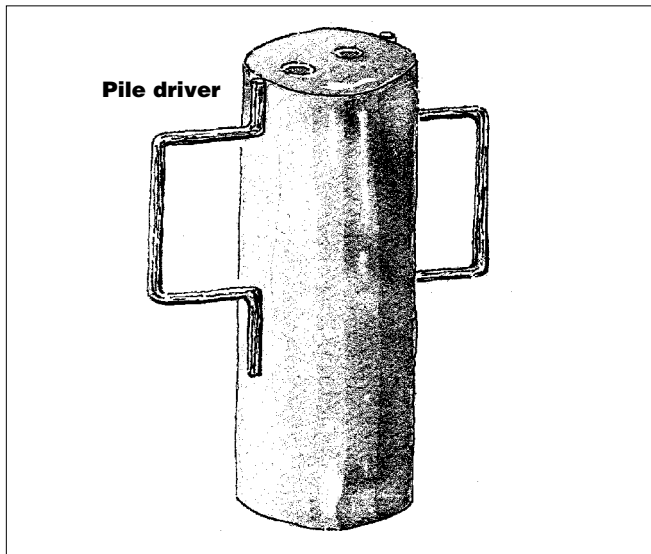

Figure 30—A pile driver (hammer) can weigh 135 pounds or more.

## ***Bent Construction***

Whether wood end-bearing or friction piles are used, once a pile is in place, the construction is similar. A second pile is placed on the opposite side of the trail centerline so that each is the same distance from the centerline. When both piles are in place, they are connected by one or two ledgers. The combination of ledgers and piles is called a bent.

On a one-ledger bent, the top of each wood pile is cut flat and level with the opposite pile. A 3 by 6 or 3 by 8 timber is placed flat on the top of both piles so that it extends a few inches beyond each of them. This timber, or ledger, is spiked to the top of each pile (figure 31).

When two ledgers are used, one is bolted to the front and one to the back of each pile, spanning the space between the piles. Drill a hole through each pile parallel with the trail centerline. These holes (and ledgers) should be level with each other. A 3- by 6-inch ledger is held in place on one side of the pile, and the hole in the pile is extended through the ledger. This is repeated until each ledger can be bolted to each pile. The ledgers should be level and level with each other.

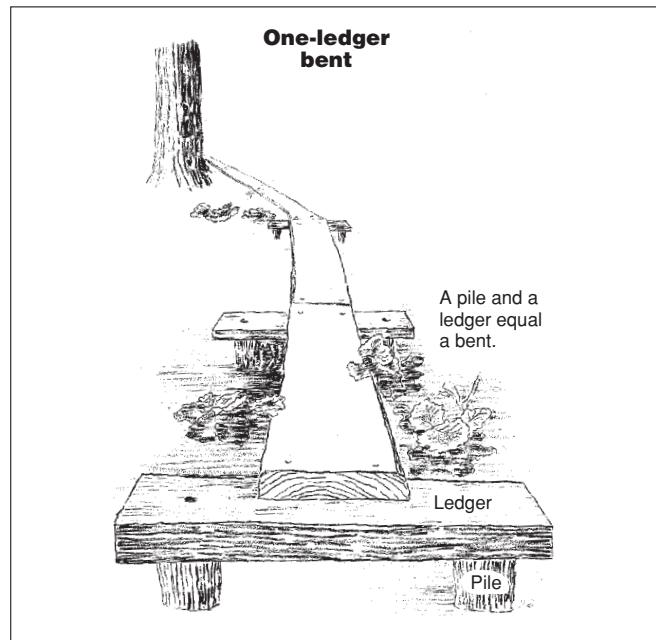

Figure 31—A bent with one ledger. Spike the ledger to the top of each pile. The pile and ledger are collectively called a bent.

Another method for the same type of installation is to determine the proper height of the ledgers and clamp the pair of ledgers to each pile of the bent. Drill a hole through the ledger, the pile, and the opposite ledger, all at once. This is faster, but requires two large clamps that can open at least 1 foot (figure 32).

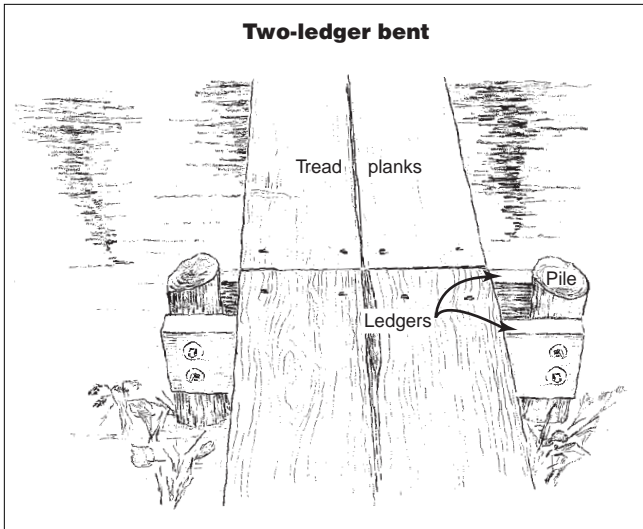
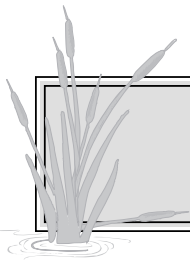

Figure 32—A bent with two ledgers. Trim the tops of the piles at an angle so they will shed water. The bolts go through the pile and both ledgers.

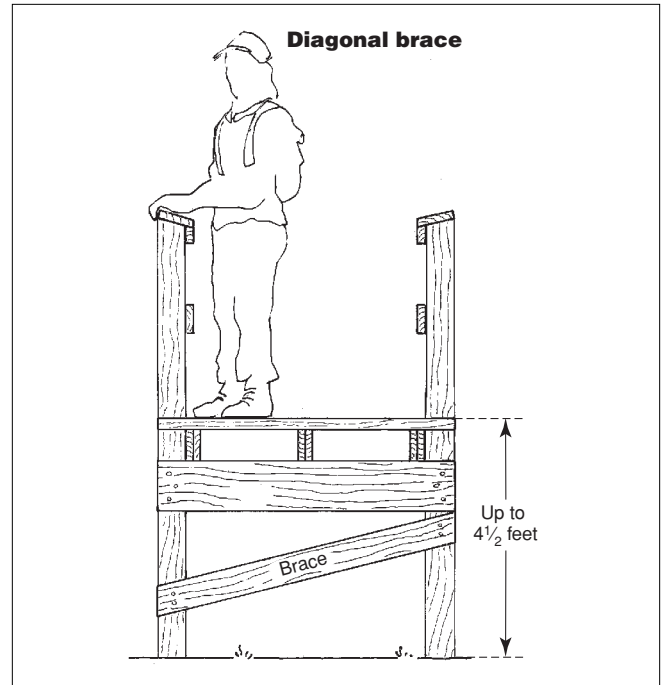

Figure 33—A single diagonal brace is adequate if the deck is no more than 4½ feet above the ground. Alternate braces on successive bents.

After installing a pair of bents, pressure-treated 3- by 12-inch tread planks are nailed to the ledger or ledgers as described for the bog bridge on sleepers. If the planks are more than 2 feet above the ground or water, the tread should be at least two planks wide for trails that do not have to meet accessibility standards. Collect and dispose of treated wood trimmings and sawdust.

Where the deck will be more than 3 feet above the ground, diagonal bracing is needed to connect the piles of a bent. A single diagonal brace is adequate if the deck is just 3 to 4½ feet above the ground (figure 33). If the deck is higher than 4½ feet, two diagonal braces are necessary. These braces should be installed as a cross brace, forming an X between the piles. Diagonal braces are normally wood (figure 34). The angle of the braces should be between 30 to 60 degrees to the horizontal to provide enough support. Angles of 30, 45, or 60 degrees, or a 3-4-5 triangle, make the mathematics of carpentry easier in the field.

Occasionally, the ground is well below the surface of the tread. If the tread is 4 feet or more above the ground and the space between the bents is 6 feet or more, diagonal bracing may be needed to connect consecutive bents. Bracing between bents is done with wood members from the right pile of one bent to the right pile of the next, and the left pile of the bent to the left pile of the next (figure 35). Keep in mind that braces impede waterflow and can contribute to debris and ice jams.

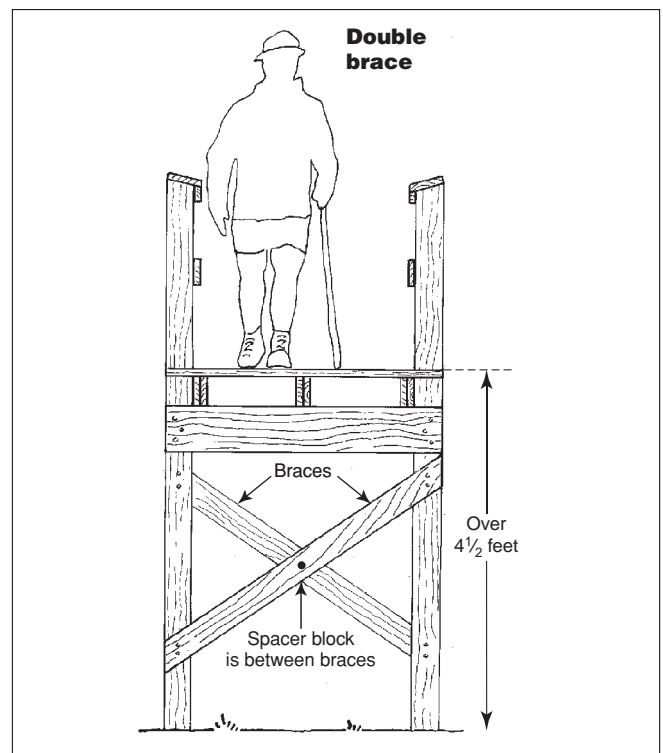

Figure 34—Use a cross brace if the deck is higher than 4½ feet above the ground. Extra-long braces can be bolted together using a spacer block to increase rigidity.

## Structures Requiring Foundations

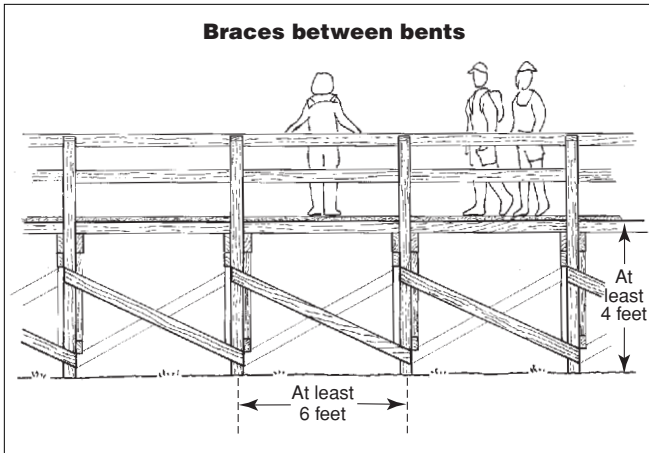
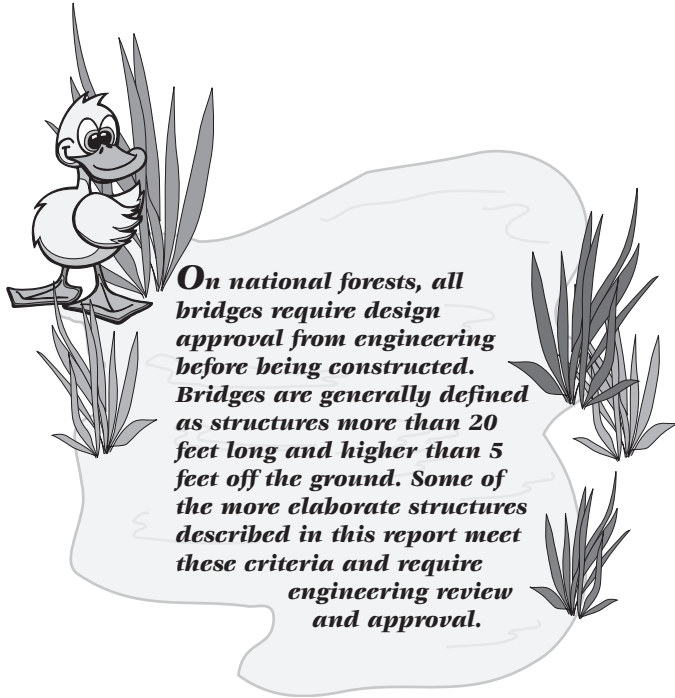

Figure 35—Bracing between bents is sometimes necessary.



**On national forests, all bridges require design approval from engineering before being constructed. Bridges are generally defined as structures more than 20 feet long and higher than 5 feet off the ground. Some of the more elaborate structures described in this report meet these criteria and require engineering review and approval.**

## Helical Piles (Screw Piles)

Helical piles, or screw piles, are more accurate terms for a recent adaptation of an old construction technique using screw anchors. Screw anchors were originally used in poor soils, often with cable guy lines. The design of the screw

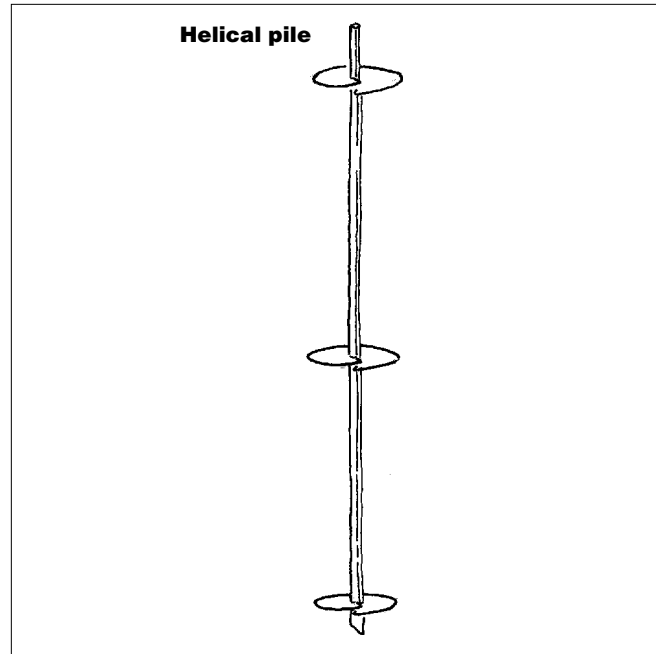

Figure 36—Helical piles are an alternative to friction piles.

anchor was modified to be used as a helical pile. Although technically incorrect, the term screw anchor is still used (figure 36).

Helical piles are now used to support anything from utility poles to large buildings built on poor wetland soils. They require special equipment and techniques to install. Many certified contractors are located throughout the country to allow for competitive bidding. Sometimes certified contractors will train volunteers to do the work. **Helical piles are an excellent alternative to friction piles. They weigh less, are easier to install with portable equipment, and result in less ground disturbance. Their overall cost may be much less than friction piles** (figure 37).

A helical pile includes a helical lead section and a beam saddle. The lead section is solid high-strength steel 3½, 5, or 7 feet long, pointed at the bottom. One, two, or three solid steel helices 8, 10, or 12 inches in diameter and spaced 2½ to 3 feet apart, are welded around a solid steel shaft. The diameter and number of helices depend on the loads to be carried and the soil conditions at the site. The helices are attached to the steel shaft with one edge of the slit lower than the other, creating a leading edge and a trailing edge. All the elements of a helical pile are hot-dipped galvanized. Bolt holes are provided at the end of each lead section for bolting another helical section to the lead section (figure 38).



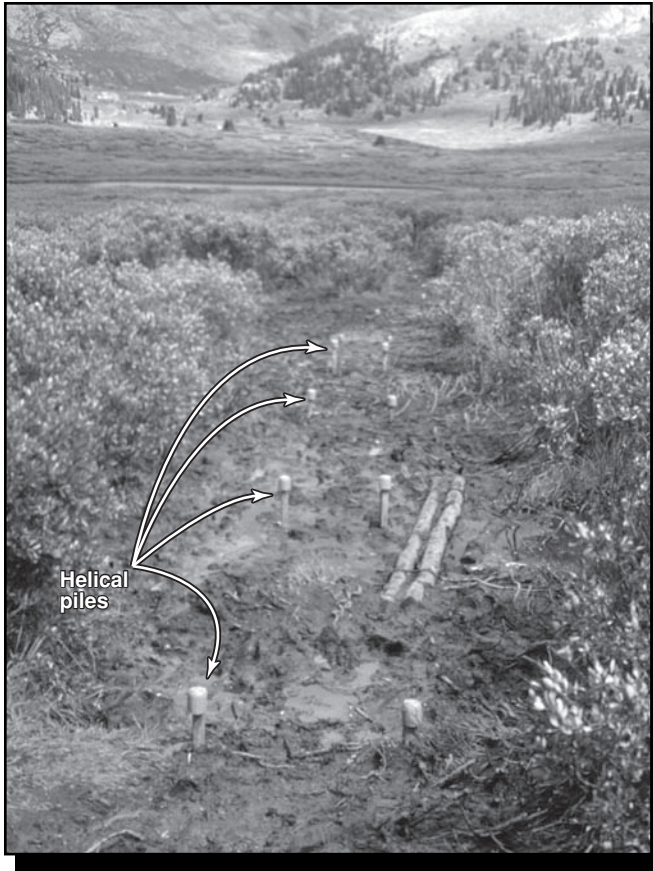
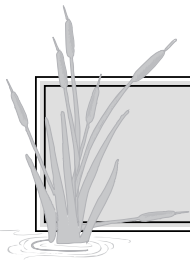

Figure 37—Helical piles installed in Colorado. The saddles are not yet attached. The ends are covered with temporary plastic caps for safety.



Figure 38—A helical pile was used for this boardwalk. Stringers are attached directly to the beam saddle, helping to keep the boardwalk close to the ground.

A 12-inch-long, L-shaped beam saddle fits into the end of the steel shaft of the helical pile where the sections are bolted together. The beam saddle consists of a steel angle welded to a pipe sleeve. Two bolt holes in the vertical leg of the steel angle are opposite two bolt holes in a steel side lockplate (figure 39). The side lockplate is held in place by two bolts through the steel angle, through a wooden ledger or stringer, and through the side lockplate. The beam bracket can be adjusted up to 3½ inches by tightening the nuts on the bolt. A custom saddle is often used to accommodate larger wood or steel ledgers.

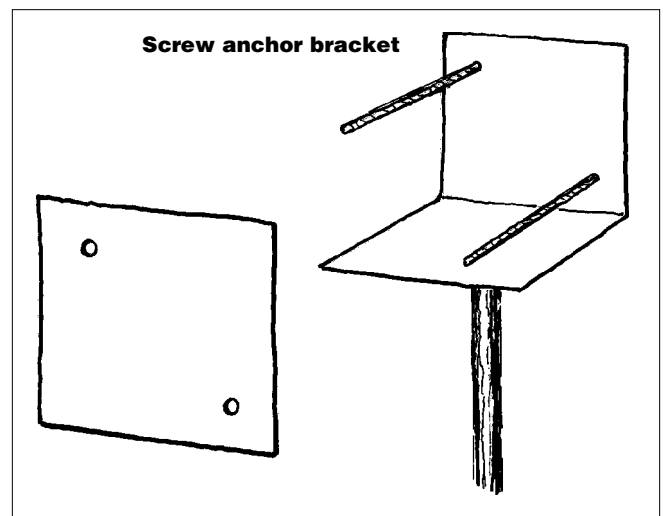

Figure 39—Screw anchor bracket for helical piles.

In poor soils, longer helical piles are sometimes used to achieve the needed load-bearing capacity. To reach that capacity, the pile is augered into the ground until a predetermined torque (the force needed to twist the lead section into the ground) is reached. Extensions can be bolted on to the lead section and augered into the ground until the correct torque is reached.

### Helical Pile Assembly

Helical pile assemblies for wetland trails usually consist of two helical piles opposite each other, one on each side of the bog bridge or boardwalk, or they may be located under the boardwalk. The two piles may be tied together with a ledger or a pair of ledgers placed on edge, resting on the beam saddle of each pile. The ledgers are usually solid wood—3 by 6, 8, 10, or 12 inch, or two or three pieces of 2 by 4s or 2 by 6s nailed together. Ledgers may also be glulamated. The ledgers are bolted to each beam saddle (figure 40).



## Structures Requiring Foundations

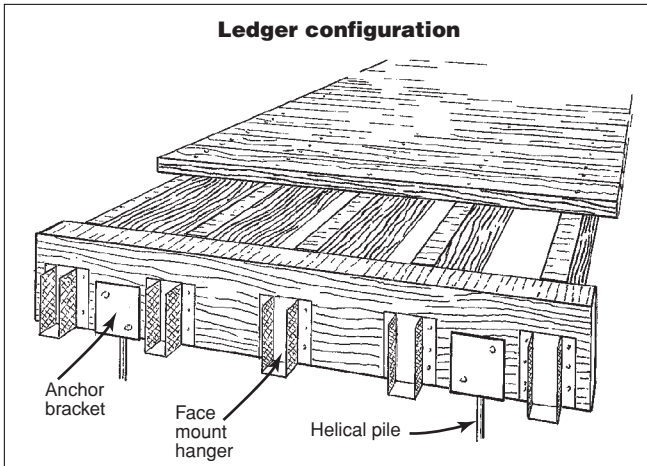

Figure 40—Typical ledger configuration of a helical pile assembly.

If the deck is 3 to 4½ feet above the ground, a diagonal brace is needed between the piles. If the deck is more than 4½ feet above the ground, two diagonal braces are needed, installed as cross braces. Diagonal braces may be additional helical piles (figure 41) or steel angles with diagonal cable attached to them. If bents are 6 feet apart or more, diagonal bracing between bents may also be needed. Consecutive bents may be braced diagonally from the left helical pile of one bent to the right helical pile of the next bent. The procedure is repeated to connect the bents' two remaining helical piles.

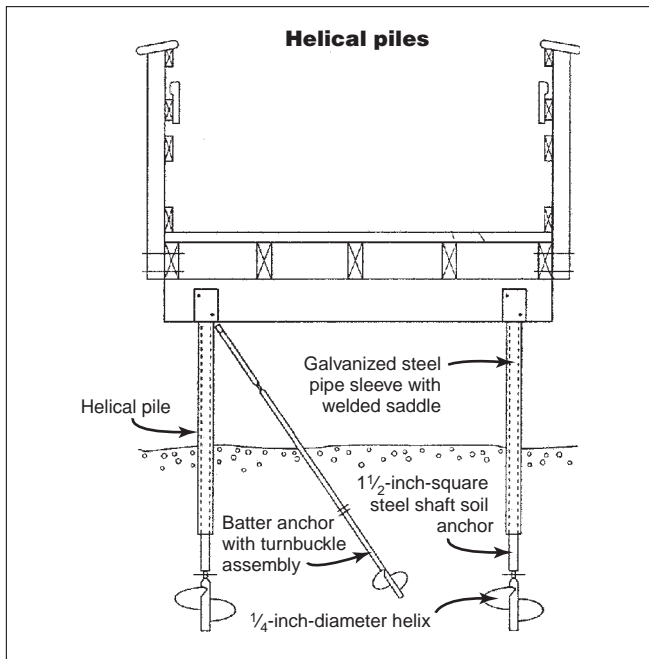

Figure 41—Typical helical pile assembly.

## Special Site Considerations

A trail in a spruce bog requires adapting wetland construction techniques to the site. The most applicable technique is the bog bridge on bents. However, unlike construction in most wetlands, the location of each pile will have to be adjusted in the field to avoid roots.

Although the upper layer of soil is organic, the underlying soil may not be. Dig test holes along the proposed route to determine whether end-bearing piles, friction piles, or a combination of both is the best technique.

The spacing between piers will vary, as will the angle of the bents to the trail centerline. Some of the tread planks will be shorter than normal, and others will be longer. Starting with tread planks that are twice the normal length will permit cutting short pieces to fit one location, leaving longer pieces for use elsewhere (figure 42).

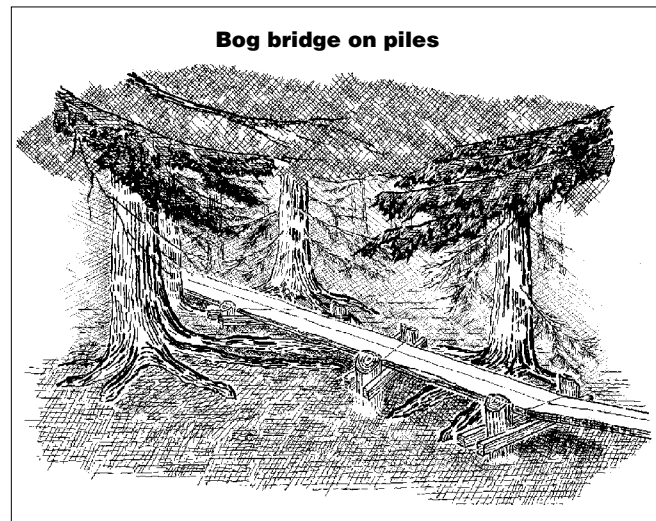

Figure 42—A bog bridge on a pile foundation. Protecting tree roots in a spruce bog requires careful placement of sleepers and piles.

Although this technique is described for northern spruce bogs, it may also have application in cypress swamps in the Southeastern United States and elsewhere.

If beaver are a problem, wrap piles with hardware cloth and staple it into place. The hardware cloth discourages beavers from chewing through the piles, timbers, or logs used in construction (figure 43).

Old beaver ponds present something of a problem in bog bridge construction, especially in mountainous areas. The

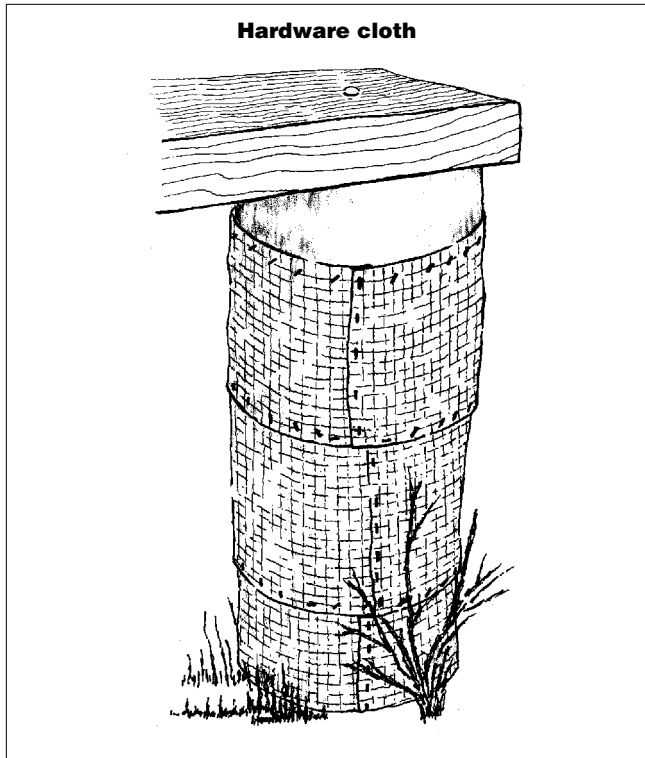
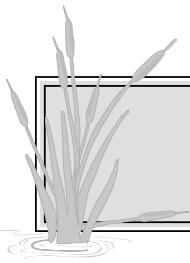

Figure 43—Hardware cloth stapled around piles helps discourage beavers.

original soil may have been of glacial origin and capable of supporting end-bearing piles. However, beaver dams trap silt, which drops to the bottom of their ponds. While end-bearing piles may work well in some locations in such ponds, friction piles are needed elsewhere. When concrete end-bearing piles were used at one pond, some settled 1 to 2 feet in 5 years. After 10 years, all concrete end-bearing piles had to be replaced with log friction piles (figure 44).

## Puncheon

Puncheon are essentially short-span footbridges or a series of connected short-span footbridges. The term puncheon means different things to different people. Puncheon on the Appalachian Trail is not the same as puncheon built in the Cascades, Rocky Mountains, or Sierras. Puncheon built in easily accessible areas may not be the same as that built in the backcountry. Puncheon can be used where the soil is wet but does not contain enough water to seriously hamper trail work. The one thing common to all puncheon construction is the use of sleepers.



Figure 44—Know your soil conditions. Concrete end-bearing piles settled 1 to 2 feet here and had to be replaced with these log friction piles.

## Type 1 Puncheon

On the Appalachian Trail, 3- to 6-foot-long logs are commonly used for the sleepers. The sleepers are notched to receive one or two tread logs and then placed in a shallow trench. The tread logs are hewn, split, or sawn, roughly in half, to provide a level plane for the walking surface or tread. The tread logs are spiked or pinned in the notch of the sleepers (figure 45).

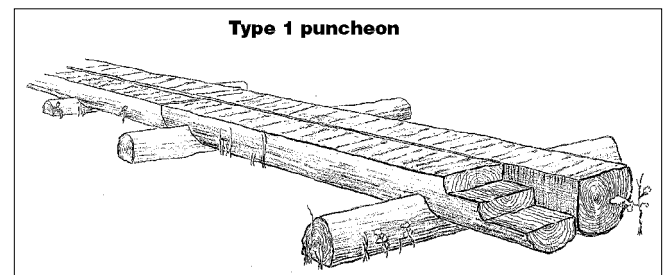

Figure 45—The rustic type 1 puncheon has sleepers and tread logs.

If the area to be crossed is longer than the logs available for the tread, the puncheon can be built as a series of connecting sections. Hiking any distance on single-tread-log puncheon can be unnerving because the hiker is looking down to avoid stepping off the tread. This is especially true if there is quite a drop from the tread to the ground or water below. Two tread logs placed side by side on longer sleepers will help. For two-tread-log construction, the inside face of each log should be hewn or sawn to butt closely to the adjacent log. A narrow gap between the two logs will help drain water, snow, and ice from the tread. This will reduce the chances of a slippery tread and retard decay.



## Structures Requiring Foundations

Two or three small spacers can be nailed to the inside face of one of the logs to control the width of this gap. The spacers can be short, straight lengths of 2- to 4-inch-diameter branches or wood scraps, hewn flat on opposite sides to provide a piece of wood about 1 inch thick.

### Type 2 Puncheon

In the Western States, puncheon uses log sleepers placed in a manner similar to that used on the Appalachian Trail. The sleepers are a few feet longer, however, and the space between them is spanned by two or three log stringers, or beams, spaced 1 to 3 feet apart (figure 46). The tread is made from 6- to 12-inch-diameter split logs, 4 to 6 feet long, or split planks. The split face becomes the tread. The bottom of the tread half-log is notched to rest on the stringer log, and the tread is spiked in place. If three stringers are used, do not spike the tread logs to the center stringer. The top of the three stringers will probably not be at the same height. Use a long carpenter's or mason's level to quickly determine the height of each stringer in relation to the others. Ideally the tread should be level from one side to the other. Handtools normally used in the field for construction make it difficult to get the tread perfectly level. Adjusting the depth of each notch, as needed, will allow for variations in stringer height. Shims under the decking also help to level the structure from side to side.

Half logs can be placed with their split sides facing up as a tread. Smaller half logs are placed split side facing down resting on the stringer and butted tightly against the tread log. These logs serve as brace logs, preventing the tread logs from wobbling. Succeeding tread log are butted snugly against the brace logs (figure 47).

If large logs are available, tread plank can be sawn from the logs, producing a number of pieces of plank of varying widths from one log. An Alaskan sawmill can be used at the site to produce planks with a uniform thickness. With this plank, there should be little—if any—need to notch or shim the stringers.

Excessive cross slope will make the surface very slippery. The meaning of excessive will vary, depending on the climate expected when the trail is being used. In a dry climate, the cross slope should not exceed  $\frac{1}{2}$  inch per foot of tread width; in a wet climate, or where snow, ice, or frost can be expected, the cross slope should be no more than  $\frac{1}{8}$  to  $\frac{1}{4}$  inch per foot of tread width. If the trail leading to the puncheon is wet, no matter what the season, hikers will track mud onto the tread, making it slippery throughout the year.

Type 2 puncheon

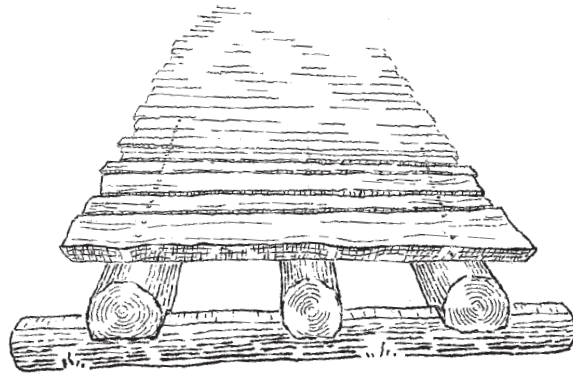

Figure 46—Type 2 puncheon has sleepers, stringers, and decking.

Rustic tread

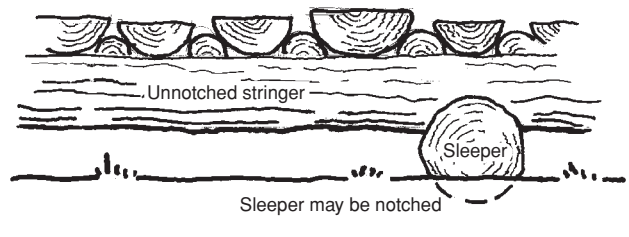

Figure 47—Rustic tread or decking made from half logs (logs cut in half lengthwise).

### Type 3 Puncheon

Type 3 puncheon also uses sleepers to support the structure, but the material is sawn timber or lumber, which should be treated with wood preservative (figure 48). This construction is popular at more accessible sites where materials are easier to transport. The longevity of treated wood and the environmental consequences and labor of cutting trees onsite make the use of sawn, treated timbers increasingly popular at remote sites as well. Helicopters, packstock, all-terrain vehicles, and workers carry in the materials.

The sleepers can be either 6- by 6- or 8- by 8-inch-square timbers placed as previously described. Two or three stringers rest on the sleepers and may be toenailed to the sleepers and bolted or nailed to the stringer in the next span. The stringers may also be attached to the sleepers with steel angles and extended (cantilevered) a short distance beyond the sleepers.

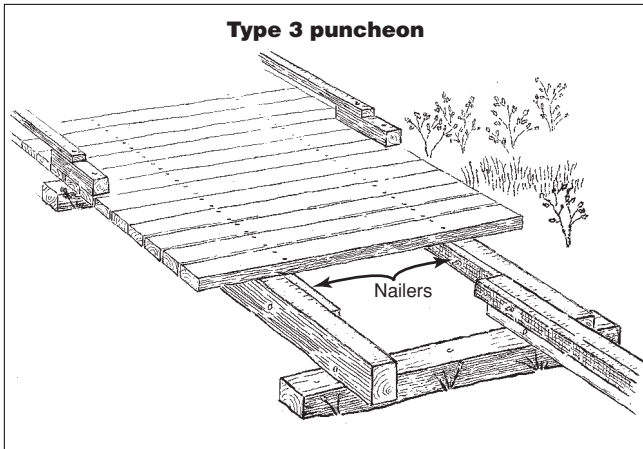
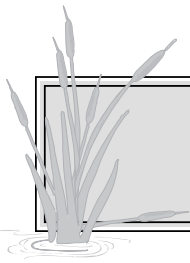

Figure 48—Type 3 puncheon is constructed from preservative-treated timbers. The nailer bolted to the inside of each stringer helps prevent decay by concentrating screw holes and associated decay in the easily replaced nailers instead of the stringers.

The size of the stringers is determined by the maximum weight they can be expected to support, which may be the snow load in snow country. For foot trails, usually the size of the stringers is calculated to support a live load of 85 pounds per square foot, the maximum weight expected for trail users standing on one section of trail. Heavier, wider puncheon is needed for horse and mule traffic.

On foot trails, the tread is often 2 by 6, 2 by 8, or 2 by 10 lumber nailed to the stringers. When three stringers are used, do not nail to the center stringer. The nails work their way out and pose a tripping hazard. The stringers are the most expensive and most difficult items to bring to the site. Do everything you can to extend their useful life; usually this means keeping them dry.

The tread will need replacement more frequently than any other portion of this type of puncheon. In some areas the wood tread will require replacement every 7 to 10 years. After three or four replacements of the tread, the top of the stringers will show signs of decay and wear. Water from runoff and condensation will follow the nails down into the wood, and repeated nailing in the same vicinity will soften the wood. To avoid this, a nailing board (nailer) of 2 by 4s or 2 by 6s can be nailed to the top or side of the stringer. A better solution is to bolt rough-sawn 2 by 4s or 3 by 4s to the side of the stringer with carriage or machine bolts. The bolts can be 2½ to 4 feet apart. The tread is nailed to the nailer instead of the stringer. Eventually, the nailer will require replacement, but the nailer is much easier to replace than the stringers. Esthetically, it is better to attach the nailers to the inside face of the stringers.

## Puncheon Summary

The type 1 and 2 puncheon do not represent sustainable design. They damage the resource if onsite trees are cut to provide construction materials. Offsite timber materials may be from more sustainable commercial sources. The type 3 puncheon meets the criteria for sustainable design because the material used is more easily renewed. Although the tread may require replacement in 7 to 10 years, the heavy stringers have a much longer life expectancy.

All three types of puncheon are raised high enough above the ground to provide little interference with the movement of floodwater. The tread width of types 2 and 3 puncheon may affect the growth of plants under the tread.

Type 3 puncheon is the most likely of the three to meet accessibility guidelines.

## Gadbury

Gadbury (figure 49), a structure similar to puncheon, was developed in the Pacific Northwest. Gadbury uses two half logs, as described for puncheon, and longer notched sleepers. The notch cut for gadbury must be about twice as wide as the notch cut for puncheon. The two half logs are placed on each side of the center of the notch with the flat surface up. Two full logs are placed in the notch on the outside of each of the half logs.

An experienced crew can construct gadbury without using spikes or steel driftpins. Such construction requires considerable skill and experience with woodworking tools. Lacking this experience, the pieces can be spiked or pinned together. Earth may be placed on the half logs and held in place by the full, outside logs.

Gadbury uses more wood than puncheon. From a standpoint of sustainable design, gadbury is less suitable than other techniques.

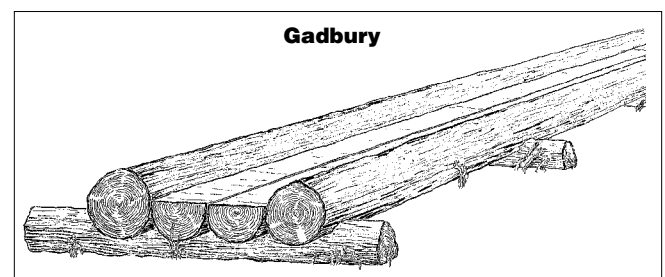

Figure 49—Gadbury is another rustic structure similar to puncheon. Use peeled logs for gadbury.

## **Bog Bridge**

A bog bridge is a form of puncheon. Normally, bog bridges have a single- or double-plank tread surface resting directly on mud sleepers (figure 50), cribbing, or piles. A puncheon, by contrast, will usually have stringers resting on the mud sleepers, with tread decking nailed perpendicular to the stringers.

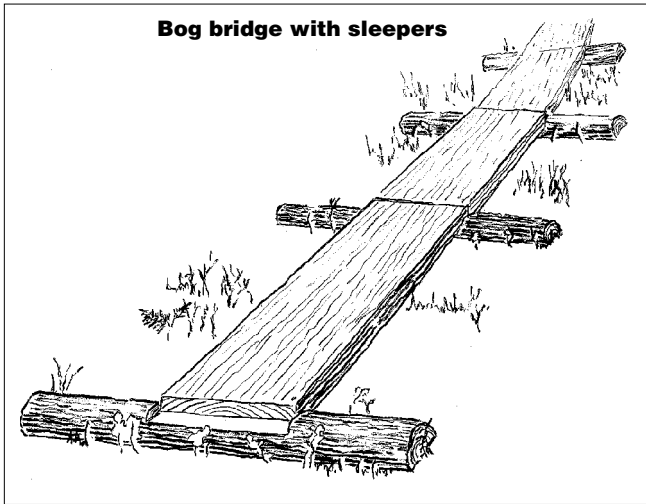

Figure 50—A simple bog bridge with sleepers. This common structure is also called a single-plank boardwalk in coastal Alaska.

To add to the confusion over terminology, in coastal Alaska, bog bridges are called boardwalks, or step-and-run boardwalks if spacers are used to create steps (figure 51). In other places, the term bog bridge is synonymous with puncheon. In parts of the Rocky Mountains and Sierras, bog bridge equates to turnpike, a structure we described as a raised walkway of stone and fill material. We define bog bridges as a series of connected, short-span bridges close to the ground.

The tread of a bog bridge is usually treated, rough-sawn 3- by 12-inch plank that is 6 to 9 feet long. The plank parallels the centerline of the trail and rests on closely spaced, lightweight foundations. This means that the tread of the bog bridge can be closer to the ground, perhaps only 6 to 12 inches above it, providing 3 to 9 inches of clear space below the tread. There is little to block the flow of water (in either direction) below the plank, and little to resist the force of floodwater going over it. In the backcountry, bog bridges are normally one 12-inch plank wide. A plank this narrow does little to interfere with plant growth underneath. The span of each of these small bridges will vary with the type of wood used for the plank, the thickness of the plank, and the anticipated weight on the plank. In areas of heavy, wet snow, the snow may be the heaviest weight on the bridge. Snow load may be as much as 300 pounds per square foot in such areas.

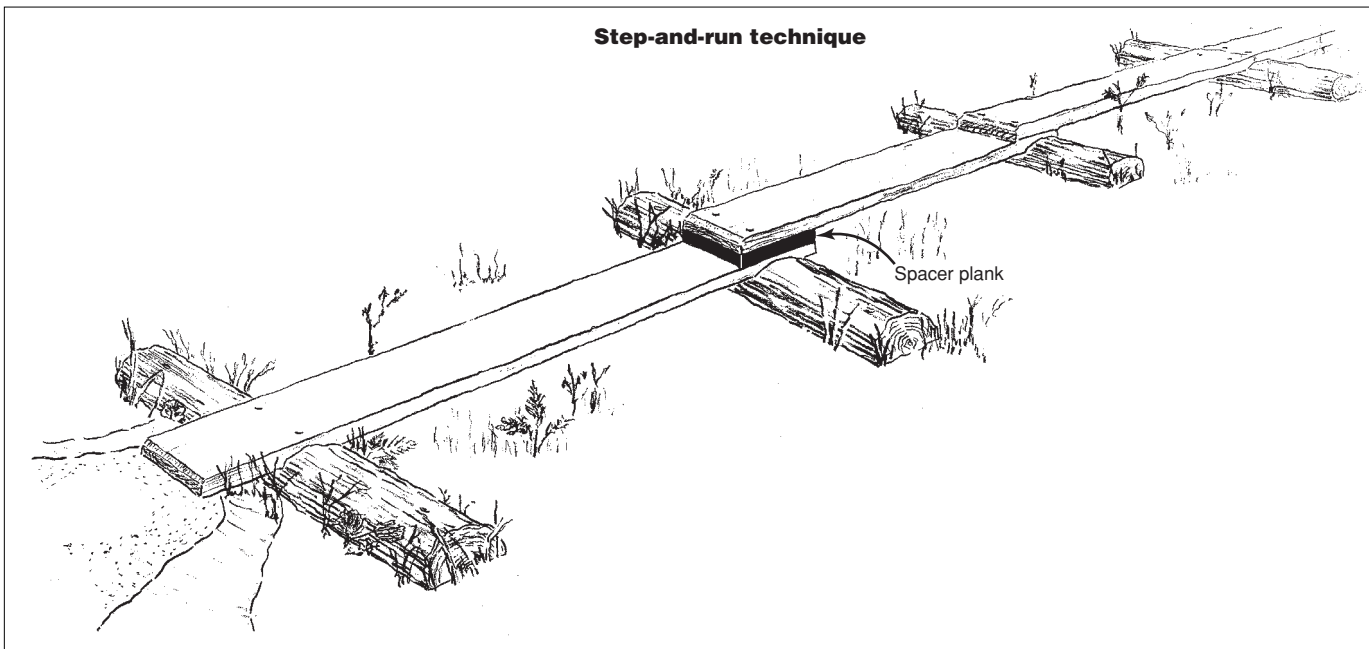
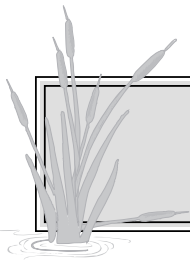

Figure 51—The step-and-run technique is a way of keeping planks level as elevation changes. Level planks help reduce slipping in wet climates.



### ***Bog Bridge on Sleepers***

In its simplest form, the plank of the bog bridge rests on sleepers. A sleeper is placed in a shallow trench at right angles to the trail centerline. A second sleeper is prepared and placed in another trench 6 to 9 feet away. This distance is the span, which is determined from older installations or with the help of someone with carpentry or structural engineering experience. Place the plank flat in the notches of the sleepers, with one cut end centered in line with the centerline of the log. Mark the plank where it meets the centerline of the next sleeper and saw it to the proper length. The plank is nailed to the sleepers at each end with two 50- or 60-penny (appendix D), ring-shank nails driven through previously drilled pilot holes. This process continues across the wetland.

### ***Bog Bridge on Cribbing***

Occasionally, log or timber cribbing can be used to support the plank of a bog bridge. Plank can either be nailed to each of the top logs or timbers, or one large-diameter log can be notched and pinned to the top logs (similar to the sleepers described earlier). If the bog bridge is more than 2 feet high, the plank should be two planks wide for safety.

### ***Bog Bridge on Piles***

Another technique for building bog bridges is to rest the plank on pile foundations. The three types of suitable piles are end-bearing piles, friction piles, and helical piles.

After installing a pair of bents or piers, pressure-treated 3- by 12-inch planks are nailed to the ledger or ledgers as described for the bog bridge on sleepers. The ledgers do not have to be notched. When piles are used, the plank may be more than 2 feet above the ground or water. In such cases, the tread should be two planks wide.

### ***Bog Bridge Summary***

Whether a bog bridge is built on sleepers, cribbing, or wood piles, it lends itself to backcountry construction. The materials are wood, steel washers, bolts, nuts, and nails. The pieces of wood are relatively small and can be carried by hand. Bog bridges as described here do not meet Forest Service accessibility guidelines, but are suitable where departures from these guidelines are allowed.

### ***Boardwalk***

For the purpose of this book, a boardwalk is a structure that uses widely spaced bents or piers as a foundation. Stringers, parallel with the centerline of the boardwalk, rest on the ledgers of the bents or piers. The stringers support the deck, which is usually 2 by 6 or 2 by 8 lumber laid perpendicular to the centerline and nailed or screwed to the stringers, or to nailers bolted to the stringers. Boardwalks usually have a curb or handrail along their edges (figure 52).

Basically, a boardwalk is a series of connected bridges, each with a span as long as is practical, perhaps 8 to 40 feet. At most wetland sites, longer stringers are not practical because they are difficult to transport. Also, building adequate foundations for the long spans often requires large pieces of specialized equipment that cannot negotiate unstable soil.



Figure 52—A typical boardwalk. Boardwalks are expensive and somewhat complicated, so seek the help of engineers and landscape designers during planning.

### ***Stringers***

At least two stringers or beams rest on the ledgers and span the space between consecutive bents or piers. As the space between bents or piers increases, a third stringer, or heftier stringers, must be used. Three stringers are always better than two. There's safety in redundancy.

Long, thick stringers are more expensive than smaller ones. However, they permit the bents or piers to be farther apart. Studies of soil conditions and problems of construction access to the site will indicate the costs for stringers compared to bents or piers. Bring in some engineering help to figure out



## Structures Requiring Foundations

the most economical spacing of bents or piers. Large stringers should be bolted to steel angles that have been bolted to the ledgers. Nailers should be used to attach the deck, as described for type 3 puncheon (figure 53).

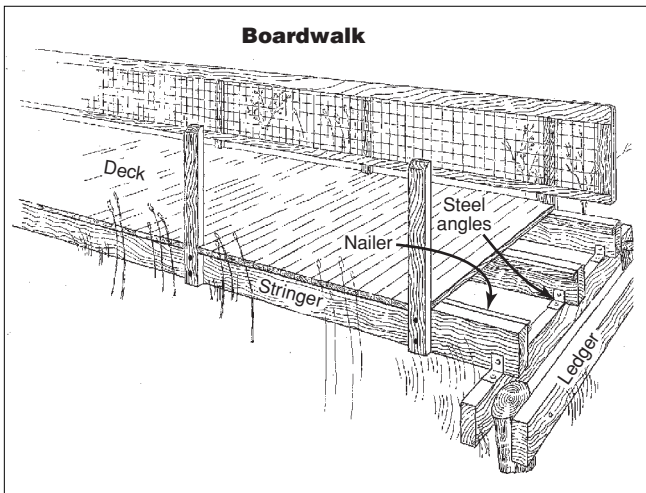

Figure 53—Details of boardwalk construction. Large stringers and ledgers connected with steel angles and nailers help increase the life of the stringers.

Ideally, the bottom of the stringers of a boardwalk should be above high-water levels, but this is often impractical. To reduce maintenance, the design of the boardwalk should avoid interference with the flow of floodwater and floating debris. To check for evidence of flooding, look for clusters of dead, broken branches stuck in shrubbery or the crowns of trees. Bark on the upstream side of trees may be scraped or stripped off. The height of anticipated floodwater may seriously affect the design of a proposed handrail. Joists can be toenailed to the ledgers, or steel top flange hangers may be nailed to the ledgers to support the joists (figure 54). Top flange hangers reduce the distance between the deck and the ground below, perhaps eliminating the need for a pedestrian railing.

Pressure-treated wood that is now available is highly corrosive to untreated metal hardware. Hot-dipped galvanized treatment is recommended for all fasteners and hardware.

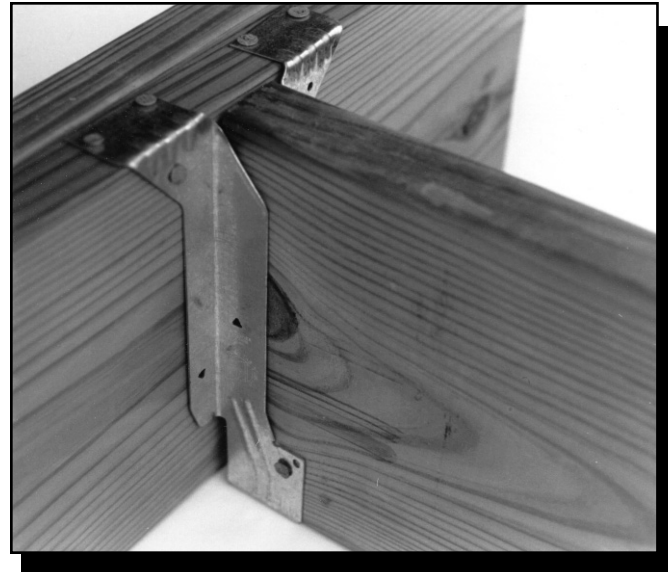

Figure 54—Supporting joists with top flange hangers helps keep a boardwalk closer to the ground.

### *Boardwalk Summary*

Often boardwalks, as described here, are found around visitor centers, heavily used interpretive trails, or at other high-use sites. The sophisticated construction and materials needed for a boardwalk are less appropriate in the back-country where the trail user expects simpler, more rustic construction and more challenging facilities.

During floods, the posts and rails can catch debris and form a dam. In most situations it is better to build as little as possible that will have to resist the force of high-velocity floodwaters. A decision on how much or how little to build should be based on the type and age of the visitors who will use the finished facility—schoolchildren, senior citizens, day hikers, or backpackers. Professional geotechnical and structural engineers and landscape architects are needed for effective design of these big-budget structures.



# Finishing Details

Although constructing the basic structure right is most important, often the mark of craftsmanship is most evident in the finishing details. Most of the following discussion applies to boardwalks. However, some finishing work can be used with other construction techniques.

## Decks

Plank used for a deck often contains heartwood and sapwood. If the plank is placed with the heartwood face up, alternating moisture and drying—and the effects of freezing and thawing—will cause knots and some of the annual rings in the wood to lift. To reduce tripping hazards and future maintenance, deck plank should be placed “green side up” (the heart face down and the bark face up) (figure 55).

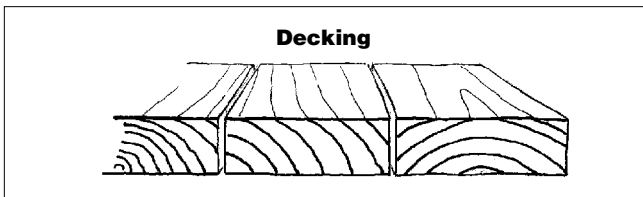

Figure 55—Place decking with the growth rings facing down to help prevent cupping. Cupping causes the wood to decay faster and creates a tripping hazard.

## Posts

A pedestrian railing system may be needed along the edge of a deck to prevent visitors from falling off. Various building and highway codes call these railing systems “handrails,” “guard-rails,” or “railings.” If you are planning to install a pedestrian railing, the details of the installation of the posts need to be thought out before placing the deck. Railing posts need to be sturdy. They are a potential liability. Flimsy railings installed as an afterthought are the ones most likely to fail. Usually, it is the connectors, not the railing, that fail.

The deck, posts, and handrail are all closely related in their construction. As a minimum, 4 by 6 timbers should be used to support handrails. Actually 4 by 4s that are surfaced on all four sides are only 3½ by 3½ inches. They make a flimsy post. The deck should extend beyond the stringers to the back of the post, or at least 4 inches. If this is not done, people standing on the deck and leaning on the railing will have their feet sticking out beyond the deck (figure 56). In

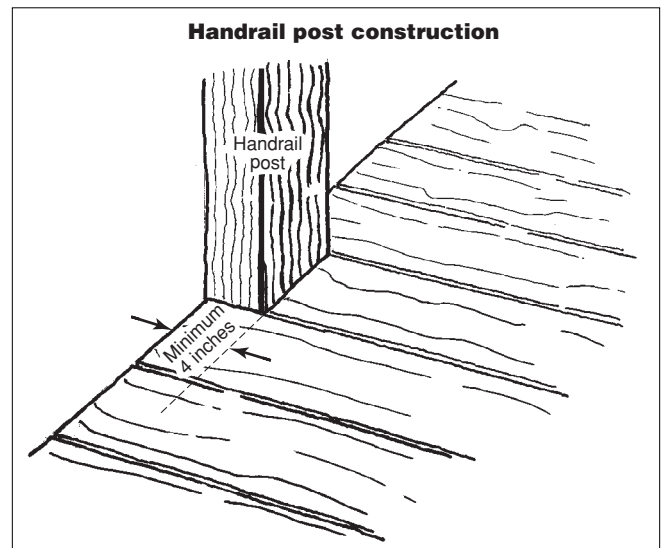

Figure 56—When the handrail post is attached to the stringer below the deck, the decking should extend at least 4 inches beyond the stringer.

addition, the decking helps keep water off the stringers, reducing decay.

There are two ways to install railing posts. The most common requires the deck to be in place. The posts are toenailed to a deck plank. By itself, this is a weak connection and requires an angle brace for support. Therefore the plank supporting the post must extend beyond the edge of the rest of the deck. If the plank is too short, the angle brace will be too close to vertical to provide much support (figure 57).

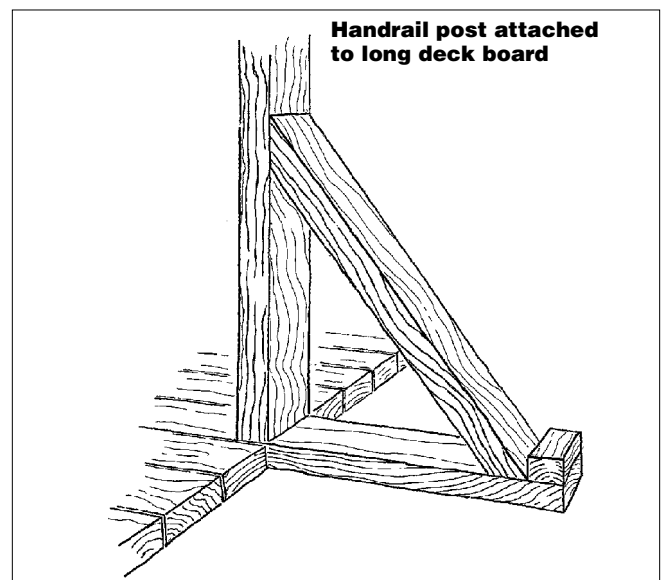

Figure 57—Attaching the handrail post directly to the decking requires long deck pieces to support an angle brace.

## Finishing Details

The second method is to attach the posts to the outside of the stringers. It is much easier to bolt the post in place before attaching the adjacent deck plank. To provide solid support, 12 inches of post should contact the stringer. The posts can be accurately cut and drilled in a shop and brought to the site. To avoid the awkward and time-consuming work of notching the planks, the width of the post should match the width of the deck planking (figure 58).

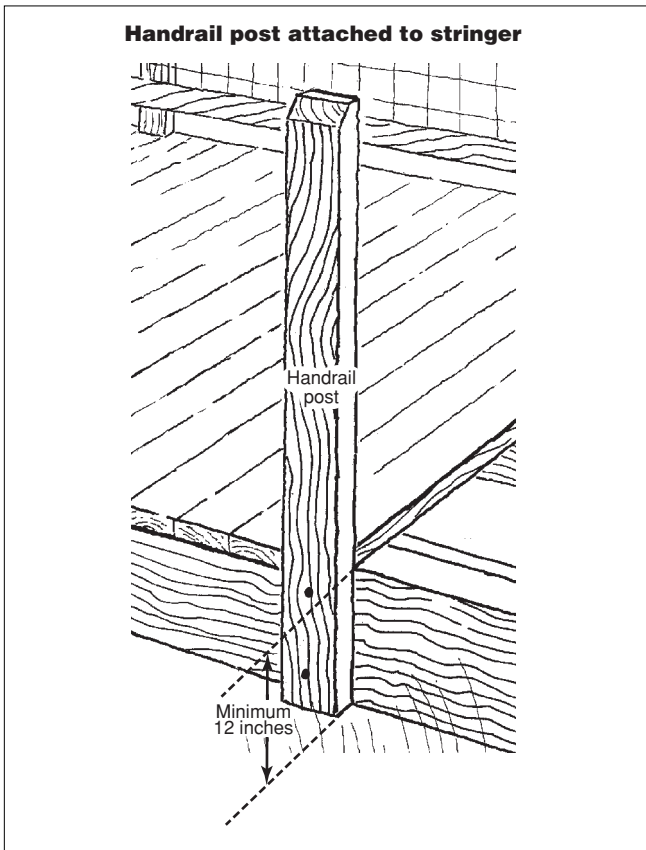
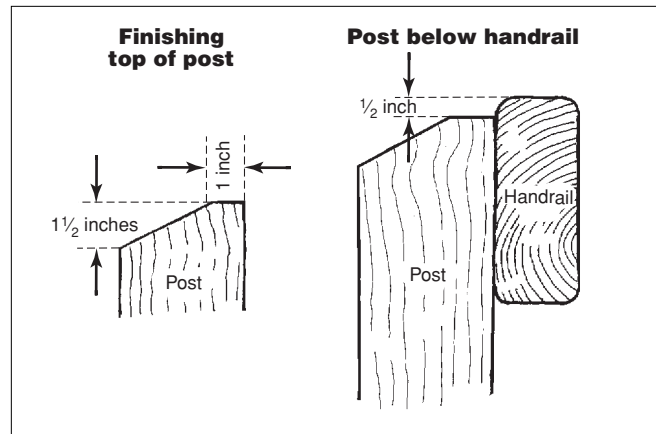
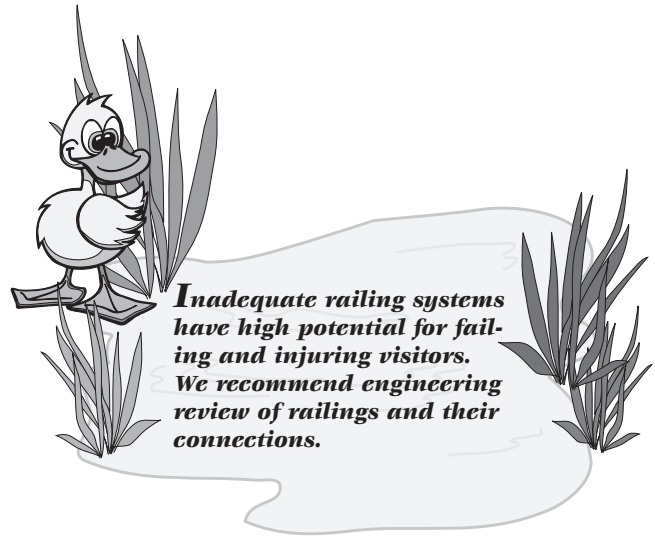

Figure 58—To provide proper support, at least 12 inches of the post needs to be in contact with the stringer.

The top of each post or pile should be cut at an angle to shed water and to help prevent decay. To avoid a sharp corner at the top of the post, a narrow 1-inch area closest to the handrail should be cut level, and the sloping portion should be pitched away from the boardwalk (figure 59). For esthetic and safety reasons, the posts should not extend above the top of the handrail (figure 60).



Figures 59 and 60—Cut the top of the post at an angle, but leave 1-inch flat on the inside edge. The post should not extend above the top of the handrail.



## Pedestrian Railing Types

Safety must be the first consideration in selecting a railing system. Safety requirements are primarily determined by the relative accessibility of the trail. Railing types must fit the appropriate Recreational Opportunity Spectrum class. Railings are of three basic types:

➤ Railings attached to buildings (visitor centers, for example), must meet building code requirements such as those listed in the International Building Code (IBC). This code requires a railing at least 42 inches high that a 4-inch sphere will not pass through.

➤ Handrails on bridges need to meet the American Association of State Highway and Transportation Officials (AASHTO) Standard Specifications for Highway Bridges. Although most of the structures described in this book are not bridges, we offer these specifications for information. AASHTO requires 42-inch-high guardrails on all pedestrian highway bridges. Bridges on fully accessible trails usually need this type of railing. This code requires handrail at least 42 inches high for pedestrian traffic and at least 54 inches high for bicycle or equestrian traffic. A 6-inch sphere must not pass through the railing in the bottom 27 inches, and an 8-inch sphere must not pass through the area above 27 inches.

➤ Handrails for more remote trail bridges must be at least 42 inches high for pedestrian traffic and at least 54 inches high for bicycle or equestrian traffic. These handrail systems must also have at least one intermediate rail so that vertical distances between rails do not exceed 15 inches. Three-fourths of all Forest Service trail bridges fall in this category.

Not all wetland trail structures need railings. If the trail itself has more hazardous drops than the trail bridge would have without a handrail, a handrail is probably not required. Other considerations, such as convenience, may justify installing a handrail. Although IBC requirements and AASHTO specifications do not govern trail construction, they can serve as guidelines. As a general rule, any fully accessible trail with a drop of 3 feet or more, or a more remote trail with a drop of 8 feet or more, should have a pedestrian railing system. All accessible trails require a curb. A wheelchair handrail is required for any accessible trail bridge on a grade of 5 percent or steeper. Document your decisions with a design warrant retained in your files.

### Railing Installation

Install the railings after the posts and deck are complete. Most railings consist of a top and bottom rail, usually 2 by 6s, although 3 by 6s make a better splice and a stronger rail. The stronger rail permits posts to be spaced more widely than if 2 by 6s were used for rails. The rail can also be cut and drilled in a shop where the splices can be cut accurately and more efficiently.

Often there is no clear direction regarding splicing the railings if the span exceeds 16 feet, the longest lumber that is readily available. It is difficult to butt splice a railing to the surface

of a post that is less than 6 inches wide without an awkward splice or a maintenance problem (figure 61).

Walking on the top rail is a potential problem. Round logs or poles have been used to discourage visitors from walking on them, as well as 4 by 4s and 6 by 6s laid diagonally with one corner up. Another technique is to cut the tops of all posts at an angle and place a 2 by 6, or 2 by 8, on the cut surface. This helps to shed water and prevent decay.

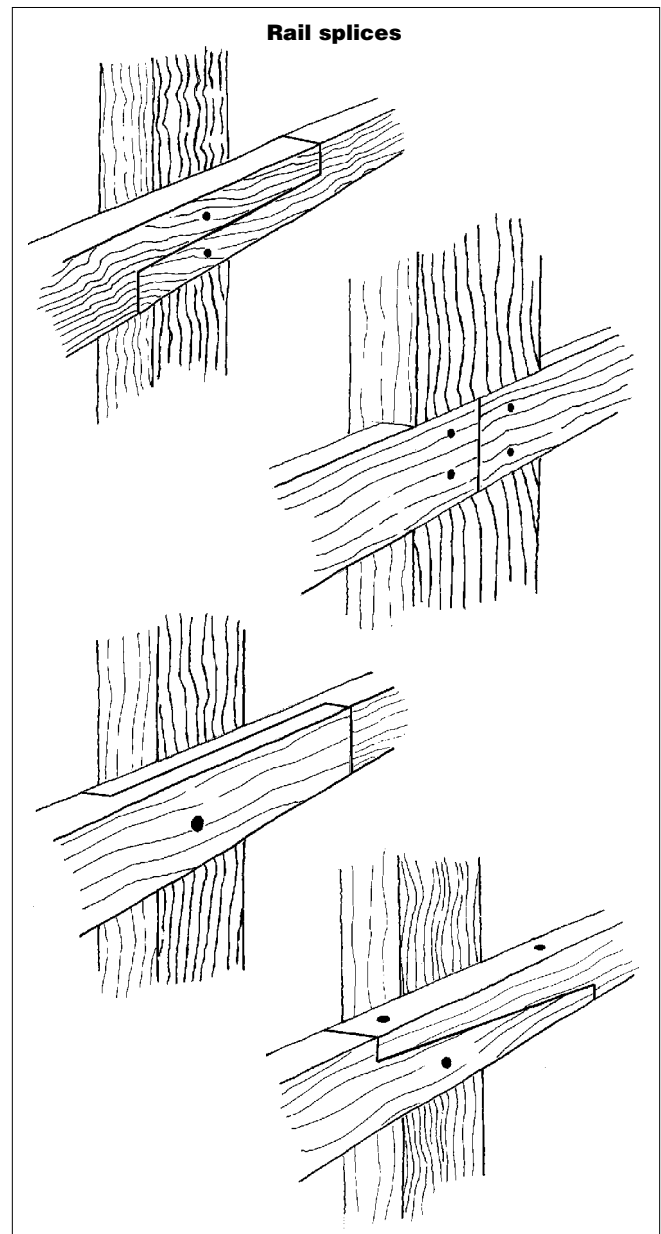

Figure 61—Four methods of splicing rails. It is best to cut the rails in the shop. Use carriage bolts with the round end on the inside of the railing to prevent users from snagging themselves.



## Finishing Details

The edges of all rails should be “edges eased.” Edges eased is a trade term indicating that the corners along the edges of the piece of wood are rounded. To reduce splinters, the radius of the handrail edge should be  $\frac{1}{2}$  inch or more.

Installing a handrail on a curved bog bridge or angled boardwalk can be a challenge. One way to do this is to use steel angles. Measure the distance between posts and cut the rail to that length. Nail or screw the angles at the ends and to the outside of a 2- by 4-inch or 2- by 6-inch rail. The angles will have to be bent slightly to conform to the different alignment of the posts. Hold the rail in place and nail or screw the angle to the side of the post with the inside face of the board flush with the inside face of the post. Measure the distance between the centerline of the two posts and cut a 2 by 6 to that length. Round the ends slightly and bolt the 2 by 6 to the 2 by 4. The result will be a stronger rail than a single piece of material. This technique may also be used for straight sections of railing to avoid nailing or screwing into the face of the post (figure 62).

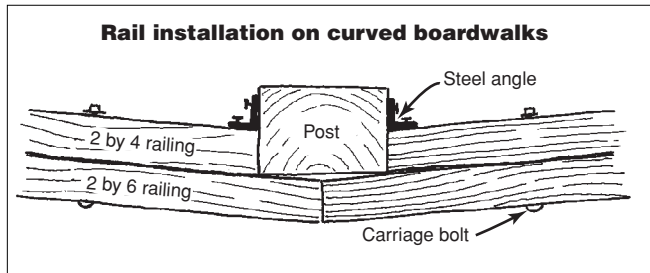

Figure 62—One method of installing rails on curving boardwalks using steel angles bent to accommodate the curvature of the structure.

For rails on curved trails, short wedge-shaped pieces of lumber can be used as shims between the posts and the rails. The wedges should be oak or cedar. Wedges are difficult to cut in the field. You could notch posts to the correct angle to accept the rails, but this is also difficult.

Cable or wire rope can be used as a railing system in some specialized applications (figure 63). Often the posts are close, 4 to 6 feet, and the cable is strung through holes drilled in the posts or through screw eyes. A single piece of cable may be strung through all the holes in the upper part of the posts, down the last post to the next lower hole and continuing this process back to the beginning through the lower holes, reducing the need for many splices. Use cable tensioners as needed.



Figure 63—Wire rope is used here as part of the railing system.

## Curbs (Bull Rails)

Curb and bull rail are two names for the same thing. If the drop from a boardwalk is about 36 inches or less, a curb is usually installed. A curb is required for accessible trails. Curbs help to delineate the trail tread (figure 64).

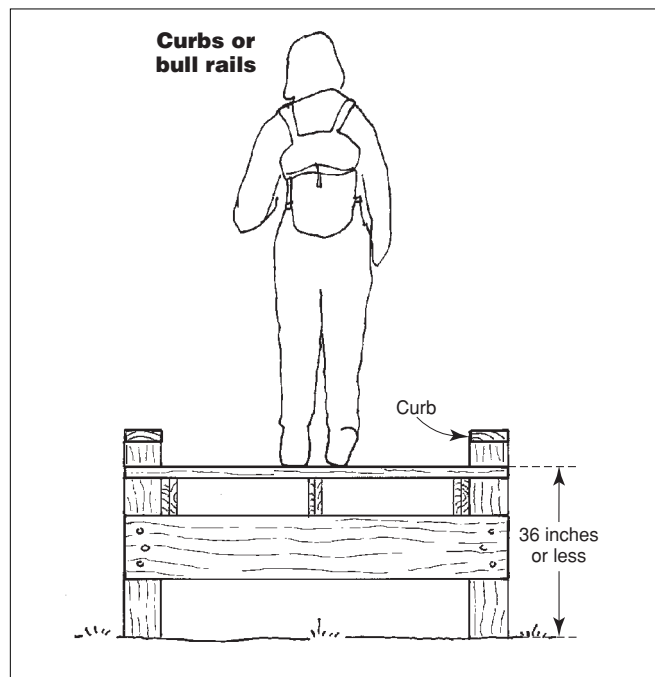
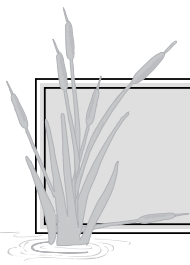

Figure 64—Typically, curbs (bull rails) are used when the deck is no more than 36 inches off the ground.



Curbs placed directly on the surface of a wood deck can cause the deck planking to decay. Leaves, needles, and dirt accumulate against the curb, absorb water, and cause additional decay. During the winter, ice and snow will build up on the deck, causing a hazardous condition.

To keep the deck from decaying, place the curbs on blocks. A finished block of 2 by 4 lumber is only 1½ inches thick. Leaves and dirt can still build up against the curb and under it. With just 1½ inches of space between the curb and the deck, it is difficult to get a shovel under the curb, making this area almost impossible to clean. A better solution is to use two blocks of 2 by 4 lumber, one on top of the other, or one block of 4 by 4 lumber (figure 65) to eliminate the opening under the curb. Litter will not be trapped, and melting ice and snow will run off more quickly. These openings underneath the curbs sometimes are called scuppers, an old nautical term.

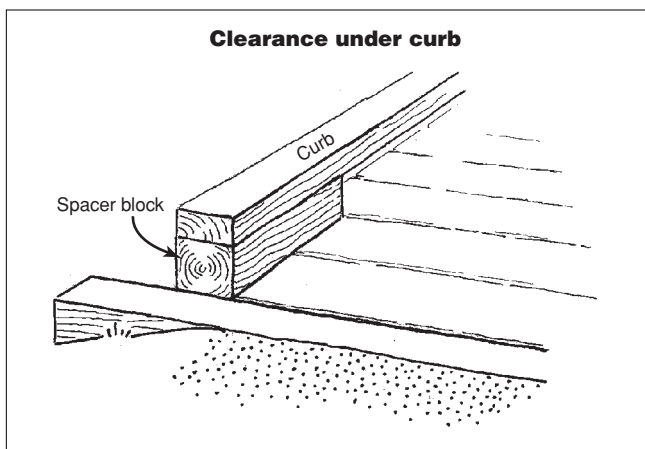

Figure 65—Having at least 4 inches of clearance under the curb is best.

## ***Bulkheads (Backwalls, End Dams, Faceplates)***

Bulkheads must be installed where wood construction meets the earth trail at each end of a puncheon, bog bridge, or boardwalk. They function as retaining walls to support the earth. They also protect the end grain of the stringers from decay and insect damage (figure 66). Bulkheads should always be treated timber.

Install the top of the bulkhead level with the top of the stringers, covering the gap with a piece of deck plank. This is the best way to keep moisture away from the stringer.

Extend the backwall 1 to 2 feet on each side of the structure to keep wet soil away from the sides of the stringers.

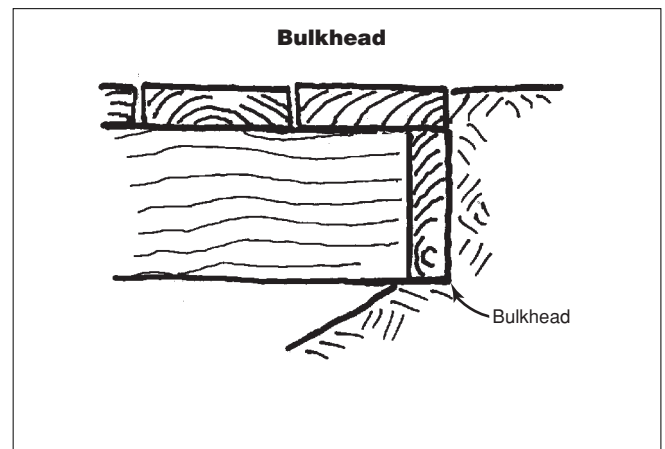

Figure 66—Bulkheads serve as retaining walls to support the earth, and they protect the stringers from decay and insect damage.



# Floating Trails

Trails that float on the surface of the water are quite rare. They are covered briefly here. For more detailed information, refer to *Floating Trail Bridges and Docks* (Neese and others 2002).

Most floating trails are engineered structures, like docks, that float on watertight drums, polystyrene-filled corrugated plastic pipe, or other specialized floating systems. Rely on your engineering and landscape architectural staff to help you design a functional, attractive system.

A floating trail needs solid anchors at each end. Depending on the length of the floating trail and the expected water condition, the anchors may be timber deadmen (buried anchors), helical piles, concrete deadmen, or long wooden piles. Two cables, connected to these anchors and the opposite ends of each float, hold the floats in place. The trail must be straight between anchor points. Bends in the route require intermediate anchor points for the cables. If there is any current, an additional cable brace should be attached to the floats toward the middle of the span to hold them in place against the current. This cable brace must also be anchored on both ends. You may need to install cable braces on both sides of the floating trail to hold it in place (figure 67).

A floating trail tends to bob around, creating an unsteady tread surface. Such trails may not be suitable for all users. During periods of rough water, the floating trail may have to be closed. Sometimes, outriggers extending to the sides of the deck can provide additional floatation and stability.

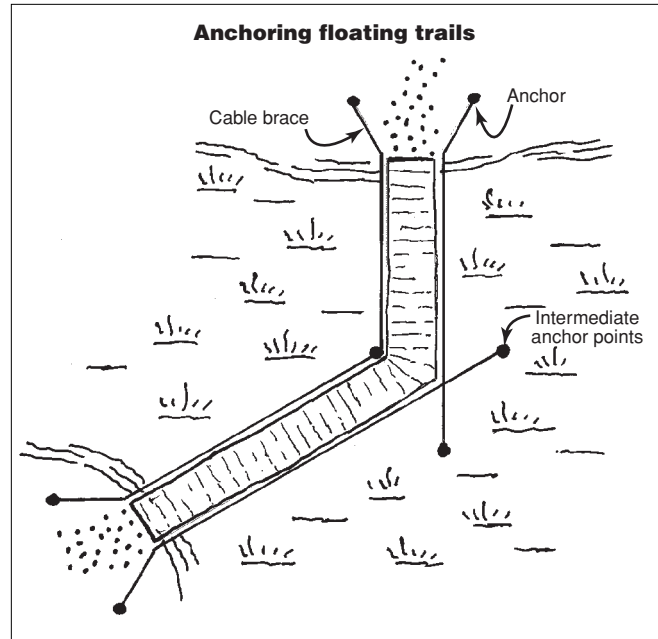

Figure 67—True floating trails need solid anchorages. Often they are secured with wire rope.



# **Construction Materials**

## **Choosing Materials**

Materials used in trail design should be appropriate for the setting. Steel, plastic, concrete, and asphalt may be appropriate in an urban greenbelt, but out of place in the backcountry. Log construction, stone masonry, and dirt trails are appropriate in a primitive, backcountry setting, but out of place in a city.

The Forest Service recognized this problem in the late 1970s and developed a system called the Recreational Opportunity Spectrum (ROS).

The ROS system establishes seven types of recreational land uses and describes the level of development, management, and construction materials suitable for each of them. The ROS principles may appear overly structured, but their application should result in construction and management that is compatible with the environment surrounding a wetland trail whether that trail is in a remote area, an urban greenbelt, or another setting. The ROS concepts are too detailed to include here, but they should be understood by anyone planning to design and construct wetland trails.

## **Logs**

Wood from logs cut onsite is commonly used in trail construction, but wood is susceptible to attack by insects and fungi. Bark separates from the wood. The gap collects water and provides shade and protection for insects and fungi. Peeling off the bark reduces the likelihood of these attacks. Depending on local conditions, removing the bark may double the life of a log.

The bark can be removed by hand or machine. Using a draw knife or bark spud is the traditional way of peeling logs. The random scrape marks left on the peeled logs gives them a rustic appearance. Machine peeling “chews” the bark and some of the wood in a spiral pattern. The finished pieces are almost uniform in size, with a machined appearance that lacks the rustic character of peeled logs.

Wood that is exposed to the weather or is in contact with the ground will eventually require replacement. In wetlands, a flood, a heavy snow, a buildup of ice, fallen trees, or animal damage may shorten the life of wooden materials. Trees growing near a wetland site are unlikely to provide a sustainable source of logs for replacement structures. Even in remote areas, logs cut from trees growing in the vicinity may not be the best choice of materials.

Using logs cut onsite for trail construction is an inefficient use of wood and does not represent sustainable design. Tearing up areas near a site and destroying the character of the wetland makes no sense. Today, responsible trail crews are taking commercially obtained logs and other wood materials to remote wetland sites by boat, horse, mule, off-highway vehicle, by hand, or by helicopter, even when adequate material is growing a few feet from where it could be used. Sometimes materials can be hauled in more easily over snow during the winter for use the following summer.

## **Lumber and Timber**

For the purposes of this text, lumber is wood that has been sawed and planed into uniform pieces with a minimum dimension of 2 inches or less. For instance, a 2 by 6 is a piece of lumber. Timber is wood that has been sawed into more or less uniform pieces, with a minimum dimension of at least 3 inches. Usually, timbers have not been planed smooth.

It helps to understand how logs are processed into lumber and timbers. Logs run through a sawmill are typically sawed into standard-size pieces, usually 1-inch thick or in increments of 2 inches. Common sizes are: 1 by 4, 1 by 6, 2 by 4, 2 by 6, 2 by 8, and 4 by 4. The pieces can also be cut into 3-inch stock. However, such nonstandard timbers would not be readily available at the local lumberyard. Most 4-by-4, 6-by-6, and larger timbers are cut from the center of the log. Generally 1- and 2-inch materials are cut from the outside of the log.

After the pieces of wood are cut from the log, they are referred to as rough sawn. The first step produces a piece that is sawn on its two widest faces. The bark remains on the narrow edges. At this point the piece is described as rough sawn and waney edged. The edges are not parallel or square. Waney-edged wood is used for rustic siding. Waney-edged lumber can be special ordered (figure 68).

Next, the piece of wood is run through another saw, the edger, that trims the edges square and to a standard 2-inch dimension. The piece of wood is now rough sawn on all four sides and is full size—a 2 by 4 is 2 inches thick, 4 inches wide, and as long as the log.

The pieces are cut to standard lengths. Normally, the shortest pieces are 8 feet long. Longer pieces are cut in multiples of 2 feet, up to 16 feet. Rough-sawn lumber or timbers can be ordered. A piece of rough-sawn, 2-inch lumber is considerably heavier than the finished lumber normally carried at a lumberyard. Rough-sawn pieces are not completely uniform.

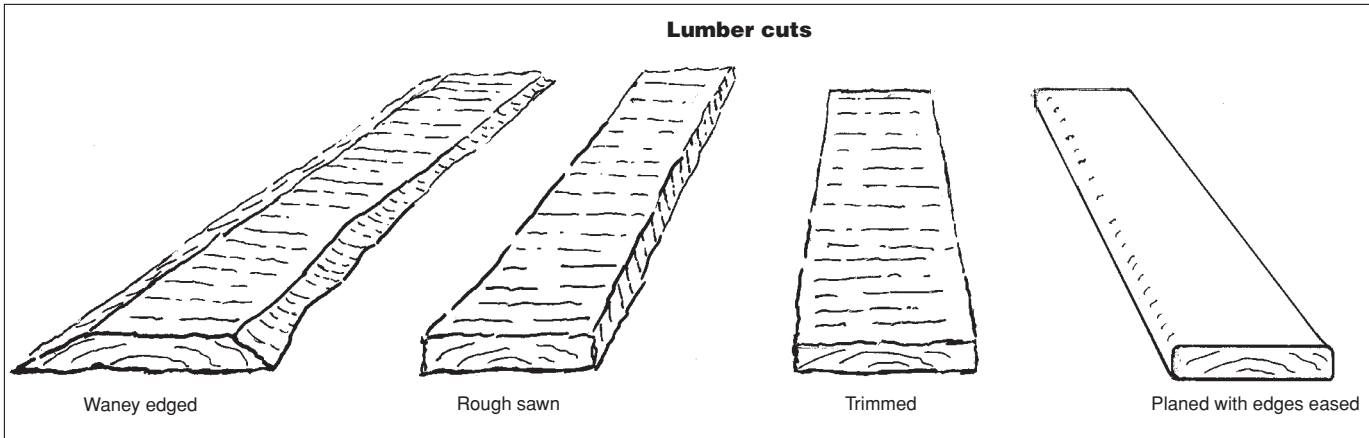

Figure 68—Lumber terminology.

Depending on the capability of the sawmill, similar pieces may vary  $\frac{1}{8}$  to  $\frac{3}{8}$  inch from each other. The pieces will not have a smooth surface, and the edges will be sharp and splintery.

Finally, the rough-sawn pieces are run through a planer. The planer removes enough wood to smooth the surface on all sides and to produce standard-size pieces. After planing, a 2 by 4 is  $1\frac{1}{2}$  inches by  $3\frac{1}{2}$  inches and is described as S4S (surfaced four sides). The size after the lumber has been surfaced on all four sides is referred to as nominal size.

Most 2-by-4 material is usually run through a special planer to round off the corners. This process is called edges eased and reduces the chances of splinters when handling the wood. Edges eased can also be specified for other dimensions of lumber and the smallest dimension timbers, but must be special ordered.

Waney-edged material should be less expensive than rough-sawn because it requires less processing. Rough-sawn material should also be less expensive than nominal-size material because it has not been through a planer or had the edges eased. If the imperfections of waney-edged or rough-sawn material are acceptable, there is no point in specifying the nominal size material for a project. Why pay for someone to turn wood into sawdust and shavings that you can't use? Besides, the additional work results in a weaker piece of wood.

Wholesalers sell wood by the thousand board feet. A board foot is 12 inches by 12 inches and 1 inch thick, or 144 cubic inches. The board footage of lumber and timber is determined at the time the piece of wood is rough sawn. See appendix E for a table of board feet contained in most standard sizes of lumber and timber, and for various standard lengths.

## ***Decay-Resistant Wood***

Using decay-resistant wood will greatly increase the life of the material and reduce maintenance. Some species of trees are naturally decay resistant. Wood from other species can be treated with preservatives to extend its life. Depending on the climate and the location of the piece of wood in the finished work, construction without decay-resistant wood may last only 7 to 10 years, while installations of naturally decay-resistant woods may last 70 years or more.

## ***Naturally Decay-Resistant Wood***

The most common decay-resistant species include the various cedars, redwood, baldcypress, black locust, honeylocust, and some white oaks. A tannin found in the wood of these trees colors the heartwood and makes it decay and insect resistant. The sapwood of the same tree is almost white and is not resistant. The wood of Douglas-fir and the white oaks does not contain a toxin, but it is dense enough to repel some fungus and insect attacks.

## ***Preservative-Treated Wood***

Using chemically-treated wood in wet environments may mean the structure lasts 30 years instead of 7 to 10 years. It is important to know which chemical treatments are appropriate, and whether or not they cause adverse health or environmental effects.



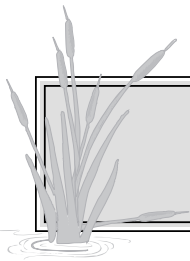

The subject of chemically-treated wood is complex, and is an area of continuing research and product development. Follow the recommendations in the *Best Management Practices for the Use of Treated Wood in Aquatic Environments* (Western Wood Preservers Institute 2006). Another comprehensive source of information is *Preservative-Treated Wood and Alternative Products in the Forest Service* (Groenier and LeBow 2006).

In a nutshell, there are several good reasons to use preservative-treated wood in wet areas and few reasons not to use them. All of the treatments effective in wet areas must be applied under pressure in a factory to exacting standards. The exception is copper naphthenate, which can be applied carefully and sparingly with a brush and is good for spot treatment. Both oil-type and waterborne preservatives are suitable for wet environments from a standpoint of preserving wood, but the person specifying materials needs to know the characteristics and effects of each type of preservative before deciding which to use. Water-soluble preservatives, such as borates, are not suited for wet environments. The borates do not permanently “fix” to the wood.

Workers need to take safety precautions when handling or disposing of treated wood. Treated wood should not be burned. Some States and other jurisdictions may also impose disposal restrictions. Best management practices call for proper collection and disposal of treated wood debris and sawdust.

Each of the preservatives containing copper imparts a color that disappears in time. Normally, the color disappears within 2 years, but depending on site conditions and exposure, the process may take several months to 3 or 4 years. One of the most popular preservative treatments, chromated copper arsenate (CCA), is no longer used if anyone is likely to contact the preservative-treated wood. Replacement treatments are more corrosive than CCA, so hot-dipped galvanized hardware and fasteners are recommended to prevent corrosion.

## ***Recycled Plastic***

Many manufacturers of recycled plastic are producing this material in the shapes and dimensions of standard wood lumber and timber products. Some of these products are being marketed as premium deck coverings. Recycled plastic can be worked like wood. It can be sawed, drilled, nailed, screwed, bolted, and painted. Although the surface is smooth, it is not slippery.

The properties of some recycled plastic may present unexpected challenges and disappointments. The material can be up to three times heavier than wood. By itself, 100-percent recycled plastic has little strength. It must be reinforced with a steel backing or core to have any structural value, increasing its weight and introducing another material.

Plastic is decay resistant. The thermodynamic properties of plastic—how much it expands and contracts in the heat or cold—are quite different from those of concrete, steel, or wood, the materials that would normally be used with recycled plastic. The surfaces of some recycled plastic severely degrade in sunlight. The problems of strength, thermodynamics, and ultraviolet degradation are being studied. These problems have resulted in new, improved formulations of recycled plastic. These products have not yet withstood the test of time.

Some recycled plastics contain sawdust or another form of wood fiber or fiberglass. These composites are usually stronger and do not have the same thermodynamic problems as most 100-percent plastics. When sawed or drilled, the exposed sawdust and wood fiber may be just as subject to fungus and insect attack as untreated wood. However, wood fibers completely encased in plastic will be decay resistant.

A problem is created when any of the recycled plastics are drilled or sawed in the field. Unlike wood, the shavings and sawdust will not decompose. This problem can be resolved by drilling and sawing over a large plastic sheet and carrying the shavings out, the same process that is recommended for disposing of treated wood residues.

Recycled plastic is not a traditional construction material. It may be inappropriate where a rustic appearance is important. Recycled plastic costs 50 to 300 percent more than treated wood. The increased weight of plastic will be reflected in higher shipping and onsite construction costs. One advantage of this plastic is that it does not support combustion.

## ***Hardware Connectors***

The nails, bolts, washers, nuts, and other connectors used for outdoor construction should be made of corrosion-resistant steel. Hot-dipped galvanizing provides more durable protection than electroplating. Products commonly available at most building supply stores are electroplated. It is especially important to use galvanized or stainless steel connectors on wood that has been treated with waterborne preservatives containing copper.

## **Nails**

Most nails used in trail construction are ringshank nails, barn spikes, or occasionally, roofing nails. Ringshank nails have closely spaced circular rings around the shank of the nail. These nails rarely work loose and are very difficult to remove if driven incorrectly. The steel is quite brittle. It will usually break off if it is bent or hit on the side. Nails are sized by the penny, an old form of measurement. See appendix D for gauge (thickness), lengths, and number of nails per pound for each size. Barn spikes are from 8 to 12 inches long, with a wide thread making a complete revolution around the shank every 4 to 6 inches.

## **Bolts**

Bolts are used for constructing bents. Bolted connections are better than screwed connections because the bolt passes completely through at least two timbers or a timber and a steel plate or angle. Both ends of the bolt are visible and can be tightened if the wood shrinks. Three different types of bolts can be used: carriage bolts, machine bolts, and long bolts that are custom cut from threaded rod (called *all thread*).

Carriage bolts were used to construct wooden wagons and carriages. A square portion of the head of a carriage bolt penetrates into the wood, preventing the bolt from turning when it is tightened. Carriage bolts were originally used with oak, a hardwood that did not allow the bolt head to turn. Carriage bolts are effective with most woods, except for softwoods such as redwood and western redcedar. Carriage bolts do not require washers between the head of the bolt and the wood, but a washer is needed between the nut and the wood. Carriage bolts may be up to 12 inches long.

Machine bolts have a hexagonal head that is flat on the top and bottom. Machine bolts require steel between the head and the wood and between the nut and the wood. The steel can be either a washer or a steel angle or plate. Machine bolts may be up to 12 inches long.

All-thread rods are available in lengths of 2, 3, 6, and 12 feet and diameters of  $\frac{1}{4}$  to 1 inch. The rod, threaded for its entire length, is useful where long bolts are needed. The appropriate length is cut from the long rod with a hacksaw, and a nut and washer are attached to each end. Bolt cutters should not be used to cut the rod. They will mash the threads, making it impossible to attach the nut (figure 69).



Figure 69—Fasteners (from left): carriage bolt, machine bolt, all-thread rod, and lag screw.

## **Lag Screws (Lag Bolts)**

Most people working with these connectors refer to them as lag bolts. Manufacturers call them lag screws. Regardless of their name, they usually have a square or hexagonal head, a threaded tapered shank, and a sharp point. They must be tightened with a wrench. They are made in lengths from 1 to 8 inches and diameters from  $\frac{1}{4}$  to  $\frac{5}{8}$  inch.

## **Washers**

Four types of washers are suitable for working with wood in a wetland trail: flat washers, fender washers, lockwashers, and malleable iron washers. Flat washers are the most commonly

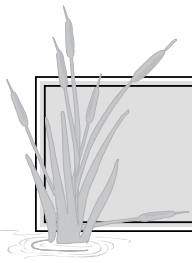

used. They are placed between the wood and nuts and between the wood and the head of machine and lag bolts. The washer prevents the bolt head or nut from being drawn into the wood. Fender washers are wider than flat washers, but they have the same purpose. Fender washers are used if the wood or other material is soft. Lockwashers are not a closed circle; they are cut once and the ends are offset on one side or the other. They are used with the other washers and against the nut to prevent the nut from loosening.

Malleable iron washers are much larger and thicker than other washers. These washers were used when large-diameter bolts joined logs and heavy timbers in traditional rustic construction. Malleable iron washers can be used with  $\frac{3}{8}$ - to 1-inch-diameter bolts.

### Nuts

Nuts fit over the threaded ends of carriage and machine bolts and all-thread rods. They must be used against a washer or a piece of structural metal. Nuts are either square or hexagonal, with a round, threaded hole in the center to fit over the bolt or rod. Locknuts fit more snugly on the bolt than common nuts. They are used when vibration may loosen a common nut. Locknuts function better than lockwashers, but they are not as readily available.

### Wood Screws (Deck Screws)

A screw is threaded and tapers to a point. The use of a screw determines the desired shape of the screw's head and point, and the material from which it is made. There are perhaps 100 kinds of screws, but wood screws are the ones most likely to be used in wetland trail construction. Wood screws are used to attach tread plank to a nailer, or an interpretive sign to a post. The head of a wood screw is wedge shaped to penetrate into the wood without protruding above the surface. Most screw heads will either have a recessed slot or cross to accommodate a standard screwdriver or a Phillips-head screwdriver. Hot-dipped galvanized steel, stainless steel, and brass screws should be used for trail work.

Most stainless steel deck screws are produced with a hexagonal recess in the head to accommodate an Allen wrench, which makes them somewhat vandal resistant. Other vandal-resistant screws require special screwdrivers for removal. These screws are best for installing signs.

### Steel Reinforcing Bars

Steel reinforcing bars used for driftpins must be protected from the weather and the copper in wood treated with preservatives. Epoxy-coated steel reinforcing bars are available from suppliers of heavy construction materials. Usually these suppliers sell only to contractors. Epoxy can be purchased from some mail-order companies. The crew building the trail can cut the uncoated bars to size and dip the ends and paint the bars with the epoxy compound. The epoxy coating will resist saltwater corrosion. Before epoxy compounds were available, steel driftpins were protected with a thin layer of heavy automobile grease. The grease also made driving the driftpins easier.

### Staples

Heavy steel fence staples,  $\frac{1}{4}$  to  $\frac{1}{2}$  inch in size, are useful for attaching hardware cloth to wooden piles used for bog bridge and boardwalk in areas frequented by beavers. Staples can also be used to attach geotextile fabric to wood.

### Hardware Cloth

Hardware cloth consists of two sets of steel wires placed perpendicular to each other and welded together. The result is a pattern of equal squares. The squares are either  $\frac{1}{4}$  or  $\frac{1}{2}$  inch. After welding, the hardware cloth is hot-dipped galvanized. It is available in 20- and 50-yard rolls, and in 2-, 3-, and 4-foot widths (figure 70). Hardware cloth is sometimes stapled around piles to discourage beavers from chewing on them.

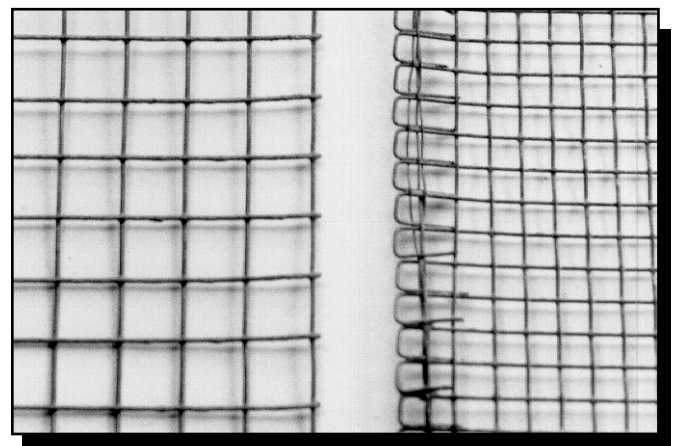

Figure 70—Two sizes of hardware cloth.



## Geosynthetics

Geosynthetics are synthetic materials used with soil or rock in many types of construction. Geosynthetics can improve construction methods and offer some alternatives to traditional trail construction practices.

The Missoula Technology and Development Center produced a detailed report, *Geosynthetics for Trails in Wet Areas: 2000 Edition* (Monlux and Vachowski 2000), about these versatile products. The following information is summarized from that report. MTDC plans to update the report in 2007.

Geosynthetics perform three major functions: separation, reinforcement, and drainage. Geosynthetic materials include geotextiles (construction fabrics), geonets, sheet drains, geogrids, and geocells. All these materials become a permanent part of the trail, but they must be covered with soil or rock to prevent ultraviolet light or trail users from damaging them.

Geotextiles, sometimes called construction fabrics, are the most widely used geosynthetic material. They are made from long-lasting synthetic fibers bonded to form a fabric. They are primarily used to separate trail construction materials from wet, mucky soil and to reinforce the trail. They have the tensile strength needed to support loads and can allow water, but not soil, to seep through. Nonporous geotextiles can be used in drainage applications to intercept and divert groundwater. Felt-like geotextiles are easier to work with than heat-bonded, slit-film, or woven products that have a slick texture.

Geotextiles are often used in trail turnpike or causeway construction. They serve as a barrier between the silty, mucky soil beneath the fabric and the mineral, coarse-grained, or granular soil placed as tread material on top of the geotextile. The importance of separation cannot be overemphasized. Once mineral soil contains about 20 percent of silt or clay, it takes on the characteristics of mud—and mud is certainly not what you want for your tread surface. Most geotextiles commonly used in road construction work for trail turnpikes. The fabric should allow water to pass through it, but have openings of 0.3 millimeters or smaller to prevent silt from passing through.

Geotextile is sensitive to ultraviolet light. It readily decomposes when exposed to sunlight. When geotextile is not exposed to sunlight, it lasts indefinitely. Always store unused geotextile in its original wrapper.

Geonets or geonet composites (figure 71) have a thin polyethylene drainage core that is covered on both sides with

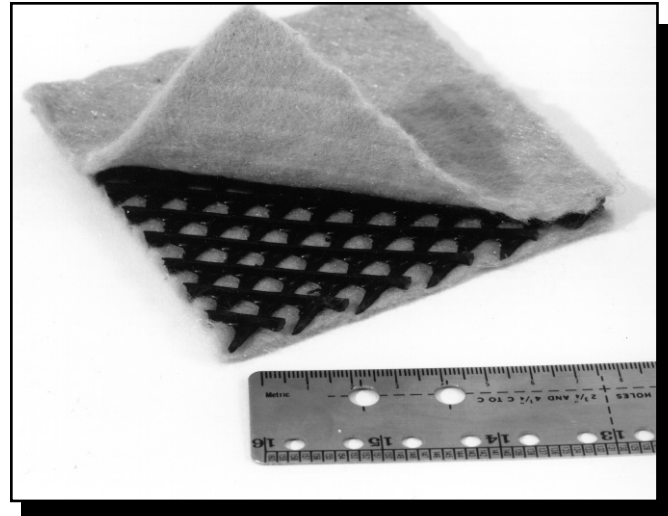

Figure 71—The net-like core of geonet allows drainage.

geotextile. They are used for all three functions—separation, reinforcement, and drainage. Since geonets have a core plus two layers of geotextile, they provide more reinforcement for the trail than would a single layer of geotextile.

Sheet drains are a form of composite made with a drainage core and one or two layers of geotextile. The core is usually made of a polyethylene sheet shaped like a thin egg crate. The core provides separation, reinforcement, and drainage. Since sheet drains have greater bending strength than geotextiles or geonets, less tread fill is often needed above them.

Geogrids are made from polyethylene sheeting that is formed into very open grid-like configurations. Geogrids are good for reinforcement because they have high tensile strengths, and because coarse aggregate can interlock in the grid structure. Geogrids are normally placed on top of a layer of geotextile for separation from saturated soil.

Geocells (figure 72) are usually made from polyethylene strips bonded to form a honeycomb structure. Each of the cells is filled with backfill and compacted. Geocells are good for reinforcement, reduce the amount of fill material required, and help hold the fill in place. Geocell usually has geotextile under it to provide separation from saturated soils. The grids need to be covered with soil so they will never be exposed. Exposed geocells present a substantial hazard to vehicles due to loss of traction, and can cause hikers or packstock to trip.



Figure 72—Geocell being laid in courses for a bridge approach. When the approach is completed, the geocell will not be visible.

### ***Nonslip Gratings and Grit-Treated Mats***

Gratings are normally used for walking surfaces at industrial sites and boat docks. They may be useful where a slippery tread in a wetland trail has become a problem, or where this problem can be anticipated because of deep shade, heavy rainfall, or icy conditions.

Gratings are made in a variety of sizes from steel, stainless steel, aluminum, and fiberglass. Some manufacturers use fine serrated teeth on the surface of the grating to prevent users from slipping; others use small, round, raised knobs on the surface; still others embed silica grit. The gratings can be attached to an existing deck or used by themselves in the original construction.

Other options to reduce the likelihood of users slipping on the trail include the use of strips of rubber-like material with a non-skid surface. The strips adhere to clean decking. When wood is painted, stained, or sealed, a nonskid additive (sold at paint stores) can be mixed with the paint, stain, or clear sealer before they are applied.

Silica-treated fiberglass mats are available from some of the grating manufacturers. They come in thicknesses of  $\frac{1}{8}$  to  $\frac{3}{4}$  inch and in panel sizes of 5 to 12 feet. Fiberglass can be sawed to size. Holes can be drilled for nailing or screwing fiberglass to wood planks.

Most gratings are extremely expensive, well beyond the budgets of most trail projects. The exceptions would be for wetland trails at very heavily used sites such as visitor centers or for short interpretive trails.

In Alaska, slippery surfaces are a reality on miles and miles of boardwalk. The Forest Service Alaska Region's *Trails Construction and Maintenance Guide* (1991) offers several ways of dealing with this problem. These methods are described next.

### ***Roughened Wood Surface***

Use a saw or adz to cut grooves perpendicular to the line of travel. Make the cuts deep enough to be effective, but not so deep that they hold enough water to cause decay.

### ***Mineral Paper***

Mineral paper is available in a 9-inch width in 50-foot rolls. This tar-fiberglass material is tacked down every 3 to 4 inches along each edge with galvanized roofing nails. Mineral paper should be used on pressure-treated wood because it will hasten the decay of untreated wood. If properly installed, it has given good service for up to 10 years. Mineral paper is inexpensive and easy to replace.



## ***Construction Materials***

### ***Fishing Net***

Nylon fishing net (No. 96 Bunt Web) has been used successfully in the Alaska Region and has been found to be durable and effective. Make sure the net is properly stapled to each pressure-treated plank before delivering and installing the planks. Use an air-driven pneumatic stapler (that can be rented with an air compressor) to drive galvanized staples. Staple at 4-inch intervals to keep the net from bunching and creating a tripping hazard. The netting can be applied in the field using hand-driven galvanized fencing staples.

Neatly hide all edges underneath the walking surface of the plank or logs. Black 1- to 2-inch mesh netting has been used

successfully on trails in Alaska. The color blends into the landscape. Used net material can usually be obtained free from net hangers in most Alaska fishing towns.

### ***Cleats***

Cleats, narrow boards screwed or bolted perpendicular to the tread at step-sized intervals, are an effective way to reduce slipping, especially on slopes. Metal cleats are common on steep gangways leading to docks subject to tidal fluctuations.



## Construction Tools

The standard tools used for trail construction are also needed for building a trail in a wetland. Standard trail tools are not described here. Instead, this report focuses on tools specifically needed for wetland trail construction. Find out more about handtools in MTDC's *Handtools for Trail Work* report (Hallman 2005) and two-part video (98-04-MTDC).

### Measuring Tapes

Measuring tapes are a necessity for estimating and constructing a wetland trail. Construction measurements for wetland trails are often taken from the trail centerline. It is frequently necessary to divide by two. Metric measurements offer an advantage over English measurements in such cases. In addition, there is a move from the English system of measurement to the metric system (appendix F). Buy new tapes that are graduated in both systems.

Tapes 50 feet and longer are made of fiberglass, cloth, or steel. Fiberglass is best for the wet, brushy environment of wetlands. Cloth is not recommended because it will wear and rip easily. Long steel tapes may rust, kink, and break when used in wetlands. Short steel tapes, 6 to 30 feet long, are essential.

The longer tapes are best for estimating quantities of materials and hours needed for construction and for laying out centerlines of sleepers, bents, and other structures. The shorter steel tapes are handy for the actual construction.

### Framing Squares

Framing squares (figure 73) are thin, L-shaped pieces of steel with a 90-degree angle at the corner. Each leg of the L is 1 to 2 inches wide and graduated in inches (or centimeters) from both the inside and outside corners of the L. The legs may be 8 inches to 2 feet long. Framing squares are used to mark hole centers and timbers to be cut at a 90-degree angle and to provide a straight, firm edge for marking angled cuts.

### Plumb Bob

A plumb bob is a solid steel or brass cone, 3 inches long by 1½ inches in diameter. The plumb bob accurately transfers

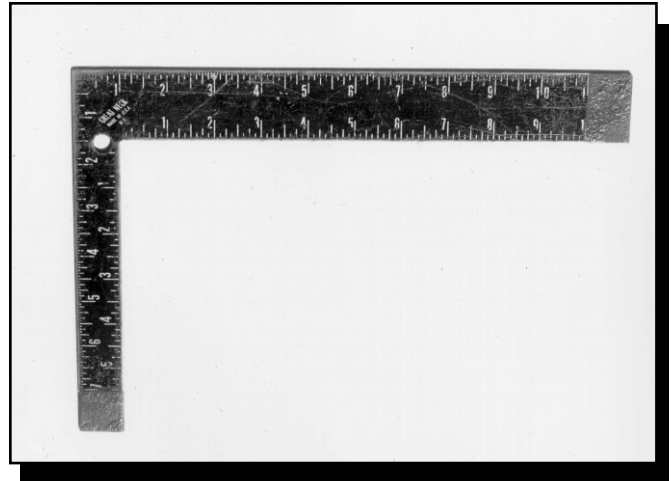

Figure 73—Framing square.

measured points above the ground to comparable points on the ground. It is useful for locating the centers of holes to be dug.

### Levels

Specialized levels are useful for wetland trail work. An Abney hand level or a clinometer is accurate enough to be used for setting grades during the preliminary layout of most wetland trails (figure 74). String or line levels and carpenter's and mason's levels are needed during construction.



Figure 74—Use a clinometer to set grades for preliminary trail layout.

### String or Line Levels

There are two types of string or line levels: one establishes percent of grade easily, the other does not. Each level is about 3 inches long by 1/2 inch in diameter and has a hook at each end to hang the level on a string. The string is pulled tight between two points in an almost horizontal line. One of the points must be at a known elevation. The string level will be used to establish the elevation of the other point.

The most common type of string level has two marks on the level tube. These marks are equidistant from the high point of the level tube. Center the level bubble between the two marks on the tube by raising or lowering the string at the second point. When the bubble is centered, the string is level. If the tread is to be level, this is the elevation to be met. If the tread is to be sloped, the difference between the two points must be calculated; the elevation to be met is established by measuring the difference needed, up or down, from the level line.

In the second type of string level, the high point of the level bubble is off center. The level tube has five graduations. The first two are widely spaced. The rest are closer together, but evenly spaced. When the bubble is centered between the two widely spaced marks, the string is level. When the edge of the bubble touches the third mark, the string is at a 1-percent grade, the fourth mark is at a 2-percent grade, and so forth. A string level is accurate enough to begin to establish relative elevations and slopes for small wetland trail projects (figure 75).

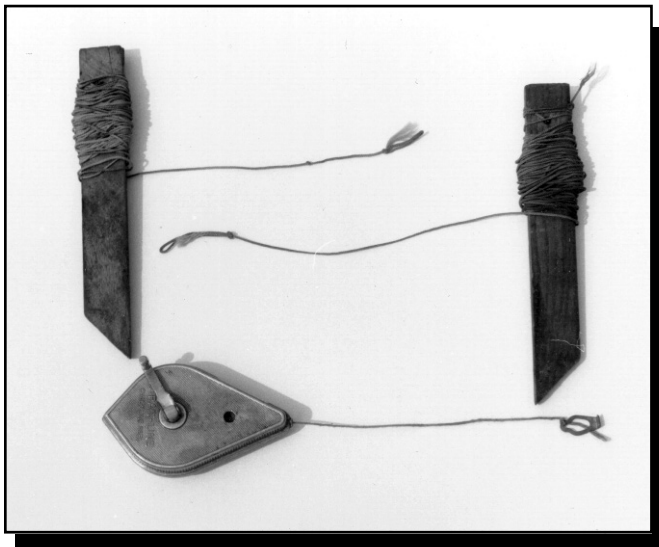

Figure 75—String levels and a chalkline.

### Stringlines

Almost any type of string can be used for a stringline, but for repeated use a professional stringline is best. This type of stringline is a tightly braided string wound around a short, narrow piece of wood, plastic, or metal. Usually there is a metal clip, or a loop, tied on the end.

The stringline extends a straight line to reference the location of the next section of construction. The stringline can also be used with string levels to establish relative elevations and slopes.

### Chalklines

A chalkline is another type of stringline used to mark a straight line between two points on a flat surface. The marked line is commonly a guide for sawing.

Professional chalklines come in a metal case that holds the coil of string and the chalk dust. One end of the chalkline is held tightly at a fixed point on the surface of the object to be marked. The chalkline is stretched to the mark at the opposite end and held tightly at that point. Hold the chalkline at about midpoint, pull the chalkline straight up from the surface and release it. The chalkline will snap back into place, leaving a sharp, straight line of chalk between the two points.

A chalkline is useful for marking the centers of sleepers and bents for a deck that needs to be in a straight line, or the edges of a deck to be trimmed uniformly, or the edges of a log to be cut with a flat face.

### Carpenter's and Mason's Levels

There used to be a distinction between carpenter's levels and mason's levels. Carpenter's levels were wood or wood with steel strips to protect the edges. The mason's level was all or mostly steel. Today, wood, steel, aluminum, and plastic are used in either type of level.

These levels are available in lengths of from 2 to 6 feet. Given the abuse trail tools take, steel or aluminum levels are best. A 3- to 4-foot-long level is more accurate than a shorter level. These levels are easier to pack than 5- to 6-foot-long levels. Plastic levels are also available and cost less.



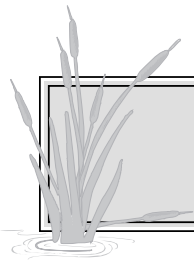

The levels have three tubes mounted in the body of the level. One level tube is parallel with the length of the level, one is perpendicular to it, and one is at 45 degrees to the other two. When a level bubble is centered, the edge of the level is either level, vertical, or at 45 degrees.

### ***Torpedo Levels***

A torpedo level is steel or aluminum and plastic and only 8 to 12 inches long and 1 to 2 inches wide. It is used to determine if a surface within a confined area is level, for example the surface of a notch. Although the torpedo level is not as accurate as the longer levels, it can be used to check whether an item is out of level, or out of plumb. If so, a more accurate level can be used to make the corrections.

### ***Post Levels***

Post levels save time when setting posts and piles. They are basically plastic right angles that are 4 inches long in three dimensions. Two level tubes are mounted in the two faces of the level. Set the level along the side of the post or pile, and use a crowbar or shovel to adjust the post or pile until it is plumb (figure 76).

## ***Surveyor's Transits and Electronic Instruments***

Hand-held tapes and levels are adequate for short destination or loop trails in a wetland, or for low, poorly drained sections of existing trails. However, for trails longer than a quarter mile or over undulating terrain, more precise measurements might avoid future problems. Control points for elevation and slope can be established using surveyor's transits or a variety of electronic instruments.

### ***Surveyor's Levels or Transits***

Old surveyor's levels or transits may be hiding in a closet or storage area at some agency offices. Blow the dust off and try to



Figure 76—Post level.

find someone who knows how to run the instrument. A builder's level or transit may be less accurate, but should work. A surveyor's level rod will be needed to obtain distances and elevations. Distances can be quickly measured optically using stadia.

## ***Electronic Distance Measuring Instruments***

Two types of electronic distance-measuring instruments (EDMs) are available. The least expensive type is hand held and can measure distances across a flat surface to a point from 2 to 250 feet away. This type of instrument does not provide elevations of points or information needed to determine slopes and relative elevations. It will not provide accurate distance measurements if vegetation impedes the line of sight.



## Construction Tools

More expensive instruments can measure distances up to 12,000 feet with an accuracy of 0.02 to 0.03 feet. A direct, clear line of sight is required.

Global positioning systems (GPS) provide horizontal positioning through the use of coordinates and can provide elevations. This equipment may cost from a hundred dollars to several thousand dollars depending on the quality. The skills needed to operate GPS equipment vary depending on the equipment's sophistication and accuracy.

The accuracy of small hand-held instruments can be close to 1 meter (3.28 feet), in open, relatively level terrain, sufficient accuracy for trail work if frequent points are taken along the route.

Survey-grade GPS instruments also are available for more precise work. These instruments require extensive training and experience in their use. They are also very expensive.

GPS technology changes quickly. Technological advances, reduced costs, and increased accuracy have resulted in many practical and affordable GPS trails applications.

## Saws

### Handsaws

Most timbers and logs used in wetland trail construction are of relatively small diameter. Usually the largest are the piles, 6 to 10 inches in diameter.

If only a few pieces must be cut, or if wilderness regulations require, a one-person crosscut saw can do the job. This is an old-fashioned large handsaw. The blade is 3 to 4 feet long and heavier than a carpenter's handsaw, with much larger teeth (figure 77).

### Chain Saws

If many pieces of wood need to be cut, and if regulations permit them, chain saws do faster work for cutting the small sleepers, piles, and planks used for some wetland trails. A small, lightweight saw designed for tree pruning is better for cutting horizontally on vertical piles, posts, and other items. Pruning saws are available weighing 8 pounds, with a 12- to 14-inch bar.

The sawyer should be adequately trained and experienced in the use of the chain saw and the safety equipment. Most government agencies, the Forest Service included, require workers to receive special training and certification before they are allowed to use a chain saw.



Figure 77—A one-person crosscut saw is a good choice for back-country settings.

### Hand-Held Pruning Saws

Small hand-held pruning saws are used on most projects. Most types have a curved blade 12 to 26 inches long. For wetland work, the shorter saws are adequate. Some saws have a wood or plastic handle that the blade folds into when it is not being used. Small pruning saws with a straight blade 6 to 8 inches long are available. The short saws with the straight blade work well for cutting shallow notches in log sleepers. When the saws are folded, they can be carried in a pocket (figure 78).



Figure 78—Pruning saws.

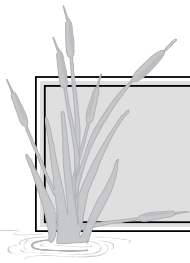

## Axes

Three kinds of axes are commonly used in trail work: single-bit, double-bit, and broad axes. The hatchet is not included in this tool list. A Maine guide once wrote that the hatchet is the most dangerous tool in the woods. He may have been right. It takes only one hand to use a hatchet. The other hand is often used to hold the piece of wood to be cut—not the safest thing to do. Few trail crews include a hatchet in their toolbox.

Proper ax selection, care, and use is described in MTDC's videos and reports: *An Ax to Grind: A Practical Ax Manual* (Weisgerber and Vachowski 1999) and *Handtools for Trail Work* (Hallman 2005).

## Adzes

If the hatchet is the most dangerous handtool in the woods, the carpenter's adz is the second most dangerous. A person getting hurt with a hatchet has usually been careless. It is not necessary to be careless to get hurt using an adz. The carpenter's adz is used for cutting a level surface on a log for some types of puncheon and gadbury and for removing knots and bulges on log surfaces.

The blade of a carpenter's adz is 5 inches wide and similar to an ax except that it is mounted perpendicular to the line of the handle, similar to a hoe. The edge must be sharp. The handle is curved, similar to a fawn's-foot handle on a single-bit ax.

Workers using an adz normally stand on a wide log (16 inches or more in diameter) and swing the adz toward their feet, almost like hoeing a garden. An adz can be used on smaller-diameter logs by a worker standing next to the log and chopping sideways along the length of the log. When one face of the log is cut to a level plane, the log can be turned and another face can be cut. It is extremely difficult to use a long-handled adz to cut anything but the upper surface of a log.

Two other types of carpenter's adzes have short handles. They are not suitable for shaping large logs, but work well for

removing knots and bulges and for cutting notches. Short-handled adzes are made with a straight or concave blade, about 3 inches wide. Striking the back of the adz head with a hammer will eventually crack the head (figure 79).

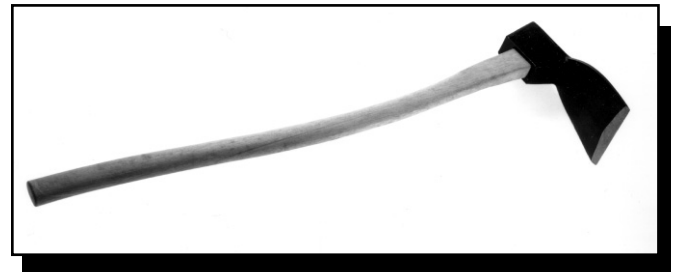

Figure 79—Using an adz safely requires that the adz has a razor-sharp edge and that the worker use the utmost control and concentration when making the swing.

## Planes

Small block planes can be used for shaping bevels and chamfers, for removing unevenness where two pieces of wood butt together, and for smoothing splintery edges that visitors might touch. Block planes are small, about 2 inches wide and 4 inches long, and easily packed to the worksite (figure 80).

## Draw Knives

Draw knives are often used to peel the bark off logs. Logs will last longer without the bark. Draw knives work best on logs with thin bark.

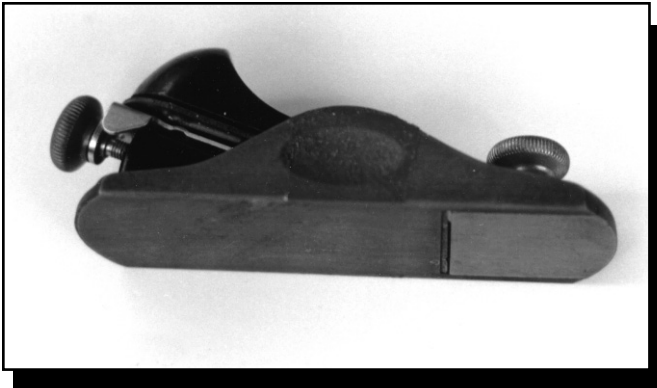

Figure 80—A small block plane is useful for finish work on wood structures.

Draw knives have either straight or concave steel blades that are 12 to 15 inches long with a wooden handle at each end. The draw knife is pulled toward the worker. The straight draw knife does not put as much of the edge against the wood as the concave knife, making the concave knife more efficient and more popular (figure 81).



Figure 81—Straight and concave draw knives.

## ***Bark Spuds***

Bark spuds are better suited for removing the bark from thick-barked or deeply furrowed logs and logs with many knots or large knots. Normally, logs are most easily peeled when the tree is still green, but this characteristic varies by tree species. Bark spuds are from 18 inches to 6 feet long. All have a steel head that is 2 to 3 inches wide and 3 to 5 inches long, sharpened on the end and both sides. The wooden handle is 15 inches to 5½ feet long (figure 82).

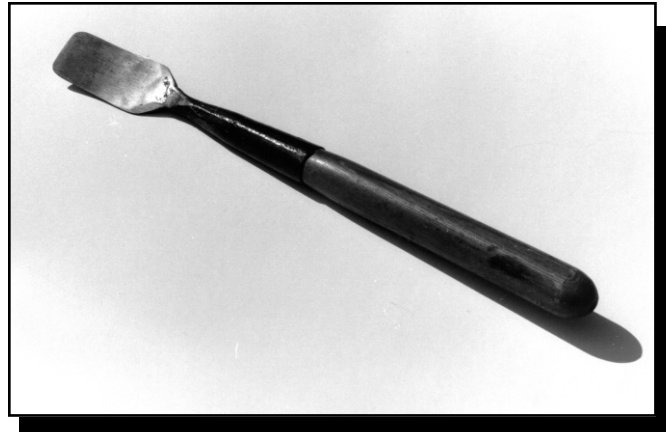

Figure 82—A bark spud works well when peeling green logs.

## ***Tools For Drilling Holes in Wood Bits***

Bits are used to drill holes in wood for bolts and for pilot holes for nails and screws. Some of the types of bits available are twist bits, chisel bits, augers, and ship augers.

Twist bits are intended for use on steel, but the smaller bits can be used for drilling pilot holes in wood for nails and screws (see appendix D for appropriate pilot hole sizes). Chisel bits resemble a chisel with a point in the center. Chisel bits tend to tear up the wood around the hole on the top and bottom surfaces of the wood, but they are readily available in diameters of 1/16-inch increments. Augers resemble a widely threaded screw with a sharp end and sharp edges. Augers do not tear up the wood like chisel bits do. A normal auger bit is 6 inches long and readily available in 1/4- to 1½-inch diameters, in 1/8-inch increments, less readily in 1/16-inch increments. With a 6-inch-long auger, it is difficult to get the holes to line up when two 3-inch ledgers are on each side of a 6 by 6 pile. Ship augers help in this situation because they are longer. Ship augers are 15, 17, 18, 23, and 29 inches long and are indispensable when working with timbers and logs.

Old auger bits were made with a four-sided shaft to fit into a manually powered brace or drill. A six-sided shaft is designed for use in a power drill and will spin uselessly when used in a manually powered brace or drill. Today, most bits are made for power drills. When selecting a bit from a maintenance shop, check to see that the shaft of the bit matches the brace or drill to be used at the worksite (figure 83).

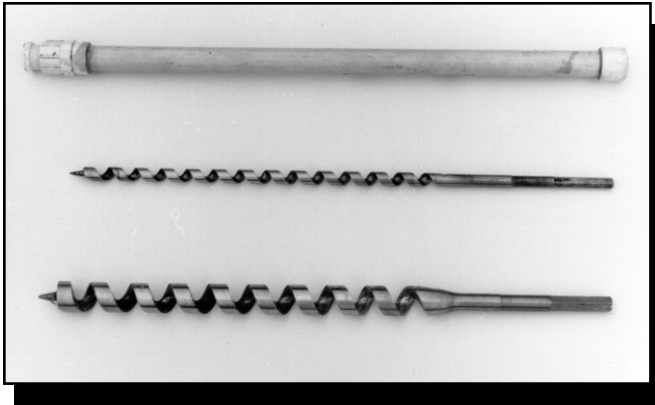
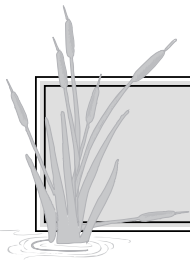

Figure 83—Ship augers are longer than normal 6-inch augers.

### **Braces**

Braces and bits are the traditional tools for drilling holes in wood. The brace, a handtool suitable for wilderness use, is extremely slow. Old braces require an auger bit with a four-sided shaft (figure 84).

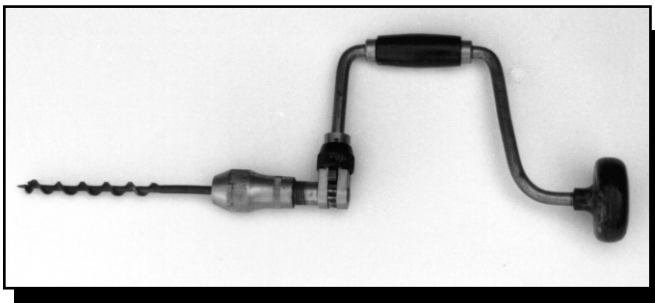

Figure 84—A traditional brace and bit.

Some braces are made with a ratchet, which is helpful when working in close situations where the brace cannot be turned a full circle. People have a tendency to lean on the brace to speed up drilling. This practice bends inexpensive braces. Buy a good brace or don't lean on it. Keep the bits sharp.

### **Battery-Powered Drills**

Small battery-powered drills are useful for drilling holes  $\frac{1}{16}$  inch to  $\frac{3}{8}$  inch in diameter. Some heavy-duty drills can drill

holes up to 1 inch in diameter. Battery-powered drills may be practical for backcountry use where only a few holes are to be drilled, where the crew returns to the shop after work, or where a generator or photovoltaic power source is available.

### **Gasoline-Powered Drills**

Many trail crews use gasoline-powered drills. These tools can drill holes up to 1 inch in diameter and weigh from 10 to 12 pounds, plus fuel (figure 85).



Figure 85—Gasoline-powered drills are great for backcountry work if regulations allow their use.

Only the more expensive heavy-duty drills, whether battery or gasoline powered, have a reverse gear. A bit can become stuck if it does not go all the way through the wood. To avoid getting a bit stuck, lift the drill up a few times while drilling each hole. If the bit does get stuck, disconnect the bit from the brace or drill and use a wrench to twist the bit backward.

If you have a generator at the worksite, another alternative is to use a  $\frac{1}{2}$ -inch-diameter electric drill. Most of these drills have a reverse. An annoying drawback is stepping over a long extension cord and getting it tangled in brush and timbers. If the operator is standing in water, electric shock is a possibility. Generators are heavy and require fuel. Although some generators have wheels, most are awkward to transport to wetland sites.

## **Clamps**

A pair of large jaw clamps can speed the installation of two ledger bents. The clamps should have at least a 12-inch opening. These clamps are used for making furniture and may be all steel or part steel and part plastic. Both ledgers are placed roughly in position and clamped loosely to each pile. The height of each ledger is adjusted, the clamps are tightened, and the bolt holes are drilled (figure 86).

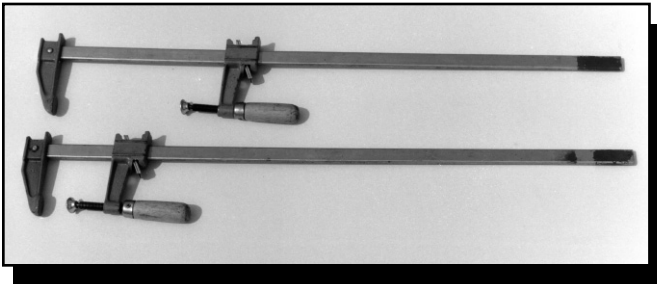

Figure 86—Large jaw clamps.

## **Wrenches**

At least one wrench is needed to securely fasten carriage bolts and lag screws. Two wrenches are needed to fasten machine bolts and all-thread rod. Specialty wrenches or screwdrivers are needed to install vandal-proof screws. Closed-end and open-end wrenches, and a set of socket wrenches, may all be needed. Tying one end of a cord to the wrench and the other end to your belt may help keep the wrench from getting lost in the water or mud.

## **Chisels**

Wood chisels are needed for wetland trail structures. The blade may be  $\frac{1}{4}$  to  $2\frac{1}{2}$  inches wide. Wood chisels are typically made with short handles, which often contribute to scraped knuckles. It is worthwhile to repair or replace the handles of old, long-handled chisels.

For a small amount of close work, the wood chisel can be hit or pushed with the palm of the hand. If this technique is impractical, use a wooden mallet. Hitting a wood chisel with a

steel hammer will damage the chisel's handle. A good wood chisel should not be used close to nails, screws, or bolts. The cutting edge should be kept sharp.

The socket slick, an oversized chisel, is a difficult tool to find. However, if considerable notching or other accurate work is required, obtaining a slick will be worth the extra effort and expense. The blade is  $3\frac{3}{8}$  inches wide with an 18-inch wooden handle. The slick weighs 3 pounds. A 2-inch-wide chisel weighs just 10 ounces. The advantages of the slick are its wide blade and long handle. The slick can remove wood twice as quickly as a wide chisel. The long handle keeps the hands farther from the wood being cut (figure 87).



Figure 87—Socket slicks can be hard to find.

## **Mallets**

Mallets are made with plastic, wooden, leather, or rubber heads. Mallets with plastic or wooden heads should be used for hitting wood chisels.

## **Hammers**

### **Claw Hammers**

A carpenter's claw hammer is helpful for nailing log culverts, bog bridges, boardwalks, and geotextile fabric. A 28-ounce framing hammer is better than the lighter models, although the heavy hammer may be awkward for workers who are unaccustomed to it.

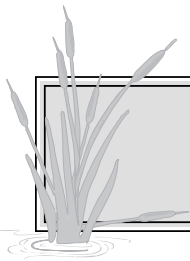

## Sledge Hammers

A variety of different weight sledge hammers should be available at the worksite. A 4-pound sledge is good for starting driftpins and spikes. A 6- or 8-pound hammer is better for driving them. The 8-pound hammer is better suited for moving heavy timbers and logs fractions of an inch when they are almost in place. Surveyor's sledge hammers have shorter handles. They are better for driving long pieces of steel because they provide better control.

## Crowbars

A crowbar is indispensable for building trails in rocky terrain. For most wetland trail work, the crowbar is used to move fallen trees and logs out of the way and to align piles, logs, and timbers. A crowbar, also called a rock bar or pry bar, is much stronger than a hollow-pipe tamping bar. The two are often confused.

## Tools for Digging Holes

### Shovels and Posthole Diggers

The sharp-pointed shovel can be used for digging a narrow deep hole, but a posthole digger or manual auger is more efficient. The posthole digger with its clamshell-like blades is most common, but it is slow and awkward to use. The auger is more expensive, but more efficient.

## Augers

The auger blade consists of two pieces of immovable curved steel set at opposing angles to each other. The wooden handle is turned in a horizontal plane while the blades drill a hole in the ground. In most soils an auger is more efficient than a posthole digger (figure 88).



Figure 88—A hand auger.

## Gasoline-Powered Augers

Gasoline-powered augers are available. These can usually be rented from local equipment rental companies. A one-person auger weighs 18 to 140 pounds. A two-person auger weighs 35 to 75 pounds. These augers are easily moved to a site. The heavier one-person augers have an engine mounted on wheels that is separate from the auger. Power augers usually make fast work of drilling holes in almost any soil. Problems occur when the auger runs into a boulder, a large root, or soil containing 4- to 6-inch pieces of gravel. The bit will stop, and the torque of the engine may cause back injury.

## Wheelbarrows

Wheelbarrows are an underrated and often forgotten piece of equipment for trail work. A wheelbarrow is a necessity for moving fill for most turnpike construction and can be helpful for moving tools, materials, and supplies. For big jobs, two wheelbarrows are handy. One can be loaded while the other is being dumped.

Steel and fiberglass are the most common materials for the body. Steel is heavier and stronger, but fiberglass is cheaper and more easily repaired.

Wheelbarrows commonly available at most local building supply stores do not withstand the rigors of trail work. Contractor's wheelbarrows are made with stronger steel, and the handles are made of heavier, better quality wood. Although more expensive, a contractor's wheelbarrow will far outlast the flimsy backyard variety. Contractor's wheelbarrows can also be rented.

The solid-body wheelbarrow is the type that comes to mind when we think of wheelbarrows, but the gardener's wheelbarrow also has a place in trail construction. This wheelbarrow, without sides, is easier to use when loading large stones, short timbers and logs, and bags and boxes of materials. Gardener's wheelbarrows are more expensive than contractor's wheelbarrows and are difficult to find. Most have steel wheels. Pneumatic rubber tires are better for trail work. The frame of a standard wheelbarrow can easily be converted to a gardener's wheelbarrow. Temporary flat-tire repair sealants, sold in aerosol cans, help prevent pneumatic tires from going flat. Motorized carriers could greatly ease the burden of moving materials, where their use is allowed.

## **Compactors**

Compactors should be used when placing fill for turnpike and for backfill around end-bearing piles. Several companies make a vibratory tamper type of compactor that is suitable for compacting small areas of fill. These companies also make vibratory plates, which are better suited for larger areas, such as turnpike and accessible surfaces. Vibratory tampers have an area 8 inches square that contacts the ground. Vibratory plates have an area 15 inches square that contacts the ground (figures 89 and 90).

A third type of compactor is an attachment to the Pionjar rock drill. It can be used for compacting backfill in narrow spaces around end-bearing piles, fenceposts, and signposts.

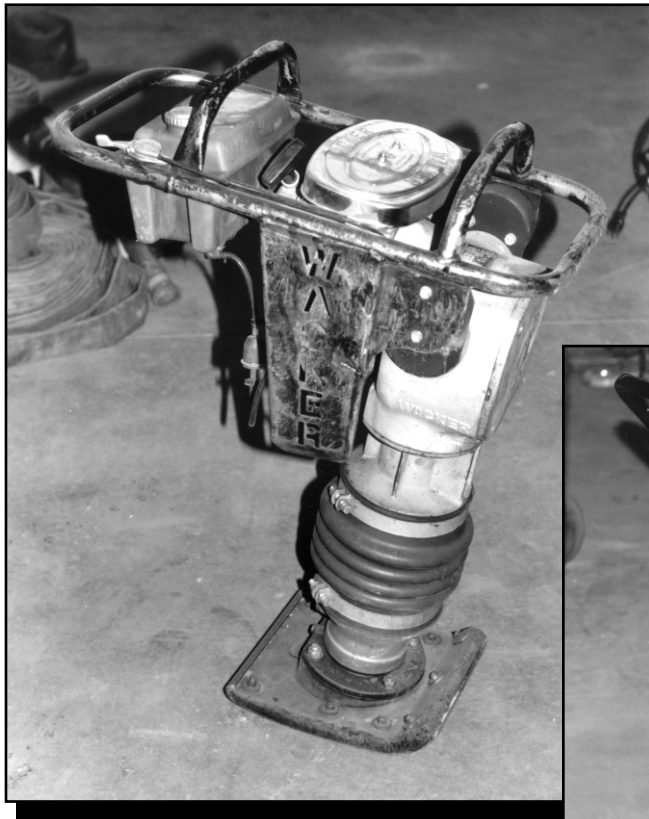

Figure 89—A vibratory tamper.



Figure 90—Vibratory plate compactor.





# Practicing the Craft

## Working With Logs

You learn some time- and labor-saving procedures after working with logs a few times. Here are some tricks that can make your work easier.

### Felling

Trees needed for log construction should be felled during the growing season, mid-April to early September in most regions. The bark is easier to remove from trees cut during this season.

Ideally, fell trees uphill from the construction site, and out of sight of trail users. Select straight trees free of obvious defects. Often defects are not noticeable until the tree is down, but outward signs of decay, fungus growth, and insect attack indicate a tree to be avoided. Special training and agency certification are required for fallers, a very hazardous occupation.

### Bucking and Seasoning

After felling, the tree is bucked, or cut, into log lengths. The logs can be peeled, which will reduce their weight and permit them to dry out, or *season*. Leaving the bark on the logs will protect the surfaces when the logs are moved, especially if the logs are dragged. Whether the logs are peeled or not, they should be stacked off the ground on two or three stringers of low-quality logs. Stickers should be used between layers of usable logs to allow uniform seasoning. Stickers can be 2 by 4s or small-diameter logs placed across a layer of logs at the ends and midpoints of a layer (figure 91).

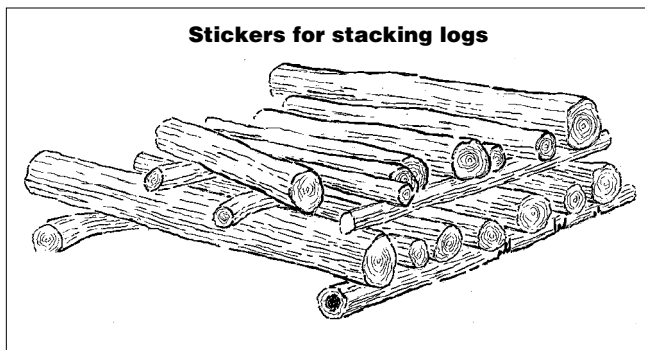

Figure 91—Stickers placed between layers of logs help the logs dry faster and reduce decay.

## Moving Logs

Logs are heavy. Footing is uneven and often slippery. Accidents can happen easily, and the emergency room is far away. When logs are carried by hand, the tendency is to pick up the logs and carry them on the shoulder or at the waist. If workers holding the log slip, the log will come down on them. The result can be a serious injury to the ribs, hip, ankle, or foot.

To avoid or reduce the severity of this type of injury, use two or more log carriers. Log carriers are large steel tongs mounted in the center of a 2- to 3-inch-diameter wooden handle that is 4 feet long. Two workers can use one log carrier to drag a log. At least two carriers are needed to lift a log, one carrier at each end. Each carrier requires one worker on each side of the log.

Log carriers are awkward to pack, heavy, and serve only one purpose. The teeth of log carriers indent the wood half an inch or so on each side of the log. The indentations mar the appearance of the log and provide a place for decay to begin.

A cheaper and lighter method for moving a log is to use rope slings and the removable handles of mattocks or adzes (or small-diameter logs that are 3 to 4 feet long). The slings are made by taking 6 feet of 1,000-pound-test nylon rope and tying a fisherman's knot, double fisherman's knot, or a grapevine knot at the ends, forming a loop.

Roll the log onto the slings and slip the handles over the log and through the loops of the slings. With one worker on each end of the handles (four workers total), lift the log off the ground. The log should be about ankle high. If anyone slips and drops the log, the most serious injury will be to the ankle or foot, and the log will not have fallen far enough to develop much force (figure 92).

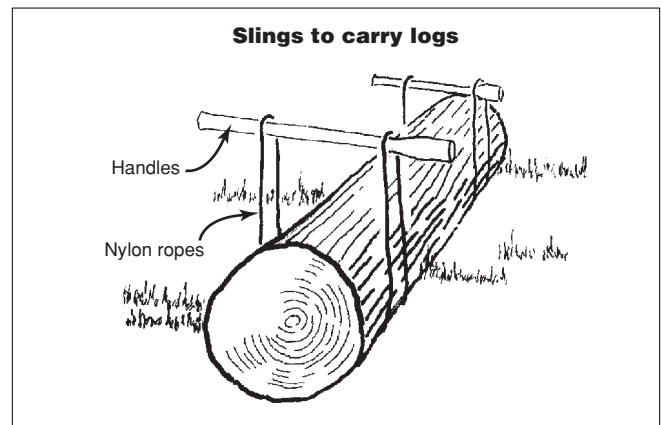

Figure 92—Slings are a good way to move logs and timbers, bundles of steel bars, wheelbarrows that must be carried over soft ground, or bags of cement carried on plywood.



## Peeling

Peeling is a tedious process. There is little reason to peel the bark off a log if you plan to hew or plane it, unless the bark is dirty and likely to dull your cutting tools. Pine, fir, and other evergreen trees may develop pitch pockets just under the bark. On freshly cut trees, pitch may be runny rather than thick or sticky. The cutting edge of a drawknife is never more than an arm's length from a worker's face, and the drawknife is pulled toward the worker's body. Cutting into a pitch pocket splatters pitch on the worker. A drop of pitch in an eye results in the same burning effect as a drop of turpentine. Wear safety glasses or goggles when peeling logs of most evergreen species.

## Squaring a Log

It is not easy to cut a uniform plane surface on a log. That difficulty plus the desirability of using treated timbers for longevity is the reason less work is being done with native logs on site. However, if you are determined to use logs because of their availability and their rustic appearance, here is how to do so. The first step is to place the log on nearly level ground and roll it over to determine which face is easiest to work with. Avoid areas with many knots or large knots. The crook of the log, if any, should be in the direction that will cause the least problem when the construction is completed. Roll the log until the best face is up and in a roughly horizontal position (figure 93).

Determine the width of the plane surface that is needed. Put a carpenter's or mason's level in a horizontal position against the end of the log. Use a measuring tape or framing square to measure the distance between the solid wood and the inside of the bark at the edge of the level. By trial and error, move the level up or down until its upper edge is level and on a line that measures the dimension needed. Draw a line across the end of the log on the edge of the level. Without moving the log, use the same process to draw a line across the other end.

Drive a nail into the bark where each horizontal line meets the bark. Stretch a chalkline or stringline between the two nails on one side of the log. If the bark is thin or has been removed, a chalkline can be used and snapped, leaving a chalk mark to work to. A chalkline will not leave an accurate or discernible mark on thick, deeply furrowed bark or on a log with an inch or more of crook. In this situation, drive nails to hold the string every 2 feet or so along the line of the string. Repeat the process on the other side of the log.

After scoring parallel cuts down to the chalkline with a chain saw or ax, use an adz to remove the wood from the top of

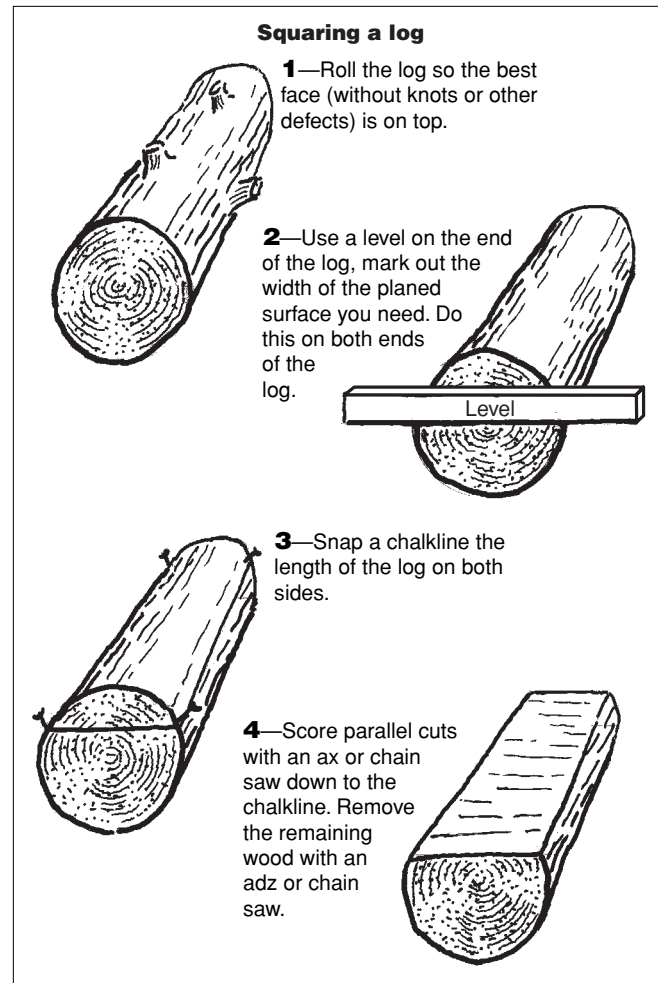

Figure 93—Steps to square a log.

the log down to the chalklines. Use small-diameter logs, 2 by 4s, or log dogs to hold small logs in place while doing the adz work. To control how much wood is removed, cut with the grain of the wood. This technique reduces the likelihood of breaking out deep chips of wood. The direction of the grain will be obvious after the first few cuts.

A chain saw will do the work much faster. A helper is needed to make sure the sawyer doesn't cut below the chalkline on the far side of the log (which the sawyer cannot see). Otherwise, you will end up with a wavy surface. If the wavy surface is used as a tread, it will cause hikers to slip and fall when the tread is wet or frosty.

If you are not using a chain saw, the technique described above is practical only on small logs. The adz is considered a finishing tool for surfaces that have already been hewed to size. If a lot of wood must be removed and power equipment is not available, hewing with a broad ax is more common and

more efficient. The process starts out much like that described for adz work, but instead of horizontal cuts, broad ax cuts are made vertically, for the length of the log along the chalkline. This technique is spelled out in more detail in *An Ax to Grind: A Practical Ax Manual* (Weisgerber and Vachowski 1999).

Check the surface with a straightedge, a framing square, or a long level. Check across the log and also along its length. Mark any high spots and remove them. It is easier to detect high spots by kneeling on the side of the straightedge in shadow and looking between the straightedge and the wood (figure 94).

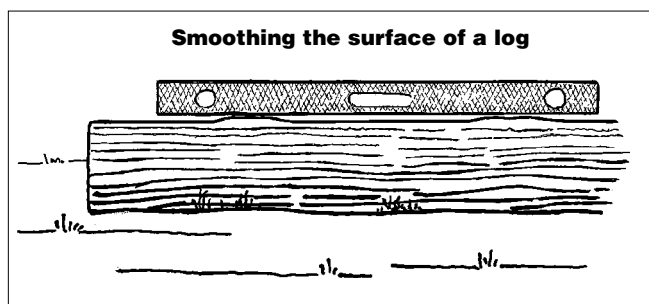

Figure 94—Use a long level to find high spots that need to be removed.

After the first surface is complete, a second surface can be marked and cut. If the second surface is perpendicular to the first, a framing square can be used to mark the ends of the log. Repeat the marking procedure with the chalkline or stringline and nails. The log can be rolled over so that the second surface is horizontal and can be adzed, or the log can be left in place so the second surface can be shaped with a broad ax. This method is suitable for making log puncheon that must be two logs wide (figure 95).

If the second surface needs to be parallel to the first, place the log with its ends resting on two other logs with the first surface facing up and the log level (figure 96). Determine either the thickness of the log needed, or the width of the second surface needed. Using the level, mark a line along the log's edge parallel with the first surface. Roll the log until the first surface is facing down and repeat the chalkline or stringline procedure for the second surface. Use an adz or saw to level the second surface. This technique is suitable for situations where one surface must be level for a tread and the bottom at each end must rest on log or stone piers.

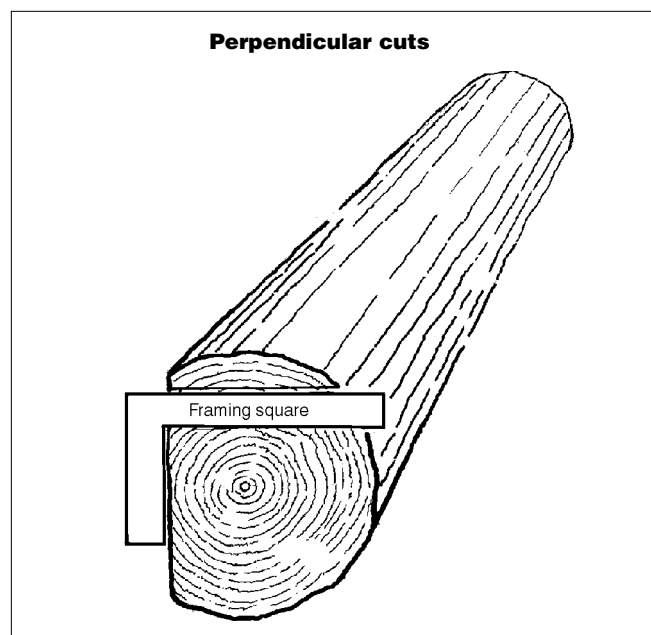

Figure 95—Use a framing square to mark a perpendicular cut.

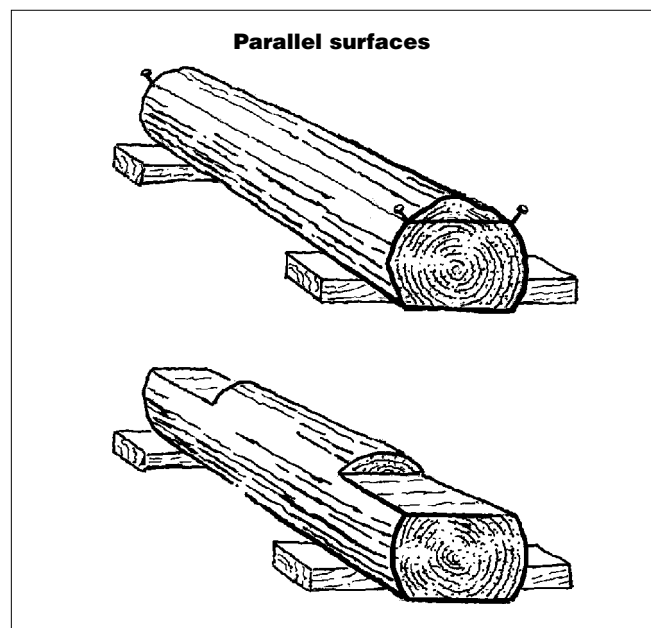
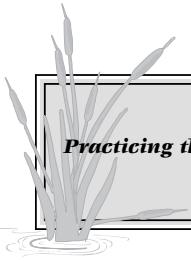

Figure 96—Use this procedure when a second flat surface must be parallel to the first.



## ***Cutting Planks With Chain Saw Mills***

Where chain saws are allowed, native logs are available, and distance or other factors preclude hauling in treated timbers, consider using an Alaskan sawmill (figure 97). This is about the only way to effectively channel the power of the saw to create uniform, square planks. Several sizes of mills are available. A basic mill costs less than \$200. You also need a powerful chain saw, one equipped with ripper teeth.

## ***Working With Timbers***

Rough-sawn timbers are splintery, and some species of wood are more prone to splinter than others. To avoid a handful of splinters, wear good-quality, heavy work gloves.

Timbers to be used in a horizontal plane, (ledgers, stringers, and culvert inverts) should be checked for camber, a slight bend in the length of a piece of wood. Although camber usually is slight—less than  $\frac{1}{2}$  inch per 10-foot length—it should be used to your advantage.

Camber can usually be determined by sighting along all the surfaces of the timber from one end. Sometimes a stringline held to each end of the timber helps to identify camber. Many timbers will not have any camber.

If camber is present, the convex face should be placed up and the concave face placed down, even if this contradicts the “green-side up” general rule of placing growth rings down to reduce cupping. Weight on a timber will cause the timber to deflect or sag. With the convex surface up, deflection will act to straighten the timber. If camber is ignored and the timber is installed with the concave surface up, it is already sagging. Additional weight will cause the timber to sag even more.



Figure 97—An Alaskan sawmill works great for creating planks from native logs. The mill requires a powerful chain saw (at least 3.8 cubic inches of displacement, more is better) and a special ripping chain.

## Working With Treated Wood

At a preservative treatment plant, freshly treated wood is stacked on areas of concrete where excess preservative drips from the stack and is collected and recycled. The treated wood is air dried, which works well in a dry climate. However, the wood is sometimes dry at the surface but wet below the surface when it is shipped. This wood will weigh more because of the moisture. You need to consider this factor when transporting the wood to remote locations. The high moisture content of newly treated wood will also cause tools to bind and tear the wood. This is not intended to deter you from using treated wood, but it is something you need to be aware of.

Treated wood may be kiln dried if that process is specified. Kiln drying to 19-percent humidity can be required. However, the minimum order for large plants may be a truckload. Most small local plants probably cannot do this at all. Kiln drying does cost more.

## Pinning Logs and Timbers

Driftpins (usually  $\frac{1}{2}$ -inch-diameter steel reinforcing bars, also called #4 deformed rebar) are used to pin logs and timbers. Some trail crews prefer to use driftpins cut from  $\frac{1}{2}$ -inch-inside-diameter galvanized steel pipe. The length of the driftpins will vary. When driftpins are used to anchor a log or timber to the ground, about 12 to 18 inches of the driftpin should be in the ground. If rock or boulders are encountered before the driftpin is driven its full length, it will have to be cut off with a hacksaw. When pinning one log or timber to another, the driftpins should be long enough to go through the upper piece and all the way through the lower piece, or at least 12 inches into it.

First, drill holes in the wood  $\frac{1}{16}$  inch smaller than the diameter of the rebar. Before driving the driftpins, dip the end of the driftpin in heavy automobile grease. The lubricant will make it easier to drive the driftpins, will protect the driftpin from the weather, and will provide a thin, protective film between the steel and the copper in treated wood. Driving the driftpins is much easier if you make a striking plate out of a short piece of pipe with a 2- to 3-inch round plate welded to one end.

The top of the driftpin should be countersunk (figure 98). Countersinking can be done neatly by placing a 4- to 6-inch piece of steel pipe around the driftpin and a 12-inch piece of a smaller diameter rebar inside the pipe. With the pipe resting on the log or timber and the smaller diameter rebar resting on the driftpin, hit the rebar with a sledge hammer until the top of the driftpin is below the surface of the wood. This depression can be filled with grease to protect the steel from rusting. Wipe any surplus lubricant off of the wood.

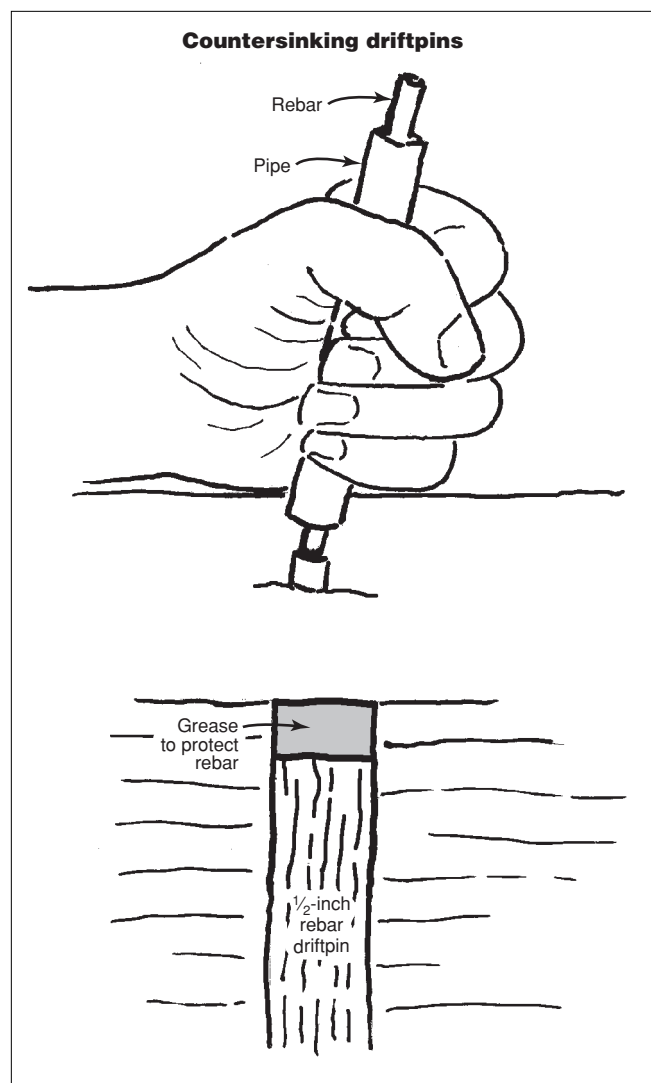

Figure 98—Countersinking the driftpin is a good practice easily accomplished by striking a short piece of rebar inside an even shorter piece of pipe.

## Tread Surface Slippery Wooden Treads

We are frequently asked how to correct a slippery wooden tread. Often, the surface is not the source of the problem. The slippery surface usually is the result of overlooking factors such as trail grade, cross slope, or soil conditions.



### **Trail Grade**

If the grade of the trail surface is too steep, there is little that can be put on the tread to eliminate slipperiness. A wooden surface that has been installed at an 8-percent grade will be slippery with only a heavy dew. Pedestrians will find a wooden surface built at 5-percent grade slippery with frost or light rain. Shaded and north-facing sites aggravate the problem. The maximum grade for a trail with a wooden surface should be 2 percent ( $\frac{1}{4}$  inch per foot).

### **Cross Slope**

Another cause of a slippery tread is a cross slope that is too steep. To prevent excessive cross slope on a trail, use a simple carpenter's, mason's, or torpedo level to identify any difference in elevation between parallel stringers, the notch in sleepers, and ledgers attached to the piles. To eliminate or reduce cross slope, shim up the stringers or ledgers, excavate the high end of the sleepers, redrill the bolt holes, or replace the ledgers (figure 99).

It is much cheaper to build the foundation correctly than to try to correct problems later through maintenance.

### **Soil Conditions**

Another factor that can create a slippery tread is settlement, a problem that occurs when soil settles after a trail has been constructed. The trail may have been built properly, but all or part of the trail may have settled over time. Perhaps sleepers or a bent on end-bearing piles were used instead of a bent on friction piles. That part of the foundation settled over time, causing the trail to sag. The result is that one or both sections of trail on each side of the sag are steeper than intended.

One part of a trail support may settle. For example, one end of a sleeper may settle and the other end may not, or one pile in a bent may settle and the other may not. Both piles may settle, but one may settle more than the other. This type of settling will affect cross slope.

Cross slope of  $\frac{1}{4}$  inch per foot (2 percent) is common for concrete and asphalt surfaces, but is excessive for wood. The cross slope should be level or  $\frac{1}{8}$  inch or less per foot (0 to 1 percent). Settlement can be corrected by shimming the low side, notching the high side, or a little of each. This is extremely difficult to do after construction and can be avoided to a degree by taking ample rod soundings and digging a number of test holes during the design phase. During construction, the crew should be alert for changes in soil conditions and should take remedial actions when necessary.

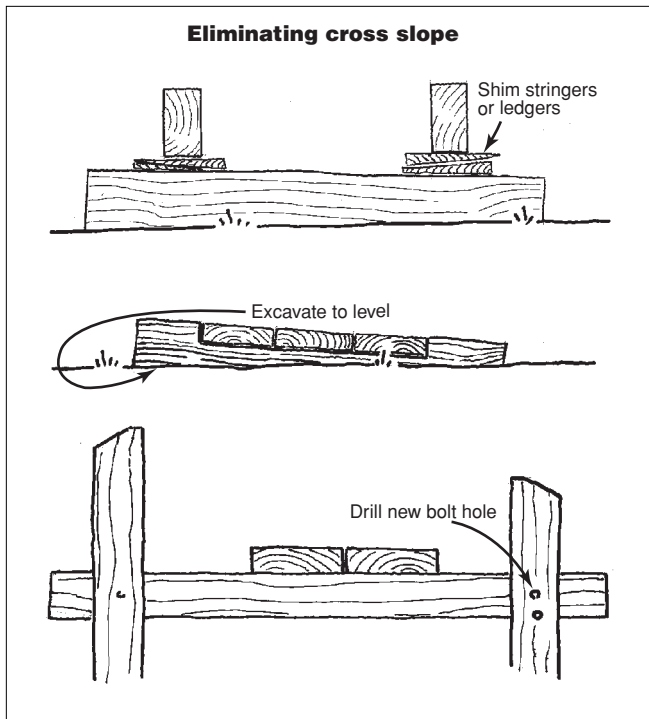

Figure 99—Eliminate cross slope with shims, by excavating the high side of sleepers, or by drilling new bolt holes on the ledgers.

### **Surface Treatments**

If the hazard of a slippery tread cannot be corrected by shimming, notching, or adding steps, a few surface treatments can be applied. These treatments will require maintenance.

### **Latex Paint**

A nonskid latex paint is made for boat decks. This paint is opaque, unlike a clear wood stain, but it can be tinted. As with all painted surfaces, peeling, scraping, and periodic repainting must be expected.

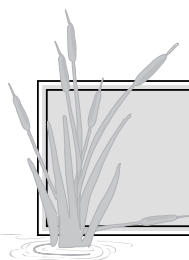

### **Walnut Chips**

Walnut chips are a hard, angular material produced in various sizes. The number 4 size is suitable for nonslip surfaces. Walnut chips can be applied to a wooden surface by sand painting (using chips and paint mixed at the factory), using chips mixed into the paint at the site, or by painting the wood and sprinkling on chips while the paint is wet.

### **Mineral Products**

Nonslip products are also made from pumice and aluminum oxide. Some are premixed. Others are sold as a gritty powder that is mixed with paint.

### **Nonslip Gratings and Grit-Treated Mats**

Another method for correcting a slippery trail tread is to replace a wooden plank tread with nonslip gratings or to apply grit-treated fiberglass mats to the planks.

## **Working With Rock, Stone, and Gravel**

The construction industry recognizes differences between rock, stone, and gravel. It helps to understand the differences in the materials so you will know what to specify or order.

### **Rock**

Rock is the parent material in and under the ground. Sometimes it is called bedrock or ledgerock. Moving rock usually requires drilling and the use of explosives.

### **Stone**

When rock is broken or crushed, the pieces are referred to as stone. Stone, when used in construction, describes usable

pieces of what once had been rock. Stone may be large enough to use for walls, or it may be small pieces that have been through a rock crusher for use as aggregate in concrete or as a base course in a road. Stone is angular on all sides.

Among the byproducts of rock-crushing operations are “crusher fines,” screened material smaller than ¼ inch that is not suitable for most crushed stone contracts. This material is often sold at a discount at crusher operations and makes a fine trail surface when it is wetted and compacted.

### **Gravel**

Small pieces of rock that have broken naturally and have been subject to glacial action or tumbled in a river or creek are called gravel. The glacial action or the effect of water has rounded and removed all the corners of the original piece of rock.

### **Uses of Stone and Gravel**

Rock is rarely found in a wetland. Stone can be brought to the site for use as riprap. Crushed stone can be used for walking surfaces. Because crushed stone is angular, when it is compacted it will knit together to form a solid mass. Gravel cannot be compacted to produce a solid mass. Gravel’s rounded shape is useful because water can move through the spaces between the gravel particles. Crushed stone should not be used for drainage (around perforated pipe or to carry water from one point to another). Use gravel for drainage (figure 100).

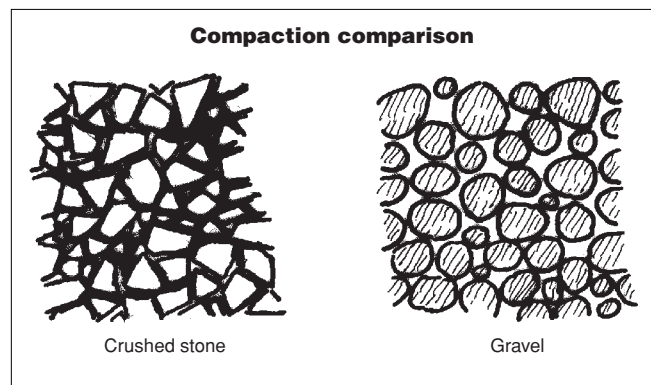
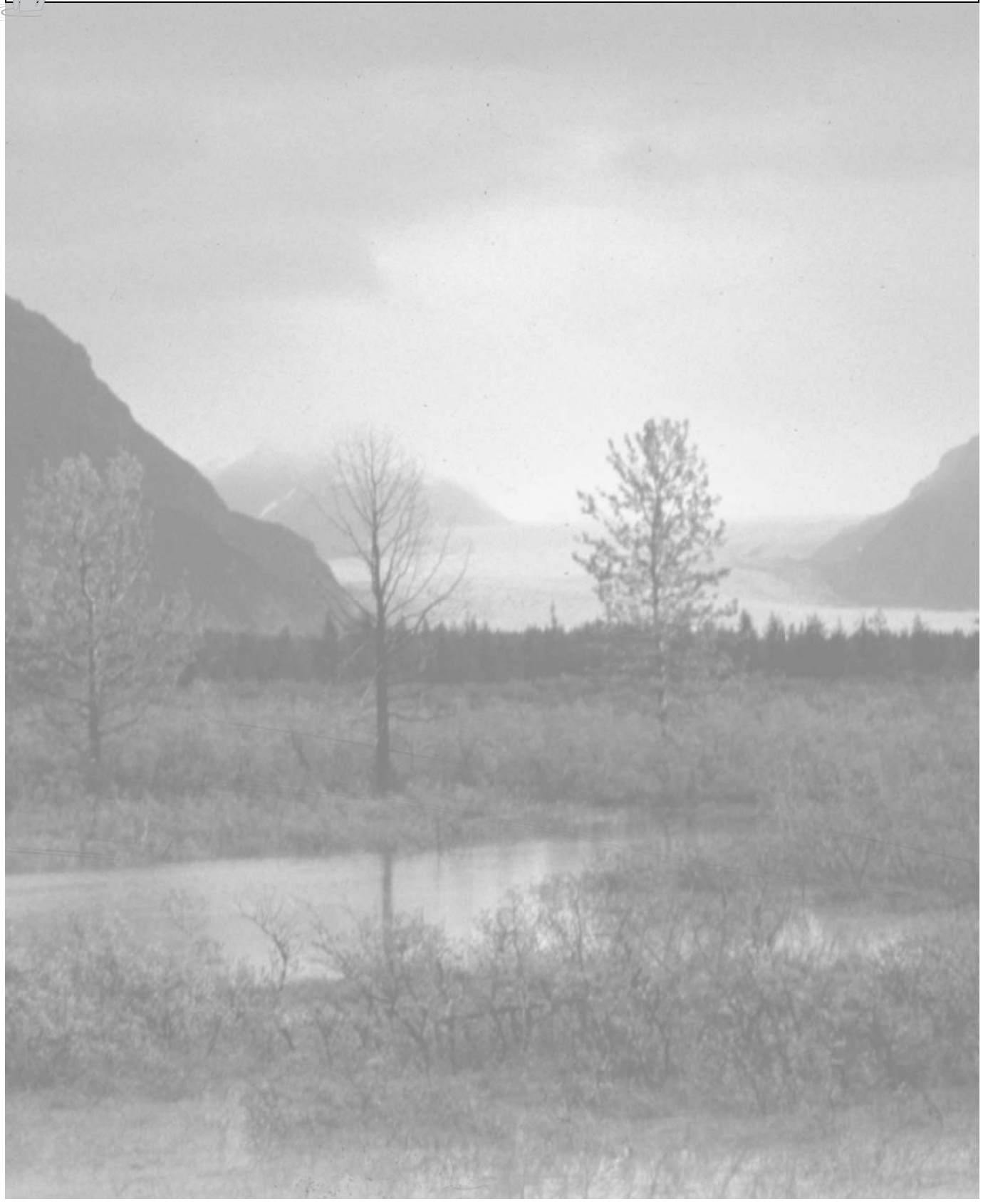

Figure 100—Crushed stone has angular edges and compacts well. It is good for tread surfacing. Gravel does not make good surfacing because it has rounded edges. Gravel is good for subsurface drainage because water flows freely through it.



**Appendix A** — *Field Note Sheets*









## Appendix B—Slope Conversion Table

Slope Conversion Table		
Percent grade	<sup>1</sup> Slope	<sup>2</sup> Pitch
0.5	1 ft per 200 ft	$\frac{1}{16}$ in per 1 ft
1	1 ft per 100 ft	$\frac{1}{8}$ in per 1 ft
2	1 ft per 50 ft	$\frac{1}{4}$ in per 1 ft
2.5	1 ft per 40 ft	$\frac{5}{16}$ in per 1 ft
3	1 ft per 33 ft	$\frac{3}{8}$ in per 1 ft
3.3	1 ft per 30 ft	$\frac{7}{16}$ in per 1 ft
4	1 ft per 25 ft	$\frac{1}{2}$ in per 1 ft
5	1 ft per 20 ft	$\frac{5}{8}$ in per 1 ft
6	1 ft per 16.5 ft	$\frac{3}{4}$ in per 1 ft
7	1 ft per 14.3 ft	$\frac{7}{8}$ in per 1 ft
8	1 ft per 12.5 ft	1 in per 1 ft
8.33	1 ft per 12 ft	1 in per 1 ft

<sup>1</sup> One unit of climb or descent per 100 units of horizontal distance.

<sup>2</sup> Number of vertical inches per horizontal foot. Vertical inches shown are rounded off to the nearest  $\frac{1}{16}$  of an inch.

Maximum grade recommended for wood surface trails = 2 percent.



## Appendix C – Comparison of Round and Rectangular Culverts

These tables show the open-end area of round culvert pipe and the open-end area of rectangular timber culverts.

Round Pipe Culverts								
<b>Diameter (inches)</b>	8	10	12	15	18	24	30	36
<b>End area (sq. ft)</b>	0.4	0.6	0.8	1.2	1.8	3.1	5.0	7.1

Rectangular Timber Culverts								
Height (inches)	Clear width (inches)							
	20	24	30	36	48	60	72	84
	End area (sq. ft)							
5	0.7	0.8	1.1	1.3	1.7	2.1	2.5	2.9
11	1.4	1.8	2.3	2.8	3.7	4.5	5.5	6.4
17	2.1	2.9	3.6	4.3	5.0	7.1	8.5	9.9
23	2.9	3.8	4.8	5.8	7.7	9.6	11.5	13.4



## Appendix D— Sizes of Hot-Dipped Galvanized Nails

<sup>1</sup> Penny (d)	Length (inches)	<sup>2</sup> Penetration required (inches)	Nails per pound	Gauge (inches)	Bit size for pilot holes (inches)
10	3	2	75	10	NA
12	3¼	2⅛	69	10	NA
16	3½	2¼	54	9	⅜ <sub>32</sub>
20	4	2⅝	33	7	⅛
30	4½	3	29	7	⅛
40	5	3¼	22	5½	⅛
50	5½	3⅝	20	5½	⅛
60	6	4	18	5½	⅜ <sub>16</sub>

<sup>1</sup> Nails are sold by the old English system of pennyweight. The value of the penny has changed since the system was devised, and today there seems to be no relation to the size and weight of the nail to the penny. The standard symbol for penny is "d."

<sup>2</sup> The "penetration required" column shows the minimum depth the nail must penetrate into the second piece of wood to make a sound connection. The penetration must be increased by one-third when nailing into the end of the piece of wood (end nailing).



## Appendix E – Table of Board Feet

The most common sizes of boards used for boardwalk and bog bridge construction.

Size of board	Length of board (ft)						Finished size (inches)
	6	8	10	12	14	16	
	Yield (board ft)						
1 x 6	3	4	5	6	7	8	¾ x 5½
2 x 4	4	5.33	6.67	8	9.7	11	1½ x 3½
2 x 6	6	8	10	12	14	16	1½ x 5½
2 x 8	8	10.67	13.33	16	19	21	Normally rough sawn
2 x 10	10	13.33	16.67	20	23	27	Normally rough sawn
2 x 12	12	16	20	24	28	32	Normally rough sawn
3 x 4	6	8	10	12	14	16	Normally rough sawn
3 x 6	9	12	15	18	21	24	Normally rough sawn
3 x 8	12	16	20	24	28	32	Normally rough sawn
3 x 10	15	20	25	30	35	40	Normally rough sawn
3 x 12	18	24	30	36	42	48	Normally rough sawn
4 x 4	8	10.67	13.33	16	19	21	3½ x 3½
4 x 6	12	16	20	24	28	32	Normally rough sawn
6 x 6	18	24	30	36	42	48	Normally rough sawn



## Appendix F—Metric Conversions

<b>METRIC CONVERSIONS</b>		
<b>To convert from this unit</b>	<b>To this unit</b>	<b>Multiply by</b>
inch	millimeter	25.4*
inch	centimeter	2.54*
foot	meter	0.3048*
yard	meter	0.9144*
mile	kilometer	1.6
millimeter	inch	0.039
centimeter	inch	0.394
centimeter	foot	0.0328
meter	foot	3.28
meter	yard	1.09
kilometer	mile	0.62
acre	hectare (square hectometer)	0.405
square kilometer	square mile	0.386*
hectare (square hectometer)	acre	2.47
ounce (avoirdupois)	gram	28.35
pound (avoirdupois)	kilogram	0.45
ton (2,000 pounds)	kilogram	907.18
ton (2,000 pounds)	megagram (metric ton)	0.9
gram	ounce (avoirdupois)	0.035
kilogram	pound (avoirdupois)	2.2
megagram	ton (2,000 pounds)	1.102
ounce (U.S. liquid)	milliliter	30
cup (inch-pound system)	milliliter	247
cup (inch-pound system)	liter	0.24
gallon (inch-pound system)	liter	3.8
quart (inch-pound system)	liter	0.95
pint (inch-pound system)	liter	0.47
milliliter	ounce (U.S. liquid)	0.034
liter	gallon	0.264
liter	quart	1.057
degrees Fahrenheit	degrees Celsius	$(^{\circ}\text{F} - 32) \div 1.8$
degrees Celsius	degrees Fahrenheit	$(^{\circ}\text{C} \times 1.8) + 32$

\*These items are exact conversion factors for the units—the others give approximate conversions.

# Glossary

**Aggregate**—Crushed stone or gravel used as a base course for riprap, asphalt, or concrete pavement. Aggregate is also used in asphalt and concrete mixes.

**Asphalt**—A mixture of aggregate and asphalt cement, correctly called asphaltic concrete.

**Baluster**—One of many vertical pieces between the top and bottom rails of a guardrail.

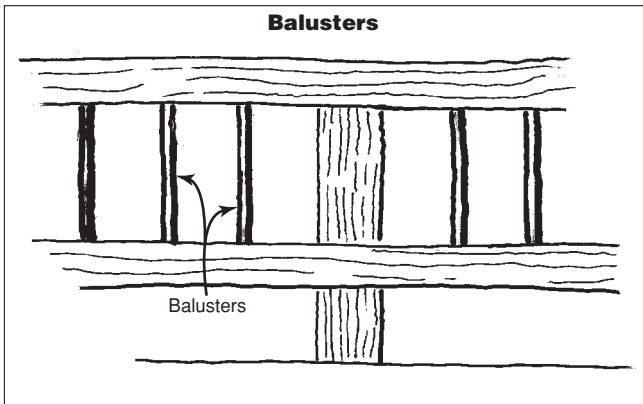

**Batter, battering**—Sloping the exposed face of a wall back either at a uniform angle, or stepping it back uniformly, the structurally sound way to build a timber wall.

**Bevel**—Finishing the corner of a piece of lumber by removing a narrow portion of wood at a uniform angle to the edge and face. A bevel follows the grain of the wood (see chamfer).

**Borrow pit**—An excavation used to obtain fill for a construction site.

**Braided trails**—Parallel trails around a low, wet spot. These trails are not constructed, but are worn in the ground by trail users who do not want to get their feet wet or walk in mud. Each new trail funnels water to a low point. Users repeat the process, producing a series of trails.

**Camber**—A slight bend in a timber.

**Cantilever**—The portion of a beam or plank extending beyond one or both of its supports.

**Chamfer**—Similar to a bevel but done at the end of the piece of wood and across the grain.

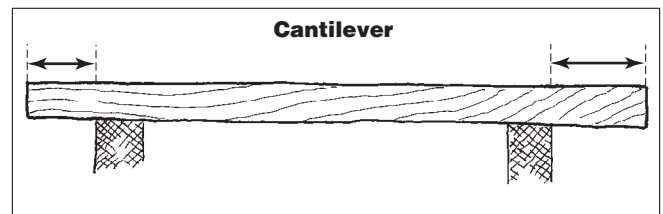
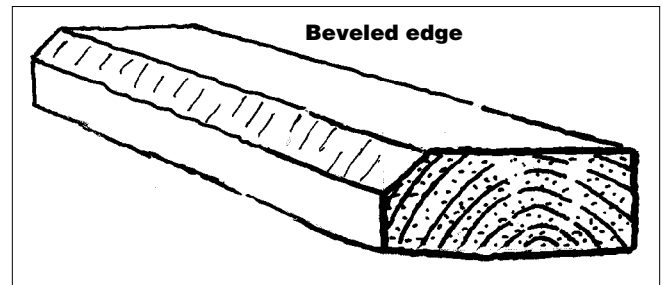
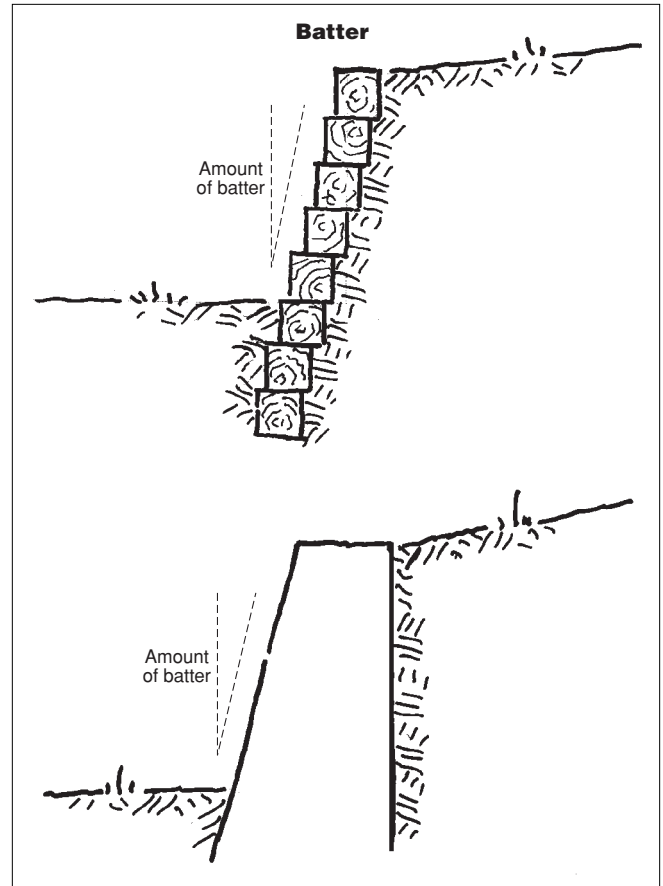

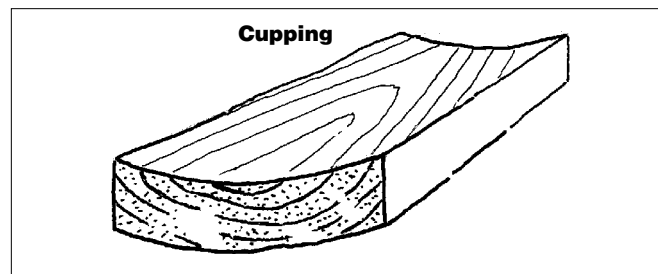
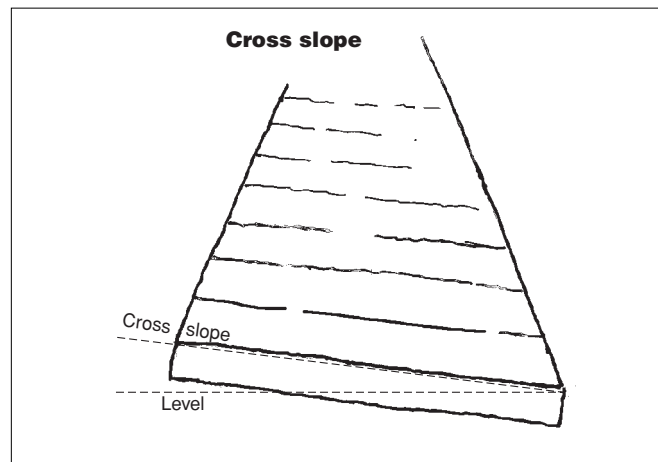
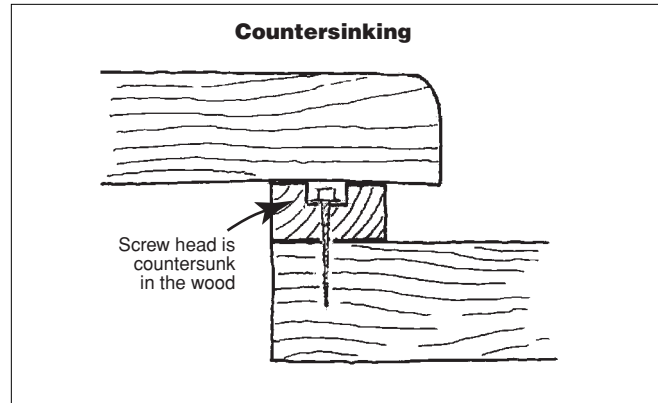
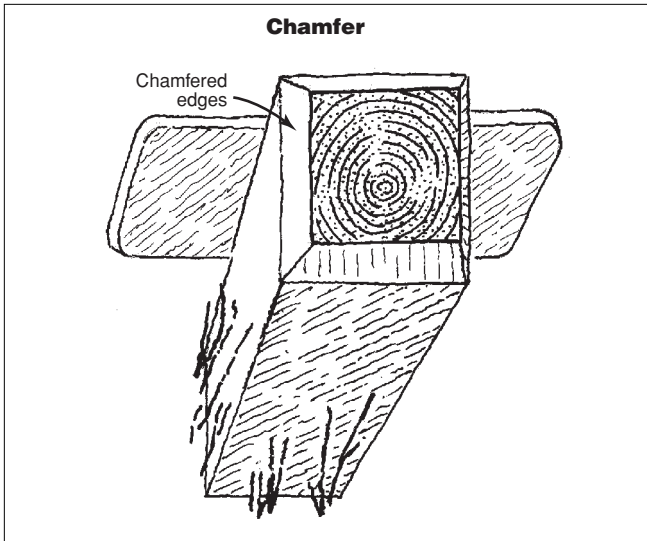

**Concrete**—A mixture of sand, coarse aggregate (crushed gravel or crushed stone), portland cement, and water correctly called Portland cement concrete. The wet mixture is placed in a form or trench and dries to a hard material.

**Control points**—Natural, recognizable features on the site or a series of survey stakes used to establish distances and elevations during trail construction.

**Countersinking**—Drilling a wide, shallow hole in a piece of wood for a washer and nut or for the head of a bolt or screw. Countersinking allows the hardware to be recessed below the surface of the wood. Countersinking reduces the amount of treated wood and will accelerate decay if the hole is exposed to moisture.

**Course**—A single layer of building material of a uniform height. The material is placed one layer (or course) at a time on top of another layer (or course). Materials laid in courses include bricks, concrete blocks, timbers, and logs.

**Crook**—A defect in a log caused by a crooked tree.

**Cross slope or cross pitch**—The amount a surface slopes, measured perpendicular to the centerline of a road or trail.

**Crown**—The branches, twigs, and leaves of a tree. Also a paved surface that is higher in the center than at the edges.

**Cupped, cupping**—A board or plank whose edges are higher or lower than the center. Cupping is often found in decks, where the board edges are higher than the middle. Water, trapped in the cupped area, accelerates decay.

**Curb**—A wood, concrete, or stone trail component that rests on the ground or on the trail tread, rising 2 to 8 inches above the trail tread.

**Dap**—A shallow hole or slot drilled or routed in a piece of wood. A dap is usually drilled to fit over a piece of hardware (a nut, the head of a bolt, or a portion of a steel plate or angle) that is connected to an adjacent piece of wood.



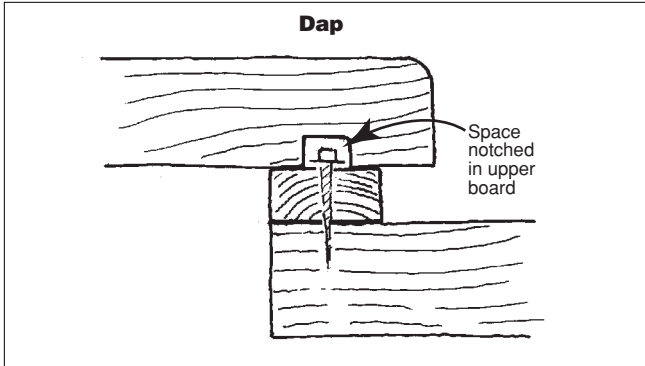
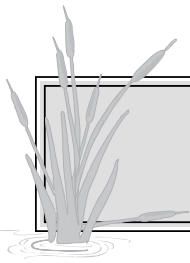

**Deadman**—A log or logs, heavy timber or timbers, a large block of concrete, a large boulder, or combination of the above that is partially or completely buried. Eyebolts placed in deadmen are used to anchor cables. Log or timber deadmen (without eyebolts) are used in log or timber retaining walls. They are placed perpendicular to the face of the wall, extending into the earth behind it to prevent the wall from falling over.

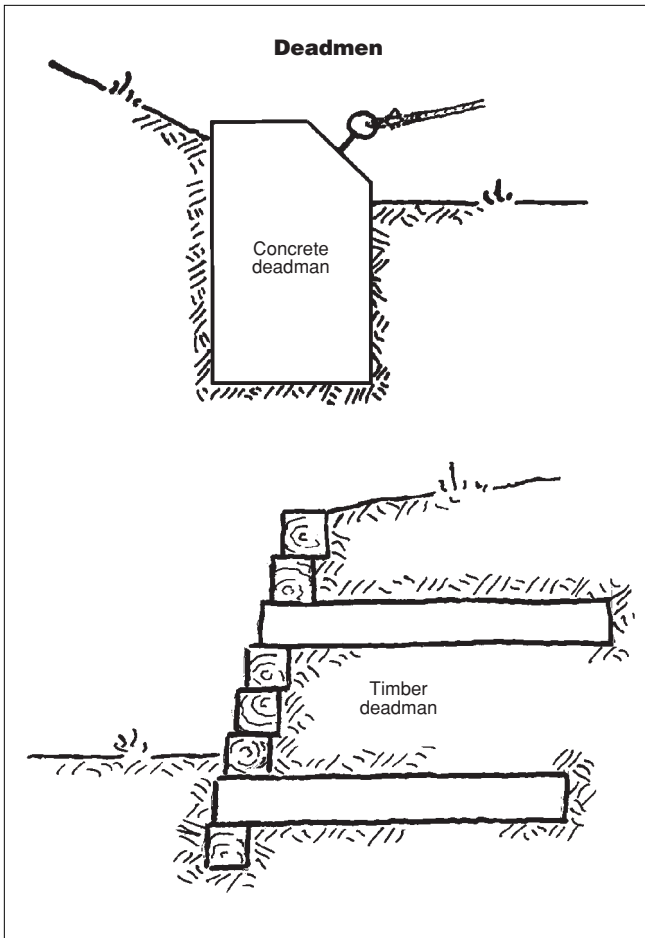

**Destination trail**—A trail route that starts at a trailhead and ends at a point of interest, the destination. The trail user returns by the same route.

**Driftpin**—A piece of 12- to 30-inch rebar or steel pipe used to keep logs and timbers in place.

**Fisherman's knot**—A knot used to tie a rope sling for moving logs and timbers. A single length of rope is tied into a loop using two overhand knots tied in each end of the rope and around the opposite end.

**Footing**—The part of a structural foundation that rests on the ground, spreading the weight of the structure and supporting the structure above. Footings are usually concrete. At remote sites the footings may also be mortared stone masonry.

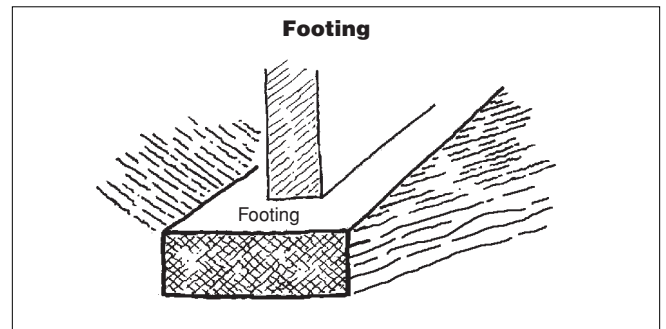

**Froe**—An old handtool used originally for splitting shingles and shakes. The froe consists of a heavy, 12-inch-long, straight steel blade with a wooden handle. The cutting edge of the blade is placed against the wood to be cut and a club or mallet is used to hit the face.

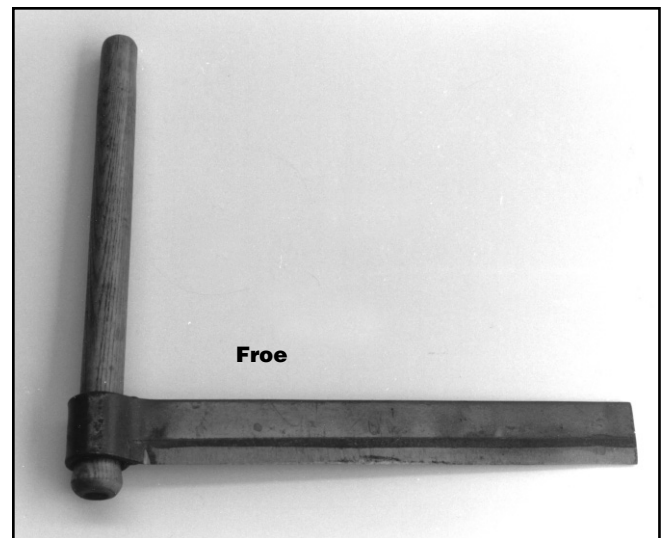



## Glossary

**Frostline**—The maximum depth that frost can be expected to penetrate into the ground.

**Glulamined**—A process used to fabricate long beams from short lengths of 2 by 4, or 2 by 6, or 2 by 10 lumber. The pieces are placed flat on top of each other with glue spread between them. Lengths are varied so that transverse joints in each layer are not opposite one another. Pressure binds the pieces together. The assembly may be two to four times longer than the longest individual piece of lumber within it.

**Grade**—The rate of climb or descent along the centerline of a trail. It is described as a percentage and expressed as the number of units of climb or descent per 100 units of horizontal distance. A +5-percent grade rises 5 feet in 100 feet, or 5 meters in 100 meters. A -2-percent grade descends 2 feet per 100 feet (or 2 meters per 100 meters). The plus symbol indicates climb. The minus symbol indicates descent.

**Groundwater**—Water contained in the soil a few inches to several feet below the surface of the ground. In wetlands, the depth to groundwater is often higher in winter and spring and lower in summer and fall.

**Guardrail**—A railing at the edge of a deck to prevent people from falling. A guardrail should be 36 to 42 inches above the deck.

**Handrail**—A railing along a stairway to help people avoid falling down the stairs. A handrail should be 32 to 35 inches above the stairs.

**Hardwood/softwood**—Inaccurate logger's terms that have nothing to do with how hard or soft the wood is. By the logger's definition, hardwoods are deciduous trees with broad leaves and softwoods are conifers with needles. Aspen and red maple are "hardwoods," but their wood is soft; Douglas-fir and Atlantic white cedar are "softwoods," but their wood is hard. Some hardwoods, such as live oak and southern magnolia, keep their leaves through the winter. Some "softwoods," such as larch and baldcypress in the northern portion of its range, lose their needles in the fall.

**Heartwood**—The oldest wood of a tree, extending from the center of a log to the sapwood. The heartwood is the densest, strongest, and darkest wood in a log.

**Helical pile**—A solid steel shaft 1½ to 2½ inches square with a series of steel helixes welded to the shaft. The helixes are similar to threads on a bolt or the threads on a powered earth auger. The smallest helical piles or screw piles are 6 inches in diameter and 30 inches long. A machine screws them into the ground.

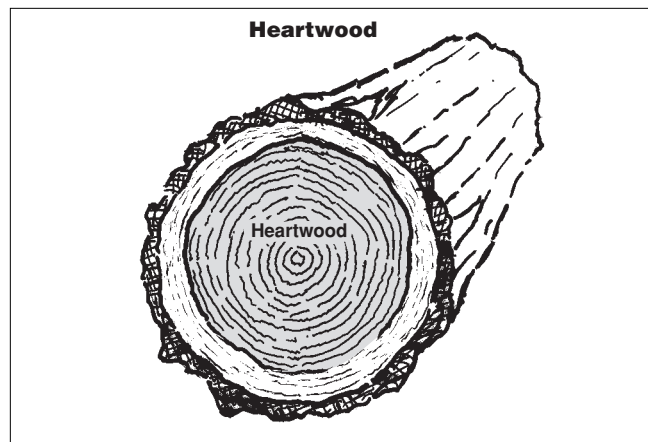

**Hewing**—Using an ax or adz to cut a log so that its cross section is a square or rectangular.

**Hummocky**—Wetland terrain containing hummocks, ridges, and small mounds of earth 2 to 4 feet higher than the surrounding area.

**Invert**—The bottom surface of a pipe, ditch, or culvert over which water flows.

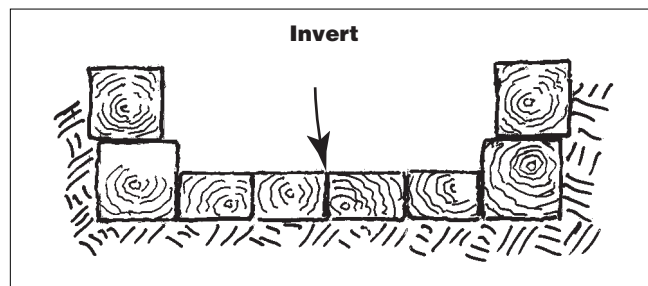

**Joist**—Usually a wooden 2 by 6, 2 by 8, 2 by 10, or 2 by 12, with the 2-inch dimension resting on a sleeper (sill) or ledger, toenailed into place, supporting a floor or deck.

**Joist hanger**—A steel angle or strap nailed to the side of a ledger and shaped to hold a joist. If a top flange hanger or face mount hanger is installed, the joist is placed within the hanger and the two are nailed together.

**Ledger**—A horizontal piece of wood attached to, and supported by, piles or concrete or stone masonry piers. The ledgers support stringers or tread timbers.

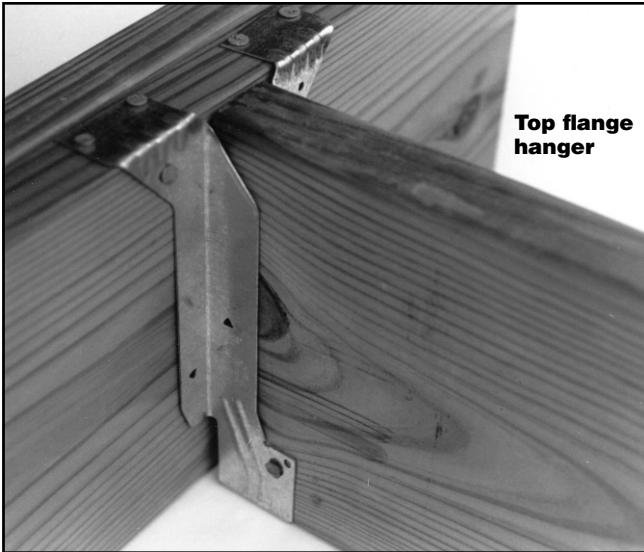

**Log dogs**—The first type of log dog is a broad U-shaped steel bar 18 to 30 inches wide, with pointed ends, which is used to temporarily hold two logs at right angles to each other.

The second type of log dog is smaller and easier to pack. It consists of a 6-inch to 12-inch-long steel plate that is 2 to 3 inches wide and pointed at each end. A second steel plate (3 to 6 inches long, identical width, pointed at one end and straight on the other) is welded across the center of the first to form a T.

**Loop trail**—A trail route that forms a closed circuit connecting a number of points of interest. The trail returns to the trailhead where it began but the trail user does not cover the same route twice.

**Lumber**—As used in this text, wood that has been sawed into a square or rectangular cross section that is 2 inches thick or less.

**Moraine**—Moraines are made of debris deposited by glaciers. The most common moraines are end (or terminal) moraines and lateral (or slide) moraines. Rock that the glacier has broken out of the valley is deposited in the moraines. Rock in moraines has been broken up and ground into boulders and various sizes of gravel and sand.

**Mortar**—A mixture of sand, lime, Portland cement, and water. Mortar is used in masonry construction to bind bricks, concrete blocks, or stone to form structural elements such as retaining walls and piers. Mortar may also be used when constructing riprap.

**Nailer**—A strip of wood attached to a stringer that tread planks are nailed or screwed to.

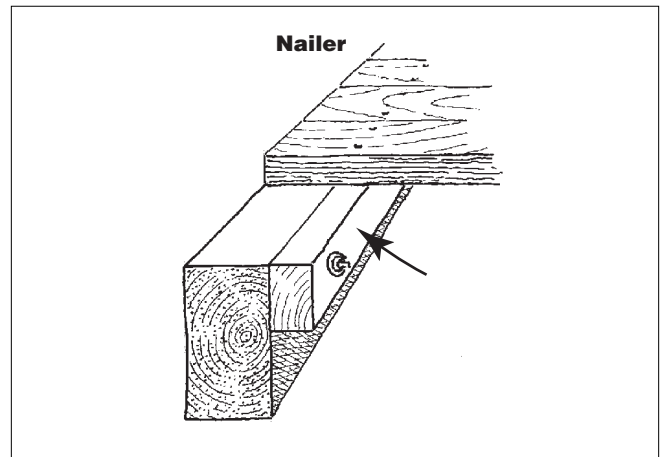
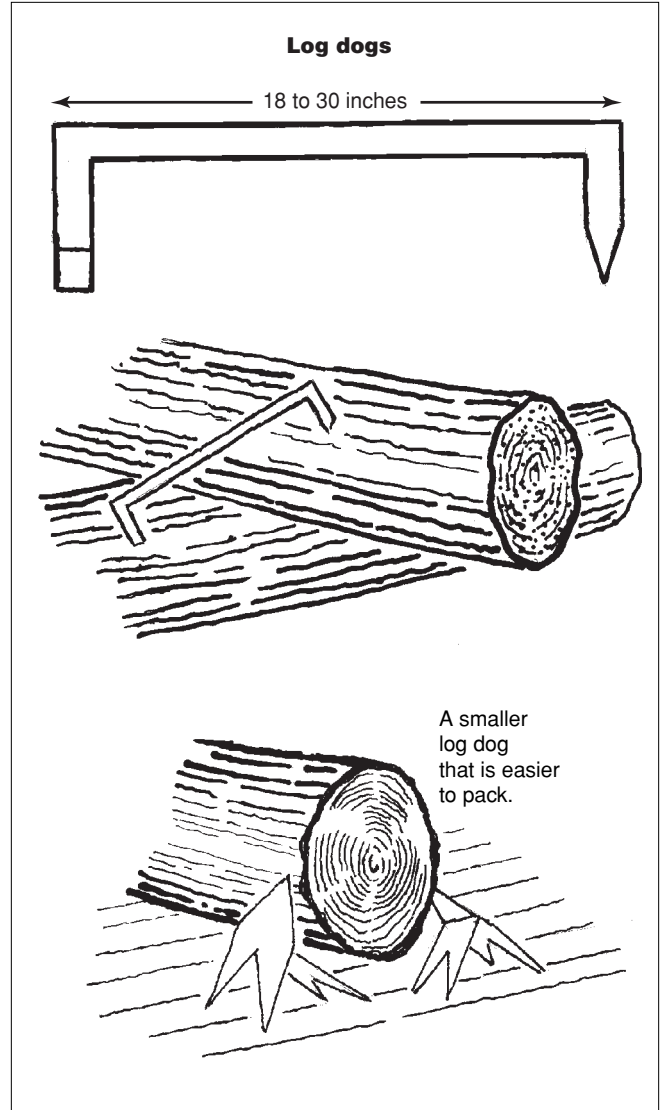



## Glossary

**Peen**—To strike a piece of metal with a hammer, denting the surface, or mashing the threads of a bolt after installing a nut, to prevent the nut from being removed.

**Pier**—Piers are used to support one or both ends of a beam or stringer. Piers may be timber or log cribbing or piles, helical piles, stone masonry, or concrete.

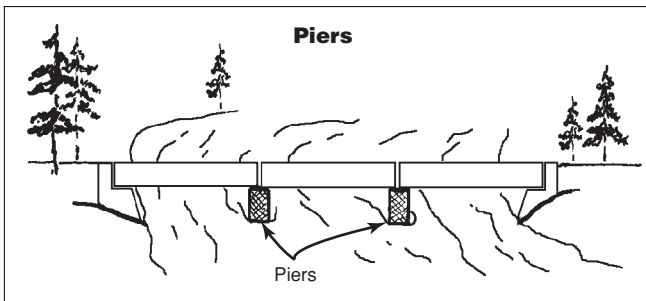

**Pile**—For wetland construction piles may be wooden logs, poles, or timbers, steel helices, or concrete that is cast in place. A pile is usually no more than 12 inches in diameter. The pile is either placed in a hole dug to the depth required (end bearing pile), driven with a heavy weight (friction pile), or screwed into the ground by a machine (helical pile).

**Pilot hole**—A small hole drilled in wood or steel to guide a nail, screw, or drill bit.

**Pinning**—Driving driftpins through a log or timber into a log or timber, or into the ground.

**Plank**—A 2 by 4, 2 by 6, 2 by 8, 3 by 6, or wider board or timber. In wetland construction, planks are usually used as a walking surface or tread.

**Plumb**—A line or plane perpendicular to the Earth's surface.

**Ponding**—Water that has accumulated in a low area.

**Portland cement**—A gray powder made from limestone that is mixed with sand and water to make mortar, or mixed with sand, small stones or gravel, and water to make Portland cement concrete. In this text Portland cement concrete is referred to as concrete.

**Puncheon**—Short-span footbridges or a series of short-span footbridges supported by sleepers.

**Riprap**—Stones placed to prevent fast water from scouring and eroding a surface. Large stones (12 by 12 by 6 inches or larger) are hand placed on a setting bed of either aggregate or mortar. With an aggregate setting bed, adjacent stones

are butted tightly together. Because of the irregularity of the stones, spalls are used to prevent them from moving. If the stones are placed on a mortared setting bed, the stones may be ½ to 3 inches apart.

**Rod sounding**—Driving a steel rod or pipe into the ground to determine the location of firm soil or rock.

**Saddle notch**—A half-circle notch cut in the bottom of a log to fit over a log in the course below.

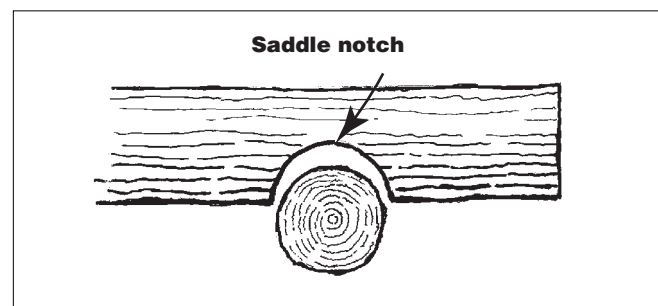

**Sapwood**—Wood just under the bark of a tree. Sapwood is only a few years old. This wood is usually a light color and not as strong or as dense as the heartwood.

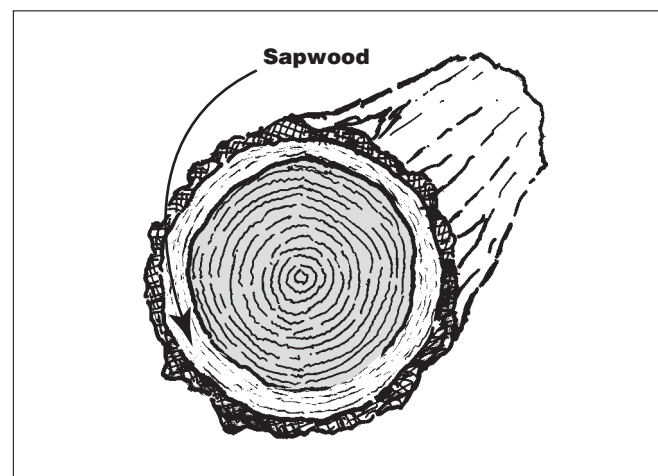

**Square notch**—A notch cut in a log to fit snugly against a square notch cut in another log, the square cut end of another log, or a plank. The portion of the notch in contact with the other log is cut as a flat, uniform plane. The end or ends of the square notch are perpendicular to the flat plane.

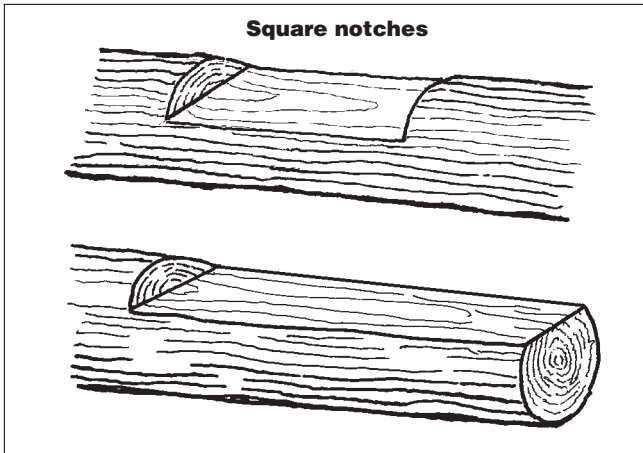

**Setting bed**—A layer of aggregate (either crushed stone or crushed gravel), or mason's sand, mortar placed on solid rock, or a compacted subgrade of existing ground or fill. Depending on the setting bed, material, and subsurface conditions, the setting bed may be from 4 to 12 inches deep.

**Shim**—A short, thin piece of wood, usually oak or redcedar, used between two pieces of wood or between a piece of wood and steel, earth, or rock. The shim is used to bring a ledger, stringer, or tread to level.

**Slackwater**—Floodwater with little or no velocity. Slackwater is formed when water in creeks, streams, and rivers backs up into low terrain, creating a temporary ponding condition.

**Sleeper B**—A horizontal log or timber laid in a shallow trench to support a plank or logs.

**Slope measurements**—Measurements taken on the ground or parallel with the slope of the ground. Slope measurements provide a true indication of the quantities of materials needed for construction. Maps and construction drawings for roads and utility lines are measured horizontally. Measurements taken electronically are also measured horizontally. Slope measurements can sometimes be as much as 10 percent greater than horizontal measurements.

**Sonotubes**—Hollow cardboard cylinders used for forming round concrete columns. The sonotube is removed after the concrete sets.

**Spalls**—Small angular pieces of hard, durable stone. Spalls are wedged between stones that have been placed without mortar. Spalls have a function similar to that of shims used in wood construction.

**Stringer**—One of two or more beams placed parallel with the centerline of the tread that supports the tread plank.

**Tamping**—Using a narrow machine compactor, a tamping bar, the handle of a shovel, or other tool to compact earth backfill around a post, pole, or pile.

**Test boring**—A deep, narrow hole drilled into the ground with a power auger. A record is kept of the types of soils encountered and their depth. Test borings are usually done by geotechnical engineers (see test holes).

**Test holes**—Frequently, soil information does not require the sophistication and accuracy of test borings. A test hole can be dug by hand, or it can be dug with a backhoe. Test holes are wider than test borings, allowing the soil strata on the sides of the hole to be easily seen. Test holes can be no deeper than the equipment can easily and safely dig. The information provided by test holes is usually sufficient to determine construction techniques needed for wetland trails in areas where there is no previous wetland construction experience. It is simpler and cheaper to dig test holes than it is to drill test borings.

**Timber**—As used in this text, wood that has been sawed or hewed into a square or rectangular cross section that is at least 3 inches thick.

**Toenail**—Joining two pieces of wood by driving nails at an angle to the surface of one piece and into the second piece.

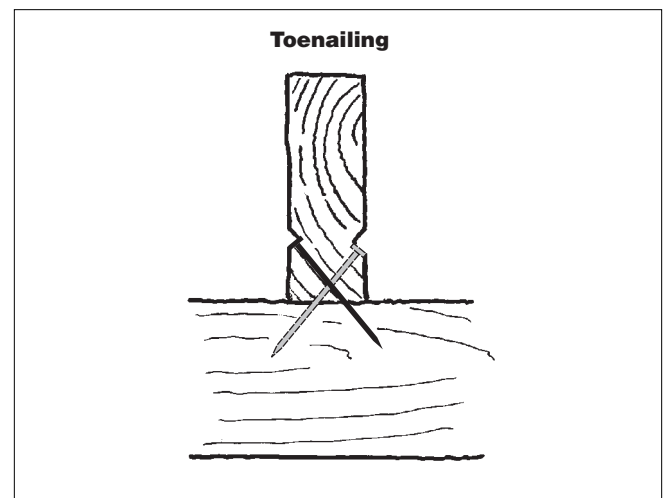

**Tread**—The walking surface of a trail. Applied to wetland trails constructed of wood, tread refers to the portion of the timber, log, or plank that the user steps on.

**Twist**—A defect in lumber and timber caused by a tree growing with a twisted grain. The result is a piece of lumber or timber with surfaces at one end that are not in the same plane as the surfaces at the other end. Occasionally, usable short

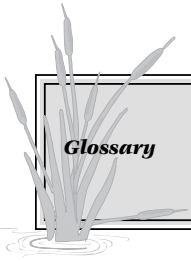

**Glossary**

lengths with little twist can be cut from the original piece. More commonly, the original piece is useless.

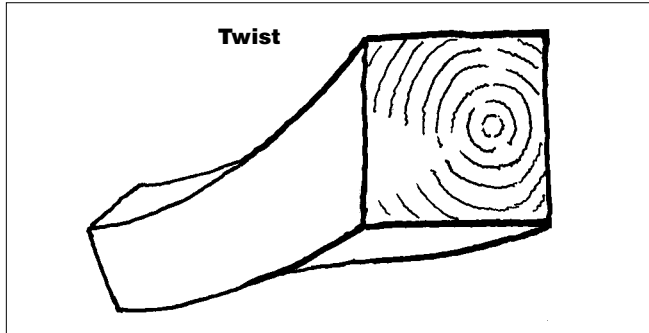

**Wane**—A defect in a piece of lumber or timber, caused by bark that was not removed or a beveled edge.

**Waney edge**—A term used at the sawmill to describe a board, plank, or timber of nonuniform width when one or two edges contain bark or irregular sapwood just below the bark. A waney edge is considered a defect, but the board or plank may be suitable for rustic construction.

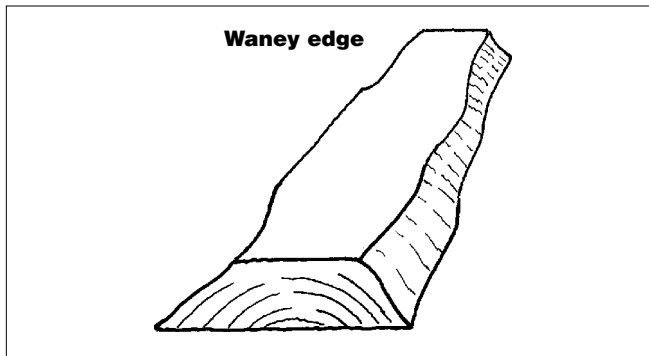

**Warp**—Severe bend in a piece of lumber or timber making it unusable in its original length. Sometimes the warp occurs mostly at one point, usually a knot, and short usable pieces can be cut on either side of that point.

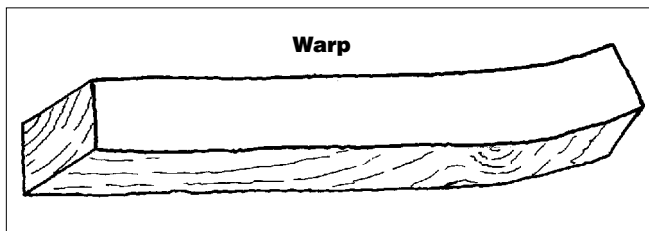

**Water table**—The level below the ground surface where groundwater will fill a test hole.

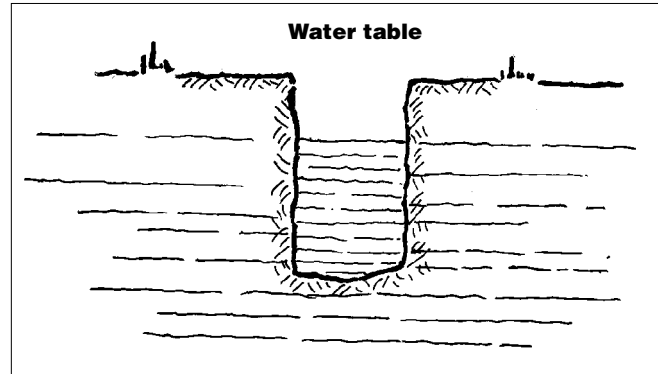

**Weir**—A depressed channel in a dam providing an outlet for the overflow water in a pond when the water level exceeds a desired height. Weirs are usually concrete or timber, or a combination of the two.

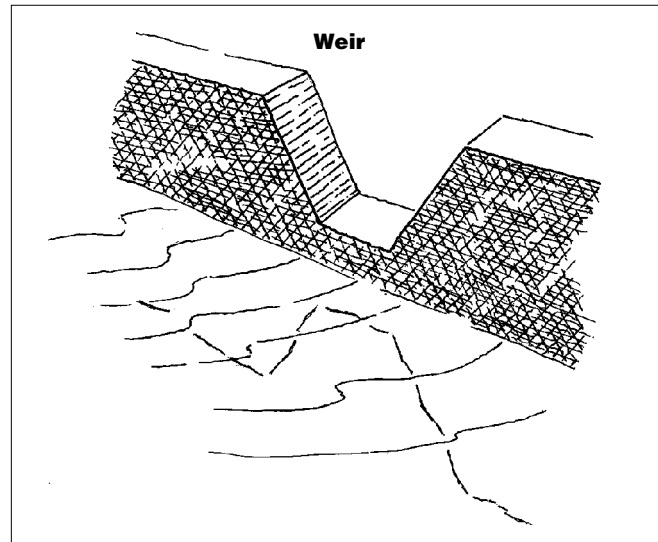

**Wetland indicator plants**—Various species of plants that are tolerant of wet soils. When many specimens of these species are present at a site, they indicate a wetland environment.



# References

**User name (t-d) and password (t-d) are required for publications on the T-D Internet site** (<http://www.fs.fed.us/t-d>).

- Groenier, James Scott; Eriksson, Merv; Kosmalski, Sharon. 2006. A guide to fiber-reinforced polymer trail bridges. Tech. Rep. 0623–2824–MTDC. Missoula, MT: U.S. Department of Agriculture Forest Service, Missoula Technology and Development Center. 98 p. Available electronically at: <http://www.fs.fed.us/t-d/pubs/htmlpubs/htm06232824/>
- Groenier, James Scott; LeBow, Stan. 2006. Preservative-treated wood and alternative products in the Forest Service. Tech. Rep. 0677–2809–MTDC. Missoula, MT: U.S. Department of Agriculture Forest Service, Missoula Technology and Development Center. 44 p. Available electronically at: <http://www.fs.fed.us/t-d/pubs/htmlpubs/htm06772809/>
- Hallman, Richard. 2005. Handtools for trail work: 2005 edition. Tech. Rep. 0523–2810–MTDC. Missoula, MT: U.S. Department of Agriculture Forest Service, Missoula Technology and Development Center. 26 p. Available electronically at: <http://www.fs.fed.us/t-d/pubs/htmlpubs/htm05232810/>
- Lebow, Stan T.; Tippie, Michael. 2001. Guide for minimizing the effect of preservative-treated wood on sensitive environments. Gen. Tech. Rep. FPL–GTR–122. Madison, WI: U.S. Department of Agriculture Forest Service, Forest Products Laboratory. 18 p. Available electronically at: [www.fpl.fs.fed.us/documents/fplgtr/fplgtr122.pdf](http://www.fpl.fs.fed.us/documents/fplgtr/fplgtr122.pdf)
- Meyer, Kevin G. 2002. Managing degraded off-highway vehicle trails in wet, unstable, and sensitive environments. Tech. Rep. 0223–2821–MTDC. Missoula, MT: U.S. Department of Agriculture Forest Service, Missoula Technology and Development Center. 48 p. Available electronically at: <http://www.fs.fed.us/t-d/pubs/htmlpubs/htm02232821/>
- Monlux, Steve; Vachowski, Brian. 2000. Geosynthetics for trails in wet areas: 2000 edition. Tech. Rep. 0023–2838–MTDC. Missoula, MT: U.S. Department of Agriculture Forest Service, Missoula Technology and Development Center. 18 p. Available electronically at: <http://www.fs.fed.us/t-d/pubs/htmlpubs/htm00232838/>
- Neese, Jasen; Eriksson, Merv; Vachowski, Brian. 2002. Floating trail bridges and docks. Tech. Rep. 0223–2812–MTDC. Missoula, MT: U.S. Department of Agriculture Forest Service, Missoula Technology and Development Center. 26 p. Available electronically at: <http://www.fs.fed.us/t-d/pubs/htmlpubs/htm02232812/>
- U.S. Department of Agriculture Forest Service. 1991. Alaska Region trails construction and maintenance guide. Tech. Rep. R10–MB–158. Anchorage, AK: U.S. Department of Agriculture Forest Service, Alaska Region.
- U.S. Department of Agriculture Forest Service. 1996. Standard specifications for construction and maintenance of trails. Eng. Man. EM–7720–103. Washington, DC: U.S. Department of Agriculture Forest Service. ISBN 0–16–048802–8. 108 p.
- U.S. Department of Agriculture Forest Service. 1996. Standard drawings for construction and maintenance of trails. Eng. Man. EM–7720–104. Washington, DC: U.S. Department of Agriculture Forest Service.
- Weisgerber, Bernie; Vachowski, Brian. 1999. An ax to grind: a practical ax manual. Tech. Rep. 9923–2823P–MTDC. Missoula, MT: U.S. Department of Agriculture Forest Service, Missoula Technology and Development Center. 60 p. Available electronically at: <http://www.fs.fed.us/t-d/pubs/htmlpubs/htm99232823/>
- Western Wood Preservers Institute. 2006. Best management practices for the use of treated wood in aquatic environments. Vancouver, WA: Western Wood Preservers Institute. 36 p.
- Western Wood Preservers Institute. [no date]. Guide to the characteristics, use and specifications of pressure-treated wood. Vancouver, WA: Western Wood Preservers Institute. 13 p.
- Zeller, Janet; Doyle, Ruth; Snodgrass, Kathleen. 2006. Accessibility guidebook for outdoor recreation and trails. Tech. Rep. 0623–2801–MTDC. Missoula, MT: U.S. Department of Agriculture Forest Service, Missoula Technology and Development Center. Available electronically at: <http://www.fs.fed.us/t-d/pubs/htmlpubs/htm06232801/>

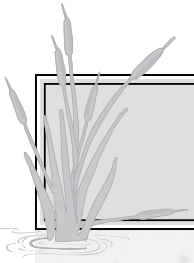

A wide, horizontal rectangular box with a thin black border, intended for a title or header.

*Notes*





**You can order a copy of this document using the order form on the Federal Highway Administration's (FHWA) Recreational Trails Program Web site at:**

*<http://www.fhwa.dot.gov/environment/rectrails/trailpub.htm>*

**It is also available electronically at:**

*<http://www.fhwa.dot.gov/fspubs/>*

**Fill out the order form and fax it to the distributor listed on the form. If you do not have Internet access, you can send a fax request to 301-577-1421 or send a mail request to:**

FHWA R&T Report Center  
9701 Philadelphia Ct., Unit Q  
Lanham, MD 20706

**Produced by:**

USDA Forest Service  
Missoula Technology and Development Center  
5785 Hwy. 10 West  
Missoula, MT 59808  
Phone: 406-329-3978  
Fax: 406-329-3719  
E-mail: *[wo\\_mtdc\\_pubs@fs.fed.us](mailto:wo_mtdc_pubs@fs.fed.us)*



This document was produced in cooperation with the Recreational Trails Program of the Federal Highway Administration, U.S. Department of Transportation.

This document is disseminated under the sponsorship of the U.S. Department of Transportation in the interest of information exchange. The United States Government assumes no liability for its contents or use thereof.

The contents of this report reflect the views of the contractor, who is responsible for the accuracy of the data presented herein. The contents do not necessarily reflect the official policy of the Department of Transportation.

This report does not constitute a standard, specification, or regulation. The United States Government does not endorse products or manufacturers. Trade or manufacturer's names appear herein only because they are considered essential to the object of this document.

## ***About the Authors***

**Robert T. Steinholtz** is a principal of Bristlecone Trails, a trail work consulting firm in Lakewood, CO. Bob was a landscape architect and trails specialist for many years with the National Park Service Planning, Design, and Construction Center in Denver, CO. His experience includes building 125 miles of new trails in 23 States from coast to coast. Bob has often been called on for his expertise by various Federal, State, and municipal agencies. He has been a coordinator or instructor at 20 hands-on courses covering trail-related subjects.

**Brian Vachowski** has been a project and program leader at the Missoula Technology and Development Center since 1993. He received a bachelor's degree in forestry from the University of Massachusetts and a master's degree in outdoor recreation from Utah State University. He has worked for the Nez Perce, Bighorn, Winema, and Routt National Forests in recreation, wilderness, lands, planning, rural community assistance, special uses, fire, and timber positions.

## ***Library Card***

Steinholtz, Robert T.; Vachowski, Brian. 2007. Wetland trail design and construction: 2007 edition. Tech. Rep. 0723–2804–MTDC. Missoula, MT: U.S. Department of Agriculture Forest Service, Missoula Technology and Development Center. 82 p.

Describes materials and techniques used to construct trails in wetlands. This manual is written primarily for workers who are inexperienced in wetland trail construction, but it also

may be helpful for experienced workers. Techniques suitable for wilderness settings and for more developed settings are included. Drawings by the author illustrate all important points. A glossary is included, as are appendixes with material specifications.

**Keywords:** boardwalks, bogs, carrs, corduroy, drainage, maintenance, marshes, muskeg, piles, puncheon, recreation, swamps, tools, trail crews, trail planning, turnpikes

---

**You can order a copy of this document using the order form on the FHWA's Recreational Trails Program Web site at:**

<http://www.fhwa.dot.gov/environment/rectrails/trailpub.htm>

**Fill out the order form and fax it to the distributor listed on the form. If you do not have Internet access, you can send a fax request to 301–577–1421 or a mail request to:**

FHWA R&T Report Center  
9701 Philadelphia Ct., Unit Q  
Lanham, MD 20706

**Forest Service and Bureau of Land Management employees may obtain additional copies from:**

USDA Forest Service  
Missoula Technology and Development Center  
5785 Hwy. 10 West  
Missoula, MT 59808  
Phone: 406–329–3978  
Fax: 406–329–3719  
E-mail: [wo\\_mtdc\\_pubs@fs.fed.us](mailto:wo_mtdc_pubs@fs.fed.us)

**Electronic copies of MTDC's documents are available on the Internet at:**

<http://www.fs.fed.us/eng/t-d.php>

**For further technical information, contact Brian Vachowski at MTDC or Bob Steinholtz.**

**Brian Vachowski:**

Phone: 406–329–3935  
Fax: 406–329–3719  
E-mail: [bvachowski@fs.fed.us](mailto:bvachowski@fs.fed.us)

**Bob Steinholtz:**

Bristlecone Trails  
10350 W. 14th Ave.  
Lakewood, CO 80215  
Phone: 303–233–4522  
E-mail: [brstlcn@aol.com](mailto:brstlcn@aol.com)