

# TIEBACKS

Office of Research  
and Development  
Washington, D.C. 20590

Report No.  
FHWA/RD-82/047

Final Report  
July 1982



U.S. Department  
of Transportation  
**Federal Highway  
Administration**

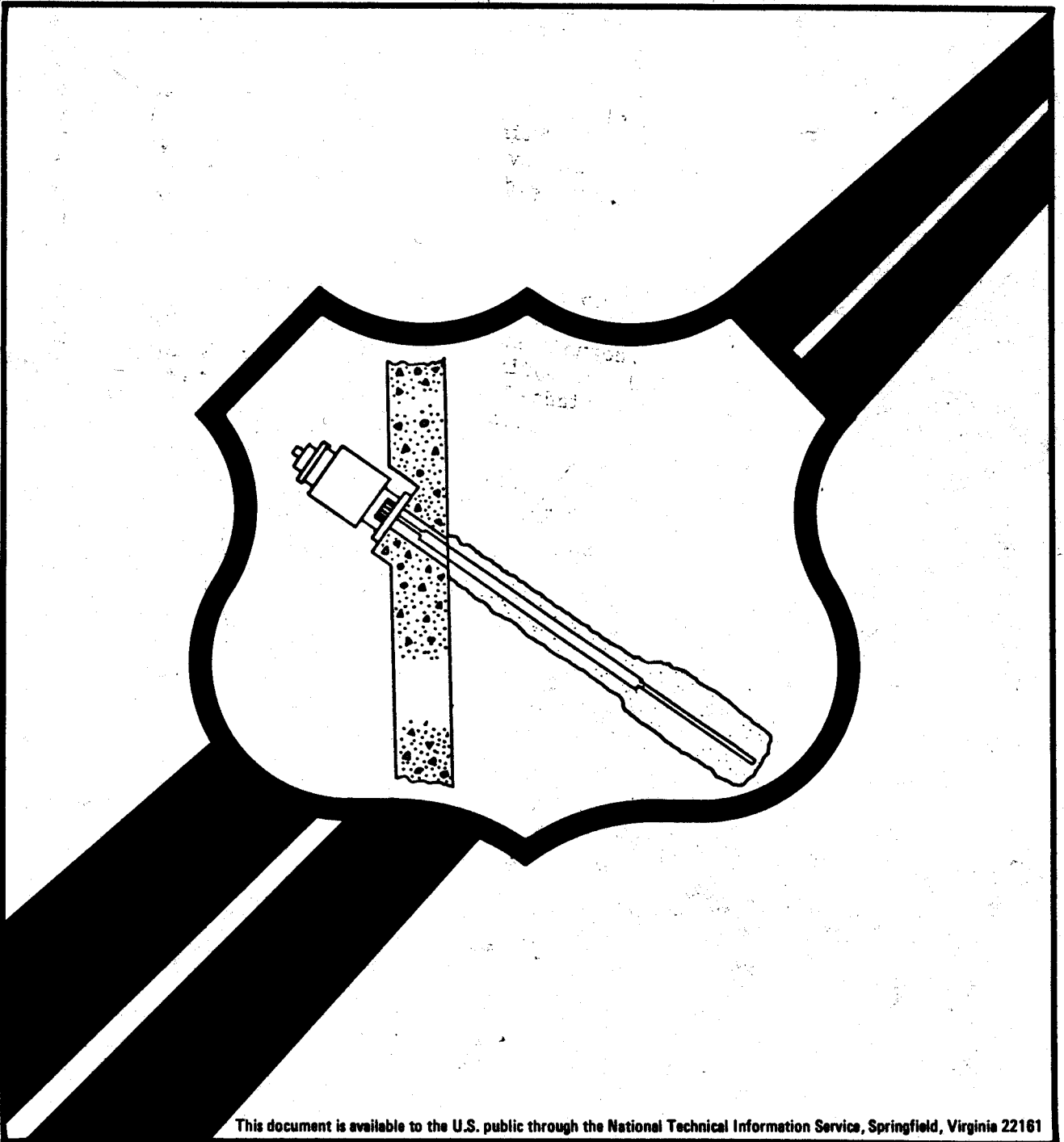

## FOREWORD

Highway engineers in the United States have been reluctant to specify permanent tiebacks as the primary support for highway structures. They are concerned about the lack of data on life expectancy of corrosion-protected tiebacks and the ability of foundation soils to sustain long-term loads without excessive movement.

This report describes tiebacks and their applications to highway work, reviews the uses of tiebacks, investigates the causes of the few reported failures, mainly in Europe, looks deeply into the problem of corrosion and creep and develops recommended procedures to assure long life to permanent tiebacks. This report consists of two volumes: the Executive Summary, FHWA/RD-82/046 and the full report "Tiebacks," FHWA/RD-82/047.

Sufficient copies of the report are being distributed to provide a minimum of two copies to each regional office, one copy to each division office and two copies to each State highway agency. Direct distribution is being made to the division offices.

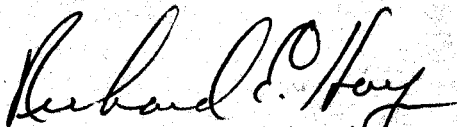

Richard E. Hay, Director  
Office of Engineering  
and Highway Operations  
Research and Development

|   |  |  |   |  |           |
|---|--|--|---|--|-----------|
| 1. Report No.<br>FHWA/RD-82/047   |  | 2. Government Accession No.                          |   | 3. Recipient's Catalog No.   |           |
| 4. Title and Subtitle<br>TIEBACKS   |  |  |   | 5. Report Date<br>July 1982  |           |
|   |  |  |   | 6. Performing Organization Code  |           |
| 7. Author(s)<br>D. E. Weatherby   |  |  |   | 8. Performing Organization Report No.  |           |
| 9. Performing Organization Name and Address<br>Schnabel Foundation Company<br>4720 Montgomery Lane, Suite 300<br>Bethesda, Maryland 20814   |  |  |   | 10. Work Unit No. (TRAIS)<br>35B1-462  |           |
|   |  |  |   | 11. Contract or Grant No.<br>DTFH 61-80-C-00064                                  |           |
| 12. Sponsoring Agency Name and Address<br>Office of Research and Development<br>Federal Highway Administration<br>U. S. Department of Transportation<br>Washington, D. C. 20590   |  |  |   | 13. Type of Report and Period Covered<br>August 1980 - June 1982<br>Final Report |           |
|   |  |  |   | 14. Sponsoring Agency Code   |           |
| 15. Supplementary Notes<br>FHWA Contract Manager: J. R. Sallberg (HNR-10)<br>Geotechnical Consultants: E. J. Cording, J. K. Mitchell, H. Schnabel, J. Sigourney<br>Materials and Corrosion Consultants: M. Schupack, R. Benedict, R. Bald,<br>P. Reinhardt, L. Sudrabin, K. Clear (FHWA)  |  |  |   |  |           |
| 16. Abstract<br><br>This report summarizes current tieback technology. It contains recommendations for the design, specification, corrosion protection, and testing of permanent and temporary tiebacks. Descriptions of tieback applications, construction techniques, load transfer mechanisms, and creep behavior also are included.<br><br>The "Executive Summary" is FHWA/RD-82/046. |  |  |   |  |           |
| 17. Key Words<br><br>tieback; ground anchors; foundation construction; creep; corrosion; performance, proof and creep testing; specification.   |  |  | 18. Distribution Statement<br><br>No restrictions. This document is available to the public through the National Technical Information Service, Springfield, Virginia 22161 |  |           |
| 19. Security Classif. (of this report)<br>Unclassified  |  | 20. Security Classif. (of this page)<br>Unclassified |   | 21. No. of Pages<br>249  | 22. Price |

## PREFACE

This report presents a summary of current tieback technology. Recommendations for the corrosion protection, design, specification, and testing of permanent and temporary tiebacks are included. Tieback applications and construction methods are also described.

This report is intended for use as a reference and a guide for design engineers, construction engineers, contractors, and inspectors.

## ACKNOWLEDGMENTS

The author acknowledges with gratitude the assistance given by the following in the preparation of this report:

To Mr. Peter Nicholson, Nicholson Construction, for giving of his time to review and comment on current practice.

To Dr. Fred Stocker, Karl Bauer Kg, for his insight and comments concerning tieback testing.

To Mr. Richard Watts, VSL Corporation, for allowing the writer unlimited access to his telex.

To Dr. Fred Stocker, Karl Bauer Kg, and Mr. Paul Dupeuble, SIF Bachy, for arranging excellent meetings with tieback specialists in Europe.

And, to all of the following people who graciously gave their time for interviews:

AG Heinv. Hatt-Haller - Switzerland  
Karl Tempelmann

Bureau BBR, Ltd. - Switzerland  
Gerald Wellbougher

Bureau Securitas - France  
Mr. Logeais

Bureau de la SOCOTEC - France  
Mr. Cazeuneuve

California Transportation Department - Sacramento, California  
George Fung  
Bill Baker  
James Moese

Colcrete Limited - England  
Dr. G. S. Littlejohn  
C. Truman Davis

Conrad Zschokke, Ltd. - Switzerland  
Paul Speiser

DBM Contractors, Inc. - Tacoma, Washington  
Philip L. Hanson

Dyckerhoff & Widmann, Inc. - San Diego, California  
Juergen L. Plaehn  
Gorden C. Tarapasky

ACKNOWLEDGMENTS  
(continued)

Dyckerhoff & Widmann Inc. - Germany  
Dr. Thomas F. Herbst

Dyckerhoff & Widmann - New York, New York  
Heinz Nierlich

Fondedile Foundations, Ltd. - England  
Ivor Ellis  
Steve Taylor

FOSROC - England  
Martin F. Annett

ICOS (Great Britain), Ltd. - England  
Malcolm Puller  
M. Fuchsberger

Institut fur Bautenschutz Baustoffe und Bauphysik - Germany  
Dr.-Ing. Gunter Rieche

Institut fur Grundbau und Bodenmechanik (IGB) - Switzerland  
Peter Honold

James Williamson & Partners - Scotland  
L. J. Arthur

Karl Bauer Kg - Spezialtiefbau - Germany  
Dr. Karl Bauer  
Dr. M. F. Stocker

Laboratoire Central des Ponts et Chaussees - France  
Mr. Bustamante

Laboratoire de Mecanique Des Solides Ecole, Polytechnique -  
France  
Pierre Habib

Lehrstuhl und Profamt fur Grundbau und Bodenmechanik Technischen  
Universitat Munchen - Germany  
Dr. Ostermayer  
Mr. Scheele

Losinger Ltd., - Switzerland  
Giovanni L. R. Crivelli  
P. Matt  
Hans G. Elsaesser

U.S. Department of Commerce, National Bureau of Standards -  
Washington, DC  
Dr. James R. Clifton

ACKNOWLEDGMENTS  
(continued)

Ove Arup & Partners - England  
J. M. Mitchell

Paul Weber & Associates - Seattle, Washington  
Paul R. Weber

PSC Freyssinet, Ltd. - England  
John T. C. Harvey

Reinforcement Steel Service, McCalls Special Products - England  
Derek Atha  
Chris Edwards  
Mike Wright

Shannon & Wilson, Inc. - Seattle, Washington  
Dr. Harvey W. Parker  
Dr. Gordon Green

Shapiro Okino Hom and Associates, Engineers - San Francisco,  
California  
John H. Hom

S. I. F. Entreprise Bachy - France  
Jacques Charlier  
Paul Dupeuble  
Michel Gandais

Soil Mechanics, Ltd. - England  
Noel Hobbs  
R. W. Isaac

Soletanche Entreprise - France  
Daniel Gouvenot  
Gerard Evers  
Maurice Guillaud

Springfield Industries - Springfield, New Jersey  
Christopher R. Parkinson

Stahlton AG - Switzerland  
K. Heer  
Mr. Bruder

University of Sheffield - England  
T. H. Hanna

Universal Anchorage Contractors Ltd. - England  
Bill Deppner  
Tony Barley

ACKNOWLEDGMENTS

(continued)

VSL Corporation - Los Gatos, California  
David T. Swanson

Wagner Construction, - San Francisco, California  
James Wagner

Washington State Department of Transportation - Olympia,  
Washington  
Art Peters

Western-Pacific Foundations Co. - Seattle, Washington  
Jordan Isaiou



TABLE OF CONTENTS

| <u>Chapter</u>  | <u>Page</u> |
|---|-------------|
| 1 INTRODUCTION . . . . .                                  | 1           |
| 2 DEFINITIONS AND TIEBACK TYPES . . . . .                 | 2           |
| 3 HISTORY . . . . .                                       | 7           |
| 4 APPLICATION . . . . .                                   | 8           |
| 5 CORROSION PROTECTION . . . . .                          | 46          |
| 6 DESIGN . . . . .  | 101         |
| 7 SPECIFICATION OF TIEBACK WORK . . . . .                 | 120         |
| 8 CONSTRUCTION . . . . .                                  | 129         |
| 9 CREEP AND LOAD TRANSFER MECHANISMS . . . . .            | 165         |
| 10 RECOMMENDATIONS FOR TIEBACK TESTING AND MONITORING . . | 182         |
| 11 CONCLUDING REMARKS . . . . .                           | 216         |
| 12 REFERENCES . . . . .                                   | 218         |
| INDEX . . . . .   | 227         |

LIST OF FIGURES

| <u>Figure</u> |  | <u>Page</u> |
|---------------|--|-------------|
| 1.            | Components of a tieback. . . . .   | 3           |
| 2.            | Components of a compression tieback. . . . .   | 4           |
| 3.            | Tieback types. . . . .   | 6           |
| 4.            | Tiedback H-beam and lagging sheeting system for a cut-and-cover station in Philadelphia. . . . .                                       | 9           |
| 5.            | Permanently tiedback composite sheeting and cast-in-place concrete wall in Alexandria, VA. . . . .                                     | 10          |
| 6.            | Tiered permanently tiedback bored pile wall with masonry finish near Innsbruck, Austria. . . . .                                       | 12          |
| 7.            | Permanently tiedback composite sheeting and concrete wall at Brookwood Medical Center, Brookwood, AL. . . . .                          | 13          |
| 8.            | Permanently tiedback tiered retaining wall for a highway cut near Rossberg bei Winterthur, Switzerland. . . . .                        | 14          |
| 9.            | Comparison of a conventional retaining wall with a permanently tiedback wall in soil. . . . .  | 15          |
| 10.           | Comparison of a conventional depressed highway cut with a permanently tiedback highway excavation. . . . .                             | 17          |
| 11.           | Permanently tiedback depressed right-of-ways. . . . .  | 18          |
| 12.           | Comparison between structural support and tiedback wall support of unbalanced lateral forces. . . . .                                  | 19          |
| 13.           | Permanently tiedback concrete bearing pads for protection of a tunnel portal on National Highway N4, Arth-Goldau, Switzerland. . . . . | 21          |
| 14.           | Permanently tiedback wall and elements for protection of a tunnel portal on the Tauern Autobahn, Austria. . . . .                      | 22          |
| 15.           | Construction of permanently tiedback bridge abutments. . . . .   | 23          |
| 16.           | Permanently Tiedback Bridge Abutment in Zurich, Switzerland. . . . .   | 24          |
| 17.           | Thick concrete mat used to resist hydrostatic uplift pressures acting on a depressed section of I-95, Philadelphia. . . . .            | 25          |

LIST OF FIGURES  
(continued)

| <u>Figure</u> |   | <u>Page</u> |
|---------------|---|-------------|
| 18.           | Permanent tiedowns for a basement slab in Harrisburg, PA.   | 25          |
| 19.           | Permanently tiedback concrete buttresses used to support a rock cut in Germany. . . . .                     | 27          |
| 20.           | Permanently tiedback concrete elements used to support a rock slope near Alpnach-Stad, Switzerland. . . . . | 28          |
| 21.           | Permanently tiedback wall used to stabilize a fill slide near Spruce Pine, NC. . . . .                      | 29          |
| 22.           | Cut and fill landslides. . . . .  | 30          |
| 23.           | Permanently tiedback wall used to prevent a landslide in Fairfax County, VA. . . . .                        | 31          |
| 24.           | Permanently tiedback wall used to prevent a landslide and protect Mercy Hospital, Scranton, PA. . . . .     | 33          |
| 25.           | Permanently tied-down tower guys for Bonneville Power. . . . .  | 34          |
| 26.           | Permanent tower tiedowns. . . . .   | 35          |
| 27.           | Permanent tiedowns used to anchor the roof of the Lufthansa Hanger, Munich, Germany. . . . .                | 36          |
| 28.           | Permanent anchors used in the renovation and deepening of a harbor. . . . .                                 | 37          |
| 29.           | Permanently tiedback cast-in-place diaphragm quay wall for the Port le Havre, France. . . . .               | 38          |
| 30.           | Permanent tiebacks used to stabilize a failing gravity retaining wall in London, England. . . . .           | 39          |
| 31.           | Permanent tiebacks used for the widening of a highway under an existing bridge. . . . .                     | 40          |
| 32.           | Tiedback existing foundation walls in Tacoma, WA. . . . .   | 41          |
| 33.           | Permanent Tiebacks Used to Stabilize Failing Retaining wall. . . . .  | 42          |
| 34.           | Permanent tiedowns used to increase the stability of Habersham Mills Dam, Habersham County, GA. . . . .     | 43          |
| 35.           | Permanent tiebacks used to protect a bridge pier on the Tauern Autobahn, Austria. . . . .                   | 44          |

LIST OF FIGURES  
(continued)

| <u>Figure</u> |   | <u>Page</u> |
|---------------|---|-------------|
| 36.           | Galvanic cell. . . . .  | 47          |
| 37.           | Differential concentration cell. . . . .  | 49          |
| 38.           | Differential aeration cell. . . . .   | 50          |
| 39.           | Stray-current corrosion system. . . . .   | 50          |
| 40.           | Pit development in a ferrous metal. . . . .   | 51          |
| 41.           | Unprotected bar tieback. . . . .  | 70          |
| 42.           | Simple corrosion protected strand tieback. . . . .  | 72          |
| 43.           | Simple corrosion protected bar tieback. . . . .   | 73          |
| 44.           | Coated bar tieback. . . . .   | 74          |
| 45.           | Encapsulated bar tieback. . . . .   | 76          |
| 46.           | Encapsulated strand tieback. . . . .  | 77          |
| 47.           | Encapsulated TMD tieback. . . . .   | 78          |
| 48.           | Compression tube tieback. . . . .   | 79          |
| 49.           | Primary and secondary grout used for corrosion protection of a wire tendon. . . . .                                   | 80          |
| 50.           | Permanent tieback anchor head protection. . . . .   | 82          |
| 51.           | Local corrosion system that could affect a simple corrosion protected tieback. . . . .                                | 83          |
| 52.           | Long-line corrosion system that could affect a simple corrosion protected tieback. . . . .                            | 85          |
| 53.           | Most feasible stray-current corrosion system that could affect a simple corrosion protected tieback. . . . .          | 86          |
| 54.           | Theoretically possible stray-current corrosion system that could affect a simple corrosion protected tieback. . . . . | 87          |
| 55.           | Insulated simple corrosion protected tieback. . . . .   | 96          |
| 56.           | Test arrangement for checking the anchor head insulation. . . . .   | 98          |

LIST OF FIGURES  
(continued)

| <u>Figure</u> |  | Page      |
|---------------|--|-----------|
| 57.           | Test arrangement for measuring the direction and magnitude of the long-line corrosion current. . . . .       | 99        |
| 58.           | Test arrangement for checking changes in aeration on the tendon. . . . .                                     | 100       |
| 59.           | Test arrangement for estimating the rate of local corrosion cell activity. . . . .                           | 100       |
| 60.           | Ultimate pressure-injected tieback capacity as a function of anchor length, density, and grain size. . . . . | 112       |
| 61.           | Ultimate capacity of postgrouted tiebacks, after Jorge..   | 113       |
| 62.           | Determination of the unbonded and total tieback length..   | 117       |
| 63.           | Determination of the total tiedown length. . . . .   | 119       |
| 64.           | Spacer. . . . .  | 133       |
| 65.           | Centralizer. . . . .   | 133       |
| 66.           | Combination centralizer-spacer. . . . .  | 133       |
| 67.           | Bar anchorage. . . . .   | 134       |
| 68.           | Strand anchorage. . . . .  | 134       |
| 69.           | Wire anchorage. . . . .  | 134       |
| 70.           | Construction steps for a tremie-grouted, straight-shafted, rock tieback. . . . .                             | 140       |
| 71.           | Construction steps for a straight-shafted rock tieback grouted after tendon insertion. . . . .               | 141       |
| 72.           | Steps in "Odex" drilling. . . . .  | 144       |
| 73.           | "Odex" drill string arrangement. . . . .   | 145       |
| 74.           | "Klemm" system drill string arrangement. . . . .   | 146       |
| 75.           | Steps in rotary overburden drilling. . . . .   | 147 & 148 |
| 76.           | Grout arrangement for upward sloping rock tieback. . .   | 151       |
| 77.           | Single-underreamed tieback. . . . .  | 154       |

LIST OF FIGURES  
(continued)

| <u>Figure</u> |   | <u>Page</u> |
|---------------|---|-------------|
| 78.           | Caisson drill with underreaming tool. . . . .   | 154         |
| 79.           | Multiunderreamed tieback. . . . .   | 155         |
| 80.           | Steps in hollow-stem-augured tieback installation. . .  | 156         |
| 81.           | Construction steps for straight-shafted, low-pressure-grouted tiebacks installed in sandy soil. . . . .   | 157 & 158   |
| 82.           | Steps for pressure-injected tieback installation. . . .   | 160         |
| 83.           | Tube a manchette tieback. . . . .   | 162         |
| 84.           | Tube a manchette packer. . . . .  | 163         |
| 85.           | TMD tieback installation sequence. . . . .  | 164         |
| 86.           | Unearthed tube a manchette tiebacks. . . . .  | 161         |
| 87.           | Strain rate vs. time relationship during undrained creep of Osaka alluvial clay. . . . .  | 166         |
| 88.           | Strain rate vs. time relationship. . . . .  | 167         |
| 89.           | Strain rate vs. deviator stress. . . . .  | 167         |
| 90.           | Creep curves predicted by the general stress-strain-time function, equations (22) and (23). . . . .   | 168         |
| 91.           | Typical stress-strain behavior of a tieback anchor. . .   | 170         |
| 92.           | Normalized skin friction distribution as a function of normalized length. . . . .   | 170         |
| 93.           | Skin friction distribution at failure as a function of anchor length and density in a gravelly sand. . . . .  | 172         |
| 94.           | Distribution of load transfer during testing of a pressure-injected tieback installed in dense fine to coarse gravelly sand. . . . .                            | 173         |
| 95.           | Distribution of load transfer during testing of a pressure-injected tieback installed in a dense fine to coarse sand and gravel. . . . .                        | 173         |
| 96.           | Tieback movement vs. time for a single-underreamed, model tieback in a normally consolidated kaolin clay with an overburden pressure at 72.5 psi (500 kPa). . . | 177         |

LIST OF FIGURES  
(continued)

| <u>Figure</u> |  | <u>Page</u> |
|---------------|--|-------------|
| 97.           | Load transfer rate vs. anchor length along an anchor installed in stiff to very stiff clay. . . . .  | 179         |
| 98.           | Skin friction along two tiebacks installed in a hard clay with an undrained strength of 39 psi (270 kPa). . . . .                                      | 180         |
| 99.           | Tieback testing arrangement. . . . .   | 183         |
| 100.          | Performance test performed on a pressure-injected tieback installed in a dense fine to medium sand. . . . .  | 188         |
| 101.          | Performance test made on a hollow-stem-augered tieback installed in a stiff silty clay. . . . .  | 189         |
| 102.          | Proof test performed on a hollow-stem-augered tieback installed in an interbedded stiff silty clay and silty sand. . . . .                             | 193         |
| 103.          | Performance test made on a postgrouted tieback installed in a stiff clay with a trace of fine to medium sand. . . . .                                  | 197         |
| 104.          | Creep test performed on a postgrouted tieback installed in a stiff clay with a trace of fine to medium sand. . . . .                                   | 198         |
| 105.          | Characteristic creep curves. . . . .   | 204         |
| 106.          | Comparison of creep movements allowed by tieback standards. . . . .  | 205         |
| 107.          | Creep test performed on a postgrouted tieback installed in a stiff to very stiff silty clay. . . . .   | 207         |
| 108.          | Creep tests performed on a postgrouted tieback installed in a soft to medium clayey silt. . . . .  | 207         |
| 109.          | Performance test made on a single-underreamed tieback installed in stiff micaceous clayey silt. . . . .  | 208         |
| 110.          | Creep test performed on a single-underreamed tieback installed in a hard to very hard clay. . . . .  | 210         |
| 111.          | Performance test made on a hollow-stem-augered tieback installed in an interbedded stiff silty clay, and silty sand. . . . .                           | 211         |
| 112.          | Creep curve for an 88 ton (783 kN) load applied to a hollow-stem-augered tieback installed in an interbedded stiff silty clay, and silty sand. . . . . | 212         |

LIST OF FIGURES  
(continued)

| <u>Figure</u> |   | <u>Page</u> |
|---------------|---|-------------|
| 113.          | Proof test and creep curve for a hollow-stem-augered tieback installed in an interbedded stiff silty clay and silty sand. . . . . | 213         |

LIST OF TABLES

| <u>Table</u> |  | <u>Page</u> |
|--------------|--|-------------|
| 1.           | Temporary tieback service life. . . . .  | 66          |
| 2.           | Tieback corrosion protection requirements. . . . .   | 67 & 68     |
| 3.           | Examples showing how risk may affect a tieback installation. . . . .                                   | 105         |
| 4.           | Predicted and observed tieback capacities. . . . .   | 106         |
| 5.           | Typical ultimate tieback capacities for tiebacks installed in a stiff clay (N = 30). . . . .           | 107         |
| 6.           | Ultimate capacity of Bachy tiebacks in cohesionless soils. . . . .                                     | 113         |
| 7.           | Summary of reported adhesion factors. . . . .  | 115         |
| 8.           | Capacity of postgrouted tiebacks in clay. . . . .  | 118         |
| 9.           | Common tieback tendon materials. . . . .   | 130         |
| 10.          | Rock drillability guide. . . . .   | 142         |
| 11.          | Soil tieback installation methods. . . . .   | 152 & 153   |
| 12.          | Performance test made on a pressure-injected tieback installed in a dense fine to medium sand. . . . . | 185         |
| 13.          | Performance test made on a hollow-stem-augered tieback installed in a stiff silty clay. . . . .        | 187         |



LIST OF TABLES  
(continued)

| <u>Table</u> |  | <u>Page</u> |
|--------------|--|-------------|
| 14.          | Proof test form for tiebacks installed in noncohesive soil or rock. . . . .  | 191         |
| 15.          | Proof test performed on a hollow-stem-augered tieback installed in an interbedded stiff silty clay and silty sand. . . . . | 192         |
| 16.          | Creep test made on a postgrouted tieback installed in a stiff clay with a trace of fine to medium sand. . . . .            | 195         |
| 17.          | Creep test made on a postgrouted tieback installed in a stiff clay with a trace of fine to medium sand. . . . .            | 196         |
| 18.          | Recommended tieback test program. . . . .  | 199         |
| 19.          | Tieback test overloads. . . . .  | 200         |
| 20.          | Percentage load loss resulting from time dependent stress relaxation of the prestressing steels. . . .                     | 202         |
| 21.          | Estimated tieback creep movement and load loss resulting from creep of the prestressing steel. . . .                       | 203         |
| 22.          | Recommend tieback monitoring. . . . .  | 215         |

## LIST OF SYMBOLS

|                  |   |  |
|------------------|---|--|
| A                | - | creep parameter, ratio of contact pressure at the anchor soil interface to the effective overburden pressure |
| B                | - | bearing capacity factor  |
| c                | - | cohesion   |
| $c_u$            | - | average undrained shear strength   |
| D                | - | anchor diameter  |
| $D_s$            | - | shaft diameter   |
| $D_u$            | - | underreamed diameter   |
| $D_{10}$         | - | grain size where 10% of the soil particles are smaller   |
| $D_{60}$         | - | grain size where 60% of the soil particles are smaller   |
| d                | - | diameter of the shaft above the anchor zone  |
| e                | - | electron   |
| fg               | - | ultimate skin friction between the grout and the soil  |
| $f_u$            | - | reduction coefficient  |
| h                | - | depth to top of the anchor zone  |
| $h_m$            | - | depth of overburden to the mid-point of the anchor   |
| I                | - | corrosion current  |
| $I_c$            | - | consistency index  |
| K                | - | a constant numerically equal to $N\phi$  |
| $K_0$            | - | coefficient of earth pressure at rest  |
| k                | - | electrochemical equivalent   |
| $l_a$            | - | anchor length  |
| $l_j$            | - | jacking length   |
| $l_s$            | - | shaft length   |
| $l_t$            | - | total tieback length   |
| $l_u$            | - | unbonded length  |
| m                | - | creep parameter  |
| N                | - | standard penetration resistance  |
| $N_c$            | - | bearing capacity factor  |
| $N_q$            | - | bearing capacity factor  |
| $N\phi$          | - | $(1 + \sin \phi)/(1 - \sin \phi)$  |
| n                | - | empirical factor used in estimating tieback capacity   |
| P                | - | ultimate tieback capacity  |
| $P_i$            | - | effective grout pressure   |
| $P_n$            | - | normal stress  |
| t                | - | time   |
| U                | - | uniformity coefficient   |
| W                | - | natural water content  |
| $W_L$            | - | liquid limit   |
| $W_P$            | - | plastic limit  |
| $\alpha$         | - | adhesion factor, creep parameter   |
| $\gamma$         | - | dry unit weight of soil  |
| $\bar{\gamma}$   | - | effective unit weight of soil  |
| $\epsilon$       | - | strain   |
| $\dot{\epsilon}$ | - | strain rate  |
| $\tau_{ult}$     | - | ultimate rock-grout bond stress  |
| $\phi$           | - | angle of internal friction   |
| $\sigma_a(ult)$  | - | uniaxial compressive strength  |
| $\sigma_1$       | - | major principal stress   |
| $\sigma_3$       | - | minor principal stress   |

## ABBREVIATIONS

|        |  |
|--------|--|
| ACI    | - American Concrete Institute                                      |
| ASCE   | - American Society of Civil Engineers                              |
| ASTM   | - American Society for Testing and Materials                       |
| AWWA   | - American Water Works Association                                 |
| FIP    | - Federation International de la Precontrainte                     |
| ICE    | - Institute of Civil Engineers                                     |
| ISSMFE | - International Society of Soil Mechanics and Foundation Engineers |
| NBS    | - National Bureau of Standards                                     |
| PCA    | - Portland Cement Association                                      |
| PCI    | - Prestressed Concrete Institute                                   |
| PTI    | - Post-Tensioning Institute  |
| RQD    | - Rock Quality Designation   |

## METRIC CONVERSIONS

| <u>To convert from</u> | <u>to</u>                    | <u>Multiply by</u>           |
|------------------------|------------------------------|------------------------------|
| degree Fahrenheit      | degree Celsius               | $T_{OC} = (T_{OF} - 32)/1.8$ |
| feet                   | metre (m)                    | 0.305                        |
| gallon                 | cubic metre (m) <sup>3</sup> | $3.785 \times 10^{-3}$       |
| inch                   | centimetre (cm)              | 2.54                         |
| inch                   | millimetre (mm)              | 25.4                         |
| kip                    | newton (N)                   | $4.45 \times 10^3$           |
| kip/ft                 | kN/m                         | 14.59                        |
| kip/ft <sup>2</sup>    | pascal (Pa)                  | $4.79 \times 10^4$           |
| ksi                    | pascal (Pa)                  | $6.895 \times 10^6$          |
| pcf (mass density)     | kg/m <sup>3</sup>            | 16.02                        |
| pcf (unit weight)      | kN/m <sup>3</sup>            | 0.157                        |
| psf                    | pascal (Pa)                  | 47.9                         |
| psi                    | pascal (Pa)                  | $6.895 \times 10^3$          |
| ton                    | kN                           | 8.90                         |
| tons/ft <sup>2</sup>   | pascal (Pa)                  | $9.58 \times 10^4$           |
| yd <sup>3</sup>        | m <sup>3</sup>               | 0.765                        |



## CHAPTER 1 - INTRODUCTION

A tieback is a relatively new construction element which can be used to ~~transfer load to an anchor formed in the ground~~. Tiebacks have been developed, in a large part, by specialty contractors who design and build temporary excavation support systems. Each contractor has evolved his own methods of performing the work, and many of the techniques are proprietary.

Permanent tiebacks have been used to support structures in Europe since the mid-1960's, and since the early 1970's in the United States. In the United States, permanent tiebacks have not been frequently used because the engineering profession has not found adequate answers to the following questions:

- 1) Can the tieback tendon be protected from corrosion?
- 2) Will a tieback maintain its load without excessive movement?
- 3) What type of test should be used to verify the short-term and long-term load holding capacity of a tieback?
- 4) Where can tiebacks be effectively used?
- 5) How can tiebacks be specified, since many tieback systems are proprietary and an accepted standard or code does not exist?

This report is intended to help answer these questions. It summarizes the current state-of-the-art concerning permanent tiebacks, and makes recommendations for improvements in current practice. The writer has attempted to:

- 1) Show a variety of applications to illustrate how permanent tiebacks have been successfully used.
- 2) Provide guidelines for determining whether or not permanent tiebacks can be used at the site.
- 3) Develop tieback corrosion protection recommendations which enable the engineer to determine the protection required based on four simple tests.
- 4) Provide guidelines for estimating the load carrying capacity of the tiebacks.
- 5) Provide guidelines for developing a performance specification which would enable the engineer to specify permanent tiebacks without eliminating suitable proprietary systems.
- 6) Recommend a testing procedure which can be used to verify the short-term load holding capacity of each tieback and predict their long-term load holding behavior.

This report is not intended to be a cookbook with a step by step description of a tieback installation. It does provide the engineer with the background and information necessary to confidently use permanent tiebacks to support a variety of structures.

## CHAPTER 2 - DEFINITIONS AND TIEBACK TYPES

A tieback system is a structural system which uses an anchor in the ground to secure a tendon which applies a force to a structure. Figures 1 and 2 show typical tiebacks and their components. Vertical or near vertical tiebacks are called tiedowns. Tiebacks are also referred to as ground anchors.

Tiebacks are used for temporary or permanent applications. A temporary tieback is used during the construction of a project; its service life is usually less than two years. A permanent tieback is required for the life of a permanent structure.

The tendon is made up of prestressing steel with sheathing, and an anchorage. The anchor transmits the tensile force in the prestressing steel to the ground. Cement grout, or polyester resin, or mechanical anchors are used to anchor the steel in the ground. The anchorage is made up of an anchor head or nut, and a bearing plate.

The anchor head or nut is attached to the prestressing steel, and transfers the tieback force to a bearing plate which evenly distributes the force to the structure. Anchor heads can be restressable or nonrestressable. A restressable anchor head is one where the tieback force can be measured or increased any time during the life of the structure. The load can not be adjusted when a nonrestressable anchor head is used. A coupling can be used to transmit the anchor force from one length of prestressing steel to another.

The anchor length is the designed length of the tieback where the tieback force is transmitted to the ground. The tendon bond length is the length of the tendon which is bonded to the anchor grout. Normally the tendon bond length is equal to the anchor length. The unbonded length of the tendon is the length which is free to elongate elastically. The jacking length is that portion which is required for testing and stressing of the tieback. The unbonded testing length is the sum of the unbonded length and the jacking length. A sheath or bond breaker is installed over the unbonded length to prevent the prestressing steel from bonding to surrounding grout. The anchor diameter is the design diameter of the anchor.

Anchor grout is used to transmit the tieback force to the ground. The anchor grout is also called the primary grout. Secondary grout is injected into the drill hole after stressing to provide corrosion protection for unsheathed tendons.

Tiebacks carry various loads during their lifetimes. The design load is the maximum anticipated load that will be applied to the tieback. The test load is the maximum load applied during testing. The lock-off load or transfer load is the load transferred to the tieback upon completion of stressing. The alignment load is a nominal load maintained on a tieback during testing to keep the testing equipment in position. The lift-off load is the load required to lift the anchor head or nut from the bearing plate. The residual load is the load carried by the tieback at any time. The load transfer rate is the tieback capacity per unit length of anchor.

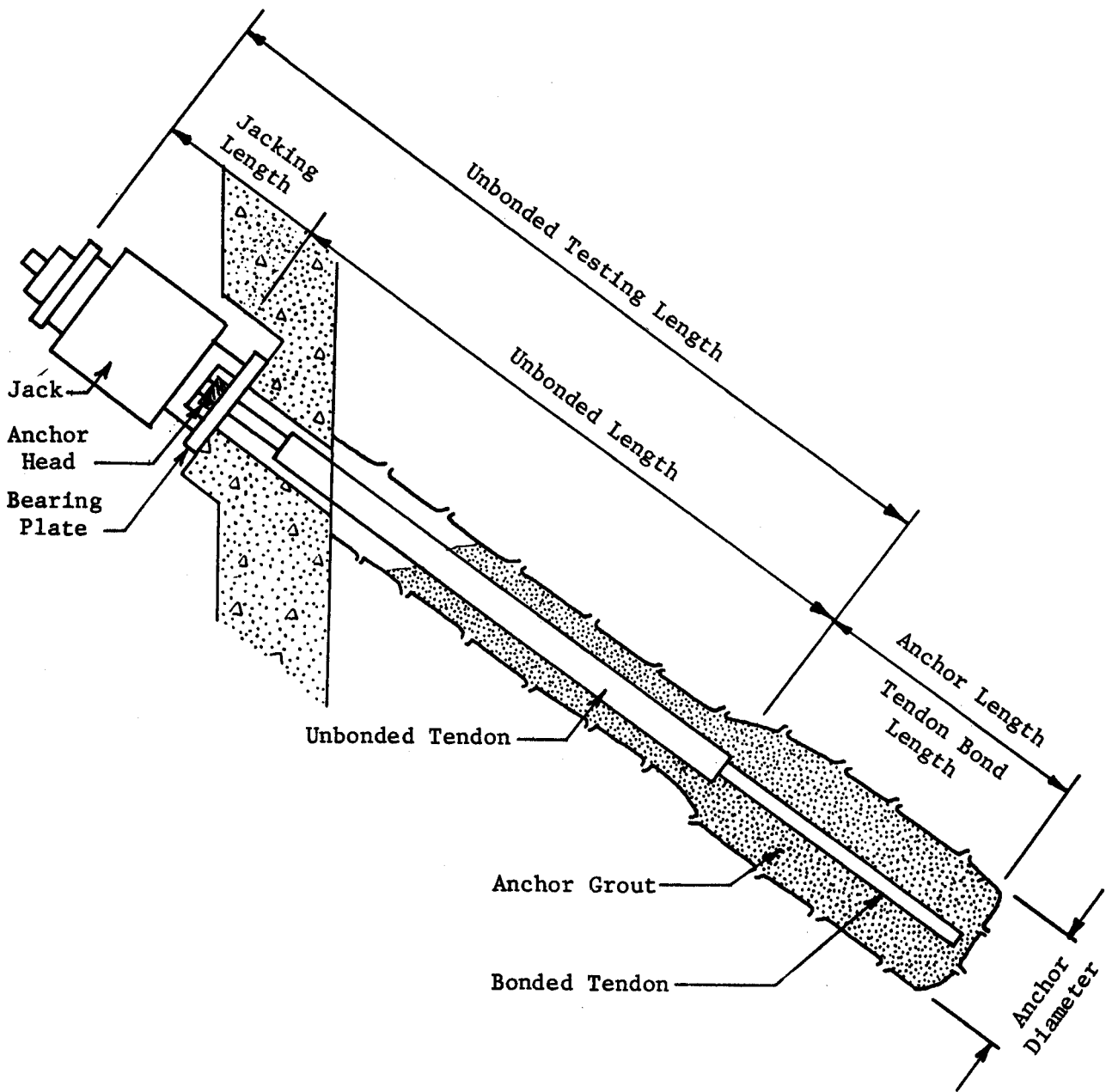

Figure 1. Components of a tieback.

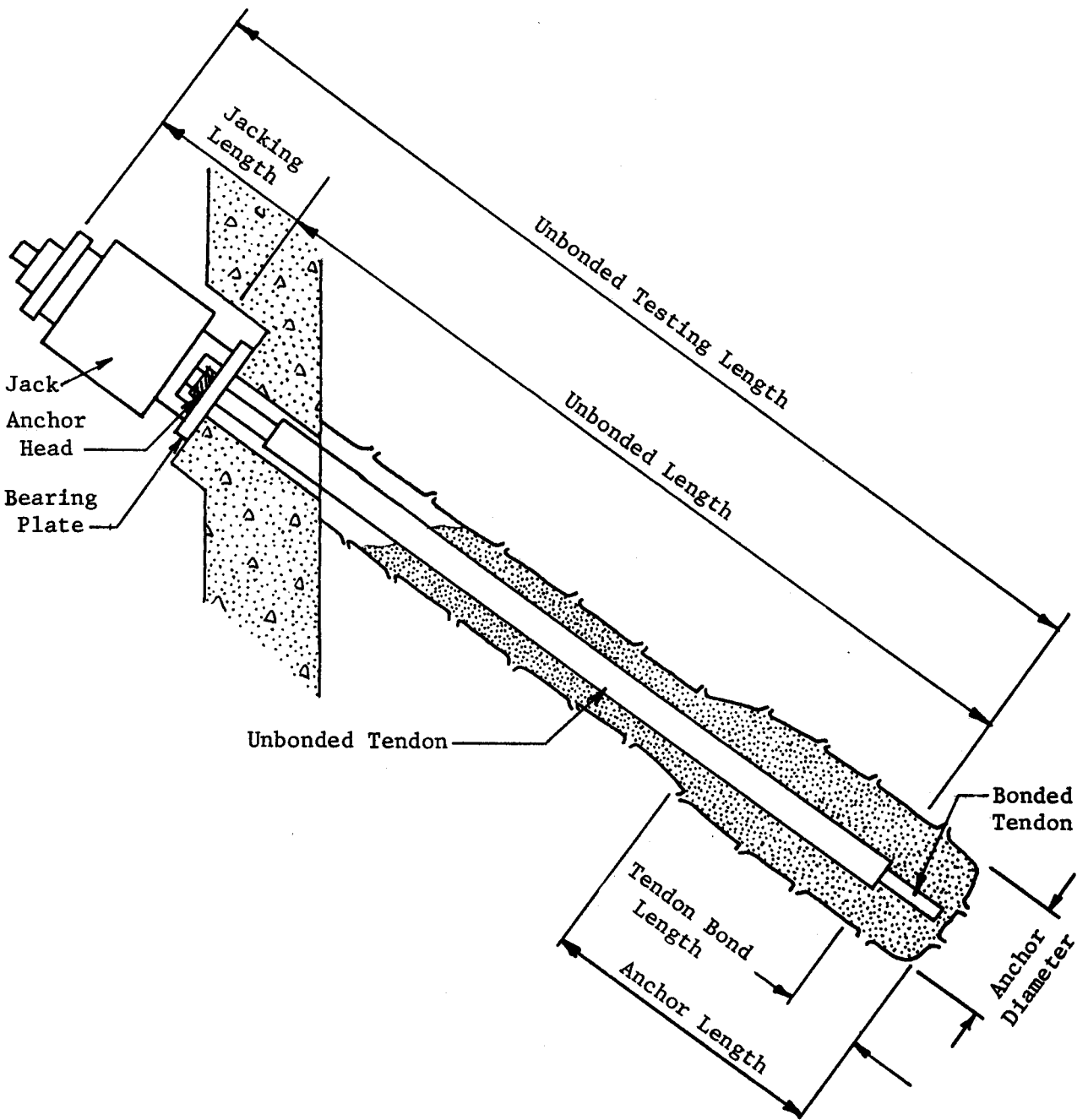

Figure 2. Components of a compression tieback.



The basic types of tiebacks are: pressure-injected; low-pressure-grouted, straight-shafted; single-underreamed; multiunderreamed; and postgrouted. These tiebacks are shown in Figure 3.

Pressure-injected tiebacks are used in sandy or gravelly soils. Grout pressures in excess of 150 psi (1034 kPa) are used to achieve high load transfer rates.

Low-pressure-grouted, straight-shafted tiebacks are installed in rock, cohesive soils, and sandy or gravelly soils. They can be made using a variety of drilling and grouting techniques. The grout pressure is less than 150 psi (1034 kPa).

Single-underreamed tiebacks are installed primarily in the United States using large uncased drill holes in cohesive soils. Sand-cement grout or concrete is used in grouting the tieback and the grout or concrete is not placed under pressure.

Multiunderreamed tiebacks are used in stiff cohesive soils and weak rocks. The spacing of the underreams is selected in order to induce a shear failure along the cylinder determined by the tips of the underreams.

Postgrouted tiebacks are primarily used in cohesive soils. In granular soils and rock, postgrouting is used to increase the rate of load transfer.

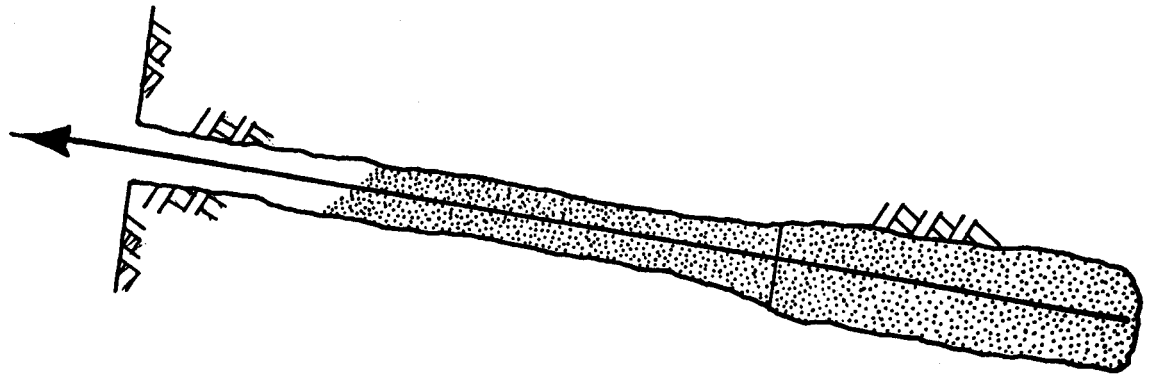

a) Pressure-injected and low-pressure-grouted, straight-shafted.

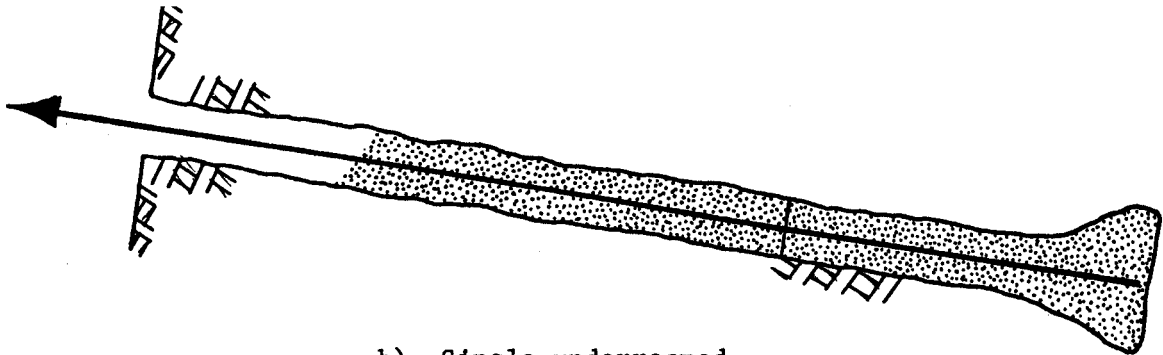

b) Single-underreamed.

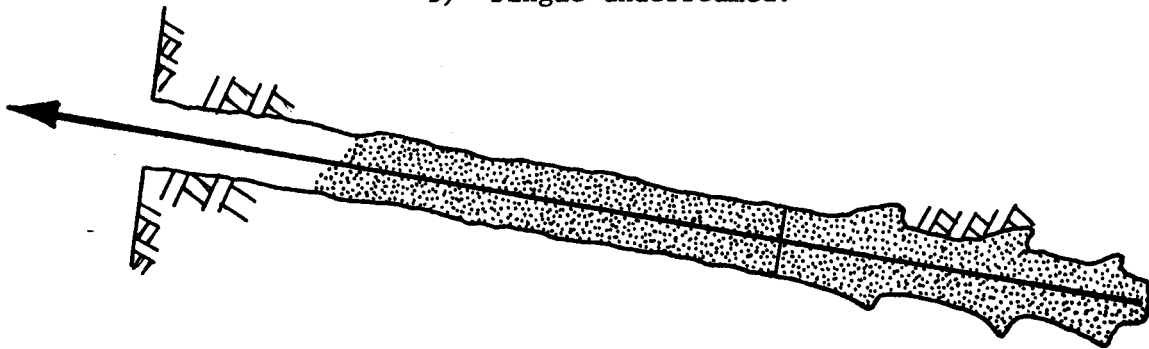

c) Multiunderreamed.

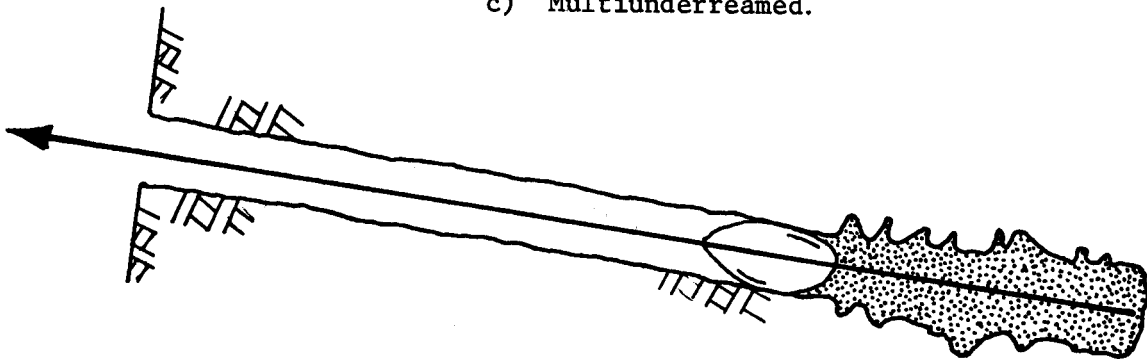

d) Postgrouted.

Figure 3. Tieback types.

### CHAPTER 3 - HISTORY

Tiebacks were first used to anchor structures in rock. The earliest permanent rock tiedown installation was in 1933 at Cheurfas Dam, Algeria [1]1/. Two thousand two hundred and five kip (9810 kN) tiedowns were employed during the reinforcing of the existing dam. By the late 1950's, permanent rock tiedowns had been used during the renovation or construction of numerous other dams [2], [3], and [4].

In the 1950's, contractors began using tiebacks to temporarily support the sides of deep excavations. These tiebacks had load carrying capacities of 40 to 200 kips (178 to 890kN). In the United States, soil tiebacks were first made in cohesive soils using truck mounted caisson drills. They were either large diameter single-underreamed or large diameter straight-shafted tiebacks. Large diameter straight-shafted temporary tiebacks were first installed in California in the mid-1950's. Hollow-stem-augered tiebacks were first used in the United States for temporary application in the early 1960's.

Multiunderreamed piles were developed in South Africa in 1955 [5]. In 1961, small diameter underreamed tiebacks were installed in a clay at Westfield Properties in Durban, Scotland [5]. By the late 1960's, multiunderreamed tiebacks were commonly used in stiff London clay. In Germany in 1958, Bauer made the first pressure-injected tieback in dense Munich sand [6]. Multiphase postgrouted tiebacks were introduced in France in 1966 by S. I. F. Bachy [7].

Hunt and Costa Nunes [8] reported that permanently tiedback walls have been the most common method of slope retention in Brazil since 1958. The first permanent soil tiebacks in the United States were installed in a very stiff silty clay in Detroit, Michigan, in 1961 [9]. They were large diameter, single-underreamed tiebacks used to support a retaining wall for a highway. By the mid-1960's permanent soil tiebacks had been installed in Switzerland, Germany, England, and France [7], [10], [11], and [12]. Compression tube permanent tiebacks were developed by Stump A.G., a Swiss contractor in the late 1960's [13].

1/ Number in brackets indicate the literature reference on Page 218.

## CHAPTER 4 - APPLICATIONS

Tiebacks are classified as temporary or permanent. A temporary tieback is only required during construction. A permanent tieback is required for the support of a permanent structure or to increase its factor of safety.

### TEMPORARY TIEBACKS

Temporary tiebacks are normally used to support the sides of deep excavations during the construction of a basement. The type of wall they support depends upon the soil or rock conditions, the ground water condition, local regulations, availability of materials, and performance requirements. In the United States, most deep excavations are supported by tiedback H-beams and lagging systems. Figure 4 shows an H-beam and lagging sheeting system used for the construction of a cut-and-cover subway station for the Center City Commuter Rail Connection, Philadelphia.

The sides of temporary excavations may also be supported by cross-lot or inclined braces. Normally tiedback systems deform less than braced excavations because: a force at or above the active earth pressure is locked-off in every tieback, tieback construction operations do not allow over excavation, tiebacks are not subject to significant temperature-caused deformations or loads, and rebracing is not required for tiedback walls. When the depth of the excavation exceeds 15 or 20 feet (4.6 or 6.1 m) and the width exceeds 60 feet (18.3 m), or when obstructions significantly impact construction, tiedback walls are usually cheaper than braced support systems. Internally braced walls interfere with excavation, concrete work, structural steel placement, and backfilling. Tiedback walls provide a clean open excavation.

Temporary tiebacks have also been used for special applications such as reactions for pile load tests, nondestructive testing of an elevated rail line, and salvaging of a ship [14].

### PERMANENT TIEBACKS

Since the mid-1960's, permanent tiebacks have been used to solve a variety of structural problems. The following describes how they have been successfully incorporated in different types of work.

#### A. Retaining Walls

Retaining walls are often supported by permanent soil or rock tiebacks. Permanently tiedback walls are used to support earth pressures resulting from the soil behind a wall or to stabilize landslides. Landslide stabilization walls are described on Page 26.

Figure 5 shows a permanently tiedback retaining wall built in lieu of a cantilevered wall in Alexandria, Virginia. A cantilevered wall would have required temporary sheeting, and the underpinning of the retaining wall

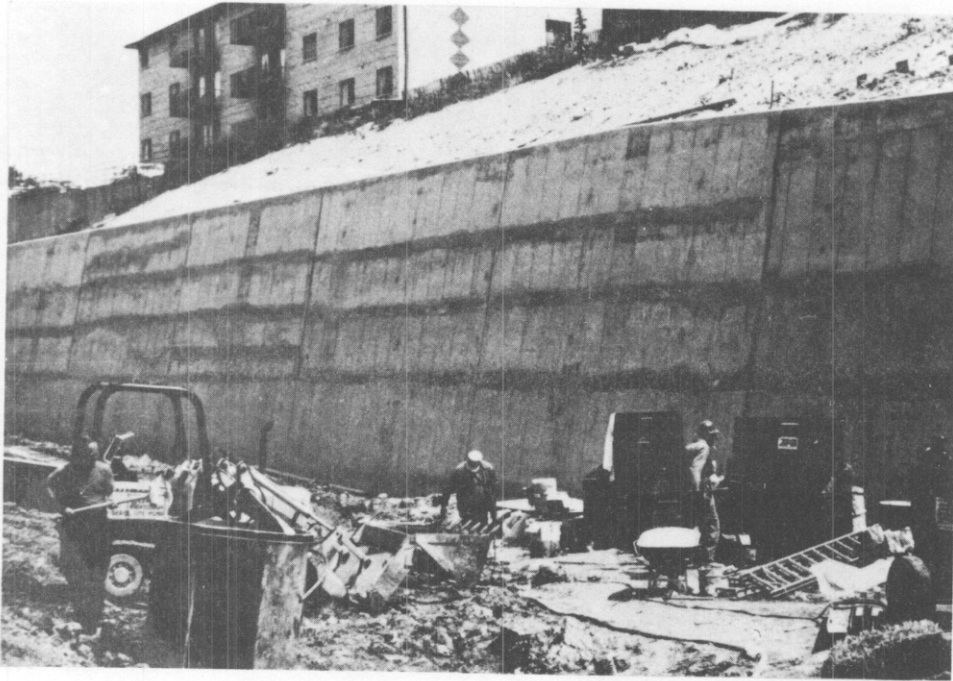

a) Permanently tiedback wall under construction.

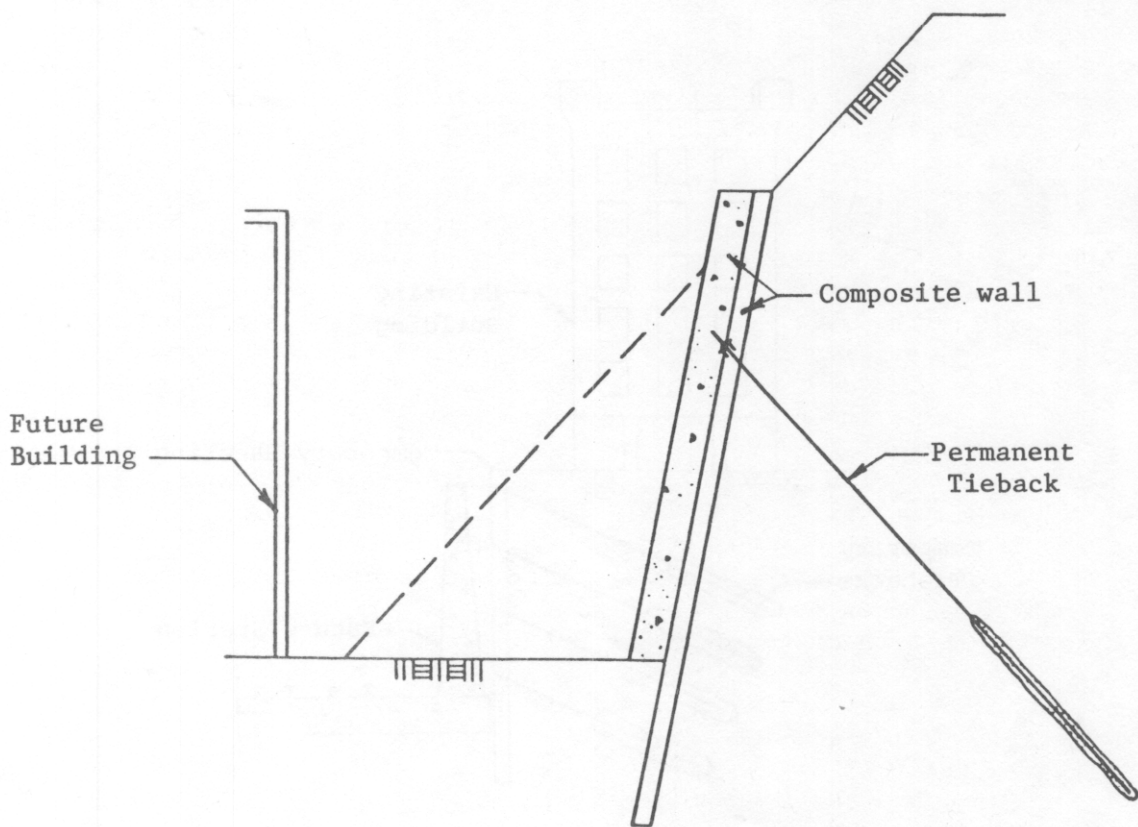

b) Section.

Figure 5. Permanently tiedback composite sheeting and cast-in-place concrete wall in Alexandria, VA.

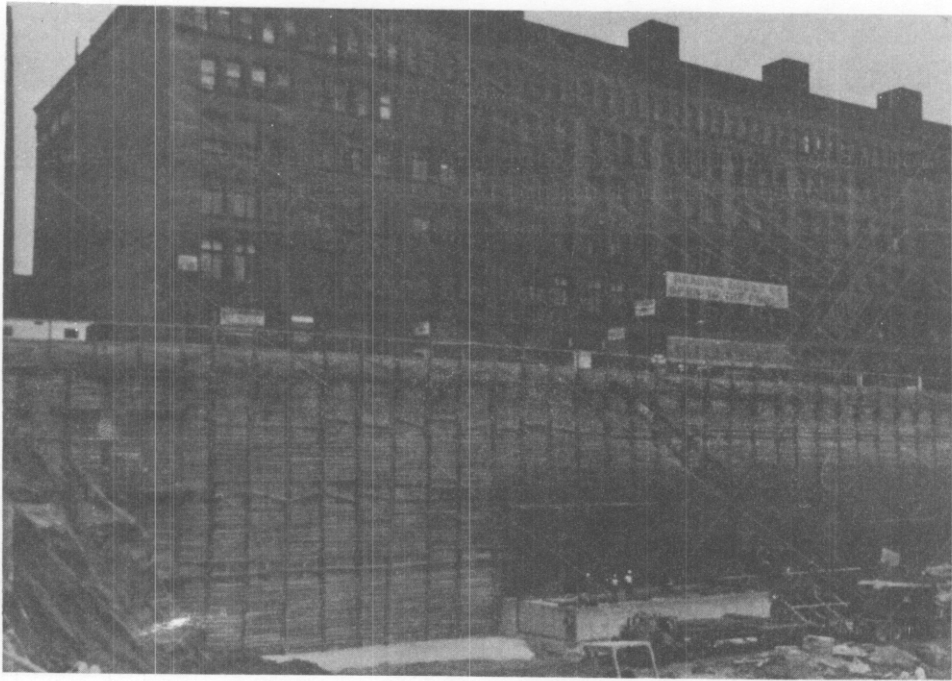

a) Station wall under construction.

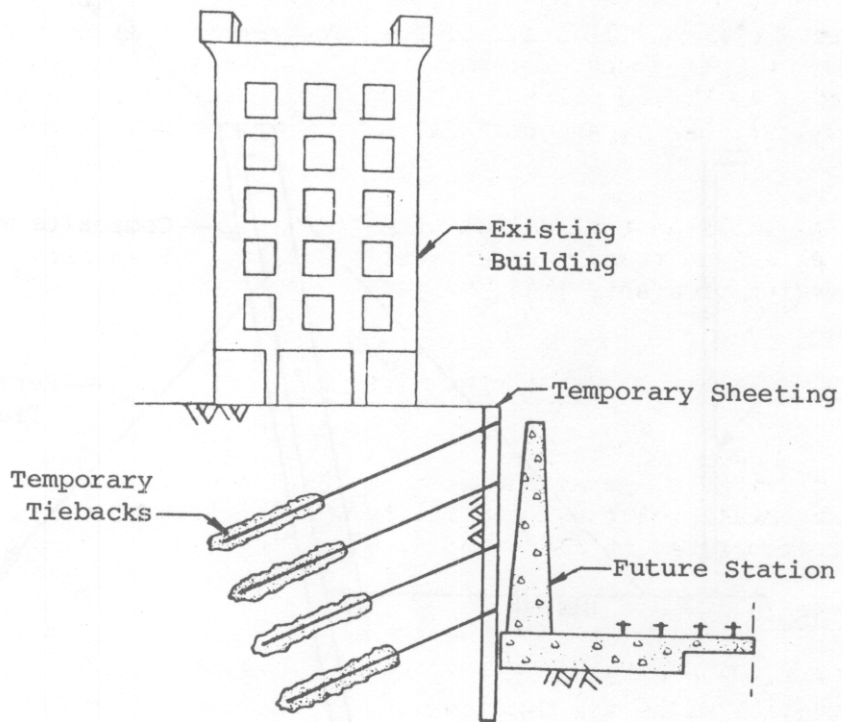

b) Section.

Figure 4. Tiedback H-beam and lagging sheeting system for a cut-and-cover station in Philadelphia.

visible in the background. The cantilevered wall also would have required foundation piles, and a large pile cap since the soil at subgrade did not have adequate bearing capacity. The tiedback wall was constructed by placing a cast-in-place concrete face on the soldier beams. Underpinning of the existing wall was not necessary since the tiedback wall did not require piles or a large footing. Backfill was not needed since the wall was cast directly onto the temporary sheeting.

Figure 6 shows two bored pile and shotcrete retaining walls supported by permanent tiebacks. The walls are located on the Autobahn south of Innsbruck, Austria. They provide two benches for a highway. The walls were built from the top down, and they are finished using architectural stone.

The permanently tiedback composite cast-in-place reinforced concrete retaining wall shown in Figure 7 was used to control ground movements and settlement of an adjacent structure. The wall also prevented large earth pressures from being applied to a masonry structure which was to be built directly in front of the wall. Temporary sheeting was installed and supported with corrosion protected permanent tiebacks. The soldier beams, which were double channels, were used as a composite member with the cast-in-place concrete. This project was at Brookwood Medical Center, Brookwood, Alabama.

Tiedback walls are used to support highway or railway cuts in mountainous regions. Figure 8 shows a wall built along a highway near Rossberg, Switzerland. The wall was built from the top down. A very large counterforted retaining wall, requiring temporary sheeting or removal of a significant portion of the slope, would have been necessary if a conventional wall had been built.

Tiedback walls are built in cuts. If temporary sheeting is required for the construction of a retaining wall, then a permanently tiedback wall offers many advantages. They are not economical if extensive fills are required behind the wall. Cantilevered retaining walls, or reinforced earth normally will provide a more economical wall in a fill. Permanently tiedback walls provide the following advantages over conventional cantilevered walls in cut situations (see Figure 9):

*advantages of tie back wall*

- 1) Incorporation of the temporary excavation support system into the permanent wall.
- 2) Reduction in the quantities of excavation.
- 3) Elimination of footing excavation and concrete.
- 4) Reduction in the amount of blasting in rock.
- 5) Elimination of foundation piles in soil.
- 6) Reduction in the quantity of reinforced concrete for the wall, since it may be designed for short spans.
- 7) Elimination of backfill.
- 8) Reduction of construction disturbance, since a large footing is not required. The temporary wall is on line with the permanent wall.
- 9) Improved worker and public safety since the wall does not require wide construction easements behind the wall.

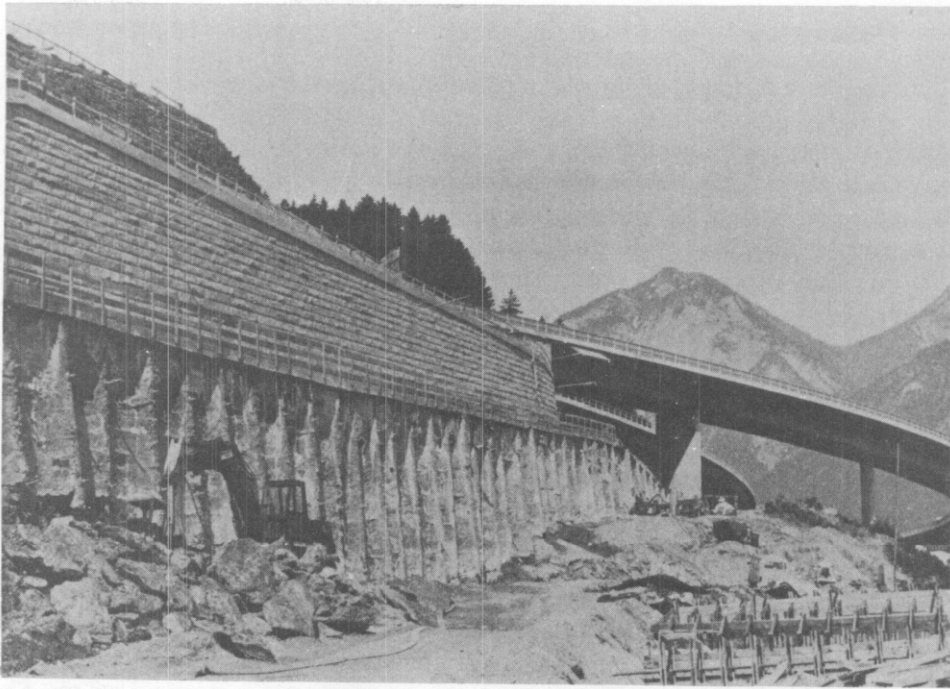

a) Tiered wall under construction (courtesy Karl Bauer).

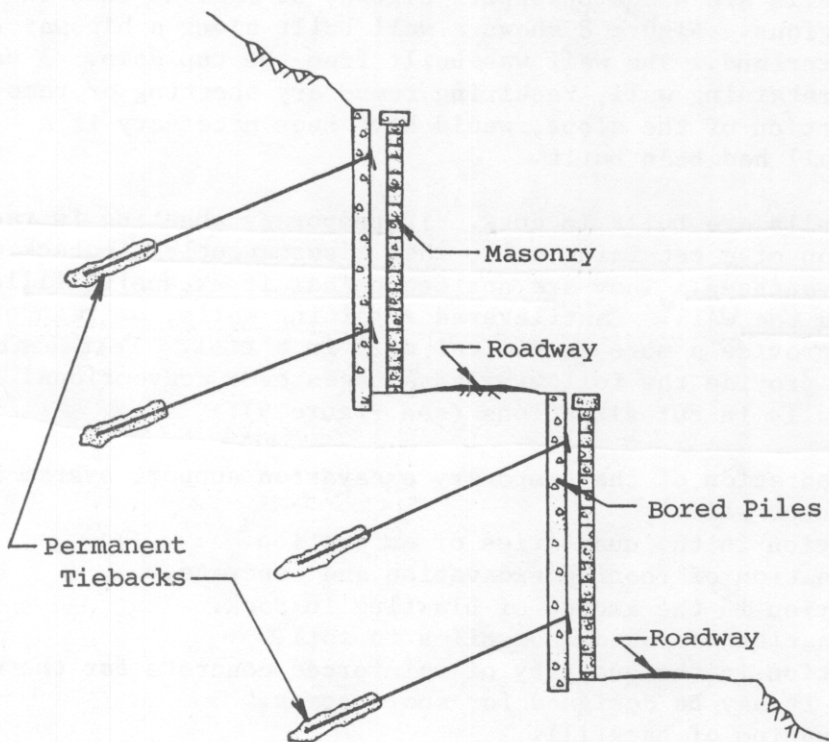

b) Section.

Figure 6. Tiered permanently tiedback bored pile wall with masonry finish near Innsbruck, Austria.



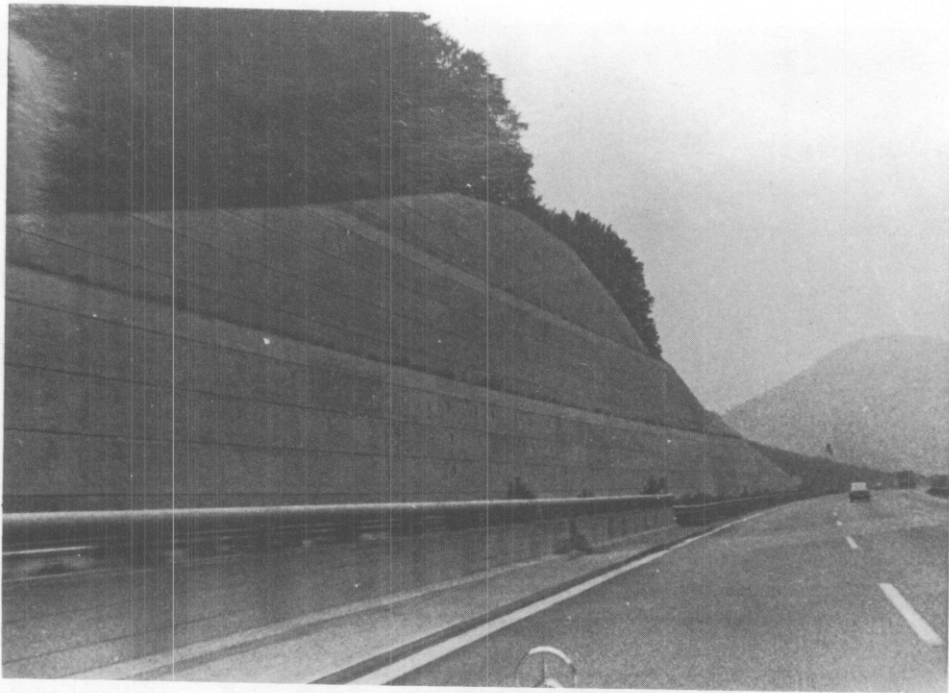

a) Completed wall (courtesy Karl Bauer),

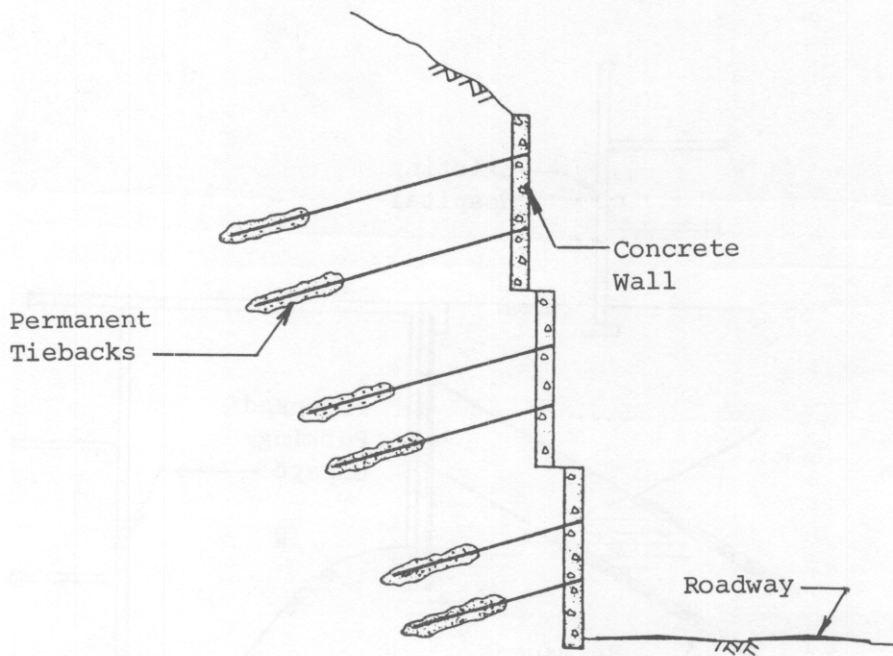

b) Section.

Figure 8. Permanently tiedback tiered retaining wall for a highway cut near Rossberg bei Winterthur, Switzerland.

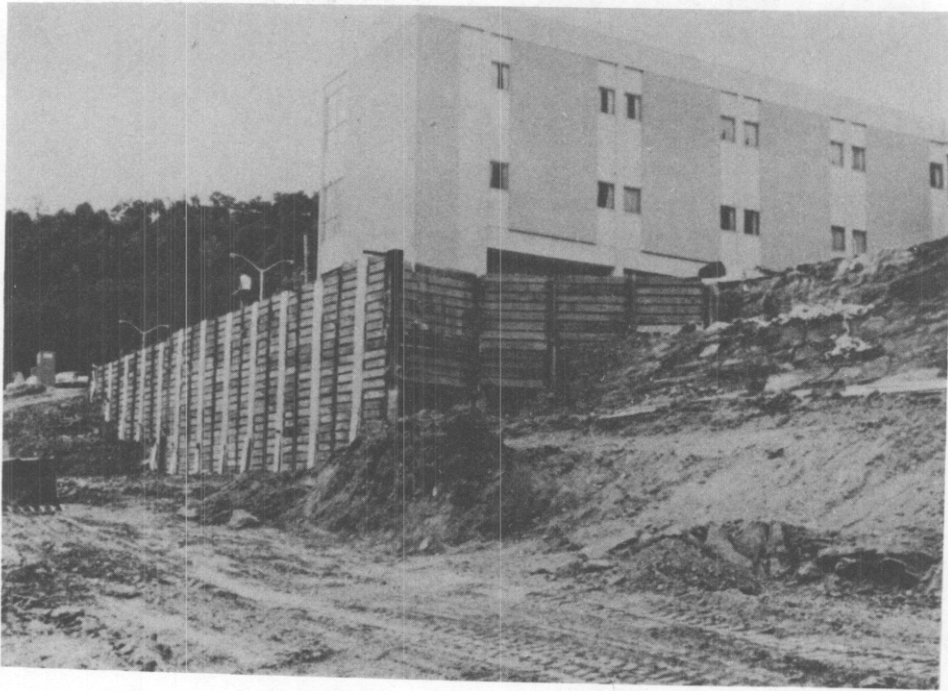

a) Composite concrete and sheeting wall under construction.

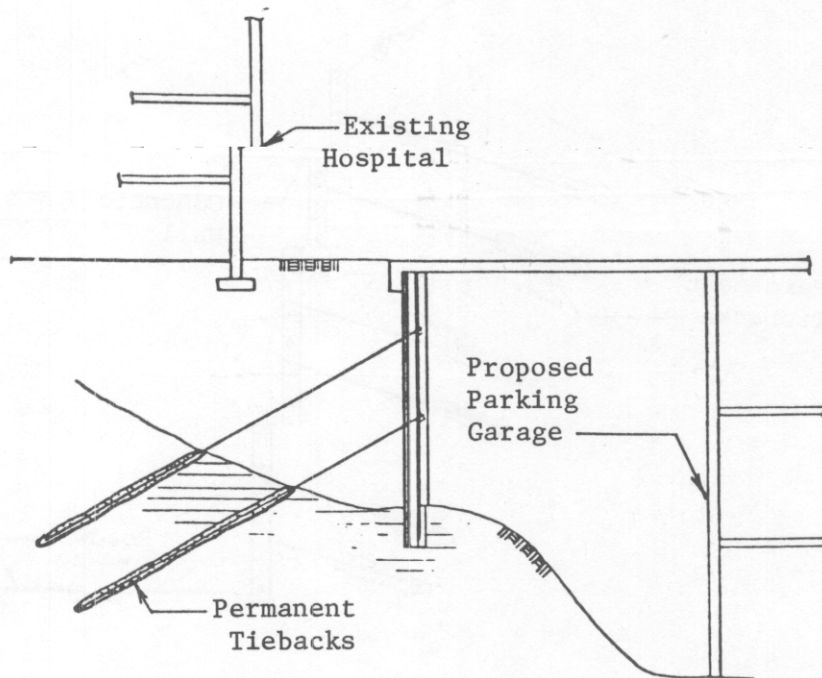

b) Section.

Figure 7. Permanently tiedback composite sheeting and concrete wall at Brookwood Medical Center, Brookwood, AL.

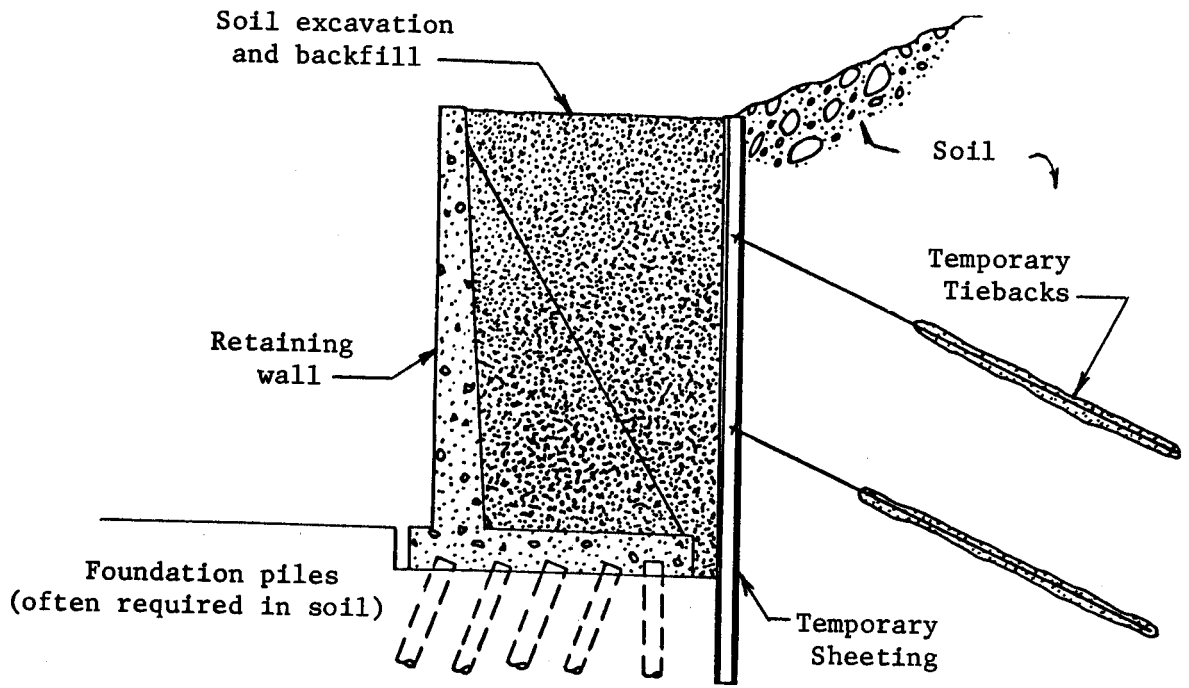

a) Conventional retaining wall .

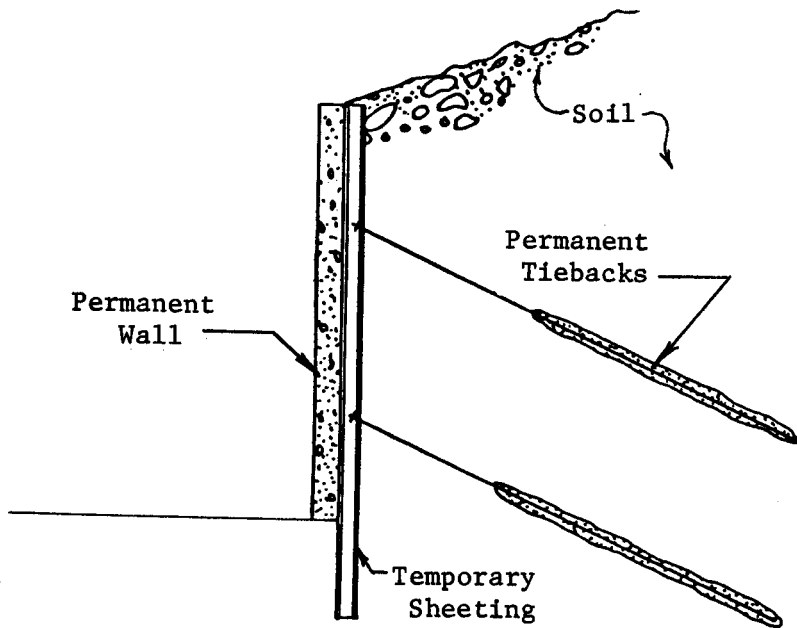

b) Permanent tiedback wall.

Figure 9. Comparison of a conventional retaining wall with a permanently tiedback wall.

Permanently tiedback walls have the following disadvantages when compared to cantilevered walls:

- 1) Permanent easements are required for the tiebacks.
- 2) Permanent tiebacks may limit the development where they are installed.
- 3) The current tiebacks systems cannot effectively be used in soft cohesive soils.
- 4) Controlled blasting techniques must be used in order to produce a rock cut which can be cast against.

Permanently tiedback walls can economically support depressed cuts for rail lines and roadways. Figure 10 shows the advantages tiedback walls can provide. The construction of the conventional wall shown in Figure 10 would require the closing of traffic lanes behind each wall, and these closings could last for more than a year. If the permanently tiedback wall shown in Figure 10 was built, construction would extend about 2 feet (0.61 m) beyond the face of the permanent wall, and traffic would not have to be interrupted. Easements for the permanent tiebacks at this site would not have been a problem since the existing roadways would be public property.

Figure 11 shows three permanently tiedback depressed excavations. A variety of finishes are attainable with a depressed wall. The wall built in Munich used exposed bored piles, and the depressed metro-railroad cut in Zurich was made using a precast diaphragm wall. Bored pile walls in Zurich have also been painted flat black, and architectural ceramic panels have been hung from the wall.

#### B. Foundation Walls

Permanent tiebacks normally are not used to support building walls since permanent easements are required from adjacent property owners. It is very expensive to obtain these easements in urban areas, since adjacent owners demand a high price for restricting the development of their land. However, tiebacks are used to support foundation walls in certain situations. Figure 12 shows the most common application for a permanently tiedback building wall. In this case the building is located on a steeply sloping site and it is subjected to large unbalanced lateral forces. A normal building foundation is not designed to resist these forces. When this type of site is developed, permanent tiebacks can be used to resist the lateral load. The cost for the tieback easements is often less than the cost of abandoning the site, sacrificing floor space, or designing the building to resist these forces.

When designing walls of this type, care must be taken to ensure that the wall and the building can accommodate relative movements. If the wall is rigidly connected to the structure, relative movement could cause damage. A separate retaining wall may be built in order to prevent wall deformations from affecting the building.

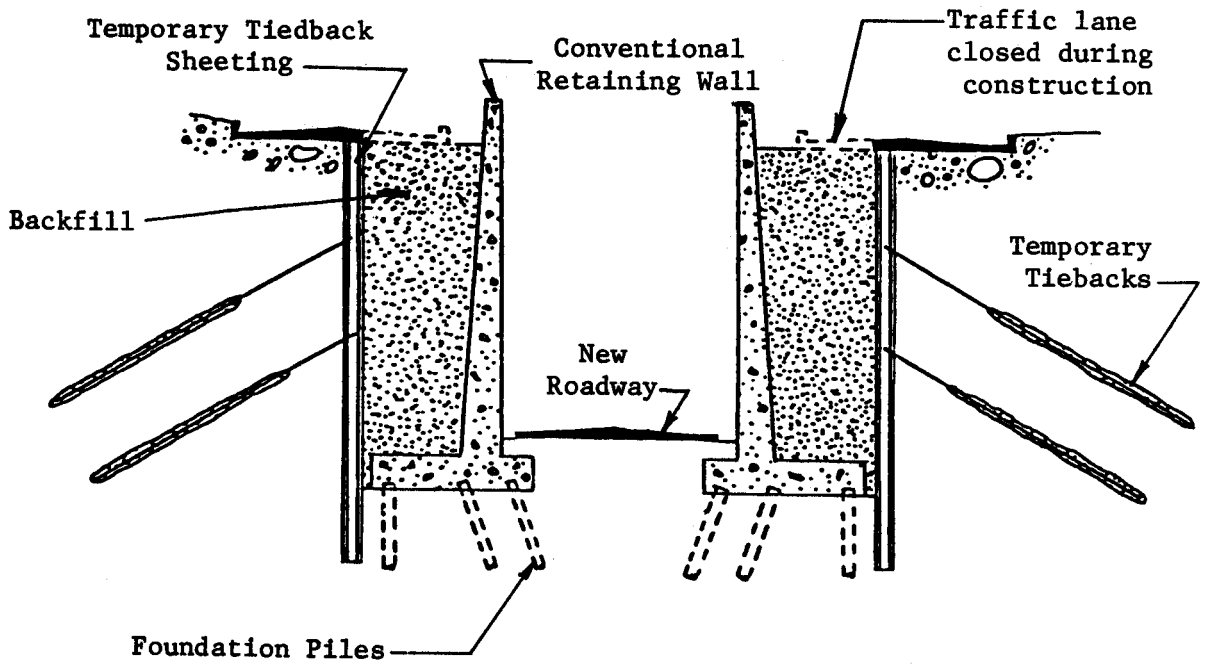

a) Conventional retaining wall.

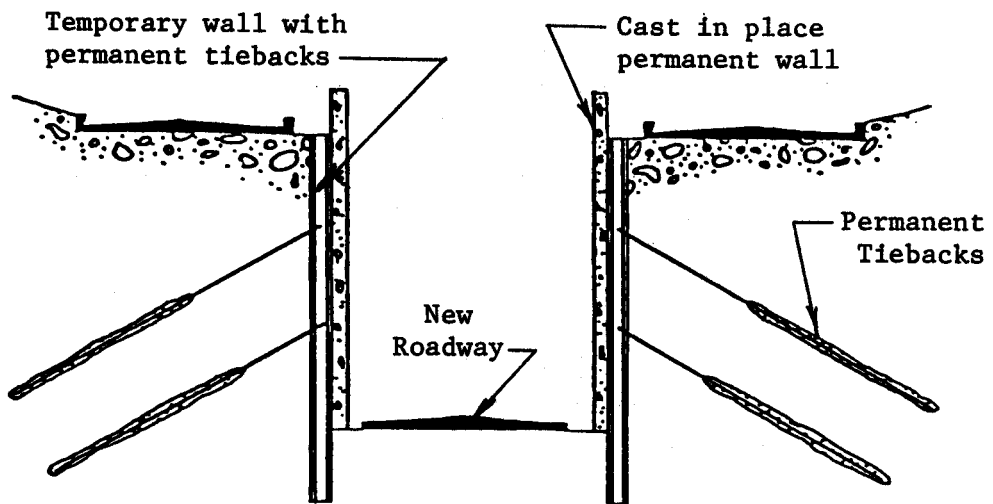

b) Permanent tieback wall.

Figure 10. Comparison of a conventional depressed highway cut with a permanently tiedback highway excavation.

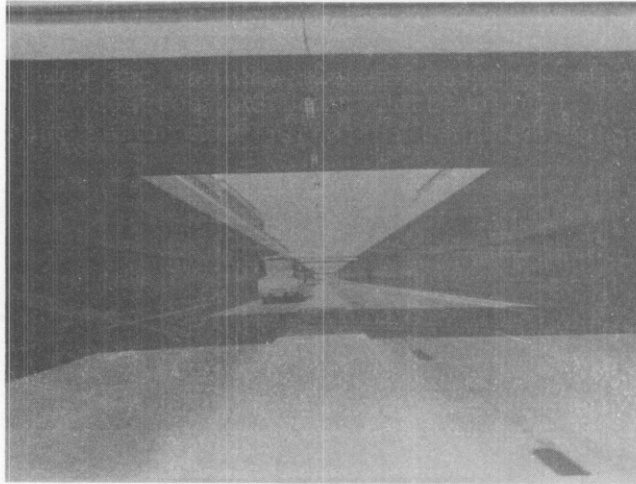

a) Highway in Munich, Germany (courtesy Karl Bauer).

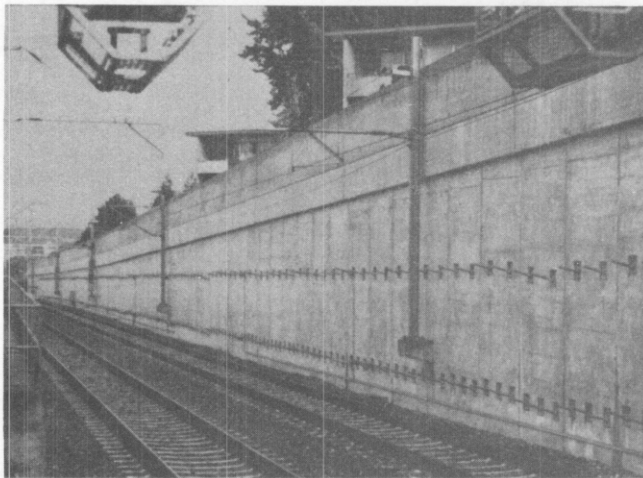

b) Precast diaphragm wall for metro and railroad in Zurich, Switzerland.

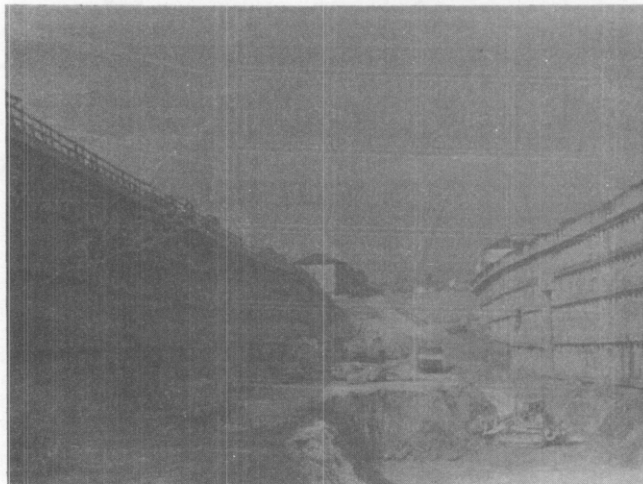

c) Highway and railway line in Zurich, Switzerland. (courtesy AG Heir Hatt-Haller).

Figure 11. Permanently tiedback depressed right-of-ways.

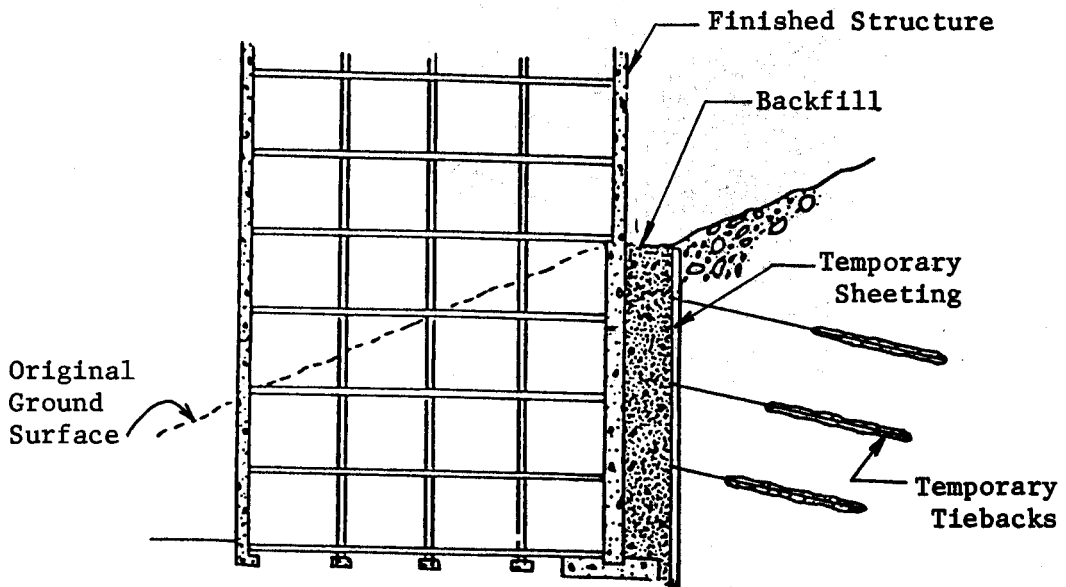

a) Structure designed to resist unbalanced lateral pressures.

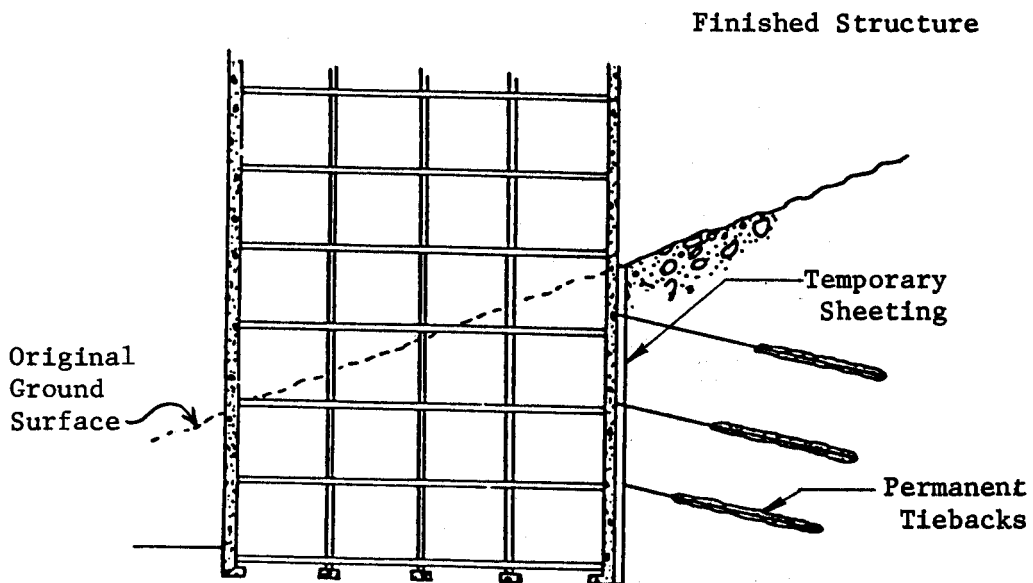

b) Permanent tiebacks used to resist unbalanced lateral pressures.

Figure 12. Comparison between structural support and tiedback wall support of unbalanced lateral forces.

### C. Tunnel Portals

Many tunnel portals are located on the sides of steep slopes or in mixed soil and rock cuts. The construction of the portal is often more difficult than the remainder of the tunnel because of poor ground conditions, the variable nature of the stratigraphy, groundwater, and existing or potential landslides. Figure 13 shows a tunnel portal protected with permanently tiedback elements. This tunnel is located on Swiss National Highway N4, between Zurich and Altdorf. The concrete bearing pads were anchored with 82 foot (25 m) long rock tiebacks having a 19.7 foot (6 m) anchor length and a design load of 449.6 to 539.5 kips (2000 to 2400 kN). The tunnel protection shown in Figure 14 was built using 134.9 kip (600 kN) design load soil tiebacks to support a permanent shotcrete and bored pile wall for the Tauern Autobahn, Austria.

By using a permanently tiedback wall at the tunnel portal, it is possible to handle difficult subsurface conditions in an open cut. As a result, the tunneling method can be selected based upon the geological conditions to be encountered along the bore and not at the portal. The wall also can be designed to provide permanent protection against slides at the portal.

### D. Bridge Abutments

Permanent tiebacks enable bridge abutments to be built from the top down. Figure 15 shows the sequence used to construct a tiedback underpass. First, a bored pile, or a cast-in-place diaphragm, or a precast diaphragm wall is constructed from existing grade. Since these wall systems are built in segments, only a portion of the existing roadway needs to be closed to traffic at any time. Bored pile walls are economical to install since drilling equipment is readily available, and they create the least disturbance.

After the wall is installed, beam seats are poured, beams are placed, and the deck is constructed. This operation can also be done in segments enabling traffic to be maintained. Upon completion of the deck, traffic can be restored without restrictions.

Once the deck is built, excavation proceeds without interrupting traffic. When the excavation reaches the tieback elevation, the wall and the tiebacks are installed. After the tiebacks are tested and locked-off, the excavation is continued to the next level of tiebacks or subgrade.

Figure 16 shows a bridge abutment built in Zurich, Switzerland. In this case, the deck was not placed since it was not necessary to maintain traffic over the excavation.



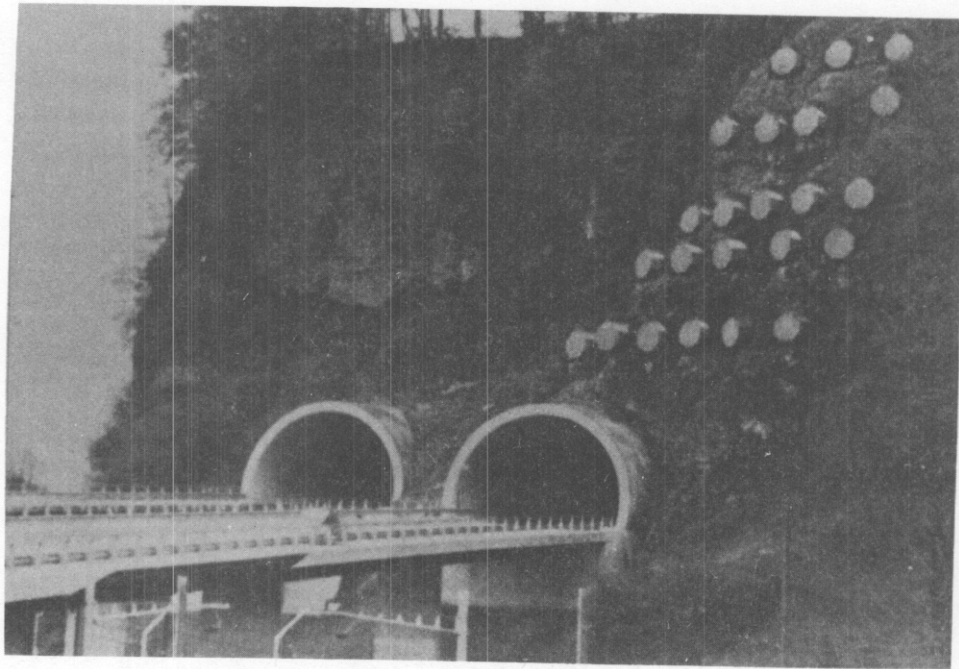

a) Tiedback bearing pads (courtesy VSL Corporation).

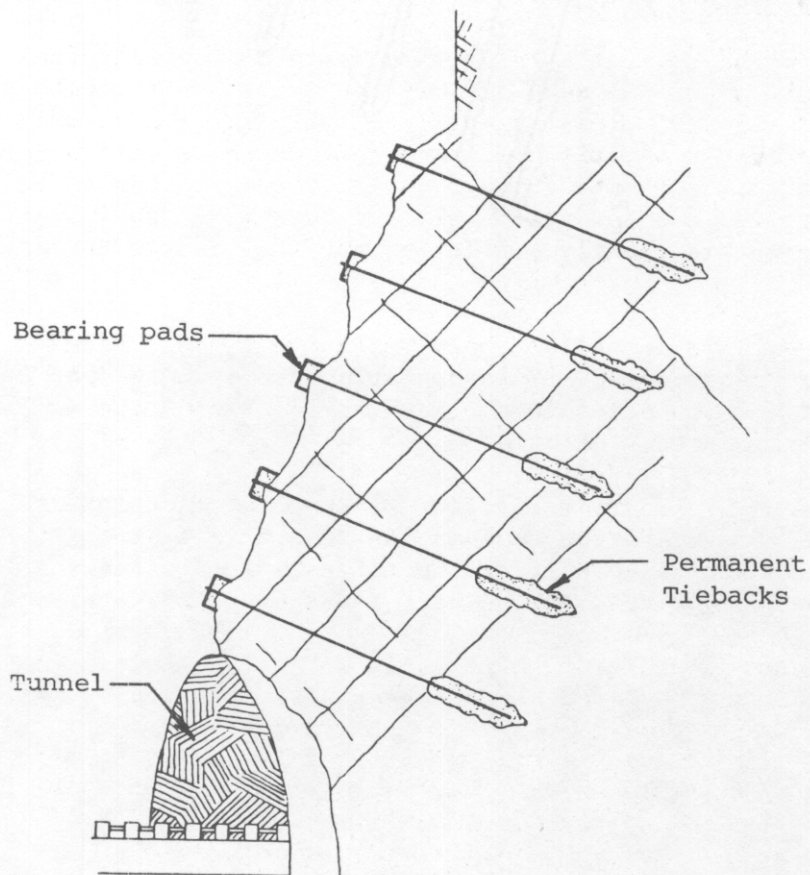

b) Section.

Figure 13. Permanently tiedback concrete bearing pads for protection of a tunnel portal on National Highway N4, Arth-Goldau, Switzerland.

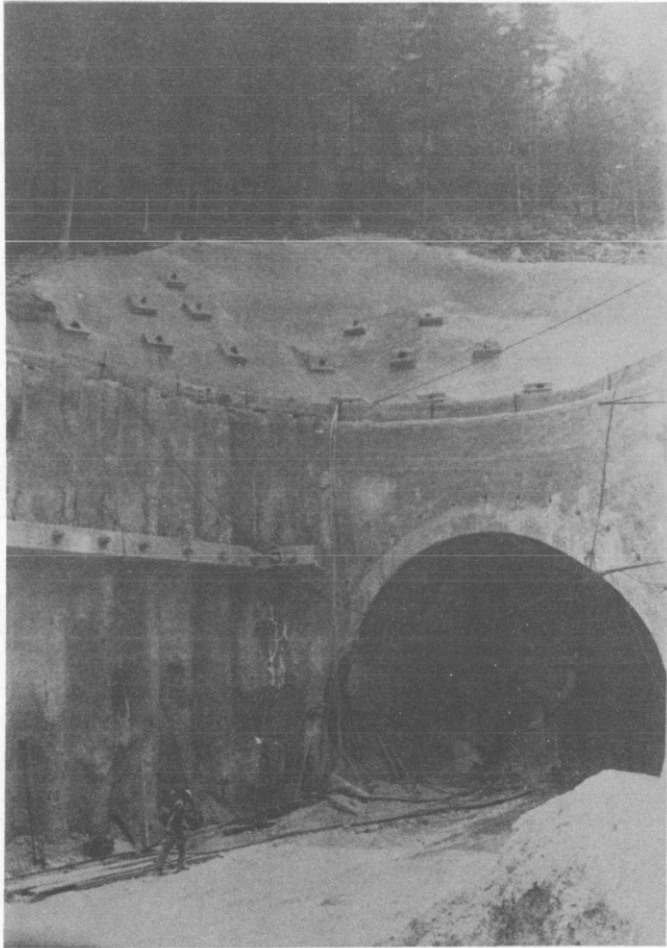

a) Tunnel portal under construction  
(courtesy Karl Bauer).

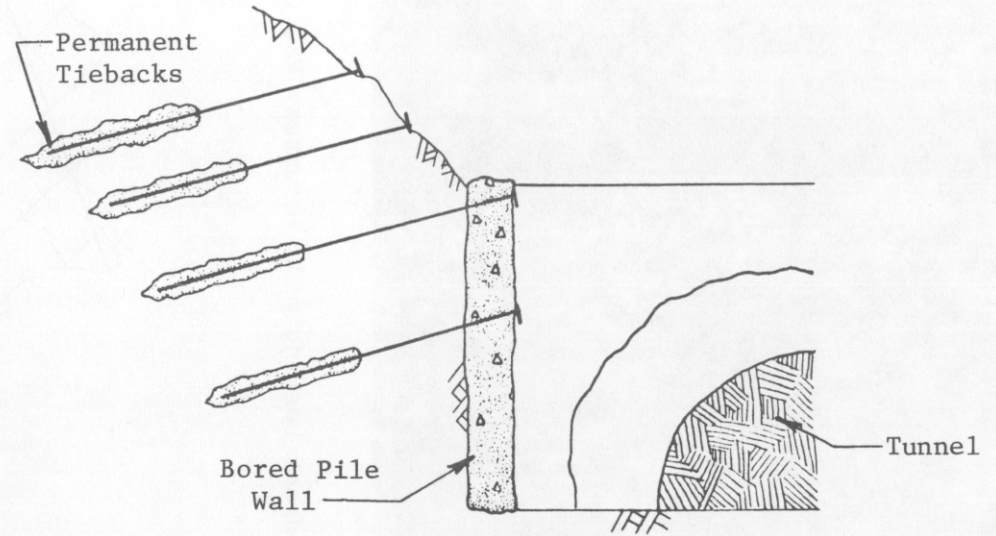

b) Section.

Figure 14. Permanently tiedback wall and elements for protection of a tunnel portal on the Tauern Autobahn, Austria.

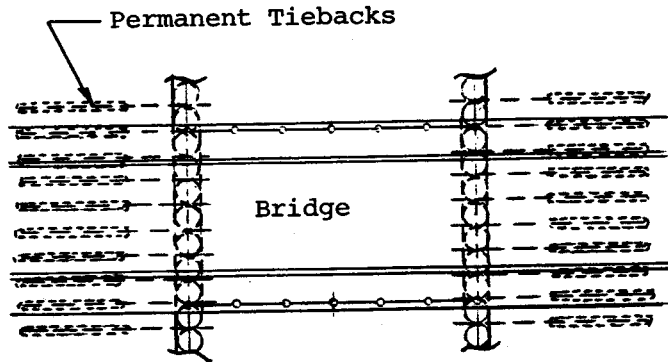

a) Plan of completed bridge.

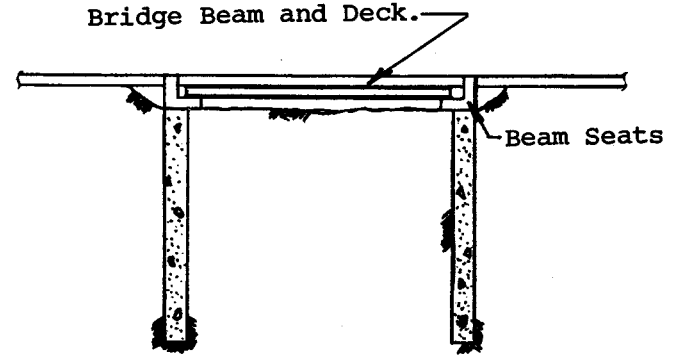

c) Installation of beam seats and deck.

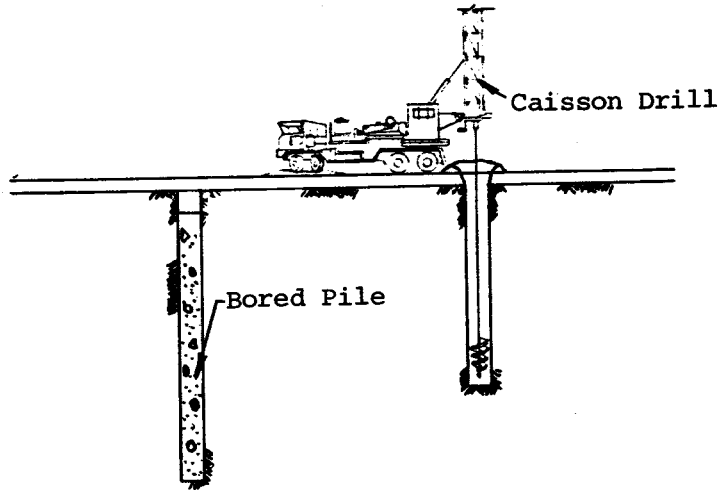

b) Installation of bored pile abutments.

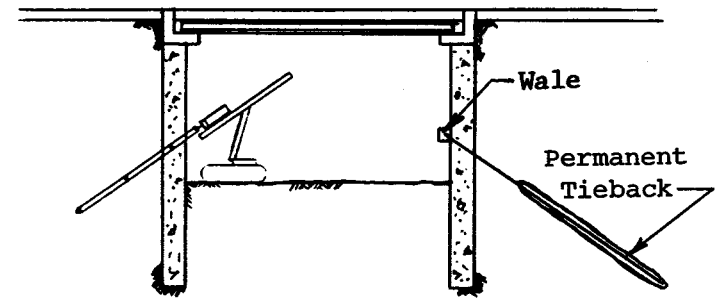

d) Excavation and tieback installation.

Figure 15. Construction of permanently tiedback abutments.

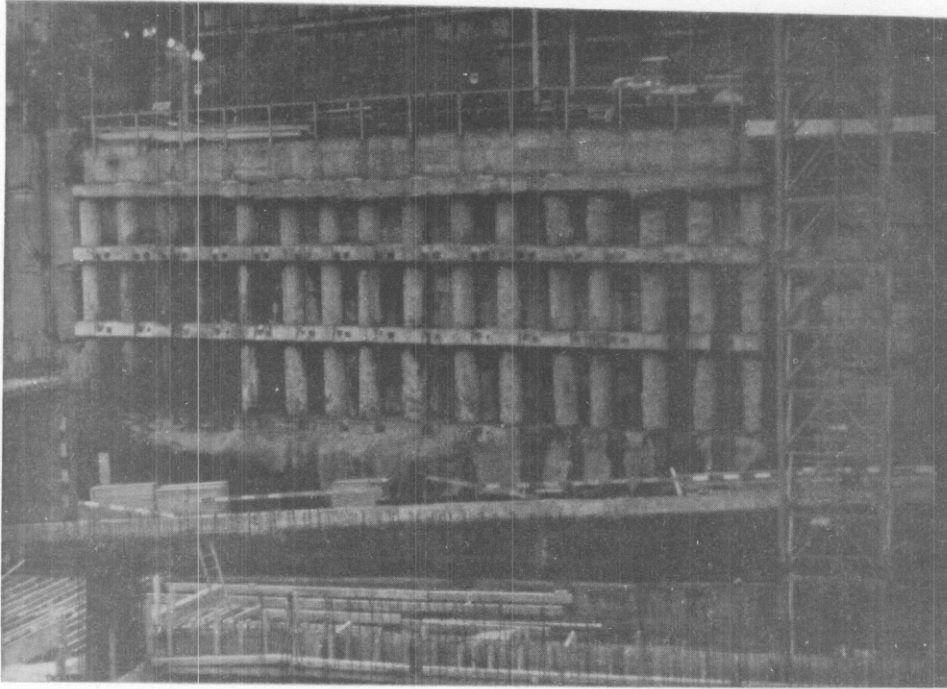

Figure 16. Permanently tiedback bridge abutment in Zurich, Switzerland.

Permanently tiedback underpasses offer the following advantages:

- 1) The bridge is built in segments while traffic is maintained.
- 2) The bridge abutments do not require footings for bending resistance. Footing construction would disrupt traffic on nearby roadways perpendicular to the bridge.
- 3) The tiedback abutment wall functions as the temporary earth support.
- 4) The quantity of excavation is reduced.
- 5) The backfill is eliminated.

Permanently tiedback bridge piers must bear on soil or rock capable of carrying the traffic load plus the vertical component of the tieback force. Each wall type can be extended to a bearing stratum located below subgrade. However, the precast diaphragm wall is restricted in depth by the weight of the panel and available crane capacity.

#### E. Hydrostatic Uplift

Permanent tiedowns are commonly used in the United States to resist hydrostatic uplift pressures. Structures located below the groundwater table will tend to float unless the structure has sufficient weight or is tied-down. Sewage treatment tanks, retention basins, basement slabs, depressed roadways or railways, dry docks, and shallow tunnels have been tied-down.

Figure 17 shows a thick concrete mat used to resist hydrostatic uplift forces applied to a depressed section of I-95 in Philadelphia. Permanent tiedowns could have economically replaced the 10-foot (3.04 m) thick mat and reduced the quantity of temporary sheeting and excavation required. Figure 18 shows permanent tiedowns used to anchor a basement slab for a building in Harrisburg, Pennsylvania.

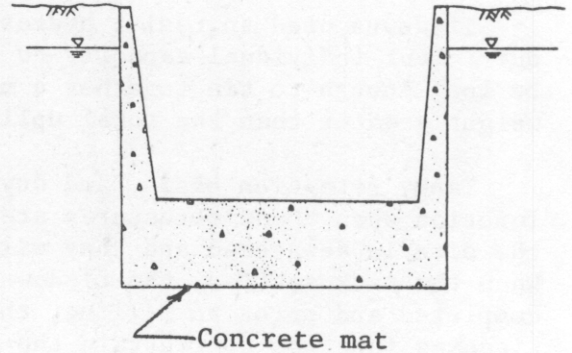
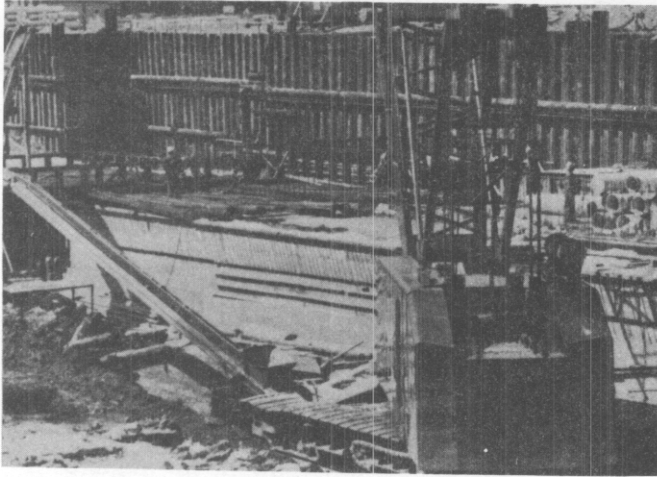

a) Concrete mat under construction.

b) Section.

Figure 17. Thick concrete mat used to resist hydrostatic uplift pressures acting on a depressed section of I-95, Philadelphia, PA.

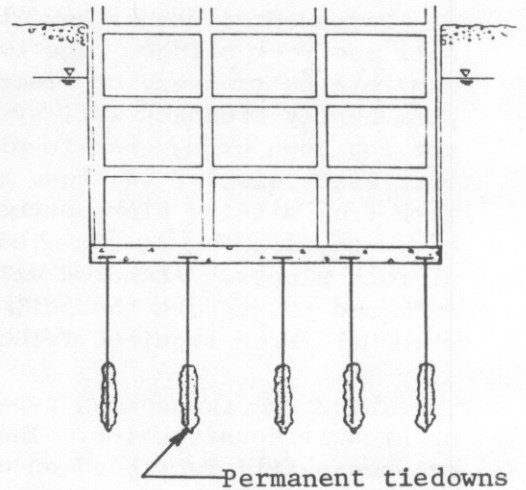
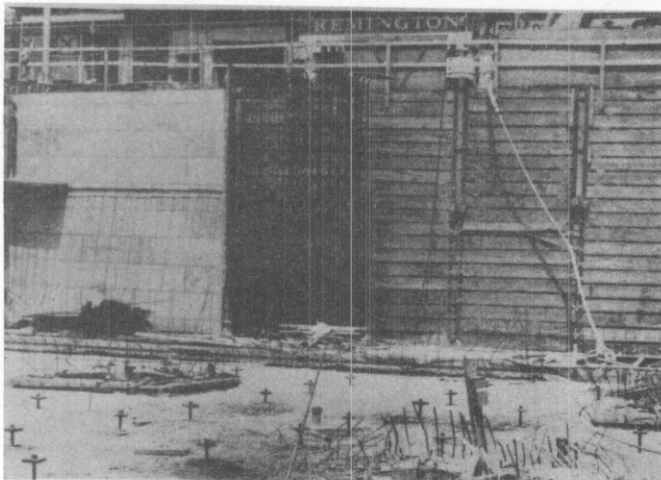

a) Completed tiedowns.

b) Section.

Figure 18. Permanent tiedowns for a basement slab in Harrisburg, PA.

When permanent tiedowns penetrate a slab subjected to uplift pressures, these penetrations must be watertight. Installing the tiedowns prior to placing the slab and then pouring the bearing plate in the concrete is one way to prevent leakage. This method is only suitable when unstressed tiedowns can be used. They can also be installed with a rigid sheath over the unbonded length. The rigid sheath extends through the slab allowing the tiedown to be locked-off. The slab can also be sleeved and the tiedowns installed through the sleeves. In this case, the annular space between the sleeve and the tendon must be sealed.

Tiedowns used to resist hydrostatic uplift forces must develop sufficient individual capacity to resist the uplift pressures and they must be long enough to tie together a mass of soil or rock which has a buoyant weight greater than the total uplift force.

Tank, retention basin, and dry dock tiedowns are only required to function when these structures are empty. These structures are built while the site is dewatered and they will settle under the applied tiedown loads. When the tank settles, the tiedown load is reduced. After the tank is completed and prior to filling, the groundwater level is restored and the tiedowns function to restrain the structure. When the tank is filled, its weight increases, and the structure settles. The tiedowns must be designed so that the unbonded length is long enough to allow these tank movements with only minimal effects on the load locked-off in the tendon. If settlements larger than the elastic extension of the unbonded length are expected, bar tendons will be placed in compression. Strand or wire tendons should be used if this condition is expected.

#### F. Landslide Stabilization

Permanent tiebacks have been effectively used to stabilize or to prevent soil and rock slides. The tiebacks support a variety of wall systems, concrete buttresses, or elements. Hunt and Costa Nunes [8] described a permanently tiedback wall system built in Brazil. The wall was built from the top down using cast-in-place concrete wall segments. Concrete buttresses similar to those shown in Figure 19 are used to prevent competent rock from sliding along structural discontinuities. Anchored concrete elements, see Figure 20, also are used to stabilize or to prevent failures of rock slopes. Anchored walls, which are used for slide stabilization, are designed to support the soil behind them and to provide the necessary external force required for stability.

There are two common types of slides associated with cut and fill rail or highway construction. These slides result when an existing slope is cut or when a fill is placed on a slope. Figure 22 shows these two conditions. Often these slides do not occur immediately upon construction, but become unstable as a result of changing groundwater conditions, frost, or loss of soil strength with time. In this case permanently tiedback walls can be constructed to stabilize either type of slide without completely closing the highway. Figure 21 shows a tiedback wall constructed on the Clinchfield RR line near Spruce Pine, North Carolina. The wall was used to stabilize a fill which was sliding along the natural slope. This wall was built without disrupting the rail traffic.

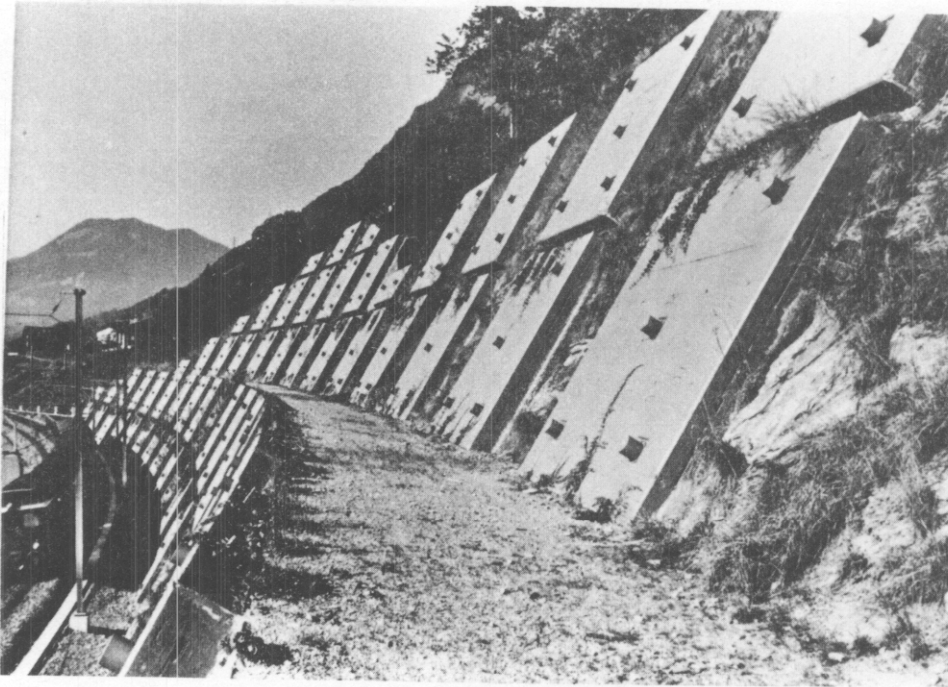

a) Completed tiedback elements (courtesy Stahlton AG).

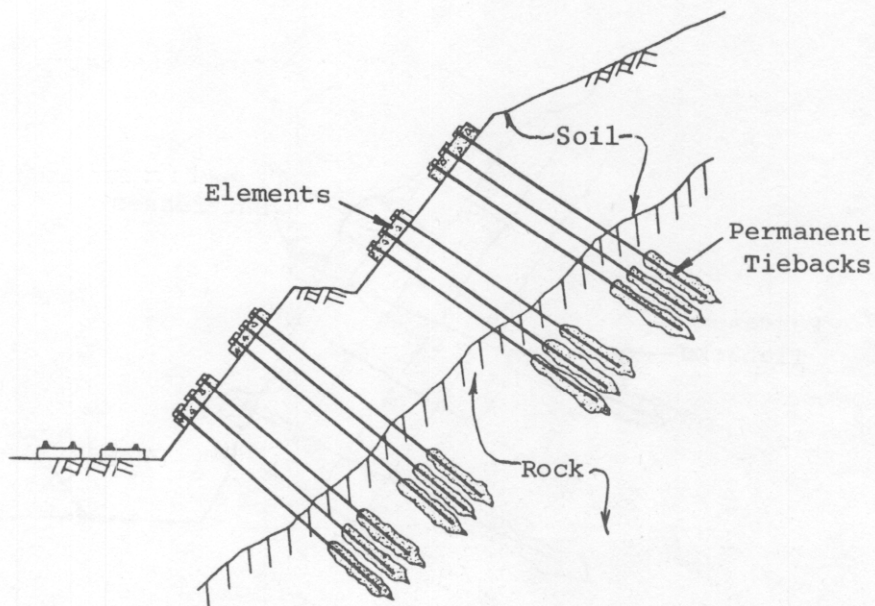

b) Section.

Figure 20. Permanently tiedback concrete elements used to support a rock slope near Alpnach-Stad, Switzerland.

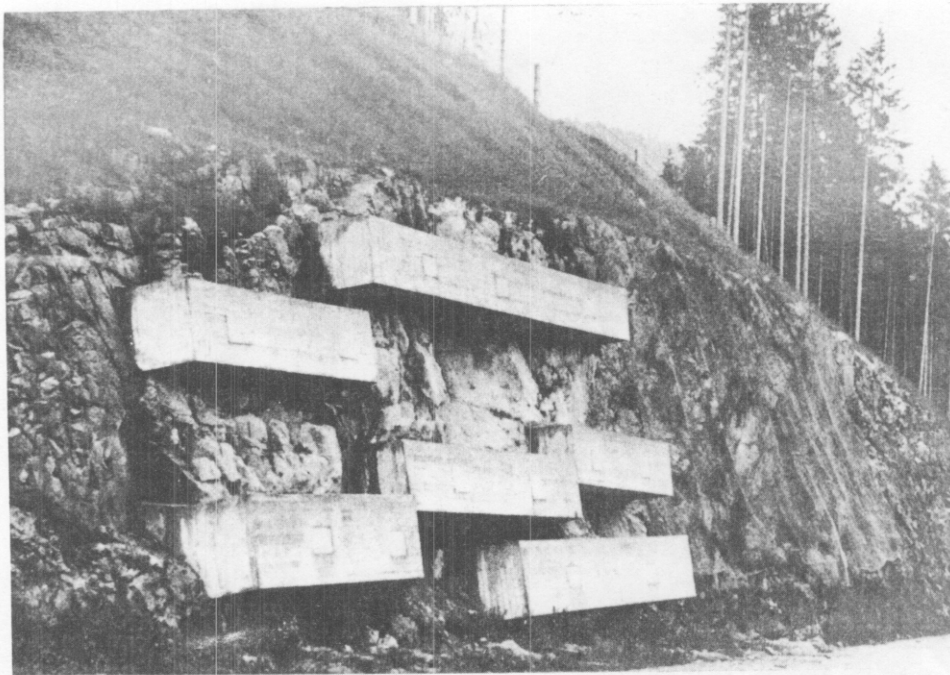

a) Completed tiedback buttresses (courtesy Karl Bauer).

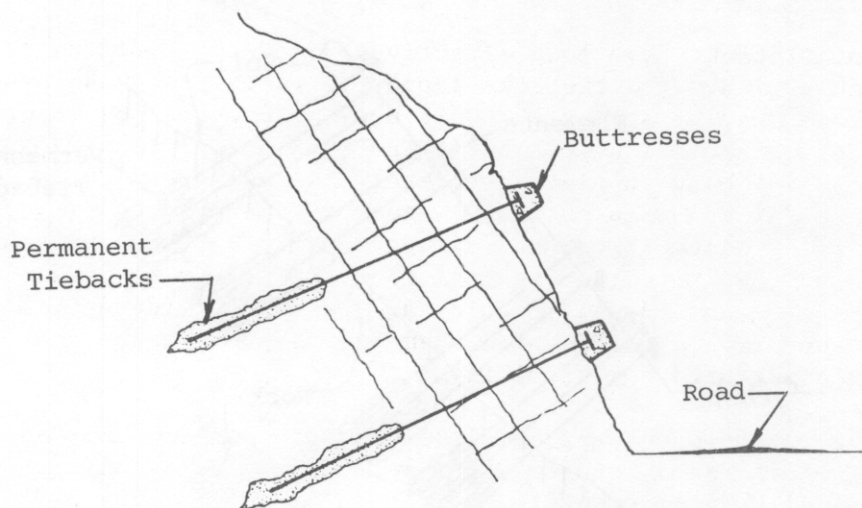

b) Section.

Figure 19. Permanently tiedback concrete buttresses used to support a rock cut in Germany.



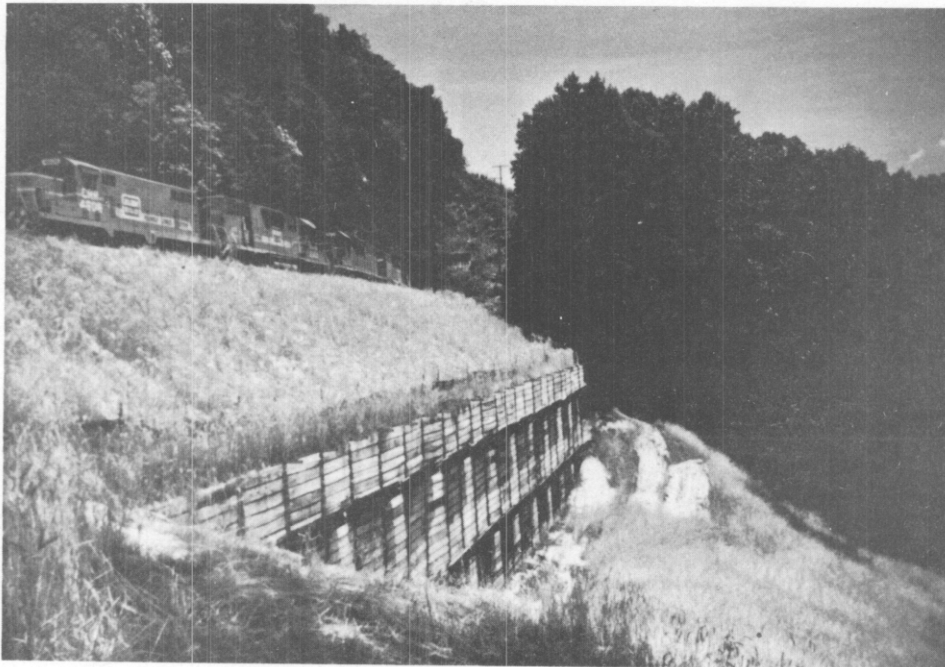

a) Completed slide control wall.

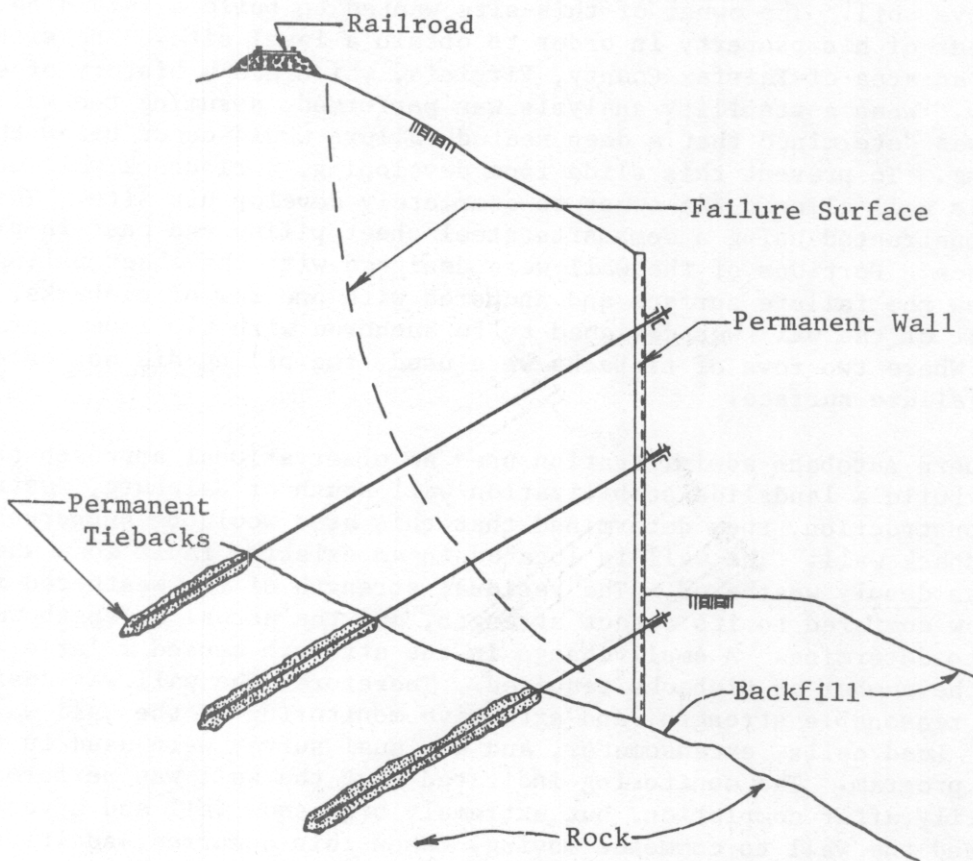

b) Section.

Figure 21. Permanently tiedback wall used to stabilize a fill slide near Spruce Pine, N.C.

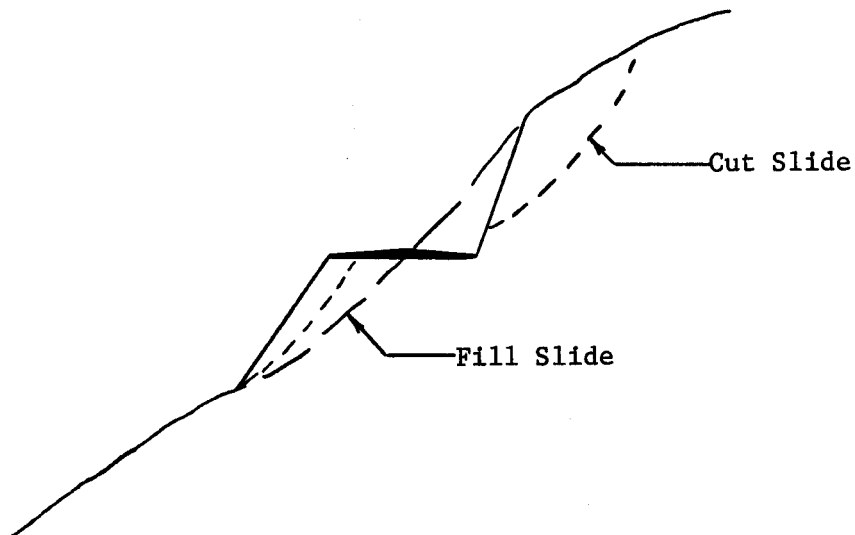
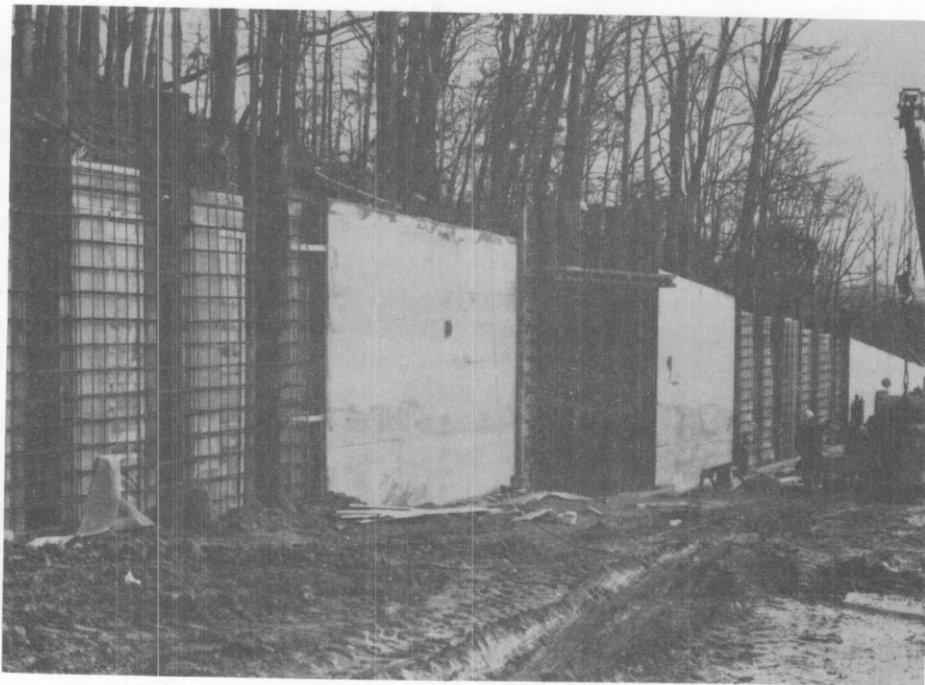

Figure 22. Cut and fill landslide.

Figure 23 shows a permanently tiedback wall used to prevent a landslide in a cohesive soil. The owner of this site wanted to build a retaining wall near the rear of his property in order to obtain a level site. The site was located in an area of Fairfax County, Virginia, which has a history of slope instability. When a stability analysis was performed, assuming the wall in place, it was determined that a deep seated failure would occur below the wall footing. To prevent this slide from developing, a tiedback wall was built. This wall allowed the owner to completely develop his site. The wall was constructed using a composite steel sheet piling and cast-in-place concrete face. Portions of the wall were designed with the sheet piling driven below the failure surface and anchored with one row of tiebacks. Another part of the wall was designed to be anchored with two levels of tiebacks. Where two rows of tiebacks were used, the piling did not extend below the failure surface.

The Tauern Autobahn administration used an observational approach to design and build a landslide stabilization wall south of Salzburg, Austria. Prior to construction, they determined that this area would be supported with a tiedback wall. The wall is located in an existing fault zone where the rock was deeply weathered. The residual strength of the weathered rock was very low compared to its intact strength, and the actual strength was difficult to determine. A small change in the strength caused a large change in the number of tiebacks required. Therefore, the wall was designed assuming a reasonable strength, and extensive monitoring of the wall was specified. Load cells, extensometer, and a visual survey were used in the monitoring program. The monitoring indicated that the wall was performing satisfactorily after completion, but extremely high snow fall and a very wet spring caused the wall to commence moving. When this occurred, additional tiebacks were installed and the wall was stabilized. However, the wall began moving again, and another group of tiebacks were installed. The last group was installed in the fall of 1976. Since then, the wall has performed satisfactorily.



a) Wall under construction.

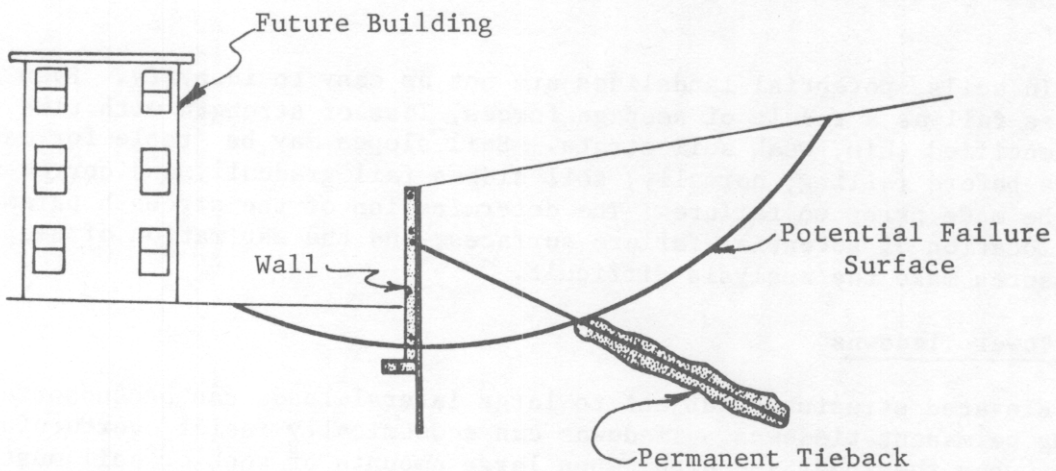

b) Section.

Figure 23. Permanently tiedback wall used to prevent a landslide in Fairfax County, Va.

Permanently tiedback walls are used to prevent slides from occurring, and to allow structures to be built into a potential slide area. Figure 24 shows a wall installed at Mercy Hospital, Scranton, Pennsylvania. A dipping coal layer, that would be exposed upon excavation for the hospital, is shown. A stability analysis was made assuming a failure would occur along the coal seam. The analysis indicated that a slide would occur. The analysis also showed that the forces required to support this cut substantially exceeded the earth pressure which the structure was designed to resist. Therefore, a permanently tiedback wall was designed to support the soil and rock cut. The permanent rock tiebacks extended below the failure surface and provide the force required for equilibrium. Double-channel soldier beams were installed prior to excavation. As the excavation proceeded, timber lagging was installed between the beams in the soil portion, and rock bolts were used in the rock portion. The permanent tiebacks were installed as the excavation proceeded. Upon completion of the excavation, concrete was cast onto the wall face and structurally connected to soldier beams and tiebacks. This particular wall was not structurally tied to the building. This was done to prevent transferring any load to the structure if the wall deflected.

In rock and residual soils, slides occur along structural fractures such as joints, shears, faults, deep weathering, or variations in stratigraphy. The potential failure surfaces usually can be identified during a geotechnical study or upon exposure in a cut. When they are identified, a tiedback wall can be designed to provide the force required to stabilize the mass.

In soils, potential landslides are not as easy to identify. Even flat slopes fail as a result of seepage forces, loss of strength with time, and unidentified thin, weak soil strata. Soil slopes may be stable for many years before failing; normally, soil slopes fail gradually and corrections can be made prior to failure. The determination of the strength parameters, the location of potential failure surfaces, and the estimation of seepage pressures make the analysis difficult.

#### G. Tower Tiedowns

Elevated structures subject to large lateral loads can be supported using permanent tiedowns. Tiedowns can economically resist overturning of a tower when the loads are high, when large amounts of rock or soil must be removed in order to construct a footing, when the site is inaccessible to large drilling or excavating equipment, or when the tower requires high capacity guys.

The anchoring of towers with rock tiedowns was one of the earlier applications of permanent tiedowns. Figure 25 shows tower guys which were anchored using groups of permanent soil tiedowns. These were installed for Bonneville Power in Washington State. Figure 26 shows permanent rock tiedowns being installed to anchor the foundations of a tower directly.

Tower tiedowns are designed similarly to the tiedowns used to resist hydrostatic uplift. They must develop sufficient capacity individually and they must be long enough to mobilize a soil or rock mass with sufficient weight to resist the applied load and moment.

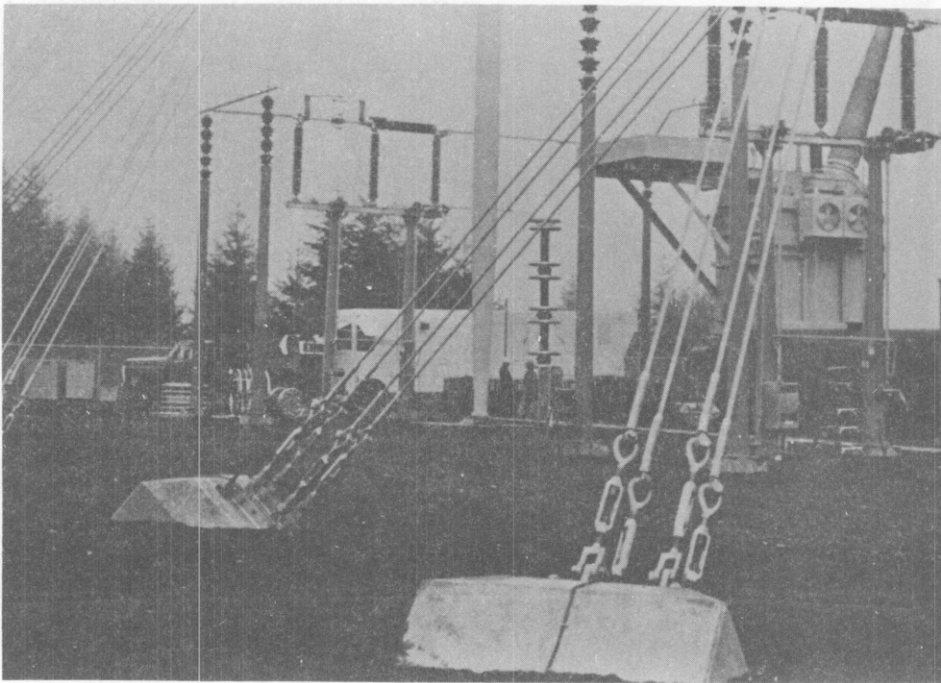

a) Completed tiedown towers (courtesy Donald B. Murphy).

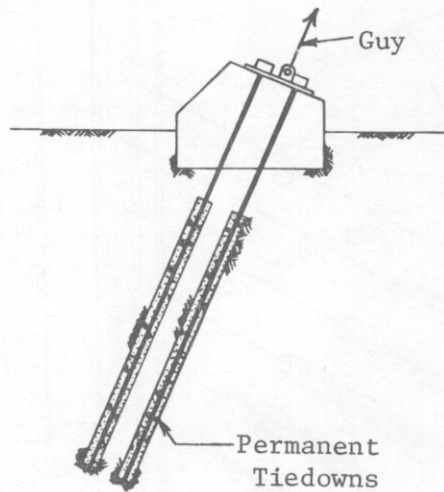

b) Section.

Figure 25. Permanently tiedown tower guys for Bonneville Power.

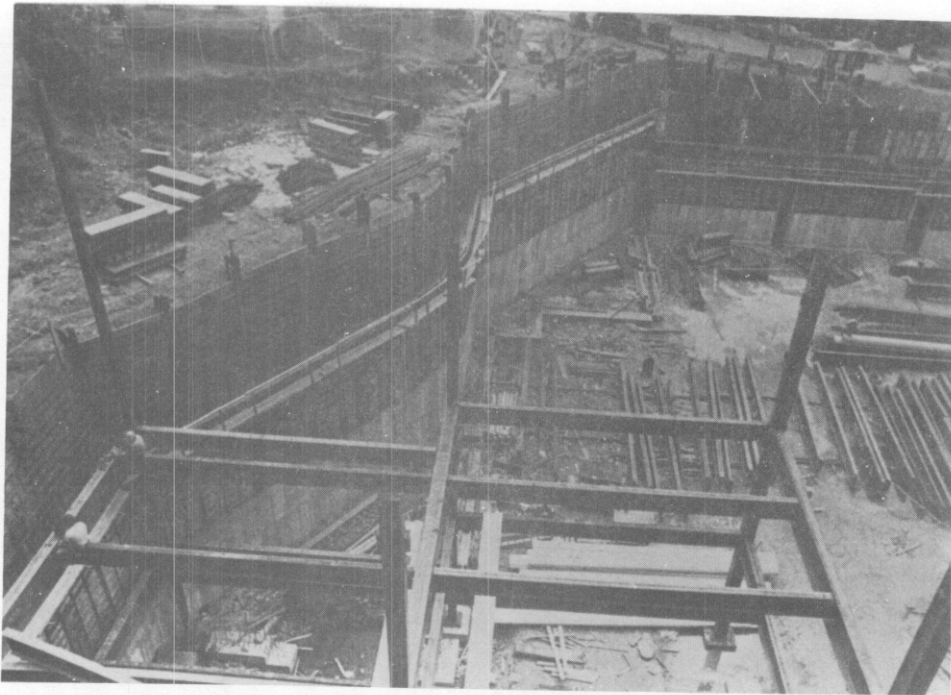

a) Cast-in-place composite concrete wall being placed.

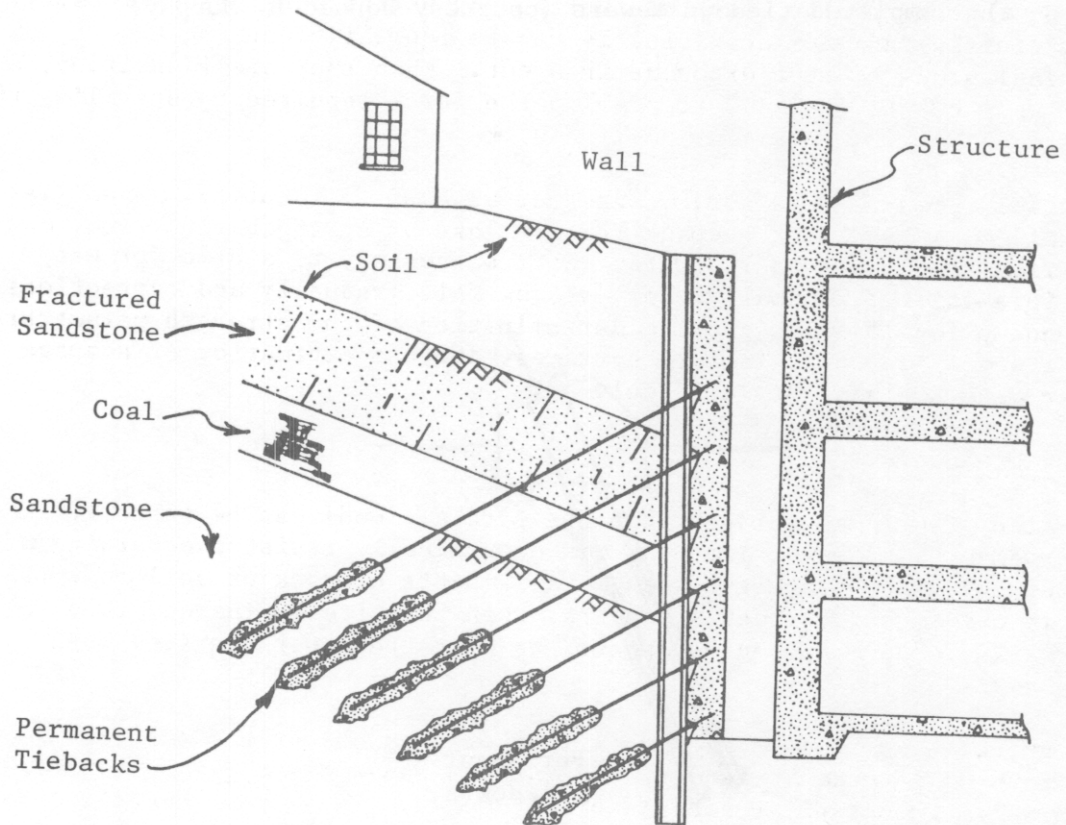

b) Section.

Figure 24. Permanently tiedback wall used to prevent a landslide and protect Mercy Hospital, Scranton, PA.

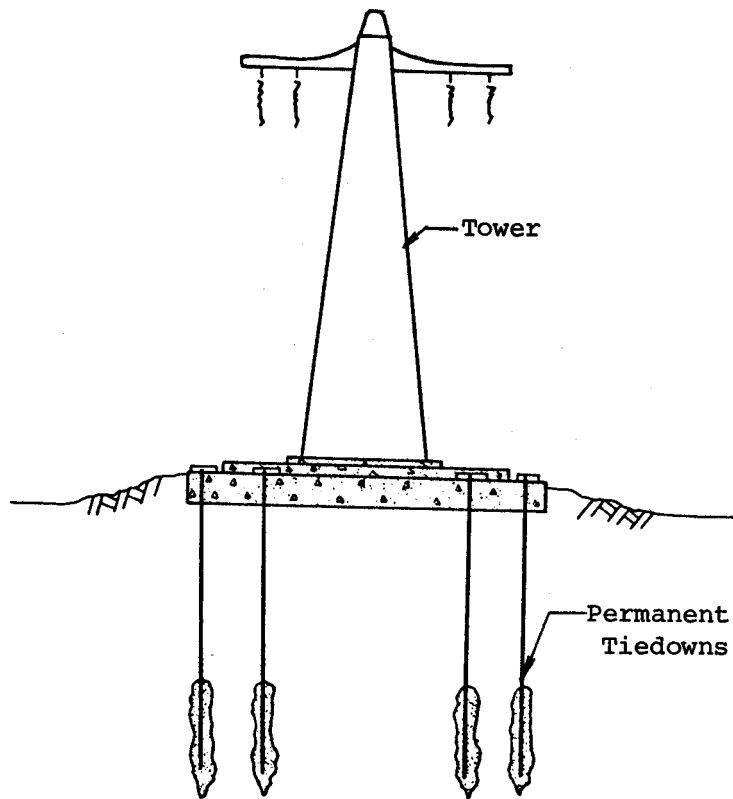

Figure 26. Permanent tower tiedowns.

#### H. Tiedowns

Two of the earliest permanent soil tieback applications were to tiedown the Munich Olympic Stadium and the Lufthansa hanger in Munich, Germany. Figure 27 shows the Lufthansa hanger. Both of these structures were anchored in soil using pressure-injected tiedowns. The cable supported tent roof of the Jeddah International Airport in Saudi Arabia and the Montreal Olympic Stadium are also anchored with permanent tiedowns.

#### I. Waterfront Structures

Existing waterfront walls are often strengthened or replaced with permanently anchored walls. Figure 28 shows a permanently tiedback wall supported by permanent rock tiebacks in Salem, Massachusetts. Numerous permanently tiedback walls have been installed in saltwater without a reported tendon corrosion failure. The oldest saltwater wall was built in Aberdeen Harbor, Scotland, in 1968. The tendons used for the tiebacks have no special corrosion protection and the anchor heads are exposed. Tiebacks installed for the replacement of an existing wall usually involve difficult and expensive drilling techniques but they are economical since they allow complete replacement of an existing wall without interrupting activities behind the wall.



a) Sideview (courtesy Karl Bauer).

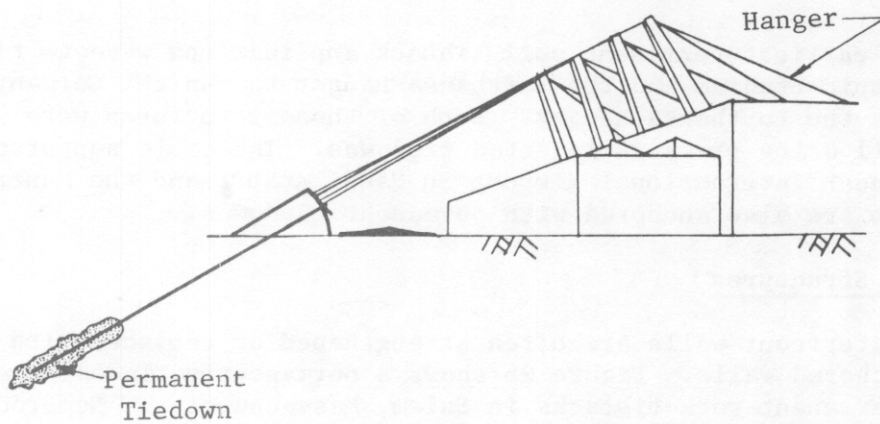

b) Section.

Figure 27. Permanent tiedowns used to anchor the roof of the Lufthansa Hanger, Munich, Germany.



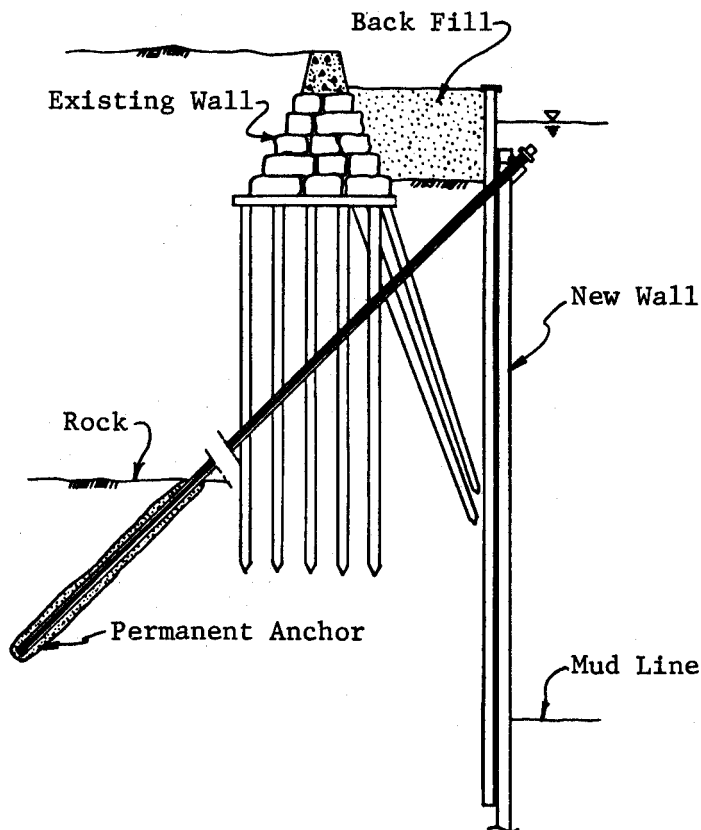

Figure 28. Permanent tiebacks used in the renovation and deepening of a harbor.

Permanently tiedback walls are used when existing harbors are deepened. Nolan [15] described a tiedback sheet pile and H-beam composite wall supported by permanent hollow-stem-augered soil tiebacks. This wall was built for the deepening and repair of Hollywood Harbor, Port Everglades, Florida. These tiebacks used the grout for corrosion protection.

New waterfront walls are also supported by permanent tiebacks. Figure 29 shows a cast-in-place diaphragm quay wall at the Port of Le Havre, France. Postgrouted tiebacks were used to support the wall. This wall was constructed from the existing ground surface. After locking-off the tiebacks, the soil in front of the wall was dredged to the desired depth.

#### J. Repair and Alterations to Existing Walls and Abutments

Many existing retaining structures can be stabilized or strengthened using permanent tiebacks. Prior to the development of tiebacks, these structures were either replaced, underpinned, or buttressed. Figure 30 shows an old brick gravity wall on a depressed rail line north of London, England. During the renovation of the roadbed, the elevation of the roadbed was lowered in order to increase the clearance under overhead structures. After lowering the roadbed, it was discovered that the existing wall was rotating, and translating laterally. A combination of micro piles and permanent, multiunderreamed tiebacks in London clay were used to underpin

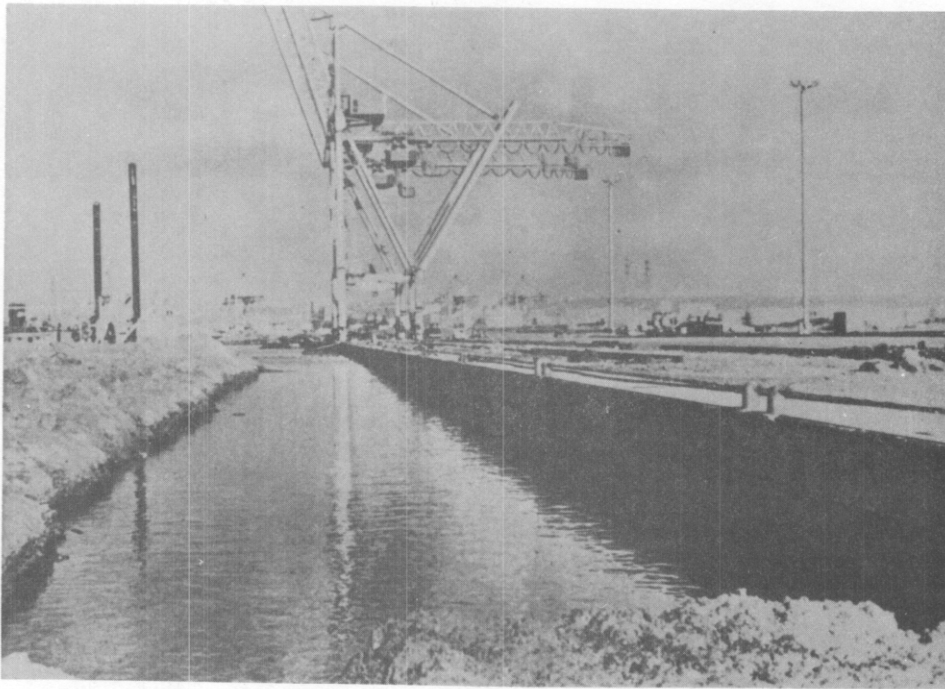

a) A view of completed quay wall (courtesy SIF Bachy).

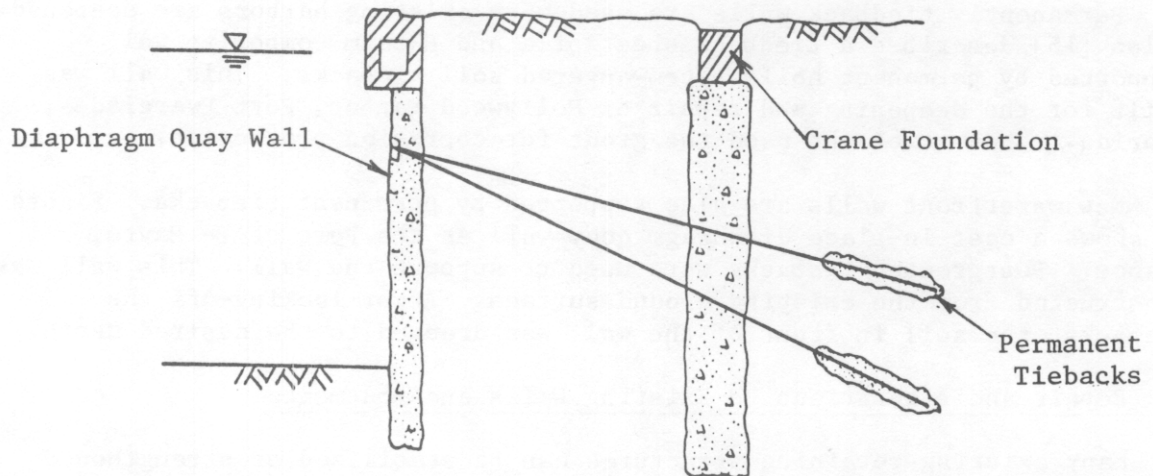

b) Section.

Figure 29. Permanently tiedback cast-in-place diaphragm quay wall for the Port de Havre, France.

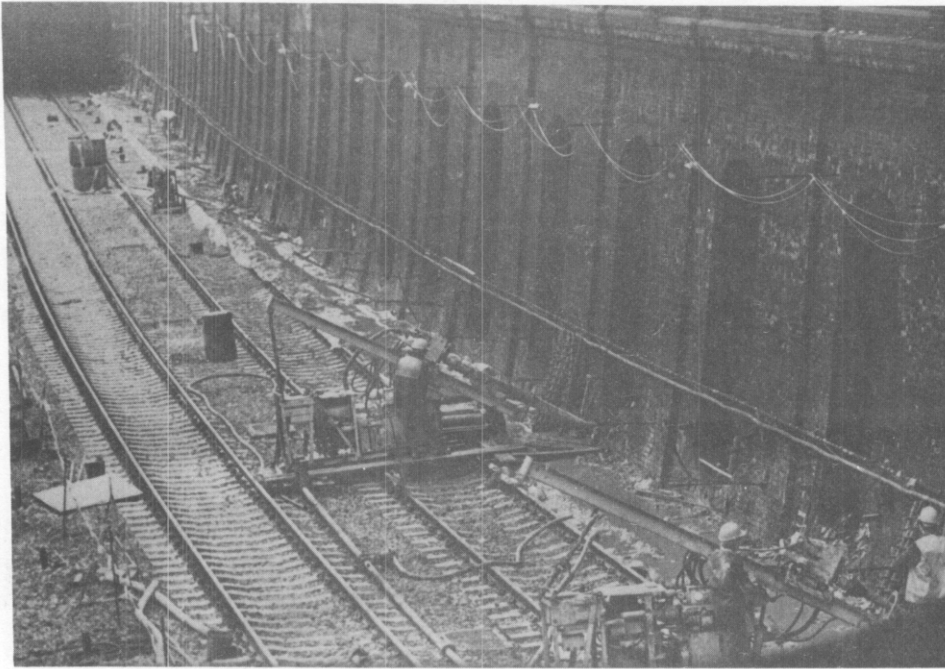

a) Permanent underreamed tieback installation (courtesy Fondedile).

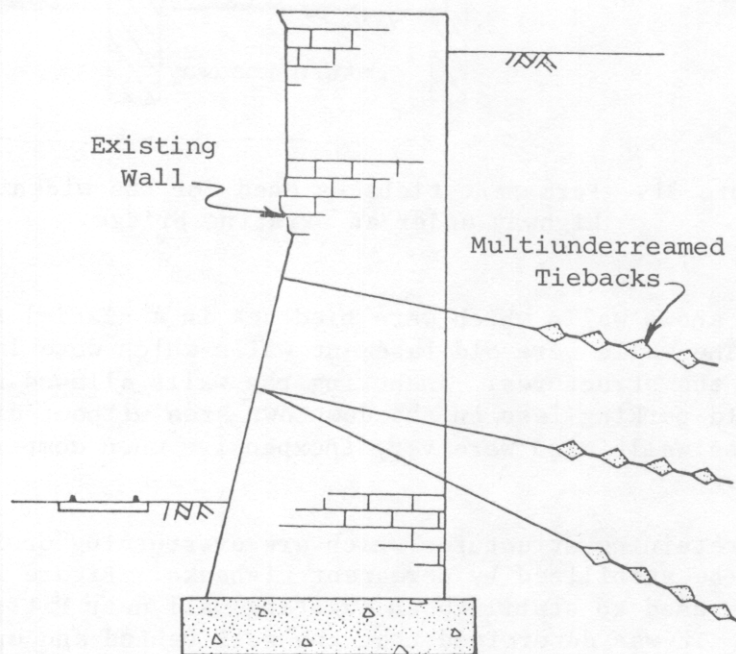

b) Section.

Figure 30. Permanent tiebacks used to stabilize a failing gravity retaining wall in London, England.

and stabilize the wall. A similar tieback installation was used during the renovation of the Red Line Extension in Boston, Massachusetts. The tiebacks were installed in order to allow the existing roadbed to be lowered at four bridge abutments.

California and Washington State highway departments have used permanently tiedback walls to widen roadways under existing bridges. Figure 31 shows how these walls were built. The wall installed in Sacramento, California was designed to support the fill behind the abutment, and the wall at Swamp Creek, Washington was designed to underpin the abutment and support the fill behind it.

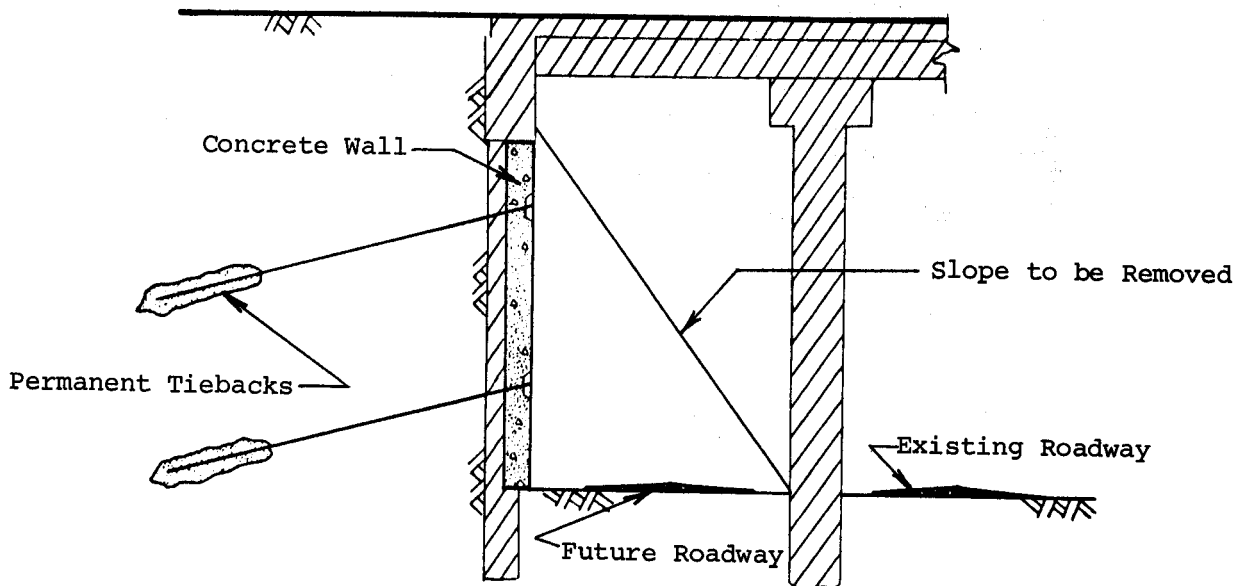

Figure 31. Permanent tiebacks used for the widening of a highway under an existing bridge.

Figure 32 shows walls which were tiedback in a glacial till in Tacoma, Washington. The walls were old basement walls which were left in place upon demolition of the structures. Anchoring the walls allowed the city of Tacoma to build parking lots in the downtown area without disrupting traffic. These walls also were very inexpensive when compared to the cost of a new wall.

Existing retaining structures which are overturning or involved in a landslide can be stabilized by permanent tiebacks. Figure 33 shows a tieback scheme used to stabilize an existing wall near Pittsburgh, Pennsylvania. It was determined that the soil behind and underneath the wall was moving down the slope carrying the wall with it. The wall was stabilized by a combination of permanent rock tiebacks and bracket piles.

#### K. Dam Tiedowns

Existing gravity dams are often strengthened using tiedowns. The tiedowns are used to increase resistance to overturning and sliding. They

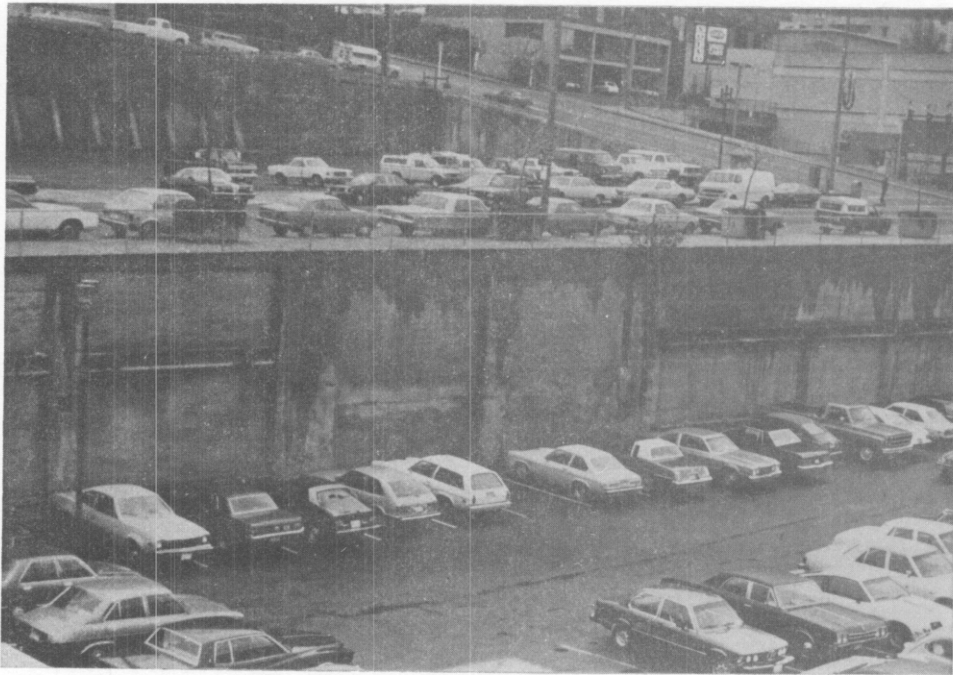

a) Completed parking lot wall (courtesy Donald B. Murphy).

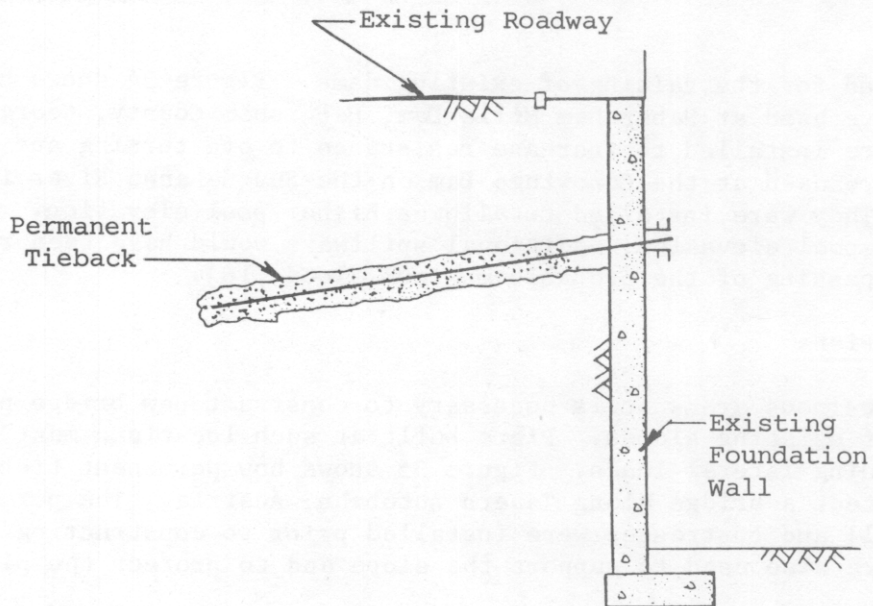

b) Section.

Figure 32. Tiedback existing foundation walls in Tacoma, Washington.

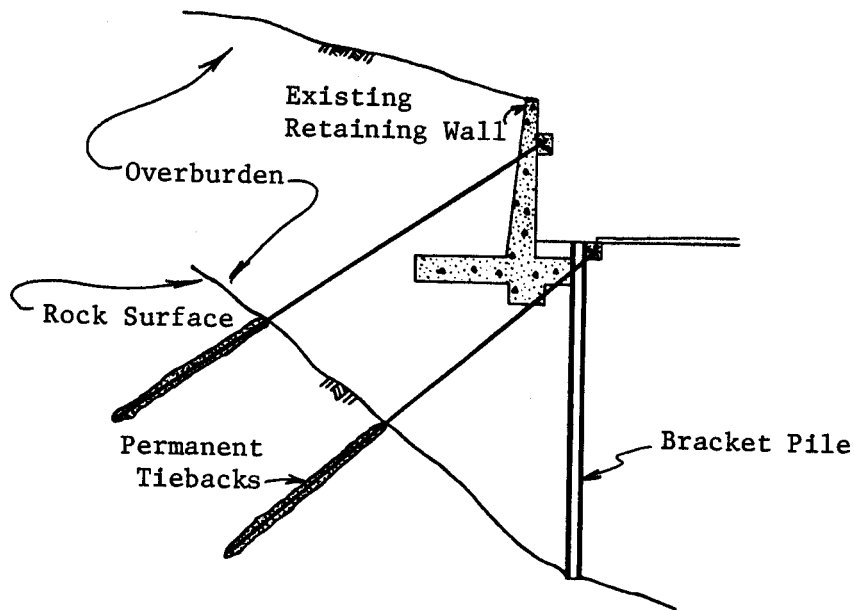

Figure 33. Permanent tiebacks used to stabilize a failing retaining wall.

are also used for the raising of existing dams. Figure 34 shows how rock tiedowns were used at Habersham Mills Dam, Habersham County, Georgia. The tiedowns were installed to increase resistance to overturning and sliding. Tiedowns were used at the Conowingo Dam on the Susquehanna River in Maryland. They were installed to allow a higher pool elevation. Without an increase in pool elevation, additional spillways would have been required to permit the passing of the probable maximum flood [16].

#### L. Bridge Piers

In mountainous areas it is necessary to construct new bridge piers into the sides of existing slopes. Piers built at such locations must be capable of withstanding lateral loads. Figure 35 shows how permanent tiebacks were used to protect a bridge along Tauern Autobahn, Austria. The permanently tiedback wall and buttresses were installed prior to constructing the pier and they were also used to support the slope and to protect the pier.

#### M. Underground Caverns

Underground caverns are built for storage, power houses, ventilating buildings, and other purposes. Today, many of these large rock openings are supported using permanent rock tiebacks, bearing pads, and shotcrete. When the tiebacks are tensioned, they create a rock compression ring around the

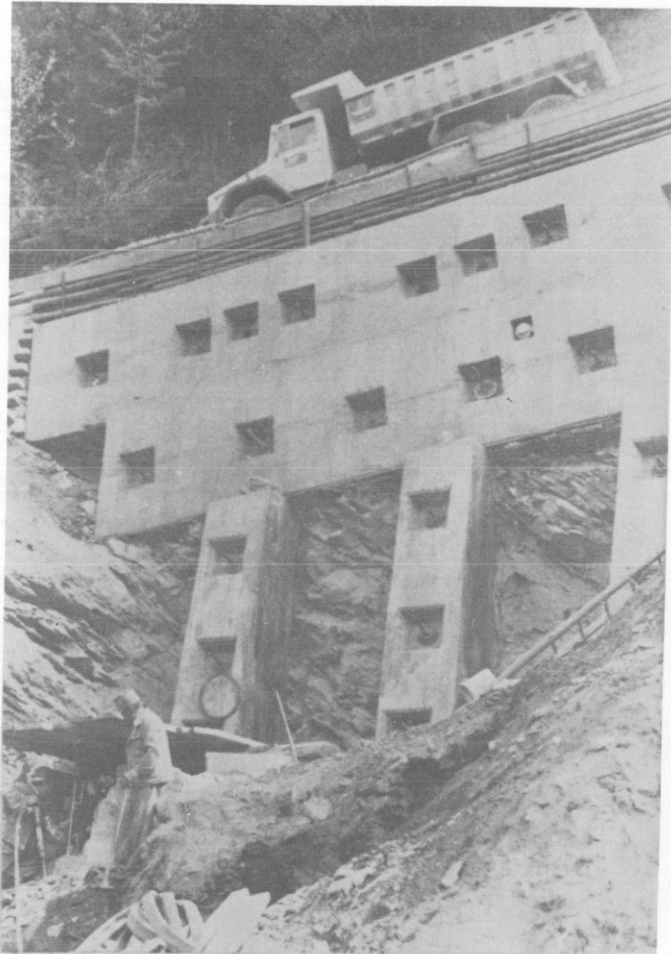

a) Protected pier under construction  
(courtesy Karl Bauer).

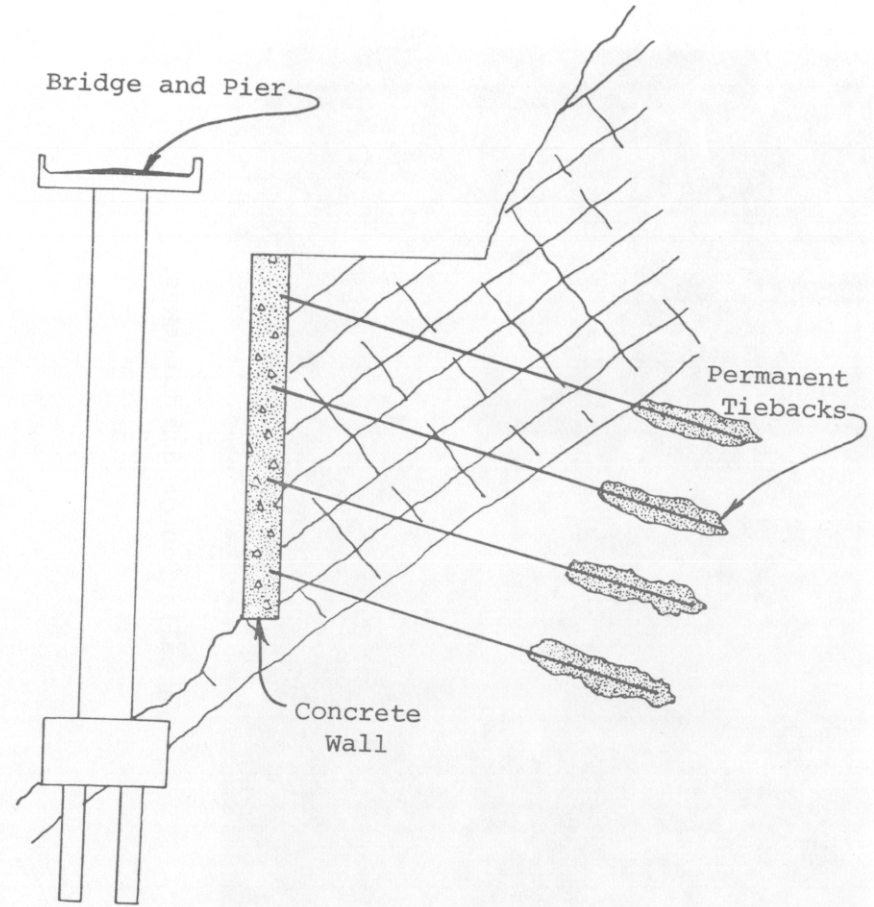

b) Section.

Figure 35. Permanent tiebacks used to protect a bridge pier on the Tauern Autobahn, Austria.

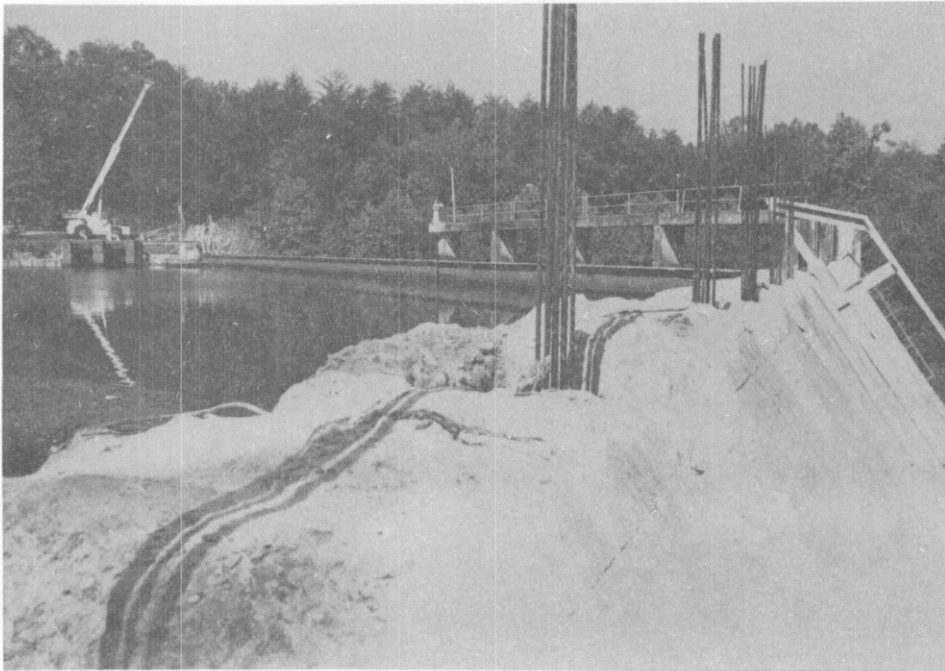

a) Installation of dam tiedowns.

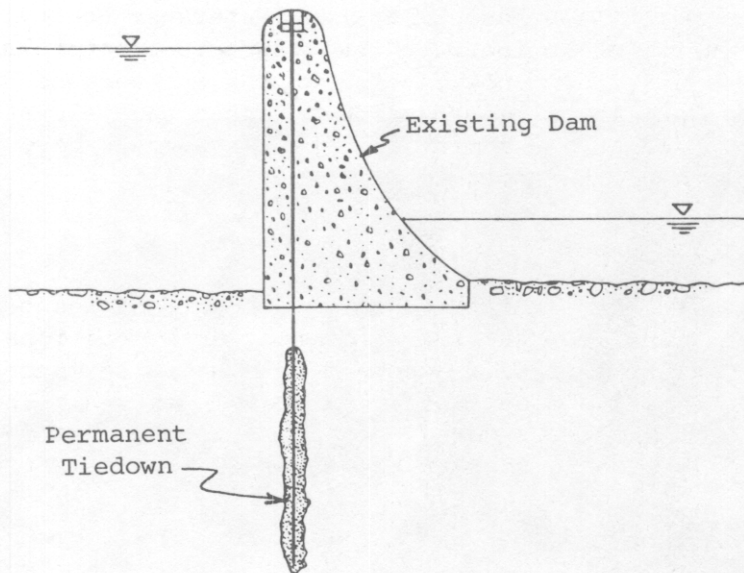

b) Section.

Figure 34. Permanent tiedowns used to increase the stability of Habersham Mills Dam, Habersham County, GA.



cavern. This post-tensioned ring is capable of accommodating the changes in the state of stress around a large opening and controlling the deformations of the rock mass.

#### N. Reactor Containment Vessels

The secondary containment structures for the R. E. Ginna Nuclear Power Station, Wayne, New York; and the Bellefonte Nuclear Power Plant, Jackson Alabama, are anchored to the foundation using rock tiedowns.

## CHAPTER 5 - CORROSION PROTECTION

Temporary and permanent tiebacks are performing well in a variety of environments. There have been no reported tieback corrosion failures where the tendon was properly encased in cement grout (See Page 71). However, few permanent tiebacks have been in service for more than 25 years, and most structures are designed to last longer than 25 years. Since it is not possible to prove the long-term corrosion performance of a tieback from actual installations, it is necessary to study the corrosion performance of other structures and extrapolate their behavior to tiebacks. It is evident from many existing structures, that with adequate attention to design details and construction, tiebacks can be used with life expectancies comparable to normal well-constructed reinforced concrete structures.

This chapter contains a review of basic corrosion theory, an evaluation of the corrosion performance of selected structures, identification of the corrosion mechanisms that might affect a tieback, an explanation for the excellent corrosion performance of tiebacks, and recommendations for the corrosion protection of tiebacks. The selection and durability of cement grouts and the selection of corrosion protection materials are discussed in Chapter 8.

### THEORY

Corrosion of steel is an electrochemical process. Romanoff stated:

"For electrochemical corrosion to occur, there must be a potential difference between two points that are electrically connected and immersed in an electrolyte. Whenever these conditions are fulfilled, a small current flows from the anode area through the electrolyte to the cathode area and then through the metal to complete the circuit, and the anode area is the one that has the most negative potential, and is the area that becomes corroded through loss of metal ions to the electrolyte. The cathode area, to which the current flows through the electrolyte is protected from corrosion because of the deposition of hydrogen or other ions that carry the current.

"The electrochemical theory of corrosion is simple, i.e., corrosion occurs through the loss of metal ions at anode points or areas. However, correlation of this theory with actual or potential corrosion of metals underground is complicated and difficult because of the many factors that singly or in combination affect the course of the electrochemical reaction. These factors not only determine the amount or rate at which corrosion occurs but also the kind of corrosion." 2/

2/ Reprinted from Underground Corrosion by Melvin Romanoff [16]

Dissimilar metal electrodes immersed in an electrolyte form a galvanic cell. Figure 36 shows a galvanic cell. An electrolyte is a solution capable of conducting electrical current by ionic flow. When the electrodes are connected by a wire, current flows through the wire from the positive electrode to the negative electrode. In a current generating cell, the electrode with a negative charge is the anode. Current is assumed to flow from the positive to the negative electrode through the wire even though electrical current results from the flow of electrons. Electrons travel from negative to positive electrodes opposite to the flow of current.

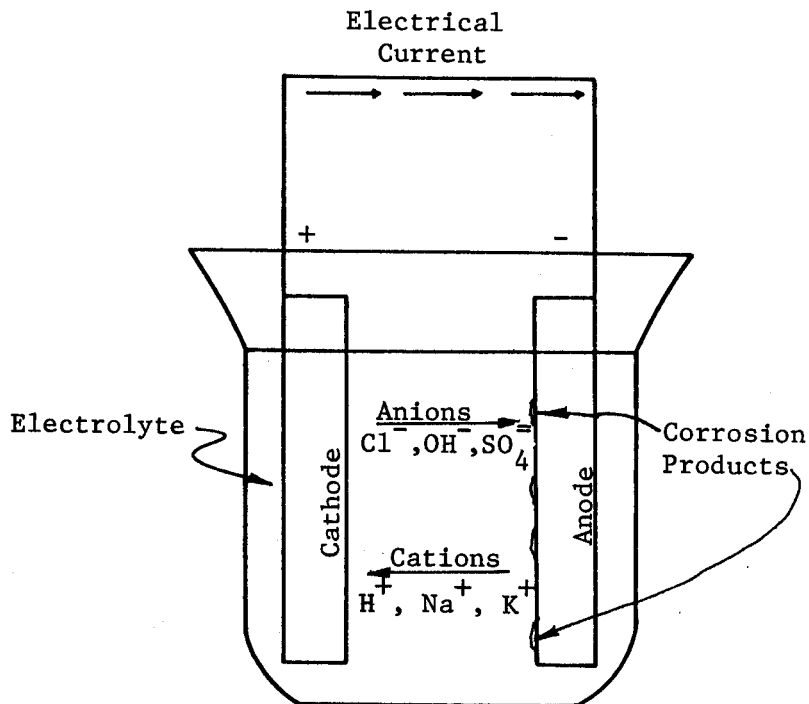

Figure 36. Galvanic cell.

The electrode at which chemical reduction occurs is called the cathode. At the cathode, current enters the electrode from the electrolyte. Examples of cathode electrochemical reactions are:



The electrode at which chemical oxidation occurs is called the anode. At the anode, current leaves the electrode and enters the electrolyte. Corrosion at the anode is the result of metal ions entering the electrolyte. An example of an anode electrochemical reaction is:



In a galvanic cell, the cathode is the positive pole and the anode is the negative pole. Cations, positively charged ions (H<sup>+</sup>, Na<sup>+</sup>, K<sup>+</sup>), migrate toward the cathode when current flows. Anions, negatively charged ions (Cl<sup>-</sup>, OH<sup>-</sup>, SO<sub>4</sub><sup>2-</sup>), migrate toward the anode.

Faraday's law is used to give the weight of metal reacting in a galvanic corrosion cell:

$$\text{Weight of metal reacting} = kIt \quad (4)$$

where: I = Corrosion current in amperes  
t = Time in seconds  
k = Electrochemical equivalent in grams per coulomb.

### A. Electrochemical Cells

Corrosion is an electrochemical process and it is divided into two broad classifications; galvanic and stray-current corrosion.

#### Galvanic Corrosion

Galvanic corrosion of a metal in an electrolyte occurs when a galvanic current originates between discrete areas of oxidation (anode) and reduction (cathode) reactions. Galvanic currents are the results rather than the cause of corrosion.

The most common types of galvanic corrosion cells are dissimilar metal and differential concentration cells. Differential concentration cells include a common metal in contact with different salt concentrations or more importantly in contact with different oxygen concentrations (differential aeration cell).

Macrocell corrosion systems have anodic and cathodic areas which are easily discernible to the naked eye. The anodic and cathodic areas of microcell corrosion system are not easily visible. They usually are less than 0.04 inches (1.0 mm) in size. The relative size of the anode and cathode is a significant factor in determining the intensity of the corrosion. If the anode area is large and the cathode area small, the corrosion current density at the anode will be low and corrosion will be uniform and negligible. For the same potential difference, if the cathode area is large and the anode area is small, the anode corrosion density will be high, and intense pitting is likely to occur. The smaller the anodic area the more severe the attack since the metal loss is directly related to the corrosion current by Faraday's law (Equation [4]). The anode corrosion density is the corrosion current divided by the anode area.

Dissimilar metal cells (galvanic cells) result when two metals such as iron and copper are metallogically coupled in a common electrolyte (See Figure 36). These cells may also develop when cold-worked metal is in contact with the same metal annealed, grain-boundary metal is in contact with metal grains, a single metal crystal is in contact with another crystal of differing orientation, and steel with mill scale is in contact with areas where the mill scale has been removed.

Differential concentration cells may be established when a metal is located in electrolytes whose ionic concentrations vary along their length (See Figure 37). The portion of the metal in the dilute solution would be attacked. Differential concentration cells often cause pitting corrosion.

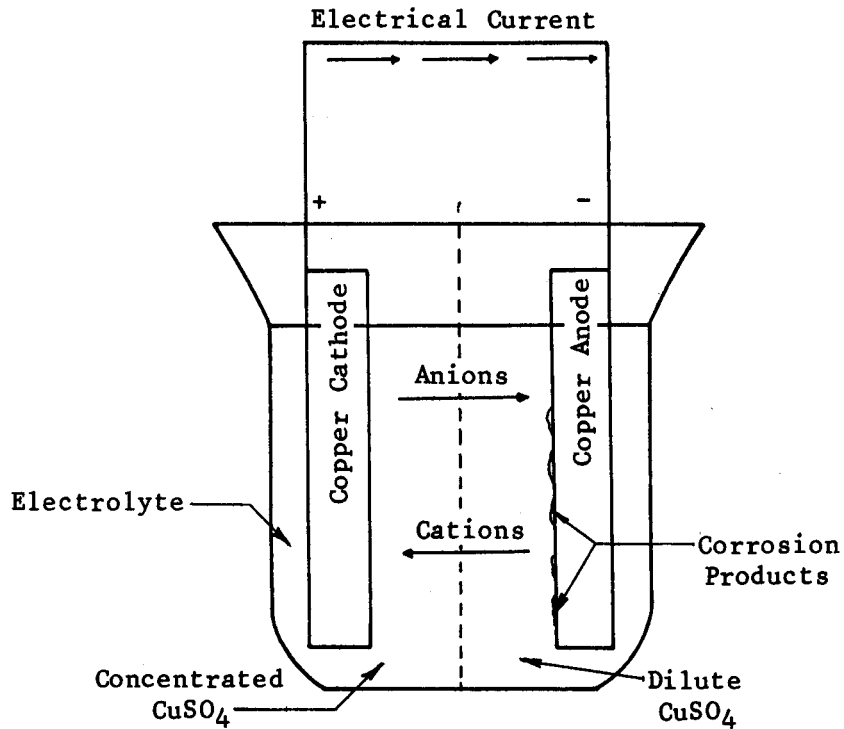

Figure 37. Differential concentration cell.

Differences in oxygen concentration on the surface of a metal produces differential aeration cells (See Figure 38). The area that is poorly \* aerated is the anode, and the better aerated area is the cathode. Corrosion occurs at the anode, and it often takes the form of pitting corrosion. Differential aeration cells frequently exist on steel in concrete in the

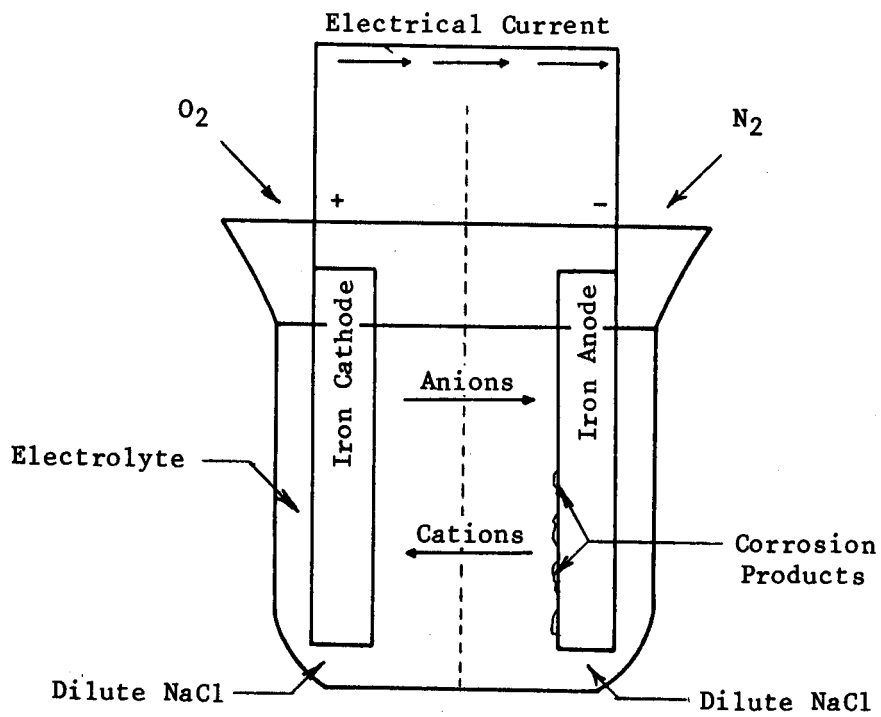

Figure 38. Differential aeration cell.

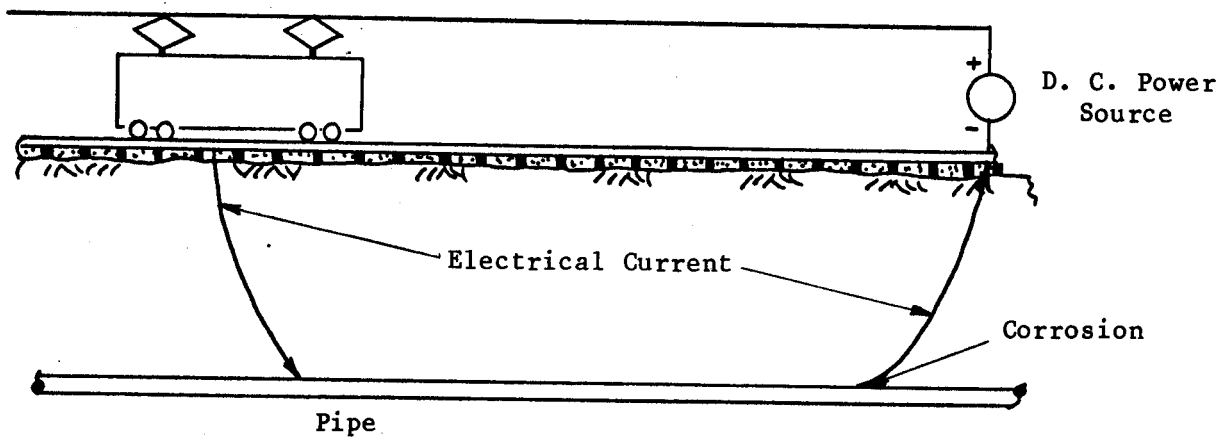

Figure 39. Stray-current corrosion system.

## B. Types of Corrosion

Steels are subject to uniform surface corrosion, pitting and embrittlement corrosion.

### Uniform Surface Corrosion

Uniform surface corrosion is caused by electrochemical reactions which proceed uniformly over the entire metal surface. When a metal uniformly corrodes, the metal loss can be estimated. Uniform surface corrosion is a result of microcell corrosion.

### Pitting Corrosion

Pitting corrosion of a metal is the result of intense localized attack in an electrolyte. Pitting is one of the most destructive forms of corrosion. It is unpredictable, both in rate and location. This form of corrosion does not require stress, but stress will accelerate the development of a pit. Pitting corrosion is of particular concern with prestressing steels since they are subjected to high stresses and have small cross-sectional areas. Reduction in area at a pit, if allowed to continue, will lead to a ductile failure of a stressed member. Stress-corrosion cracking may appear to be similar to pitting, but it causes a brittle failure. Stress corrosion is discussed on Page 53.

Pitting corrosion is a unique type of galvanic corrosion. Once initiated, the corrosion process within the pit produces a condition stimulating and sustaining further corrosion. Figure 40 illustrates the pitting process of a ferrous metal in an aerated electrolyte containing sodium chloride.

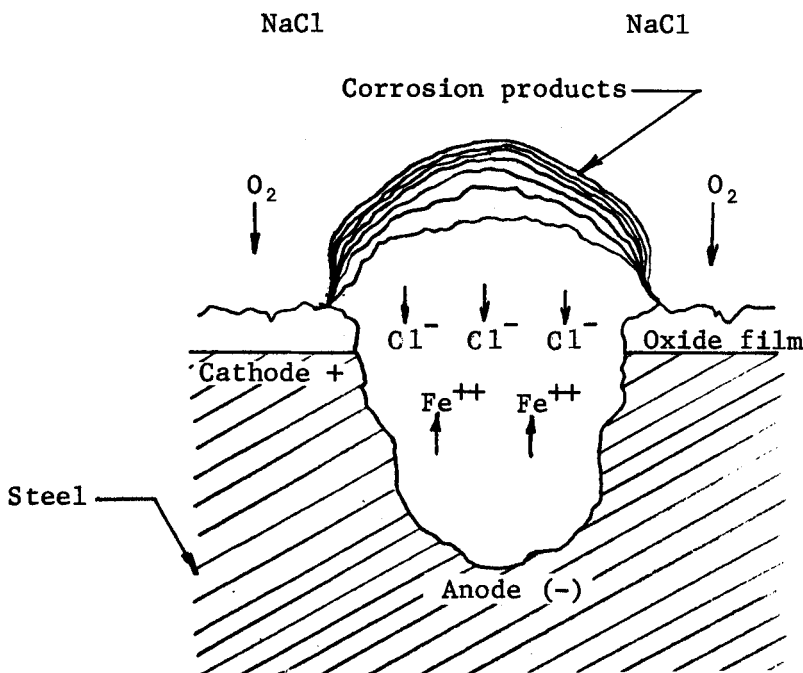
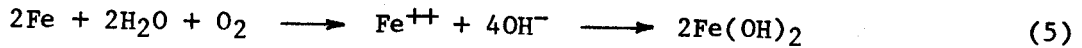

Figure 40. Pit development in a ferrous metal.

The pit is formed at an area where chloride ions locally weaken the passive film which protects the steel. The anode is established where the passive film is destroyed and the surrounding steel becomes cathodic. The oxidation reaction at the anode is given by the Equation (3), and the reduction reactions at the cathode are given by equations (1) and (2). The overall reaction that produces the corrosion products surrounding the pit is given by the equations:



In oxygenated waters the reaction would continue to yield rust (corrosion products) in many forms such as:



Clear [123] reported that a different anode electrochemical reaction may cause the corrosion of reinforcing bars in chloride contaminated concrete. With oxygen absent at the anode, he suggests that the anode reaction would be:

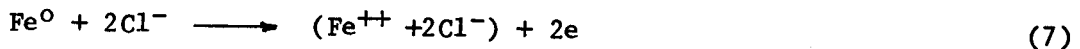

followed by:

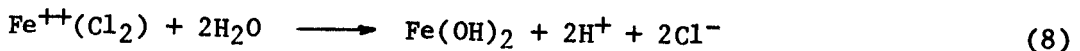

The  $\text{Cl}^-$  ions facilitates the corrosion at the anode through iron chloride complexing and hydrolysis. The  $\text{H}^+$  ions generated are responsible for the low pH in the pit.

Regardless which reaction occurs, as the corrosion process continues, the pH of the cathode increases as hydroxyl ions accumulate. The corrosion products also retard the diffusion of oxygen into the pit sustaining a differential aeration cell between the pit and the better aerated cathodic area. In addition, chloride and the other anions present in the electrolyte migrate into the pit (anode) under the influence of the corrosion current. The pH within the pit then becomes lower with time. Hydrogen ion concentrations (pH) as low as 2.5 have been measured within pits. When the pH drops below 9.5 the passive film which protects the steel will not develop, and when the pH drops below 4.5 acidic attack occurs.

### Bacterial Corrosion

Sulfate-reducing anerobic bacteria are often responsible for accelerating the corrosion of iron and steel in deaerated soils. These bacteria exist throughout the world when moisture, sulfates, and organic matter are present. They are most active in soils with a pH between 6.2 and 7.8 [17]. They do not survive in high pH environments. Wet clays, marshes, and organic soils below the water table are likely to have active sulfate-reducing bacteria.

These bacteria reduce inorganic sulfates to sulfides in the presence of hydrogen or organic matter. If the bacteria are in direct contact with bare



iron or steel; the metal will supply hydrogen, which is absorbed on its surface, to be used in the reduction of the sulfates. As the hydrogen is consumed, ferrous ions from the metal enter solution to form rust and ferrous sulfide.

### Stress-Corrosion Cracking

Stress-corrosion cracking is a brittle failure which occurs when a normally ductile metal or alloy is subjected to tensile stresses above a threshold level in the presence of specific corrosive environments. The metallurgical and environmental factors which control the cracking are not completely understood. Most research to date has concentrated on identifying alloys which are resistant to attack in specific environments.

Stress-corrosion cracking is an anodic corrosion process with the crack developing at anodic sites. As corrosion continues, the crack tip moves deeper into the metal until the cross-sectional area is reduced causing a brittle failure. Uhlig [18] indicates that high strength steels with yield strengths above 180 ksi (1,241 MPa), or a Rockwell C hardness value greater than forty are susceptible to stress-corrosion cracking. Phillips [19] furthered stated that if sulfides are present, steels with a Rockwell C hardness greater than twenty-two are susceptible to stress-corrosion cracking.

### Hydrogen Embrittlement

Hydrogen embrittlement occurs when atomic hydrogen resulting from a corrosion reaction or cathodic polarization enters the metal lattice at cathodic sites, and upon reaching a void of favorable site, combines to form molecular hydrogen. Sulfide ions accelerate hydrogen embrittlement by "poisoning" the steel surface enabling atomic hydrogen to easily penetrate the metal. The interstitial molecular hydrogen significantly reduces the ductility of the metal. Hydrogen embrittlement does not have to be accompanied by visual evidence of corrosion, but under high tensile stresses, cracking and brittle failures result. Hydrogen may enter the metal over an extended period of time, and hydrogen embrittlement failures have been reported years after completion of the structure.

## CORROSION PERFORMANCE OF STEEL IN SOILS

### A. National Bureau of Standards Tests

The National Bureau of Standards (NBS) performed extensive studies of underground corrosion between 1910 and 1955. More than 36,500 metal samples were exposed at 128 test locations throughout the United States. In 1957 Romanoff presented the results of these investigations in Underground Corrosion [17]. When the NBS work was begun, stray electrical currents were assumed to be responsible for underground corrosion. The studies showed that most underground corrosion was a complex electrochemical process dependent upon the properties of the soil.

The NBS studies were primarily concerned with buried pipeline corrosion. Since pipes are installed in backfilled trenches, the NBS work

was performed on specimens placed in trenches ranging from 18 inches (46 cm) to 6 feet (1.8 m) deep. The following conclusions can be drawn from these studies:

- 1) Stray electrical currents were not solely responsible for underground corrosion.
- 2) Atmospheric oxygen or oxidizing salts stimulates corrosion by combining with metal ions to form oxides, hydroxides, or metallic salts.
- 3) The permeability of the soil, moisture content, and soluble salt content determine the electrical conductivity of the soil.
- 4) Corrosive soils contained large amounts of soluble salts.
- 5) The least corrosive soils had resistivities above 3,000 ohm-cm and low soluble salt concentrations.

Underground Corrosion [17] also contained a complete description of the soil at each test site. These descriptions can be used as a guide to identifying corrosive soils.

✧ In 1972 Romanoff [20] reported that driven steel piles did not experience appreciable corrosion when driven into undisturbed soils. These findings were obtained during NBS studies of steel pile corrosion. Romanoff also stated that the NBS corrosion data for steel exposed in disturbed soils was not applicable to steel piles driven in undisturbed soil. He concluded:

"that soil environments which are severely corrosive to iron and steel buried under disturbed conditions in excavated trenches were not corrosive to steel pilings driven in the undisturbed soil. The difference in corrosion is attributed to the differences in oxygen concentration. The data indicates that undisturbed soils are so deficient in oxygen at levels a few feet below the ground line or below the water table zone that steel pilings are not appreciably affected by corrosion, regardless of the soil types or the soil properties. Properties of soils such as type, drainage, resistivity, pH, or chemical composition are of no practical value in determining the corrosiveness of soils toward steel pilings driven underground." 3/

These two NBS studies provide the following information that is helpful in developing the corrosion protection requirements for tiebacks:

- 1) Oxygen would be required at cathodic sites to support underground corrosion of a tieback tendon.
- 2) Disturbed soils (fills) contain an adequate supply of oxygen to support underground corrosion, at least at shallow depths. The unbonded length and the anchor head of a tieback must be well protected if they are in a fill.

3/ Reprinted from "Corrosion of Steel Pilings in Soils" by Melvin Romanoff [20]. Contained in National Bureau of Standards Monogram 127, NBS Paper on Underground Corrosion of Steel Pilings (1962-1971, March 1972.

- 3) The aggressiveness of disturbed soils can be measured, and they can be classified as aggressive and nonaggressive.
- 4) Undisturbed soils were deficient in oxygen a few feet below the ground surface, or below the water table. The anchor length of a tieback will be installed in deaerated soil or rock.
- 5) Steel piles in undisturbed soils do not experience significant corrosion. Tieback tendons in undisturbed soils should not experience corrosion problems. (Pitting, stress-corrosion cracking, and hydrogen embrittlement of the prestressing steel must be separately evaluated since these forms of corrosion would not affect the performance of foundation piles.)
- 6) The portion of pilings installed in fill soils above the water table or in the zone of a fluctuating water table were vulnerable to corrosion. The portion of a tieback tendon in a similar environment must be protected from corrosion.

## B. Pipeline Corrosion

Buried steel pipelines have numerous corrosion problems and they are protected by a variety of means. Steel pipelines are subject to stray-current corrosion, differential concentration and aeration cells, and dissimilar metal cells. Pipelines are installed in backfilled trenches enabling atmospheric oxygen and moisture to come in contact with the pipe.

Pipelines are protected by coating, encapsulation, impressed cathodic protection, and sacrificial anodes. Fiber reinforced coal-tar coatings are the most common pipe protection. Electrostatically applied epoxies have proven effective in protecting buried pipelines as long as they are not mechanically damaged. Metallic coatings have been used, but they deteriorate rapidly when the pipe is in contact with bare steel or other dissimilar metals. Portland cement encapsulation and linings have been used to protect steel or iron pipes. Heat shrinkable sleeves with elastic adhesives also have been used for pipe encapsulation. A combination of impressed cathodic protection and reinforced coal-tar enamel coatings has proven to be the most effective means of protecting buried pipelines. The coating provides general protection, and the cathodic protection controls the corrosion on the pipe where the coating is damaged, or where the pipeline crosses stray-current fields. Pipe sections are often electrically insulated to interrupt long-line corrosion systems.

Pipeline corrosion experience provides the following information which is useful in developing the corrosion protection requirement for tiebacks:

- 1) Oxygen is readily available in backfill, and tiebacks should be protected when they are installed in a backfill.
- 2) Brittle coatings could be used to protect a tieback if the coating is not damaged during installation.
- 3) Pitting corrosion may occur at coating holidays.
- 4) Coal tar enamel coatings and heat shrinkable sleeves have provided good protection in a variety of environments. These protections could possibly be used to protect the tieback along the unbonded length.
- 5) Impressed cathodic protection systems require continuing maintenance and adjustment to remain effective.

- 6) Galvanizing does not provide suitable protection unless special precautions are taken to isolate the pipeline from bare steel or dissimilar metals.
- 7) Portland cement provides suitable protection of buried steel as long as it is dense, and not damaged during handling and installation. Cement grout provide adequate protection for a tieback in many soil environments.
- 8) Electrical isolation can be used to interrupt long-line corrosion systems. Stray-current corrosion systems and long-line corrosion cells that might affect a tieback could be interrupted by isolating the tieback from the structure it supports.

### C. Reinforced Earth and Metal Culverts

Reinforced Earth systems employ tensile elements to reinforce backfilled soil structures. Few Reinforced Earth corrosion problems have been reported. Reinforced Earth elements (strips) are fabricated from mild steel and protected from corrosion by galvanizing [21]. Care is also taken to avoid dissimilar metal cells where the strips connect to the wall. If dissimilar metals are used, the galvanized strips may corrode.

King [21] reported that differential aeration cells could be established along the strips between well-aerated portions (cathode) and poorly aerated areas (anode). Differences in compaction, cohesion, and depth of cover could cause variations in oxygen content. King [21] also indicated that differential concentration cells might develop when water saturated with deicing salts infiltrated the backfill underlying a highway shoulder. To date, these corrosion mechanisms have not caused serious problems.

Pitting corrosion is assumed to be localized and small for Reinforced Earth elements. Estimation of metal loss, assuming uniform surface corrosion, is used to determine the thickness of the metal strips [21]. When water and oxygen are the corrosive agents, the strips are galvanized but no increase in cross-sectional area is recommended if the backfill has a pH between 6 and 10 and a resistivity greater than 5,000 ohm-cm [22]. For marine structures, Long [22] reports that the thickness of the strips is increased by 0.08 inches (2 mm), prior to galvanizing.

California Department of Transportation uses a chart for estimating the rate of metal loss for Reinforced Earth and uncoated galvanized culverts [23]. The chart assumes uniform surface corrosion, and shows the relationship between corrosion rate, minimum soil resistivity, and pH values for acid and alkaline soils.

However, since Reinforced Earth strips do corrode, alternate strip materials are continuously being evaluated. Stainless steels, fiber reinforced plastics, fabrics, and epoxy coated strips have been investigated. To date, galvanized steel still remains the most economical and effective strip material.

Corrugated steel culverts are used for drainage structures. These culverts are installed under highways in environments similar to Reinforced Earth. The culverts are fabricated from bituminous-coated or uncoated galvanized steel. Crum [24] reported that uncoated culverts did not perform well in brackish waters, while bituminous-coated metal pipes performed

satisfactorily. Acid mine wastes also have caused rapid deterioration of uncoated galvanized culverts [25]. Mine drainage in West Virginia has been reported to have pH's ranging from 6 to as low as 2.7 [26].

Haviland, et al [25], indicated that uncoated and coated galvanized steel culverts are assumed to corrode uniformly. Their service life is estimated, assuming a rate of metal loss due to corrosion and erosion. The rates of metal loss are determined empirically.

Reinforced Earth and metal culverts are installed in fills. It is interesting to note that Reinforced Earth structures have not experienced the corrosion culverts have. This is probably due to the care taken in the selection and compaction of the fills, the very aggressive waters which flow through culverts, and the unrestricted availability of oxygen inside a culvert. The corrosion performance of uncoated galvanized culverts is similar to the corrosion of galvanized samples examined during the NBS underground corrosion studies. Romanoff [17] reported that galvanizing only extended the service life of steels and that once the zinc coating was removed corrosion proceeded at the same rate as it did on bare steel.

The corrosion performance of culverts and Reinforced Earth cannot be directly extrapolated to tiebacks since culverts and Reinforced Earth are:

- 1) Installed in oxygen-rich fills and aggressive surface waters.
- 2) Fabricated using mild steels.
- 3) Not seriously damaged by pitting corrosion.

However, the corrosion performance of these structures show that:

- 1) Brackish waters and acid mine wastes constitute aggressive environments for tiebacks.
- 2) Galvanizing would not be suitable for the protection of tieback tendons.
- 3) Bituminous coatings provide adequate protection for galvanized culverts in aggressive environments. Coatings with similar properties should be evaluated for the protection of the unbonded length of a tieback.

#### CORROSION PERFORMANCE OF CONCRETE STRUCTURES

Prestressed, post-tensioned, and reinforced concrete structures have performed well in aggressive environments [27], [28], and [29]. Schupack [29] and Phillips [27] reported few corrosion failures of structures using prestressing steels. Both reported that most of these failures could have been avoided. They concluded that the failures they studied resulted from the selection of corrosion susceptible quenched and tempered prestressing steels, poor design details, poor construction practices, or inadequate protection in aggressive environments, particularly chlorides. Phillips [27] also indicated that many failures in Europe resulted from hurried repairs after World War II. At that time, knowledge concerning prestressing materials and design was very limited.

Steel encased in concrete is protected by a passive film. The protective film is formed of hydrous ferrous oxide which is highly insoluble in solutions with a pH above 4.5. Hydrated cement has a pH above 12.4 and it provides an ideal environment for maintaining this film. This hydrous ferrous oxide film is responsible for the excellent performance of reinforced concrete structures in aggressive environments.

★ The mechanism responsible for the corrosion of steel in concrete is well understood. A depassivator, an electrolyte, and oxygen must simultaneously be present in order for reinforcing steels to corrode. Oxygen is required at the cathodic areas where the reduction reaction  $H_2 + O_2 + 2e^- \rightarrow 2OH^-$  occurs. The depassivator attacks the passive film, and the oxidation reaction (corrosion)  $Fe \rightarrow Fe^{++} + 2e^-$  occurs at these anodic areas. An electrolyte is necessary to complete the corrosion cell.

Steel is depassivated when the pH directly on the metal surface is reduced below 9.5. The alkalinity of cement is lowered when atmospheric carbon dioxide reacts with calcium hydroxide in the cement paste to form calcium carbonate. This process is called carbonation. When the depth of carbonation reaches the steel, the passive film is destroyed and corrosion begins if oxygen and moisture are present. All concrete structures exposed to the atmosphere experience some loss of alkalinity with time. The depth of carbonation is dependent on the permeability and porosity of the concrete and the amount of carbon dioxide present in the environment. Carbonation usually extends only a few millimeters and normal embedment depths provide sufficient cover for the steel. Wiebenga [30] reported that carbonation extended less than 5 millimeters on 48 of 51 concrete structures inspected in the Netherlands. These structures ranged in age from 3 to 62 years old. He also reported that carbonation had occurred to a depth of 6 millimeters, 7 millimeters, and 10 millimeters respectively on the other three structures inspected.

Chloride ions are the primary depassivator of steel embedding in concrete. These aggressive anions locally destroy the passive film when they reach the steel. Chlorides are present in fresh concrete when calcium chloride is used as an accelerator or when chlorides are present in the mixing water or aggregates. When concrete structures are exposed to marine environments or to deicing salts, chloride ions gradually penetrate the concrete. The rate of penetration and depth to which the chloride ions penetrate are functions of the concrete permeability and porosity. When chloride ions depassivate the steel, only oxygen and moisture are required for corrosion to occur.

Most reinforced concrete structures develop fine cracks. Cracks result from shrinkage, changes in humidity and temperature, corrosion, and loading conditions. Cracks, if wide enough, will enable chloride ions and/or carbon dioxide to reach embedded steel more rapidly than through uncracked concrete. Considerable research has been performed to determine the relationship between crack size, and reinforcement corrosion. Houston, et al [31], and Ryell, et al [32], showed that cracks less than 0.01 inches (0.3 mm) wide had little influence on the corrosion of reinforcing steels. Griess and Naus [33] reported that for crack widths up to 0.03 inches (0.76 mm) portland cement provided protection for prestressing steel strands in aggressive environments. Naus [34] reported that cement grout could contain cracks up to 0.004 inches (0.1 mm) wide and still protect

prestressing steels in aggressive environments. O'Neil [35] reported that flexural cracks greater than 0.016 inches (0.4 mm) wide were necessary for reinforcing steel to corrode. Schiell [36] reported that cracking effected the initiation of corrosion, but other factors determined the rate.

The investigators do not agree on the crack width which can be tolerated in a reinforced concrete structure. Their work does indicate that cracks less than 0.004 inches (0.1 mm) wide, will not impair the passivity of steels embedded in good quality concrete. Their works also show that when the crack widths increase above a given size, the steel is easily depassivated if carbon dioxide or chlorides are present. Their research confirmed that steel can be depassivated, but oxygen must be available at cathodic areas for corrosion to occur [37].

Prestressing steels are reported to be susceptible to stress-corrosion cracking and hydrogen embrittlement [38], [39], [40], [29], [41], and [42]. A review of published case histories and several research studies concerning prestressing steel corrosion indicates the following:

- 1) In the past, foreign building codes allowed quenched and tempered prestressing steels to be used. These steels are susceptible to stress-corrosion cracking and hydrogen embrittlement [29], [27], and [43]. Many reported corrosion incidents occurred in structures where these steels were used. These steels should not be used for tieback tendons.
- 2) The Federation Internationale de la Precontrainte (FIP) and the American Concrete Institute (ACI) have recognized that heat treated prestressing steels are generally more susceptible to brittle corrosion failures than other types of prestressing steels. They do not recommend their use [44].
- 3) Stress-relieved prestressing steel wires, bars, and strands (ASTM A-421, ASTM A-722, ASTM A-799, and ASTM A-416 specifications) are less susceptible to brittle corrosion failures than heat treated steels. There are very few reported corrosion failures of unbonded tendons made using stress-relieved wires and strands, or high strength bars [27], [29], [41], and [45]. Tieback tendons should be fabricated from steels meeting these specifications. The ACI [46] has made provisions for other steels to be used if they conform to the minimum requirements of the appropriate ASTM specification.
- 4) Corrosion failures of prestressing steels have resulted when the steels have not been encased in concrete, grout, or an impermeable grease filled duct. As a minimum, tieback tendons should be completely encased in grout along the anchor length, and the unbonded length should be covered with an impermeable grease filled sheath.
- 5) Laboratory studies reported by Caton, et al [47], Klodt [43], and Griess and Naus [33] indicate that prestressing steels fabricated from cold drawn high strength steel (ASTM A-416, Grade 270) are not susceptible to stress-corrosion cracking in chloride environments. Caton, et al, and Griess and Naus did report that ASTM A-416 steel was susceptible to stress-corrosion cracking in the presence of nitrates. Griess and Naus reported that the temperature had to be in excess of 100°F (38°C). Caton, et al, reported that failures

occurred at a temperature of 70°F (21°C). ~~★~~ Griess and Naus [33] reported that ASTM A-416, Grade 270 steel was not susceptible to stress-corrosion cracking in the presence of sulfates, nitrates, and chlorides at room temperature. Tieback tendons may not be attacked by stress-corrosion cracking since the temperature underground is less than 55°F (13°C).

- 6) Prestressing steels are susceptible to hydrogen embrittlement [33], [42], and [43].

In the United States, concrete structures fabricated using prestressing steels have not experienced significant corrosion problems. Schupack [29] reported corrosion damage to twenty-eight prestressed, or post-tensioned structures. He found that these corrosion incidents involved:

"...some 200 tendons of an estimated 30 million tendons in completed structures using stress-relieved steel. This represents a corrosion incidence of 0.007% which is negligible even if it was several times greater. This represents such a small percentage of occurrence as to be of no practical concern. This is particularly so since the corrosion incidents are understood and could have been avoided."4/

The corrosion performance of reinforced, prestressed, and post-tensioned concrete structures provides an excellent background for developing recommendations for the corrosion protection of tieback tendons. Their performance indicates that:

- ★ 1) A depassivator, oxygen, and moisture, are required for corrosion of a tieback tendon. The elimination of one of these elements would prevent corrosion from occurring.
- 2) Good quality, crack-free, low permeability grout provides excellent protection for prestressing steels. The anchor length of a tieback may be protected by grout.
- 3) The ungrouted portion of a tieback tendon will be susceptible to corrosion if it is not encased in an impermeable sheath or tube.
- 4) Quenched and tempered prestressing steels, which are susceptible to brittle corrosion failures, should not be permitted.
- 5) Calcium chloride admixtures, or chloride contaminated water, or aggregates, should not be used.
- 6) Inadequate concrete cover, or poor quality concrete, enable the steel to be depassivated. A grout protected tieback tendon should be constructed so the steel is encased in dense grout.
- 7) Carbon dioxide and chlorides are the primary depassivators of steels embedded in concrete.
- 8) UngROUTED tendons must be completely protected since the environment surrounding them may not have a high pH.
- 9) Corrosion can occur at open joints or cracks. The transition between a tieback's unbonded length corrosion protection, and the anchor head protection, must be water tight.

stand  
ms Relative  
to tieback  
Corrosion

4/ Reprinted from "A Survey of the Durability Performance of Post-Tensioning Tendons" by Morris Schupack [29] by permission of Post-Tensioning Institute. Year of first publication 1978.



- 10) Tendons should not come in contact with more noble metals. They would cause the tendon to become the anode in a dissimilar metal cell.
- 11) Stray electrical currents can cause tendon corrosion failures.
- 12) Restricting oxygen from reaching a tieback tendon would prevent it from corroding.
- 13) Stress-relieved wires and stands, and high strength bars (ASTM A-421, ASTM A-416 ASTM A-779, and ASTM A-722 specifications) in properly grouted ducts have not been susceptible to pitting corrosion, stress-corrosion cracking, or hydrogen embrittlement.

### CORROSION PERFORMANCE OF TIEBACKS

Permanent tiebacks have been installed routinely since the mid-1960's. They have performed well in a variety of environments. The majority of these tiebacks used cement grout for protection over their anchor length. Portier [48], and Herbst [49] reported that there is no evidence of a tieback failure in the anchor zone where the tendon is encased in cement grout. The writer has discussed tieback corrosion protection with over fifty tieback contractors, consultants, and steel suppliers, and no corrosion failures were reported where the tendon was surrounded by grout. The reported tendon failures have been along the unbonded length, with most of them occurring within 6.56 feet (2 m) of the anchor head. Quenched and tempered prestressing steels were involved with a significant number of these failures. These steels have proven to be susceptible to brittle failures.

Several tieback corrosion failures have been documented. Nurnberger [40] published a report including a description of nine failures.

Case 1 dealt with forty-two permanent tiebacks installed in 1959 in West Germany. They were installed in an underground power station located 197 to 262 feet (60 to 80 m) below the ground surface. The permanent rock tiebacks were 26 to 49 feet (8 to 15 m) long and anchored in pregouted rock sockets. Each tendon consisted of a bundle of fifteen oval bars with an ultimate strength of 228 ksi (1,570 MPa) and an elastic limit of 210 ksi (1,450 MPa).

Corrosion protection for the tendon in the unbonded length consisted of a cold applied coating and a wrapping of gauze-like material impregnated with hot bitumen. The tendon was not protected at the anchor head. The anchorage used with this prestressing system caused the bars to be bent. The steel was stressed to 155 ksi (1,068 N/mm<sup>2</sup>) at lock-off. It was postulated that bending, and tension caused the tendon to be stressed above its ultimate strength in the region near the anchor head.

The tiebacks were checked ten months after lock-off. It was discovered that seventeen tendons were broken, ten were probably broken, eight were damaged, and seven were still functioning. All the tendons broke within the unbonded length with 30% breaking at the anchor head, and 43% breaking within 19.7 inches (50 cm) of the anchor head.

The tiebacks were unearthed to reveal that the tendons were deeply corroded where the bitumen was missing. The water coming out of the drill holes contained very little chlorides. The report concluded that the failure was due to localized corrosion which led to the formation of stress cracks. It was postulated that the corrosion protection system may have contributed to the failure since the damaged gauze wrapping could cause differential aeration cells to develop along the tendon. The coating system could not withstand damage during installation.

Case 2 dealt with tiebacks installed along the Rhine River in Germany. These tiebacks were installed using 22-0.315 inch (8 mm) wires having an ultimate strength of 213 ksi (1,470 MPa), and a yield strength of 196 ksi (1,350 MPa), German designation ST 135/150. The tendons were encased with grout. After a few years, three tiebacks failed. Eighty-five percent of the ruptured wires failed in the vicinity of the anchor head. In this area, only a thin coating of grout covered the tendons.

The tiebacks were installed in soil below the groundwater table. The groundwater contained the industrial pollutants found in the Rhine River. It was assumed that failure was caused by stress-corrosion cracking. Both surface corrosion and pitting were observed on the tendons. Insufficient grout cover near the anchor head was given as the primary reason for the initiation of corrosion. It was also observed that the tendons were bent as a result of the settling of the soil behind the wall. The Rhine River had a high chloride ion content in the vicinity.

Case 3 also occurred in West Germany. During the construction of an underpass a tiedback sheet pile wall was built to support a railway line. The tendons were fabricated from 6-0.48 inch (12.2 mm) bars having an ultimate strength of 199 ksi (1,373 MPa). The first tendon failed days after lock-off. Other tendons failed between 99 and 100 days. The tendons were not heavily corroded, but near the failure a group of short transverse cracks were found.

The failure mechanism was postulated to be a fatigue failure resulting from bending. The tiebacks were bent when the railroad load was transmitted directly to the tendons through hard, frozen ground. Fill soil also surrounded the tiebacks.

Case 4 occurred in the United States in 1971. Here, four tiebacks supporting a sheet pile wall failed six weeks after lock-off. The tendons were fabricated from one 1 1/4 inch (32 mm), hot-rolled, drawn, and stress-relieved bars. The ultimate strength of the steel was 160 ksi (1,100 MPa) and the yield strength was 139 ksi (960 MPa). No corrosion protection was provided over the unbonded length of the tendon, which was located in a railway embankment. The embankment consisted primarily of blast furnace slag. The soil was acidic, and moist in the vicinity of the tendon. Failure of the tendon was postulated to be a result of stress-corrosion cracking.

Case 5 involved 1 3/8 inch (36 mm) bars similar to the bar in Case 4. In this application, temporary tiebacks failed four weeks after lock-off. The tendons had no corrosion protection in the unbonded zone and they were installed in a moist soil with a low pH. Again, stress corrosion was suspected as the cause of the failure.

Case 6 took place at an airport. Corrosion failure of several tiebacks occurred eight years after installation. The tendons were fabricated from 0.205 inch (5.2 mm) wires. After removing corrosion products from the wires, heavy pitting was observed. Some of the pits also contained small fissures. A layer of bitumen had been applied for corrosion protection. With time, this layer had broken down. It was postulated that stress corrosion had caused the failure. Upon examination, no corrosion producing elements were found.

Case 7 involved tiebacks fabricated using 0.205 inch (5.2 mm) wires. These were temporary soil tiebacks, but they were required to function for an extended period of time. Two 15-wire tendons failed. The wires were heavily pitted and some of the pits had cracks emanating from their roots. Chemical analysis of the corrosion products revealed a sulfur content of 0.25%, but no chlorides.

Case 8 involved five tiebacks. The tendons were fabricated from 0.205 inch (5.2 mm) wire, and they were used to support a retaining wall. The tendons failed within a year of lock-off. In some areas, deep pits were visible. Some of the failed wires still had grout covering a portion of the tendon. In these areas, the steel was more or less free of corrosion. On the sides where the grout was absent, heavy corrosion occurred. Uniform surface corrosion was observed on the lengths of the wires which were completely grout free.

No cracks were observed in the steel. Analysis of the corrosion products showed a 0.63% sulfate content, but no chlorides or sulfides were found. The fractures emanated from pits, and the breaks were purely brittle. The cause of these brittle breaks is surmised to have been a result of combined stresses due to bending and tension. The tendons were bent as a result of backfill settlement behind the retaining wall.

Case 9 occurred in West Germany in 1977. Temporary tiebacks fabricated from 1 1/4 inch (32 mm) hot-rolled, and threaded bars were used to support a sheet pile wall. These bars had an ultimate strength of 181 ksi (1,250 MPa), and a yield strength of 160 ks (1,100 MPa). The unbonded length was covered by a pipe, no corrosion protection was provided at the anchor head. Two of the tiebacks failed between 16 and 17 weeks after lock-off. The first tieback failed 2 inches (5 cm) behind the anchor head. The second failed in the middle of the unbonded length, and a slight bend was observed at the failure.

The tiebacks were installed in a fill which consisted of slag and light ash. Investigation of the groundwater revealed a sulfate content of 200 mg/l. The tendons did not come in direct contact with the groundwater.

The first tieback failed in a brittle fracture at a relatively large corrosion pit. The pit was located in the unprotected area near the anchor head. It is postulated that localized high stresses developed at the pit, and bending could have over-stressed the tendon. Sulphur compounds were also present as corrosion products. The investigators concluded that hydrogen embrittlement played a minor role in the corrosion.

The second failure was attributed to hydrogen embrittlement. Corrosion could have been caused by stress concentration, the lack of corrosion

protection, and the use of a corrosion susceptible steel. Only sulphur compounds were present as corrosion products.

Portier [48] described a tiedown corrosion failure that occurred at Joux Dam, Tarare, France. The tiedowns were installed in 1952, and locked-off at 2600 kips (11,570 kN). The tendons were fabricated from steel with a 214 ksi (1,470 MPa) ultimate strength, and stressed to 157 ksi (1,080 MPa) at lock-off. Two months after lock-off, it was discovered that two tiedowns carried almost no load. Upon examination of the tendons, it was observed that the wires had broken. A replacement tiedown was made using steel from the same reel as that used for the two failed tiedowns. The replacement also failed in a similar manner. Samples of unused wire from the same reel were then tested in the laboratory. These tests showed failures similar to those observed at the dam. The failures were brittle ones, and they occurred within three months of loading. They were classified as corrosion under tension.

Nicholson, [50] and [51], reported corrosion failures at the unprotected anchor head of several permanent tiebacks. The tendons were fabricated from 1 1/4 inches (32 mm) high strength bars having an ultimate strength of 150 ksi (1,033 MPa). The tiebacks were installed in 1969 to support a wall at an industrial facility. The tendons were repaired, and the area around the anchor head was protected in 1972. Since that time, they have performed satisfactorily. Nicholson Construction provided the writer with one of the failed tendons. Heavy pitting was observed where the bar was unprotected, and brittle failure surface was noted. The protected portion of the bar did not show any evidence of corrosion even though it was exposed to the same environment.

A draft British National Physical Laboratory report [52] reviewed a corrosion failure associated with tiedback construction. Two tiebacks failed when individual bar tendons fractured without warning. The tendons were single bars fabricated from a quenched and tempered steel with an ultimate strength of 217.7 ksi (1,500 MPa). The tiebacks had been locked-off at a stress of 145.1 ksi (1,000 MPa), and they were unprotected. The failure occurred three months after lock-off. The paper indicates that the failures were due to hydrogen-induced stress corrosion, starting at corrosion pits. Approximately five years ago the remaining bars were protected with grout. Since grouting, no corrosion failures have been observed.

The slurry wall for New York's World Trade Center was temporarily supported with tiebacks. The tendons were protected with grout along the anchor length. The unbonded length was protected by a bentonite-filled steel pipe. The lower end of the pipe was grouted into the top of the rock. A sacrificial zinc ribbon anode was also installed with each tendon. The site was in a landfill along the Hudson River, and the soil contained large amounts of organic matter. Several of the tiebacks experienced brittle corrosion failures. These failures were located near the anchor head just above the bentonite. The bentonite level had dropped as much as three or four feet during the construction period. Hydrogen sulfide gas was present in the soil, and the sacrificial anode was consumed near the anchor head of the failed tiebacks.

Schupack [29] reported a temporary tieback failure resulting from tack welding on 1 1/4 inch (32 mm) high strength bars. The bar failed at 40 kips (22 percent of its ultimate capacity). Schnabel Foundation Company has observed a similar failure when a prestressing bar was tack welded. These types of failures are brittle and they occur at relatively low loads. They are not due to corrosion, but they can have the appearance of a brittle corrosion failure.

Schnabel Foundation Company has experienced tendon failures on one permanent tieback project. High strength bar tendons with an ultimate strength of 150 ksi (1,933 MPa) were used. The tiebacks were installed at the face of a rock cut and extended to support a wall as backfill was placed between a wall and the cut. The tendons had a plastic sheath over the unbonded length and no protection was provided at the anchor head. The tendons failed about one year after the completion of the wall. All the failures occurred near the interface between the backfill and the rock cut, and they were believed to have been caused by corrosion. When the tiebacks were unearthed, large boulders were found resting directly on top of the tendons, and the tendons were bent near some of the fractures. An independent metallurgist reported that the fractures were not a result of corrosion. Instead, they resulted when combined bending and tensile stresses exceeded the ultimate strength of the tendons.

The tieback failures summarized above show that:

- 1) Combined bending and tensile stresses have caused or contributed to tendon failures when they exceed the ultimate strength of bar tendons. (Nurnberger's cases 1, 2, 3, and 8, and Schnabel's reported failure.)
- 2) Quenched and tempered prestressing steels (Nurnberger's cases 1, 2, 3, 6, 7, and 8 and, the British National Physical Laboratory reported failure), which are susceptible to embrittlement corrosion failures, have been involved in a significant number of the tieback failures. These steels should not be used for tieback tendons.
- 3) The unprotected portion of a tendon just behind the anchor head is susceptible to corrosion. (Nurnberger's cases 1--9, Nicholson reported failure, and World Trade Center failures.) Care must be taken to protect this area.
- 4) Blast furnace slag (Nurnberger's case 4), moist low pH soil (Nurnberger's case 5), slag and light ash (Nurnberger's case 9), industrial environments (Nicholson's failures), and organic fills (World Trade Center failure) have caused corrosion failures of unprotected tieback tendons.
- 5) All reported failures occurred in the unbonded length of the tendon, and most occurred near the anchor head. Poor quality protection, or no protection was provided over the unbonded length of those tendons which failed.

The corrosion performance of temporary tiebacks is useful in evaluating the performance of permanent tiebacks. The number of temporary tieback corrosion failures are very small, and no structural collapses have resulted from these failures. Temporary tiebacks often function for extended periods of time due to construction or financing delays. The potential for properly

protected permanent tiebacks to fail, due to corrosion, is slight when considering the excellent corrosion performance of unprotected temporary tiebacks.

### TIEBACK CORROSION PROTECTION SPECIFICATIONS

Temporary and permanent tieback corrosion protection standards and recommendations have been developed due to increased tieback usage and the concern about tendon corrosion. These standards are the French Recommendations [53], the Draft British Code [54], the German Standard [55] and [56], the Swiss Standard [57], the FIP Rules [58], and the PTI Recommendations [59].

Each tieback standard, or recommendation, primarily uses service life to determine if a tieback is temporary or permanent. They recommend little or no corrosion protection for temporary tiebacks, and most require corrosion protection for permanent ones. Table 1 summarizes the specified service life for temporary tiebacks. A tieback is considered to be permanent if its service life exceeds those listed. The corrosion protection requirements of the seven standards are summarized in Table 2.

Table 1. Temporary tieback service life.

| TIEBACK STANDARD            | MAXIMUM SERVICE LIFE<br>(MONTHS) |
|-----------------------------|----------------------------------|
| PTI Recommendations [59]    | $\leq 18$                        |
| Swiss Standard [57]         | $\leq 36$                        |
| German Standard [55]        | $\leq 24$                        |
| Draft British Code [54]     | $< 24$                           |
| French Recommendations [53] | $\leq 18$                        |
| FIP Rules [58]              | $< 24$                           |

Table 2. Tieback corrosion protection requirements.

| STANDARD  | TYPE OF PROTECTION   |   |
|---|--|---|
|   | TEMPORARY TIEBACKS   | PERMANENT TIEBACKS  |
| PTI Recommendations<br>[59]                                   | Engineer to select protection based upon nature of environment and risk.   | Engineer to select protection based upon nature of environment and risk.  |
| Swiss Standard<br>[57]  | Contractor to furnish details of proposed corrosion protection so the degree of protection can be evaluated by the design engineer.  | Contractor to furnish details of proposed corrosion protection so the degree of protection can be evaluated. The protection of the tendon in the anchor zone shall be as effective and reliable as that provided over the rest of the anchor. If no other protection than grout is to be used, the grout cover should be at least 0.79 inches (2 cm). |
| German Standard Part 1 (1972) and Part 2 (1976) [55] and [56] | A 0.79 (2 cm) grout cover in the anchor zone in non-aggressive environments, and a 1.18 inch (3 cm) grout cover in aggressive environments.                                      | The protection must protect the tendon from a microscopic point of view. (Encapsulation of the complete tendon is considered to fulfill this requirement).  |
| Draft British Code [54]                                       | Special protection is not required. Designer engineer is required to specify whether protection is necessary after he has considered anticipated life and nature of environment. | The anchor and unbonded lengths must be protected by two or more physical barriers to corrosion which can be inspected prior to insertion. Exception, in non-aggressive rocks with a permeability of less than $(10^{-10} \text{ m/sec})$ , then the anchor length does not have to be encapsulated.  |
| French Recommendations [53]                                   | (1) No special protection is recommended in a non-aggressive environment if the service life is less than 9 months.  | A protection equivalent to the protection provided by a continuous cement grout (rigid protection) or a   |

Table 2. Tieback corrosion protection requirements (continued).

| STANDARD                       | TYPE OF PROTECTION   |   |
|--------------------------------|--|---|
|                                | TEMPORARY TIEBACKS   | PERMANENT TIEBACKS  |
| French Recommendations<br>[53] | <p>(2) In the unbonded length a water-tight sheath with a filled annulus is recommended if the environment is moderately aggressive and the service life is less than 9 months.</p> <p>(3) It is recommended that the complete tendon be protected by an equivalent to continuous cement grout if the environment is very aggressive regardless of service life.</p> <p>(4) In the unbonded length a water-tight sheath with a filled annulus is recommended if the environment is non-aggressive and the service life is between 9 and 18 months.</p> <p>(5) It is recommended that the complete tendon be protected by a protection equivalent to a continuous cement grout if the environment is moderately aggressive and the service life is between 9 and 18 months.</p> | <p>continuous filling of high performance resins (such as asphalts-epoxy resins). In soils it is recommended that the anchor be continuously protected over the total length.</p>       |
| FIP Rules<br>[58]              | <p>(1) A 0.79 inch (2 cm) grout cover in the anchor zone in a non-aggressive environment. The unbonded length should be sheathed.</p> <p>(2) A 1.18 inch (3 cm) grout cover in the anchor zone in an aggressive environment. The unbonded length should be sheathed.</p> <p>(3) A 0.39 inch (1 cm) grout cover in the anchor zone in water tested drill holes in sound rock. The unbonded length should be sheathed.</p> <p>(4) No minimum grout cover is required in the anchor zone or sheathing over the unbonded length if the service life is less than 12 months and the environment is non-aggressive.</p>  | <p>Recommends that the tendon protection be made and checked under workshop or some other equivalent conditions. The tendon should be entirely surrounded by the protection system.</p> |



The German temporary tieback standard was adopted in 1972, and it influenced the development of the other standards. The German Industrial Norm DIN 4125, Part 1 [55], required that tieback contractors and their tieback systems be licensed. In order to license a tieback, a contractor had to install tiebacks which were load tested and unearthed. Longitudinal and transverse cracks were observed in the grout bodies of the unearthed tiebacks. As permanent tiebacks became more common in Germany, DIN 4125, Part 2 [56], was adopted in 1976. This permanent tieback standard required the tieback tendons to be completely encapsulated in an airtight corrugated sheath. The encapsulation was required because the anchor grout was known to crack, and cracked concrete and grout had not provided corrosion protection for concrete structures exposed to the atmosphere. Another factor that led the Germans to completely encapsulate the tendon was the excessive corrosion problems associated with European quenched and tempered prestressing steels. In Germany and other European countries, commercial pressure kept these steels from being prohibited even though their greater susceptibility to brittle failures was documented.

The FIP, British, and French tieback standards have been influenced by the German standard, and by the corrosion problems associated with the quenched and tempered steels. They recommend encapsulation for all permanent soil tieback tendons. However, the writer's review of current practice found that only in Germany is every permanent tieback encapsulated. In Europe and the United States, most permanent tiebacks still use grout protection along the anchor length, a grease filled tube over the unbonded length, a grease, or grout filled transition between the unbonded length protection and the anchor head, and a grease filled cap or concrete encasement at the anchor head. \*

#### COMMONLY USED TIEBACK CORROSION PROTECTIONS

A variety of tieback corrosion protection systems has been developed. Many of these systems are proprietary and some are not compatible with certain installation methods or tendon types. Except for the unprotected tendons, all of the following corrosion protection systems have adequately protected permanent tiebacks.

##### A. Unprotected Tieback

Unprotected tiebacks are used for temporary applications. Figure 41 shows an unprotected bar tendon. Neat cement grout provides protection for the tendon along the anchor length. The unbonded length may be sheathed or unsheathed. If a sheath is used, the annular space between the sheath and the tendon does not have to be filled with a corrosion resistant grease, or grout. The anchor head and the transition between the unbonded length and the anchor head is unprotected. This is the area most susceptible to corrosion. In this area the bare tendon is exposed to oxygen, moisture, and the environment.

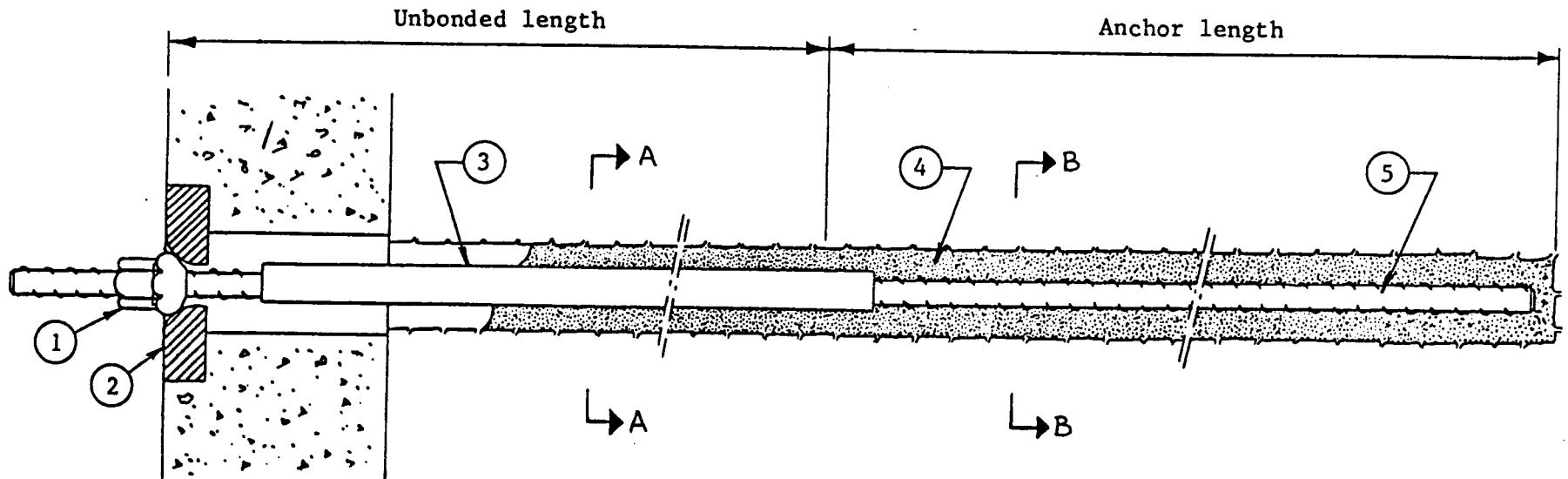

70

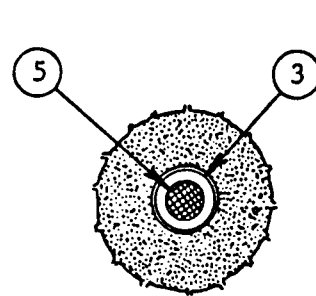

Section A-A

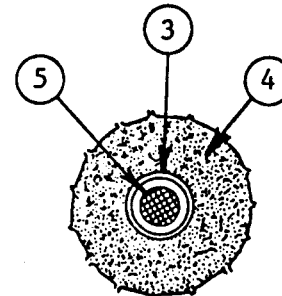

Section B-B

Legend:

- |                          |                 |
|--------------------------|-----------------|
| 1) Nut                   | 4) Anchor grout |
| 2) Bearing plate         | 5) Bar tendon   |
| 3) Bond breaker (sheath) |                 |

Figure 41. Unprotected bar tieback.

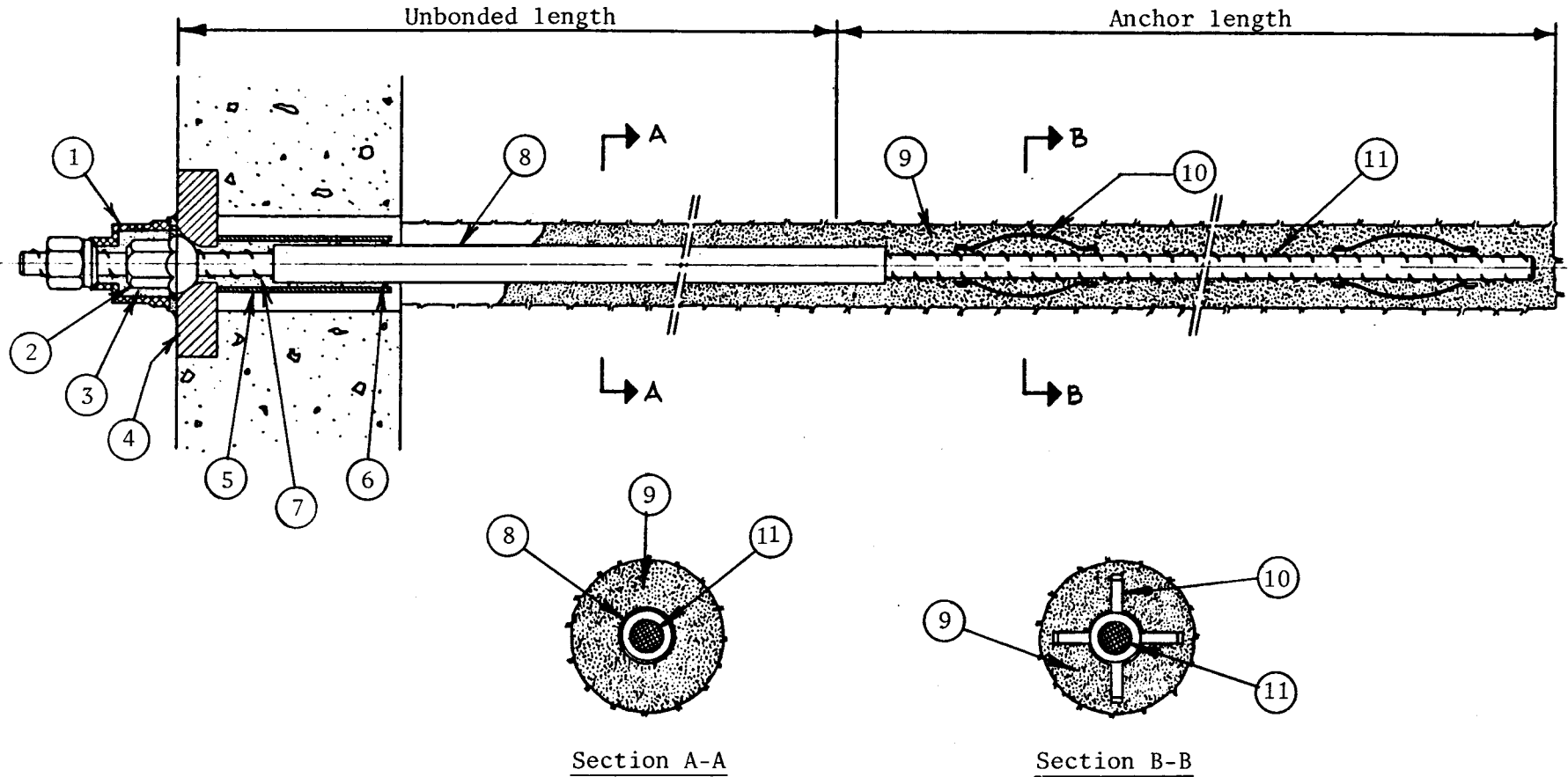

- Legend:**
- |                         |                                     |
|-------------------------|-------------------------------------|
| 1. Anchorage cover      | 7. Anticorrosion grease or grout    |
| 2. Nut                  | 8. Steel, PVC, or polyethylene tube |
| 3. Anticorrosion grease | 9. Anchor grout                     |
| 4. Bearing plate        | 10. Centralizer                     |
| 5. Trumpet              | 11. Tendon                          |
| 6. Seal                 |                                     |

Figure 43. Simple corrosion protected bar tieback.



Figures 45 and 46 show a completely encapsulated bar and strand tendon respectively. The strand tendon is protected by a corrugated high density polyethylene tube, and the bar is protected by a corrugated PVC tube.

★ Figure 47 shows a TMD tieback, which uses a deformed metal tube to protect the tendon. SIF Bachy, a French contractor developed this tieback. TMD is an abbreviation for "terrain meuble deferré" (deferred grouting in shifting ground). First the metal tube is grouted into the ground. After the tube has been grouted in place, the tendon is grouted into the tube, (See Page 159 for construction details).

The annular space between the capsule and the prestressing steel are usually filled with neat cement grout. The grout used to bond the steel to the capsule often contains an admixture to control bleeding of water from the grout (See Page 137). In Britain, polyester resins have been used to fill the annular space. Bars are usually grouted into their corrugated encapsulations prior to insertion into the drill hole. Long or large tendons may be grouted into their capsules after they are placed in the drill hole. When they are grouted depends upon whether or not the pregrouted tendon can be handled without damaging the corrosion protection. Heavy pregrouted tendons require mechanical handling.

Section A-A in Figures 45, 46, and 47 show how the unbonded lengths of encapsulated tiebacks can be protected. When bar tendons are used, a grout-filled corrugated tube covers the complete tendon, and a smooth bond breaker is placed over the corrugated tube in the unbonded length. When strand tendons are used, the unbonded length of each strand is greased and sheathed and the strand bundle is encased in a grout-filled tube.

#### E. Compression Tube Tiebacks

Stump Bohr AG, a Swiss contractor, and Karl Bauer, a German contractor, use compression tubes to protect bar tieback tendons from corrosion. Figure 48 shows a typical compression tube tieback. The principle behind the compression tube is that the grout can be prevented from cracking if it is placed in compression. The length of the tube is 11.5 feet (3.5 m) for cohesive soils, and 8.2 feet (2.5 m) for dense cohesionless soils and rock. The annular space between the compression tube, and the tendon is filled with an anticorrosion grease. The unbonded length is covered with a smooth PVC tube, and the annular space is also filled with grease.

#### F. End Anchor Plate Compression Tiebacks

Another type of compression tieback is made using an end anchor plate at the bottom of the anchor length. Figure 49 shows an end anchor plate compression tiedown fabricated using a button-headed wire tendon. Smooth bars, or totally greased and sheathed strands and deformed bars could also be used with end anchor plates.

When smooth tendons are used, end anchor plates are required because it is not possible to determine whether or not the smooth tendon will develop the necessary bond with the anchor grout.

End anchor plate compression tiebacks place the anchor grout in compression and this grout is assumed to be crack free. However, the force

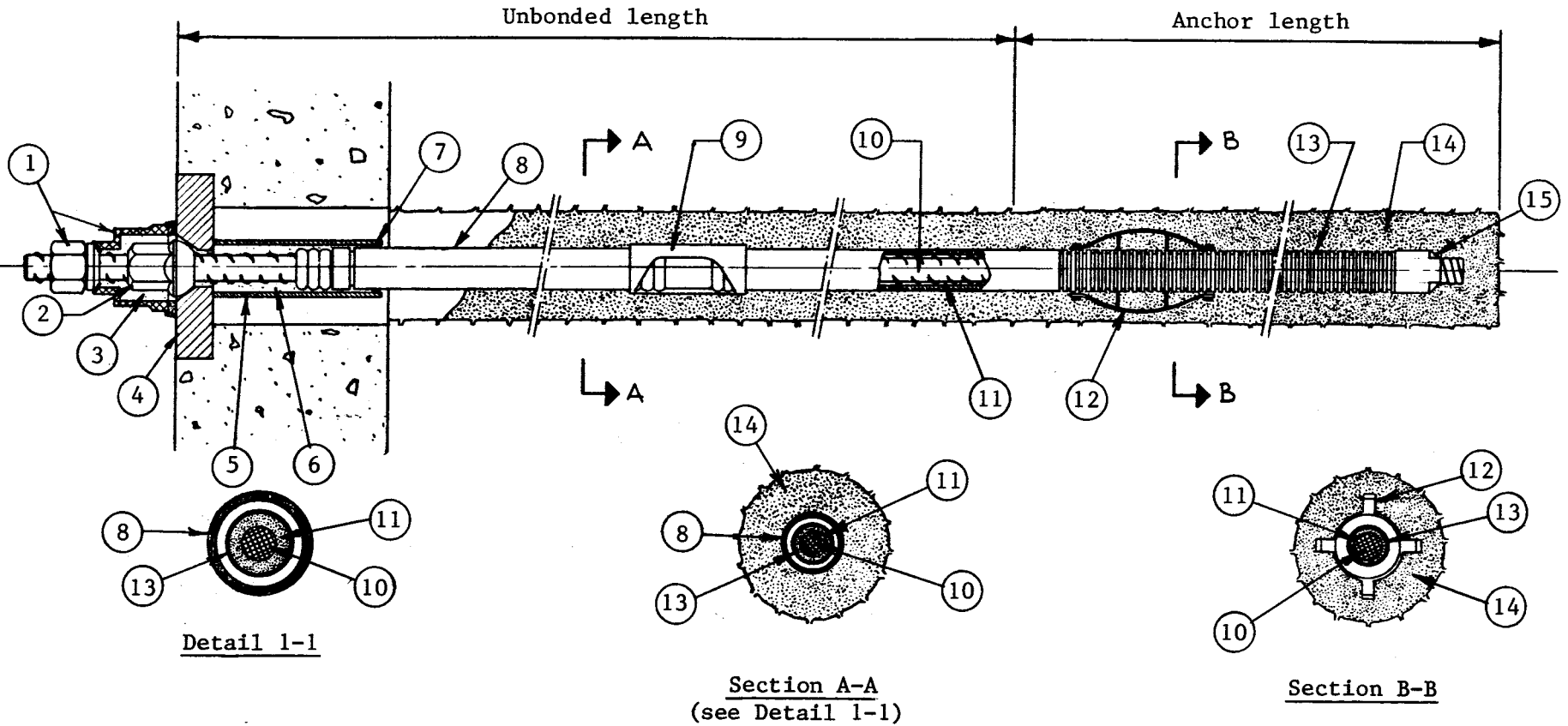

Legend:

- |                                  |                          |
|----------------------------------|--------------------------|
| 1. Anchorage cover               | 9. Protected bar coupler |
| 2. Nut                           | 10. Bar tendon           |
| 3. Anticorrosion grease          | 11. Encapsulation grout  |
| 4. Bearing plate                 | 12. Centralizers         |
| 5. Trumpet                       | 13. Corrugated PVC       |
| 6. Anticorrosion grease or grout | 14. Anchor grout         |
| 7. Seal                          | 15. End cap              |
| 8. PVC bond breaker              |                          |

Figure 45. Encapsulated bar tieback.



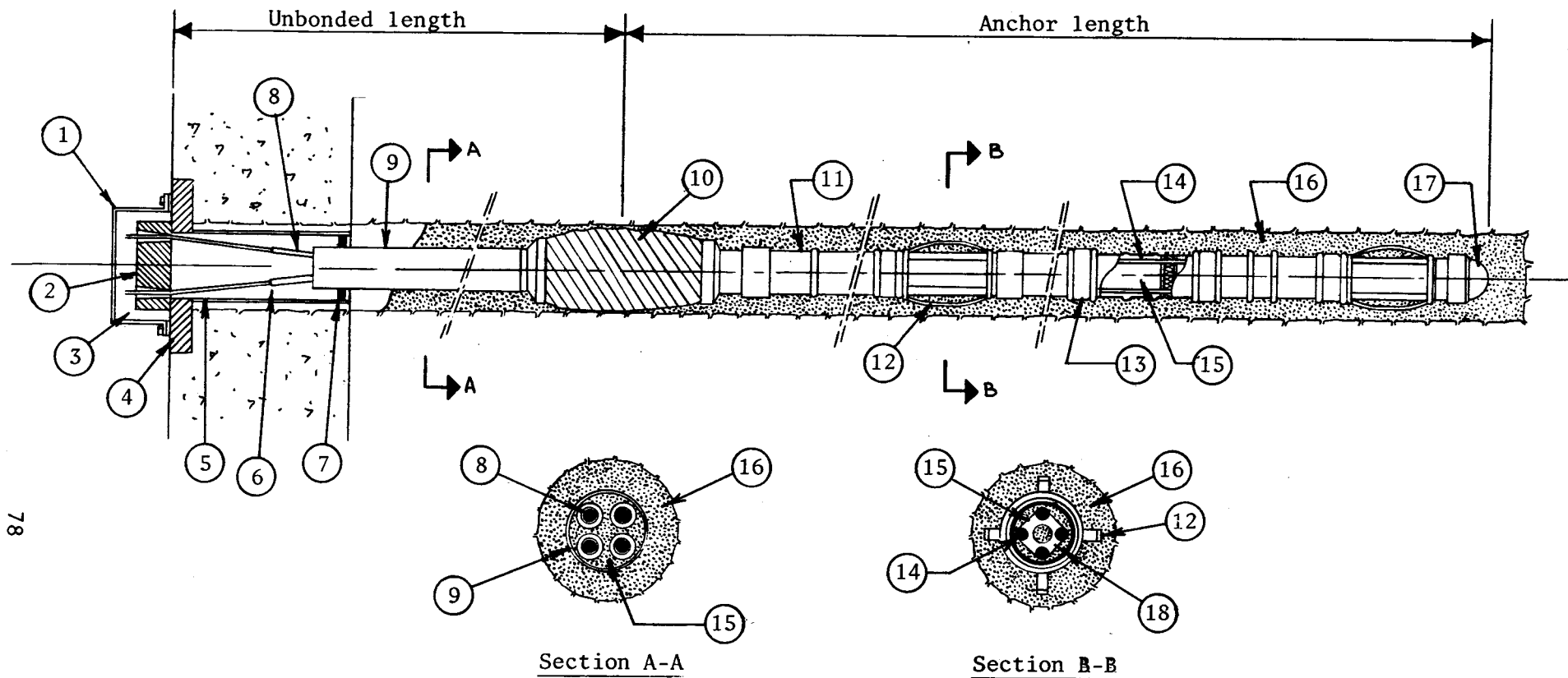

78

- 1. Anchorage cover
- 2. Anchor head and wedges
- 3. Anticorrosion grease or grout
- 4. Bearing plate
- 5. Trumpet
- 6. Anticorrosion grease or grout
- 7. Seal
- 8. Greased and sheathed strands
- 9. PVC bond breaker

Legend:

- 10. Inflatable bag
- 11. Deformed metal tube
- 12. Centralizer
- 13. Grouting valve
- 14. Strand
- 15. Encapsulation grout
- 16. Anchor grout
- 17. End cap
- 18. Spacer

Figure 47. Encapsulated TMD tieback.



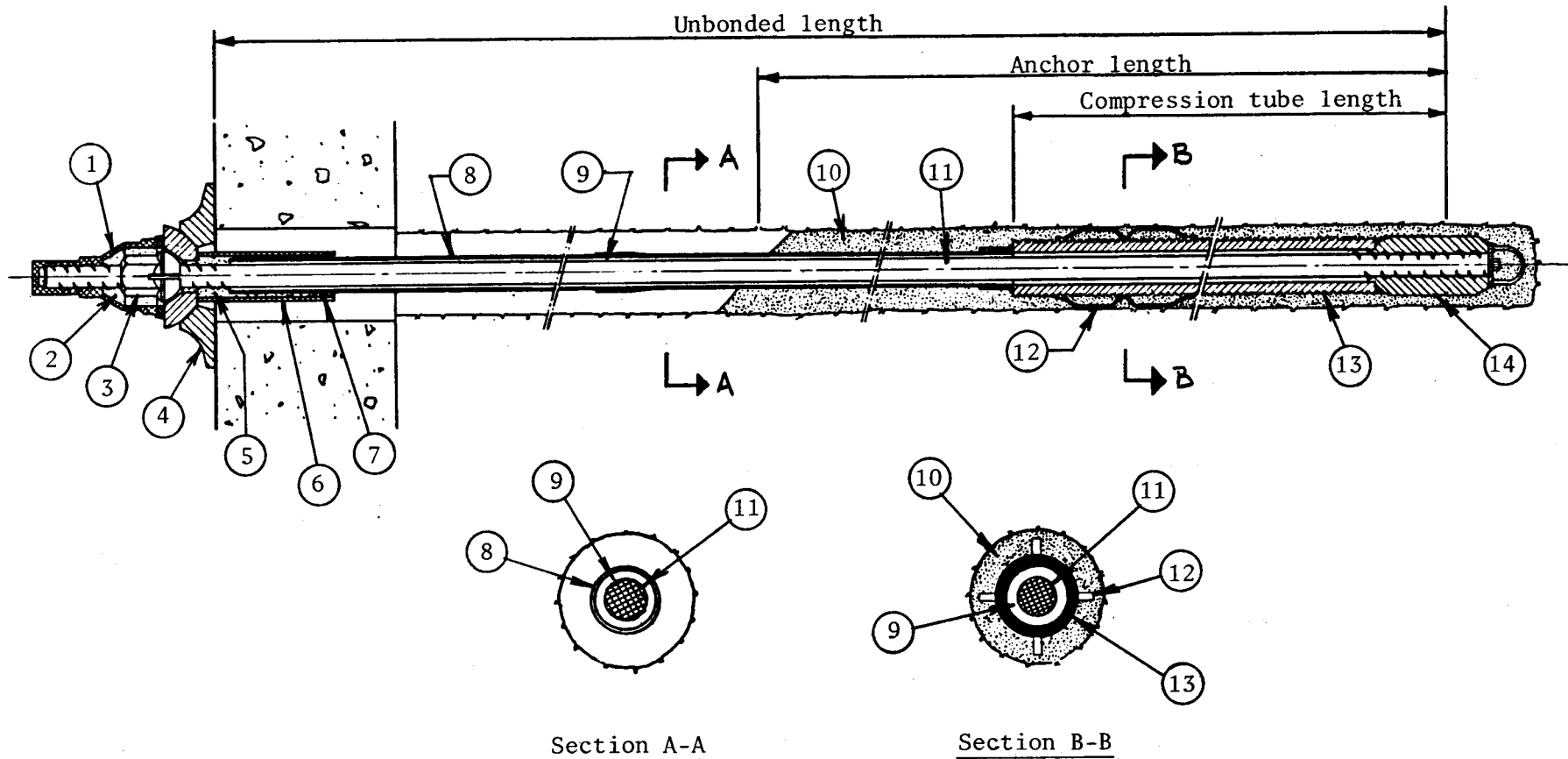

Section A-A

Section B-B

Legend:

- |                         |                         |
|-------------------------|-------------------------|
| 1. Anchorage cap        | 8. PVC pipe             |
| 2. Anticorrosion grease | 9. Anticorrosion grease |
| 3. Nut                  | 10. Anchor grout        |
| 4. Bearing plate        | 11. Bar tendon          |
| 5. Anticorrosion grease | 12. Centralizer         |
| 6. Trumpet              | 13. Compression tube    |
| 7. Seal                 | 14. Coupler             |

Figure 48. Compression tube tieback.

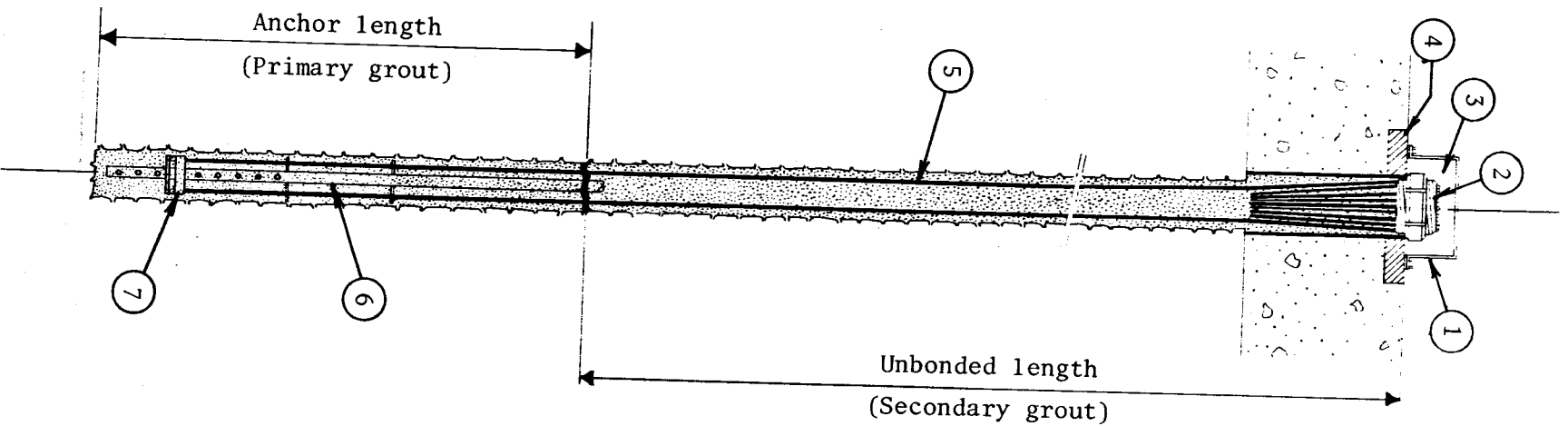

- Legend:
- 1) Anchorage cover
  - 2) Anchor head
  - 3) Anticorrosion grease or grout
  - 4) Bearing plate
  - 5) Wire tendon
  - 6) Grout tube
  - 7) End anchor plate

Figure 49. Primary and secondary grout used for corrosion protection of a wire tendon.

exerted on the grout by the end anchor plate can crush the grout if soft ground surrounds the grout. These tiebacks are primarily used in rock, where the anchor grout is adequately confined.

Secondary grouting is used to protect the unbonded length of bare tendons. First the anchor grout (primary grout) is placed and then the tieback is tested and locked-off. After lock-off the secondary grout is tremied into the unbonded length through a grout tube. Secondary grouting bonds the unbonded length of the tendon to the ground. Secondary grouting is more fully described on Page 149.

Many of the early rock tiedowns were made using end anchor plate button-headed wire tendons. Today, they are not common because:

- 1) Prestressing bars and strands can transfer the tieback force to the grout in bond.
- 2) End anchor plates and anchor heads are installed in the shop fixing the tieback length. The tieback length cannot be increased in the field.
- 3) Secondary grouting is often difficult because of damage to the grout tube or stoppages.
- 4) Permeable grout is likely to be present at the joint between primary and secondary grout.
- 5) Grout bleed may create voids under the bearing plate exposing the tendon to corrosion.

#### G. Protection at the Anchor Head

✱ The most critical area to protect from corrosion is in the vicinity of the anchor head. Below the bearing plate, the corrosion protection over the unbonded length must be terminated, exposing the bare tendon. Above the bearing plate, the bare tendon is gripped by either wedges or nuts, or deformed in the case of wires. Regardless of the type of tendon, the transfer mechanism creates stress concentrations, and mechanically damages the surface of the tendon.

It must be assumed that the environment at the anchor head is corrosive since oxygen, moisture and aggressive elements are readily available. The aggressiveness in this area is demonstrated by the fact that most corrosion failures occur within a short distance of the anchor head. Bending of the tendon at the anchor head also has contributed to failures of bar tendons. The draft British Code [54], and the German Standards [55] and [56] require the anchorage to be designed to prevent excessive bending of the tendon. ✱ The draft British Code [54] specifies that the angle between the tendon and the bearing plate may not vary from 90° by more than 5° in the case of a strand or wire tendon, and by more than 3° in the case of a bar tendon.

Figure 50 shows a corrosion protection system for the anchorage. A steel or plastic trumpet is used to transition from the anchor head to the unbonded length corrosion protection. One end of the trumpet is fastened to the bearing plate and the other end is fitted with a deformable seal. The seal fits tightly around the corrosion protection over the unbonded length, and allows the tendon to move within the trumpet. The annular space between the trumpet and the tendon is filled with anticorrosion grease or grout. The anchor head is protected by an anticorrosion grease, or grout filled

cover, or it is embedded in concrete. The anchor head is protected by a grease-filled cover if lift-off tests or load adjustments are anticipated. Care is required to ensure that the grease or grout fills the entire space inside the trumpet and the anchorage cover.

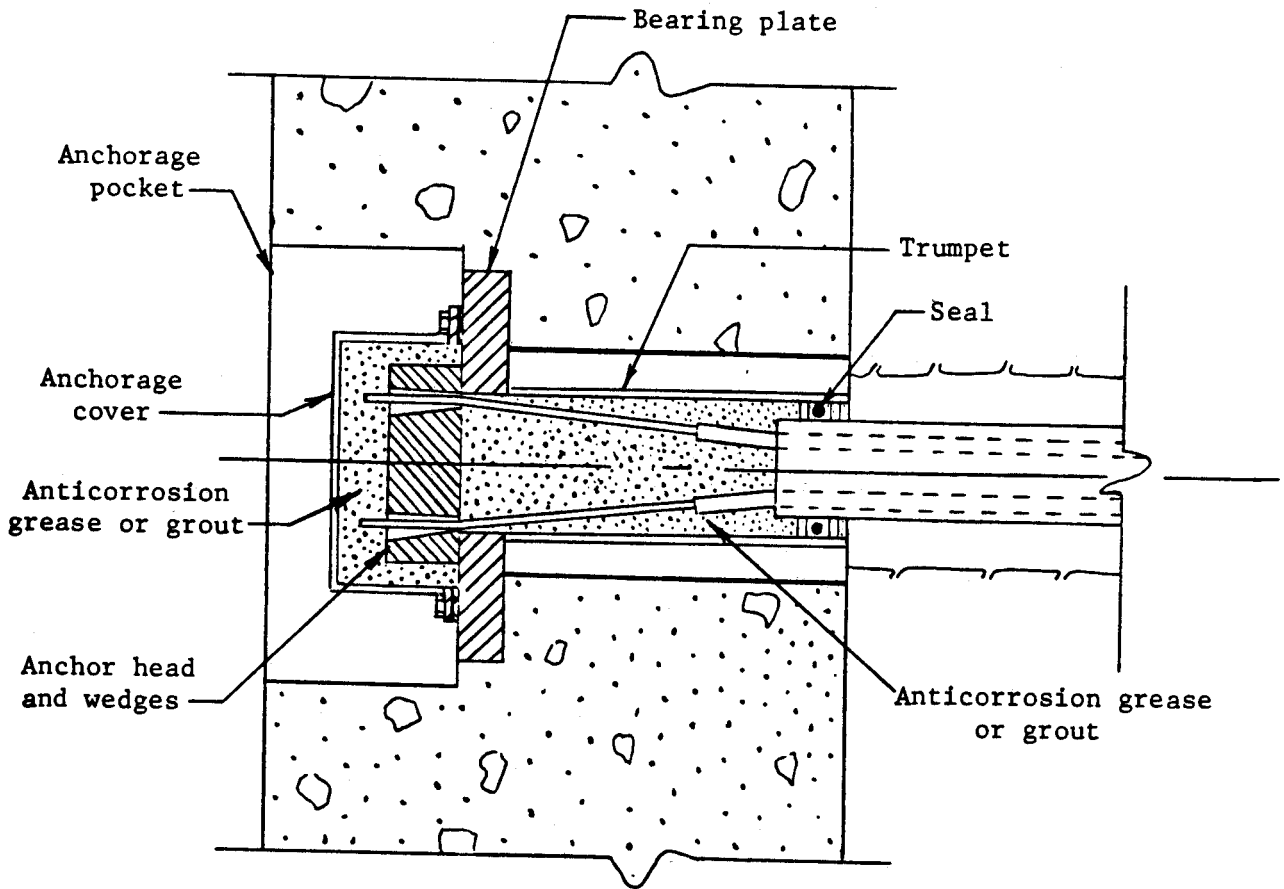

Figure 50. Permanent tieback anchor head protection.

#### POTENTIAL CORROSION MECHANISMS AFFECTING THE ANCHOR LENGTH

Tieback corrosion failures have not occurred in the anchor length. The known failures have all been in the unbonded length. However, since few tiebacks have been installed for a period of time equal to their service life, there is a question as to whether or not corrosion problems might develop with time. By identifying and studying the potential corrosion mechanisms that might affect the tendon within the anchor length, it becomes apparent why tiebacks have not suffered from corrosion along the anchor length, and how to design a corrosion protection system to further minimize the risk of corrosion. Four corrosion mechanisms might possibly affect the tieback tendon along the anchor length:

- 1) A local corrosion system, particularly at the upper end where the anchor grout cracks. This corrosion cell is solely influenced by the immediate soil environment, and the permeability and thickness of the grout cover.

- 2) A long-line corrosion system established between the tendon and steel in the structure to which it is electrically coupled (the rebars in a tiedback concrete wall).
- 3) A stray-current corrosion system where direct current enters a tiedback structure at one location and travels along the structure returning to the ground through a tieback.
- 4) A stray-current corrosion system where direct current enters a tieback tendon at one location along the anchor length and returns to the ground at another location along the anchor length.

#### A. Local Corrosion Systems

Figure 51 shows the local corrosion system that could theoretically affect the prestressing steel along the anchor length of a grout protected tieback. If this system develops, both the cathode and the anode would be located along the anchor length. In order for a local cell to exist, the tendon must be depassivated, and oxygen must be present in the soil. Depassivation occurs when the hydrous ferrous oxide film (passive film), which protects the tendon, is destroyed. Chlorides attack the passive film, and they are the most common depassivators. Acids also can depassivate a tendon by attacking the ferrous oxide film. The hydrous ferrous oxide film is soluble when the pH drops below about 4.5. Since the grout cracks at the top of the anchor zone, an aggressive environment could depassivate the tendon. Even if the tendon is depassivated, it will not corrode by local cell action if oxygen is not available in the soil around the anchor, and the pH is greater than 4.5. Uhlig [20] confirms that between a pH of 4 to 10 the corrosion rate is independent of pH, and depends only on the availability of oxygen at the metal surface. He also states that almost all natural waters have a pH between 4 and 10.

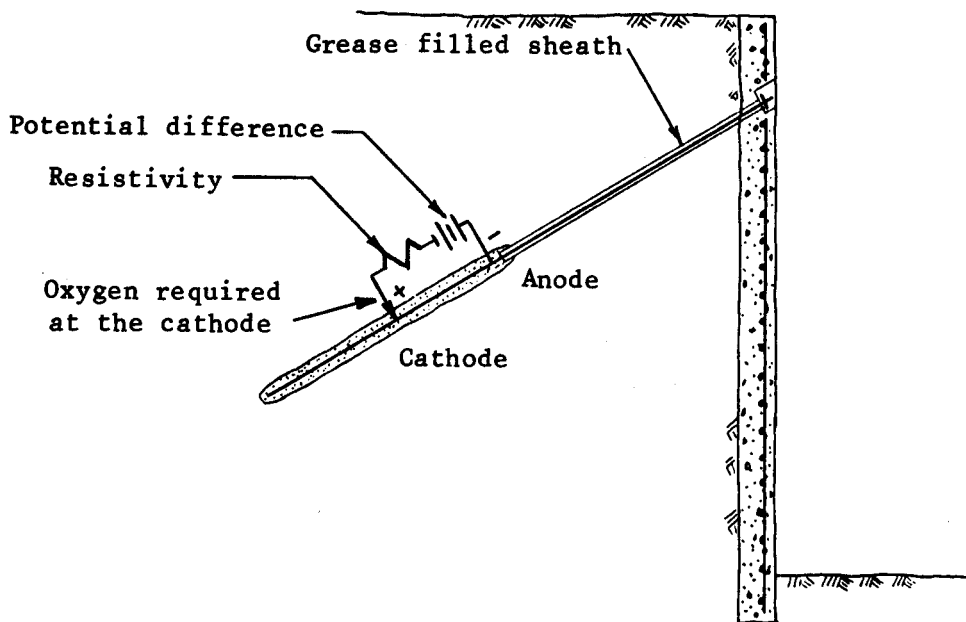

Figure 51. Local corrosion system that could affect a simple corrosion protected tieback.

The NBS pile corrosion studies indicated that natural soil deposits are oxygen deficient [20]. However, coarse-grained semiarid or arid soils located in the western United States may be potentially corrosive since atmospheric oxygen may penetrate to considerable depths. These soils are alkaline having large quantities of soluble salts. They can be easily identified, since they have high resistivities when dry (as great as 50,000 ohm-cm), and low resistivities when saturated (as low as 50 ohm-cm). They are usually damp less than three months of the year, but when damp they could be corrosive since oxygen, an electrolyte, and a depassivator, such as chlorides, are likely to be present.

If the groundwater or soil pH is below 4.5, then the ferrous oxide film may be attacked and the tendon may suffer acid attack. If this occurs, the corrosion reaction is not solely controlled by the availability of oxygen. At low pH's, portland cement may also be attacked. The amount of deterioration depends on the type of acid, the water-cement ratio of the grout, the grout permeability, and the circulation of the corrosive agent (See Page 137). Since the high pH of the grout provides the ideal environment for maintaining the ferrous oxide film, which protects the steel, then the steel should be encapsulated if the pH drops below 4.5, or if nearby buried concrete structures are known to suffer from chemical attack.

Tieback corrosion failures have not been caused by local corrosion cells established along the anchor length. This confirms that most undisturbed soils are oxygen deficient and that they have a pH above 4.5.

However, a fluctuating groundwater level in low resistivity soil (resistivity less than 2,000 ohm-cm) around the anchor length may initiate and sustain a local differential aeration cell. Since it is difficult to predict how the groundwater level will vary, the prestressing steel should be encapsulated if the resistivity is less than 2,000 ohm-cm.

The presence of sulfides increase the risk of stress-corrosion cracking or hydrogen embrittlement. Organic soils contain hydrogen sulfide, but the anchor lengths are normally not installed in these soils, since they are not suitable for developing tieback capacity. If sulfides are present in the soil surrounding the anchor length, then a permanent tieback tendon should be encapsulated regardless of soil pH or resistivity.

The tests required to determine the aggressiveness of the environment are described on Pages 93 and 94.

## B. Long-Line Corrosion System

Figure 52 shows the long-line corrosion system that could possibly affect a tieback. A long-line corrosion cell may be established if the tendon is depassivated within the cracked anchor grout, and electrically connected to steel in a structure. Reinforcing steel or steel piles exposed to the atmosphere, even if encased in concrete, will act as the cathode, and the depassivated areas on the tendon would become the anode. The corrosion current would flow from the tendon, through the soil electrolyte to the oxygenated cathode and back to the tendon completing the circuit. This differential aeration cell would cause pitting of the tendon. The attack could be severe since a large cathode (reinforcing steel embedded in an oxygenated concrete wall) is connected to a small anode (tendon in cracked

anchor grout). For the long-line cell to exist, the anode (tendon) must be depassivated, and the tieback tendon must be electrically connected to the cathode (steel exposed to oxygen).

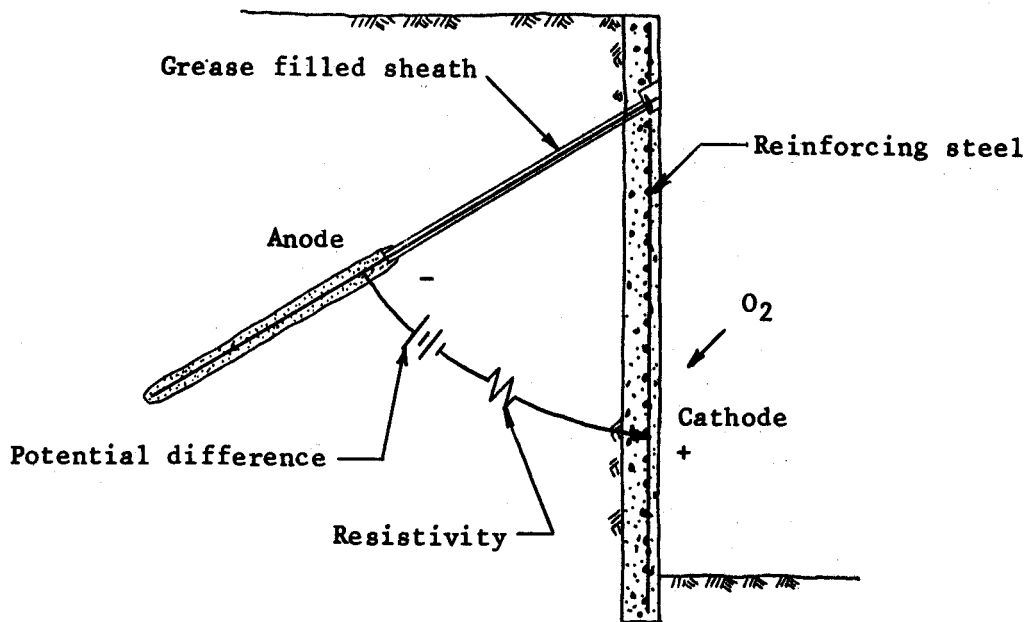

Figure 52. Long-line corrosion system that could affect a simple corrosion protected tieback.

Stratfull and Seim [60] reported a long-line corrosion system acting on steel piles at the Richmond--San Rafael Bridge. The steel piles were electrically coupled to the reinforcing steel in the concrete piers which were exposed to the atmosphere. Oxygen in the piers was being reduced on the reinforcing (cathode) to hydroxyl ions, while corrosion was occurring on the buried steel piles (anodes). They concluded that this corrosion cell could have been interrupted by cutting off the supply of oxygen to the reinforcing steel in the piers.

To date, no tieback corrosion failures have been attributed to long-line corrosion systems. This could be explained by several factors:

- 1) The tendons have not been depassivated.
- 2) The corrosion current is not strong enough to overcome the soil resistance.
- 3) Time has not been long enough for the accumulative effect of this weak corrosion cell to result in failure.

The potential long-line corrosion system can be easily prevented by electrically insulating a simple corrosion protected tendon from the structure, or by encapsulating the tendon. Encapsulation or insulation of the tendon will interrupt the corrosion circuit.

### C. Stray-Current Corrosion System

Two stray-current corrosion systems could affect a simple corrosion protected tieback. Experience with stray-current corrosion of other buried structures indicates that the corrosion mechanism shown in Figure 53 is potentially aggressive. If this system develops, direct current would enter a tieback structure, travel along the structure, and discharge back to the soil through a tieback. Corrosion would occur where the current discharged from the tendon. In order for this system to exist, the tieback tendon has to be electrically connected to the structure and the ground. Figure 54 shows the other system which theoretically could develop if the tendon is electrically connected to the ground and a stray-current enters the tendon and discharges back to the soil at another point along the tieback's anchor length. The corrosion system shown in Figure 54 should not seriously affect a tieback because the anchor length is short preventing the possibility of significant potential differences along its length, and it is surrounded by a reasonably good insulator (grout). In practice, tieback corrosion failures have not been attributed to stray-current corrosion. Both stray-current corrosion systems theoretically could be prevented by using impressed cathodic protection (See Page 89), or encapsulation (See Page 71), or bonding. Impressed cathodic protection would prevent corrosion current from being discharged from the tendon. Encapsulation would interrupt the corrosion circuit. Bonding would provide a metallic path for the current to return to the negative bar of the current source instead of discharging through the tieback. Electrically insulating the tieback from the structure it supports would interrupt the corrosion system where the corrosion current travels along the structure and then discharges back to the soil through a tieback.

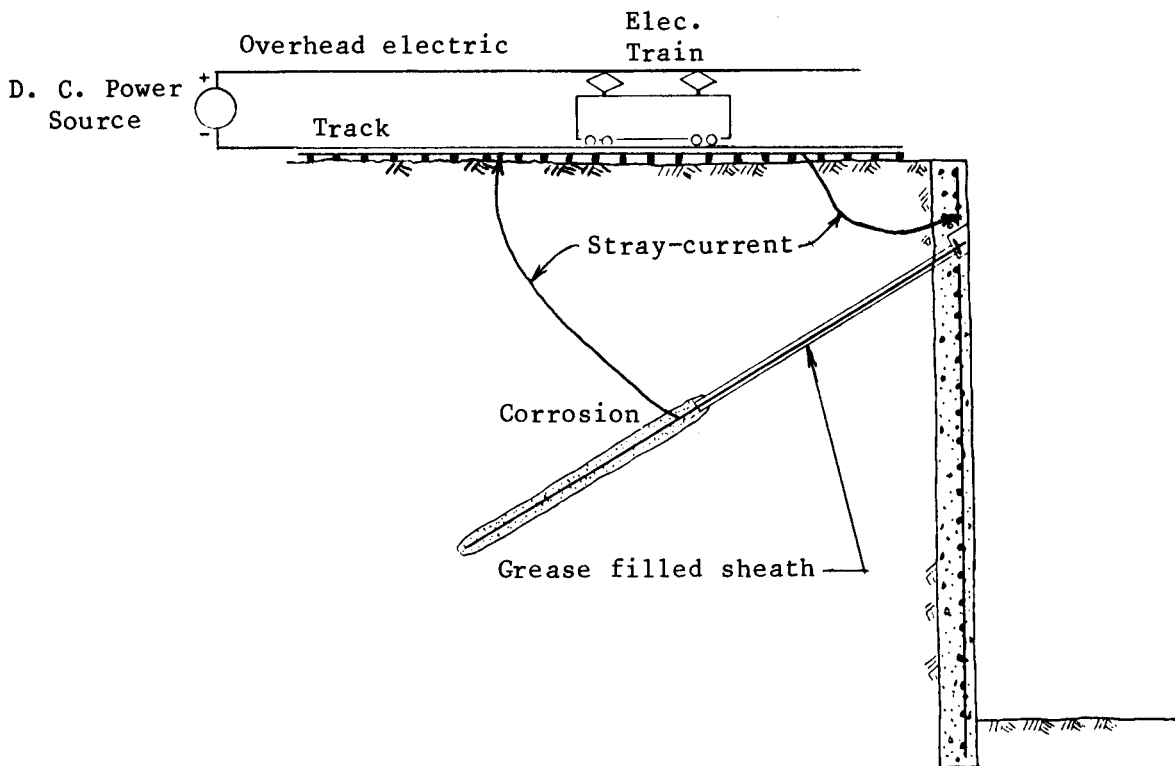

Figure 53. Most feasible stray-current corrosion system that could affect a simple corrosion protected tieback.



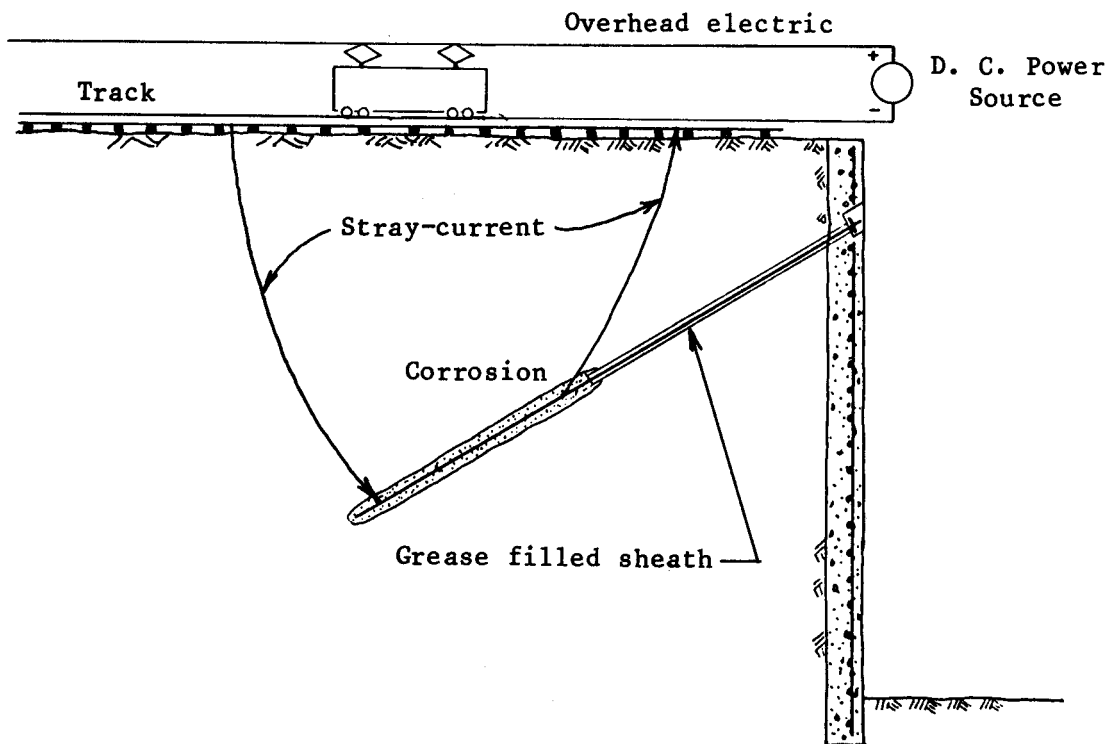

Figure 54. Theoretically possible stray-current corrosion system that could affect a simple corrosion protected tieback.

POTENTIAL CORROSION MECHANISMS AFFECTING THE UNBONDED LENGTH AND ANCHOR HEAD

The unbonded length and anchor head of a tieback is exposed to a variety of corrosive environments. All of the known corrosion failures have occurred in the unbonded length, and most of them occurred near the anchor head. The corrosion performance of tiebacks indicates that, the unbonded length, and the anchor head of permanent tiebacks should be carefully protected.

The unbonded length of temporary tiebacks normally will not require any protection (See Figure 41). Their unbonded length should be protected if the service life is more than 12 months, and the tendon is exposed to:

- 1) A fluxuating salt water level.
- 2) Soils with a pH less than 4.5 (slag, acid mine wastes and industrial wastes).
- 3) Soils containing large amounts of H<sub>2</sub>S (organic fills and natural soil deposits).

The tests required to determine the aggressiveness of the environment are described on Pages 93 and 94. Temporary tieback protection is described on Page 95.

## EVALUATION OF POTENTIAL TIEBACK CORROSION PROTECTION METHODS

Various corrosion protection methods were evaluated to determine if they should be recommended for protecting tieback tendons.

### A. Metallic Coatings

In the past, prestressing steels were galvanized in an attempt to improve their corrosion resistance. Today, prestressing steels are not galvanized because:

- 1) They may contact bare steel and cause a dissimilar metal corrosion system to develop.
- 2) Zinc coatings are sacrificial and atomic hydrogen is evolved as the galvanizing is consumed. Atomic hydrogen could cause hydrogen embrittlement of the tendon.
- 3) Galvanizing only provides protection until it is consumed [16].

Galvanizing or cadmium plating, a similar sacrificial coating, should not be used for the protection of tieback tendons.

### B. Nonmetallic Coatings

Coal-tars, vinyls, epoxies, urethanes, and other coating materials have been evaluated to determine whether or not they could be used to protect reinforcing bars in bridge decks [61]. The tests showed that only electrostatically applied epoxies (powdered epoxies) had adequate bond strengths, creep characteristics, and flexibility. Powdered epoxies may be damaged during handling, and it is impractical to expect a holiday-free coating. Small holidays do not impair the performance of normal reinforcing but, they may impair the performance of coated prestressing steels if a long-line or stray-current corrosion system develops. Then, the corrosion attack would be concentrated at the holidays increasing the likelihood of pitting.

Insulating coated tieback tendons from the structure would interrupt any long-line corrosion system, and the stray-current corrosion system where the corrosion current travels along the structure and discharges back to the soil through a tieback. Coating insulated tieback tendons would practically prevent any local corrosion system, and should also eliminate any stray-current corrosion system where the corrosion current enters the tendon and discharges back to the soil at another point along the same tendon. For a local corrosion system to develop on a coated tendon, the anchor grout must be cracked at a coating holiday, the tendon must be depassivated at the holiday, and oxygen and an electrolyte must be present in the soil. In addition, the corrosion current and the anode corrosion current density would be very small if a local corrosion cell developed on a coated tendon since the anode and the cathode would be established on the same holiday. Coatings have been successfully used to prevent hydrogen blistering of storage containers, and a coating impervious to hydrogen should also protect a tieback from hydrogen embrittlement.

At this time, coatings have only been applied to bar tendons. Coated, deformed bar tendons develop high mechanical bond strengths, and before

using powdered epoxy coated bars in aggressive environments pullout tests need to be performed to evaluate whether or not powdered epoxied prestressing bars can withstand abrasion resulting from relative motion between cracked grout and the tendon.

#### C. Estimation of Metal Loss

Estimation of corrosion caused metal loss is commonly used to size many buried steel structures. These structures are not destroyed by pitting corrosion. The assumption is that uniform surface corrosion is occurring on the metal, and its cross-sectional area is increased to allow for the metal loss. When a structure is sensitive to pitting, i.e., pipe lines and prestressing steel; a small amount of corrosion could cause failure.

#### D. Admixtures

Using admixtures to prevent corrosion is desirable because they would be simple to use. Calcium nitrite has been used as a corrosion inhibitor in reinforced concretes exposed to chlorides, but it has not been used to inhibit corrosion of prestressing steels.

More research is required in order to determine whether or not admixtures can be effective in preventing prestressing steel corrosion. Even if other admixtures are developed for reinforced concrete, they must be evaluated to determine if they can protect prestressing steels from pitting and embrittlement corrosion.

#### E. Impressed Cathodic Protection

Impressed cathodic protection systems are used to protect buried steel piles and pipe lines. These systems use an external power source to apply a direct current in the proper direction so that corroding anodes are prevented from discharging metallic cations. Impressed current systems must be constantly maintained in order to function properly. Atomic hydrogen may be involved at cathodic sites on the metal being protected, in this case the tendon, if the system is not maintained. Atomic hydrogen could cause hydrogen embrittlement, particularly in the presence of sulfides. At this time, potential evolution of hydrogen, and the need for constant maintenance make impressed cathodic protection systems undesirable for tieback tendon protection. In the future, impressed cathodic protection systems may use automatic monitoring and control units which could adjust the applied voltage to each tieback and make impressed current systems safe for use with tiebacks.

#### F. Sacrificial Anode Cathodic Protection Systems

Sacrificial anode cathodic protection systems are also used to protect buried structures. In these systems, an anodic metal electrode is electrically connected to the metal to be protected. The electrode is higher on the electromotive series than the protected metal. Zinc and magnesium are the most common sacrificial anodes used with steel in concrete. A dissimilar metal cell is established when zinc or magnesium is connected to a steel tendon. The zinc or magnesium anode corrode while the cathode is protected.

Sacrificial anodes could be used to protect electrically insulated, simple corrosion protected prestressing steel along the anchor zone. A zinc anode would be the safest anode for this purpose since the driving potential between it and steel is relatively low. A magnesium anode would have a higher driving potential which increases the possibility of evolving hydrogen atoms on the surface of the steel. Hydrogen embrittlement could result if hydrogen atoms are produced by overprotecting the tendons and sulfides are present.

The corrosion performance of tiebacks has not indicated that a sacrificial anode cathodic protection is required. Insulated, simple corrosion protected tiebacks (See Figure 55) with sacrificial anodes could be monitored to determine whether or not they could resist attack in low resistivity soils. The monitoring procedures and equipment are described on Pages 97 -- 101.

#### G. Tapes, Jackets, and Heat Shrinkable Sleeves

Buried metal structures use coated or impregnated tapes, tightly extruded jackets, and adhesive lined heat shrinkable sleeves for corrosion protection. Some of these products are proprietary. These materials are semirigid, and they can withstand a reasonable amount of impact and abrasion without damage. Tapes, jackets, or heat shrinkable sleeves with a Buna rubber sealant are designed for buried applications. They can be used to protect the unbonded length of a tieback tendon.

#### H. Corrosion Inhibiting Greases

Corrosion inhibiting greases have been used to protect unbonded prestressing steel. The majority of the tendons used in reactor containment vessels are protected with these greases. The greases are organic, petrolatum-based compounds. They are formulated to bond to steel, displace water, be self-healing, thixotropic, and have a high reserve alkalinity. Corrosion inhibiting greases are used inside the sheaths, trumpets, and anchorage covers of permanent tiebacks. They have provided excellent protection for the unbonded length and anchor head.

#### I. Electrical Insulation

Insulated flanges are used to interrupt stray-current and long-line corrosion systems that might affect buried pipelines. Tiebacks should be insulated from the structures they support. Simple corrosion protected tiebacks will require electrical insulation between the anchor head and the structure to insulate them from the structure. Plastic or steel encapsulation of the entire prestressing steel (Figures 45, 46, and 47) will also interrupt the stray-current or long-line corrosion systems.

#### J. Cement Cover

Portland cement encapsulation is a common method of protecting prestressing steels from corrosion. A detailed discussion of the corrosion protection qualities of cement is contained on Pages 57--61. Briefly, hydrated cement provides a high pH environment, normally greater than 12.5. Steel surrounded by an alkaline environment with a pH greater than 9.5 will be protected by a passive film. Aggressive anions, particularly chlorides,

or carbonation can locally destroy the passive film. Depassivated steel will corrode in the presence of oxygen and moisture. Hydrogen sulfide has caused brittle failures of prestressing steels surrounded by cracked cement grout or permeable concrete or grout.

Grout protected tiebacks have not failed due to corrosion but there is still some question as to whether or not cement grout will provide adequate protection for a service life of 50 or 100 years. In nonaggressive environments (pH greater than 4.5, resistivity greater than 2,000 ohm-cm, and very low sulfide content) cement grout is suitable for corrosion protection along the anchor length unless other buried concrete structures are deteriorating as a result of chemical attack. A pH greater than 4.5 will assure that the tendon will not be subjected to acid attack. A resistivity greater than 2,000 ohm-cm indicates that there are relatively few aggressive anions, particularly chlorides, in the soil electrolyte, and the electrolyte is a poor conductor. A very low sulfide content indicates that hydrogen sulfide is not present in the soil. The role sulfides play in the corrosion of prestressing steels is not completely understood and the sulfide content below which corrosion will not occur has not been determined. If the sulfide test on Page 94 indicates the presence of sulfide, encapsulated tiebacks should be used.

In conclusion, portland cement grout may be used for the protection of the anchor length of a permanent tieback if:

- 1) The tendon is electrically insulated from the structure.
- 2) The anchor length is in oxygen deficient ground (undisturbed natural soils, rocks, or fills below the water table).
- 3) The pH of the ground is greater than 4.5. (If other buried concrete structures in the vicinity are experiencing chemical attack, then the tendon should be encapsulated regardless of pH.).
- 4) The resistivity of the soil is greater than 2000 ohm-cm.
- 5) The sulfide test described on Page 94 indicates sulfides are not present in the soil surrounding the anchor length.

#### K. Encapsulation

Prestressing steels are protected by encapsulating the tendon inside a grout filled steel or plastic duct. In the United States, galvanized ducts are frequently used, and dissimilar metal corrosion cells have not developed between the tendon and the duct.

A plastic or metal tube can be used to encapsulate a tieback tendon since it acts as a barrier preventing:

- 1) The tendon from being depassivated.
- 2) Sulfides from reaching the tendon.
- 3) Oxygen from reaching the tendon and creating or maintaining a local corrosion system in low resistivity (2000 ohm-cm) soils.
- 4) Acid attack of the tendon in low pH environments.
- 5) Long-line and stray-current corrosion systems.

The capsule should be capable of withstanding damage during shipment, storage, and installation. It also must be capable of transmitting bond stresses from the grout surrounding the tendon to the anchor grout.

## L. New Tendon Materials

Stainless steels, and carbon or glass fibers are known to be resistant to corrosion. Stainless prestressing steels are not commercially available. It is not likely that they will be developed soon because they would be expensive and susceptible to brittle corrosion at high stresses. Carbon or glass fibers have been developed with high ultimate tensile strengths. It is possible that synthetic tendon material may be developed in the future, but it is unlikely that stress-relieved prestressing steels will be replaced in the near future.

### RECOMMENDATIONS FOR TIEBACK CORROSION PROTECTION

If encapsulated or compression tube tiebacks could be installed for about the cost of a simple corrosion protected tieback, then it would be logical to recommend these protections for all applications. However, these protections are significantly more expensive than grout protection of the anchor length. The material for an encapsulated or compression tube tieback adds between \$200.00 and \$500.00 (1981 dollars) to the cost of a tieback. These extra costs are typical over a wide range of loads and tieback lengths. In addition, the installation costs for these tiebacks may be two or three times that of a grout protected one. Encapsulation or compression tubes increase the diameter of the tendon, and larger tendons affect the drill hole diameter and may preclude economical installation methods.

For example, a 3 inch (76 mm) driven casing can be used to install bare strands and coated bar tendons in cohesionless soils. The inside diameter of the casing is about 2 inches (50.8 mm). Encapsulated or compression tube tiebacks require 4.5 or 5 inch (114.3 or 127 mm) casing. Casing in these diameters must be rotary drilled since they cannot be driven to the necessary depths. Rotary drilled tiebacks are grouted using different techniques than those used for driven casing. These grout methods increase the cost of the tieback and the length required to develop the desired capacity. Schnabel Foundation Company finds that rotary drilling often doubles the cost of a 180 kip (801 kN) tieback in sand.

The cost of a tieback in rock is also affected by the diameter of the drill hole. Medium size air tracks are capable of drilling holes up to 4 inches (101.6 mm) in diameter. If the corrosion protection system requires a larger hole, more expensive drilling equipment or different methods are required. Holes between 4 and 5 inches (101.6 and 127 mm) in diameter can be drilled with a large air track. These holes cost about 40 percent more per foot of depth than a smaller one. Down-the-hole-hammers are required to drill holes larger than 5 inches (127 mm) in diameter. The hammer is mounted on a rotary drill which is 2 to 3 times as expensive as a medium sized air track, and their penetration rate is about 1/2 to 1/3 as fast as an air track for holes less than 100 feet (30.5 m) long.

This cost comparison between installation methods, hole sizes, and protection materials is provided to illustrate how the corrosion protection system can affect the cost of a tieback. Cement grout can protect tieback tendons in certain environments, while encapsulation or compression tubes

are necessary in aggressive environments. The following recommendations permit the most economical corrosion protection to be used without compromising the protection of the tendon.

The type of corrosion protection chosen for a particular project will depend upon the:

- 1) Aggressiveness of the environment.
- 2) Relative costs of the various protection systems.
- 3) Tendon type.
- 4) Installation methods.
- 5) Risk associated with a tieback failure.
- 6) Contractors' patents.

#### A. Soil Tests and Field Observations

Soil tests and field observations are used to classify the aggressivity of the environment. Soil aggressivity is influenced by:

- 1) The resistivity of the soil.
- 2) The pH of the soil.
- 3) The chemical composition of the groundwater and the soil.
- 4) The water and air permeability of the soil.
- 5) The groundwater elevation (stable or fluctuating).
- 6) External electrochemical and physical factors (long-line and stray-current corrosion systems).

The following tests and observations should be made to evaluate these factors, and provide information for estimating the corrosivity of the ground.

#### Soil Resistivity

The electrical resistivity of the soil is the simplest method of estimating its corrosivity. Soil resistivity depends on the nature and quantity of dissolved salts in the soil and its moisture content. Soil resistivity can be measured in the laboratory or the field. ASTM 57-78, Standard Method for Field Measurement of Soil Resistivity Using The Wenner Four-Electrode Method, describes the test.

Field resistivity measurements are made on fresh boring samples immediately after removal from the sampling device. Laboratory measurements are made on samples which were sealed in air tight containers for shipment and storage. The samples should be taken from the different strata along the tieback. Boring and recovery techniques should prevent sample contamination from wash boring water.

A soil box is used to determine soil resistivity. The writer's soil box required approximately 17.5 in<sup>3</sup> (28.7 cm<sup>3</sup>) of soil. A current is applied to two electrodes at the end of the box, and the voltage drop between two interior electrodes is measured using a soil resistance meter. The resistivity is read directly on the meter. The resistivity should be determined for the soil at the natural moisture content, and again when it is saturated with distilled water. The lowest resistivity should be used for evaluating the tieback corrosion protection requirements.

## Hydrogen Ion Concentration

Hydrogen ion concentration (pH) should be measured on fresh boring samples as soon as they are recovered from the bore hole. The pH of soils may undergo changes if they are exposed to the atmosphere or allowed to dry. There are a variety of portable meters which can be used to measure pH. ASTM G 51-77, Standard Test Method for pH of Soil for Use in Corrosion Testing, describes the tests.

## Chemical Properties of the Soil and Groundwater

The presence of sulfides, and the soluble sulfate content should be determined. Field tests can be used to determine if sulfides are present. Laboratory tests are required to determine the soluble sulfate content.

A sodium azide-iodine qualitative test is used to detect sulfides. Nitrogen gas is evolved when a 3 percent sodium azide in a 0.1 N iodine solution is added to a soil containing sulfides. The rotten egg smell or the amount of bubbling observed provides a qualitative indication of the sulfide content of the soil. This test must be performed in the field on a fresh sample.

Laboratory tests are performed to determine the soluble sulfate content. Samples uncontaminated by wash water should be recovered and placed in sealed containers for storage and shipment to the laboratory. The sulfate content is determined since sulfates may attack portland cement grout (See Page 137). The quantity of soluble sulfates is reported as milligram-equivalents per kilogram of soil. The milligram-equivalent is the chemical equivalent weight of the sulfate radical expressed in milligrams.

## Physical Properties of the Soil and Groundwater

The soil should be completely described. The Unified Soil Classification System [62] provides a good description of the physical properties of the soil. Whether the soil is a natural deposit or a fill, the location of nearby mining operations, and the proximity of the site to chemical plants or chemical storage areas should be indicated.

The groundwater level should be measured, and fluctuations in the level should be noted. Highly permeable soils with flowing groundwater should be identified since these waters may transport aggressive anions.

## Potential Stray Current Sources

Existing impressed current and sacrificial anode cathodic protection systems should be identified. Potential sources of stray direct currents should also be noted. Direct current railways, welding operations, mine transportation equipment, and grounded industrial equipment are potential sources of stray direct current.

## B. Recommended Corrosion Protections

Each current tieback standard uses service life to determine if a tieback should be protected. This could be dangerous for unprotected temporary tiebacks, since unprotected tiebacks in aggressive environments



have failed within one year of installation. The writer recommends that a functional definition for temporary and permanent tiebacks be used rather than a service life definition. A permanent tieback is one which will become part of a permanent structure, while a temporary tieback is only required during construction. This distinction is important since tiebacks with short service lives (less than 2 years) may require corrosion protection.

Soil tests and field observations should be used to evaluate the aggressiveness of the environment. Romanoff [16], Boyd and Nowacki [63], Rehm [64], the AWWA [65], the French Recommendations [53], and the draft British Code [54] have developed systems for rating the aggressivity of soil environments. Not all the rating systems were developed for tieback applications but they provided the background for developing the following tieback corrosion protection recommendations.

Chapter 8 contains a description of the corrosion protection materials used to fabricate a tendon. A general description of the corrosion protection is given here.

#### Permanent Tieback Protections

Simple corrosion protected tiebacks similar to those shown in Figure 55 will satisfactorily protect a permanent tieback if the soil surrounding the anchor length has a pH greater than or equal to 4.5, not caused chemical attack to other buried concrete structures, a resistivity greater than or equal to 2,000 ohm-cm, and no sulfides present. The minimum sulfide content which could be tolerated has not been determined at this time. The prestressing steel should be electrically insulated from the structure it supports.

Encapsulated tiebacks similar to those shown in Figures 45, 46, and 47; or a compression tube tieback, Figure 48, are recommended for permanent applications if the soil surrounding the anchor length has a pH less than 4.5, or caused chemical attack of other buried concrete structures, or a resistivity less than 2,000 ohm-cm, or sulfides present.

An electrically insulated, simple corrosion protected tieback can be inspected if an insulated test lead wire is attached to the tendon and another lead wire is attached to the rebars or wales in the structure. To determine if the tendon has been properly insulated, one can apply a voltage to the tendon and use an ammeter to measure any current flow. If the tendon has not been insulated from the structure, then a current indicating little or no circuit resistance should be measured. A small current flow may be measured if current flows from the anchor zone through the soil to steel at the wall.

#### Temporary Tieback Protection

Most temporary tiebacks will not require any special corrosion protection. Based on the corrosion performance of stress-relieved prestressing steels, it is reasonable to assume that unprotected tieback tendons in nonaggressive environments should perform satisfactorily for at



least five years. However, the unbonded length of a temporary tieback should be protected if the service life exceeds 12 months, and if the unbonded length passes through:

- 1) A soil with a pH of 4.5 or less.
- 2) Cinder, ash, or slag fills.
- 3) Tidal marshes.
- 4) Salt water.
- 5) Organic fills containing humic acid.
- 6) Peat bogs.
- 7) Acid mine wastes.
- 8) Industrial wastes.

#### Protection During Storage, Shipping and Handling

Prestressing steels should be protected from the environment. A light coating of rust on the prestressing steels is acceptable. Heavy pitting or corrosion should not be present. Small pits that develop during storage can cause stress concentrations and possible failure of the tendon.

#### POTENTIAL CORROSION PROTECTION IMPROVEMENTS

The corrosion mechanism for buried steels is understood. However, our ability to predict how a steel will perform is limited. At present, no research has been directed toward field evaluation of the level of corrosion protection required for a permanent tieback.

The basic corrosion protection decision is whether or not to rely on the anchor grout to protect the prestressing steel or to fully encapsulate the steel. For many tieback systems, encapsulation can significantly increase their cost. The following tests should enable a scientific evaluation of cement grout corrosion protection, electrical insulation, and determine whether or not simple corrosion protected tiebacks can be used in aggressive low resistivity soils (less than 2,000 ohm-cm).

The tests should be performed on insulated tiebacks similar to the one shown in Figure 55. The test tiebacks should be installed in different aggressive and nonaggressive soils. Two #12 insulated lead wires (Numbers 1 and 2) should be attached to the tendon at the anchorage, and two lead wires (Numbers 3 and 4) should be attached to steel in the wall or a soldier beam supported by the tieback. All four lead wires should be terminated in a waterproof enclosure at a permanently accessible location. The following tests can then be performed:

- 1) Test No. 1 - Check the insulation of the anchor head. Apply a known voltage between lead wires 1 and 3 and measure the current in the circuit before load testing the tieback (See Figure 56). Calculate and record the circuit resistance. A current which indicates a very low circuit resistance means that the tieback was not properly insulated. A small current flow may be detected, since current can also flow from the tieback tendon through the soil to steel in the wall. This circuit should have a high resistance.

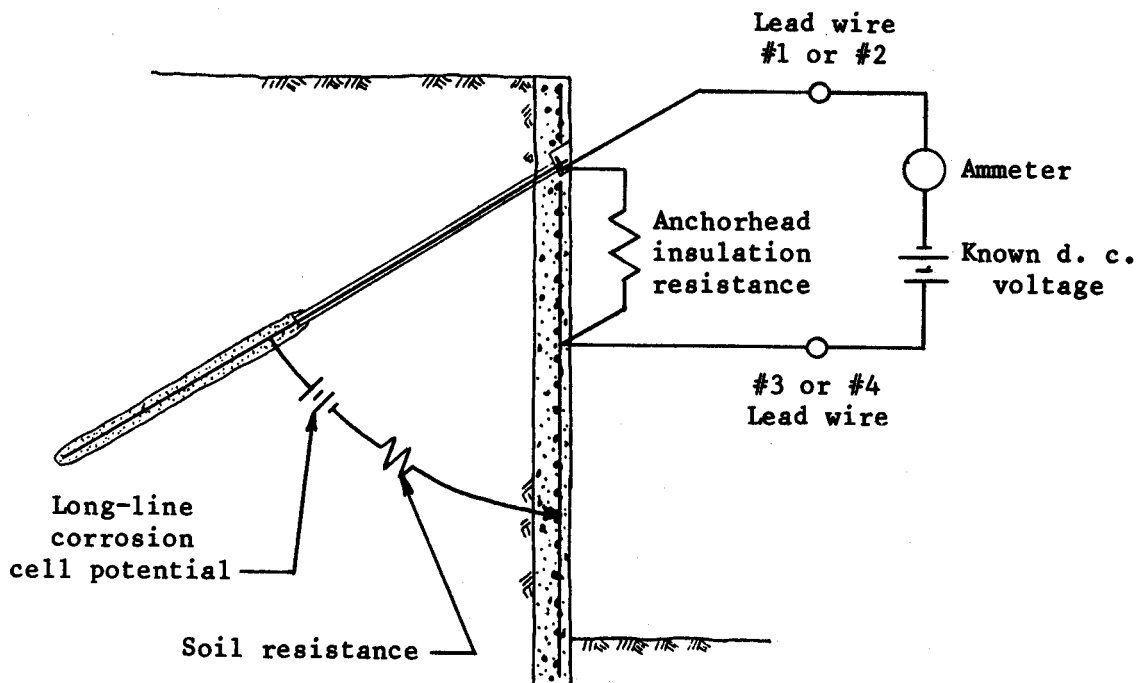

Figure 56. Test arrangement for checking anchor head insulation.

- 2) Test No. 2 - Determine the circuit resistance after load testing. Repeat Test No. 1 after the tieback has been load tested and locked-off. Measure the current, and calculate and record the circuit resistance. A current which indicates a very low circuit resistance means that the insulation at the anchor head was damaged during loading. If the current observed indicates that the insulation was not damaged, then a significant change in resistance from that observed in Test No. 1 indicates that an electrolyte has come in direct contact with the tendon when the anchor was loaded. Since these tests have never been performed a corrosion engineer should be used to determine what constitutes a significant change in resistance.
- 3) Test No. 3 - Determine whether or not a long-line corrosion system exists. With no external voltage applied, measurement of the voltage and current between wires 1 or 2 and wires 3 or 4 will indicate the direction and magnitude of the long-line corrosion current which would exist if the tieback was not insulated from the structure (See Figure 57). If long-line corrosion current is observed, then electrical insulation should continue to be used to interrupt the corrosion circuit. If the long-line cell does not exist, then electrical insulation of simple-corrosion protected tiebacks can be discontinued.

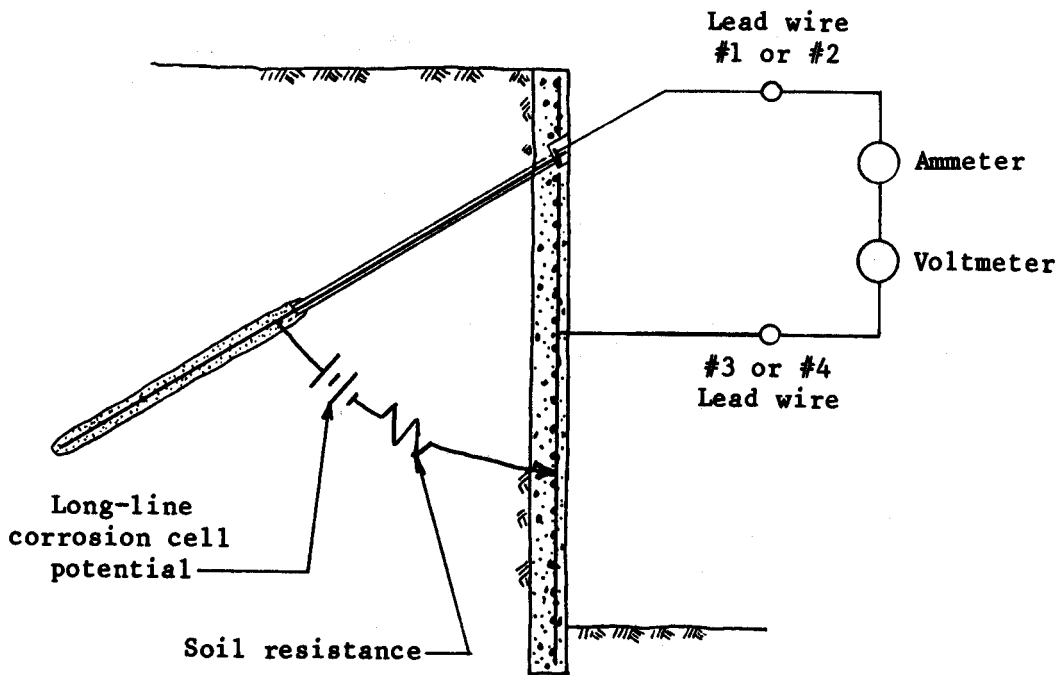

Figure 57. Test arrangement for measuring the direction and the magnitude of the long-line corrosion current.

- 4) Test No. 4 - Determine changes in aeration on the tendon surface. The measurement of the grout protected tendon potential to a copper sulfate reference electrode will indicate changes in aeration on the tendon surface. The potential differences are measured between lead wires 1 or 2 and lead wire 5, which is connected to a copper sulfate electrode located above the grouted anchor (See Figure 58). The measurements should be made soon after construction is completed and at regular intervals. An increasing electronegative potential indicates a deficiency in oxygen, and a decreasing potential indicates that oxygen is present in the soil surrounding the anchor length. The measurement of potential differences does not indicate the rate of corrosion, but it does provide an indication of the existence or absence of corrosion. Once the existence of corrosion is established, other methods must be used to measure the corrosion rate.
- 5) Test no. 5 - Estimation of the rate of local corrosion cell activity. A good approximation of the magnitude of the local corrosion cell activity can be determined by the Stern-Gearly linear polarization resistance method [18]. Lead wires 1 and 5 are used for potential measurement between the tendon and a reference electrode. The reference electrode is located above the anchor zone as shown in Figure 59. Lead wires 2 and 3 are used to make the structure a counter electrode and for applying a test current onto the tendon. An instrument for measuring the tendon polarization free of IR drop is required.

These tests should be performed under the direction of a corrosion engineer familiar with underground corrosion. It is likely that the significance of these measurements will have to be determined by comparing test results from other similar underground corrosion measurements.

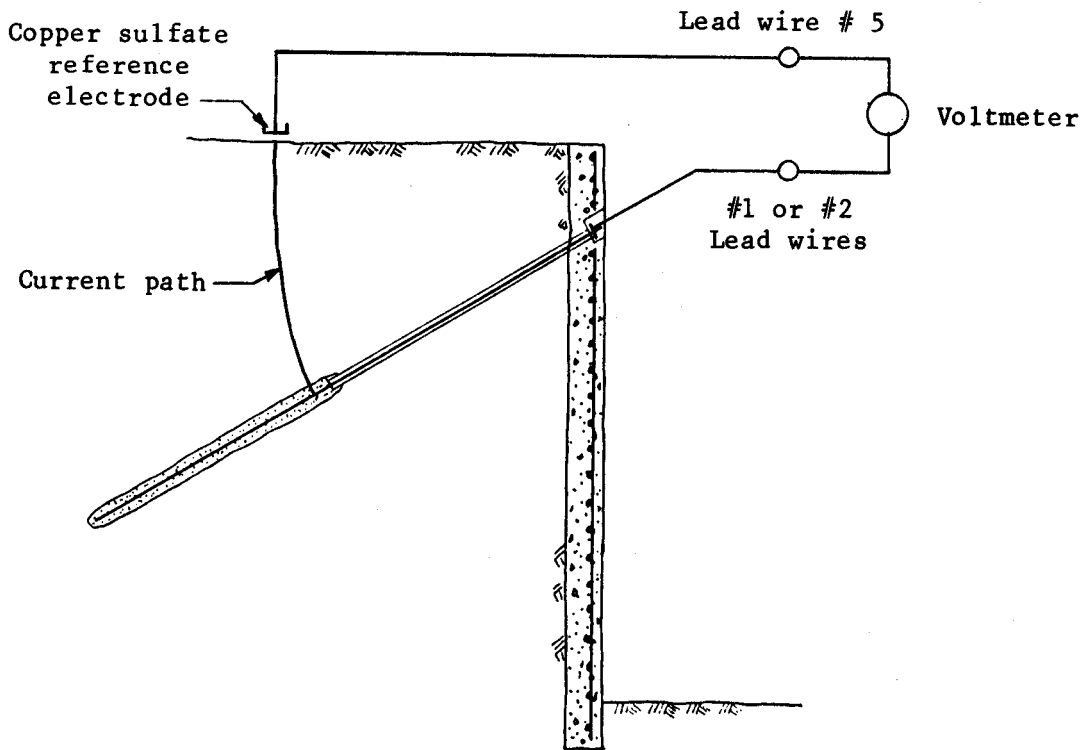

Figure 58. Test arrangement for checking changes in aeration on the tendon.

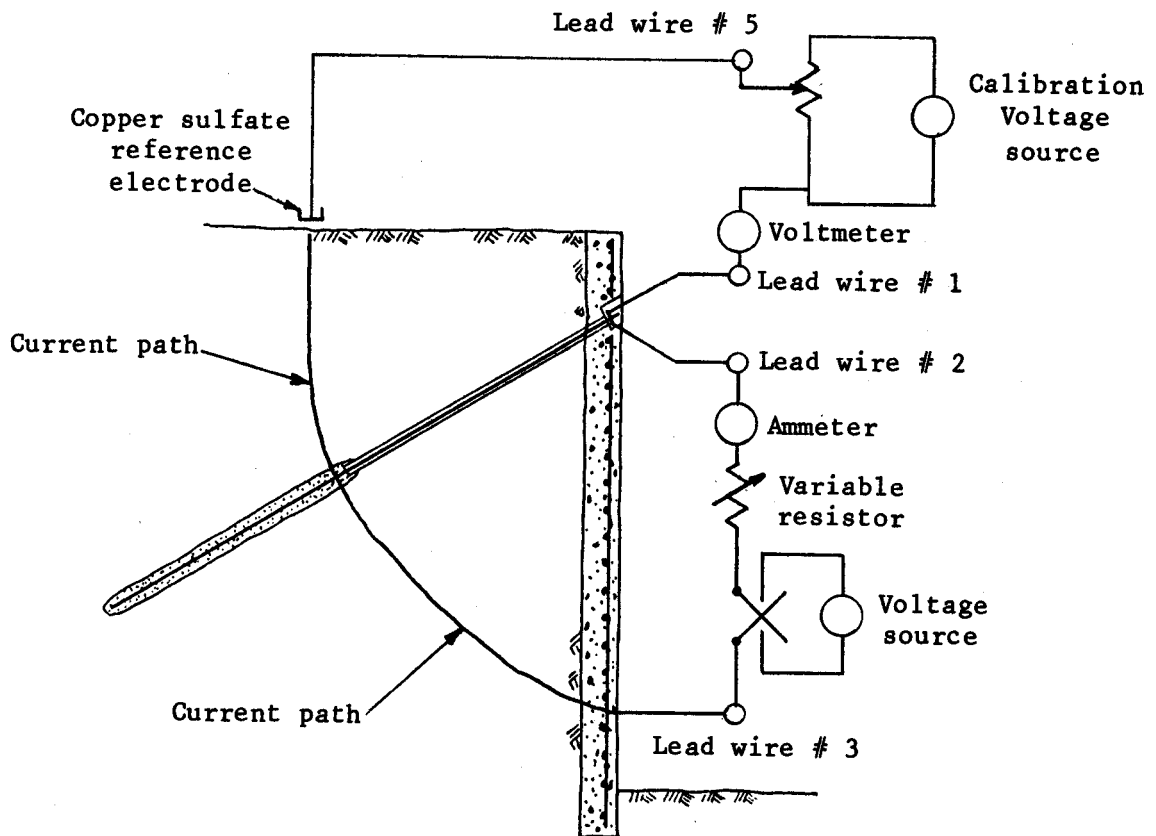

Figure 59. Test arrangement for estimating the rate of local corrosion cell activity.

## CHAPTER 6 - DESIGN

Tieback design includes:

- 1) A tieback feasibility evaluation.
- 2) An evaluation of the risk; consequences of failure.
- 3) The selection of a tieback type.
- 4) The estimation of the tieback capacity.
- 5) The determination of the unbonded and total tieback length.
- 6) The selection of a corrosion protection system (Chapter 5).
- 7) The selection of a tieback testing procedure (Chapter 10).
- 8) Establishing observation and monitoring requirements (Chapter 10).

This chapter concentrates on items 1, 2, 3 and 4. The determination of the unbonded length is not discussed in detail since it results from a stability analysis for the particular structure. Corrosion protection of a tieback is considered separately in Chapter 5. Tieback testing and monitoring is considered in Chapter 10.

### SOIL OR ROCK PROPERTIES

The designer must know the soil or rock properties in the vicinity of the tiebacks in order to determine if tiebacks can be used. The contractor also requires this information in order to select the tieback type and estimate their capacities.

If the tieback is to be made in soil, the following properties or test results should be included in the contract documents or soils report:

- 1) Boring logs with standard penetration resistances, visual classifications, groundwater levels, and drillers observations.
- 2) Unified Soil Classification [62] of the soil.
- 3) Plastic and liquid limits.
- 4) Unconfined compressive strength on undisturbed and remolded clay samples.
- 5) Grain size distribution curves for fine grained sands and silts.
- 6) Resistivity, soil pH, soluble sulfate content, and sulfide content are required for corrosion protection selection. (If these tests are not performed, the designer should describe the corrosion protection required.)

If the tieback is to be located in rock the following properties or test results should be included in the contract documents or geotechnical report:

- 1) Boring logs with rock classifications, penetration rates, recoveries, RQD's [66], groundwater levels and drillers observations.
- 2) Unconfined compressive strength.
- 3) Groundwater pH.

## FEASIBILITY OF TIEBACKS

The designer determines if permanent tiebacks are feasible for a site. When temporary tiebacks are used, the contractor normally makes the determination. The decision is based on an evaluation of the contractor's ability to:

- 1) Install the tiebacks.
- 2) Develop adequate tieback capacity.
- 3) Maintain tieback capacity without excessive movements or loss of load.
- 4) Construct the tiebacks economically.

The presence of utilities, subways or other underground structures may determine whether or not tiebacks can be installed at a site. Normally, tiebacks used to support a wall are installed at angles varying between horizontal and  $45^\circ$  from horizontal. If a tieback is installed steeper than  $45^\circ$ , the majority of its load will be applied vertically to the wall. If tiebacks can be physically installed, the owner must obtain tieback easements from adjacent property owners.

Tiebacks can develop high capacities in rock without significant loss of load or movement with time. Highly fractured rock with open joints or cavernous limestone should be avoided if possible since grouting is difficult in these open formations. Grouting techniques for these formations are discussed on Pages 149 and 150.

Temporary and permanent tiebacks are routinely installed in sandy and gravelly soils with a standard penetration resistance greater than ten blows per foot [67]. The German Standard [56] indicates that tiebacks, should not be installed in soils with a relative density less than 0.3. Testing and monitoring of many installations indicates that permanent tiebacks installed in cohesionless soils will perform satisfactorily. If soils with a standard penetration resistance less than 10 blows per foot, or fills are encountered, a tieback contractor should be consulted in order to determine if tiebacks can be used at the site.

Hollow-stem-augered, single-underreamed, multiunderreamed and postgrouted temporary tiebacks are frequently installed in cohesive soils. Hollow-stem-augered and postgrouted ones have been used in soils with an unconfined compressive strength as low as  $0.50 \text{ tons/ft}^2$  (48 kPa). The performance of temporary tiebacks in clay has been satisfactory.

Permanent tiebacks are not routinely installed in cohesive soils because of the concern about their long-term behavior. Long-term load carrying behavior is discussed in Chapters 9 and 10. All soils exhibit time-dependent deformations and stress variations under load. In most cases, when a stress is applied to a soil, the strain rate decreases with time until creep stops. However, in laboratory triaxial creep tests, saturated soft sensitive clays under undrained conditions, and heavily overconsolidated clays under drained conditions, are susceptible to loss of strength with time [68]. At present, there is no single soil property which will enable the designer to determine whether a tieback anchored in a



cohesive soil is creep susceptible. Soil strength, Atterberg limits, and natural water content coupled with experience in similar soils will provide the best indication of the long-term performance of a permanent tieback.

The German Standard [56] states that permanent tiebacks may not be used in the following cohesive soils, without special approval:

- 1) Organic soils.
- 2) Soils with a consistency index ( $I_c$ ) less than 0.9:

$$I_c = \frac{W_L - W}{W_L - W_P} \quad (9)$$

where:  $I_c$  = Consistency index  
 $W_L$  = Liquid limit  
 $W$  = Nature water content  
 $W_P$  = Plastic limit

- 3) Cohesive soils with a liquid limit ( $W_L$ ) greater than 50%.

The French Recommendations [53] classify soils with a plasticity index greater than or equal to 20 as soils which are likely to creep, and it recommends an extensive full-scale tieback test program for tiebacks installed in these soils.

Soil strength should be considered when determining if permanent tiebacks can be used in a clay. The writer's experience with postgrouted and hollow-stem-augered tiebacks indicates that tiebacks installed in soils with an unconfined compressive strength less than 1.0 ton/ft<sup>2</sup> (96 kPa), and remolded strength less than 0.5 ton/ft<sup>2</sup> (48 kPa) may be creep susceptible. Straight-shafted tiebacks installed in soils that exceed these strengths, and have a water content near the plastic limit, normally are not creep susceptible at loads significantly below 80 percent of their ultimate capacity. Ultimate tieback capacity, for the purpose of this discussion, is the test load which can only be maintained on the jack by continuous pumping of a hydraulic pump.

A full-scale test program is recommended if permanent tiebacks are to be anchored in a cohesive soil. If the project is large enough, the program should be performed under a separate contract prior to bid.

Because of the wide variety of tieback systems, lengths, capacities, and installation methods, it is not possible to give detailed cost information for permanent tiebacks. Schnabel Foundation Company finds that:

- 1) A 50 ton (445 kN) design load tieback installed in sand costs between \$1,000 and \$2,500.
- 2) A 50 to 70 ton (445 to 623 kN) design load tieback installed in clay costs between \$1,000 and \$3,500.
- 3) A 50 to 150 ton (445 to 1335 kN) design load tieback used for landslide stabilization or waterfront walls costs between \$1,000 and \$5,500.

## RISK

The degree of risk associated with the tieback installation will influence the design of the tiebacks, and in cohesive soils it may determine whether or not permanent tiebacks are used. The amount of risk may also influence the selection of the corrosion protection, the monitoring requirements, and the overload applied to a tieback during testing.

The Swiss Standard [57] defines a low-risk project as one where tieback failures would have few serious consequences and would not endanger public safety and order. It also defines a high-risk project as one where tieback failures would have serious consequences and would probably endanger public safety and order. The designer is the one who should evaluate the risk associated with his project. Table 3 gives examples showing how risk might affect a tieback installation.

## ESTIMATION OF ANCHOR CAPACITY

Tieback capacity depends upon the size and shape of the grouted anchor, the tendon type and size, the relative density of the soil, the in situ strength of the soil or rock, the drilling method, the method used to clean the drill hole, and the grouting method. These variables affect the load transfer mechanism between the grouted anchor and the soil or rock.

To date, there appears to be no theoretical relationship that can accurately predict tieback capacity. The inability to estimate capacity was demonstrated in 1974 at the ASCE Geotechnical Division Specialty Conference in Austin, Texas [69]. At the Austin Conference five engineers, familiar with tieback design and construction, were given soil data and construction information concerning four tieback installations. The five engineers used theoretical relationships and experience to estimate the ultimate tieback capacities. Table 4 summarizes their predictions and the actual capacities. The actual capacities varied by plus or minus 33 percent, and the prediction varied by a considerably wider margin. It is apparent that, at best, only a range of capacities can be estimated, and that testing is required in order to verify capacity.

The relationships used to estimate tieback capacity assume that the anchor is formed in only one type of soil. In reality, a tieback anchor is normally formed in different soils with one soil type dominating its behavior. The heterogeneous nature of the soil makes careful testing of each tieback very important.

Table 5 illustrates how tieback capacity may be affected by the type of tieback selected. The table gives typical ultimate capacities for different tiebacks installed in a very stiff clay ( $N = 30$  blows per foot).

### A. Rock Tiebacks

The majority of the rock tiebacks are made in tremie-grouted straight-shafted drill holes. The grout is pumped into the drill hole through a grout tube or the drill rods.

Table 3. Examples showing how risk may affect a tieback installation.

| Tieback Type   | Recommendations   |  |
|--|---|--|
|  | For Low Risk Work   | For High Risk Work   |
| All Permanent Tiebacks   | <ul style="list-style-type: none"> <li>a) Maximum test load equal to 1.33 Design Load</li> <li>b) Visual observations used to check performance</li> </ul>  | <ul style="list-style-type: none"> <li>a) Maximum test load equal to 1.33 Design Load</li> <li>b) Optical survey used to measure deformation of the structure</li> </ul>   |
| Permanent Tiebacks Installed in Cohesive Soils                                     | <ul style="list-style-type: none"> <li>a) Maximum test load equal to 1.33 to 1.50 Design Load</li> <li>b) Monitoring during construction is necessary and it should include measurement of structural deformations</li> </ul> | <ul style="list-style-type: none"> <li>a) Maximum test load <math>\geq</math> 1.5 Design Load</li> <li>b) Monitoring after completion of construction is necessary and it should include measurement of tieback load and deformation of the structure</li> </ul> |
| Permanent Tiebacks Installed in Sandy Soils or Rocks                               | <ul style="list-style-type: none"> <li>a) Maximum test load equal to 1.33 Design Load</li> <li>b) Visual observation used to check performance</li> </ul>   | <ul style="list-style-type: none"> <li>a) Maximum test load equal to 1.33 Design Load</li> <li>b) Monitoring after completion of construction is necessary and it should include measurement of tieback load and deformation of the structure</li> </ul>         |
| Permanent Tieback Installed in Nonaggressive Environments (Tieback replaceable)    | Simple corrosion protection   | Simple corrosion protection  |
| Permanent Tieback Installed in Nonaggressive Environments (Tieback nonreplaceable) | Simple corrosion protection   | Encapsulation  |

Table 4. Predicted and observed tieback capacities [69].

| Engineer                              | Method Used to Determine Capacity | Anchor Capacity (kips)<br>(1 kip = 4.45 kN) |                  |                  |                |
|---------------------------------------|-----------------------------------|---|------------------|------------------|----------------|
|                                       |                                   | Calumet Harbour                             | Washington Metro | Morris-town (NJ) | Parque Central |
| Dr. Costa-Nunes, Tecnosolo            | Theory                            | 160-510                                     | 125-300          | 80-260           | 70-380         |
| Mr. Malijina, LeRoy Crandell          | Theory                            | 300-500                                     | 250              | 200-250          | 400-600        |
| Mr. Nelson, Spencer White and Prentis | Experience                        | 250-300                                     | 120-150          | 100-120          | 250-300        |
| Dr. Murphy                            | Theory                            | 295   | 150              | 120              | 215            |
| Dr. Bassett, King's College           | Theory                            | 200-290                                     | 130              | 125              | 145-205        |
| Actual Test Results                   |                                   | 320-450                                     | 160-220          | 150-260          | 200-280        |

The ultimate capacity of a straight-shafted rock tieback is given by Equation (10).

$$P = \pi D l_a \tau_{ult} \quad (10)$$

where:

- P = ultimate tieback capacity
- D = anchor diameter
- $l_a$  = anchor length
- $\tau_{ult}$  = ultimate rock-grout bond stress

Equation (10) assumes a uniform bond or shear stress distribution along the anchor length even though the the actual bond stresses are not uniformly distributed. Actual load distribution along rock tiebacks is discussed in Chapter 9.

Table 5. Typical ultimate tieback capacities for tiebacks installed in a stiff clay (N = 30 blows per foot).

| Tieback Type   | Ultimate Capacity     |
|--|-----------------------|
| Pressure injected tieback (3 inch (76 mm) driven casing and a 20 foot (6.1 m) anchor length)                               | 40 kips<br>(178 kN)   |
| Hollow stem augered tieback (10 inch (254 mm) diameter shaft and a 35 foot (10.7 m) anchor length)                         | 110 kips<br>(490 kN)  |
| Single underreamed tieback (18 inch (457 mm) diameter shaft, 36 inch (914 mm) underream and 20 foot (6.1 m) anchor length) | 150 kips<br>(668 kN)  |
| Postgrouted tieback (6 inch (152 mm) initial diameter and 30 foot (9.1 m) anchor length)                                   | 270 kips<br>(1202 kN) |

~~Littlejohn and Bruce [70] indicated that in soft rocks with uniaxial compressive strength less than 1,000 psi (6,900 kPa), values of  $\tau_{ult}$  should not exceed the minimum shear strength of the rock. This recommendation is misleading because as Equations (11) through (13) show, it gives values of  $\tau_{ult}$  larger than those used in practice. The Mohr-Coulomb relationship between major and minor principal stresses at failure can be expressed by Equation (11):~~

$$\sigma_1 = \sigma_3 N_\phi + 2 c \sqrt{N_\phi} \quad (11)$$

where:  $\sigma_1$  = major principal stress  
 $\sigma_3$  = minor principal stress  
 $N_\phi$  =  $(1 + \sin \phi) / (1 - \sin \phi)$   
 $c$  = cohesion

Hendron [71] showed that the relationship between major and minor and principal stresses for a rock could also be approximated by Equation (12):

$$\sigma_1 = K \sigma_3 + \sigma_{a(ult)} \quad (12)$$

where:  $\sigma_1$  = major principal stress  
 $K$  = a constant numerically equal to  $N_\phi$   
 $\sigma_3$  = minor principal stress  
 $\sigma_{a(ult)}$  = uniaxial compressive strength

Therefore, the minimum shear strength or the maximum bond strength of a rock can be estimated by setting Equations (11) and (12) equal to each other and solving for the cohesion, "c":

$$c = \frac{\sigma_{a(ult)}}{2N_\phi} \quad (13)$$

where:  $c$  = cohesion, shear strength  
 $\sigma_{a(ult)}$  = uniaxial compressive strength  
 $N_\phi = (1 + \sin\phi)/(1 - \sin\phi)$

☆ Hendron [71] reported values of  $N_\phi$  between 4 and 6 for soft rocks which would give a value for  $\tau_{ult}$  of 204 psi (1,408 kPa) for a rock with an uniaxial compressive strength of 1,000 psi (6,900 kPa). This bond stress is about 10 times larger than those used in practice.

☆ In competent massive rocks, 100% core recovery,  $\tau_{ult}$  can be assumed to be equal to ten percent of the uniaxial compressive strength up to a maximum of 609 psi (4,200 kPa) assuming that the crushing strength of the grout is equal to or greater than 6,087 psi (42,000 kPa) [70].

☆ When rock strength information is not available, ultimate bond strengths of 30 to 50 psi (207 to 345 kPa) can be used for soft sedimentary rocks, and 200 psi (1,380 kPa) can be used for component rocks. The bond between the tendon and the grout will normally fail first if the bond between the grout and the rock is greater than 100 psi (690 kPa).

Multiunderreamed tiebacks have been installed in weak rock. Multiunderreamed tiebacks installed in a medium hard to soft, slightly sandy shale, at Newburgh Dam, Newburgh, Indiana, had three 21 inch (53.3 cm) diameter underreams, 18 (45.7 cm) inches long, and a 9 inch (22.9 cm) diameter shaft. They were tested to 1,500 kips (6,675 kN) [72].

## B. Cohesionless Soil Tiebacks

### Low-Pressure-Grouted Tiebacks

Low-pressure-grouted tiebacks are installed using an effective grout pressure less than 150 psi (1,035 kPa). These tiebacks are normally installed in a cased, rotary-drilled, hole. Littlejohn [73] indicated that





Equation (15) may not be valid because it assumes relationships which have not been theoretically established, and because the anchor, and shaft diameters cannot be determined unless the tieback is unearthed.

Littlejohn [73] and Nicholson Construction Company [72] report that Equation (16) can be used to estimate the ultimate capacity of low-pressure-grouted tiebacks in fine to medium sands.

$$P \cong p_i \pi D l_a \tan \phi \tag{16}$$

- where
- P = ultimate anchor capacity
  - $p_i$  = effective grout pressure, maximum of 2 psi/ft.?
  - D = anchor diameter
  - $l_a$  = anchor length
  - $\phi$  = angle of internal friction

Equation (16) is another form of Equation (14). By setting Equations (14) and (16) equal to each other, the anchor diameter is shown to be about 60 inches (23.6 cm) if  $n = 15$  kips/ft (20.4 kN/m), and  $p_i = 80$  psi (552 kPa). This diameter is not reasonable and raises additional questions about the validity of Equations (14) and (16).

estimating capacity

The writer recommends that load transfer rates be used to estimate the capacity of low-pressure-grouted tiebacks in cohesionless soils. Equations (14), (15), and (16) should not be used for estimating their capacities because they are misleading and they have no apparent physical significance. Load transfer rates of 5 to 8 kips/ft (73 to 117 kN/m) for fine to medium sands and 13 to 25 kips/ft (190 to 365 kN/m) for dense sands and gravels can be used to estimate the capacities of low-pressure-grouted tiebacks in sandy and gravelly soils.

### Hollow-Stem-Augered Tiebacks

Continuous hollow-stem augers can be used to install tiebacks in silty sands, sandy residual soils, interbedded clays and sands, and sands. Hollow-stem augers do not effectively drill soils if cobbles or boulders are present. Loss of ground may result in cohesionless soils if augers are used to install tiebacks which are inclined at angles less than 30° from the horizontal, or below the groundwater table. Hollow-stem augers are widely used in the United States, but they are seldom used in Europe.

The ultimate capacities of a hollow-stem-augered tiebacks in sand are empirically estimated. Nolan [15] reported that hollow-stem-augered tiebacks in a sand with discontinuous layers of fossiliferous limerock were proof tested to 195.0 kips (867.8 kN). He did not provide any details concerning the installation. In the absence of experience with a particular soil, Schnabel Foundation Company [75] uses a shear strength of 1000 psf (47.9 kPa) for estimating the ultimate capacity of a hollow-stem-augered tieback. Carson [76] indicated that sixty foot (18.3 m) long bored concrete piles would have a 120 kip (534 kN) design load. Using a safety factor of 2, this would give an ultimate shear strength of about 1.25 kips/ft<sup>2</sup> (59.9 kPa).



## Pressure-Injected Tiebacks

Pressure-injected tiebacks are only installed in cohesionless soils. They use an effective grout pressure in excess of 150 psi (1,035 kPa). Pressure-injected tiebacks use a drilled or driven casing to seal the hole, which allows the anchor zone to be grouted under high pressure during the extraction of the casing.

Estimations of the ultimate capacity of pressure-injected tiebacks are based upon field experience. To date, no theoretical relationship has been developed to accurately predict their capacities. Figure 60 shows design curves developed by Ostermayer [11] for pressure-injected tiebacks. These curves show tieback capacity as a function of anchor length. The curves also show the influence of soil type, density, and uniformity. Ostermayer did not use test results for many tiebacks with an anchor length longer than 26.2 ft (8 m), and most of the tiebacks were not tested to their ultimate capacity.

## High-Pressure-Grouted Tiebacks

Postgrouting can be used to place the anchor grout under high pressure. Rotary drilling is used to install the tieback, and an inflatable bag or packer is used to isolate the anchor length so the grout can be pressurized. Single phase postgrouting or multiphased postgrouting are possible depending upon the grouting method. Postgrouted tiebacks are described in detail on Page 159 and Pages 161--164.

Jorge [77] developed the design curves shown in Figure 61 for multiphase postgrouted tiebacks used by Soletanche. These curves show the ultimate rate of load transfer as a function of grouting pressure. It is apparent that pressure has a significant effect on the rate of load transfer for postgrouted tiebacks installed in soil. The ultimate tieback capacity of Soletanche "IRP" tiebacks can be estimated by multiplying the ultimate rate of load transfer by the anchor length.

Table 6 summarized Bachy's experience with high-pressure-grouted tiebacks in cohesionless soils [78]. It should be pointed out that Bachy did not use grout pressure as a variable in developing Table 6. Pressures in excess of 200 psi (1,380 kPa) were used for each tieback.

When pressure is used to grout an anchor in cohesionless soils, there is general agreement that anchor diameter is not significant in determining capacity. Since small diameter driven or rotary drilled casings are used to install high-pressure-grouted tiebacks, grout diameters are often less than 6 inches (152 mm).

\* Regardless of tieback type, high ultimate capacities in excess of 140 kips (623 kN) can be developed in cohesionless soils with a standard penetration resistance greater than 10 blows per foot.

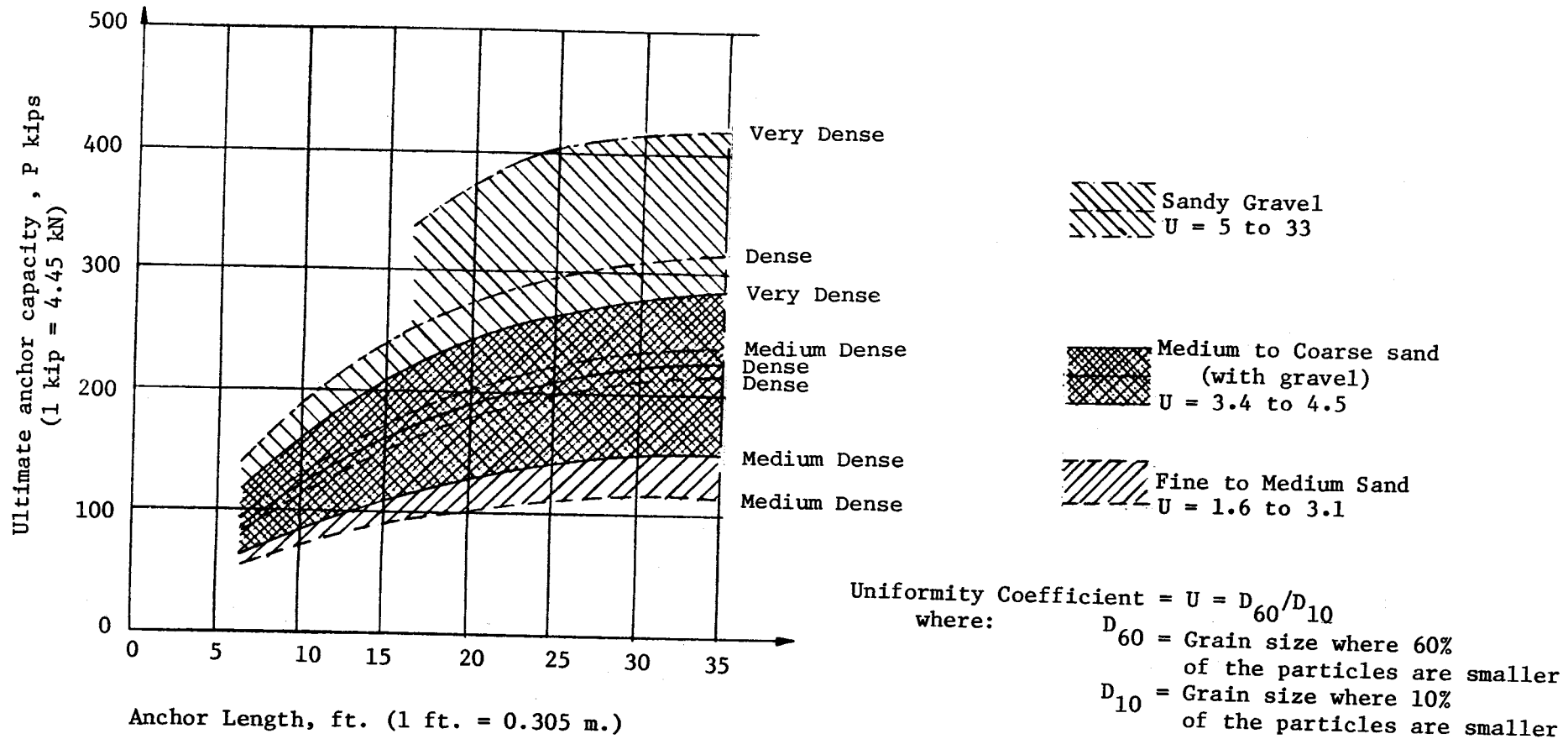

Figure 60. Ultimate pressure-injected tieback capacity as a function of anchor length, density, and grain size (Anchor diameter = 3.9 to 5.9 inches [10 to 15 cm]. Overburden  $\geq$  13.1 ft. [4 m]), [11].

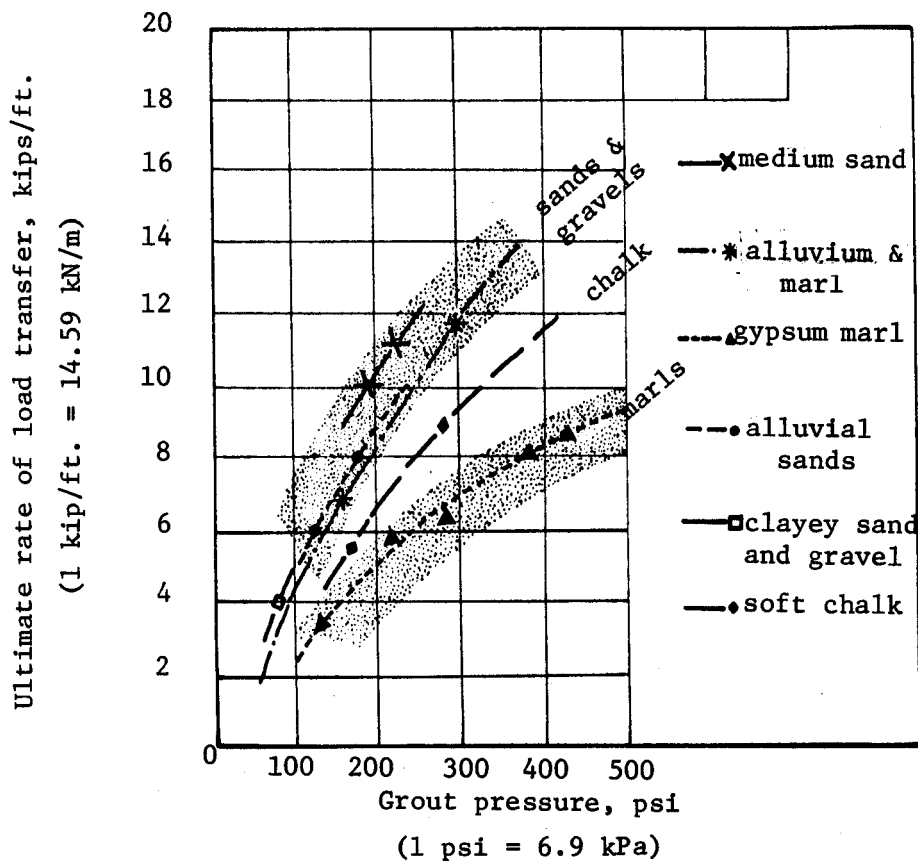

Figure 61. Ultimate capacity of postgrouted tiebacks, after Jorge [77].

Table 6. Ultimate capacity of Bachy tiebacks in cohesionless soils [78].

| Soil Type   | Grouting Method                    | Ultimate Capacity                                    |
|---|------------------------------------|--|
| Dense sand and gravel (well graded 0.4 mm to 20 mm)                             | single and multiphase postgrouting | greater than 340 kips (1513 kN)                      |
| Sand and gravel (uniformly graded form 0.2 mm to 5 mm)                          | single and multiphase postgrouting | between 180 kips and 340 kips (801 kN and 1513 kN)   |
| Fine to medium silty sand (20% silt, 80% sand, 0.05 mm to 2 mm) N = 36 blows/ft | multiphase postgrouting            | between 200 kips and 250 kips (890 kN and 1112.5 kN) |
| Very loose fine to fine sand (uniformly graded from 0.02 mm to 0.5 mm)          | multiphase postgrouting            | 180 kips (801 kN)                                    |

## C. Cohesive Soil Tiebacks

### Low-Pressure-Grouted Tiebacks

Low-pressure-grouted tiebacks in a cohesive soil are installed using an effective grout pressure less than 150 psi (1,035 kPa). ~~When tiebacks in cohesive soils are not postgrouted, the grout pressure is normally less than 150 psi (1,035 kPa), and equal to the pressure which will fracture the ground.~~ If fractures develop, grout can be continuously pumped into the soil without any increase in grout pressure. Ground heave results from continuous pumping and structures overlying the tieback may be damaged.

Straight-shafted tiebacks are the most common type used in cohesive soils. They are made using hollow-stem augers or by tremie grouting an open drill hole.

Low-pressure-grouted tiebacks in clays are assumed to have a uniform rate of load transfer along their lengths. Tests measuring the actual load distribution are included in Chapter 9. Equation (17) is used to estimate the ultimate capacity of low-pressure-grouted, straight-shafted tiebacks in clay.

$$P = \pi D l_a \alpha c_u \quad (17)$$

where:

|          |   |                                  |
|----------|---|----------------------------------|
| P        | = | ultimate anchor capacity         |
| D        | = | anchor diameter                  |
| $l_a$    | = | anchor length                    |
| $\alpha$ | = | adhesion factor                  |
| $c_u$    | = | average undrained shear strength |

Table 7 contains measured adhesion values reported in the literature. Hanna [83] has recommended using an adhesion value of 0.3 for design if there is no experience with a particular soil.

The ultimate capacity of straight-shafted tiebacks in clay can also be estimated by Equation (18):

$$P = \pi D l_a f_g \quad (18)$$

where:

|       |   |   |
|-------|---|---|
| P     | = | ultimate anchor capacity                              |
| D     | = | anchor diameter                                       |
| $l_a$ | = | anchor length   |
| $f_g$ | = | ultimate skin friction between the grout and the soil |

Schnabel Foundation Company [75] used a maximum skin friction value of 1,000 psf (47.9 kPa) unless experience has indicated that a larger value can be used. When the undrained shear strength of the clay is less than 1,000 psf (47.9 kPa), Schnabel uses an ultimate skin friction value equal to the undrained shear strength.

Tomlinson [84], Peck [85], and Woodward, et al [86], have reported that the ultimate value of skin friction for a pile in a stiff clay is likely to be less than 50% of the undrained shear strength of the clay. A similar reduction is reasonable for tiebacks installed in a stiff cohesive soil.

Tieback and pile experience indicates that the ultimate capacity of low-pressure-grouted, straight-shafted tiebacks in clay can be estimated by Equation (18). The adhesion factor "α" should be equal to 1 for clays with undrained shear strength less than 1,000 psf (47.9 kPa) and it should decrease to a minimum of 0.3 as the strength increases.

Table 7. Summary of reported adhesion factors.

| Soil Type                                       | Soil Strength               | α           | Source |
|---|-----------------------------|-------------|--------|
| Stiff London Clay                               | Cu > 1880 psf<br>(9.0 kPa)  | 0.3 - 0.35  | [79]   |
| Stiff overconsolidated clay at Taranta, Italy   | Cu = 5639 psf<br>(27.0 kPa) | 0.28 - 0.36 | [80]   |
| Stiff to very stiff marl at Leicester, England  | Cu = 5994 psf<br>(28.7 kPa) | 0.48 - 0.60 | [73]   |
| Stiff clayey silt at Johannesburg, South Africa | Cu = 1984 psf<br>(9.5 kPa)  | 0.45        | [81]   |
| Heavily overconsolidated clay in Sweden         | Cu = 1041 psf<br>(5.0 kPa)  | 0.50        | [82]   |

Single-underreamed tiebacks are used in cohesive soils in the United States. They develop capacity from friction along the shaft, and bearing on the underream. Equation (19) can be used to estimate the ultimate capacity of a single-underreamed tieback.

$$P = \alpha c_u l_s \pi D_s + \pi/4 (D_u^2 - D_s^2) N_c c_u \quad (19)$$

where: P = ultimate anchor capacity  
 α = adhesion factor  
 c<sub>u</sub> = average undrained shear strength  
 l<sub>s</sub> = shaft length  
 D<sub>s</sub> = shaft diameter  
 D<sub>u</sub> = underreamed diameter  
 N<sub>c</sub> = bearing capacity factor = 9

The adhesion factor "α", in Equation (19), is equal to the value used in Equation (17).

Multiunderreamed tiebacks were developed for use in stiff London clay. Littlejohn [5] has stated that underreamed tiebacks are ideally suited to London clay with an undrained shear strength greater than 1,880 psf (90 kPa). He reported that underreamed tiebacks have been made in London clay with a shear strength of 1,044 psf (50 kPa), but that local collapse of the underreams or breakdown of the shaft between underreams is common when the shear strength is below 1,462 psf (70 kPa). These construction problems limit the use of underreamed tiebacks to stiff or very stiff clays.

Multiunderreamed tiebacks in clay are assumed to develop capacity from adhesion along the shaft above the underreams, end bearing of the first underream, and shear along a cylinder established by the tips of the underreams. Equation (20) was proposed by both Littlejohn [73] and Bassett [87] to account for each one of the components.

$$P = \alpha c_u l_s \pi D_s + \pi/4 (D_u^2 - D_s^2) N_c c_u + f_u c_u l_u \pi D_u \quad (20)$$

where:

|          |   |   |
|----------|---|---|
| P        | = | ultimate anchor capacity                |
| $\alpha$ | = | adhesion factor                         |
| $D_s$    | = | shaft diameter                          |
| $l_s$    | = | shaft length                            |
| $c_u$    | = | average undrained shear strength        |
| $N_c$    | = | bearing capacity factor                 |
| $D_u$    | = | underreamed diameter                    |
| $f_u$    | = | reduction coefficient                   |
| $l_u$    | = | length of underreamed portion of anchor |

Littlejohn's form of Equation (20) had  $f_u = 1.0$ ,  $N_c = 9.0$ , and  $\alpha = 0.3$  to 0.35. Littlejohn's equation was developed for the Cementation Piling and Foundations' brush underreamer. This underreamer is basically an expanded wire brush which is rotated and gradually expanded as it abrades the surface of the drill hole. Bassett's form of Equation (20) has  $f_u = 0.75$  to 0.95,  $N_c = 6$  to 13, and  $\alpha = 0.3$  to 0.6. Bassett's relationship was developed for the blade cutter of Universal Anchorage Contractors, Ltd. The spacing of the underreams determines if a shear failure occurs along a cylinder established by their tips. If the spacing becomes too large, the failure surface will not occur along the cylindrical surface established by the underreams, but will intersect the shaft between underreams. Bassett [87] indicated that the underreams are made at a spacing equal to about 1.5 times their diameter. Model studies indicate that the underreams could be spaced between 2 or 2.5 times the diameter of the underreams [87].

### High-Pressure-Grouted Tiebacks

High-pressure-grouted tiebacks in a cohesive soil are installed using a grout pressure greater than 150 psi (1,035 kPa). It is the writer's opinion that only postgrouting can be used to obtain these high grout pressures in a cohesive soils. Postgrouting is described on Page 159 and Pages 161--164. Without postgrouting, clay soils are fractured at a grout pressure less than 150 psi (1,035 kPa).

The mechanism by which a postgrouted tieback develops its capacity is not completely understood. It has been demonstrated that postgrouting

increased the diameter of the anchor by breaking the original grout body and forcing wedges of grout outward against the soil. The skin friction between the grout and soil may also be increased by postgrouting.

Jorge [77], Ostermayer [11], Goldberg, et al [88], Bustamante [89], and Bachy [78] have presented the results of tests performed on postgrouted tiebacks in clay. Table 8 summarizes these tests. These investigators did not provide information about the postgrouting system, drilling methods, or a complete soil description. To date, no one has published a relationship for estimating the capacity of postgrouted tiebacks in clay. Each tieback contractor uses experience to estimate the ultimate capacity of tiebacks installed by his particular techniques.

The general consensus is that postgrouting improves the capacity of tiebacks in cohesive soils. Depending on the soil and the postgrouting system, increases ranging from 25% to more than 300% are common.

#### MINIMUM UNBONDED, ANCHOR, AND TOTAL TIEBACK LENGTH

The unbonded length of a tieback must be long enough to place the anchor in soil or rock which would not be affected by movement of the structure. For a wall, the unbonded length should place the anchor behind the critical failure surface (See Figure 62). Without the tieback, the factor of safety against sliding along the critical failure surface is one. A minimum unbonded length of 15 feet (4.50 m) should be used to avoid high load losses as a result of long-term steel relaxation, creep in the soil, anchorage seating losses, and structural deformations.

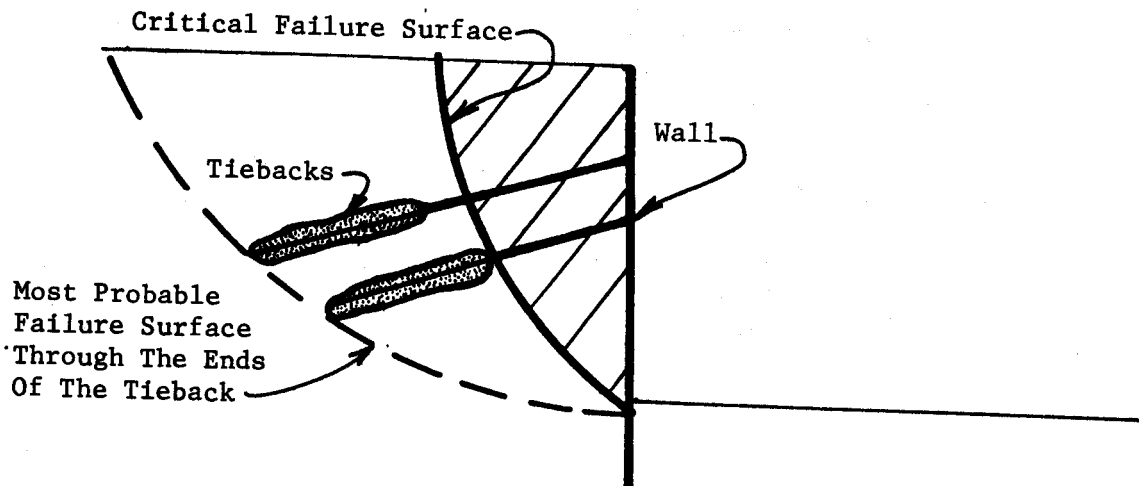

Figure 62. Determination of the unbonded and total tieback length.

The total tieback length should be selected so the tiebacks are anchored in soil or rock which is stable. For the wall shown in Figure 62, a stability analysis can be used to calculate the factor of safety against sliding along the most probable failure surface through the ends of the

Table 8. Capacities of postgrouted tiebacks in clay.

| Soil Type   | Soil Properties      |                |                |                    | Calculated Skin Friction |                           | Anchor Length (ft) | Ultimate Tieback Capacity (kips)                                | Source |
|---|----------------------|----------------|----------------|--------------------|--------------------------|---------------------------|--------------------|---|--------|
|   | C <sub>u</sub> (psi) | W <sub>L</sub> | I <sub>p</sub> | I <sub>c</sub> (1) | w/post grouting (psi)    | w/out post grouting (psi) |                    |   |        |
| Very stiff to hard sandy silt, medium plasticity (Marl) | --                   | 45             | 22             | 1.25               | 51.5-74.7                | 33.4-56.6                 | --                 | --  | [11]   |
| Very stiff clay, medium plasticity (Marl)               | --                   | 32-45          | 14-25          | 1.03-1.5           | --                       | 18.9-49.3                 | --                 | --  | [11]   |
| Stiff clay, medium plasticity (Marl)                    | --                   | 32-45          | 14-25          | 1.03-1.5           | --                       | 11.6-31.9                 | --                 | --  | [11]   |
| Very stiff clay, medium to high plasticity              | --                   | 48-58          | 23-35          | 1.1-1.2            | 18.9-43.5                | 11.6-27.6                 | --                 | --  | [11]   |
| Stiff clay, medium to high plasticity                   | --                   | 45-59          | 16-32          | 0.8-1.0            | --                       | 2.9-14.5                  | --                 | --  | [11]   |
| Silt, medium plasticity                                 | --                   | 23-28          | 5-11           | 0.7-0.85           | --                       | 18.9-30.5                 | --                 | --  | [11]   |
| Stiff to very stiff clay, medium plasticity             | --                   | --             | --             | --                 | 19.1-51.4                | --                        | --                 | --  | [88]   |
| Plastic clay  | 8.7-11.6             | 80-90          | 50-60          | --                 | 38.4 (1 grouting)        | --                        | 19.7               | 179.8   | [89]   |
| Plastic clay  | 8.7-11.6             | 80-90          | 50-60          | --                 | 29.0 (2 groutings)       | --                        | 19.7               | 202.3   | [89]   |
| Plastic clay  | 8.7-11.6             | 80-90          | 50-60          | --                 | 34.8 (3 groutings)       | --                        | 19.7               | 247.3   | [106]  |
| Marl  | 4.3-11.4             | --             | --             | --                 | --                       | --                        | 19.7               | 48.4 (1 grouting)<br>118.7 (2 groutings)<br>164.6 (3 groutings) | [77]   |
| Marl  | 4.3-11.4             | --             | --             | --                 | --                       | --                        | 19.7               | 51.1 (1 grouting)<br>157.2 (2 groutings)<br>211.7 (3 groutings) | [77]   |
| Marl  | 4.3-11.4             | --             | --             | --                 | --                       | --                        | 13.1               | 24.0 (1 grouting)<br>51.5 (2 groutings)<br>119.8 (3 groutings)  | [77]   |
| Marl  | 4.3-11.4             | --             | --             | --                 | --                       | --                        | 26.2               | 55.6 (1 grouting)<br>119.8 (2 groutings)                        | [77]   |

$$(1) I_c = \frac{W_L - W}{W_L - W_p}$$

where: W<sub>L</sub> = liquid limit  
W = natural water content  
W<sub>p</sub> = plastic limit

1 kip = 4.45 kN  
1 psi = 6.9 kPa  
1 ft. = 0.305 m



tiebacks. If the factor of safety is not satisfactory, the tieback length can be increased. Schnabel [90] discusses the stability of tieback structures. Morgenstern and Sangrey [91] present a good summary of limit equilibrium stability methods, and Ranke and Ostermayer [92] present an analysis based on calculating the force required to dislodge a block of soil containing the tiebacks. For the tank shown in Figure 63, the buoyant weight of the crosshatched soil or rock mass must equal the hydrostatic uplift force acting on the bottom of the tank, times the factor of safety. The stability of a tank is a function of tieback length regardless of the individual tiedown capacity.

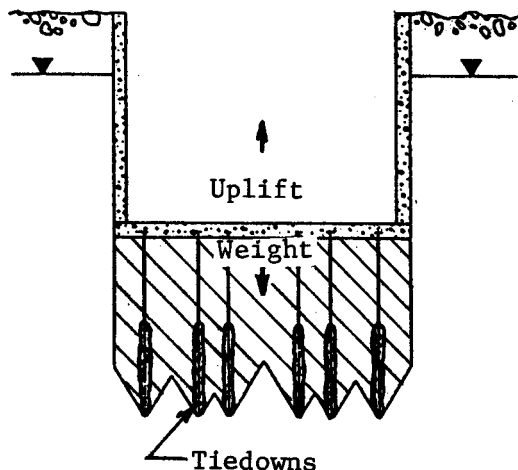

Figure 63. Determination of the total tiedown length.

Tieback contractors normally provide a minimum anchor length of 15 feet (4.58 m) for straight-shafted tiebacks.

#### Observations

Today, the estimation of tieback capacity is based on field experience or empirical relationships. The relationships or graphs that have been presented in this chapter are based on actual tieback tests. However, in many cases, they were developed from a small number of tests, and these tests were performed on unique tiebacks systems at only one or two sites.

The state-of-the-art has not progressed to the stage where the load transfer mechanism for the various types of tiebacks are completely understood. The writer believes that the information provided in this chapter can be used by the designer to determine whether or not a tieback can be installed in a particular soil, and to estimate ranges of ultimate capacity that may be obtained. In most cases, the designer does not need to specify the tieback type or capacity. The most economical installation will be obtained if the design will enable the tieback contractor to select the tieback type and the capacity. The designer should specify the minimum unbonded length, the minimum total length, and the unit tieback capacity required. Finally, each production tieback must be tested to verify that the anchor can carry the design load over its service life. Testing is discussed in Chapter 10.

## CHAPTER 7 - SPECIFICATION OF TIEBACK WORK

This chapter contains recommendations for the specification of permanent tieback work. The specifications are difficult to prepare since some of the tieback systems or corrosion protection methods are patented, and many contractors have developed unique installation methods. It is virtually impossible for the designer to be familiar with all the various tieback systems which are used. Therefore, the designer needs to prepare a specification that will establish a quality level without eliminating suitable proprietary systems or methods. The specifications should enable qualified contractors to use their experience gained on previous jobs.

### PERFORMANCE SPECIFICATION

A performance specification which establishes a quality level and describes the desired end-results enables the designer and the contractor to use their experience and expertise. The designer establishes those things which affect his design, and he specifies a tieback testing procedure and monitoring requirements to verify performance. The installation methods, and the development of the tieback capacity should be the responsibility of the contractor. This enables the contractor to provide his most economical tieback, and still satisfy the requirements of the design. The designer and the contractor will share the responsibility for the work.

The Swiss Standard [57] is a performance specification and it outlines the responsibilities of the designer and the contractor. The designer is required to:

- 1) Provide a detailed geotechnical site investigation.
- 2) Determine the design load.
- 3) Specify a testing procedure and acceptance criterion.
- 4) Estimate the settlement of adjacent structures and establish permissible deformations.
- 5) Specify the tieback clearance around utilities.
- 6) Provide installation tolerances.
- 7) Rate the risk associated with the work, and establish the safety factors.
- 8) Determine the unbonded length, and minimum total length.
- 9) Determine the lock-off load.
- 10) Determine the monitoring requirements.
- 11) Describe the level of corrosion protection required and evaluate the contractor's proposed corrosion protection system.

The Swiss standard requires the contractor to:

- 1) Design the tendon.
- 2) Select the installation method.
- 3) Select the anchor length.
- 4) Propose the corrosion protection system.
- 5) Be responsible for the contract compliance of the materials used.

- 6) Guarantee the tieback capacity.
- 7) Obtain the required unbonded length.
- 8) Provide the required records.

The French Recommendation [53], the FIP Rules [58], the German Standards [55] and [56], and the PTI Recommendation [59], are also performance specifications. They establish quality levels without specifying tieback type. They also recognize that most tieback systems have been developed by contractors, and many of the methods are patented.

#### CLOSED SPECIFICATIONS

In contrast to European practice, American designers often design the complete tieback installation. They specify the type of tieback, the corrosion protection system, the tieback capacity, the installation methods, and the testing procedures. The contractor is required to submit material certifications, and install the tiebacks in accordance with the specification. When this contracting method is used the engineer or owner is responsible for performance, if the contractor complies with the specifications. This form of specification does not enable the experienced contractor to make best use of his patents or expertise, and it encourages contractors not familiar with tieback work to bid. If the inexperienced contractor obtains the work, then the owner must be prepared to direct the contractor's work if the tiebacks fail. This type of specification does not guarantee low prices; in fact, higher prices, change orders, and delays often result when the wrong tieback systems or drilling methods are specified.

The working group, who developed the French Recommendations [53] recognized that closed specifications should not be used for tieback work. They stated that tieback techniques were evolutionary in nature, and it was important not to "freeze" the technology by rigid specifications. The French committee also indicated that the specification cannot replace the professional experience and consciousness of the contractor's personnel at all levels.

#### PREQUALIFICATION

The designer may require the prequalification of the tieback contractor. The prequalification may be based on experience, or a list of acceptable contractors may be included in the specification. An alternate type of prequalification should be tried and evaluated for permanent tieback work. The specification would require the submission and approval of the tieback system design, and the corrosion protection method prior to bid. The submission must be detailed enough for the designer to determine whether or not his design is satisfied. This method would enable the contractor to know if his proprietary techniques would be acceptable, and to provide the most economical installation. Preparation and review of the submittal would not require a substantial effort, and this contracting practice would encourage alternate tieback types, continued tieback development, and the most economical tieback.

## SAMPLE PERMANENT TIEBACK SPECIFICATION

(NOTE: The dimensions given are provided for example purposes only. They are not intended to be used for other applications.)

### Scope of the Work

This section of the specification describes the materials, labor, and equipment required for the installation and monitoring of the permanent tiebacks shown on the contract drawings.

### Tieback Capacity

The contractor shall be responsible for obtaining the desired tieback capacity in accordance with the tieback testing section of this specification. (The engineer can use one of the following alternates.)

- 1) Alternate A: The contract drawings contain a loading diagram which the contractor shall use to determine the number and capacity of the tiebacks. The anchor zones of the tiebacks shall be at least 5 feet (1.52 m) apart.
- 2) Alternate B: The contract drawings contains tieback loadings per linear foot of wall. The contractor shall use these loadings to determine the number and capacity of the tiebacks. The anchor zones of the tiebacks shall be at least 5 feet (1.52 m) apart.
- 3) Alternate C: The contract drawings indicate the location and capacity of tiebacks.

### Minimum Unbonded Length and Tieback Angle

Each tieback shall have a minimum unbonded length of 15 feet (4.58 m). The contract drawings indicate the unbonded length required for each tier of tiebacks. The tieback shall be installed at an angle varying between 10° and 30° from the horizontal.

### Total Tieback Length and Minimum Anchor Length

The minimum total tieback lengths are indicated on the contract drawing. In no case shall the anchor length be less than 10 feet (3.05 m). The tieback must not extend beyond the easement shown on the contract drawing.

### Prequalification

Twenty (20) working days prior to the bid date, the tieback contractor shall submit to the engineers for review and approval a proposal describing the tieback system he intends to provide. The submission shall include:

- 1) Qualifications if required.
- 2) A description of the tieback installation. Includes drilling, grouting, and stressing information.

- 3) Estimated tieback capacity.
- 4) Tendon type and capacity.
- 5) Anchorage type.
- 6) Corrosion protection details--shop drawings required.
- 7) Exceptions to the specification and reasons for exceptions.

The engineer will review the submission and telegraph comments to the prospective bidders within five (5) working days after receipt of the submission. Within five (5) working days, the contractor can resubmit a revised proposal. The engineer will notify the contractor by telegraph five (5) working days before bid whether or not his tieback system and corrosion protection meets the requirements of the specification.

### Materials

- 1) Tieback tendons shall be fabricated from single or multiple elements of the following:
  - a) Steel bars conforming to ASTM Designation A-722, "Uncoated High-Strength Steel Bars for Prestressed Concrete."
  - b) Seven-wire strand conforming to ASTM Designation A 416, "Uncoated Seven-Wire Stress-Relieved Strand for Prestressed Concrete."
  - c) Wires conforming to ASTM Designation A 421, "Uncoated Stress-Relieved Wire for Prestressed Concrete."
  - d) Compact seven-wire strands conforming to ASTM Designation A 779-80, "Uncoated Seven-Wire Compacted, Stress-Relieved Steel Strand for Prestressed Concrete."
- 2) Anchorages shall be capable of developing 95 percent of the guaranteed minimum ultimate tensile strength of the prestressing steel. (The engineer shall indicate if the anchor head must be restressable and/or capable of load adjustment [See Page 132]).
- 3) The bearing plate shall be fabricated from mild steel and it shall be capable of developing 95 percent of the guaranteed minimum ultimate tensile strength of the prestressing steel.
- 4) Prestressing steel couplers shall be capable of developing 100 percent of the ultimate strength of the prestressing steel.
- 5) Centralizers shall be fabricated from material which is nondetrimental to the prestressing steel. (Steel or plastic is commonly used. Wood should not be used.) The centralizer shall position the tendon in the drill hole so a minimum of 0.5 inch (12.7 cm) of grout cover is provided. (Pressure-injected tiebacks do not require centralizers. (See Page 132)
- 6) Spacers shall be used to separate elements of multielement tendons. They shall be fabricated from material which is nondetrimental to the prestressing steel (See comment in 5). A combination centralizer--spacer can be used.

- 7) Type I, II, or III portland cement conforming to ASTM C-150 specifications shall be used for grout. (If the soluble sulfate content of the soil or the groundwater is greater than 2,000 mg/kg, then Type V cement should be used. See Pages 137 and 138.) (If the soil or groundwater pH is less than 4.5 or nearby buried concrete structures have experienced chemical attack, then portland cement grout should not be used. Acid resistant cements may be used in acidic conditions. See Pages 137 and 138.) Cement should be fresh and should not contain any lumps or other indications of hydration.
- 8) Water for mixing grout should be potable.
- 9) Grout additives should be avoided. Accelerators should not be used. Expansive admixtures should only be used for secondary grouting, and filling trumpets and anchorage covers. Admixtures which control bleed and retard set may be used. Additives shall be mixed and placed in accordance with the manufacturer's recommendations (See Page 137).
- 10) The sheath or bond breaker shall be either a steel, PVC, polyethylene, or polypropylene pipe or tube. The sheath may surround individual tendon elements or the entire tendon. The material shall be capable of withstanding damage during shipping, handling, and installation. The material is subject to the approval of the engineer.
- 11) Grease injected under the sheath shall be formulated to provide lubrication and inhibit corrosion. The chlorides, nitrates, and sulfides present in the grease shall not exceed the following limits:
  - a) Chlorides 10 ppm
  - b) Nitrates 10 ppm
  - c) Sulfides 10 ppm
- 12) (The contract documents should indicate if simple or encapsulation corrosion protection is required.) A simple protected tieback tendon shall be provided. Details of the protection system shall be submitted to the engineers for review and approval. The contract drawings show a simple corrosion protected tieback (See Page 96). The ends of the grease filled sheath shall be sealed with tape, heat shrinkable tubes, or other means subject to the approval of the engineer. A plastic trumpet shall be used to make the transition from the bearing plate to the corrosion protection over the unbonded length. A tight fitting seal shall be provided at the end of the trumpet. Insulating bearing strips shall be provided under the bearing plate. The bearing strips material must:
  - a) Be an electrical insulator.
  - b) Be resistant to attack from cement, grease, or aggressive environments.
  - c) Be nondetrimental to the prestressing steel.
  - d) Have compressive strengths greater than concrete.
  - e) Not be susceptible to significant creep deformations.

Manufacturer's literature describing the bearing material shall be submitted to the engineer for review and approval.

The insulation over the anchorage and bearing plate shall be fabricated from a heat shrinkable cap with an elastic adhesive, a moldable sealant, or other suitable material. Manufacturer's literature describing the insulation shall be submitted to the engineer for review and approval. The anchorage insulation must be:

- a) An electrical insulator.
  - b) Resistant to attack from cement, grease, or aggressive environments.
  - c) Nondetrimental to the prestressing steel.
  - d) Capable of withstanding atmospheric exposure and ultraviolet light if the anchor head is intended to remain exposed.
- 13) An encapsulated tieback tendon is required. Details of the proposed encapsulated protection system shall be submitted to the engineer for review and approval. The contract drawings show an encapsulated tendon (See Pages 76--79). The anchor length shall be encapsulated in a corrugated plastic or deformed metal tube. The capsule must be:
- a) Capable of transferring stresses from the encapsulation grout to the anchor grout.
  - b) Accommodate movement during testing, and after lock-off.
  - c) Resistant to chemical attack from aggressive environments, grout, or grease.
  - d) Fabricated from materials nondetrimental to the tendon.
  - e) Capable of withstanding abrasion, impact, and bending during handling and installation.
  - f) Leak proof.

The tendon shall be centralized inside the capsule. Cement grout shall be used to secure the tendon inside the capsule. A leak tight transition shall be provided between the anchor length capsule and the unbonded length capsule. A heat shrinkable sleeve, or other suitable splices, subject to the approval of the engineer, shall be used. A smooth plastic or metal tube can be used over the unbonded portion of the tendon. If the tendon is greased and sheathed within the smooth portion of the capsule, then grout should be used to fill the annular space between the tendon and the plastic or metal tube. If the tendon is not sheathed, grease shall be used to fill the annular space between the smooth tube and the steel. The smooth tube must:

- a) Accommodate movement during testing, and after lock-off.

- b) Resistant to chemical attack from aggressive environments, grout, or grease.
- c) Fabricated from materials nondetrimental to the tendon.
- d) Capable of withstanding abrasion, impact, and bending during handling and installation.
- e) Leak proof.

A steel or plastic trumpet shall be used to make the transition from the bearing plate to the protection over the unbonded length. A tight fitting seal shall be provided at the end of the trumpet. (The anchorage shall be encased in concrete if possible.) Exposed anchorages shall be covered with a grease or grout filled cover. The contractor shall ensure that the grease or grout fully covers the anchor head.

### Tendon Fabrication

- 1) Prestressing steel shall be protected from dirt, rust, or deleterious substances. (A light coating of rust on the steel will not affect its function.) Heavy corrosion or pitting is cause for tendon rejection. If there is a question about the extent of the corrosion, the steel can be tested to determine if it still meets the appropriate ASTM specification.
- 2) Tendons can be either shop or field fabricated.
- 3) Tendons shall be stored and handled in such a manner as to avoid damage or corrosion.

### Installation

- 1) Core drilling, rotary drilling, or percussion drilling can be used to drill rock foundations. Auger drilling, rotary drilling, or percussion driven casing can be used for soil tiebacks. The drill hole shall be located within 3 inch (76 mm) of the desired location.
- 2) (The engineer may specify a watertightness test for rock tiebacks. The test is not necessary for every tieback. Cavernous limestone formations, open jointed or fractured rock, and formations where water loss or gain was observed during exploratory drilling should be checked for watertightness. The engineer should determine the number of tests to be performed. If the need for watertightness testing is uncertain, then the initial drill holes need to be tested. If it is certain that the formation is open, then watertightness testing may be required for each tieback (See Page 143). Pressure grouting the anchor zone using the casing or a packer to seal the hole can be used in lieu of a watertightness test (See Page 150). If pressure grouting is used in rock, the engineer should specify a minimum refusal pressure.)

After drilling the permanent rock tieback hole to the desired depth, a watertightness test shall be performed to de-



termine the tightness of the drill hole. If the unbonded length portion of the drill hole is in fractured rock or soil, a packer or casing shall be used to isolate the anchor length so it can be tested. The hole shall be filled with water and subjected to a pressure of 5 psi (34.5 kPa) in excess of the hydrostatic head measured at the top of the drill hole. If the leakage rate from the drill hole exceeds 5 gallons in a ten minute period, then the hole should be consolidated grouted, redrilled or water flushed, and retested. If the second watertightness test fails, the process should be repeated. The water level in adjacent drill holes should be observed during the test.

The water--cement ratio of the consolidation grout may be adjusted as required to seal the hole.

If flowing water is observed in the drill hole or artesian water flows out of the hole, then the consolidation grout should be pressurized.

The contractor shall submit for review and approval a description of the watertightness test procedures and equipment.

- 3) The anchor grout shall have a water--cement ratio between 0.35 and 0.50. The grouting equipment should include a mixer capable of producing a grout free of lumps and undispersed cement. A positive displacement grout pump shall be used. The pump shall be equipped with a pressure gauge to monitor grout pressures. The grouting equipment shall be sized to enable the tieback to be grouted in one continuous operation. Neat cement grouts should be screened to remove lumps. The maximum size of the screen openings shall be 0.250 inches (6.4 mm). Mixing and storage times should not cause excessive temperature build in the grout. The mixer should be capable of continuously agitating the grout.
- 4) The anchor grout shall be injected from the lowest point of the tieback. The grout may be placed using grout tubes, casing, or drill rods. The grout can be placed before or after insertion of the tendon. The quantity of the grout and the grout pressures shall be recorded. The grout pressures and grout takes shall be controlled to prevent excessive heave in cohesive soils or fractured rock.
- 5) The tieback shall remain undisturbed for a minimum of 3 days or until the grout has cured.

### Testing

(The engineer should select the appropriate tests from Chapter 10 and specify the number of each type to be performed.)

## Monitoring

Permanent load cells and extensometers shall be provided where indicated on the contract drawings. The contractor shall read the instrumentation biweekly during construction. Upon completion of construction, the contractor shall turn over to the owner's engineer the readout equipment required to continue monitoring. The engineer shall monitor the tiebacks for \_\_\_\_\_ additional years.

## Records

The contractor shall provide the owner's representative with the following records:

- 1) Drawings showing the location of the tiebacks, total tieback length, anchor length, and unbonded length.
- 2) Steel and grout certifications and/or mill reports.
- 3) Grouting records indicating the cement type, quantity injected, and the grout pressures.
- 4) Tieback test results.
- 4) Monitoring results.

## PRICING

When performance specifications are used, the owner will be able to obtain lump sum bids for the work. It may be desirable to use unit prices for watertightness tests, consolidation grouting and redrilling. A lump sum price makes the contractor responsible for performance and eliminates record keeping and disputes about quantities installed.

Tieback construction methods vary depending on ground conditions, tieback capacity, tieback length, corrosion protection requirements, tendon type, patents, designer and contractor experience, specifications, site restrictions, and equipment availability. A variety of installation methods are described in this chapter. Each one has been successfully used for permanent applications. The different types were described so the designer can become familiar with the various tieback systems that might be provided if he uses a performance specification.

### TENDON FABRICATION

#### A. Prestressing Steels

The tendon type, size, and length are determined by the tieback capacity, allowable strength of the steel, corrosion protection requirements, anchor length, and installation method. Only bars, strands, and wires meeting ASTM standards should be used for tieback tendons. Bars are manufactured from hot-rolled alloy steel meeting ASTM A-722-75, Specification for Uncoated High Strength Steel Bar for Prestressed Concrete. Strands are normally 0.5 inch (12.5mm) or 0.6 inch (15.2 mm) diameter 7-wire strands manufactured to meet ASTM A-416-74, Specification for Uncoated Seven-Wire Stress-Relieved Strand for Prestressed Concrete, or ASTM A-779-80, Specification for Steel Strand, Seven-Wire, Uncoated, Compacted, Stress-Relieved for Prestressed Concrete. Wire tendons are buttonheaded and fabricated from wire which is manufactured to meet ASTM A-421-77, Specifications for Uncoated Stress-Relieved Wire for Prestressed Concrete.

Table 9 describes the various tendon materials used for tiebacks in the United States. Bars are manufactured in 60 foot (18.3 m) lengths. The bars can be cut or coupled in order to fabricate a tendon of the required length. Couplers should not be located in the anchor length of simple corrosion protected permanent tiebacks. Both smooth and continuously threaded bars are available. Multistrand tendons are fabricated in any length and capacity. Prestressing strand is manufactured in long rolls and cut to length in a shop or at the site. Multiwire tendons are shop fabricated in any length and capacity. Wire tendons are not deformed and they are designed to transfer of load to an end anchor plate, but actually they are bonded to the grout. Wires use cold-formed buttonheads to transfer load to the anchor plates.

The maximum test load on a tieback should not exceed 80 percent of the guaranteed ultimate capacity of the prestressing steel, and the design load should not exceed 60 percent of the guaranteed ultimate capacity.

#### B. Sheaths

The unbonded length of a tendon is created by sheathing the individual elements or groups of elements in the tendon. Low or high density polyethylene or polypropylene tubes, or PVC pipe are used to sheath the

Table 9. Common tieback tendon materials.

| Tendon Type               | Diameter |      | Ultimate Strength |        | Ultimate Capacity |        | Yield Capacity (1) |        | Nominal Steel Area |                    | Weight   |        |
|---------------------------|----------|------|-------------------|--------|-------------------|--------|--------------------|--------|--------------------|--------------------|----------|--------|
|                           | (inches) | (mm) | (ksi)             | (M Pa) | (kips)            | (kN)   | (kips)             | (kN)   | (in <sup>2</sup> ) | (mm <sup>2</sup> ) | (lbs/ft) | (kg/m) |
| Bar (2)                   | 1        | 26.5 | 150               | 1034.7 | 127.8             | 568.7  | 106.1              | 472    | 0.85               | 548                | 2.96     | 4.40   |
| Bar (2)                   | 1        | 26.5 | 160               | 1103.7 | 136.3             | 606.5  | 113.1              | 503    | 0.85               | 548                | 2.96     | 4.40   |
| Bar (2)                   | 1.25     | 32   | 150               | 1034.7 | 187.5             | 834.4  | 155.6              | 692    | 1.25               | 806                | 4.40     | 6.55   |
| Bar (2)                   | 1.25     | 32   | 160               | 1103.7 | 200.0             | 890.0  | 166.0              | 739    | 1.25               | 806                | 4.40     | 6.55   |
| Bar (2)                   | 1.375    | 36   | 150               | 1034.7 | 234.0             | 1041.3 | 194.2              | 864    | 1.56               | 1006               | 5.31     | 7.90   |
| 7-Wire Strand (3)         | 0.5      | 12.5 | 270               | 1862.5 | 41.30             | 183.78 | 37.17              | 165.41 | .153               | 98.7               | 0.525    | 0.781  |
| 7-Wire Compact Strand (4) | 0.5      | 12.5 | 270               | 1862.5 | 47.00             | 209.15 | 40.90              | 182.00 | .174               | 112.3              | 0.600    | 0.893  |
| 7-Wire Strand (3)         | 0.6      | 15.2 | 270               | 1862.5 | 58.60             | 260.77 | 52.74              | 234.67 | .217               | 140.0              | 0.740    | 1.101  |
| 7-Wire Compact Strand (4) | 0.6      | 15.2 | 260               | 1793.5 | 67.44             | 300.11 | 58.70              | 261.22 | .256               | 165.2              | 0.873    | 1.295  |
| Wire (5)                  | 0.250    | 6.35 | 240               | 1655.5 | 11.78             | 52.4   | 9.43               | 41.96  | 0.0491             | 31.7               | 0.167    | 0.249  |

- (1) Yield capacity for wires and strands are the minimum loads at 1% extension when tested using methods specified in ASTM A-370. Yield capacity for bars are assumed to be 83% of ultimate.
- (2) Bars conform to ASTM A-722-75, Specification for uncoated High Strength Steel Bar for Prestressed Concrete.
- (3) Strands conform to ASTM A-416-74, Specification for Uncoated Seven-Wire Stress-Relieved Strand for Prestressed Concrete.
- (4) Compact strands conform to ASTM A-779-80, Specification for Steel Strand, Seven-Wire, Uncoated, Compacted Stress-Relieved for Prestressed Concrete.
- (5) Wires conform to ASTM A-421-77, Specification for Uncoated Stress-Relieved Wire for Prestressed Concrete.

tendon. The sheath functions as a bond-breaker between the tendon and the grout, corrosion protection, and as a containment for grease. The sheath must be:

- 1) Resistant to chemical attack from aggressive environments, grout, or grease.
- 2) Fabricated from material nondetrimental to the tendon.
- 3) Capable of withstanding abrasion, impact, and bending during handling and installation.
- 4) Leak proof.
- 5) Accommodate movements during testing and stressing.
- 6) Allow movements after lock-off if the tendon remains unbonded.

Sheaths may be shop extruded directly over greased wires or strands, or they can be pulled over greased elements in the shop or field. They should have a minimum wall thickness of 0.020 inches (0.5mm).

The annular space between the sheath and the tendon does not have to be filled with grease if the tieback is going to be used for temporary applications in nonaggressive environments (See Page 95).

#### C. Grease

Corrosion inhibiting greases are used to protect the prestressing steel under the sheath. They have been formulated to inhibit corrosion and provide lubrication for the tendon. The greases were originally developed for prestressing steel tendons in nuclear reactors. The PTI [59] recommends that permanent tiebacks have a minimum grease thickness of 0.010 inches (0.25 mm), and that the chlorides, nitrates, and sulfides in the grease cannot exceed the following limits:

- |              |         |
|--------------|---------|
| 1) Chlorides | 10 ppm. |
| 2) Nitrates  | 10 ppm. |
| 3) Sulfides  | 10 ppm. |

Greases provided by the tendon suppliers meet these requirements.

#### D. Encapsulations

Corrugated PVC, high density polyethylene, or deformed metal tubes are used to encapsulate the anchor length when aggressive environments are encountered (See Page 95). The capsule must be:

- 1) Capable of transferring stresses from the encapsulation grout to the anchor grout.
- 2) Accommodate movements during testing, and after lock-off.
- 3) Resistant to chemical attack from aggressive environments, grout, or grease.
- 4) Fabricated from materials nondetrimental to the tendon.
- 5) Capable of withstanding abrasion, impact, and bending during handling and installation.
- 6) Leak proof.

Cement grout is used to grout the tendon inside the capsule. Admixtures which improve flowability and control bleed, without significant strength decrease, may be used with the encapsulation grout (See Page 137). Polyester resins recently have been used for encapsulation grouts in Great Britain. The formulation, and the creep and corrosion resistance properties of these resins have not been published.

#### E. Spacers

Spacers are installed in multi-element strand and wire tendons to separate the individual strands or wires so that each one is adequately bonded to the anchor grout. Figure 64 shows a typical strand spacer. Spacers are fabricated from materials that are not detrimental to the tendon. It is not certain if spacers are required. Many tiebacks are installed without them; in fact, some tiebacks can not be installed with spacers.

#### F. Centralizers

Centralizers are used to provide minimum grout cover over the tendon. Grout cover is necessary for corrosion protection and for the development of bond between the tendon and the grout. Figure 65 shows a centralizer for a bar tendon. Centralizers are fabricated from materials that are not detrimental to the tendon, and they should provide a minimum of 0.5 inches (12.7 mm) of grout cover. Other standards [55], [57], and [58] have recommended greater minimum grout covers. The excellent corrosion performance of concrete pressure pipes [93] and Raymond cylinder piles [94] indicates that a thin dense grout cover will provide satisfactory corrosion protection for a tieback.

Dr. Stocker [95] stated that pressure-injected tiebacks, installed in sandy and gravelly soils using a grout pressure greater than 150 psi (1035 kPa), do not require centralizers. When this type of tieback is made, the high grout pressures force the excess water in the grout into the soil leaving a dense grout. This low water-cement ratio grout is stiff enough to support the tendon without centralizers.

Figure 66 shows a combination centralizer spacer which can be used with a multistrand tendon.

#### G. Anchorages

The anchor heads and bearing plates are fabricated from steel. The anchorage should develop at least 95 percent of the minimum specified ultimate strength of the prestressing steel. Figures 67, 68, and 69 show typical bar, strand, and wire anchorages respectively. The bearing plate should be installed perpendicular to the tendon in order to prevent bending of the tendon. Careful alignment of the bearing plate or using an anchorage designed to accommodate misalignment are recommended. The draft British Code [54] indicates that strand and wire tendons may deviate up to 5 degrees from perpendicular and bar tendons up to 2 degrees.

Anchorages are designed to be restressable, adjustable, or capable of lift-off. A restressable anchor head is one which enables load to be

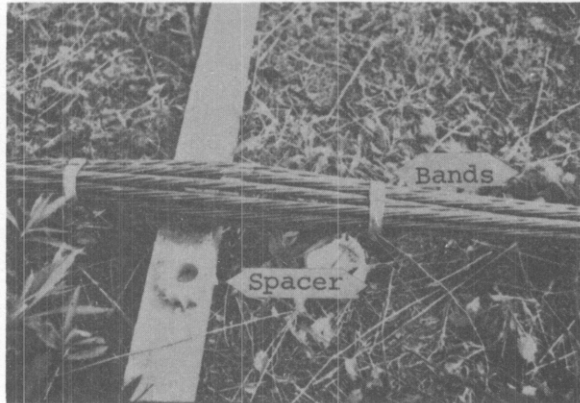

Figure 64. Spacer.

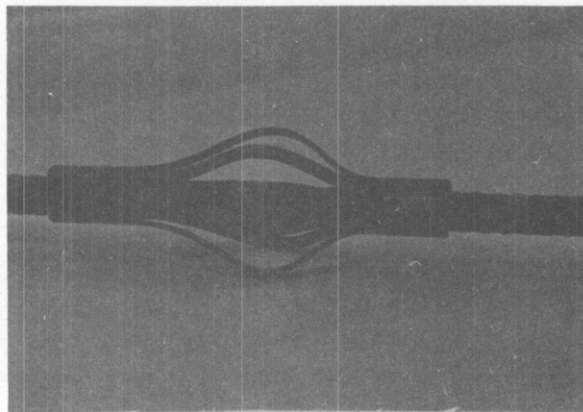

Figure 65. Centralizer.

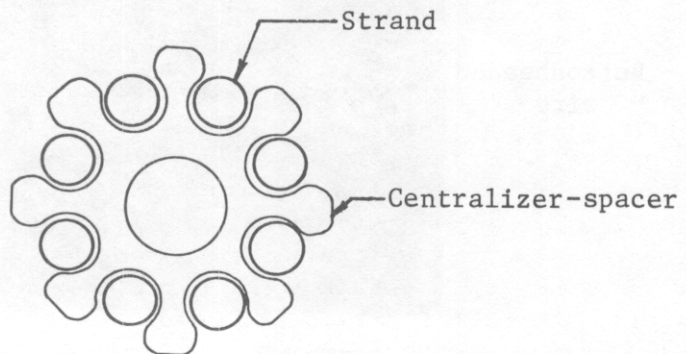

Figure 66. Combination centralizer-spacer.

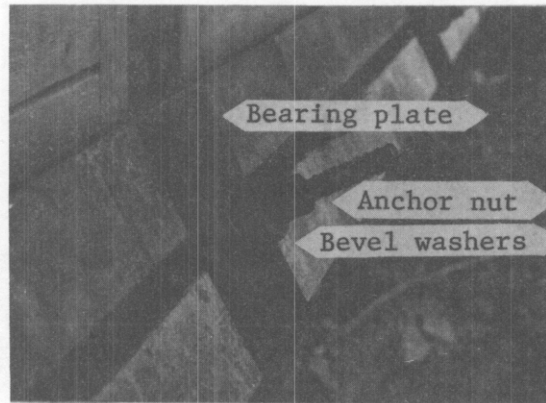

Figure 67. Bar anchorage.



Figure 68. Strand anchorage.

Buttonheaded  
wire

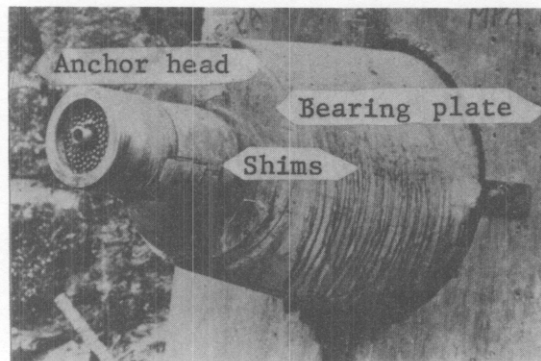

Figure 69. Wire anchorage.



reapplied to the tendon, or increased at any time. Adjustable anchor heads enable the load to be increased or decreased at any time. An anchor head which can be lifted-off is designed to enable a jack to apply a load to the tieback until the anchor head rises from the bearing plate. Threaded bar tendons with nuts are restressable, adjustable, and capable of lift-off. Until the strand has been cut near the anchor head, short-term lift-off of strand tendons can be accomplished by regripping the tendon. Threaded anchor heads and/or shims enable strand and wire tendons to be restressed, adjusted, or lifted-off. Figure 69 shows a shim stack under a wire tendon anchor head.

The anchor head should be encased in concrete or grout unless load adjustment is anticipated. If the anchor head is recessed in a pocket, normal or expansive grout can be used to fill the pocket. Encased tiebacks can be monitored using load cells. Tiebacks used for landslide stabilization or cavern support may require load adjustment. Accessibility and load adjustment capability should be provided for slide tiebacks if the failure surface is not well defined, or if small changes in the soil or rock strengths cause large changes in the estimated tieback force. All tiebacks used for underground cavern support should be accessible and adjustable.

Anchorage caps or covers (see Figures 50 and 55) are used to provide corrosion protection for anchor heads which must remain accessible. The covers are fabricated from plastic or steel. The space between the covers and the anchor head is filled with anticorrosion grease.

Electrical insulation of the anchor head is recommended for simple corrosion protected tiebacks. Figure 55 shows an electrically insulated anchor head. The material used to insulate the bearing plate and the anchor head from the structure must:

- 1) Be an electrical insulator.
- 2) Not be chemically attacked by cement, grease, or aggressive environments.
- 3) Be fabricated from material nondetrimental to the tendon.

The material under the bearing plate also must:

- 1) Have high compressive strength (greater than concrete).
- 2) Not creep significantly under load at service temperatures.

Plastic bearing strips between 0.125 and 0.250 inches (3.2 and 6.4 mm) thick can be used under the bearing plates. These materials are designed for use with precast concrete construction.

Heat shrinkable caps with elastic adhesives, tapes, or grease or grout filled plastic covers can be used to electrically insulate the anchorage. The trumpet for electrically insulated tiebacks should be fabricated from plastic pipe.

## ANCHOR GROUT

### A. Materials

Portland cement grout usually without aggregate is the most common grout used to anchor the tendon to the ground. Occasionally polyester resin cartridges and liquids have been used.

Most anchor grouts are neat grouts (containing no aggregate), made up of ASTM C-150, Type I portland cement, potable water, and sometimes, admixtures. ASTM C-150 Type III cement may be used when high early strength is desired. Type III cement generally has a higher water demand than Type I cement. ASTM C-150 Type II cement is used to obtain increased setting time, and also to provide better sulfate resistance. Type I portland cement grout usually has a water-cement ratio of 0.35 to 0.5. For a water-cement ratio of 0.4, the 7-day compressive strength will generally exceed 3,500 psi (24,150 kPa).

Sand-cement grout is used for hollow-stem augered, single-underreamed, and large diameter straight-shafted tiebacks. This grout is usually proportioned to assure pumpability. Sand-cement grout may be mixed at the site or delivered to the site in ready-mix trucks. Admixtures may be used to increase the flowability, decrease the water cement ratio, and control the setting time. A typical mix has 846 lbs. (386.3 kg) of cement per cubic yard (0.765 m<sup>3</sup>) of grout, and a maximum water-cement ratio of 0.45. Retarders may be used with ready-mix grout.

A flowable, 2,500 psi (17,250 kPa) or better, transit-mix concrete may be used for single-underreamed and larger diameter straight-shafted tiebacks. The mix must have adequate flowability to ensure the filling of the hole. If concrete is used for simple protected permanent tiebacks, a six- or seven-sack per cubic yard (0.765 m<sup>3</sup>) mix should be used to maintain a high pH environment around the tendon.

Polyester resin cartridges are proprietary products developed for rock bolting. Occasionally they have been used for temporary and permanent rock tiebacks. The resin cartridges are used with continuously deformed bar tendons. The cartridges are inserted into drill holes which are slightly larger than the tendon diameter. Then, the tendon is continuously rotated into the hole breaking the cartridges and mixing the two-component resin. A fast setting resin is used along the anchor length and a slow setting resin is used over the unbonded length. Resin cartridge tiebacks are seldom used because drilling equipment is unable to economically drill long, small diameter holes; and tendon insertion and breaking of the cartridges is difficult when the tendon exceeds 20 feet (6.1 m). Resin cartridges are not recommended for permanent tiebacks because the resin may not completely encapsulate the tendon, and they do not provide a high pH environment.

Pumped liquid resins have been used in Germany for rock tiebacks. The grouting methods are similar to those used for cement grout. Pumped resin permanent tiebacks should be encapsulated in a manner similar to that shown in Figures 45 or 46.

## B. Admixtures

Some tieback specifications require the use of water reducing or expanding admixtures while others forbid their use. These admixtures generally retard the grout set and promote sedimentation of the cement particles in the grout solution prior to set. Sedimentation may cause intermittent voids in low-pressure-grouted tiedowns [96], particularly at the spacers and centralizers, and it is exaggerated in strand type tendons because of the filtering action along the interstices formed by the six outer wires surrounding the center wire. Admixtures containing gelling agents, which improve the water retention of the grout solution, can be used to control grout sedimentation. Gelling agents may reduce grout strength. The manufacturer should be consulted before specifying them for anchor grout.

Expansive agents such as aluminum powder are sometimes specified in an attempt to control grout shrinkage and settlement caused by sedimentation. They achieve expansion by the generation of gas. These admixtures reduce the compressive strength of the grout in an approximate direct relationship to the decrease in density caused by gaseous expansion. Nicholson [50] reported a significant strength loss when an aluminum powder admixture was used. Expansive admixtures are not recommended for tieback applications.

When the anchor length is grouted under pressure in sandy soils, it is desirable to use the bleed or water separation phenomenon to permit the water to be driven from the grout. In this type of application, admixtures which control the bleed are not desirable.

Admixtures to accelerate the time of set to avoid freezing generally are not required for the anchor length since the ground temperature in the temperate zone is about 55° F. (13° C) year round. However, where grout is used to protect the anchorage, accelerators may be required in freezing weather. Accelerators should not contain chlorides.

## C. Chemical Attack on Portland Cement Grout

There are no reported tieback failures resulting from chemical attack on the grout. ASTM C-150 Type I portland cement grout is the most common tieback grout, and it will perform satisfactorily when exposed to most environments.

However, all types of portland cement will deteriorate when exposed to acid environments, and Type I and Type III cements are susceptible to sulfate attack. The amount of deterioration increases with increasing water-cement ratio, grout permeability, temperature, and circulation of the corrosive agent. In a stagnant environment, the products formed by the attack will form a barrier and limit further deterioration. Dense, low water-cement ratio grout would be the most resistant to chemical attack.

Acid attack results when organic or inorganic acids react with the cement to form soluble salts which are removed by leaching. If buried concrete structures in similar environments have experienced acid attack, then portland cement grout should not be used for permanent tiebacks. If the performance information on other structures is not available, then

portland cement should not be used if the pH is less than 5.0. Acid resistant cements are available, but they have not been used for tieback applications. Field tests should be performed to determine which acid resistant cements could be used for permanent tiebacks.

Sulfates of sodium, magnesium, potassium, and calcium, frequently found in soils in the western United States, attack portland cement by chemically reacting with hydrated lime and hydrated calcium aluminate to form calcium sulfate and calcium sulfoaluminate, respectively. These compounds have a low solubility, and they disrupt the grout because their volume is greater than the volume of the cement paste from which they were formed. The tests necessary to determine the sulfate content of the soil or ground water are discussed in Chapter 5.

Mather [97] reported that there is a correlation between the tricalcium aluminate content and the sulfate resistance of the cement. ASTM C-150 Type II cement specifications limit its tricalcium aluminate content to 8 percent and it is classified as moderately sulfate resistant. ASTM C-150 cement specifications set the maximum tricalcium aluminate content for Type V cement at 5 percent, and it is classified as sulfate resistant.

The ACI [28] and the Bureau of Reclamation [98] have published recommendations for the selection of cement used for normal weight concrete and subjected to sulfate attack. Low permeability dense anchor grout probably do not require sulfate resistant cements in accordance with these recommendations. However, until more is learned about sulfate attack on grout, Type V cement grout should be used if the water soluble sulfate content exceeds 2000 mg/kg.

#### D. Mixing and Pumping

Neat cement tieback grouts are mixed with paddle mixers or high turbulence mixers. Paddle mixers mix by agitating the cement and water with blades rotating at speeds up to 100 rpm. High turbulence mixers rotate impellers or shear discs at speeds in excess of 1500 rpm. They mix the grout by shearing the fluid. Each mixing unit has a separate agitated holding tank. The grout is usually sieved to remove lumps before entering the holding tank.

Site mixed sand-cement grout is mixed in conventional horizontal or vertical mortar paddle mixers. Depending on the capacity and configuration of the mixer, an agitated holding tank may be used.

Neat cement anchor grout is pumped with progressive cavitating screw pumps, or positive displacement piston pumps. Screw or piston pumps are used for pressures less than 150 psi (1,035 kPa). Piston pumps are used to obtain the high pressures required for pressure injected and postgrouted tiebacks.

Sand-cement grout is pumped with conventional grout pumps. They are piston pumps capable of pumping grout with an aggregate size of 3/8 inch (9.5 mm) or less.

The grouting equipment is sized so that the grouting operations are not interrupted during the grouting of an individual tieback. Sections 4.1 through 4.5, and 4.7 through 5.2 of the PCI, Recommended Practice for Grouting of Post-Tensioned Prestressed Concrete, [99] provide additional descriptions of grouting equipment and grout mixing.

## ROCK TIEBACK INSTALLATION

Rock tiebacks are normally installed in straight-shafted drill holes. Figure 70 shows a typical rock tieback installation sequence. After the drill hole is made and cleaned, then it is tremie grouted. Finally, the tendon is placed in the grout filled hole. As an alternate, the tendon and a grout tube can be inserted into the hole simultaneously, see Figure 71. After they are in position, grout is pumped through the grout tube filling the drill hole. Regardless of the method, the grout is always placed from the lowest point.

### A. Rock and Overburden Drilling

Depending on the hardness of the rock formation, rock can be drilled with percussion and/or rotary techniques. Table 10 is a guide to the drillability of various rock formations.

#### Percussion Drilling

Air tracks or down-the-hole hammers are used to percussion drill all types of rock formations. Air tracks are capable of drilling uncased holes up to 5 inches (127 mm) in diameter. They are used for rock tiebacks when the total tieback length is less than 100 feet (30.5 m). Down-the-hole hammers are used with rotary drills. Hammers for rock tieback work are available in sizes, from 3 to 10 inches (76 to 254 mm) in diameter. Down-the-hole hammers are used for rock tiebacks when the drill hole exceeds four or five inches (102 or 127 mm) in diameter, when the length of the hole exceeds 100 feet (30.5 m), or when both rotary and percussion drilling are required.

Air tracks and down-the-hole hammers use carbide cross bits or button bits. These bits crush and chip the rock when impacted. Normally compressed air is used to exhaust the cuttings from the drill hole.

Hydraulic rotary percussion hammers have been developed in Europe. These drills are crawler mounted, and the hammer has high rotary torque. When a hydraulic hammer is used, water and/or air can be used to exhaust the cuttings from the drill hole. Hydraulic rotary percussion drills have enabled the development of a lost-bit drilling technique for rock tiebacks. In this method a carbide inserted bit, slightly larger than the casing, is fitted on the casing. The casing usually has an outside diameter of 3 to 4 inches (76 to 102 mm). During drilling the casing functions as the drill steel. Upon completion of the hole, the tendon is inserted into the casing, and the bit is knocked off the end. The tieback is grouted as the casing is extracted.

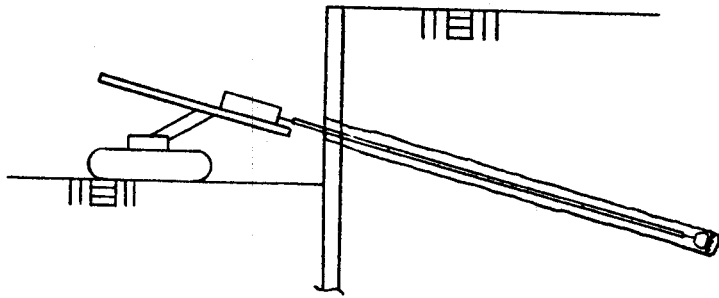

a) Drill and clean hole.

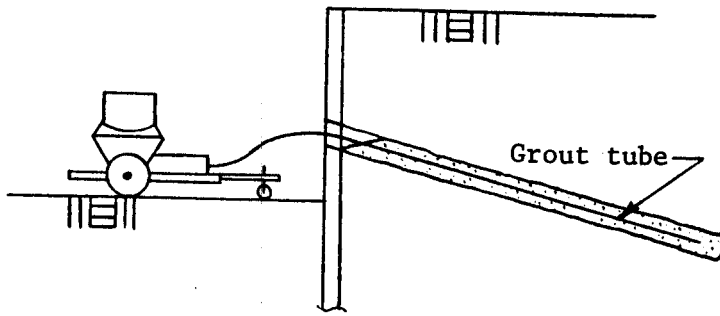

b) Fill hole with grout.

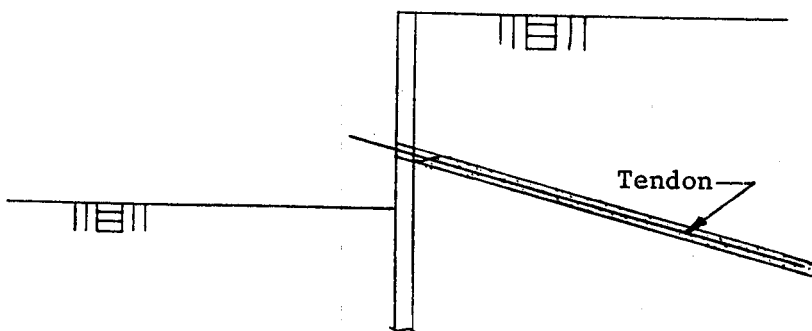

c) Insert tendon.

Figure 70. Construction steps for a tremie-grouted, straight-shafted rock tieback.

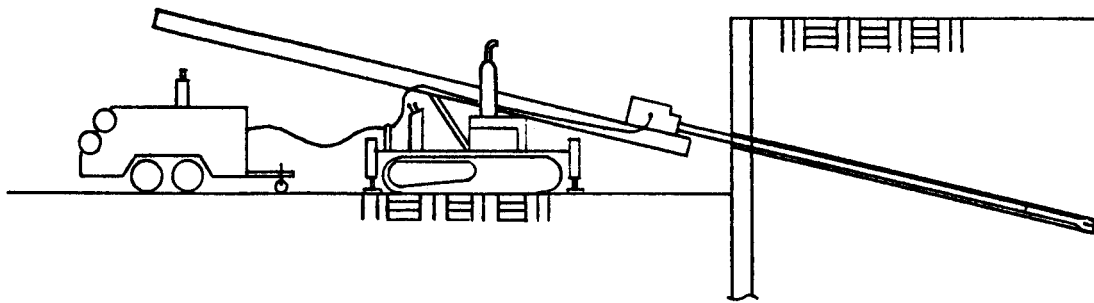

a) Drill and clean hole.

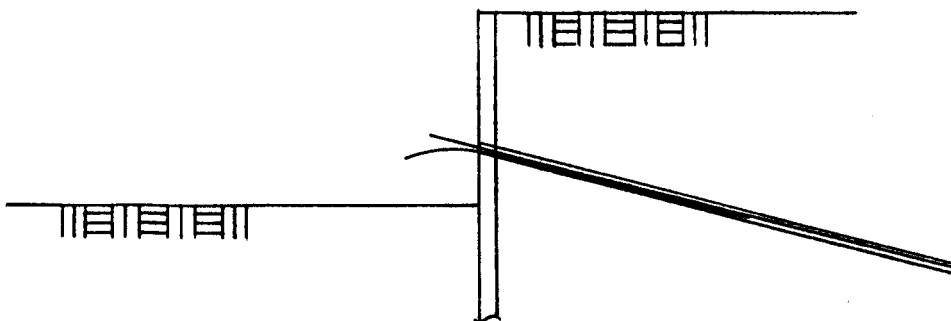

b) Insert tendon with grout tube.

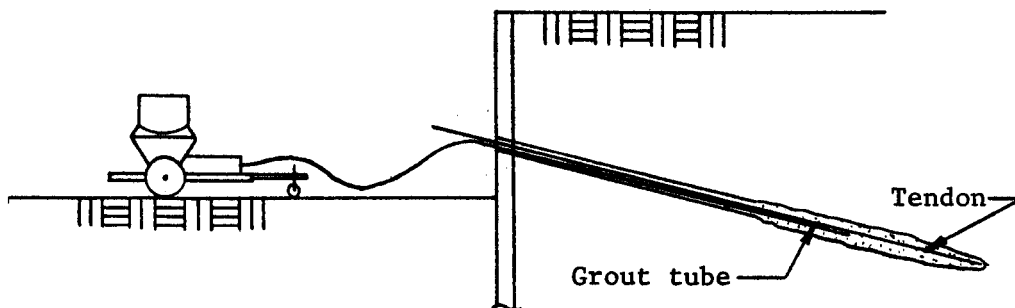

c) Grout tieback.

Figure 61. Construction steps for a straight-shafted rock tieback grouted after tendon insertion.

Table 10. Rock drillability guide.

| Rock formation |                           | Drilling Method |            |                     |
|----------------|---------------------------|-----------------|------------|---------------------|
| Hardness       | Type                      | Drag bit        | Roller bit | Percussion Drilling |
| Soft           | Soft Shale                | *               |            |                     |
|                | Marl and Chalk (No Flint) | *               |            |                     |
|                | Shale                     | *               | *          |                     |
| Medium         | Boulder Clay              | *               |            |                     |
|                | Siltstone                 | *               | *          |                     |
|                | Coal                      | *               | *          | *                   |
|                | Limestone and Sandstone   |                 | *          | *                   |
|                | Dolomitic Limestone       |                 | *          | *                   |
|                | Slate                     |                 | *          | *                   |
|                | Tuff                      |                 | *          | *                   |
| Medium Hard    | Schist                    |                 |            | *                   |
|                | Limestone (Silicious)     |                 |            | *                   |
|                | Gneiss                    |                 |            | *                   |
| Hard           | Diorite                   |                 |            | *                   |
|                | Gabbro                    |                 |            | *                   |
|                | Andesite                  |                 |            | *                   |
| Very Hard      | Basalt                    |                 |            | *                   |
|                | Sandstone (Cemented)      |                 |            | *                   |
|                | Rhyolite                  |                 |            | *                   |
|                | Granite                   |                 |            | *                   |
|                | Pegmatite                 |                 |            | *                   |
|                | Quartzite                 |                 |            | *                   |

### Rotary Drilling

When the rock formation is relatively soft, rotary drilling with a drag or a roller cone bit is used. These bits are available in sizes ranging from 3.75 to 12.25 inches (9.5 to 31.2 cm). Rock holes drilled by rotary methods are normally cleaned with water. Air can be used to clean these holes, but air is not as efficient as water. The method used to clean the drill hole can affect the capacity of the tieback if fine-grained soil or rock particles coat the wall of the hole.

### Overburden Drilling

The drilling techniques required to drill through overburden to the top of sound rock are called overburden drilling. Often caving soils, boulders, fractured rock, or weathered rock overlie the rock formation where the tieback will be anchored. In order to install the rock tieback, the drill hole must be cased in the soil overburden.



"Odex" Drilling is the tradename for a drilling technique developed by Atlas Copco and Sandvik. The method uses a drill bit with an eccentric reamer to drill a hole larger than the outside diameter of the casing. The drilling method uses a top drive hammer for 3 inch (76 mm) diameter holes and a down-the-hole hammer for 4.5 inch (115 mm) holes. Figure 72 shows the basic drilling method, and Figure 73 shows the drill strings for both the top drive and the down-the-hole hammers. A similar drilling method using down-the-hole hammers, called Saturn drilling, has been developed by Stenwick in Belgium. Large loss of ground was reported when "Odex" drilling was used to install tieback casing through sandy overburden at Locks and Dam Number 26, Alton, Illinois [100].

"Klemm System" drilling is a tradename which describes an overburden drilling technique developed by Gunter Klemm. This method uses a two-tube drilling technique to advance a drill hole through soil with boulders. The drill string is arranged as shown in Figure 74. A top drive hammer is used to impact and rotate both the outside casing and the inside drill rods. A carbide cross-bit is used on the rods. Air, water, or a mixture of air and water are used to clean the hole. The flushing fluid is returned to the surface in the annular space between the casing and the rods. Once the hole has been advanced to the top of sound rock, the rock is percussion drilled using the carbide bit on the rods.

Overburden is frequently drilled by spinning a casing down to the top of sound rock. The casing is provided with a casing shoe or coring bit. Figure 75 shows the rotary drilling sequence used to drill through the overburden. Pilot drilling in front of the casing with the interior drill string, or simultaneously rotating and advancing an interior drill string and casing may be used to advance the casing. Water is normally used to flush the casing clean. Once the casing is sealed on the rock, the rock is drilled using a roller cone bit, drag bit, or down-the-hole hammer.

## B. Rock Tieback Grouting

The anchor grout is used to transfer load from the tendon to the rock and to provide corrosion protection.

### Watertightness of the Rock

Sometimes the watertightness of a drill hole in rock is tested prior to grouting the tieback. The purpose of the test is to evaluate the possibility of grout loss from around a permanent rock tieback. Littlejohn and Bruce [101] stated that watertightness testing was not routinely performed. The decision whether to require this test has been left to the judgment of the engineer responsible for the work. If large water losses are observed during core drilling, then watertightness tests should be performed. Corrosion protection, not load carrying ability, is the main reason for attempting to control the loss of grout. If the grout loss is large enough to affect the capacity of the tieback, this will become apparent upon testing.

The watertightness test, "waterpressure test," measures the gain or loss of water from the drill hole. A standpipe, or a packer with flow meter and pressure gauge are used to measure the gain or loss of water. If artesian

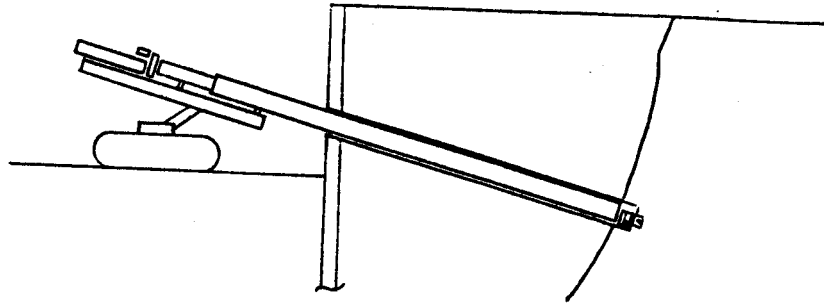

a) Advance casing to top of rock using eccentric bit.

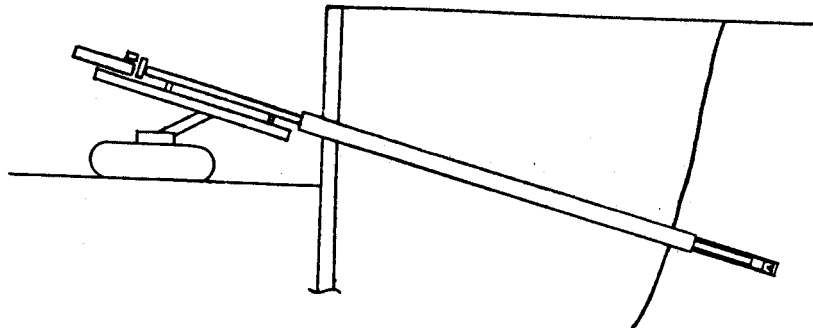

b) Drill rock with interior drill rods and carbide bit.

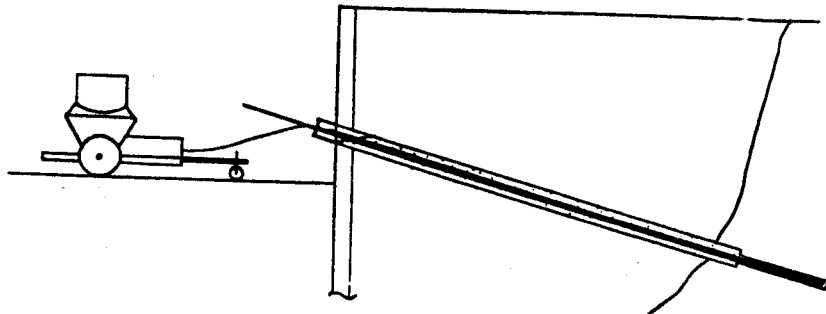

c) Tremie grout the drill hole and insert tendon.

Figure 72. Steps in "Odex" drilling.

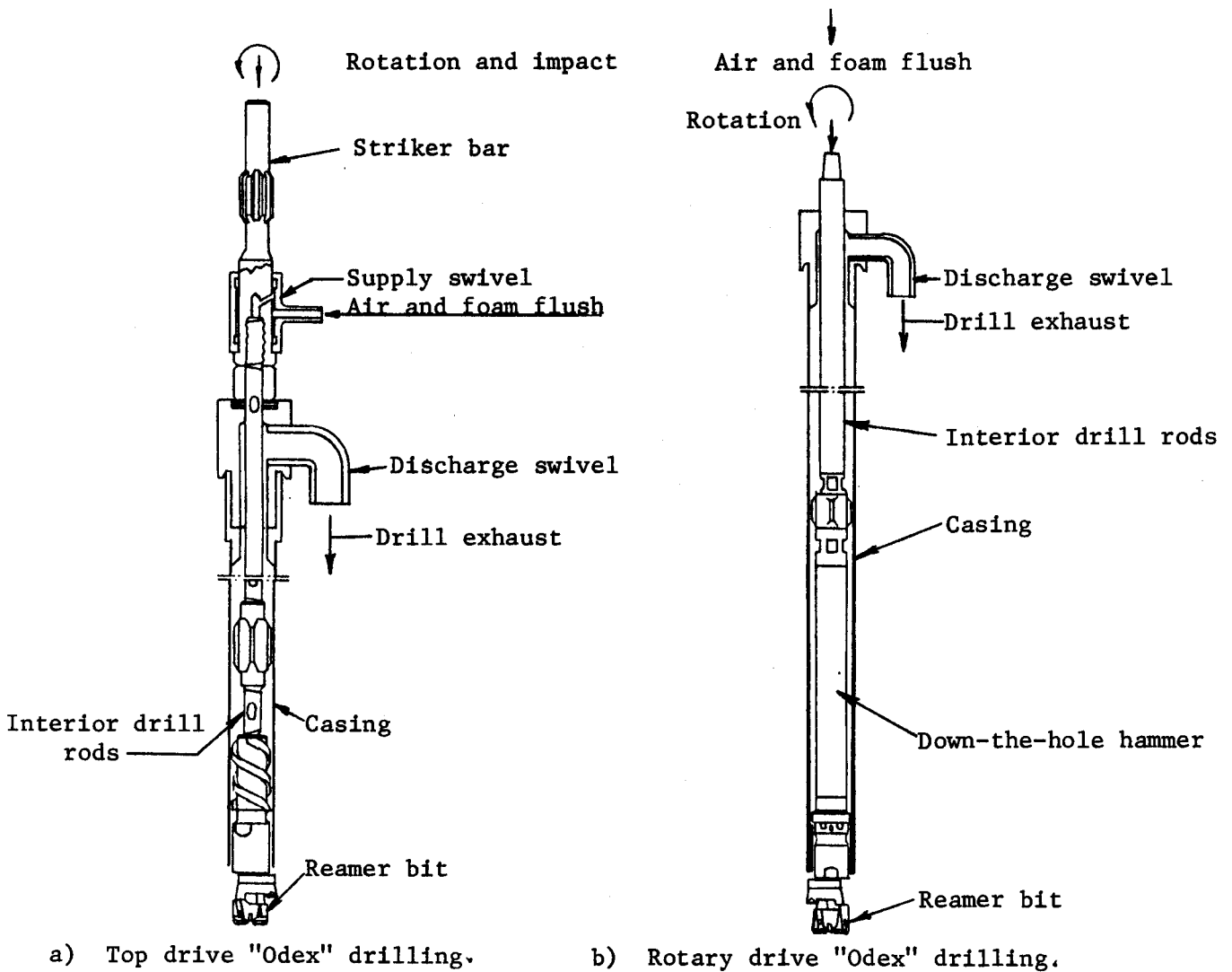

Figure 73. "Odex" drill string arrangement.

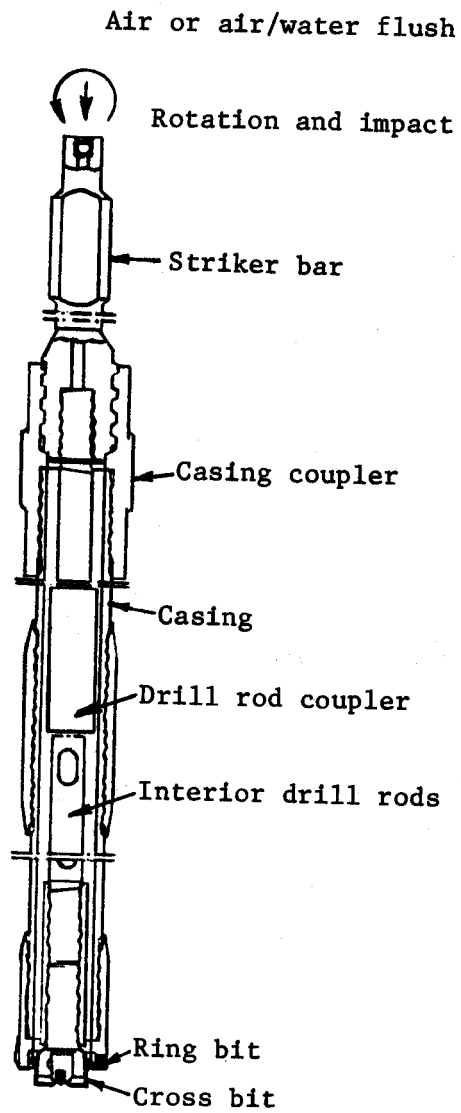
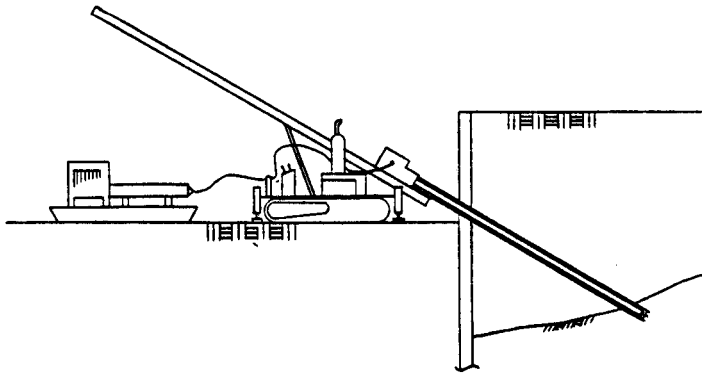
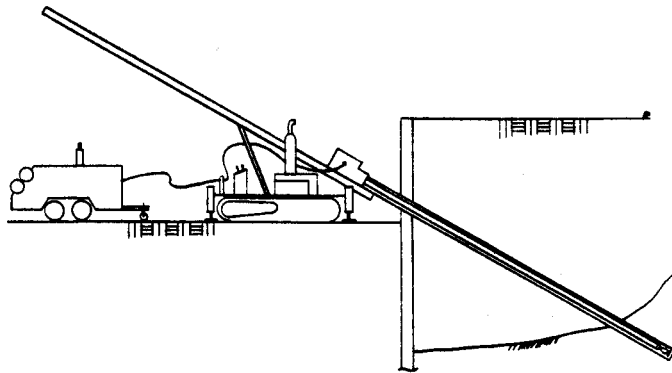

Figure 74. "Klemm" system drill string arrangement.



a) Drill overburden using casing and drill rods.



b) Drill rock socket with drag or roller cone bits, or a down-the-hole hammer.

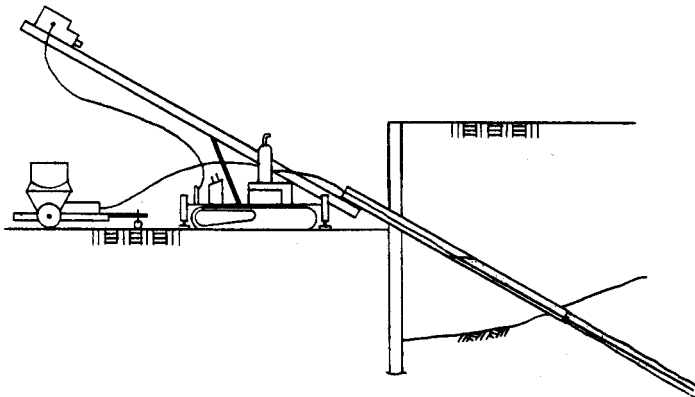

c) Tremie grout the drill hole.

Figure 75. Steps in rotary overburden drilling.

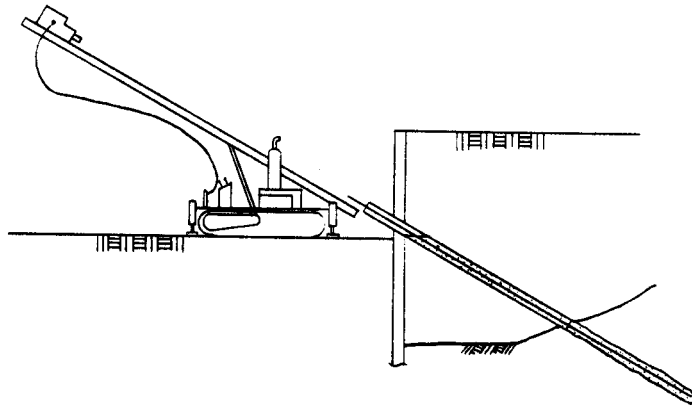

d) Insert the tendon.

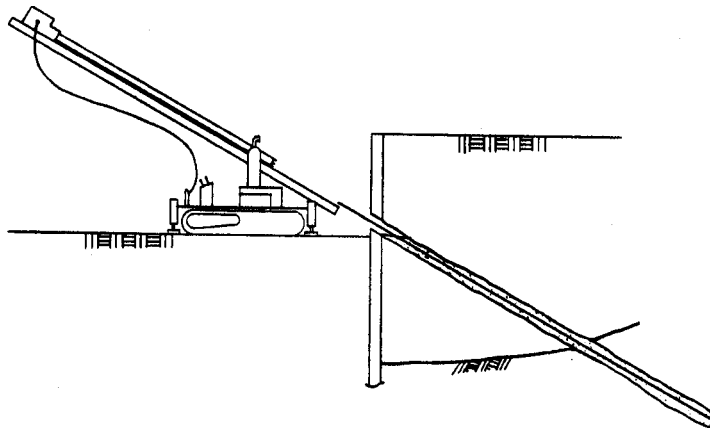

e) Extract the casing.

Figure 75. Steps in rotary overburden drilling.  
(continued)

water is not observed at the top of the drill hole, the elevation of the water is measured. Then the rate of water flow into the drill hole at a constant pressure in excess of hydrostatic pressure is measured. If the flow rate exceeds a limit value, then it is assumed that grout loss may be excessive and the hole should be waterproofed by grouting. There is a difference of opinion concerning acceptable flow rates. Littlejohn [102] indicated that the water flow rate should be based upon the fissure width that would permit cement grout to flow under low pressure. A 160 micron crack or joint may be permeable to cement grout and under a one atmosphere pressure it would enable 0.84 gallons (0.0032 m<sup>3</sup>) of water per minute (3.2 litres/min.) to flow from the hole [102]. A water pump, a flow meter, and an inflatable packer are required in order to develop a one atmosphere pressure in a drill hole. However, a 5 psi (34.5 kPa) pressure can be easily obtained using a stand pipe with an 11.5 foot (3.52 m) head of water. At 5 psi a 160 micron crack would enable about 0.5 gallons (0.0019 m<sup>3</sup>) of water per minute to flow from the hole. A water pressure test should be performed for 10 minutes, and the flow rate should be used to determine whether or not waterproofing is necessary.

If artesian water is observed then simple corrosion protected tiebacks should be made tight by grouting.

If artesian conditions do not exist and waterproofing is required, grout is tremied into the drill hole. If artesian pressure is present, a packer will be placed at the top of the hole and the grout will be placed under pressure. The grout used to waterproof a drill hole is also referred to as consolidation grout. Twenty-four hours after grouting, the hole is redrilled and the watertightness of the hole is rechecked. If the drill hole passes the test, the tieback can be completed. If the test fails, the process is repeated.

When the tieback tendon is fully encapsulated in a corrosion protection, watertightness testing is not required. In addition, water pressure testing is not performed on drill holes when the anchor grout is placed using pressure grouting techniques (See Page 150).

### Grouting

Most rock tiebacks are tremie grouted without pressure. A separate grout tube is placed to the bottom of the drill hole. Grout is then pumped into the drill hole until good quality grout is observed flowing from the top of the hole. Grout can also be pumped through the drill string if rotary drilling was used to drill the rock. After the drill hole is filled with grout, the tendon is inserted.

The tendon may be placed prior to grouting. In this case the tendon is inserted with a grout tube. After the tendon is in place, grout is pumped until good quality grout completely fills the hole.

Fully-bonded tendons are a special type of rock tieback. These tendons are not sheathed over their unbonded length, and they require two separate groutings. First the anchor grout, primary grout, is placed around the anchor length. After testing and lock-off, the unbonded length is grouted with secondary grout. The anchor length of a fully bonded tieback may be grouted through a grout tube inserted in the drill hole before the tendon is

placed or with a grout tube inserted with the tendon. Any grout above the anchor length is flushed out with water. After lock-off, the secondary grout is placed around the unbonded length through a separate grout tube. The secondary grout bonds the tendon along the unbonded length and it provides corrosion protection over the unbonded length. Expansive, antibleed grouts should be used for secondary grouting of permanent tiebacks. They prevent grout bleed and voids under the bearing plate.

Rock tiebacks may also be installed using a grouting method which enables the grout to be pressurized. In order for the grout to be pressurized, the anchor length must be isolated from the rest of the drill hole. This is accomplished by using a tight fitting casing over the unbonded length, or by placing an inflatable bag above the anchor length. These tiebacks are drilled in a similar manner to any rock tieback. If the casing is going to be used to create the seal, it is installed during drilling or just after completion of the hole. Then the tendon is placed in the drill hole and tremie grouted. After tremie grouting is completed, a grout hose is connected to the casing surrounding the tendon and the grout is pressurized. If a bag is used to seal the hole, the drill hole is tremie grouted and the tendon is placed. Then the bag is inflated to form a seal. Once the seal is made, the anchor grout is pressurized through a separate grout tube. Pressure grouting a rock tieback is done to increase the rate of load transfer, improve the density and strength of the grout and to simultaneously grout and waterproof the drill hole.

An upward sloping rock tieback requires special grouting procedures. Figure 76 shows a typical grouting arrangement for an upward sloping tieback. The drill hole is sealed near the anchorage. Grout is then pumped through a grout tube terminating just behind the anchorage. The grout flows upward along the tieback completely filling the drill hole. Upon filling the drill hole, the grout enters the vent tube and flows through the tube back to the front side of the anchorage. When good quality grout is observed flowing from the vent tube, the vent is sealed and grouting is stopped.

## SOIL TIEBACKS

Soil tiebacks are installed by a variety of drilling and grouting procedures. The selection of installation method depends upon the soil type, corrosion protection system, groundwater conditions, site restrictions and equipment availability. Table 11 indicates where different soil tiebacks could be used.

### A. Single-Underreamed Tiebacks

Single-underreamed tiebacks are installed in the United States in soils where the drill hole and the underream will remain open during construction. Figure 77 shows a single-underreamed tieback which was unearthed during a test program. These tiebacks are made using a caisson drill. Figure 78 shows a caisson drill and underreaming or belling tool. First, a 12 to 18 inch (304.8 to 457.2 mm) diameter shaft is drilled to the desired depth. Then, the end of the shaft is enlarged using an underreaming



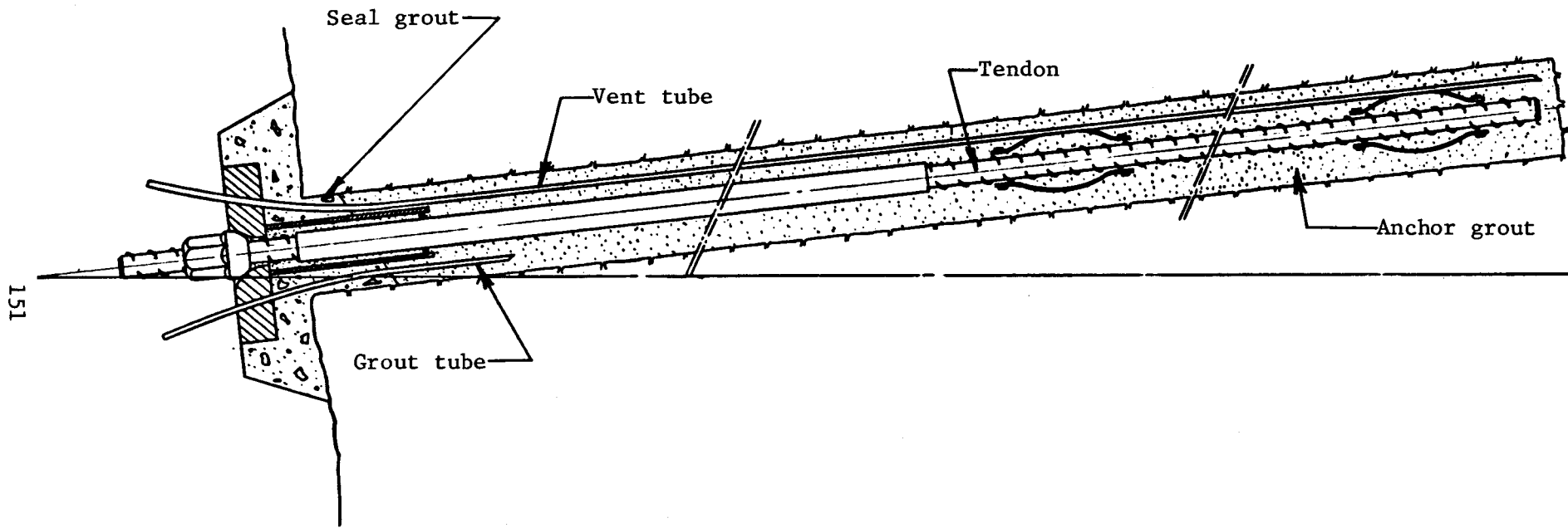

151

Figure 76. Grout arrangement for upward sloping rock tiebacks.

Table 11. Soil tieback installation methods.

| Tieback Type  | Soil Conditions   | Tendon Type  | Drilling Equipment   | Tieback Length   | Angle of Inclination (from horizontal)                                | Grouting  | Centralizers | Spacers                       | Unbonded Length   |
|---|---|--|--|--|---|---|--------------|-------------------------------|---|
| Single underreamed tiebacks   | Cohesive soils which will remain open without casing.   | Multistrand or single bar tendon                                   | Caisson drills   | Up to 60 ft. (18.3 m) common. 100 ft. (30.5 m) possible.   | 20° to 45°  | Poured or pumped concrete, or pumped sand cement grout                            | Yes          | Can be used on strand tendons | Sheathed and the grout is extended to near the surface  |
| Multiunderreamed tiebacks   | Stiff to very stiff cohesive soils. Shaft must remain open without casing along the anchor length.  | Multistrand tendons are normally used but a single bar is possible | Rotary drills  | Capacity of drill is the only limit on length. Lengths greater than 60 ft. (18.3 m) are routine. | 15° to 45°  | Frame grouted with neat cement grout  | Yes          | Can be used on strand tendons | Sheathed and backfilled with soil or lean concrete  |
| Hollow stem augered tiebacks  | Clays, interbedded silty clays and sands, silty clays, and residual soils. Sands under the groundwater table should not be drilled with augers. | Single bar or multistrand tendon                                   | Single pass augers. Sectional augers on rotary drills may be used but production is very slow. | Up to 80 ft. (24.4 m)  | 10° to 90° except clean sands where the angle varies from 30° to 90°. | Sand cement grout or neat cement grout is pumped to the auger as it is extracted. | No           | No                            | Unsheathed and back-filled with soil or lean grout. Sheathed and backfilled with grout or lean grout. |
| Straight-shafted low pressure grouted tiebacks (Two tube rotary drilling) | Sand, silty sand, and gravel  | Single bar or multistrand tendon                                   | Rotary drills with casing and rods   | Up to 250 ft. (76.2 m)   | 0° to 90°   | Neat cement grout   | Yes          | Can be used on strand tendons | Sheathed and the grout is extended to near the surface  |
| Straight-shafted low pressure grouted tiebacks (Caisson drill)            | Cohesive soils which remain open without casing   | Single bar or multistrand tendon                                   | Caisson drills   | Up to 60 ft. (18.3 m) common. 100 ft. (30.5 m) possible  | 20° to 45°  | Pumped concrete or sand cement grout  | Yes          | Can be used on strand tendons | Sheathed and back-filled with high strength or weak grout.  |
| Straight-shafted low pressure grouted tiebacks (uncased rotary drilling)  | Cohesive soils which will remain open with water or cement drilling fluids  | Single bar or multistrand tendon                                   | Rotary drills  | Up to 250 ft. (76.2 m)   | 0° to 90°   | Neat cement grout   | Yes          | Can be used on strand tendons | Sheathed and the grout is extended to near the surface  |

Table 11. Soil tieback installation methods (continued).

| Tieback Type                                    | Soil Conditions                                 | Tendon Type   | Drilling Equipment  | Tieback Length         | Angle of Inclination (from horizontal) | Grouting  | Centralizers | Spacers                       | Unbonded Length   |
|---|---|---|---|------------------------|--|---|--------------|-------------------------------|---|
| Pressure injected tiebacks (driven casing)      | Sand, silty sands, and gravels                  | Single bar tendons are normally used but multistrand tendons are possible | Air track used to drive a closed end casing. No soil is removed during installation | Up to 60 ft. (18.3 m)  | 0° to 90°                              | Neat cement grout is pumped through the casing under high pressure during extraction          | No           | No                            | Sheathed and low pressure grouting is continued to near the surface |
| Pressure injected tiebacks (drilled casing)     | Sands, silty sands, and gravels                 | Single bar or multistrand tendons   | Rotary drill with lost drag bit   | Up to 250 ft. (76.2 m) | 0° to 90°                              | Neat cement grout is pumped through the casing under high pressure during extractions         | Yes          | Can be used on strand tendons | Sheathed and low pressure grouting is continued to near the surface |
| Straight-shafted high pressure grouted tiebacks | Sands, silty sands, and gravels                 | Single bar or multistrand tendons   | Rotary drills   | Up to 250 ft. (76.2 m) | 0° to 90°                              | A bag is used to seal the hole and the anchor length is pressure grouted through a grout tube | Yes          | Can be used on strand tendons | Sheathed and low pressure grout is placed to near the surface       |
| Postgrouted tiebacks                            | Cohesive soils but they can be used in any soil | Single bar or multistrand tendon  | Rotary drills   | Up to 250 ft. (76.2 m) | 0° to 90°                              | Multiphase post-grouted is achieved by using a manchette tube and packer                      | Yes          | Can be used on strand tendons | Sheathed and low pressure grout is placed to near the surface       |

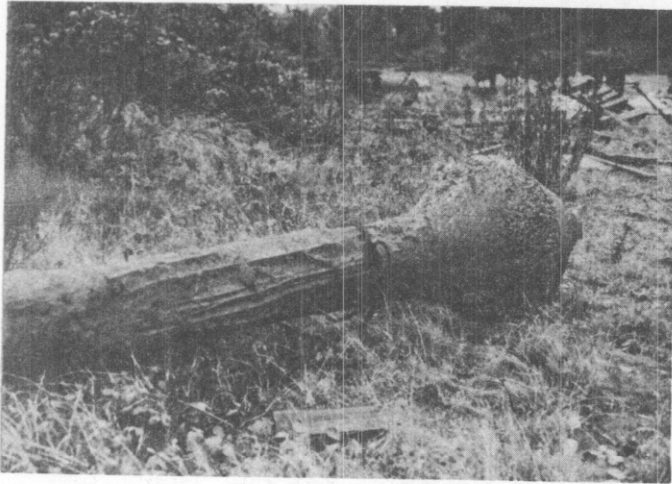

Figure 77. Single-underreamed tieback.  
(courtesy Donald B. Murphy)

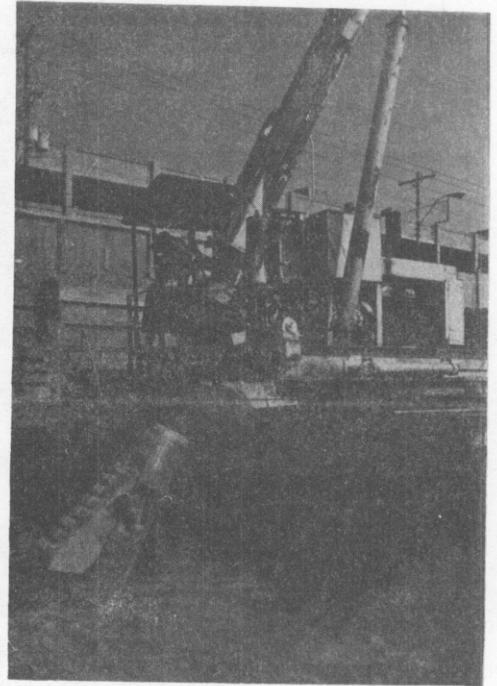

Figure 78. Caisson drill with underreaming tool.

tool. The diameter of the underreams vary from 24 to 54 inches (61.0 to 1,37.2 cm). After the bell is formed, the tendon is placed in the drill hole. The drill hole is then grouted using transit-mix concrete or sand-cement grout. If concrete is used, it is poured down the tieback shaft. If a sand-cement grout is used, the tieback is tremie grouted using a pump. The grout is not pressurized.

#### B. Multiunderreamed Tiebacks

Multiunderreamed tiebacks are used in stiff cohesive soil deposits. The soil must be stiff enough to prevent collapse of the underreams or drill hole in the anchor length. Multiunderreamed tiebacks are installed in drill holes having a shaft diameter between 5.5 and 7 inches (140 and 178 mm). Figure 79 shows a multiunderreamed tieback exposed during a test program in England.

Multiunderreamed tiebacks can be cased over their unbonded length so the tieback can be installed in cohesive soils which are overlain by caving soils. The hole is cased to the top of the anchor length and augers are used to drill the shaft. After the shaft has been drilled to the desired depth, the underreaming tool is inserted in the hole. There are a variety of patented underreaming tools. Fondedile uses a multiple hinged blade underreamer which is capable of excavating up to seven underreams simultaneously. Universal Anchorage Contractors, Ltd., uses a blade underreamer which excavates two bells at a time. Cementation Piling, Ltd., uses a brush underreaming tool which slowly opens and shaves the soil, one underream at a time. During underreaming, water is used to clean the drill

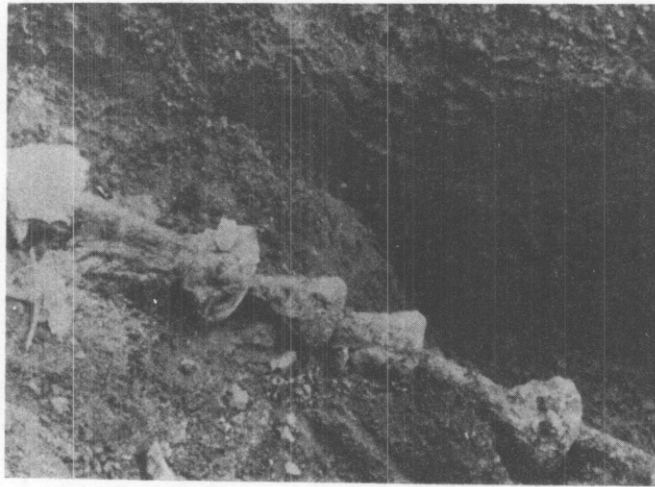

Figure 79. Multiunderreamed tieback (Courtesy Soil Mechanics Ltd.).

hole. The effectiveness of the particular underreaming method depends on the amount of time spent drilling and cleaning the hole, and the amount of debris remaining after cleaning. After the underreams are formed and the drill hole is cleaned, the tool is removed and neat cement grout is pumped into the drill hole through a tremie pipe. The grout is pumped until it completely displaces the water and clean grout is observed at the top of the hole. The tendon is then inserted into the drill hole. Centralizers for these tiebacks are designed to keep the tendon in the center of the hole even over the underreams.

### C. Straight-Shafted Tiebacks, Low Grout Pressure

Hollow stem augers are used to install straight-shafted tiebacks in a variety of soils. Hollow stem augers have been successfully used in stiff clay, interbedded silty clays and sands, sand, silty clay, and residual soil. Figure 80 shows a hollow-stem auger installation sequence. A slip fit point is attached to the tendon. The tendon is inserted into the auger and the point is engaged. Next, the auger is positioned and the hole is drilled. Upon completion of the hole, grout is pumped down the auger as the it is extracted. Hollow stem augered tiebacks are normally installed using a one piece auger. A sectional auger can be used with smaller rotary drills. Hollow stem augered tiebacks are common in the United States.

Low-pressure-grouted tiebacks are installed in sandy or gravelly soils using a grout pressure less than 150 psi (1,035 kPa). Figure 81 shows a typical installation sequence for a low-pressure-grouted tieback. The drill hole for these tiebacks is made by rotating a casing into the soil. The casing normally has an outside diameter of 4 to 6 inches (102 to 152 mm). The soil inside the casing is removed by a drag or roller cone bit on an inside drill string using air or water flushing. After the casing has been advanced to the desired depth, the inside drill rods and bit are removed leaving a cased hole. The hole is then tremie grouted and the tendon is inserted. The casing is reconnected to the drill, and grout is pumped down the casing during extraction. Low-pressure-grouted tiebacks are common in the United States and Europe.

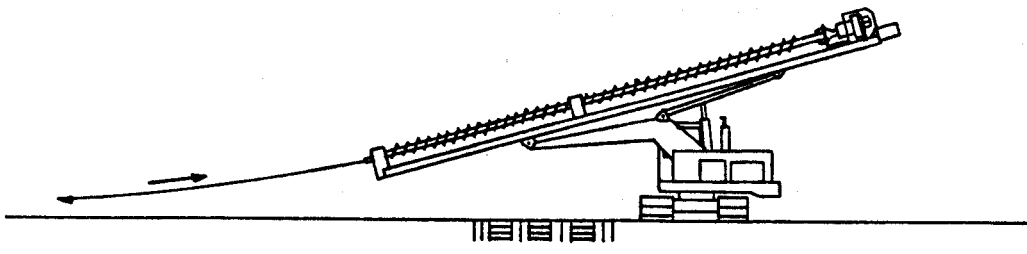

a) Insert tendon in auger.

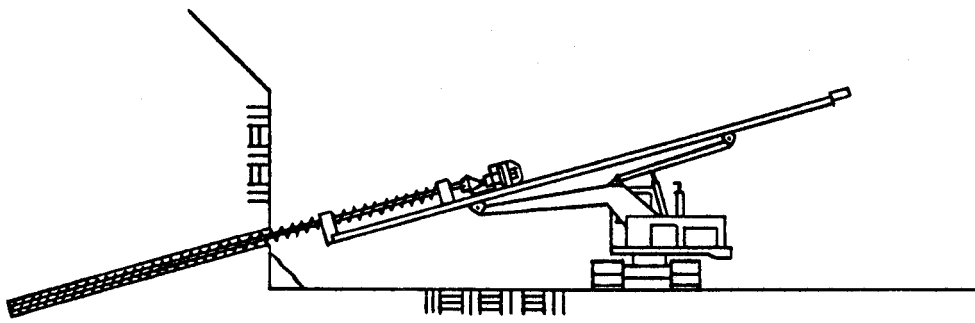

b) Drill.

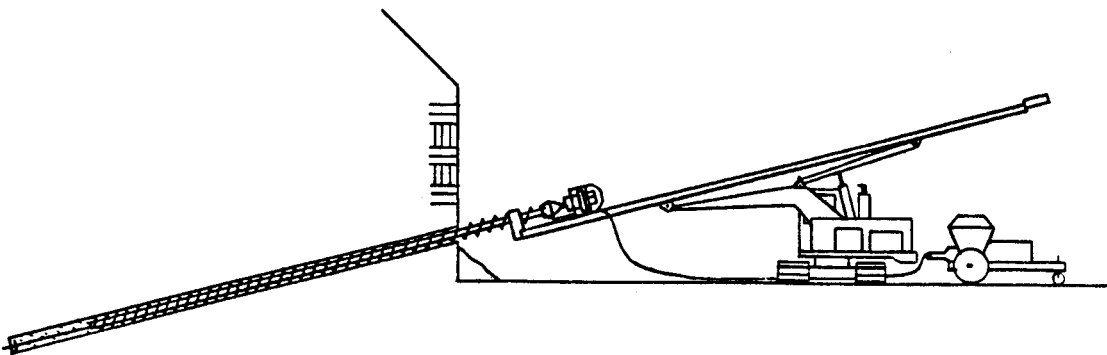

c) Pump grout while extracting the auger.

Figure 80. Steps in hollow-stem-augered tieback installation.

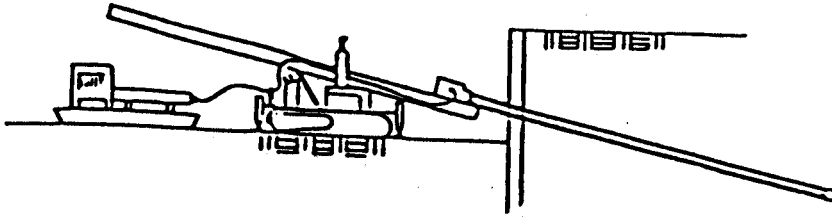

a) Position drill and drill hole by advancing casing and drill rods simultaneously. Clean casing by flushing air or water down rods.

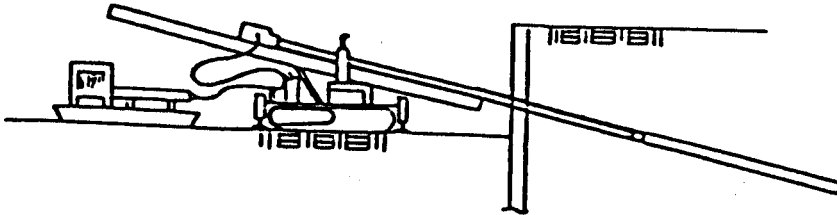

b) Remove the drill rods.

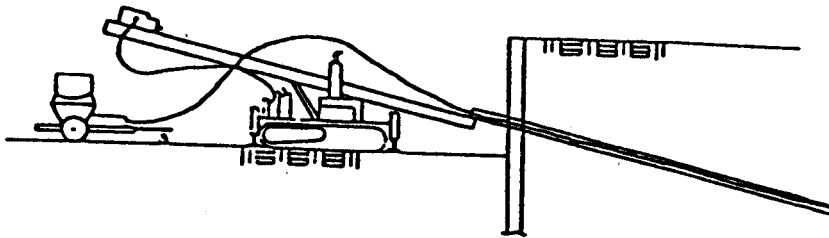

c) Tremie grout the casing.

Figure 81. Construction steps for straight-shafted, low-pressure-grouted tiebacks installed in sandy soils.

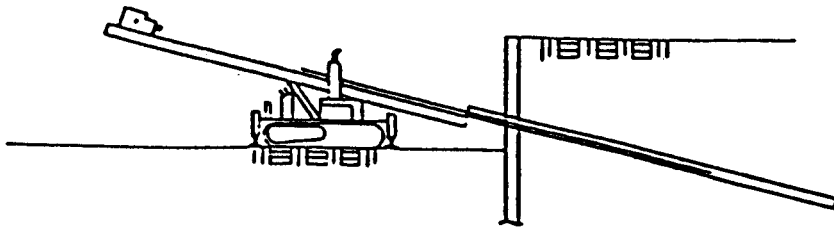

d) Insert tendon.

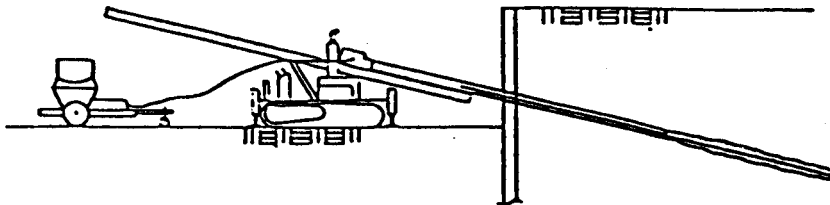

e) Extract casing while pumping grout.

Figure 81. Construction steps for straight-shafted, low-pressure-grouted tiebacks installed in sandy soils (continued).



In soils where a drill hole will stand open, caisson drills have been used to auger drill straight-shafted tiebacks. These soils are normally cohesive, or dense well-graded silty sands above the water table, or cemented sands. A 12 to 18 inch (305 to 457 mm) diameter caisson auger is used to drill the hole. Upon completion of the hole, the tendon is inserted and transit-mix grout is pumped through a grout pipe installed with the tendon. The grout is not pressurized. Large diameter straight-shafted tiebacks are very common in the western United States.

Small diameter continuous augers also have been used to drill tiebacks. These tiebacks are installed in soils similar to those where large diameter caisson augers are used. These holes normally are 8 inches (203 mm) in diameter or less. After the hole is completed, the augers are removed and the hole is tremie grouted with neat cement grout. Then the tendon is inserted. If tremie grouting is not done, the tendon and a grout tube are simultaneously inserted in the hole. Low-pressure-grouted, small-diameter, augered tiebacks do not develop high capacities.

Cohesive soils are rotary drilled without casing using drag bits and water or air flushing. This type of drilling is limited to soils which will not cave during drilling. "Heavy" drilling fluids such as bentonite and cement slurries may be used to maintain the drill hole if the soil tends to cave. Bentonite should not be used to drill the anchor length portion of a tieback. After the hole is completed, grout is tremied into the hole and the tendon is inserted. These tiebacks do not usually develop capacities greater than 80 kips (356 kN).

#### D. Pressure-Injected Tiebacks

Pressure-injected tiebacks are installed in sandy and gravelly soils using a driven or drilled casing. Figure 82 shows a driven pressure-injected tieback installation sequence. Air tracks are used to drive 3.0 or 3.5 inch (76 or 89 mm) casing with a solid closure point. No soil is removed during the installation. Driven pressure-injected tiebacks can be installed in sands below the groundwater table without loss of ground. Rotary drills are used to install casing with an expendable drag bit. Drilling is normally required to install casings larger than 3.5 inches (89 mm). Once the casing is installed, the tendon is inserted in the casing. The casing is then extracted a short distance using center-hole hydraulic jacks. The closure point or drag bit is driven free and grout is pumped down the casing under pressure while the casing is extracted. The grout pressure is maintained above 150 psi (1035 kPa) until the anchor length is grouted. Pressure-injected tiebacks are common in Europe and the United States.

#### E. Postgrouted Tiebacks

Postgrouted tiebacks are used primarily in cohesive soils. Postgrouting is used to enlarge the anchor grout by delayed multiple grout injections. Each injection is separated by about one day. These techniques attempt to fracture the grout already in place and wedge it outward into the soil. These tiebacks can be installed in cased or uncased drill holes made by rotary or auger drilling. A special grout tube with valves located along the anchor length (tube à manchette) enables postgrouting to be performed. The grout tube is designed so a double packer can be used inside the tube to selectively grout each value.

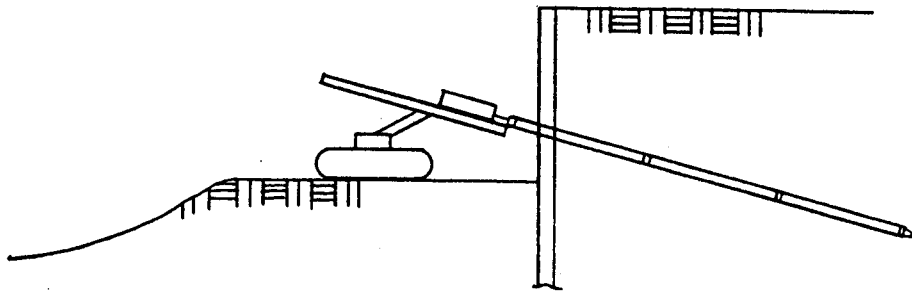

a) Drive casing.

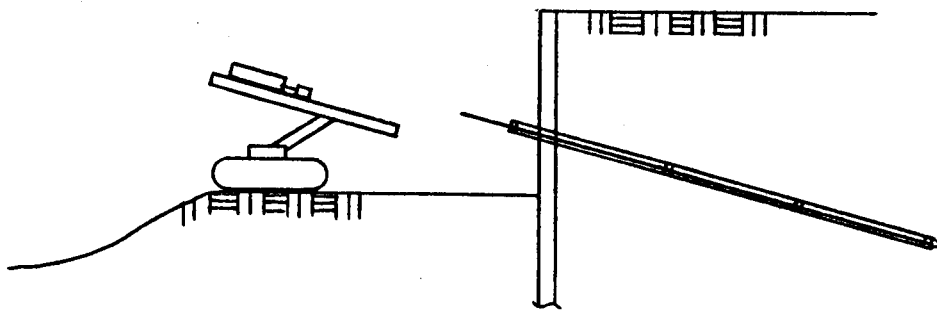

b) Insert tendon and disengage point.

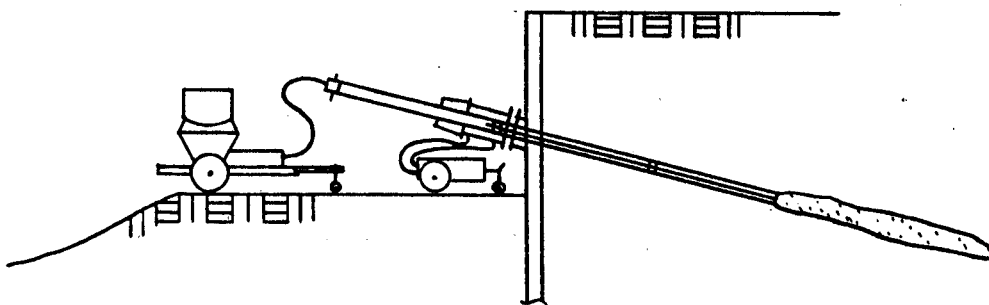

c) High pressure grout the anchor length and low pressure grout the unbonded length while extracting the casing.

Figure 82. Steps for pressure-injected tieback installation.

There are two effective methods of making postgrouted tiebacks. One type uses a 1 inch (25.4 mm) grout tube with valves located every foot (0.305 m) along the tube. The valves are constructed by applying a tight fitting rubber sleeve over holes drilled in the tube. Figure 83 shows the 1 inch (25.4 mm) tube à manchette tieback using a strand tendon and Figure 84 shows the packer and a grout valve. The other type of tube à manchette tieback is called a TMD tieback. The TMD tieback was developed by SIF Bachy, see Figure 47. In this system a deformed metal tube, 2.0 to 3.0 inches (51 to 76 mm) in diameter is grouted into the ground. Grout valves are located every 3.28 feet (1.0 m) along the anchor length. An inflatable double packer is used inside the deformed tube to grout each individual valve. After the metal tube is grouted into the ground, the tendon is grouted inside the tube. Figure 85 shows the installation sequence for a TMD tieback.

Both tube à manchette systems are grouted in a similar manner. First the tube à manchette is placed inside a tremie-grouted drill hole. The bag is inflated to seal the hole or the grout is allowed to cure for approximately twenty-four hours. Then the packer is positioned in the tube opposite the bottom grouting valve. Grout is pumped through the valve fracturing the original anchor grout. Upon pumping a predetermined volume of grout or reaching a limit pressure for the soil, grouting is discontinued. Then the packer is moved to the next grout valve, and it is grouted in a similar manner. After all of the valves are grouted, the grout is allowed to cure for an additional twenty-four hours. A second phase of grouting is performed if the grout pressure or volume indicates repeated grouting will improve the load carrying capacity of the tieback. As many as three or four grouting phases are economical in cohesive soils. Figure 86 shows an unearthed TMD and tube à manchette tieback.

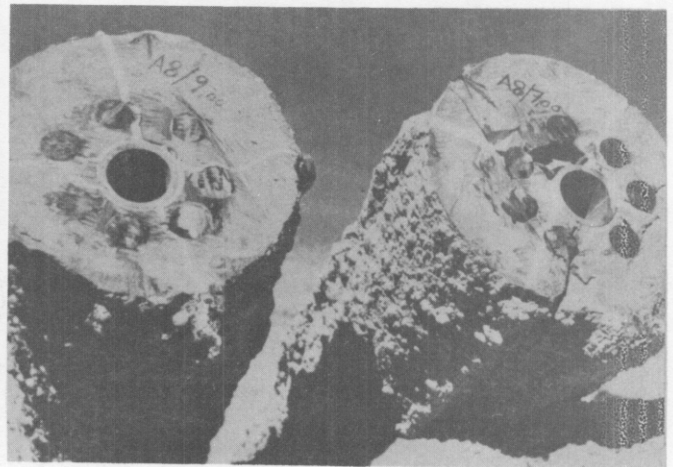
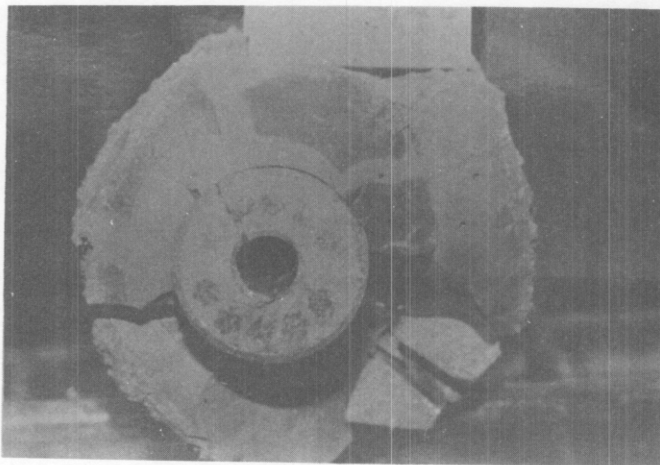

a) TMD tieback (courtesy SIF Bachy).

b) One inch tube à manchette tieback (courtesy Karl Bauer)

Figure 86. Unearthed tube à manchette tiebacks.

Other postgrouting systems are used, but they are not able to achieve the high percentage increases in capacity that are obtainable with tube à manchette methods. These systems are not able to isolate each individual valve, and some only allow one regrouting.

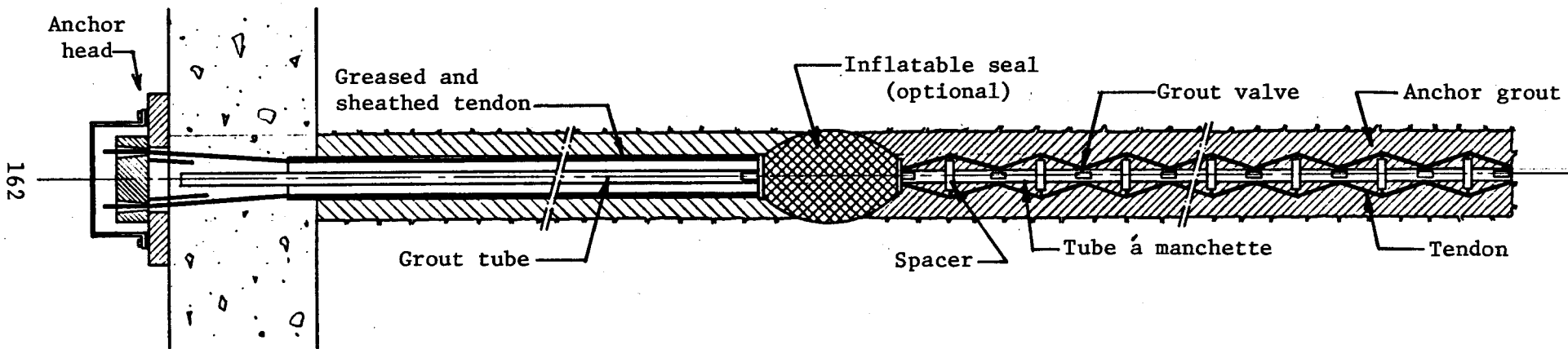

Figure 83. Tube à manchette tieback.

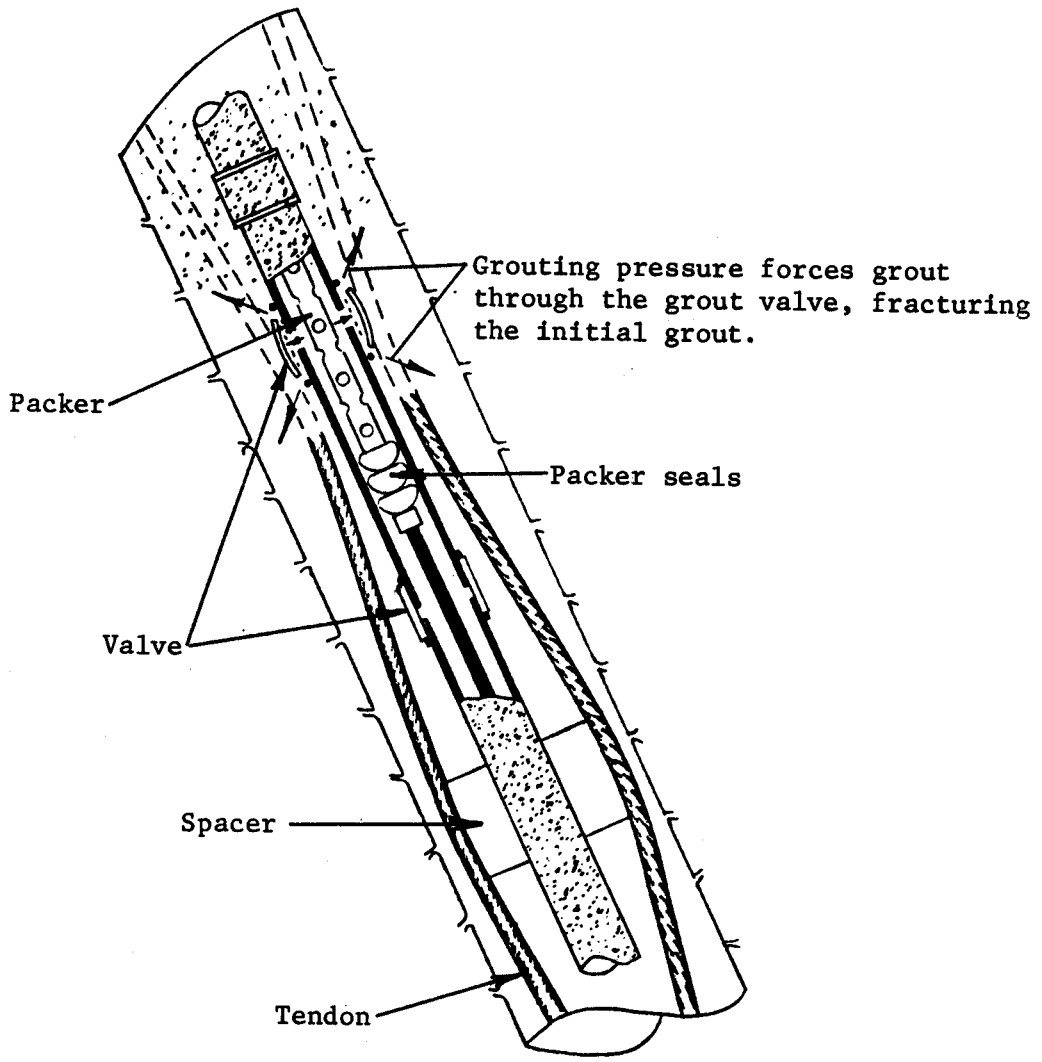
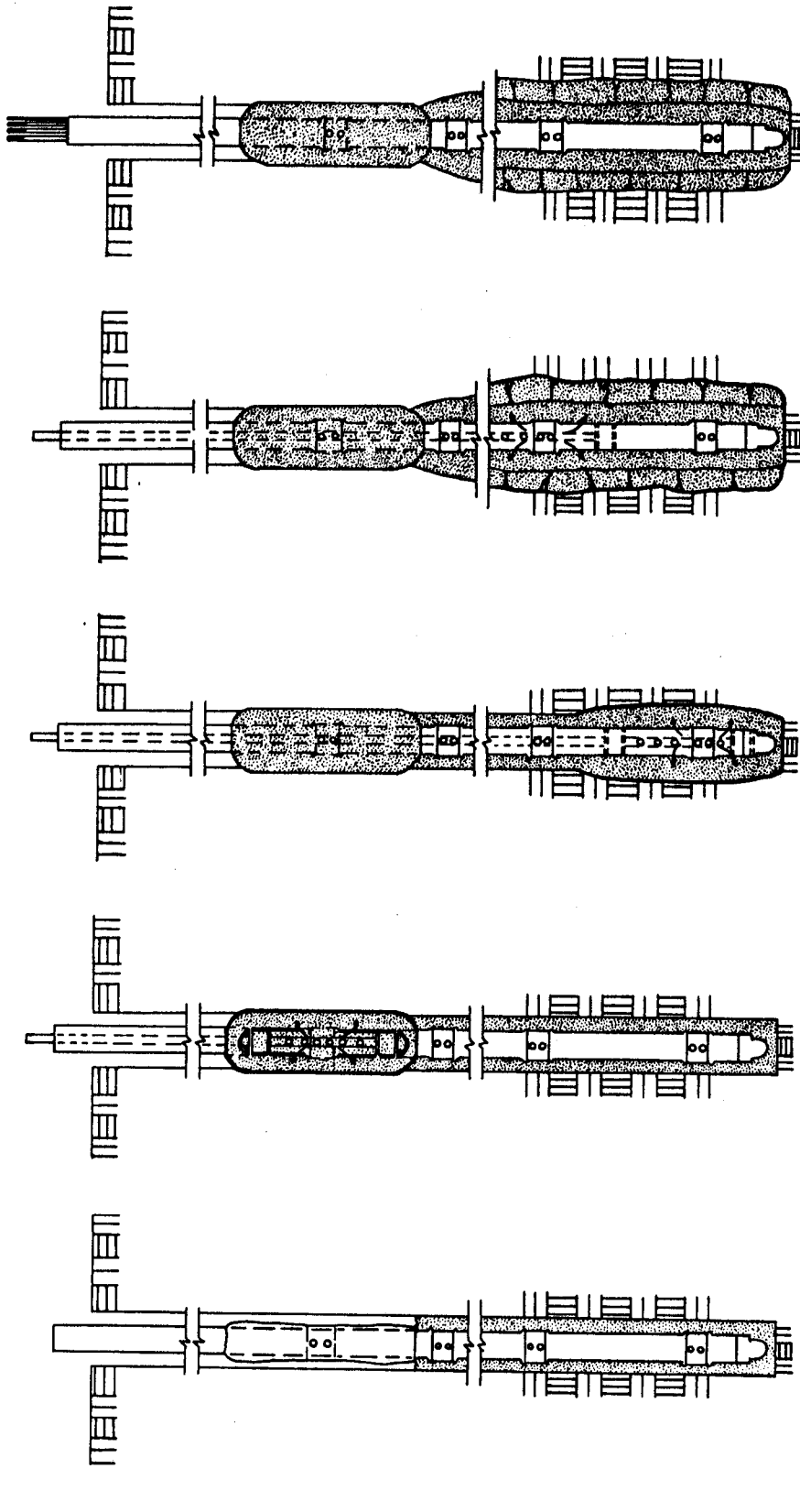

Figure 84. Tube à manchette packer.



- a) Insert deformed metal tube in grout filled drill hole.
- b) Inflate seal.
- c) First phase grouting of each valve.
- d) Multiphase grouting of each valve.
- e) Fill tube with grout and insert tendon.

Figure 85. TMD tieback installation sequence.

## CHAPTER 9 - CREEP AND LOAD TRANSFER MECHANISMS

Tiebacks develop holding capacity by many different load transfer mechanisms. Understanding how they transmit force to the soil or rock is helpful in predicting capacity, developing a test procedure, interpreting test results, and developing an acceptance criteria. Since all soils experience time-dependent deformations (creep) and stress variations (relaxation), it is also helpful to understand what causes a tieback anchor to lose holding capacity and move through the soil.

Permanent tiebacks installed in dense sandy or gravelly soils or rock have not experienced significant loss of load holding capacity or movement with time. A variety of testing procedures has been used to evaluate the long-term capacity of these tiebacks. Suitable long-term performance has been obtained if the tiebacks were overloaded to 1.20 times the design load or higher.

A simple overload during testing has not been sufficient to evaluate the long-term load holding capacity of tiebacks anchored in cohesive soils. Some of these tiebacks have, on occasion, continued to lose load or move through the soil as a result of creep or relaxation. The slow movement of the tieback anchor through the soil under constant load is called anchor creep or creep movement. The tendency for an anchor to creep is measured during a tieback test. Loss of load after the tieback is locked-off is a result of creep and relaxation.

### CREEP AND RELAXATION THEORY

The creep and relaxation behavior of soils vary. In general, the greater the organic content or the more plastic the clay, the more pronounced the creep or relaxation. The type and amount of clay are important in establishing the potential for relaxation or creep. The plasticity index reflects both the type and amount of clay. It can be used to give an indication whether or not a soil would be susceptible to large time-dependent deformations or stress variations.

Creep deformations are time-dependent shear strains controlled by the resistance of the soil structure. Relaxation is the time-dependent stress decrease at constant strain which is also controlled by the resistance of the soil structure. When a stress is applied to a soil sample in the laboratory it will respond in one of two ways. In most cases, it will strain at a decreasing rate until creep stops. However, some soils will continue to strain until creep rupture occurs. Bishop [103], Murayama and Shibata [104], Singh and Mitchell [105], and Edger, et al [106], have observed that there is a relationship between strain rate and time for most soils. In general, they found that the log of strain rate decreases linearly with the log of time regardless of stress level, soil type, drainage conditions, and stress history. Figure 87 shows the relationship between strain rate and time for Osaka alluvial clay.

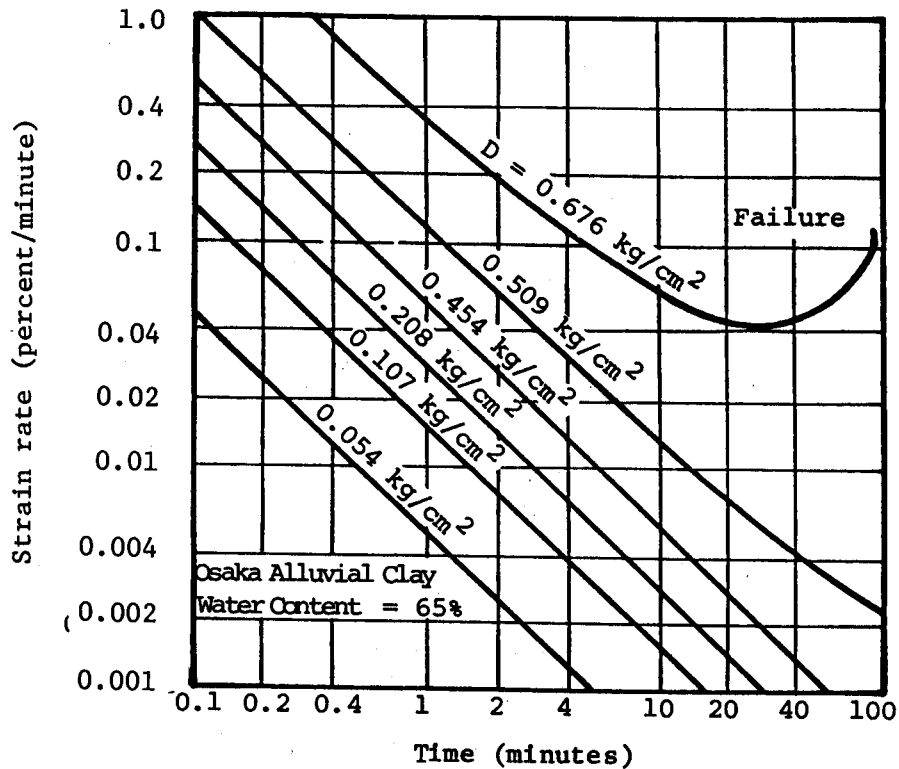

Figure 87. Strain rate vs. time relationship during undrained creep of Osaka alluvial clay (Murayama and Shibata [104]).

Singh and Mitchell [105] developed a three parameter relationship that describes the creep rate behavior shown on Figure 87. Equation (21) expresses this relationship:

$$\dot{\epsilon} = Ae^{\alpha D} (t_1/t)^m \quad (21)$$

where:  $\dot{\epsilon}$  = strain rate at any time,  $t$   
 $A, \alpha, m$  = are creep parameters  
 $D$  = creep stress  
 $t_1$  = reference time ( $t = 1$  minute)  
 $t$  = time after application of creep stress

Two laboratory creep tests are needed to determine the creep parameters ( $A, \alpha$ , and  $m$ ) for a particular soil. These tests are performed on identical specimens using two different stress levels. A plot of log strain rate versus log time (Figure 88), and a plot of log strain rate versus creep stress for different values of time (Figure 89) are made. The value " $m$ " is the absolute value of the slope of the linear portion of the plots of log strain rate versus log time. The value " $A$ " is the intercept at unit time ( $t_1$ ) and the value " $\alpha$ " is the slope of the linear portion of the log of strain versus stress plot for any time increment.



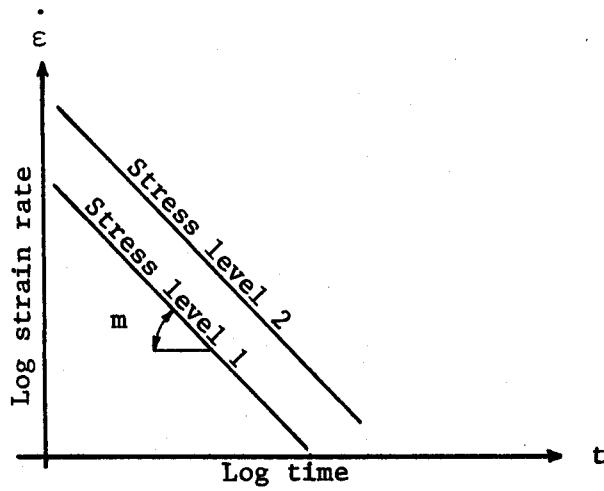

Figure 88. Strain rate vs. time relationship.

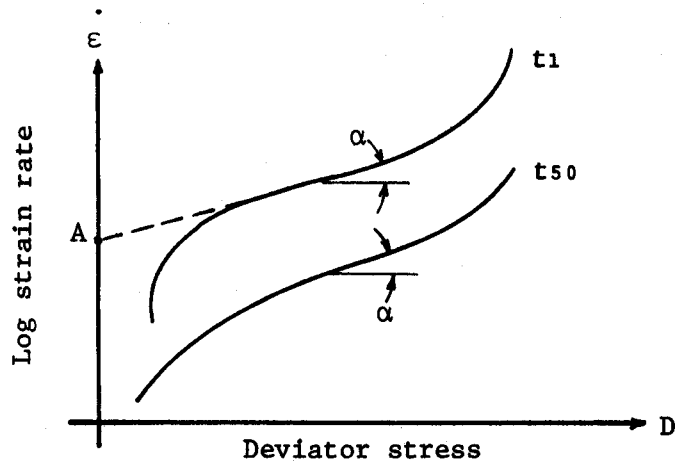

Figure 89. Strain rate vs. deviator stress.

Equation (21) is integrated to establish a general relationship between strain ( $\epsilon$ ) and time ( $t$ ). Two solutions are obtained depending on the values of "m". If  $\epsilon = \epsilon_1$ , at  $t = 1$  and  $t_1 = 1$ , then:

$$\epsilon = \epsilon_1 + \frac{A}{1-m} e^{\alpha D} (t^{1-m} - 1) \quad \text{for } m \neq 1 \quad (22)$$

and

$$\epsilon = \epsilon_1 + Ae^{\alpha D} \log_e t \quad \text{for } m = 1, t = 1 \quad (23)$$

These two relationships define the curves shown in Figure 90 and Singh and Mitchell [105] observed that creep curves for soils were similar to the curves defined by Equation (22) and (23). They also showed that actual soil creep data would fit these equations.

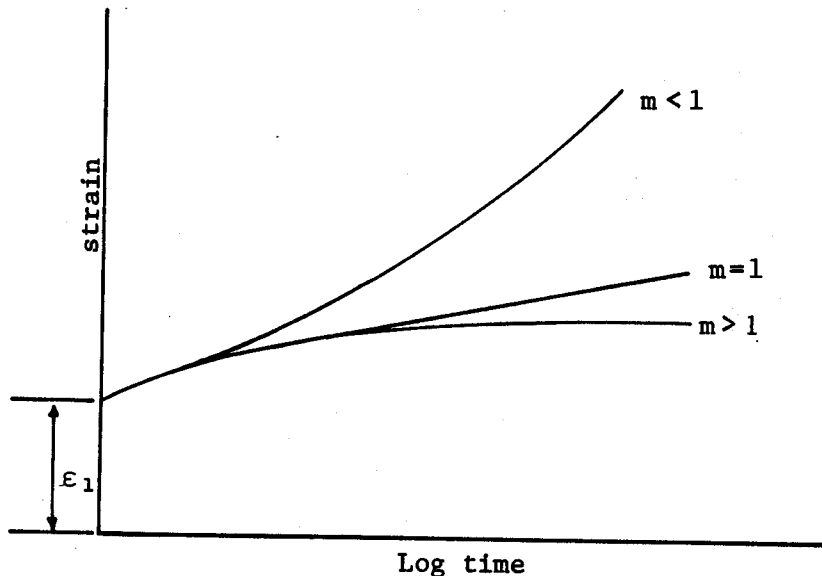

Figure 90. Creep curves predicted by the general stress-strain-time function, Equations (22) and (23).

Singh and Mitchell [107] also reported the parameter "m" appears to be a property of the material. They found that:

- 1) Soils with "m" less than 1.0 had a high potential for strength loss during creep, and creep rupture.
- 2) The strain at failure is a constant for a given soil and it is independent of stress level.

However, subsequent studies have shown that "m" may vary with stress history, overconsolidation ratio, and loading conditions. The parameter "m" does remain a constant for the same loading conditions.

Equations (22) and (23) have been used to describe the time-dependent strain of soils in a variety of applications, and they appear to describe

the time-dependent movement of a tieback under constant load. They are currently being evaluated in tieback research in Germany, France, and the United States.

The creep research performed has identified soft clays loaded under undrained conditions, and heavily overconsolidated clays loaded under drained conditions as being susceptible to creep rupture at stresses as low as 35 percent of their normal strength. Pore pressures increase when soft clays are sheared under undrained conditions, and the decrease in effective stress causes a reduction in strength. Negative pore water pressures develop when heavily overconsolidated clays are sheared under drained conditions. The negative pore water pressures cause water to be sucked into the soil matrix. The increased water content causes a loss of strength with time.

The consistency index ( $I_c$ ) (See equation [9], page 103) is used in Germany to identify cohesive soils where a tieback would not be creep susceptible. They require the consistency index to be greater than 0.9. The writer's experience with straight-shafted tiebacks indicates that permanent tiebacks should not be installed in soils with a consistency index less than 0.8. The writer has also observed that straight-shafted tiebacks are often susceptible to excessive creep movements, if the unconfined compressive strength is less than 1.0 ton/ft<sup>2</sup> (96 kPa), and the remolded strength is less than 0.5 tons/ft<sup>2</sup> (48 kPa). Tiebacks installed in soils that exceed these strengths, and have a water content near the plastic limit are not usually creep susceptible. The French Recommendations [53] require careful testing of tiebacks installed in soils with a plasticity index greater than or equal to 20.

#### SKIN FRICTION OR SHEAR STRESS ALONG A SHAFT TIEBACK

The drilling technique and the method used to clean the drill hole do affect the skin friction along an anchor. Skin friction along a tieback anchor is a function of strain. Figure 91 shows two possible skin friction-strain curves for a tieback. Curve A represents a soil or rock where very little strain is required to mobilize most of the skin friction and where skin friction continues to increase or remain stable with increasing strain. Curve B represents a weaker soil or rock which requires more strain to reach its maximum skin friction, and the skin friction is reduced to a residual value with increasing strain.

#### ROCK TIEBACK LOAD DISTRIBUTION

Load distribution along the anchor length of tiebacks installed in sound rock have not been intensively investigated. Coates and Yu [108], have used a finite element analysis to study the stress distribution along straight-shafted tiebacks in three dimensional space. Figure 92 shows the distribution of skin friction along an anchor with depth for elastic materials with differing Young's moduli. Their analysis indicated that the skin friction will be concentrated near the front of the anchor for rocks

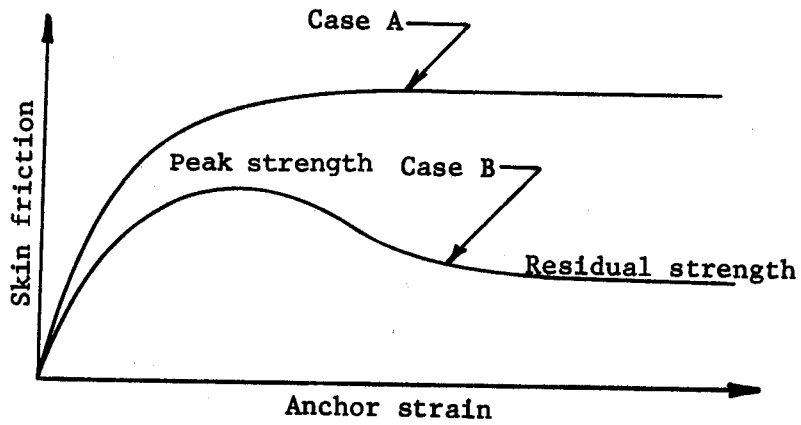

Figure 91. Typical stress-strain behavior of a tieback anchor.

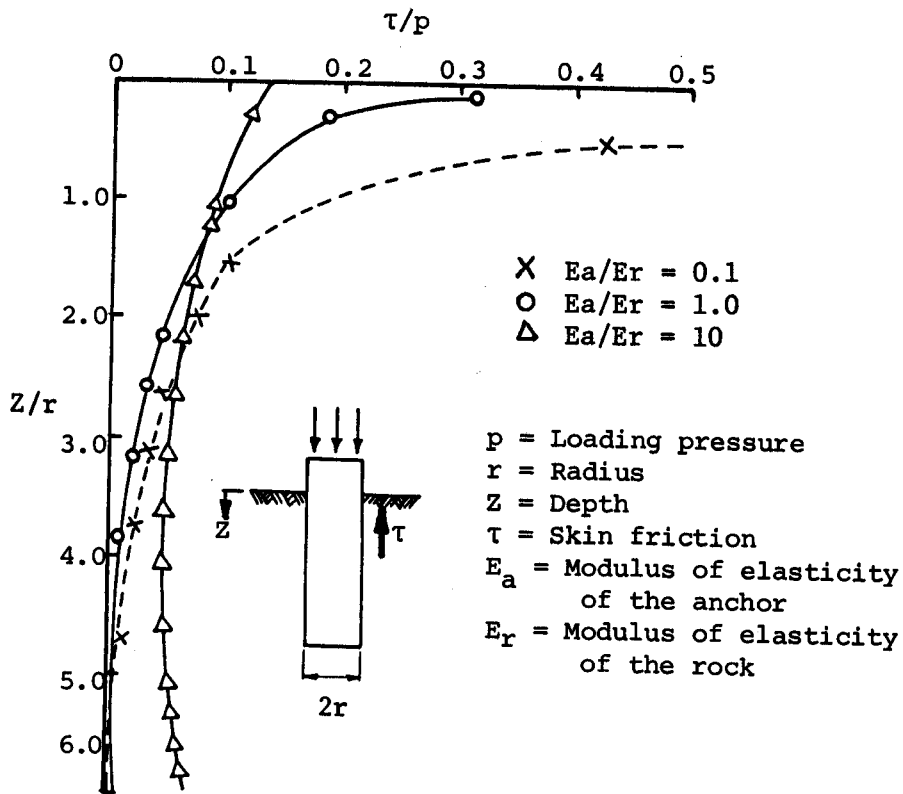

Figure 92. Normalized skin friction distribution as a function of normalized length [108].

with a modulus equal to or higher than the modulus of the anchor. However, for rocks with  $E_a/E_r \geq 10$ , the skin friction distribution was shown to be nearly uniform. The modulus of the anchor will be equal to the Young's modulus for the tendon if the grout cracks. Cracking is likely to occur in most tiebacks and  $E_a$  will then become  $29 \times 10^6$  psi ( $20 \times 10^7$  kPa). Based on Coates and Yu work it may be assumed that a rock with a modulus less than  $3 \times 10^6$  psi ( $20.7 \times 10^6$  kPa) would have a near uniform distribution of skin friction over the cracked section. The shear stress would not be uniformly distributed over the uncracked portion since  $E_a$  would be equal to  $3 \times 10^6$  psi ( $2 \times 10^4$  kPa).

Rock tiebacks have not experienced significant anchor creep, and rocks do not exhibit creep behavior in the laboratory. Soft or weathered clay shales may exhibit creep behavior. A short-term tieback test procedure should adequately predict the long-term load carrying ability of a rock tieback, unless it is installed in a soft or weathered clay shale. Tiebacks installed in these weak rocks should be creep tested.

## LOAD DISTRIBUTION AND LOAD TRANSFER MECHANISM IN NONCOHESIVE SOILS

### A. Pressure-Injected Tiebacks

Actual load distribution along pressure-injected tiebacks in sandy and gravelly soils have been reported by Ostermayer and Scheele [109], and Shields, et al [110]. Ostermayer and Scheele developed Figure 93 which shows the distribution of skin friction at the ultimate load for rotary-drilled, pressure-injected, tiebacks with varying lengths installed in gravelly sands of different densities. The skin friction was calculated after the tiebacks were unearthed and the diameter of the anchor was measured. For the dense and very dense soils the curves shown in Figure 93 indicate that the skin friction is not uniformly distributed along the anchor length. The tiebacks installed in loose and medium dense soil had approximately a constant skin friction along the anchor. Ostermayer and Scheele [109] postulated that the skin friction on all the tiebacks would have been approximately uniform at failure if the anchor grout had not extended above the anchor length. Drilled pressure-injected tiebacks are normally constructed with the grout remaining along the unbonded length, with higher grout pressures, and longer anchor lengths than were used in these tiebacks.

Shields, et al [110], presented Figures 94 and 95 showing the rate of load transfer along driven pressure-injected tiebacks installed at two sites. These curves show that the tieback load is transferred nonuniformly to the soil. The tiebacks were not tested to their ultimate load. The tieback shown in Figure 94 was installed in a dense fine to coarse gravelly sand, and the tieback shown in Figure 95 was installed in a dense fine to coarse silty sand and gravel with a trace of clay and mica. The load transfer rate for the tieback shown in Figure 94 is higher than the one shown in Figure 95 and the load was transferred farther down the anchor length of the tieback shown in Figure 95. The soil surrounding the tieback in Figure 94 was denser and contained fewer fines than the soil surrounding

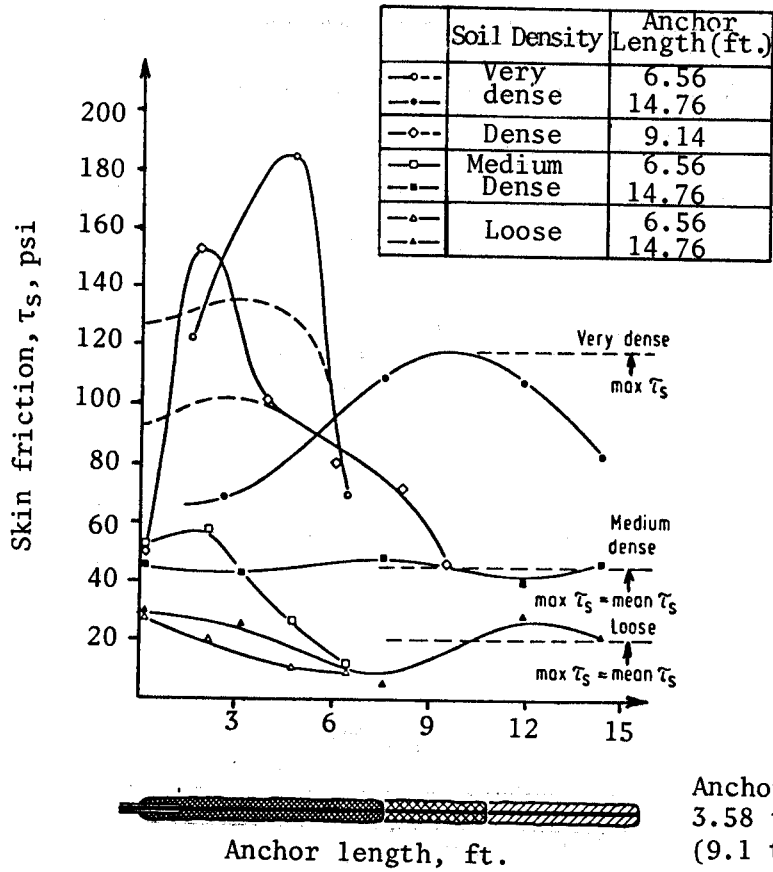

Note: 1 psi = 6.9 kPa, 1 ft. = 0.305 m

Figure 93. Skin friction distribution at failure as a function of anchor length and density in a gravelly sand [109].

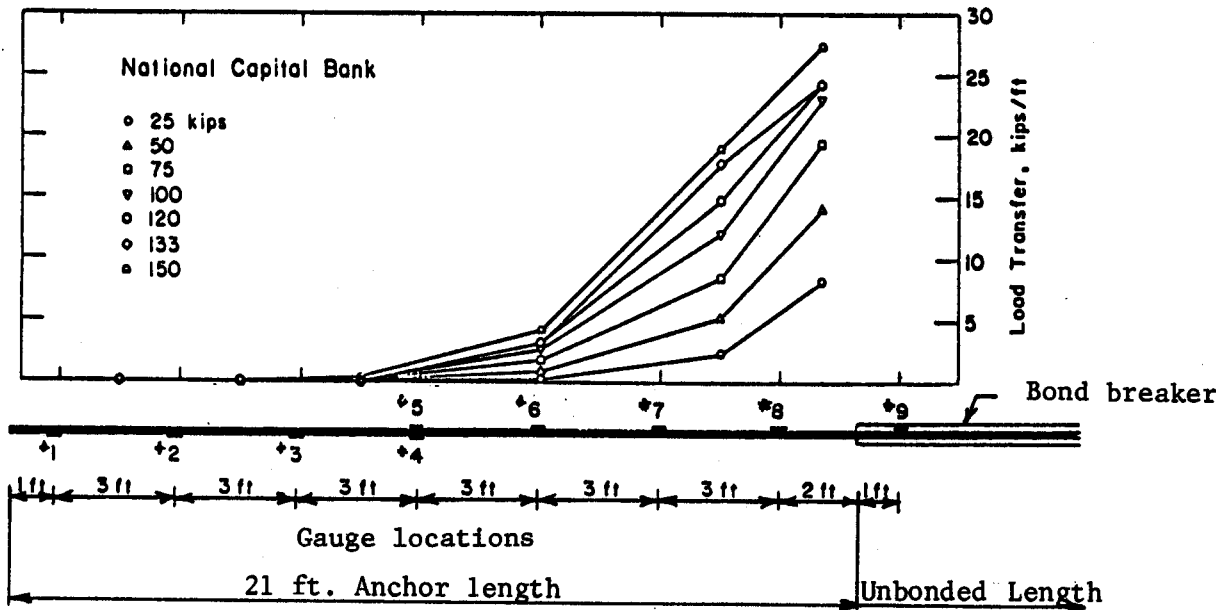

Note: 1 kip = 4.45 kN, 1 kip/ft. = 14.59 kN/m, 1 ft. = .305 m

Figure 94. Distribution of load transfer during testing of a pressure-injected tieback installed in dense, fine to coarse, gravelly sand [110].

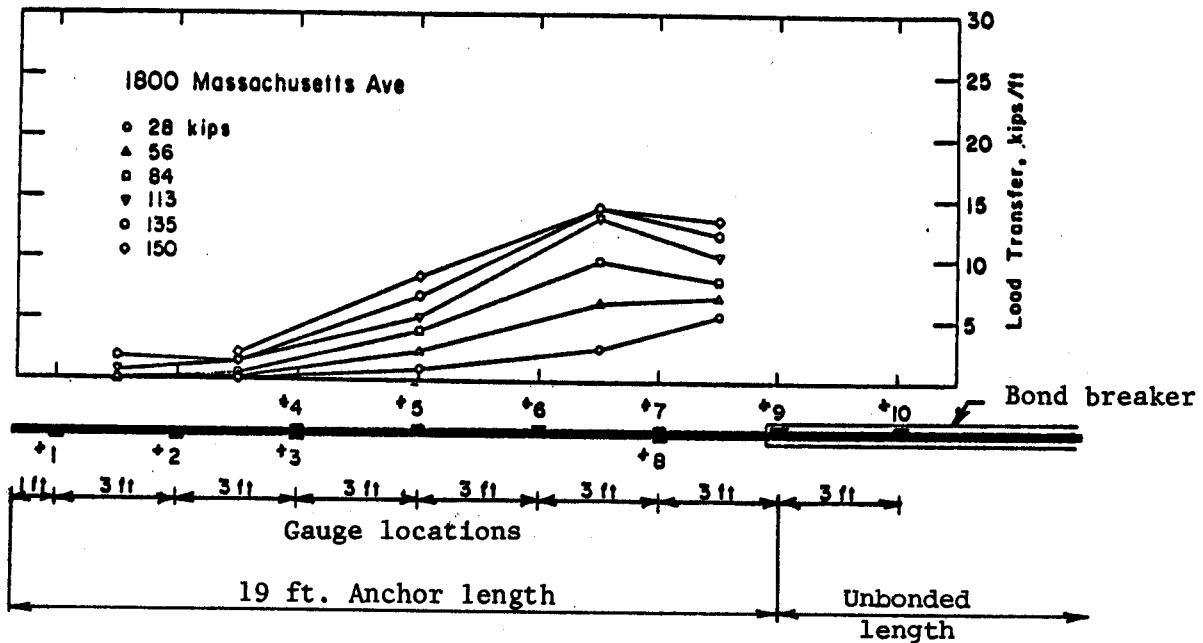

Note: 1 kip = 4.45 kN, 1 kip/ft. = 14.59 kN/m, 1 ft. = .305 m

Figure 95. Distribution of load transfer during testing of a pressure-injected tieback installed in a dense, fine to coarse, silty sand and gravel [110].

the tieback in Figure 95. Higher grout pressures were used during the installation of the tieback shown in Figure 94. These factors may explain the differences in the load transfer rates.

Pressure-injected tiebacks are used in soils ranging from silty sands to sandy gravels. A description of how they are installed is contained in Chapter 8, and Chapter 6 contains the empirical relationships used to estimate their ultimate capacity.

Pressure-injected tiebacks develop load transfer rates in excess of 30 kips/ft (438 kN/m) in dense sands and gravels. These high frictional resistances probably result from high radial stresses locked into the soil surrounding the anchor length. These radial forces are applied to the soil during grouting, and they are permanently locked into the soil when the grout becomes a semisolid. At grout pressures above 150 psi (1035 kPa) water is forced out of the neat cement grout causing it to rapidly solidify. Stocker [95] confirmed that pressure injected grout is partially dehydrated by the high grout pressures. Grouting pressures twenty times the effective overburden pressure are routinely used for pressure-injected tiebacks. If a portion of these pressures are permanently locked into the soil surrounding the anchor, then these high load transfer rates can be explained.

The load transfer rates for pressure-injected tiebacks are not uniform along the anchor length, but by assuming a uniform rate it is possible to estimate the magnitude of the normal stress acting on the interface between the soil and the grout. Assuming a uniform skin friction distribution, the normal stresses can be calculated by the Equation (24).

$$P_n = \frac{P}{\pi D \tan\phi l_a} \quad (24)$$

where:  $P$  = normal stress  
 $P^n$  = ultimate tieback capacity  
 $D$  = anchor diameter  
 $\phi$  = angle of internal friction  
 $l_a$  = anchor length

Figure 60 indicates that a 15-foot-(4.58 m)-long pressure-injected tieback can develop an ultimate capacity of 250 kips (1112.5 kN). If a 35° angle of internal friction is assumed and substituting  $P = 250$  kips (1112.5 kN),  $D = 4.6$  inches (11.7 cm) and  $l_a = 180$  inches (457 cm) into Equation (24) a normal stress of 137 psi (945 kPa) is calculated. The load transfer mechanism for pressure-injected tiebacks is not as simple as that described by Equation (24), but this relationship does show that high normal stresses are necessary to develop the tieback capacities obtained in the field.

Most of the permanent soil tiebacks have been made using pressure injected techniques in sandy and gravelly soils. These tiebacks have performed well and they have not been susceptible to creep. A short-term tieback test should be able to predict the long-term performance of a pressure-injected tieback installed in a sandy or gravelly soil.



## B. Low-Pressure-Grouted Tiebacks

Low-pressure-grouted tiebacks are used in soils ranging from silty sands to sandy gravels. They are installed by either hollow-stem augers or rotary drills. Descriptions of their installation methods are contained in Chapter 8, and Chapter 6 contains information on the estimation of their capacities.

The grouting pressures used for making these tiebacks are not sufficient to lock in large normal stresses, and the soil around the anchor length is likely to be loosened as a result of the drilling operation. Their ultimate capacity is probably a function of the geometry of the anchor grout, and the angle of internal friction of the soil. Experience has shown that their capacities are affected by the quantity of grout pumped into the anchor zone. Assuming a uniform skin friction distribution, the ultimate capacity of a low-pressure grouted tieback installed above the groundwater table might be estimated by Equation 25.

$$P = \pi D l_a \gamma h_m \tan \phi \quad (25)$$

where: P = ultimate tieback capacity  
D = anchor diameter  
l<sub>a</sub> = anchor length  
γ<sup>a</sup> = dry unit weight of the soil  
h<sub>m</sub> = depth of overburden to the mid-point of the anchor  
φ = angle of internal friction

The PTI [76] indicates that a working skin friction of 10 to 20 psi (69 to 138 kN/m<sup>2</sup>) may be assumed for an average overburden depth of 20 feet (6.1 m). If a 30° angle of internal friction is assumed and substituting D = 0.75 feet (0.23 m), l<sub>a</sub> = 1 foot (0.305 m), γ = 120 pcf (1,922 kN/m<sup>3</sup>), and h = 20 feet (6.1 m) Equation (25) gives an ultimate skin friction of 22.7 psi (157 kPa). This ultimate skin friction is in good agreement with the working skin friction reported by the PTI, and it indicates that locked-in stresses probably do not significantly affect the load transfer mechanism.

Low-pressure-grouted tiebacks in sandy and gravelly soils have performed well in temporary and permanent applications. They have not exhibited a tendency to creep and a short-term tieback test should be able to predict their long-term performance.

## C. Postgrouted Tiebacks

Postgrouted tiebacks have been installed in sandy and gravelly soils using rotary drilling techniques. Postgrouting is described in Chapter 8. High grout pressures, similar to those used for pressure-injected tiebacks, are used during postgrouting, and the load transfer mechanism for a postgrouted tieback is likely to be similar to that of a pressure injected one.

Postgrouted tiebacks have been used for permanent applications and their long-term performance may be predicted by a short-term tieback test.

## LOAD DISTRIBUTION AND LOAD TRANSFER MECHANISM IN COHESIVE SOILS

### A. Single-Underreamed Tiebacks

Single-underreamed tiebacks are only installed in cohesive soils. Chapter 8 contains a description of how they are made, and Equation (19) (Page 115) is used to estimate their capacity. They develop their capacity from bearing on the underream, and friction along the shaft. The shaft capacity will be fully mobilized at significantly less movement than that required to mobilize the resistance of the underream [111]. This load transfer mechanism should be remembered when interpreting the total movement curves for tiebacks which develop capacity by bearing, particularly underreamed ones (See Figure 109, page 208).

Model studies reported by Beard [112] and Tanaka [113] are helpful in understanding single-underreamed tieback behavior. Beard investigated the performance of flat plate anchors in cohesive soils, and Tanaka investigated single-underreamed tiebacks. They were able to measure pore water pressures in the clay surrounding the anchor while a constant load was applied. For deeply embedded underreams (depth of embedment equal to six times the underream diameter), they found that positive pore water pressures developed in the soil in front of the underream and negative pressures developed behind it. Beard [112] concluded that the suction force resulting from the negative pore water pressures might contribute to the short-term capacity of an underreamed tieback in clay, and thus overestimate its long-term capacity.

Figure 96 shows a plot of tieback movement versus time for one of Tanaka's tests. Beard and Tanaka's other tests are similar. Each curve shown on Figure 96 represents the tieback's response to a different load. The soil used in the test was a normally consolidated kaolin clay with an overburden pressure of 72.5 psi (500 kPa). Each movement-time plot in Figure 96 is similar to a consolidation curve. The excess pore water pressure behavior also suggested that consolidation was occurring above the underream. Because soil strengths increase with consolidation, the long-term capacities of single-underreamed tiebacks in normally consolidated clays should be equal to or greater than their short-term capacities (Underreamed tiebacks are not normally installed in normally consolidated clays.)

Beard [112] and Tanaka [113] also performed tests in overconsolidated clays. Beard found that the long-term capacity of those tiebacks were greater than their short-term capacity if the anchor was embedded six times the diameter of the underream. At shallow depths (embedment less than 3 times the underream diameter), Beard found that the long-term capacity was less than the short-term capacity. In addition, negative pore water pressures developed in front of all the shallow anchors. Negative pore water pressures would cause the soil to soften and lose strength with time.

There have been few permanent single-underreamed tiebacks installed. Their scarcity does not mean that they will not perform satisfactorily. In fact, the model tests reported by Beard [112] and Tanaka [113] indicated that single-underreamed tiebacks should perform very well in over-consolidated cohesive soils. Single-underreamed tiebacks should not

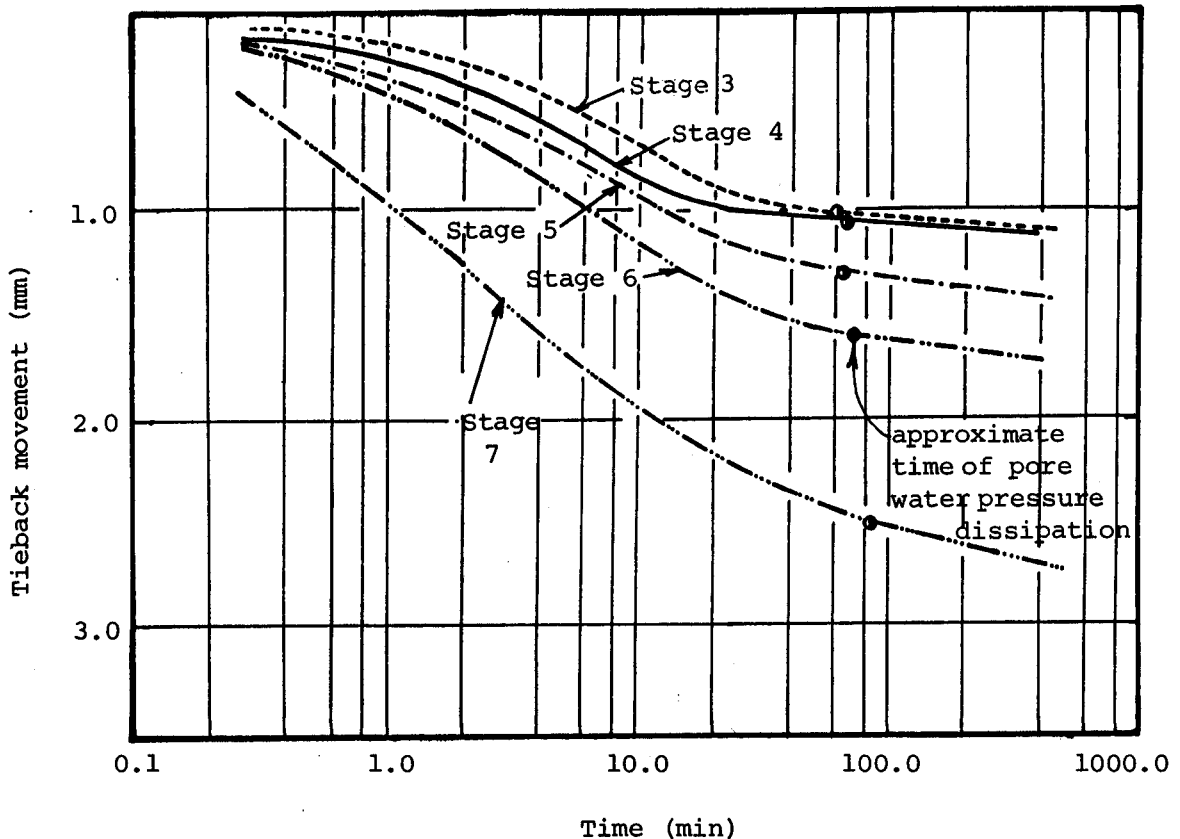

Figure 96. Tieback movement vs. time for a single-underreamed model tieback in a normally consolidated kaolin clay with the overburden pressure at 72.5 psi (500 kPa) [113].

have significant creep movements since they are embedded deep enough to avoid the development of negative pore water pressures in front of the underream, and a short-term test should give a good indication of their long-term performance.

#### B. Multiunderreamed Tiebacks

Multiunderreamed tiebacks are normally installed in cohesive soils. Chapter 8 contains a description of how they are constructed and Equation (20) (Page 116) is used to estimate their capacity. They develop their capacity from friction along the shaft above the underreams, end bearing of the first underream, and shear along a cylinder established by the tips of the underreams. Bassett [87] confirmed this load transfer mechanism on model multiunderreamed tiebacks.

The long-term performance of multiunderreamed tiebacks in cohesive soils has not been well documented. Littlejohn [114] reported a significant loss of load at a permanent, multiunderreamed tiebacks installation on the River Mole, England. This load loss may have resulted from strain softening (creep) in the undisturbed overconsolidated clay along the cylinder defined by the tips of the underreams. A stiff clay would soften if negative pore

water pressures developed as a result of shear strains. If softening occurs, the strength along the shaft would be reduced to a residual strength and excessive movement would occur as the load redistributed down along the anchor length.

### C. Straight-Shafted, Low-Pressure-Grouted Tiebacks

Straight-shafted tiebacks can be installed by a variety of drilling methods (See Chapter 8). Their capacities are estimated by Equations (17) and (18) (Page 114). Each one of the drilling methods disturbs or remolds the soil adjacent to the wall of the hole, and the soil shear strength is reduced as a result of drilling disturbance.

Fedderson [115] reported the load transfer rates along a tieback with a 59 ft (18 m) long anchor length. The tiebacks were installed in a stiff to very stiff, highly plastic clay. The load in the tendon was measured with strain gauges, and the load transfer rate was calculated assuming a uniform rate of load transfer between the gauges. Figure 97 shows the measured force in the tendon for different load increments, and the calculated load transfer rate as a function of distance along the anchor length. It is obvious that the rate of load transfer is not uniform.

Evangelista and Sapio [116] presented the results of tests on two 8.7 inch (220 mm) tiebacks installed in a stiff clay. The clay had an average water content of 23.6%, unit weight of 130 pcf (2,083 kN/m<sup>3</sup>), and an undrained shear strength of 5,632 psf (270.3 kPa). Figure 98 shows the calculated skin friction along the anchor length at failure. The skin friction was calculated from the strain gage determined load distribution, assuming an anchor diameter. The calculated skin friction was less than 50 percent of the undrained shear strength of the clay and it was not uniform.

Straight-shafted, low-pressure-grouted tiebacks installed in low-strength clays (undrained shear strength less than 1000 psf [47.9 kN/m<sup>2</sup>]) are likely to creep, and these tiebacks should not be used for permanent applications unless long-term testing and monitoring indicate acceptable performance.

Straight-shafted, low-pressure-grouted tiebacks in stiff to hard clays (undrained shear strength greater than 1000 psf [47.9 kN/m<sup>2</sup>]) may not be subject to significant loss of load as a result of creep. When creep occurs in a stiff clay, the strength along the shear surface is reduced to a residual value. The drilling methods used for low-pressure-grouted tiebacks also remolds the clay and reduces the strength to a residual value. It is possible that the creep mechanism in stiff and hard clays is destroyed by drilling. This hypothesis has not yet been confirmed by model- or full-scale testing. Low-pressure-grouted tiebacks in clay must be carefully tested and monitored if they are going to be used for permanent applications.

### D. Postgrouted Tiebacks

Postgrouted tiebacks are installed mainly in cohesive soils, but they can also be effectively used in sands and gravels. Their installation is described in Chapter 8. At present each tieback contractor uses experience to estimate the capacity of his particular postgrouting system. The load transfer mechanism for these tiebacks is not well

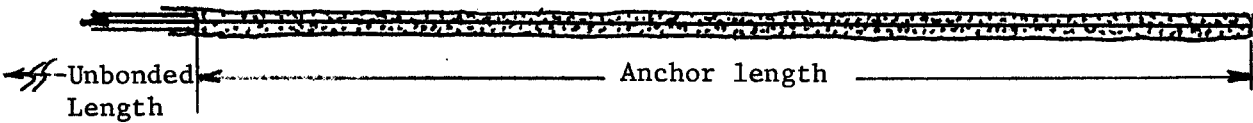
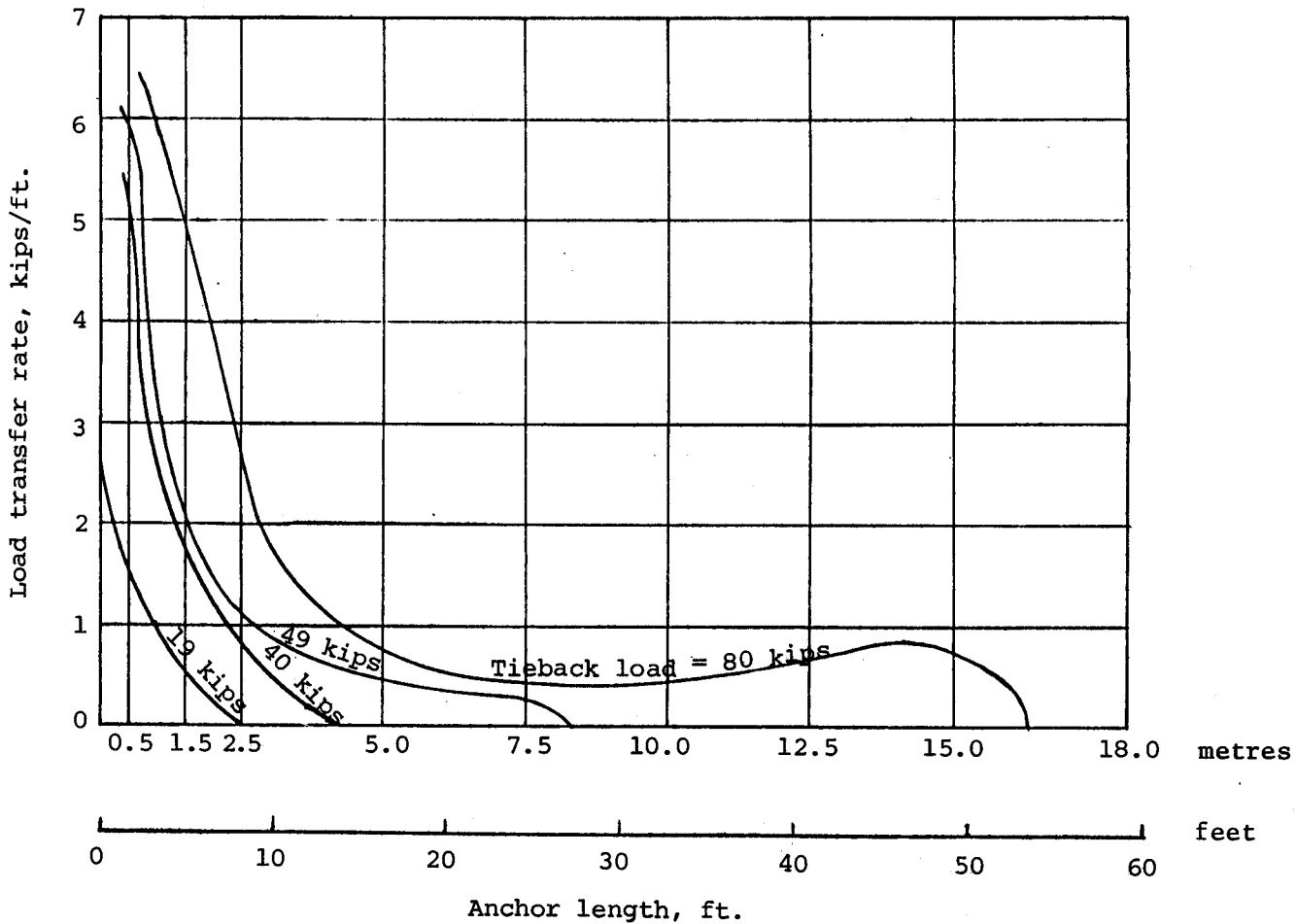

Note: 1 kip = 4.45 kN, 1 kip/ft. = 14.59 kN/m

Figure 97. Load transfer rate vs. anchor length along a tieback installed in a stiff to very stiff clay [115].

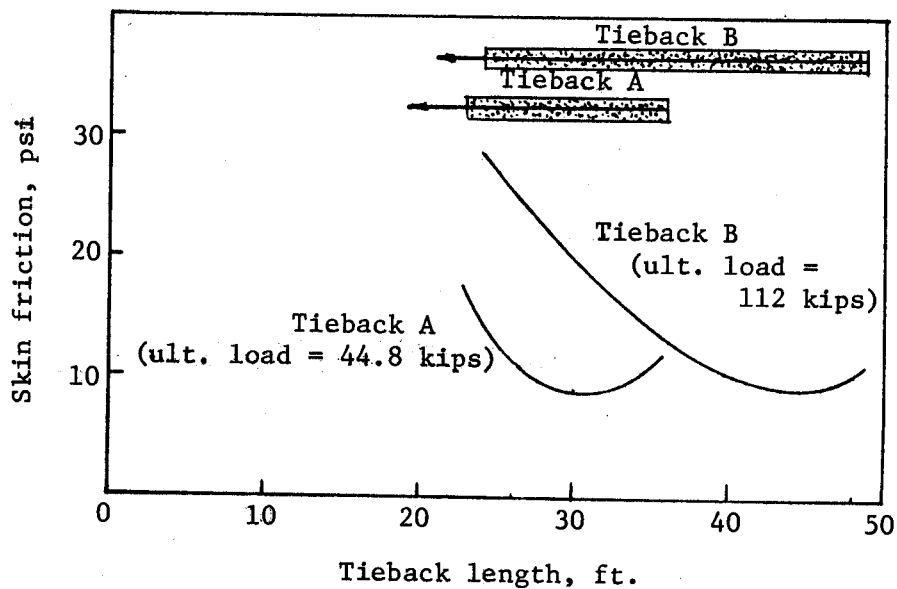

Note: 1 psi = 6.9 kPa , 1 ft. = 0.305 m  
1 kip = 4.45 kN

Figure 98. Skin friction along two tiebacks installed in a hard clay with an undrained strength of 39 psi (270 kPa) [116].

understood and very little load distribution test data has been reported in the literature. Bustamante, et al [89], reported on extensive testing performed on TMD postgrouted tiebacks installed in an overconsolidated clay having a unit weight of 118 to 124 pcf (1,890 to 1,986 kN/m<sup>3</sup>), a natural water content of 30 to 40 percent, a liquid limit of 80 to 90 percent, a plasticity index between 50 and 60, and an cohesion between 1,253 and 1,671 psf (60 and 80 kPa). One of these tiebacks was monitored for 116 days, and they found that the 185.4 kips (825 kN) lock-off load was reduced by 7.9 kips (35kN). Gandais and Delmas [117] reported that additional observations on the same tieback showed a total loss of load of 15.8 kips (70kN) over 250 days. They had predicted a 13.5 kips (60kN) reduction using short-term test results. Gandais and Delmas [117] also reported that the ultimate capacity of this tieback increased 20 percent upon retesting after being locked-off for 9 months. This increase in capacity indicates that consolidation rather than creep may have caused the observed time-dependent movements.

Bustamante, et al [89], also showed that the tieback capacity was not proportional to the amount of grout injected or grouting pressure, but it was proportional to the volume of grout which formed the grout body directly around the tendon. A significant amount of the grout injected was found in horizontal lenses away from the anchor zone.

Schnabel Foundation Company has used TMD tiebacks in a silty clay with an average undrained shear strength of 1,500 psf (71.9 kPa), a plastic limit between 40 and 55 percent, and a natural water content between 17 and

24 percent. These tiebacks were tested to 120 kips (534 kN), and locked-off at 80 kips (356 kN). After one year of monitoring the maximum loss of load was less than one kip (4.45 kN).

Based upon these tests, postgrouted tieback in stiff clay may be used for permanent applications. Careful short-term testing and monitoring is recommended for any permanent postgrouted tieback installed in a clay.

### CONCLUSION

The observed performance of permanent tiebacks suggests that the load transfer mechanisms presented in this chapter are valid. Creep theory indicates that the time-dependent movements of a tieback can be evaluated by studying the tieback movements as a function of the log of time.

Permanent tiebacks in dense sandy or gravelly soil or rock will not experience significant loss of load holding capacity, or movements with time. Tiebacks can be anchored in clay, but they must be carefully tested to determine whether or not they will perform satisfactorily. Straight-shafted tiebacks installed in low strength clays (undrained shear strength less than 1,000 psf [47.9 kN/m<sup>2</sup>]) will probably be creep susceptible. Straight-shafted and postgrouted tiebacks in stiff to hard clays (undrained shear strength greater than 1,000 psf [47.9 kN/m<sup>2</sup>]) may not be subject to significant loss of load as a result of creep. Multiunderreamed tiebacks may experience large loss of loads as a result of strain softening.

The plasticity index is an indication of the type and amount of clay present in the soil. A soil with a high plasticity index will be more creep susceptible than one with a low plasticity index. The French Recommendations [53] require careful creep testing when the tieback is installed in a cohesive soil with a plasticity index greater than or equal to 20. A consistency index (See Page 103) less than 0.8 indicates that a straight-shafted tieback may be creep susceptible. If the tieback must be anchored in soils with properties poorer than those given above, then low design loads, less than 40 tons (356 kN), should be used, careful testing should be performed (See Chapter 10), and regular long-term monitoring should be used.

Many temporary installations offer an excellent opportunity to evaluate tiebacks installed in cohesive soils. Valuable information concerning their long-term performance can be obtained if temporary tiebacks are tested in accordance with the procedures recommended in Chapter 10. Then, the long-term performance can be evaluated by monitoring the deformations of the structure, and the tieback load during construction.

Tieback tests are performed to verify that the tieback will carry the design load for the service life of the structure without excessive movements. Tests can also be used to check that the unbonded length has been established. Tiebacks are one of the few structural systems where every member can normally be tested before placing them into service.

A tieback testing procedure should identify the load-deformation behavior of the tieback for each project, and provide the engineer with data that will enable him to make an engineering decision as to their adequacy. At this time, it is not possible to establish a universal failure criteria that can be used for every type of tieback. The failure criteria that exist in many of the standards are only satisfactory for a particular tieback type. The tieback test data should also enable new tieback systems to be developed.

If load-deformation patterns are to be used rather than an arbitrary failure criteria to evaluate the tieback, then it is very important that a standard test procedure be established. By using standard tests, engineers will become familiar with the movement patterns of each type of tieback. A standard test will also simplify contract specifications, improve the understanding of tieback behavior, and reduce construction claims and delays. The tests should not be modified because even minor changes in the testing procedure may affect the results. For example, the loading sequences used to reach the maximum test load and the length of time each load increment is held will affect the rate of movement at the maximum test load for a straight-shafted tieback installed in a cohesive soil.

The tieback tests contained in the French Recommendations [53], the German Standards [55] and [56], the Swiss Standard [57], the FIP Recommendations [58], and the PTI Recommendations [59], are constant load tests. They are performed using a hydraulic jack to apply and maintain the load. The tieback movement is measured using a dial gauge or vernier. These standards use a detailed test(s) on a selected number of tiebacks, and a simple test or stressing procedure on the remaining ones. The details of these testing programs are not presented, although they form the basis for the following recommended testing program.

#### RECOMMENDED TESTING AND STRESSING EQUIPMENT

Figure 99 shows typical tieback testing arrangements for a bar and a strand tendon. A hydraulic jack and pump is used to apply the load to the tendon. Monostrand jacking should not be used for the testing of multistrand tiebacks, because it is practically impossible to establish the load-deformation behavior of a tieback by incrementally loading and unloading one strand at a time. A jack chair (See Figure 99) is used between the jack and the bearing plate to enable the test to be performed with the anchor head or nut in place. A stressing or testing anchorage is used behind the hydraulic jack to grip the tendon during loading. The movement of the tieback is measured with a dial gauge or a vernier supported on a reference which is independent of the structure being supported. The



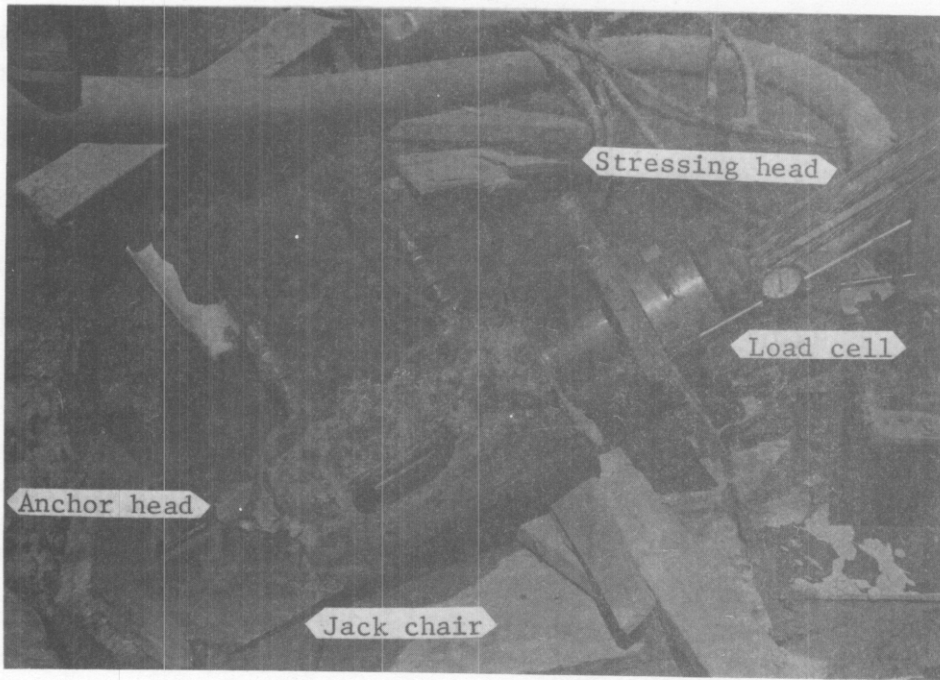

a) Strand tendon.

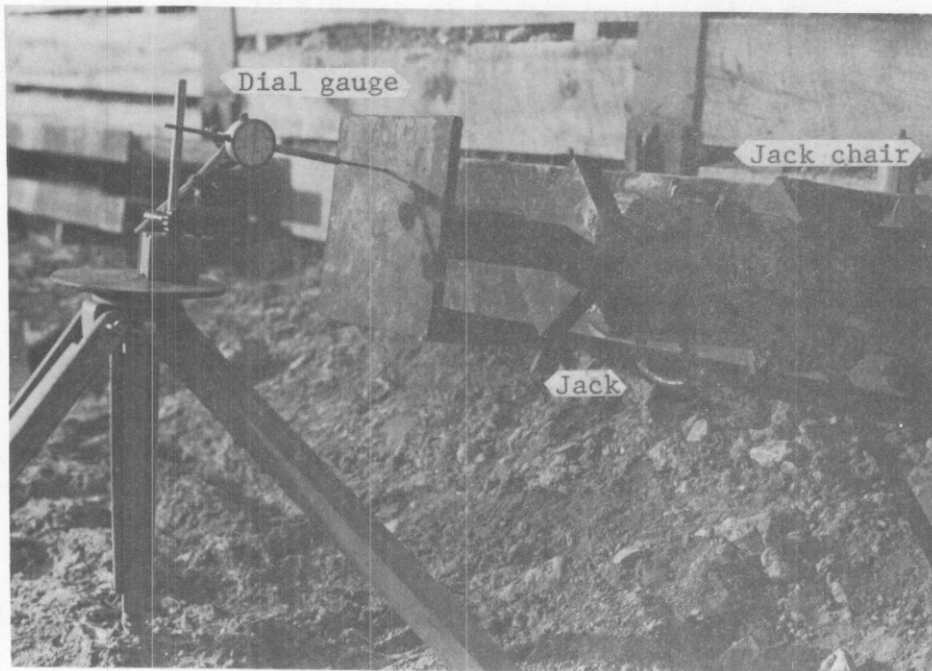

b) Bar tendon.

Figure 99. Tieback testing arrangement.

tieback movement cannot be accurately measured by measuring jack ram travel because the extension of the ram includes movement of the structure in response to the applied tieback load.

The hydraulic jack and pressure gauge should be calibrated as a set. The calibration should be done before the start of each project, and recalibrated if pressure measurements are suspected to be erratic. The calibration should be done using a minimum of three loading cycles over the full range of the jack. A minimum of six increments should be used during each loading cycle. The pressure gauge used for testing should be large enough to distinguish 100 psi (690 kPa) changes in pressure. Load cells are used to monitor changes in load while the tieback load is being held constant for extended periods of time. Load cells can detect small changes in load that cannot be accurately measured on a pressure gauge. Total load should not be measured with a load cell unless its accuracy can be shown to be greater than the accuracy of the pressure gauge. The accuracy of a load cell can be affected by cell construction, friction on the cell's bearing surfaces, misalignment, bending of the bearing plates, and damage. The ram travel of the jack must be long enough to enable the tieback to deform. The hydraulic pump must be capable of raising the load from one load increment to another in less than 60 seconds.

A dial gauge is normally used to measure tieback movement. The gauge may be mounted on a tripod or fixed to any support which is independent of the structure. The dial gauge should be capable of measuring to the nearest 0.001 inches (0.025 mm). A wire and vernier can also be used to measure movements, if they are expected to be large. The wire is aligned coaxial to the tendon and it is placed over a pulley. A weight is used to tension the wire, and the movement is measured using a scale attached to a frame and a vernier attached to the weight.

#### RECOMMENDED PERFORMANCE TEST

The first three tiebacks and a selected percentage of the remaining tiebacks should be performance tested. The tests should be located near borings. The tiebacks are tested as soon as the grout has gained sufficient strength. Pressure injected and postgrouted tiebacks in sandy or gravelly soil can be tested 3 days after installation. Other types of tiebacks made with Type I cement require 5 to 7 days curing before testing. If Type III cement is used, the tiebacks can normally be tested after 3 days.

The performance test is used to verify capacity and establish the load-deformation behavior for the tiebacks at a particular site. It is also used to separate and identify the causes of tieback movement, and to check that the unbonded length has been established. The movement patterns developed during the performance test are used to interpret the load-deformation curves for the simpler proof tests.

Performance testing is done by measuring the load applied to the tieback and its movement during incremental loading and unloading. Table 12 gives the performance test loading schedule that should be used for a tieback anchored in rock, or a sandy or gravelly soil. Since these tiebacks are

Table 12. Performance test made on a pressure-injected tieback installed in a dense fine to medium sand.

| Load increment | Basis of load (P <sub>DL</sub> = design load) | Load (tons) | Observation period (min) | Jack pressure (psi) | Movement (inches) | Remarks |
|----------------|---|-------------|--------------------------|---------------------|-------------------|---------|
| 0              | 0   | 0           |                          | 0                   | 0                 |         |
| T <sub>0</sub> | (1)   | 2           |                          | 190                 | 0.068             | **      |
| P <sub>1</sub> | 0.25 P <sub>DL</sub>                          | 13          |                          | 1230                | 0.268             | **      |
| T <sub>0</sub> |   | 2           |                          | 190                 | 0.103             | **      |
| P <sub>1</sub> | 0.25 P <sub>DL</sub>                          | 13          |                          | 1230                | 0.274             | *       |
| P <sub>2</sub> | 0.50 P <sub>DL</sub>                          | 26          |                          | 2460                | 0.553             | *       |
| T <sub>0</sub> |   | 2           |                          | 190                 | 0.124             | **      |
| P <sub>1</sub> | 0.25 P <sub>DL</sub>                          | 13          |                          | 1230                | 0.289             | *       |
| P <sub>2</sub> | 0.50 P <sub>DL</sub>                          | 26          |                          | 2460                | 0.567             | *       |
| P <sub>3</sub> | 0.75 P <sub>DL</sub>                          | 40          |                          | 3780                | 0.860             | *       |
| T <sub>0</sub> |   | 2           |                          | 190                 | 0.153             | **      |
| P <sub>1</sub> | 0.25 P <sub>DL</sub>                          | 13          |                          | 1230                | 0.283             | *       |
| P <sub>2</sub> | 0.50 P <sub>DL</sub>                          | 26          |                          | 2460                | 0.571             | *       |
| P <sub>3</sub> | 0.75 P <sub>DL</sub>                          | 40          |                          | 3780                | 0.872             | *       |
| P <sub>4</sub> | 1.00 P <sub>DL</sub>                          | 53          |                          | 5010                | 1.179             | *       |
| T <sub>0</sub> |   | 2           |                          | 190                 | 0.194             | **      |
| P <sub>1</sub> | 0.25 P <sub>DL</sub>                          | 13          |                          | 1230                | 0.285             | *       |
| P <sub>2</sub> | 0.50 P <sub>DL</sub>                          | 26          |                          | 2460                | 0.574             | *       |
| P <sub>3</sub> | 0.75 P <sub>DL</sub>                          | 40          |                          | 3780                | 0.879             | *       |
| P <sub>4</sub> | 1.00 P <sub>DL</sub>                          | 53          |                          | 5010                | 1.185             | *       |
| P <sub>5</sub> | 1.20 P <sub>DL</sub>                          | 63          |                          | 5950                | 1.520             | *       |
| T <sub>0</sub> |   | 2           |                          | 190                 | 0.245             | **      |
| P <sub>1</sub> | 0.25 P <sub>DL</sub>                          | 13          |                          | 1230                | 0.290             | *       |
| P <sub>2</sub> | 0.50 P <sub>DL</sub>                          | 26          |                          | 2460                | 0.579             | *       |
| P <sub>3</sub> | 0.75 P <sub>DL</sub>                          | 40          |                          | 3780                | 0.886             | *       |
| P <sub>4</sub> | 1.00 P <sub>DL</sub>                          | 53          |                          | 5010                | 1.197             | *       |
| P <sub>5</sub> | 1.20 P <sub>DL</sub>                          | 63          |                          | 5950                | 1.533             | *       |
| P <sub>6</sub> | 1.33 P <sub>DL</sub>                          | 70.5        | 1                        | 6660                | 1.750             | *       |
| P <sub>6</sub> | 1.33 P <sub>DL</sub>                          |             | 2                        |                     | 1.755             |         |
| P <sub>6</sub> | 1.33 P <sub>DL</sub>                          |             | 3                        |                     | 1.758             |         |
| P <sub>6</sub> | 1.33 P <sub>DL</sub>                          |             | 4                        |                     | 1.759             |         |
| P <sub>6</sub> | 1.33 P <sub>DL</sub>                          |             | 5                        |                     | 1.760             |         |
| P <sub>6</sub> | 1.33 P <sub>DL</sub>                          |             | 7                        |                     | 1.761             |         |
| P <sub>6</sub> | 1.33 P <sub>DL</sub>                          |             | 10                       |                     | 1.763             |         |
| P <sub>5</sub> | 1.20 P <sub>DL</sub>                          | 63          |                          |                     | 1.607             | *       |
| P <sub>4</sub> | 1.00 P <sub>DL</sub>                          | 53          |                          |                     | 1.401             | *       |
| Lock-off       |   |             |                          |                     |                   |         |

(1) T<sub>0</sub> is the alignment load. It is normally between 2 and 10 percent of the design load and it is maintained in order to keep the testing equipment aligned. The actual value of this load depends upon the type of tendon and the weight of the jack.

(2) 1 ton = 8.9 kN, 1 inch = 25.4 mm, 1 psi = 6.9 kPa.

\* Total movement readings

\*\* Residual anchor movement readings.

not susceptible to significant loss of holding capacity with time, the maximum test load is held constant for 10 minutes. During the load hold, the movements of the tieback should be recorded at 0, 1, 2, 3, 4, 5, 7, and 10 minutes. If the change in movement between 1 and 10 minutes exceeds 0.04 inches (1 mm), then the movement shall be observed for a total of 60 minutes. (Allowances for creep in the steel and variations in the creep rates for different types of tendons may be necessary. [See Page 202]). If the observation period is extended to 60 minutes, then the movements should also be recorded at 15, 20, 25, 30, 45, and 60 minutes. The observation period starts when the pump begins to apply load to the tieback. The load should be raised from the previous increment in less than 60 seconds, and the one minute reading is taken one minute after the pump was started.

Table 13 gives the performance test loading schedule that should be used for a tieback anchored in a cohesive soil. The 60 minute load hold is used to evaluate the long-term load holding ability of the tieback. During the load hold, the movements of the tieback should be recorded at 0, 1, 2, 3, 4, 5, 7, 10, 15, 20, 25, 30, 45, and 60 minutes. If the change in movements between 1 and 10 minutes is less than 0.04 inches (1 mm) (after allowing for tendon creep [See Page 202]), then the load hold can be discontinued.

A creep curve should be plotted for each performance test where the load was held for 60 minutes. Interpretation of the test results is discussed in the section beginning on Page 194.

Two types of load-deformation curves should be plotted for each performance test; a total movement curve, and a residual anchor movement curve. Figure 100 (a) shows the total movement curve for the pressure-injected tieback test results contained in Table 12. In order to simplify the presentation of the data and to highlight the behavior of the tieback, only the movement at the maximum load in each increment is plotted. The data to be plotted is identified with an asterisk (\*) in the remarks column in Table 12.

Figure 100 (b) shows the residual anchor movement curve for the data in Table 12. When a tieback is loaded, the anchor moves through the soil as it develops capacity. When the load is reduced to zero, a portion of the anchor movement is elastic and recovered, but some of the movement is nonrecoverable. This nonrecoverable movement (residual anchor movement), is also measured during a performance test. The residual movements are plotted as a function of the highest previous load. The movements to be plotted are identified with a double asterisk (\*\*) in the remarks column in Table 12.

The total movement of a tieback is made up of elastic movements (recoverable movements), and residual anchor movements (nonrecoverable movements). The elastic movements result from elastic elongation of the tendon and elastic movements of the anchor through the soil, and it is equal to the total movement minus the residual anchor movement. Time-dependent movements (creep movements) make up a portion of the residual anchor movement if the load is held constant for a period of time. The creep movements are a result of time-dependent movement of the anchor through the soil, progressive debonding of the tendon in the grout, and creep movements in the tendon. These components of movement can be identified in a performance test, and they are identified in Figure 101. Figure 101 is a plot of the data presented in Table 13.

Table 13. Performance test made on a hollow-stem-augered tieback installed in a stiff silty clay.

| Load increment | Basis of load ( $P_{DL}$ =design load) | Load (tons) | Observation period (min) | Jack pressure (psi) | Movement (inches) | Remarks |
|----------------|--|-------------|--------------------------|---------------------|-------------------|---------|
| 0              | 0                                      | 0           |                          | 0                   | 0                 |         |
| T <sub>0</sub> | (1)                                    | 5           |                          | 245                 | 0                 |         |
| P <sub>1</sub> | 0.25 P <sub>DL</sub>                   | 17.5        |                          | 860                 | 0.449             |         |
| T <sub>0</sub> |  | 5           |                          | 245                 | 0.131             |         |
| P <sub>1</sub> | 0.25 P <sub>DL</sub>                   | 17.5        |                          | 860                 | 0.426             |         |
| P <sub>2</sub> | 0.50 P <sub>DL</sub>                   | 31          |                          | 1525                | 1.102             |         |
| T <sub>0</sub> |  | 5           |                          | 245                 | 0.203             |         |
| P <sub>1</sub> | 0.25 P <sub>DL</sub>                   | 17.5        |                          | 860                 | 0.435             |         |
| P <sub>2</sub> | 0.50 P <sub>DL</sub>                   | 31          |                          | 1525                | 1.097             |         |
| P <sub>3</sub> | 0.75 P <sub>DL</sub>                   | 52          |                          | 2555                | 1.761             |         |
| T <sub>0</sub> |  | 5           |                          | 245                 | 0.298             |         |
| P <sub>1</sub> | 0.25 P <sub>DL</sub>                   | 17.5        |                          | 860                 | 0.446             |         |
| P <sub>2</sub> | 0.50 P <sub>DL</sub>                   | 31          |                          | 1525                | 1.101             |         |
| P <sub>3</sub> | 0.75 P <sub>DL</sub>                   | 52          |                          | 2555                | 1.778             |         |
| P <sub>4</sub> | 1.00 P <sub>DL</sub>                   | 70          |                          | 3440                | 2.622             |         |
| T <sub>0</sub> |  | 5           |                          | 245                 | 0.391             |         |
| P <sub>1</sub> | 0.25 P <sub>DL</sub>                   | 17.5        |                          | 860                 | 0.458             |         |
| P <sub>2</sub> | 0.50 P <sub>DL</sub>                   | 31          |                          | 1525                | 1.123             |         |
| P <sub>3</sub> | 0.75 P <sub>DL</sub>                   | 52          |                          | 2555                | 1.787             |         |
| P <sub>4</sub> | 1.00 P <sub>DL</sub>                   | 70          |                          | 3440                | 2.631             |         |
| P <sub>5</sub> | 1.20 P <sub>DL</sub>                   | 84          |                          | 4130                | 3.679             |         |
| T <sub>0</sub> |  | 5           |                          | 245                 | 0.762             |         |
| P <sub>1</sub> | 0.25 P <sub>DL</sub>                   | 17.5        |                          | 860                 | 0.862             |         |
| P <sub>2</sub> | 0.50 P <sub>DL</sub>                   | 31          |                          | 1525                | 1.523             |         |
| P <sub>3</sub> | 0.75 P <sub>DL</sub>                   | 52          |                          | 2555                | 2.007             |         |
| P <sub>4</sub> | 1.00 P <sub>DL</sub>                   | 70          |                          | 3440                | 2.638             |         |
| P <sub>5</sub> | 1.20 P <sub>DL</sub>                   | 84          |                          | 4130                | 3.689             |         |
| P <sub>6</sub> | 1.33 P <sub>DL</sub>                   | 92          | 1                        | 4525                | 4.367             |         |
| P <sub>6</sub> | 1.33 P <sub>DL</sub>                   |             | 2                        |                     | 4.484             |         |
| P <sub>6</sub> | 1.33 P <sub>DL</sub>                   |             | 3                        |                     | 4.529             |         |
| P <sub>6</sub> | 1.33 P <sub>DL</sub>                   |             | 4                        |                     | 4.554             |         |
| P <sub>6</sub> | 1.33 P <sub>DL</sub>                   |             | 5                        |                     | 4.573             |         |
| P <sub>6</sub> | 1.33 P <sub>DL</sub>                   |             | 7                        |                     | 4.593             |         |
| P <sub>6</sub> | 1.33 P <sub>DL</sub>                   |             | 10                       |                     | 4.616             |         |
| P <sub>6</sub> | 1.33 P <sub>DL</sub>                   |             | 15                       |                     | 4.635             |         |
| P <sub>6</sub> | 1.33 P <sub>DL</sub>                   |             | 20                       |                     | 4.646             |         |
| P <sub>6</sub> | 1.33 P <sub>DL</sub>                   |             | 25                       |                     | 4.655             |         |
| P <sub>6</sub> | 1.33 P <sub>DL</sub>                   |             | 30                       |                     | 4.662             |         |
| P <sub>6</sub> | 1.33 P <sub>DL</sub>                   |             | 45                       |                     | 4.680             |         |
| P <sub>6</sub> | 1.33 P <sub>DL</sub>                   |             | 60                       |                     | 4.691             |         |
| P <sub>5</sub> | 1.20 P <sub>DL</sub>                   | 84          |                          | 4130                | 4.632             |         |
| P <sub>4</sub> | 1.00 P <sub>DL</sub>                   | 70          |                          | 3440                | 4.448             |         |
| Lock-off       |  |             |                          |                     |                   |         |

(1) T<sub>0</sub> is the alignment load. It is normally between 2 and 10 percent of the design load and it is maintained in order to keep the testing equipment aligned. The actual value of this load depends upon the type of tendon and the weight of the jack.

(2) 1 ton = 8.9 kN, 1 inch = 25.4 mm, 1 psi = 6.9 kPa

Test load (tons)

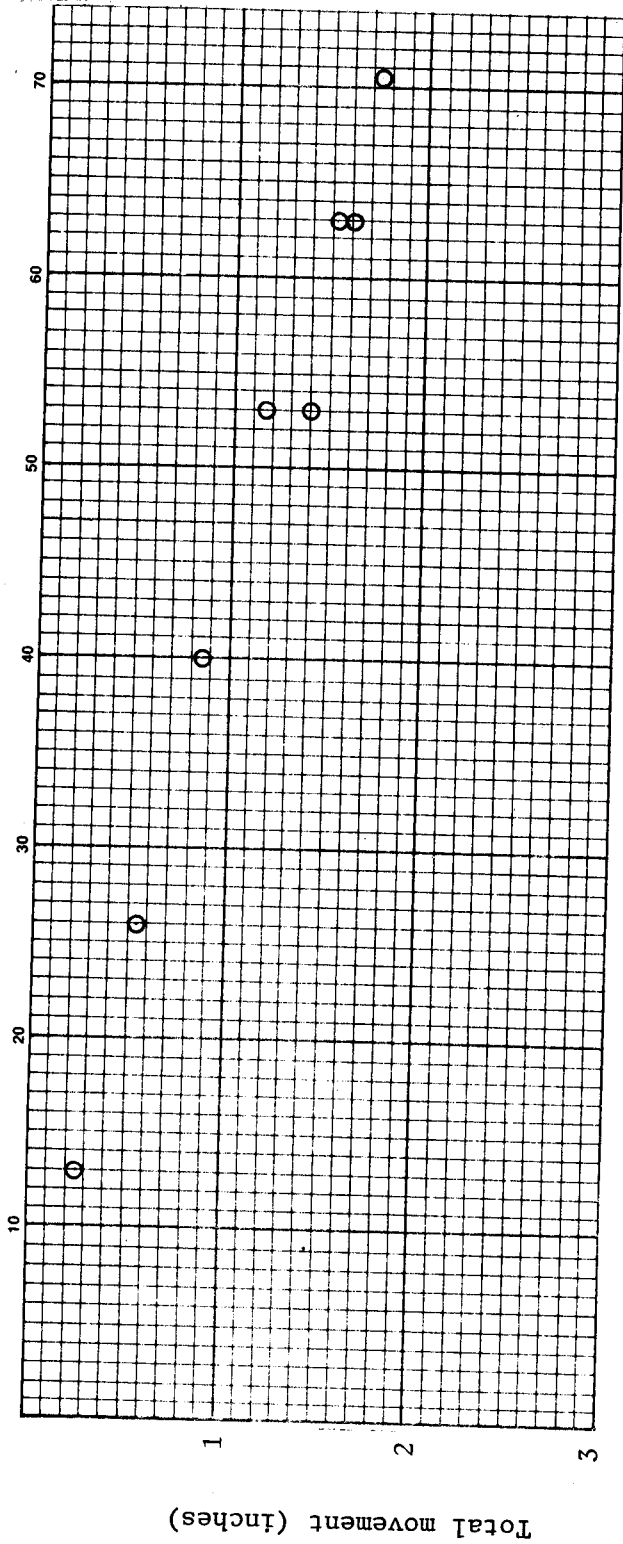

a) Total movement curve

Test load (tons)

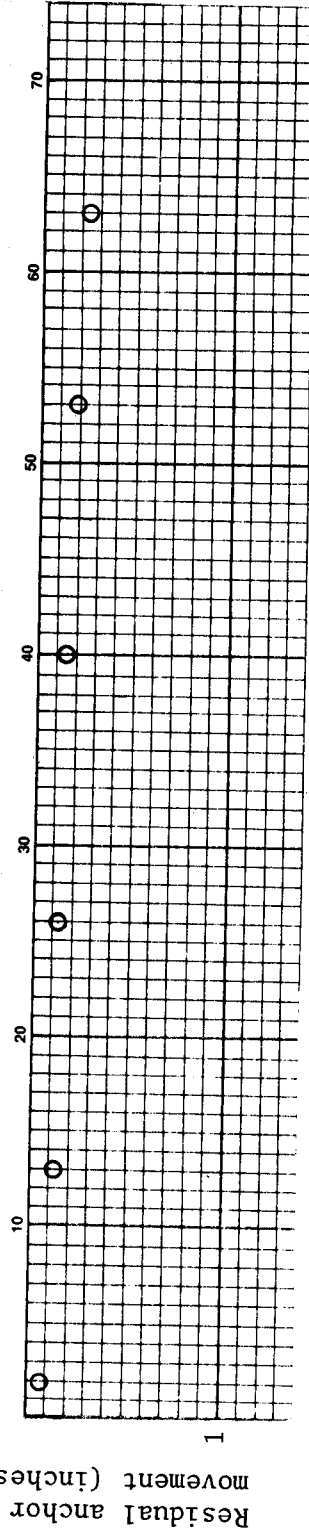

b) Residual anchor movement curve

Figure 100. Performance test performed on a pressure-injected tieback installed in a dense fine to medium sand.

Tieback data:

Lengths:

Total = 45 ft.

Unbonded = 15 ft.

Anchor = 30 ft.

Jacking = 4 ft.

Tendon:

1 1/4" Bar

Grouting:

16 bags of cement  
200 psi pressure

Note:

- 1 ton = 8.9 kN
- 1 inch = 25.4 mm
- 1 foot = 0.305 m
- 1 psi = 6.9 kPa



Many tieback specifications have specified a minimum and a maximum elastic movement for the tiebacks. Typically the minimum elastic movement has been required to exceed 0.8 times the calculated elastic elongation of the unbonded length, and the maximum elastic movement has been required to be less than the calculated elastic elongation of the unbonded length plus half of the anchor length.

The checking of the minimum elastic movement is a reasonable thing to do because it verifies that the unbonded length actually has been provided. Requiring the maximum elastic movement to be less than a calculated elastic elongation, assumes that the skin friction along a straight-shafted tieback is uniform and that the end of the tieback does not move. Measurements and tieback tests have shown that these assumptions often are not true, most tiebacks do not transfer load to the soil uniformly, even in uniform soil deposits. In a uniform soil deposit the skin friction along an anchor is a function of strain. The skin friction--strain relationship for the tieback will determine the load transfer rate. Chapter 9 contained a detail discussion of skin friction distributions and load transfer rates. A shaft tieback in a uniform soil deposit will normally have elastic movements less than the calculated elastic elongation of the unbonded length plus half of the anchor length. However, if a shaft tieback is installed in a nonuniform soil deposit, then the skin friction will be affected by the soil and the skin friction--strain relationship for each soil. If weak soils are located around the front of the anchor, and stronger soils surround the lower portion of the anchor, then the actual elastic movements will exceed the maximum allowed. These tiebacks should not be rejected. The 1972 French Recommendations [118] had a criteria for the maximum elastic movement, but that criteria was dropped when the 1977 Recommendations [53] were developed. The requirement was dropped because many successful installations had not been able to meet the criteria.

Interpretation of performance test results will be discussed in the interpretation of tests results section of this chapter.

#### RECOMMENDED PROOF TESTS

Each production tieback which is not performance or creep tested should be proof tested. A proof test is a simple test which is used to measure total movement of the tieback during incremental loading. The increments of load are the same as those used in the performance test except the maximum increment is normally equal to 1.20 times the design load.

If the performance test indicates that the tiebacks are not creep susceptible, and the tiebacks are installed in rock or sandy soils, then the proof tests can be run in accordance with the schedule contained in Table 14. The table was designed to enable five tieback tests to be recorded on the same form. The maximum load applied during the test is held constant for 5 minutes and the tieback movement is recorded. If the movement between 1 and 5 minutes is less than 0.03 inches (0.76 mm) (after allowing for tendon creep [See Page 202]) then the test is discontinued. If the movement exceeds 0.03 inches (0.76 mm), then the load should be maintained until the creep rate can be determined.





In cohesive soils the test results are often more erratic than in rock or cohesionless soils. These tests may require extended observations at the maximum test load, and a plot of the total movement versus load is helpful in comparing the results with the results of the performance and creep tests. Table 15 gives the loading schedule for a proof test in cohesive soils, and it contains the results of a test performed on a hollow-stem-augered tieback installed in an interbedded stiff clay and silty sand. Figure 102 shows a plot of the data in Table 15.

In cohesive soils, the engineer should review the creep curves developed from the creep and performance tests, and determine the length of the observation period and the magnitude or pattern of acceptable creep movements for the proof tests. Normally, a five minute observation period will be sufficient in cohesive soils. However, the time period may have to be extended if the creep movement is erratic or excessive.

Interpretation of proof test results is discussed in the Interpretation of Test Results section of this chapter.

Table 15. Proof test performed on a hollow-stem-augered tieback installed in an interbedded stiff silty clay and silty sand.

| Load increment | Basic of load ( $P_{DL}$ = design load) | Load (tons) | Observation period (min) | Jack pressure (psi) | Movement (inches) | Remarks |
|----------------|---|-------------|--------------------------|---------------------|-------------------|---------|
| 0              | 0                                       | 0           |                          | 0                   | -                 |         |
| $T_0$          | (1)                                     | 3.5         |                          | 170                 | 0                 |         |
| $P_1$          | 0.25 $P_{DL}$                           | 19          |                          | 950                 | 0.419             |         |
| $P_2$          | 0.50 $P_{DL}$                           | 38          |                          | 1850                | 1.059             |         |
| $P_3$          | 0.75 $P_{DL}$                           | 57          |                          | 2800                | 1.781             |         |
| $P_4$          | 1.00 $P_{DL}$                           | 75.5        |                          | 3700                | 2.355             |         |
| $P_5$          | 1.20 $P_{DL}$                           | 90.5        | 1                        | 4450                | 2.818             |         |
| $P_5$          | 1.20 $P_{DL}$                           |             | 2                        |                     | 2.835             |         |
| $P_5$          | 1.20 $P_{DL}$                           |             | 3                        |                     | 2.838             |         |
| $P_5$          | 1.20 $P_{DL}$                           |             | 4                        |                     | 2.841             |         |
| $P_5$          | 1.20 $P_{DL}$                           |             | 5                        |                     | 2.845             |         |
| $P_5$          | 1.20 $P_{DL}$                           |             | 7                        |                     | 2.847             |         |
| $P_5$          | 1.20 $P_{DL}$                           |             | 10                       |                     | 2.851             |         |
| $P_5$          | 1.20 $P_{DL}$                           |             | 15                       |                     | 2.856             |         |
| $P_5$          | 1.20 $P_{DL}$                           |             | 20                       |                     |                   |         |
| $P_5$          | 1.20 $P_{DL}$                           |             | 25                       |                     |                   |         |
| $P_5$          | 1.20 $P_{DL}$                           |             | 30                       |                     |                   |         |
| $P_5$          | 1.20 $P_{DL}$                           |             | 45                       |                     |                   |         |
| $P_5$          | 1.20 $P_{DL}$                           |             | 60                       |                     |                   |         |
| $P_4$          | 1.00 $P_{DL}$                           | 75.5        |                          | 3700                | 2.680             |         |
| Lock-Off       |   | 57          |                          | 2800                | 2.220             |         |

(1)  $T_0$  is the alignment load. It is normally between 2 and 10 percent of the design load and it is maintained in order to keep the testing equipment aligned. The actual value of this load depends upon the type of tendon and the weight of the jack.

(2) 1 ton = 8.9 kN, 1 inch = 25.4 mm, 1 psi = 6.9 kPa.

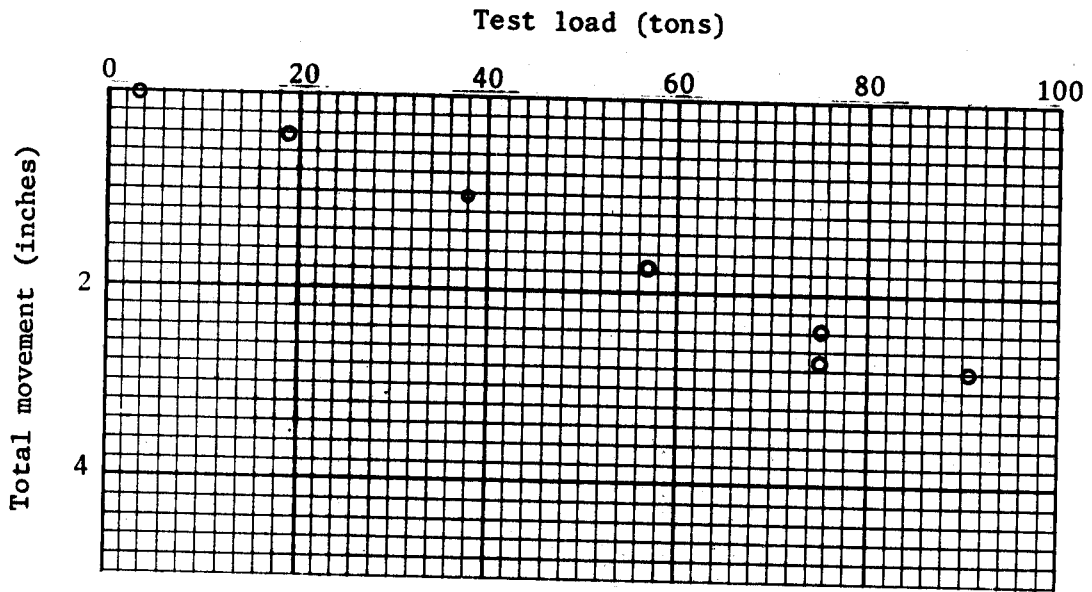

Tieback data:

Lengths:  
 Total = 55 ft. (16.8 m)  
 Unbonded = 10 ft. (3.1 m)  
 Anchor = 45 ft. (13.7 m)  
 Jacking = 5 ft. (1.5 m)

Shaft diameter - 12 inches  
 Tendon: 7 - 0.5 in. strands

Grouting:  
 1½ cu. yds.  
 100 psi

Note: 1 ton = 8.9 kN  
 1 psi = 6.9 kPa

1 inch = 25.4 mm  
 1 cu. yd. = 0.765 m<sup>3</sup>

Figure 102. Proof test performed on a hollow-stem-augered tieback installed in an interbedded stiff silty clay and silty sand.

## RECOMMENDED CREEP TEST

The long-term behavior of tiebacks installed in cohesive soils is not well understood. In order to predict the long-term behavior of tiebacks installed in clays, the engineer should select at least two tiebacks for creep testing. Normally, these tests are performed on two of the initial three performance-tested tiebacks.

The test arrangement for a creep test is similar to that used for performance or proof tests, except a load cell is used to monitor the tieback load. Table 16 contains a loading schedule, and Table 17 gives the creep movement schedule for a creep test. The increments of load are the same as those used during a performance test. Each observation period starts when the pump begins to apply load and the one minute reading is recorded one minute after the pump starts. All times in Table 17 are taken from the time when the pump began to apply the load. The load must be increased in less than 60 seconds. Tables 16 and 17 also contain the results of a creep test performed on a postgrouted tieback installed in a stiff clay with a trace of fine to medium sand, and Figures 103 and 104 show the residual anchor movement, and creep curves for the tieback.

The total movement and residual anchor movement curves are similar to those developed for a performance test. The creep movement at any time is the change in movement from the movement at 1 minute. The creep curve is a plot of the creep movement during each increment of load with respect to the log of time. The creep rate is the slope of the line per decade of time. A decade of time is one log cycle of time. A semilogarithmic plot of creep movements as a function of time was selected because laboratory triaxial creep results are described by similar curves. The French Recommendation [53] and the German Standard [56] also use similar creep curves.

The length of the observation periods in Table 16 increase as the load increases. This was done so that the creep movements are not significantly influenced by the previous loads. The writer has found that previous load history can affect the creep rate. The observation periods were selected so that the tests could be completed in a reasonable amount of time, and a virgin creep rate could be established. Since the creep movements are plotted as a function of the log of time, it would take 1,000 minutes to add one additional log cycle to a temporary tieback test and 3,000 minutes to add one more cycle to a permanent tieback test. Extension of the test for an additional log cycle is not justified, since excessive anchor creep usually is apparent early in the second log cycle.

## RECOMMENDED ON-SITE TESTING PROGRAM

The number of creep and performance tests performed on a project depends upon whether the tiebacks are used for temporary or permanent applications; whether the anchor is in rock, cohesive soil, or cohesionless soil; and, the variable nature of the ground. Table 18 gives an indication of the number of creep and performance tests that may be necessary. The engineer should review the ground conditions, and specifically identify those tiebacks which

Table 16. Creep test made on a postgrouted tieback installed in a stiff clay with a trace of fine to medium sand.

| Load increment | Basis of load ( $P_{DL}$ = design load) | Load (tons) | Jack pressure (psi) | Load cell ( $\mu\epsilon$ ) (2) | Movement @ $t=1$ min. (inches) | Observation periods (min) |       |
|----------------|---|-------------|---------------------|---------------------------------|--------------------------------|---------------------------|-------|
|                |   |             |                     |                                 |                                | Temp.                     | Perm. |
| 0              |   | 0           | 0                   | 2384                            | 0                              |                           |       |
| $T_0$          | (1)                                     | 2           |                     | 2453                            | 0.069                          |                           |       |
| $P_1$          | 0.25 $P_{DL}$                           | 13.4        |                     | 2844                            | 0.224                          |                           | 10    |
| $T_0$          |   | 2           |                     | 2453                            | 0.114                          |                           |       |
| $P_1$          | 0.25 $P_{DL}$                           | 13.4        |                     | 2844                            | 0.243                          |                           |       |
| $P_2$          | 0.50 $P_{DL}$                           | 26.9        |                     | 3307                            | 0.465                          | 10                        | 30    |
| $T_0$          |   | 2           |                     | 2453                            | 0.146                          |                           |       |
| $P_1$          | 0.25 $P_{DL}$                           | 13.4        |                     | 2844                            | 0.308                          |                           |       |
| $P_2$          | 0.50 $P_{DL}$                           | 26.9        |                     | 3307                            | 0.508                          |                           |       |
| $P_3$          | 0.75 $P_{DL}$                           | 40.3        |                     | 3767                            | 0.743                          | 15                        | 30    |
| $T_0$          |   | 2           |                     | 2453                            | 0.212                          |                           |       |
| $P_1$          | 0.25 $P_{DL}$                           | 13.4        |                     | 2844                            | 0.399                          |                           |       |
| $P_2$          | 0.50 $P_{DL}$                           | 26.9        |                     | 3307                            | 0.628                          |                           |       |
| $P_3$          | 0.75 $P_{DL}$                           | 40.3        |                     | 3767                            | 0.862                          |                           |       |
| $P_4$          | 1.00 $P_{DL}$                           | 53.8        |                     | 4230                            | 1.100                          | 30                        | 45    |
| $T_0$          |   | 2           |                     | 2453                            | 0.341                          |                           |       |
| $P_1$          | 0.25 $P_{DL}$                           | 13.4        |                     | 2844                            | 0.506                          |                           |       |
| $P_2$          | 0.50 $P_{DL}$                           | 26.9        |                     | 3307                            | 0.735                          |                           |       |
| $P_3$          | 0.75 $P_{DL}$                           | 40.3        |                     | 3767                            | 0.964                          |                           |       |
| $P_4$          | 1.00 $P_{DL}$                           | 53.8        |                     | 4230                            | 1.200                          |                           |       |
| $P_5$          | 1.20 $P_{DL}$                           | 64.5        |                     | 4597                            | 1.400                          | 30                        | 60    |
| $T_0$          |   | 2           |                     | 2453                            | 0.420                          |                           |       |
| $T_1$          | 0.25 $P_{DL}$                           | 13.4        |                     | 2844                            | 0.593                          |                           |       |
| $T_2$          | 0.50 $P_{DL}$                           | 26.9        |                     | 3307                            | 0.833                          |                           |       |
| $T_3$          | 0.75 $P_{DL}$                           | 40.3        |                     | 3767                            | 1.075                          |                           |       |
| $T_4$          | 1.00 $P_{DL}$                           | 53.8        |                     | 4230                            | 1.320                          |                           |       |
| $T_5$          | 1.20 $P_{DL}$                           | 64.5        |                     | 4597                            | 1.508                          |                           |       |
| $T_6$          | 1.33 $P_{DL}$                           | 71.5        |                     | 4837                            | 1.657                          | 100                       | 300   |
| $P_5$          | 1.20 $P_{DL}$                           | 64.5        |                     | 4597                            | 1.598                          |                           |       |
| $P_4$          | 1.20 $P_{DL}$                           | 53.8        |                     | 4230                            | 1.439                          |                           |       |
| Lock-Off       |   |             |                     |                                 |                                |                           |       |

(1)  $T_0$  is alignment load. It is normally between 2 and 10 percent of the design load and it is maintained in order to keep the testing equipment aligned. The actual value of this load depends upon the type of tendon and weight of the jack.

(2)  $\mu\epsilon$  = microstrains ( $10^{-6}$  inches)

(3) 1 ton = 8.9 kN, 1 inch = 25.4 mm, 1 psi = 6.9 kPa

Table 17. Creep test performed on a postgrouted tieback installed in a stiff clay with a trace of fine to medium sand.

| Load increment                  | 0.25 P <sub>ult</sub> | 0.50 P <sub>ult</sub> | 0.75 P <sub>ult</sub> | 1.00 P <sub>ult</sub> | 1.20 P <sub>ult</sub> | 1.33 P <sub>ult</sub> |
|---------------------------------|-----------------------|-----------------------|-----------------------|-----------------------|-----------------------|-----------------------|
| Load (tons)                     | 13.4                  | 26.9                  | 40.3                  | 53.8                  | 64.8                  | 71.5                  |
| Jack pressure (psi)             |                       |                       |                       |                       |                       |                       |
| Load cell $\mu\epsilon$ (1)     | 2844                  | 3307                  | 3767                  | 4230                  | 4597                  | 4837                  |
| Time minutes                    |                       |                       |                       |                       |                       |                       |
| 1                               | .230                  | .486                  | .759                  | 1.128                 | 1.431                 | 1.685                 |
| 2                               | .232                  | .499                  | .770                  | 1.135                 | 1.445                 | 1.692                 |
| 3                               | .234                  | .501                  | .770                  | 1.138                 | 1.449                 | 1.694                 |
| 4                               | .236                  | .509                  | .772                  | 1.138                 | 1.454                 | 1.699                 |
| 5                               | .237                  | .514                  | .772                  | 1.145                 | 1.459                 | 1.699                 |
| 7                               | .238                  | .514                  | .775                  | 1.147                 | 1.462                 | 1.702                 |
| 10                              | .239                  | .514                  | .773                  | 1.156                 | 1.468                 | 1.712                 |
| 15                              |                       | .514                  | .775                  | 1.158                 | 1.478                 | 1.719                 |
| 20                              |                       |                       | .777                  | 1.165                 | 1.483                 | 1.719                 |
| 25                              |                       |                       | .780                  | 1.166                 | 1.486                 | 1.720                 |
| 30                              |                       |                       | .777                  | 1.173                 | 1.492                 | 1.726                 |
| 45                              |                       |                       |                       |                       |                       | 1.737                 |
| 60                              |                       |                       |                       |                       |                       | 1.746                 |
| 75                              |                       |                       |                       |                       |                       | 1.747                 |
| 100                             |                       |                       |                       |                       |                       | 1.753                 |
| 200                             |                       |                       |                       |                       |                       |                       |
| 300                             |                       |                       |                       |                       |                       |                       |
| Total movement during load hold | 0.015                 | 0.045                 | 0.034                 | 0.073                 | 0.092                 | 0.096                 |

(1)  $\mu\epsilon$  = microstrains ( $10^{-6}$  inches)

(2) 1 ton = 8.9 kN, 1 inch = 25.4 mm

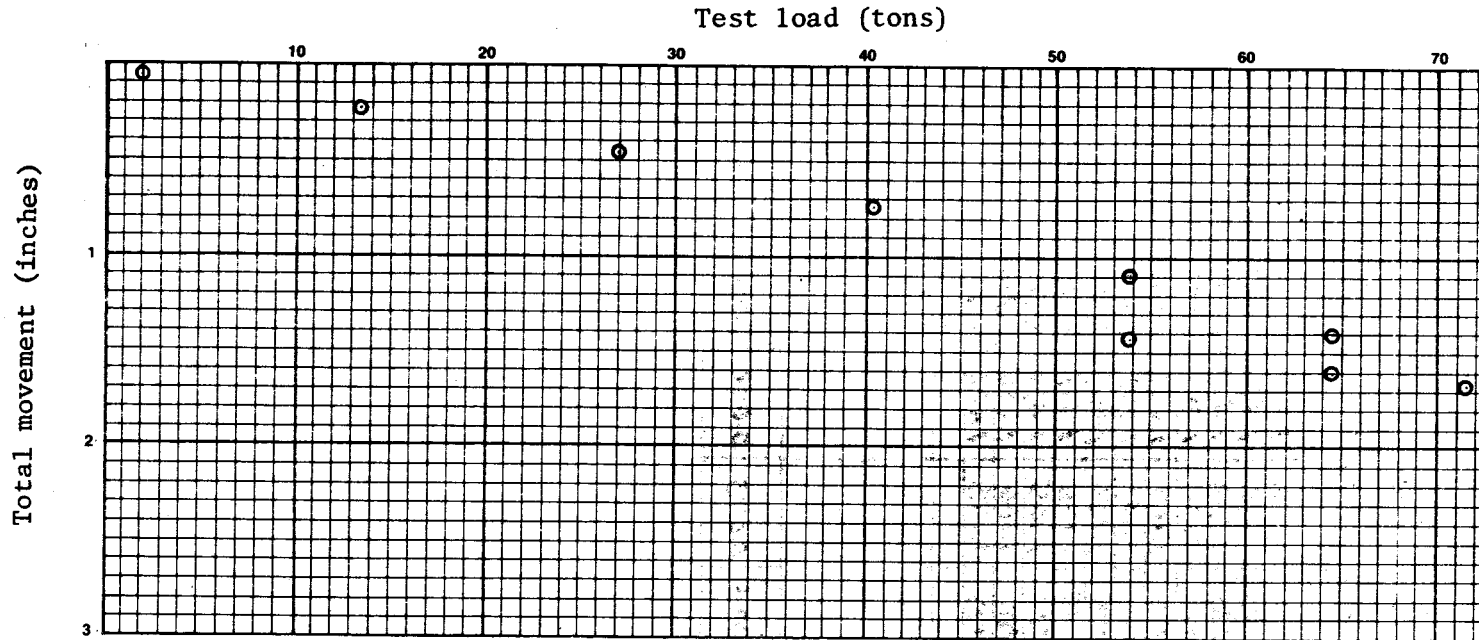

a) Total movement curve.

Tieback data:

Lengths:

Total = 49 ft.

Unbonded = 19 ft.

Anchor = 30 ft.

Jacking = 6 ft.

Tendon:

1 1/4" Bar

Grouting:

3 phases  
maximum  
pressure  
450 psi

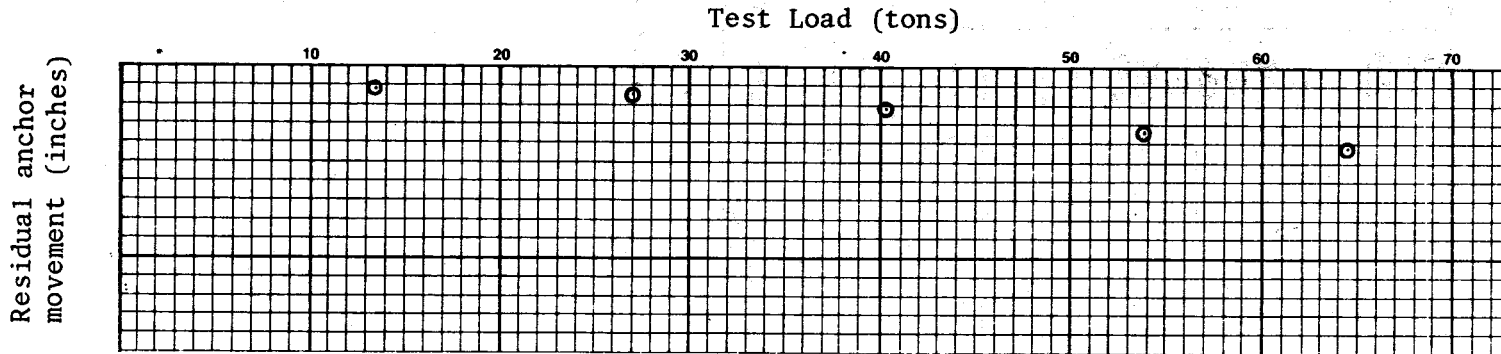

b) Residual anchor movement curve

Note:

- 1 ton = 8.9 kN
- 1 inch = 25.4 mm
- 1 foot = 0.305 m
- 1 psi = 6.9 kPa

Figure 103. Performance test made on a postgrouted tieback installed in a stiff clay with a trace of fine to medium sand.

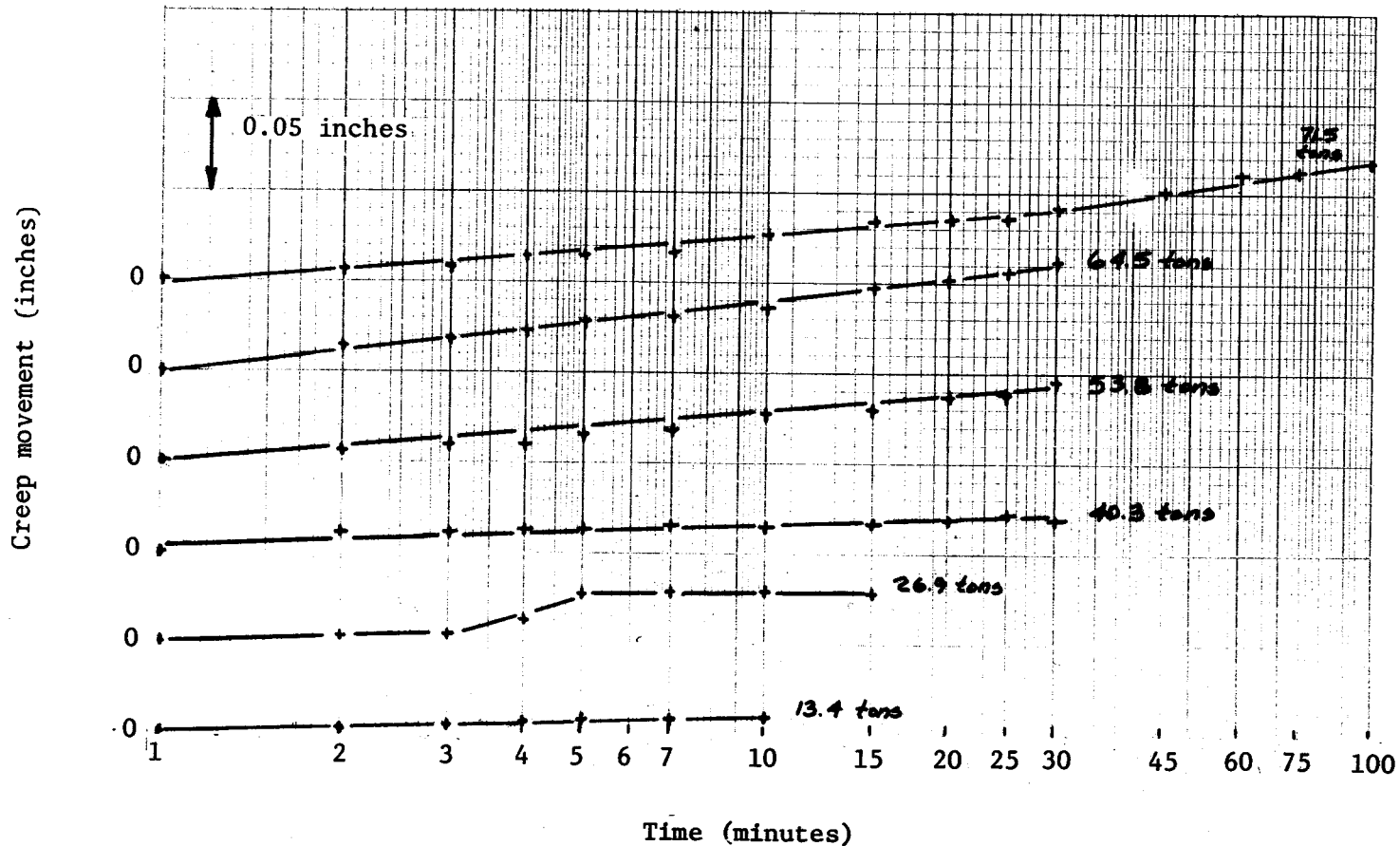

Note: 1 ton = 8.9 kN, 1 inch = 25.4 mm

Figure 104. Creep test performed on a postgrouted tieback installed in a stiff clay with a trace of fine to medium sand.



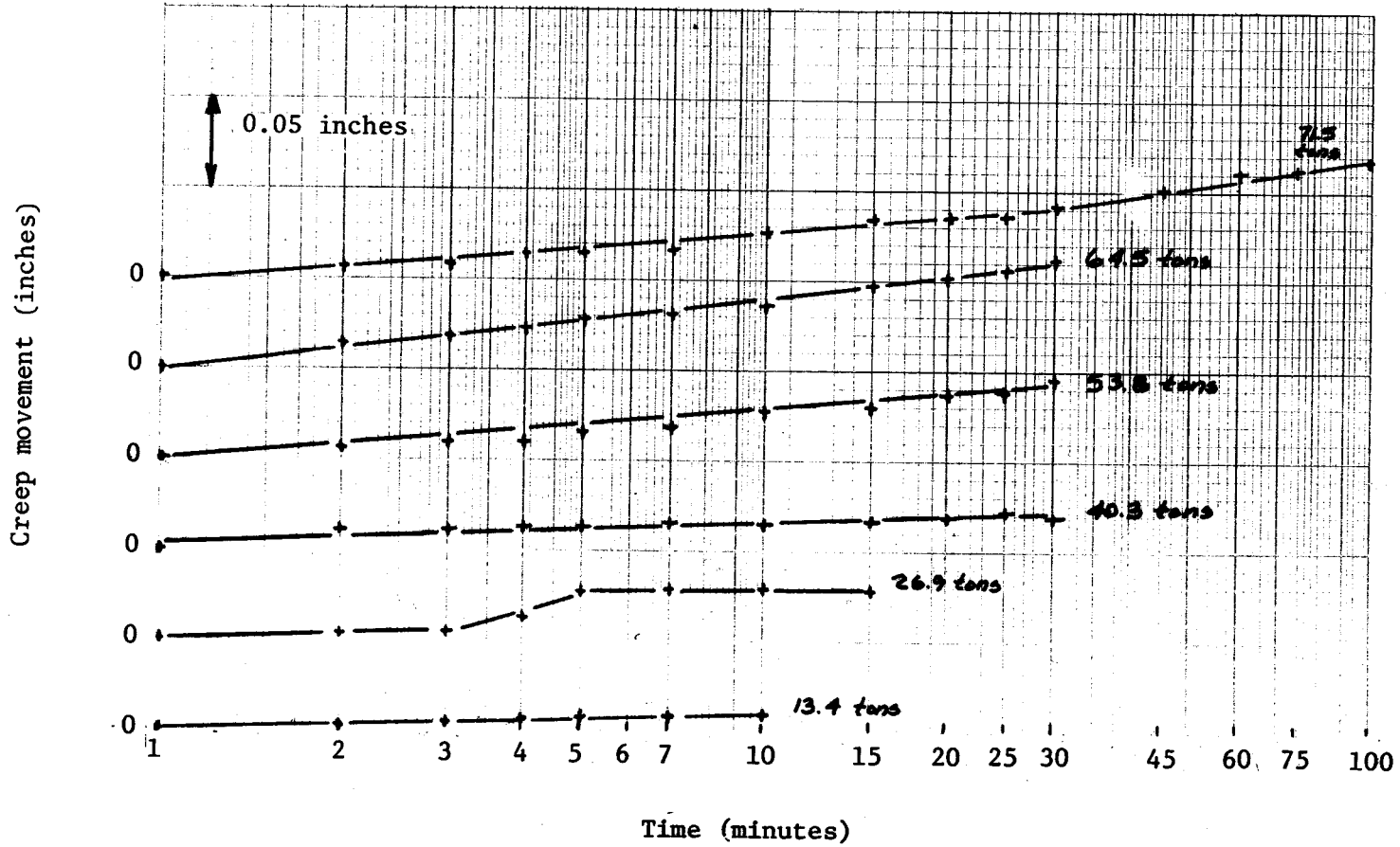

Note: 1 ton = 8.9 kN, 1 inch = 25.4 mm

Figure 104. Creep test performed on a postgrouted tieback installed in a stiff clay with a trace of fine to medium sand.

should be creep or performance tested. If the installation method is changed or modified significantly, each new tieback type should be creep or performance tested. All the remaining tiebacks should be proof tested.

Table 18. Recommended tieback testing program.

| Ground conditions                       | Creep tests (number)  | Performance tests (number/percentage)                           |
|---|---|---|
| Temporary rock tiebacks                 | None  | First three tiebacks plus 1% of the remaining ones.             |
| Permanent rock tiebacks                 | None  | First three tiebacks plus 2% of the remaining ones.             |
| Temporary tiebacks in noncohesive soils | None  | First three tiebacks plus 2% of the remaining ones.             |
| Permanent tiebacks in noncohesive soils | None  | First three tiebacks plus 2% of the remaining ones.             |
| Temporary tiebacks in cohesive soils.   | First two tiebacks plus additional groups of two if soil conditions vary significantly over the site. | One of the first three tiebacks plus 5% of the remaining ones.  |
| Permanent tiebacks in cohesive soils.   | First two tiebacks plus additional groups of two if soil conditions vary over the site.               | One of the first three tiebacks plus 10% of the remaining ones. |

Occasionally, tiebacks will fail to pass a test, indicating a construction problem or a change in soil type. If several tiebacks fail to pass a performance or creep test, then the design load should be reduced, or the installation method should be modified or changed. Minor modifications such as increasing the anchor length, total tieback length, or adjusting the angle of the tieback are very common. After changing or adjusting the installation methods, then performance or creep tests should be run in accordance with the recommendations in Table 18. When a proof-tested tieback fails, its load-movement curve should be studied and a revised design load should be assigned to it. Any additional capacity required should be provided by adjacent or additional tiebacks.

The maximum test load may be increased above 1.33 times the design load. However, in sandy or gravelly soils and rock there is no engineering reason for increasing the overload. In cohesive soils a higher overload will cause higher creep movements at the test load, and delay the initiation of creep at the lock-off load. Table 19 gives the overloads recommended by the various standards. The writer is not aware of any long-term performance problems when the tiebacks have been proof tested to 1.20 times the design load, and creep and performance tested to 1.33 times the design load. When it is not possible to establish an independent reference point to measure the movement of each tieback, i.e., waterfront walls, some landslides, retaining wall repairs, and underground caverns, then a maximum test load between 150 and 200 percent of the design load can be used for the creep and performance tests. Then the remaining tiebacks need only to be stressed and locked-off.

Table 19. Tieback test overloads.

| Tieback type                                     | Overload                     | Source                  |
|--|------------------------------|-------------------------|
| Temporary and permanent soil tieback             | 1.5                          | Germany [55] [56]       |
| Temporary tieback in soil or rock                | 1.3 to 1.8 depending on risk | Switzerland [57]        |
| Permanent tiebacks in soil or rock               | 1.6 to 2.0 depending on risk | Switzerland [57]        |
| Temporary and permanent tiebacks in soil or rock | 1.25 to 1.5                  | United States [59]      |
| Temporary tiebacks in soil or rock               | 1.2                          | France [53]<br>FIP [58] |
| Permanent tiebacks in soil or rock               | 1.3                          | France [53]<br>FIP [58] |

INTERPRETATION OF TEST RESULTS

Typical total movement, residual anchor movement, and creep curves are shown in this chapter. They were presented in order to familiarize the reader with characteristic curves for common types of tiebacks, and to illustrate typical behavior patterns. The curves reflect the load transfer mechanism for the particular tieback, and they are helpful in evaluating a tieback's ability to carry load. The magnitude of the total, residual, and elastic movements by themselves are not significant in determining the adequacy of a tieback. They represent the tieback's response to an applied load. They can be used to compare the tieback's behavior to other tests at

the site or tests in similar soils, and to verify that the anchor is located beyond the critical failure surface. The movement of the tieback during the load hold is very significant, since it is used to evaluate the long-term load holding ability of the tieback.

Loss of tieback load with time may be caused by anchor creep, debonding of the tendon, tendon relaxation, and structural deformations. Some understanding of these mechanisms is necessary in order to evaluate the creep test results.

Anchor creep is defined as the slow movement of the anchor through the soil under constant load. As discussed in Chapter 9, this movement may result from consolidation and/or creep. Anchor relaxation is defined as a slow change in tieback load resulting from movement of the anchor through the soil. Anchor creep is observed during a constant-load test, and anchor relaxation is observed during monitoring after the load has been locked-off in the tieback. At present, there is not a complete understanding of the mechanism that causes an anchor to slowly move through the soil. Experience has shown that tiebacks installed in rock and cohesionless soils are not subject to significant anchor movements with time. However, tiebacks installed in some cohesive soils may experience anchor movements and loss of load with time.

The tendon grout bond may degrade with time during the testing of a tieback. The complex behavior of the grout body surrounding the tendon is difficult to predict because it is a function of:

- 1) Type of prestressing steel. (Bars develop bond by mechanical interlock along the deformations, wire develops bond by adhesion and strands develop bond by a combination of both mechanisms.)
- 2) Amount of grout surrounding the tendon.
- 3) Method used to drill and clean the drill hole.
- 4) Type and strength of the grout, i.e., cement grout, sand-cement grout, concrete, and polyester resins.
- 5) Grouting method, i.e., tremie, low pressure, and high pressure.
- 6) Radial restraint of the ground, i.e., radial shear or confinement.
- 7) Level of stress in the tendon.

When a portland cement grout, sand-cement grout, or concrete is stressed close to its ultimate strength, it normally will fail with time. Because of the complex stresses induced in the grout around a tieback and the gradation of stresses along the anchor length, it is possible to have progressive bond deterioration until a point of stability is reached. Considering the various factors listed above and the variation that exists from tieback to tieback, bond degradation with time may be observed during the testing of a tieback. Bond degradation or debonding may manifest itself by sudden jumps in movement during a constant load hold. Figure 107 shows a creep curve (60 ton curve) where bond degradation probably caused a sudden increase in creep movement, and the transfer of load farther down the anchor length. The slope of the creep curve is approximately equal before and after the jump. Cyclically incrementing the test load will cause the bond degradation to occur during loading, and bond degradation will normally not be observed during a test.

The creep or relaxation in the prestressing steel tendon will affect the tieback creep movements during testing and the loss of load after lock-off. Prestressing steels creep under constant load or relax (lose load) at a constant length. Most available information on time-dependent behavior of prestressing steel deals with relaxation. Creep information is limited, but the indications are that the percentage of creep and relaxation are approximately the same. The amount of steel creep observed during a test is a function of the stress level, duration of test, the unbonded length, and the tendon type. Table 20 gives typical relaxation percentages for various tendon types. The stress level used in developing the table was 70 percent of the ultimate strength, and the steel temperature was 68° F (20° C). Using the relaxation data in Table 20, load loss and creep movements can be estimated for bar and strand tiebacks. Table 21 summarizes these estimated values for a 20 foot (6.1 m) and a 30 foot (9.15 m) unbonded length. It is clear that the unbonded length, tendon type, and duration of load increment significantly influences the creep and relaxation behavior of the tendons. \* The allowable creep movements given for the performance, proof, and creep tests, assumes that the measured movements have been corrected for creep in the steel.

Table 20. Percentage load loss resulting from the time dependent stress relaxation of the prestressing steels (initial load = 70 % ultimate strength at a temperature of 68°F [20°C]).

| Tendon                | Percentage Load Loss |           |          |           |           |            |                         |
|-----------------------|----------------------|-----------|----------|-----------|-----------|------------|-------------------------|
|                       | 0.1 Hour             | 1.0 Hours | 10 hours | 100 hours | 500 hours | 1000 hours | 40 Years - Extrapolated |
| Pre-straightened Wire |                      |           |          |           |           |            |                         |
| Normal Relaxation     | 0.25                 | 0.80      | 1.90     | 2.90      | 4.00      | 4.50       | 10-12                   |
| Low Relaxation        | 0.09                 | 0.20      | 0.40     | 0.65      | 0.95      | 1.10       | 4                       |
| 7-Wire Strands        |                      |           |          |           |           |            |                         |
| Normal Relaxation     | 0.35                 | 1.15      | 2.10     | 3.40      | 4.70      | 5.50       | 10-14                   |
| Low Relaxation        | 0.07                 | 0.33      | 0.60     | 0.84      | 0.98      | 1.10       | 4                       |
| Bars                  | 0.20                 | 1.00      | 1.86     | 2.75      | 3.37      | 3.65       | 6                       |

Tieback structures move in response to the applied tieback load. Normally the load causes the structure to be pulled towards the anchor. As the structure moves, the unbonded length is shortened, and a corresponding load reduction occurs. The magnitude of the load reduction depends upon the unbonded length, tendon type, and the amount of movement. For example, a 0.25 inch (6.4 mm) movement in a 1 1/4 inch (32 mm) bar tendon with an ultimate capacity of 187.5 kips (834.4 kN) and a 20 foot (6.1 m) unbonded length would result in a 37.8 kip (168.2 kN) loss of load. A 0.25 inch (6.4 mm) movement in a 4 - 0.5 inch (12.7 m) strand tendon with an ultimate capacity of 165.2 kips (735.1 kN) and a 20 foot (6.1 m) unbonded length would result in 17.85 kip (79.4 kN) loss of load.

Table 21. Estimated tieback creep movement and load loss resulting from creep of the prestressing steel. (Initial load = 70% of ultimate strength, temperature = 68°F [20°C], unbonded length = 20 ft [6.1 m]).

| Time<br>(hours)    | Tendon Type                                     |                        |  |                        |
|--------------------|---|------------------------|--|------------------------|
|                    | 1½ inch (32 mm)<br>Bar (ult. cap. = 187.5 kips) |                        | 5 - 0.5 inch (12.7 mm)<br>Strands (ult. cap. = 206.5 kips) |                        |
|                    | Creep<br>Movement<br>(inches)                   | Load<br>Loss<br>(kips) | Creep<br>Movement<br>(inches)                              | Load<br>Loss<br>(kips) |
| 0.1                | 0.0017  | 0.26                   | 0.0057   | 0.51                   |
| 1.0                | 0.0087  | 1.31                   | 0.0186   | 1.66                   |
| 10.0               | 0.0161  | 2.44                   | 0.0340   | 3.03                   |
| 100.0              | 0.0239  | 3.60                   | 0.0550   | 4.91                   |
| 500.0              | 0.0292  | 4.41                   | 0.0761   | 6.79                   |
| 1000.0             | 0.0317  | 4.78                   | 0.0890   | 7.95                   |
| 350,400 (40 years) | 0.0520  | 7.86                   | 0.1943   | 17.34                  |

1 inch = 25.4 mm

1 kip = 4.45 kN

Figure 105 shows the three characteristic types of creep curves observed during a test. These curves are similar to the laboratory creep curves described in Chapter 9. Curves (a) and (b) indicated an acceptable behavior, as long as the creep movement estimated by projecting the design load creep rate over the life of the structure, is not excessive. A creep rate of 0.08 inches (2.0 mm) per decade would produce a creep movement of approximately 0.5 inches (12.7 mm) during 50 years. Curve (c) indicates that the tieback would continue to creep until it failed. In the region between curve (b) and (c), it is possible to have a creep curve which would curve gradually upward at the maximum load. This tieback could be accepted if the creep curve for the design load is similar to either curve (a) and (b), and the estimated creep movements would not cause damage to the structure.

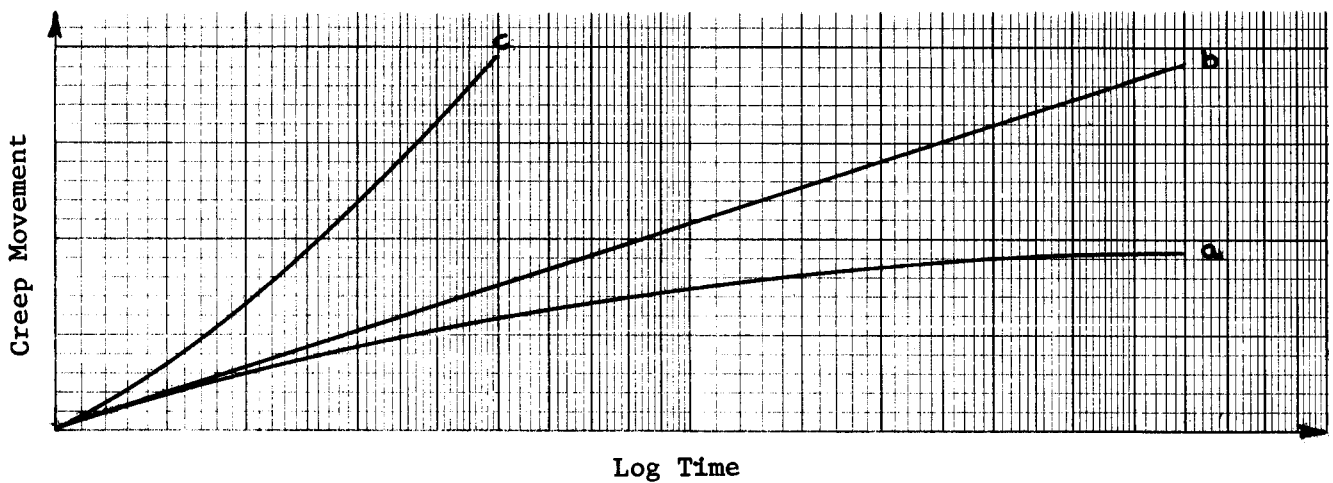

Figure 105. Characteristic creep curves.

#### A. Pressure Injected and Postgrouted Tiebacks

The various tieback standards and recommendations, [53], [55], [56], [57], [58], and [59], were developed for pressure injected and postgrouted straight-shafted tiebacks. Each one of these standards uses an allowable creep rate to determine the acceptability of the tieback. In addition, some standards require the measured elastic movements to be within a specified range. Figure 106 shows plots of the creep criteria used in these standards. The Swiss Standard [57] uses a different criteria for cohesionless and cohesive soils, while the other standards propose the same criteria for all tiebacks. The French Recommendations [53] allow for creep in the steel, and the creep criteria for the Swiss Standard [57] and the French Recommendations [53] is a function of the unbonded length and the tendon type. The German Standard [56] uses a single creep rate regardless of tendon type, length, or soil type.

The curves in Figure 106 also show that the allowable creep rates for the short-term French and German tests are significantly greater than the creep rates for their respective long-term tests. This difference probably results from the loading sequences used for the different tests. Only the maximum load in the short-term test is held, while each increment is held in the long-term test. The loading history imparted during the load holds at lower loads reduces the creep rate at the maximum load in the long-term test.

Figure 100 shows a typical performance test made on a pressure-injected tieback in a dense, fine to medium sand. The total movement curve is primarily elastic and very small residual anchor movements are measured. These small residual anchor movements indicate that little movement is required to mobilize the skin friction along the anchor. The amount of residual anchor movement reflects the stiffness of the tieback-soil system. If a pressure-injected tieback is installed in a medium dense sand, then the residual anchor movement would be greater than that shown in Figure 100.

The writer does not recommend performing creep tests on pressure-injected tiebacks in sandy or gravelly soils because:

- 1) Creep rupture is not observed in cohesionless soils at stress levels significantly below their ultimate strength.

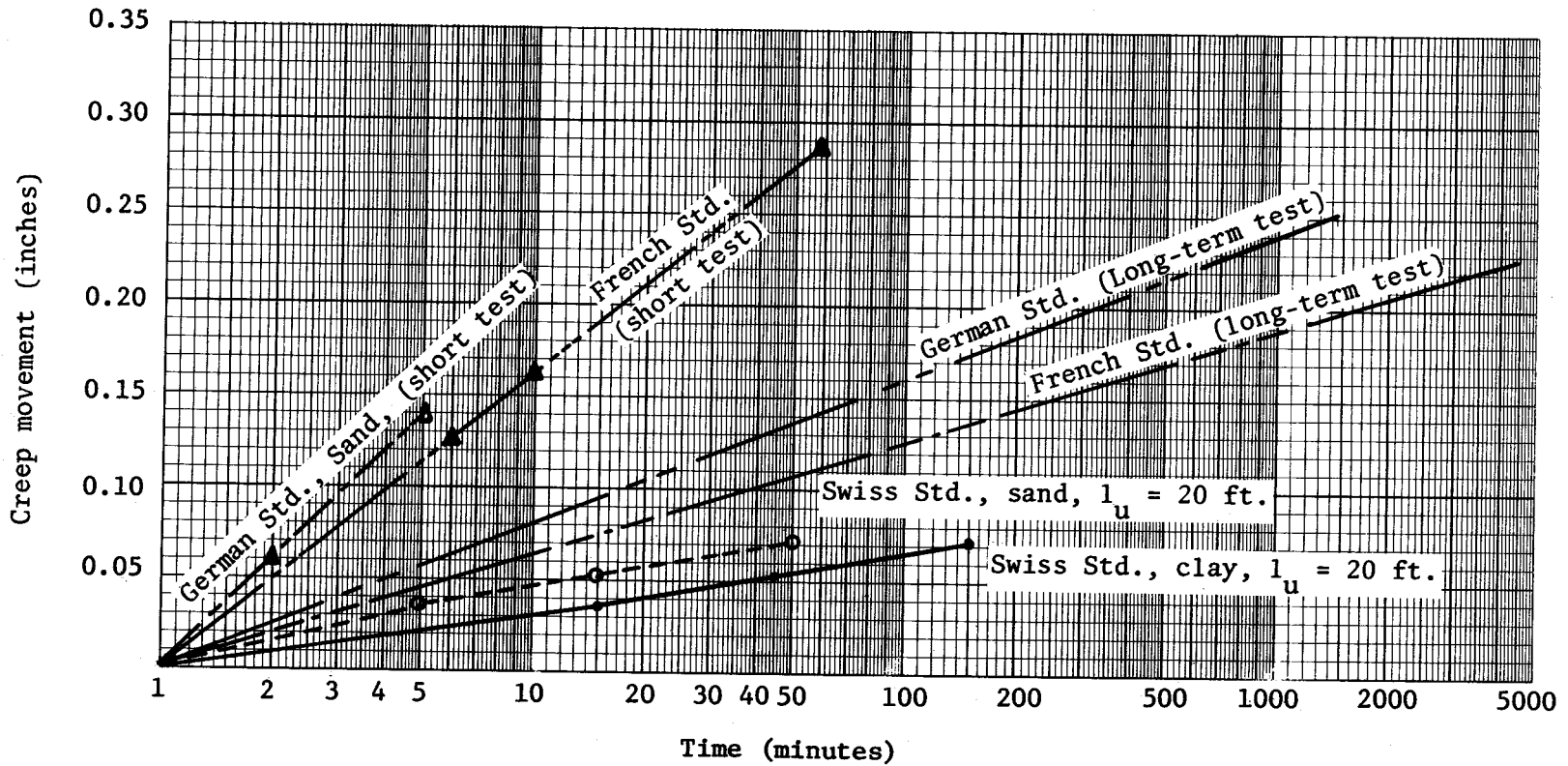

Note: 1 inch = 25.4 mm, 1 ft. = 0.305 m

Figure 106. Comparison of creep movements allowed by tieback standards.



- 2) Tieback load test failures are immediately apparent during testing if the tieback is installed in cohesionless soil. Ostermayer [11], Bernath, et al [119], and Gandais and Delmas [117] have all reported that pressure injected and postgrouted tiebacks in cohesionless soils have a creep rate of less than 0.04 inches (1 mm) per decade of time until the ultimate load is applied. These creep rates include the creep of the steel which is more significant than the creep movement of the anchor. The writer, too, has observed that the failure load for pressure-injected tiebacks in sandy and gravelly soils is a well-defined load, and the creep rate is less than 0.04 inches (1 mm) per decade at each load, increment before failure and it exceeds 0.04 inches (1 mm) per decade at the failure load.

Creep tests are recommended for postgrouted tiebacks in cohesive soils. Figures 103 and 104 show a performance test and creep test for a postgrouted tieback installed in a stiff clay with a trace of fine to medium sand. This creep test was not performed exactly in accordance with the recommendations made in this chapter. The clay had a natural moisture content of 30 percent, and a liquid limit and plasticity index of 60 and 32 respectively. The creep rate at the maximum increment was equal to about 0.075 inches (1.9 mm) per decade which is significantly greater than the creep rates observed during the testing of tiebacks installed in sand. A significantly higher creep rate in clay is to be expected since the stress-strain behavior of a clay is different from that of a sand, and the elastic modulus of a stiff to hard clay is about one tenth that of a dense sand [120].

The creep curve for the maximum load in Figure 104 changes slope at about 30 minutes. It is likely that the steeper slope is more representative of the creep rate for the applied load since the creep during the first 25 minutes may have been affected by the previous loading increments.

Figure 107 shows creep curves for a postgrouted tieback installed in a stiff to very stiff silty clay with an unconfined compression strength of between 2,000 and 3,000 psf (96 and 144 kPa), a natural water content between 18 and 21 percent, a plastic limit between 17 and 21, and a plasticity index between 25 and 32. The tieback whose creep curves are shown in Figure 104 had a creep rate about 3 times as large as the tieback shown in Figure 107. This is not unusual in cohesive soils, and it is possible that creep rates greater than 0.08 inches (2 mm) per decade may be acceptable for tiebacks in cohesive soils. At failure, the creep curve for a postgrouted tieback will be similar to the 45 ton (400.5 kN) creep curve shown in Figure 108. This tieback was installed in a soft to medium clayey silt with a cohesion of 750 psf (36 kPa), an angle of internal friction of 15 degrees, a natural water content between 17 and 23 percent, a plastic limit of 13.8, and a plasticity index of 12.2. The creep curve for the 40 ton (356 kN) load was linear which indicates that failure occurred at a well-defined load.

## B. Single-Underreamed Tiebacks

Single-underreamed tiebacks develop their load carrying capacity by skin friction along the shaft and bearing on the bell. Figure 109 shows a performance test which clearly shows this load transfer mechanism. The tieback was installed in a stiff micaceous clayey silt which was derived

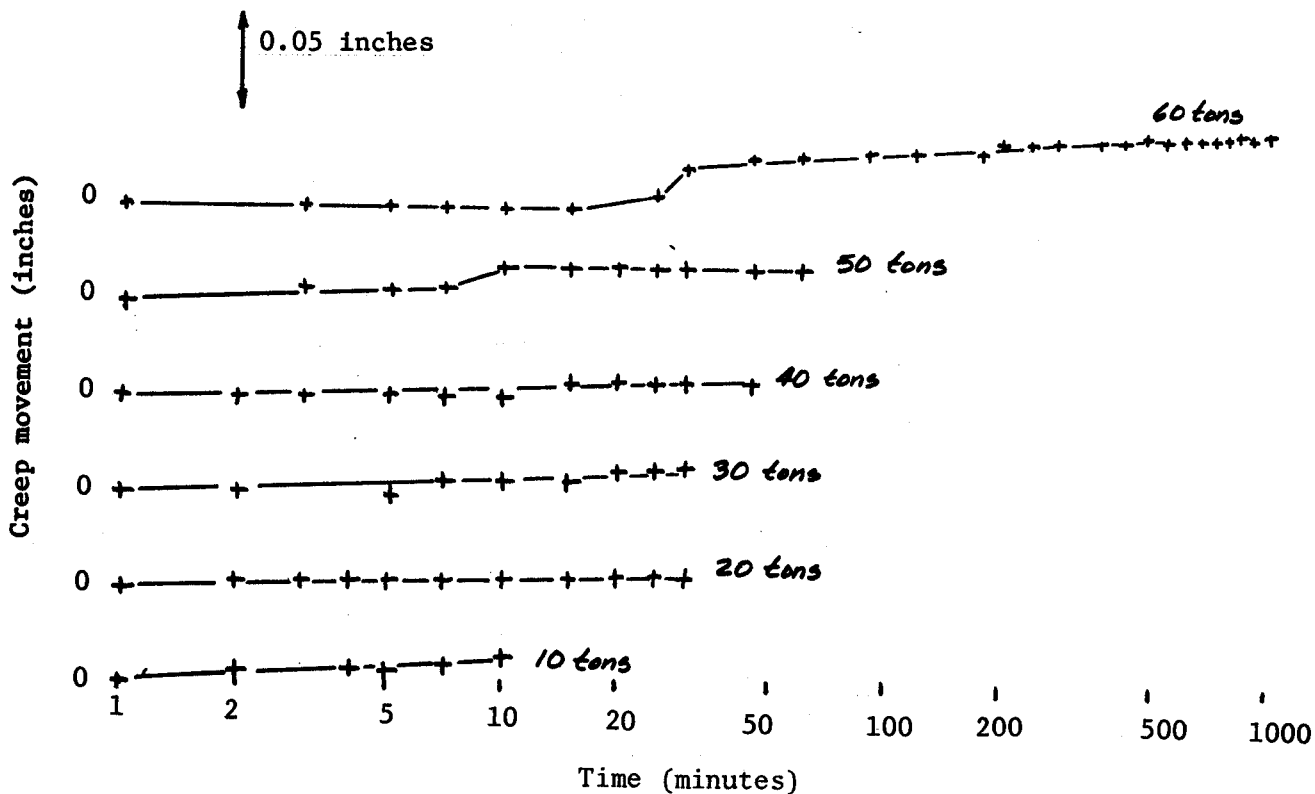

Note: 1 inch = 25.4 mm, 1 ton = 8.9 kN

Figure 107. Creep test performed on a postgrouted tieback installed in a stiff to very stiff silty clay.

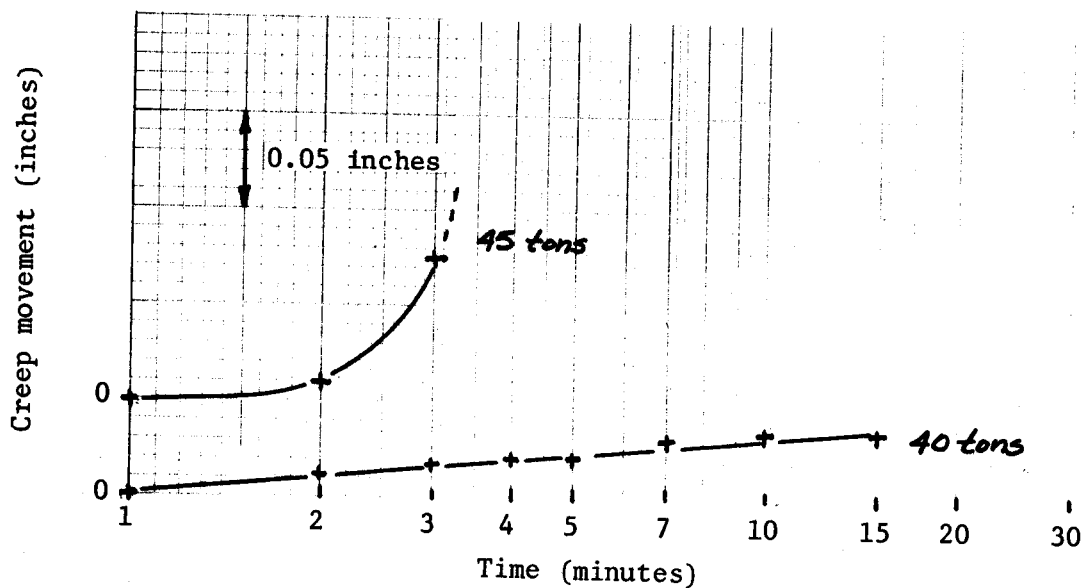

Note: 1 inch = 25.4 mm, 1 ton = 8.9 kN

Figure 108. Creep tests performed on a postgrouted tieback installed in a soft to medium clayey silt.

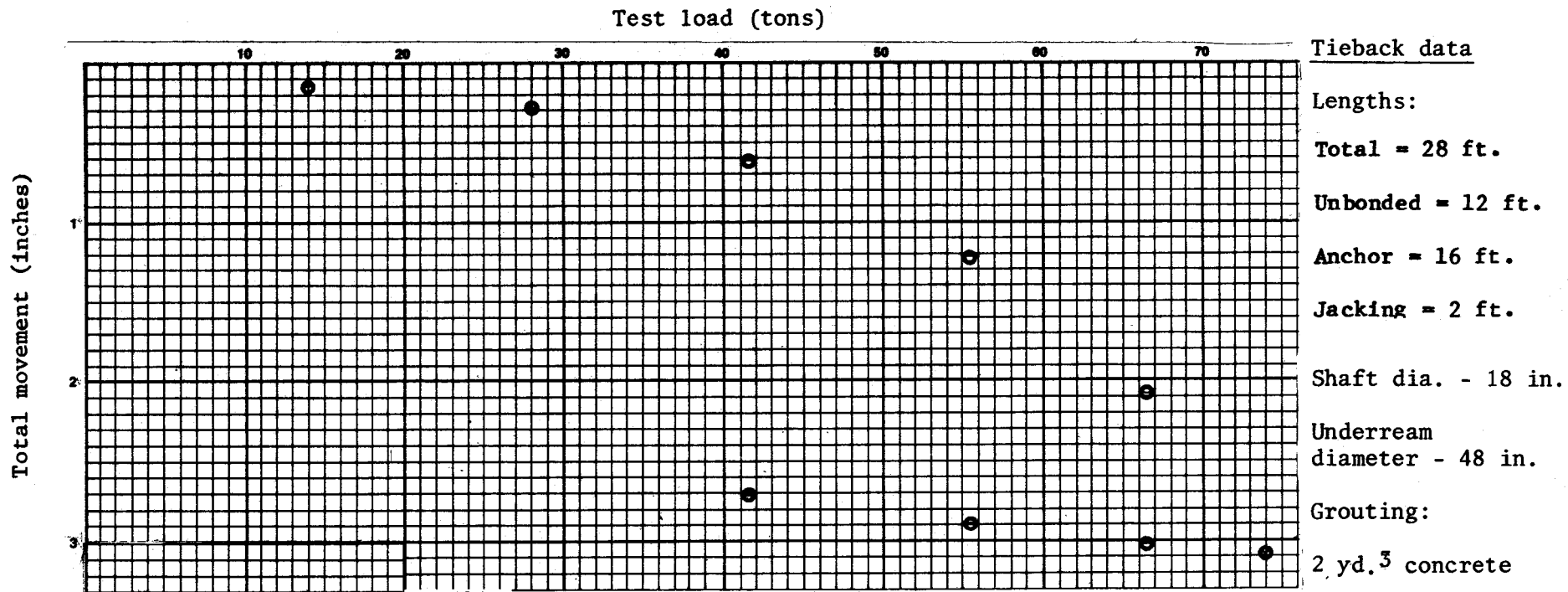

a) Total movement curve.

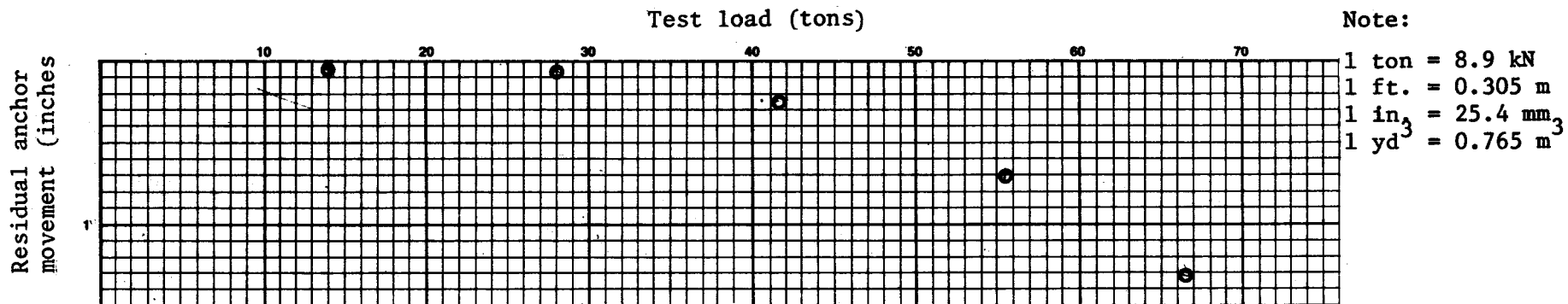

b) Residual anchor movement curve.

Figure 109. Performance test made on a single-underreamed tieback installed in stiff micaceous clayey silt.

from the weathering of a mica schist. The total movement curve and the residual anchor movement curve show that the shaft above the underream carried most of the load up to 30 tons (267 kN). When the load was increased to 41.5 tons (369.4 kN), then the underream began to carry load, and large anchor movements were required to develop the bearing capacity of the underream. The large residual anchor movements observed could, in part, have been a result of the method used to place the anchor concrete. This tieback was made by pouring concrete down the shaft and into the underream. This method does not assure bearing of the bell, and some anchor movement would be expected just to develop intimate contact between the soil and the concrete.

Figure 110 shows the result of a creep test performed on a single-underreamed tieback in a hard to very hard clay with a standard penetration resistance between 60 and 75 blows per foot. The creep curves for the first five load increments are approximately straight lines with a low creep rate. These curves are similar to curves for a straight-shafted tieback and the residual anchor movement for the first five increments indicates that load was carried primarily by the shaft. The creep curve for the 72 ton (640.8 kN) increment is significantly different from the other curves. The 72 ton (640.8 kN) curve is similar to a consolidation curve. Model tests discussed in Chapter 9 also showed a consolidation type creep curve.

### C. Large Diameter Straight-Shafted Tiebacks

Augered tiebacks are commonly used in cohesive soils. Figure 111 shows a performance test for a hollow-stem-augered tieback installed in an interbedded stiff silty clay, and silty sand. The maximum load (88 tons [783.2 kN]) during this performance test was held for sixty minutes, and Figure 112 shows the creep curve. The elastic movement of this tieback almost equaled the calculated elastic elongation of the entire tendon. This means that the end of the tiebacks probably moved through the soil. This fact does not indicate failure as the creep curve clearly shows.

Figure 113 shows a proof test and a creep test for another hollow-stem-augered tieback installed at the same site. This tieback failed during the load hold and a high creep rate was apparent during the first 10 minutes of the test.

### LONG-TERM MONITORING

The long-term performance of a tieback can be evaluated by monitoring changes in the tieback load, and deformations of the tieback structure. Monitoring includes:

- 1) The measurement of tieback load by lifting-off the anchor head or nut, or by load cells.
- 2) The observation of structural deformation by visual checks, optical surveys, extensometers, or slope indicators.

Lift-off tests can be used to verify that the load locked-off in the tieback has not changed substantially. Normally, the load will be reduced slightly as a result of tendon relaxation, anchor relaxation, and movement

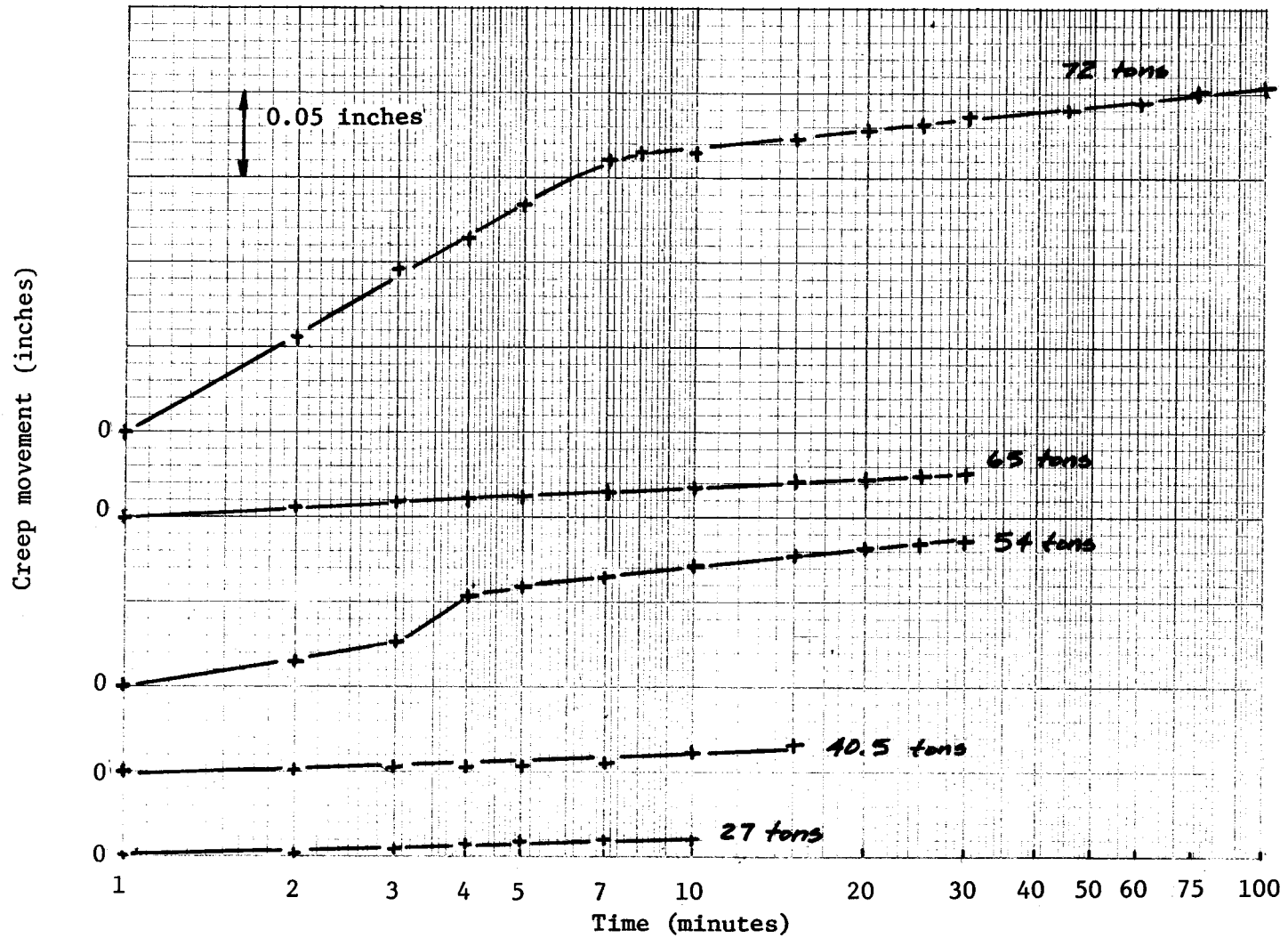

Note: 1 in. = 25.4 mm, 1 ton = 8.9 kN

Figure 110. Creep test performed on a single-underreamed tieback installed in a hard to very hard clay.

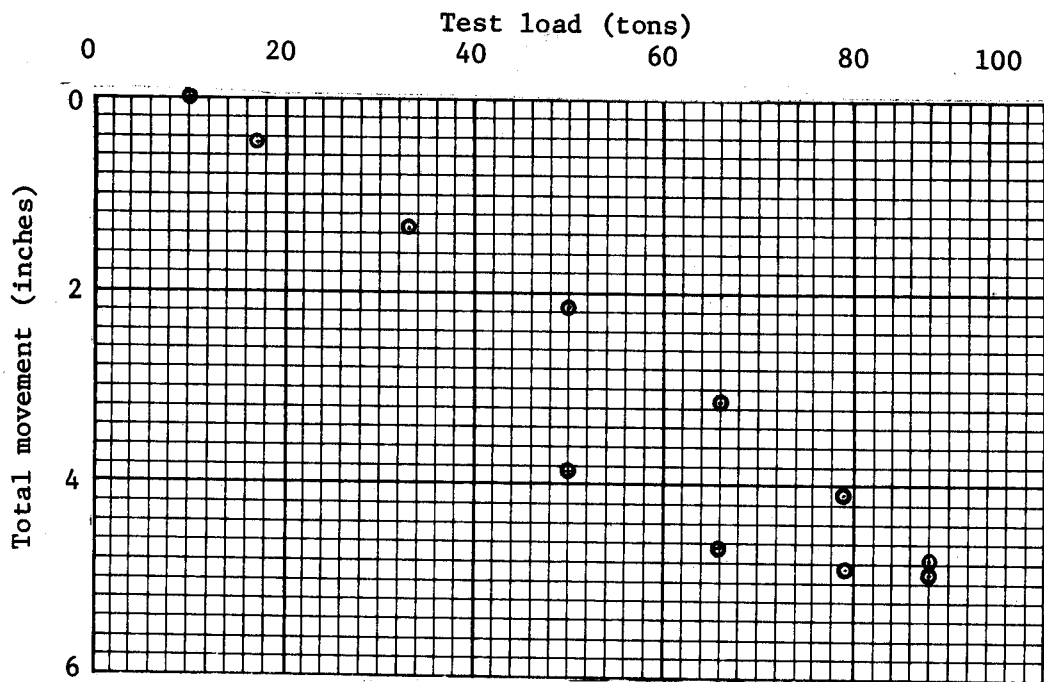

a) Total movement curve

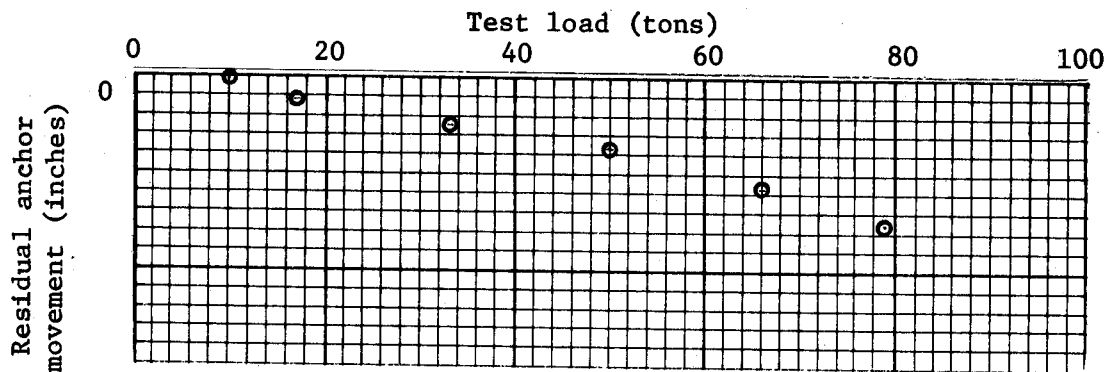

b) Residual anchor movement curve

Tieback data

|                           |                            |                   |
|---------------------------|----------------------------|-------------------|
| Lengths:                  | Shaft diameter = 12 inches | Grouting:         |
| Total = 55 ft. (16.8 m)   |                            | 2 yd <sup>3</sup> |
| Unbonded = 18 ft. (5.5 m) | Tendon:                    |                   |
| Anchor = 37 ft. (11.3 m)  | 6 - 0.5 inches strands     |                   |
| Jacking = 5 ft. (1.5 m)   |                            |                   |

|       |                 |                                  |
|-------|-----------------|----------------------------------|
| Note: | 1 ton = 8.9 kN  | 1 inch = 25.4 mm                 |
|       | 1 psi = 6.9 kPa | 1 cu. yd. = 0.765 m <sup>3</sup> |

Figure 111. Performance test made on a hollow-stem-augered tieback installed in an interbedded stiff silty clay, and silty sand.

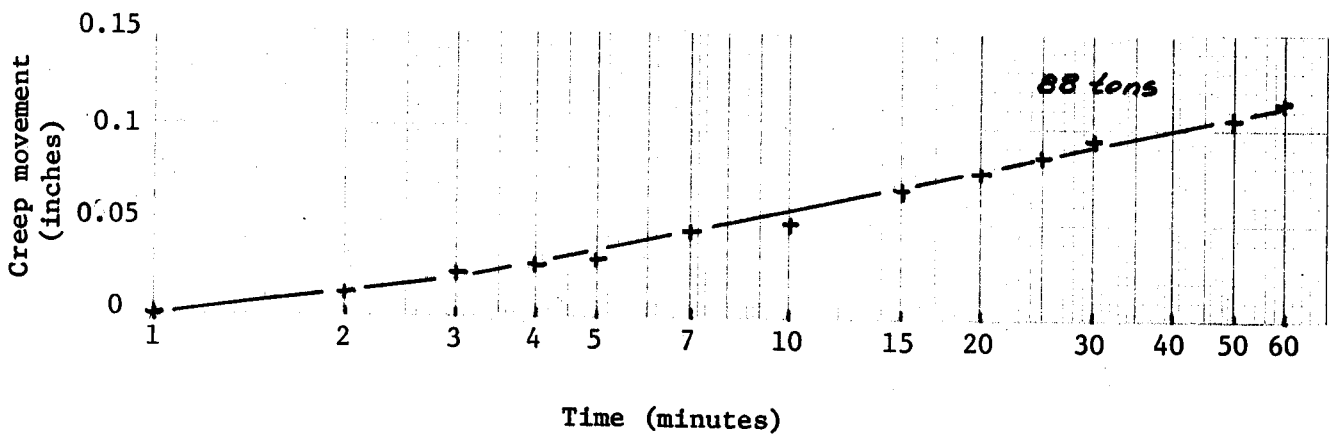

Note: 1 in. = 25.4 mm, 1 ton = 8.9 kN

Figure 112. Creep curve for an 88 ton (783 kN) load applied to a hollow-stem-augered tieback installed in an interbedded stiff silty clay, and silty sand.

of the structure. In order to perform the test, the load locked-off in the tieback should be checked immediately after lock-off. This is done by recording the load required to lift the anchor head or nut from the bearing plate. One to three days later a lift-off test can be performed by reinstalling the hydraulic jack and recording the load required to lift-off the anchorage. The hydraulic jack should not be used to continuously monitor the load. Oil seepage and temperature will affect the oil pressure in the jack and make it impossible to accurately monitor the load. The movement of the structure must be known in order to interpret the results of lift-off tests. If the structural movements are small, a ten percent reduction in load is not unreasonable during the initial 3 days. If the anchorage remains accessible, lift-off tests can be performed any time during the life of the structure.

Load cells can be permanently installed to measure the load in a tieback. In the United States, electrical resistance load cells are generally used. There are a variety of load cells manufactured for the purpose of monitoring rock bolts and tiebacks. These instruments may not be stable over a period of years but this is not critical since the most meaningful monitoring is done during the first year after installation. Load cells can be encased in concrete and they can be remotely read using a simple light-weight strain indicator.

The structural movements in response to the tieback load must be accurately measured if load measurement data is to be analyzed. Extensometers anchored behind the anchor zone, inclinometer, and optical surveys can be used to monitor the movement of the structure.

Permanent tiebacks installed in cohesive soils should be monitored. The extent of the monitoring program will depend on the variability of the

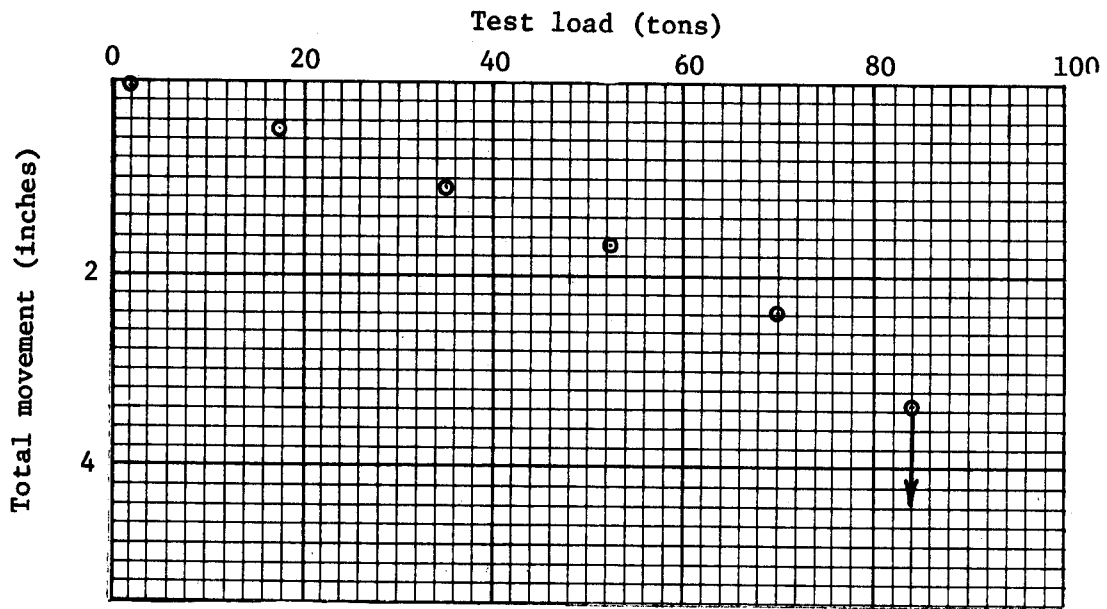

a) Total movement curve

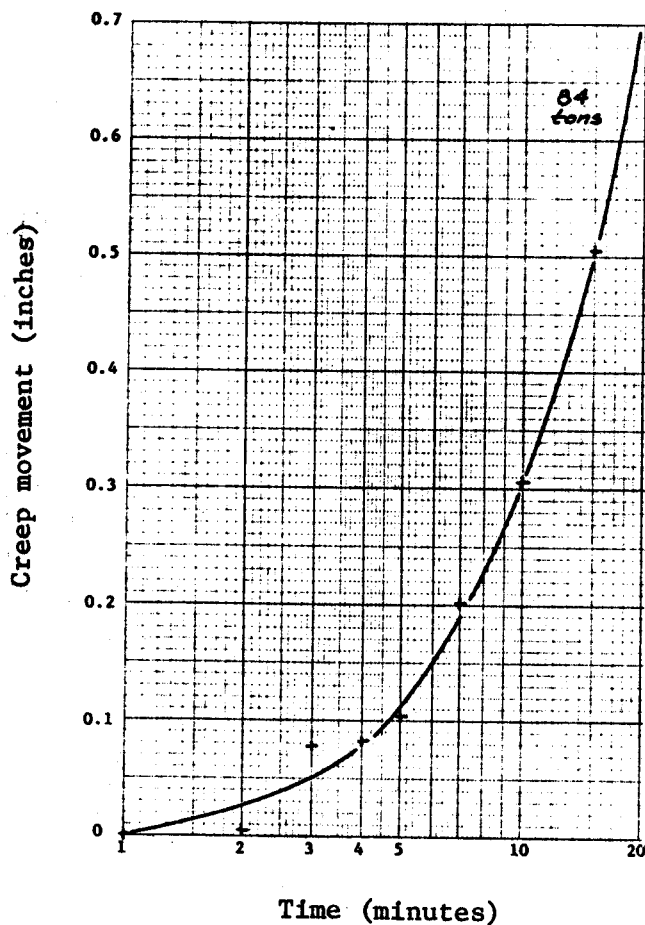

b) Creep curve for 84 ton load.

Tieback data:

Lengths:

Total = 55 ft. (16.8 m)

Unbonded = 18 ft. (5.5 m)

Anchor = 37 ft. (11.3 m)

Jacking = 5 ft. (1.5 m)

Shaft diameter = 12 inches.

Tendon: 6-0.5 in. strands

Grouting: 2.3 yd<sup>3</sup>

Note:

1 ton = 8.9 kN

1 in. = 25.4 mm

1 ft. = 0.305 m

1 yd<sup>3</sup> = 0.765 m<sup>3</sup>

Figure 113. Proof test and creep curve for a hollow-stem-augered tieback installed in an interbedded stiff silty clay and silty sand.



ground, risk, and the reliability of the monitoring instruments. Readings should be regularly taken during construction so unusual behavior can be identified and corrected before the contractor has left the site. Upon completion of the installation, monitoring should continue, but at a decreasing rate. A typical monitoring schedule might include a check at 3, 6, and 12 months. If no unusual performance can be detected, the engineer may decide to discontinue the monitoring program after one year.

Tiebacks used for landslide stabilization and underground cavern support have, on occasion, experienced large increases in load. Landslide stabilization tiebacks should be monitored if the failure surface is not well-defined, or if small changes in soil or rock strengths cause large changes in the total tieback force required. All cavern tiebacks should be monitored. The monitoring program is provided to determine if the tendon is becoming overstressed, and whether or not additional tiebacks may be necessary. Monitoring of these structures may extend for several years.

In Germany, tieback monitoring has been required on every permanent tieback project. These monitoring programs have shown that it is not unusual for the tieback load to decrease by 10 to 20 percent during the first six months after installation and then stabilize. When monitoring shows that the load has decreased without significant structural deformations, it is assumed that this drop results from the tieback-structure system attempting to reach an equilibrium condition, and tendon relaxation. When monitoring indicates that the structure is deforming and the tieback load is decreasing, it is an indication that the anchor is "creeping" out of the ground.

Table 22 contains a summary of the monitoring requirements or recommendations of the various anchor standards. The recommendations can be used as a guide in developing the monitoring program for a particular project.

Cording, et al [121], and Dunnicliff and Sellers [122], have prepared detailed manuals which describe the instrumentation required to monitor tiebacks. These can be used as a guide in developing the program and in selecting the equipment.

Table 22. Recommended tieback monitoring.

| TIEBACK STANDARD  |  |   |   |  |   |
|---|--|---|---|--|---|
| Swiss Std.<br>[57]  | PTI Recommendations<br>[59]  | German Std.<br>[56]   | French Recommendations<br>[53]  | FIP Recommendations<br>[58]  | Draft British Code<br>[54]  |
| <p>Monitoring of deformations is recommended for tiebacks whose failures would have few serious consequences, but would not endanger public safety or order.</p> <p>Monitoring of deformations is required for tiebacks whose failure would have quite serious consequences, but would not endanger public safety or order.</p> <p>Monitoring of the load on 5% of the tiebacks is required when a failure would have quite serious consequences, but would not endanger public safety or order.</p> <p>Monitoring of the load on 10% of the tiebacks is required when a failure would have serious consequences and would probably endanger public safety and order.</p> | <p>In order to monitor tieback load, the tendon must remain unbonded.</p> <p>Load cells and extensometers are recommended for monitoring.</p> <p>The engineer must establish the monitoring program.</p> | <p>The monitoring requirements are determined by whether the performance of the tieback structure can be observed, by the construction techniques, and by the nature of the soil.</p> <p>Monitoring is required if a tieback failure would endanger public safety and order.</p> <p>Monitoring is required if the tieback is installed in a cohesive soil.</p> <p>License will specify monitoring requirements for each tieback system.</p> | <p>Permanent tiebacks should be monitored.</p> <p>Structures must be monitored quarterly for one (1) year after construction and monitored annually for the next nine (9) years.</p> <p>The load must be monitored on the following number of tiebacks<br/>                     --10% of the first 50<br/>                     -- 7% of 51-100 anchors<br/>                     -- 5% of 101 and up.</p> <p>The monitoring device can be an all or nothing device.</p> <p>A 20% variation in load should be investigated.</p> | <p>Lift-off reading or load cells may be required.</p> <p>The displacements of the structure are required to be checked.</p> | <p>Lift-off reading or load cells are required for all installations with a service life over two (2) years.</p> <p>Movements should be monitored and the design should state the maximum permissible movement.</p> |

## CHAPTER 11 - CONCLUDING REMARKS

Experience has shown that permanent tiebacks can be effectively protected from corrosion, and that they can maintain their load carrying capacity in most soils and rock without excessive movement.

Permanent tiebacks are being used on privately funded construction projects where the owner, designer, and the contractor can work together to produce a well designed installation. In order for permanent tiebacks to be widely used on publicly funded projects, most designers will have to increase their knowledge of tieback work, and government agencies will have to modify their contracting practices.

This report was prepared to provide interested designers with up-to-date information concerning tieback applications, design, corrosion protection methods, specification, construction, and testing. With this knowledge, a designer should be able to prepare a performance specification which will allow qualified contractors to competitively obtain work using their expertise and proprietary systems, and enable the designer to review the contractor's system and verify its performance.

Experience has shown that increased knowledge in itself will not encourage widespread use of innovative construction methods on publicly funded projects. The owner must also modify established contracting practices if permanent tiebacks are to gain wide acceptance on government work. Reinforced Earth is a good example of one instance where contracting practices were changed in order to enable an economical, innovative technique to be widely used. The following changes in contracting practices should be considered in order to effectively incorporate permanent tiebacks and other innovative techniques on publicly funded construction.

First, the owner must be prepared to pay the additional costs necessary to obtain a competently prepared tieback design and specification. The designer may require more time to design a tiedback structure than a conventional structure. The extra design costs should be offset by reduced construction costs.

Second, the designer must be involved during the construction of the project. The designer on government work often is reluctant to incorporate innovative techniques in his design as long as he is not involved in the selection of the contractor and the construction of the project. It is not reasonable to expect him to prepare a performance specification for a new construction method if he does not know the technical competence of the reviewing agency or the inspectors. Normally the contractor is selected on the basis of price, and often the inspection of the work is performed by the owner or an engineering firm other than the designer. This contracting practice forces the designer to specify every detail of the tieback system and every step of the installation. The owner then assumes that if he requires the contractor to perform in accordance with the specifications, a satisfactory installation will result. The opposite is often the case, because contractors with little or no experience bid and obtain work specified in this manner. Now, the owner or his engineer, must accept responsibility for the performance of the design if the contractor complies

with the specifications. When the contractor cannot install the tiebacks in accordance with the specification, or the tiebacks fail to carry the test load, claims and delays normally result.

Third, the owner must develop effective methods of prequalifying contractors for difficult, innovative work in order to obtain a satisfactory installation. Prequalifying contractors based solely on years of experience or the number of jobs he has done has not achieved the desired result. The most effective prequalification procedure currently used is to list the contractors who will be allowed to bid the work. In Chapter 7 an alternate prequalification procedure was suggested. This procedure requires prequalified contractors to submit for review by the designer a description of their tieback system prior to bid. The designer then would review the submission and inform the contractors if their system meets the requirements of the specification or indicate what changes would be required in order for the systems to be acceptable. This type of procedure prequalifies the contractor and his system, and it allows the contractor to use his proprietary techniques.

Fourth, the designer must also be involved in the construction of the project in order to verify that his design is satisfied, and he should be available to respond to changes that may occur during construction. When any new technique is developed, the development will be evolutionary. It is impossible to detail the finished product, and expect no changes during construction. The contracting methods must allow incremental development and additional fees for engineering, or the owner must accept the fact that these innovative methods will not be widely used.

Fifth, the owner must be willing to accept a portion of the risk associated with using a new technique such as permanent tiebacks. This is only reasonable since the owner will benefit from any savings realized. In order to minimize the risk, the owner should encourage designers to use permanent tiebacks on simple, straight-forward projects where experience can be developed. Without the owners encouragement, most designers will only use permanent tiebacks when conventional structures are very costly or practically impossible to build. Tiedback or tied-down structures are an alternative to conventional structures, and the most significant cost savings are going to result from the best solution to routine problems, not a unique solution to isolated difficult problems.

Sixth, the contract also has to make the contractor legally responsible for those portions of the design which he performs. The owner cannot expect the designer to be responsible for the contractors work. Experienced tieback contractors are willing to take this responsibility.

In summary, when the work is properly specified, the designer becomes responsible for the structural design and the contractor becomes responsible for the tieback materials, construction methods, and capacity. Performance specifications enable experienced contractors, who are able to perform and willing to be responsible for the work, to install the tiebacks.

## CHAPTER 12 - REFERENCES

1. Khaova, M., Montel, B., Civard, A. and Lauga, R., "Cheurfas Dam Anchorage: 30 Years of Controls and Recent Reinforcement," Proc. 7th International Conference, ISSMFE, Mexico, Paper 15-12, pp. 167-171, 1969.
2. Evans, R. H., "Application of Prestressed Concrete to Water Supply and Drainage," Public Health Engineering Division Meeting 3rd May 1955, Public Health Paper No. 12, London, 1955.
3. Morris, S. S., "Steenbras Dam Strengthened by Post Tensioning Cables," Civil Engineering, Vol. 2, 1956.
4. Middleton, H., "Raising the Argal Dam," The Consulting Engineer, Vol. II, 1961.
5. Littlejohn, G. S., "Design Estimation of the Ultimate Load Holding Capacity of Ground Anchors," Symposium - Prestressed Ground Anchors, September 1979.
6. Bauer, K., "Injektionszuanler in nicht bindigen Boden," Bau und Bauindustrie, 16, pp. 520-522, 1960.
7. Dupeuble, P. and Brulois, J., "Measurements and Observations on the Behavior of Anchorages in Soils," 7th International Conference of the ISSMFE, Mexico, Paper No. 15-8, pp. 147-155, 1969.
8. Hunt, R. E. and Costa Nunes, A. J. da, "Retaining Walls: Taking It From the Top," Civil Engineering, pp. 73-75, May 1978.
9. Jones, N. C. and Kerkhoff, G. O., "Belled Caissons Anchor Walls as Michigan Remodels an Expressway," Engineering News Record, pp. 28-31, May 11, 1961.
10. Descoedres, J., "Permanent Anchors in Rock and Soils," 7th International Conference, ISSMFE, Mexico, Paper No. 15-17, pp. 195-197, 1969.
11. Ostermayer, H., "Construction, Carrying Behaviour and Creep Characteristics of Ground Anchors," Proceeding of Diaphragm Walls and Anchorages Conference, Institute of Civil Engineers, London, pp. 141-151, 1975.
12. Littlejohn, G. S., "Ground Anchors State-of-the-Art," Civil Engineering Surveyor, June, July, and August 1980.
13. Ivering, J. W., "Developments in the Concepts of Compression Tube Anchors," Ground Engineering, Vol. 14, No. 2, pp. 31-34, March 1981.
14. Wycliff-Jones, P. T., "Ground Anchors Used for Ship Salvage Operation," Ground Engineer, Vol. 9, May 1975.

15. Nolan, A. A., "Innovative Design at Port Everglades Bulkhead Reduces Material and Construction Costs," Civil Engineering, ASCE, pp. 81-84, May 1976.
16. Romanoff, M., Underground Corrosion, National Bureau of Standards Circular 579, p. 227, April 1957.
17. Hadley, R. F., "Microbiological Anaerobic Corrosion of Steel Pipe Lines," Oil Gas Journal 38, (No. 19), p. 92, 1939.
18. Uhlig, H. H., Corrosion and Corrosion Control, John Wiley and Sons Inc., New York, New York, p. 134, 1971.
19. Phelps, E. H., "A Review of the Stress-Corrosion Behavior of Steels with High-Yield Strength," presented at the Conference on Fundamental Aspects of Stress-Corrosion Cracking, Ohio State University, Columbus, OH, September 11-15, 1967.
20. Romanoff, M., "Corrosion of Steel Pilings in Soils," Contained in National Bureau of Standards Monogram 127, NBS Papers on Underground Corrosion of Steel Pilings (1962-1971), p. 63, March 1972.
22. King, R. A., "Corrosion in Reinforced Earth," Reinforced Earth and Other Composite Techniques, TRRL, Supplementary Report 457, Transport and Road Research Laboratory, Crowthorne, Berkshire, England, pp. 276-285, 1979.
23. Chang, J. C., "Earthwork Reinforcement Techniques," California Division of Highways Transportation Laboratory Research Report CA-DOT-TL-2115-9-74-37, p. 12 and p. 61, November 1974.
24. Crum, R. W., "Report on Culvert Durability and Performance," Highway Research Board Proceedings, Vol. 11, Part II, pp. 338-363, 1931.
25. Haviland, J. E., Bellair, P. J., and Morrell, V. D., "Durability of Corrugated Metal Culverts," Highway Research Record Number 242, Highway Research Board, pp. 41-64, 1968.
26. Downs, W. S., "A Survey of Culverts in West Virginia," Research Bulletin No. 13, West Virginia University Engineering Experiment Station, December 15, 1934.
27. Phillips, E., "Survey of Corrosion of Prestressing Steel in Concrete Water-Retaining Structures," Australian Water Resources Council Technical Paper No. 9, 1975.
28. American Concrete Institute, Committee 201, "Guide to Durable Concrete," ACI Journal, American Concrete Institute, Detroit, Michigan, pp. 573-609, December 1977.
29. Schupack, M., "A Survey of the Durability Performance of Post-Tensioning Tendons," Post-Tensioning Institute, pp. 10, 1978.

30. Weibenga, J. G., "Durability of Concrete Structures Along the North Sea Coast of the Netherlands," Performance of Concrete in Marine Environments, SP-55, American Concrete Institute, pp. 437-452, 1980.
31. Houston, J. T., Atimay, E., and Ferguson, P. M., "Corrosion of Reinforcing Steel Embedded in Structural Concrete." Rep. No. CFHR-3-5-68-112-1F, Center for Hwy. Res., U. of Texas (1972).
32. Ryell, J., and Richardson, B. S., "Cracks in Concrete Bridge Decks and Their Contribution to Corrosion of Reinforcing Steel and Prestressing Cables." IR 51, Ontario Ministry of Transp. and Com. (1972).
33. Griess, J. C. and Naus, D. J., "Corrosion of Steel Tendons Used in Prestressed Concrete Pressure Vessels," Corrosion of Reinforcing Steel in Concrete, ASTM STP 713, American Society for Testing and Materials, pp. 32-50, 1980.
34. Naus, D. J., "An Evaluation of the Effectiveness of Selected Corrosion Inhibitors for Protection of Prestressing Steels in PCPV's," Oak Ridge National Laboratory, Oak Ridge, Tennessee, p. 61, March 1979.
35. O'Neil, E. F., "Study of Reinforced Concrete Beams Exposed to Marine Environments," Performance of Concrete in Marine Environments, SP-65, American Concrete Institute, pp. 113-132, 1980.
36. Schiessel, P., "Admissable Crack Width in Reinforced Concrete Structures," Contribution II 3-17, Inter-Association Colloquium on the Behaviour of In-service Concrete Structures, Liege 1975.
37. Roberts, M. H., "Carbonation of Concrete Made with Dense Natural Aggregates," Building Research Establishment Information Paper IP 6/81, Building Research Establishment Garston, Watford, England, April 1981.
38. Carter, C. S., Hyatt, M. V. and Cotton, J. E., Stress-Corrosion Susceptibility of Highway Bridge, Construction Steels, Federal Highway Administration Report FHWA-RD-73-46, p. 300, 1972.
39. Gilchrist, J. D., "Stress Corrosion in British Prestressing Wire," Research No. PCR 1, Prestressed Concrete Development Group, Grosvenor Gardens, London SW1, June 1965.
40. Nurnberger, U., "Analyse und Auswertung von Schadensfallen an Spannstählen." (Analysis and Evaluation of Failures in Prestressed Steel) Report No. 308, German Department of Transportation, pp. 248-195, 1980.
41. Szilard, R., "Corrosion and Corrosion Protection of Tendons in Prestressed Concrete Bridges," Title No. 66-5; Journal of the American Concrete Institute, No. 1 Proceedings V. 66, pp. 42-59, January 1969.
42. ENR, "Hydrogen attacks prestressing," ENR, pp. 26-27, May 14, 1981.

43. Klodt, D. T., "Studies of Electrochemical Corrosion and Brittle Fracture, Susceptibility of Prestressing Steel in Relation to Prestressed Concrete Bridges," Proceedings of the 25th meeting of the National Association of Corrosion Engineers, pp. 78-87, 1969.
44. ACI-ASCE Joint Committee #323, "Tentative Recommendations for Prestressed Concrete," Journal of the American Concrete Institute, V. 29, No. 7, p. 571, January 1958.
45. Freyermuth, C., "PTI Newsletter," Post-Tensioning Institute, Phoenix, Arizona, July 10, 1981.
46. American Concrete Institute, Building Code Requirements for Reinforced Concrete, (ACI 318-77), American Concrete Institute, p. 11, 1977.
47. Caton, R. G., Guthrie, J. L. and Carter, C. S., Stress Corrosion Susceptibility of Highway Bridge Construction Steels - Phase IIB, Federal Highway Administration Report FHWA-RD-77-9, 1976, p. 68.
48. Portier, J. L., "Protection of Tie-Backs Against Corrosion," Prestressed Concrete Foundations and Ground Anchors Federation Internationale de la Precontrainte, Wexham Springs, Slough SL3 6PL England, pp. 39-53, 1974.
49. Herbst, T. F., "Safety and Reliability in Manufacture of Rock Anchors," Presented at International Symposium on Rock Mechanics Related to Dam Foundations, Rio de Janeiro, 1978.
50. Nicholson, P. J., "Permanent Rock Anchor System Secures Failing Retaining Wall," Preprint 3259, ASCE Spring Convention and Exhibit, Pittsburgh, PA, April 24-28, 1978.
51. Nicholson, P. J., Personal Communications, March 10, 1981.
52. Great Britain's National Physical Laboratory, "Draft Report on Prestressing Steel Corrosion, London, 1981.
53. Bureau Securitas, Recommandations Concernant La Conception, Le Calcul, L'Execution et Le Controle des Tirants D'Anchrage, (Recommendations Concerning the Conception, the Calculation, the Execution and the Control of Ground Anchors) T.A. 77, Editions Eyrolles, 61, Boulevard Saint-Germain 75005 Paris, 1977.
54. British Standards Institute, October 1980 Draft British Code of Practice for Ground Anchorages, DSB 22 Committee, Oct. 1980.
55. Deutsche Industrie Norm "Verpressanker fur vorubergehende Zwecke im Lockergestein" (Soil and rock anchors; temporary soil anchors, analysis, structural design and testing) DIN 4125, Part 1, pp. 1-9, June 1972.



56. Deutsche Industrie Norm, "Verpressanker fur dauernde Verankerungen (Daueranker) im Lockergestein," (Soil and rock anchors; permanent soil anchors; analysis structural design and testing) DIN 4125, Part 2, pp. 1-9, February 1976.
57. Swiss Society of Engineers and Architects, Ground Anchors, SN 531 191, p. 46, 1977.
58. Federation Internationale de la Precontrainte, "Ground Anchors" Proceedings of the 7th Congress of the FIP, New York, pp. 33-42, May 26-June 1, 1974.
59. Post Tensioning Institute, Recommendations for Prestressed Rock and Soil Anchors, PTI, 301 W. Osborn, Suite 3500, Phoenix, AZ 85013, p. 57, 1980.
60. Stratfull, R. F. and Seim, C., "Corrosion of Steel Piles at the Richmond San Rafael Bridge," California Department of Transportation, Sacramento, California 95807, p. 51, June 1979.
61. Clifton, J. R., Beeghly, H. F. and Mathley, R. G., "Nonmetallic Coatings for Concrete Reinforcing Bars," National Bureau of Standards Building Science Series 65, pp. 34, August 1975.
62. Casagrande, A., "Classification and Identification of Soils," Transaction ASCE, Vol. 113, pp. 901-992, 1948.
63. Boyd, W. K. and Nowacki, L. J., "Final Report on Protection of Steel Storage Tanks and Pipe Underground to American Iron and Steel Institute," Battelle Memorial Institute, Columbus, OH 43201, March 24, 1967.
64. Rehm, G., "Corrosion Protection for Injection Anchors" Essen, pp. 37-55, 1971.
65. American Water Works Association, "Notes on Procedures for Soil Survey Tests and Observations and Their Interpretation to Determine Whether Polyethylene Encasement Should Be Used," Appendix A, AWWA C105-75, 1972.
66. Deere, D. U., Hendron, Jr., A. J., Patton, F. D. and Cording, E. J., "Design of Surface and Near Surface Construction in Rock," 8th Rock Mechanics Symposium, Minnesota, 1966.
67. Schnabel, Jr., H. and Sigourney, J. W., "Design and Installation of Earth Tiebacks," Piletalk Seminar, Saddle Brook, NJ, Associated Pile & Fitting Corp., Clifton, NJ, pp. 1-21, 1976.
68. Mitchell, J. K., Fundamentals of Soil Behavior, John Wiley and Sons, Inc., New York, p. 291, 1976.
69. Clough, G. W., "Tied-back Walls" Proceedings of the Conference on Analysis and Design in Geotechnical Engineering, Vol II, pp. 100-102, ASCE, 1975.

70. Littlejohn, G. S. and Bruce, D. A., "Rock Anchors State-of-the-Art, Part I: Design, Ground Engineering, May 1975.
71. Hendron, Jr., A. J., "Mechanical Properties of Rock," Chapter 2, Rock Mechanics in Engineering Practice, Wiley & Sons, New York, pp. 32 and 33, 1968.
72. Nicholson Construction, Rock and Soil Anchor Manual, P. O. Box 98, Bridgeville, PA 15017.
73. Littlejohn, G. S., "Soil Anchors," Ground Engineering, Proceedings of an ICE Conference, June 16, 1970, ICE, London, pp. 36-40, 1970.
74. Berezantzeu, V. G., et al, "Load Bearing Capacity and Deformation of Pile Foundations," Proceedings 5th ICSMFE, Vol. 2, pp. 11-15, 1961.
75. Schnabel Foundation Company, Permanent Tieback Manual, 4720 Montgomery Lane, Bethesda, MD 20814, 1978.
76. Carson, A. B., Foundation Construction, McGraw-Hill Book Co., Inc., New York, 1965.
77. Jorge, G. R., "The Regroutable IRP Anchorage for Soft Soils, Low Capacity or Karstic Rocks," Paper No. 15-10, VII ICSMFE, Specialty Sessions No. 14 and 15, pp. 159-163, 1969.
78. Bachy, SIF, "Criteria to Define the Choice between TMD and TMS Ground Anchors," Personal Correspondence, November 11, 1978.
79. Littlejohn, G. S., "Recent Developments in Ground Anchor Construction," Ground Engineering, Vol. 1, Number 3, pp. 32-36 and 46, 1968.
80. Sapio, G. "Comportamento di tiranti de ancoraggio in formazioni de argille preconsolidate," XII Convegno Nazionale de Geotecnica, Consenza, Italy, 1975.
81. Neely, W. J. and Montague-Jones, M., "Pull-out Capacity of Straight-Shafted and Under-Reamed Ground Anchors," Die Siviele Ingenieur in Suid-Africa, Jaargang 16, NR 14, pp. 131-134, 1974.
82. Broms, B. B., "Swedish Tieback System for Sheet Pile Walls," Proceedings 3rd Budapest Conference on Soil Mechanics and Foundation Engineering, pp. 391-403, 1968.
83. Hanna, T. H., Design and Construction of Ground Anchors, Report 65, Construction Industry Research and Information Association, 6 Storey's Gate, London, July 1977.
84. Tomlinson, M. J., "The Adhesion of Piles Driven in Clay Soils," Proceedings 4th ICSMFE, London, Vol. 2, pp. 66-71, 1957.
85. Peck, R. B., "A Study of the Comparative Behavior of Friction Piles," Highway Research Board Special Report No. 36, p. 72, 1958.

86. Woodward, R. J., Lundgren, R. and Boitano, J. D., "Pile Loading Tests in Stiff Clays," Proceedings 5th ICSMFC, Paris, Vol. 2, pp. 177-184, 1961.
87. Bassett, R. H., "Underreamed Ground Anchors," IX ICSMFE, Japan, Special Session, No. 4, Review Francaise Geotechnique, No. 3, pp. 11-17, 1978.
88. Goldberg, D. T., Jaworski, W. E. and Gordon, M. D., Lateral Support Systems and Underpinning, Vol. 1, Design and Construction, FHWA-RD-75-128, pp. 205-208, 1976.
89. Bustamante, M., Delmas, F. and Lacour, J., "Behavior of Prestressed Anchors in Plastic Clay," IX ICSMFE, Japan, Special Session No. 4, Review Francaise Geotechnique, No. 3, pp. 24-34, 1978.
90. Schnabel, Jr., H., Tiebacks in Foundation Engineering and Construction, McGraw-Hill Book Company, New York, New York, 1982.
91. Morgenstern, N. R., and Sangrey, D. A., "Methods of Stability Analysis," contained in Landslides Analysis and Control edited by Schuster, R. L., and Krizek, R. J., Transportation Research Board, National Academy of Sciences, Washington, DC, 1978.
92. Ranke, A. and Ostermayer, H., "A Contribution to the Stability Calculations of Multiple Tiedback Walls" ("Beitrag zur Stabilitats Untersuchung . . ."), Die Bautechnik, Vol. 45, No. 10, pp. 341-349, 1968.
93. American Water Works Association, Concrete Pressure Pipe, AWWA Manual M9, American Water Works Association, Denver, Colorado, 1979, p. 124.
94. Schupack, M., "Design of Permanent Seawater Structures to Prevent Deterioration," Presented at the ACI Fall Convention in San Juan, Puerto Rico, September 26, 1980.
95. Stocker, M., "General Discussion," Proceedings of the Diaphragm Walls and Anchorages Conference, September 18-20, 1974, Institute of Civil Engineers, p. 218, 1975.
96. Schupack, M., "Grouting Aid for Controlling the Separation of Water for Cement Grout for Grouting Vertical Tendons in Nuclear Concrete Pressure Vessels" presented at the International Conference on Experience in the Design, Construction, and Operation of Prestressed Concrete Vessels and Containments for Nuclear Reactors at the University of York in September 1975.
97. Mather, B., "Field and Laboratory Studies of the Sulphate Resistance of Concrete," Performance of Concrete-Resistance of Concrete to Sulphate and Other Environmental Conditions. Thorvaldson Symposium, University of Toronto Press, Toronto, pp. 66-76, 1968.
98. U.S. Bureau of Reclamation, Concrete Manual, 8th Edition, U.S. Bureau of Reclamation, Department of Interior, 1975.

99. PCI Committee on Post-Tensioning, "Recommended Practice for Grouting of Post-Tensioned Prestressed Concrete," Journal of the PCI, Vol. 17, No. 6, November-December 1972.
100. Perez, J.-Y. and Fasano, R. A., Foundation Investigation and Test Program, Locks and Dam 26, Mississippi River, Alton, Illinois, Vol. V, p. 124, 1979.
101. Littlejohn, G. S. and Bruce, D. A., "Rock Anchors - State-of-the-Art, Part II: Construction" Ground Engineering Vol. 8, Number 5, 1975.
102. Littlejohn, G. S. "Acceptable Water Flows for Rock Anchor Grouting," Ground Engineering, Vol. 8, Number 2, pp. 46-48, 1975.
103. Bishop, A. W., "The Strength of Soils as Engineering Materials," Geotechnique, Vol. 16, pp. 91-128, 1966.
104. Murayama, S., and Shibata, T., "On the Rheological Characteristics of Clays," Part I, Bulletin No. 26, Disaster Prevention Research Institute, Kyoto, Japan, 1958.
105. Singh, A., and Mitchell, J. K., "General Stress-Strain-Time Function for Soils," Journal of the Soil Mechanics and Foundation Division, ASCE, Vol. 94, No. SM I, pp. 21-46, 1968.
106. Edgers, L., Ladd, C. C., and Christian, J. T., Undrained Creep of Atchafalaya Levee Foundation Clays, Vol. 1, Research Report R73-16, Soils Publication 319, Dept. of Civil Engr., Mass. Inst. of Tech., pp. 1-268, Feb. 1973.
107. Singh, A., and Mitchell, J. K., "Creep Potential and Creep Rupture of Soils," Proceedings of the 7th ICSMFE, Vol. 1, pp. 379-384, 1969.
108. Coates, D. F. and Yu, Y. S., "Three Dimensional Stress Distribution Around a Cylindrical Hole and Anchor," Proceedings 2nd International Conference on Rock Mechanics, Belgrade, Vol 2, pp. 175-182, 1979.
109. Ostermayer, H., and Scheele, F., "Research on Ground Anchors in Noncohesive Soils," Special Session 4, IXICSMFE, Tokyo, 1977.
110. Shields, D. R., Schnabel, Jr., H., and Weatherby, D. E., "Load Transfer in Pressure Injected Anchors," Journal Geotechnical Engineering Division, ASCE, No. GT9, pp. 1183-1196, 1978.
111. Swain A., Model Ground Anchors in Clay, Ph.D. Thesis, Cambridge University, Cambridge, England, 1976.
112. Beard, R. M., Long-Term Holding Capacity of Statically Loaded Anchors in Cohesive Soils, Technical Note N-1545, Naval Facilities Engineering Command, January 1979.

113. Tanaka, Y., Consolidation Behavior of a Single Underreamed Anchor in Clay, PhD Thesis, University of Sheffield, Sheffield, England, September 1980.
114. Littlejohn, G. S., Personal Communications, October 16, 1980.
115. Feddersen, I., "Verpressanker im Lockergestein," (Grouted Anchors Used in Soils), *Bauingenieur* 49, No. 8, pp. 302-310, 1974.
116. Evangelista, A., and Sapio, G., "Behavior of Ground Anchors in Stiff Clays," Specialty Session No. 4, Ground Anchors, IXICSMFE, Tokyo, Japan, 1977.
117. Gandais, M., and Delmas F., "Long-Term Anchor Tests in Plastic Clay" SIF Bachy technical notes and comments, June 1979.
118. Bureau Securitas, Recommendations Concernant la Conception, le Calcul, l'Execution et le Control des Tirants d'Anchorage, (Recommendations Concerning the Conception, the Calculation, the Execution, and the Control of Ground Anchors) TA 72, Editions Eyrolles, 61, Boulevard Saint-Germain 75005 Paris, 1972.
119. Bernath, J., Hirt, F., Marth, E., and Matt, U. von, "Uersuche an Vertikalen Zuguerankerungen," (Tests on Vertical Tensile Anchorings), *Schweiz. Bauztg.* 93, No. 48, pp. 779-783, 1975.
120. Winterkorn, H. F., and Fong, H.-Y., Foundation Engineering Handbook, Van Nostrand Reinhold Company, New York, New York, p. 569 (1975).
121. Cording, E. J., Hendron, Jr., A. J., Mahar, J. W., MacPherson, H. H., Jones, R. A., and O'Rourke, T. D., Methods for Geotechnical Observations and Instrumentation in Tunneling, National Science Foundation Research Grant GI-33644X, UILU-ENG 75 2022, Department of Civil Engineering, University of Illinois, Urbana, Illinois, p. 566, December 1975.
122. Dunnicliff, J. and Sellers, B., Geotechnical Instrumentation, Notebook from FHWA Training Course, U.S. DOT, FHWA, Washington, DC 20590.
123. Clear, K.C., "Cost Effective Rigid Concrete Construction and Rehabilitation in Adverse Environments," FCP Annual Progress Report, Year Ending Sept. 30, 1980, Project 4K, FHWA, 1980.

## INDEX

- Alignment load, 2
- Anchor, 2
- Anchor capacities:
  - cohesionless soils, 108-113
  - cohesive soils, 114-117
  - rock, 104-108
- Anchor length:
  - corrosion mechanisms affecting the, 82-87
  - corrosion protection of the, 71-81, 88, 90, 91, 95, 96
  - definition of, 2-4
  - design, 104-119
    - soil properties required to, 101
    - rock properties required to, 101
  - minimum, 119
- Anchor movement:
  - (See Creep)
  - (See Elastic movement)
  - (See Residual anchor movement)
- Anchorage:
  - anchor head, 2, 132, 134
  - bearing plate, 2, 132, 134
  - corrosion mechanism affecting the, 87
  - corrosion protection of the, 81, 82, 90, 135
  - definition of, 2
  - nonrestressible, 2, 132
  - restressible, 2, 132, 135
- Bond breaker, 2, 129, 131
- Cement grout, (See grout)
- Contraction practices:
  - prequalification, 121
  - recommended improvements in, 216, 217
  - specifications,
    - closed, 121
    - performance, 120, 121
    - sample, 122-128
- Corrosion:
  - definition of, 46
  - galvanic,
    - differential aeration cells, 49, 50, 55, 56, 62, 84
    - differential concentration cells, 48, 49, 55, 56
    - differential stress cells, 49
    - dissimilar metal cells, 47, 48, 55, 56, 61, 88, 89
  - stray-current, 49, 50, 55, 56, 83, 86, 87, 88, 90

INDEX  
(continued)

Corrosion (continued):

- types of,
  - bacterial, 52
  - hydrogen embrittlement, 53, 59-61, 63, 84, 88-90
  - pitting, 51, 52, 55, 56, 62-64, 84, 88
  - rust, (See uniform surface corrosion)
  - stress-corrosion cracking, 53, 59-62, 84
  - uniform surface, 51, 56, 89

Corrosion of:

- buried steel, 53-55
- concrete structures, 57-61
- culverts, 56, 57
- pipelines, 55-56
- reinforced earth, 56-57
- tiebacks, 61-66  
(See Tiebacks)

Corrosion protection systems for tiebacks:

- anchorage, 81, 82, 90, 135
- coatings, 71, 74, 88, 89
- compression tiebacks, (See also secondary grout protection)
- compression tube, 75, 79, 95
- encapsulation, 71, 75-78, 91, 95, 131, 132
- grout, (See simple corrosion protection)
- insulation, 86, 88, 90, 91, 95
- recommended, 94-97
- secondary grout, 75, 80, 81, 149, 150
- simple corrosion protected, 71-73, 90, 91, 95, 97

Corrosion tests:

- to measure soil or groundwater aggressivity,
  - chemical properties, 94
  - pH, 94
  - physical properties, 94
  - resistivity, 93
  - stray current, 94
- to measure corrosion attack on a tieback, 97-100

Creep in:

- grout, 201
- prestressing steel, 186, 201-203
- soil, 165-169
- tiebacks, 102, 103, 165, 171, 177, 178, 180, 181, 190

Depassivator, 58-61

Design load, 2

INDEX  
(cointinued)

Drilling, rock:

- percussion, 139
- rotary, 142
- (See overburden drilling)

Drilling, soil:

- auger, 159
- caisson, 150, 159
- driven casing, 159
- hollow-stem auger, 155, 156
- rotary, 155, 157, 158

Elastic movement, 186, 190, 204

Grout:

- acid resistant, 138
- admixtures, 137
- anchor, 2, 136-139
- cement, 136
- chemical attack of, 137, 138
- concrete, 136
- encapsulation, 132
- materials, 136
- mixing, 138, 139
- primary, 2, 149, 150
- pumping, 138, 139
- resin, 132, 136
- sand-cement, 136
- secondary, 2, 149, 150
- sulfate resistant, 138

Hollow-stem-augered tiebacks:

- capacity in cohesionless soils, 110
- capacity in cohesive soils, 114, 115
- creep test of 212, 213
- installation, 152, 155, 156
- performance test of, 189, 209, 211
- proof test of, 192, 193, 213

Jacking length, 2-4

Lift-off load, 2

Low-pressure-grouted tiebacks:

- capacity in cohesionless soils, 108-110
- capacity in cohesive soils, 114, 115
- definition of, 5, 6
- installation, 152, 155-159
- load transfer, 175, 178-180

Monitoring, 209, 214, 215



INDEX  
(continued)

- Multiunderreamed tiebacks:
  - capacity in cohesive soils, 116
  - definition of, 5, 6
  - installation, 152, 154, 155
  - load transfer, 176-178
  
- Overburden drilling, 142, 143
  
- Permanent tiebacks:
  - applications, 8, 10-45
  - definition of, 3, 66
  
- Postgrouted tiebacks:
  - capacity in cohesionless soils, 111, 113
  - capacity in cohesive soils, 116-118
  - creep test of, 195, 196, 198, 204, 206, 207
  - definition of, 5, 6
  - installation, 152, 159, 161-164
  - load transfer, 175, 178, 180, 181
  - performance test of, 197
  - TMD, 75, 161, 164
  - Tube à manchette, 159, 161-163
  
- Pressure-injected tiebacks:
  - capacity in cohesionless soils, 111, 112
  - creep test of, 204, 206
  - definition of, 5, 6
  - installation, 153, 159, 160
  - load transfer, 171-174
  - performance test of, 186-188
  
- Residual anchor movement, 186, 189, 194, 204, 209
  
- Residual load, 2
  
- Resin grout, (See grout)
  
- Risk, 104, 105, 214
  
- Rock tiebacks:
  - anchor capacity, 104-108
  - installation, 139-151
  - load distribution, 169-171
  
- Sheath, 2, 129, 131
  
- Single-underreamed tiebacks:
  - capacity in cohesive soils, 115
  - definition of, 5, 6
  - installation, 150-152, 154
  - load transfer, 176, 177
  - performance test of, 206, 208-210

INDEX  
(continued)

Soil tiebacks:

- anchor capacity, 108-117
- installation, 150-164
- load distribution, 171-181
- load transfer, 171-181
- (See also creep)

Specifications:

- sample, 122-128
- (See also contracting practices)

Tendon:

- anchorage, 132-135
- bar, 129, 130
- bond breaker, 2, 129, 131
- bond length, 2
- centralizers, 132, 133
- coupling, 2
- creep, 186, 201-203
- definition of, 2
- fabrication, 129-135
- grease, 131
- jacking length, (See jacking length)
- materials, alternate, 92
- relaxation, 186, 201-203
- sheath, 2, 129, 131
- spacers, 132, 133
- strand, 129, 130
- unbonded length, (See unbonded length)
- wire, 129, 130

Tests:

- equipment for load, 182-184
- interpretation of load, 200-213
- recommendations for tieback, 194, 199, 200
- overload during, 199, 200
- types of,
  - creep, 194-196, 198, 207, 210, 212, 213
  - performance, 184-190, 197, 208, 211
  - proof, 190-193

Test load, 2

Temporary tiebacks:

- applications, 8
- definition of, 2, 66

Tiebacks:

- corrosion mechanisms affecting the anchor head, 87
- corrosion mechanisms affecting the anchor length, 82-87
- corrosion mechanisms affecting the unbonded length, 87
- definition of, 2

INDEX  
(continued)

Tiebacks (continued):

- history, 7
  - low-pressure-grouted, straight-shafted, 5, 6, (See also  
Hollow-stem-augered tiebacks, Low-pressure-grouted tiebacks)
  - multiunderreamed, 5, 6 (See also Multiunderreamed tiebacks)
  - pressure-injected, 5, 6 (See also Pressure-injected tiebacks)
  - single-underreamed, 5, 6 (See also Single-underreamed tiebacks)
  - uses of,
    - for bridge abutments, 20, 23, 24
    - for bridge piers, 42, 44
    - for depressed roadways, 16-18
    - for excavation support, 8, 9
    - for foundation walls, 16, 19
    - for landslide stabilization, 26-33
    - for repair or alteration of existing walls, 37, 39-42
    - for retaining walls, 8, 10-17
    - for tunnel portals, 20-22
    - for underground caverns, 42
    - for waterfront walls, 35, 37, 38
- (See also Corrosion)

Tiedowns:

- definition of, 2
- uses of,
  - for depressed roadways, 24-26
  - for dams, 40, 42, 43
  - for roof support, 35, 36
  - for reactor containment vessels, 45
  - for slabs, 24-26
  - for towers, 32-35

Total tieback length:

- design of, 117

Unbonded length:

- corrosion mechanisms affecting the, 87
- corrosion protection of the, 71-81, 90,
- definition of, 2-4
- design of, 117

Unbonded testing length, 2-4

Watertightness testing of rock, 143, 149

