

# ROADSIDE IMPROVEMENTS FOR LOCAL ROADS AND STREETS

OCTOBER 1986

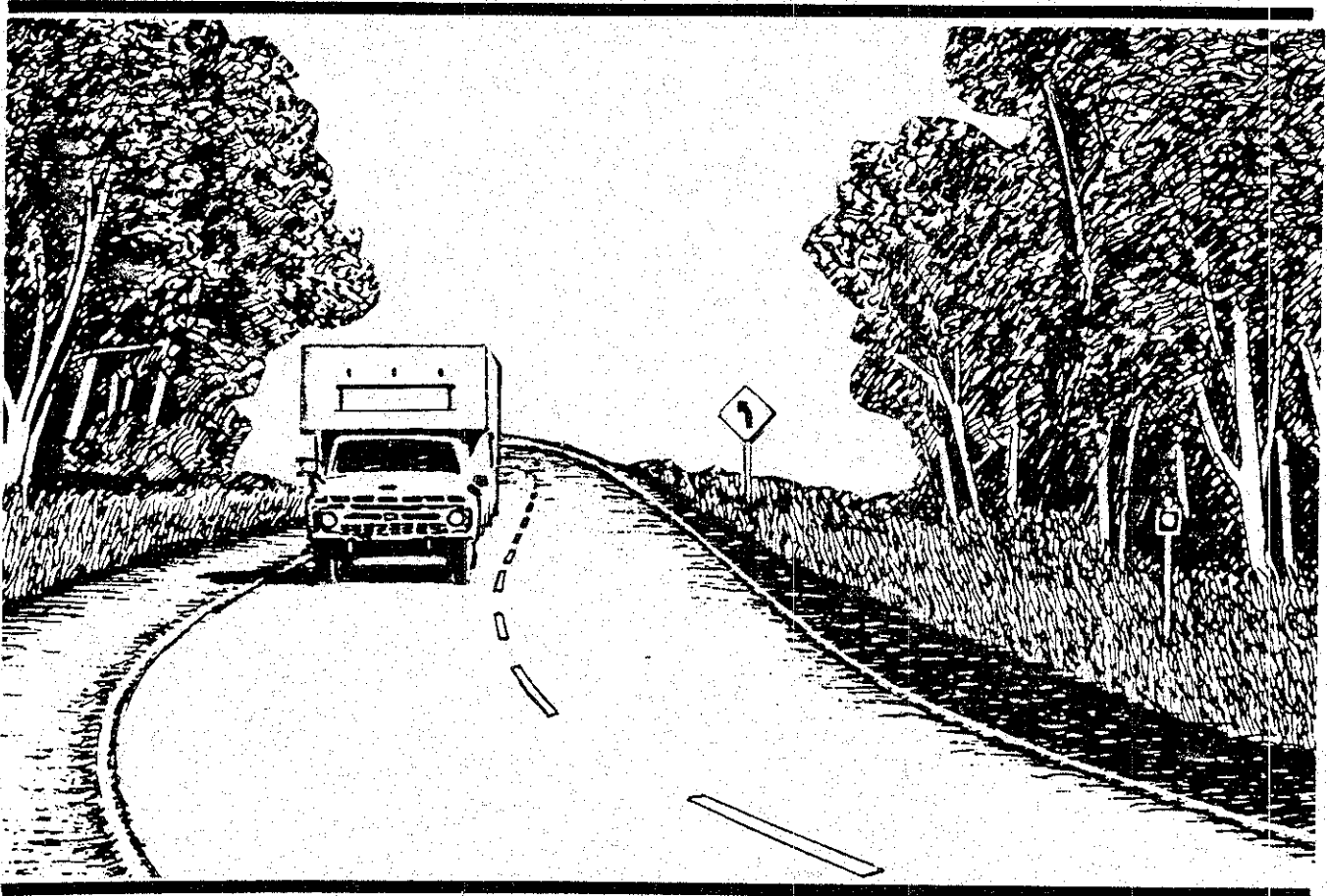

U.S. Department of Transportation  
**Federal Highway Administration**

**ROADSIDE IMPROVEMENTS  
FOR  
LOCAL ROADS AND STREETS**

**Prepared by:**

**Federal Highway Administration**

**Office of Highway Safety**

**Office of Engineering**

**NOTICE**

The contents of this pamphlet do not reflect the official views or policy of the Federal Highway Administration (FHWA). The FHWA does not endorse particular products or manufacturers. This pamphlet does not constitute a standard, specification, or regulation. It is intended as a general guide to effective, low cost methods of improving roadside safety. Detailed technical information on the subjects covered in this pamphlet is available through the state highway agency or FHWA division offices or through Technology Transfer Centers.

## Table of Contents

I. Introduction	1
II. Forgiving Roadside	2-4
III. Roadside Hazards	5
o Fixed Objects	7
- Large Rigid Structures	7
-- Bridge Piers and Abutments	7
-- Bridge Rails	8
-- Culvert Headwalls and Retaining Wall Ends	9
- Drainage Structures	10
-- Culvert Openings	10-11
-- Raised Drop Inlets	12
- Rigid Support Systems	13
-- Utility Poles	13
-- Sign Supports	14
-- Light Poles	14
-- Mailbox Supports	15
- Trees	16-17
- Small Rigid Structures	18
- Delineator Posts	19
o Terrain Features	20
- Side Slopes	20-21
- Non-Traversable Ditches	22
IV. Safety Hardware	23
o Sign Posts	23
- Wood Posts	23
- Steel U-Post	24
- Steel Pipe Tube Post	25
- Steel Perforated Tube	26
- Splicing and Bracing Sign Posts	27
o Breakaway Light Poles	28
V. Clear Zone	29-30
VI. References	31

## Introduction

This pamphlet is intended as a general guide to effective, low cost methods of improving and enhancing roadside safety. It is not intended as a design manual or a substitute for engineering knowledge, experience, or judgement. Technical safety hardware information such as hardware standards, warrants for selecting safety hardware, installation details, and cost-effectiveness analysis can be found in the material listed in the references. The guidelines and examples included in the pamphlet are based on actual situations and observations made in a series of national reviews. They reflect the actual needs and opportunities for highway safety improvements existing on many local roads and streets.

There are three general types of changes that can be made to improve highway safety. These include:

Roadway Improvements help drivers stay on the roadway and in their own lanes and consist of improvements made to the geometric features of the roadway such as lane and shoulder width, horizontal and vertical alignment, and pavement cross slope. Roadway improvements can reduce the number of accidents occurring by providing consistent and uniform conditions and improve driving comfort.

Operational Improvements provide the driver with necessary and important information and consist of improvements generally made to the signs, pavement markings, traffic signals, delineation, and other features. Operational improvements are often used to supplement or mitigate the effects of substandard or unexpected roadway features by providing the driver with information on potential hazards ahead or establishing rules (speed limit, etc.) under which the section of road can be safely negotiated.

Roadside Improvements provide the driver with a better chance of recovering from an accident and/or reduce the potential severity of accidents along the edge of the highway. These improvements include such work as slope flattening, culvert extensions, tree removal, ditch shaping, installing guardrail.

This pamphlet deals only with the area of Roadside Improvements.

## Forgiving Roadside

Over the past two decades, particular emphasis has been placed on improving roadside safety in an effort to reduce the severity of accidents resulting from vehicles "running off the road." This effort to provide a safer or forgiving roadside requires particular attention be given to shoulders, slopes, drainage features, sign and light supports, utility poles, landscaping, guardrail, and other roadside obstacles. Forgiving roadsides provide a recovery area or "clear zone" to allow vehicles which leave the roadway room to regain control and return to the roadway or come to a controlled stop. (see figure 1).

Clear zone width can vary depending on the curvature of the road and steepness of side slopes. It should be as wide as feasible and free of potentially hazardous features or elements. It is often impractical to provide a clear zone completely free of potential hazards. Features such as bridge rail ends, utility poles and traffic signals are often located close to traffic lanes. Other features such as trees, culvert headwalls, raised drop inlets, steep side slopes, rocks, and drainage ditches can present serious hazards to vehicles leaving the traveled way.

A roadside feature or group of features is considered potentially hazardous when it can cause a vehicle to abruptly stop, cause an object to penetrate the passenger compartment, or cause a vehicle to become unstable (spin, vault or rollover).

## ROADWAY CROSS SECTION

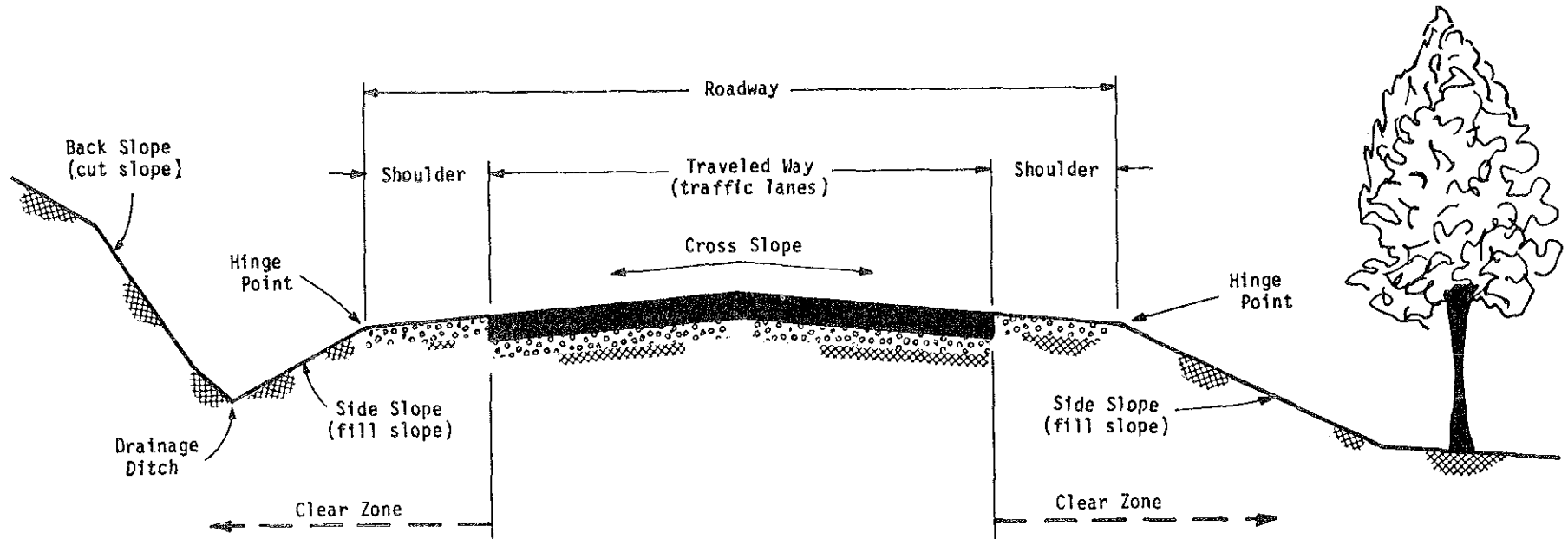

Figure 1.

- Traveled Way (traffic lanes) - That portion of the roadway for the movement of vehicles (does not include shoulders or extra turning lanes).
- Shoulder ----- That portion of the roadway next to the traveled way for use by stopped vehicles or emergency situations.
- Clear Zone ---- That area along the side of the traveled way including the shoulder that is available for recovery of an errant vehicle.
- Side Slopes --- Slopes along the side of the roadway identified by their distance from the traveled way, their slope rate, and their height.
- Slope Rate ---- The steepness of the slope - usually the ratio of the horizontal distance divided by the vertical change. See page 21.
- Hinge Point --- Point where the slope rate changes.

## Forgiving Roadside

Roadside safety improvements can effectively reduce the severity of accidents. Vehicular accidents, as generally defined, occur when vehicles involuntarily leave the traveled way and enter either an opposing lane or the roadside area. An accident becomes a crash only when the vehicle hits something or rolls over. Roadside improvements are intended to either reduce the chances of a crash occurring, (removing a fixed object) or reduce the severity of the crash (making the fixed object breakaway). Roadside improvements can be accomplished by:

- Removing      First, try to remove fixed objects and provide traversable terrain features. This provides the driver with room and conditions needed to regain control of the vehicle and either return to the highway or stop.
- Relocating    Second, try to relocate fixed objects that can not be removed. The further away a fixed object (such as a utility poles or culvert end) is located from the travel lane, the less the chance it will be hit.
- Retrofitting   Third, when the object can't be removed or relocated try to improve the device by making it breakaway or crashworthy. Certain fixed objects such as signs, culverts, and light poles, often are by necessity located near the roadway and for many of these objects, methods exist to make them less hazardous. Examples of breakaway sign posts are shown on pages 23-26.
- Shielding      Fourth, shield the driver from potential hazards that can not be improved. When roadside hazards can not be removed, relocated or retrofitted and are considered sufficiently harmful to warrant protection, guardrail can be used to shield the motorist from the potential hazard. Bridge abutments are a good example of this type hazard.
- Delineating   Finally, when it is impractical to do anything else or as a temporary measure, a low cost option such as delineating the hazard can help a driver who has control of this vehicle avoid hitting the hazard.

Most of the material included in this pamphlet is related to the types of retrofitting commonly employed on local roads and streets. Breakaway devices such as signs, luminaires (light poles) and mailboxes are discussed on page 15, retrofitting potentially hazardous structures are discussed on pages 7-9, and improving side slopes and ditches on pages 21-22. Delineation is discussed throughout the pamphlet.

The remainder of this pamphlet is intended to assist in developing an understanding of desirable roadside conditions. Additional material on this and other related safety subjects is available through the Federal Highway Administration's (FHWA) Division Offices or through Technology Transfer Centers. There are approximately 40 Technology Transfer Centers located throughout the Nation at different land grant universities. For information on the closest one, contact the local FHWA Division Office, usually located in the State capital.

## Roadside Hazards

Evaluating roadside safety is an evolving art. Many efforts are currently underway to help understand and develop better methods for analyzing the relative safety of roadsides. Currently, most evaluations are a mixture of known factors and engineering judgement that focus on two concerns. The concerns are:

- The chance or probability a vehicle will leave the traffic lane and encounter a hazardous roadside feature or element.
- The severity or extent of damage that can be expected when a vehicle encounters a hazardous roadside feature or element.

The primary focus of this pamphlet is on the second concern - The severity or extent of damage that can be expected. Several factors should be considered in any evaluation. These include:

<u>Speed</u>	The lower the speed, the lower the energy available to crush and deform the vehicle and the less severe the forces are on the driver or passenger(s).
<u>Location</u>	The further away a feature is from the lane, the better the chance a driver has to regain control and avoid hitting the feature or reducing the speed at which the feature or object is hit.
<u>Size</u>	The larger or longer a hazard is, the greater its chance of being hit.
<u>Severity Index</u>	A rating of injury and property damage resulting from hitting a specific hazard (hitting a utility pole is generally more severe than hitting a guardrail).
<u>Other Features and Elements</u>	The safety of any feature, even a safety device, can be influenced by other features. As an example, terrain can increase or decrease the potential severity of an accident (vehicles traveling up a cut slope lose speed and will then hit a fixed object at a reduced speed).



## ROADSIDE HAZARDS

### Common causes of vehicle instability

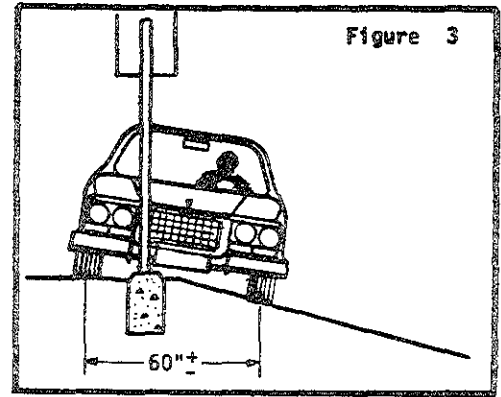
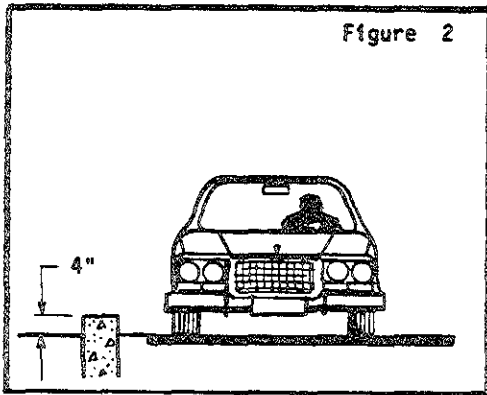

Snagging occurs when a vehicle undercarriage catches on a fixed object. Locating fixed objects on or near the roadside hinge point should be avoided because the chances of snagging are greater. Generally, objects more than 4 inches above the surrounding terrain (as shown in figure 3) can cause snagging.

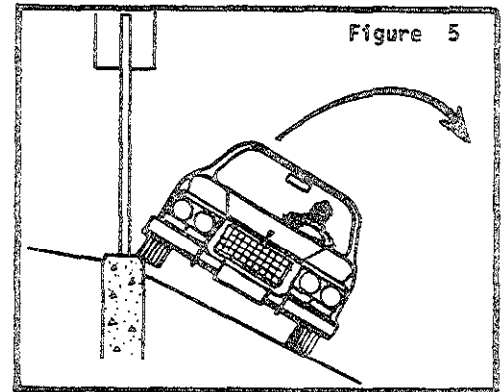
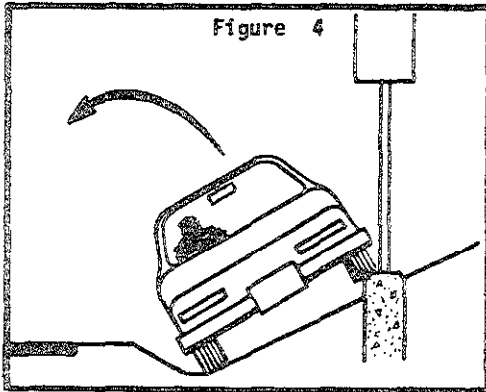

Rolling of the vehicle can occur when the undercarriage or wheel rides up on a fixed object such as a concrete footing. Although rolling is generally associated with steep side slopes, sign and luminaire bases extending above the surrounding terrain can initiate rolling on otherwise acceptable side slopes (figures 4 and 5).

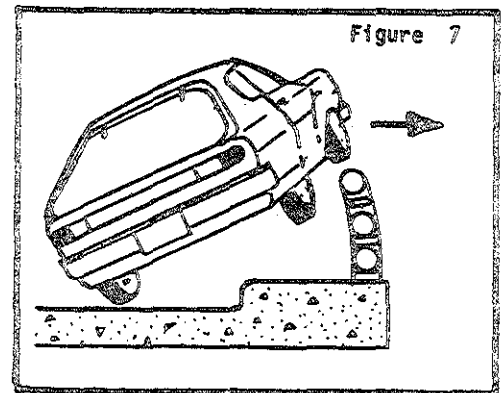
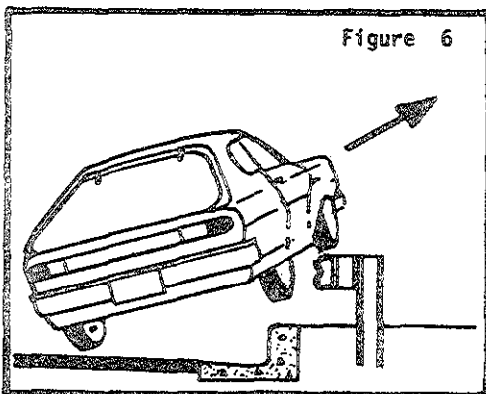

Vaulting over a barrier can occur when a tire hits a small structure such as a curb or safety walk (see figures 6 and 7) in front of guardrails or bridge rails causing a vehicle to become airborne. Curbs or raised safety walks in front of barriers should be avoided on highways with speeds over 40 miles/hour.

## Roadside Hazards

A roadside feature is considered potentially hazardous when one or more of the following events occur.

- o The vehicle is abruptly stopped.
- o The passenger compartment is penetrated by some external object.
- o The vehicle becomes unstable - snagging, vaulting or rolling over (see figures 2 thru 7)

### Fixed Objects

Fixed objects make up the greatest number of potential hazards along the roadside. The following pages address many common examples of potential hazards found along many local roads and streets.

The fixed objects discussed in this pamphlet are generally arranged in the order of declining severity. The most severe accidents occur with large rigid structures close to the traveled way.

Bridge piers and abutments that are either in or adjacent to an underpassing roadway are considered extremely hazardous and should be shielded with guardrail or protected in some other manner to reduce the severity of an accident.

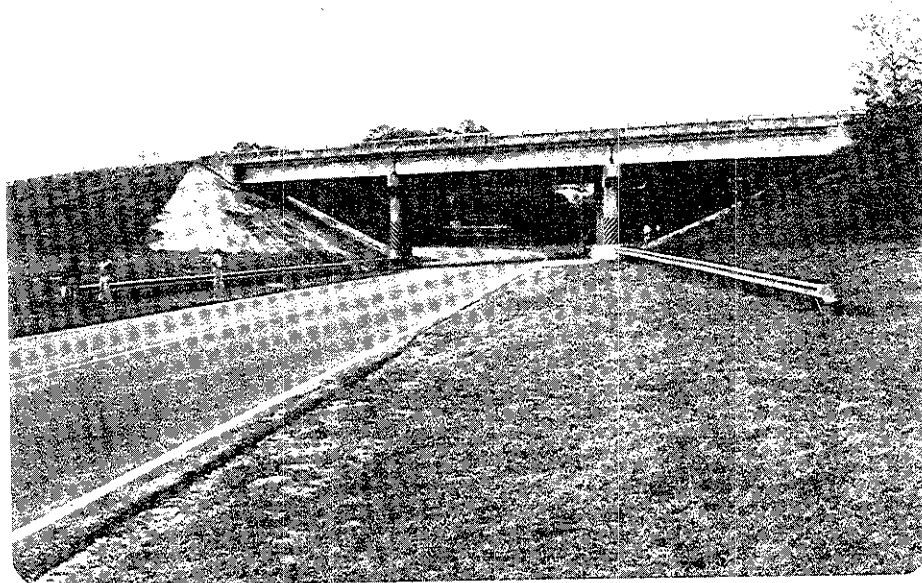

The picture above demonstrates the most common way of reducing the hazard at this location. A concrete barrier section was used at the piers to ensure the maximum opening was maintained while eliminating any chance of the barrier deflecting into the piers. Outside of this area, where deflection could be tolerated, the strong post w-beam guardrail was used. Additional reflectorized delineation was also used on both the piers and the guardrail terminals to mark the hazards.

## Fixed Objects

Bridge rails by necessity need to be large strong structures (bridge rail can tolerate only minimum deflection and penetration of the rail usually results in very severe accidents). Most bridge rail is rigid and can result in a very severe accident if hit head-on by a vehicle. Bridge rail ends, like bridge piers and abutments, cannot be removed, relocated, or made breakaway.

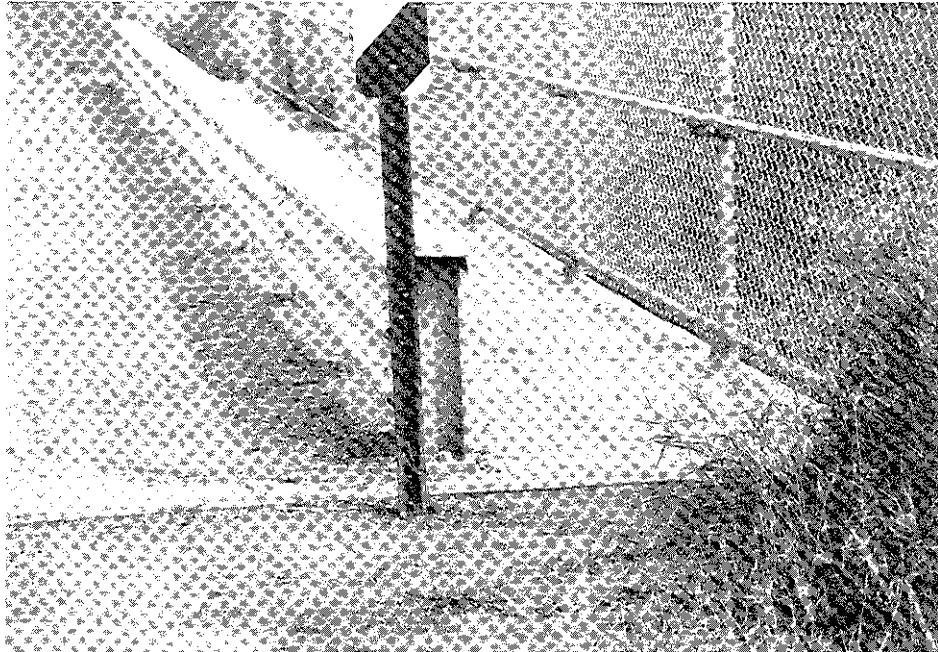

The picture above shows a relatively new bridge rail that has been left unprotected. In this case there is no doubt a head-on accident with the bridge rail end will be severe.

The appropriate method for reducing the potential severity of bridge rail ends is to use bridge approach guardrail. Approach guardrail can safely redirect an impacting vehicle. It provides a smoother transition from semi-rigid guardrail into the stiffer or more rigid bridge rail system. Special attention to detail is important in proper bridge approach guardrail design, installation and maintenance.

Additional information and details on guardrail approaches to bridges is being prepared and will be available from any of the technology transfer centers in the near future.

## Fixed Objects

Culvert headwalls and retaining wall ends are very similar to bridge rail ends. They are strong rigid structures often with high vertical faces that can abruptly stop or roll a vehicle. Many of the older headwall installations were specially designed to prevent a vehicle from running off the road into the streambed. More recent improvements in culvert design suggest the culverts be made traversable and the ground around the culvert shaped to reduce the potential for snagging, rolling or stopping a vehicle.

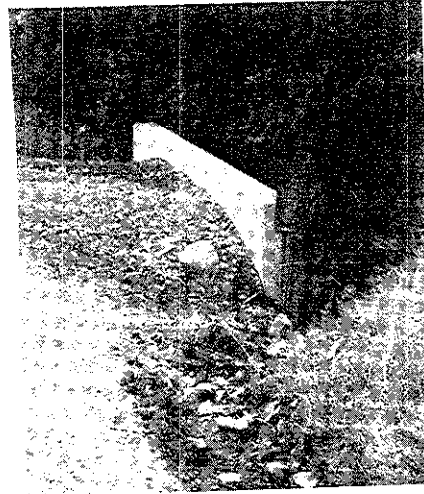
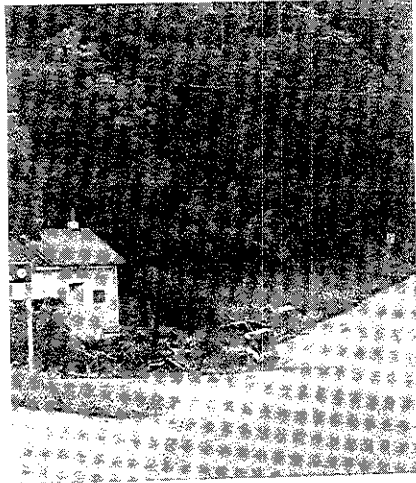

The headwalls shown above are of an old and a new installation. In both cases these headwalls represent a serious hazard that could easily be corrected. Headwalls should be no higher than 4 inches above the surrounding ground and wingwalls, when used, should conform to the surrounding ground.

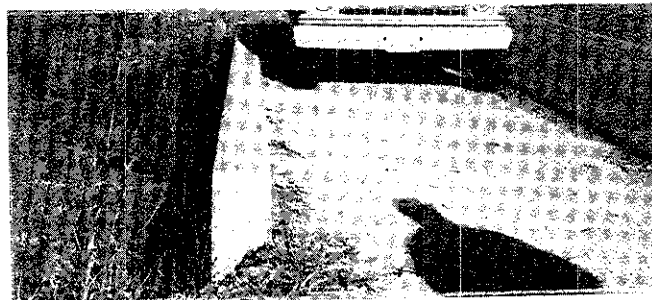

Low headwalls, as shown in the picture above, may not abruptly stop a vehicle but are still considered hazardous because they can initiate vehicle instability (see page 6).

Several methods exist for reducing the potential severity of accidents with these rigid structures. These include:

- Removing the headwall and extending the culvert and/or using a traversable opening (such as a grate),
- Using guardrail to reduce the hazards of exposed ends, and
- As a temporary measure, using delineation to warn the driver of the hazard.

## Fixed Objects

Drainage Structures with low headwalls can also be hazardous. They can abruptly stop a vehicle, causing the vehicle to rollover, or cause the driver to lose control.

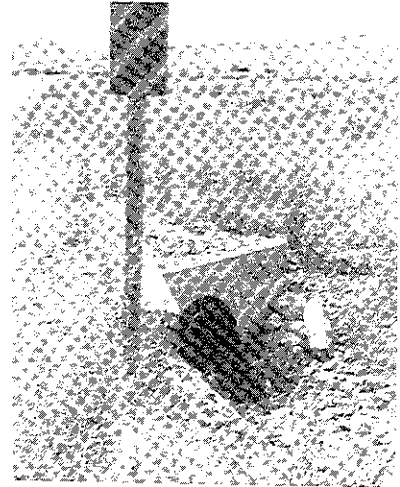
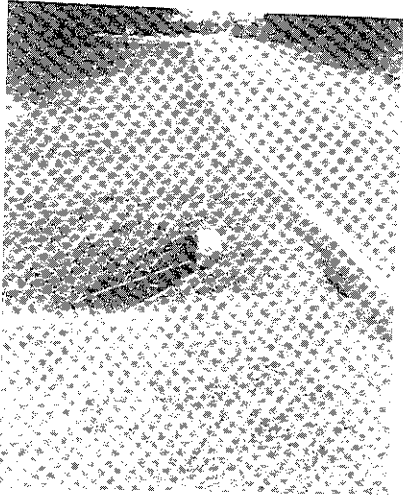

The culvert openings shown above are common in many areas. Although the headwall is not a hazard, the culvert remains potentially hazardous because a vehicle can drop into the opening and strike the wingwall (or embankment) or snag on the structure and become unstable.

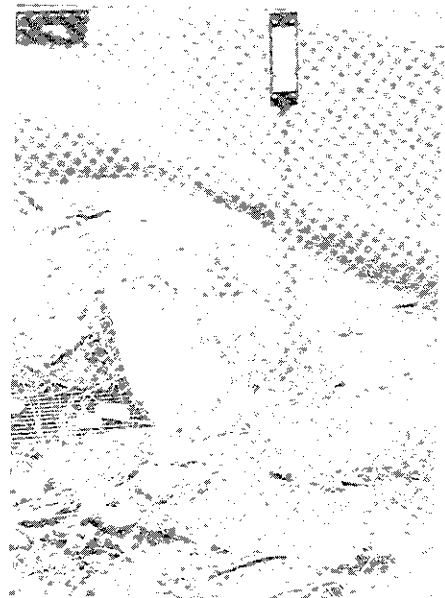
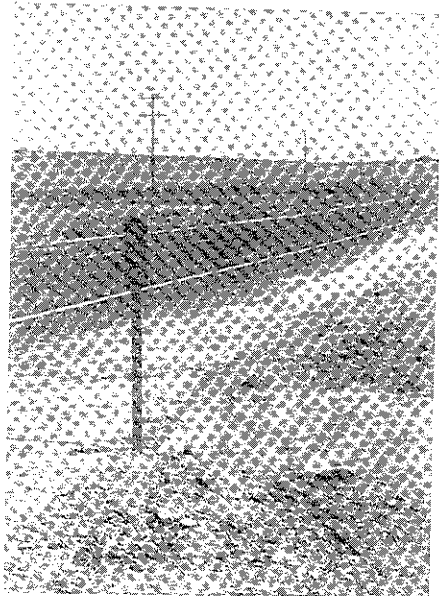

Even small drainage structures which can be driven over with relative safety can be considered hazardous when they are located next to or within the shoulder area. Culverts such as the one shown above can surprise the inattentive driver who has wandered from the travel lane. Surprised drivers often oversteer and end up driving into oncoming traffic or the opposite roadside.

## Fixed Objects

Culvert hazards can be improved in several ways. Some of the most common methods for reducing the hazard are shown below:

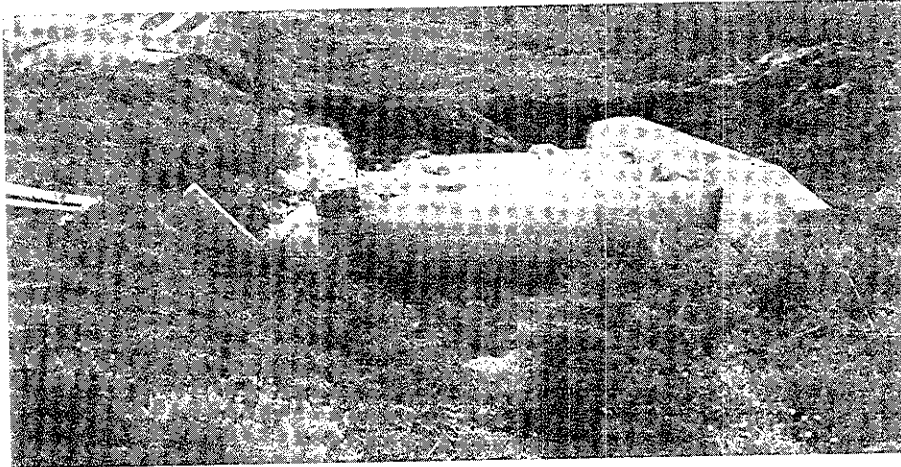

- o Relocating the culvert opening beyond the clear zone (as shown above) provides additional recovery area and reduces the chances of a vehicle reaching the hazard.

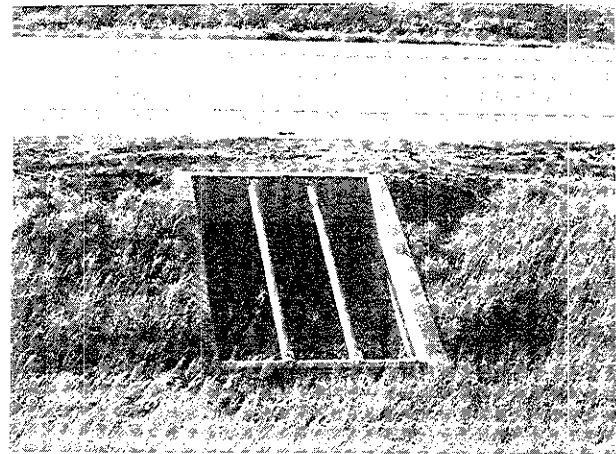
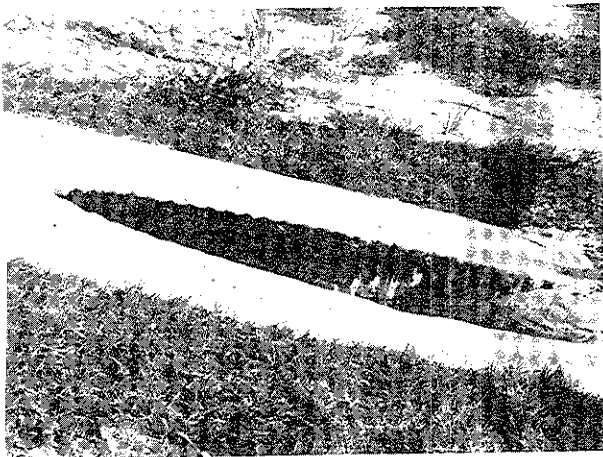

- o Retrofitting the culvert opening to conform to the existing ground and on larger culvert openings, using traversable grates are effective. Current research indicates a 20 inch opening, such as shown above, can be safely traversed. Grading around the culvert opening is important. As shown in the photo on left, a concrete apron helps maintain the grading by preventing erosion and pipe crushing. In the photo on the right, the area around the grate has eroded and the sides of the culvert opening are now significantly higher than the ground. This could cause vehicle instability.

## Fixed Objects

Raised Drop Inlets are common features along many roadsides. This type of drainage structure allows for water and debris to enter the sides and/or top of the structure. They are frequently covered with a concrete slab or grate to prevent a vehicle wheel from dropping in the inlet.

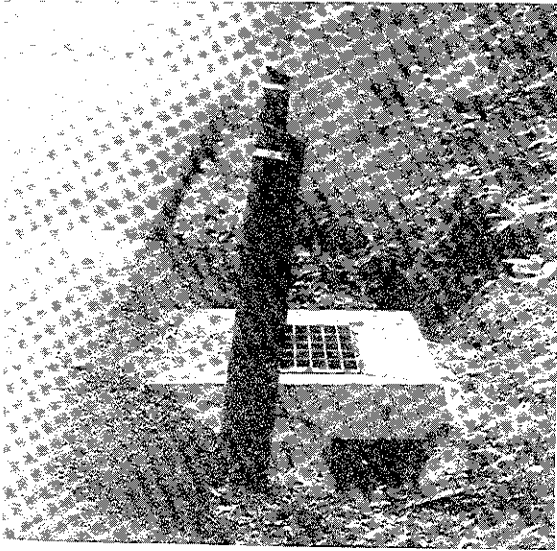

Raised drop inlets, such as the ones shown above, that are 4 or more inches above the surrounding ground, can be hazardous. They can cause instability by snagging or vaulting a vehicle.

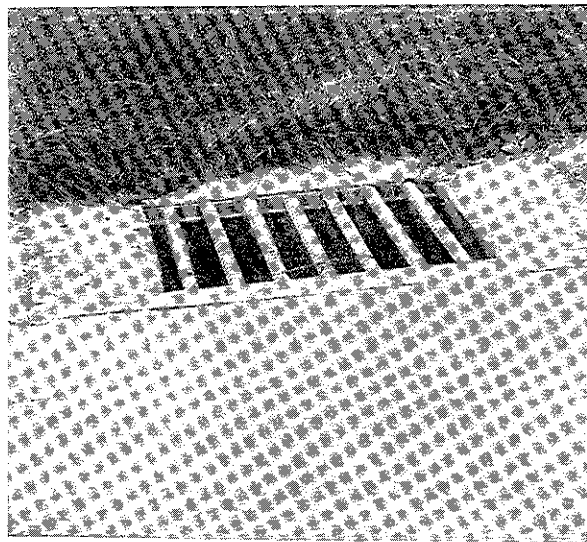

Retrofitting drop inlets so the tops (or grates) are flush with the surrounding ground or ditch line can eliminate the potential for snagging or vaulting. Delineation as a temporary improvement can also be effective in warning the driver of such a hazard (the use of large wood posts as shown above, is not a recommended method for delineation).



## Fixed Objects

Utility poles are strong rigid objects that do not safely break away when hit. There are over 100 million utility poles along the Nation's highways and although most of these will never be hit by a vehicle, they are the third most common fixed objects involved in fatal accidents. Identifying individual utility poles or groups of poles that warrant special attention is difficult and usually requires an accident analysis. The most significant factors found to relate to hazardous utility poles are:

- o The traffic volume
- o How close the pole is to the traffic lane
- o The highway conditions (such as curvature, surface condition, etc.)
- o The vehicle speed
- o The pole spacing and number of poles per mile.

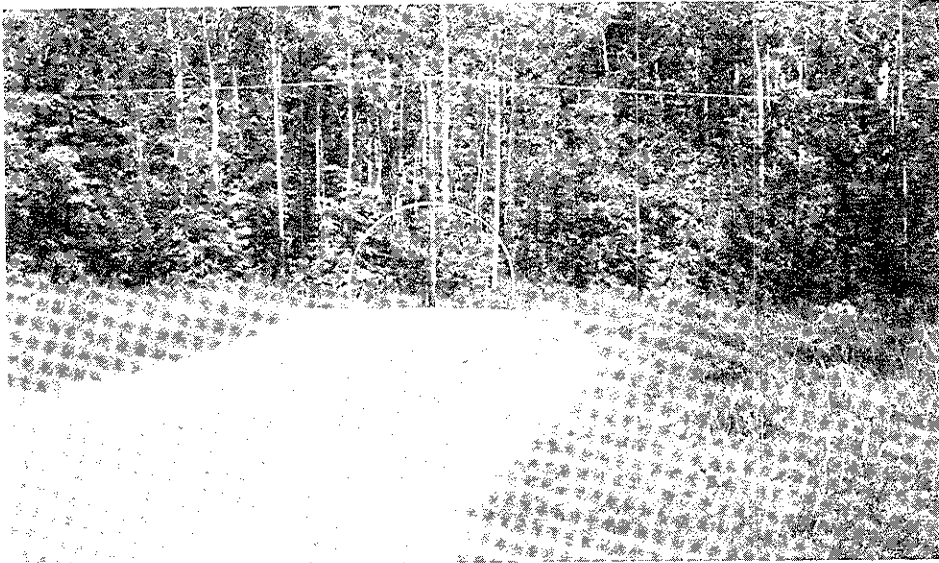

As an example, the utility poles in this picture could be considered a potential hazard because:

- The pole is located within 3 feet of the road while the tree line is about 14 feet away.
- It is at the beginning and on the outside of a sharp unmarked curve.
- The pavement is flat, not superelevated, and this area is subject to frequent snows and freezing rain.

Relocating of individual utility poles or entire utility lines is the most common methods of improving safety. Often this work can be done in conjunction with other highway work, such as pavement overlays or shoulder widening. Some of the more common methods to reduce hazards include:

- o Relocating the utility poles further away from the traffic lanes.
- o Relocating the utility poles away from access points (utility poles are often placed on or close to corners where they are more likely to be hit or conflict with other features).
- o Relocating the utility poles from the outside to the inside of sharp curves.
- o Reducing the number of poles by using single poles for multiple systems (electric, telephone, cable).
- o Increase spacing between poles.



## Fixed Objects

Rigid sign supports and highway lighting poles that are non-breakaway can be hazardous. Over the last decade many excellent yielding support systems have been produced and are in use today. One of the problems in evaluating sign supports is recognizing the difference between a safe or yielding device, and a non-yielding device. Single post sign supports with no special breakaway mechanism and larger than the ones shown on pages 23 thru 26 are considered unsafe. Information on large support slip base systems, light poles, and yielding multi-support systems can be obtained from the technology transfer center, State highway agency, or the local FHWA Division Office. Several alternatives exist for reducing the hazard potential of non-yielding supports. These include:

- o Removing - eliminating signs that are no longer necessary.
- o Relocating - moving sign panels onto another existing sign support or overhead structure, or moving the sign behind existing guardrail, up on a cut slope, or in some other area where it is unlikely to be hit.
- o Retrofitting - converting the sign support into a yielding system.
- o Shielding - installing guardrail or a crash cushion to shield large massive structures, such as overhead sign bridges or large cantilevered signs.

Highway light poles are often located close to the roadway. Several general methods for improving safety of these poles include:

- o Locating light poles behind existing or planned guardrail sections.
- o Locating light arms on existing utility poles.
- o Using a breakaway base when a light pole can be hit. (Non-breakaway bases are recommended when there is a significant chance that a falling pole will hit a pedestrian).
- o Removing poles which are no longer in use.

There are several types of breakaway bases available. The three most common breakaway bases are discussed on page 28.

## Fixed Objects

Mailbox supports come in various shapes and sizes. As with some of the other fixed objects it is often necessary to locate mailboxes close to the roadway. The mailbox is a unique fixed object because, by design, the box is usually located at windshield height. The two concerns in mailbox safety are (1) the support (which should breakaway or yield) and (2) the box, boxes, or system on top of the support (which should not become detached and penetrate a windshield).

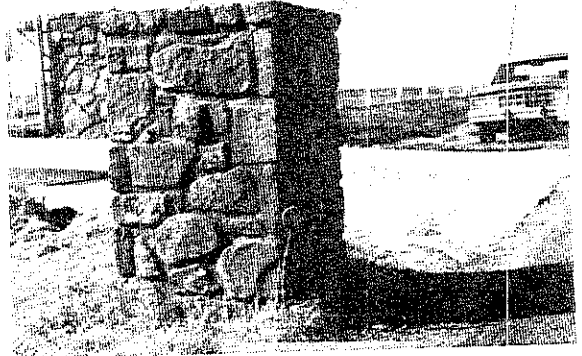
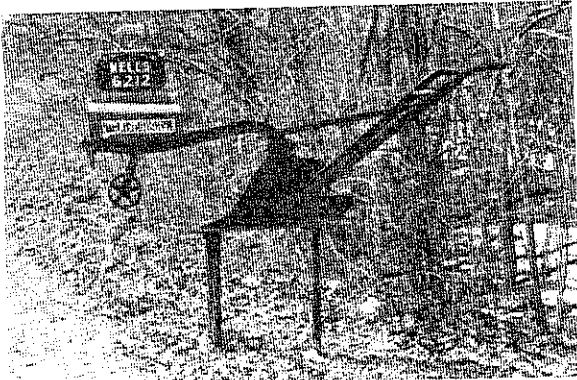

If the local community has the jurisdiction or authority to regulate objects in the highway right-of-way, care should be taken to ensure supports such as those shown above are not used (the example shown on the top left could easily penetrate a vehicle while the support on the top right is not "breakaway").

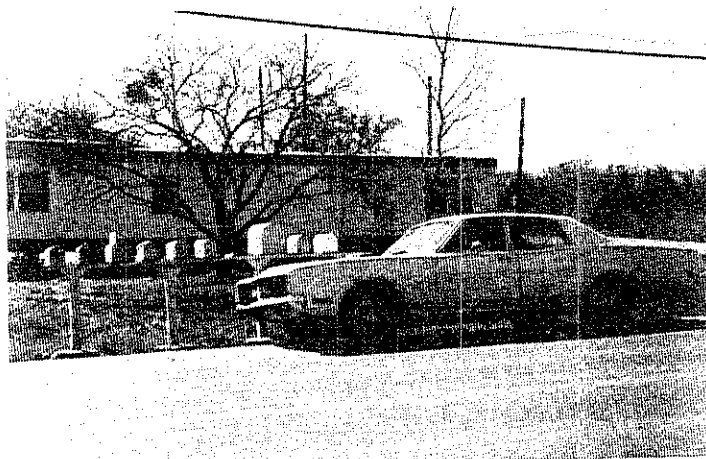

Another potential hazard is a series of mailboxes attached to a large horizontal mount. The horizontal member pictured above can easily penetrate the windshield of a vehicle. Additional information on safer mailbox support systems and mountings can be found in "A Guide for Erecting Mailboxes on Highways", AASHTO 1984.

## Fixed Objects

Trees are the fixed object most often hit and result in more fatalities than any other fixed object.



As a general rule individual trees will abruptly stop a vehicle when their trunk diameter is greater than 4 inches (or 13 inches in circumference-measured 4 inches above the surrounding ground). Trees with multiple trunks, groups of small trees or a small tree and another fixed object can act together (see figure 8) and should be considered as potentially hazardous when their combined cross section exceeds 13 square inches.

Removing hazardous trees can be difficult because removal can be a very emotional community issue. Besides removal, several other actions can be taken to enhance safety. These include:

- Maintaining the clear zones by removing secondary growth before it becomes an issue.
- Avoid planting tree types that will grow into hazards, and
- Avoid locating other devices or plantings near existing trees.

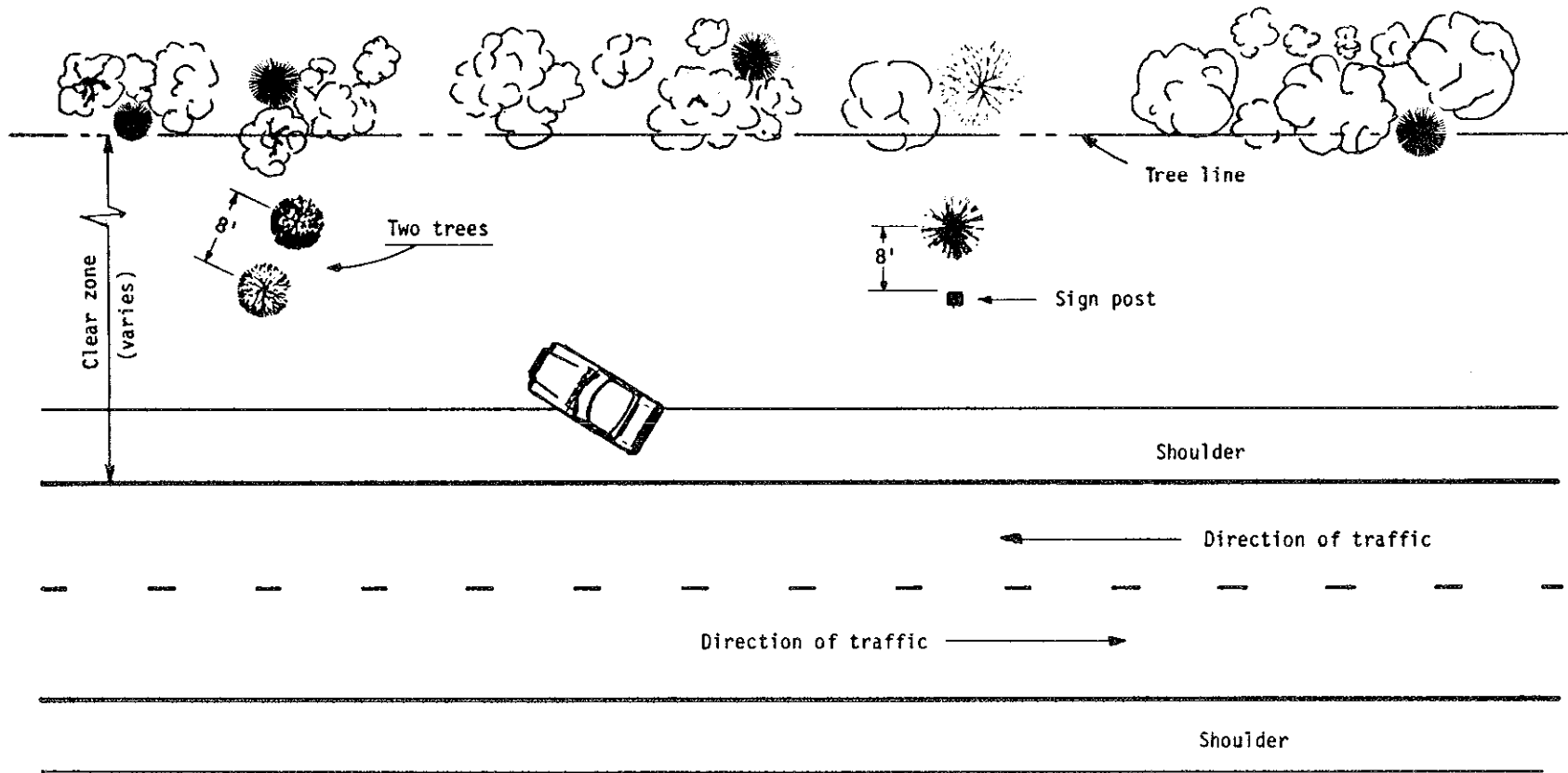
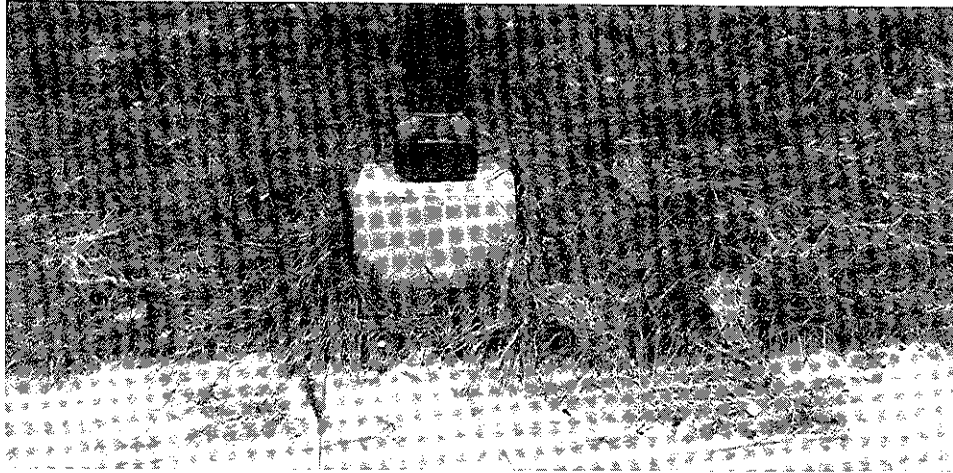

Figure 8

Two fixed objects such as trees, light poles, sign supports or any combination of these within 8 feet of each other should be considered as acting together. For example two 3-inch diameter trees would be considered hazardous because their total cross section is greater than a 4-inch tree.

## Fixed Objects

Small rigid structures such as curbs and low concrete pedestal bases (footings) are not generally considered hazardous. However, this type structure or other fixed object, such as a tree stump or rock outcropping, can in combination with other terrain features create a hazardous situation.



The photo above shows a new breakaway light pole on a concrete pedestal. However, the top forward edge of the pedestal is about 14 inches above the "60-inch" ground line (see page 6). The safety treatment of this light pole (breakaway frangible coupling) is not effective if the pedestal snags the vehicle undercarriage. As previously discussed, the height of the pedestal above the ground should be less than 4 inches. Safety improvements to these potentially hazardous small rigid objects can be handled in a similar manner to other potential hazards (remove, relocate, or retrofit). Additionally, as in the case of the pedestal above, regrading around the pedestal can significantly reduce the hazardous potential of the object.

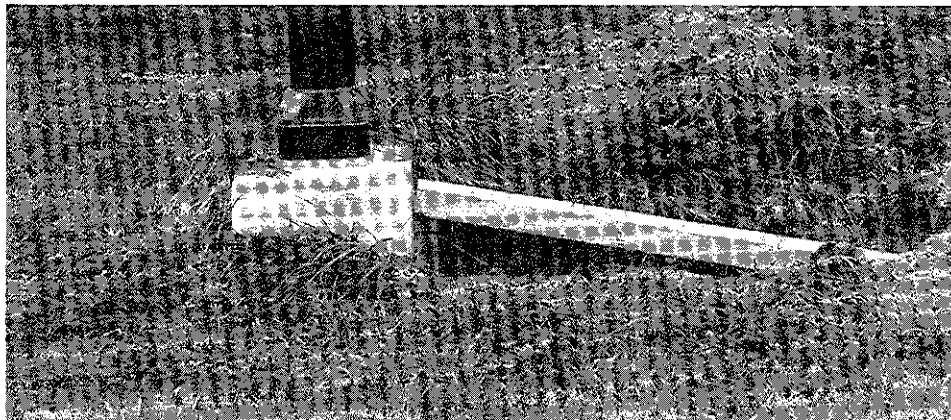

Note in the photo above, the hazard was eliminated by constructing a precast concrete ramp that prevents a vehicle undercarriage from snagging on the pedestal base. The work was completed by regrading with extra material around the pedestal and the ramp to form a flat traversable approach to the breakaway device.

## Fixed Objects

Delineation can be used to warn drivers of hazards. Common locations where good delineation practices would enhance safety include sharp curves, culverts or inlets, narrow roadway sections, narrow bridges, and crash cushions or guardrail terminals. Delineation should be in accordance with the "Manual on Uniform Traffic Control Devices" and mounted on a yielding or bending support,

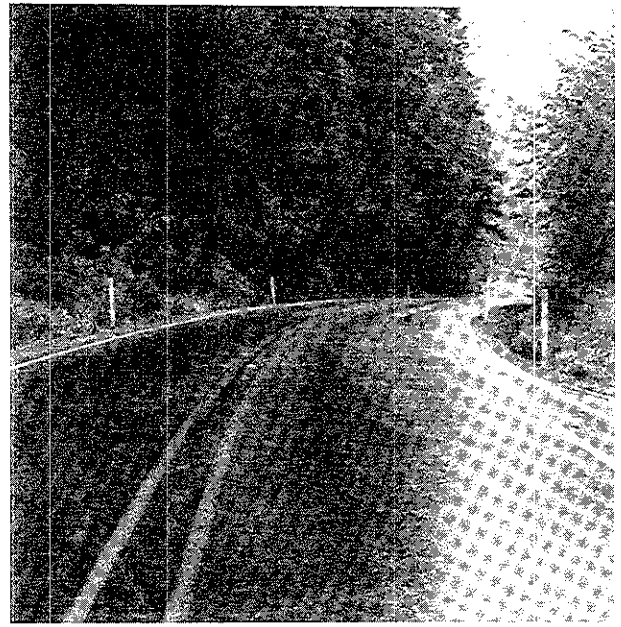
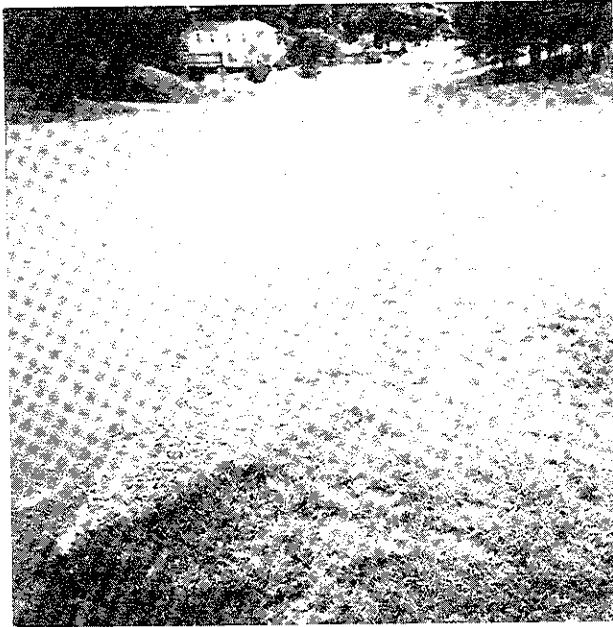

The above photo on the left and other photos on page 12 demonstrate a common practice used in the past to delineate/barricade an area. This method of using heavy wood posts is considered hazardous. Often painted or non-reflectorized posts are not visible at night, and when hit, the post can increase the severity of an accident by initiating vehicle instability.

Safer light weight delineation supports, as shown in the photo on the right, are commercially available. Several types of delineator posts are of the self restoring type and will generally return to the vertical position after being hit.

## Terrain Features

Side slope Fill side slopes often are the most significant factor influencing safety along the roadway. The steepness of a fill slope can have a very significant effect on the driver's ability to control the vehicle after it leaves the roadway. Side slopes that are not protected by guardrail should be as safe as conditions permit. How safe or acceptable a fill or cut side slope is depends on the following conditions.

- The steepness of the slope.
- The presence of other features on or at the bottom of the slope (such as trees, headwalls, and sign supports).
- The condition of the slope face (how well graded, rocky, grassy or eroded the slope is).
- The length of the slope (or the height of the embankment).
- The distance the slope is from the traveled way (the further away the slope is, the better chance a driver has to regain control.)

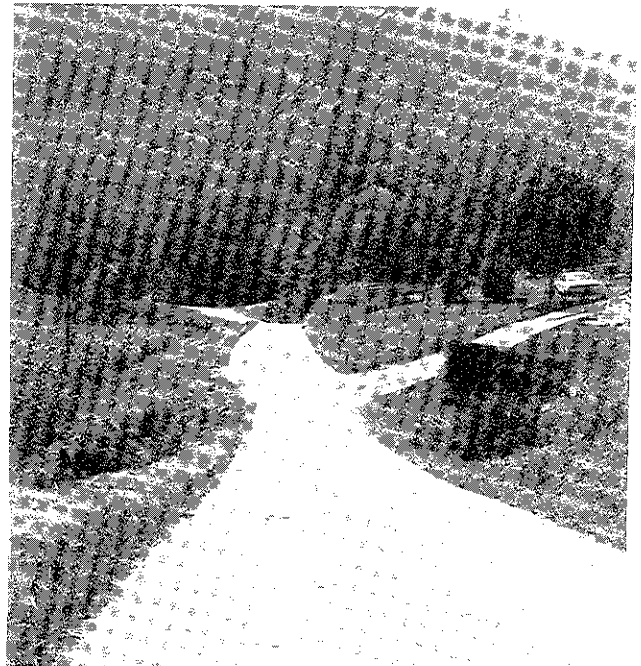
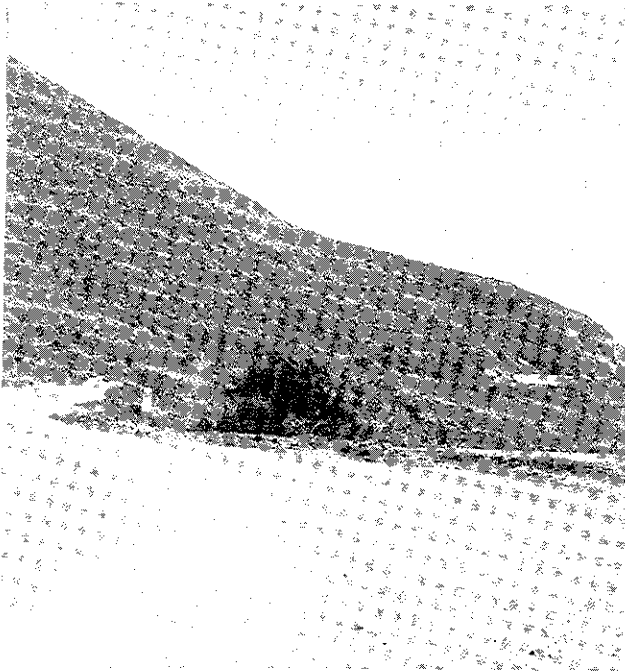

Side slope improvements are often warranted where adverse terrain and roadway geometrics can surprise the driver. As an example, steeper side slopes, such as those shown in the figure on the left, are often acceptable on low speed-low volume highways where there are numerous sharp curves. The driver in this situation adjusts to the characteristics of the highway and drives accordingly. Side slope improvements should be considered, as shown on the figure on the right, when the roadway geometrics can surprise the driver. In this case, a sharp curve follows along a nearly tangent section.

## Terrain Features

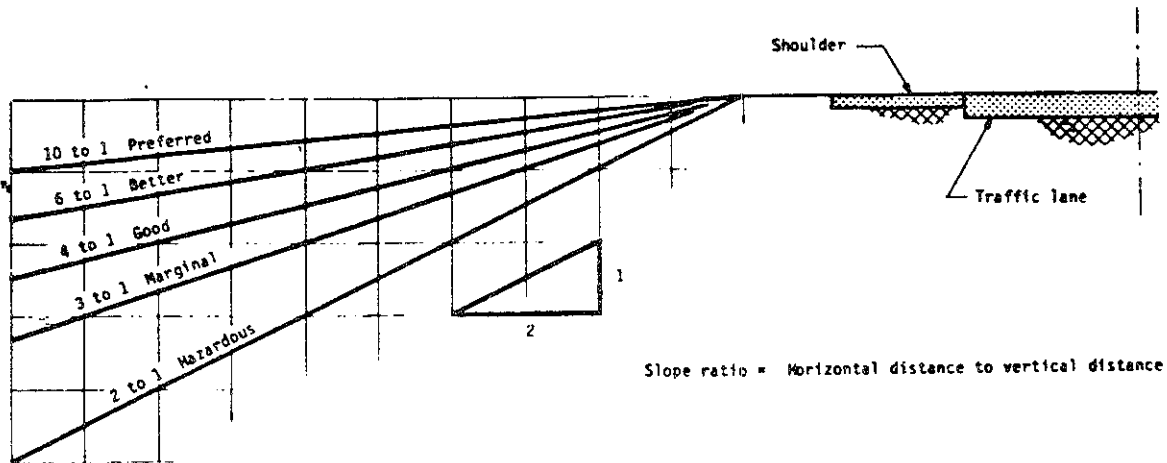

The slope ratio (slope rate) is the measure of the steepness of the slope. The following information can be used to help evaluate hazardous and safe slopes.

- o 2:1 slopes are hazardous to motorists. Vehicle stability on 2:1 slopes is questionable because of the likelihood of vehicle rollover. 2:1 slopes next to the highway should be avoided or shielded with guardrail.
- o 3:1 slopes are marginally safe. Vehicles leaving the roadway and driving onto a 3:1 slope (even at a shallow angle where the vehicle is almost parallel to the road) will generally go down to the bottom of the slope. The driver will not be able to steer the vehicle up the slope or brake effectively. On a well graded 3:1 slope, vehicle stability is marginal. If other features (such as sign posts, trees, erosion, culvert pipes) are present, vehicle stability is questionable.
- o 4:1 slopes that are well graded are generally traversable. Drivers will often have some control over steering and braking (depending on how fast they are going and the angle at which they approach the slope). Again other features (such as trees, drainage culverts, guardrail or erosion) can cause vehicle instability.
- o 6:1 slopes are better than 4:1 slopes. Drivers generally can steer up the slope and brake. Minor rutting, wet grass, small shrubs and safety treated culverts don't appear to adversely affect vehicle stability. However, a vehicle traveling at 45 mph can vault a guardrail located on a 6:1 slope.
- o 10:1 slopes are best. This is the preferred slope. Although these slopes are often impractical, particularly on high embankments, they are the preferred slopes in front of guardrail sections, and at other places where safety hardware is being used.

The relative safety of side slopes is also influenced by embankment height and the steepness of the back slope or ditch. Generally, low embankments (several feet high) are considered safe when the adjacent ground is relatively flat and free of fixed objects. Steep back slopes, as often used on "V" shaped drainage ditches can be hazardous.



## Terrain Features

Highway ditches can influence roadside safety. The three significant factors related to highway safety are location, shape and size of the ditch. These three factors are generally interrelated, as discussed below:

- Location - Ditches located at the bottom of the side slopes (particularly the steeper slopes) can, if not shaped correctly, abruptly stop a vehicle.
- Shape - Ditches, even those on flat terrain and close to the roadway, can act as a ramp causing a vehicle to vault over a guardrail and into a fixed object.
- Size - deep ditches with steep sides, such as "V" ditches, can trap a vehicle tire and cause vehicle instability or trap and guide a vehicle into a hazardous object located in or near the ditch.

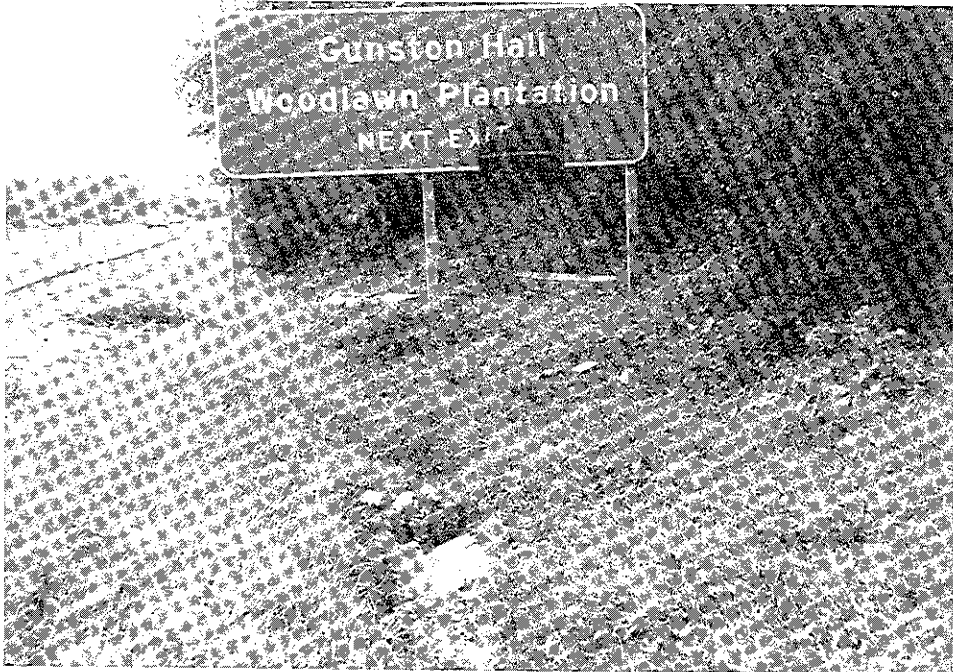

This picture provides an example of how ditch shape, size, and location can affect safety. The previous breakaway sign supports which can be seen laying on the ground failed to function. The vehicle was ramped up by the ditch end and struck the posts too high to activate the breakaway slip base. A second accident was a result of a motorcycle being vaulted by the ditch slope into the new sign panel. This situation has since been improved by relocating the sign. More information related to ditch safety is available in the "Guide For Selecting, Locating, and Designing Traffic Barriers".

Safety Hardware  
Sign Posts  
Wood Posts

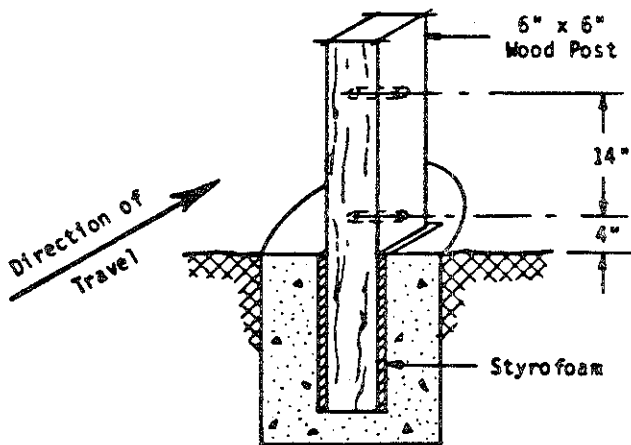
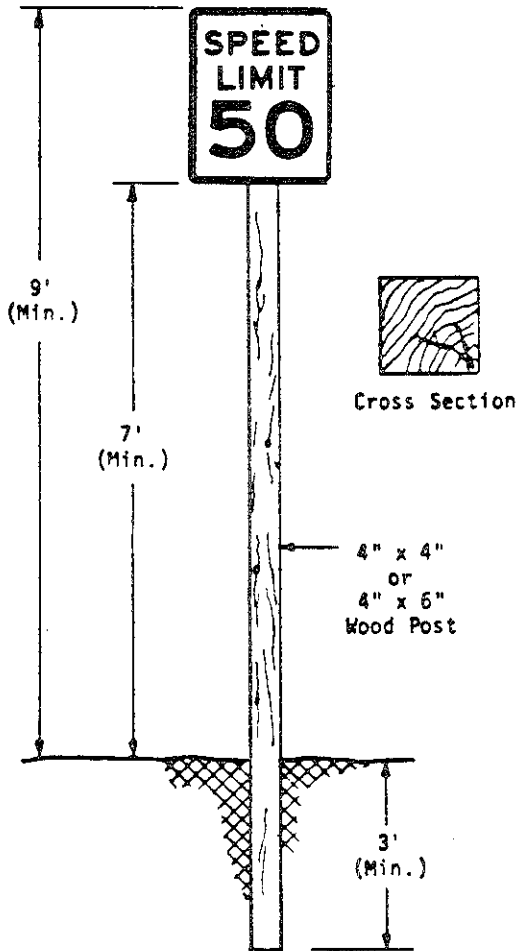

Wood post sign supports are the most commonly used. Properly sized wood posts will fracture when impacted by a vehicle. Some of the more important features of these supports are:

Small Supports (cross section less than 24 sq. in.) - The posts should be buried in firm ground. The minimum recommended depth is 3-feet (greater depth may be necessary to prevent vandalism). The posts should not be encased in concrete.

Large Supports should be drilled - A 6" x 6" wood post can be used if the cross section is weakened by drilling two 1-inch holes (perpendicular to the roadway) as shown. The 6" x 6" is the largest post recommended for a breakaway design. The posts should be set in nonreinforced concrete as shown at left. Sheet styrofoam (1/2-inch thick) wrapped around the post will facilitate removal of damaged post sections. Larger posts, such as 6" x 8" even when drilled, are not recommended.

Maximum Post Sizes -

<u>Max. Sign Panel</u>	<u>Post Size</u>
3 sq. ft.	4" x 4" nom.
7 sq. ft.	4" x 6" nom.
12 sq. ft.	6" x 6" nom. (with holes)

The posts should be southern pine, grade 2 or equivalent, penta treated.

Sign Panels - Sign panels should be adequately bolted to the post with oversized washers to prevent the panel from separating on impact and penetrating a windshield. It is recommended that the bottom of the sign panel be a minimum of 7 feet above the ground or the top of the panel a minimum of 9 feet above the ground to prevent the possibility of the sign panel and post rotating on impact into the windshield of a vehicle.

Safety Hardware  
 Sign Post  
 U-Channel Steel Post

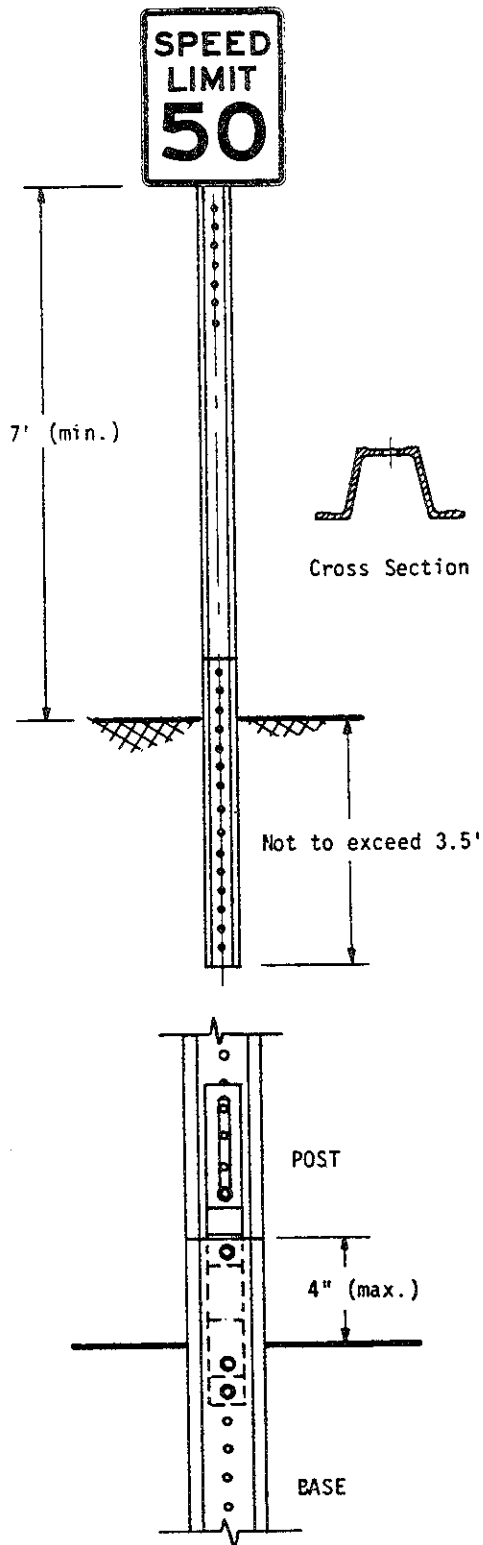

The U-channel rolled steel post is the second most common small sign support. This support is considered breakaway and will bend, fracture, or pull out of the ground on impact. Some of the more important features are:

Post Support - The post should be driven into the ground and not encased in concrete. For ease in removing damaged posts, the driven depth should generally not exceed 3.5 feet.

Breakaway Devices - There are several commercially available devices, similar to the one at lower left. Breakaway devices improve the safety characteristics of the post and generally reduce maintenance costs. They should be used if signs are in a location where they can be hit.

Maximum Post Sizes -

<u>Max. Size Panel</u>	<u>Post Size</u>
3 sq. ft.	2 lb./ft.
7 sq. ft.	3 lb./ft.
12 sq. ft.	two-2 lb./ft.

Sign Panels - Sign panels should be adequately bolted to the post with oversized washers to prevent the panel from separating on impact and penetrating a windshield.

Mounting Height - A minimum mounting height of 7 feet from the bottom of the sign panel to the ground or 9 feet from the top of the panel to the ground is recommended. Signs mounted at or above these minimum heights reduce the chances of windshield penetration by a sign that bends or yields into the vehicle on impact.

Safety Hardware  
 Sign Posts  
 Steel Pipe Post

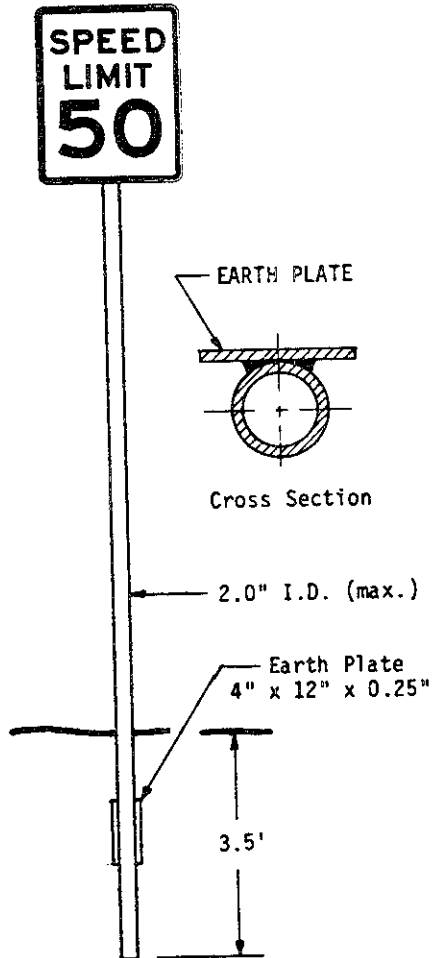

Steel pipe posts, although less common, are used principally in urbanized areas. The circular cross section provides for sign orientation in any direction. The steel pipe will generally fracture at the base upon impact. Some of the more important features of this type of support are:

Post Support - Steel pipe posts can be driven directly in the ground to a depth of at least 3.5 feet. A steel plate measuring 4"x12"x0.25" should be welded or bolted to the pipe, as shown, to prevent twisting from wind loads.

Breakaway Devices - A collar assembly similar to the one shown is recommended if the support is in a location where it can be hit. The collar assembly consists of a concrete footing (usually 2.5' x 1' dia), 2-foot pipe base (usually one size larger than post), and a pipe reduction collar. Upon impact, the post will generally shear off just above the collar allowing quick and easy replacement with a new collar assembly. The post is often salvageable.

Maximum Post Size -

<u>Max. Sign Panel</u>	<u>Pipe Size</u>
7 sq. ft.	2.0 in. I.D.
12 sq. ft.	2.5 in. I.D.

Standard steel pipe, schedule 40, galvanized should be used.

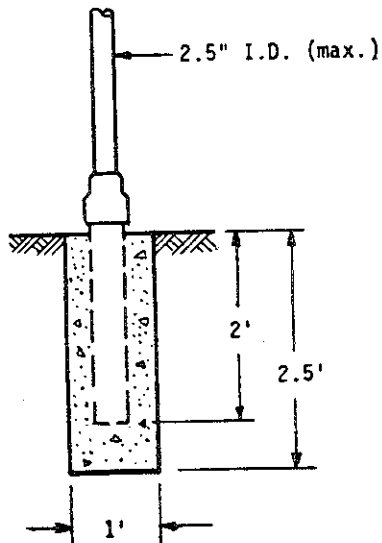

Sign Panels - Sign panels should be securely mounted with pipe clamps to prevent the sign panel from rotating or slipping from the posts and penetrating a windshield.

Safety Hardware  
 Sign Posts  
 Square Steel Tube (Perforated)

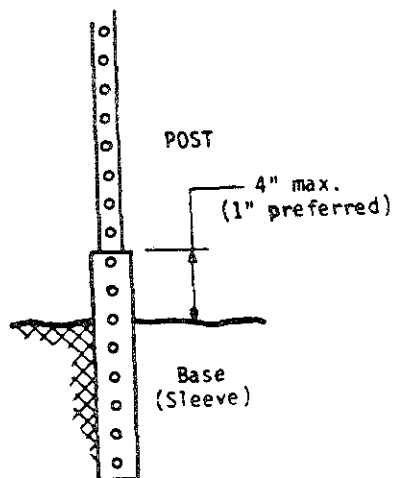
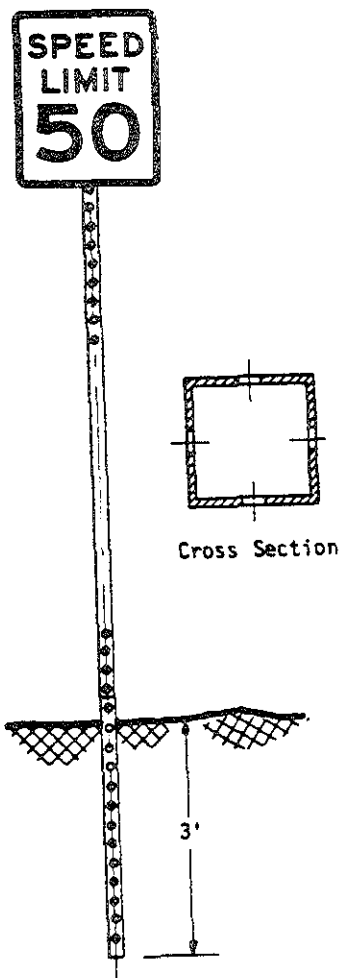

There are a number of other commercially available sign supports. The FHWA does not endorse any particular proprietary product. Usage will depend on site conditions, local requirements, and cost considerations.

One of the more common commercially available sign supports is the square tube design. This sign support is used in many areas. Signs can be readily attached to any of the sides. The square tube usually yields then fractures upon impact. Some of the more important features of these supports are:

Post Support - Posts can be driven into the ground and not encased in concrete. For ease in removal, the driven depth of the anchor should not exceed 3 feet.

Breakaway Devices Sleeve assemblies, such as the one on the left, can be used to improve the breakaway characteristics of the support and reduce maintenance. This type of assembly concentrates the tube fracture just above the sleeve. The old post stub can usually be easily removed and a new post inserted. Details for the sleeve assembly (several are commercially available) can be obtained through a local technology transfer center.

Maximum Post Size -

Max. Sign panel	Post Size
7 sq. ft.	2.25"x2.25" x0.105"
12 sq. ft.	2.5"x2.5" x0.135"

Sign Panels - Sign panels should be securely bolted to the post with oversized washers to prevent the panel from separating on impact.

## Safety Hardware Splicing and Bracing Sign Posts

### Splicing

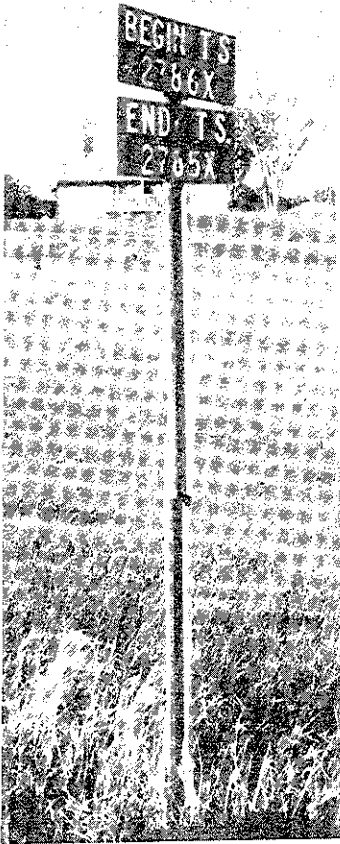

Post splicing can affect the safety characteristics of a sign support. Incorrect practices (as shown in the photo on the left) can result in vehicle snagging or flying parts that may penetrate the vehicle windshield. Some of the important features of good splices are:

- Use no more than one splice - Multiple splices should be avoided.
- Keep splice close to the ground. Splices should be less than 24 inches above the ground.
- Keep the upper section of the support "behind" or downstream of the bottom section - so as to reduce the chances of snagging or separation.

### Bracing

Diagonal sign support bracing helps maintain the position of sign panels; however, any stiffening of the support system makes it more hazardous. Braces should be avoided. When it is absolutely necessary to increase the strength of the post support system, larger breakaway or multiple breakaway posts should be considered. When as an interim measure, a brace is used, it should be:

- Lighter in weight (weaker) than the main vertical support.
- Attached near the top of the post to reduce the chances of spearing.
- Attached at the ground in a manner that will allow it to "kick free".

## Safety Hardware Breakaway Light Poles

Several types of breakaway light pole bases are available. Two more common types are shown on the left.

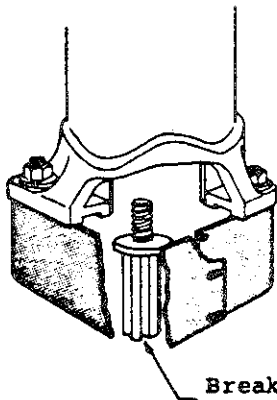
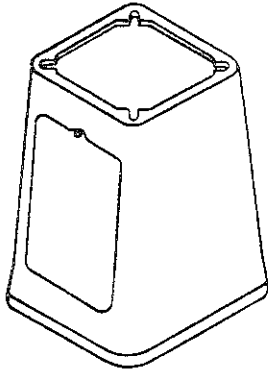

Breakaway coupling  
attached to anchor bolt.

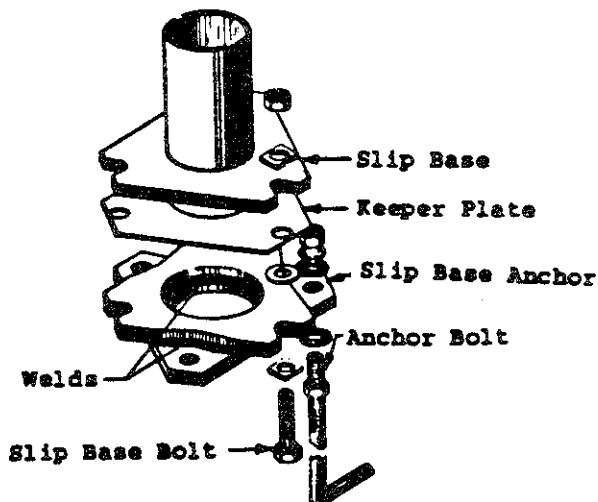

### Breakaway Transformer Base

The transformer base is cast from an alloy. Certain bases are certified as meeting the breakaway criteria and structural requirements as set forth in the 1975 AASHTO publication "Standard Specifications for Structural Supports for Highway Signs, Luminaires, and Traffic Signals".

### Breakaway Support Coupling

The breakaway coupling are fabricated from either die cast aluminum or extruded from an alloy. When couplings are specified, each light pole will require four (4) couplings, four (4) galvanized or stainless steel threaded studs, eight (8), flat washers, and four (4) hex or torque nuts.

### Slip Base

The slip base is fabricated from steel plate and is welded to the pole shaft prior to galvanizing. Two factors are important to the proper functioning of a slip base: the torque on the bolts should be approximately 250 foot-pounds for a standard 1-inch anchor bolt and the slip anchor plate height should not exceed 4 inches above the ground. The area around the slip base may need to be regraded to ensure that this 4-inch height is not exceeded as measured by a line connecting wheel tracks 60 inches apart.

Check with State highway department, or local technology transfer center for specific details.

## Clear Zone

One of the best ways to approach roadside safety is to establish a realistic clear zone criteria and then try to consistently apply it.

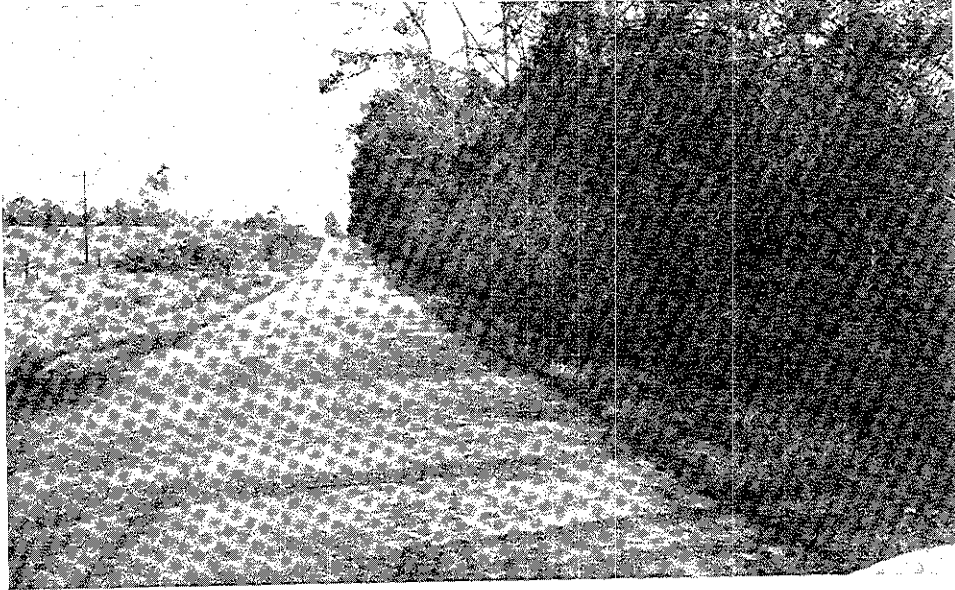

The picture above shows a low volume road that is going to be resurfaced and along with this roadway work it was decided to establish a clear zone within the highway right-of-way. Trees and other fixed objects on the left side are being cleared to the fence/utility poles located at the right-of-way line).

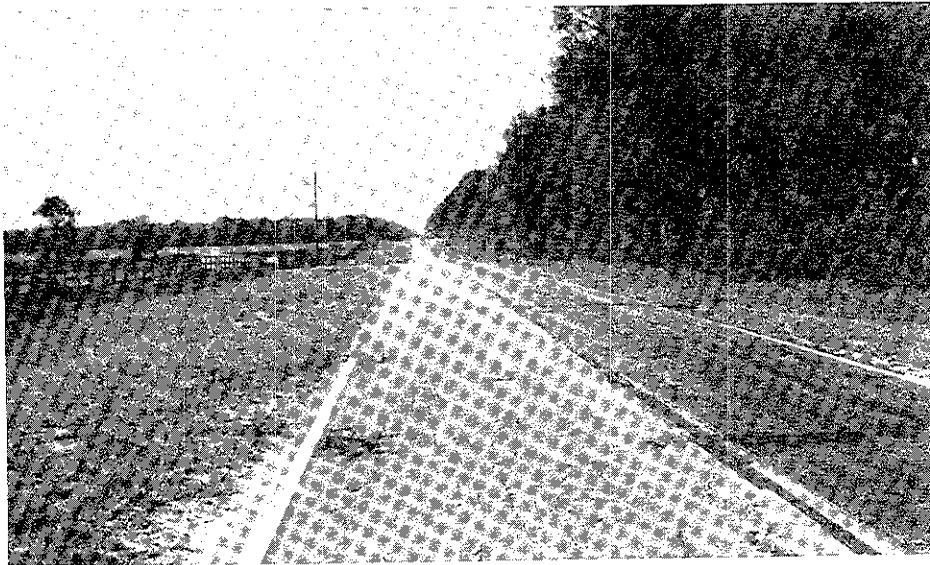

This picture shows the same road in a section where the clear zone has already been improved. Note the consistency in the section being improved as compared to the existing section.



## Clear Zone

Often establishing a clear zone requires tree removal which can be a very emotional issue. When it is decided to remove trees, it is important to remember tree stumps and roots can act like small structures (described on page 6). The stump should be removed or at least cut lower than 4 inches above the existing ground.

Relocated features should be located consistent with other fixed objects. Utility poles and culvert ends can be located at the the edge of tree line or as far back into the desired clear zone as right-of-way allows.

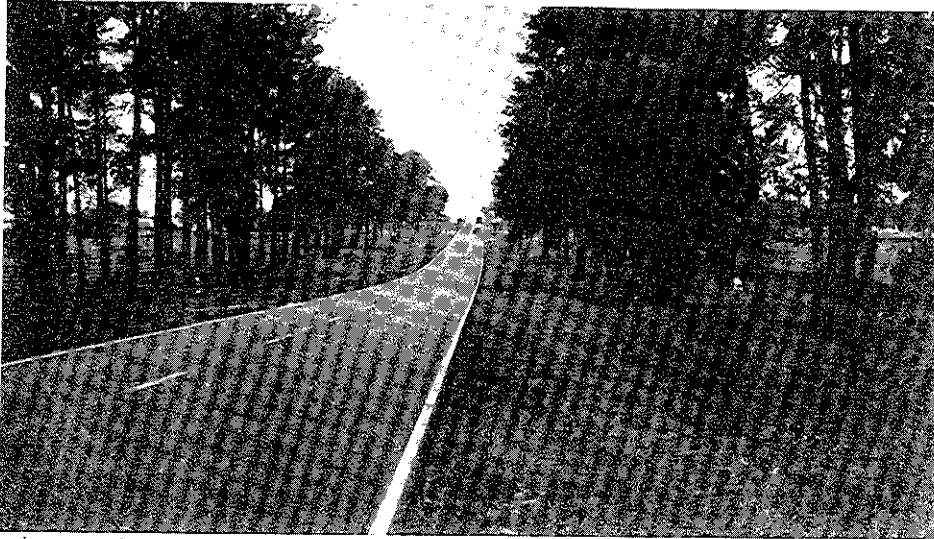

The picture above shows a consistent approach to establishing a clear zone. Trees have been selectively removed, utility poles relocated to the tree line, side slopes and ditches are well graded; and culvert ends have been extended into the tree line. The culvert end is on the right side where the individual is standing.

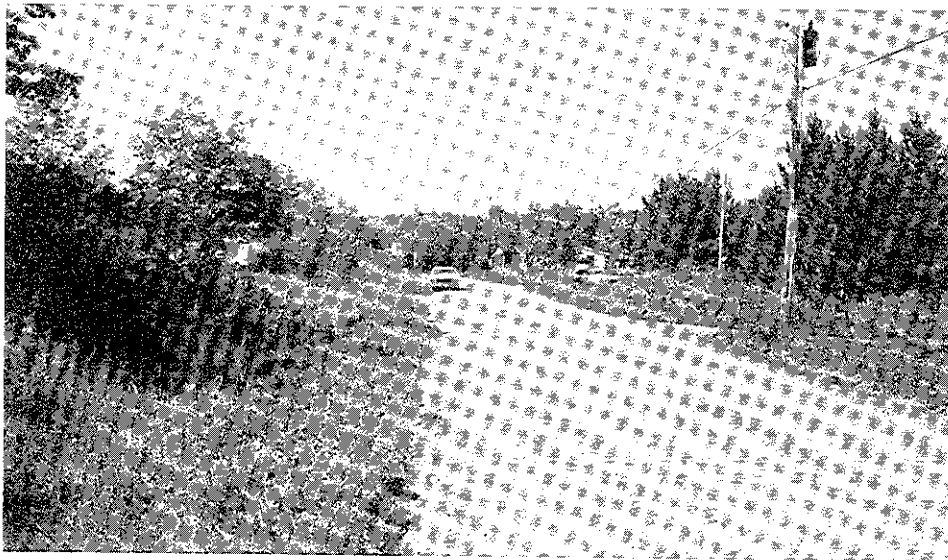

In this picture a minimum 10-foot clear zone has been established along a low volume gravel road. The clear zone is free of fixed objects and provides a well graded relatively flat slope and ditch adequate for a low speed, low volume road.

## Reference Index

This section provides references for detailed information on the identification and treatment of roadside hazards.

1. Guide for Selecting, Locating, and Designing Traffic Barriers

This publication summarizes the current state of knowledge related to clear zones, severity of features, warrants for barriers and cost effective analysis methods for considering alternatives. It is available from the American Association of State Highway and Transportation Officials, (AASHTO) 444 North Capital Street, N.W., Suite 275, Washington, D.C. 20001.

2. Guide for Selecting a Cost-Effective Small Highway Sign Support System.

This publication summarizes an objective method to select a cost-effective sign support system. The publication also covers the crash worthiness of different single post support systems.

It is available under stock number 050-001-00158-6 from the Superintendent of Documents, U.S. Government Printing Office, Washington, D.C. 20402.

3. A Guide to Standardized Highway Lighting Pole Hardware

This publication provides details and specifications on several of the most common breakaway lighting pole supports and bases in use. It is available from the American Road and Transportation Builders Association, 525 School Street, S.W., Washington, D.C. 20024.

4. A Guide to Erecting Mailboxes on Highways

This publication provides information on potentially hazardous mailbox situations. It also provides details and specifications on improved mailbox installations. It is available from AASHTO.

5. State Highway Agency Standard Drawings and Specifications

State highway agency standard drawings often provide details of breakaway devices, specifications for installation, and methods of payment. State standards may also relate procedures and details that are unique to the State or geographical area. State standards and specifications can be obtained through the State highway agency.