

REPORT

05-0005

SDMS 268551

REFERENCE

LENOX LIBRARY ASSOCIATION
LENOX, MASSACHUSETTS 01240

MCP INTERIM PHASE II REPORT FOR
NEWELL STREET PARKING LOT SITE
AND CURRENT ASSESSMENT SUMMARY FOR
USEPA AREA 5B

VOLUME IV OF IV

General Electric Company

Pittsfield, Massachusetts

March 1994



BLASLAND, BOUCK & LEE, INC.
ENGINEERS & SCIENTISTS

MCP INTERIM PHASE II REPORT FOR
NEWELL STREET PARKING LOT SITE
AND CURRENT ASSESSMENT SUMMARY FOR USEPA AREA 5B

VOLUME IV OF IV

SUBMITTED TO THE MASSACHUSETTS DEPARTMENT
OF ENVIRONMENTAL PROTECTION AND
U.S. ENVIRONMENTAL PROTECTION AGENCY

GENERAL ELECTRIC COMPANY
PITTSFIELD, MASSACHUSETTS

MARCH 1994

BLASLAND, BOUCK & LEE, INC.
6723 TOWPATH ROAD, BOX 66
SYRACUSE, NY 13214

MCP INTERIM PHASE II REPORT FOR
NEWELL STREET PARKING LOT SITE
AND CURRENT ASSESSMENT SUMMARY FOR USEPA AREA 5B

TABLE OF CONTENTS

VOLUME IV OF IV

Appendix G	Supplemental Surficial Soil Sampling - Newell Street II Site
Appendix H	Supplemental Surficial Soil Sampling - 153 Newell Street
Appendix I	Well Construction Details
Appendix J	Groundwater Contour Map, June 1988
Appendix K	Ambient Air Monitoring for Polychlorinated Biphenyls (Zorex, November 1993), including Appendix XIX thereto
Appendix L	Decommissioning of Phenols Metering Station
Section 1 -	Various Information Related to the Former Phenols Metering Building
Section 2 -	Results of Phenols Analysis for Tank Liquids
Section 3 -	Results of TCLP Analysis for Tank Liquids
Section 4 -	Results of TOC Analysis for Tank Liquids
Section 5 -	August 27, 1992 Letter Dealing With the Removal of the Former Phenols Metering Building
Section 6 -	Results of Phenols Analysis of Interior Tank Surface Prior to Cleaning
Section 7 -	PCB Results for 19 Wipe Samples Collected From Surface of Cleaned Tank

APPENDIX G

SUPPLEMENTAL SURFICIAL SOIL SAMPLING - NEWELL STREET II SITE



November 19, 1993

Environmental & Facility Programs
Environmental Group
111 South Avenue, Amherst, MA 01001

Ms. J. Lyn Cutler
Section Chief, Special Projects
Department of Environmental Protection
436 Dwight Street
Springfield, MA 01103

**Re: GE Newell Street
Imminent Hazard Evaluation; Results of Sampling
1-1057 Pittsfield**

Dear Ms. Cutler:

In accordance with your letter of September 23, 1993, I am enclosing a report by Blasland and Bouck Engineers titled "Supplemental Surficial Soil Sampling Newell Street II Site." It contains the PCB results of four evenly spaced surficial soil samples along the southern GE property line adjacent to 153 Newell Street. As noted in the report, the PCB concentrations detected ranged from 0.47 to 9.6 ppm total PCBs.

The sample which showed the highest PCB concentration was also analyzed for the Appendix IX+3 constituents. The Appendix IX+3 results are presented in the enclosed report.

In accordance with your September 23 letter, the enclosed report also presents the VOC field screening results and soil descriptions for each sample.

Based on these results, there appears to be no need for concern with an "imminent hazard" in this area. The PCB concentrations detected are all below even DEP's surficial soil guideline level of 10 ppm for Short-Term Measure evaluation in high-use residential areas (which, as you know, GE does not accept and believes is overly conservative). Moreover, the appendix IX+3 results reveal no constituent levels of concern which would warrant an STM.

Please call me if you have any questions.

Yours truly,

G. Grant Bowman
Manager, Environmental Engineering

Enclosure

cc: R. Bell, DEP
J.R. Bieke, Shea & Gardner
L. Bolduc, Pittsfield Commissioner of Public Health
R.F. Desgroseilliers, GE
E. Ebert, ChemRisk
R.K. Goldman, Blasland & Bouck
S.F. Joyce, DEP Commissioner's Office
A. Kurpaska, DEP
B. Olson, EPA Region I
Mayor Edward Reilly, City of Pittsfield
A.J. Thomas, Jr., GE
A. Weinberg, DEP
Housatonic River Initiative
ECL IP(IV)(A)1

SUPPLEMENTAL SURFICIAL SOIL SAMPLING - NEWELL STREET II SITE

GENERAL ELECTRIC COMPANY
PITTSFIELD, MASSACHUSETTS
NEWELL STREET MCP SITE

I. BACKGROUND

In a letter to the General Electric Company (GE) dated August 25, 1993, the Massachusetts Department of Environmental Protection (MDEP) directed GE to provide within 20 days a proposal for conducting surficial soil sampling and PCB analysis at the southern end of the GE Newell Street Parking Lot (the GE Newell Street II site). The specific area of interest was the area of the parking lot adjacent to the fence that borders the property at 153 Newell Street. These data were requested to facilitate the MDEP's performance of an "imminent hazard evaluation" of this area.

On September 13, 1993, GE submitted a proposal to collect soil samples at the Newell Street II site in accordance with the MDEP's August 25, 1993 letter. The MDEP provided conditional approval of the proposed sampling plan in a letter dated September 23, 1993.

On behalf of GE, Blasland & Bouck Engineers, P.C. implemented the proposed sampling plan, amended in accordance with the MDEP's September 23, 1993 letter. These activities were performed on October 6, 1993. A description of these activities and a summary of the associated results are presented below.

II. PROTOCOLS AND METHODS

A total of four soil samples were collected from four separate locations from within the grassy area located at the southern end of the GE Newell Street Parking Lot (see Figure 1) and submitted for laboratory analyses. These

samples were collected and analyzed using protocols outlined in the MCP Sampling and Analysis Plan (Blasland & Bouck, September 1990).

In general, discrete soil samples were collected from 0 to 6 inches below the ground surface. Prior to sample collection, the grass and approximately one-half inch of root matter were removed and set aside. A sufficient volume of soil was collected from the 0- to 6-inch depth interval and placed onto a flat aluminum pan where it was thoroughly mixed with a stainless steel spatula. After a sufficient sample volume had been collected, the hole was filled with clean potting soil, and the grass and root matter were replaced.

Prior to mixing, the physical characteristics of each sample were recorded, and a subsample from each sample was removed and screened in the field using a photoionization detector (PID). A summary of this information is presented in Table 1.

Subsequent to mixing, the soil samples were placed into appropriate sample containers, with a subsample of each sample being removed and screened for PCBs at the OBG Laboratories' facility at the GE Plant in Pittsfield. The sample exhibiting the highest PCB concentration (NS-24) was submitted to CompuChem Laboratories, Inc., Research Triangle Park, North Carolina, for analysis of constituents listed in Appendix IX of 40 CFR Part 264, plus benzidine, 2-chloroethylvinyl ether, and 1,2-diphenylhydrazine (Appendix IX+3). Subsamples of all four samples were also submitted to IT Analytical Services, Knoxville, Tennessee, for PCB and total organic carbon (TOC) analyses. The results of these PCB and TOC analyses, as well as the Appendix IX+3 results are summarized in Figure 1. Only the constituents detected are shown on that figure (although most are at concentrations below the Contract Laboratory Program quantitation limit). The analytical data sheets and associated chain-of-custody forms are included in Appendix A.

III. SUMMARY OF ANALYTICAL DATA

As shown in Figure 1, PCB concentrations of the four soil samples collected ranged from 0.47 to 9.6 parts per million-dry weight (ppm) with sample NS-24 exhibiting the highest PCB concentration. TOC ranged from 25,600 to 64,500 ppm. The Appendix IX+3 analysis of sample NS-24 indicated the presence of methylene chloride at 0.022 ppm; however, this analyte, a common laboratory contaminant, was also found in the associated method blank. Various semivolatile constituents (SVOCs) were noted to be present in sample NS-24; however, with the exception of total phenols at 0.38 ppm, each of the SVOCs found were indicated to be at levels which were below the Contract Laboratory Protocol quantitation limit. The estimated concentrations of the various SVOCs detected are presented in Figure 1 with appropriate qualification. Various metal constituents were also detected; however, the levels at which these constituents were found generally represent background conditions.

TABLE 1
 GENERAL ELECTRIC COMPANY
 PITTSFIELD, MASSACHUSETTS
 NEWELL STREET PARKING LOT
SUPPLEMENTAL SOIL SAMPLING - GENERAL DATA

Sample ID	Sample Depth (inches)	Average PID Results	Sample Description
NS-21	0-6	0.25	Gray-brown, fine to medium sand with some silt and gravel
NS-22	0-6	1.95	Brown, silty, fine to medium sand with some gravel and coarse sand
NS-23	0-6	0.35	Brown, fine, sandy silt with some gravel and medium to coarse sand
NS-24	0-6	0.30	Brown silt with some fine to medium sand

Notes:

1. Samples were collected on October 6, 1993 by Blasland & Bouck Engineers, P.C.
2. Samples were screened in the field with a photoionization detector (PID).
3. All samples were submitted for laboratory analysis of PCBs.
4. Sample NS-24, which exhibited the highest PCB concentration, was also submitted for laboratory analysis of constituents listed in Appendix IX of 40 CFR Part 264, plus benzidine, 2-chloroethyl vinyl ether, and 1,2-diphenylhydrazine.
5. Refer to Figure 1 for a summary of the associated analytical results.

APPENDIX A

- **ANALYTICAL DATA SHEETS**
- **CHAIN-OF-CUSTODY FORMS**

ANALYTICAL DATA SHEETS

Client Sample ID: G. E. Pittsfield - Newell St.

Job Number: BLB 55192

PCBs ANALYSIS

Results in $\mu\text{g}/\text{kg}$ (ppb)

Sample Matrix: Soil

Client Sample ID	Lab Sample ID	Aroclor 1016, 1232, 1242† and/or		Aroclor 1254	Aroclor 1260	Total Aroclors
		1248				
NS-21	ZZ6302	40	U	210 *	260 *	470
NS-22	ZZ6303	390	U	2100 *	1500 *	3600
NS-23	ZZ6304	240	U	3600 *	4500 *	8100
NS-24	ZZ6305	75	U	4800 *	4800 *	9600
Method Blank	BLM1407	40	U	90 U	90 U	90 U

Extraction Date: 10/14/93
 Analysis Date: 10/21/93, 10/22/93, 10/25/93

- † - Sample Aroclor pattern identified and/or calculated as Aroclor 1242.
- U - Compound was analyzed for but not detected. The number is the detection limit for the sample.
- * - Sample exhibits alteration of standard aroclor pattern.

Blasland & Bouck Engineers, P.C.
October 27, 1993

IT ANALYTICAL SERVICES
5815 MIDDLEBROOK PIKE
KNOXVILLE, TN

Client Sample ID: G. E. Pittsfield - Newell St.

Job Number: BLB 55192

TOTAL ORGANIC CARBON ANALYSIS

Results in mg/kg (ppm)

Sample Matrix: Soil

<u>Client Sample ID</u>	<u>Lab Sample ID</u>	<u>Result</u>
Method Blank	P5573	100 U
NS-21	ZZ6302	25600
NS-22	ZZ6303	43100
NS-23	ZZ6304	46600
NS-24	ZZ6305	64500

Analysis Date: 10/12/93, 10/13/93

U - Compound was analyzed for but not detected. The number is the detection limit for the sample.

1A
VOLATILE ORGANICS ANALYSIS DATA SHEET

EPA SAMPLE NO.

NS-24RE

Lab Name: COMPUCHEM, RTP Contract: 500077
 Lab Code: COMPU Case No.: 27893 SAS No.: _____ SDG No.: 01
 Matrix: (soil/water) SOIL Lab Sample ID: 582450
 Sample wt/vol: 5.0 (g/mL) G Lab File ID: GR082450C03
 Level: (low/med) LOW Date Received: 10/08/93
 % Moisture: not dec. 20 Date Analyzed: 10/21/93
 Column: (pack/cap) CAP Dilution Factor: 1.0

CONCENTRATION UNITS:
(ug/L or ug/Kg) UG/KG

CAS NO.	COMPOUND	CONCENTRATION UNITS: (ug/L or ug/Kg) <u>UG/KG</u>	Q
74-87-3	-----Chloromethane	12	U
74-83-9	-----Bromomethane	6	U
75-01-4	-----Vinyl Chloride	12	U
75-00-3	-----Chloroethane	12	U
75-09-2	-----Methylene Chloride	22	B
67-64-1	-----Acetone	12	U
75-15-0	-----Carbon Disulfide	6	U
75-35-4	-----1,1-Dichloroethene	6	U
75-34-3	-----1,1-Dichloroethane	6	U
67-66-3	-----Chloroform	6	U
107-06-2	-----1,2-Dichloroethane	6	U
78-93-3	-----2-Butanone	12	U
71-55-6	-----1,1,1-Trichloroethane	6	U
56-23-5	-----Carbon Tetrachloride	6	U
108-05-4	-----Vinyl Acetate	12	U
75-27-4	-----Bromodichloromethane	6	U
78-87-5	-----1,2-Dichloropropane	6	U
10061-01-5	-----cis-1,3-Dichloropropene	6	U
79-01-6	-----Trichloroethene	6	U
124-48-1	-----Dibromochloromethane	6	U
79-00-5	-----1,1,2-Trichloroethane	6	U
71-43-2	-----Benzene	6	U
10061-02-6	-----Trans-1,3-Dichloropropene	6	U
110-75-8	-----2-Chloroethylvinylether	12	U
75-25-2	-----Bromoform	12	U
108-10-1	-----4-Methyl-2-Pentanone	19	U
591-78-6	-----2-Hexanone	19	U
127-18-4	-----Tetrachloroethene	6	U
79-34-5	-----1,1,2,2-Tetrachloroethane	12	U
108-88-3	-----Toluene	6	U
108-90-7	-----Chlorobenzene	6	U
100-41-4	-----Ethylbenzene	6	U
100-42-5	-----Styrene	6	U
1330-20-7	-----Total Xylenes	6	U
74-88-4	-----Iodomethane	12	U
107-02-8	-----Acrolein	110	U

FORM I VOA

1/87 Rev.

107-02-8-----Acrolein	110	U
107-13-1-----Acrylonitrile	150	U
75-69-4-----Trichlorofluoromethane	6	U
107-05-1-----3-Chloropropene	6	U
76-13-1-----1,1,2-Trichloro-1,2,2-trifluo	6	U
354-58-5-----1,1,1-Trichloro-2,2,2-trifluo	6	U
74-95-3-----Dibromomethane	12	U
4170-30-3-----Crotonaldehyde	6	U
106-93-4-----1,2-Dibromoethane	6	U
630-20-6-----1,1,1,2-Tetrachloroethane	6	U
764-71-0-----cis-1,4-Dichloro-2-butene	6	U
96-18-4-----1,2,3-Trichloropropane	19	U
764-71-0-----trans-1,4-Dichloro-2-butene	6	U
96-12-8-----1,2-Dibromo-3-chloropropane	6	U
96-18-4-----Ethylmethacrylate	12	U

FORM I VOA

1/87 Rev.

1B
SEMIVOLATILE ORGANICS ANALYSIS DATA SHEET

EPA SAMPLE NO.

NS-24

Lab Name: COMPUCHEM, RTP Contract: 500077

Lab Code: COMPU Case No.: 27893 SAS No.: _____ SDG No.: 02

Matrix: (soil/water) SOIL Lab Sample ID: 582454

Sample wt/vol: 30.0 (g/mL) G Lab File ID: GH082454B15

Level: (low/med) LOW Date Received: 10/08/93

% Moisture: not dec. 20 dec. _____ Date Extracted: 10/12/93

Extraction: (SepF/Cont/Sonc) SONC Date Analyzed: 11/04/93

GPC Cleanup: (Y/N) N pH: _____ Dilution Factor: 1.00

CAS NO.	COMPOUND	CONCENTRATION UNITS: (ug/L or ug/Kg) <u>UG/KG</u>	Q
62-75-9	N-Nitrosodimethylamine	820	U
110-86-1	Pyridine	690	U
97-63-2	Ethyl methacrylate	31	U
123-63-7	Paraldehyde	450	U
109-06-8	2-Picoline	1500	U
10595-95-6	Nitrosomethylethylamine	680	U
66-27-3	Methyl methanesulfonate	880	U
108-95-2	Phenol	160	J
55-18-5	N-Nitrosodiethylamine	750	U
62-50-0	Ethyl methanesulfonate	750	U
62-53-3	Aniline	700	U
76-01-7	Pentachloroethane	1000	U
111-44-4	bis(2-Chloroethyl) Ether	740	U
95-57-8	2-Chlorophenol	790	U
541-73-1	1,3-Dichlorobenzene	640	U
100-44-7	Benzyl Chloride	720	U
106-46-7	1,4-Dichlorobenzene	650	U
100-51-6	Benzyl Alcohol	690	U
95-50-1	1,2-Dichlorobenzene	740	U
99-65-0	1,3-Dinitrobenzene	700	U
56-57-5	4-Nitroquinoline 1-oxide	6000	U
465-73-6	Isodrin	1200	U
95-48-7	2-Methylphenol	810	U
52-85-7	Famphur	2500	U
108-60-1	bis(2-Chloroisopropyl) Ether	810	U
108-39-4	3-Methylphenol	1600	U
106-44-5	4-Methylphenol	1600	U
930-55-2	N-Nitrosopyrrolidine	660	U
59-89-2	N-Nitrosomorpholine	940	U
98-86-2	Acetophenone	820	U
621-64-7	N-Nitroso-Di-n-Propylamine	760	U
636-21-5	o-Toluidine hydrochloride	2500	U
67-72-1	Hexachloroethane	750	U
98-95-3	Nitrobenzene	850	U

FORM I SV-1

1/87 Rev.

100-75-4-----N-Nitrosopiperidine	920	U
78-59-1-----Isophorone	850	U
88-75-5-----2-Nitrophenol	780	U
105-67-9-----2,4-Dimethylphenol	760	U
108-70-3-----1,3,5-Trichlorobenzene	760	U
98-87-3-----Benzal Chloride	660	U
65-85-0-----Benzoic Acid	2400	U
111-91-1-----bis(2-Chloroethoxy)Methane	840	U
120-83-2-----2,4-Dichlorophenol	690	U
120-82-1-----1,2,4-Trichlorobenzene	690	U
91-20-3-----Naphthalene	57	J
106-47-8-----4-Chloroaniline	860	U
87-65-0-----2,6-Dichlorophenol	1500	U
1888-71-7-----Hexachloropropene	710	U
87-68-3-----Hexachlorobutadiene	700	U
87-61-6-----1,2,3-Trichlorobenzene	750	U
98-07-7-----Benzotrichloride	780	U
924-16-3-----N-Nitroso-di-n-butylamine	1800	U
59-50-7-----4-Chloro-3-Methylphenol	940	U
94-59-7-----Safrole	720	U
126-68-1-----Triethylphosphorothioate	6600	U
91-57-6-----2-Methylnaphthalene	1000	U
90-12-0-----1-Methylnaphthalene	1400	U
95-94-3-----1,2,4,5-Tetrachlorobenzene	1600	U
634-90-2-----1,2,3,5-Tetrachlorobenzene	1600	U
77-47-4-----Hexachlorocyclopentadiene	820	U
88-06-2-----2,4,6-Trichlorophenol	1600	U
95-95-4-----2,4,5-Trichlorophenol	1600	U
120-58-1-----Isosafrole	1600	U
91-58-7-----2-Chloronaphthalene	1200	U
90-13-1-----1-Chloronaphthalene	1500	U
634-66-2-----1,2,3,4-Tetrachlorobenzene	800	U
88-74-4-----2-Nitroaniline	1400	U
130-15-4-----1,4-Naphthoquinone	2000	U
131-11-3-----Dimethyl Phthalate	1200	U
208-96-8-----Acenaphthylene	140	J
606-20-2-----2,6-Dinitrotoluene	940	U

1C
SEMIVOLATILE ORGANICS ANALYSIS DATA SHEET

EPA SAMPLE NO.

NS-24

Lab Name: COMPUCHEM, RTP Contract: 500077

Lab Code: COMPU Case No.: 27893 SAS No.: _____ SDG No.: 02

Matrix: (soil/water) SOIL Lab Sample ID: 582454

Sample wt/vol: 30.0 (g/mL) G Lab File ID: GH082454B15

Level: (low/med) LOW Date Received: 10/08/93

% Moisture: not dec. 20 dec. _____ Date Extracted: 10/12/93

Extraction: (SepF/Cont/Sonc) SONC Date Analyzed: 11/04/93

GPC Cleanup: (Y/N) N pH: _____ Dilution Factor: 1.00

CAS NO.	COMPOUND	CONCENTRATION UNITS: (ug/L or ug/Kg) <u>UG/KG</u>	Q
99-09-2	3-Nitroaniline	860	U
83-32-9	Acenaphthene	820	U
51-28-5	2,4-Dinitrophenol	2100	U
100-02-7	4-Nitrophenol	5600	U
132-64-9	Dibenzofuran	860	U
121-14-2	2,4-Dinitrotoluene	820	U
608-93-5	Pentachlorobenzene	820	U
91-59-8	2-Naphthylamine	1100	U
134-32-7	1-Naphthylamine	1800	U
58-90-2	2,3,4,6-Tetrachlorophenol	1800	U
84-66-2	Diethylphthalate	900	U
297-97-2	Zinophos	840	U
7005-72-3	4-Chlorophenyl-phenylether	750	U
86-73-7	Fluorene	62	J
100-01-6	4-Nitroaniline	1400	U
99-55-8	5-Nitro-o-toluidine	1200	U
122-66-7	1,2-Diphenylhydrazine	860	U
534-52-1	4,6-Dinitro-2-Methylphenol	2200	U
86-30-6	N-Nitrosodiphenylamine (1)	1800	U
122-39-4	Diphenylamine	1800	U
99-35-4	1,3,5-Trinitrobenzene	1100	U
62-44-2	Phenacetin	760	U
101-55-3	4-Bromophenyl-phenylether	940	U
2303-16-4	Diallate	820	U
60-51-5	Dimethoate	820	U
118-74-1	Hexachlorobenzene	960	U
92-67-1	4-Aminobiphenyl	510	U
23950-58-5	Pronamide	810	U
87-86-5	Pentachlorophenol	1800	U
82-68-8	Pentachloronitrobenzene	800	U
85-01-8	Phenanthrene	650	J
120-12-7	Anthracene	93	J
84-74-2	Di-n-Butylphthalate	97	J
91-80-5	Methapyrilene	1600	U

(1) - Cannot be separated from Diphenylamine
FORM I SV-2

1/87 Rev.

50-18-0-----Cyclophosphamide	790	U
206-44-0-----Fluoranthene	760	J
92-87-5-----Benzidine	2000	U
129-00-0-----Pyrene	890	J
140-57-8-----Aramite	820	U
60-11-7-----p-Dimethylaminoazobenzene	840	U
510-15-6-----Chlorobenzilate	890	U
119-93-7-----3,3'-Dimethylbenzidine	1200	U
85-68-7-----Butylbenzylphthalate	850	U
53-96-3-----2-Acetylaminofluorene	890	U
101-14-4-----Methylene-bis(2-Chloroaniline	560	U
91-94-1-----3,3'-Dichlorobenzidine	600	U
106-51-4-----3,3'-Dimethoxybenzidine	1200	U
56-55-3-----Benzo(a)Anthracene	520	J
218-01-9-----Chrysene	610	J
117-81-7-----bis(2-Ethylhexyl)Phthalate	940	U
117-84-0-----Di-n-Octyl Phthalate	600	U
205-99-2-----Benzo(b)Fluoranthene	910	JX
57-97-6-----7,12-Dimethylbenzanthracene	510	U
207-08-9-----Benzo(k)Fluoranthene	910	JX
50-32-8-----Benzo(a)Pyrene	500	J
56-49-5-----3-Methylchloranthrene	760	U
224-42-0-----Dibenzo(a,j)acridine	510	U
193-39-5-----Indeno(1,2,3-cd)Pyrene	200	J
53-70-3-----Dibenz(a,h)Anthracene	540	U
191-24-2-----Benzo(g,h,i)Perylene	120	J

(1) - Cannot be separated from Diphenylamine

1D
ORGANOCHLORINE PESTICIDES AND PCBs ANALYSIS DATA SHEET

SAMPLE NO.

NS-24

Lab Name: COMPUCHEM, RTP

Contract:

Lab Code: COMPU

Case No.: 27893

SAS No.:

SDG No.: 310PE

Matrix: (soil/water) SOIL

Lab Sample ID: 582458

Sample wt/vol: 30.40(g/ml)G

Lab File ID:

% Moisture: 20 decanted: (Y/N) N

Date Received: 10/08/93

Extraction: (SepF/Cont/Sonc) SONC

Date Extracted: 10/13/93

Concentrated Extract Volume: 20000(uL)

Date Analyzed: 10/14/93

Injection Volume: 3.0(uL)

Dilution Factor: 1

GPC Cleanup: (Y/N) N

pH:

Sulfur Cleanup: (Y/N) N

CONCENTRATION UNITS:
(ug/L or ug/Kg) UG/K Q

CAS NO.	COMPOUND	CONCENTRATION UNITS: (ug/L or ug/Kg) <u>UG/K</u>	Q
58-89-9	gamma-BHC (Lindane)	1.2	U
76-44-8	Heptachlor	1.2	U
309-00-2	Aldrin	1.2	U
959-98-8	Endosulfan I	1.9	U
60-57-1	Dieldrin	1.9	U
33213-65-9	Endosulfan II	4.3	U
50-29-3	4,4'-DDT	4.3	U
72-43-5	Methoxychlor	4.3	U
319-84-6	alpha-BHC	1.2	U
319-85-7	beta-BHC	1.2	U
319-86-8	delta-BHC	1.2	U
1024-57-3	Heptachlor epoxide	1.2	U
72-55-9	4,4'-DDE	4.3	U
72-20-8	Endrin	3.1	U
72-54-8	4,4'-DDD	4.3	U
7421-93-4	Endrin aldehyde	1.2	U
1031-07-8	Endosulfan sulfate	2.5	U
11096-82-5	Aroclor-1260	3000	P
12674-11-2	Aroclor-1016	25	U
11104-28-2	Aroclor-1221	25	U
11141-16-5	Aroclor-1232	25	U
53469-21-9	Aroclor-1242	25	U
12672-29-6	Aroclor-1248	25	U
11097-69-1	Aroclor-1254	25	U
8001-35-2	Toxaphene	25	U
57-74-9	Chlordane (Technical)	4.9	U

1D
ORGANOPHOSPHORUS PESTICIDES ANALYSIS DATA SHEET

SAMPLE NO.

NS-24

Lab Name: COMPUCHEM, RTP

Contract:

Lab Code: COMPU Case No.: 27893 SAS No.: SDG No.: 2410P

Matrix: (soil/water) SOIL Lab Sample ID: 582462

Sample wt/vol: 30.00(g/ml)G Lab File ID:

% Moisture: 20 decanted: (Y/N) N Date Received: 10/08/93

Extraction: (SepF/Cont/Sonc) SONC Date Extracted: 10/13/93

Concentrated Extract Volume: 10000(uL) Date Analyzed: 10/16/93

Injection Volume: 3.0(uL) Dilution Factor: 1

GPC Cleanup: (Y/N) N pH: Sulfur Cleanup: (Y/N) N

CAS NO.	COMPOUND	CONCENTRATION UNITS: (ug/L or ug/Kg) <u>UG/KG</u>	Q
298-02-2-----	Phorate	4.2	U
3689-24-5-----	Sulfotepp	4.2	U
298-04-4-----	Disulfoton	4.2	U
60-51-5-----	Dimethoate	4.2	U
298-00-0-----	Methyl Parathion	4.2	U
56-38-2-----	Parathion	4.2	U
52-85-7-----	Famphur	4.2	U

1D
HERBICIDE ORGANICS ANALYSIS DATA SHEET

SAMPLE NO.

NS-24

Lab Name: COMPUCHEM, RTP

Contract:

Lab Code: COMPU

Case No.: 27893

SAS No.:

SDG No.: 365H

Matrix: (soil/water) SOIL

Lab Sample ID: 582466 D50

Sample wt/vol: 50.30(g/ml)G

Lab File ID:

% Moisture: 20 decanted: (Y/N) N

Date Received: 10/08/93

Extraction: (SepF/Cont/Sonc) SEPF

Date Extracted: 10/13/93

Concentrated Extract Volume: 5000(uL)

Date Analyzed: 10/28/93

Injection Volume: 1.0(uL)

Dilution Factor: 5

GPC Cleanup: (Y/N) N

pH:

Sulfur Cleanup: (Y/N) N

CAS NO.	COMPOUND	CONCENTRATION UNITS: (ug/L or ug/Kg) <u>UG/KG</u>	Q
---------	----------	--	---

94-75-7-----	2,4-D	620	U
93-72-1-----	2,4,5-TP (Silvex)	160	U
93-76-5-----	2,4,5-T	160	U

COMPUCHEM LABORATORIES

PCDD/PCDF SUMMARY REPORT

SAMPLE: NS-24
PROJECT ID: 93-29

SPECIFIC ANALYTES	CONC (PPB)	DL (PPB)	BLANK (PPB)	Definitions:
2,3,7,8-TCDD	ND	0.11	ND	CONC - The concentration, given in parts per billion (ppb) or parts per trillion (ppt). DL - The detection limit, given in parts per billion (ppb), parts per trillion (ppt), or in nanograms (ng). BLANK - The concentration of the method blank. ND - (Non-Detect) The concentration of the analyte is less than the detection limit.
1,2,3,7,8-PeCDD	ND	0.2	ND	
1,2,3,4,7,8-HxCDD	ND	0.32	ND	
1,2,3,6,7,8-HxCDD	ND	0.16	ND	
1,2,3,7,8,9-HxCDD	ND	0.27	ND	
1,2,3,4,6,7,8-HpCDD	ND	0.33	ND	
OCDD	ND	0.43	ND	
2,3,7,8-TCDF	ND	0.099	ND	
1,2,3,7,8-PeCDF	ND	0.15	ND	
2,3,4,7,8-PeCDF	ND	0.16	ND	
1,2,3,4,7,8-HxCDF	ND	0.18	ND	
1,2,3,6,7,8-HxCDF	ND	0.14	ND	
2,3,4,6,7,8-HxCDF	ND	0.26	ND	
1,2,3,7,8,9-HxCDF	ND	0.34	ND	
1,2,3,4,6,7,8-HpCDF	ND	0.27	ND	
1,2,3,4,7,8,9-HpCDF	ND	0.29	ND	
OCDF	ND	0.54	ND	

TOTAL ANALYTES	CONC (PPB)	DL (PPB)	
TOTAL TCDD	ND	0.11	
TOTAL PeCDD	ND	0.20	
TOTAL HxCDD	ND	0.32	
TOTAL HpCDD	ND	0.33	
TOTAL TCDF	ND	0.10	
TOTAL PeCDF	ND	0.16	
TOTAL HxCDF	ND	0.34	
TOTAL HpCDF	ND	0.29	

TOTAL DIOXINS/FURANS: ND

TOTAL 2,3,7,8-TCDD TOXICITY (1989 ITEF) EQUIVALENTS: ND

For information, please reference the following when contacting our Technical Services Department:

TLH Project: P012644
 TLH Batch: B000563S
 TLH File: MA00867

TRIANGLE LABS.

12823 Park One Drive • Sugar Land, Texas 77478

Phone: (713) 240-5340 • FAX: (713) 240-5341

1
INORGANIC ANALYSIS DATA SHEET

CLIENT SAMPLE NO.

NS-24

Lab Name: COMPUCHEM ENV. CORP. Contract: SW-846
 Lab Code: COMPU Case No.: 50007 SAS No.: _____ SDG No.: 937361
 Matrix (soil/water): SOIL Lab Sample ID: 582470
 Level (low/med): LOW Date Received: 10/08/93
 % Solids: 79.8

Concentration Units (ug/L or mg/kg dry weight): MG/KG

CAS No.	Analyte	Concentration	C	Q	M
7429-90-5	Aluminum	12100		E	P
7440-36-0	Antimony	8.7	U		P
7440-38-2	Arsenic	14.2			F
7440-39-3	Barium	118			P
7440-41-7	Beryllium	1.1	U		P
7440-43-9	Cadmium	1.2	U		P
7440-70-2	Calcium	12500		E	P
7440-47-3	Chromium	17.0			P
7440-48-4	Cobalt	7.8	B		P
7440-50-8	Copper	75.8			P
7439-89-6	Iron	24900			P
7439-92-1	Lead	200			F
7439-95-4	Magnesium	6250		E	P
7439-96-5	Manganese	354		E	P
7439-97-6	Mercury	.68			CV
7440-02-0	Nickel	25.9			P
7440-09-7	Potassium	583	B		P
7782-49-2	Selenium	4.7		A	F
7440-22-4	Silver	1.3	U		P
7440-23-5	Sodium	105	B		P
7440-28-0	Thallium	1.2	U	W	F
7440-62-2	Vanadium	31.0			P
7440-66-6	Zinc	289			P
	Cyanide				NR
	Tin	32.1			P

Color Before: BLACK Clarity Before: _____ Texture: MEDIUM
 Color After: YELLOW Clarity After: _____ Artifacts: _____

Comments:

FORM 1.05 - PAGE 1

U.S. EPA - CLP

1
INORGANIC ANALYSIS DATA SHEET

CLIENT SAMPLE NO.

NS-24

Lab Name: COMPUCHEM ENV. CORP. Contract: 3/90
 Lab Code: COMPU Case No.: 50007 SAS No.: _____ SDG No.: 278937
 Matrix (soil/water): SOIL Lab Sample ID: 582476
 Level (low/med): LOW Date Received: 10/08/93
 % Solids: 79.8

Concentration Units (ug/L or mg/kg dry weight): MG/KG

CAS No.	Analyte	Concentration	C	Q	M
7429-90-5	Aluminum				NR
7440-36-0	Antimony				NR
7440-38-2	Arsenic				NR
7440-39-3	Barium				NR
7440-41-7	Beryllium				NR
7440-43-9	Cadmium				NR
7440-70-2	Calcium				NR
7440-47-3	Chromium				NR
7440-48-4	Cobalt				NR
7440-50-8	Copper				NR
7439-89-6	Iron				NR
7439-92-1	Lead				NR
7439-95-4	Magnesium				NR
7439-96-5	Manganese				NR
7439-97-6	Mercury				NR
7440-02-0	Nickel				NR
7440-09-7	Potassium				NR
7782-49-2	Selenium				NR
7440-22-4	Silver				NR
7440-23-5	Sodium				NR
7440-28-0	Thallium				NR
7440-62-2	Vanadium				NR
7440-66-6	Zinc				NR
	Cyanide	.63	U		AS

Color Before: BROWN Clarity Before: _____ Texture: MEDIUM
 Color After: COLORLESS Clarity After: _____ Artifacts: _____

Comments:

FORM 1.05 - PAGE 1

COMPOUND LIST

CLIENT SAMPLE ID: NS-24
LAB SAMPLE ID: 582480

	CONCENTRATION (mg/Kg)	DETECTION LIMIT (mg/Kg)
1. PHENOLS, TOTAL	0.38	0.10

Page 2
Received: 11/17/93

Hebb Technical REPORT
Results by Sample

Work Order # 93-11-752

SAMPLE ID 587669

SAMPLE # 01 FRACTIONS: A
Date & Time Collected not specified Category _____

SFID S 2.71*
MG/KG DRY SOLID

DEC 08 '93 03:16PM WEBB TECHNICAL GROUP

CHAIN-OF-CUSTODY FORMS

To: Bob Curry - I.T. Corp

CHAIN OF CUSTODY RECORD

PROJ. NO.		PROJECT NAME				NO. OF CONTAINERS	REMARKS				
101.96.03		G.E. - P. Hsfield - Newell St.									
SAMPLERS: (Signature)						PCRF	TOC				
<i>Maggie Palmer</i>											
STA. NO.	DATE	TIME	COMP.	GRAB	STATION LOCATION						
NS-21	10/6/93	9:05		X	NS-21 0"-6"	1	✓	✓			5'0 BLR 55192
NS-22	10/6/93	9:15		X	NS-22 0"-6"	1	✓	✓			Turn around time as per your letter to Rick P. Fiore at Blasland & Bouck Engineers, dated 10/5/92
NS-23	10/6/93	9:25		X	NS-23 0"-6"	1	✓	✓			
NS-24	10/6/93	9:35		X	NS-24 0"-6"	1	✓	✓			
Relinquished by: (Signature)						Date / Time	Received by: (Signature)		Date / Time	Received by: (Signature)	
<i>Maggie Palmer</i>						10/6/93 17:00	<i>Byron Blomquist</i>			10/07/93 8:15	
Relinquished by: (Signature)						Date / Time	Received by: (Signature)		Date / Time	Received by: (Signature)	
Relinquished by: (Signature)						Date / Time	Received for Laboratory by: (Signature)		Date / Time	Remarks	
										Fed. Ex. A. B. 11 # 9726322841	

226202 of 04 03

Distribution: Original Accompanies Shipment; Copy to Coordinator Field Files

000000



To: Don Tomak - CompuChem

BLASLAND & BOUCK ENGINEERS, P.C.

6723 Tow Path Road, Box 66, Syracuse, New York 13214

(315) 446-9120

PLEASE SEND LAB REPORT TO:

BRUCE EULIAN
BLASLAND & BOUCK ENGINEERS
C/O GE POWER TRANSFORMER DEPT.
MAILCODE D-32
100 WOODLAWN AVE.
PITTSFIELD, MA 01201

RECEIVED IN
GOOD CONDITION
ms
10/8/93

CHAIN OF CUSTODY RECORD

PROJECT NO		PROJECT NAME						NO. OF CONTAINERS	REMARKS			
CUSTODY TAPE NUMBER		DATE	TIME	COMP.	GRAB	SAMPLE TYPE						
Sample ID						SOLID Soil	WPE			WATER		
101.96.03		G.E. Pittsfield - Newell St.										
NS-24		10/7/93	11:30		X	✓			2	Appendix II + 3 compounds	✓	Samples to be analyzed for Appendix IX compounds plus benzidine, 2-chloroethyl-vinylether & 1,3-diphenylhydrazine. Analyze dioxin & furans as Isomer specific Dioxin and Furans. Do Not Analyze For PCBs or TOC! Contact & send copy of Report to John Ciompa for Additional Information.
							582450					
							454					
							458					
							462					
							466					
							470					
							474					
							484					
							480					

SAMPLED BY: (SIGNATURE) <i>Larry Palusis</i>	DATE/TIME 10/7/93 11:30	RECEIVED BY: (SIGNATURE)	RELINQUISHED BY: (SIGNATURE)	DATE/TIME	RECEIVED BY: (SIGNATURE)
RELINQUISHED BY: (SIGNATURE) <i>Larry Palusis</i>	DATE/TIME 10/7/93 13:30	RECEIVED BY: (SIGNATURE)	RELINQUISHED BY: (SIGNATURE) <i>Paul H...</i>	DATE/TIME 10/7/93 1800	RECEIVED BY: (SIGNATURE)
RELINQUISHED BY: (SIGNATURE)	DATE/TIME	RECEIVED FOR LABORATORY BY: (SIGNATURE) <i>Melissa Stevens</i>	DATE/TIME 10/8/93 0830	REMARKS FEL EXP# 9726322830	

APPENDIX H

SUPPLEMENTAL SURFICIAL SOIL SAMPLING - 153 NEWELL STREET



February 4, 1994

Ms. J. Lyn Cutler
Section Chief, Special Projects
Department of Environmental Protection
436 Dwight Street
Springfield, MA 01103

**Re: GE Newell Street, Area II
Imminent Hazard Evaluation; Results of Sampling, 153 Newell Street
1-1057 Pittsfield**

Dear Ms. Cutler:

In accordance with your letter of December 15, 1993, I am attaching a figure which presents the results of the surficial soil sampling conducted at 153 Newell Street on January 4, 1994. Four surficial soil samples were collected at this property, screened with a photoionization detector (PID), and submitted for laboratory analysis for PCBs and total organic carbon (TOC). These activities were conducted in accordance with the DEP-approved Sampling and Analysis Plan. The attached figure presents a soil description, the PID readings, and the PCB and TOC analytical results for the four samples. The laboratory analytical data sheets are also enclosed.

As shown on the attached figure, the PCB concentrations detected in these samples ranged from 4.0 to 5.3 total PCBs. These PCB concentrations are all below DEP's surficial soil guideline level of 10 ppm for Short-Term Measure evaluation in high-use residential areas (which, as you know, GE does not accept and believes is overly conservative).

Please call me if you have any questions.

Yours truly,

G. Grant Bowman
Manager, Environmental Engineering

Attachment: Figure 1
*Enclosure

cc: *Mr. And Mrs. A. Aiello, 153 Newell Street
*R. Bell, DEP
*J.R. Bieke, Shea & Gardner
*L. Bolduc, Pittsfield Commissioner of Public Health
*R.F. Desgroseilliers, GE
*E. Ebert, ChemRisk
*R.K. Goldman, Blasland & Bouck
*S.F. Joyce, DEP Commissioner's Office
*A. Kurpaska, DEP
*B. Olson, EPA Region I
Mayor Edward Reilly, City of Pittsfield
*A.J. Thomas, Jr., GE
A. Weinberg, DEP
*ECL IP(IV)(A)1
*S.P. Winslow

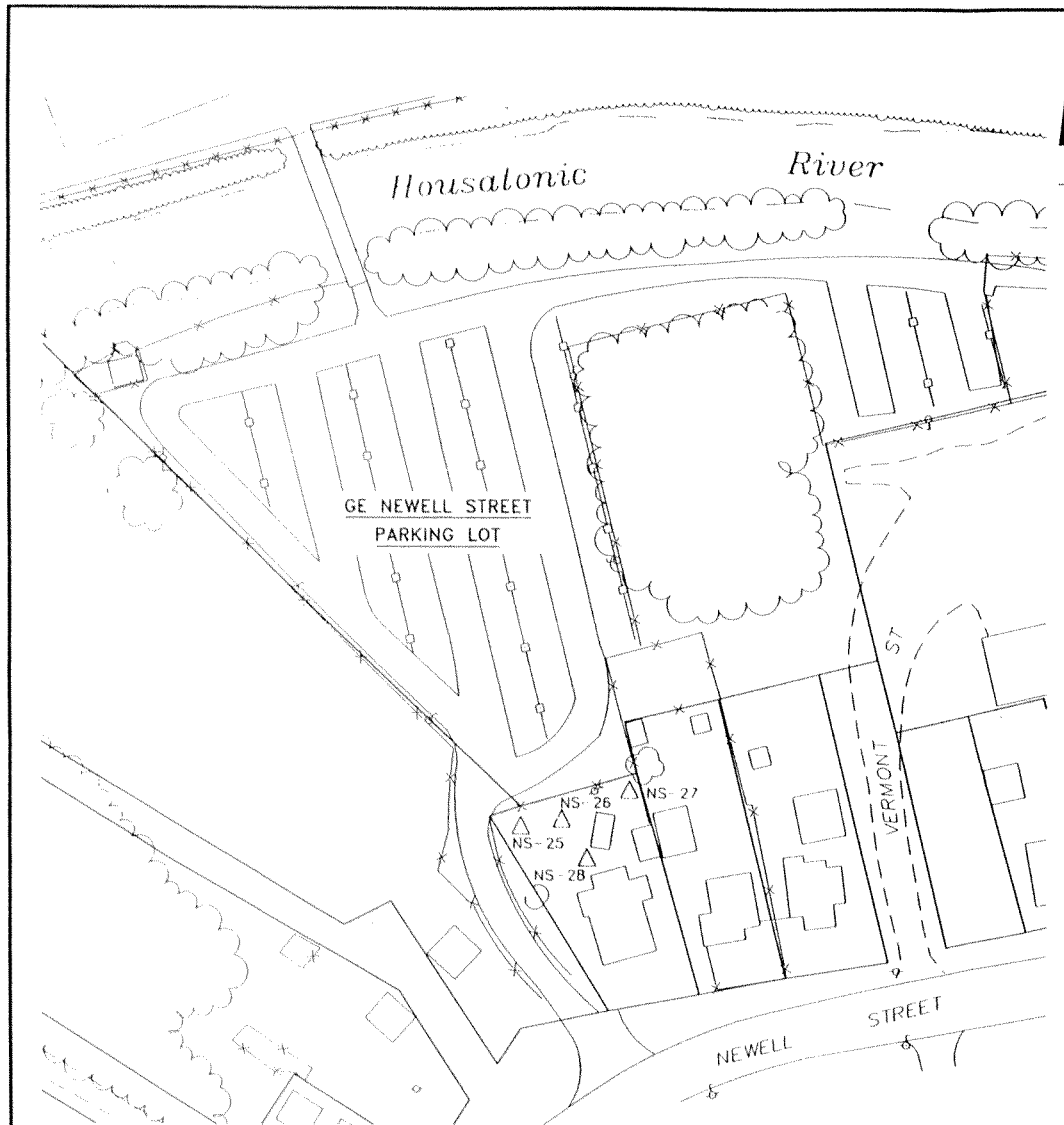

GENERAL ELECTRIC COMPANY
PITTSFIELD, MASSACHUSETTS
153 NEWELL STREET

SAMPLE IDENTIFICATION	PID READING (PID UNITS)	PCB CONCENTRATION (DRY WT.-PPM)			TOC CONCENTRATION (DRY WT.-PPM)	SOIL DESCRIPTION
		AROCLOR 1254	AROCLOR 1260	TOTAL PCBs		
NS-25	0.1	3.7	1.6	5.3	51,000	GARDEN AREA - DARK BROWN COARSE SOIL WITH SOME GRAVEL
NS-26	0.15	2.8	1.2	4.0	74,000	GARDEN AREA - LIGHT BROWN COARSE SOIL WITH SOME GRAVEL
NS-27	0.2	3.2	1.6	4.8	87,000	GRASS COVERED AREA - LIGHT BROWN TO BROWN COARSE SOIL WITH SOME GRAVEL
NS-28	0.2	3.1	1.3	4.4	43,000	GRASS COVERED AREA - DARK BROWN SILT WITH SOME FINE SAND

NOTES:

1. SAMPLES WERE COLLECTED ON JANUARY 4, 1994 BY BLASLAND, BOUCK & LEE, INC. AND SUBMITTED TO HT ANALYTICAL SERVICES, KNOXVILLE, TN FOR PCB AND TOTAL ORGANIC CARBON (TOC) ANALYSIS. EACH SAMPLE WAS ALSO SUBJECT TO A HEADSPACE ANALYSIS USING A PHOTOIONIZATION DETECTOR (PID).
2. ONLY AROCLORS 1254 AND 1260 WERE DETECTED.
3. SAMPLE LOCATIONS ARE APPROXIMATE.

LEGEND

- NS 25 SURFICIAL SOIL SAMPLE
- EDGE OF WATER
- FENCING
- VEGETATION



BL

BLASLAND, BOUCK & LEE, INC.
ENGINEERS & SCIENTISTS

GENERAL ELECTRIC COMPANY
PITTSFIELD, MASSACHUSETTS
153 NEWELL STREET

SURFICIAL SOIL SAMPLING AT RESIDENTIAL PROPERTY FIGURE 1

ANALYTICAL DATA SHEETS AND CHAIN-OF-CUSTODY FORMS

CERTIFICATE OF ANALYSIS

Blasland & Bouck Engineers, P.C.
Mail Code D-32
100 Woodlawn Avenue
Pittsfield, MA 01201
Attn: Bruce Eulian

January 25, 1994

Job Number: BLB 55768

P.O. Number: 101.96.03

This is the Certificate of Analysis for the following samples:

Client Project ID:	Newell St. Sampling
Date Received by Lab:	01/05/94
Number of Samples:	Four (4)
Sample Type:	Soil

I. Introduction

On 01/05/94 four (4) soil samples arrived at the ITAS-Knoxville, Tennessee, laboratory from Blasland & Bouck Engineers, Syracuse, New York, in support of the General Electric, Newell St. project. The list of analytical tests performed, as well as date of receipt and analysis, can be found in the attached report.

II. Analytical Results/Methodology

The analytical results for this report are presented by analytical test. Each set of data will include sample identification information and the analytical results. Please note that the data are not blank corrected.

The samples were analyzed for PCBs by gas chromatography/electron capture detection (GC/ECD) based on EPA SW-846 2nd edition method 8080.

The samples were analyzed for total organic carbon (TOC) based on EPA method 9060.

Reviewed and Approved:

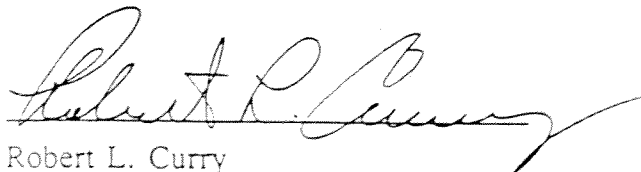

Robert L. Curry
Project Manager

American Council of Independent Laboratories
International Association of Environmental Testing Laboratories
American Association for Laboratory Accreditation

Blasland & Bouck Engineers, P.C.
January 25, 1994

IT ANALYTICAL SERVICES
5815 MIDDLEBROOK PIKE
KNOXVILLE, TN

Client Sample ID: Newell St. Sampling

Job Number: BLB 55768

III. Quality Control

Routine laboratory level III QC was followed.

The samples were analyzed for PCBs on 01/06/94 using an SP2250/2401 column on a Varian 3740-6 GC. The samples, LCS and associated method blanks were treated to remove interferences using a validated, modified Florisil procedure and a mercury cleanup procedure. All of the samples exhibited altered patterns of a mixture of Aroclors 1254 and 1260. No other problems were encountered.

The TOC content of the samples was determined by chemical wet oxidation followed by infrared detection on 01/20/94 and 01/21/94. No problems were encountered. Matrix spike/matrix spike duplicate analyses were performed using sample NS-28. All QC results were acceptable. Because of the high TOC concentration the MS and MSD were spiked at a 1000 ppm spiking level.

PCBs ANALYSIS

000003

Laboratory Name:	ITAS-KNOXVILLE	SDG Number:	N/A
Contract Name:	NEWELL ST. SAMPLING	Job Number:	BLB 55768
Client Sample ID:	NS-25	Collection Date:	N/A
Lab Sample ID:	AB5136	Extraction Date:	01/06/94
Sample Matrix:	SOIL	Analysis Date:	01/06/94
Concentration Units:	mg/kg (ppm)	Confirmation Date:	N/A

Aroclor 1016, 1232 †1242 &/or 1248	Aroclor 1254	Aroclor 1260	Total Aroclors
0.05 U	3.7 *	1.6 *	5.3

- * - Sample exhibits alteration of standard Aroclor pattern.
- † - Sample Aroclor pattern identified and/or calculated as Aroclor 1242.
- U - Compound was analyzed for but not detected. The number is the detection limit for the sample.

PCBs ANALYSIS

000004

Laboratory Name:	ITAS-KNOXVILLE	SDG Number:	N/A
Contract Name:	NEWELL ST. SAMPLING	Job Number:	BLB 55768
Client Sample ID:	NS-26	Collection Date:	N/A
Lab Sample ID:	AB5137	Extraction Date:	01/06/94
Sample Matrix:	SOIL	Analysis Date:	01/06/94
Concentration Units:	mg/kg (ppm)	Confirmation Date:	N/A

Aroclor 1016, 1232 †1242 &/or 1248	Aroclor 1254	Aroclor 1260	Total Aroclors
0.05 U	2.8 *	1.2 *	4.0

- * - Sample exhibits alteration of standard Aroclor pattern.
- † - Sample Aroclor pattern identified and/or calculated as Aroclor 1242.
- U - Compound was analyzed for but not detected. The number is the detection limit for the sample.

PCBs ANALYSIS

000005

Laboratory Name:	ITAS-KNOXVILLE	SDG Number:	N/A
Contract Name:	NEWELL ST. SAMPLING	Job Number:	BLB 55768
Client Sample ID:	NS-27	Collection Date:	N/A
Lab Sample ID:	AB5138	Extraction Date:	01/06/94
Sample Matrix:	SOIL	Analysis Date:	01/06/94
Concentration Units:	mg/kg (ppm)	Confirmation Date:	N/A

Aroclor 1016, 1232 †1242 &/or 1248	Aroclor 1254	Aroclor 1260	Total Aroclors
0.05 U	3.2 *	1.6 *	4.8

- * - Sample exhibits alteration of standard Aroclor pattern.
- † - Sample Aroclor pattern identified and/or calculated as Aroclor 1242.
- U - Compound was analyzed for but not detected. The number is the detection limit for the sample.

PCBs ANALYSIS

000006

Laboratory Name:	ITAS-KNOXVILLE	SDG Number:	N/A
Contract Name:	NEWELL ST. SAMPLING	Job Number:	BLB 55768
Client Sample ID:	NS-28	Collection Date:	N/A
Lab Sample ID:	AB5139	Extraction Date:	01/06/94
Sample Matrix:	SOIL	Analysis Date:	01/06/94
Concentration Units:	mg/kg (ppm)	Confirmation Date:	N/A

Aroclor 1016, 1232 †1242 &/or 1248	Aroclor 1254	Aroclor 1260	Total Aroclors
0.05 U	3.1 *	1.3 *	4.4

- * - Sample exhibits alteration of standard Aroclor pattern.
- † - Sample Aroclor pattern identified and/or calculated as Aroclor 1242.
- U - Compound was analyzed for but not detected. The number is the detection limit for the sample.

PCBs ANALYSIS

000007

Laboratory Name:	ITAS-KNOXVILLE	SDG Number:	N/A
Contract Name:	NEWELL ST. SAMPLING	Job Number:	BLB 55768
Client Sample ID:	METHOD BLANK	Collection Date:	N/A
Lab Sample ID:	BLM2221	Extraction Date:	01/06/94
Sample Matrix:	SOIL	Analysis Date:	01/06/94
Concentration Units:	mg/kg (ppm)	Confirmation Date:	N/A

Aroclor 1016, 1232 †1242 &/or 1248	Aroclor 1254	Aroclor 1260	Total Aroclors
0.05 U	0.05 U	0.05 U	0.05 U

† - Sample Aroclor pattern identified and/or calculated as Aroclor 1242.
 U - Compound was analyzed for but not detected. The number is the detection limit for the sample.

PCBs ANALYSIS

000008

Laboratory Name:	ITAS-KNOXVILLE	SDG Number:	N/A
Contract Name:	NEWELL ST. SAMPLING	Job Number:	BLB 55768
Client Sample ID:	METHOD BLANK	Collection Date:	N/A
Lab Sample ID:	BLM2232	Extraction Date:	01/06/94
Sample Matrix:	SOIL	Analysis Date:	01/06/94
Concentration Units:	mg/kg (ppm)	Confirmation Date:	N/A

Aroclor 1016, 1232 †1242 &/or 1248	Aroclor 1254	Aroclor 1260	Total Aroclors
0.05 U	0.05 U	0.05 U	0.05 U

† - Sample Aroclor pattern identified and/or calculated as Aroclor 1242.
 U - Compound was analyzed for but not detected. The number is the detection limit for the sample.

MATRIX SPIKE/MATRIX SPIKE DUPLICATE ANALYSIS

000009

Laboratory Name:	ITAS-KNOXVILLE	SDG Number:	N/A
Contract Name:	NEWELL ST. SAMPLING	Job Number:	BLB 55768
Client Sample ID:	NS-28	Collection Date:	N/A
Lab Sample ID:	AB5139, AB5342 MS, AB5343 MSD	Extraction Date:	01/06/94
Sample Matrix:	SOIL	Analysis Date:	01/06/94
Concentration Units:	mg/kg (ppm)	Dryness Factor:	N/A

Compound	Sample Result	Conc. Spike Added	Conc. MS	% Rec.	Conc. MSD	% Rec.	RPD
aroclor 1242	0.05 U	0.25	0.23	92	0.24	96	4

U - Compound was analyzed for but not detected. The number is the detection limit for the sample.

TOTAL ORGANIC CARBON ANALYSIS

000010

Laboratory Name:	ITAS-KNOXVILLE	SDG Number:	N/A
Contract Name:	NEWELL ST. SAMPLING	Job Number:	BLB 55768
Sample Matrix:	SOIL	Extraction Date:	N/A
Concentration Units:	mg/kg (ppm)	Analysis Date:	01/20/94, 01/21/94

Client Sample ID	Lab Sample ID	Result	Qualifiers
NS-25	AB5136	51000	+
NS-26	AB5137	74000	+
NS-27	AB5138	87000	+
NS-28	AB5139	43000	+

- Positive result.
 U Compound was analyzed for but not detected. The number is the detection limit for the sample.

MATRIX SPIKE/MATRIX SPIKE DUPLICATE ANALYSIS

000011

Laboratory Name:	ITAS-KNOXVILLE	SDG Number:	N/A
Contract Name:	NEWELL ST. SAMPLING	Job Number:	BLB 55768
Client Sample ID:	NS-28	Collection Date:	N/A
Lab Sample ID:	AB5139, AB5342 MS, AB5343 MSD	Extraction Date:	N/A
Sample Matrix:	SOIL	Analysis Date:	01/21/94
Concentration Units:	mg/kg (ppm)	Dryness Factor:	N/A

Compound	Orig. Sample Result	Conc. Spike Added		Conc. MS	% Rec.	Conc. MSD	% Rec.	RPD
		MS	MSD					
total organic carbon	43000	33000	40000	74000	94.0	97000	135.3	36

TOTAL ORGANIC CARBON ANALYSIS

000011A

Laboratory Name:	ITAS-KNOXVILLE	SDG Number:	N/A
Contract Name:	NEWELL ST. SAMPLING	Job Number:	BLB 55768
Sample Matrix:	SOIL	Extraction Date:	N/A
Concentration Units:	mg/kg (ppm)	Analysis Date:	01/20/94, 01/21/94

Client Sample ID	Lab Sample ID	Result	Qualifiers
NS-25	AB5136	51000	+
NS-26	AB5137	74000	+
NS-27	AB5138	87000	+
NS-28	AB5139	43000	+
Method Blank	P5878	100	U

+ - Positive result.
 U - Compound was analyzed for but not detected. The number is the detection limit for the sample.

SPIKED BLANK ANALYSIS

000012

Laboratory Name:	ITAS-KNOXVILLE	SDG Number:	NA
Contract Name:	NEWELL ST. SAMPLING	Job Number:	BLB 55768
Client Sample ID:	BLANK SPIKE	Collection Date:	N/A
Lab Sample ID:	M2233	Extraction Date:	01/06/94
Sample Matrix:	SOIL	Analysis Date:	01/06/94
Concentration Units:	mg/kg (ppm)	Dryness Factor:	N/A

Compound	Conc. Spike Added	Conc. Blank Spike	% Rec.
aroclor 1242	0.20	0.15	75

* - QC limits not yet established.

000013

TRAFFIC REPORTS

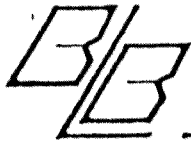

BLASLAND & BOUCK ENGINEERS, P.C.

6723 Tow Path Road, Box 66, Syracuse, New York 13214
(315) 446-9120

BLB 55768

CHAIN OF CUSTODY RECORD

PROJECT NO.		PROJECT NAME							NO. OF CONTAINERS	TOTAL PCB'S METHOD 30180	TOC	REMARKS	
101.96.03		NEWELL ST. SAMPLING (MCP) 153 NEWELL ST											
LAB ID	CUSTODY TAPE NUMBER	DATE	TIME	COMP.	GRAB	SAMPLE TYPE							
						SOIL SOLID	WIPE	WATER					
NS-25		1/4/94	1300		X	X			1	X	X	2°C FAA 1-9-95 TO. IT ANALYTICAL * RUSH TULWOUND *	
NS-26		1/4/94	1330		X	X			1	X	X		
NS-27		1/4/94	1400		X	X			1	X	X		
NS-28		1/4/94	1430		X	X			1	X	X		
SAMPLED BY: (SIGNATURE)		DATE/TIME		RECEIVED BY: (SIGNATURE)				RELINQUISHED BY: (SIGNATURE)		DATE/TIME		RECEIVED BY: (SIGNATURE)	
<i>James J. Bennett Jr.</i>		1-4-94 1430		<i>James J. Bennett Jr.</i>				<i>James J. Bennett Jr.</i>		1-1-94 1545			
RELINQUISHED BY: (SIGNATURE)		DATE/TIME		RECEIVED BY: (SIGNATURE)				RELINQUISHED BY: (SIGNATURE)		DATE/TIME		RECEIVED BY: (SIGNATURE)	
RELINQUISHED BY: (SIGNATURE)		DATE/TIME		RECEIVED FOR LABORATORY BY: (SIGNATURE)				DATE/TIME		REMARKS			
				<i>Drew allen</i>				1-5-94 9:15		FED EX AIRBILL # 0775595026			

001101

APPENDIX I

WELL CONSTRUCTION DETAILS

WELL CONSTRUCTION LOG
(UNCONSOLIDATED)

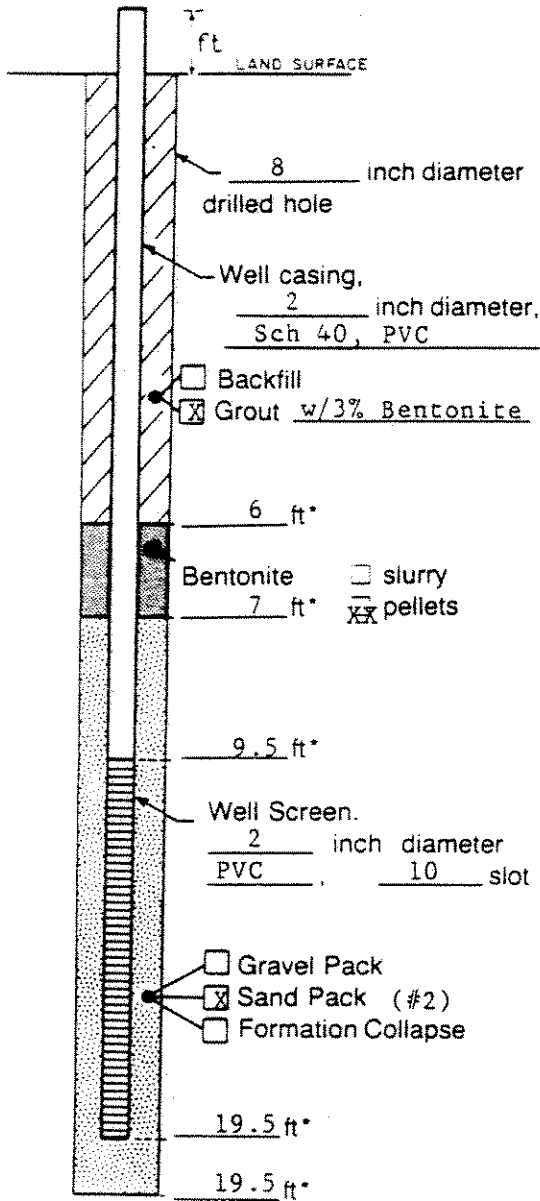

Measuring Point is
Top of Well Casing
Unless Otherwise Noted.

*Depth Below Land Surface

Project NY360QP02 Well GE-3

Town/City Pittsfield

County Berkshire State MA

Permit No. _____

Land-Surface Elevation
and Datum _____ feet Surveyed
 Estimated

Installation Date(s) 5/5/88

Drilling Method Hollow-Stem Auger

Drilling Contractor Soil & Material Testing

Drilling Fluid None

Development Technique(s) and Date(s)

Fluid Loss During Drilling _____ gallons

Water Removed During Development _____ gallons

Static Depth to Water 11.0 feet below M.P.

Pumping Depth to Water _____ feet below M.P.

Pumping Duration _____ hours

Yield _____ gpm Date _____

Specific Capacity _____ gpm/ft

Well Purpose Monitoring Well

Remarks _____

Prepared by W. Gray

WELL CONSTRUCTION LOG

(UNCONSOLIDATED)

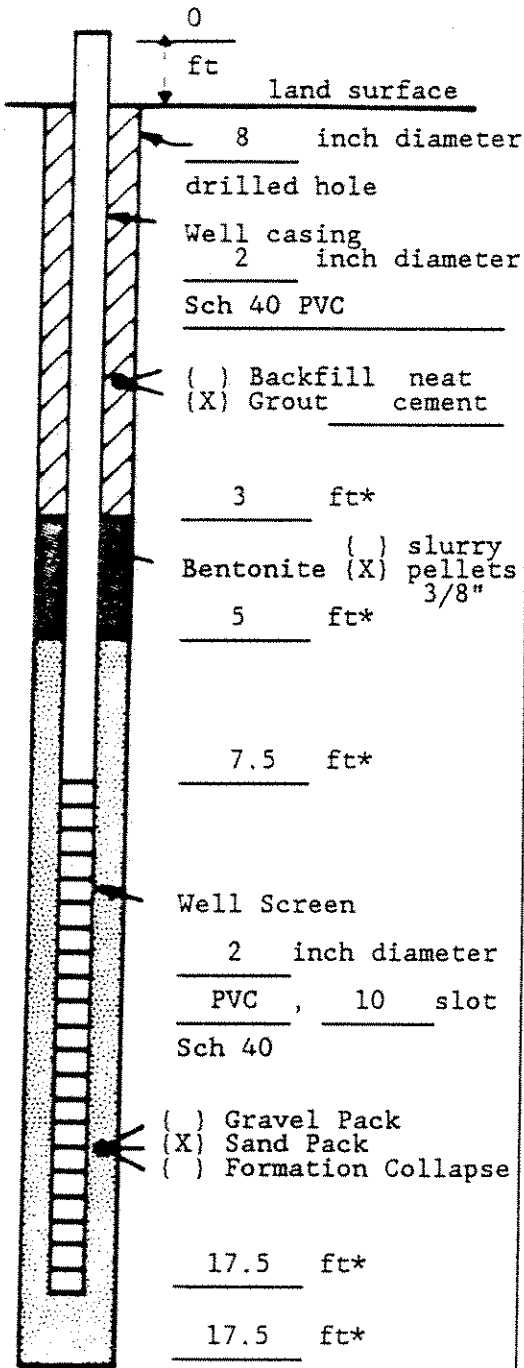

Project NY036ORB02 Well NS-1
 Town/City Pittsfield
 County Berkshire State MA
 Permit No. _____

Land-Surface Elevation _____ feet () Surveyed
 and Datum _____ () Estimated

Installation Date(s) 8/30/89

Drilling Method Auger

Drilling Contractor Soil & Material Testing

Drilling Fluid None

Development Technique(s) and Date(s)

Fluid Loss During Drilling _____ gallons

Water Removed During Development _____ gallons

Static Depth to Water approx. 12 feet below M.P.

Pumping Depth to Water _____ feet below M.P.

Pumping Duration _____ hours

Yield _____ gpm Date _____

Specific Capacity _____ gpm/ft

Well Purpose Monitoring well

Fracture Zones _____

Remarks _____

Measuring Point is Top of Well Casing Unless Otherwise Noted.

* Depth Below Land Surface

Prepared by B. Gray and V. Betro

APPENDIX J

GROUNDWATER CONTOUR MAP, JUNE 1988

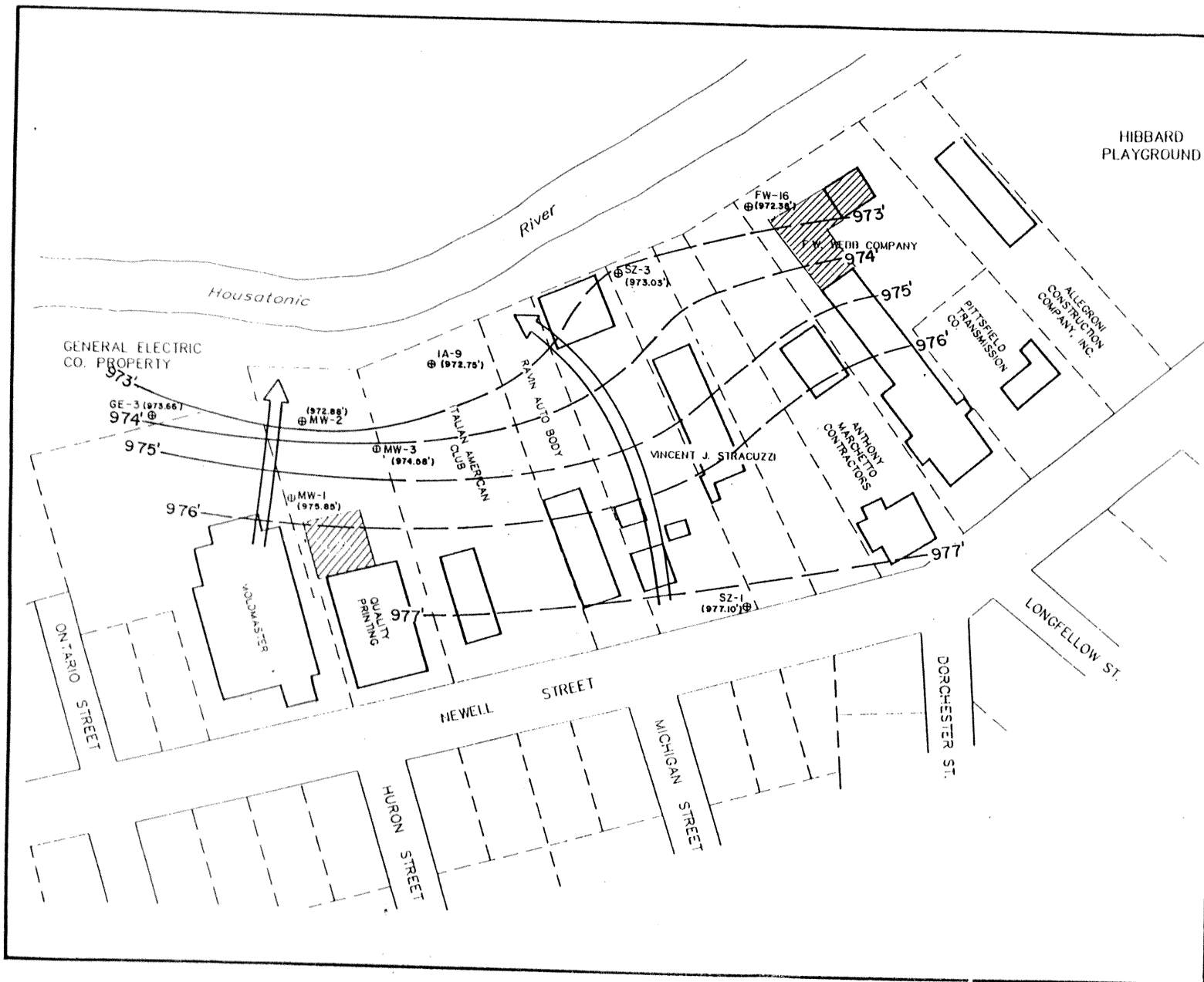

LEGEND

- ⊕ GROUND-WATER MONITORING WELL
- 973' GROUND-WATER CONTOUR LINE
- (973.03') GROUND-WATER ELEVATION

GENERAL ELECTRIC COMPANY
PITTSFIELD, MA.

GROUND-WATER CONTOUR MAP
JUNE 7, 1988



APPENDIX K

AMBIENT AIR MONITORING FOR POLYCHLORINATED BIPHENYLS

(ZOREX, NOVEMBER 1993)

**AMBIENT AIR MONITORING FOR
POLYCHLORINATED BIPHENYLS (PCB)**

MAY 4, 1993 to AUGUST 17, 1993

**General Electric Company
Pittsfield, Massachusetts**

Book 1 of 3

Book 1: Ambient Air Monitoring Report
Book 2: Appendices I - VII
Book 3: Appendices VIII - XX

Prepared by:

Zorex Environmental Engineers, Inc.
247 South Street
Pittsfield, MA 01201
(413) 447-7585

TABLE OF CONTENTS

- Project Summary
- 1.0 Introduction
- 2.0 Ambient Air Sampling Project Description
 - 2.1 Ambient Air Sampling Program
 - 2.1.1 High-Elevation
 - 2.1.1.1 Building 32S
 - 2.1.2 Low-Elevation
 - 2.2 Ambient Air Sampling Methods
 - 2.2.1 High-Elevation Methods
 - 2.2.2 Low-Elevation Methods
 - 2.3 Analytical Methods
 - 2.3.1 Method 608
 - 2.3.2 High-Resolution
 - 2.4 Project Detection Limits
 - 2.5 Meteorological Data
 - 2.6 Quality Assurance/Quality Control
 - 2.6.1 Calibrations
 - 2.6.2 Quality Control
 - 2.6.3 Data Validation
 - 2.6.4 Meteorological Data
- 3.0 Qualitative Analysis Performed by GE
 - 3.1 Ambient Air Qualitative Analysis
 - 3.2 Other Media Qualitative Analysis
- 4.0 Analytical Results
 - 4.1 Ambient PCB Concentrations
 - 4.1.1 Method 608

TABLE OF CONTENTS
(Continued)

- 4.1.2 High-Resolution
 - 4.1.3 Data Anomalies
 - 4.2 Qualitative Evaluation of Results by GE
 - 4.3 Meteorological Data
 - 5.0 Data Quality
 - 5.1 Ambient Air Monitoring
 - 5.1.1 Data Quality in Terms of the Data Quality Objectives
 - 5.1.1.1 Validity
 - 5.1.1.2 Representativeness
 - 5.1.1.3 Comparability
 - 5.1.1.4 Completeness
 - 5.1.1.5 Precision
 - 5.1.1.6 Accuracy
 - 5.1.2 Quality Assurance/Quality Control
 - 5.1.3 Problems and Disruptions
- 6.0 Interpretation of Ambient Air Data
 - 6.1 Meteorological Variables
 - 6.1.1 Temperature
 - 6.1.2 Wind Speed
 - 6.1.3 Wind Direction
 - 6.1.4 Barometric Pressure
 - 6.1.5 Precipitation
 - 6.1.6 Summary
 - 6.2 Comparison with 1991-1992 Ambient PCB Data
 - 6.3 Implications of Ambient Air Studies in Determining Sources
 - 6.3.1 Newell Street Area
 - 6.3.1.1 High-Volume/Low-Volume Comparison
 - 6.3.1.2 Variations Between High-Volume Sampling Locations
 - 6.3.1.3 Wind Directional Data

TABLE OF CONTENTS
(Continued)

6.3.1.4	Comparison of Soil Chromatograms with Ambient Air Chromatograms
6.3.1.5	Overall Interpretation
6.3.2	Lyman Street Area
6.3.2.1	High-Volume/Low-Volume Comparison
6.3.2.2	Wind Directional Data
6.3.2.3	Comparison of Oil and Filter Cake Chromatograms with Ambient Air Chromatograms
6.3.2.4	Overall Interpretation
6.3.3	Silver Lake Area
6.3.3.1	High-Volume/Low-Volume Comparison
6.3.3.2	Variations Between High-Volume Sampling Locations
6.3.3.3	Wind Directional Data
6.3.3.4	Comparison of Sediment Chromatograms with Ambient Air Chromatograms
6.3.3.5	Overall Interpretation
7.0	Evaluation of Potential Risk
7.1	Estimated Average PCB Concentrations for the Newell Street Area
7.2	Risk Evaluation
8.0	Evaluation of Need for Further Sampling
9.0	Evaluation of Appropriateness of Air Dispersion Modeling

TABLES

1	Ambient Air Samples Analyzed by General Electric - High-Resolution
2	Ambient Air Samples Analyzed by General Electric - Method 608
3	Other Media Samples Analyzed by General Electric
4	24-hour High-Volume Ambient PCB Concentrations in ug/m ³
5	24-hour Low-Volume Ambient PCB Concentrations in ug/m ³
6	Building 32S Winter Sampling Results in ug/m ³
7	Comparison Between High-and Low-Volume Sampling
8	High-Resolution Confirm Data

TABLE OF CONTENTS
(Continued)

9	Mean, Maximum and Minimum Temperature (°F) on Sampling Days
10	Mean, Maximum and Minimum Wind Speed (mph) on Sampling Days
11	Average Barometric Pressure and Total Precipitation on Sampling Days
12	Conditions at Maximum Concentration found during High-Elevation Sampling
13	Conditions at Minimum Concentration found during High-Elevation Sampling
14	Conditions at Maximum Concentration found during Low-Elevation Sampling
15	Conditions at Minimum Concentration found during Low-Elevation Sampling
16	Comparison of 1991/92 and 1993 Data

FIGURES

A	Site Map
---	----------

APPENDICES

I	EPA Compendium Method TO-4
II	EPA Compendium Method TO-10
III	General Electric Analysis Figures
IV	Method 608 Analytical Results from IT Analytical Services
V	High-Resolution Analytical Results from IT Analytical Services
VI	Sampling Event Wind Roses
VII	Table of Contents from the QAPP
VIII	Sum of Difference and Standard Deviation Calculations
IX	Calibration Logs
X	One-Point Calibration Checks
XI	Sampling Data Sheets
XII	Air Flow Calculation Sheets
XIII	Chain of Custody/Request for Analysis Sheets
XIV	Sampler Maintenance Forms
XV	Meteorological Station Data Log
XVI	Temperature vs. Concentration Graphs
XVII	Wind Speed vs. Concentration Graphs
XVIII	Barometric Pressure vs. Concentration Graphs
XIX	ChemRisk Risk Evaluation
XX	Calculations of Concentrations for ChemRisk

PROJECT SUMMARY

Zorex Environmental Engineers, Inc. has completed additional ambient air monitoring for polychlorinated biphenyls (PCBs) at and around the General Electric (GE) facility in Pittsfield, Massachusetts. This sampling program follows a one year sampling program for ambient PCBs conducted from August 14, 1991 to August 20, 1992, by Zorex Environmental Engineers on behalf of General Electric Company. The current ambient air sampling program was conducted to obtain valid and representative ambient air data for the following purposes: 1) to more accurately identify suspected sources of ambient PCBs from the GE facility and, if possible, estimate emission rates from identified sources; and 2) to further characterize ambient air levels of PCB downwind of the Newell Street MCP site.

To augment the ambient air sampling program, GE collected samples from other media at and around the GE facility. Soil, oil, sediment and sludge samples were collected from identified MCP sites and analyzed for PCB. The additional media sampling was conducted to assist in the identification of suspected sources of ambient PCBs.

The ambient air sampling program consisted of eight sampling events between May 4, 1993 and August 17, 1993. Five high-elevation samplers were located at or downwind from suspected PCB sources at or near the GE facility. A sixth high-elevation sampler, used for determining background PCB concentrations, was located 3.5 miles west of the GE facility at Berkshire Community College. Low-elevation sampling was conducted close to ground level at three of the five high-elevation sampling sites. Meteorological data from an on-site weather station was collected concurrently with the ambient PCB data.

The ambient monitoring program was conducted in accordance with the MCP Scope of Work for Additional PCB Ambient Air Monitoring, General Electric Company, Pittsfield, Massachusetts, dated March 10, 1993, the Quality Assurance Project Plan (QAPP) for the August 1991 - 1992 ambient air monitoring program, and the Massachusetts Department of Environmental Protection (MA DEP) letter of March 17, 1993.

The ambient high-elevation samples were collected in accordance with the EPA Compendium Method TO-4. Ambient low-elevation samples were collected in accordance with EPA Compendium Method TO-10. Sample extracts were analyzed for seven PCB Aroclors using gas chromatography with electron capture detection (GC-ECD) as described in EPA Method 608. Additional high-resolution analyses using gas chromatography/mass spectrometry (GC/MS) were conducted to confirm Method 608 results.

The analytical results of the samples from the high-elevation monitors reveal the following:

- At the Newell Street site, the ambient PCB concentrations measured in the rear of 191 Newell Street were at about the same level as those measured at that station during the same months (May-August) in the 1991-92 study. However,

the PCB concentrations measured at two new stations in the front of 191 Newell Street and at the F.W. Webb property were significantly lower -- on average about one-third of the levels measured in the rear of 191 Newell Street.

- At the Lyman Street site, the measured ambient PCB concentrations were somewhat higher than those measured at this station during May-August in the prior study.
- At the new Silver Lake station, located on the edge of Silver Lake, the measured ambient PCB concentrations were, on average, about twice as high as the concentrations measured during the same months in the prior study at a station located approximately 400 feet east of Silver Lake.

The PCB concentrations measured at the low-elevation monitors in the rear of 191 Newell Street, at Lyman Street and at Silver Lake were significantly higher than any of the concentrations found at the high-elevation monitors, ranging from 2 to 87 times as high. However, these samples were collected by a different sampling method using a different type of sampler (low-volume versus high-volume) and were subject to a much higher detection limit; and it is unclear whether or to what extent the higher measured PCB concentrations in these samples were attributable to such differences, rather than reflecting true differences in ambient PCB concentrations. Further sampling is proposed to investigate this question.

The analytical data also show that the results of the high-resolution analyses, which are likely to produce more accurate measurements of PCBs in ambient air than the Method 608 analyses, are about 40-60% lower than the Method 608 analytical results.

An evaluation of the PCB analytical data in relation to meteorological data reveals that:

- At the monitored sites (excluding the background site), ambient daily temperature appears to have some impact on ambient PCB concentrations, although it is not clear to what degree. At ambient temperatures below about 50-60°F, there are unlikely to be measurable concentrations of ambient PCBs, while at higher temperatures, particularly above about 60°F, there is a strong likelihood of obtaining measurable PCB concentrations. Thus, temperatures above about 50-60°F appear to be related to ambient PCB concentrations, although that relationship is not direct or linear at the high-elevation stations. The relationship between temperature and ambient PCB concentrations is stronger and more direct at the low-elevation stations.
- There is no apparent relationship between wind speed and ambient PCB concentrations at the high-elevation monitors, but the data do suggest an inverse relationship at the low-elevation monitors.

- There are no consistent associations between wind direction and ambient PCB concentrations, although it seems apparent that wind direction in concert with wind speed plays a role in the dispersion of PCBs from assumed source areas.
- There is no apparent relationship between barometric pressure and ambient PCB concentrations.

An evaluation of chromatograms prepared by GE using extracts of selected air samples returned from the laboratory reveals that at each of the sampling sites the distribution of PCB isomers has a consistent pattern over time. This evaluation also shows a similarity in the major peaks in the PCB isomer distribution between the high-volume and low-volume samples from Newell Street and between the high-volume and low-volume samples from Silver Lake. A similar comparison could not be made for the Lyman Street site. Review of these chromatograms also shows that those from the various Newell Street stations have a similar pattern of PCB isomer distribution, but can be distinguished from the Silver Lake and Lyman Street chromatograms, thus indicating the influence of different PCB sources.

A comparison of the air sample chromatograms with chromatograms from the soil, sediment, sludge, and oil samples collected from potential source areas reveals that the PCB isomer distribution in the air extracts is not directly comparable to that in the samples from the other media. However, this difference may be explained by the fact that PCBs volatilizing from other media would be expected to provide a higher proportion of the more volatile isomers to the ambient air that have a lower retention time.

Overall, review of the data from this monitoring program, particularly the comparisons of ambient PCB concentrations and air extract chromatograms among the various stations (including high-elevation versus low-elevation comparisons), indicate that surficial soil in the rear of the Newell Street site and the sediments in Silver Lake -- both of which are known to contain elevated concentrations of PCBs -- are principal sources of the PCBs detected in the ambient air around those respective areas. The data are insufficient, however, to identify the source of ambient PCBs at Lyman Street. At this time, no firm conclusions can be drawn about the magnitude of the low-elevation PCB concentrations due to the need for further sampling to evaluate the comparability of the low-volume and high-volume sampling methods. Moreover, emission rates from the assumed source areas cannot be accurately determined, although they are clearly higher in summer than in winter. The data do strongly indicate, however, that there is rapid dispersion of PCBs with elevation above the assumed source areas and that PCB concentrations further decrease rapidly with distance from those assumed sources.

Finally, an evaluation of the air monitoring data from a risk perspective indicates that, even using standard MA DEP exposure assumptions and toxicity values, the PCBs in the ambient air in these areas do not present any imminent hazard or significant risk to the populations likely to be most exposed -- i.e., residents living on Newell Street, students at the Hibbard School (on Newell Street), and residents living near Silver Lake.

1.0 Introduction

Zorex Environmental Engineers, Inc. (Zorex) was retained by General Electric Company (GE) to conduct additional ambient PCB air sampling at and around the General Electric facility in Pittsfield, Massachusetts. The sampling program was predicated on the results of a year-long ambient monitoring program for PCBs completed between August 20, 1991 and August 14, 1992. As with the year-long ambient air monitoring program for PCBs, this additional PCB ambient air monitoring program was conducted as part of continuing Massachusetts Contingency Plan (MCP) work to address Massachusetts Department of Environmental Protection (MA DEP) concerns about potential air pathway exposures to PCBs.

The objectives of the sampling program were: 1) to provide valid and representative ambient air data to more accurately identify suspected sources of ambient PCBs from the GE facility and, if possible, to estimate emission rates from potential sources; and 2) to further characterize ambient air levels of PCB downwind of the Newell Street MCP site.

To augment the ambient air sampling program, GE collected and analyzed several samples of other environmental media at and around the GE MCP sites. Soil, oil, sediment and sludge samples were collected and analyzed to assist in the identification of suspected sources of ambient PCBs.

Ambient air monitoring consisted of eight sampling events beginning on May 4, 1993 and ending on August 17, 1993. Meteorological data from an on-site weather station were collected concurrently with the ambient PCB sampling. All ambient air sampling, field work, sample collection, sample shipment and recordkeeping were completed by Zorex Environmental Engineers, Inc., Pittsfield, Massachusetts. The samples were analyzed by IT Analytical Services in Cincinnati, Ohio and in Knoxville, Tennessee.

The GE Environmental Laboratory at the Pittsfield facility completed the sampling and analysis of soil, oil, sediment and sludge samples. The GE Environmental Laboratory also completed confirming qualitative analyses of the ambient air samples (using extracts remaining from IT analysis). An evaluation of the data from a risk perspective was conducted by ChemRisk of Portland, Maine.

This final report presents a summary of all ambient air and other media analytical results, sampling activities, quality assurance/quality control objectives, laboratory data sheets, a summary of meteorological data and a discussion of problems and disruptions related to the sampling program. An interpretation of analytical data with respect to possible source areas is presented as well as a discussion of the need for further sampling and the appropriateness of air dispersion modeling.

2.0 Ambient Air Sampling Project Description

2.1 Ambient Air Sampling Program

2.1.1 High-Elevation

Ambient air sampling was completed at elevations 2-6 meters above the ground at six sampling sites. Five of these sites were at or downwind of potential sources of ambient PCBs around the GE Pittsfield facility. A sixth monitor was located on the grounds of Berkshire Community College (BCC), approximately 3.5 miles west of the GE facility. For data quality assessment, a seventh monitor was co-located at the 191 Newell Front Site. The locations of the monitoring stations are presented below and are shown in Figure A. The placement of the monitoring stations at the sites identified in Figure A was based on the results of the 1991-1992 ambient air monitoring program, the location of potential PCB source areas and the general direction of prevailing winds in the area.

<u>Sampling Location</u>	<u>Sampling Site#</u>	<u>MCP Site</u>
Roof of F.W. Webb, Newell St.	9	Downwind of Newell
Rear of 191 Newell Street	2	Newell
Lyman Street Parking Lot	3	Lyman
Berkshire Community College (Background)	6	Background
Silver Lake	11	Silver Lake
Front of 191 Newell Street	10	Newell
Front of 191 Newell Street (Co-located)	10-Co	Newell

High-elevation samples were collected using high-volume samplers in accordance with EPA Method TO-4 described below in Section 2.2.1. Samples were collected every fifteen days starting May 4, 1993, and ending August 17, 1993, for a total of eight sampling events.

2.1.1.1 Building 32S

In addition to the foregoing, three rounds of high-elevation samples (2/2/93, 2/10/93, 2/18/93) were collected at the former General Electric Building 32S located east-northeast of Silver Lake. The purpose of this sampling was to provide seasonal winter data to complement data collected during the previous year long study (Ambient Air Monitoring for PCB, August 20, 1991 - August 14, 1992, General Electric Co., Pittsfield, MA, November 13, 1993). During the year long-study, sampling at Building

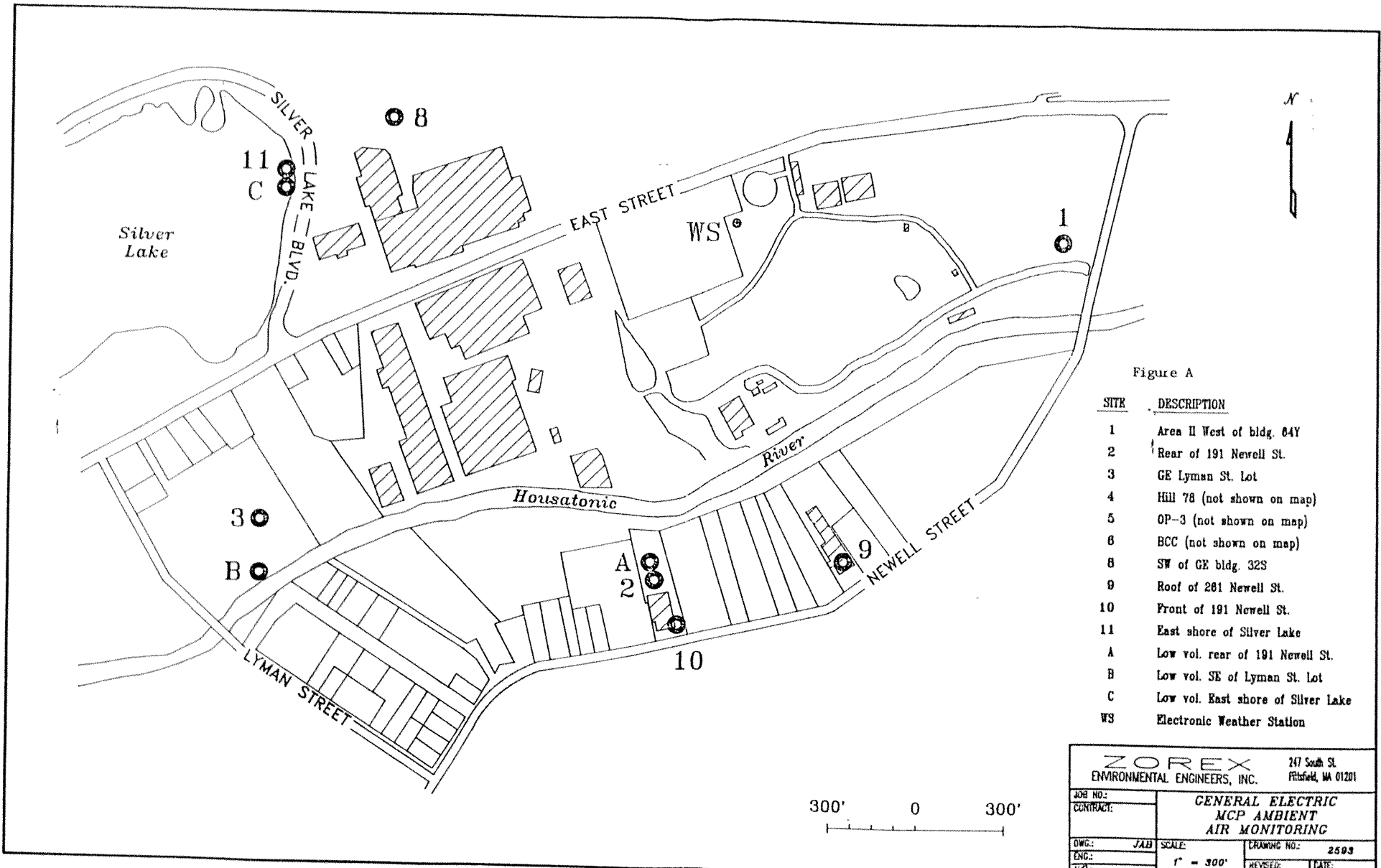

Figure A

SITE	DESCRIPTION
1	Area II West of bldg. 64Y
2	Rear of 191 Newell St.
3	GE Lyman St. Lot
4	Hill 78 (not shown on map)
5	OP-3 (not shown on map)
6	BCC (not shown on map)
8	SW of GE bldg. 32S
9	Roof of 281 Newell St.
10	Front of 191 Newell St.
11	East shore of Silver Lake
A	Low vol. rear of 191 Newell St.
B	Low vol. SE of Lyman St. Lot
C	Low vol. East shore of Silver Lake
WS	Electronic Weather Station

ZOREX ENVIRONMENTAL ENGINEERS, INC.		247 South St. Pittsfield, MA 01201	
JOB NO.:	CONTRACT:	GENERAL ELECTRIC MCP AMBIENT AIR MONITORING	
DWG.:	JAB	SCALE:	DRAWING NO.:
ENG.:		1" = 300'	2593
A-P.:		REVISED:	DATE:
			7/20/93

32S was not begun until June 15, 1992 and concluded in August, 1992, providing no winter data for the Silver Lake area. The samples were collected and analyzed using the methods described in Section 2.2.1 below for high-elevation sampling.

2.1.2 Low-Elevation

Low-elevation sampling at or near ground level was completed at three locations. The three locations are areas with known elevated PCB concentrations suspected of contributing to previously monitored levels of ambient PCBs. The three sites were also monitored at high-elevations (2-6 meters) as described in Section 2.1.1 above. A fourth low-elevation sampling site was co-located at Site #2 for data quality assessment. The locations of the low-elevation monitoring stations are presented below and are shown in Figure A.

<u>Sampling Location</u>	<u>Sampling Site #</u>	<u>MCP Site</u>
191 Newell Street Rear	A	Newell
Newell Street Rear (Co-located)	A-Co	Newell
Lyman Street, River Bank	B	Lyman
Silver Lake, Lake Front	C	Silver Lake

Low-elevation samples were collected using low-volume samplers in accordance with EPA Method TO-10 described below in Section 2.2.2. Samples were collected every fifteen days starting May 4, 1993, and ending August 17, 1993 for a total of eight sampling events.

2.2 Ambient Air Sampling Methods

2.2.1 High-Elevation Methods

A 24-hour sample was collected from 7 a.m. to 7 a.m. on each sampling day at each of the high-elevation sampling sites. The samples were collected according to the U.S. EPA Compendium Method TO-4, Method for the Determination of Organochlorine Pesticides and Polychlorinated Biphenyls in Ambient Air. This method employs a General Metal Works PS-1 modified high-volume sampler consisting of a glass fiber filter with a polyurethane foam (PUF) backup absorbent cartridge. The sampler inlet was located 2-6 meters from the ground. Ambient air was drawn through the cartridge at a rate of 200-280 L/minute for 24-hours. The total air volume collected for each sample was approximately 370 standard cubic meters. A figure describing the sampler and a complete copy of EPA Compendium Method TO-4 is presented in Appendix I.

The samplers were monitored at six-hour intervals over the 24-hour sampling period. At the end of the sampling period, the sampling modules

containing the fiber filters and PUF adsorbents were removed from the samplers. Each glass fiber filter was placed in a glass petri dish and each PUF adsorbent (inside a glass cartridge) was wrapped in hexane rinsed aluminum foil. Each fiber filter and PUF adsorbent set was labeled as one sample. The samples were wrapped, packaged in blue ice and sent under chain of custody to the IT Analytical Laboratory in Cincinnati, Ohio for analysis.

2.2.2 Low-Elevation Methods

A 24-hour air sample was collected from 7 a.m. to 7 a.m. on every sampling day at each of the low-elevation sampling sites. The samples were collected according to the U.S. EPA Compendium Method TO-10, Method for the Determination of Organochlorine Pesticides in Ambient Air Using Low-Volume Polyurethane Foam (PUF) Sampling with Gas Chromatography/Electron Capture Detector (GC/ECD). This method employs a low-volume pump controlled by a flowmeter which draws ambient air through a polyurethane foam cartridge (PUF) contained in a glass holder. The sampler inlet was located approximately 12 inches from the ground. Ambient air was drawn through the cartridge at a rate of approximately 5 L/minute for 24-hours. The total air volume collected for each sample was approximately 7.0 standard cubic meters. A copy of EPA Compendium Method TO-10 and a graphic illustration of the sampling system is presented in Appendix II.

The samplers were monitored at six-hour intervals over the 24-hour sampling period. During these six-hour checks, barometric pressure, temperature, flow and magnehelic pressure readings were taken. When necessary, the air flow was adjusted to the target flowrate. At the end of the sampling period, the PUF cartridges were removed from the sampling train. Each PUF cartridge (inside a glass holder) was wrapped in hexane rinsed aluminum foil. The PUF samples were wrapped, packaged in blue ice and sent under chain of custody to the IT Analytical Laboratory in Cincinnati, Ohio for analysis.

2.3 Analytical Methods

2.3.1 Method 608

The PCBs in both the high-and low-elevation samples were recovered by Soxhlet extraction with 5% ether in hexane. The extracts were reduced in volume using Kuderna-Danish (K-D) concentration techniques and subjected to column chromatographic cleanup. The extracts were analyzed for PCBs using gas chromatography with electron capture detection (GC-ECD), as described in EPA Method 608.

IT Analytical Services analyzed the samples for the following individual PCB Aroclors:

- PCB-1016
- PCB-1221
- PCB-1232
- PCB-1242
- PCB-1248
- PCB-1254
- PCB-1260

The quantities of PCBs in each sample were reported by IT Analytical Services as a specific Aroclor in ug/PUF above the analytical detection limit of 0.2 ug/PUF. These volumes were divided by the standard air volume sampled to provide ambient concentrations in micrograms per cubic meter (ug/m³).

2.3.2 High-Resolution

For confirmation of the results from Method 608, some high-and low-elevation samples were split and analyzed by both Method 608 and high-resolution gas chromatography/mass spectrometry (GC/MS). A total of 16 high-elevation samples and three low-elevation samples were sent for high-resolution analysis. The high-resolution analyses were completed by IT Analytical Services, Knoxville, Tennessee.

2.4 Project Detection Limits

The PCB project detection limit for high-elevation samples is 0.0005 ug/m³, based on a laboratory detection limit of 0.2 ug/PUF for an average 24-hour air volume of 370 m³. The project detection limit for low-elevation samples is 0.029 ug/m³ based on a laboratory detection limit of 0.2 ug/PUF for an average 24-hour air volume of 6.8 m³.

2.5 Meteorological Data

An on-site weather station was installed in East Street Area 2 at the GE facility in July 1991 to continuously record meteorological data concurrently with sampling. The Climatronics Electronic Weather Station (EWS) measures and records, every 15 minutes, wind speed, wind direction, wind direction standard deviation, precipitation, relative humidity, temperature and integrated solar radiation. The location of the weather station is identified on Figure A.

The station was installed and continues to operate in accordance with EPA guidance contained in On-Site Meteorological Program Guidance for Regulatory Modeling

Applications, U.S. EPA, June, 1987 and the Quality Assurance Plan for Meteorological Monitoring Station at General Electric Company, Pittsfield, Massachusetts. The siting of the meteorological station was approved by MA DEP in May 1991.

2.6 Quality Assurance/Quality Control

The objective of the Quality Assurance Project Plan was to ensure that the data collected on ambient levels of PCB were adequate to meet the objective of the monitoring program and the intended uses of the data. The following procedures were carried out to assure quality in the design and implementation of the monitoring program.

- The sampling and analytical procedures were conducted in accordance with EPA Compendium Method TO-4, EPA Compendium Method TO-10 and EPA recommended guidelines.
- All phases of the sampling program were adequately documented. Documentation was maintained to evidence the validity of calibrations, sample collection, flow calculations, sample custody, analytical performance, data reduction and audit procedures. A record book has been maintained to identify and reconstruct sampling events, calibration procedures, maintenance and repair activity, and other related information.
- The GE Project Manager was kept informed of sampling activity with update memoranda.

2.6.1 Calibrations

Calibrations for all sampling equipment were conducted in accordance with the schedules and procedures specified in the EPA High Volume Reference Method TO-4 and Method TO-10. All data and calculations for the calibrations are maintained in a calibration log file.

2.6.2 Quality Control

The following internal quality control checks were performed on each high-elevation sampler:

- A one-point calibration check of the calibrated flow rate versus sampler magnehelic pressure indication was performed on each sampler before and after each sampling event;
- A zero check on the samplers' pressure gauges was verified before and after each sampling event;

- A leak check was performed on each sampler before and after each sampling event;
- A recording and adjustment of the sampler pressure indicator was undertaken to maintain a constant rate flow at six-hour intervals during the sampling event; and
- One additional sampler was located at 191 Newell Front as a sampling precision check on the field sampler. The ambient PCB data from the co-located sampler were used to verify the precision of the primary sampler.

The following internal quality control checks were performed on each low-elevation sampler:

- A zero check on the samplers' pressure gauges was verified before and after each sampling event;
- A leak check was performed on each sampler before and after each sampling event;
- A recording and adjustment of the sampler's pressure indicator and flowmeter reading was undertaken to maintain a constant rate flow at six-hour intervals during the sampling event; and
- One additional sampler was located at 191 Newell Rear as a sampling precision check on the primary sampler. The ambient PCB data from the co-located sampler were used to verify the precision of the primary sampler.

The following quality control measures were performed in both high-and low-elevation sampling to insure the integrity of the ambient air samples:

- One PUF from each batch of 21 PUFs was extracted by IT Analytical Services before the batch was shipped from IT. The PUF was analyzed as a Method Blank check for PCBs for that batch. The blank control limit was the detection limit. Each set of PUFs used for sampling was verified using this method.
- One PUF field blank was transported with the samples to and from the field and was handled like all of the other PUFs, except no air was drawn through it. The PUF was shipped along with the

samples to the laboratory for analysis. All field blanks analyzed by IT were verified blank.

- All samples were labeled and transported under chain of custody by Federal Express to IT Cincinnati. At IT, the samples were recorded and handled according to strict chain-of-custody outlined in the SOP provided in the Quality Assurance Project Plan (QAPP) for this project.

2.6.3 Data Validation

All sampling data recorded in the field and flow calculations based on the field data were verified by the Project Manager or her designee before final recording. Calibration charts for flow calculations were validated by the Project QA Manager.

IT Analytical Services has documented procedures for data validation of analytical results. These procedures comply at a minimum with the requirements in Method TO-4, Method TO-10 and associated references. These were submitted as part of the QAPP. Analytical results and laboratory validation procedures were reviewed by the Zorex Project Manager.

2.6.4 Meteorological Data

The meteorological station was installed and operates in accordance with the standard operating procedures recommended by the manufacturer, Climatronics Corporation. Additional EPA guidance is contained in On-Site Meteorological Program Guidance for Regulatory Modeling Applications, U.S. EPA, revised February 1993. The meteorological station is operated in accordance with the Quality Assurance Plan for Meteorological Monitoring Station at General Electric Company, Pittsfield, Massachusetts. The siting of the meteorological station was approved by MA DEP in May 1991. The Department of Environmental Protection conducted a Quality Assurance audit of the station in August 1993.

3.0 Qualitative Analysis Performed by General Electric

3.1 Ambient Air Qualitative Analysis

The extracts from a total of 25 air samples were returned to GE from IT Analytical Services for qualitative analysis. The air samples chosen for additional analysis by GE included all samples which were split and analyzed by both Method 608 and High-Resolution analysis (17 samples), and eight samples for events for which no high-resolution analyses were requested (including two background samples).

These extracts were analyzed by capillary column GC/MS using methods developed by GE for the characterization of PCB degradation. These methods were developed to support bioremediation studies, particularly at Woods Pond, over the past year and a half. As part of this study, GE has determined retention times for 120 PCB isomers which occur in Aroclors 1242, 1254 and 1260, as well as for 45 other PCB isomers which may be formed by the selective dechlorination of the Aroclor isomer.

The analyses of the PUF extracts in this way generated a uniform set of chromatograms for the PCB isomers captured on the PUF Cartridges to qualitatively compare the PCB isomer distribution found at the air monitoring sites and to compare the distribution of airborne PCB isomers with the PCB isomers found in soil, sediment and oil samples from the surrounding area.

One group of PUF extracts returned from IT had been concentrated by IT for high-resolution (capillary column) GC/MS analysis. These are listed in Table 1. Only small volumes (250 ul) of these extracts were available. 2-Fluorobiphenyl (2FBP), which serves as a retention time reference and as an internal standard in the GC/MS method, was added to each of the extracts. Isooctane (1.0 ul) containing 100 ug/ml of 2FBP was added to 100 ul of extract. (Ordinarily, for quantitative analysis, the 2FBP is added in a dilution step so that the resulting solution contains exactly 1.0 ug/ml 2FBP.) Since the analysis of the PUF extracts was intended to be qualitative, and since it was undesirable to dilute the extracts any more than necessary, the 2FBP concentration was approximated.

TABLE 1
 AMBIENT AIR SAMPLES ANALYZED BY GENERAL ELECTRIC - HIGH RESOLUTION

PUF ID	IT Lab ID	Monitoring site	Monitoring date	Appendix III Figure
Z29-050493-1	AA2101	FW Webb	May 4, 1993	1
Z48-052093-1	AA2153	FW Webb	May 20, 1993	2
Z37-061893-1	AA2262	FW Webb	Jun 18, 1993	3
Z26-070393-1	AA2342	FW Webb	Jul 3, 1993	4
Z07-071893-1	AA2410	FW Webb	Jul 18, 1993	5
Z32-080293-1	AA2432	FW Webb	Aug 2, 1993	6
Z132-080293-1	AA2433	FW Webb	Aug 2, 1993	7
Z17-061893-2	AA2256	191 Newell - Rear	Jun 18, 1993	8
Z111A-061893-2	AA2259	191 Newell - Rear LV	Jun 18, 1993	9
Z02-070393-5	AA2408	191 Newell - Front	Jul 3, 1993	10
Z46-071893-7	AA2411	191 Newell - Front	Jul 18, 1993	11
Z06-061893-3	AA2257	Lyman Street	Jun 18, 1993	12
Z113A-061893-3	AA2260	Lyman Street - LV	Jun 18, 1993	13
Z49-070393-3	AA2407	Lyman Street	Jul 3, 1993	14
Z57-071893-3	AA2409	Lyman Street	Jul 18, 1993	15
Z27-061893-8	AA2258	Silver Lake	Jun 18, 1993	16
Z114A-061893-8	AA2261	Silver Lake - LV	Jun 18, 1993	17

A second group of extracts had been prepared at IT for analysis solely by GC/ECD using Method 608. These are listed in Table 2. Larger quantities (2.5 to 3.5 ml) of these extracts were available. However, preliminary screening (by GC/ECD) indicated that all of these extracts would need to be concentrated to obtain solutions suitable for analysis by GC/MS. The total amount of each extract was taken to dryness in a stream of pure nitrogen at room temperature. The residue was dissolved in 100 ul of isooctane containing 1.0 ug/ml 2FBP. It would have been desirable to concentrate these extracts 100:1, but due to the limited volumes, GE was only able to achieve from 20:1 to 30:1 increase in analyte concentration. Most of these extracts were still too dilute for satisfactory analysis by GC/MS.

All of the concentrates were analyzed on a 30 m X 0.25 mm DB5 capillary column in a HP 5890 GC equipped with a 5871A MS detector. The carrier gas was helium at a flow rate of 0.932 ml/min (40 psi head pressure) at 80°C. The injector was operated in splitless mode and maintained at 290°C. The injection volume was 1.0 ul. The injector purge valve was opened at 2.00 min after injection. The column oven was held at 80°C for 2.05 min. The oven temperature was increased to 120°C at a rate of 20.00 Deg-C/min and held at 120°C for 1.45 minutes. The oven temperature was next increased to 270°C at a rate of 4.00 Deg-C/min and held at 270°C for 7.00 minutes for a total analysis time of 50 minutes.

The GC-MS transfer line was held at 290°C. The MS was tuned to the standard autotune parameters for perfluorotributylamine (PFTBA). The MS was operated in the SIM mode, acquiring only the ions appropriate for the PCB congener groups (and 2FBP). The response of the MS was calibrated with mixed calibration standards which contained known amounts of Aroclors 1242, 1254 and 1260. Three calibration standards (three different concentrations of the mixed Aroclors) and several blanks were run with each batch of extracts.

The chromatograms generated by these qualitative analyses are presented in figures in Appendix III. Figures 1-17 in that appendix show the chromatograms from GE's qualitative analyses of the extracts that were prepared by IT for high-resolution analysis, while Figures 18-25 show the chromatograms from GE's qualitative analyses of the remaining extracts. These chromatograms are discussed in Section 4.2 below.

3.2 Other Media Qualitative Analysis

Several samples of soil, sediment and oil were analyzed for PCB isomer distribution by the GE Environmental Laboratory in Pittsfield. These samples, as well as several known Aroclors (1242, 1248, 1254, and 1260), were analyzed by capillary column GC/MS using methods developed by GE for the characterization of PCB degradation. These methods were developed to support bioremediation studies, particularly at Woods Pond, over the past year and a half. As part of this study, GE has

TABLE 2
AMBIENT AIR SAMPLES ANALYZED BY GENERAL ELECTRIC - METHOD 608

PUF ID	IT LAB ID	Monitoring Site	Monitoring Date	Appendix III Figure
Z12-060393-2	AA7450	191 Newell Rear	Jun 3, 1993	18
Z35-060393-P5	AA7458	191 Newell Front	Jun 3, 1993	19
Z18-060393-3	AA7453	Lyman Street	Jun 3, 1993	20
Z50-060393-6	AA7455	BCC	Jun 3, 1993	21
Z56-061893-6	AA8527	BCC	Jun 18, 1993	22
Z40-060393-8	AA7456	Silver Lake	Jun 3, 1993	23
Z102A-080293-8	AB2017	Silver Lake LV	Aug 2, 1993	24
Z03A-081793-8	AB3548	Silver Lake LV	Aug 18, 1993	25

determined retention times for 120 PCB isomers which occur in Aroclors 1242, 1254 and 1260 as well as for 45 other PCB isomers which may be formed by the selective dechlorination of the Aroclor isomer.

A listing of the soil, sediment, oil and Aroclor samples analyzed in this way is presented in Table 3. As shown in that table, these included (in addition to the known Aroclor samples): oil samples from the burn tank at GE's Thermal Oxidizer; oil samples recovered from a well at the Lyman Street site; samples of the filter press residue from the Building 64T waste water treatment operation and the Building 64G groundwater treatment plant in the East Street Area 2 at the GE facility; a sample of filter press residue from the groundwater treatment facility at the Lyman Street site; a sample of the Silver Lake sediment; and soil samples from 191 Newell Street taken near the air sampling station in the rear of that property. GE's analyses of these samples generated a uniform set of chromatograms to qualitatively compare the PCB isomer distribution found in the soil, sediment, oil and Aroclor samples with the distribution of airborne PCB isomers in the extracts of PUF cartridges from various monitoring sites in the Pittsfield area.

The liquid samples were prepared for GC/MS analysis by dilution (Method 3580A - SW846) to an appropriate PCB concentration range and the addition of 1.0 ug/ml of 2-Fluorobiphenyl (2FBP) which serves as a retention time reference and an internal standard on the GC/MS method.

The soil and sediment samples were prepared for a GC/MS analysis by modified Soxhlet extraction (modified Method 3540A - SW846). The method modification consisted of the addition of a Dean-Stark trap between the condenser and the Soxhlet extractor. This trap removes the water from the system and permits the efficient extraction of PCB isomers from soil and sediment samples without the addition of anhydrous sodium sulfate. This method has been shown to give acceptable analyte recoveries from soil and sediment samples.

All of the resulting solutions were analyzed for PCBs by capillary GC/MS. The resulting chromatograms are shown as Figures 28-48 in Appendix III. These are compared with the air sample chromatograms in Section 4.2.

TABLE 3
 OTHER MEDIA SAMPLES ANALYZED BY GENERAL ELECTRIC

Sample ID	File ID	Source	Media/ Phase	Sample Date	Appendix III Figure
Aroclor 1242		Monsanto	Liquid		28
Aroclor 1248		Monsanto	Liquid		29
Aroclor 1254		Monsanto	Liquid		30
Aroclor 1260		Monsanto	Liquid		31
TK1 5/19-20/93	P5486	Burn Tank Comp [a]	Liquid	May 19&20, 1993	32
TL1 6/2-3/93	P5494	Burn Tank Comp [a]	Liquid	Jun 2&3, 1993	33
TK1 6/17/93	P5509	Burn Tank Comp [b]	Liquid	Jun 17, 1993	34
TK1 6/18/93	P5509	Burn Tank Comp [b]	Liquid	Jun 18, 1993	35
TK1 7/2/93	P5518	Burn Tank Comp [b]	Liquid	Jul 2, 1993	36
TK3 7/2/93	P5518	Burn Tank Comp [b]	Liquid	Jul 2, 1993	37
TK3 7/3/93	P5518	Burn Tank Comp [b]	Liquid	Jul 3, 1993	38
LS-2-C1	P5238	Lyman Street Well	Liquid	Jul 31, 1992	39
LS-21-C1	P5044	Lyman Street Well	Liquid	Feb 13, 1992	40
LS-4-C1	P5044	Lyman Street Well	Liquid	Feb 13, 1992	41
F3-64T&G-13	P5519	Filter Cake 64T/G[c]	Solid	Jun 29, 1993	42
71-41958-c1	P5632	Filter Cake 64T/G[c]	Solid	Jul 1, 1993	43
H3-Lyman-10	P5559	Filter Cake Lyman[d]	Solid	Aug 10, 1993	44
Silver Lake NO2	P5355	Silver Lake	Sediment	Dec 2, 1992	45
QP-12	P5607	191 Newell Rear	Soil	Sep 29, 1993	46
QP-19	P5607	191 Newell Rear	Soil	Sep 29, 1993	47
QP-20	P5607	191 Newell Rear	Soil	Sep 29, 1993	48

NOTES:

- a - Mixture of daily composite samples from the burn tank of the Thermal Oxidizer on days when air monitoring was underway.
- b - Individual daily composite sample from burn tank of Thermal Oxidizer on days when air monitoring was underway.
- c - Filter Press residue from Bldg 64T wastewater treatment operation and Bldg 64G ground water treatment operation.
- d - Filter Press residue from Lyman Street groundwater treatment operation.

4.0 Analytical Results

4.1 Ambient PCB Concentrations

4.1.1 Results

Ambient 24-hour concentrations of total PCBs in $\mu\text{g}/\text{m}^3$ from high-elevation samples collected between May 4, 1993 and August 20, 1993, for each of the monitoring locations are presented in Table 4. Ambient 24-hour concentrations of total PCBs in $\mu\text{g}/\text{m}^3$ from low-elevation samples collected between May 4, 1993 and August 20, 1993, for each of the monitoring locations are presented in Table 5. In both of these tables, the Method 608 analytical results are presented without parentheses, while the high-resolution analytical results for those samples that were subjected to high-resolution analysis are shown in parentheses. (The two methods are compared in Section 4.1.2.) In computing the average site concentrations for the May - August sampling period, non-detect (ND) measurements were assumed for the purposes of this report to be one half the detection limit (per EPA Guidance in Air/Superfund National Technical Guidance Study Series. Volume 4, Procedures for Dispersion Modeling and Air Monitoring for Superfund Air Pathway Analysis. U.S. EPA, July 1989). Table 6 is a summary of results from winter sampling at Building 32S. Table 7 presents a comparison between the results from the high-elevation samples and those from the low-elevation samples (using the Method 608 analytical data) at each location where both high- and low-elevation sampling was performed.

Complete sets of the analytical results provided by IT Analytical Services are contained in Appendix IV for the Method 608 analyses and in Appendix V for the high-resolution analyses.

4.1.2 Comparison of Method 608 and High-Resolution Analysis

Method 608 is the specified analytical method for the EPA TO-4 PCB sampling procedure. It is not a compound-specific method, but quantifies PCB as Aroclors by matching a pattern of peaks on a chromatogram with a known standard. The total PCBs in a sample are quantified as the Aroclor which most closely matches the peak pattern. It is a visual method subject to interpretation by the analyst. In addition, the quantification of PCBs using Method 608 chromatograms is further complicated by the potential for non-PCB compounds with similar retention times as PCB isomers being interpreted as PCB isomers. Thus, Method 608 tends to provide a very conservative quantification of total PCBs in the sample.

High-resolution analysis, unlike Method 608, does not make the assumption of an Aroclor mixture of PCB isomers and allows the identification of true PCB isomers. Each group of PCB isomers (di-'s, tri-'s, etc.) is quantified with an isomer of the same group. For these reasons, this approach results in more accurate quantification of PCB concentrations than does Method 608.

A comparison of the results from the high-resolution analyses with the Method 608 analytical results is presented in Table 8 for all samples for which both types of analyses were performed. That table also lists the percent difference, standard deviation, and an indication of whether the difference was positive (high-resolution results were higher than Method 608 results) or negative (high-resolution results were lower than Method 608 results). As shown in Table 8, the high-resolution analytical results are generally lower than the Method 608 results.

4.1.3 Data Anomalies

As part of the data validation procedures, all of the sampling results were reviewed for trends and characteristic values. Data that appeared to be unusually high, low, or otherwise irregular were flagged for further evaluation. Due to the fact that there were only eight sampling events, it was difficult to identify true data anomalies. The following, however, appear to be suspect:

- A ND was recorded at the primary high-elevation sample at 191 Newell Front on June 3, 1993. However, the results of the co-located sample, collected during the same time, showed a concentration of 0.0035 ug/m³.
- A ND was recorded at the primary high-elevation sample at 191 Newell Front on August 2, 1993. However, the results of the co-located sample, collected during the same time, showed a concentration of 0.010 ug/m³.
- The analytical results of both low-elevation samples taken on May 20, 1993, show that no PCBs were detected (ND). However, low-elevation samples at Lyman and Silver Lake showed 0.071 ug/m³ and 0.072 ug/m³ respectively.

A review of these data has not provided any explanation or reason for the apparent anomalies. Hence, these data are included in the summary tables on ambient PCB concentrations. However, they should be viewed with caution.

TABLE 4
24-HOUR HIGH-VOLUME AMBIENT PCB CONCENTRATIONS IN $\mu\text{g}/\text{m}^3$ ¹
METHOD 608 (HIGH RESOLUTION)²

DATE	F.W. WEBB	191 NEWELL REAR	LYMAN	BCC	SILVER LAKE	191 NEWELL FRONT	191 NEWELL FRONT CO-LOCATOR
May 4, 1993	ND ³ (0.000038)	0.0056	0.0035	0.0014	0.014 ⁴	0.0021	0.0016
May 20, 1993	0.0027(0.00084)	ND	0.0027	NA ⁵	0.0027	0.0024	0.0019
June 3, 1993	0.0030 ⁶	0.0075 ⁷	0.0054 ⁶	0.0035 ⁶	0.0054 ⁶	ND	0.0035 ⁶
June 18, 1993	0.0090(0.0054)	0.012 ⁷ (0.013)	0.0051 ⁷ (0.0026)	0.0021 ⁷	0.014 ⁷ (0.015)	0.0078 ⁷	0.0084 ⁷
July 3, 1993	0.0057(0.0026)	0.0089	0.0087(0.0023)	ND	0.023 ⁷	0.0097 ⁷ (0.0033)	0.0075 ⁷
July 18, 1993	0.0084(0.0054)	0.023	0.0052(0.0026)	ND	0.011	NA ⁸	0.010(0.0062)
August 2, 1993	0.0068(0.0036)	0.028	0.011(0.0056)	0.0016	0.0040	ND	0.010
August 17, 1993	0.0038(0.0022)	0.035	0.0072(0.0048)	0.0011	0.012	0.0065	0.0024
Mean Concentration	0.0053(0.0029)	0.015(0.015)	0.0061(0.0037)	0.0015	0.011(0.011)	0.0041(0.0032)	0.0057(0.0052)
Max 24-Hour Occurrence Date of Occurrence	0.0090 6/18/93	0.035 8/17/93	0.011 8/2/93	0.0035 ⁷ 6/3/93	0.023 ⁷ 7/3/93	0.0097 ⁷ 7/3/93	0.010 7/18/93 & 8/2/93
Min 24-Hour Occurrence Date of Occurrence	0.0027 ⁹ 5/20/93	ND 5/20/93	0.0027 5/20/93	ND 7/3/93 & 7/18/93	0.0027 5/20/93	ND 6/3/93 & 8/2/93	0.0016 5/4/93

ND Non-Detect (ND) samples had a detection limit of 0.0005 $\mu\text{g}/\text{m}^3$ unless otherwise noted.

¹ Quantified as Aroclor 1254 unless otherwise noted.

² Results of the Method 608 analyses are presented without parentheses; results of the high resolution GC/MS analyses (where performed) are presented in parentheses.

³ Sample detection limit raised to 0.005 $\mu\text{g}/\text{m}^3$ due to interference. Samples were submitted for high resolution GC/MS analysis.

⁴ A power failure occurred on 5/4/93 at Silver Lake Boulevard. Samples were collected 5/6 - 5/7/93.

⁵ A power failure occurred on 5/19/93 at BCC. There is no background sample for 5/19 - 5/20/93.

⁶ Quantified as Aroclor 1242

⁷ Quantified as Aroclor 1248

⁸ A power failure occurred at the Newell Street front sampler; however, a co-located sample was taken.

⁹ A non-detect was found on 5/4/93; however, the laboratory detection limit was raised to 2.0 $\mu\text{g}/\text{PUF}$ due to matrix interferences. The detection limit for that sample was 0.0054 $\mu\text{g}/\text{m}^3$.

NOTE: For averaging purposes, one-half of the detection limit was used for Non-Detect (ND).

TABLE 5
 24-HOUR LOW-VOLUME AMBIENT PCB CONCENTRATIONS IN $\mu\text{g}/\text{m}^3$ ¹
 METHOD 608 (HIGH RESOLUTION)²

DATE	191 NEWELL REAR	191 NEWELL REAR CO-LOCATED	LYMAN	SILVER LAKE
May 4, 1993	0.029	0.034	0.057	0.073 ³
May 20, 1993	ND	ND	0.071 ⁴	0.072
June 3, 1993	ND ⁵	ND	ND	0.073 ⁶
June 18, 1993	0.073 ⁶	0.087 ⁶ (0.025)	0.058 ⁶ (0.028)	0.14 ⁶ (0.11)
July 3, 1993	ND	ND	ND	ND
July 18, 1993	0.058	NA ⁷	ND	0.15
August 2, 1993	0.14	0.13	0.10	0.35
August 17, 1993	0.092	0.10	0.071	0.25
Mean Concentration	0.055	0.056(0.048)	0.050(0.046)	0.14(0.14)
Max 24-Hour Occurrence Date of Occurrence	0.14 8/2/93	0.13 8/2/93	0.10 8/2/93	0.35 8/2/93
Min 24-Hour Occurrence Date of Occurrence ⁸	ND ---	ND ---	ND ---	ND 7/3/93

ND Non-Detect (ND) samples had a detection limit (DL) of 0.029 $\mu\text{g}/\text{m}^3$ unless otherwise noted.
¹ Quantified as Aroclor 1254 unless otherwise noted.
² Results of the Method 608 analyses are presented without parentheses; results of the high resolution GC/MS analyses (where performed) are presented in parentheses.
³ A power failure occurred on 5/4/93 at Silver Lake Boulevard. Samples were collected on 5/6 - 5/7/93
⁴ Quantified as Aroclor 1260
⁵ Sample had a DL of 0.032 $\mu\text{g}/\text{m}^3$.
⁶ Quantified as Aroclor 1248
⁷ Samples invalidated due to sampling system problems.
⁸ "—" Indicates a Non-Detect (ND) was found on more than one date.

TABLE 6
BUILDING 32S WINTER SAMPLING RESULTS IN $\mu\text{g}/\text{m}^3$

Date	Concentration
February 2, 1993	0.0005 ¹
February 10, 1993	ND(<0.0005)
February 18, 1993	ND(<0.0005)

¹ Quantified as Aroclor 1260

TABLE 7
COMPARISON BETWEEN HIGH AND LOW VOLUME SAMPLING (ug/m³)
(USING METHOD 608 ANALYTICAL RESULTS)

DATE	SITE	HIGH-VOLUME	LOW VOLUME	RATIO (low/high)
MAY 4, 1993	191 NEWELL R.	0.0056	0.029	5.2
	191 NEWELL R. CO	*	0.034	6.1
	LYMAN	0.0035	0.057	16.0
	SILVER LAKE	0.014 ¹	0.073 ¹	5.2
MAY 20, 1993	191 NEWELL R.	ND	ND	---
	191 NEWELL R. CO	*	ND	---
	LYMAN	0.0027	0.071 ²	26.0
	SILVER LAKE	0.0027	0.072	27.0
JUNE 3, 1993	191 NEWELL R.	0.0075 ³	ND	---
	191 NEWELL R. CO	*	ND	---
	LYMAN	0.0054 ⁴	ND	---
	SILVER LAKE	0.0054 ⁴	0.073 ³	14.0
JUNE 18, 1993	191 NEWELL R.	0.012 ³	0.073 ³	6.1
	191 NEWELL R. CO	*	0.087 ³	7.3
	LYMAN	0.0051 ³	0.058 ³	11.0
	SILVER LAKE	0.014 ³	0.14 ³	10.0
JULY 3, 1993	191 NEWELL R.	0.0089	ND	---
	191 NEWELL R. CO	*	ND	---
	LYMAN	0.0087	ND	---
	SILVER LAKE	0.023 ³	ND	---
JULY 18, 1993	191 NEWELL R.	0.023	0.058	2.5
	191 NEWELL R. CO	*	NA ⁵	---
	LYMAN	0.0052	ND	---
	SILVER LAKE	0.011	0.15	14.0
AUGUST 2, 1993	191 NEWELL R.	0.028	0.14	5.0
	191 NEWELL R. CO	*	0.13	4.6
	LYMAN	0.011	0.10	9.1
	SILVER LAKE	0.0040	0.35	88.0
AUGUST 17, 1993	191 NEWELL R.	0.035	0.092	2.6
	191 NEWELL R. CO	*	0.10	2.9
	LYMAN	0.0072	0.071	9.9
	SILVER LAKE	0.012	0.25	21.0

* NOTE: High volume data from Newell rear is used for comparison with both Newell rear low-volume samples.

¹ A power failure occurred on May 4, 1993. Both high and low-volume samples were collected on May 7, 1993.

² Aroclor 1260

³ Aroclor 1248

⁴ Aroclor 1242

⁵ Sample invalidated due to a power failure.

TABLE 8
HIGH RESOLUTION CONFIRM DATA

DATE	SITE	SAMPLE VOLUME (m ³)	METHOD 608 CONCENTRATION (ug/m ³)	HIGH RESOLUTION CONCENTRATION (ug/m ³)	PERCENT DIFFERENCE %
MAY 4, 1993	F.W. WEBB (HV)	368.6	ND(<0.005)	0.000038	---
MAY 20, 1993	F.W. WEBB (HV)	365.8	0.0027	0.00084	-69
JUNE 18, 1993	F.W. WEBB (HV)	368.6	0.0090	0.0054	-40
	191 NEWELL REAR (HV)	373.0	0.012	0.013	+8.3
	LYMAN (HV)	370.1	0.0051	0.0026	-49
	SILVER LAKE (HV)	373.0	0.014	0.015	+7.1
	191 NEWELL REAR CO(LV)	6.88	0.087	0.025	-71
	LYMAN (LV)	6.87	0.058	0.028	-52
JULY 3, 1993	F.W. WEBB (HV)	370.1	0.0057	0.0026	-54
	191 NEWELL FRONT (HV)	373.0	0.0097	0.0033	-66
	LYMAN (HV)	367.2	0.0087	0.0023	-74
JULY 18, 1993	F.W. WEBB (HV)	370.2	0.0084	0.0054	-36
	191 NEWELL FRONT CO(HV)	373.0	0.010	0.0062	-38
	LYMAN (HV)	367.4	0.0052	0.0026	-50
AUGUST 2, 1993	F.W. WEBB (HV)	368.6	0.0068	0.0036	-47
	LYMAN (HV)	362.9	0.011	0.0056	-49
AUGUST 17, 1993	F.W. WEBB (HV)	370.1	0.0038	0.0022	-42
	LYMAN (HV)	373.0	0.0072	0.0048	-33
			STANDARD DEVIATION	LOW ELEVATION HIGH ELEVATION	17.8 6.3

(HV) High-Volume Samples
(LV) Low-Volume Samples
"-" Indicates a negative percent difference
"+" Indicates a positive percent difference

4.2 Evaluation of Chromatograms from Qualitative Analyses by General Electric

All of the chromatograms from the analysis of the PUF extracts as described in Section 3.1 are shown in Appendix III, Figures 1 through 25. The large peak at 10.3 minutes in each chromatogram is due to the internal standard, 2FBP. The peak which occurs immediately after the 2FBP peak in some of the chromatograms is due to biphenyl. All the remaining peaks are due to PCB isomers. Biphenyl was found in some of the PUF extracts.

With two exceptions, all of the extract chromatograms show very similar patterns of PCB isomer distribution. The two exceptions, Appendix III Figures 1 and 18, show a pattern of large, uniformly spaced peaks. These peaks are clearly seen in Figure 1, which has no other significant peaks. The same pattern of peaks is seen in Figure 18, superimposed on a more typical pattern for the PUF extracts. The origin of these peaks is unknown. The appearance of these peaks suggests that they are caused by several, individual PCB isomers such as would be contained in a mixture added by the laboratory to mark the retention times for isomer identification. Hence, GE believes that these peaks do not reflect PCBs from the environment.

The remainder of the PUF chromatograms all show very similar patterns. The general upward drift of the baseline between 20 and 28 minutes is typical of samples that contain non-PCB materials (such as oil) in combination with low concentrations of PCB. These non-PCB materials do not produce distinct peaks, but, due to their high concentration compared to the PCB isomers, tend to cause significant noise in the detector, which appears as a drifting baseline. The sudden drop of the baseline that occurs at 28 minutes, is caused by the shift of the MS from one PCB parent ion to the parent ion of the next congener group.

In general, the chromatograms of the PUF extracts from a given site show a consistent pattern of PCB isomer distribution over time. Although the concentration of airborne PCB varies with time, the PCB isomer composition remains relatively constant. This is illustrated for the F.W. Webb station in Figure 26, which shows a composite of all the F.W. Webb chromatograms (except for sample AA2101 - Figure 1).

Further comparison of the chromatograms from the high-volume samples from the 191 Newell Street Rear sampler (Figures 8 and 18) with the low-volume sample chromatogram from 191 Newell Street Rear (Figure 9) shows that the major peaks in PCB isomer distribution are very similar. There is likewise a great similarity in the major peaks in PCB isomer distribution between the chromatograms from the Silver Lake high-volume samples (Figures 16 and 23) and those from the low-volume samples from Silver Lake (Figures 17, 24 and 25). Isomer peaks on the Lyman Street low-volume sample chromatogram could not be discerned because of the small amount of PCB in the sample; therefore, a comparison of the chromatograms from the Lyman Street low-volume and high-volume samplers was not possible.

Comparison of the PCB chromatograms of the PUF extracts with the chromatograms of authentic Aroclors (Appendix III, Figures 28-31) shows that the airborne PCBs are not Aroclor mixtures. Thus, as noted previously, the analysis of PUF extracts by packed column GC methods (Method 608) is likely to produce inaccurate results since these methods rely on the assumption that the PCB isomers in the sample are the same isomers found in the Aroclors and that these isomers occur in the same relative ratios in both the sample and the Aroclor standards. Capillary column GC/MS methods are much more likely to be accurate since these methods quantify PCBs by congener group (mono-, di-, tri-, etc.) versus a PCB standard for each group. Alternatively, the GC/MS method developed by GE for the study of PCB degradation quantifies each peak of the chromatogram against a response curve established for the PCB isomer(s) which that peak represents.

Appendix III, Figure 27 (A through H) shows a comparison of one chromatogram from each of the monitoring stations. Figure 27A shows the entire chromatogram from each station. Figures 27B through H show the same chromatograms expanded to five-minute intervals for better comparison. All of the PUF extracts have very similar PCB isomer distributions. However, it appears that there are relatively more of the shorter-retention-time isomers (Figures 27C-E) in the Silver Lake samples, and to some extent in the Lyman Street samples, than there are in the samples from the Newell Street area. This is especially noticeable in Figure 27C, which shows a distinct peak at 17.99 minutes in both the Silver Lake and the Lyman Street chromatograms. This is also shown by the peaks at 21.25 and 22.99 minutes (Figure 27D) and the peaks at 24.35 and 24.49 minutes (Figure 27E). Also in Figure 27D, the pair of peaks at 22.43 and 22.54 minutes shows a reversal of their relative abundances between the Silver Lake/Lyman Street chromatograms and the chromatograms from the Newell Street area.

These differences suggest that the source(s) of the airborne PCBs at the Silver Lake and Lyman Street sites are somewhat different from the source(s) of the airborne PCBs at the Newell Street stations. This is consistent with the view that most of the airborne PCB isomers absorbed on the PUFs are of nearby origin and that their concentration in air diminishes rapidly as one moves away from the source.

The chromatograms of the PUF extracts from the BCC site (Appendix III, Figures 21 and 22) show a few of the lower chlorinated PCB isomers (di- and tri-), but no evidence of significant amounts of the higher chlorinated isomers. These two extracts show more "background" material (drifting baseline), relative to the PCB peak, than most of the other chromatograms. Unfortunately, the only extracts of PUFs from the BCC site were too dilute to obtain good quality GC/MS chromatograms.

Finally, a comparison has been made between the PUF extract chromatograms and the chromatograms from the soil, sediment, filter cake, and oil samples collected from potential source areas (which are listed in Table 3 and presented in Appendix III, Figures 32-48). None of the PUF extract chromatograms shows a PCB isomer distribution

directly comparable to any of the isomer distributions in the chromatograms from the other media samples. However, if the PCB isomers absorbed on the PUFs were attributable to volatilization from such other media (rather than carried on dust particles or droplets), one would expect that the isomer distribution in the PUF extracts would be somewhat different from the isomer distribution in the source media. Specifically, in this event, the more volatile (higher vapor pressure) isomers which have a shorter retention time should appear as a larger fraction of the PCB isomer distribution in the air. Preliminary calculations by GE of the theoretical PCB isomer distribution that would be expected in air samples assuming the volatilization of PCBs of the type found in soil and sediment samples from around the monitors bears out this hypothesis. This factor could thus explain the increased presence of shorter retention time isomers in the PUF chromatograms compared to the soil/sediment chromatograms.

4.3 Meteorological Data

Data from the on-site weather station were summarized and tabulated for each of the sampling days. Table 9 summarizes the mean, maximum and minimum temperatures for each sampling day. Table 10 summarizes the mean, maximum and minimum wind speed for each sampling day. Table 11 presents barometric pressure and total precipitation for each sampling day. The wind speed and wind direction data were combined to produce wind roses for each of the sampling days. The wind roses are presented in Appendix VI.

TABLE 9
 MEAN, MAXIMUM AND MINIMUM TEMPERATURE (°F)
 ON SAMPLING DAYS

DATE	MEAN	MAXIMUM	MINIMUM
May 4, 1993	57.39	65.56	47.03
May 7, 1993	59.24	70.30	45.58
May 20, 1993	50.57	51.67	47.87
June 3, 1993	53.78	63.58	43.43
June 18, 1993	64.52	78.10	51.16
July 3, 1993	63.88	68.63	55.50
July 18, 1993	64.19	74.40	51.11
August 2, 1993	72.25	81.80	59.67
August 17, 1993	69.29	78.20	64.75

TABLE 10
 MEAN, MAXIMUM AND MINIMUM WIND SPEED (mph)
 ON SAMPLING DAYS

DATE	MEAN	MAXIMUM	MINIMUM
May 4, 1993	5.45	11.30	<0.75
May 7, 1993	5.04	11.74	<0.75
May 20, 1993	2.59	6.58	<0.75
June 3, 1993	6.18	14.85	<0.75
June 18, 1993	3.24	7.27	<0.75
July 3, 1993	4.10	8.55	1.39
July 18, 1993	5.22	12.16	<0.75
August 2, 1993	2.51	6.07	<0.75
August 17, 1993	3.15	7.51	<0.75

TABLE 11
AVERAGE BAROMETRIC PRESSURE AND TOTAL PRECIPITATION
ON SAMPLING DAYS

DATE	MEAN PRESSURE (in Hg)	TOTAL PRECIPITATION (in)
May 4, 1993	29.33	0
May 7, 1993	29.17	0
May 20, 1993	28.66	0.01
June 3, 1993	28.80	0
June 18, 1993	29.09	0
July 3, 1993	29.02	0.04
July 18, 1993	28.93	0
August 2, 1993	28.77	0.42
August 17, 1993	28.96	0.23

5.0 Data Quality

5.1 Ambient Air Monitoring

5.1.1 Data Quality in Terms of the Data Quality Objectives

Prior to the initiation of sampling, a Quality Assurance Project Plan (QAPP) was developed and submitted to the MA DEP. The QAPP defined the quality assurance objectives in terms of comparability, completeness, representativeness, precision and accuracy. The QAPP also fully described the organization of the project including the assignment of responsibility for specific quality assurance and quality control procedures to meet the project's quality assurance objectives. The QAPP was developed in accordance with the OTS Guidance Document for the Preparation of Quality Assurance Project Plans, U.S. EPA, 1984, and the Quality Assurance Handbook for Air Pollution Measurement Systems, U.S. EPA, 1976. A copy of the Table of Contents from the QAPP is included in Appendix VII.

5.1.1.1 Validity

A valid sample was defined as an air sample that was collected over 24-hours, +/- 30 minutes, from 7 AM to 7 AM, at a rate of 200 - 280 l/min. Additionally, a valid sample must represent a minimum total collected volume of air of 288 cubic meters. Only samples which met the criteria for validity were used in the calculations for completeness, precision and accuracy.

5.1.1.2 Representativeness

All samples were collected at the locations and during the time period approved by MA DEP as being representative for the purpose of this study.

5.1.1.3 Comparability

All measured PCB concentrations were converted to $\mu\text{g}/\text{m}^3$ for comparison with the standard.

5.1.1.4 Completeness

There were 88 possible samples (high- and low-elevation) from the entire monitoring event (including the co-located sampling sites). Of these, 85 samples met the criteria for validity as defined in the QAPP. Completeness, therefore, was measured as 97 percent.

5.1.1.5 Precision

Field sampling precision was measured by samples taken at the co-located samplers. The high-elevation co-located sampler was at 191 Newell Street Front. The samplers were 2-4 meters apart. Sampler 2 was considered the primary sampler and Sampler 2-Co was designated as the duplicate, co-located sampler. The calibration, sampling and analysis procedures for the two samplers were the same as for all samplers. The co-located sampler operated whenever the primary sampler operated.

The low-elevation co-located sampler was located at 191 Newell Street Rear. The samples were located approximately one meter apart. Sampler A was designated the primary sampler and Sampler A-Co was designated the co-located sampler. The calibration, sampling and analysis procedures for the two samplers were the same as for all samplers. The co-located sampler was operated whenever the primary sampler was operated.

The average percent difference and standard deviation were calculated in accordance with procedures defined in the QAPP. The calculations were made only with data which were considered hits (i.e. not ND). The calculations are presented in Appendix VIII. Using this approach, the average percent difference in ambient concentrations between the high-elevation co-located sampling sites was 25 percent and the standard deviation was 13 percent. The average percent difference in ambient concentrations between the low-elevation co-located sampling sites was 9.4 percent and the standard deviation was 6.9 percent. A control limit of variation between the samplers was not specified in the QAPP. It should be noted that because there were only eight sampling events, the number of events actually used after eliminating all NDs for high- and low-elevation sampling was five and four, respectively. This is not a statistically significant number of samples; therefore, the standard deviation calculation may provide little meaning.

5.1.1.6 Accuracy

One-point calibration checks were conducted before and after each sampling event and were used as a check of flow measurements. The one-point calibration checks on all samplers were within $\pm 10\%$ deviation of calculated flow values.

5.1.2 Quality Assurance/Quality Control

Calibrations for all sampling equipment were conducted in accordance with the schedules and procedures specified in the EPA High Volume Reference Method, Method TO-4, and Method TO-10. Copies of all calibrations conducted on the high-elevation samplers and their associated parts (ETMs, timers, etc.) are presented in Appendix IX. Also presented in Appendix IX are copies of the calibration conducted on the calibration orifice. The calibration orifice calibration was completed by BGI Incorporated of Waltham, MA. Calculations to determine the calibration curve of the calibration orifice are also included.

One-point calibration checks of the calibrated flow rate versus sampler magnehelic pressure indication were performed on each sampler before and after each sampling event. The readings were documented and copies of all of the one-point calibration checks are located in Appendix X.

Six-hour recordings of the sampler pressure indicators, adjusted flowrate, flowmeter readings, temperature readings, and barometric pressure readings were recorded on the high- and low-elevation sampling event data sheets. All sampling event data sheets are presented in Appendix XI.

All high- and low-volume air flow calculations to determine air flow through the samplers were conducted on air flow calculation sheets, contained in the sampling event file. Copies of all air flow calculation sheets are contained in Appendix XII.

All samples were sent to IT Analytical Services under Chain of Custody/Request for Analysis (COC/RA) by Federal Express. All COC/RA forms and Federal Express Airbills are presented in Appendix XIII.

All maintenance activities and repair work done on the samplers were recorded in the maintenance log. All entries are presented in Appendix XIV.

Activities involving the Meteorological Station on East Street were recorded in a calibration/maintenance log. A copy of this log is found in Appendix XV. Also included in Appendix XV is a copy of the MA DEP audit of the meteorological station conducted in August 1993.

All Method Blank check confirmation sheets are presented together with the analytical data in Appendices IV and V.

5.1.3 Problems and Disruptions

The following problems and disruptions occurred during the sampling program:

- A power failure occurred at the Silver Lake station on May 4, 1993. Power was restored to the site and both high- and low-elevation samples were re-taken on May 6 - 7, 1993.
- The analysis of the high-volume sampling field blank for the May 6-7, 1993, Silver Lake retest, showed that the blank PUF contained PCB levels above the detection limit. IT Analytical Services explained that there was an interference peak in all the samples and the blank, therefore all of the data were blank corrected.
- It was necessary to sample on May 19-20, 1993, in the place of the scheduled May 18-19, 1993 sampling event, due to a lack of TO-4 PUFs. IT Analytical Services did not have a cleaned supply of TO-4 PUFs, and therefore it was necessary to identify a laboratory that had a supply of cleaned TO-4 PUFs. Ross Analytical Services had a cleaned supply, the PUFs were sent out by Federal Express, and sampling was begun on the morning of May 19, 1993.
- A power failure occurred on May 20, 1993, at Berkshire Community College. For the May 20, 1993, sampling event, there is no background sample. Power was restored to the site within 24-hours.
- A motor failure in the 191 Newell Street Front high-elevation sampler on July 18, 1993, invalidated that sample. A sample was taken from the co-located sampler at that site. The sampler's motor was replaced within 24-hours and all other samplers' motors were inspected or replaced to prevent future problems.
- The sample taken from the 191 Newell Street Rear co-located low-elevation sampler on July 18, 1993 was invalidated due to a problem with the sampling system. The sampling system was corrected and all other sampling systems were inspected to prevent a similar problem.

- The East Street meteorological station wind direction indicator was found to be misaligned on November 5, 1992, and was repaired on June 11, 1993. Meteorological data from the East Street Area 2 meteorological station were supplemented by weather data from the F.T. Rose Site meteorological station when East Street data were not available.

- It is believed that lightning struck the meteorological station on July 28, 1993. This event placed the meteorological station out of order between July 29 and August 3, 1993. When the situation was discovered, the equipment was inspected, repaired, recalibrated and restored to service. Meteorological data from the East Street Area 2 meteorological station were supplemented by weather data from the F.T. Rose Site meteorological station when East Street data were not available.

All of the problems and disruptions listed above were resolved in an expedient manner and to the satisfaction of the GE Project Manager. The problems encountered were not unusual for the type of sampling program undertaken, and they did not affect the quality of data for the purposes of this study. These problems were considered while assessing the Quality Assurance/Quality Control techniques performed to assure valid data. All of the data quality objectives defined in the QAPP were met.

6.0 Interpretation of Data

6.1 Meteorological Variables

Before completing an evaluation of the implications of the ambient PCB concentrations in determining potential source areas, an attempt was made to identify what impact various meteorological parameters had on the ambient concentrations of PCBs. The meteorological parameters of temperature, wind speed, barometric pressure, precipitation and wind direction measured at the on-site weather station were compared with the measured PCB concentrations at all of the sampling sites. To assist in the interpretation of ambient concentrations and meteorological parameters, several graphs of measured PCB concentrations against the various meteorological parameters were developed. Tables 9, 10 and 11 provide data on sampling days for temperature, wind speed, barometric pressure and precipitation. In addition, Tables 12, 13, 14 and 15 provide summaries of meteorological data for the days on which the highest and lowest PCB concentrations occurred at each of the sampling sites. These materials were developed to assist in identifying any patterns in the ambient concentrations that could be explained by meteorological variables which were monitored on-site.

A summary of the identified relationships between the 1993 PCB concentrations and meteorological variables of temperature, wind speed, wind direction, barometric pressure and precipitation is presented in the following sections. Since previous efforts at statistical evaluations of meteorological data and ambient concentrations did not prove to be effective in interpreting ambient PCB data, no statistical analyses were conducted.

6.1.1 Temperature

Appendix XVI includes graphs of ambient PCB concentration versus temperature for the six high-elevation and three low-elevation sampling locations for the eight sampling events in the May-August 1993 study. It also includes, for comparison and completeness, graphs of ambient PCB concentration versus temperature from the year-long 1991-92 study for the stations involved in that study. Inspection of these graphs shows that, at the high-elevation stations (excluding the background site), ambient PCB concentrations begin to increase at ambient temperatures around 50-60°F. This trend can be seen both in the graphs for 1993 and in the graphs for 1991-92, particularly at the locations of interest here (i.e., those at and around Newell Street, near Silver Lake, and at the Lyman Street site). At temperatures of 50-60°F and higher, temperature appears to be related to ambient PCB concentrations, although it is not a direct linear relationship. For the low-elevation monitors, the graphs show that temperature begins to be associated with ambient PCB concentration at around 63-64°F, and that at these and higher temperatures there is a strong and more direct relationship between increasing temperature and increasing PCB concentrations.

TABLE 12
 CONDITIONS AT MAXIMUM CONCENTRATION FOUND DURING HIGH ELEVATION SAMPLING

SITE	CONCENTRATION	DATE	TEMP	WIND SPEED	PREDOMINANT WIND DIRECTION
WEBB	0.0090	6/18/93	64.52	3.24	W/SW
191 NEWELL FRONT	0.0097	7/3/93	63.88	4.10	E/SE
191 NEWELL REAR	0.035	8/17/93	69.29	3.15	E
LYMAN	0.011	8/2/93	72	2.51	Calm, N-S, NW, NNW
SILVER LAKE	0.023	7/3/93	63.9	4.0	E/SE
BCC	0.0035	6/3/93	53.78	6.18	

TABLE 13
 CONDITIONS AT MINIMUM CONCENTRATION FOUND DURING HIGH ELEVATION SAMPLING

SITE	CONCENTRATION	DATE	TEMP	WIND SPEED	PREDOMINANT WIND DIRECTION
WEBB	0.0027	5/20/93	50.57	2.59	SE
191 NEWELL FRONT	ND	6/3/93	53.8	6.18	NW
	ND	8/2/93	72	2.51	Calm, N-S, NW, NNW
191 NEWELL REAR	ND	5/20/93	50.57	2.59	SE
LYMAN	0.0027	5/20/93	50.57	2.59	SE
SILVER LAKE	0.0027	5/20/93	50.57	2.59	SE
BCC	ND	7/3/93	63.88	4.10	
		7/18/93	64.19	5.22	

TABLE 14
 CONDITIONS AT MAXIMUM CONCENTRATION FOUND DURING LOW ELEVATION SAMPLING

SITE	CONCENTRATION	DATE	TEMP	WIND SPEED	PREDOMINANT WIND DIRECTION
191 NEWELL REAR	0.14	8/2/93	72.25	2.51	Calm, N-S, NW, NNW
LYMAN	0.10	8/2/93	72.25	2.51	Calm, N-S, NW, NNW
SILVER LAKE	0.35	8/2/93	72.25	2.51	Calm, N-S, NW, NNW

TABLE 15
 CONDITIONS AT MINIMUM CONCENTRATION FOUND DURING LOW ELEVATION SAMPLING

SITE	CONCENTRATION	DATE	TEMP	WIND SPEED	PREDOMINANT WIND DIRECTION
191 NEWELL REAR	ND	---	---	---	
LYMAN	ND	---	---	---	
SILVER LAKE	ND	7/3/93	63.9	4.10	E/SE

"---" Indicates there were more than two occasions on which a non-detect was found.

Review of the tables showing meteorological data on days with maximum and minimum PCB concentrations reveals information consistent with the foregoing conclusions. The maximum concentration at each of the low-elevation monitors occurred on August 2, 1993, coinciding with the date of the highest recorded average daily temperature (Table 14; see also Table 9). The maximum concentrations at all of the high-elevation monitors, except BCC, occurred when the average daily temperature was greater than 63° (Table 12). The maximum PCB concentrations at the high-elevation monitors, however, did not necessarily occur on the day with the highest average daily temperature.

The minimum concentrations recorded at each sampling location, excluding BCC, tended to occur on days with average daily temperatures less than 60°F, particularly at the high-elevation monitors (Table 13). (One obvious exception was the ND recorded at 191 Newell Street Front on August 2, 1993 when the average daily temperature was 72°F.)

Review of these data indicates that average daily temperature appears to have some impact on ambient PCB concentrations, but it is not clear to what degree. At the monitored sites, excluding BCC, the overall data demonstrate that at ambient temperatures below about 50°F, there are unlikely to be measurable concentrations of ambient PCBs, while at higher temperatures, particularly above 60°F, there is a strong likelihood of obtaining measurable concentrations of PCBs. Thus, temperatures above about 50-60°F appear to be related to ambient PCB concentrations, although that relationship is not direct at the high-elevation locations. At the low-elevation sampling stations, PCB concentrations appear to be more sensitive to temperature (above about 63-64°F). Indeed, at these stations, the warmest days produced the maximum concentrations, whereas the warmest days did not consistently coincide with the maximum concentrations at the high-elevation stations.

6.1.2 Wind Speed

To investigate whether ambient PCB concentrations may be linked to wind speed, the ambient PCB concentrations for the high-elevation and low-elevation monitors were plotted against the 24-hour average wind speed for each sampling day. These graphs are presented in Appendix XVII. Again, these graphs include data both from the May-August 1993 study and the year-long 1991-92 study.

An inspection of these graphs reveals no evidence of a relationship between wind speed and ambient concentrations of PCBs at the high-elevation monitors. The graphs for the low-elevation monitors, however, are suggestive of an inverse relationship of PCB concentrations with wind speed (i.e., higher concentrations associated with lower wind speed). In addition, as shown in Table 5, the highest ambient PCB concentration at all of the low-elevation monitors occurred on

August 2, 1993, which was also the date with the lowest wind speed (Table 10) - as well as the highest average daily temperature (Table 9) and the greatest daily precipitation (Table 11).

6.1.3 Wind Direction

To assist in the evaluation of wind direction, wind roses depicting the wind speed and wind direction during each of the sampling events were created. Copies of these wind roses are included in Appendix VI. In addition, Tables 12, 13, 14, and 15 were used to examine the meteorological conditions at each site on the days of the highest and lowest observed concentrations.

In the evaluations of wind direction, it was assumed that the Silver Lake, Lyman Street and 191 Newell St. Rear samplers are located at or directly above sources of the airborne PCBs, since those areas are known to contain elevated PCB concentrations. The evaluation also took into account that the 191 Newell Street Front and F.W. Webb monitors are located at some distance (potentially downwind) from the assumed source area at 191 Newell Street Rear.

This evaluation of the data indicated that wind direction alone does not account for the observed concentrations of ambient PCBs at the sampling locations. The wind direction varied from day to day, and it was not possible to establish a consistent relationship between measurable ambient PCB concentrations and the wind direction. It does appear, however, that wind direction and wind speed are mechanisms which play a role in the dispersion and dilution of PCBs from the assumed source areas. This is evidenced in the Newell Street area by higher concentrations observed close to the potential source area (i.e. the rear of 191 Newell Street) and lower concentrations observed farther away (i.e. 191 Newell Street Front and F.W. Webb).

6.1.4 Barometric Pressure

In reviewing the previous year-long study, MA DEP had suggested that ambient PCB concentrations may be linked to increasing or decreasing barometric pressure. To investigate this possibility, the ambient PCB concentrations for the high-elevation and low-elevation monitors were plotted against the average barometric pressure for each sampling day. These graphs are presented in Appendix XVIII. (They include only the 1993 data.) An inspection of these graphs shows no identifiable pattern or relationship, with the possible exception of the high-elevation sampling at Silver Lake. There was considerable variation within stations and between stations. There is thus no evidence, again with the possible exception of the Silver Lake high-elevation station, to suggest that barometric pressure impacted ambient concentrations of PCB.

6.1.5 Precipitation

The precipitation data (Table 11) reveal that a significant amount of precipitation occurred on two of the eight sampling days (August 2 and August 17, 1993). There were two additional days with minor accumulations (drizzle) of precipitation (May 20 and July 3, 1993). As shown in Table 5, the two days with the highest ambient PCB concentrations at all of the low-elevation sampling locations coincided with the two days of significant precipitation (August 2 and 17, 1993). There is no obvious relationship between precipitation and PCB concentrations at the high-elevation stations. Overall, the precipitation data are insufficient to draw any supportable conclusions about the impact of precipitation on ambient concentrations of PCBs.

6.1.6 Summary

The meteorological parameters of temperature, wind speed and wind direction appear to have some impact on the variation in ambient PCB concentrations. The impacts of temperature and wind speed appear to be more pronounced at the low-elevation stations than the high-elevation stations. The impact of wind speed and wind direction is evidenced by the dispersion and dilution of PCBs in the air. It is nevertheless not clear to what degree these parameters directly affect ambient PCB concentrations. These meteorological parameters are, by their very nature, variable and characteristically do not operate independently of one another. It is more likely that these factors along with other factors, which may include source strength and proximity to the source area(s), combine in various ways to determine the concentration of ambient PCBs at a given point on any given day.

6.2 Comparison of Data With 1991-1992 Year-Long Study

Three of the high-volume sampling stations from the 1993 sampling program are directly comparable to three of the sampling stations from the 1991-1992 sampling program. Table 16 below summarizes and compares the average PCB concentrations from these stations:

TABLE 16
COMPARISON BETWEEN 1991-92 AND 1993
SAMPLING PROGRAMS

	Average PCB Conc. (ug/m ³) May-August, 1991-92*	Average PCB Conc.(ug/m ³) May-August, 1993
BCC	<0.0005	0.0015
Lyman Street	0.0029	0.0061
191 Newell Rear	0.015	0.015

* Samples collected during months of May, June, July and August in the 1991-1992 year-long study.

It is unclear why the concentration at the background site at BCC is three times higher in 1993 than in 1991-92. There were several more NDs recorded at BCC in 1991-92 than there were in 1993. It is also unclear why the concentration at Lyman Street is twice as high in 1993 as during 1991-1992.

6.3 Implications of Ambient Air Studies in Determining Sources

GE's analyses of PCB isomer distribution (Section 4.2) show that at each of the sampling stations, the distribution of PCB isomers in the air samples has a consistent pattern over time. Although the concentrations vary with time, the PCB isomer composition remains relatively constant at each station. The analyses further show that PCB isomer distributions on chromatograms from air samples at the Newell Street area sampling stations (including 191 Newell Front, 191 Newell Rear and F.W. Webb) can be distinguished from the PCB isomer distributions on chromatograms from air samples at the Lyman Street and Silver Lake sampling stations. This is demonstrated in Figures 27 C, D and E of Appendix III showing several isomer peaks (e.g. peaks eluted at 7.99, 21.25, 24.35, and 24.49) in the Silver Lake and Lyman Street samples that do not appear in the samples from the Newell Street area stations. In addition, the peak patterns in the Lyman Street and Silver Lake samples show a different proportionality than corresponding peaks in the Newell Street area samples. This phenomenon can be observed by examining peaks eluted at 22.43 and 22.54 in Figure 27D.

This isomer distribution and peak ratio analysis indicates that the source of airborne PCBs in the Newell Street area is different from the source(s) of airborne PCBs at Lyman Street and Silver Lake. Based on this position, the implications of this ambient

air study in determining source areas for the Newell Street area, Lyman Street and Silver Lake sampling locations have been evaluated separately.

6.3.1 Newell Street Area

6.3.1.1 High-Volume/Low-Volume Comparison

A comparison of the GE Environmental Laboratory's PUF extract chromatograms from the 191 Newell Street Rear low-elevation sample (Figure 9, Appendix III) and high-elevation samples (Figures 8 and 18, Appendix III) shows a very similar distribution of the major PCB isomer peaks. This similarity in isomer peak distribution indicates that the source of PCBs in the low-elevation air sample is the same as the source of PCBs in the high-elevation air samples.

The PCB concentration recorded at the low-elevation sampler was consistently greater than the PCB concentration recorded at the high-elevation sampler. Table 7 shows that the low-elevation concentrations were 2.8 to 6 times greater than high-elevation concentrations. If the ground behind 191 Newell Rear were the source of airborne PCBs, one would expect to see higher PCB concentrations closer to the ground and lower PCB concentrations at higher elevations, and this is in fact what was found.

It should be noted, however, that there is some question about the comparability of the low-elevation and the high-elevation sampling results, since the samples were collected using different sampling methods (TO-10 for the low-elevation samples versus TO-4 for the high-elevation samples). The low-volume samplers used at the low-elevation stations pull a total volume of approximately only 7 m³ of air over 24 hours, compared to approximately 370 m³ of air at the high-volume samplers used at the high-elevation locations. Moreover, due to the lower volume, the low-volume samples have a PCB detection limit of 0.029 ug/m³, which is substantially higher than the detection limit of 0.0005 ug/m³ for the high-volume samples. In these circumstances, any PCBs detected by the low-volume sampler would be quantified at a relatively elevated concentration. Further sampling is proposed in Section 8 to evaluate the comparability between high-volume and low-volume methods. Until that sampling is completed, any comparisons between the high-elevation and low-elevation sampling data should be viewed with considerable caution.

6.3.1.2 Variations Between High-Volume Sampling Locations

GE's analyses of the chromatograms have shown that the peak ratios and isomer distributions in PUF extracts from 191 Newell Street Rear (Figures 8 and 18, Appendix III), 191 Newell Street Front (Figures 10, 11 and 19, Appendix III) and F. W. Webb (Figures 1-7, Appendix III) are all very similar, suggesting that the same source(s) are influencing the Newell Street area monitors. As noted in section 6.3.1.1, above, this pattern is also evident in the chromatogram from the low-elevation samples in the rear of 191 Newell Street.

The PCB concentrations recorded at 191 Newell Street Front and F.W. Webb averaged less than the concentrations recorded at 191 Newell Street Rear, which is assumed to be directly over the assumed source area. The PCB concentrations at 191 Newell Street Front and F.W. Webb are approximately one-third of the PCB concentrations at 191 Newell Street Rear. This seems logical because if the source of airborne PCBs is assumed to be the ground area behind 191 Newell Street, one would expect to see lower PCB concentrations at monitors farther away from the source due to the effects of dispersion and dilution.

6.3.1.3 Wind Directional Data

The wind roses in Appendix VI, the PCB site concentration data in Table 4 and the predominant wind direction recorded on days with the maximum and minimum PCB concentrations (Tables 12-15) were used to evaluate whether the Newell Street rear area might be a source of ambient PCBs for the Newell St. area sites. On some days, as on June 18, 1993, when the highest ambient concentration of PCBs was recorded at the F.W. Webb station, the wind direction (W/SW on that date) seemed to suggest that the ambient PCBs found at F.W. Webb may be coming from the assumed source area (i.e. 191 Newell Street Rear). However, this wind direction association could not be consistently applied.

6.3.1.4 Comparison of Soil Chromatograms with Ambient Air Chromatograms

A comparison has been made between the PUF extract chromatograms from the Newell Street area (Appendix III, Figures 8-11, 18-19) and the chromatograms from the soil samples from 191 Newell Street Rear (Appendix III, Figures 46-48). None of the PUF extract chromatograms shows a PCB isomer distribution directly comparable to the isomer distribution in the soil sample chromatograms. However, as discussed in Section 4.2, the differences are consistent with, and may be

explained by, the expectation that if the PCBs volatilized from the soil, the isomer distribution in the PUF extracts would show a greater proportion of the more volatile isomers that have a shorter retention time.

6.3.1.5 Overall Interpretation

Review of all the data, particularly the comparison of ambient PCB concentrations among the various monitors in the Newell Street area and the comparison of air extract chromatograms among those monitors, indicates that the ground surface in the rear of 191 Newell Street is a principal source of PCBs in the ambient air of the surrounding area. Emission rates from this assumed source cannot be determined with any precision, although it is clear that they are higher in warm periods than in cold periods. Moreover, the data indicate that there is rapid dispersion of PCB concentrations with elevation above the assumed source area, and that ambient PCB concentrations further decrease rapidly with distance from the source.

6.3.2 Lyman Street Area

6.3.2.1 High-Volume/Low-Volume Comparison

Because of the small quantities of PCBs in the Lyman Street low-elevation samples, GE Environmental Laboratory was unable to make a direct comparison of PUF extract chromatograms from the Lyman Street low-elevation monitor (Appendix III, Figure 13) and high-elevation monitor (Appendix III, Figures 12, 14 and 20). A few of the major isomer peaks are evident in the low-elevation chromatogram, but they are not sufficient to draw any conclusions regarding similarity with the high-elevation chromatogram peaks.

The PCB concentrations recorded at the Lyman Street low-elevation sampler were consistently greater than the PCB concentration recorded at the high-elevation sampler. Table 7 shows that the low-elevation concentrations were 9.2 to 26 times greater than high-elevation concentrations. If the Lyman Street river bank were the source of airborne PCBs, one would expect to see higher PCB concentrations closer to the ground and lower PCB concentrations farther away. Again, however, given the questions about the comparability of the sampling methods used in the high-elevation and low-elevation sampling (as discussed in Section 6.3.1.1), any comparisons between these data sets should be viewed with caution.

6.3.2.2 Wind Directional Data

The wind roses and wind directional data provide no real assistance in identifying the Lyman Street river bank or any other potential area as the source of airborne PCBs at Lyman Street. For example, on August 2, 1993 and July 3, 1993, the two days with the highest recorded PCB concentrations at Lyman Street, the predominant wind direction was from the N/NW and E/SE, respectively.

6.3.2.3 Comparison of Oil and Filter Cake Chromatograms with Ambient Air Chromatograms

A comparison has been made between the PUF extract chromatograms from the Lyman Street site (Appendix III, Figures 12-15 & 20) and the chromatograms from the oil and filter cake samples taken from this site (Appendix III, Figures 39-41 & 44). Again, the PCB isomer distribution in the PUF extract chromatograms is not comparable to that in the oil and filter cake chromatograms, although the differences may be explained by the volatilization of shorter retention time isomers.

6.3.2.4 Overall Interpretation

The chromatograms of the high-volume samples at Lyman Street were consistent over time. However, unlike the Newell Street area, the quantity of PCBs in the low-volume sample was insufficient to characterize the low-volume and high-volume samples as similar. Therefore it was not possible to identify the river bank as the source area for ambient PCBs recorded at the high-volume monitor. In general, there are insufficient data to identify the source of ambient PCBs at Lyman Street.

6.3.3 Silver Lake Area

6.3.3.1 High-Volume/Low-Volume Comparison

A comparison of the GE Environmental Laboratory's PUF extract chromatograms from the Silver Lake low-elevation samples (Appendix III, Figures 17, 24 and 25) and high-elevation samples (Appendix III, Figures 16 and 23) shows a very similar distribution of the major PCB isomer peaks. This similarity in isomer peaks distribution indicates that the source of PCBs in the low-elevation air sample is the same as the source of PCBs in the high-elevation air samples.

The PCB concentrations recorded at the low-elevation monitor at Silver Lake were consistently greater than the PCB concentrations recorded at the high-elevation monitor. Table 7 shows that the low-elevation PCB concentrations varied from 5.2 to 87.5 times greater than high-elevation PCB concentrations. This wide variability between the high-volume and low-volume sampling results did not occur at the other sites. It is also noticeable that, unlike the Newell Street Rear and Lyman Street sites, the highest PCB concentrations at the Silver Lake low-elevation monitor did not correspond with the days when the highest PCB concentrations occurred at the Silver Lake high-elevation monitor.

The high PCB concentrations at the low-elevation monitor suggest that Silver Lake is a source of ambient PCBs. The results also illustrate that significantly higher concentrations are observed at low elevations than at higher elevations at breathing height. However, no firm conclusions can be reached regarding the magnitude of the low-elevation PCB concentrations or the extent of differences between them and high-elevation concentrations until the questions regarding the comparability of the high-volume and low-volume sampling methods are resolved (See Section 8).

6.3.3.2 Variations Between High-Volume Sampling Locations

A comparison between PCB levels found at Building 32S (approximately 400 feet east of Silver Lake) during the summer of 1991-92 and the concentrations found at the eastern edge of Silver Lake in 1993 show consistently higher ambient PCB concentrations at the Silver Lake shore. This comparison shows that the PCB levels at Building 32S are roughly one-half those found at the edge of Silver Lake. This comparison is analogous to the comparison of the 191 Newell Street Rear sampling location with 191 Newell Street Front and F.W. Webb. In each case, the data illustrate that PCBs diminish rapidly with distance from the potential source area.

6.3.3.3 Wind Directional Data

As with the other sites, wind direction was not especially helpful in identifying the source areas of PCBs. On some days, the wind direction from the west seemed to provide an explanation for the PCB concentrations observed, but there was no evident consistent pattern or relationship.

6.3.3.4 Comparison of Sediment Chromatograms with Ambient Air Chromatograms

A comparison has been made between the PUF extract chromatograms from the Silver Lake site (Appendix III, Figures 16-17, 23-25) and the chromatogram of a sediment sample from Silver Lake (Appendix III, Figure 45). Once again, the PCB isomer distribution in the PUF extract chromatograms is not comparable to that in the sediment sample chromatogram. Again, too, the differences involve a greater proportion of shorter retention time isomers in the PUF extract chromatograms, which is consistent with the theoretical PCB isomer distribution that would be expected assuming the volatilization of PCBs from the sediments.

6.3.3.5 Overall Interpretation

Review of all the data, particularly the ambient monitoring data from Silver Lake and Building 32S and comparisons of the low-volume and high-volume sample chromatograms from Silver Lake, indicates that Silver Lake is a principal source of PCBs in the ambient air in this area. Emission rates cannot be determined, although they appear to be higher in warmer months. Significantly, PCB concentrations appear to decrease rapidly with elevation above the lake surface and to decrease rapidly further with distance from the lake.

7.0 Evaluation of Potential Risk

GE requested ChemRisk of Portland, Maine, to evaluate the potential health risks associated with the inhalation of airborne PCBs, based on the PCB monitoring data collected in 1991-92 and in May-August 1993. This evaluation focused principally on the area around the Newell Street site, since the monitoring data show the highest ambient PCB concentrations at that site. However, since there is no potential for continuous 24-hour exposures at that site itself, the assessment was directed to the residential properties adjacent to the site and to the nearby Hibbard School. A comparative evaluation was also made of the potential risks to residents living near Silver Lake. In addition, alternative assessments were made for all these areas using an approach recommended by MA DEP's Office of Research and Standards. ChemRisk's evaluation is presented in Appendix XIX.

7.1 Estimated Average PCB Concentrations for Newell Street Area

For analysis of potential exposures and risks to the residents on Newell Street, ChemRisk and Zorex jointly determined that the most representative, but still conservative, data are the data from 191 Newell Street Front and F.W. Webb, since those locations are closer to the receptor areas of interest than 191 Newell Street Rear. Similarly, it was determined that the most representative data for the analysis of potential exposures and risks for the Hibbard School students are the data from F.W. Webb due to the proximity of that sampling station to the school. Monitoring data are available for the 191 Newell Street Front and F.W. Webb stations for May-August 1993. For some of the shorter-term exposure analyses, these data could be used directly. For the chronic exposure analyses, however, it was necessary to estimate annual or other long-term average concentrations for those two stations. These estimates were made by the application of calculated ratios to the year-long 1991-92 monitoring data from 191 Newell Street Rear, as discussed below.

For the various averaging periods specified by ChemRisk, Zorex calculated the appropriate average PCB concentrations. A description of the calculations and the resulting averages is provided below, while a copy of the underlying calculations is presented in Appendix XX. Note that these calculations are based on the data from the Method 608 analyses, rather than the high-resolution analyses, because the former constitute a more complete data set. Thus, the risk assessment is overly conservative because the Method 608 analyses generally produce higher PCB concentrations than the high-resolution analyses which generate more accurate values for actual ambient PCB levels. See Section 4.1.2 above.

1. Ratios. For several of the estimates, it was necessary to calculate a ratio of the concentrations at 191 Newell Street Front or F.W. Webb to those at 191 Newell Street Rear. For the calculation for 191 Newell Street Front, the average concentration for this station from all 1993 sampling events (0.0041 ug/m^3) was divided by the average concentration for 191 Newell Street Rear from the same sampling events (0.015 ug/m^3). Similarly, for F.W. Webb, the average concentration for this station for the 1993 events (0.0053 ug/m^3) was divided by the 191 Newell Street Rear average for these events (0.015 ug/m^3). The resulting ratios are:

191 Newell St. Front	F.W. Webb
0.27	0.35

2. Annual Averages. To estimate the annual average PCB concentrations for 191 Newell Street Front and F.W. Webb, the foregoing ratios were applied to the annual average concentration at 191 Newell Street Rear in 1991-92 (0.0062 ug/m^3). The results are (in ug/m^3):

191 Newell St. Front	F.W. Webb
0.0017	0.0022

The combined average for these two stations is 0.0020 ug/m^3 .

3. September-June Average at F.W. Webb. To estimate the average concentration for F.W. Webb for the school year, all concentrations detected at 191 Newell Street Rear in the 1991-92 study were multiplied by the foregoing ratio for F.W. Webb (to simulate a full year of data at F.W. Webb), and the average of the calculated values from September through June was then determined. That average was 0.0018 ug/m^3 .
4. Confirmatory Comparison. To evaluate the accuracy of this approach of applying 1993 ratios to the 1991-92 Newell Street Rear data and thus to judge the accuracy of the simulated data sets based on application of the ratios, average concentrations were calculated for May-August from the simulated data sets for 191 Newell Street Front and F.W. Webb; and these calculated concentrations were then compared with the average of the actual concentrations measured at 191 Newell Street Front and F.W. Webb in May-August 1993. These comparisons show good agreement between the calculated and the actual data:

Average of	191 Newell St. Front	F.W. Webb
Calc. Data (May-Aug)	0.0038	0.0050
Actual Data (May-Aug)	0.0041	0.0053

5. June-August Averages. To calculate averages for the summer months, the actual measured data for the sampling events in June through August 1993 were averaged. These averages were (in ug/m³):

191 Newell St. Front	F.W. Webb
0.0058	0.0061

The combined average for these two stations is 0.0060 ug/m³.

6. April-June Average for F.W. Webb. To estimate the highest average concentration at F.W. Webb for any consecutive three-month period during the school year, the calculated data for April, May, and June from the simulated data set for F.W. Webb were averaged. That average was 0.0039 ug/m³.
7. Maximum 24-Hour Concentrations. To determine the maximum estimated 24-hour concentrations for 191 Newell Street Front and F.W. Webb, the foregoing ratios were applied to the maximum 24-hour concentration measured at 191 Newell Street Rear in 1991-92 (0.030 ug/m³). These estimates were then compared to the highest 24-hour concentrations actually monitored at 191 Newell Street Front and F.W. Webb in 1993. The results are (in ug/m³):

	191 Newell St. Front	F.W. Webb
Max Calc.	0.0081	0.011
Max Actual	0.0097	0.0090

7.2 Risk Evaluation

Using the foregoing airborne PCB concentrations as appropriate, ChemRisk has completed an evaluation of the carcinogenic, chronic noncarcinogenic, and subchronic noncarcinogenic risks for the residents living on Newell Street and for the students at the

Hibbard School. This evaluation, which uses standard MA DEP exposure assumptions and toxicity values, is provided in Appendix XIX. It demonstrates that the PCBs in the ambient air do not present any imminent hazard or significant risk to the target population groups evaluated. ChemRisk's assessment also includes a comparative risk evaluation for residents living near Silver Lake. This evaluation likewise indicates that the airborne PCBs pose no imminent hazard or significant risk to those residents. Alternative analyses following an approach recommended by MA DEP's Office of Research and Standards confirm the lack of such risks for the areas near Newell Street and Silver lake.

ChemRisk thus concludes that there is no risk-based justification for further short-term measures or immediate response actions to address the ambient PCB concentrations at the Newell Street site and Silver Lake.

8.0 Evaluation of Need for Further Sampling

This section provides an evaluation of the need to conduct further ambient air sampling at sites at or near the GE facility. In addition, to the extent that further sampling appears to be warranted, a proposal is presented for such additional sampling.

There does not appear to be any need for additional high-volume air sampling. For the spring/summer months, the results from the May-August monitoring in 1993 support and confirm the general characteristics of ambient PCB concentrations resulting from the 1991-92 data. For the winter, additional sampling is not likely to provide useful information, since the ambient PCB concentrations are much lower, with most levels below the detection limit. Further, given the evaluation presented in Section 6.3, it seems unlikely that additional high-volume sampling would provide further useful information about the sources of the PCBs detected in the ambient air at the various sites.

Additional air sampling is needed, however, to evaluate the validity of the low volume sampling method. As discussed above, the reported PCB concentrations from the low-volume low-elevation samples are much higher than any of the concentrations found at the high-volume high-elevation stations. This leads to some question about the comparability of the two sampling methods. The low-volume samplers pull a total of only 7 m³ of air over a 24-hour period, compared to 370 m³ for a high-volume sampler. Moreover, due to the lower volume, the low-volume samples have a much higher detection limit, at 0.029 ug/m³, than the 0.0005 ug/m³ detection limit for the high-volume samples. In these circumstances, any PCBs detected by the low-volume sampler will be quantified at a relatively elevated concentration level. The data collected to date do not allow for a direct comparison of the two methods, since the data do not include any high-volume and low-volume results from the same elevation or any low-volume results from a high elevation or from an area with no known ground-level source of PCBs. Hence, questions about the validity of the low-volume sampling method and its comparability with the high-volume method remain open and need to be resolved before any firm conclusions can be drawn from comparisons of the high-volume and low-volume data sets.

To evaluate the accuracy and consistency of the low volume sampling method, it is proposed to co-locate two low-volume sampling systems, one at high elevation and one at low elevation, at the Silver Lake sampling location. A high-volume sample would also be collected concurrently from the existing high-volume monitor at this location for comparative purposes. It is proposed to collect at least three rounds of samples from these monitors for PCB analysis. Such sampling would best be conducted during the summer months, when ambient PCB concentrations are expected to be the highest. Comparisons among these results should provide important information regarding whether the existing low-volume sampling results reflect truly elevated PCB concentrations or have been inflated through some artifact of the low-volume method.

9.0 Evaluation of Appropriateness of Air Dispersion Modeling

A review of the existing ambient air monitoring data and the potential benefits of performing an ambient air dispersion modeling procedure to further characterize downwind concentrations of airborne PCBs indicates that it would be inappropriate and unnecessary to carry out such dispersion modeling. There are a number of reasons for this conclusion.

First, the dimensions of and emission rates from specific source areas have not been, and are not likely to be, accurately defined. Hence, the completion of a dispersion modeling exercise would be subject to significant supposition and a great deal of uncertainty.

Furthermore, a principal purpose of performing a dispersion modeling procedure would be to generate an estimate of the "worst case" ambient PCB concentration resulting from emissions from one or several source areas. However, given the lack of data on emission rates, the most appropriate way to calculate emission rates (maximum or average) from source areas, if they were defined, would be simply to back-calculate those rates from the monitored data. In these circumstances, since dispersion models for ground-level sources assume that concentrations decrease with increasing distance from the source, the modeled concentrations would likely not be more "worse case" than the concentrations monitored at the sites with the highest concentrations (i.e., 191 Newell Street Rear and Silver Lake). Rather, the model would likely predict ambient concentrations further downwind at levels lower than those monitored.

Finally, the existing monitoring data can themselves be used to make conservative estimates of the ambient PCB concentrations to which downwind receptors of interest could be exposed. An evaluation using those data already shows no significant risk to populations of concern, as demonstrated in ChemRisk's analysis in Appendix XIX.

APPENDIX XIX



Stroudwater Crossing
1685 Congress Street
Portland, ME 04102
(207) 774-0012
FAX (207) 774-8263

MEMORANDUM

To: Grant Bowman; Jeff Ruebesam
From: Mark Maritato *McM*
Date: November 4, 1993
Subject: PCB Inhalation Risk Issues at Newell Street and Silver Lake Sites
cc Ellen Ebert

INTRODUCTION

At your request, ChemRisk has conducted an evaluation of potential health risks that could result from the inhalation of PCBs in ambient air in certain areas around the GE facility in Pittsfield, Massachusetts. This evaluation is based on the results of PCB air monitoring conducted by Zorex Environmental Engineers (Zorex) from August 1991 through August 1992 and again in May-August 1993, as well as certain estimates of ambient PCB concentrations derived from those results (Zorex, 1992, 1993). The purpose of this evaluation is to determine whether levels of PCBs in the ambient air in these areas present an "imminent health hazard" under criteria established by the Massachusetts Department of Environmental Protection (DEP), and thus whether they warrant the implementation of Short-Term Measures (STMs), now known as Immediate Response Actions (IRAs) under the Massachusetts Contingency Plan (MCP).

The main risk assessment presented herein focuses on the area around the Newell Street site, because the monitoring conducted by Zorex consistently shows the highest ambient PCB concentrations at that site. DEP has recognized this. In a memorandum of March 5, 1993, DEP expressed concern that PCB levels in the air on certain days at the Newell Street site were sufficiently high that if one were to breathe those levels for 24 hours, there might be a potential for adverse health effects (Manganaro and Hutcheson, 1993). DEP also acknowledged, however, that this type of exposure would not occur at the Newell Street site itself (Manganaro and Hutcheson,

1993). It is our understanding that, in verbal discussions with GE, DEP expressed concern about off-site exposures at the residential properties adjacent to the Newell Street site and at the nearby Hibbard School. Hence, the present analysis evaluates potential inhalation risks for the residents living in the vicinity of the Newell Street site and for the teenage children attending the Hibbard School.

For these populations, ChemRisk has conducted a screening-type evaluation of carcinogenic, chronic noncarcinogenic, and subchronic noncarcinogenic risks, using standard DEP exposure assumptions and the toxicity values prescribed by DEP for PCBs. Although ChemRisk believes that some of the exposure assumptions used could be modified based on site-specific data and that the DEP toxicity values are not scientifically justified, it has nevertheless used those assumptions and values in this analysis in order to provide a highly conservative screening-level assessment which should be acceptable to DEP without detailed discussion.

In addition, as an even more conservative (and unrealistic) "worst-case" analysis, ChemRisk has evaluated the potential risks to residents from a single-day exposure using the highest concentration measured in the front of the Newell Street site and the most conservative receptor (a small child).

An evaluation of the potential risks associated with the inhalation of PCBs by residents living adjacent to Silver Lake is also provided. This evaluation is based on a comparison of the estimated PCB concentrations to which such residents might be exposed with the estimated concentrations for areas in the front of the Newell Street site, and an assessment of potential risks for residents near Silver Lake relative to the risks calculated for residents on Newell Street.

Finally, as an alternative risk evaluation method, ChemRisk has followed the approach recommended by DEP's Office of Research and Standards (ORS) in a memorandum of August 24, 1993 (Hutcheson, 1993). This approach (which is also overly conservative) involves comparison of daily PCB levels with DEP's Threshold Effects Limit (TEL) for PCBs, using a hazard index of 5 to 50. This comparison has been made for measured and estimated ambient PCB concentrations in the front of the Newell Street site, considered as conservatively representing exposure point concentrations for the nearby residents and Hibbard School students. A similar comparison has also been made for estimated ambient PCB concentrations in the residential area near Silver Lake.

RISK ANALYSIS FOR AREA AROUND NEWELL STREET

To analyze potential exposures and risks for the residents living near the Newell Street site and the students at Hibbard School, it is necessary to determine the ambient PCB concentrations to which such populations would be expected to be exposed. Although PCB air monitoring data were obtained for a full year (1991-92) from a monitoring station located in the rear of 191 Newell Street, those data are not representative of levels that would be expected to occur at the residential properties or at Hibbard School. Rather, data from the front of 191 Newell Street and from the front of the F.W. Webb property are more representative of expected levels at the residential properties and at the school, due to the closer proximity of these monitoring stations to the receptor areas of interest. However, data are available from these monitoring stations only for the months of May-August 1993, which are known to be among the months with the highest PCB concentrations. Hence, for the analysis of chronic exposures, it was necessary to estimate annual or other long-term average ambient PCB concentrations for the front of 191 Newell Street and the F.W. Webb property. Zorex has made such estimates by first calculating the ratio of the average concentration measured at each of those locations in 1993 to the average concentration measured at the rear of 191 Newell Street for the same time period, and then applying those ratios to the pertinent 1991-92 data from the rear of 191 Newell Street. These calculations and results are presented in detail in Section 7.1 of the Zorex (1993) report. The specific data used and the rationales for their use in each exposure scenario are presented in the appropriate sections below.

It should also be noted that the PCB monitoring data used in this analysis, either directly or as the basis for estimated concentrations, are the analytical results from the high-volume samples, analyzed for PCBs by Method 608. Although the results of the high-resolution GC/MS analyses would be expected to be more accurate, those results are less complete than the Method 608 results. Hence, the latter have been used in this analysis, which is conservative since these results are almost always higher than the high-resolution analytical results.

Finally, it was assumed that all inhalation exposures to PCBs occur in the vapor phase. This assumption is consistent with the data presented by Zorex (1992) indicating that almost all the PCBs detected in the ambient air in this area were in the vapor phase. This assumption is conservative because vapors are assumed to be 100% inhaled and 100% bioavailable, whereas for particulates lesser percentages may be justified to model these parameters.

Evaluation of Exposures to Residents on Newell Street

For the residential population living across Newell Street from the Newell Street site, chronic carcinogenic, chronic noncarcinogenic, and subchronic noncarcinogenic risks have been estimated (Tables la, lb, and lc). For chronic exposures, it was assumed that an individual could be exposed for a total of 30 years, age 0 to <30, during a lifetime. To model exposures, this 30-year period was divided into three periods during which behavior patterns would be expected to differ. These periods were preschool years (age 0 to <6), school years (age 6 < 18), and adult years (age 18 < 30). To evaluate subchronic hazard, exposure of a 2-year old child was modeled. Selection of this age group was based on the high air intake rate reported for this age group in Table 10 of DEP's Summary of Interim Procedures and Assumptions Used in Relating Soil Contaminant Levels and Risk to Human Health (DEP, 1993).

1. Average Air Concentration

For the chronic cancer and noncancer residential analyses, an estimated average annual concentration of $0.002 \mu\text{g}/\text{m}^3$ was used, representing an annual average combined concentration for the front of the F.W. Webb and 191 Newell Street properties. To derive this estimate, Zorex (1993) calculated an annual average concentration for each of the stations in the front of the Newell Street site (the front of 191 Newell Street and the F.W. Webb property) by: (a) calculating the ratio of the average concentration monitored at each of those properties in 1993 to the average concentration monitored during the same time period at the rear of 191 Newell Street; and (b) applying those ratios to the annual average of the 1991-92 monitoring data collected at the rear of 191 Newell Street (refer to Section 7.1 of Zorex (1993) report). The estimated annual average PCB concentrations for these two stations ($0.0017 \mu\text{g}/\text{m}^3$ for the front of 191 Newell Street and $0.0022 \mu\text{g}/\text{m}^3$ for F.W. Webb) were then averaged together to produce the estimated exposure point concentration of $0.002 \mu\text{g}/\text{m}^3$.

To evaluate subchronic exposure, an ambient air concentration of $0.006 \mu\text{g}/\text{m}^3$ was used. This concentration was calculated by determining, for each of the stations in the front of Newell Street, the average of the actual measured concentrations for the period of June through August 1993, and then combining those averages (see Section 7.1 of Zorex (1993) report). This average concentration should thus represent a worst-case scenario corresponding to a single, consecutive 90-day summer exposure period.

2. Ventilation Rates

The adult ventilation rate selected was based on EPA's (1989) recommended value of 20 m³/day, divided by 24 hours to derive an hourly rate of 0.83 m³/hour. EPA (1989) does not provide detailed ventilation data for all age groups. Thus, to derive an estimated hourly ventilation rate for the 0 to 6 year-old child, ChemRisk calculated a weighted average based on minute ventilation rates for each year for resting and light activity as provided in Table 2 of DEP's Interim Procedures document (DEP, 1993). As recommended by DEP (1993), it was assumed that 8 of the hours spent were engaged in resting activity and that the remainder of the exposure period was spent engaged in light activity. The resulting weighted inhalation value for this age group was 0.32 m³/hour.

For 6 to 18 year old, a similar approach was used. A weighted average of 0.6 m³/hr was derived based on DEP's (1993) recommended minute ventilation rates for each year of age, assuming that eight hours of the day were spent resting and that the remainder of the exposure period was spent in light activity.

To evaluate subchronic exposures, a ventilation rate for a 2-year-old child, 0.27 m³/hour, was used. This estimate is based on DEP's (1993) recommended minute ventilation rates for children aged 2<3, assuming 8 hours of resting activity and 16 hours of light activity.

3. Vapor Penetration Factor

It was assumed that indoor PCB air levels were equivalent to outdoor levels. This is a conservative assumption because walls, windows, and doors are likely to provide a partial barrier to the infiltration of off-site fugitive PCB vapors.

4. Exposure Time

In estimating exposure times for each potentially exposed resident, ChemRisk conservatively assumed that adults and 0 to 6 year-old children are at home 24 hours per day. For 6 to 18 year-old children, it was conservatively assumed that 16 hours are spent at home during the school year (180 days), and that 24 hours per day are spent at home during non-school days. This resulted in

a time-weighted average of 20 hours per day. For the subchronic evaluation, an exposure time of 24 hours per day was assumed.

5. Exposure Frequency

For chronic exposures, all exposure groups were assumed to reside at home 350 days per year, assuming that a total of 2 weeks per year are spent away from home on vacation. For subchronic childhood exposures, an exposure frequency of 90 days over the summer months was assumed.

6. Exposure Duration

Chronic exposure durations for each age group correspond to the total number of years within each age group. The 30-year cumulative exposure duration corresponds to the EPA's (1989) upper 90th percentile for tenure in a single residential location and is therefore a very conservative measure. The exposure duration for the subchronic evaluation is equivalent to 1 because the period evaluated is a single 90-day event.

7. Body Weights

In this screening-level assessment, body weights correspond to an average of the median values for males and females. Because ventilation rates do not vary appreciably by gender, average male/female body weights were deemed appropriate for this assessment. For the 0 to 6 and 6 to 18 year-old age groups, body weights of 14 kg and 42 kg, respectively, were utilized. A body weight of 68 kg was used for adults. These correspond to the average of EPA's (1989) age-specific median body weights for males and females. Finally, a body weight of 13 kg was assumed for the 2-year-old child (EPA, 1989).

8. Averaging Time

An averaging time of 27,375 days was assumed for the carcinogenic residential evaluation, based on 365 days per year times a lifetime of 75 years. In the evaluation of chronic noncarcinogenic risks, averaging periods were determined for each group by multiplying the age group-specific exposure duration times 365 days per year. Lastly, the averaging period for the subchronic residential evaluations is equivalent to the exposure frequency (90 days).

9. Cancer Slope Factor

For the purposes of this screening-level assessment, ChemRisk has relied on the EPA cancer slope factor (CSF) of $7.7 \text{ (mg/kg-day)}^{-1}$ for PCBs, which is based on the female rat bioassay in a study by Norback and Weltman (1985) of Aroclor 1260. However, we believe that this value is no longer scientifically justified. A recent independent analysis of the rat liver slides from Norback and Weltman (1985) and from other studies on the carcinogenic potency of various PCB mixtures indicates that the tumor incidence in the studies of PCBs with 60% chlorination was less than previously reported and that lesser chlorinated PCB mixtures were not shown to be carcinogenic at all (IEHR, 1991). For Aroclor 1260, use of the results of this reanalysis, together with a revised cross-species scaling approach proposed jointly by the EPA, the Food and Drug Administration, and the Consumer Products Safety Commission in 1992, results in a revised CSF of $3.3 \text{ (mg/kg-day)}^{-1}$ if only the Norback and Weltman (1985) female rat bioassay data are considered, and a revised CSF of $1.2 \text{ (mg/kg-day)}^{-1}$ if one considers the results of all relevant bioassays of 60% chlorinated PCBs (ChemRisk, 1993a). The CSF for Aroclor 1254, if it is considered carcinogenic at all, would be even lower. Thus, the use of EPA's CSF of $7.7 \text{ (mg/kg-day)}^{-1}$ for the PCBs detected in the air around the Pittsfield facility, which were quantified principally as Aroclor 1254, is substantially overconservative.

10. Noncarcinogenic Acceptable Dose

DEP has adopted a value of $0.02 \text{ } \mu\text{g/kg-day}$ as a chronic allowable daily intake (ADI) for Aroclor 1254 and other mixtures of highly chlorinated PCBs (Harnois, 1993a). This ADI is based on immunological effects observed in rhesus monkeys that were exposed to Aroclor 1254 at doses ranging from $5 \text{ } \mu\text{g/kg-day}$ to $80 \text{ } \mu\text{g/kg-day}$ (Tryphonas et al., 1989; 1991a,b). To derive this ADI, the LOAEL of $5 \text{ } \mu\text{g/kg-day}$ was adjusted by uncertainty factors of 10 for use of a LOAEL, 3.16 for extrapolation from monkeys to humans, and 10 to compensate for variation in human sensitivity. In addition to the ADI, DEP has adopted a "acceptable" dose for PCBs which is considered the dose at which adverse effects are expected with a high degree of confidence (Harnois, 1993b). This acceptable dose of $0.2 \text{ } \mu\text{g/kg-day}$ is based on the LOAEL in the same study used to derive the ADI, adjusted by the uncertainty factors for human sensitivity and for extrapolation from monkeys to humans. DEP recommends the use of this acceptable dose based on an adjusted LOAEL when evaluating the potential for imminent hazards (Harnois, 1993b).

For the purposes of this screening-level assessment, ChemRisk has used DEP's acceptable dose of 0.2 $\mu\text{g}/\text{kg}\text{-day}$ to evaluate noncarcinogenic effects of PCBs. We believe, however, that this value is not scientifically justified. ChemRisk has conducted a thorough analysis of the Tryphonas et al. studies and has found no evidence that the immunological health of the primates was impaired by chronic exposure to PCBs at the doses tested (ChemRisk, 1993a,b). Based on this analysis, ChemRisk has concluded that the results of the Tryphonas et al. studies do not form an appropriate foundation for establishing a toxicity dose-response value for Aroclor 1254 or other PCB mixtures. Several leading immunologists have reached similar conclusions (Dosch, 1993; Letvin, 1993, Whitaker, 1993).

Evaluation of Exposures to Hibbard School Students

Potential chronic and subchronic hazards to Hibbard School students (teenagers) resulting from exposures to PCBs in air were also evaluated (Tables 2a, 2b, and 2c). For this scenario, the assumption for the vapor penetration factor and the toxicity values are identical to those used in the residential scenario. Other parameters are discussed below.

1. Air Concentration

Because the air monitor at the F.W. Webb property is closest to the school, air data from this location exclusively were used in estimating exposures for the students. For the chronic exposure analyses, the concentration used is the estimated average PCB concentration for the school year (September through June) at the F.W. Webb property. This concentration was calculated by Zorex to be 0.0018 $\mu\text{g}/\text{m}^3$, based on applying the previously calculated ratio for F.W. Webb/Newell Street rear to the 1991-92 data set from the rear of 191 Newell Street (to simulate a full year of data at F.W. Webb), and then determining the average of the calculated values for September through June (see Section 7.1 of Zorex (1993) report).

For the evaluation of subchronic exposure, a 90-day average PCB air concentration of 0.0039 $\mu\text{g}/\text{m}^3$ was used. This concentration was calculated by Zorex to represent the highest average concentration for any consecutive 90-day period during the September through June school year. It was derived by determining the average of the calculated concentrations for April through June in

the simulated annual data set that had been calculated for F.W. Webb through application of the F.W. Webb/Newell Street rear ratio (refer to Section 7.1 of Zorex (1993) report).

2. Ventilation Rate

The assumed ventilation rate was 0.82 m³/hr. This is based on an average of DEP's recommended minute ventilation rates for 15, 16, 17, and 18 year-old children (DEP, 1993).

3. Exposure Frequency and Duration

An exposure time of 7 hours/day was selected to conservatively represent a typical school day. In the chronic exposure analyses, an exposure frequency of 180 days per year was assumed, representing the length of a school year. For the subchronic analysis, it was assumed that students would attend school five days per week during the 90-day period in question; this is equivalent to an exposure frequency of 64 days. An exposure duration of 4 years was determined to be the typical period of attendance at Hibbard School.

4. Body Weight

A body weight of 58 kg (EPA, 1989) was utilized. This represents the average of median body weights for females and males aged 15 to 18.

5. Averaging Period

An averaging time of 27,375 days (365 days per year, 75 years) was assumed for the carcinogenic exposure analysis. For the chronic noncarcinogenic analysis, the averaging period equaled the product of the exposure duration (4 years) and 365 days/year. As with the residential analyses, the subchronic evaluation assumed that subchronic exposures occur during a 90-day period in a single year.

Risk Characterization Results

The calculations of PCB intake and estimated risks for the carcinogenic, chronic noncarcinogenic, and subchronic analyses are presented in Tables 1a, 1b, and 1c, respectively, for the residents of

properties near the Newell Street site, and in Tables 2a, 2b, and 2c, respectively, for the students at the Hibbard School. The results of these screening-level calculations indicate that neither the residents nor the students are at risk from exposure to ambient air concentrations of PCBs. Estimates of the total incremental carcinogenic risks due to PCB inhalation are 2.0×10^{-6} for the residents and 3.6×10^{-8} for the students. Both of these cancer risk estimates are well below the 1×10^{-4} cancer risk level generally used by DEP as the level at which an imminent hazard is considered to exist and at which further immediate response action must be taken. Chronic noncarcinogenic hazard indices, based on the DEP's "acceptable" toxicity value of $0.2 \mu\text{g}/\text{kg}\text{-day}$ range from 0.0108 for the 30-year resident to 0.0004 for the Hibbard School student. Even when subchronic noncarcinogenic risks are estimated based on the relevant 90-day period with the highest measured air levels, the hazard indices range from 0.0150 for the 2-year old resident to 0.00137 for the Hibbard School student. These are well below levels of concern and thus indicate that there is no need to take immediate response actions to address the concentrations of PCBs in the ambient air in this area.

COMPARATIVE RISK EVALUATION FOR RESIDENTS NEAR SILVER LAKE

In an October 13, 1993 letter to GE, DEP indicated its belief that Silver Lake "appears to be a likely source of [PCB] contamination in ambient air." ChemRisk has prepared the following comparative analysis to offer perspective on measured PCB air concentrations near Silver Lake.

Estimation of Ambient Air Concentrations

Two air monitoring stations are positioned closely to Silver Lake. One station, referred to as the Silver Lake air monitor, is located on the eastern side of the lake on top of a permanent concrete platform at which water levels in the lake are controlled. The second air monitoring station, located at GE's Building 32S, lies approximately 400 feet east of Silver Lake (Zorex, 1993). There is no residential area adjacent to the eastern shore of the lake; rather, all nearby residential properties are located at the southwestern corner of the lake. All of those homes are set back from the lake and are separated from the lake by areas of heavy vegetation and undergrowth. Thus, exposure points for nearby residents would be at some distance from the lake. Finally, because the prevailing wind in this area is from the west (Zorex, 1992), the tendency would be for any vapor emissions from the lake to be dispersed and distributed in an easterly direction.

Given these site-specific considerations, ChemRisk believes that it is inappropriate to assume that air levels measured at the Silver Lake monitor would be representative of air levels at the residential properties, for several reasons. First, the monitoring station is located in the area of the lake where sediment levels are the highest and may not be considered representative of emissions from the entire lake. Second, the monitor is located just above the surface of the lake so that there is little opportunity for mixing and dispersion to occur before the air reaches the monitor. Mixing and dispersion would occur before lake emissions reached any residential properties. Third, the prevailing winds tend to move emissions in an easterly direction, away from residential areas and toward the Silver Lake monitoring station. As a result, it is expected that air levels measured at that monitoring station would be far higher, generally, than the levels that would be measured in the nearest residential area.

For these reasons, ChemRisk believes that the PCB air concentrations reported at the Building 32S sampling station are the more appropriate available data to use in evaluating PCB air impacts on nearby residents. This monitor lies essentially downwind of Silver Lake and is located at a generally similar distance from the lake as are the residences. Because of the prevailing winds, it is likely that the impact of vapor emissions from Silver Lake (if any) would result in higher measured concentrations at Building 32S than would be expected to occur at the residential neighborhood to the southwest. For this reason, the air monitoring data collected at Building 32S in 1992 may be considered to be conservative but reasonably representative surrogates for hypothetical air concentrations at the residential properties.

Based on six samples collected at the Building 32S monitoring station over the summer months in 1992, Zorex (1992) reported a mean PCB air concentration of $0.005 \mu\text{g}/\text{m}^3$. Three winter sampling events at this location resulted in a single detected PCB air concentration of $0.0005 \mu\text{g}/\text{m}^3$ and two nondetect events with a reported detection limit of $<0.0005 \mu\text{g}/\text{m}^3$ (Zorex, 1993). These data indicate a winter average PCB concentration below the detection limit for this location.

The available data for the Building 32S monitoring station indicate that the PCB concentration levels at that location are generally similar to the levels at the stations in the front of the Newell Street site. Thus, the average summer concentration of $0.005 \mu\text{g}/\text{m}^3$ for Building 32S is similar to the average summer concentration of $0.006 \mu\text{g}/\text{m}^3$ for the stations in the front of the Newell Street properties. The low winter concentrations at Building 32S are likewise similar to those estimated

for the front of the Newell Street site through application of the front-to-rear ratios to the winter data from the rear of 191 Newell Street (Zorex, 1993, App. XX)

Discussion of Potential Risks for Residents Near Silver Lake

Based on the assumptions that ambient PCB concentrations measured at Building 32S are conservatively representative of ambient levels in the residential area near Silver Lake and that those concentration levels are generally similar to the levels measured or estimated for the front of the Newell Street properties, risks to the residents near Silver Lake can be qualitatively evaluated through a comparison with the estimated risks for the Newell Street residents.

For subchronic risks, this evaluation is straightforward. As shown in Table 1c, the calculated subchronic noncarcinogenic risk for a two-year-old resident on Newell Street for a 90-day summer exposure period (which represents worst-case conditions), using an average summer PCB concentration of $0.006 \mu\text{g}/\text{m}^3$, results in a hazard index of 0.015. This hazard index is far below that which DEP considers a concern. The monitoring data from Building 32S, which are considered to represent levels in the residential area near Silver Lake, show a slightly lower average summer PCB concentration ($0.005 \mu\text{g}/\text{m}^3$) than that for the stations in the front of the Newell Street site. Hence, it follows that subchronic risks are also acceptable for the residents living near Silver Lake.

As indicated earlier, annual air sampling data are not available for Building 32S. However, because average summer and winter PCB concentrations at 32S are similar to average summer and winter PCB concentrations at the front of Newell Street, it seems reasonable to assume that annual concentrations at 32S are also similar. Given that assumption, it follows that chronic cancer and noncancer risk estimates for 32S would be similar to those presented in Tables 1a and 1b of the Newell Street residential risk analysis. Because both risk estimates were well below the DEP's risk benchmarks triggering the need for an immediate response action, the same would be true for conditions at station 32S. Thus, based on sampling data from 32S, PCB air concentrations in residential areas adjacent to Silver Lake would not be expected to pose any short- or long-term health risks.

ALTERNATIVE RISK EVALUATION AND SENSITIVITY ANALYSES

In a memorandum dated August 24, 1993, ORS recommended that daily ambient PCB concentrations be compared with DEP's Threshold Effects Limit (TEL) for PCBs to determine the need for STMs (now IRAs) (Hutcheson, 1993). This approach indicates a view that it is appropriate to use the results from a single sampling day to estimate health risks from PCBs. ChemRisk does not agree with that approach. Nevertheless, as a sensitivity analysis, ChemRisk has conducted an evaluation using the highest applicable single-day exposure concentration for the Newell Street residents. We have also conducted the comparisons recommended by ORS for the PCB concentrations pertinent to the Newell Street residents and Hibbard School students and to residents living near Silver Lake.

Sensitivity Analysis Using Worst-Case Single-Day Exposure

As a worst-case analysis, a single-day exposure has been evaluated for the residents of Newell Street using the highest 24-hour concentration measured in the front of the Newell Street site. That maximum 24-hour concentration was $0.0097 \mu\text{g}/\text{m}^3$, measured in the front of 191 Newell Street on July 3, 1993. To complete this analysis, a single-day exposure to that concentration by a two year-old child was modeled using an inhalation rate of $0.27 \text{ m}^3/\text{hr}$ (based on DEP's (1993) recommended minute ventilation rates), an exposure time of 24 hours, an exposure frequency of one day, a body weight of 13 kg, and an averaging time of one day. DEP's noncarcinogenic intake level of $0.2 \mu\text{g}/\text{kg}\text{-day}$ for imminent hazard evaluations was used in this analysis. The results are presented in Table 3. They show an estimated noncarcinogenic hazard index of 0.024, which is substantially lower than DEP's suggested intake level, indicating that the risks are acceptable even in this worst-case analysis. It should also be recognized that this calculation is highly conservative due to the use of a chronic health criterion ($0.2 \mu\text{g}/\text{kg}\text{-day}$) for an acute exposure event.

Comparisons with the TEL

As noted above, the ORS memorandum of August 24, 1993, recommended a comparison of 24-hour PCB concentrations with DEP's TEL for PCBs ($0.003 \mu\text{g}/\text{m}^3$). The memorandum recommended further that in any case where that comparison results in a hazard index of 5 or greater (i.e., where any concentration exceeds the TEL by 5 or more times), further action should

be required. According to the ORS memorandum, the ambient PCB concentration associated with a hazard index of 5, based on DEP's TEL value of $0.003 \mu\text{g}/\text{m}^3$ for PCBs (and considering certain rounding off), is $0.014 \mu\text{g}/\text{m}^3$.

1. Newell Street Area

As explained by ORS (Hutcheson, 1993), DEP's TEL of $0.003 \mu\text{g}/\text{m}^3$ is based on an occupational exposure limit, adjusted to more closely represent continuous exposures to more sensitive populations. It was derived using a number of adjustment factors, including a relative source allocation factor of five to account for possible exposure to PCBs via other exposure routes. While it may be appropriate to apply a relative source allocation factor when there is potential for exposure through dermal or ingestion pathways, it does not appear to be relevant when considering off-site inhalation exposures attributable to the Newell Street site. Because the Newell Street properties are commercial properties providing very limited access to contaminated areas, it would not be expected that nearby residents or Hibbard School students would experience direct contact with contaminated soils. For this reason, comparison of sampling results with the TEL is an overly conservative approach.

Nevertheless, for screening-level purposes, we have made a comparison of relevant monitoring data from the Newell Street site with the $0.014 \mu\text{g}/\text{m}^3$ action level derived by ORS. In this comparison, we have not used concentrations measured at the monitor in the rear of 191 Newell Street, because that monitor is located in an area that has highly restricted access and no potential for continuous 24-hour exposure. Rather, we have used concentrations from the monitors in the front of 191 Newell Street and at the F.W. Webb property, which are more representative of actual exposures at the residences on Newell Street and at Hibbard School. The comparison has been made both for the 24-hour concentrations measured at these stations in 1993 and for the estimated 24-hour concentrations calculated for these stations by Zorex based on application of the 1993 front-to-rear ratios to the 1991-92 data from the rear of 191 Newell Street. None of the measured or estimated 24-hour PCB concentrations for the stations in the front of the Newell Street properties exceeds the ORS acceptable of $0.014 \mu\text{g}/\text{m}^3$. The maximum measured 24-hour concentration at either of these stations was $0.0097 \mu\text{g}/\text{m}^3$ and the maximum calculated concentration is $0.011 \mu\text{g}/\text{m}^3$ (see Section 7.1 of Zorex (1993) report).

2. Silver Lake Area

A similar comparison has been made to assess exposures for residents living near Silver Lake. In this comparison, for the reasons articulated earlier in the Silver Lake exposure and relative risk discussion, it is not considered appropriate to use the ambient PCB concentrations measured at the Silver Lake monitoring station itself, which is located on the eastern side of the lake. The location of the residential properties (on the western side of the lake), the distance of those properties from the lake, the dispersion and mixing that occur above the lake, and the prevailing wind direction from the west (Zorex, 1992) all indicate that concentrations of PCBs in air would be lower in the residential locations than the levels measured at the Silver Lake monitor. As discussed above, it is more reasonable to consider the ambient PCB concentrations measured at the Building 32S monitoring station as a conservative, yet reasonable, surrogate for air concentrations at the residential properties.

Despite the fact that the Silver Lake PCB emissions would generally be expected to move in the direction of monitor 32S, none of the sampling days for 1992 at that monitor exceeded the DEP's action level of $0.014 \mu\text{g}/\text{m}^3$. The maximum 24-hour concentration at that monitor was $0.0071 \mu\text{g}/\text{m}^3$ (Zorex, 1992). This indicates that dispersion and dilution reduce concentrations before they reach the monitor. It is expected that air concentrations in the residential neighborhood west of the lake would be even lower than those measured at 32S; consequently, it is unlikely that residential air levels are in exceedance of the DEP's action level.

CONCLUSION

The foregoing deterministic risk calculations, together with the sensitivity and alternative analyses presented above, indicate that the PCBs measured in the ambient air at the Newell Street site and Silver Lake do not present an imminent hazard or a significant risk to residents in the area or to students at Hibbard School. On a risk basis, therefore, further STMs or IRAs are unwarranted.

REFERENCES

- ChemRisk. 1993a. Comments on the Proposed Revisions to the Massachusetts Contingency Plan (310 CMR 40.000). Attachment D: Dose-Response Analysis for Polychlorinated Biphenyls. Prepared for the General Electric Company, Pittsfield, MA. February 22.
- ChemRisk. 1993b. Revised Risk Assessment to Evaluate the Need for Short Term Measures in the Flood Plain of the Housatonic River. Volume II, Appendix A. Prepared for the General Electric Company, Pittsfield, MA. April 12.
- DEP. 1993. Summary of Interim Procedures and Assumptions Used in Relating Soil Contaminant Levels and Risk to Human Health. Massachusetts Department of Environmental Protection, Office of Research and Standards. Boston, MA. June.
- Dosch, H-M. 1993. Letter to J. McCrodden, ChemRisk, Portland, Maine from H-M Dosch, Professor of Pediatrics and Immunology, The Hospital for Sick Children, Toronto, Ontario RE: Analysis of the Tryphonas et al. studies. February 22.
- EPA. 1989. *Exposure Factors Handbook*. U.S. Environmental Protection Agency, Office of Health and Environmental Assessment, Washington, DC. EPA/600/8-89/043. July.
- Harnois, M. 1993a. Memorandum to Carol Rowan West, Department of Environmental Protection, Re: Chronic Oral Allowable Daily Intake for Aroclors. May 10.
- Harnois, M. 1993b. Memorandum to Carol Rowan West, Department of Environmental Protection, Re: Soil PCB Concentrations Associated with Various Risk Management Criteria. June 14.
- Hutcheson, M. 1993. Memorandum to Alan Weinberg, Department of Environmental Protection Re: Risk Management Criteria for PCB Air Sampling Data. August 24.
- IEHR. 1991. *Reassessment of Liver Findings in Five PCB Studies in Rats*. Institute for Evaluating Health Risks, Washington, DC.
- Letvin, N.L. 1993. Letter to Dr. Stephen Hamilton, General Electric, Fairfield, CT from N.L. Letvin, Harvard Medical School. RE: Review of Tryphonas et al. February 24.
- Norback, D.H. and R.H. Weltman. 1985. Polychlorinated biphenyl induction of hepatocellular carcinoma in the Sprague-Dawley rat. *Environ. Health Perspect.* 60:97-105.
- Tryphonas, H., S. Hayward, L. O'Grady, J.C.K. Loo, D.L. Arnold, F. Bryce, and Z.Z. Zawidzka. 1989. Immunotoxicity studies of PCB (Aroclor 1254) in the adult rhesus (*Macaca mulatta*) monkey- preliminary report. *Int. J. Immun.* 11(2):199-206.
- Tryphonas, H., M.I. Luster, G. Schiffman, L.L. Dawson, M. Hodgen, D. Germolec, S. Hayward, F. Bryce, J.C.K. Loo, F. Mandy, and D.L. Arnold. 1991a. Effect of chronic exposure of PCB (Aroclor 1254) on specific and nonspecific immune parameters in the rhesus (*Macaca mulatta*) monkey. *Fund. Appl. Toxicol.* 16:773-786.
- Tryphonas, H., M.I. Luster, K.L. White, P.H. Taylor, M.R. Erdos, G.R. Burlison, D. Germolec, M. Hodgen, S. Hayward, and D.L. Arnold. 1991b. Effects of PCB (Aroclor 1254) on non-specific immune parameters in rhesus (*Macaca mulatta*) monkeys. *J. Immunopharm.* 13(6):639-648.

ChemRisk® - A Division of McLaren/Hart

November 4, 1993

Page 17

Whitaker, B. 1993. Letter to J. McCrodden, ChemRisk, Portland, Maine from B. Whitaker, ImmuNet, Lewiston, Maine. RE: Comments on the studies by Tryphonas et al. February 24.

Zorex. 1992. *Ambient Air Monitoring for PCB, August 20, 1991 - August 14.* Zorex Environmental Engineers. Pittsfield, MA. November 13.

Zorex. 1993. *Ambient Air Monitoring for PCB, May 4 - August 17.* Zorex Environmental Engineers, Inc. Pittsfield, MA.

EXPOSURE AND RISK CALCULATIONS

Table 1a. Off-site Residential Carcinogenic Risk Via Inhalation

$LADI = AC \cdot IR \cdot VPF \cdot ET \cdot EF \cdot ED \cdot 1/BW \cdot 1/ATc \cdot CF$
 $Risk = CSF \cdot LADI$

Receptor	AC Average Air Concentration (ug/m ³)	IR Inhalation Rate (m ³ /hr)	VPF Vapor Penetration Factor (unitless)	ET Exposure Time (hr/day)	EF Exposure Frequency (days/year)	ED Exposure Duration (years)	BW Body Weight (kg)	ATc Averaging Time, Carcinogen (days)	CF Conversion Factor (mg/ug)	LADI Lifetime Average Daily Intake (mg/kg-day)	CSF Cancer Slope Factor kg-day/mg	Cancer Risk Estimate unitless
Adult: 18<30 yr	0.002	0.83	1.0	24	350	12	68	27375	1.00E-03	8.99E-08	7.7	6.92E-07
Child:												
0 < 6 yrs	0.002	0.32	1.0	24	350	6	14	27375	1.00E-03	8.42E-08	7.7	6.48E-07
6 < 18 yrs	0.002	0.6	1.0	20	350	12	42	27375	1.00E-03	8.62E-08	7.7	6.64E-07

Total Inhalation Risk: 2.00E-06

Table 1b. Off-site Residential Chronic Noncarcinogenic Hazard Via Inhalation

$CDI = AC \cdot IR \cdot VPF \cdot ET \cdot EF \cdot ED \cdot 1/BW \cdot 1/ATnc$
 $Risk = Hazard Index = CDI/RfD$

Receptor	AC Average Air Concentration (ug/m ³)	IR Inhalation Rate (m ³ /hr)	VPF Vapor Penetration Factor (unitless)	ET Exposure Time (hr/day)	EF Exposure Frequency (days/year)	ED Exposure Duration (years)	BW Body Weight (kg)	ATnc Averaging Time, Noncarcinogen (days)	CDI Chronic Daily Intake (ug/kg-day)	RfD Reference Dose (ug/kg-day)	Noncancer Hazard Index (Chronic) unitless
Adult: 18<30 yr	0.002	0.83	1.0	24	350	12	68	4380	5.62E-04	0.2	2.81E-03
Child:											
0 < 6 yrs	0.002	0.32	1.0	24	350	6	14	2190	1.05E-03	0.2	5.26E-03
6 < 18 yrs	0.002	0.6	1.0	20	350	12	42	4380	5.39E-04	0.2	2.69E-03

Total Hazard Index: 1.08E-02

Table 1c. Off-site Residential Subchronic Noncarcinogenic Hazard Via Inhalation

$SCDI = AC \cdot IR \cdot VPF \cdot ET \cdot EF \cdot 1/BW \cdot 1/ATnc$
 $Risk = Hazard Index = CDI/RfD$

Receptor	AC Average Air Concentration (ug/m ³)	IR Inhalation Rate (m ³ /hr)	VPF Vapor Penetration Factor (unitless)	ET Exposure Time (hr/day)	EF Exposure Frequency (days)	BW Body Weight (kg)	ATnc Averaging Time, Noncarcinogen (days)	SCDI Subchronic Daily Intake (ug/kg-day)	RfD Reference Dose (ug/kg-day)	Noncancer Hazard Index (Subchronic) unitless
Child (2 years)	0.0060	0.27	1.0	24	90	13	90	2.99E-03	0.2	1.50E-02

Table 2a. Off-site Carcinogenic Risk to Hibbard School Students Via Inhalation

$$LADI = AC \cdot IR \cdot VPF \cdot ET \cdot EF \cdot ED \cdot 1/BW \cdot 1/ATc \cdot CF$$

$$Risk = CSF \cdot LADI$$

Receptor	AC Average Air Concentration (ug/m ³)	IR Inhalation Rate (m ³ /hr)	VPF Vapor Penetration Factor (unitless)	ET Exposure Time (hr/day)	EF Exposure Frequency (days/year)	ED Exposure Duration (years)	BW Body Weight (kg)	ATc Averaging Time, Carcinogen (days)	CF Conversion Factor (mg/ug)	LADI Lifetime Average Daily Intake (mg/kg-day)	CSF Cancer Slope Factor kg-day/mg	Cancer Risk Estimate unitless
Teenager	0.0018	0.82	1.0	7	180	4	58	27375	1.00E-03	4.69E-09	7.7	3.61E-08

Table 2b. Off-site Chronic Noncarcinogenic Hazard to Hibbard School Students Via Inhalation

$$CDI = AC \cdot IR \cdot VPF \cdot ET \cdot EF \cdot ED \cdot 1/BW \cdot 1/ATnc$$

$$Risk = Hazard Index = CDI/RfD$$

Receptor	AC Average Air Concentration (ug/m ³)	IR Inhalation Rate (m ³ /hr)	VPF Vapor Penetration Factor (unitless)	ET Exposure Time (hr/day)	EF Exposure Frequency (days/year)	ED Exposure Duration (years)	BW Body Weight (kg)	ATnc Averaging Time, Noncarcinogen (days)	CDI Chronic Daily Intake (ug/kg-day)	RfD Reference Dose (ug/kg-day)	Noncancer Hazard Index (Chronic) unitless
Teenager	0.0018	0.82	1.0	7	180	4	58	1460	8.78E-05	0.2	4.39E-04

Table 2c. Off-site Subchronic Noncarcinogenic Hazard to Hibbard School Students Via Inhalation

$$SCDI = AC \cdot IR \cdot VPF \cdot ET \cdot EF \cdot 1/BW \cdot 1/ATnc$$

$$Risk = Hazard Index = CDI/RfD$$

Receptor	AC Average Air Concentration (ug/m ³)	IR Inhalation Rate (m ³ /hr)	VPF Vapor Penetration Factor (unitless)	ET Exposure Time (hr/day)	EF Exposure Frequency (days)	BW Body Weight (kg)	ATnc Averaging Time, Noncarcinogen (days)	SCDI Subchronic Daily Intake (ug/kg-day)	RfD Reference Dose (ug/kg-day)	Noncancer Hazard Index (Subchronic) unitless
Teenager	0.0039	0.82	1.0	7	64	58	90	2.74E-04	0.2	1.37E-03

Table 3. Single-Day Hazard for Two Year Old Resident Via Inhalation

$AI = AC \cdot IR \cdot VPF \cdot ET \cdot EF \cdot 1/BW \cdot 1/ATnc$

$Risk = Hazard\ Index = CDI/RfD$

Receptor	AC Average Air Concentration (ug/m ³)	IR Inhalation Rate (m ³ /hr)	VPF Vapor Penetration Factor (unitless)	ET Exposure Time (hr/day)	EF Exposure Frequency (days)	BW Body Weight (kg)	ATnc Averaging Time, Noncarcinogen (days)	AI Acute Intake (ug/kg-day)	RfD Reference Dose (ug/kg-day)	Noncancer Hazard Index (acute) unitless
Child (2 years)	0.0097	0.27	1.0	24	1	13	1	4.84E-03	0.2	2.42E-02

APPENDIX L

DECOMMISSIONING OF PHENOLS METERING STATION

SECTION 1

VARIOUS INFORMATION RELATED TO THE FORMER
PHENOLS METERING BUILDING



FIGURE 1

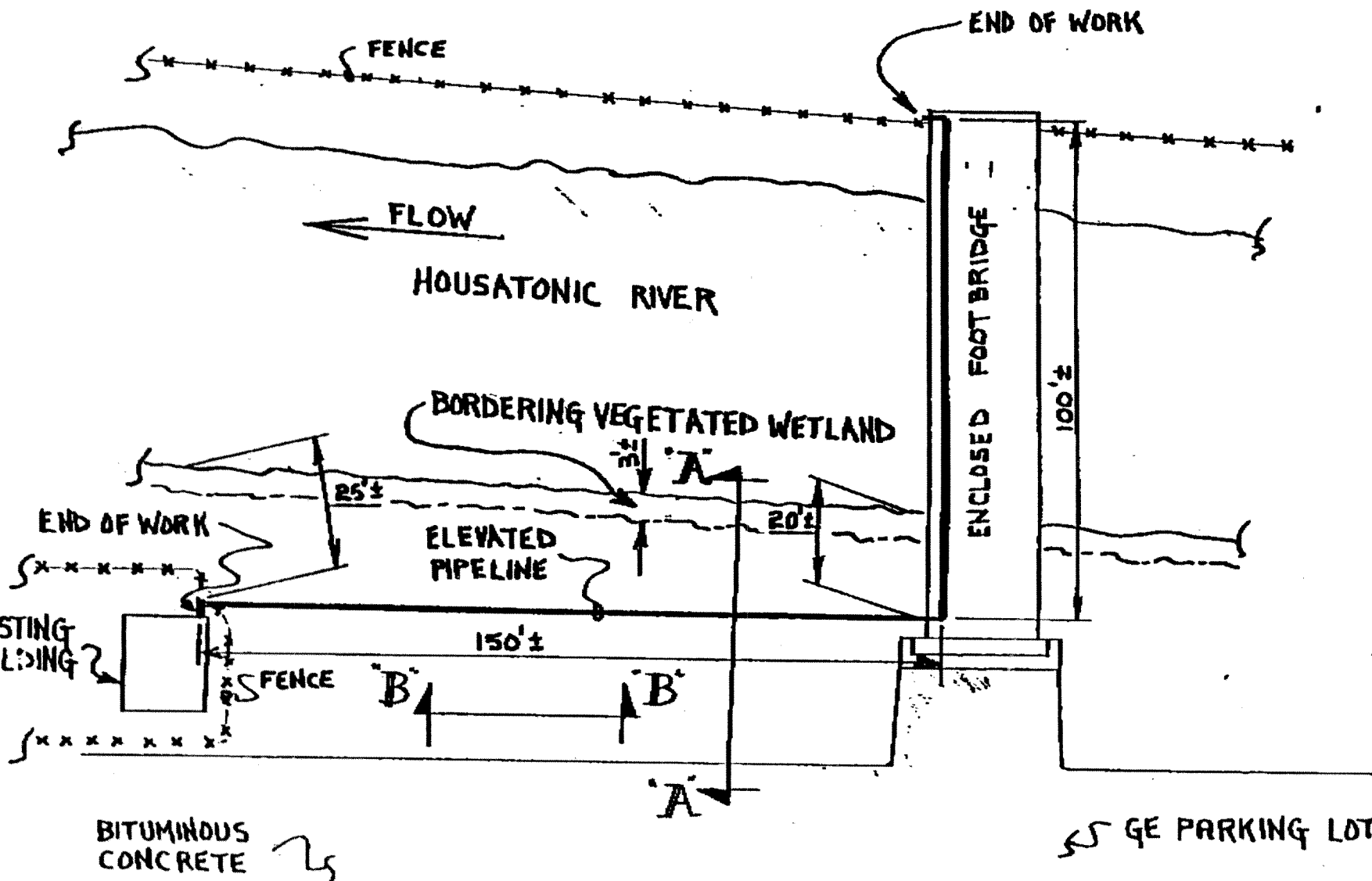
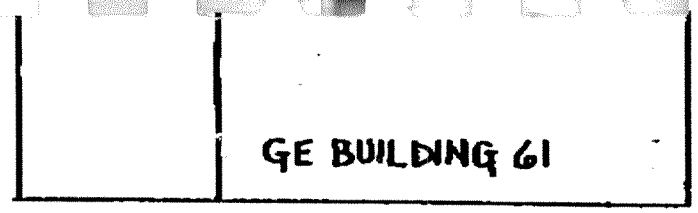

SCALE 1"=30'±

UNLESS OTHERWISE SPECIFIED USE THE FOLLOWING —			
APPLIED PRACTICES	SURFACES	TOLERANCES ON MACHINED DIMENSIONS	
✓		FRACTIONS	DECIMALS
		+	+
		°	°

A
B
C
D
E
F
H

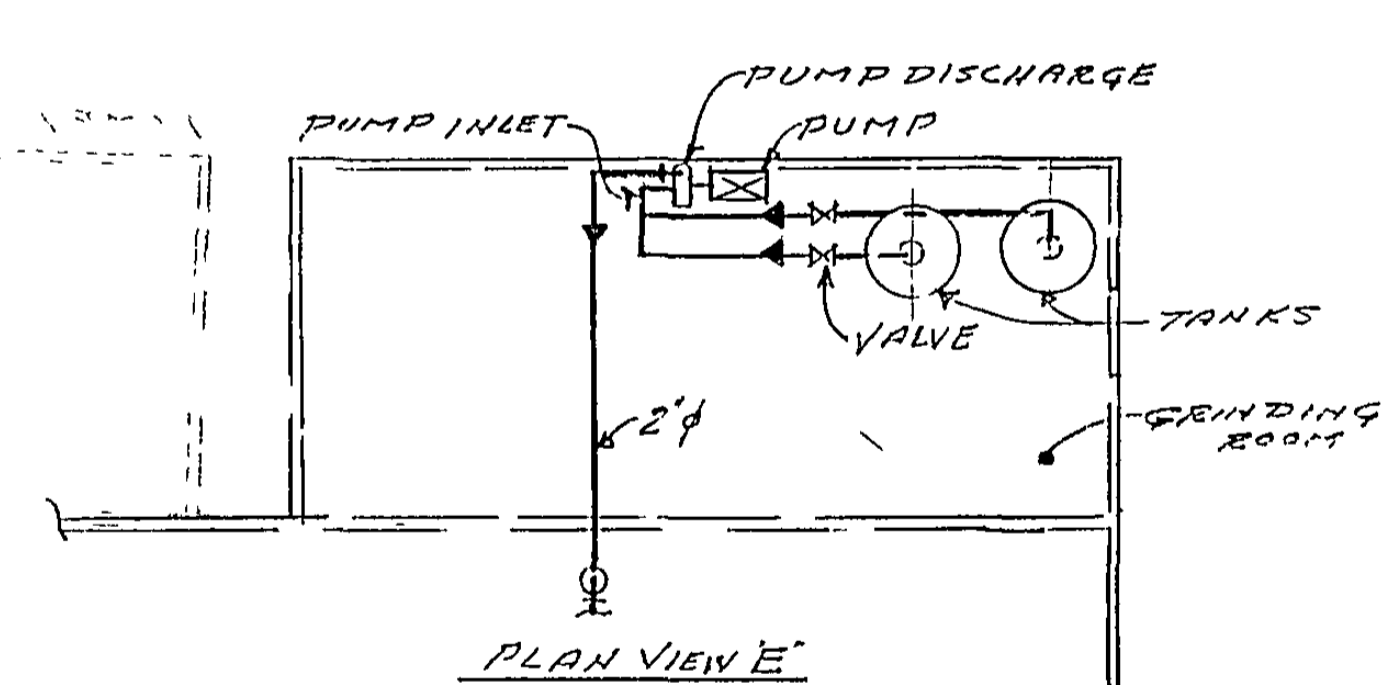
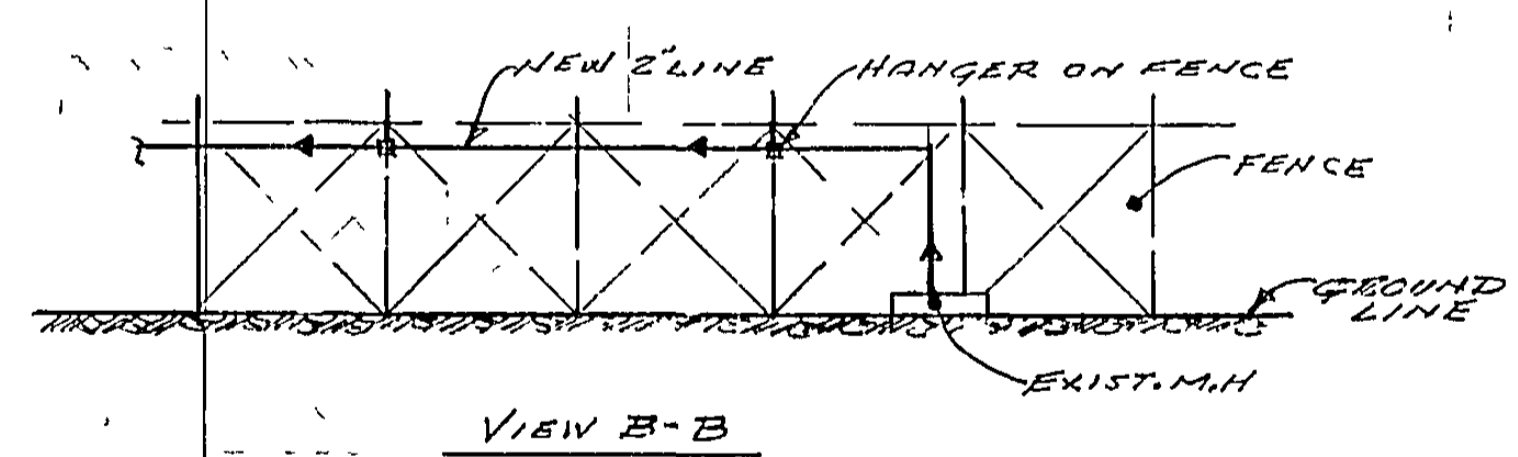
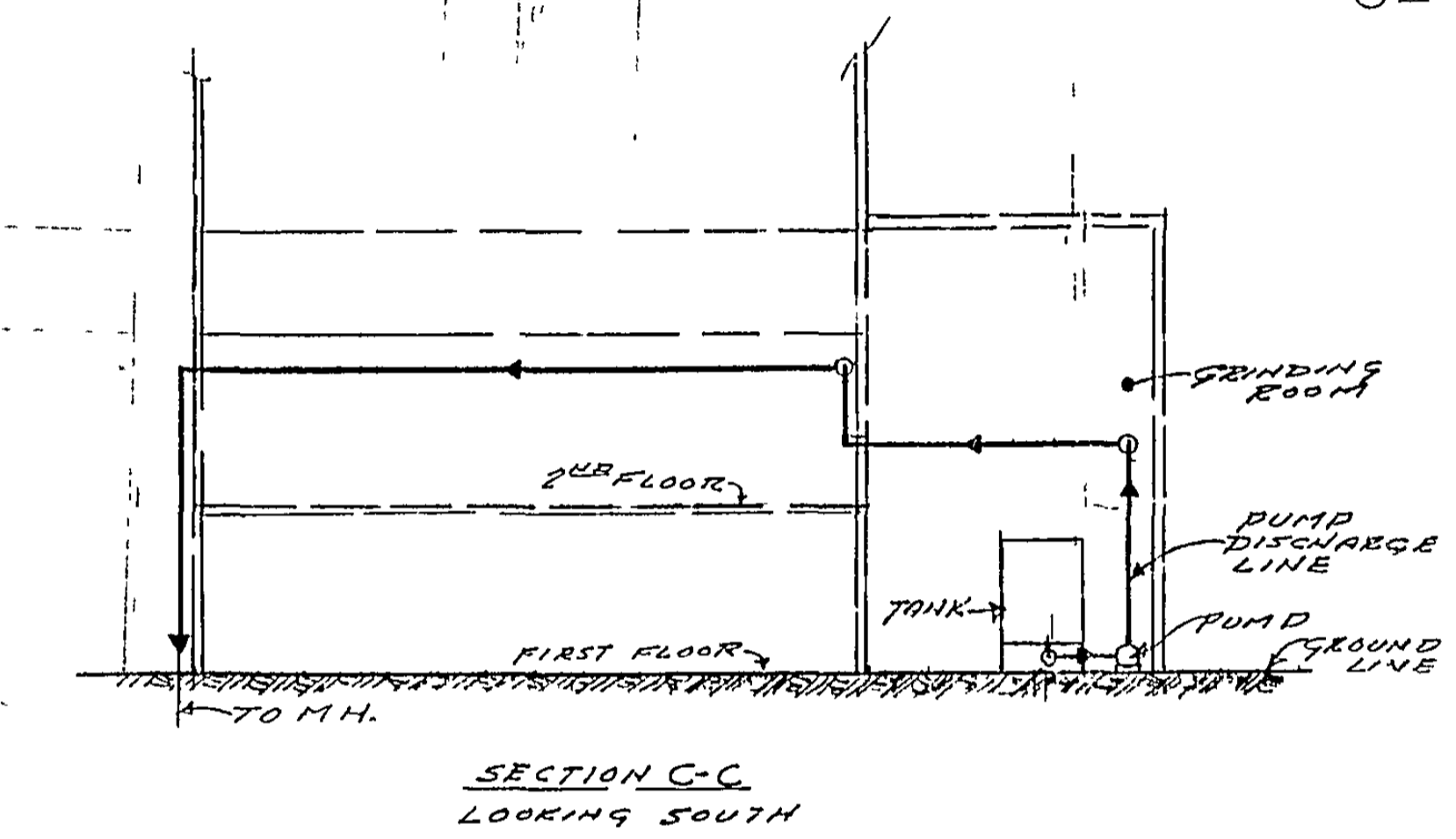
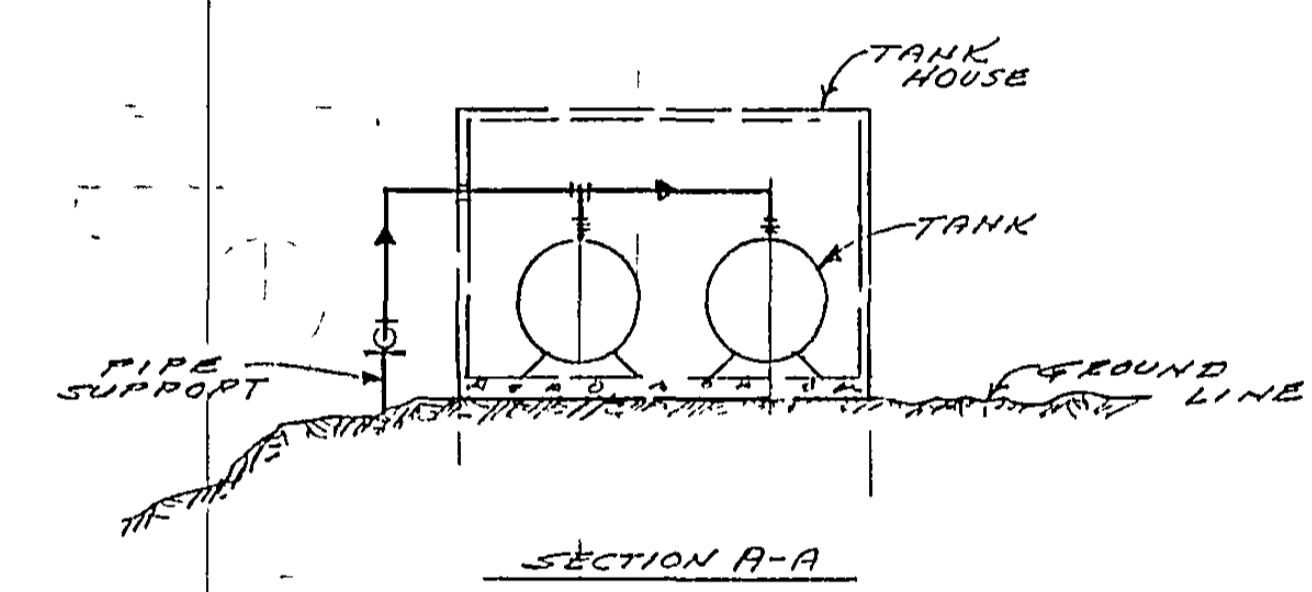
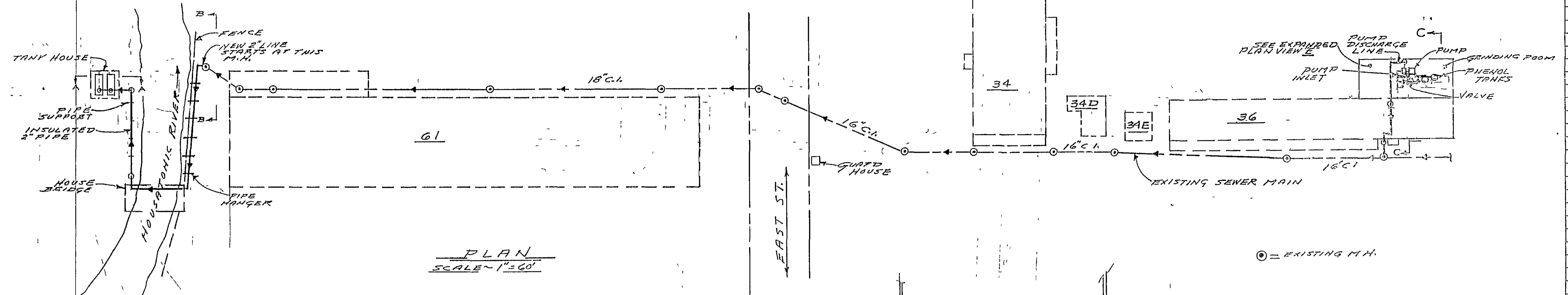

SEE REFERENCE DWG. SEWER MAINS.

DESCRIPTION OF GROUPS	REVISIONS	PRINTS TO

NAME: *J. Robinson* ON OR DATE: *11/30/60*
 ISSUED: *11/30/60* APPROVALS: *J. Robinson* LOCATION: *PITTSFIELD*
 106000 113D6018 106000 F7 23

SECTION 2

RESULTS OF PHENOLS ANALYSIS FOR TANK LIQUIDS

BLASLAND & BOUCK ENGINEERS P.C.
(REQUEST FOR SAMPLING)

PRELIMINARY

To: Files

Date: 4-29-92

From: Bruce Eulian

File No: 101-75-01

Re: Newell St Parking Lot (above ground)
Tank Sampling

INITIATOR: Jeff Ruebesam (GE)

DATE: 2-7-92

BLDG. LOCATION: Newell St Parking Lot

CONTACT PERSON: Jeff Ruebesam (GE)

EXT: 3728

ITEM DESCRIPTION:

1.) Liquid (discrete-grab)

PURPOSE: To verify if there is any Phenol (liquid) remaining in the two above ground tanks (tank #1 & tank #2) at the Newell St. Parking lot. If either tank is found to have any liquid remaining in it, we are to collect a sample of the liquid and have it analyzed so Ge can determine the proper disposal method.

NOTES: The following sampling program was implemented at the request of Jeff Ruebesam (GE).

1.) Liquid from the above ground tanks to be sampled for Phenols. Samples are to be analyzed by the GE lab in Pittsfield, Ma. (Bill Fessler GE) for Total Phenols.

agp

E N V I R O N M E N T A L L A B O R A T O R Y -

**** TEST REPORT ****

SUBJECT: WATER SAMPLE FROM NEWELL STREET PARKING LOT
REQUESTOR: A. COLE
TEST(S) BY G.J. DESNOYERS, 11-331, C23, x4351
REPORT BY G.J. DESNOYERS, 11-331, C23, x4351
BOOK 9004, PAGE(S) 88

OBJECT:
PHENOL CONCENTRATION IN WATER

SAMPLE ID:
TWO JARS OF DIRTY WATER FROM THE NEWELL STREET PARKING LOT. THE
TWO JARS HAD THE SAME IDENTIFICATION, AS FOLLOWS:
NEWL-TANK-C1
INITIALS: BEE-AGP
2/6/92 SAMPLE TIME = 1100
PROJECT 101.75.01 GE PITT
SAMPLES WERE TAKEN BY BLASLAND & BOUCK.

METHODS:
APHA METHOD 510C. TWO JARS WERE ANALYZED SEPARATELY. ANALYSES
WERE MADE USING 0.1% DILUTIONS OF SAMPLE. DIRECT 4-AAP METHOD
WITHOUT DISTILLATION. EXTRACTION WITH CHLOROFORM WAS NOT NEEDED.

RESULTS:

1ST JAR	456 MG/L PHENOL
2ND JAR	507 MG/L PHENOL

DISTRIBUTION:
A. COLE, G56;
G.J. DESNOYERS, C23;
W.A. FESSLER, C23.

SECTION 3

RESULTS OF TCLP ANALYSIS FOR TANK LIQUIDS

①

BLASLAND & BOUCK ENGINEERS P.C.
(REQUEST FOR SAMPLING)

To: Files

Date: 3-6-92

From: Bruce Eulian

File No: 101-75-01

Re: Newell St Parking Lot (above ground)
Tank Sampling

INITIATOR: Ross Clark (GE)

DATE: 2-27-92

BLDG. LOCATION: Newell St Parking Lot

CONTACT PERSON: Ross Clark (GE)

EXT: 2091

ITEM DESCRIPTION:

1.) Liquid (discrete-grab)

PURPOSE: To collect a sample for GE of the liquid remaining in the Phenol & Water tank (Tank #1) located at the Newell St. Parking Lot to determine the proper disposal method..

NOTES:

1.) The liquid from (Tank #1) located at the Newell St. Parking Lot is to be sampled for TCLP (no herbicides or pesticides).

2.) GE requests the sample to be analyzed by Alpha Analytical (to Pittsfield GE Lab for courier).

sem

**GENERAL ELECTRIC
ENVIRONMENTAL LABORATORY
Test Report**

Title: TCLP Analysis of Newell Street Tank Sample Number: EL-92-029
Date: March 18, 1992
Test by: Alpha Analytical Requested by: RD Clark
Report by: WA Fessler Approved: *WAJ*
3-19-92

A sample from the Newell Street Tank was sent to Alpha Analytical Laboratories for determination of toxicity characteristics listed in the Toxicity Characteristic Leaching Procedure (TCLP, 40CFR268, Appendix I). The results are summarized in the attached table.

Parameters which exceeded the regulatory limits are identified by the comment 'EXCEED'.

Sample NEWL-TANK-C2 showed the characteristic of toxicity due to the presence of cadmium.

A copy of the report from Alpha is attached.

DISTRIBUTION: Manager, Environmental Laboratory C23
RD Clark 11-205

EL-92029
 Mar 18, 1992

Sample ID	Result	Regulatory Limit	
NEWL-TANK-C2	mg/L	mg/L	
Arsenic	< .5	5.000	OK
Barium	.55	100.000	OK
Cadmium	2.1	1.000	EXCEED
Chromium	< .1	5.000	OK
Lead	.3	5.000	OK
Mercury	.007	.200	OK
Selenium	< .025	1.000	OK
Silver	< .05	5.000	OK
<hr/>			
o-Cresol	<	200.000	OK
m-Cresol	<	200.000	OK
p-Cresol	<	200.000	OK
Cresols	.591	200.000	OK
2,4-Dinitrotoluene	< .06	.130	OK
Hexachlorobenzene	< .044	.130	OK
Hexachlorobutadiene	< .128	.500	OK
Hexachloroethane	< .08	3.000	OK
Nitrobenzene	< .0304	2.000	OK
Pentachlorophenol	< .147	100.000	OK
2,4,5-Trichlorophenol	< .076	400.000	OK
2,4,6-Trichlorophenol	< .044	2.000	OK
Pyridine	< .4	5.000	OK
<hr/>			
Benzene	< .005	.500	OK
Carbon Tetrachloride	< .005	.500	OK
Chlorobenzene	< .018	100.000	OK
Chloroform	< .0075	6.000	OK
1,4-Dichlorobenzene	< .05	7.500	OK
1,2-Dichloroethane	< .0075	.500	OK
1,1-Dichloroethylene	< .0075	.700	OK
Tetrachloroethylene	< .0075	.700	OK
Trichloroethylene	< .005	.500	OK
Vinyl Chloride	< .018	.200	OK
Methyl Ethyl Ketone	< .05	200.000	OK

SECTION 4

RESULTS OF TOC ANALYSIS FOR TANK LIQUIDS

BLASLAND & BOUCK ENGINEERS, P.C.
(REQUEST FOR SAMPLING)

TO: Files

DATE: 8-19-92

FROM: Bruce Eulian

FILE NO: 101.75.01

RE: Newell St. Parking Lot Tank Sampling

INITIATOR: Aimee Cole (GE)

DATE: 7-1-92

LOCATION: Newell St. Parking Lot

CONTACT PERSON: Aimee Cole (GE)

EXT: 2534

ITEM DESCRIPTION:

1.) Liquid

PURPOSE: To collect a sample for GE of the liquid remaining in the Phenol & Water tank (Tank #1) located at the Newell St. Parking Lot and analyze for Total Organic Carbon (TOC) per GE request.

NOTES:

1.) The liquid from Tank #1 located at the Newell St. Parking lot is to be sampled for Total Organic Carbon (TOC).

2.) The sample is to be taken to Bldg 120X to be analyzed. See the attached sampling request letter from Aimee Cole (GE) dated 7-1-92.

jjh

GE COMPANY
ENVIRONMENTAL
REPORT

Requested by: Aimee Cole

Date: 7/17/92

Sample Identification

Total Organic Carbon

Newell St Parking Lot
Tank-C3 Proj. #101.75.01

23,567 ppm

Comments: _____

Analysis by: Mark Wasniewsky (technician)

Date of Analysis: 7/17/92

SECTION 5

AUGUST 27, 1992 LETTER DEALING WITH THE REMOVAL
OF THE FORMER PHENOLS METERING BUILDING



Area Environmental & Facility Programs
General Electric Company
100 Woodlawn Avenue, Pittsfield, MA 01201

August 27, 1992

Mr. Richard M. Green
Bureau of Waste Site Cleanup
Department of Environmental Protection
436 Dwight Street
Springfield, MA 01103

Dear Mr. Green:

Per my telecon with Tony Kurpaska on August 26, 1992, this letter will finalize our plans to remove the former metering building from the northwest corner of the Newell Street parking lot. The subject was first raised in the January 1992 MCP activities status report, enclosed as Figure 1. It is again mentioned in the July 1992 status report (Figure 2).

Also enclosed is a copy of the NOI submitted to the Pittsfield Conservation Commission and DEP Western Region Bureau of Resource Management (wetlands). The Conservation Commission hearings have been held and closed, and an order of conditions is expected within the next two weeks. It has been assigned file number 263-352.

The procedures to be followed in the removal process are covered in the NOI. The job has been put out to bid to four firms qualified in handling the hazardous materials (phenol) expected to be encountered in the project. We have specified no disturbance of riverbank soils having notified the bidders that PCBs are present in the soils.

I plan to award the contract to begin work in early September with completion expected by the middle of October.

Please contact me should you have any questions or concerns.

Yours truly,

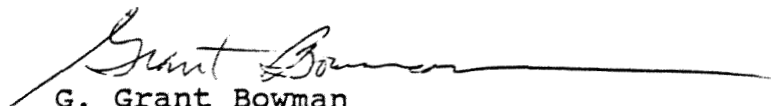
G. Grant Bowman
Manager - Environmental Engineering

/ljr

Enclosures

cc: A. Kurpaska
M. White

NEWELL STREET - PHASE II MCP ACTIVITIES
JANUARY 1992

1. Activity Summary

- Work on the Phase II Interim Report due to be submitted to DEP on February 28, 1992 is in progress.
- During a tour of security items, a broken asbestos covered pipe was observed along the northwestern edge of the Newell Street parking lot. Steps have been taken to contain the asbestos, and it will be removed as soon as all appropriate permits have been obtained.

The line runs to a small shed in the extreme NW corner. It reportedly once conducted wastewater from the former Plastics manufacturing facility on Silver Lake Blvd. for purposes of a treatability study with the City POTW. The building contains two small steel tanks in a concrete dike. One tank is empty. The other, containing approximately 700 gallons of liquid, has been tested for total phenol and found to contain approximately 500 parts per million. Since the building has not been used for over 20 years, it is planned to immediately verify the security of the dike and prepare a scope of work for a removal plan to be implemented as soon as weather permits complete sampling of the liquid for proper disposal.

2. Analytical Results

- Soil and groundwater analytical results from the Newell Street parking lot borings and monitoring well installations received in January are listed in the following table. Analytical laboratory data sheets are provided in Attachment 1.

3. Issues

- None.

NEWELL STREET - PHASE II MCP ACTIVITIES
JULY 1992

1. Activity Summary

- DEP comments are being awaited on the Phase II Interim Report submitted on February 27, 1992.
- A Notice of Intent (NOI) was submitted to the Pittsfield Conservation Commission for removal of the building and two abandoned metering tanks located adjacent to the Newell Street parking lot. Review of the NOI is scheduled for the August Conservation Commission meeting.

2. Analytical Results

- Sampling was not conducted during this reporting period.

3. Issues

- None.

NEWELL STREET - PHASE II MCP ACTIVITIES
OCTOBER 1992

1. Activity Summary

- Demolition of the metering building is complete. The two storage tanks were cleaned, removed and are awaiting disposal. Wipe samples were collected from both tanks.
- The proposal for short term measure for drainage swale was submitted.

2. Analytical Results

- Analytical results from tank testing are being awaited.

3. Issues

- None.

NEWELL STREET - PHASE II MCP ACTIVITIES
NOVEMBER 1992

1. Activity Summary

- Demolition of the metering building is complete. The two storage tanks have been disposed as scrap steel for meltdown after appropriate cleaning and wipe sampling.
- The proposal for the short term measure for drainage swale was approved on November 23. An amended order of conditions has been submitted to the Pittsfield Conservation Commission for approval in December.

2. Analytical Results

- Analytical results from tank testing are being awaited.

3. Issues

- While the requirement in the November 23 letter to place a layer of filter fabric in the swale while waiting approval (should approval require the full four months) is not anticipated to be a problem, physically accessing the site with the current snow cover may be a hindrance. We will make every reasonable effort to complete this work at the earliest possible date.

*NOTICE OF INTENT FOR
GENERAL ELECTRIC COMPANY
DEMOLITION OF FORMER
METERING BUILDING*

P.O. Box 293 ■ 50 Depot Street ■ Dalton, MA 01226 ■ (413) 684 0925 ■ TELEFAX (413) 684-0267

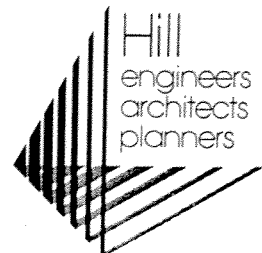



Commonwealth of Massachusetts



DEQE File No.

[Empty box for DEQE File No.]

(To be provided by DEQE)

City/Town _____

Applicant _____

Notice of Intent Under the Massachusetts Wetlands Protection Act, G.L. c. 131, §40 and Application for a Department of the Army Permit

Part I: General Information

- 1. Location: Street Address Newell Street Lot Number 12
2. Project: Type Demolition Description Clean and remove contents of former Metering Building and demolish and dispose of building.
3. Registry: County Berkshire Current Book 393 & Page 83 Certificate (If Registered Land)
4. Applicant GE Area Environmental & Facility Programs Tel. (413) 494-3952 Address 100 Woodlawn Avenue, Pittsfield, MA 01201
5. Property Owner Same as Applicant Tel. Same Address
6. Representative Hill Engineers, Architects, Planners, Inc. Tel. (413) 684-0925 Address 50 Depot Street, Dalton, MA 01226
7. a. Have the Conservation Commission and the Department's Regional Office each been sent, by certified mail or hand delivery, 2 copies of completed Notice of Intent, with supporting plans and documents? Yes [X] No []
b. Has the fee been submitted? Yes [X] No []
c. Amount of the fee submitted:
d. Is a brief statement attached indicating how the applicant calculated the fee? Yes [] No []

8. Have all obtainable permits, variances and approvals required by local by-laws been obtained?

Yes No

Obtained:

Applied For:

Not Applied For:

Demolition Permit

9. Is any portion of the site subject to a Wetlands Restriction Order pursuant to G.L. c. 131, §40A or G.L. c. 130, §105? Yes No

10. List all plans and supporting documents submitted with this Notice of Intent.

Identifying
Number/Letter

Title, Date

A	U.S.G.S Locus Map
B	Estimated Wildlife Habitat Map
C	Metering Building Demolition Site Plan Drawing GE-946-1
D	Project Description

11. Check those resource areas within which work is proposed:

(a) Buffer Zone

(b) Inland:

- | | |
|---|---|
| <input type="checkbox"/> Bank * | Land Subject to Flooding, |
| <input type="checkbox"/> Bordering Vegetated Wetland * | <input checked="" type="checkbox"/> Bordering |
| <input type="checkbox"/> Land Under Water Body & Waterway * | <input type="checkbox"/> Isolated |

(c) Coastal:

- | | |
|---|--|
| <input type="checkbox"/> Land Under the Ocean * | <input type="checkbox"/> Designated Port Area * |
| <input type="checkbox"/> Coastal Beach * | <input type="checkbox"/> Coastal Dune |
| <input type="checkbox"/> Barrier Beach | <input type="checkbox"/> Coastal Bank |
| <input type="checkbox"/> Rocky Intertidal Shore * | <input type="checkbox"/> Salt Marsh * |
| <input type="checkbox"/> Land Under Salt Pond * | <input type="checkbox"/> Land Containing Shellfish * |
| <input type="checkbox"/> Fish Run * | |

* Likely to involve U.S. Army Corps of Engineers concurrent jurisdiction. See General Instructions for Completing Notice of Intent.

12. Is the wetland resource area to be altered by the proposed work located on the most recent Estimated Habitat Map (if any) of rare, "state-listed" vertebrate and invertebrate animal species occurrences provided to the conservation commission by the Natural Heritage and Endangered Species Program?

YES [] NO [xx]
NO MAP AVAILABLE []

Date printed on the Estimated Habitat Map issued
(if any) 1992

If yes, have you completed an Appendix A and a Notice of Intent and filed them, along with supporting documentation with the Natural Heritage and Endangered Species Program by certified mail or hand delivery, so that the Program shall have received Appendix A prior to the filing of this Notice of Intent?

YES [] NO []

Part II: Site Description

Indicate which of the following information has been provided (on a plan, in narrative description or calculations) to clearly, completely and accurately describe existing site conditions.

Identifying
Number/Letter
(of plan, narrative
or calculations)

Natural Features:

- _____ Soils
- _____ Vegetation
- A & C Topography
- A, B, & C Open water bodies (including ponds and lakes)
- A, B, & C Flowing water bodies (including streams and rivers)
- None Public and private surface water and ground water supplies on or within 100 feet of site
- N/A Maximum annual ground water elevations with dates and location of test
- C Boundaries of resource areas checked under Part I, item 11 above
- _____ Other

Man-made Features:

- C Structures (such as buildings, piers, towers and headwalls)
- C Drainage and flood control facilities at the site and immediately off the site, including culverts and open channels (with inverts), dams and dikes
- C Subsurface sewage disposal systems
- C Underground utilities
- C Roadways and parking areas
- C Property boundaries, easements and rights-of-way
- _____ Other

Part III: Work Description

Indicate which of the following information has been provided (on a plan, in narrative description or calculations) to clearly, completely and accurately describe work proposed within each of the resource areas checked in Part I, item 11 above.

Identifying
Number/Letter
(of plan, narrative
or calculations)

Planview and Cross Section of:

- C Structures (such as buildings, piers, towers and headwalls)
- None Drainage and flood control facilities, including culverts and open channels (with inverts), dams and dikes
- C Subsurface sewage disposal systems & underground utilities
- None Filling, dredging and excavating, indicating volume and composition of material
- None Compensatory storage areas, where required in accordance with Part III, Section 10:57 (4) of the regulations
- None Wildlife habitat restoration or replication areas
- _____ Other

Point Source Discharge

- None Description of characteristics of discharge from point source (both closed and open channel), when point of discharge falls within resource area checked under Part I, item 11 above, as supported by standard engineering calculations, data and plans, including but not limited to the following:

1. Delineation of the drainage area contributing to the point of discharge;
2. Pre- and post-development peak run-off from the drainage area, at the point of discharge, for at least the 10-year and 100-year frequency storm;
3. Pre- and post-development rate of infiltration contributing to the resource area checked under Part I, item 11 above;
4. Estimated water quality characteristics of pre- and post-development run-off at the point of discharge.

Part IV: Mitigating Measures

1. Clearly, completely and accurately describe, with reference to supporting plans and calculations where necessary:
 - (a) All measures and designs proposed to meet the performance standards set forth under each resource area specified in Part II or Part III of the regulations; or
 - (b) why the presumptions set forth under each resource area specified in Part II or Part III of the regulations do not apply.

<input type="checkbox"/> Coastal <input checked="" type="checkbox"/> Inland	Resource Area Type: Bordering Land Subject To Flooding	Identifying number or letter of support documents
See Exhibit D - Project Description and Mitigating Measures -		D

<input type="checkbox"/> Coastal <input type="checkbox"/> Inland	Resource Area Type:	Identifying number or letter of support documents



LENOX 8 MI.
1.7 MI. TO U

403

27' 30"

402

401

6368 IV NE (PITTSFIELD WEST)

489

4598

25'

H
engineers
architects
planners

50 Depot Street
Dartmouth, MA 01228
(413) 684-0925

EXHIBIT "A"

SCALE	
DATE	6/16/92
DRAWN	GCB
CHECKED	
TITLE	USGS LOCUS MAP



Use only in reference to the Wetlands Protection Act Regulations (310 CMR 18)
 Natural Heritage & Endangered Species Program
 Massachusetts Division of Fisheries & Wildlife

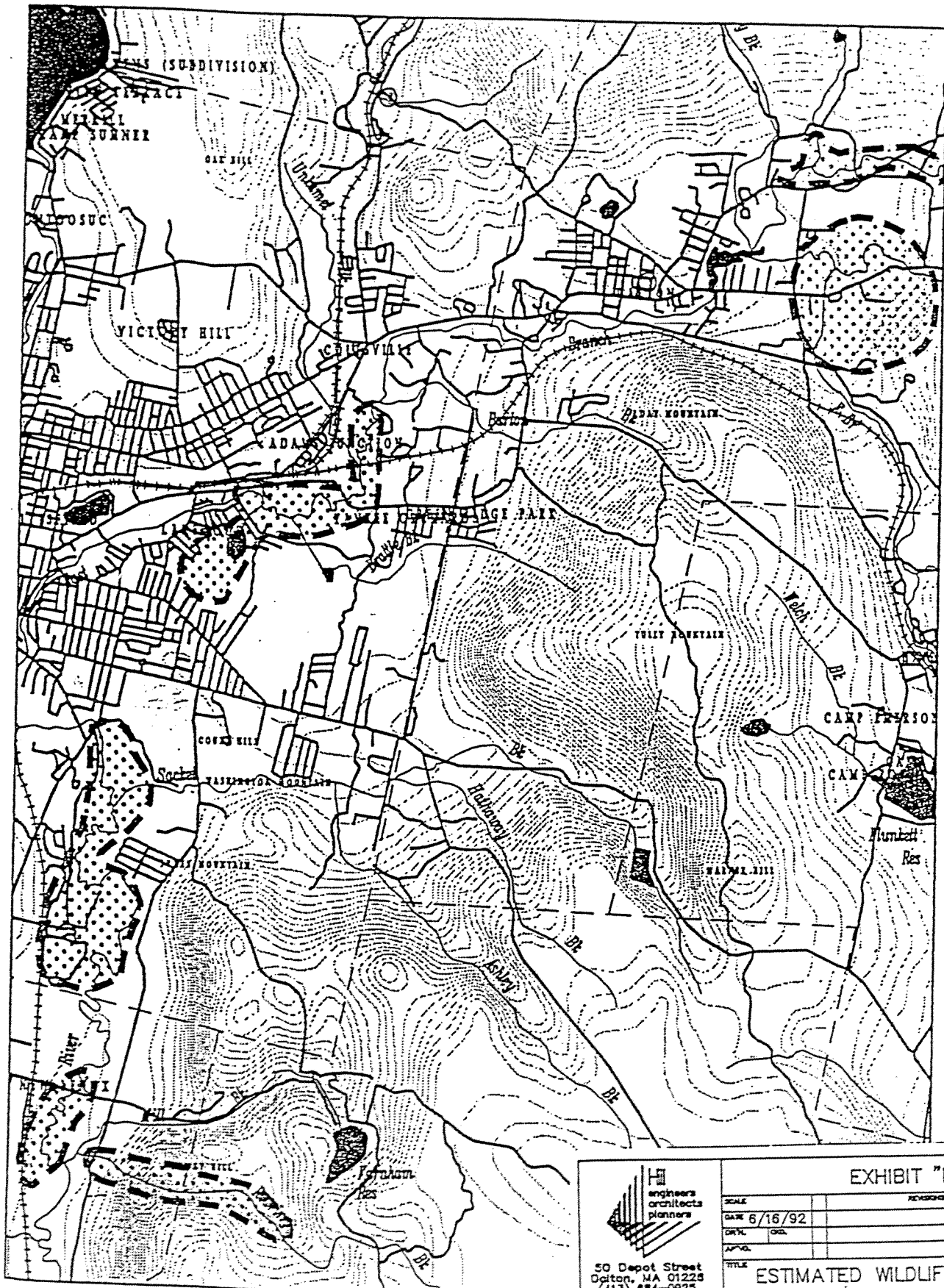



 H
 engineers
 architects
 planners
 50 Depot Street
 Dalton, MA 01226
 (413) 684-0925

EXHIBIT "B"		REVISIONS	BY
SCALE			
DATE	8/16/92		
DRAWN			
CHECKED			
TITLE	ESTIMATED WILDLIFE HABITAT MAP		

Scale 1:50,000 (1 inch = 5,000 feet)
 See County Index Maps to locate adjacent quadrangles

1992 EDITION

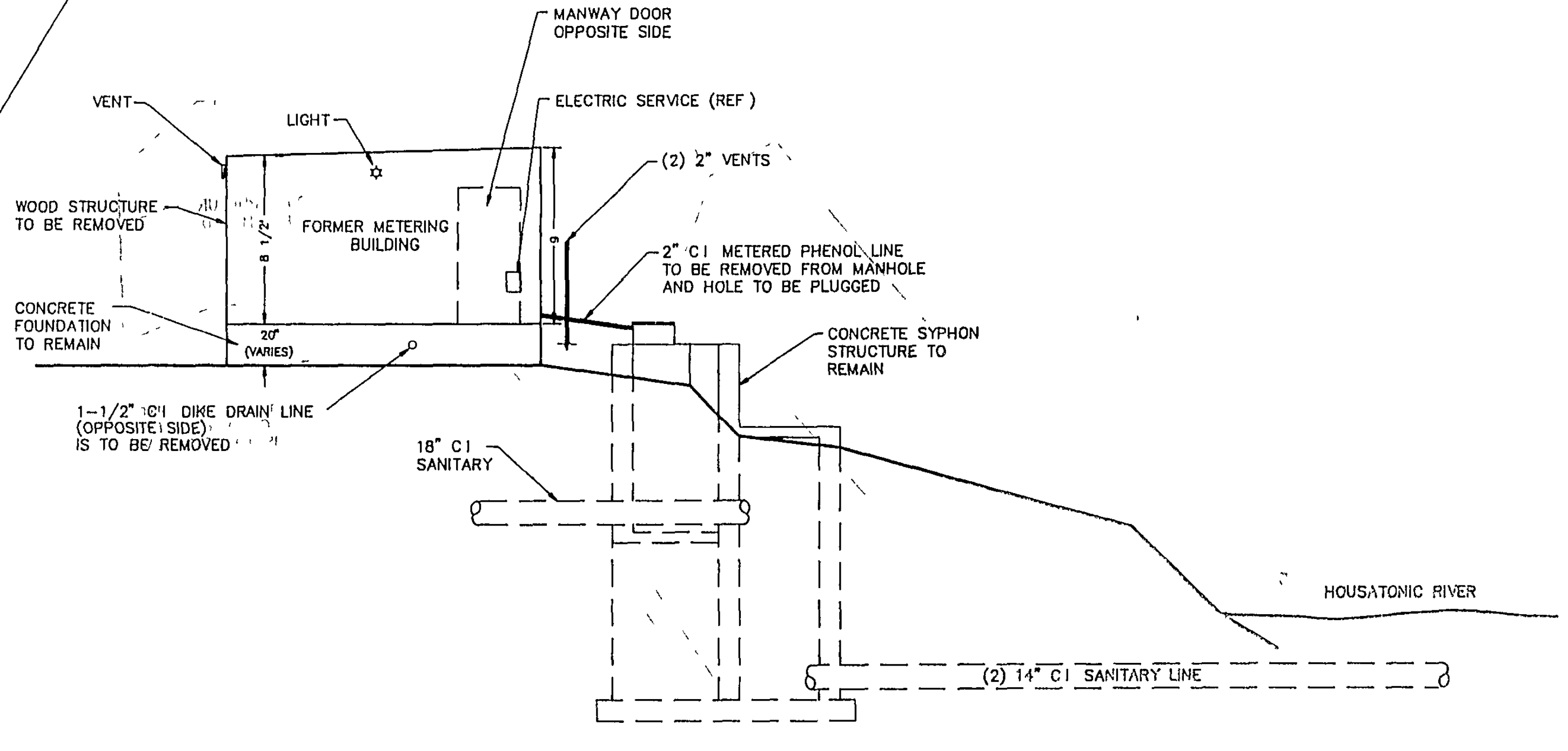
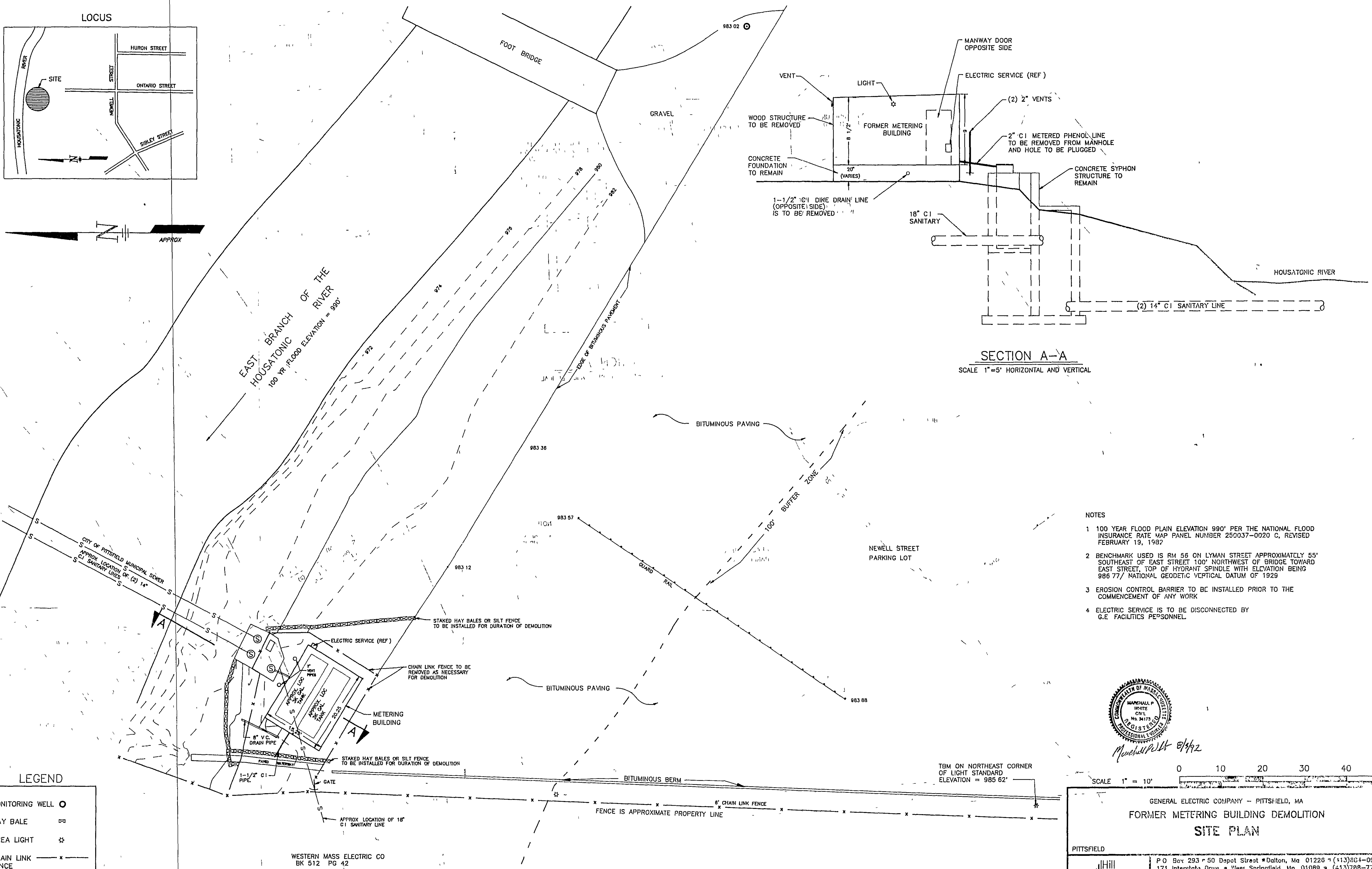
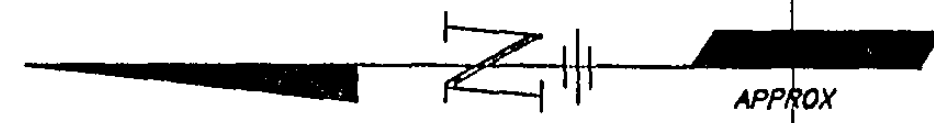
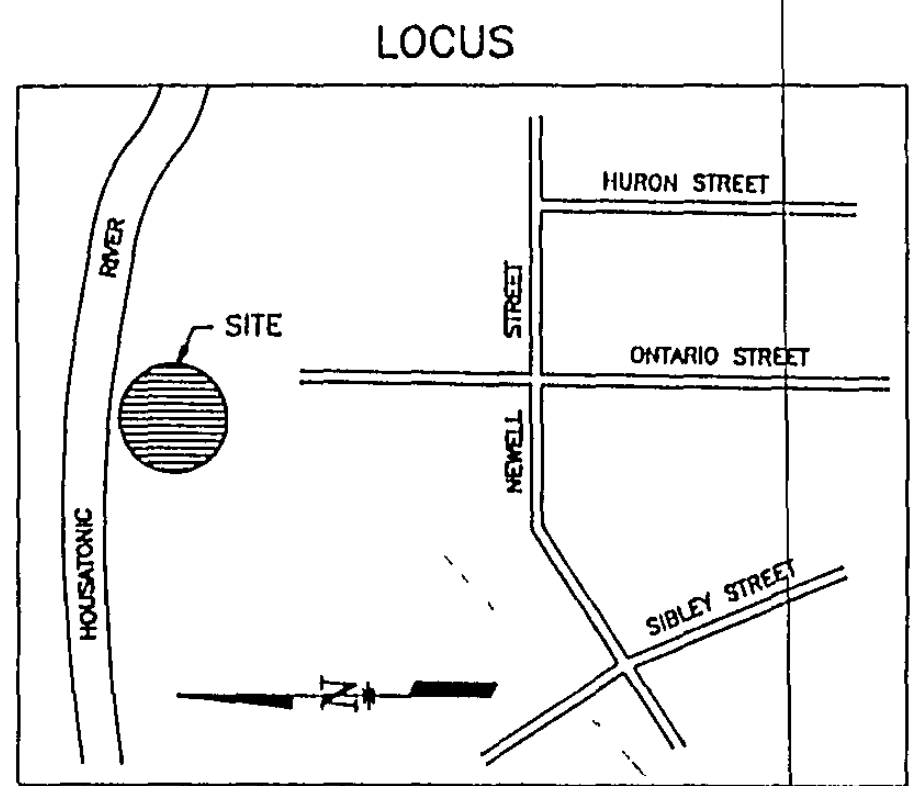

SECTION A-A
SCALE 1"=5' HORIZONTAL AND VERTICAL

- NOTES
- 1 100 YEAR FLOOD PLAIN ELEVATION 990' PER THE NATIONAL FLOOD INSURANCE RATE MAP PANEL NUMBER 250037-0020 C, REVISED FEBRUARY 19, 1982
 - 2 BENCHMARK USED IS RM 56 ON LYMAN STREET APPROXIMATELY 55' SOUTHEAST OF EAST STREET 100' NORTHWEST OF BRIDGE TOWARD EAST STREET, TOP OF HYDRANT SPINDLE WITH ELEVATION BEING 986.77/ NATIONAL GEODETIC VERTICAL DATUM OF 1929
 - 3 EROSION CONTROL BARRIER TO BE INSTALLED PRIOR TO THE COMMENCEMENT OF ANY WORK
 - 4 ELECTRIC SERVICE IS TO BE DISCONNECTED BY G.E. FACILITIES PERSONNEL



Marshall P. White 8/3/92

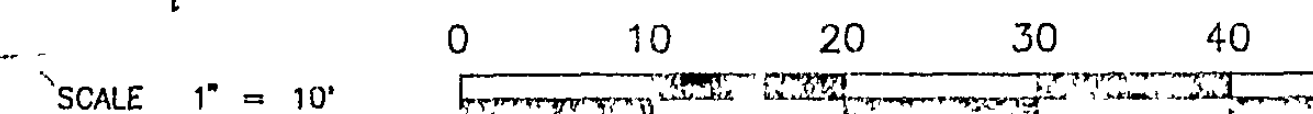

LEGEND

- MONITORING WELL ○
- HAY BALE [Symbol]
- AREA LIGHT ☆
- CHAIN LINK FENCE [Symbol]
- SEWER MANHOLE [Symbol]

WESTERN MASS ELECTRIC CO
BK 512 PG 42

TBM ON NORTHEAST CORNER OF LIGHT STANDARD ELEVATION = 985.62'

No	Description	Date	Checked By
1	GENERAL	8/3/92	
REVISIONS			

GENERAL ELECTRIC COMPANY - PITTSFIELD, MA
FORMER METERING BUILDING DEMOLITION
SITE PLAN

PITTSFIELD MA

P.O. Box 293 • 50 Depot Street • Dalton, Ma 01226 • (413) 684-0925	
171 Interstate Drive • West Springfield, Ma 01089 • (413) 788-7771	
COMP CODE	BOOK NO ACAD CODE
00-0	BOOK GE946-1A
DATE	DRAWN BY CHECKED BY REV.
7/20/92	WSK

DRAWING NO
GE-946-1

EXHIBIT D

GE AREA ENVIRONMENTAL & FACILITY PROGRAMS BUILDING DEMOLITION FORMER METERING BUILDING, NEWELL STREET, PITTSFIELD, MA GE-946

PROJECT DESCRIPTION

This project consists of the safe cleaning, demolition, and removal of the former Metering Building and its contents located off the Newell Street Parking Lot in Pittsfield, MA. The building is a wood structure located near the bank of the Housatonic River. It was built in approximately 1960 for the purpose of coordinating the metering of waste water containing Phenol to the City of Pittsfield Sanitary Treatment Plant. It contains two (2) fiberglass 3,000 gallon tanks and associated metering equipment. The facility was used for less than one year. The tanks currently contain a small amount of water and sludge with approximately 500 PPM of Phenol. The roof of the building has collapsed.

This project will consist of the removal of all of the wood structure and dike wall. The foundation portion of the building will remain in place.

Disturbances to be kept to a minimum. The earth is not to be disturbed.

PROJECT METHODOLOGY

- 1. Erect erosion control barriers as shown on plan.*
- 2. Plug holes in dike wall of building to insure containment.*
- 3. Erect temporary security fence.*
- 4. GE personnel to remove electric service to building.*
- 5. Remove sections of chain link fence as shown on plan.*
- 6. Remove wooden structure from the foundation around the tanks.*
- 7. Remove water and sludge from the tanks and the dike to an appropriate transport vehicle or containers supplied by the Owner.*
- 8. Clean the floor and interior and exterior of both tanks and associated equipment to acceptable Phenol levels.*
- 9. Remove tanks and remaining equipment.*
- 10. Clean dike walls and foundation floor to acceptable phenol levels.*
- 11. Remove 2" cast iron pipe from sewer manhole and permanently plug hole.*
- 12. Remove dike wall.*
- 13. Replace fence to pre-demolition condition.*
- 14. Remove erosion control barriers.*

MITIGATING MEASURES

There is minimal disturbance to wetland resource areas for this project.

Flood storage will not be affected since the building and storage tanks will be removed.

There is no change of grades proposed for this project.

SECTION 6

RESULTS OF PHENOLS ANALYSIS OF INTERIOR TANK SURFACE
PRIOR TO CLEANING

PRELIMINARY

①

BLASLAND & BOUCK ENGINEERS, P.C.
(REQUEST FOR SAMPLING)

TO: Files

DATE: 11-11-92

FROM: Bruce Eulian

FILE NO: 101.75.01

RE: Bldg 12X-1 Tank Sampling
(originating from the Newell St. Parking Lot)

INITIATOR: Aimee Cole (GE)

DATE: 11-3-92

LOCATION: Bldg 12X-1 (photos available in Pittsfield file)

CONTACT PERSON: Aimee Cole (GE)

EXT: 2534

ITEM DESCRIPTION:

1.) Residue (Scrape)

PURPOSE: To collect a sample for GE of the residue remaining on the inside wall of the Phenol & Water tank (Tank #1) located in Bldg 12X-1 (originating from the Newell St. Parking Lot) and analyze for Phenol.

NOTES:

1.) The residue remaining on the inside wall of the Phenol & Water tank (Tank #1) located in Bldg 12X-1 (originating from the Newell St. Parking Lot) is to be sampled for Phenol Method 420.1.

2.) GE requests the sample to be analyzed for Phenol at OBG Laboratories in Syracuse, NY.

jsh

⊗

PACKAGE / SAMPLE SCHEDULE

Wed, Nov 11, 1992

Project Manager: A C

Page 1 of 6

000110000



PACKAGE

Client: Blastand and Smuck Engineers, P.C.

Job No.: 2887.26.517 Description: NEWELL ST. PARKING LOT TANK SAMPLING

Scheduled: 11-NOV-92 Due: 25-NOV-92

Package number: 3269 QC Level: 1

Samples: 0009215 - 0009215 Number of samples: 1

Certification: 10155

Comments: PROJECT#101.75.01

SCHEDULED SAMPLES

Sample	Number	Group	Parameter	ID	Method	Matrix	Comments
0009215 - 009215	1	(MC)	% Total Solids	828	S.M.16 209F	Solid	97.
0009215 - 009215	1	(MC)	Phenol	873	EPA 420.1	Solid	10. mg/Kg. Dry Wt.

LIST OF ALL SAMPLES IN PACKAGE:

Sample	Description	Bin	Type	Collected	Received	Due	Comments
0009215	NEWL-TANK-C4	28	Grab	10-NOV-92	11-NOV-92 09:00	25-NOV-92	

SECTION 7

PCB RESULTS FOR 19 WIPE SAMPLES
COLLECTED FROM SURFACE OF CLEANED TANK



LABORATORIES, INC.

Laboratory Report

CLIENT BLASLAND & BOUCK ENGINEERS, P.C.

JOB NO. 2887.026.520

DESCRIPTION G.E., Pittsfield, MA

B&B Job No. 201.16.01

Bldg. 12Y-1 Cleaning Center

Date Analyzed 1-28,29-93

DATE COLLECTED See Below

DATE RECEIVED 1-27-93

LAB ID NO.	DATE SAMPLED	PCB	COMMENTS	QC RESULTS
[REDACTED]	1-26-93	[REDACTED]	wipe	A
12Y-EB-W4416		12.		
12Y-EB-W4417		<1.		
12Y-EB-W4418		2.6		
12Y-EB-W4419		1.0		
[REDACTED]				
[REDACTED]				
[REDACTED]				
[REDACTED]				
[REDACTED]				
A) Reagent Blank 012793-2		<1.		
Reference Sample 012793-2		28./30	= 93%	

Comments:

Certification No.: NY034

Units: Total µg

Authorized:

Date: February 26, 1993



Laboratory Report

CLIENT BLASLAND & BOUCK ENGINEERS, P.C. JOB NO. 2887.026.520

DESCRIPTION G.E., Pittsfield, MA B&B Job No. 201.16.01

12Y-1 Cleaning Center

Date Analyzed 2-11-93 DATE COLLECTED See Below DATE RECEIVED 2-10-93

LAB ID NO.	DATE SAMPLED	PCB	COMMENTS	QC RESULTS
[REDACTED]	2-10-93	[REDACTED]	. wipe	A
[REDACTED]	[REDACTED]	[REDACTED]	[REDACTED]	[REDACTED]
[REDACTED]	[REDACTED]	[REDACTED]	[REDACTED]	[REDACTED]
[REDACTED]	[REDACTED]	[REDACTED]	[REDACTED]	[REDACTED]
[REDACTED]	[REDACTED]	[REDACTED]	[REDACTED]	[REDACTED]
12Y-EB-W4471		3.4		
12Y-EB-W4472		1.1		
12Y-EB-W4473		3.3		
12Y-EB-W4474		<1.		
12Y-EB-W4475		1.6		
12Y-EB-W4476		<1.		
12Y-EB-W4477		1.0		
12Y-EB-W4478		<1.		
A) Reagent Blank 021193-1		<1.		
Reference Sample 021193-1		25./30	= 83%	

Comments:

Certification No.: NY034

Units: Total µg

Authorized:

Date: February 26, 1993



Laboratory Report

CLIENT BLASLAND & BOUCK ENGINEERS, P.C. JOB NO. 2887.026.520
 DESCRIPTION G.E., Pittsfield, MA B&B Job No. 201.16.01
12Y-1 Cleaning Center
 Date Analyzed 2-11-93 DATE COLLECTED See Below DATE RECEIVED 2-10-93

LAB ID NO.	DATE SAMPLED	PCB	COMMENTS	QC RESULTS
12Y-EB-W4479	2-10-93	1.3	wipe	A
12Y-EB-W4480	↓	<1.	↓	↓
12Y-EB-W4481	↓	1.4	↓	↓
A) Reagent Blank 021193-1		<1.		
Reference Sample 021193-1		25./30	= 83%	

Comments:

Certification No.: NY034
 Units: Total µg

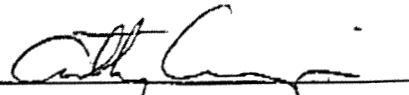
Authorized: 
 Date: February 26, 1993