

*Proposal for Supplemental  
Source Control  
Containment / Recovery  
Measures*

General Electric Company  
Pittsfield, Massachusetts

January 1999

**BBL**  
BLASLAND, BOUCK & LEE, INC.  
*engineers & scientists*

---

6723 Towpath Road, P.O. Box 66  
Syracuse, New York, 13214-0066  
(315) 446-9120

# ***Acknowledgments***

---

This *Proposal for Supplemental Source Control Containment / Recovery Measures* was prepared on behalf of the General Electric Company by Blasland, Bouck & Lee, Inc., with input from HSI GeoTrans, Inc. and Geophysical Application, Inc.

# Table of Contents

---

<b>Section 1.</b>	<b>Introduction</b> .....	<b>1-1</b>
1.1	General .....	1-1
1.2	Format of Report .....	1-1
<b>Section 2.</b>	<b>Summary of Recent Source Control Investigations</b> .....	<b>2-1</b>
2.1	General .....	2-1
2.2	Field Investigations .....	2-1
2.3	Investigation Results .....	2-2
<b>Section 3.</b>	<b>Description of Supplemental LNAPL Control Measures</b> .....	<b>3-1</b>
3.1	General .....	3-1
3.2	Extent and Type of Containment Barrier .....	3-1
3.2.1	Horizontal Extent .....	3-2
3.2.2	Vertical Extent of the LNAPL Containment Barrier .....	3-2
3.2.2.1	Historical Groundwater Data .....	3-3
3.2.2.2	Predictive Groundwater Modeling .....	3-4
3.2.2.3	Geotechnical/Structural Considerations .....	3-5
3.2.3	Selection of Containment Barrier Type .....	3-6
3.3	Proposed Implementation Activities .....	3-7
3.3.1	Permits and Approvals / Pre-Mobilization Activities .....	3-7
3.3.2	Working Limits .....	3-8
3.3.3	Site Preparation .....	3-8
3.3.4	Removal of Soils and Sediments Adjacent to the Containment Barrier .....	3-9
3.3.5	Sheetpile Alignment and Installation .....	3-10
3.3.6	Existing Oil-Water Separator Drainage Outlets .....	3-10
3.3.7	Site Restoration .....	3-10
3.4	Future Monitoring Activities .....	3-12
<b>Section 4.</b>	<b>Further Evaluation of DNAPL</b> .....	<b>4-1</b>
<b>Section 5.</b>	<b>Summary and Anticipated Schedule</b> .....	<b>5-1</b>
<b>Tables:</b>	1. Groundwater Elevations	
	2. River Elevations	
<b>Figures:</b>	1. Site Plan	
	2. Top of Till	
	3. Geological Cross-Section	
	4. Containment Barrier Plan	
	5. Containment Barrier Profile	
	6. Historical River and Groundwater Elevations	
	7. Riverbank Area - Groundwater Elevation Contour Map 4/14/94	
	8. Riverbank Area - Groundwater Elevation Contour Map 1/7,8/98	
	9. Conceptual Riverbank Restoration	
	10. Anticipated Implementation Schedule	

---

**Appendices:**

- A Summary of 1998 Investigations Source Controls - East Street Area 2
- B. Groundwater Hydraulic Modeling Results
- C. Sheetpile Geotechnical and Structural Calculations
- D. Containment Barrier Technical Drawings

# **1. Introduction**

---

## **1.1 General**

This *Proposal for Supplemental Source Control Containment / Recovery Measures* (Source Control Proposal) summarizes the activities recently performed by the General Electric Company (GE) related to non-aqueous phase liquids (NAPLs) present in certain areas of the USEPA Area 4/MCP East Street Area 2 site (the site) in Pittsfield, Massachusetts. The activities described in this document supplement the information GE previously submitted to the United States Environmental Protection Agency and the Massachusetts Department of Environmental Protection (the Agencies) in a letter report dated November 18, 1998. That letter report described the activities that had been conducted by GE for the site, as of that date, pursuant to a document entitled *Source Control Work Plan - Upper Reach of Housatonic River (First ½ Mile)*, dated September 1998 (Source Control Work Plan). Included was a summary of field investigations conducted to further assess the presence of NAPLs in the vicinity of GE's existing 64V oil recovery system and near the adjacent riverbank, as well as preliminary information concerning the selection and design of NAPL containment/recovery measures to supplement those currently in place.

Several of the activities referenced in the November 18, 1998 submittal have been updated or completed. Specifically, GE has (1) received and summarized all of the analytical data related to recent soil and NAPL investigations in East Street Area 2, (2) revised and updated the geologic cross sections, (3) developed additional details concerning its proposal (and supporting technical evaluation) for supplemental containment/recovery measures for light NAPLs (LNAPLs), and (4) developed an approach to further evaluate dense NAPLs (DNAPLs) identified in the riverbank area. This proposal also provides additional information in response to comments received from the Agencies in a December 3, 1998 meeting and a December 16, 1998 letter from USEPA, pertaining to the November 18, 1998 letter report.

## **1.2 Format of Report**

Over the last several years, GE has conducted extensive investigations and has implemented numerous activities to control, contain, and recover LNAPLs in this area of the GE facility. These previously collected data were useful in defining the scope of the recent source control investigations; understanding and assessing the results of the recent activities; and selecting and designing the supplemental LNAPL containment/recovery measures proposed herein. A comprehensive summary of the historic information is beyond the scope of this Source Control Proposal. However, it can be found in other documentation previously provided by GE. Where appropriate, an expanded discussion of

---

relevant historical information is provided. The remainder of this Source Control Proposal is provided in four sections as described below.

Section 2 of this Source Control Proposal describes the field investigations conducted on behalf of GE between October 7 and December 18, 1998. The summary provided in Section 2 focuses primarily on subsurface NAPLs and incorporates several tables, figures, and attachments to supplement the summary provided in the report text.

Section 3 of this Source Control Proposal presents GE's proposal for supplemental LNAPL containment/recovery within the riverbank area, and presents information (and supporting technical information) regarding the design of a proposed sheetpile containment barrier. Section 3 also describes the anticipated implementation activities associated with the proposed containment barrier, including the anticipated construction sequence, measures to mitigate potential environmental disturbances during construction, temporary/final site restoration details, and post-construction monitoring activities. Section 4 presents GE's approach for the further evaluation of detected DNAPL, while Section 5 presents a summary and anticipated project schedule

## **2. Summary of Recent Source Control Investigations**

### **2.1 General**

This section of the Source Control Proposal describes the scope and results of field investigations conducted by GE within the USEPA Area 4 / East Street Area 2 portion of the GE facility. Such activities were originally identified by GE in the September 1998 Source Control Work Plan. Although generally conducted in accordance with that work plan, certain modifications to the proposed work efforts were implemented either in response to the USEPA's letter dated October 6, 1998 (providing conditional approval of the Source Control Work Plan) and/or visual observations made during the field investigations. Modifications made as a result of field observations were discussed with and approved by USEPA prior to implementation.

The activities summarized in this Source Control Proposal focus solely on the work conducted by GE in the vicinity of the existing 64V oil recovery system and near the adjacent riverbank. Concurrently, over the last several weeks, GE has conducted similar investigations at the Newell Street and Lyman Street areas pursuant to the September 1998 Source Control Work Plan. The results of these activities will be addressed in one or more future reports.

### **2.2 Field Investigations**

HSI GeoTrans, Inc. supervised the advancement of a total of 22 borings at 20 locations (E2SC-1 through E2SC-20) between October 7 and December 18, 1998. The majority of these soil borings were installed in the area of the existing 64V oil recovery system, the existing slurry wall, and the adjacent riverbank, as shown on Figure 1. Other borings (E2SC-12 and E2SC-15) were located to the southwest in the Building 60 and 61 areas, as shown on Figure 2-1 in Appendix A. Most of the borings were advanced to a depth sufficient to intercept the water table and/or the first confining layer. However, borings E2SC-18, E2SC-19, and E2SC-20 were shallow borings advanced along the lower portion of the riverbank immediately downstream of the 64-X oil/water separator. These borings were advanced to further delineate the extent of potential historic LNAPL occurrences along the alignment of the proposed containment barrier.

Thirteen of the soil borings were converted into monitoring wells to supplement the visual observations collected during the soil boring activities and to monitor the subsurface for the potential presence of NAPL. The 13 wells were installed based on the locations and selection criteria proposed in the Source Control Work Plan and comments included in the USEPA October 6, 1998 approval letter. During the performance of these investigations, oversight of GE's activities was performed by USEPA's oversight contractor.

---

With the exception of E2SC-18 through E2SC-20, representative soil samples were collected from each boring and analyzed for polychlorinated biphenyls (PCBs) and other constituents listed in Appendix IX of 40 CFR 264, excluding herbicides/pesticides, and including benzidine, 2-chloroethylvinyl ether, and 1,2-diphenylhydrazine (Appendix IX+3). Soil samples collected from E2SC-18 through E2SC-20 were analyzed for total petroleum hydrocarbons (TPH). Following installation, each monitoring well was gauged periodically for water level elevation and the presence of NAPLs. Finally, a sample of accumulated DNAPL was collected from well E2SC-3I and analyzed for PCBs and Appendix IX+3 constituents. Appendix A provides a brief description and evaluation of the investigation results, and includes the boring/well construction logs, analytical chemistry results, and geotechnical testing (i.e., grain-size and atterberg limits); a summary is provided below.

### **2.3 Investigation Results**

The data collected from the recent investigations, combined with data available from prior investigations in this portion of the GE Facility, have been used to further delineate the type(s) of subsurface deposits present in this area and to assess the depth to the basal till layer. The investigation indicates that the till layer is approximately 30 to 45 feet below ground surface in the riverbank area. There appears to be a distinct depression in the top of till surface downgradient of the existing slurry wall. The lowest portion of the observed depression includes borings E2SC-3I and E2SC-17. A till layer elevation contour map is presented in Figure 2. Overlying the till are stratified sand, gravel, and silt deposits. A cross-section depicting the hydrogeologic features along the riverbank is shown on Figure 3. Appendix A also includes a similar cross-section oriented perpendicular to the river and an additional cross-section located along the lower portion of the riverbank.

Information from the soil boring logs and well gauging activities indicate that certain areas of soil staining, sheens, and separate-phase light and dense NAPLs are present in the subsurface soils. The information related to soil staining and presence of sheens in the area associated with LNAPL is generally consistent with prior investigation results.

Of the 13 recently installed monitoring wells, a measurable thickness of LNAPL was detected in only one well, E2SC-6. However, the NAPL in this well is very viscous and appears (based on field observations) to be a mixture of LNAPL and DNAPL. This well is located upgradient of the existing slurry wall and 64V oil recovery system, so that the NAPL detected at this location is adequately addressed. In addition, during weekly well measurements, a sheen was noted on one occasion in shallow well E2SC-16S. However, a measurable thickness of LNAPL has not been detected in this well or in adjacent wells 53, 54, and E2SC-4.



---

Measurable accumulations of DNAPL have been detected in three of the newly installed wells (E2SC-2, E2SC-3I and E2SC-17). Periodic gauging has indicated a measured DNAPL thickness of approximately 5 feet in wells E2SC-3I and E2SC-17, and a thickness of less than one foot in E2SC-2. Note these measurements may not be representative of actual DNAPL thickness in the soil formation immediately surrounding the well, and instead the wells may serve as a sump for accumulating DNAPL. These well locations are generally located in a depression in the till layer located approximately 40 to 45 feet below the ground surface, or approximately 30 feet below the river bed. In well E2SC-16I, a trace of NAPL was noted on the oil/water interface probe, but a measurable thickness of NAPL has not been detected. Sheens have also been detected sporadically on the probe when measuring deep wells E2SC-1, E2SC-4, and E2SC-9, although no measurable NAPL has been detected.

Visual, physical, and chemical information associated with the DNAPL in the riverbank area (provided in Appendix A) indicates that its physical and chemical characteristics are similar to typical coal tar byproducts. Numerous semi-volatile organic compounds were detected in the DNAPL sample collected from E2SC-3I with individual constituent concentrations up to 110,000 parts per million (naphthalene). PCBs were not detected in the sample and its specific gravity of 1.076 is consistent with coal tars. The DNAPL sample had an interfacial tension of approximately 30 dyne/cm, however it was not possible to conduct laboratory testing for viscosity since the laboratories' instrument became coated with DNAPL during the test procedure. The identification of coal tar byproducts during these recent investigations is consistent with the results of previous investigations within this area, where similar material was detected in wells located north and west of the newly installed wells (this general area is downgradient of a former manufactured gas facility). Monitoring during prior investigations in this area has detected DNAPL in wells 28, 64V, and ES2-6, although no DNAPL has been detected in ES2-6 during monthly monitoring (initiated in May 1996).

To further assess the vertical extent of historic LNAPL occurrences along the alignment of the proposed containment barrier, three shallow soil borings (E2SC-18, E2SC-19, and E2SC-20) were advanced along the lower portion of the riverbank immediately downstream of the 64X oil/water separator. Soil samples were collected for visual examination between the elevations of approximately 980 feet to 972 feet. Visible soil staining was observed only in the deepest samples from borings E2SC-18 (at an elevation 974 feet to 975 feet) and E2SC-19 (at an elevation 972 feet to 973 feet). This visual assessment was supplemented by a series of shake tests conducted using soil samples from each one foot boring increment. While no NAPL residuals were observed in the shake tests associated with E2SC-18, a small amount of NAPL residual was observed in the deepest soil sample collected from E2SC-19 (corresponding to an elevation 972 feet to 973 feet) and in the shake tests conducted for E2SC-20 (elevation 973 feet to 975). Based on the above results, visual LNAPL residuals are not observed above an elevation of 975 feet in the lower portion of the riverbank. This information is summarized in Figure 2-6 and Table 2-11 of Appendix A.

## **3. Description of Supplemental LNAPL Control Measures**

---

### **3.1 General**

Based on the results of the recent and prior investigations, supplemental containment/recovery measures have been identified to address the known or potential presence of LNAPLs within the subsurface soils. These proposed measures are in addition to the existing containment/recovery activities that have been implemented by GE over the last several years and continue to be operated today. As previously indicated, GE believes that the ongoing NAPL monitoring, control, and recovery activities currently conducted in the areas along the first ½ mile of the river are effective in preventing any significant migration of NAPL. The activities proposed herein serve as a supplement to the existing measures and should provide further assurances of LNAPL containment. The primary component of the proposed supplemental LNAPL containment/recovery measure is the installation of a physical containment barrier along and parallel to a portion of the Housatonic River riverbank. Specifically, GE proposes the installation of an approximately 450-foot long sealed steel sheetpile wall along the edge of the river, as shown on Figure 4.

The location of the proposed containment barrier has been selected based on the results of the field investigations to include those areas (both vertically and horizontally) where separate phase LNAPLs are potentially present. Once this area was determined, several technical and operational factors were considered, such as possible impacts to the existing hydrogeologic conditions in the area (and the existing LNAPL containment/recovery measures) and possible effects of future river flooding on the containment of LNAPLs. In addition, the design of the proposed containment barrier also considered the performance of future response actions to be performed within the first ½ mile of the Housatonic River. Specifically, for this section of the river, GE is evaluating potential response actions involving river sediments and bank soils. Although the scope of these activities have not yet been fully developed, the structural and geotechnical design of the proposed containment barrier takes into account potential excavation and restoration requirements for the response actions for the first ½ mile. Other anticipated components of the response actions for the river have also been considered in the development of this Source Control Proposal, as discussed in this section.

### **3.2 Extent and Type of Containment Barrier**

As previously indicated, the existing LNAPL control/recovery measures in this area of the GE facility are sufficient to preclude any significant LNAPL migration. Nonetheless, a sheetpile wall is proposed to provide an additional and supplemental containment/recovery measure. The location of the proposed containment barrier has been selected based on a number of considerations, including evidence of LNAPLs and/or soil staining, laboratory analytical results,

---

historic groundwater elevations, typical river elevations, and existing bank geometries. A summary of information supporting the proposed horizontal and vertical extent of the sheetpile containment barrier, and type of sheetpile, is presented below.

### **3.2.1 Horizontal Extent**

The horizontal extent of the proposed containment barrier is shown on Figure 4. This location has been selected based on a review of information obtained from the recent investigations described in Section 2 and pertinent data from prior investigations conducted in this area. Using this information, the location of the proposed containment barrier was initially established to address known areas of separate phase LNAPL; the limits were then conservatively expanded to address adjacent areas where evidence of soil staining is present.

The western end of the proposed containment barrier will include well location PZ-1S, where a small quantity of LNAPL has been observed on occasion as part of GE's ongoing well monitoring program. In that area, the containment barrier will conservatively extend to include soil boring SB-1 and new soil boring E2SC-10 (even though evidence of LNAPLs or soil staining were not observed at either of these locations).

The easternmost area where small quantities of LNAPL have been detected (although on an intermittent basis) is well PZ-4S. As a conservative measure, the eastern end of the wall extends approximately 120 feet past this well to include wells 54 and E2SC-16. Some soil staining near the water table was identified on soil samples collected during installation of these wells, but no evidence of LNAPL has been observed during subsequent monitoring (well 54 has been monitored semi-annually since 1988). Additionally, historic data from the abandoned "B-series" wells (B-3 through B-10) was reviewed. Data associated with these wells (which indicates no detections of LNAPL) is reported in groundwater monitoring reports for East Street Area 2 between 1984 and 1987. However, it should be noted that wells B-3, B-9, and B-10 are included within a 1981 map illustrating the horizontal limits of LNAPL, but no actual well monitoring data from these locations is available to confirm this. Although well monitoring data collected since 1984 does not indicate the presence of separate phase LNAPL in this area, the containment barrier conservatively includes wells B-3, B-9, B-10, 54, and E2SC-16.

### **3.2.2 Vertical Extent of the LNAPL Containment Barrier**

Several considerations were taken into account in selecting the vertical extent of the proposed containment barrier, including the results from recent and prior investigations; historic, current, and predicted groundwater hydraulics;

---

existing and ongoing NAPL containment/recovery measures; and geotechnical considerations. From this information, it has been determined that the proposed upper elevation of the containment barrier will be positioned at a elevation of approximately 977 feet. The sheetpile sections along the river will typically be 20 feet long so that the bottom elevation will be approximately 957 feet. The installation of the proposed sheetpile containment barrier between approximately 977 feet and 957 feet will provide adequate penetration below the groundwater table to contain potential separate phase LNAPL. This sheetpile depth will also provide sufficient structural stability during bank and river excavation and restoration activities associated with the first ½ mile.

In addition to the presence of LNAPL and adjacent areas with stained soils, groundwater hydraulics and geotechnical considerations were factored into the selection of the vertical extent of the proposed containment barrier. A summary is presented below.

### **3.2.2.1 Historical Groundwater Data**

The historical groundwater elevations immediately adjacent to the river were evaluated using data from the WP series of well points located along the lower portion of the riverbank. Available groundwater elevations for well points WP-1, WP-3, and WP-5, as well as river elevations adjacent to East Street Area 2, are presented in Table 1. The most complete set of data begins in June 1993 with the commencement of weekly well point and river level monitoring. These data are depicted on Figure 6.

The water levels in the WP well series immediately adjacent to the river are usually similar, and the groundwater levels range from a low of approximately 970.5 feet to a high of approximately 977.5 feet, with a mean value of approximately 972 feet. The typical range is 971 to 973 feet. On a single occasion (April 1994) the groundwater levels immediately adjacent to the river exceeded 977 feet. However, as shown on Figure 7, the groundwater flow during this event was primarily landward.

Groundwater levels in the riverbank area were generally the same as the river level or significantly lower. This was particularly true for some wells at the top of the riverbank which had groundwater levels 2 to 3 feet lower than the river. A similar trend of hydraulic gradients oriented landward from the river is also evident in the second highest peak river flow monitoring event (January 7 and 8, 1998). During this high water event, the measured river elevation was 975.51 feet. The monitoring well readings indicate that the river elevations were approximately 2 feet higher than groundwater elevations measured in the wells located near the top of the riverbank (as shown on Figure 8).

---

The well readings during these high flow events indicate that water from the river generally flows inward toward the site. This effect is enhanced by the groundwater pumping in RW-1(X) and RW-2(X). This gradient reversal helps prevent LNAPL migration toward the river during high river flow events. Another factor which hinders the migration of LNAPL during elevated river flow events is the fact the water has a higher mobility relative to oil. This allows the groundwater to respond more rapidly to transient water table increases which results in residual oil being “trapped” in the soil pores below the top of the phreatic surface. Also, recent sampling in the riverbank area confirms that soils above the normal groundwater level do not contain high TPH levels (see Appendix A). This indicates that although river water/groundwater may occasionally rise above the 977 foot elevation for brief time periods, LNAPL does not appear to migrate vertically upward in response to this water elevation. Once the proposed containment barrier is constructed, it is expected that the response time for groundwater elevation changes in areas behind the barrier due to changes in the river elevation will be further dampened, thereby further reducing the potential for LNAPL migration during a high-flow river event.

From June 1993 to the present, weekly measurements of the river elevation (collected at the existing 64-X oil/water separator discharge) are commonly below elevation 973 feet and average approximately 972 feet (Table 2). As previously mentioned, there are several specific measurements that show brief periods higher than this elevation, but only one reading (April 1994) exceeded elevation 977 feet. Since the highest measured river elevation (977.44 feet) matches the computed two-year flood elevation of 977.4 feet to 977.7 feet, it is clear that these events are transient in nature and apparently produce a localized landward groundwater flow direction before the river drops back to more typical levels.

### **3.2.2.2 Predictive Groundwater Modeling**

The groundwater hydraulics associated with typical hydrogeologic conditions in this area were modeled using the publicly available and well-documented Visual MODFLOW™ program. This three-dimensional model uses two layers to simulate the flow system. The recharge pond, Housatonic River, and the existing groundwater pumping wells are included in the simulation. A detailed discussion of the modeling with graphical output is provided in Appendix B; a summary is provided below.

The model was initially calibrated to simulate the groundwater elevations observed in both February and May 1998. The groundwater boundary conditions at those times were groundwater elevations to the north along East Street at 980 feet, a Housatonic River elevation of 971.6 feet in February and 973.2 feet in May, and a recharge pond elevation of 983 feet. The river elevation of 973 feet was conservatively selected to account for the high end of the typical

---

groundwater conditions that can be sustained for more than a few hours or days, as it is slightly less than the one-year flood elevation (973.7 to 973.9 feet). Based on weekly monitoring, there were 26 occasions since June 1993 when the river elevation exceeded 973 feet but only six of those occurrences had consecutive weekly readings greater than 973 feet.

After calibration of the model, the proposed containment barrier was added to the model. No significant changes in the groundwater flow pattern occurred, and the capture zones of the current recovery systems were not significantly altered. The resulting equipotential and drawdown contours indicate that the groundwater immediately upgradient of the proposed barrier may be approximately 0.5 to 1 foot higher than the existing elevations if the pumping rates and recharge pond elevation remain the same. This estimate is believed to be conservative as discussed in Appendix B. Therefore, the typical sustainable peak groundwater elevation adjacent to the sheetpiling after its installation should be approximately 974 feet or less. Based on this analysis, the elevation of 977 feet as the upper elevation of the proposed containment barrier provides a significant factor of safety against groundwater overtopping.

MODFLOW™ modeling was also performed to evaluate the potential head and gradient distribution through the reduced aquifer flow area immediately below the proposed containment barrier. The potential impacts on DNAPL which is present at a depth of approximately 45 feet below the top of the river bank were evaluated. The analysis indicates that, based on the depths of the till and DNAPL, the upward gradients in the vicinity of the DNAPL under the existing and proposed conditions are minimal and upward mobilization is not likely.

### **3.2.2.3 Geotechnical/Structural Considerations**

Concurrent with the preparation of this Source Control Proposal, GE is in the process of evaluating and proposing response actions for the bank soils and sediments within the first ½ mile of the Housatonic River (i.e., between Lyman Street and Newell Street) (a work plan identifying such response actions will be submitted by GE in the near future). With respect to the proposed containment barrier, the depth of the proposed sheetpiling (to an elevation of approximately 957 feet) facilitates the removal of approximately 2 to 3 feet of sediment from the portion of the river located immediately adjacent to the sheetpiling. Appendix C to this Source Control Proposal provides the supporting geotechnical and structural calculations. This removal depth is compatible with the range of sediment removal depths that are currently being contemplated for this section of the river.

The lowest potential groundwater levels in this area would likely correspond to the temporary dewatering that may occur during the future response actions to be conducted for the Housatonic River sediment and bank soils. As

---

previously mentioned, the anticipated sediment excavation depths would be significantly above the lower elevation of proposed containment barrier (957 feet). In addition, historical soil staining potentially attributed to LNAPLs has not been observed below elevation of approximately 960 feet in soil borings along the riverbank. Therefore, the proposed sheetpile wall base elevation of 957 feet will be adequate to prevent LNAPL migration into potential sediment excavation areas.

### **3.2.3 Selection of Containment Barrier Type**

The proposed containment barrier will be constructed of a steel sheetpile wall with sealable joints. Similar steel sheetpiling has been successfully installed at a location less than a ¼-mile downstream at GE's Building 68 area. The sheetpile wall will be constructed of Waterloo brand medium walled sealable sheetpiling (WZ75) manufactured by Canadian Metal Rolling Mills under license to the University of Waterloo. The sheeting will be driven into place with a vibratory or impact hammer. Waterloo Barrier™ sheetpiling consists of a L-shaped steel sheetpile section, which has a cold-rolled joint that is larger than a typical hot-rolled joint and therefore facilitates sealing to form a low-permeability barrier. Extensive field testing at the CFB Borden site in Canada and at other locations has demonstrated that permeabilities of  $1 \times 10^{-8}$  to  $1 \times 10^{-10}$  cm/sec are achieved in practice. Waterloo Barrier™ has also been installed at a number of sites in the United States, including Hill Air Force Base (Utah), Lowry Air Force Base (Colorado), Dover Air Force Base (Delaware), and Alameda Naval Station (California).

Common joint sealants for the Waterloo barrier and other sealable sheetpile walls include bentonite, vermiculitic, or cementitious grouts; epoxies; and other organic polymers. The potential deflection of the wall has been calculated for various loading conditions that may be expected during the response actions associated with the first ½ mile of the river. The tensile stress and strain due to bending were compared to the properties of a typical grout to evaluate if significant cracking would be likely. These analyses (included in Appendix D) indicate that the wall system is very stiff and that potential deformations are insignificant and unlikely to cause cracking of the grouted joint. Nevertheless, since there will be future construction activities performed in the vicinity of the containment barrier during the sediment and bank soil response actions for the first ½ mile, the sheetpile joints will be left ungrouted until the completion of the response actions to avoid potential joint damage that may be caused by construction-related impacts.

The expected life of the sheetpile containment barrier is in excess of 60 years. Corrosion of steel sheetpiles requires either the presence of low resistivity or low pH materials in moist, aerobic environments, or the presence of sulphate-reducing bacteria in anaerobic conditions. None of these conditions appear to be present at the site. Recent

---

groundwater pH values from wells in the area are 6.3 to 7.4 (wells 43, 44, P-6, WP-2, WP-4, WP-5, and WP-13). Published information indicates that sheetpile corrosion may be significantly accelerated due to acidic conditions only in environments with pH of less than 4. The specific conductance of groundwater from these wells was measured to be 0.7 to 1.2 mS/cm. These specific conductances are within the range of potable water, indicating a non-saline, and therefore low-corrosivity, environment.

Published data indicates that the buried components of the steel sheetpiling, even if installed in materials such as slag, are likely to have a corrosion loss of 0.03 mm or less per year resulting in corrosion-related lifespans of 100 years or more. Due to the lack of oxygen, normal underground anaerobic environments help protect steel. Exposed portions of the sheetpiling may have faster corrosion rates due to the presence of air and water, but would still be less than the loss rate of 0.05 mm/year that can be assumed for splash zones in marine environments. This would result in corrosion-related expected lifespans longer than 60 years.

### **3.3 Proposed Implementation Activities**

#### **3.3.1 Permits and Approvals / Pre-Mobilization Activities**

All permits and approvals necessary for the implementation the activities discussed above will be obtained by either GE or its selected contractor(s) prior to initiation of any on-site activities. Upon Agency approval of this Source Control Proposal, GE will prepare information to support review and approval requirements under the Massachusetts Wetlands Protection Act (310 CMR 10.00). Toward this, GE will prepare a Notice of Intent application for submittal to the Pittsfield Conservation Commission (PCC). Upon receipt of an Order of Conditions and after the public comment period, GE will initiate construction activities. Alternatively, if scheduling constraints dictate the need for expedited review and approval under 310 CMR 10.00, GE will pursue an Emergency Certification with the PCC and MDEP.

Other pre-mobilization activities to be performed/coordinated by GE concurrent with Agency review and/or prior to the start of on-site activities will include selection of a contractor; discussion with the sheetpile manufacturer regarding availability; and contact with utility companies to identify potential subsurface utilities in the riverbank area.



---

### **3.3.2 Working Limits**

The construction of the proposed containment barrier will require use of the area located north of the Housatonic River and entirely within GE-owned property. The grassed and paved areas adjacent to the top of the bank will be the primary location for contractor equipment and work areas. Current access restrictions (i.e., perimeter fencing and controlled/monitored access gates) will be maintained and supplemented as necessary through temporary measures. While it is anticipated that the contractor's work will generally be restricted to the areas on the bank and immediately adjacent to the bank, other existing GE facilities and paved areas south of East Street will also be used for required work items such as water sources and excavated soil staging areas. The anticipated work limits are shown on the technical drawings included as Appendix D to this Source Control Proposal.

### **3.3.3 Site Preparation**

A number of site preparation activities will be performed/coordinated by GE prior to the start of on-site construction activities, including contractor mobilization; installation of erosion and sedimentation control measures; clearing and removal of existing vegetation; protection of existing structures and facilities; and relocation of existing utilities. A summary of the various site preparation activities is provided below.

Once a remediation contractor has been selected and the necessary pre-mobilization submittals have been prepared and submitted to GE (including a contractor-specific health and safety plan), the contractor will mobilize to the site. The initial mobilization may include the provision of temporary office facilities, health and safety equipment, and materials necessary to conduct the initial site preparation activities.

Prior to the initiation of vegetation clearing and soil removal actions, the contractor will install the necessary erosion control measures. Such measures -- which are expected to include the use of staked hay bales, silt fencing, and silt curtains -- will be selected in consideration of the area subject to control measures and the applicable provisions of the Massachusetts Wetlands Protection Act. For example, along the base of the river bank, a silt fence will be installed. It is also proposed that a silt curtain will be installed within the river along the base of the bank. Any control measures that are installed will be inspected on a regular basis and repaired/replaced as needed.

To facilitate access for the equipment associated with the sheetpile installation, the majority of the existing bank vegetation will need to be cleared and removed from the bank. However, with the exception of the lowest portion of the bank along the river (which is subject to removal and sheetpile installation), it will not be necessary to remove

---

the root structures or stumps associated with the existing vegetation. All vegetation cleared from the site will be transported to an appropriate off-site disposal location.

With regard to existing utilities, there is an existing overhead 100 amp, 480 volt electric service and an existing telephone line located along the top of the bank. These lines will be rerouted prior to start of the project. In addition, existing chainlink fencing along the top of the bank will be temporarily removed by the contractor and then replaced at the end of construction. Finally, the steel sheetpiling will be delivered to the site and stored in an area located adjacent to the top of the bank near the east end of the proposed containment barrier. The sheetpiling will be stored flat on blocking per manufacturer's recommendations.

### **3.3.4 Removal of Soils and Sediments Adjacent to the Containment Barrier**

Along the length of the proposed containment barrier, it is expected that certain bank soil and sediment removal actions will occur within the first ½ mile of the river. Additionally, certain removals are necessary to facilitate the installation of the proposed containment barrier and to minimize the potential for migration of residual LNAPLs, if any, which may be located between the proposed containment barrier and the river. The scope of these activities is described below.

Prior to installing the proposed containment barrier, GE will remove certain bank soils positioned between the proposed containment barrier and the edge of the river. The primary purpose of this pre-installation soil removal is to minimize the potential for sloughing of the soils located immediately adjacent to the river during the subsequent installation of the steel sheetpiling. As shown on Figure 9, the existing bank soils subject to removal will be excavated to a depth approximately equivalent to the typical elevation of the river (i.e., 972 feet). A specific soil handling and disposition plan will be developed based on the existing soils information, as supplemented by any further soil delineation and characterization activities. It is expected that all soils subject to removal will be transported to an off-site facility for disposal, and that, as necessary, separate material excavation and handling practices will be established to address soils requiring different off-site disposal (e.g., RCRA, TSCA, solid waste). Prior to initiating the soil excavations described above, a silt curtain will be installed as described in Section 3.3.3 and shown on the technical drawings included as Appendix D to this report. Also, as the excavations are performed and prior to the initiation of sheetpile installation, a silt fence will be installed along the edge of the river. The silt fence installation is also described in Section 3.3.3 and shown on the technical drawings

---

Current response action evaluations being conducted for sediments located in the first ½ mile of the river indicate that sediment removal will likely be limited to the eastern section of the barrier. To further evaluate the potential for historic LNAPL residuals to be present in sediments and bank soils located in other areas adjacent to the containment barrier, GE will conduct additional sediment investigations. Such investigations will focus on the western section of the proposed containment barrier and will include sampling locations positioned between the bottom of the bank and the sediment sampling locations that were previously advanced within the river (a specific sampling proposal will be submitted to the Agencies in a separate transmittal following submittal of the work plan addressing the first ½ mile bank soils and sediments). At this time, it is anticipated that sediment samples will be collected from the 0- to 1-foot, 1- to 2-foot, and 2- to 3-foot intervals and analyzed for PCBs and TPH. Depending on the results of these additional investigations, GE will evaluate the need for and scope of additional bank soil and sediment removal (beyond those to be proposed in the forthcoming work plan addressing the first ½ mile of the river).

### **3.3.5 Sheetpile Alignment and Installation**

The sheetpiling associated with the proposed containment barrier will be installed using a vibratory or impact hammer along the approximate alignment shown on Figure 4. Driving will be restricted to daylight hours due to safety and noise considerations. The alignment may be modified slightly in the field to better accommodate specific obstructions (e.g., stormwater outfall) or slope geometries that may be encountered.

### **3.3.6 Existing Oil-Water Separator Drainage Outlets**

The 64-X oil/water separator has two gravity-flow outlets. The west outlet, with an invert elevation of 974.70 feet, is the primary outlet, while the east invert (elevation 977.45) is used as an overflow outlet. To incorporate the operation of the oil/water separator and the proposed containment barrier, and to allow the continued gravity discharge of water through these outlets, certain details have been prepared and are shown on the technical drawings contained in Appendix D of this Source Control Proposal.

### **3.3.7 Site Restoration**

Figure 9 illustrates the restoration activities that will be implemented for the lower portion of the riverbank following installation of the proposed containment barrier. As described in Section 3.3.4, the soils in this area will be removed in order to minimize the potential for sloughing caused by the vibratory or impact nature of the sheetpile installation. The bank restoration activities for this lower bank area have been developed in consideration of river hydraulics.

---

existing flood storage capacity of the riverbank, and structural considerations. Note that the restoration measures presented herein are conceptual at this time and subject to further development based on the results of ongoing evaluations being conducted by GE as part of the response actions for the first ½ mile of the Housatonic River (to be described in a forthcoming work plan). With respect to the remaining portions of the riverbank potentially affected by the proposed containment barrier installation, GE will coordinate the restoration/enhancement activities with the activities to be implemented as part of the response actions for the first ½ mile.

The primary component of the lower bank restoration activity involves the placement of stone rip-rap (6- to 18-inch diameter) between the existing edge of the river and the proposed containment barrier. This installation -- which will be similar in design and aesthetics to the recently completed installation for the Building 68 containment barrier located approximately 1/4 mile downriver -- has been selected for a number of reasons, including the ability to re-establish the previously and relatively steep topography in this section of the river with an adequate structural capacity, the ability of the rip-rap material to withstand future river hydraulics, and the ability to provide a diversification to the existing wetlands/riverbank habitat.

Modeling of river hydraulics for this section of the Housatonic River indicate that rip-rap with a minimum dimension of approximately 6 inches will be sufficient to withstand river flow events and velocities associated with a 25-year flood event and velocities in the range of 6 to 8 feet per second. In addition, the use of rip-rap in combination with the proposed containment barrier will provide structural stability of the riverbank in this area. From a structural perspective, the placement of the rip-rap materials will occur at a slope of approximately one vertical to one horizontal (i.e., the approximate angle of repose for these materials) to provide a sufficient structural stability for the placed materials.

One component of the wetlands-related permitting process described in Section 3.3.1 will be an evaluation of potential changes to the compensatory flood storage, if any, resulting from the proposed sheetpile installation and related pre-installation riverbank soil removal. It is not expected that there will be a significant change in the existing flood storage capacity, but that a slight decrease (i.e., loss) in current flood storage capacity may result from the proposed activities. As part of the permitting process described above, GE will assess changes in compensatory storage by developing several representative riverbank cross-sections under both existing and anticipated post-construction activities. These cross sections (5 to 10 locations in total) will be used to identify topographic changes between the existing and post-construction conditions, and subsequent calculations of lost/gained flood storage by depth increments.

---

The need for post-construction erosion control measures will be evaluated based on the condition of the bank at the end of construction and the expected timing for commencement of response actions related to the first ½ mile of the Housatonic River. Since portions of the bank may be subject to such response actions associated with the first ½ mile, backfilling, restoration, and erosion control activities will be limited to those that are necessary to control erosion until final measures can be implemented.

### **3.4 Future Monitoring Activities**

Currently, as part of the MCP Short-Term Measures and RCRA Interim Measures being performed for the riverbank area of the East Street Area 2 Site, 20 wells and well points are monitored on a weekly/monthly basis (53, 54, 64X-N, 64X-S, 64X-W, RW-1(X), RW-2(X), PZ-1S, PZ-2S, PZ-4S, PZ-5S, PZ-6S, RB-1, WP-1 through WP-6, and WP-13) along with visual inspections of the riverbank. Following installation of the proposed containment barrier in this area, the current riverbank well/well point monitoring program will be expanded to include monitoring well E2SC-16 located at the east end of the containment barrier and a new well to be installed near locations E2SC-10 and E2SC-11 at the west end of the containment barrier. The new well will be screened across the water table to allow for seasonal fluctuations in groundwater elevation.

The potentiometric conditions and oil recovery systems will continue to be evaluated based on future monitoring data acquired following installation of the containment barrier. The monitoring results will be provided in the monthly status report for the East Street Area 2 site and will be summarized in associated semi-annual reports. The existing pumping rates of the riverbank recovery wells and the recharge pond surface water elevation will initially be maintained. Future monitoring will be utilized to assess whether changes to the currently operating conditions are warranted.

The physical condition of the riverbank will be monitored weekly following completion of the containment barrier construction and until the response actions for the first ½ mile of the Housatonic River commence in this area. Future monitoring of the bank will be incorporated into the long-term monitoring program for the first ½ mile of the Housatonic River.

Existing wells and well points along the riverbank will be protected to the extent practical. It is anticipated that some of the well points may be destroyed during construction. Monitoring wells and well points that may be destroyed will be replaced.

## ***4. Further Evaluation of DNAPL***

---

In its November 18, 1998 letter (presenting the results of ongoing source control investigations and preliminary information concerning the proposed containment barrier design), GE indicated that additional evaluations related to the detection of dense NAPLs (DNAPL) would be conducted. Such evaluations would supplement the information presented in that letter and further consider the need for and technical practicability of an active DNAPL recovery system. Since that letter, GE has performed certain follow-up activities and evaluations; a summary is presented below.

As previously indicated, the available visual, physical, and chemical information associated with the detected DNAPL is similar to the characteristics of typical coal tar byproducts. Sampling and analysis of the DNAPLs associated with the site indicates high levels of several semi-volatile organic compounds and a specific gravity of 1.076. Since their installation, GE has periodically gauged wells E2SC-3I and E2SC-17. More recently, GE has gauged these wells on a weekly basis and, if DNAPL accumulations of greater than one foot are detected, performs manual well bailing to remove the accumulated DNAPL. The results of this DNAPL gauging and removal activity will be provided to the Agencies as part of the monthly status reports prepared for East Street Area 2. In addition to wells E2SC-3I and E2SC-17, GE will begin to include well E2SC-2 in the weekly monitoring/removal program, based on the recent detection of DNAPL in that well.

To date, GE has experienced difficulties in manually removing DNAPL from these wells because of the vicious nature of the material. This generally illustrates the difficulties which can be encountered with an active DNAPL recovery system. Specifically, in such a system, DNAPL movement is controlled largely by the DNAPL viscosity, interfacial tension, and slope of the confining aquitard, rather than groundwater flow. In addition to potential geologic, hydrogeologic, and material-specific limitations associated with the operation of an active DNAPL recovery systems, there are also potential mechanical difficulties (e.g., pump limitations) that must be considered in evaluating a potential recovery system. For example, given the viscosity and depth of the accumulated DNAPLs within this area, it may be difficult to identify suitable pumping equipment. Nevertheless, GE will evaluate potential recovery pumps that may be suitable for this application and, if such pumps are identified, will conduct a pump test. The details of the pump test will be discussed with the Agencies prior to implementation but will likely include pumping of multiple wells over a several-day period.

Until such time that the aforementioned pump test is performed (if possible), GE will continue to conduct the weekly monitoring program described above. In the event that a suitable pump cannot be identified, GE will continue to perform manual well gauging and DNAPL recovery activities.

---

Finally, based on the detection of DNAPL in a localized depression in the basal till adjacent to and north of the river, additional investigations are warranted in the area south of the river. As a result, a soil boring is proposed for a location along the southern riverbank next to the existing Hibbard playground, as shown on Figure 2. The proposed location was selected based on the results of the geophysical survey conducted along the south side of the Housatonic River and geologic information derived from the borings on the north side of the river. The results of this additional boring and the evaluation of the feasibility to pump accumulated DNAPL in the wells located on the north side of the river will be submitted to the Agencies shortly after completion (see Figure 10).

## ***5. Summary and Anticipated Schedule***

---

This Source Control Proposal describes the activities recently performed by GE related to the presence of NAPLs in the vicinity of GE's existing 64V oil recovery system and the adjacent riverbank area. Included herein is a summary of field investigations conducted by GE to determine the presence and extent of NAPLs within the subsurface soils. The results of these recent investigations, combined with information available from prior investigations in this area, support the selection and design of a proposed LNAPL containment barrier. Such a barrier, proposed to supplement the containment/recovery measures that are currently in place, will involve the installation of an approximate 450-foot long steel sheetpile wall located generally parallel to the river and within the lower portion of the riverbank. Both the length and depth of the proposed containment barrier have been conservatively selected to encompass areas where evidence of residual and small quantities of separate phase LNAPL have been identified. In addition, the depth of the proposed barrier has been determined in consideration of future response actions related to the first ½ mile of Housatonic River bank soils and river sediments (i.e., between Newell Street and Lyman Street).

In addition to proposing measures to further address LNAPL, this Source Control Proposal also describes the activities proposed by GE to further assess the presence of DNAPL in this area. Currently, GE performs weekly gauging of those wells where DNAPL accumulations have been identified, and removes the accumulated materials (if greater than 1 foot in thickness) to the extent possible. GE will continue to conduct this weekly program, and will supplement these activities with the performance of a pump test, if suitable pumping equipment can be located. This test would be performed to assess the feasibility and practicability of installing and operating an active DNAPL recovery system, or alternatively, the continued performance of a manual well bailing approach.

From a scheduling standpoint, the anticipated implementation components and schedule are presented in Figure 10. This schedule assumes that expedited Agency review and approval, permitting, and equipment purchase and delivery can be obtained, and that weather conditions remain favorable. As necessary, updates to the anticipated implementation schedule will be provided to the Agencies.



# **Tables**

BLASLAND, BOUCK & LEE, INC.  
*engineers & scientists*

---

TABLE 1

GENERAL ELECTRIC COMPANY  
PITTSFIELD, MASSACHUSETTS  
EAST STREET AREA 2 SOURCE CONTROL PROPOSAL

## GROUNDWATER ELEVATIONS

DATE	WELL NUMBER		
	WP-1	WP-3	WP-5
06/02/93	971.49	971.48	971.42
06/09/93	971.37	971.36	
06/16/93	971.27	971.23	
06/23/93	971.15	971.13	
06/30/93	971.12	971.09	
07/07/93	971.15	971.12	971.08
07/16/93	970.91	970.89	
07/21/93	970.88	970.85	
07/28/93	971.02	970.99	
08/04/93	971.14	971.11	971.07
08/11/93	970.95	970.91	
08/19/93	971.06	971.02	
08/25/93	970.86	970.83	
09/02/93	970.76	970.76	
09/09/93	971.17	971.13	971.11
09/15/93	970.91	970.86	
09/23/93	971.39	971.38	
09/30/93	971.17	971.13	
10/06/93	971.24	971.19	971.2
10/13/93	971.61	971.61	
10/22/93	971.85	971.81	
10/27/93	971.49	971.47	
11/04/93	971.46	971.43	971.47
11/11/93	971.34	971.33	
11/18/93	972.44	972.48	
11/24/93	971.54	971.55	
12/01/93	971.94	971.93	971.94
12/08/93	972.45	972.48	972.47
12/17/93	972.06	972.04	972.08
12/22/93	972.16	972.08	972.17
12/29/93	971.77	971.76	971.77
01/05/94	971.66	971.59	971.61
01/12/94	971.63	971.64	971.61
01/20/94	972.04	972.03	972.07
01/26/94	972.12	972.06	972.12
02/02/94	971.74	971.71	971.71
02/09/94	971.46	971.46	971.46
02/15/94	971.33	971.31	971.32
02/25/94	971.97	971.95	971.97
03/02/94	971.71	971.71	971.71
03/09/94	973.35	973.37	973.35
03/16/94	972.65	972.65	972.65
03/23/94	972.99	973.02	972.97
04/01/94	973.07	973.09	973.05
04/04/94			
04/06/94	976.35		976.36

TABLE 1

GENERAL ELECTRIC COMPANY  
PITTSFIELD, MASSACHUSETTS  
EAST STREET AREA 2 SOURCE CONTROL PROPOSAL

## GROUNDWATER ELEVATIONS

DATE	WELL NUMBER		
	WP-1	WP-3	WP-5
04/14/94	977.57		
04/20/94	973.17	973.2	973.09
04/27/94	972.56	972.59	972.5
05/04/94	972.39	972.39	972.34
05/11/94	972.32	972.29	972.26
05/18/94	972.6	972.62	972.58
05/25/94	972	971.94	971.91
06/02/94	971.57	970.55	971.53
06/08/94	971.42	971.41	971.38
06/16/94	971.3	971.28	971.27
06/23/94	971.2	971.18	971.14
06/30/94	971.79	971.76	971.75
07/07/94	971.11	971.08	971.06
07/13/94	971.06	971.03	971
07/20/94	971.49	971.46	971.45
07/28/94	971.21	971.17	971.17
08/03/94	971.18	971.13	971.13
08/10/94	970.99	970.94	970.94
08/17/94	971.88	971.84	971.96
08/24/94	971.58	971.56	971.61
08/31/94	971.22	971.16	971.18
09/06/94	971.01	970.97	970.97
09/14/94	970.96	970.9	970.95
09/21/94	971.35	971.27	971.37
09/28/94	971.69	971.67	971.71
10/05/94	971.7	971.64	971.7
10/12/94	971.45	971.43	971.42
10/20/94	971.15	971.06	971.16
10/25/94	971.22	971.17	971.16
10/27/94	971.22	971.17	971.16
11/03/94	971.29	971.22	971.27
11/09/94	971.3	971.21	971.32
11/16/94	971.21	971.22	971.13
11/23/94	971.82	971.74	971.87
11/30/94	971.82	971.75	971.86
12/07/94	972.7	972.67	972.76
12/15/94	971.64	971.57	971.67
12/21/94	971.54	971.48	971.57
12/28/94			
01/04/95	971.77	971.72	971.8
01/11/95	971.76	971.71	971.78
01/18/95	972.89	972.88	972.94
01/25/95	972.57	972.56	972.54
02/01/95	971.85	971.83	971.87
02/08/95	971.7	971.66	971.67
02/15/95	971.54	971.49	971.55

TABLE 1

GENERAL ELECTRIC COMPANY  
PITTSFIELD, MASSACHUSETTS  
EAST STREET AREA 2 SOURCE CONTROL PROPOSAL

## GROUNDWATER ELEVATIONS

DATE	WELL NUMBER		
	WP-1	WP-3	WP-5
02/22/95	971.61	971.57	971.62
03/01/95	971.99	972	972.05
03/08/95			
03/16/95	973.83	973.82	973.85
03/22/95	972.86	972.88	972.82
03/29/95	971.88	971.89	971.87
04/06/95	971.79	971.78	971.75
04/12/95	972.85	972.75	972.85
04/19/95	972.68	972.66	972.65
04/26/95	971.66	971.68	971.63
05/03/95	971.65	971.63	971.61
05/10/95	971.66	971.63	971.61
05/17/95	971.62	971.59	971.57
05/23/95	971.49	971.46	971.46
05/31/95	971.17	971.1	971.22
06/07/95	971.32	971.25	971.35
06/14/95	971.15	970.96	971.07
06/22/95	970.96	970.88	970.96
06/28/95	970.95	970.86	970.96
07/05/95	970.93	970.86	970.93
07/12/95	971	970.87	971.02
07/19/95	970.87	970.84	970.91
07/26/95	971.07	970.98	971.08
08/02/95	970.86	970.75	970.86
08/09/95	970.96	970.86	970.97
08/16/95	970.89	970.76	970.86
08/23/95	970.73	970.68	970.71
08/30/95	970.71	970.64	970.73
09/07/95	970.71	970.64	970.7
09/14/95	970.87	970.72	970.88
09/21/95	970.87	970.75	970.84
09/27/95	970.84	970.8	970.88
10/05/95	971.39	971.32	971.46
10/11/95	971.16	971.03	971.17
10/18/95	971.22	971.12	971.26
10/23/95	972.11	972.05	972.16
10/26/95	972.11	972.05	972.16
11/01/95	972.56	972.59	972.64
11/08/95	972.11	972.04	972.15
11/15/95	973.76	973.79	973.86
11/21/95			
11/29/95	971.8	971.78	971.86
12/06/95	971.74	971.7	971.78
12/13/95	971.51	971.52	971.52
12/19/95	971.47	971.43	971.51
12/27/95	971.4	971.34	971.43

TABLE 1

GENERAL ELECTRIC COMPANY  
PITTSFIELD, MASSACHUSETTS  
EAST STREET AREA 2 SOURCE CONTROL PROPOSAL

## GROUNDWATER ELEVATIONS

DATE	WELL NUMBER		
	WP-1	WP-3	WP-5
01/04/96	971.47	971.42	971.49
01/10/96	971.62	971.56	971.67
01/17/96	971.56	971.48	971.59
01/24/96	973.8	973.84	973.89
01/31/96	972.85	972.89	972.91
02/06/96	971.9	971.92	971.97
02/14/96	971.64	971.63	971.66
02/22/96	973.98	973.71	974.01
02/28/96	972.92	972.97	972.97
03/06/96	972.59	972.6	972.54
03/13/96	972.06	972.06	972.1
03/20/96	973.08	973.07	973.13
03/27/96	972.46	972.5	972.51
04/03/96	972.82	972.84	972.85
04/09/96	972.36	972.32	972.36
04/17/96	974.67	974.76	974.73
04/24/96	973.88	973.92	973.87
05/01/96	974.1	974.16	974.1
05/07/96	972.69	972.74	972.69
05/16/96	972.87	972.89	972.85
05/22/96	972.33	972.33	972.3
05/29/96	971.78	971.79	971.76
06/05/96	971.65	971.65	971.63
06/11/96	972.06	972.06	972.06
06/19/96	972.21	972.21	972.24
06/26/96	971.42	971.41	971.41
07/03/96	971.33	971.31	971.31
07/11/96	971.33	971.31	971.31
07/17/96	972.35	972.35	972.32
07/24/96	971.58	971.56	971.55
07/31/96	971.44	971.52	971.52
08/07/96	971.73	971.73	971.75
08/15/96	971.28	971.28	971.27
08/21/96	971.32	971.32	971.32
08/28/96	971.32	971.29	971.29
09/05/96	971.13	971.09	971.1
09/11/96	971.12	971.09	971.07
09/19/96	973.33	973.35	973.4
09/26/96	972.35	972.37	972.29
09/30/96	972.35	972.37	972.29
10/02/96	971.86	971.85	971.84
10/08/96	972.89	972.9	972.96
10/17/96	971.81	971.79	971.82
10/24/96	972.62	972.61	972.59
10/30/96	972.21	972.21	972.18
11/06/96	971.6	971.57	971.62

TABLE 1

GENERAL ELECTRIC COMPANY  
PITTSFIELD, MASSACHUSETTS  
EAST STREET AREA 2 SOURCE CONTROL PROPOSAL

## GROUNDWATER ELEVATIONS

DATE	WELL NUMBER		
	WP-1	WP-3	WP-5
11/13/96	972.17	972.17	972.2
11/20/96	972.05	972.05	972.06
11/27/96			
12/04/96	973.06	973.12	973.07
12/10/96	972.59	972.58	972.62
12/17/96	973.78	973.76	973.77
12/26/96	973.98	974.01	973.98
01/02/97	972.46	972.46	972.45
01/08/97	971.95	971.96	971.94
01/15/97	971.92	971.89	971.89
01/22/97	971.98	971.97	971.97
01/29/97	971.87	971.86	971.83
02/06/97	972.43	972.42	972.43
02/13/97	971.64	971.63	971.6
02/19/97	972.32	972.32	972.33
02/26/97	972.96	972.86	972.99
03/05/97	973.2	973.15	973.22
03/12/97	971.99	972.01	971.98
03/19/97	971.87	971.86	971.81
03/26/97	973.45	973.46	973.49
04/03/97	973.2	973.24	973.24
04/09/97	973.07	973.12	973.1
04/16/97	972.63	972.64	972.64
04/23/97	972.61	972.61	972.6
04/28/97	972.61	972.61	972.6
04/30/97	972.12	972.13	972.13
05/07/97	973.18	973.17	973.15
05/14/97	972.16	972.14	972.14
05/20/97	973.01	973.02	972.99
05/28/97	971.85	971.86	971.83
06/04/97	971.57	971.55	971.55
06/11/97	971.36	971.34	971.37
06/18/97	971.43	971.41	971.43
06/25/97	971.22	971.21	971.22
07/02/97	971.34	971.31	971.37
07/10/97	971.94	971.89	971.95
07/16/97	971.35	971.3	971.35
07/23/97	971.03		971.03
07/31/97	971.19	971.16	971.18
08/06/97	971.36	971.36	971.37
08/13/97	972.5	972.48	972.51
08/20/97			
08/27/97	971.16	971.12	971.15
09/03/97	971.06	971.04	971.06
09/10/97	971.65	971.62	971.66
09/17/97	971.64	971.6	971.69

TABLE 1

GENERAL ELECTRIC COMPANY  
 PITTSFIELD, MASSACHUSETTS  
 EAST STREET AREA 2 SOURCE CONTROL PROPOSAL

GROUNDWATER ELEVATIONS

DATE	WELL NUMBER		
	WP-1	WP-3	WP-5
09/24/97	971.7	971.66	971.76
10/01/97	971.81	971.81	971.86
10/06/97	971.66	971.66	971.67
10/08/97	971.66	971.66	971.67
10/15/97	971.67	971.73	971.72
10/22/97	971.7	971.72	971.74
10/29/97	971.59	971.63	971.62
11/05/97	971.6	971.63	971.72
11/12/97	972.12	972.12	972.13
11/19/97	971.9	971.92	971.9
11/26/97			
12/03/97	971.79	971.89	971.9
12/10/97	971.54	971.49	971.52
12/17/97	971.43	971.39	971.43
12/23/97			
01/02/98	971.47	971.44	971.48
01/07/98	975.32	975.35	975.34
01/14/98	972.61	972.57	972.55
01/21/98	971.87	971.87	971.85
01/28/98	971.68	971.67	971.67
02/04/98	971.61	971.58	971.59
02/11/98	972.38	972.25	972.4
02/17/98	972.52	972.5	972.53
02/25/98	972.22	972.19	972.21
03/04/98	972.45	972.45	972.46
03/10/98	973.23	973.27	973.17
03/18/98	973.26	973.16	973.26
03/25/98	972.15	972.15	972.14
04/02/98	974.11	974.14	974.14
04/08/98	972.9	972.88	972.91
04/15/98	971.77	971.78	971.77
04/22/98	972.16	972.18	972.13
04/27/98	971.77	971.75	971.75
04/29/98	971.77	971.75	971.75
05/06/98	973.23	973.26	973.24
05/13/98	972.34	972.37	972.34
05/20/98	971.52	971.51	971.51
05/28/98	971.3	971.28	971.28
06/03/98	971.31	971.29	971.27
06/10/98	971.31	971.29	971.27
06/17/98	974.12	974.19	974.13
06/24/98	971.84	971.82	971.82

TABLE 2  
 GENERAL ELECTRIC COMPANY  
 PITTSFIELD, MASSACHUSETTS  
 EAST STREET AREA 2 SOURCE CONTROL PROPOSAL  
 RIVER ELEVATIONS AT 64-X OIL/WATER SEPARATOR

DATE	RIVER ELEVATION	DATE	RIVER ELEVATION	DATE	RIVER ELEVATION	DATE	RIVER ELEVATION	DATE	RIVER ELEVATION
06/03/93	971.47	01/05/95	971.75	01/04/96	971.56	01/09/97	971.94	01/02/98	971.47
06/10/93	971.34	01/12/95	971.78	01/11/96	971.7	01/16/97	971.94	01/07/98	975.51
06/17/93	971.24	01/19/95	972.93	01/18/96	971.64	01/23/97	971.94	01/15/98	972.51
06/24/93	971.15	01/25/95	972.59	01/26/96	973.88	01/30/97	971.84	01/22/98	971.83
07/01/93	971.11	02/02/95	971.86	02/01/96	972.88	02/06/97	972.42	01/29/98	971.68
07/08/93	971.14	02/09/95	971.7	02/08/96	971.94	02/13/97	971.61	02/05/98	971.59
07/16/93	970.9	02/15/95	971.56	02/15/96	971.66	02/20/97	972.32	02/12/98	972.55
07/22/93	970.87	02/23/95	971.64	02/22/96	971.24	02/27/97	973.15	02/19/98	972.54
07/29/93	971.04	03/02/95	972.05	02/29/96	972.94	03/06/97	973.31	02/26/98	972.2
08/05/93	971.16	03/16/95	973.83	03/07/96	972.5	03/13/97	971.92	03/05/98	972.42
08/12/93	970.98	03/23/95	972.78	03/14/96	972.1	03/20/97	971.79	03/12/98	973.1
08/19/93	971.1	03/29/95	971.86	03/21/96	973.14	03/27/97	973.46	03/19/98	973.3
08/26/93	970.88	04/06/95	971.89	03/28/96	972.47	04/03/97	973.2	03/26/98	972.08
09/03/93	970.86	04/13/95	972.9	04/04/96	973.8	04/10/97	973.06	04/02/98	974.1
09/09/93	971.22	04/20/95	972.64	04/11/96	972.36	04/17/97	972.62	04/09/98	972.88
09/16/93	970.96	04/27/95	971.65	04/18/96	974.67	04/24/97	972.59	04/16/98	971.76
09/23/93	971.37	05/04/95	971.65	04/25/96	973.81	05/01/97	972.12	04/23/98	972.08
09/30/93	971.22	05/11/95	971.65	05/02/96	974.08	05/08/97	973.12	04/30/98	971.74
10/07/93	971.31	05/18/95	971.58	05/09/96	972.64	05/20/97	972.96	05/07/98	973.2
10/14/93	971.69	05/26/95	971.45	05/16/96	972.84	05/29/97	971.88	05/14/98	972.3
10/21/93	971.92	06/01/95	971.2	05/23/96	972.26	06/05/97	971.78	05/21/98	971.51
10/28/93	971.55	06/08/95	971.37	05/30/96	971.72	06/13/97	971.39	05/28/98	971.24
11/04/93	971.5	06/15/95	971.2	06/06/96	971.6	06/19/97	971.45	06/04/98	971.26
11/12/93	971.36	06/22/95	971	06/11/96	972.03	06/26/97	971.97	06/11/98	971.26
11/19/93	972.44	06/29/95	971	06/20/96	972.23	07/03/97	971.42	06/18/98	974.07
11/24/93	971.52	07/13/95	971.04	06/27/96	971.45	07/10/97	971.98	06/25/98	973.05
12/02/93	971.92	07/20/95	970.94	07/11/96	971.31	07/17/97	971.39		
12/09/93	972.44	07/27/95	971.12	07/19/96	972.29	07/24/97	971.02		
12/16/93	972.05	08/03/95	970.92	07/25/96	971.53	08/07/97	971.38		
12/22/93	972.24	08/10/95	971.02	08/01/96	971.51	08/14/97	972.54		
12/30/93	971.52	08/24/95	970.79	08/08/96	971.74	08/28/97	971.16		
01/06/94	971.7	08/31/95	970.84	08/15/96	971.3	09/05/97	971.05		
01/13/94	971.65	09/07/95	970.78	08/22/96	971.46	09/11/97	971.7		
02/03/94	971.71	09/14/95	970.96	08/29/96	971.42	09/18/97	971.7		
02/10/94	971.52	09/21/95	970.92	09/05/96	971.15	09/25/97	971.8		
02/17/94	971.37	09/28/95	970.98	09/12/96	971.12	10/02/97	971.66		
02/25/94	972.03	10/05/95	970.92	09/19/96	973.4	10/09/97	971.66		
03/03/94	971.8	10/12/95	971.18	09/26/96	972.28	10/17/97	971.74		
03/11/94	973.58	10/19/95	971.32	10/03/96	971.88	10/23/97	971.78		
03/17/94	972.43	10/26/95	972.4	10/10/96	972.99	10/30/97	971.33		
03/24/94	972.96	11/03/95	972.76	10/17/96	971.84	11/07/97	971.68		
04/01/94	973.89	11/09/95	972.26	10/24/96	972.62	11/13/97	972.12		
04/07/94	976.27	11/16/95	973.94	10/31/96	972.18	11/20/97	971.66		
04/14/94	977.44	11/30/95	971.86	11/07/96	971.64	12/04/97	971.96		
04/22/94	972.85	12/07/95	971.78	11/14/96	972.2	12/11/97	971.56		
04/29/94	972.27	12/15/95	971.6	11/21/96	972.08	12/18/97	971.42		
05/05/94	972.1	12/21/95	971.5						
05/12/94	972.03	12/28/95	971.48						
05/20/94	972.32								
06/24/94	971.09								
06/30/94	971.74								
07/07/94	971.01								
07/14/94	971.02								
07/21/94	971.44								
07/27/94	971.16								
08/04/94	971.17								
08/11/94	971.01								
08/18/94	972.05								
08/25/94	971.63								
09/01/94	971.2								
09/09/94	971.01								
09/15/94	971.01								
09/23/94	971.43								
09/30/94	971.71								
10/04/94	971.72								
10/13/94	971.45								
10/20/94	971.18								
10/27/94	971.22								
11/07/94	971.32								
11/10/94	971.4								
11/18/94	971.12								
11/22/94	971.9								
12/01/94	971.85								
12/07/94	972.87								
12/15/94	971.69								
12/20/94	971.56								



# ***Figures***

BLASLAND, BOUCK & LEE, INC.  
*engineers & scientists*

---

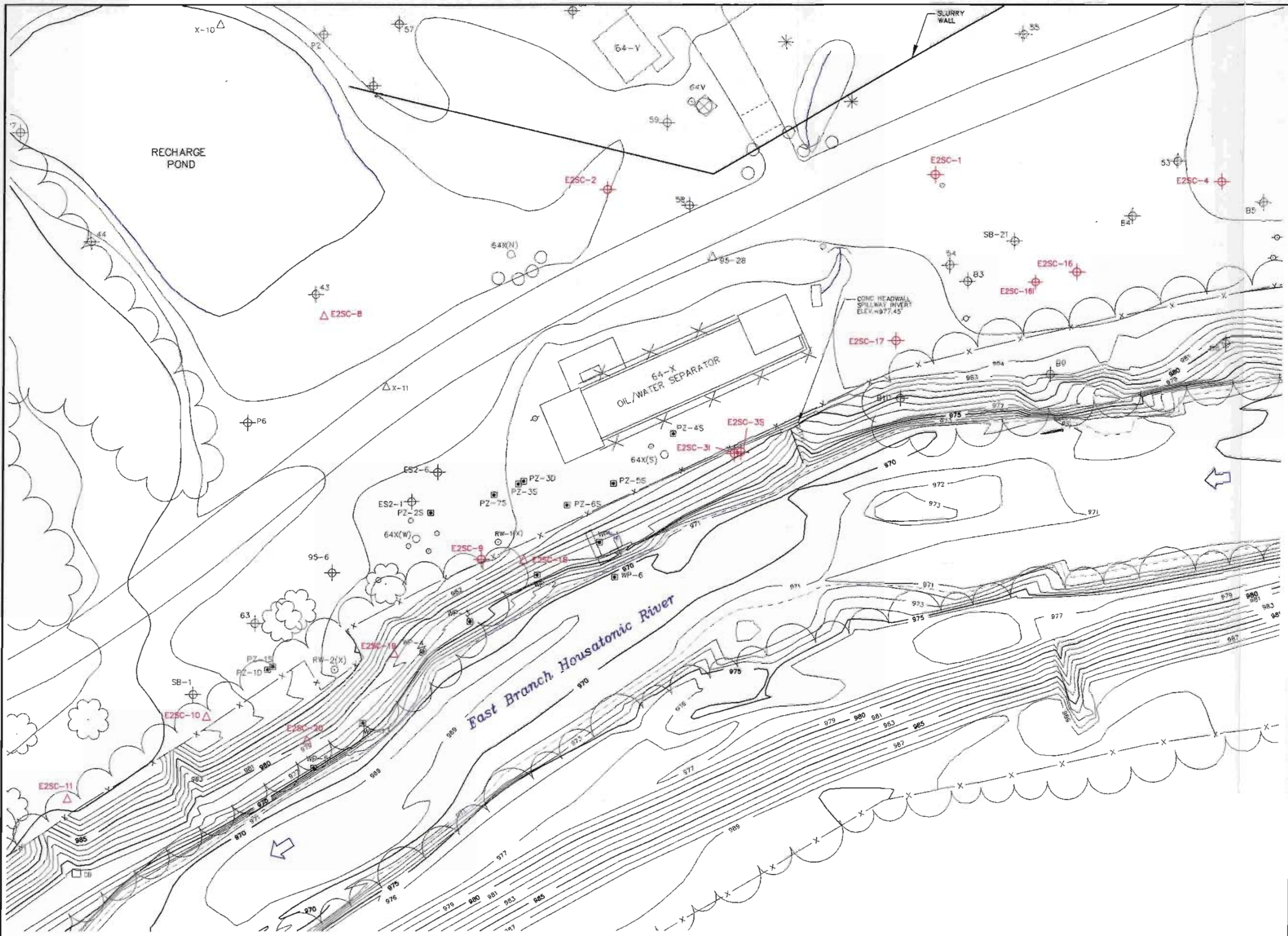

**LEGEND:**

- EXISTING INDEX ELEVATION CONTOUR
- 980 — EXISTING INTERMEDIATE ELEVATION CONTOUR
- - - TYPICAL WATER LINE
- ☁ DECIDUOUS TREE
- \* CONIFEROUS TREE
- ⊗ MANHOLE
- x-x- CHAIN LINK FENCE
- POLE (NON-UTILITY)
- ⊙ POLE (OVERHEAD UTILITY)
- ⊕ E2-1 PREVIOUSLY INSTALLED MONITORING WELL
- 64X(W) ○ PREVIOUSLY INSTALLED OIL RECOVERY CAISSON
- RW-1(X) ○ PREVIOUSLY INSTALLED PUMPING WELL
- X-11 △ PREVIOUSLY INSTALLED SOIL BORING
- PZ-4S ⊕ PREVIOUSLY INSTALLED PIEZOMETER
- E2SC-1 ⊕ 1998 MONITORING WELLS
- E2SC-B △ 1998 SOIL BORINGS

**NOTES:**

1. BASE MAP PROVIDED BY LOCKWOOD MAPPING, INC. PREPARED FROM 1990 AERIAL PHOTOGRAPHY. RIVERBANK AND RIVER BED TOPOGRAPHIC INFORMATION PROVIDED BY BBL FROM OCTOBER 12-24, 1995 FIELD SURVEY.
2. COORDINATE GRID BASED ON 1927 STATE PLANE COORDINATES.
3. ELEVATION DATUM REFERENCED TO NGVD 1929.
4. CONTOUR INTERVAL IN THE RIVER AND ON RIVERBANK = 1 FOOT; CONTOUR INTERVAL OUTSIDE RIVERBANK AREA = 2 FEET.
5. ALL MONITORING WELL, BORING, PUMPING WELL, CAISSON, FENCE, MANHOLE, AND TREE LOCATIONS ARE APPROXIMATE.



GENERAL ELECTRIC COMPANY  
 PITTSFIELD, MASSACHUSETTS  
**EAST STREET AREA 2 SUPPLEMENTAL  
 SOURCE CONTROL PROPOSAL**

**EXISTING SITE PLAN**

**BBL** BLASLAND, BOUCK & LEE, INC.  
 engineers & scientists

FIGURE  
**1**

X: 20140X03, 20140X05  
 L: 09/03, 09/05  
 P: STD/PCP-DL  
 1/12/99 519-54-FRM AK QMS  
 20140005\20140B13.DWG

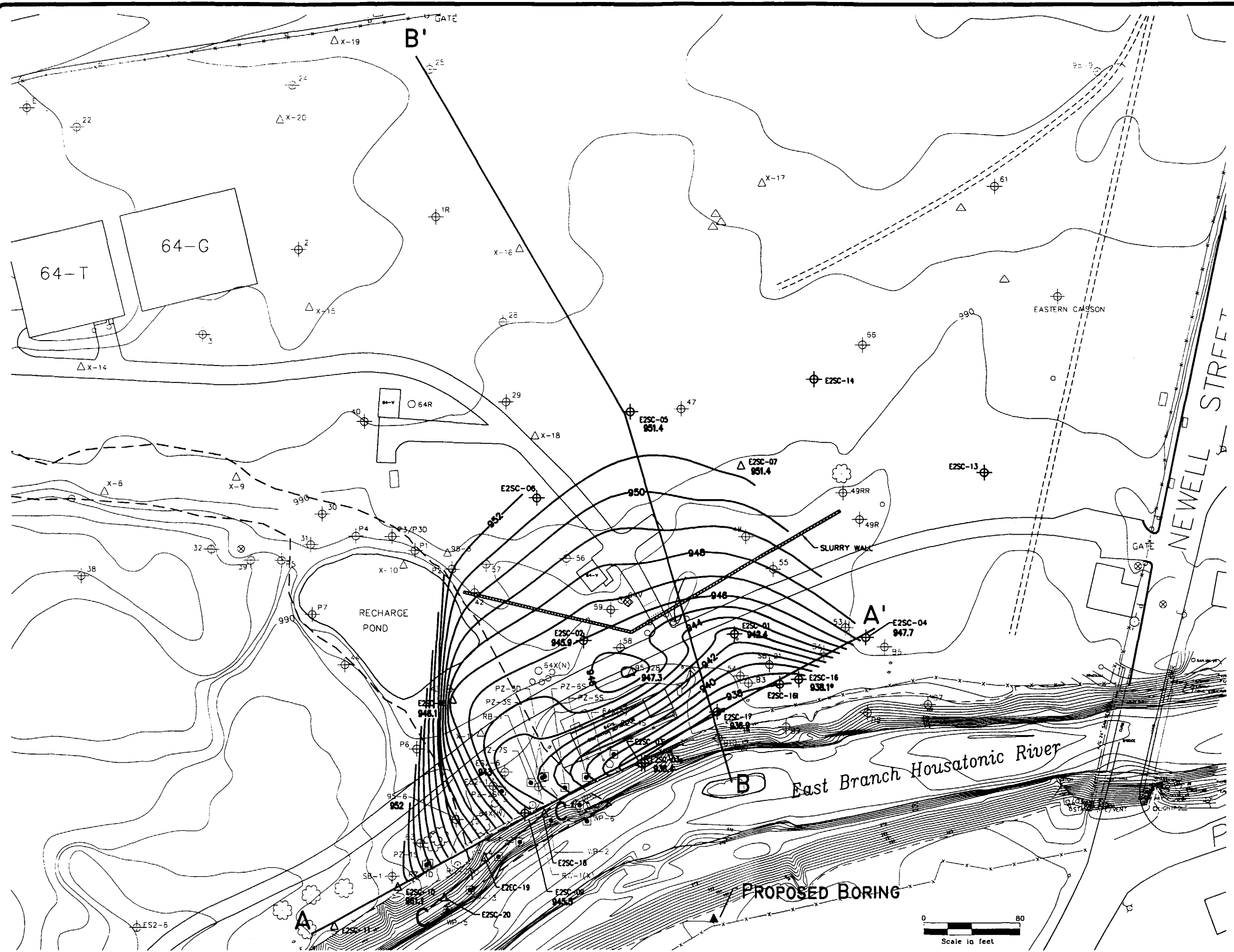

**EXPLANATION**

- A—A'** SECTION LOCATION
- - - - -** APPROXIMATE DELINEATION OF FORMER OXBOW H
- ⊕ ES2-1** PREVIOUSLY INSTALLED MONITORING WELL
- 64X(N)** PREVIOUSLY INSTALLED OIL RECOVERY CAISSON
- ⊙ RW-1(X)** PREVIOUSLY INSTALLED PUMPING WELL
- △ X-11** PREVIOUSLY INSTALLED SOIL BORING
- ⊠ WP-3** PREVIOUSLY INSTALLED PIEZOMETER
- ⊕ E2SC-1** SOURCE CONTROL MONITORING WELL (INSTALLED 1998)
- △ E2SC-7** SOURCE CONTROL BORING (INSTALLED 1998)
- ▲** PROPOSED BORING
- 961.2** TOP OF TILL ELEVATION
- 946 —** TOP OF TILL CONTOUR 1 FOOT INTERVAL
- \*** APPROX. TOP OF TILL ELEVATION
- △**

NOTE: BASE MAP AND ALL DATA LOCATIONS PRIOR TO 1998 PROVIDED BY BLASLAND, BOUCK & LEE. ALL SOURCE CONTROL INVESTIGATION BORINGS AND WELL LOCATIONS PROVIDED BY HILL ENGINEERING.



Figure 2 Top of Till Contour Map



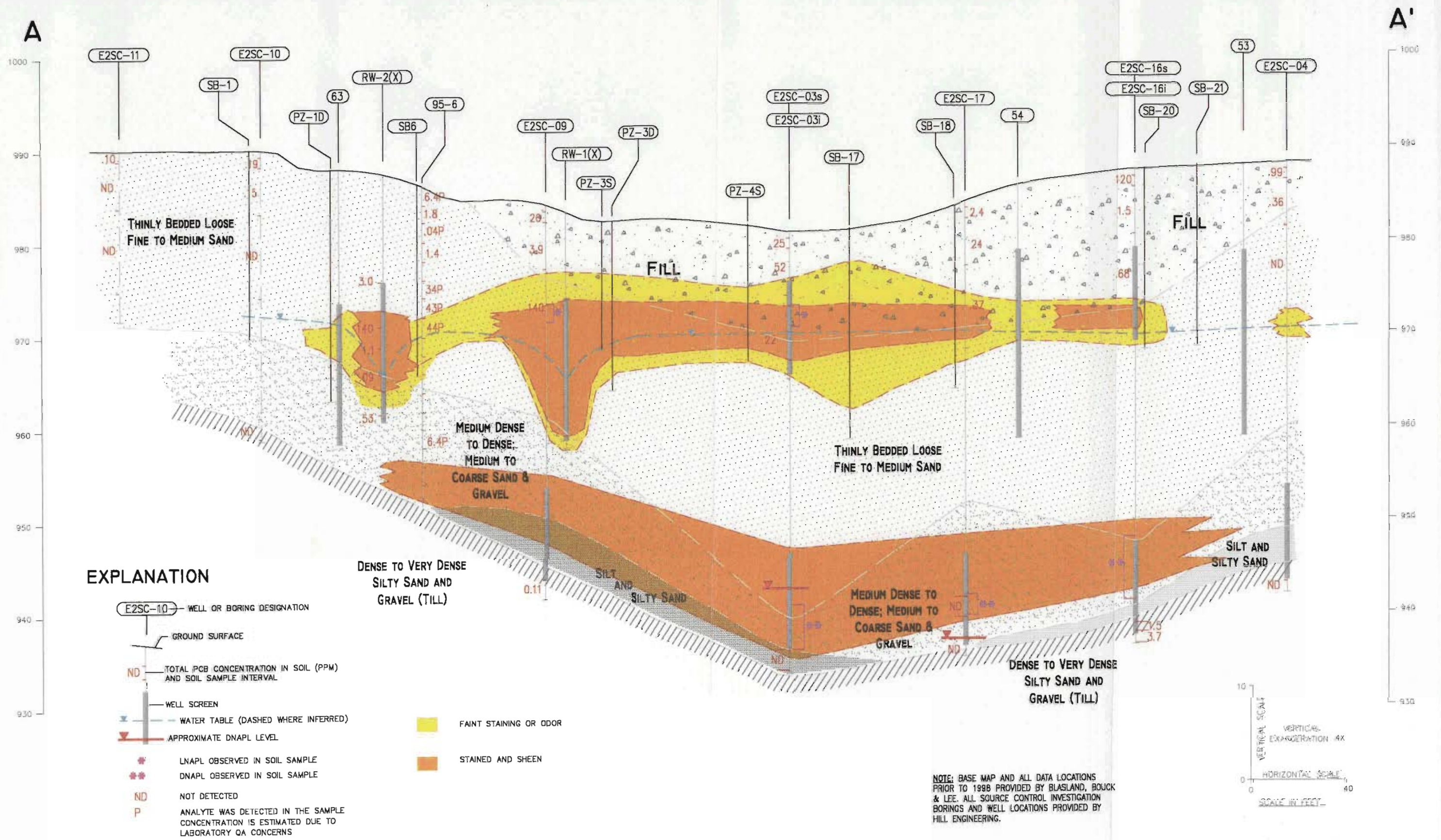

**EXPLANATION**

- E2SC-10 WELL OR BORING DESIGNATION
- GROUND SURFACE
- ND TOTAL PCB CONCENTRATION IN SOIL (PPM) AND SOIL SAMPLE INTERVAL
- WELL SCREEN
- WATER TABLE (DASHED WHERE INFERRED)
- APPROXIMATE DNAPL LEVEL
- ◆ LNAPL OBSERVED IN SOIL SAMPLE
- ◆◆ DNAPL OBSERVED IN SOIL SAMPLE
- ND NOT DETECTED
- P ANALYTE WAS DETECTED IN THE SAMPLE CONCENTRATION IS ESTIMATED DUE TO LABORATORY QA CONCERNS
- FAINT STAINING OR ODOR
- STAINED AND SHEEN

NOTE: BASE MAP AND ALL DATA LOCATIONS PRIOR TO 1998 PROVIDED BY BLASLAND, BOUCK & LEE. ALL SOURCE CONTROL INVESTIGATION BORINGS AND WELL LOCATIONS PROVIDED BY HILL ENGINEERING.

VERTICAL SCALE  
VERTICAL EXAGGERATION 4X  
HORIZONTAL SCALE  
SCALE IN FEET

Figure 3 Cross-Section A-A'



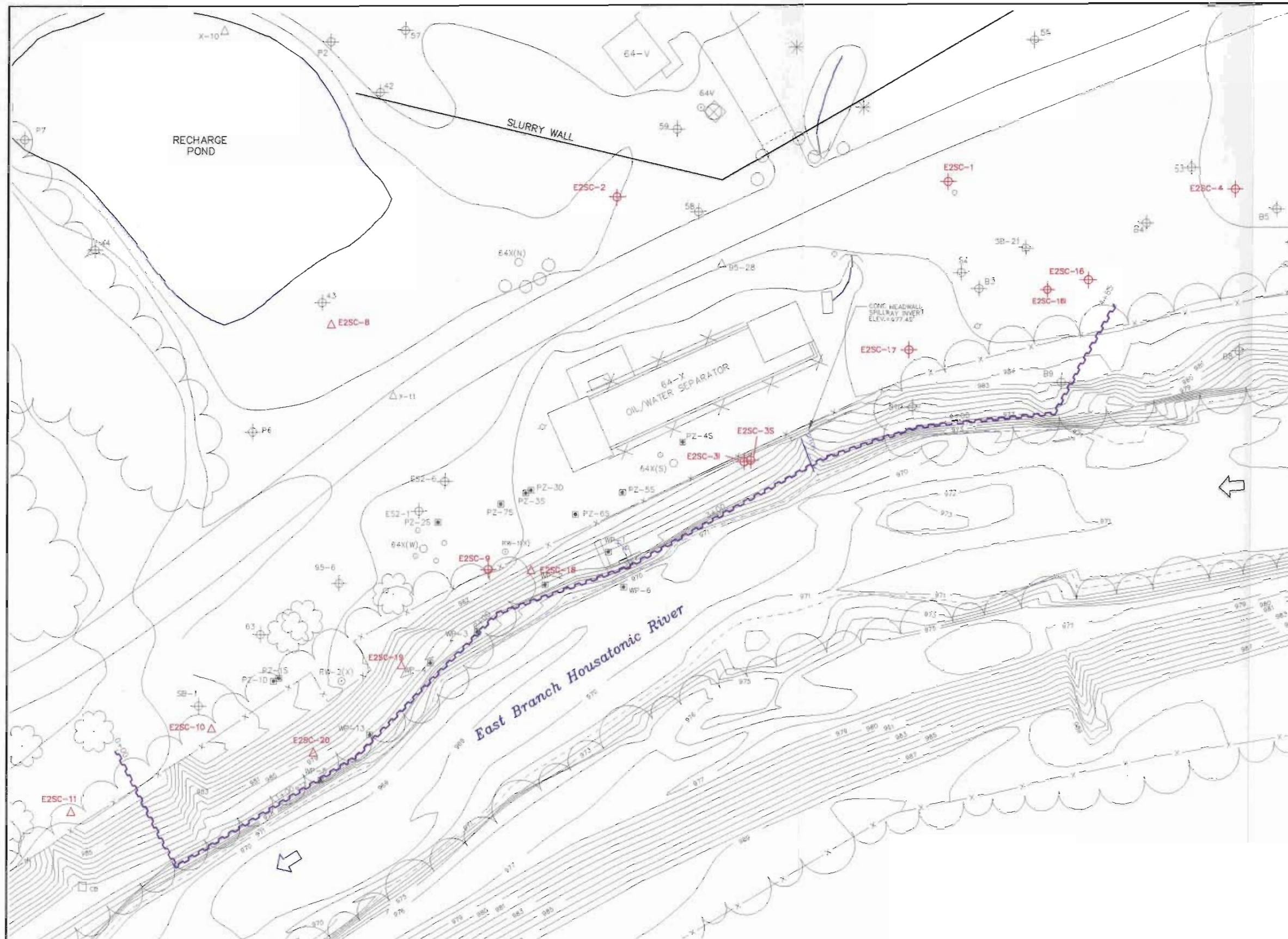

**LEGEND:**

- EXISTING INDEX ELEVATION CONTOUR
- 980- EXISTING INTERMEDIATE ELEVATION CONTOUR
- - - TYPICAL WATER LINE
- ☼ DECIDUOUS TREE
- \* CONIFEROUS TREE
- ⊗ MANHOLE
- X — CHAIN LINK FENCE
- POLE (NON-UTILITY)
- ⊕ POLE (OVERHEAD UTILITY)
- E52-1 ⊕ PREVIOUSLY INSTALLED MONITORING WELL
- 64X(W) ○ PREVIOUSLY INSTALLED OIL RECOVERY CAISSON
- RW-1(X) ○ PREVIOUSLY INSTALLED PUMPING WELL
- X-11 △ PREVIOUSLY INSTALLED SOIL BORING
- PZ-45 ⊕ PREVIOUSLY INSTALLED PIEZOMETER
- E2SC-1 ⊕ 1998 MONITORING WELLS
- E2SC-8 △ 1998 SOIL BORINGS
- (wavy line) — LOCATION OF PROPOSED CONTAINMENT BARRIER

**NOTES:**

1. BASE MAP PROVIDED BY LOCKWOOD MAPPING, INC. PREPARED FROM 1990 AERIAL PHOTOGRAPHY. RIVERBANK AND RIVER BED TOPOGRAPHIC INFORMATION PROVIDED BY BBL FROM OCTOBER 12-23, 1998 FIELD SURVEY.
2. COORDINATE GRID BASED ON 1927 STATE PLANE COORDINATES.
3. ELEVATION DATUM REFERENCED TO NGVD 1929.
4. CONTOUR INTERVAL IN THE RIVER AND ON RIVERBANK = 1 FOOT CONTOUR. INTERVAL OUTSIDE RIVERBANK AREA = 2 FEET.
5. ALL MONITORING WELL, BORING, PUMPING WELL, CAISSON, FENCE, MANHOLE, AND TREE LOCATIONS ARE APPROXIMATE.
6. PROFILE OF SHEETPILE WALL ALIGNMENT, INCLUDING SHEETPILE LENGTHS AND CUTOFF ELEVATIONS, SHOWN ON DRAWING 4.



**GENERAL ELECTRIC COMPANY**  
**PITTSFIELD, MASSACHUSETTS**  
**EAST STREET AREA 2 SUPPLEMENTAL**  
**SOURCE CONTROL PROPOSAL**  
  
**CONTAINMENT**  
**BARRIER PLAN**

K 20140003, 20140010  
 L ON: OFF: REF:  
 PL: STD: POC: DL:  
 1/12/99 5/18/99 8/1/99 10/1/99  
 20140005, 20140012, 20140013

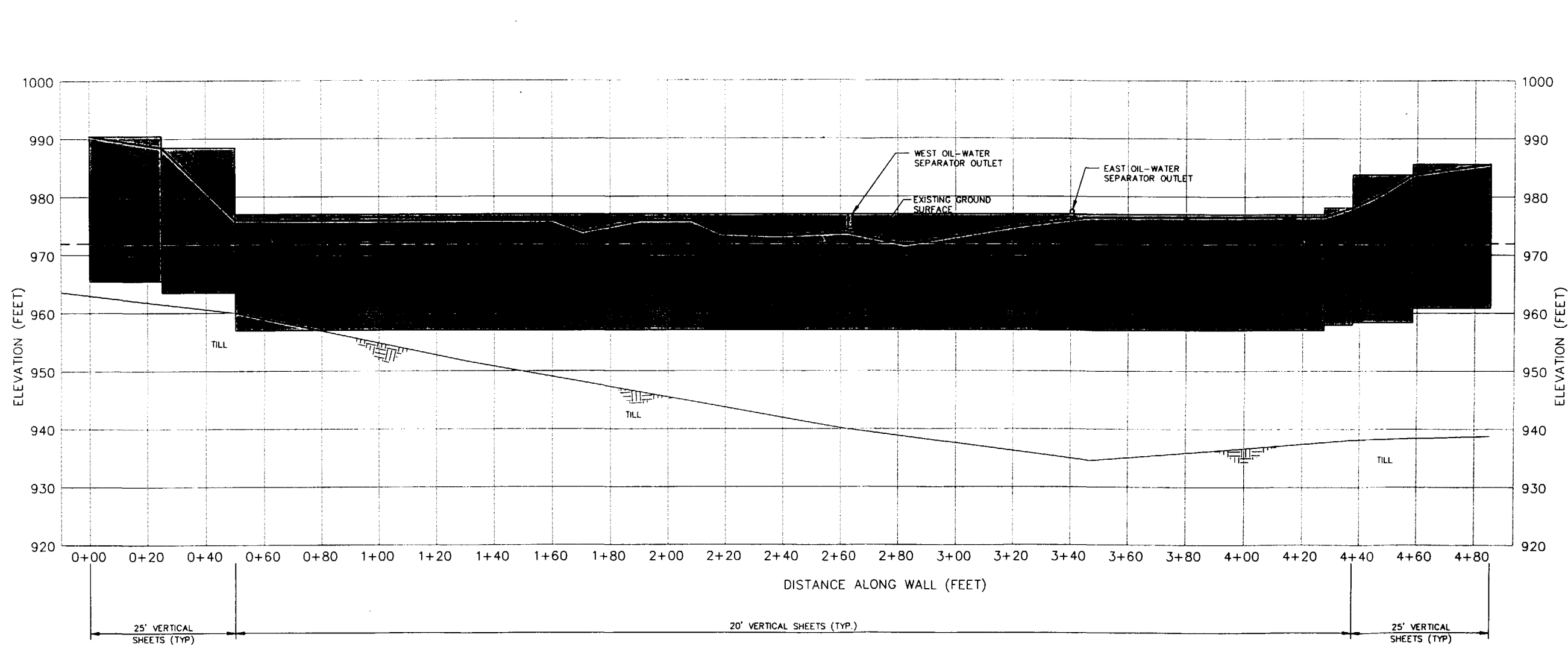

- LEGEND:**
- CP10 SHEET PILE ALIGNMENT CONTROL POINT
  - TYPICAL RIVER SURFACE WATER ELEVATION
  - █ VERTICAL EXTENT OF PROPOSED CONTAINMENT BARRIER

- NOTE:**
1. TOP OF TILL TAKEN FROM SECTION A-A' OF FIGURE 3 IN SOURCE CONTROL PROPOSAL.
  2. ALL THE DIMENSIONS AND ELEVATIONS ARE APPROXIMATE. FIELD CONDITIONS MAY VARY.
  3. CUTOFF SHEETING AT APPROXIMATELY GROUND SURFACE AT STATIONS 0+00 TO 0+50 AND STATIONS 4+30 TO 4+85.

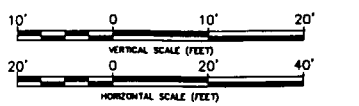

GENERAL ELECTRIC COMPANY  
PITTSFIELD, MASSACHUSETTS  
**EAST STREET AREA 2 SUPPLEMENTAL  
SOURCE CONTROL PROPOSAL**

**CONTAINMENT  
BARRIER PROFILE**

**BBL** BLASLAND, BOUCK & LEE, INC.  
engineers & scientists

FIGURE  
**5**

L: ON=\*, OFF=REF  
P: STD-PCP/DL  
1/12/99 SYR-54-RJM AK GMS  
20140005/20140V05.DWG

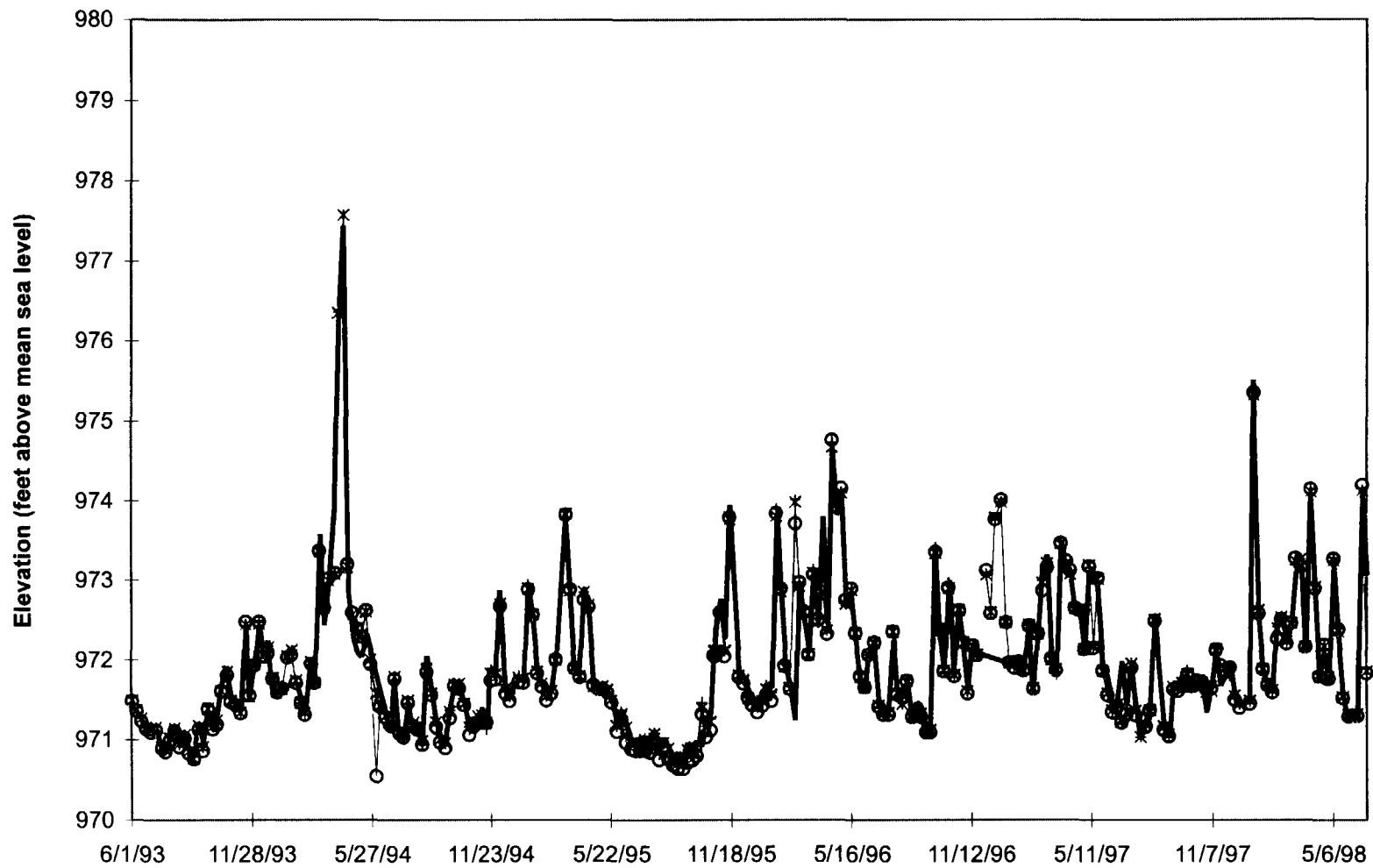

— RIVER ELEVATION    \* WP-1    o WP-3    + WP-5

**NOTE:**

River gage inoperable from December 5, 1996 to January 9, 1997.

GENERAL ELECTRIC COMPANY  
 PITTSFIELD, MASSACHUSETTS  
 EAST STREET AREA 2  
 SOURCE CONTROL PROPOSAL

**EAST STREET AREA 2 / USEPA AREA 4  
 RIVERBANK AREA HYDROGRAPHS**

**BBL**

BLASLAND, BOUCK & LEE, INC.  
 engineers & scientists

FIGURE

**6**

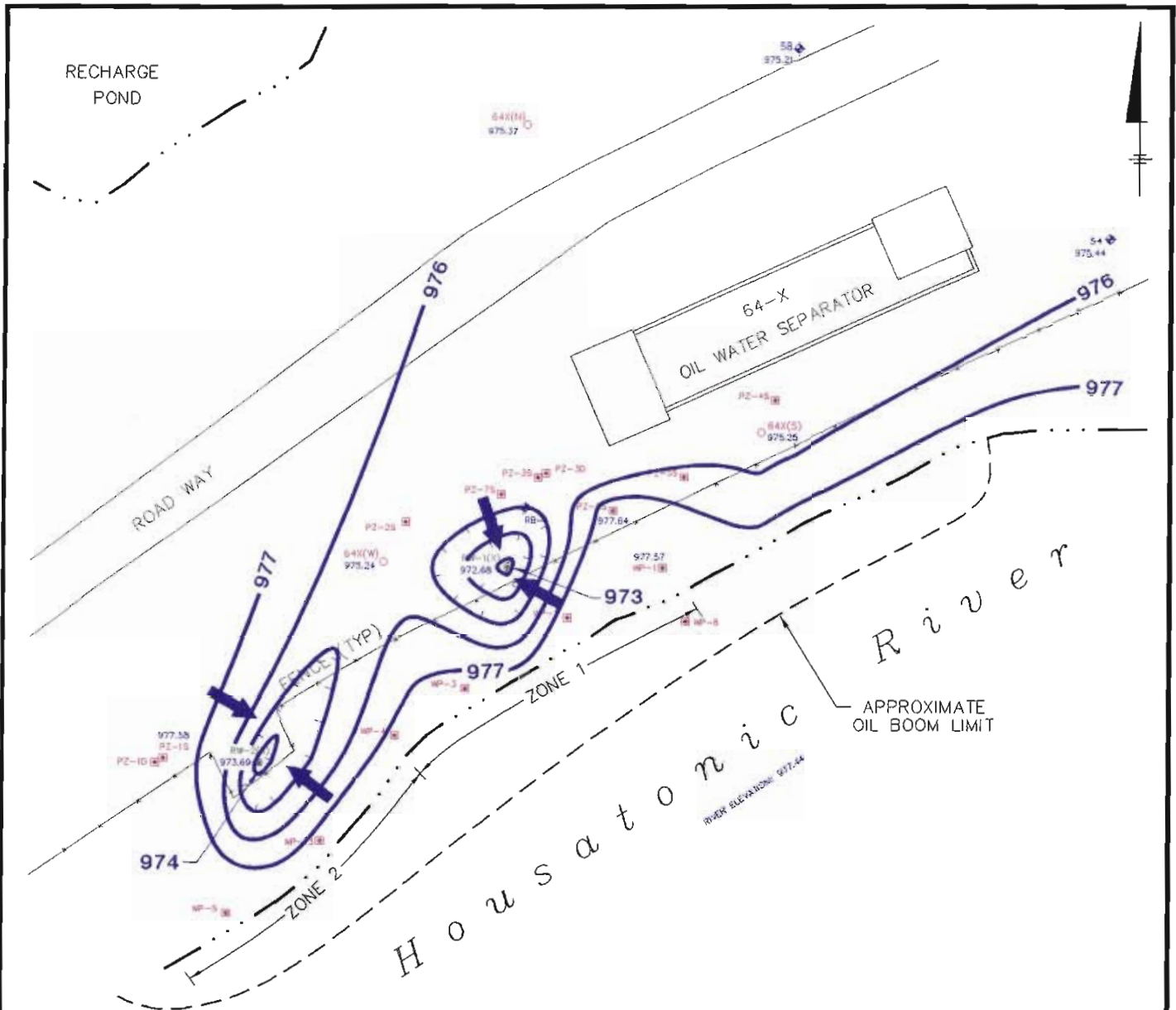

**LEGEND:**

- PZ-10      PIEZOMETER
- ⊕ RW-1(X)      PUMPING WELL
- 64X      OIL RECOVERY CAISSON
- + 25      MONITORING WELL
- 977.64      GROUNDWATER ELEVATION (FT)
- 977      GROUNDWATER ELEVATION CONTOUR (1 FT INTERVAL)
- GROUNDWATER FLOW DIRECTION

**NOTES:**

1. MAPPING IS BASED ON AERIAL PHOTOGRAPHS AND PHOTOGRAMMETRIC MAPPING BY LOCKWOOD MAPPING, INC. - FLOWN IN APRIL 1990.
2. NOT ALL PHYSICAL FEATURES SHOWN.
3. ALL WELL/PIEZOMETER LOCATIONS ARE APPROXIMATE.



APPROXIMATE SCALE: 1" = 40'

GENERAL ELECTRIC COMPANY  
PITTSFIELD MASSACHUSETTS  
MCP EAST STREET AREA 2/USEPA AREA 4

**RIVERBANK AREA  
GROUNDWATER ELEVATION  
CONTOUR MAP - 4/13,14/94**



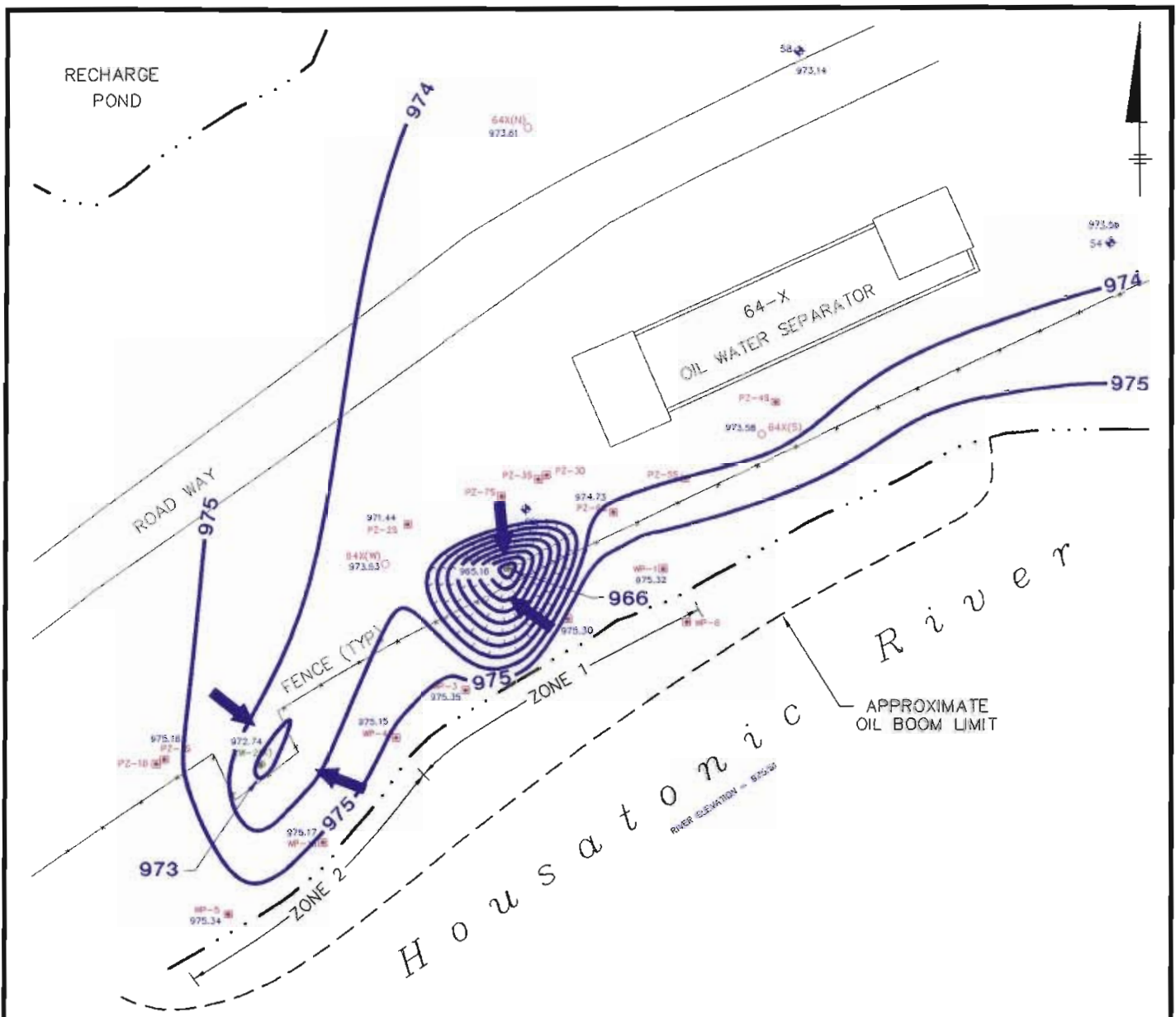

**BBL**      BLASLAND, BOUCK & LEE, INC.  
engineers & scientists

FIGURE  
**7**





**LEGEND:**

-  PZ-15 PIEZOMETER
-  PW-10 PUMPING WELL
-  O4X OIL RECOVERY CAISSON
-  M5 MONITORING WELL
-  973.50 GROUNDWATER ELEVATION (FT)
-  974 GROUNDWATER ELEVATION CONTOUR (1 FT INTERVAL)
-  GROUNDWATER FLOW DIRECTION

**NOTES:**

1. MAPPING IS BASED ON AERIAL PHOTOGRAPHS AND PHOTOGRAMMETRIC MAPPING BY LOOKWOOD MAPPING, INC. - FLOWN IN APRIL 1990.
2. NOT ALL PHYSICAL FEATURES SHOWN.
3. ALL WELL/PIEZOMETER LOCATIONS ARE APPROXIMATE.

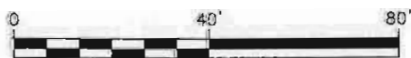

APPROXIMATE SCALE: 1" = 40'

GENERAL ELECTRIC COMPANY  
PITTSFIELD MASSACHUSETTS  
MCP EAST STREET AREA 2/USEPA AREA 4

**RIVERBANK AREA  
GROUNDWATER ELEVATION  
CONTOUR MAP - 1/7,8/98**

**BBL**

BLASLAND, BOUCK & LEE, INC.  
engineers & scientists

FIGURE  
**8**

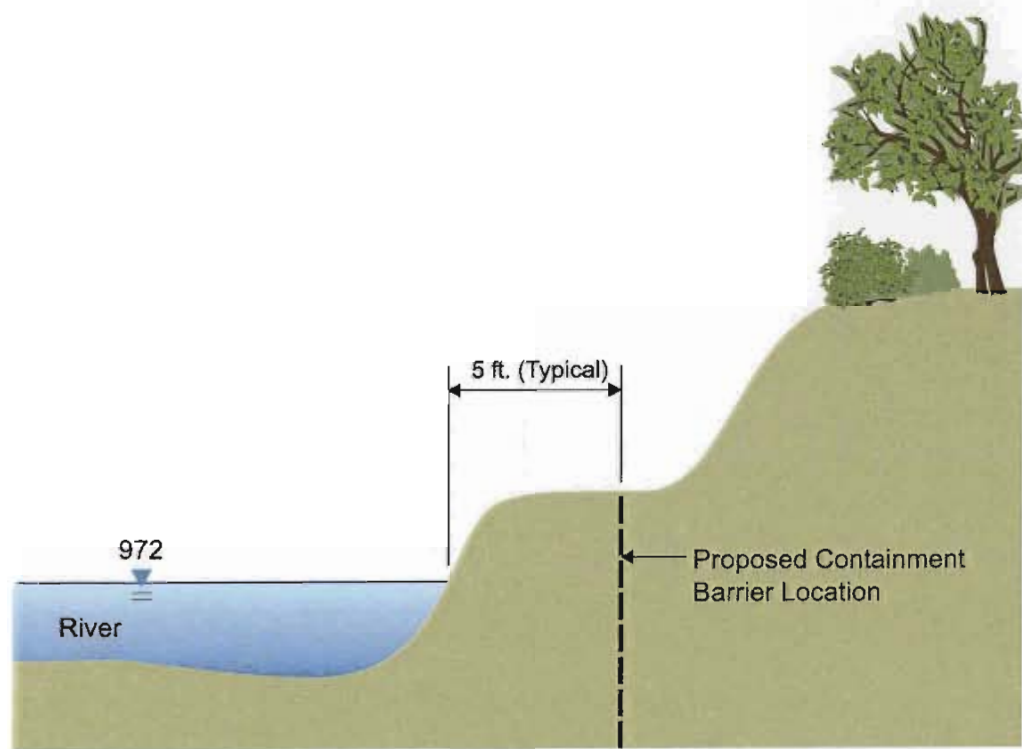

**EXISTING CONDITIONS**

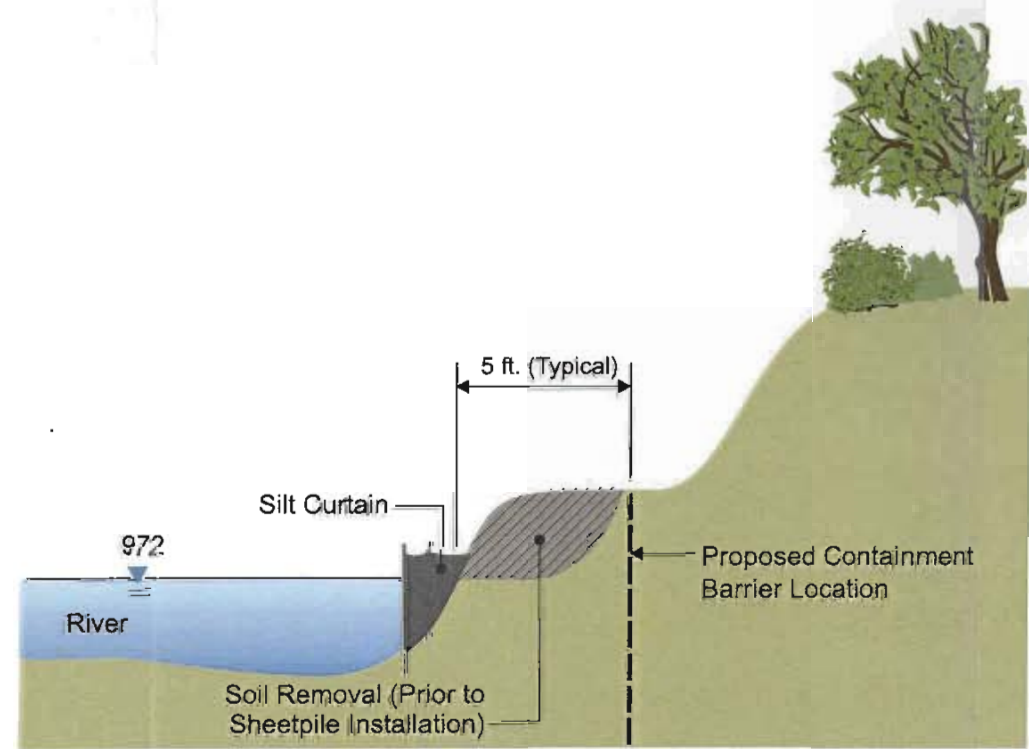

**SOIL REMOVAL**

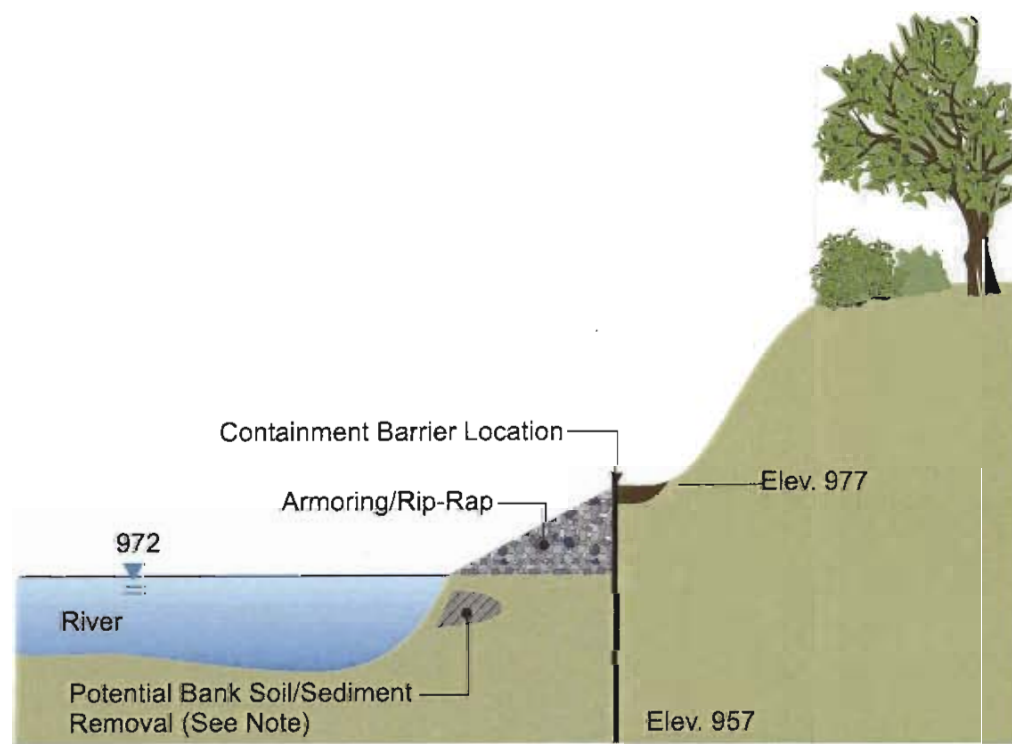

**RESTORATION WITH RIPRAP**

NOT-TO-SCALE

**NOTE:**

1. Restoration to be completed after sediment/bank removal activities within first 1/2 mile.
2. Extent of bank soil/sediment removal (and related restoration activities) to be evaluated following additional sampling and analysis.

GENERAL ELECTRIC COMPANY  
PITTSFIELD, MASSACHUSETTS  
EAST STREET AREA 2  
SOURCE CONTROL PROPOSAL

**CONCEPTUAL RIVERBANK RESTORATION**

**BBL** BLASLAND, BOUCK & LEE, INC.  
*engineers & scientists*

**FIGURE 9**

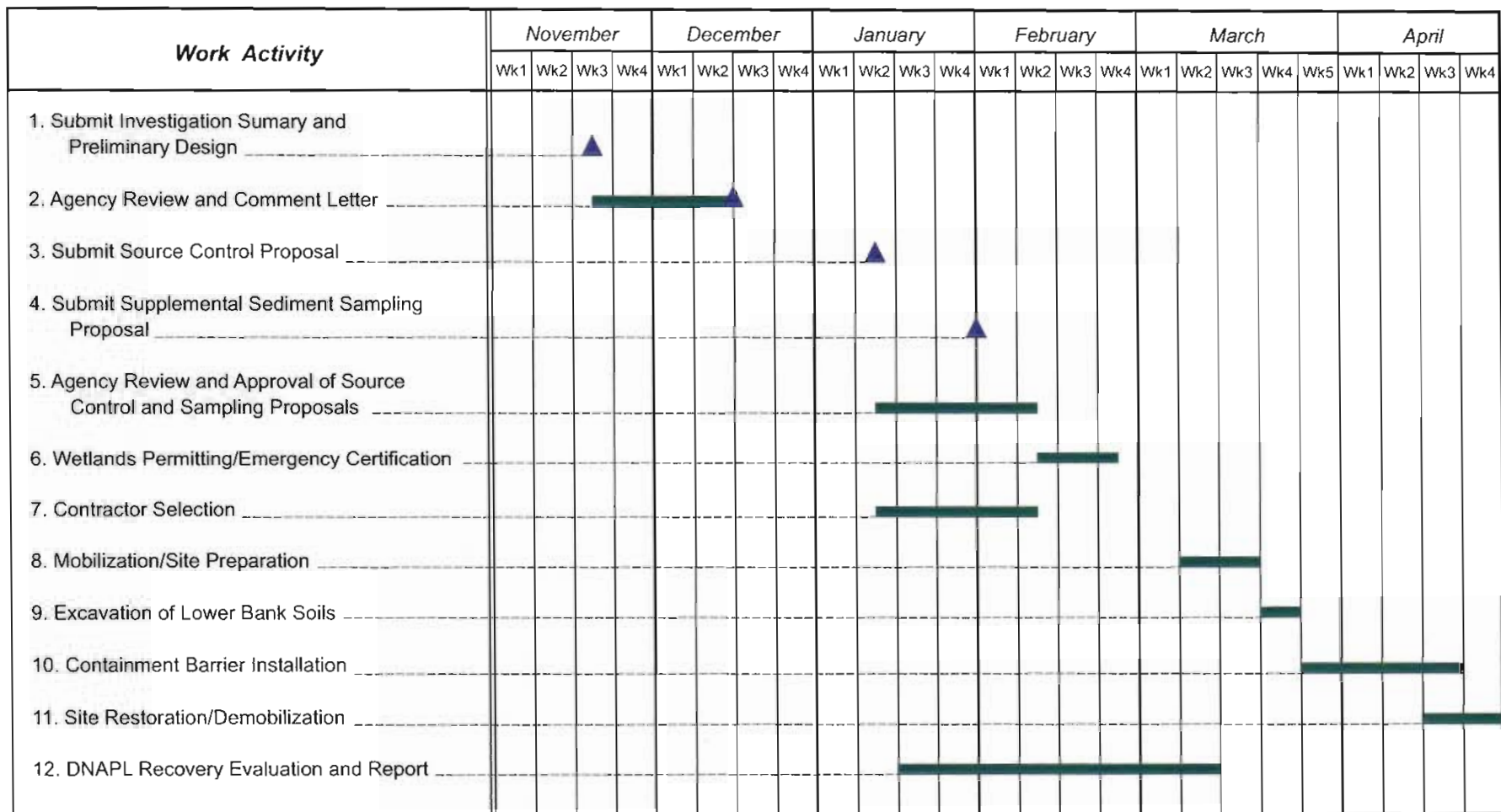

**Notes:**

1. The above schedule assumes an Emergency Certification will be obtained from the Pittsfield Conservation Commission or MDEP.
2. Assumes sheetpile can be obtained within 6 weeks of Agency approval of Source Control Proposal.

GENERAL ELECTRIC COMPANY  
 PITTSFIELD, MASSACHUSETTS  
 EAST STREET AREA 2  
 SOURCE CONTROL PROPOSAL

**ANTICIPATED IMPLEMENTATION  
 SCHEDULE**

BBL	BLASLAND, BOUCK & LEE, INC. engineers & scientists	<b>FIGURE 10</b>
-----	---	----------------------

# ***Appendix A***

BLASLAND, BOUCK & LEE, INC.  
*engineers & scientists*

---

## ***Summary of 1998 Investigations Source Controls - East Street Area 2***

APPENDIX A

---

1998 SOURCE CONTROL INVESTIGATIONS

SOURCE CONTROL INVESTIGATION REPORT  
EAST STREET AREA 2

---

PREPARED FOR:  
GENERAL ELECTRIC CO.  
PITTSFIELD, MASSACHUSETTS

PREPARED BY:  
HSI GEOTRANS, INC.  
6 LANCASTER COUNTY ROAD  
HARVARD, MASSACHUSETTS 01451

# TABLE OF CONTENTS

	PAGE
1 INTRODUCTION .....	1-1
2 FIELD INVESTIGATIONS .....	2-1
3 CONCLUSIONS .....	3-1
4 REFERENCES .....	4-1
ATTACHMENT A      BORING AND WELL CONSTRUCTION LOGS	
ATTACHMENT B      SOIL PHYSICAL PROPERTIES	
ATTACHMENT C      SEISMIC REFRACTION DATA	

## LIST OF TABLES

		PAGE
TABLE 2-1.	WELL CONSTRUCTION DATA FOR THE EAST STREET AREA 2 SOURCE CONTROL INVESTIGATION .....	2-7
TABLE 2-2.	SAMPLE COLLECTION DATA FOR THE EAST STREET AREA 2 SOURCE CONTROL INVESTIGATION .....	2-8
TABLE 2-3.	LIST OF ANALYTES .....	2-12
TABLE 2-4.	PCB SOIL CONCENTRATION DATA .....	2-13
TABLE 2-5.	DETECTED VOLATILE ORGANIC COMPOUND SOIL CONCENTRATION DATA .....	2-16
TABLE 2-6.	DETECTED SEMI-VOLATILE ORGANIC COMPOUND SOIL CONCENTRATION DATA .....	2-17
TABLE 2-7.	DETECTED DIOXIN AND FURAN SOIL CONCENTRATIONS DATA .....	2-18
TABLE 2-8.	DETECTED METALS SOIL CONCENTRATION DATA .....	2-19
TABLE 2-9.	WATER LEVEL AND NAPL MEASUREMENTS, EAST STREET AREA 2 .....	2-20
TABLE 2-10.	SUMMARY OF DETECTED APPENDIX IX CONCENTRATIONS IN DNAPL SAMPLE FROM MONITORING WELL E2SC-031 .....	2-21
TABLE 2-11.	TOTAL PETROLEUM HYDROCARBON SOIL CONCENTRATION DATA FROM SHALLOW BORINGS E2SC-18, E2SC-19 AND E2SC-20 .....	2-23



## LIST OF FIGURES

	PAGE
FIGURE 1-1. SITE LOCATION MAP .....	1-2
FIGURE 2-1. BORING AND WELL LOCATION MAP .....	2-24
FIGURE 2-2. TOP OF TILL ELEVATION CONTOUR MAP .....	2-25
FIGURE 2-3. CROSS SECTION A-A <sup>1</sup> .....	2-26
FIGURE 2-4. CROSS SECTION B-B <sup>1</sup> .....	2-27
FIGURE 2-5. AREAL DISTRIBUTION OF PCB SOIL CONCENTRATIONS .....	2-28
FIGURE 2-6. CROSS SECTION C-C <sup>1</sup> .....	2-29

## 1 INTRODUCTION

---

Source control field investigations at the East Street Area 2 site (see Figure 1-1) were conducted between October 7, 1998 and December 18, 1998. The field work was generally conducted in accordance with the Source Control Work Plan - Upper Reach of Housatonic River (First ½ Mile) (BBL, 1998a) as conditionally approved by the Environmental Protection Agency in its letter dated October 6, 1998. Minor modifications were made to the field investigation program, with Agency concurrence, during implementation. The field work consisted of drilling borings, collecting samples of the unconsolidated deposits for chemical and physical analyses, installing of monitoring wells, measuring non-aqueous phase liquid water levels and (NAPL) levels, and analyzing dense non-aqueous phase liquid (DNAPL). All sampling was conducted in accordance with the Sampling and Analysis Plan / Data Collection and Analysis Quality Assurance Plan (BBL,1994) and the Revised Sampling and Analysis Plan / Data Collection and Analysis Quality Assurance Plan (BBL, 1998b).

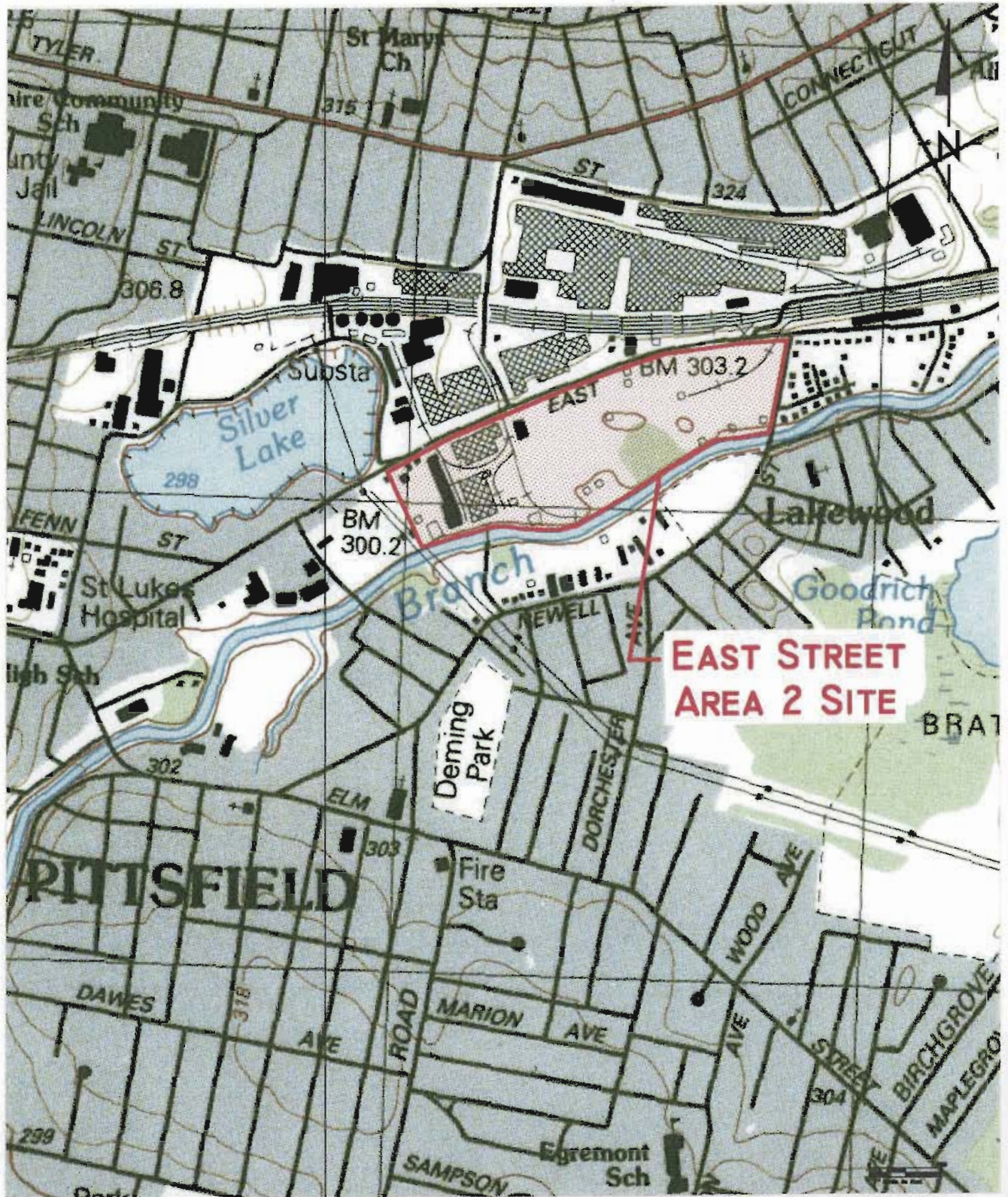

**EAST STREET  
AREA 2 SITE**

QUADRANGLE LOCATION

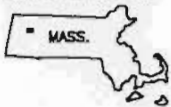

0 1000

Scale in feet

Contour Interval 3 Meters

National Geodetic Vertical Datum Of 1929

FROM U.S.G.S. QUADRANGLE  
PITTSFIELD, MASSACHUSETTS

Figure 1-1 Site Location



## 2 FIELD INVESTIGATIONS

---

The borings and monitoring well installation began October 7, 1998. Initially, nineteen borings were drilled at 17 locations, E2SC-01 through E2SC-17, utilizing hollow-stem auger and drive and wash techniques. Monitoring wells were installed in 13 of these borings. With Agency approval, three additional shallow borings were drilled (using the direct push method) on December 18, 1998, to further delineate the upper limits of potential LNAPL along the alignment of the proposed sheet-pile wall. Figure 2-1 shows the locations of the borings and monitoring wells, and Table 2-1 lists the construction details. Boring and well construction logs are included in Attachment A. Continuous samples of the unconsolidated deposits were collected by the standard penetration test method. The samples were screened in the field for the presence of volatile organic compounds (VOCs) using a photoionization detector (PID). All samples were visually screened for non aqueous phase liquids (NAPL), and water shake tests were performed on samples suspected of containing NAPL, based on the PID screening or visual observations. Representative samples of selected split-spoon cores were collected for laboratory analysis of chemical and physical properties. Table 2-2 lists the samples collected and the analyses performed. The results of grain-size analyses are included in Attachment B.

Based on a review of the existing and new soil boring information, the East Street Area 2 site is underlain by fill, stratified sand, gravel and silt deposits, and a basal till layer. In the riverbank area, the till surface forms a depression with the lowest elevation of approximately 936 ft. above the 1929 National Vertical Datum (NGVD) in the vicinity of wells E2SC-03 and E2SC-17. Figure 2-2 is a contour map which depicts the till surface elevation. The till consists of dense to very dense silty sand and gravel. Overlying the till is 15 to 35 feet of stratified sand, gravel and silt. Up to 12 feet of fill consisting of sand, gravel, cinders, and brick overlies the stratified deposits. Figures 2-3 and 2-4 are geologic cross sections through the portions of the East Street Area 2 site. Figure 2-3 (cross section A-A<sup>1</sup>) is generally parallel to the river and Figure 2-4 (cross section B-B<sup>1</sup>) is perpendicular to the

river. The cross section locations are shown on figure 2-2. The geologic data collected during these source control investigations is generally consistent with the previous investigations. The additional data from the new borings and wells have provided a more complete definition of the till surface.

Seismic refraction surveys were also performed along the lines identified in the Work Plan. The seismic refraction data suggests that a depression in the till surface may exist on the south side of the river. The seismic survey report is included in Attachment C.

Selected samples of the unconsolidated deposits were collected for laboratory analysis. Composite samples from 0 to 1 foot, 1 to 6 feet and 6 to 15 feet depths were collected from each boring for PCB analyses. Additionally one sample for VOC analysis was collected from a discrete interval in the top 15 feet. The VOC sampling interval was selected based on PID field screening. In addition, from the borings that reached the till surface, a sample from the stratified deposit / till interface was collected for PCB analysis. One sample from each boring was also collected for Appendix IX+3 analyses. This sample was selected based on the PID headspace screening. One sample from each boring in which field observations indicated the presence of DNAPL was also collected for Appendix IX + 3 analysis. Table 2-3 is a list of the compounds analyzed for.

The total PCB concentration in the upper 15 feet of the unconsolidated deposits ranged from non-detect (at several locations) to 210 mg/kg in the six to 15 foot sample from boring E2SC-08. The PCBs detected were predominantly aroclor 1260. Aroclor 1254 was also detected. Table 2-4 summarizes the results of the PCB analyses. Figure 2-5 shows the location of each new boring and the corresponding total PCB concentrations. Figures 2-3 and 2-4 illustrate the PCB concentration distribution in cross section.

Analyses for VOCs and SVOCs detected compounds which are typically associated with coal derived manufactured gas plant (MGP) wastes. The highest VOC concentrations were detected in the sample collected between 44 and 46 feet from boring E2SC-03.

Benzene, ethylbenzene, toluene and xylene were present at concentrations between 15 mg/kg and 240 mg/kg. Acetone, methylene chloride and styrene were also detected. Table 2-5 summarizes the concentrations of detected VOCs. A sample from boring E2SC-06, collected between six and 15 feet, contained the highest concentrations of SVOCs. The highest SVOCs concentrations were polynuclear aromatic hydrocarbons (PAH) typically found in MGP waste. Naphthalene was the individual compound detected at the highest concentration, 12,000 mg/kg. Detected SVOCs are summarized in Table 2-6. Some dioxin and furans were also detected. The concentrations of detected dioxins and furans, and Appendix IX metals are summarized in Tables 2-7 and 2-8, respectively.

Water level and NAPL measurements were collected approximately weekly after the wells were completed. Table 2-9 lists the water level and NAPL measurements recorded. Two wells, E2SC-03I and E2SC-17, have consistently contained measurable DNAPL. DNAPL thickness in wells E2SC-03I and E2SC-17 has typically been 4 to 6 feet. Measurable DNAPL was not detected in well E2SC-02 for the first several weeks of monitoring, but a thickness of 0.9 feet was measured on December 17, 1998. It should be noted that those thicknesses are not necessarily representative of the actual DNAPL thickness in the surrounding formation and instead the wells may serve as a sump for accumulating DNAPL. Sheens have been observed on the measuring probe while monitoring E2SC-01, E2SC-04, E2SC-09 and E2SC-16I.

NAPL, which is reported as LNAPL, has been consistently observed in well E2SC-06. Analysis of soil samples from E2SC-06 indicates that the NAPL at this location contains MGP byproducts. Field observations of the E2SC-06 NAPL indicated that it is apparently contained more than one fluid phase with some phases lighter than water and some heavier than water.

A DNAPL sample was collected from well E2SC-03I for chemical and physical analyses. The DNAPL is a black, viscous, tarry material typical of MGP byproducts. The specific gravity of the DNAPL was 1.076 g/cc, and the interfacial tension between the oil and

distilled water ranged from 27.7 to 28.5 dyne/cm. Viscosity measurements could not be made with the equipment available because the DNAPL coated the capillary wall of the viscometer making the lines on the tube unreadable. Numerous SVOCs were detected in the DNAPL sample. The compound detected at the highest concentration was naphthalene at 110,000 mg/kg. No PCBs were detected in the DNAPL. Table 2-10 summarizes the concentrations of Appendix IX +3 constituents detected in the DNAPL sample.

On December 18, 1998 three shallow borings, E2SC-18, E2SC-19 and E2SC-20. were drilled along the proposed alignment of the sheet pile wall. The locations of the shallow borings are shown on Figure 2-2 and boring logs are included in Attachment A. Each of the shallow borings began at a ground surface elevation of approximately 980 feet. The borings were drilled to depths of six to eight feet below ground surface. Continuous samples were collected at one-foot intervals from the ground surface to the maximum depth of each boring. The samples were examined in the field for indications of staining and the presence of LNAPL. Water shake tests were performed on each sample to evaluate the presence of LNAPL residuals. A representative sample from each one-foot core was collected for total petroleum hydrocarbon (TPH) analysis, by EPA method 418.1. The TPH concentrations ranged from not detected, at a reporting limit of 100 mg/kg to 61,000 mg/kg in the sample collected between the elevations of 975.1 to 974.1 NGVD in boring E2SC-18. The results of the TPH analyses, visual observations and shake test results are summarized on Table 2-11 and Figure 2-6. Selected soil samples were collected for pH determination to evaluate potential corrosion of the steel sheet piles. The pH of the samples ranged from 6.68 to 7.50 standard units. A sample of the LNAPL from the RW-1X/64-X oil recovery system was also collected for TPH analysis. The TPH concentration of the LNAPL was 480,000 mg/kg or 48%.

One of the main purposes of installing borings E2SC-18, 19 and 20 was to measure TPH values at various depths to assess the degree to which there has been potential vertical migration of LNAPL above the typical elevation of the water table (approximate elevation of 971 - 972 feet NGVD). To evaluate this, measured soil TPH values were compared to the

actual TPH of the LNAPL and estimates of saturation level based upon the physical properties of the soil and LNAPL. Typically, NAPL which is present at residual saturation for a given soil will not be mobilized as separate phase product (Cohen and Mercer, 1993). Based on a combination of site specific measurements and typical assumptions, estimates were made of corresponding TPH values which would be generally representative of soil samples which were at full oil saturation and residual saturation levels.

The following data from the shallow borings, the TPH concentration of the oil, and site specific assumption were used for this analysis:

Oil density	0.9 g/cc (site oil)
Soil dry density	1.6 g/c ( Lamb and Whitman, 1969)
porosity	0.3 to 0.35 ( Lamb and Whitman, 1969)
Residual saturation	0.2 to 0.3 (estimates from site soil)
LNAPL TPH Concentration	480,000 mg/kg (48%)

Based on these inputs, the estimated TPH concentration for a fully oil saturated sample ranges from 69,000 mg/kg using a soil porosity of 0.30, to 78,900 mg/kg with a soil porosity of 0.35. The estimated TPH concentration at residual saturation ranges from a low of 15,700 mg/kg (residual saturation level of 0.2, porosity of 0.3) to 26,800 mg/kg (residual saturation level of 0.3 porosity of 0.35). Based on a comparison to previously collected TPH data in RW-2(x), these estimates of residual saturation appear reasonable. In that well, TPH ranged from 5,560 mg/kg to 22,000 mg/kg in samples collected over a depth range of 15.5 feet to 18 feet. Although some droplets of LNAPL were indicated in the core, the soil appears to be at or below residual saturation since separate phase LNAPL did not accumulate in the well until groundwater pumping had been ongoing for 5 months. Only one of the newly collected riverbank samples, E2SC-18 SS06 contained TPH at a concentration near the estimated saturation concentration. This sample was collected between elevation 974 and 975 feet. Samples above an approximate elevation of 975 feet contained TPH concentrations that were non-detectable or far less than the estimated residual saturation concentration. The



results of the TPH analyses, visual inspection of core samples, and shake tests indicate that no significant vertical movement of LNAPL has occurred above an elevation of approximately 975 feet NGVD in the lower portion of the riverbank.

Table 2-1. Well construction data for the East Street Area 2 source control investigation

LOCATION	DATE DRILLED	BORING DEPTH FT (BGS)	GROUND SURFACE ELEVATION	MEASURING POINT ELEV.	MEASURING POINT	SCREEN INT FT. (BGS)	CASING TYPE	SCREEN TYPE	GRAVEL PACK TYPE	WELL SURF DETL.
E2SC-01	10/14/98	46	986.42	988.36	TOC PVC	31.0' - 41.0'	2" PVC	.010 Slot 2" PVC	#0 Silica Sand	4" steel stick-up
E2SC-02	10/23/98	42	985.93	987.57	TOC PVC	31.0' - 41.0'	2" PVC	.010 Slot 2" PVC	#0 Silica Sand	
E2SC-03I	10/15/98	47	980.43	982.12	TOC PVC	34.5' - 44.5'	2" PVC	.010 Slot 2" PVC	#0 Silica Sand	4" steel stick-up
E2SC-03S	10/16/98	20	980.57	982.15	TOC PVC	10.0' - 20.0'	2" PVC	.010 Slot 2" PVC	#0 Silica Sand	4" steel stick-up
E2SC-04	10/13/98	46	983.53	989.11	TOC PVC	34.0' - 44.0'	2" PVC	.010 Slot 2" PVC	#0 Silica Sand	4" steel stick-up
E2SC-05	10/26/98	42	991.42	993.24	TOC PVC	30.0' - 40.0'	2" PVC	.010 Slot 2" PVC	#0 Silica Sand	4" steel stick-up
E2SC-06	10/24/98	19.5	990.46	992.49	TOC PVC	8.7' - 18.7'	2" PVC	.010 Slot 2" PVC	#0 Silica Sand	4" steel stick-up
E2SC-07	10/27/98	40	989.13	None	None	None	2" PVC	.010 Slot 2" PVC	#0 Silica Sand	4" steel stick-up
E2SC-08	10/19/98	44	986.07	None	None	None	None	None	None	None
E2SC-09	10/21/98	42	983.48	984.78	TOC PVC	30' - 40'	2" PVC	.010 Slot 2" PVC	#0 Silica Sand	4" steel stick-up
E2SC-10	10/20/98	30	989.19	None	None	None	None	None	None	None
E2SC-11	10/9/98	17	990.06	None	None	None	None	None	None	None
E2SC-12	10/19/98	32	978.87	None	None	None	None	None	None	None
E2SC-13	10/7/98	18	988.09	989.89	TOC PVC	8.0' - 18.0'	2" PVC	.010 Slot 2" PVC	#0 Silica Sand	4" steel stick-up
E2SC-14	10/8/98	20	990.19	992.25	TOC PVC	10.0' - 20.0'	2" PVC	.010 Slot 2" PVC	#0 Silica Sand	4" steel stick-up
E2SC-15	10/20/98	36	984.34	None	None	None	None	None	None	None
E2SC-16I	11/10/98	50	N/A	N/A	TOC PVC	38.5' - 48.5'	2" PVC	.010 Slot 2" PVC	#0 Silica Sand	4" steel stick-up
E2SC-16S	10/8/98	17	985.78	987.69	TOC PVC	7.0' - 17.0'	2" PVC	.010 Slot 2" PVC	#0 Silica Sand	4" steel stick-up
E2SC-17	10/27/98	49	983.76	985.38	TOC PVC	36.7"-46.7'	2" PVC	.010 Slot 2" PVC	#0 Silica Sand	4" steel stick-up
E2SC-18	12/18/98	6	980.13	None	None	None	None	None	None	None
E2SC-19	12/18/98	8	980.07	None	None	None	None	None	None	None
E2SC-20	12/18/98	8	980.38	None	None	None	None	None	None	None

Table 2-2. Sample collection data for the East Street Area 2 source control investigation

BORING	SAMPLE ID	DATE	DEPTH	ANALYSIS REQUESTED
E2SC-01	CS01	10/9/98	0-1	PCBs
E2SC-01	CS0106	10/9/98	1-6	PCBs
E2SC-01	CS0615	10/9/98	6-15	PCBs & App IX - 3
E2SC-01	CS3840	10/12/98	38-40	PCBs & App IX - 3
E2SC-01	SS09	10/9/98	14-15	App IX Volatile Organics
E2SC-01	SS22	10/12/98	38-40	App IX Volatile Organics
E2SC-01	SS25	10/12/98	44-46	PCBs
E2SC-02	CS01	10/21/98	0-1	PCBs
E2SC-02	CS0106	10/21/98	1-6	PCBs
E2SC-02	CS0615	10/21/98	6-15	PCBs & App IX + 3
E2SC-02	CS0615D	10/23/98	6-15	Dup PCBs & App IX + 3 BNA, Metals, & Cyanide
E2SC-02	CS4042	10/23/98	40-42	PCBs & App IX + 3
E2SC-02	CS4042D	10/23/98	40-42	Dup App IX + 3 Sulfide & Dioxide
E2SC-02	SS09	10/21/98	14-15	App IX Volatile Organics
E2SC-02	SS22	10/23/98	38-40	App IX Volatile Organics
E2SC-03	CS01	10/15/98	0-1	PCBs
E2SC-03	CS0106	10/15/98	1-6	PCBs
E2SC-03	CS0615	10/15/98	6-15	PCBs & App IX + 3
E2SC-03	CS4448	10/15/98	44-48	PCBs & App IX - 3
E2SC-03	SS08	10/15/98	12-14	App IX Volatile Organics
E2SC-03	SS25	10/15/98	44-46	App IX Volatile Organics
E2SC-04	CS01	10/13/98	0-1	PCBs
E2SC-04	CS0106	10/13/98	1-6	PCBs
E2SC-04	CS0615	10/13/98	6-15	PCBs & App IX + 3
E2SC-04	CS4244	10/13/98	42-44	PCBs
E2SC-04	SS09	10/13/98	14-15	App IX Volatile Organics
E2SC-04	GS01	10/14/98	0-5	PCB, Grain Size
E2SC-04	GS02	10/15/98	5-15.4	PCB, Grain Size
E2SC-04	GS03	10/16/98	15.4-24	PCB, Grain Size
E2SC-04	GS04	10/17/98	24-39	PCB, Grain Size
E2SC-04	GS05	10/18/98	39-43	PCB, Grain Size, Atteburg limit
E2SC-04	GS06	10/19/98	43-	PCB, Grain Size,

Table 2-2. Continued

BORING	SAMPLE ID	DATE	DEPTH	ANALYSIS REQUESTED
				Atterberg limit
E2SC-05	CS01	10/25/98	0-1	PCBs
E2SC-05	CS0106	10/25/98	1-6	PCBs
E2SC-05	CS0615	10/25/98	6-15	PCBs & App IX - 3
E2SC-05	CS3840	10/26/98	38-40	PCBs & App IX - 3
E2SC-05	CS4042	10/26/98	40-42	PCBs
E2SC-05	SS07	10/25/98	10-12	App IX Volatile Organics
E2SC-05	SS22	10/26/98	38-40	App IX Volatile Organics
E2SC-06	CS01	10/23/98	0-1	PCBs
E2SC-06	CS0106	10/23/98	1-6	PCBs
E2SC-06	CS0615	10/23/98	6-15	PCBs & App IX - 3
E2SC-06	SS08	10/23/98	12-14	App IX Volatile Organics
E2SC-07	CS01	10/27/98	0-1	PCBs
E2SC-07	CS0106	10/27/98	1-6	PCBs
E2SC-07	CS0615	10/27/98	6-15	PCBs & App IX - 3
E2SC-07	CS3840	10/27/98	38-40	PCBs
E2SC-07	SS09	10/27/98	14-15	App IX Volatile Organics
E2SC-08	CS0106	10/14/98	1-6	PCBs
E2SC-08	CS0615	10/14/98	6-15	PCBs
E2SC-08	CS4244	10/19/98	42-44	PCBs
E2SC-08	GS06	10/14/98	N/A	
E2SC-09	CS01	10/21/98	0-1	PCBs
E2SC-09	CS0106	10/21/98	1-6	PCBs
E2SC-09	CS0615	10/21/98	6-15	PCBs & App IX + 3
E2SC-09	CS4042	10/21/98	40-42	PCBs
E2SC-09	SS06	10/21/98	8-10	App IX Volatile Organics
E2SC-10	CS01	10/20/98	0-1	PCBs
E2SC-10	CS0106	10/20/98	1-6	PCBs & App IX + 3
E2SC-10	CS0615	10/20/98	6-15	PCBs
E2SC-10	CS2830	10/20/98	28-30	PCBs
E2SC-10	SS03	10/20/98	3-5	App IX Volatile Organics
E2SC-11	CS01	10/9/98	0-1	PCBs
E2SC-11	CS0106	10/9/98	1-6	PCBs

Table 2-2. Continued

BORING	SAMPLE ID	DATE	DEPTH	ANALYSIS REQUESTED
E2SC-11	CS0615	10/9/98	6-15	PCBs & App IX - 3
E2SC-11	SS05	10/9/98	6-8	App IX Volatile Organics
E2SC-12	CS01	10/19/98	0-1	PCBs
E2SC-12	CS0106	10/19/98	1-6	PCBs
E2SC-12	CS0615	10/19/98	6-15	PCBs & App IX - 3
E2SC-12	CS3032	10/19/98	30-32	PCBs
E2SC-12	SS05	10/19/98	6-8	App IX Volatile Organics
E2SC-13	CS01	10/9/98	0-1	PCBs
E2SC-13	CS0106	10/9/98	1-6	PCBs
E2SC-13	CS0516	10/7/98	8-15	PCBs & App IX - 3
E2SC-13	SS08	10/7/98	14-15	App IX Volatile Organics
E2SC-14	CS01	10/8/98	0-1	PCBs
E2SC-14	CS0106	10/8/98	1-6	PCBs
E2SC-14	CS0615	10/8/98	6-15	PCBs & App IX + 3, App IX Volatile Organics
E2SC-15	CS01	11/25/98	0-1	PCBs & Dup. PCBs
E2SC-15	CS0106	10/20/98	1-6	PCBs
E2SC-15	CS0615	10/20/98	6-15	PCBs & App IX + 3
E2SC-15	CS3436	10/20/98	34-36	PCBs
E2SC-15	SS08	10/20/98	12-14	App IX Volatile Organics
E2SC-16	CS01	10/8/98	0-1	PCBs
E2SC-16	CS0106	10/8/98	1-6	PCBs
E2SC-16	CS0615	10/8/98	6-15	PCBs & App IX + 3
E2SC-16	SS10	10/8/98	15-17	App IX Volatile Organics
E2SC-161	CS4042	11/10/98	40-42	PCBs & App IX + 3
E2SC-161	CS4850	11/10/98	48-50	PCBs
E2SC-161	SS23	11/10/98	40-42	App IX Volatile Organics
E2SC-17	CS01	10/27/98	0-1	PCBs
E2SC-17	CS0106	10/26/98	1-6	PCBs
E2SC-17	CS0615	10/26/98	6-15	PCBs & App IX + 3
E2SC-17	CS4244	10/26/98	42-44	PCBs & App IX + 3
E2SC-17	CS4749	10/27/98	47-49	PCBs

Table 2-2. Continued

BORING	SAMPLE ID	DATE	DEPTH	ANALYSIS REQUESTED
E2SC-17	SS05	10/26/98	6-8	App IX Volatile Organics
E2SC-17	SS24	10/26/98	42-44	App IX Volatile Organics
E2SC-18	SS01	12/18/98	0-1	TPH
E2SC-18	SS02	12/18/98	1-2	TPH
E2SC-18	SS03	12/18/98	2-3	TPH
E2SC-18	SS04	12/18/98	3-4	TPH
E2SC-18	SS05	12/18/98	4-5	TPH
E2SC-18	SS06	12/18/98	5-6	TPH
E2SC-19	SS01	12/18/98	0-1	TPH
E2SC-19	SS02	12/18/98	1-2	TPH
E2SC-19	SS03	12/18/98	2-3	TPH
E2SC-19	SS04	12/18/98	3-4	TPH
E2SC-19	SS05	12/18/98	4-5	TPH
E2SC-19	SS06	12/18/98	5-6	TPH
E2SC-19	SS07	12/18/98	6-7	TPH
E2SC-19	SS08	12/18/98	7-8	TPH
E2SC-20	SS01	12/18/98	0-1	TPH
E2SC-20	SS02	12/18/98	1-2	TPH
E2SC-20	SS03	12/18/98	2-3	TPH
E2SC-20	SS04	12/18/98	3-4	TPH
E2SC-20	SS05	12/18/98	4-5	TPH
E2SC-20	SS06	12/18/98	5-6	TPH
E2SC-20	SS07	12/18/98	6-7	TPH
E2SC-20	SS08	12/18/98	7-8	TPH

---

**Table 2-3. List of Analytes**

---

<i>Type</i>	<i>Compound</i>
<i>Dioxin</i>	1,2,3,4,6,7,8-HpCDD
	1,2,3,4,6,7,8-HpCDF
	1,2,3,4,7,8,9-HpCDF
	1,2,3,4,7,8-HxCDD
	1,2,3,4,7,8-HxCDF
	1,2,3,6,7,8-HxCDD
	1,2,3,6,7,8-HxCDF
	1,2,3,7,8,9-HxCDD
	1,2,3,7,8,9-HxCDF
	1,2,3,7,8-PeCDD
	1,2,3,7,8-PeCDF
	13C-1,2,3,4,6,7,8-HpCDD
	13C-1,2,3,4,6,7,8-HpCDF
	13C-1,2,3,4,7,8-HxCDF
	13C-1,2,3,6,7,8-HxCDD
	13C-1,2,3,7,8-PeCDD
	13C-1,2,3,7,8-PeCDF
	13C-2,3,7,8-TCDD
	13C-2,3,7,8-TCDF
	13C-OCDD
	2,3,4,6,7,8-HxCDF
	2,3,4,7,8-PeCDF
	2,3,7,8-TCDD
	2,3,7,8-TCDF
	HpCDDs (total)
	HpCDFs (total)
	HxCDDs (total)
	HxCDFs (total)
	OCDD
	OCDF
	PeCDDs (total)
	PeCDFs (total)
	Percent Water
TCDDs (total)	
TCDFs (total)	
<i>Metals</i>	Antimony
	Arsenic

<i>Type</i>	<i>Compound</i>
	Barium
	Beryllium
	Cadmium
	Chromium
	Cobalt
	Copper
	Lead
	Mercury
	Nickel
	Selenium
	Silver
	Thallium
	Tin
	Vanadium
	Zinc
<i>Misc.</i>	Acid-insoluble Sulfide
	Percent Solids
	Total Cyanide
	Total Petroleum Hydrocarbons
<i>PCB's</i>	Aroclor 1016
	Aroclor 1221
	Aroclor 1232
	Aroclor 1242
	Aroclor 1248
	Aroclor 1254
	Aroclor 1260
<i>SVOC</i>	1,2,4,5-Tetrachlorobenzene
	1,2,4-Trichlorobenzene
	1,2-Dichlorobenzene
	1,2-Diphenylhydrazine
	1,2-Diphenylhydrazine (as Azob
	1,3,5-Trinitrobenzene
	1,3-Dichlorobenzene
	1,3-Dinitrobenzene
	1,4-Dichlorobenzene
	1,4-Naphthoquinone
	1-Naphthylamine
	2,3,4,6-Tetrachlorophenol



<i>Type</i>	<i>Compound</i>
	2,4,5-Trichlorophenol
	2,4,6-Trichlorophenol
	2,4-Dichlorophenol
	2,4-Dimethylphenol
	2,4-Dinitrophenol
	2,4-Dinitrotoluene
	2,6-Dichlorophenol
	2,6-Dinitrotoluene
	2-Acetylaminofluorene
	2-Chloronaphthalene
	2-Chlorophenol
	2-Methylnaphthalene
	2-Methylphenol
	2-Naphthylamine
	2-Nitroaniline
	2-Nitrophenol
	2-Picoline
	3&4 Methylphenol total
	3,3'-Dichlorobenzidine
	3,3'-Dimethylbenzidine
	3-Methylcholanthrene
	3-Methylphenol & 4-Methylpheno
	3-Nitroaniline
	4,6-Dinitro-2-methylphenol
	4-Aminobiphenyl
	4-Bromophenyl phenyl ether
	4-Chloro-3-methylphenol
	4-Chloroaniline
	4-Chlorophenyl phenyl ether
	4-Nitroaniline
	4-Nitrophenol
	4-Nitroquinoline-1-oxide
	5-Nitro-o-toluidine
	7,12-Dimethylbenz(a)anthracene
	a,a-Dimethylphenethylamine
	Acenaphthene
	Acenaphthylene
	Acetophenone
	Aniline
	Anthracene

<i>Type</i>	<i>Compound</i>
	Aramite
	Benzidine
	Benzo(a)anthracene
	Benzo(a)pyrene
	Benzo(b)fluoranthene
	Benzo(ghi)perylene
	Benzo(k)fluoranthene
	Benzyl alcohol
	bis(2-Chloroethoxy)methane
	bis(2-Chloroethyl) ether
	bis(2-Chloroisopropyl) ether
	bis(2-Ethylhexyl) phthalate
	Butyl benzyl phthalate
	Chrysene
	Di-n-butyl phthalate
	Di-n-octyl phthalate
	Diallate
	Dibenz(a,h)anthracene
	Dibenzofuran
	Diethyl phthalate
	Dimethyl phthalate
	Dinoseb
	Diphenylamine
	Ethyl methanesulfonate
	Fluoranthene
	Fluorene
	Hexachlorobenzene
	Hexachlorobutadiene
	Hexachlorocyclopentadiene
	Hexachloroethane
	Hexachlorophene
	Hexachloropropene
	Indeno(1,2,3-cd)pyrene
	Isophorone
	Isosafrole
	Methapyrilene
	Methyl methanesulfonate
	N-Nitrosodi-n-butylamine
	N-Nitrosodi-n-propylamine
	N-Nitrosodiethylamine

<i>Type</i>	<i>Compound</i>
	N-Nitrosodimethylamine
	N-Nitrosodiphenylamine
	N-Nitrosomethylethylamine
	N-Nitrosomorpholine
	N-Nitrosopiperidine
	N-Nitrosopyrrolidine
	Naphthalene
	Nitrobenzene
	o-Toluidine
	p-Chlorobenzilate
	p-Dimethylaminoazobenzene
	p-Phenylene diamine
	Pentachlorobenzene
	Pentachloroethane
	Pentachloronitrobenzene
	Pentachlorophenol
	Phenacetin
	Phenanthrene
	Phenol
	Pronamide
	Pyrene
	Pyridine
	Safrole
VOC	1,1,1,2-Tetrachloroethane
	1,1,1-Trichloroethane
	1,1,2,2-Tetrachloroethane
	1,1,2-Trichloroethane
	1,1-Dichloroethane
	1,1-Dichloroethene
	1,2,3-Trichloropropane
	1,2-Dibromo-3-chloropropane
	1,2-Dibromoethane (EDB)
	1,2-Dichloroethane
	1,2-Dichloropropane
	1,4-Dioxane
	2-Butanone (MEK)
	2-Chloroethyl vinyl ether
	2-Hexanone
	4-Methyl-2-pentanone (MIBK)

---

*Type*

---

*Compound*

---

Acetone  
Acetonitrile  
Acrolein  
Acrylonitrile  
Allyl chloride  
Benzene  
Bromodichloromethane  
Bromoform  
Bromomethane  
Carbon disulfide  
Carbon tetrachloride  
Chlorobenzene  
Chloroethane  
Chloroform  
Chloromethane  
Chloroprene  
cis-1,2-Dichloroethene  
cis-1,3-Dichloropropene  
Dibromochloromethane  
Dibromomethane  
Dichlorodifluoromethane  
Ethyl methacrylate  
Ethylbenzene  
Iodomethane  
Isobutyl alcohol  
Methacrylonitrile  
Methyl methacrylate  
Methylene chloride  
Propionitrile  
Styrene  
Tetrachloroethene  
Toluene  
trans-1,2-Dichloroethene  
trans-1,3-Dichloropropene  
trans-1,4-Dichloro-2-butene  
Trichloroethene  
Trichlorofluoromethane  
Vinyl acetate  
Vinyl chloride  
Xylenes (total)

Table 2-4. PCB soil concentration data

Boring	Sample Number	Depth (Ft.)	Aroclor Concentration (mg/kg)							Total
			1016	1221	1232	1242	1248	1254	1260	
E2SC-01	E2SC-01-CS01	0-1	ND	ND	ND	ND	ND	ND	0.66	0.66
E2SC-01	E2SC-01-CS0106	1-6	ND	ND	ND	ND	ND	ND	0.71	0.71
E2SC-01	E2SC-01-CS0615	6-15	ND	ND	ND	ND	ND	ND	0.06	0.06
E2SC-01	E2SC-01-CS3840	38-40	ND	ND	ND	ND	ND	ND	ND	ND
E2SC-01	E2SC-01-SS25	44-46	ND	ND	ND	ND	ND	ND	ND	ND
E2SC-02	E2SC-02-CS01	0-1	ND	ND	ND	ND	ND	ND	49.00	49.00
E2SC-02	E2SC-02-CS0106	1-6	ND	ND	ND	ND	ND	ND	43.00	43.00
E2SC-02	E2SC-02-CS0615	6-15	ND	ND	ND	ND	ND	ND	17.00	17.00
E2SC-02	E2SC-02-CS4042	40-42	ND	ND	ND	ND	ND	ND	ND	ND
E2SC-03	E2SC-03-CS01	0-1	ND	ND	ND	ND	ND	ND	25.00	25.00
E2SC-03	E2SC-03-CS0106	1-6	ND	ND	ND	ND	ND	ND	52.00	52.00
E2SC-03	E2SC-03-CS0615	6-15	ND	ND	ND	ND	ND	ND	22.00	22.00
E2SC-03	E2SC-03-CS4448	44-48	ND	ND	ND	ND	ND	ND	ND	ND
E2SC-04	E2SC-04-CS01	0-1	ND	ND	ND	ND	ND	ND	0.99	0.99
E2SC-04	E2SC-04-CS0106	1-6	ND	ND	ND	ND	ND	0.17	0.19	0.36
E2SC-04	E2SC-04-CS0615	6-15	ND	ND	ND	ND	ND	ND	ND	ND
E2SC-04	E2SC-04-CS4244	42-44	ND	ND	ND	ND	ND	ND	ND	ND
E2SC-04	E2SC-04-GS01	0-5	ND	ND	ND	ND	ND	ND	0.12	0.12
E2SC-04	E2SC-04-GS02	5-15.4	ND	ND	ND	ND	ND	ND	ND	ND
E2SC-04	E2SC-04-GS03	15.4-24	ND	ND	ND	ND	ND	ND	ND	ND
E2SC-04	E2SC-04-GS04	24-39	ND	ND	ND	ND	ND	ND	ND	ND
E2SC-04	E2SC-04-GS05	39-43	ND	ND	ND	ND	ND	ND	ND	ND
E2SC-04	E2SC-04-GS06	43-44	ND	ND	ND	ND	ND	ND	ND	ND
E2SC-05	E2SC-05-CS01	0-1	ND	ND	ND	ND	ND	ND	1.60	1.60
E2SC-05	E2SC-05-CS0106	1-6	ND	ND	ND	ND	ND	ND	0.29	0.29
E2SC-05	E2SC-05-CS0615	6-15	ND	ND	ND	ND	ND	ND	0.13	0.13
E2SC-05	E2SC-05-CS3840	38-40	ND	ND	ND	ND	ND	ND	ND	ND
E2SC-05	E2SC-05-CS4042	40-42	ND	ND	ND	ND	ND	ND	ND	ND

Table 2-4. Continued

Boring	Sample Number	Depth (Ft.)	Aroclor Concentration (mg/kg)							Total
			1016	1221	1232	1242	1248	1254	1260	
E2SC-06	E2SC-06-CS01	0-1	ND	ND	ND	ND	ND	ND	0.59	0.59
E2SC-06	E2SC-06-CS0106	1-6	ND	ND	ND	ND	ND	ND	0.07	0.07
E2SC-06	E2SC-06-CS0615	6-15	ND	ND	ND	ND	ND	ND	ND	ND
E2SC-07	E2SC-07-CS01	0-1	ND	ND	ND	ND	ND	ND	0.79	0.79
E2SC-07	E2SC-07-CS0106	1-6	ND	ND	ND	ND	ND	ND	0.28	0.28
E2SC-07	E2SC-07-CS0615	6-15	ND	ND	ND	ND	ND	ND	1.40	1.40
E2SC-07	E2SC-07-CS3840	38-40	ND	ND	ND	ND	ND	ND	ND	ND
E2SC-08	EW2SC-08-CS0106	1 - 6	ND	ND	ND	ND	ND	ND	170.00	170.00
E2SC-08	EW2SC-08-CS0615	6 - 15	ND	ND	ND	ND	ND	ND	210.00	210.00
E2SC-08	E2SC-08 CS4244	42-44	ND	ND	ND	ND	ND	ND	0.13	0.13
E2SC-09	E2SC-09-CS01	0-1	ND	ND	ND	ND	ND	ND	20.00	20.00
E2SC-09	E2SC-09-CS0106	1-6	ND	ND	ND	ND	ND	ND	3.90	3.90
E2SC-09	E2SC-09-CS0615	6-15	ND	ND	ND	ND	ND	ND	140.00	140.00
E2SC-09	E2SC-09-CS4042	40-42	ND	ND	ND	ND	ND	ND	0.11	0.11
E2SC10	E2SC-10-CS01	0-1	ND	ND	ND	ND	ND	ND	0.19	0.19
E2SC10	E2SC-10-CS0106	1-6	ND	ND	ND	ND	ND	ND	0.15	0.15
E2SC10	E2SC-10-CS0615	6-15	ND	ND	ND	ND	ND	ND	ND	ND
E2SC10	E2SC-10-CS2830	28-30	ND	ND	ND	ND	ND	ND	ND	ND
E2SC-11	E2SC-11-CS01	0-1	ND	ND	ND	ND	ND	ND	0.10	0.10
E2SC-11	E2SC-11-CS0106	1-6	ND	ND	ND	ND	ND	ND	ND	ND
E2SC-11	E2SC-11-CS0615	6-15	ND	ND	ND	ND	ND	ND	ND	ND
E2SC-12	E2SC-12-CS01	0-1	ND	ND	ND	ND	ND	ND	0.19	0.19
E2SC-12	E2SC-12-CS0106	1-6	ND	ND	ND	ND	ND	83.00	91.00	91.00
E2SC-12	E2SC-12-CS0615	6-15	ND	ND	ND	ND	ND	ND	65.00	65.00
E2SC-12	E2SC-12-CS3032	30-32	ND	ND	ND	ND	ND	0.11	0.15	0.26
E2SC-13	ES2C-13-CS01	0-1	ND	ND	ND	ND	ND	ND	0.21	0.21



**Table 2-5 Detected Volatile Organic Compound Soil Concentration Data.**

<i>Location</i>	<i>Sample Name</i>	<i>Sample Depth (feet)</i>	<i>Compound</i>	<i>Result</i>	<i>Qualifier</i>	<i>Modifier</i>	<i>Units</i>
<i>E2SC-01</i>							
	SS22	38-40	Acetone	0.45	J		mg/kg
			Ethylbenzene	0.21	J		mg/kg
			Xylenes (total)	0.3			mg/kg
<i>E2SC-02</i>							
	SS09	14-15	Acetone	0.42	J		mg/kg
			Chlorobenzene	0.21	J		mg/kg
			Ethylbenzene	1.3			mg/kg
			Xylenes (total)	1.6			mg/kg
<i>E2SC-03</i>							
	SS08	12-14	Acetone	0.045			mg/kg
	SS25	44-46	Benzene	15			mg/kg
			Ethylbenzene	67			mg/kg
			Methylene chloride	3.8	J		mg/kg
			Styrene	140			mg/kg
			Toluene	150			mg/kg
			Xylenes (total)	240			mg/kg
<i>E2SC-03I</i>							
			Benzene	1.3	J		mg/kg
			Ethylbenzene	53			mg/kg
			Toluene	19			mg/kg
			Xylenes (total)	43			mg/kg
<i>E2SC-04</i>							
	SS09	14-15	Acetone	0.026			mg/kg
			Methylene chloride	0.0035	J		mg/kg
<i>E2SC-05</i>							
	SS07	10-12	Acetone	0.021			mg/kg
	SS22	38-40	Acetone	0.0049	J		mg/kg
			Ethylbenzene	0.024			mg/kg



<i>Location</i>	<i>Sample Name</i>	<i>Sample Depth (feet)</i>	<i>Compound</i>	<i>Result</i>	<i>Qualifier</i>	<i>Modifier</i>	<i>Units</i>
<i>E2SC-06</i>	SS08	12-14	Tetrachloroethene	0.0012	J		mg/kg
			Toluene	0.004	J		mg/kg
			Xylenes (total)	0.033			mg/kg
			Benzene	2.1			mg/kg
<i>E2SC-07</i>	SS09	14-15	Styrene	2.1			mg/kg
			Toluene	2.3			mg/kg
			Xylenes (total)	1.6			mg/kg
			Acetone	0.018			mg/kg
<i>E2SC-08</i>	GS06	N/A	Benzene	0.002	J		mg/kg
			Chlorobenzene	0.035			mg/kg
			Ethylbenzene	0.023			mg/kg
			Tetrachloroethene	0.0015	J		mg/kg
			Xylenes (total)	0.071			mg/kg
			Methylene chloride	0.0018	J		mg/kg
<i>E2SC-09</i>	SS06	8-10	Acetone	0.63	J		mg/kg
			Benzene	0.13	J		mg/kg
			Chlorobenzene	8.5			mg/kg
			Xylenes (total)	0.37			mg/kg
<i>E2SC-12</i>	SS05	0-1	Acetone	0.024	J		mg/kg
			Acetone	0.052			mg/kg
<i>E2SC-15</i>	SS08	12-14	Acetone	0.024	J		mg/kg
			Ethylbenzene	1.4			mg/kg
<i>E2SC-16I</i>	SS23	40-42					

<i>Location</i>	<i>Sample Name</i>	<i>Sample Depth (feet)</i>	<i>Compound</i>	<i>Result</i>	<i>Qualifier</i>	<i>Modifier</i>	<i>Units</i>
			Styrene	3.8			mg/kg
			Toluene	1.6			mg/kg
			Xylenes (total)	7.7			mg/kg
<i>E2SC-17</i>							
	SS05	6-8					
			Acetone	0.0053	J		mg/kg
	SS24	42-44					
			Ethylbenzene	1			mg/kg
			Styrene	1.1			mg/kg
			Toluene	0.7			mg/kg
			Xylenes (total)	3.6			mg/kg

**Qualifier**

J For organics, result is between MDL and RL.

**Modifier**

D Dilution

DUP Duplicate Sample

**Table 2-6 Detected Semi-Volatile Organic Compound Soil Concentration Data.**

<i>Location</i>	<i>Sample Name</i>	<i>Sample Depth (feet)</i>	<i>Compound</i>	<i>Result</i>	<i>Qualifier</i>	<i>Modifier</i>	<i>Units</i>
<i>E2SC-01</i>							
	CS0615	6-15	bis(2-Ethylhexyl) phthalate	0.062	J		mg/kg
			Fluoranthene	0.049	J		mg/kg
			Phenanthrene	0.042	J		mg/kg
			Pyrene	0.043	J		mg/kg
	CS3840	38-40	2-Methylnaphthalene	61		D	mg/kg
			Acenaphthylene	26	J	D	mg/kg
			Anthracene	46		D	mg/kg
			Benzo(a)anthracene	23	J	D	mg/kg
			Benzo(a)pyrene	21	J	D	mg/kg
			Benzo(b)fluoranthene	14	J	D	mg/kg
			Benzo(ghi)perylene	7.4	J	D	mg/kg
			Benzo(k)fluoranthene	6.2	J	D	mg/kg
			Chrysene	21	J	D	mg/kg
			Dibenzofuran	3.3	J	D	mg/kg
			Fluoranthene	51		D	mg/kg
			Fluorene	44		D	mg/kg
			Indeno(1,2,3-cd)pyrene	6.3	J	D	mg/kg
			Naphthalene	95		D	mg/kg
			Phenanthrene	140		D	mg/kg
<i>E2SC-02</i>							
	CS0615	6-15	2-Methylnaphthalene	5.5			mg/kg
			Acenaphthene	6.1			mg/kg
			Acenaphthylene	0.49	J		mg/kg
			Anthracene	3.3			mg/kg
			Benzo(a)anthracene	1.7	J		mg/kg
			Benzo(a)pyrene	1.4	J		mg/kg
			Benzo(b)fluoranthene	0.94	J		mg/kg
			Benzo(ghi)perylene	0.73	J		mg/kg
			Benzo(k)fluoranthene	0.5	J		mg/kg
			Chrysene	1.4	J		mg/kg
			Dibenzofuran	0.31	J		mg/kg
			Fluoranthene	4.4			mg/kg
			Fluorene	3.7			mg/kg

<i>Location</i>	<i>Sample Name</i>	<i>Sample Depth (feet)</i>	<i>Compound</i>	<i>Result</i>	<i>Qualifier</i>	<i>Modifier</i>	<i>Units</i>
			Indeno(1,2,3-cd)pyrene	0.54	J		mg/kg
			Naphthalene	14			mg/kg
			Phenanthrene	11			mg/kg
			Pyrene	5.2			mg/kg
	CS0615D	6-15	2-Methylnaphthalene	1300		D, DUP	mg/kg
			Acenaphthene	140		DUP	mg/kg
			Acenaphthylene	1500		D, DUP	mg/kg
			Anthracene	1700		D, DUP	mg/kg
			Benzo(a)anthracene	390	J	D, DUP	mg/kg
			Benzo(a)pyrene	240		DUP	mg/kg
			Benzo(b)fluoranthene	300		DUP	mg/kg
			Benzo(ghi)perylene	84		DUP	mg/kg
			Benzo(k)fluoranthene	130		DUP	mg/kg
			Chrysene	390	J	D, DUP	mg/kg
			Dibenz(a,h)anthracene	26	J	DUP	mg/kg
			Dibenzofuran	70		DUP	mg/kg
			Fluoranthene	970		D, DUP	mg/kg
			Fluorene	850		D, DUP	mg/kg
			Indeno(1,2,3-cd)pyrene	82		DUP	mg/kg
			Naphthalene	3700		D, DUP	mg/kg
			Phenanthrene	2800		D, DUP	mg/kg
			Phenol	3.2	J	DUP	mg/kg
			Pyrene	1600		D, DUP	mg/kg
	CS4042	40-42	Acenaphthene	0.24	J		mg/kg
			Acenaphthylene	0.11	J		mg/kg
			Anthracene	0.34	J		mg/kg
			Benzo(a)anthracene	0.31	J		mg/kg
			Benzo(a)pyrene	0.28	J		mg/kg
			Benzo(b)fluoranthene	0.17	J		mg/kg
			Benzo(ghi)perylene	0.097	J		mg/kg
			Benzo(k)fluoranthene	0.081	J		mg/kg
			bis(2-Ethylhexyl) phthalate	0.081	J		mg/kg
			Chrysene	0.26	J		mg/kg
			Fluoranthene	0.55			mg/kg
			Fluorene	0.26			mg/kg
			Indeno(1,2,3-cd)pyrene	0.08	J		mg/kg
			Phenanthrene	1.5			mg/kg

<i>Location</i>	<i>Sample Name</i>	<i>Sample Depth (feet)</i>	<i>Compound</i>	<i>Result</i>	<i>Qualifier</i>	<i>Modifier</i>	<i>Units</i>	
E2SC-03	CS0615	6-15	Pyrene	0.99			mg/kg	
			2,4-Dimethylphenol	0.058	J		mg/kg	
			2-Methylnaphthalene	0.33	J		mg/kg	
			Acenaphthene	2.2			mg/kg	
			Acenaphthylene	0.21	J		mg/kg	
			Anthracene	0.3	J		mg/kg	
			Benzo(a)anthracene	0.31	J		mg/kg	
			Benzo(b)fluoranthene	0.29	J		mg/kg	
			Benzo(k)fluoranthene	0.11	J		mg/kg	
			bis(2-Ethylhexyl) phthalate	0.24	J		mg/kg	
	Chrysene	0.34	J		mg/kg			
	Dibenzofuran	0.11	J		mg/kg			
	Fluoranthene	0.8			mg/kg			
	Fluorene	1			mg/kg			
	Naphthalene	5		D	mg/kg			
	Phenanthrene	2.2			mg/kg			
	Pyrene	0.76			mg/kg			
	CS4448	44-48	2-Methylnaphthalene	1800			D	mg/kg
			Acenaphthene	130				mg/kg
			Acenaphthylene	1300			D	mg/kg
Anthracene			530				mg/kg	
Benzo(a)anthracene			370				mg/kg	
Benzo(a)pyrene			320				mg/kg	
Benzo(b)fluoranthene			210				mg/kg	
Benzo(ghi)perylene			160				mg/kg	
Benzo(k)fluoranthene			100				mg/kg	
Chrysene			320				mg/kg	
Dibenz(a,h)anthracene			41	J			mg/kg	
Dibenzofuran			67	J			mg/kg	
Fluoranthene			830			D	mg/kg	
Fluorene			780			D	mg/kg	
Indeno(1,2,3-cd)pyrene			130				mg/kg	
Naphthalene			4600			D	mg/kg	
Phenanthrene			2400			D	mg/kg	
Pyrene			1200			D	mg/kg	

E2SC-03I

Monday, January 11, 1999

Page 3 of 11

<i>Location</i>	<i>Sample Name</i>	<i>Sample Depth (feet)</i>	<i>Compound</i>	<i>Result</i>	<i>Qualifier</i>	<i>Modifier</i>	<i>Units</i>
			2-Methylnaphthalene	34000			mg/kg
			Acenaphthene	3800			mg/kg
			Acenaphthylene	19000			mg/kg
			Acetophenone	160	J		mg/kg
			Anthracene	8500			mg/kg
			Benzo(a)anthracene	5500			mg/kg
			Benzo(a)pyrene	4500			mg/kg
			Benzo(b)fluoranthene	2800			mg/kg
			Benzo(ghi)perylene	1100	J		mg/kg
			Benzo(k)fluoranthene	1300	J		mg/kg
			Chrysene	4800			mg/kg
			Dibenz(a,h)anthracene	320	J		mg/kg
			Dibenzofuran	770	J		mg/kg
			Fluoranthene	11000			mg/kg
			Fluorene	11000			mg/kg
			Indeno(1,2,3-cd)pyrene	980	J		mg/kg
			N-Nitrosodiphenylamine	110	J		mg/kg
			Naphthalene	110000			mg/kg
			Phenanthrene	32000			mg/kg
			Pyrene	15000			mg/kg
<i>E2SC-04</i>							
	CS0615	6-15					
			bis(2-Ethylhexyl) phthalate	0.14	J	D	mg/kg
<i>E2SC-05</i>							
	CS0615	6-15					
			2-Methylnaphthalene	0.64			mg/kg
			Acenaphthene	0.1	J		mg/kg
			Acenaphthylene	0.84			mg/kg
			Acetophenone	0.021	J		mg/kg
			Anthracene	2			mg/kg
			Benzo(a)anthracene	0.49			mg/kg
			Benzo(a)pyrene	0.45			mg/kg
			Benzo(b)fluoranthene	0.33	J		mg/kg
			Benzo(ghi)perylene	0.12	J		mg/kg
			Benzo(k)fluoranthene	0.16	J		mg/kg
			bis(2-Ethylhexyl) phthalate	0.17	J		mg/kg
			Chrysene	0.53			mg/kg
			Dibenzofuran	0.055	J		mg/kg

Location	Sample Name	Sample Depth (feet)	Compound	Result	Qualifier	Modifier	Units
			Fluoranthene	1			mg/kg
			Fluorene	0.73			mg/kg
			Indeno(1,2,3-cd)pyrene	0.1	J		mg/kg
			Naphthalene	0.97			mg/kg
			Phenanthrene	2.8			mg/kg
			Pyrene	1.5			mg/kg
	CS3840	38-40	2-Methylnaphthalene	3.1		D	mg/kg
			Acenaphthene	3.5		D	mg/kg
			Acenaphthylene	1.6			mg/kg
			Anthracene	2.4			mg/kg
			Benzo(a)anthracene	1.4			mg/kg
			Benzo(a)pyrene	1.2			mg/kg
			Benzo(b)fluoranthene	0.87			mg/kg
			Benzo(ghi)perylene	0.22	J		mg/kg
			Benzo(k)fluoranthene	0.38			mg/kg
			bis(2-Ethylhexyl) phthalate	0.14	J		mg/kg
			Chrysene	1.2			mg/kg
			Dibenz(a,h)anthracene	0.06	J		mg/kg
			Dibenzofuran	0.28	J		mg/kg
			Fluoranthene	2.6		D	mg/kg
			Fluorene	2.8		D	mg/kg
			Indeno(1,2,3-cd)pyrene	0.21	J		mg/kg
			Naphthalene	4.3		D	mg/kg
			Phenanthrene	9.1		D	mg/kg
			Pyrene	4.5		D	mg/kg
E2SC-06							
	CS0615	6-15	2,4-Dimethylphenol	11	J		mg/kg
			2-Methylnaphthalene	4400		D	mg/kg
			3-Methylphenol & 4-Methyl	19	J		mg/kg
			Acenaphthene	340			mg/kg
			Acenaphthylene	4400		D	mg/kg
			Anthracene	8100		D	mg/kg
			Benzo(a)anthracene	1100	J	D	mg/kg
			Benzo(a)pyrene	590			mg/kg
			Benzo(b)fluoranthene	730			mg/kg
			Benzo(ghi)perylene	240			mg/kg
			Benzo(k)fluoranthene	300			mg/kg

<i>Location</i>	<i>Sample Name</i>	<i>Sample Depth (feet)</i>	<i>Compound</i>	<i>Result</i>	<i>Qualifier</i>	<i>Modifier</i>	<i>Units</i>
			Chrysene	1200	J	D	mg/kg
			Dibenz(a,h)anthracene	66	J		mg/kg
			Dibenzofuran	200			mg/kg
			Fluoranthene	2500		D	mg/kg
			Fluorene	2700		D	mg/kg
			Indeno(1,2,3-cd)pyrene	230			mg/kg
			Naphthalene	12000		D	mg/kg
			Phenanthrene	8200		D	mg/kg
			Phenol	7.9	J		mg/kg
			Pyrene	4300		D	mg/kg
<i>E2SC-07</i>							
	CS0615	6-15					
			2-Methylnaphthalene	0.12	J		mg/kg
			Acenaphthene	0.5			mg/kg
			Acenaphthylene	0.4			mg/kg
			Anthracene	0.52			mg/kg
			Benzo(a)anthracene	0.25	J		mg/kg
			Benzo(a)pyrene	0.22	J		mg/kg
			Benzo(b)fluoranthene	0.16	J		mg/kg
			Benzo(ghi)perylene	0.059	J		mg/kg
			Benzo(k)fluoranthene	0.067	J		mg/kg
			bis(2-Ethylhexyl) phthalate	0.23	J		mg/kg
			Chrysene	0.24	J		mg/kg
			Dibenzofuran	0.053	J		mg/kg
			Fluoranthene	0.56			mg/kg
			Fluorene	0.45			mg/kg
			Indeno(1,2,3-cd)pyrene	0.053	J		mg/kg
			Naphthalene	0.67			mg/kg
			Phenanthrene	1.2			mg/kg
			Pyrene	0.49			mg/kg
<i>E2SC-08</i>							
	CS0615	6-15					
			1,4-Dichlorobenzene	2.4			mg/kg
			2-Methylnaphthalene	4.6	J		mg/kg
			Acenaphthene	17			mg/kg
			Acenaphthylene	3	J		mg/kg
			Anthracene	19			mg/kg
			Benzo(a)anthracene	19			mg/kg
			Benzo(a)pyrene	15			mg/kg



<i>Location</i>	<i>Sample Name</i>	<i>Sample Depth (feet)</i>	<i>Compound</i>	<i>Result</i>	<i>Qualifier</i>	<i>Modifier</i>	<i>Units</i>
			Benzo(b)fluoranthene	17			mg/kg
			Benzo(ghi)perylene	6.2	J		mg/kg
			Benzo(k)fluoranthene	7.5	J		mg/kg
			bis(2-Ethylhexyl) phthalate	1.4	J		mg/kg
			Chrysene	20			mg/kg
			Di-n-butyl phthalate	0.96	J		mg/kg
			Dibenz(a,h)anthracene	2.1	J		mg/kg
			Dibenzofuran	7.7	J		mg/kg
			Fluoranthene	56			mg/kg
			Fluorene	19			mg/kg
			Indeno(1,2,3-cd)pyrene	6.5	J		mg/kg
			Naphthalene	5.3	J		mg/kg
			Phenanthrene	79			mg/kg
			Pyrene	38			mg/kg
<i>E2SC-09</i>							
	CS0615	6-15					
			1,4-Dichlorobenzene	1	J		mg/kg
			2,4-Dimethylphenol	0.26	J		mg/kg
			2-Methylnaphthalene	0.37	J		mg/kg
			Acenaphthene	2.3			mg/kg
			Benzo(a)anthracene	0.86	J		mg/kg
			Benzo(a)pyrene	0.76	J		mg/kg
			Benzo(b)fluoranthene	0.84	J		mg/kg
			Benzo(k)fluoranthene	0.4	J		mg/kg
			bis(2-Ethylhexyl) phthalate	0.2	J		mg/kg
			Chrysene	1	J		mg/kg
			Fluoranthene	1.9			mg/kg
			Indeno(1,2,3-cd)pyrene	0.18	J		mg/kg
			Naphthalene	2.4			mg/kg
			Pyrene	1.5	J		mg/kg
<i>E2SC-10</i>							
	CS0106	1-6					
			2-Methylnaphthalene	0.19	J		mg/kg
			Acenaphthene	0.11	J		mg/kg
			Acenaphthylene	0.25	J		mg/kg
			Anthracene	0.17	J		mg/kg
			Benzo(a)anthracene	0.15	J		mg/kg
			Benzo(a)pyrene	0.12	J		mg/kg
			Benzo(b)fluoranthene	0.14	J		mg/kg

<i>Location</i>	<i>Sample Name</i>	<i>Sample Depth (feet)</i>	<i>Compound</i>	<i>Result</i>	<i>Qualifier</i>	<i>Modifier</i>	<i>Units</i>
			Benzo(k)fluoranthene	0.059	J		mg/kg
			bis(2-Ethylhexyl) phthalate	0.21	J		mg/kg
			Chrysene	0.14	J		mg/kg
			Fluoranthene	0.43			mg/kg
			Fluorene	0.22			mg/kg
			Naphthalene	0.31	J		mg/kg
			Phenanthrene	0.79			mg/kg
			Pyrene	0.32	J		mg/kg
<i>E2SC-11</i>							
	CS0615	6-15					
			bis(2-Ethylhexyl) phthalate	0.13	J		mg/kg
<i>E2SC-12</i>							
	CS0615	6-15					
			1,3-Dichlorobenzene	0.13	J		mg/kg
			1,4-Dichlorobenzene	0.66			mg/kg
			2-Methylnaphthalene	0.28	J		mg/kg
			Acenaphthene	0.38	J		mg/kg
			Acenaphthylene	0.15	J		mg/kg
			Anthracene	0.42	J		mg/kg
			Benzo(a)anthracene	0.54			mg/kg
			Benzo(a)pyrene	0.46			mg/kg
			Benzo(b)fluoranthene	0.55			mg/kg
			Benzo(ghi)perylene	0.084	J		mg/kg
			Benzo(k)fluoranthene	0.24	J		mg/kg
			bis(2-Ethylhexyl) phthalate	0.066	J		mg/kg
			Chrysene	0.66			mg/kg
			Di-n-butyl phthalate	0.089	J		mg/kg
			Fluoranthene	1.2			mg/kg
			Fluorene	0.31			mg/kg
			Indeno(1,2,3-cd)pyrene	0.089	J		mg/kg
			Naphthalene	0.18	J		mg/kg
			Phenanthrene	1.5			mg/kg
			Pyrene	1.1			mg/kg
<i>E2SC-13</i>							
	CS0516	6-15					
			Anthracene	0.035	J		mg/kg
			Benzo(a)anthracene	0.089	J		mg/kg
			Benzo(a)pyrene	0.078	J		mg/kg
			Benzo(k)fluoranthene	0.19	J		mg/kg

Location	Sample Name	Sample Depth (feet)	Compound	Result	Qualifier	Modifier	Units
			bis(2-Ethylhexyl) phthalate	0.62			mg/kg
			Chrysene	0.091	J		mg/kg
			Fluoranthene	0.22	J		mg/kg
			Phenanthrene	0.13	J		mg/kg
			Pyrene	0.15	J		mg/kg
E2SC-14	CS0615	6-15					
			bis(2-Ethylhexyl) phthalate	0.28	J		mg/kg
			Di-n-butyl phthalate	0.16	J		mg/kg
E2SC-15	CS0615	6-15					
			Acenaphthylene	0.031	J		mg/kg
			Benzo(a)anthracene	0.043	J		mg/kg
			Benzo(a)pyrene	0.068	J		mg/kg
			Benzo(b)fluoranthene	0.091	J		mg/kg
			bis(2-Ethylhexyl) phthalate	0.032	J		mg/kg
			Chrysene	0.058	J		mg/kg
			Fluoranthene	0.08	J		mg/kg
			Phenanthrene	0.042	J		mg/kg
			Pyrene	0.055	J		mg/kg
E2SC-16	CS0615	6-15					
			2,4-Dimethylphenol	0.22	J		mg/kg
			2-Methylnaphthalene	0.84			mg/kg
			2-Methylphenol	0.067	J		mg/kg
			3-Methylphenol & 4-Methyl	0.26	J		mg/kg
			Acenaphthene	0.38			mg/kg
			Acenaphthylene	2.4			mg/kg
			Anthracene	4.5		D	mg/kg
			Benzo(a)anthracene	5.8		D	mg/kg
			Benzo(a)pyrene	2.2			mg/kg
			Benzo(ghi)perylene	0.26	J		mg/kg
			Benzo(k)fluoranthene	3.1	J	D	mg/kg
			bis(2-Ethylhexyl) phthalate	0.22	J		mg/kg
			Chrysene	5.1		D	mg/kg
			Di-n-butyl phthalate	0.098	J		mg/kg
			Dibenzofuran	2.5			mg/kg
			Fluoranthene	14		D	mg/kg
			Fluorene	2			mg/kg

<i>Location</i>	<i>Sample Name</i>	<i>Sample Depth (feet)</i>	<i>Compound</i>	<i>Result</i>	<i>Qualifier</i>	<i>Modifier</i>	<i>Units</i>
			Indeno(1,2,3-cd)pyrene	0.44			mg/kg
			Naphthalene	0.96			mg/kg
			Phenanthrene	17		D	mg/kg
			Pyrene	11		D	mg/kg
<i>E2SC-16I</i>							
	CS4042	40-42					
			2-Methylnaphthalene	210			mg/kg
			Acenaphthylene	140			mg/kg
			Anthracene	55		J	mg/kg
			Benzo(a)anthracene	36		J	mg/kg
			Benzo(a)pyrene	32		J	mg/kg
			Benzo(ghi)perylene	10		J	mg/kg
			Chrysene	32		J	mg/kg
			Fluoranthene	76			mg/kg
			Fluorene	82			mg/kg
			Indeno(1,2,3-cd)pyrene	8.7		J	mg/kg
			Naphthalene	460			mg/kg
			Phenanthrene	240			mg/kg
			Pyrene	110			mg/kg
<i>E2SC-17</i>							
	CS0615	6-15					
			2-Methylnaphthalene	0.2		J	mg/kg
			Acenaphthene	0.47			mg/kg
			Acenaphthylene	0.14		J	mg/kg
			Acetophenone	0.048		J	mg/kg
			Anthracene	0.65			mg/kg
			Benzo(a)anthracene	1.1			mg/kg
			Benzo(a)pyrene	1.1			mg/kg
			Benzo(b)fluoranthene	1.5			mg/kg
			Benzo(ghi)perylene	0.32		J	mg/kg
			Benzo(k)fluoranthene	0.56			mg/kg
			bis(2-Ethylhexyl) phthalate	0.036		J	mg/kg
			Chrysene	1.2			mg/kg
			Dibenz(a,h)anthracene	0.12		J	mg/kg
			Dibenzofuran	0.19		J	mg/kg
			Fluoranthene	1.9			mg/kg
			Fluorene	0.67			mg/kg
			Indeno(1,2,3-cd)pyrene	0.35		J	mg/kg
			Naphthalene	1.9			mg/kg

<i>Location</i>	<i>Sample Name</i>	<i>Sample Depth (feet)</i>	<i>Compound</i>	<i>Result</i>	<i>Qualifier</i>	<i>Modifier</i>	<i>Units</i>
			Phenanthrene	2.1			mg/kg
			Pyrene	1.6			mg/kg
	CS4244	42-44	2-Methylnaphthalene	990			mg/kg
			Acenaphthene	62	J		mg/kg
			Acenaphthylene	730			mg/kg
			Anthracene	300			mg/kg
			Benzo(a)anthracene	200			mg/kg
			Benzo(a)pyrene	170	J		mg/kg
			Benzo(b)fluoranthene	120	J		mg/kg
			Benzo(ghi)perylene	36	J		mg/kg
			Benzo(k)fluoranthene	52	J		mg/kg
			Chrysene	170	J		mg/kg
			Dibenzofuran	33	J		mg/kg
			Fluoranthene	440			mg/kg
			Fluorene	420			mg/kg
			Indeno(1,2,3-cd)pyrene	34	J		mg/kg
			Naphthalene	1700		D	mg/kg
			Phenanthrene	1200			mg/kg
			Pyrene	540			mg/kg

**Qualifier**

J For organics, result is between MDL and RL.

**Modifier**

D Dilution

DUP Duplicate Sample

**Table 2-7 Detected Dioxin and Furan Concentration Data.**

<i>Location</i>	<i>Sample Name</i>	<i>Sample Depth</i>	<i>Compound</i>	<i>Result</i>	<i>Qualifier</i>	<i>Units</i>
E2SC-01	CS0615	6-15	1,2,3,4,6,7,8-HpCDD	0.000055	j	ug/kg
			HpCDDs (total)	0.000097		ug/kg
			OCDD	0.000091		ug/kg
			TCDFs (total)	6.1E-07		ug/kg
E2SC-02	CS0615	6-15	1,2,3,4,6,7,8-HpCDD	0.000043	j	ug/kg
			1,2,3,4,6,7,8-HpCDF	0.000014		ug/kg
			1,2,3,4,7,8,9-HpCDF	0.000012		ug/kg
			1,2,3,4,7,8-HxCDF	0.000016		ug/kg
			2,3,7,8-TCDF	0.000017	g	ug/kg
			HpCDDs (total)	0.000091		ug/kg
			HpCDFs (total)	0.000046		ug/kg
			HxCDDs (total)	0.000053		ug/kg
			HxCDFs (total)	0.000031		ug/kg
			OCDD	0.000017		ug/kg
			OCDF	0.000047		ug/kg
			PeCDFs (total)	0.000014		ug/kg
			TCDDs (total)	0.000012		ug/kg
			TCDFs (total)	0.000052		ug/kg
E2SC-03	CS0615	6-15	1,2,3,4,6,7,8-HpCDD	0.00004		ug/kg
			1,2,3,4,6,7,8-HpCDF	0.00012		ug/kg
			1,2,3,4,7,8,9-HpCDF	0.000022		ug/kg
			1,2,3,4,7,8-HxCDF	0.000028		ug/kg
			1,2,3,6,7,8-HxCDD	0.000046	j	ug/kg
			1,2,3,7,8,9-HxCDD	0.000004	j	ug/kg
			2,3,4,6,7,8-HxCDF	0.000067		ug/kg
			2,3,4,7,8-PeCDF	0.000005	j	ug/kg
			2,3,7,8-TCDF	0.000045	g	ug/kg
			HpCDDs (total)	0.000078		ug/kg
			HpCDFs (total)	0.00025		ug/kg
			HxCDDs (total)	0.000034		ug/kg
			HxCDFs (total)	0.00018		ug/kg
			OCDD	0.00033		ug/kg
			OCDF	0.00011		ug/kg
			PeCDFs (total)	0.000085		ug/kg
			TCDFs (total)	0.000037		ug/kg
OCDD	0.000024		ug/kg			

<i>Location</i>	<i>Sample Name</i>	<i>Sample Depth</i>	<i>Compound</i>	<i>Result</i>	<i>Qualifier</i>	<i>Units</i>
<i>E2SC-04</i>	CS0615	6-15	TCDDs (total)	0.0000091		ug/kg
			1,2,3,4,6,7,8-HpCDD	0.0000032	j	ug/kg
			HpCDDs (total)	0.000007		ug/kg
			HpCDFs (total)	0.0000041		ug/kg
			HxCDFs (total)	0.0000012		ug/kg
<i>E2SC-05</i>	CS0615	6-15	OCDD	0.000032		ug/kg
			2,3,7,8-TCDF	0.0000033	g	ug/kg
			HxCDFs (total)	0.0000045		ug/kg
			PeCDFs (total)	0.000014		ug/kg
			TCDFs (total)	0.000016		ug/kg
<i>E2SC-06</i>	CS0615	6-15	OCDD	0.0000088	j	ug/kg
<i>E2SC-08</i>	CS0615	6-15	1,2,3,4,6,7,8-HpCDD	0.0027		ug/kg
			1,2,3,4,6,7,8-HpCDF	0.0034	E	ug/kg
			1,2,3,4,7,8,9-HpCDF	0.00057		ug/kg
			1,2,3,4,7,8-HxCDD	0.00011		ug/kg
			1,2,3,4,7,8-HxCDF	0.00074		ug/kg
			1,2,3,6,7,8-HxCDD	0.00017		ug/kg
			1,2,3,6,7,8-HxCDF	0.00021		ug/kg
			1,2,3,7,8,9-HxCDD	0.00014		ug/kg
			1,2,3,7,8,9-HxCDF	0.000014		ug/kg
			1,2,3,7,8-PeCDD	0.000071		ug/kg
			1,2,3,7,8-PeCDF	0.000063		ug/kg
			2,3,4,6,7,8-HxCDF	0.00023		ug/kg
			2,3,4,7,8-PeCDF	0.000097		ug/kg
			2,3,7,8-TCDD	0.000016		ug/kg
			2,3,7,8-TCDF	0.00011	g	ug/kg
			HpCDDs (total)	0.0059		ug/kg
			HpCDFs (total)	0.004		ug/kg
			HxCDDs (total)	0.0016		ug/kg
			HxCDFs (total)	0.0083		ug/kg
			OCDD	0.024	E	ug/kg
			OCDF	0.0027		ug/kg
			PeCDDs (total)	0.00018		ug/kg
			PeCDFs (total)	0.0065		ug/kg
			TCDDs (total)	0.00059		ug/kg
			TCDFs (total)	0.0018		ug/kg

*E2SC-09* CS0615 6-15

Monday, January 11, 1999

Page 2 of 6

<i>Location</i>	<i>Sample Name</i>	<i>Sample Depth</i>	<i>Compound</i>	<i>Result</i>	<i>Qualifier</i>	<i>Units</i>
			1,2,3,4,6,7,8-HpCDD	0.0011		ug/kg
			1,2,3,4,6,7,8-HpCDF	0.0042	E	ug/kg
			1,2,3,4,7,8,9-HpCDF	0.00034		ug/kg
			1,2,3,4,7,8-HxCDD	0.000068		ug/kg
			1,2,3,4,7,8-HxCDF	0.00033		ug/kg
			1,2,3,6,7,8-HxCDD	0.00011		ug/kg
			1,2,3,6,7,8-HxCDF	0.000084		ug/kg
			1,2,3,7,8,9-HxCDD	0.00012		ug/kg
			1,2,3,7,8,9-HxCDF	0.0000066	j	ug/kg
			1,2,3,7,8-PeCDD	0.000048		ug/kg
			2,3,4,6,7,8-HxCDF	0.000096		ug/kg
			2,3,4,7,8-PeCDF	0.000053		ug/kg
			2,3,7,8-TCDD	0.000021		ug/kg
			2,3,7,8-TCDF	0.000043	g	ug/kg
			HpCDDs (total)	0.0025		ug/kg
			HpCDFs (total)	0.0082		ug/kg
			HxCDDs (total)	0.0024		ug/kg
			HxCDFs (total)	0.0045		ug/kg
			OCDD	0.0075	E	ug/kg
			OCDF	0.0027		ug/kg
			PeCDDs (total)	0.00058		ug/kg
			PeCDFs (total)	0.0023		ug/kg
			TCDDs (total)	0.001		ug/kg
			TCDFs (total)	0.00096		ug/kg
<i>E2SC-10</i>	<i>CS0106</i>	<i>1-6</i>	1,2,3,4,6,7,8-HpCDF	0.0000043	j	ug/kg
			2,3,7,8-TCDF	0.0000033	g	ug/kg
			HpCDFs (total)	0.0000043		ug/kg
			HxCDFs (total)	0.0000043		ug/kg
			OCDD	0.000017		ug/kg
			PeCDFs (total)	0.000011		ug/kg
			TCDFs (total)	0.00003		ug/kg
<i>E2SC-12</i>	<i>CS0615</i>	<i>6-15</i>	1,2,3,4,6,7,8-HpCDD	0.0015		ug/kg
			1,2,3,4,6,7,8-HpCDF	0.0051	E	ug/kg
			1,2,3,4,7,8,9-HpCDF	0.00043		ug/kg
			1,2,3,4,7,8-HxCDD	0.00012		ug/kg
			1,2,3,4,7,8-HxCDF	0.00049		ug/kg
			1,2,3,6,7,8-HxCDD	0.00018		ug/kg
			1,2,3,7,8,9-HxCDD	0.00021		ug/kg

Monday, January 11, 1999

Page 3 of 6



<i>Location</i>	<i>Sample Name</i>	<i>Sample Depth</i>	<i>Compound</i>	<i>Result</i>	<i>Qualifier</i>	<i>Units</i>
			1,2,3,7,8,9-HxCDF	0.0000099		ug/kg
			1,2,3,7,8-PeCDD	0.000085		ug/kg
			1,2,3,7,8-PeCDF	0.00013		ug/kg
			2,3,4,6,7,8-HxCDF	0.00019		ug/kg
			2,3,4,7,8-PeCDF	0.00015		ug/kg
			2,3,7,8-TCDD	0.00005		ug/kg
			2,3,7,8-TCDF	0.00031	g	ug/kg
			HpCDDs (total)	0.0033		ug/kg
			HpCDFs (total)	0.011		ug/kg
			HxCDDs (total)	0.0026		ug/kg
			HxCDFs (total)	0.0076		ug/kg
			OCDD	0.0093	E	ug/kg
			OCDF	0.0036		ug/kg
			PeCDDs (total)	0.00048		ug/kg
			PeCDFs (total)	0.0048		ug/kg
			TCDDs (total)	0.00095		ug/kg
			TCDFs (total)	0.0043		ug/kg
<i>E2SC-13</i>	<i>CS0516</i>	<i>6-15</i>	TCDFs (total)	0.0000016		ug/kg
<i>E2SC-15</i>	<i>CS0615</i>	<i>6-15</i>	1,2,3,4,6,7,8-HpCDF	0.0000035	j	ug/kg
			2,3,7,8-TCDF	0.0000028	g	ug/kg
			HpCDFs (total)	0.0000075		ug/kg
			HxCDFs (total)	0.000022		ug/kg
			OCDD	0.000014		ug/kg
			PeCDFs (total)	0.000043		ug/kg
			TCDFs (total)	0.000024		ug/kg
<i>E2SC-16</i>	<i>CS0615</i>	<i>6-15</i>	1,2,3,4,6,7,8-HpCDD	0.00005		ug/kg
			1,2,3,4,6,7,8-HpCDF	0.00001		ug/kg
			2,3,7,8-TCDF	0.0000039	g	ug/kg
			HpCDDs (total)	0.000095		ug/kg
			HpCDFs (total)	0.000044		ug/kg
			HxCDDs (total)	0.0000092		ug/kg
			HxCDFs (total)	0.000014		ug/kg
			OCDD	0.00097		ug/kg
			OCDF	0.000021		ug/kg
			PeCDFs (total)	0.000021		ug/kg
			TCDDs (total)	0.000032		ug/kg
			TCDFs (total)	0.000033		ug/kg

*E2SC-16I*      *CS4042*      *40-42*

*Monday, January 11, 1999*

*Page 4 of 6*

<i>Location</i>	<i>Sample Name</i>	<i>Sample Depth</i>	<i>Compound</i>	<i>Result</i>	<i>Qualifier</i>	<i>Units</i>
			1,2,3,4,6,7,8-HpCDD	0.0000046	j	ug/kg
			1,2,3,4,6,7,8-HpCDF	0.0000031	j	ug/kg
			1,2,3,4,7,8,9-HpCDF	0	U	ug/kg
			1,2,3,4,7,8-HxCDD	0	U	ug/kg
			1,2,3,4,7,8-HxCDF	0.0000059		ug/kg
			1,2,3,6,7,8-HxCDD	0	U	ug/kg
			1,2,3,6,7,8-HxCDF	0.0000036	j	ug/kg
			1,2,3,7,8,9-HxCDD	0	U	ug/kg
			1,2,3,7,8,9-HxCDF	0	U	ug/kg
			1,2,3,7,8-PeCDD	0	U	ug/kg
			1,2,3,7,8-PeCDF	0	U	ug/kg
			13C-1,2,3,4,6,7,8-HpCD	0		ERCEN
			13C-1,2,3,4,6,7,8-HpCDF	0		ERCEN
			13C-1,2,3,4,7,8-HxCDF	0		ERCEN
			13C-1,2,3,6,7,8-HxCDD	0		ERCEN
			13C-1,2,3,7,8-PeCDD	0		ERCEN
			13C-1,2,3,7,8-PeCDF	0		ERCEN
			13C-2,3,7,8-TCDD	0		ERCEN
			13C-2,3,7,8-TCDF	0		ERCEN
			13C-OCDD	0		ERCEN
			2,3,4,6,7,8-HxCDF	0	U	ug/kg
			2,3,4,7,8-PeCDF	0	U	ug/kg
			2,3,7,8-TCDD	0	U	ug/kg
			2,3,7,8-TCDF	7.8E-07	gj	ug/kg
			HpCDDs (total)	0.0000094		ug/kg
			HpCDFs (total)	0.0000082		ug/kg
			HxCDDs (total)	0.000011		ug/kg
			HxCDFs (total)	0.000021		ug/kg
			OCDD	0.000022		ug/kg
			OCDF	0.000008	j	ug/kg
			PeCDDs (total)	0	U	ug/kg
			PeCDFs (total)	0.0000053		ug/kg
			TCDDs (total)	0.000004		ug/kg
			TCDFs (total)	0.0000031		ug/kg
E2SC-17	CS0615	6-15	2,3,7,8-TCDF	8.9E-07	g, j	ug/kg
			OCDD	0.000058		ug/kg
			TCDDs (total)	0.0000027		ug/kg
			TCDFs (total)	0.0000012		ug/kg

<i>Location</i>	<i>Sample Name</i>	<i>Sample Depth</i>	<i>Compound</i>	<i>Result</i>	<i>Qualifier</i>	<i>Units</i>
-----------------	--------------------	---------------------	-----------------	---------------	------------------	--------------

**Qualifier**

- j* Result is an estimated value that is below the lower calibration limit but above the target detection level.
- g* 2, 3, 7, 8. -TCDF results have been confirmed on a DB-225 column.
- E* Result exceeds calibration range.

**Table 2-8 Detected Metals Soil Concentration Data.**

<i>Location</i>	<i>Sample Name</i>	<i>Sample Depth (feet)</i>	<i>Compound</i>	<i>Result</i>	<i>Qualifier</i>	<i>Modifier</i>	<i>Units</i>
<i>E2SC-01</i>							
	CS0615	6-15	Antimony	0.24	B		mg/kg
			Arsenic	2.7			mg/kg
			Barium	28.6			mg/kg
			Beryllium	0.29	B		mg/kg
			Cadmium	0.083	B		mg/kg
			Chromium	10			mg/kg
			Cobalt	8.8			mg/kg
			Copper	11.1			mg/kg
			Lead	6.9			mg/kg
			Mercury	0.026	B		mg/kg
			Nickel	12.9			mg/kg
			Thallium	1.9			mg/kg
			Vanadium	11			mg/kg
			Zinc	55			mg/kg
	CS3840	38-40	Antimony	0.26	B		mg/kg
			Arsenic	5.7			mg/kg
			Barium	13.8	B		mg/kg
			Beryllium	0.14	B		mg/kg
			Cadmium	0.27	B		mg/kg
			Chromium	10			mg/kg
			Cobalt	12.1			mg/kg
			Copper	22.8			mg/kg
			Lead	6.8			mg/kg
			Nickel	18.1			mg/kg
			Selenium	0.26	B		mg/kg
			Thallium	1.6			mg/kg
			Vanadium	7.6			mg/kg
			Zinc	61.8			mg/kg
<i>E2SC-02</i>							
	CS0615	6-15	Antimony	0.29	B		mg/kg
			Arsenic	3.6			mg/kg
			Barium	31			mg/kg
			Beryllium	0.33	B		mg/kg

<i>Location</i>	<i>Sample Name</i>	<i>Sample Depth (feet)</i>	<i>Compound</i>	<i>Result</i>	<i>Qualifier</i>	<i>Modifier</i>	<i>Units</i>
			Chromium	12.8			mg/kg
			Cobalt	11.1			mg/kg
			Copper	13.4			mg/kg
			Lead	6			mg/kg
			Mercury	0.042	B		mg/kg
			Nickel	16.7			mg/kg
			Selenium	0.89			mg/kg
			Thallium	2			mg/kg
			Vanadium	11.1			mg/kg
			Zinc	58.5			mg/kg
	CS0615D	6-15					
			Antimony	0.61	B	DUP	mg/kg
			Arsenic	7.3		DUP	mg/kg
			Barium	30		DUP	mg/kg
			Beryllium	0.25	B	DUP	mg/kg
			Cadmium	0.48	B	DUP	mg/kg
			Chromium	8.1		DUP	mg/kg
			Cobalt	6.4		DUP	mg/kg
			Copper	25.4		DUP	mg/kg
			Lead	92.5		DUP	mg/kg
			Mercury	0.13		DUP	mg/kg
			Nickel	10.1		DUP	mg/kg
			Selenium	2.6		DUP	mg/kg
			Thallium	2.6		DUP	mg/kg
			Vanadium	7.5		DUP	mg/kg
			Zinc	78.5		DUP	mg/kg
	CS4042	40-42					
			Arsenic	4.3			mg/kg
			Barium	15.3	B		mg/kg
			Beryllium	0.16	B		mg/kg
			Cadmium	0.4	B		mg/kg
			Chromium	6.2			mg/kg
			Cobalt	7.4			mg/kg
			Copper	11.5			mg/kg
			Lead	5.5			mg/kg
			Mercury	0.015	B		mg/kg
			Nickel	12.3			mg/kg
			Thallium	1.6			mg/kg
			Vanadium	6.7			mg/kg

Monday, January 11, 1999

Page 2 of 12

<i>Location</i>	<i>Sample Name</i>	<i>Sample Depth (feet)</i>	<i>Compound</i>	<i>Result</i>	<i>Qualifier</i>	<i>Modifier</i>	<i>Units</i>
			Zinc	59.8			mg/kg
E2SC-03							
	CS0615	6-15					
			Antimony	5.4			mg/kg
			Arsenic	12.3			mg/kg
			Barium	34.1			mg/kg
			Beryllium	0.29	B		mg/kg
			Chromium	32.6			mg/kg
			Cobalt	16.8			mg/kg
			Copper	201			mg/kg
			Lead	477			mg/kg
			Mercury	0.033	B		mg/kg
			Nickel	42			mg/kg
			Selenium	2			mg/kg
			Thallium	4.7			mg/kg
			Vanadium	26			mg/kg
			Zinc	106			mg/kg
	CS4448	44-48					
			Arsenic	9.8			mg/kg
			Barium	21.2	B		mg/kg
			Beryllium	0.091	B		mg/kg
			Chromium	17.7			mg/kg
			Cobalt	11.5			mg/kg
			Copper	19.1			mg/kg
			Lead	8			mg/kg
			Nickel	21.7			mg/kg
			Selenium	0.24	B		mg/kg
			Thallium	2.4			mg/kg
			Vanadium	7.2			mg/kg
			Zinc	50.4			mg/kg
E2SC-031							
			Antimony	0.13	B		mg/kg
			Arsenic	3			mg/kg
			Barium	0.22	B		mg/kg
			Chromium	0.079	B		mg/kg
			Copper	8.7			mg/kg
			Lead	1.3			mg/kg
			Mercury	0.061	B		mg/kg

Monday, January 11, 1999

Page 3 of 12

<i>Location</i>	<i>Sample Name</i>	<i>Sample Depth (feet)</i>	<i>Compound</i>	<i>Result</i>	<i>Qualifier</i>	<i>Modifier</i>	<i>Units</i>
			Mercury	0.051			mg/kg
			Nickel	0.66	B		mg/kg
			Selenium	0.92			mg/kg
			Tin	2.2	B		mg/kg
			Zinc	2.2			mg/kg
<i>E2SC-04</i>							
	CS0615	6-15					
			Antimony	0.29	B		mg/kg
			Arsenic	1.7			mg/kg
			Barium	20.7	B		mg/kg
			Beryllium	0.3	B		mg/kg
			Cadmium	0.079	B		mg/kg
			Chromium	8.5			mg/kg
			Cobalt	8.4			mg/kg
			Copper	7.1			mg/kg
			Lead	2.9			mg/kg
			Mercury	0.013	B		mg/kg
			Nickel	11.5			mg/kg
			Selenium	0.49	B		mg/kg
			Thallium	1.1			mg/kg
			Vanadium	8.6			mg/kg
			Zinc	44.7			mg/kg
<i>E2SC-05</i>							
	CS0615	6-15					
			Antimony	0.29	B		mg/kg
			Arsenic	7.5			mg/kg
			Barium	35.3			mg/kg
			Beryllium	0.37	B		mg/kg
			Cadmium	0.29	B		mg/kg
			Chromium	10.9			mg/kg
			Cobalt	12.8			mg/kg
			Copper	17.3			mg/kg
			Lead	10.7			mg/kg
			Mercury	0.037	B		mg/kg
			Nickel	19.2			mg/kg
			Vanadium	12.1			mg/kg
			Zinc	68.5			mg/kg
	CS3840	38-40					
			Arsenic	3			mg/kg

Monday, January 11, 1999

Page 4 of 12

<i>Location</i>	<i>Sample Name</i>	<i>Sample Depth (feet)</i>	<i>Compound</i>	<i>Result</i>	<i>Qualifier</i>	<i>Modifier</i>	<i>Units</i>
			Barium	8.3	B		mg/kg
			Beryllium	0.065	B		mg/kg
			Cadmium	0.18	B		mg/kg
			Chromium	3.8			mg/kg
			Cobalt	4.2	B		mg/kg
			Copper	8.6			mg/kg
			Lead	4.2			mg/kg
			Mercury	0.012	B		mg/kg
			Nickel	4.4			mg/kg
			Vanadium	3	B		mg/kg
			Zinc	19.6			mg/kg
<i>E2SC-06</i>							
	CS0615	6-15					
			Antimony	0.53	B		mg/kg
			Arsenic	6.3			mg/kg
			Barium	42.1			mg/kg
			Beryllium	0.33	B		mg/kg
			Cadmium	0.45	B		mg/kg
			Chromium	12.4			mg/kg
			Cobalt	8.8			mg/kg
			Copper	23.6			mg/kg
			Lead	47.1			mg/kg
			Mercury	0.064	B		mg/kg
			Nickel	16.2			mg/kg
			Selenium	1.3			mg/kg
			Thallium	2.1			mg/kg
			Vanadium	10			mg/kg
			Zinc	122			mg/kg
<i>E2SC-07</i>							
	CS0615	6-15					
			Antimony	0.16	B		mg/kg
			Arsenic	4.2			mg/kg
			Barium	11.7	B		mg/kg
			Beryllium	0.27	B		mg/kg
			Chromium	6.4			mg/kg
			Cobalt	9.1			mg/kg
			Copper	14.5			mg/kg
			Lead	6.8			mg/kg
			Mercury	0.13			mg/kg



<i>Location</i>	<i>Sample Name</i>	<i>Sample Depth (feet)</i>	<i>Compound</i>	<i>Result</i>	<i>Qualifier</i>	<i>Modifier</i>	<i>Units</i>
			Nickel	12.8			mg/kg
			Thallium	0.84	B		mg/kg
			Vanadium	6.6			mg/kg
			Zinc	37.2			mg/kg
<i>E2SC-08</i>							
	CS0615	6-15					
			Antimony	1.5			mg/kg
			Arsenic	11.3			mg/kg
			Barium	73.2			mg/kg
			Beryllium	0.37	B		mg/kg
			Cadmium	0.86			mg/kg
			Chromium	48.6			mg/kg
			Cobalt	11.2			mg/kg
			Copper	180			mg/kg
			Lead	180			mg/kg
			Mercury	0.69			mg/kg
			Nickel	28			mg/kg
			Selenium	1.4			mg/kg
			Thallium	2.9			mg/kg
			Tin	29.2			mg/kg
			Vanadium	13.5			mg/kg
			Zinc	212			mg/kg
	CS0615 DUP	6-15					
			Antimony	2		DUP	mg/kg
			Arsenic	9.6		DUP	mg/kg
			Barium	78.6		DUP	mg/kg
			Beryllium	0.35		DUP	mg/kg
			Cadmium	1		DUP	mg/kg
			Chromium	47.6		DUP	mg/kg
			Cobalt	12		DUP	mg/kg
			Copper	175		DUP	mg/kg
			Lead	197		DUP	mg/kg
			Mercury	0.43		DUP	mg/kg
			Nickel	29.4		DUP	mg/kg
			Selenium	1.3		DUP	mg/kg
			Thallium	2.9		DUP	mg/kg
			Tin	6.7		DUP	mg/kg
			Vanadium	15.2		DUP	mg/kg
			Zinc	200		DUP	mg/kg

Monday, January 11, 1999

Page 6 of 12

<i>Location</i>	<i>Sample Name</i>	<i>Sample Depth (feet)</i>	<i>Compound</i>	<i>Result</i>	<i>Qualifier</i>	<i>Modifier</i>	<i>Units</i>
<i>E2SC-09</i>							
	CS0615	6-15	Antimony	0.63	B		mg/kg
			Arsenic	8			mg/kg
			Barium	40.5			mg/kg
			Beryllium	0.27	B		mg/kg
			Cadmium	0.65			mg/kg
			Chromium	22.4			mg/kg
			Cobalt	9.5			mg/kg
			Copper	34.7			mg/kg
			Lead	54.4			mg/kg
			Mercury	0.081	B		mg/kg
			Nickel	16.1			mg/kg
			Selenium	0.85			mg/kg
			Thallium	2.1			mg/kg
			Tin	20.6			mg/kg
			Vanadium	11			mg/kg
			Zinc	88.2			mg/kg
<i>E2SC-10</i>							
	CS0106	1-6	Antimony	0.15	B		mg/kg
			Arsenic	5.8			mg/kg
			Barium	15.2	B		mg/kg
			Beryllium	0.14	B		mg/kg
			Chromium	8.3			mg/kg
			Cobalt	10.4			mg/kg
			Copper	20.3			mg/kg
			Lead	9.5			mg/kg
			Mercury	0.013	B		mg/kg
			Nickel	16.2			mg/kg
			Thallium	1.3			mg/kg
			Vanadium	7			mg/kg
			Zinc	52.7			mg/kg
<i>E2SC-11</i>							
	CS0615	6-15	Arsenic	5.1			mg/kg
			Barium	13.1	B		mg/kg
			Beryllium	0.15	B		mg/kg
			Cadmium	0.25	B		mg/kg

<i>Location</i>	<i>Sample Name</i>	<i>Sample Depth (feet)</i>	<i>Compound</i>	<i>Result</i>	<i>Qualifier</i>	<i>Modifier</i>	<i>Units</i>
			Chromium	7.5			mg/kg
			Cobalt	9.5			mg/kg
			Copper	15.2			mg/kg
			Lead	5.3			mg/kg
			Nickel	13.8			mg/kg
			Thallium	1.6			mg/kg
			Vanadium	7.1			mg/kg
			Zinc	51.4			mg/kg
<i>E2SC-12</i>							
	CS0615	6-15					
			Antimony	2.4			mg/kg
			Arsenic	3.6			mg/kg
			Barium	34.3			mg/kg
			Beryllium	0.27	B		mg/kg
			Cadmium	0.71			mg/kg
			Chromium	24.3			mg/kg
			Cobalt	9.7			mg/kg
			Copper	33.2			mg/kg
			Lead	71			mg/kg
			Mercury	0.25			mg/kg
			Nickel	15.9			mg/kg
			Selenium	0.54	B		mg/kg
			Thallium	2			mg/kg
			Vanadium	10.5			mg/kg
			Zinc	105			mg/kg
<i>E2SC-13</i>							
	CS0516	6-15					
			Antimony	0.3	B		mg/kg
			Arsenic	1.7			mg/kg
			Barium	23.3			mg/kg
			Beryllium	0.24	B		mg/kg
			Cadmium	0.13	B		mg/kg
			Chromium	8.9			mg/kg
			Cobalt	7.7			mg/kg
			Copper	7.8			mg/kg
			Lead	5			mg/kg
			Mercury	0.023	B		mg/kg
			Nickel	13.5			mg/kg
			Thallium	2.1			mg/kg

<i>Location</i>	<i>Sample Name</i>	<i>Sample Depth (feet)</i>	<i>Compound</i>	<i>Result</i>	<i>Qualifier</i>	<i>Modifier</i>	<i>Units</i>
			Vanadium	8.4			mg/kg
			Zinc	53.1			mg/kg
<i>E2SC-14</i>							
	CS0615	6-15					
			Antimony	0.13	B		mg/kg
			Arsenic	7.4			mg/kg
			Barium	24.6			mg/kg
			Beryllium	0.28	B		mg/kg
			Cadmium	0.099	B		mg/kg
			Chromium	11.8			mg/kg
			Cobalt	13.4			mg/kg
			Copper	19.2			mg/kg
			Lead	6.4			mg/kg
			Mercury	0.012	B		mg/kg
			Nickel	21			mg/kg
			Thallium	2.7			mg/kg
			Vanadium	10.9			mg/kg
			Zinc	64.9			mg/kg
<i>E2SC-15</i>							
	CS0615	6-15					
			Antimony	0.29	B		mg/kg
			Arsenic	2.1			mg/kg
			Barium	28.3			mg/kg
			Beryllium	0.28	B		mg/kg
			Chromium	9.1			mg/kg
			Cobalt	7.3			mg/kg
			Copper	19.7			mg/kg
			Lead	7.5			mg/kg
			Mercury	0.032	B		mg/kg
			Nickel	12			mg/kg
			Selenium	0.56	B		mg/kg
			Thallium	1.7			mg/kg
			Vanadium	10.2			mg/kg
			Zinc	57.4			mg/kg
<i>E2SC-16</i>							
	CS0615	6-15					
			Antimony	3.4			mg/kg
			Arsenic	13.3			mg/kg
			Barium	168			mg/kg

<i>Location</i>	<i>Sample Name</i>	<i>Sample Depth (feet)</i>	<i>Compound</i>	<i>Result</i>	<i>Qualifier</i>	<i>Modifier</i>	<i>Units</i>
			Beryllium	0.35	B		mg/kg
			Cadmium	0.26	B		mg/kg
			Chromium	46.2			mg/kg
			Cobalt	15.8			mg/kg
			Copper	175			mg/kg
			Lead	181			mg/kg
			Mercury	0.12			mg/kg
			Nickel	55.6			mg/kg
			Thallium	7.1			mg/kg
			Vanadium	41.8			mg/kg
			Zinc	256			mg/kg
<i>E2SC-161</i>							
	CS4042	40-42					
			Antimony	0.29	B		mg/kg
			Arsenic	7.3			mg/kg
			Barium	14.3	B		mg/kg
			Beryllium	0.13	B		mg/kg
			Cadmium	0.27	B		mg/kg
			Chromium	15.4			mg/kg
			Cobalt	11.7			mg/kg
			Copper	19.7			mg/kg
			Lead	10.3			mg/kg
			Mercury	0.012	B		mg/kg
			Nickel	20.2			mg/kg
			Thallium	0.7	B		mg/kg
			Vanadium	7.1			mg/kg
			Zinc	59.9			mg/kg
	CS4042 DUP	40-42					
			Antimony	0.18			mg/kg
			Arsenic	6.4			mg/kg
			Barium	15.9			mg/kg
			Beryllium	0.076			mg/kg
			Cadmium	0.17			mg/kg
			Chromium	13.9			mg/kg
			Cobalt	8			mg/kg
			Copper	16			mg/kg
			Lead	41.6			mg/kg
			Nickel	15.6			mg/kg
			Vanadium	4.8			mg/kg

Monday, January 11, 1999

Page 10 of 12

<i>Location</i>	<i>Sample Name</i>	<i>Sample Depth (feet)</i>	<i>Compound</i>	<i>Result</i>	<i>Qualifier</i>	<i>Modifier</i>	<i>Units</i>			
<i>E2SC-17</i>	CS0615	6-15	Zinc	40.2			mg/kg			
			Antimony	3.3			mg/kg			
			Arsenic	6.5			mg/kg			
			Barium	91.5			mg/kg			
			Beryllium	0.51	B		mg/kg			
			Cadmium	0.15	B		mg/kg			
			Chromium	25.2			mg/kg			
			Cobalt	10.1			mg/kg			
			Copper	74.5			mg/kg			
			Lead	83.5			mg/kg			
			Mercury	0.053	B		mg/kg			
			Nickel	21.4			mg/kg			
			Selenium	0.33	B		mg/kg			
			Vanadium	33.5			mg/kg			
			Zinc	108			mg/kg			
	CS0615 DUP	6-15	Antimony	3.9		DUP	mg/kg			
			Arsenic	6.7		DUP	mg/kg			
			Barium	74.4		DUP	mg/kg			
			Beryllium	0.51		DUP	mg/kg			
			Cadmium	0.19		DUP	mg/kg			
			Chromium	23.3		DUP	mg/kg			
			Cobalt	10.9		DUP	mg/kg			
			Copper	59.9		DUP	mg/kg			
			Lead	49.8		DUP	mg/kg			
			Nickel	22.3		DUP	mg/kg			
			Thallium	0.74		DUP	mg/kg			
			Vanadium	31.1		DUP	mg/kg			
			Zinc	157		DUP	mg/kg			
				CS4244	42-44	Arsenic	7			mg/kg
						Barium	20.6	B		mg/kg
Beryllium	0.15	B					mg/kg			
Cadmium	0.29	B					mg/kg			
Chromium	7.2						mg/kg			
Cobalt	14.8						mg/kg			
Copper	20.3						mg/kg			

Monday, January 11, 1999

Page 11 of 12

<i>Location</i>	<i>Sample Name</i>	<i>Sample Depth (feet)</i>	<i>Compound</i>	<i>Result</i>	<i>Qualifier</i>	<i>Modifier</i>	<i>Units</i>
			Lead	7.3			mg/kg
			Mercury	0.02	B		mg/kg
			Nickel	15.5			mg/kg
			Vanadium	6			mg/kg
			Zinc	52.5			mg/kg

**Qualifier**

J For organics, result is between MDL and RL.

**Modifier**

D Dilution

DUP Duplicate Sample

**Table 2-9 Waterlevel and NAPL Measurements, East Street Area 2 GE Pittsfield, MA.**

<i>Boring</i>	<i>Date Measured</i>	<i>Measuring Point Elevation</i>	<i>Depth to LNAPL</i>	<i>Depth to Water</i>	<i>Groundwater Elevation</i>	<i>LNAPL Thickness</i>	<i>Depth to DNAPL</i>	<i>DNAPL Elevation</i>	<i>Notes</i>
53									
	11/13/98	986.9		15.01	971.89				
	12/10/98	986.9		15.06	971.84				
	12/17/98	986.9		15.18	971.72				
	12/23/98	986.9		14.92	971.98				
	12/30/98	986.9		15.15	971.75				
54									
	12/10/98	985.78		14.33	971.45				
	12/17/98	985.78		14.50	971.28				
	12/23/98	985.78		14.25	971.53				
	12/30/98	985.78		14.41	971.37				
63									
	11/13/98	986.48		15.08	971.40				
	12/10/98	986.48		15.13	971.35				
	12/17/98	986.48		15.30	971.18				
	12/23/98	986.48		14.91	971.57				
	12/30/98	986.48		15.22	971.26				
E2SC-01									
	10/20/98	988.36		16.30	972.06				
	10/22/98	988.36		17.30	971.06				
	10/26/98	988.36		17.69	970.67				
	10/28/98	988.36		16.50	971.86				
	11/4/98	988.36		16.63	971.73				Sheen
	11/6/98	988.36		16.65	971.71				

P:\Projects\GE\Pittsfield\Database\N869DB.RPT\_Prod.Rnd



<i>Boring</i>	<i>Date Measured</i>	<i>Measuring Point Elevation</i>	<i>Depth to LNAPL</i>	<i>Depth to Water</i>	<i>Groundwater Elevation</i>	<i>LNAPL Thickness</i>	<i>Depth to DNAPL</i>	<i>DNAPL Elevation</i>	<i>Notes</i>
	11/9/98	988.36		16.67	971.69				Sheen
	11/13/98	988.36		16.46	971.90				
	11/25/98	988.36		16.66	971.70				
	12/8/98	988.36		16.64	971.72				
	12/17/98	988.36		16.70	971.66				
<i>E2SC-02</i>									
	10/26/98	987.57		22.74	964.83				
	10/28/98	987.57		16.26	971.31				
	11/2/98	987.57		16.10	971.47				
	11/4/98	987.57		16.11	971.46				DNAPL on probe, Sheen
	11/6/98	987.57		16.11	971.46				Sheen
	11/9/98	987.57		16.14	971.43				Sheen
	11/13/98	987.57		15.93	971.64				Sheen
	11/25/98	987.57		16.13	971.44				Sheen
	12/8/98	987.57		16.12	971.45				NAPL Blebs
	12/17/98	987.57		16.18	971.39		42.73	944.84	
<i>E2SC-031</i>									
	10/22/98	982.12		10.29	971.83		40.68	941.44	
	10/26/98	982.12		10.45	971.67		40.35	941.77	
	10/28/98	982.12		10.49	971.63		38.96	943.16	
	11/6/98	982.12		10.59	971.53		38.54	943.58	
	11/10/98	982.12		10.55	971.57		38.72	943.40	
	11/13/98	982.12		10.41	971.71		38.83	943.29	
	11/25/98	982.12		10.57	971.55		38.53	943.59	
	12/8/98	982.12		10.53	971.59		38.82	943.30	
	12/17/98	982.12		10.61	971.51		38.71	943.41	

<i>Boring</i>	<i>Date Measured</i>	<i>Measuring Point Elevation</i>	<i>Depth to LNAPL</i>	<i>Depth to Water</i>	<i>Groundwater Elevation</i>	<i>LNAPL Thickness</i>	<i>Depth to DNAPL</i>	<i>DNAPL Elevation</i>	<i>Notes</i>
<i>E2SC-03S</i>									
	10/26/98	982.15		10.95	971.20				
	10/28/98	982.15		11.03	971.12				
	11/6/98	982.15		11.05	971.10				
	11/10/98	982.15		10.98	971.17				
	11/13/98	982.15		10.87	971.28				
	11/25/98	982.15		10.99	971.16				
	12/8/98	982.15		10.97	971.18				
	12/17/98	982.15		11.04	971.11				
<i>E2SC-04</i>									
	10/20/98	989.11		16.54	972.57				
	10/22/98	989.11		17.40	971.71				
	10/26/98	989.11		16.91	972.20				
	10/28/98	989.11		16.71	972.40				
	11/4/98	989.11		17.28	971.83				Sheen
	11/6/98	989.11		17.27	971.84				
	11/9/98	989.11		17.28	971.83				
	11/13/98	989.11		17.08	972.03				
	11/25/98	989.11		17.28	971.83				
	12/8/98	989.11		17.26	971.85				
	12/17/98	989.11		17.32	971.79				
<i>E2SC-05</i>									
	10/28/98	993.24		21.23	972.01				
	11/2/98	993.24		21.65	971.59				
	11/4/98	993.24		21.41	971.83				
	11/6/98	993.24		21.44	971.80				

<i>Boring</i>	<i>Date Measured</i>	<i>Measuring Point Elevation</i>	<i>Depth to LNAPL</i>	<i>Depth to Water</i>	<i>Groundwater Elevation</i>	<i>LNAPL Thickness</i>	<i>Depth to DNAPL</i>	<i>DNAPL Elevation</i>	<i>Notes</i>
	11/9/98	993.24		21.49	971.75				
	11/13/98	993.24		21.36	971.88				
	11/25/98	993.24		21.51	971.73				
	12/8/98	993.24		21.55	971.69				
	12/17/98	993.24		21.60	971.64				odor and sheen on bottom, sheen and odor
<i>E2SC-06</i>									
	10/26/98	992.49		20.25	972.24				2.5' NAPL on tape, Sheen
	10/28/98	992.49	15.40	20.51	971.98	5.11			
	11/2/98	992.49	21.50	21.90	970.59	0.40			
	11/4/98	992.49	16.90	18.01	974.48	1.11			
	11/6/98	992.49		20.42	972.07				NAPL on probe
	11/9/98	992.49	17.72						Probe will not sink through NAPL.
	11/13/98	992.49	17.73						Probe will not sink through NAPL.
	11/25/98	992.49							Casing appears to be smeared with NAPL., NAPL on probe
<i>E2SC-09</i>									
	10/22/98	984.78		18.05	966.73				
	10/26/98	984.78		13.65	971.13				
	10/28/98	984.78		13.54	971.24				Sheen
	11/6/98	984.78		13.60	971.18				
	11/13/98	984.78		13.32	971.46				Sheen
	11/25/98	984.78		13.55	971.23				
	12/8/98	984.78		13.54	971.24				
	12/17/98	984.78		13.61	971.17				
<i>E2SC-13</i>									

<i>Boring</i>	<i>Date Measured</i>	<i>Measuring Point Elevation</i>	<i>Depth to LNAPL</i>	<i>Depth to Water</i>	<i>Groundwater Elevation</i>	<i>LNAPL Thickness</i>	<i>Depth to DNAPL</i>	<i>DNAPL Elevation</i>	<i>Notes</i>
	10/20/98	989.89		19.82	970.07				
	10/22/98	989.89		17.76	972.13				
	10/26/98	989.89		19.82	970.07				
	10/28/98	989.89		19.81	970.08				
	11/2/98	989.89		18.00	971.89				
	11/4/98	989.89		18.01	971.88				
	11/6/98	989.89		18.01	971.88				
	11/9/98	989.89		18.06	971.83				
	11/13/98	989.89		17.84	972.05				
	11/25/98	989.89		18.04	971.85				
	12/8/98	989.89		18.02	971.87				
	12/17/98	989.89		18.12	971.77				
<i>E2SC-14</i>									
	10/20/98	992.25		19.90	972.35				
	10/22/98	992.25		19.95	972.30				
	10/26/98	992.25		20.04	972.21				
	10/28/98	992.25		19.99	972.26				
	11/2/98	992.25		20.15	972.10				
	11/4/98	992.25		20.15	972.10				
	11/6/98	992.25		20.18	972.07				
	11/9/98	992.25		20.23	972.02				
	11/13/98	992.25		20.01	972.24				
	11/25/98	992.25		20.26	971.99				
	12/8/98	992.25		20.28	971.97				
	12/17/98	992.25		20.34	971.91				
<i>E2SC-16I</i>									

<i>Boring</i>	<i>Date Measured</i>	<i>Measuring Point Elevation</i>	<i>Depth to LNAPL</i>	<i>Depth to Water</i>	<i>Groundwater Elevation</i>	<i>LNAPL Thickness</i>	<i>Depth to DNAPL</i>	<i>DNAPL Elevation</i>	<i>Notes</i>
	11/13/98	987.77		13.99	973.78				Sheen
	11/25/98	987.77		14.86	972.91				
	12/8/98	987.77		14.80	972.97				Trace Sheen
	12/17/98	987.77		15.80	971.97				sheen on probe tip, sheen
<i>E2SC-16S</i>									
	10/20/98	987.69		15.81	971.88				
	10/22/98	987.69		15.92	971.77				
	10/26/98	987.69		16.37	971.32				
	10/28/98	987.69		16.04	971.65				
	11/4/98	987.69		16.19	971.50				Sheen
	11/6/98	987.69		16.13	971.56				
	11/9/98	987.69		16.15	971.54				
	11/13/98	987.69		15.90	971.79				
	11/25/98	987.69		16.11	971.58				
	12/8/98	987.69		16.10	971.59				
	12/17/98	987.69		16.17	971.52				
<i>E2SC-17</i>									
	10/28/98	985.38		13.59	971.79				
	11/4/98	985.38		13.66	971.72		47.90	937.48	
	11/6/98	985.38		13.65	971.73		47.75	937.63	
	11/9/98	985.38		13.66	971.72		47.70	937.68	
	11/13/98	985.38		13.46	971.92		47.57	937.81	
	11/25/98	985.38		13.67	971.71		46.61	938.77	
	12/8/98	985.38		13.65	971.73		45.07	940.31	
	12/17/98	985.38		14.71	970.67		43.85	941.53	

Table 2-10. Summary of detected Appendix IX concentrations in DNAPL sample from monitoring well E2SC-031

COMPOUND	RESULT	QUALIFIER	UNITS	REPORTING LIMIT
<b>Metals</b>				
Antimony	0.13	B	mg/kg	1
Arsenic	3		mg/kg	1
Barium	0.22	B	mg/kg	20
Chromium	0.079	B	mg/kg	1
Copper	8.7		mg/kg	2.5
Lead	1.3		Mg/kg	0.3
Mercury	0.051		mg/kg	0.1
Mercury	0.061	B	mg/kg	0.1
Nickel	0.66	B	mg/kg	4
Selenium	0.92		mg/kg	0.5
Tin	2.2	B	mg/kg	10
Zinc	2.2		mg/kg	2
<b>SVOC</b>				
2-Methylnaphthalene	3400		mg/kg	2000
Acenaphthene	3800		mg/kg	2000
Acenaphthylene	19000		mg/kg	2000
Acetophenone	160	J	mg/kg	2000
Anthracene	8500		mg/kg	2000
Benzo(a)anthracene	5500		mg/kg	2000
Benzo(a)pyrene	4500		mg/kg	2000
Benzo(b)fluoranthene	2800		mg/kg	2000
Benzo(ghi)perylene	1100	J	mg/kg	2000
Benzo(k)fluoranthene	1300	J	mg/kg	2000
Chrysene	4800		mg/kg	2000
Dibenz(a,h)anthracene	320	J	mg/kg	2000
Dibenzofuran	770	J	mg/kg	2000
Fluoranthene	11000		mg/kg	2000
Fluorene	11000		mg/kg	2000

Table 2-10. Continued

COMPOUND	RESULT	QUALIFIER	UNITS	REPORTING LIMIT
Indeno(1,2,3-cd)pyrene	980	J	mg/kg	2000
N-Nitrosodiphenylamine	110	J	mg/kg	2000
Naphthalene	110000		mg/kg	2000
Phenanthrene	32000		mg/kg	2000
Pyrene	15000		mg/kg	2000
<b>VOC</b>				
Benzene	13	J	mg/kg	2.5
Ethylbenzene	53		mg/kg	2.5
Toluene	19		mg/kg	2.5
Xylenes (total)	43		mg/kg	2.5
<b>PCBs</b>				
No PCBs were detected at a reporting limit of 10 mg/kg				
Notes:				
B	For organics, compound found in method blank. For metals, result is between MDL and RL			
J	For organics, result is between MDL and RL			
DUP	Duplicate sample			
P	Preliminary result			















Table 2-11. Total Petroleum Hydrocarbon soil concentration data from shallow borings E2SC-18, E2SC-19 and E2SC-20

BORING	GROUND SURFACE ELEVATION	SAMPLE NUMBER	ELEVATION RANGE	CONCENTRATION (MG/KG)	STAINED	SHAKE TEST <sup>1</sup>
E2SC-18	980.13	SS01	980.13 - 979.13	220	No	No
		SS02	979.13 - 978.13	ND	No	No
		SS03	978.13 - 977.13	310	No	No
		SS04	977.13 - 976.13	170	No	No
		SS05	976.13 - 975.13	210	No	No
		SS06	975.13 - 974.13	61,000	Yes	No
E2SC-19	980.07	SS01	980.07 - 979.07	ND	No	No
		SS02	979.07 - 978.07	ND	No	No
		SS03	978.07 - 977.07	ND	No	No
		SS04	977.07 - 976.07	ND	No	No
		SS05	976.07 - 975.07	ND	No	No
		SS06	975.07 - 974.07	1,700	No	No
		SS07	974.07 - 973.07	4,700	No	No
		SS08	973.07 - 972.07	9,300	Yes	Slight
E2SC-20	980.38	SS01	980.38 - 979.38	ND	No	No
		SS02	979.38 - 978.38	ND	No	No
		SS03	978.38 - 977.38	ND	No	No
		SS04	977.38 - 976.38	ND	No	No
		SS05	976.38 - 975.38	110	No	No
		SS06	975.38 - 974.38	1,900	No	Slight
		SS07	974.38 - 973.38	4,400	No	Slight
		SS08	973.38 - 972.38	10,000	No	Yes

Note: 1. Water shake tests were performed on all samples to evaluate the potential presence of LNAPL residuals. No indicates that none were observed. Yes indicates LNAPL residual was observed and Slight indicates that a slight sheen formed on the water surface during the test.



**EXPLANATION**

-  APPROXIMATE DELINEATION OF FORMER OXBOW H
-  PREVIOUSLY INSTALLED MONITORING WELL
-  PREVIOUSLY INSTALLED OIL RECOVERY CAISSON
-  PREVIOUSLY INSTALLED PUMPING WELL
-  PREVIOUSLY INSTALLED SOIL BORING
-  PREVIOUSLY INSTALLED PIEZOMETER
-  RIVER BANK SAMPLING LOCATION
-  SOURCE CONTROL MONITORING WELL (INSTALLED 1998)
-  SOURCE CONTROL BORING (INSTALLED 1998)
-  980 EXISTING INDEX ELEVATION CONTOUR
-  EXISTING INTERMEDIATE ELEVATION CONTOUR
-  MANHOLE
-  CHAIN LINK FENCE
-  POLE (NON-UTILITY)
-  POLE (OVERHEAD UTILITY)

NOTE: BASE MAP AND ALL DATA LOCATIONS PRIOR TO 1998 PROVIDED BY BLASLAND, BOUCK & LEE. ALL SOURCE CONTROL INVESTIGATION BORINGS AND WELL LOCATIONS PROVIDED BY HILL ENGINEERING.

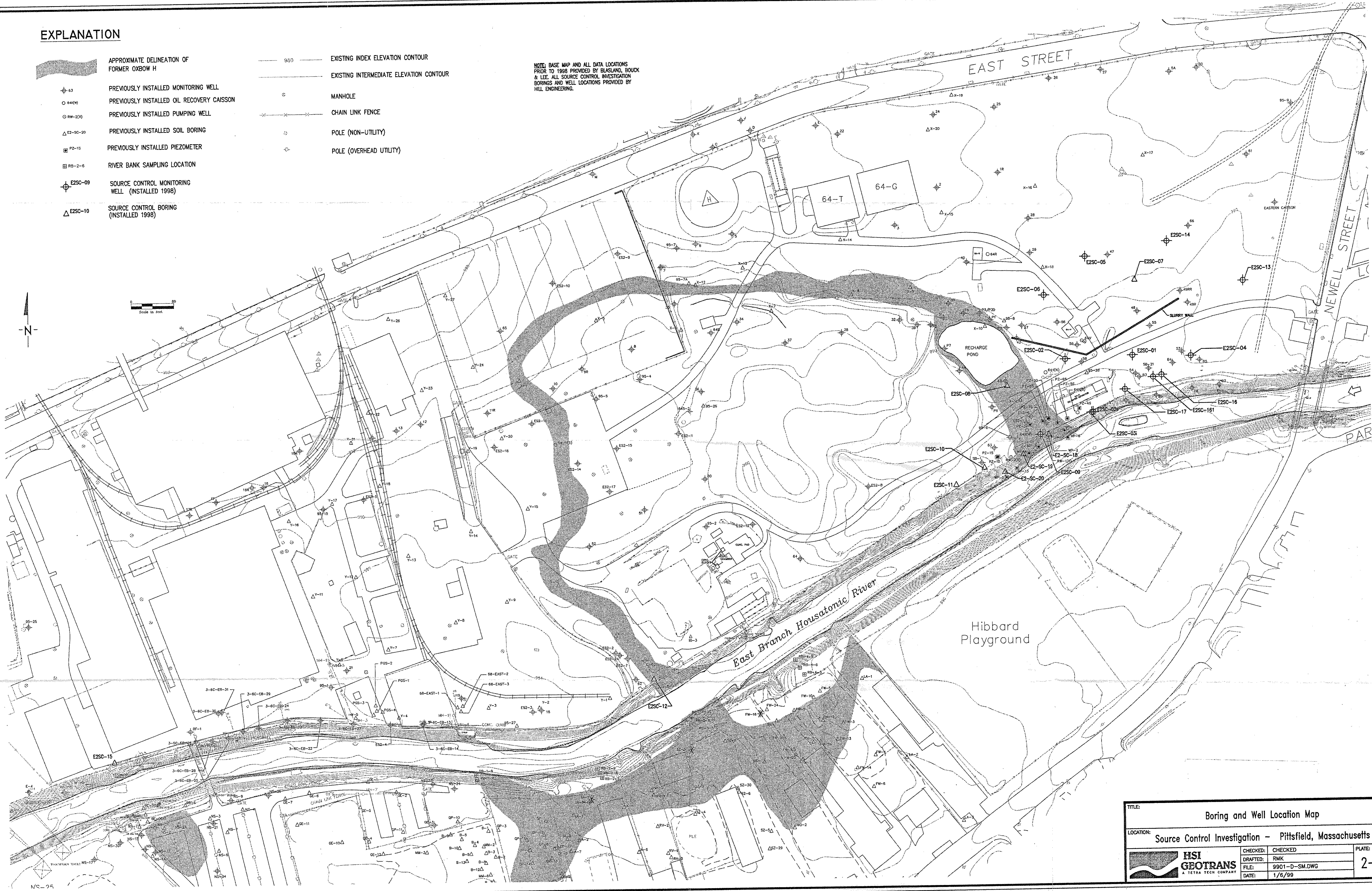

TITLE: Boring and Well Location Map			
LOCATION: Source Control Investigation - Pittsfield, Massachusetts			
	CHECKED: RMK	CHECKED: RMK	PLATE: 2-1
	FILE: 9901-D-SM.DWG	FILE: 9901-D-SM.DWG	
	DATE: 1/6/99	DATE: 1/6/99	

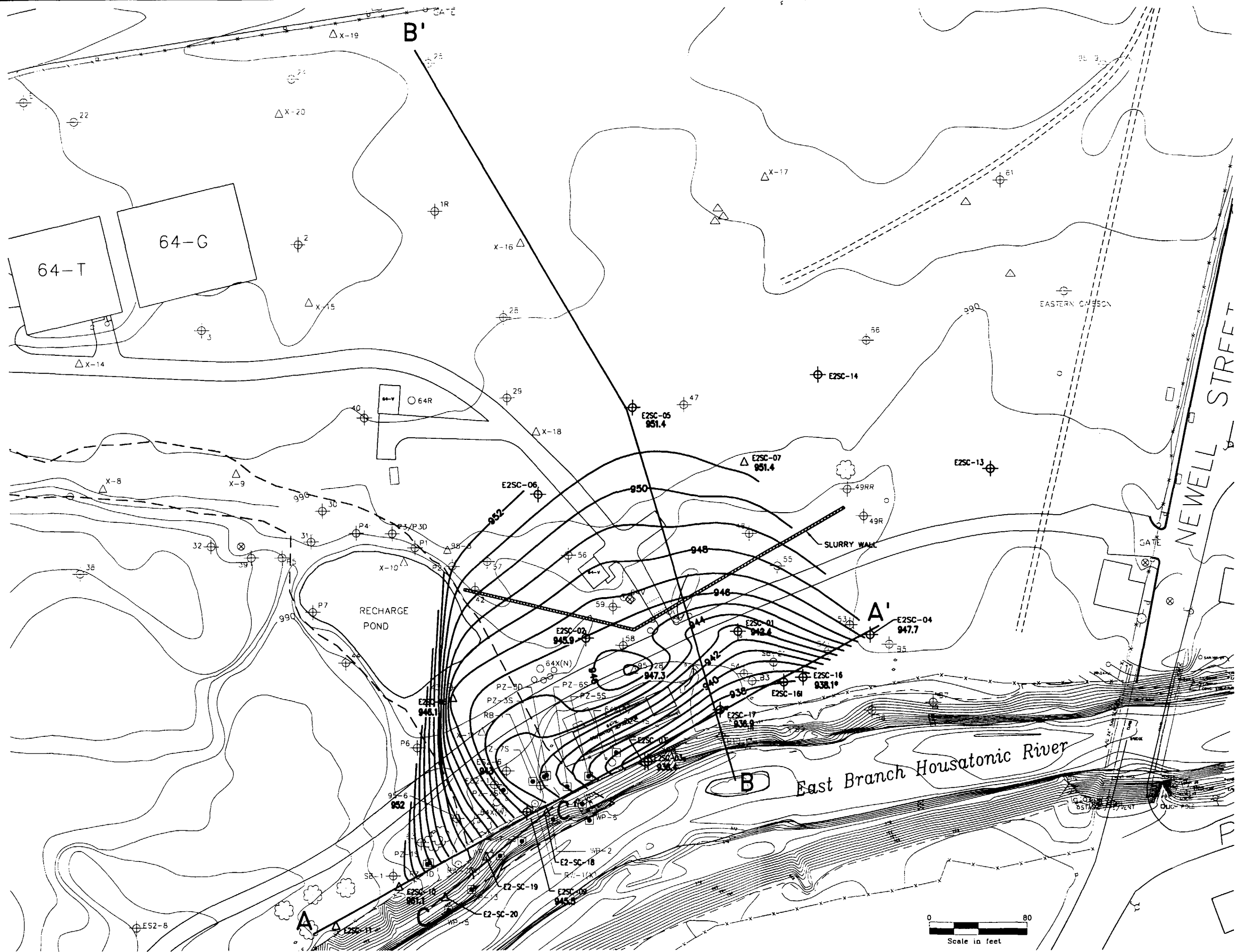

- EXPLANATION**
- A—A'** SECTION LOCATION
  - - - - -** APPROXIMATE DELINEATION OF FORMER OXBOW H
  - ⊕ ES2-1** PREVIOUSLY INSTALLED MONITORING WELL
  - 64X(N)** PREVIOUSLY INSTALLED OIL RECOVERY CAISSON
  - ⊙ RW-1(X)** PREVIOUSLY INSTALLED PUMPING WELL
  - △ X-11** PREVIOUSLY INSTALLED SOIL BORING
  - WP-3** PREVIOUSLY INSTALLED PIEZOMETER
  - ⊕ E2SC-1** SOURCE CONTROL MONITORING WELL (INSTALLED 1998)
  - △ E2SC-7** SOURCE CONTROL BORING (INSTALLED 1998)
  - 961.2** TOP OF TILL ELEVATION
  - 946 —** TOP OF TILL CONTOUR 1 FOOT INTERVAL
  - \*** APPROX. TOP OF TILL ELEVATION

**NOTE:** BASE MAP AND ALL DATA LOCATIONS PRIOR TO 1998 PROVIDED BY BLASLAND, BOUCK & LEE. ALL SOURCE CONTROL INVESTIGATION BORINGS AND WELL LOCATIONS PROVIDED BY HILL ENGINEERING.

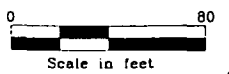
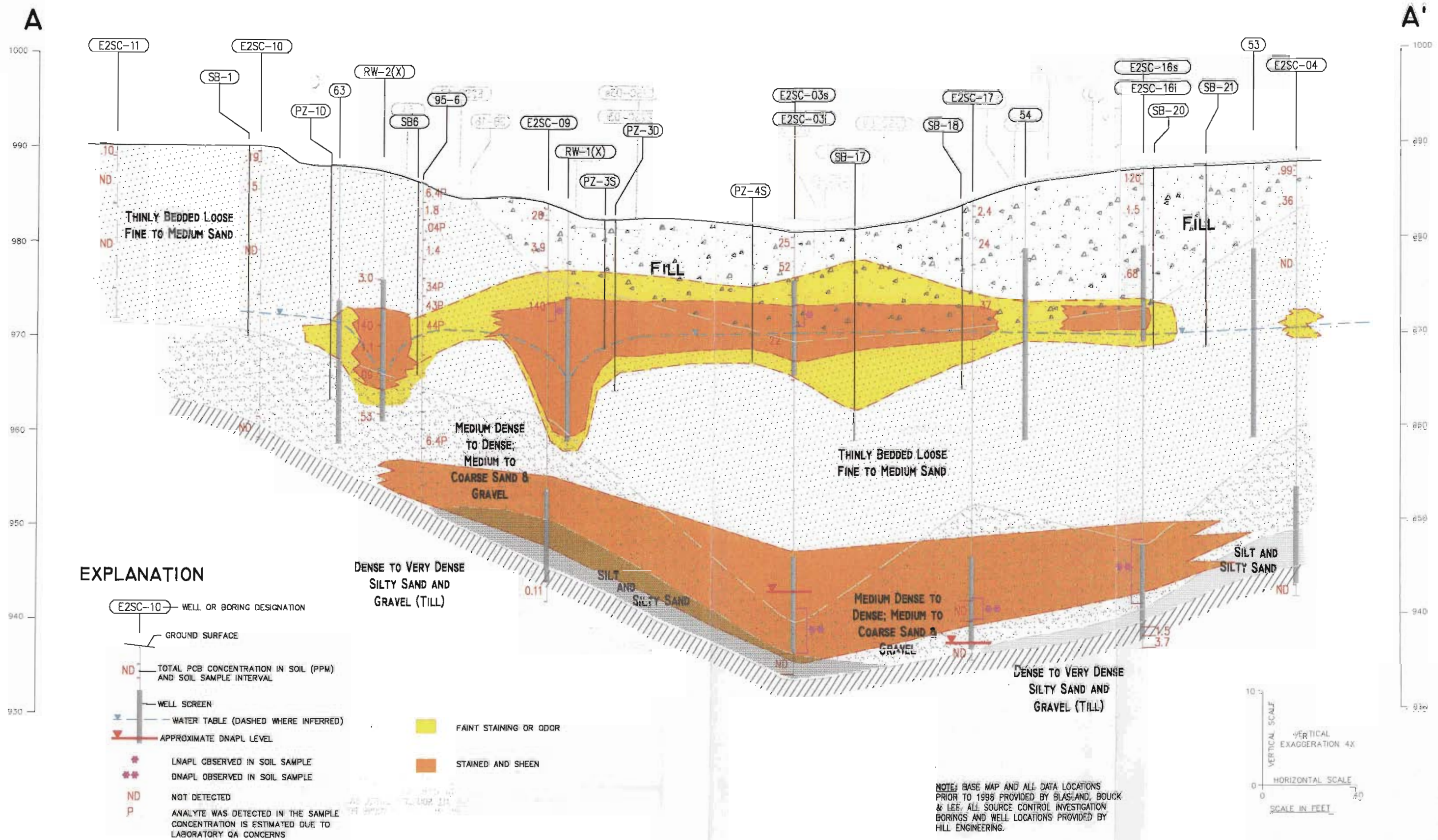

Figure 2-2 Top of Till Contour Map





**EXPLANATION**

E2SC-10 WELL OR BORING DESIGNATION

GROUND SURFACE

ND TOTAL PCB CONCENTRATION IN SOIL (PPM) AND SOIL SAMPLE INTERVAL

WELL SCREEN

WATER TABLE (DASHED WHERE INFERRED)

APPROXIMATE DNAPL LEVEL

LNAPL OBSERVED IN SOIL SAMPLE

DNAPL OBSERVED IN SOIL SAMPLE

ND NOT DETECTED

P ANALYTE WAS DETECTED IN THE SAMPLE CONCENTRATION IS ESTIMATED DUE TO LABORATORY QA CONCERNS

FAINT STAINING OR ODOR

STAINED AND SHEEN

NOTE: BASE MAP AND ALL DATA LOCATIONS PRIOR TO 1998 PROVIDED BY BLASLAND, BOUCK & LEE. ALL SOURCE CONTROL INVESTIGATION BORINGS AND WELL LOCATIONS PROVIDED BY HILL ENGINEERING.

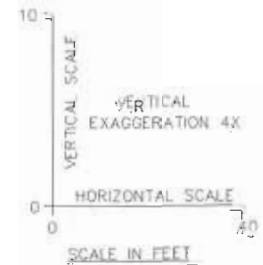

Figure 2-3 Cross-Section A-A'



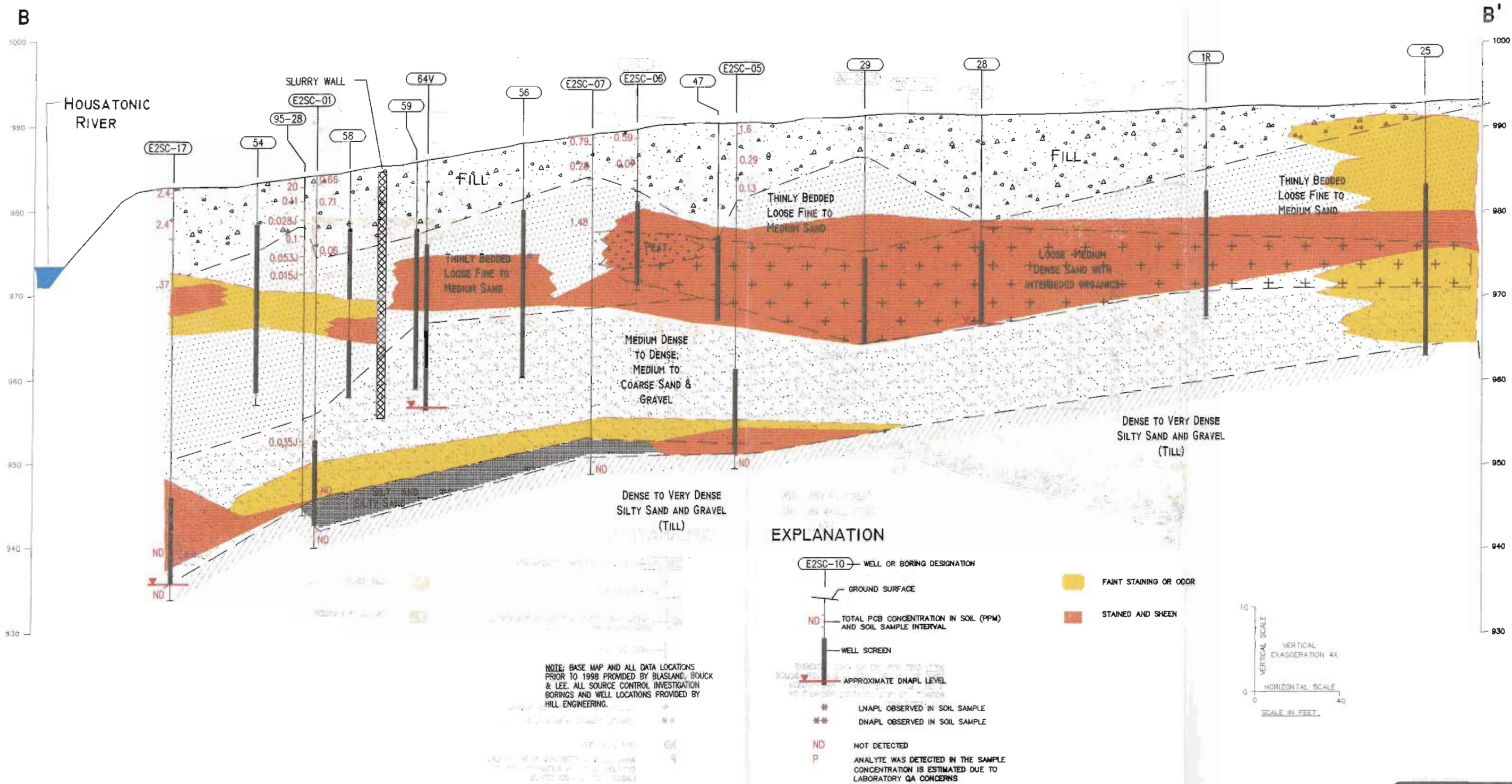











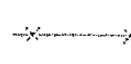



Figure 2-4 Cross-Section B-B'

**EXPLANATION**

-  APPROXIMATE DELINEATION OF FORMER OXBOW H
-  PREVIOUSLY INSTALLED MONITORING WELL
-  PREVIOUSLY INSTALLED OIL RECOVERY CAISSON
-  PREVIOUSLY INSTALLED PUMPING WELL
-  PREVIOUSLY INSTALLED SOIL BORING
-  PREVIOUSLY INSTALLED PIEZOMETER
-  RIVER BANK SAMPLING LOCATION
-  SOURCE CONTROL MONITORING WELL (INSTALLED 1998)
-  SOURCE CONTROL BORING (INSTALLED 1998)
-  950 EXISTING INDEX ELEVATION CONTOUR
-  EXISTING INTERMEDIATE ELEVATION CONTOUR
-  MANHOLE
-  CHAIN LINK FENCE
-  POLE (NON-UTILITY)
-  POLE (OVERHEAD UTILITY)

NOTE: BASE MAP AND ALL DATA LOCATIONS PRIOR TO 1998 PROVIDED BY BASLAND, BOUCK & LEE. ALL SOURCE CONTROL INVESTIGATION BORINGS AND WELL LOCATIONS PROVIDED BY HILL ENGINEERING.

0-1	0.17	TOTAL PCB SOIL CONCENTRATION (mg/kg)
1-6	1.2	
ND		SAMPLE DEPTH (feet)
ND		NOT DETECTED

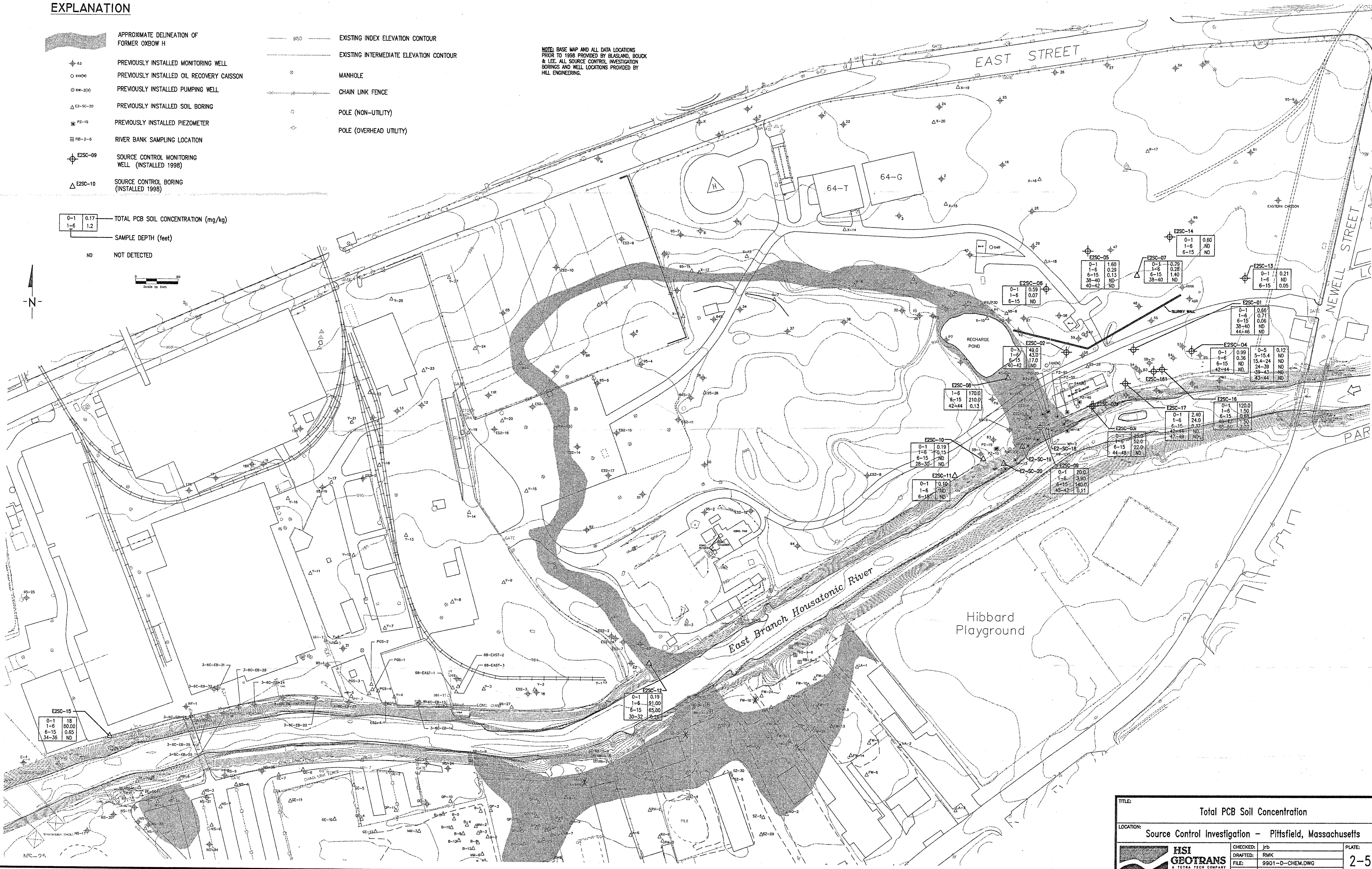
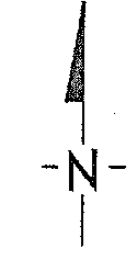
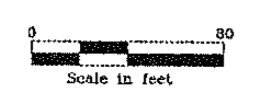

TITLE: Total PCB Soil Concentration			
LOCATION: Source Control Investigation - Pittsfield, Massachusetts			
	CHECKED: jrb	PLATE:	
	DRAFTED: RMK	2-5	
	FILE: 9901-D-CHEM.DWG		
	DATE: 1/8/99		

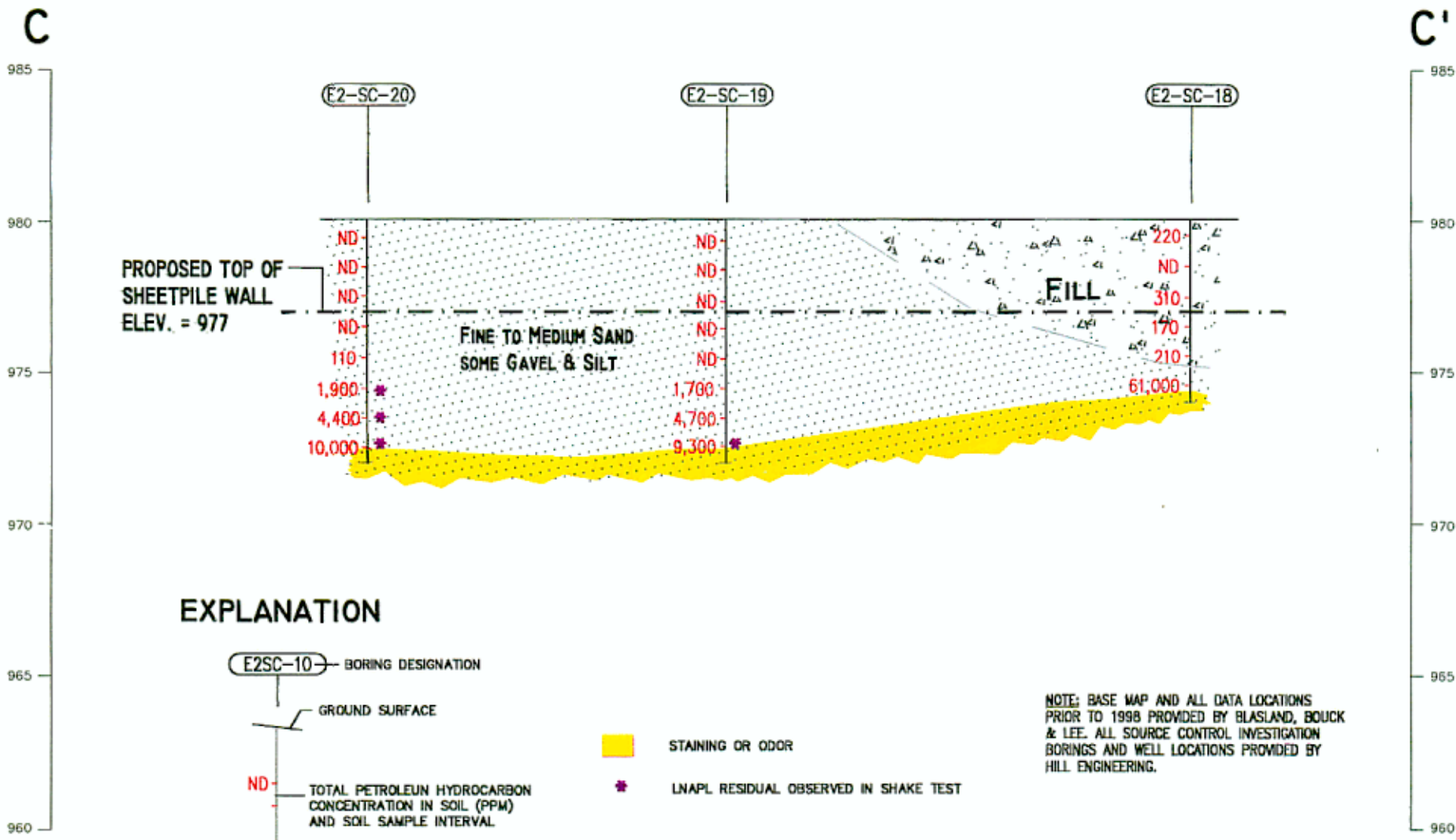

Figure 2-6 Cross-Section C-C'



### 3 CONCLUSIONS

---

The data collected during the 1998 source control field investigations generally confirm the existing information on NAPL distribution at the East Street Area 2 site. The investigations have provided additional detail regarding the stratigraphy configuration of the till surface and DNAPL distribution. The investigations have also provided the data necessary to proceed with the design of the proposed sheet pile barrier along the river. Additional information, such as further drilling and DNAPL pumping tests, to evaluate the nature and extent of the coal tar DNAPL near the river appears warranted.

#### 4 REFERENCES

---

BBL, 1998a. Source Control Work Plan - Upper Reach of Housatonic River (First ½ Mile).  
September 1998.

BBL, 1994. Sampling and Analysis Plan/Data Collection and Analysis Quality Assurance  
Plan, May 1994.

BBL, 1998b. Revised Sampling and Analysis Plan/Data Collection and Analysis Quality  
Assurance Plan, October 1998.

Cohen, R.M. and Mercer, J.W., 1993 DNAPL Site Evaluation, C.K. Smoley, Boca Raton, Fl.

Lamb, T.W., Whitman, R.V., 1969 Soil Mechanics, John Wiley & Sons, New York.



ATTACHMENT A

---

BORING AND WELL CONSTRUCTION LOGS



**BORING/WELL CONSTRUCTION LOG**

PROJECT NUMBER P009-001  
 PROJECT NAME Source Control Upper Reach Housatonic River  
 LOCATION Pittsfield, Massachusetts  
 DRILLING METHOD HSA  
 SAMPLING METHOD SS  
 GROUND ELEVATION 986.42  
 TOP OF CASING 988.36  
 LOGGED BY MJJ  
 REMARKS \_\_\_\_\_

BORING/WELL NUMBER E2SC-01  
 DATE DRILLED 10/14/98  
 CASING TYPE/DIAMETER 2" PVC  
 SCREEN TYPE/SLOT .010 Slot 2" PVC  
 GRAVEL PACK TYPE #0 Silica Sand  
 GROUT TYPE/QUANTITY Portland/Volclay  
 DEPTH TO WATER \_\_\_\_\_  
 GROUND WATER ELEVATION \_\_\_\_\_

FID (ppm)	BLOW COUNTS	SAMPLE ID.	EXTENT DEPTH (ft. BGL)	U.S.C.S.	GRAPHIC LOG	LITHOLOGIC DESCRIPTION	CONTACT DEPTH	WELL DIAGRAM
1.2	6	SS01				Medium dense, Moderate Brown, SAND w/ little organics, trace gravel, moist, well graded (SW-Pt) (soil horizon).	1.0	<p>Portland / Volclay Grout</p> <p>Bentonite Seal</p>
0.1	6	SS02				Medium dense, Moderate Brown, fine SAND w/ little gravel, moist, well graded, (SW) (poor recovery).	3.0	
1.2	6	SS03				Medium dense, Moderate olive Brown, SAND w/ little gravel, few fines, moist, well graded, (SW).	5.0	
	5	SS04				Same as above.	6.0	
1	2	SS05				Loose, Light to Moderate yellowish Brown, fine SAND w/ little silt, moist, poorly graded, orange mottling, (SP).	8.0	
0	3	SS06				Same as above	10.0	
0	7	SS07				Top 1.2, Same as above. Bottom 0.5', Medium dense, Light olive Brown, fine to medium SAND w/ little silt, moist, poorly graded, laminated (SP).	12.0	
0.6	5	SS08				Medium dense, Light Grey to Medium Brown, Interbedded fine SAND and organic peat w/ little silt, moist (SP-Pt).	14.0	
12	25	SS09				Same as above	15.0	
11	3	SS10				Loose, Light to Moderate Grey, interbedded fine SAND w/organics, wet, well graded, (SP-Pt) (soil horizon).	17.0	
25	3	SS11				Same as above	19.0	
3	2	SS12				Same as above	20.0	
2	4	SS13				Same as above	22.0	
1	6	SS14				Same as above	24.0	
2.5	19	SS15				Medium dense, Brownish Black, medium SAND, wet, well graded, SW, stained.	26.0	
2	4	SS16				Similar too above except, little fines, few gravel	28.0	
3.1	12	SS17				Similar too above except, trace gravel	30.0	
0.6	19	SS18				Top 1.0, Same as above. Bottom .4, Medium dense, Light to Moderate olive Brown, GRAVEL w/ little sand, few silt, wet, well graded, sub-angular (GW).	32.0	
2	14	SS19				Medium dense, Light olive, sandy GRAVEL w/ few fines, wet, well graded, sub-round, (GW).	34.0	
N/A	9	SS20				Medium dense, Grayish Olive, gravelly SAND w/trace silt,	35.0	

BORING\_WELL\_P009\_GPJ\_HSI\_MA\_GDT\_1/11/99

Continued Next Page

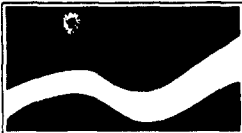

**BORING/WELL CONSTRUCTION LOG**

PROJECT NUMBER P009-001

BORING/WELL NUMBER E2SC-01

PROJECT NAME Source Control Upper Reach Housatonic River

DATE DRILLED 10/14/98

*Continued from Previous Page*

FID (ppm)	BLOW COUNTS	SAMPLE ID.	EXTENT	DEPTH (ft. BGL)	U.S.C.S.	GRAPHIC LOG	LITHOLOGIC DESCRIPTION	CONTACT DEPTH	WELL DIAGRAM
	10	SS21	X				wet, well graded, sub round, Quartz cobbles, (SW-GW).	36.0	<p>#0 Filter Sand            .010 Slot 2"            PVC Schd 40            Screen</p> <p>1' 2" PVC Schd            40 Sump</p> <p>Bentonite Seal</p>
	15						No recovery/ no sample (sluff in spoon has sheen headspace 5.6).	38.0	
63.2	16	SS22	X				Medium dense, Black, gravelly SAND, wet, well graded, heavily stained, sheen, laminated fine sand at tip has faint staining, (SW-GW).	40.0	
	10						Medium dense, Moderate yellowish Brown, fine SAND w/little silt, wet, poorly graded, (SP-SM).	42.0	
	17	SS23	X	40			Similar to above except, trace clay, laminated 1-3mm, tip has angular gravel.	44.0	
0	4						Medium dense, Light olive Brown, SAND w/ some silt, little gravel, trace clay, wet, well graded, (SW-SM), (Till).	46.0	
	11	SS24	X						
	17								
	4	SS25	X	45					
1	9								
	4								
	6								
	6								
	8								
	13								
	12								
	11								

BORING\_WELL\_P009.GPJ HSI\_MA.GDT 1/11/99



**BORING/WELL CONSTRUCTION LOG**

PROJECT NUMBER P009-001  
 PROJECT NAME Source Control Upper Reach Housatonic River  
 LOCATION Pittsfield, Massachusetts  
 DRILLING METHOD HSA  
 SAMPLING METHOD SS  
 GROUND ELEVATION 985.93  
 TOP OF CASING 987.57  
 LOGGED BY MJJ  
 REMARKS \_\_\_\_\_

BORING/WELL NUMBER E2SC-02  
 DATE DRILLED 10/23/98  
 CASING TYPE/DIAMETER 2" PVC  
 SCREEN TYPE/SLOT .010 Slot 2" PVC  
 GRAVEL PACK TYPE #0 Silica Sand  
 GROUT TYPE/QUANTITY Portland/Volclay  
 DEPTH TO WATER \_\_\_\_\_  
 GROUND WATER ELEVATION \_\_\_\_\_

FID (ppm)	BLOW COUNTS	SAMPLE ID.	EXTENT DEPTH (ft. BGL)	U.S.C.S.	GRAPHIC LOG	LITHOLOGIC DESCRIPTION	CONTACT DEPTH	WELL DIAGRAM
0	4	SS02				Medium dense, Moderate olive Brown, fine SAND w/ some subangular gravel, few fines, dry, well graded, (SW).	3.0	
0.2	6	SS03				Dense, Light - Moderate olive Brown, SAND w/ little subangular gravel, few fines, dry, well graded, (SW).	5.0	
2.2	8	SS04	5			Same as above	6.0	
0.2	2	SS05				Top 1.0 Medium dense, Light olive Brown, clayey SILT w/ wood fragments, dry, poorly graded, (CL- ML). Bottom .3 Medium dense, Moderate olive Brown, medium SAND, moist, poorly graded, SP.	8.0	
0	4	SS06				Loose, Olive Grey, medium - fine SAND w/ few fines, trace organics, dry, graded, laminated, (SP), (native).	10.0	
0.4	2	SS07	10			Loose, Olive Grey, organic fine SAND w/ trace fines, moist, graded, wood fragments, faint organic odor (SW-SM).	12.0	
32	2	SS08				Top 1.4 Similar to above except, Interbedded. Bottom .3 Similar too above except, Loose, wet, petroleum odor, free product, (light yellow).	14.0	
56	4	SS09				Loose, Olive Grey, fine SAND w/ little gravel, few organic (wood fragments), wet, faint odor, black staining in finer zones, (SW).	15.0	
80	4	SS10	15			Loose, Moderate olive Brown, SAND w/ little gravel, few fines, wet, well graded, product observed, strong petroleum odor, (SW).	16.0	
62	3	SS11				Loose, Moderate olive Brown, gravelly SAND w/ trace fines, wet, well graded, subrounded, oil sheen on spoon, (SW-GW).	18.0	
50	3	SS12				Medium Dense, Moderate olive Brown, sandy subrounded GRAVEL w/ few fines, wet, well graded, sheen and odor present, (GW).	20.0	
26	14	SS13	20			Medium Dense, Olive Grey, medium - coarse SAND and subrounded GRAVEL w/ few fines, wet, well graded, (SW-GW).	22.0	
46	4	SS14				No Recovery.	24.0	
32	10	SS15	25			Loose, Olive Grey, medium - coarse SAND, w/ some subround gravel little fines, wet, well graded, (SW).	26.0	
58	13	SS16				Medium Dense, Olive Grey, gravelly SAND, wet, well graded, subround, (SW-GW).	28.0	
62	12	SS17				Similar to above except, visible NAPL.	30.0	
210	18	SS18	30			Medium Dense, Moderate olive Brown - Grey, fine - medium SAND interbedded w/ gravel, wet, poorly sorted, NAPL present in coarser zones (SW-GW).	32.0	
180	11	SS19				Dense, Moderate olive Brown - Olive Grey, sandy GRAVEL w/ few fines, wet, well graded, subangular, (GW).	34.0	
160	29	SS20				Same as above		

BORING WELL P009.GPJ HSI, MA GDT 1/11/99

Continued Next Page



**BORING/WELL CONSTRUCTION LOG**

PROJECT NUMBER P009-001 BORING/WELL NUMBER E2SC-02  
PROJECT NAME Source Control Upper Reach Housatonic River DATE DRILLED 10/23/98

*Continued from Previous Page*

FID (ppm)	BLOW COUNTS	SAMPLE ID.	EXTENT	DEPTH (ft. BGL)	U.S.C.S.	GRAPHIC LOG	LITHOLOGIC DESCRIPTION	CONTACT DEPTH	WELL DIAGRAM
200	29 29 32 25 15 11	SS21	X				Same as above	36.0	 #0 Filter Sand .010 Slot 2" PVC Schd 40 Screen  1' 2" PVC Schd 40 Sump
16	11 9 15 36 69	SS22	X				Top .2 Same as above. Bottom .2 Medium dense, Olive Grey, fine SAND, wet, graded, product sheen on interior of SS, sample, (SW).	38.0	
			X	40			Top .9 Medium dense, Light - Moderate olive Brown, SILT w/ fine sand, trace clay, wet, poorly graded, (ML). Bottom .4 Dense, light - Light - Moderate olive Brown, silty fine SAND w/ some gravel few clay, wet, well graded, (CLG), (Till).	40.0 42.0	

BORING\_WELL\_P009.GPJ HSI\_MA.GDT 1/11/99



**BORING/WELL CONSTRUCTION LOG**

PROJECT NUMBER P009-001  
 PROJECT NAME Source Control Upper Reach Housatonic River  
 LOCATION Pittsfield, Massachusetts  
 DRILLING METHOD HSA  
 SAMPLING METHOD SS  
 GROUND ELEVATION 980.43  
 TOP OF CASING 982.12  
 LOGGED BY MJJ  
 REMARKS \_\_\_\_\_

BORING/WELL NUMBER E2SC-031  
 DATE DRILLED 10/15/98  
 CASING TYPE/DIAMETER 2" PVC  
 SCREEN TYPE/SLOT .010 Slot 2" PVC  
 GRAVEL PACK TYPE #0 Silica Sand  
 GROUT TYPE/QUANTITY Portland/Volclay  
 DEPTH TO WATER \_\_\_\_\_  
 GROUND WATER ELEVATION \_\_\_\_\_

FID (ppm)	BLOW COUNTS	SAMPLE ID.	EXTENT	DEPTH (ft. BGL)	U.S.C.S.	GRAPHIC LOG	LITHOLOGIC DESCRIPTION	CONTACT DEPTH	WELL DIAGRAM
0.2	3	SS01	X				Very loose, Moderate dark Brown, organic SAND, (SW) (topsoil).	1.0	<p>Portland / Volclay Grout</p> <p>Bentonite Seal</p>
0.2	2	SS02	X				Very loose, Moderate Brown, SAND w/ little gravel, few organics, moist, well graded, faint order, (SW).	3.0	
	2		X						
	2		X						
32	5	SS03	X				Loose, Light-Moderate olive Brown, SAND w/ few gravel, trace fines, moist, well graded, (SW), (Fill) (poor recovery).	5.0	
	5		X						
	4		X						
N/A	3	SS04	X	5			No Recovery.	6.0	
	3		X						
6.8	5	SS05	X				Top .3 Loose, Moderate olive Brown, SAND w/ few gravel, trace fines, dry, well graded, (SW). Bottom .4 Medium dense, Black, Coal Ash and slag, dry, well graded, fractured from drive, (Fill).	8.0	
	3		X						
	25		X						
28	11	SS06	X				Medium dense, Black, SAND w/ little gravel, trace fines, few wood fragments, moist to wet, well graded, heavily stained sheen present on soil (w/ NAPL), (SW).	10.0	
	16		X						
	9		X						
	13		X						
32	2	SS07	X	10			Loose, Black, SAND w/ NAPL, sheen on spoon (poor recovery), (FILL).	12.0	
	2		X						
	3		X						
38	6	SS08	X				Black, medium - fine SAND, wet, poorly graded, heavily stained sheen on spoon and sample, (SP).	14.0	
	5		X						
	4		X						
	5		X						
10	1	SS09	X				Top .4 Same as above. Bottom .3 Very loose, Olive gray, medium SAND, moist, faint staining, (SW).	15.0	
	2		X						
N/A	2	SS10	X	15			No Recovery.	17.0	
	1		X						
	3		X						
13.2	3	SS11	X				Loose, Light olive Brown, fine SAND, wet, poorly graded, finely laminated, (SP).	19.0	
	3		X						
	3		X						
N/A	4	SS12	X				Same as above.	20.0	
	3		X						
N/A	4	SS13	X	20			Loose, Light olive Brown, fine SAND w/ few silt, wet, poorly graded, finely laminated 1-4 mm, (SM).	22.0	
	4		X						
	4		X						
N/A	5	SS14	X				Same as above.	24.0	
	4		X						
	4		X						
N/A	4	SS15	X				Same as above (loose).	26.0	
	3		X						
	4		X						
	8		X						
N/A	2	SS16	X	25			Same as above (poor recovery due to loose material).	28.0	
	1		X						
	4		X						
N/A	2	SS17	X				Same as above, Trace organics in units.	30.0	
	3		X						
	4		X						
N/A	2	SS18	X	30			Loose, Light olive Brown to Light olive Grey, fine SAND w/ trace fines, poorly graded, laminated 1-3mm, (SM).	32.0	
	3		X						
	4		X						
N/A	3	SS19	X				Same as above.	34.0	
	4		X						
	4		X						
N/A	6		X						
	3	SS20	X				Loose, Light olive Brown, fine SAND w/ few silt, wet,		
			X	35					

BORING\_WELL\_P009\_GPJ\_HSI\_MA\_GDT\_1/11/99

Continued Next Page



**BORING/WELL CONSTRUCTION LOG**

PROJECT NUMBER P009-001 BORING/WELL NUMBER E2SC-031  
 PROJECT NAME Source Control Upper Reach Housatonic River DATE DRILLED 10/15/98

Continued from Previous Page

FID (ppm)	BLOW COUNTS	SAMPLE ID.	EXTENT	DEPTH (ft. BGL)	U.S.C.S.	GRAPHIC LOG	LITHOLOGIC DESCRIPTION	CONTACT DEPTH	WELL DIAGRAM
N/A	4	SS21	X				poorly graded, loose laminated 1-3 mm, (SP).	36.0	<p>#0 Filter Sand            .010 Slot 2" PVC Schd 40 Screen            1' 2" PVC Schd 40 Sump</p>
	6						Same as above.		
N/A	7	SS22	X				Loose, Moderate olive Brown, medium - coarse SAND w/ few fines, wet, well graded, subrounded, heavily stained (DNAPL sheen), (SW).	38.0	
	10								
N/A	4	SS23	X	40			Medium dense, Moderate olive Brown, SAND w/ few gravel, trace fines, wet, well graded, heavily stained, NAPL observed in soil, (SW).	40.0	
	5								
N/A	2	SS24	X				Dense, Moderate - Dark Brown, sandy GRAVEL w/ little fines, wet, well graded, subrounded gravel, heavily stained, (GW-SW).	42.0	
	7								
N/A	14	SS25	X	45			Very dense, Moderate Brown to Moderate olive Brown, gravelly SAND w/ few silt trace clay, moist, well graded, heavily stained (prdt in preferential pathways), (SW-GW).	44.0	
	9								
6	32	SS26	X				Dense, Light Olive, fine SAND w/ little silt, rafted clasts, well graded, (SM).	46.0	
	98								
0	73							47.0	
	103								
	18								
	17								
	15								
	10								

BORING WELL P009 GPJ HSI MA GDT 1/11/99



**BORING/WELL CONSTRUCTION LOG**

PROJECT NUMBER P009-001  
 PROJECT NAME Source Control Upper Reach Housatonic River  
 LOCATION Pittsfield, Massachusetts  
 DRILLING METHOD HSA  
 SAMPLING METHOD SS  
 GROUND ELEVATION 980.57  
 TOP OF CASING 982.15  
 LOGGED BY MJJ  
 REMARKS \_\_\_\_\_

BORING/WELL NUMBER E2SC-03S  
 DATE DRILLED 10/16/98  
 CASING TYPE/DIAMETER 2" PVC  
 SCREEN TYPE/SLOT .010 Slot 2" PVC  
 GRAVEL PACK TYPE #0 Silica Sand  
 GROUT TYPE/QUANTITY Portland/Volclay  
 DEPTH TO WATER \_\_\_\_\_  
 GROUND WATER ELEVATION \_\_\_\_\_

FID (ppm)	BLOW COUNTS	SAMPLE ID.	EXTENT	DEPTH (ft. BGL)	U.S.C.S.	GRAPHIC LOG	LITHOLOGIC DESCRIPTION	CONTACT DEPTH	WELL DIAGRAM
				5 10 15			See Boring Log "E2SC-031"	20.0	<p>Portland / Volclay Grout          Bentonite Seal          #0 Filter Sand .010 Slot 2" PVC Schd 40 Screen          Cave in</p>





**BORING/WELL CONSTRUCTION LOG**

PROJECT NUMBER P009-001  
 PROJECT NAME Source Control Upper Reach Housatonic River  
 LOCATION Pittsfield, Massachusetts  
 DRILLING METHOD HSA  
 SAMPLING METHOD SS  
 GROUND ELEVATION 987.29  
 TOP OF CASING 989.11  
 LOGGED BY MJJ  
 REMARKS \_\_\_\_\_

BORING/WELL NUMBER E2SC-04  
 DATE DRILLED 10/13/98  
 CASING TYPE/DIAMETER 2" PVC  
 SCREEN TYPE/SLOT .010 Slot 2" PVC  
 GRAVEL PACK TYPE #0 Silica Sand  
 GROUT TYPE/QUANTITY Portland/Volclay  
 DEPTH TO WATER \_\_\_\_\_  
 GROUND WATER ELEVATION \_\_\_\_\_

FID (ppm)	BLOW COUNTS	SAMPLE ID.	EXTENT	DEPTH (ft. BGL)	U.S.C.S.	GRAPHIC LOG	LITHOLOGIC DESCRIPTION	CONTACT DEPTH	WELL DIAGRAM
N/A	4	SS01	X				Loose, Moderate - Dark Brown, organic SAND w/ little fines, moist, well graded, brick fragments, (SW) (FILL).	1.0	<p>Portland / Volclay Grout</p> <p>Bentonite Seal</p>
0	4 54	SS02	X				Dense, Light - Moderate olive Brown, SAND w/ little fines, little gravel, moist, well graded, SW, angular, brick and coal fragments. (FILL).	3.0	
0	5 5 5	SS03	X				Loose, Moderate olive Brown, SAND w/ little silt, few gravel, trace coal fragments, moist, well graded, subrounded, (SW) (FILL).	5.0	
0	2 3	SS04	X	5			Very loose, Light - Moderate Brown, fine SAND w/ trace fines, moist, poorly graded, subangular, (SM).	6.0	
2	4 4 4	SS05	X				Loose, Light Brown, fine SAND, moist, poorly graded, subangular, (SM).	8.0	
2.9	4 4 6	SS06	X				Loose, Light yellowish Brown, fine SAND, dry, poorly graded, trace bedding, (SM).	10.0	
3.2	4 6 6	SS07	X	10			Top .8 Same as above. Bottom .7 Loose, Light olive Grey, fine SAND w/ trace silt, dry, poorly graded, subangular, laminated 3-6 mm, (SM).	12.0	
3.1	3 5 4	SS08	X				Loose, Light olive Grey to Moderate yellowish Brown, interbedded fine SAND w/ trace fines, moist, poorly graded, some fine bedded lamination, (SM).	14.0	
3.6	5 3	SS09	X	15			Loose, Moderate yellowish Brown, moderate - fine SAND w/ trace fines, moist, poorly graded, (SM).	15.0	
2.8	3 4 4	SS10	X				Top .2 loose, Moderate yellowish Brown, medium SAND, Bottom .7 Loose, Moderate Grey, medium - coarse SAND, wet, graded, visible staining at WT, (SW).	17.0	
1	4 3 5 6	SS11	X				Loose, Olive Grey, medium SAND w/ coarse interval at top, wet, graded, faint odor present, staining, (SW).	19.0	
N/A	2 3		X	20			No Recovery.	20.0	
0.9	3 4 7	SS12	X				Loose, Light - Moderate olive Grey, fine - medium SAND w/course gravel, wet, graded, (SW).	22.0	
0	2 2 7	SS13	X				Same as above	24.0	
0	6 7 9 10	SS14	X	25			Medium dense, Moderate olive Brown, gravelly SAND w/ little silt, wet, well graded, angular, (SW).	26.0	
0	7 8 11 11	SS15	X				Similar to above except, few - trace fines.	28.0	
0	10 9 11 13	SS16	X				Medium dense, Light olive Grey, sandy GRAVEL w/ trace silt, wet, well graded, sub rounded, (GW-SW).	30.0	
0	9 10 11	SS17	X	30			Same as above.	32.0	
0	5 8 10 9	SS18	X				Similar to above except, trace silt few cobbles, color being lost w/ fines.	34.0	
N/A	20	SS19	X	35			Same as above		

BORING\_WELL\_P009\_GP1\_HSI\_MA\_GDT\_1/11/99

Continued Next Page



**BORING/WELL CONSTRUCTION LOG**

PROJECT NUMBER P009-001

BORING/WELL NUMBER E2SC-04

PROJECT NAME Source Control Upper Reach Housatonic River

DATE DRILLED 10/13/98

*Continued from Previous Page*

FID (ppm)	BLOW COUNTS	SAMPLE ID.	EXTENT	DEPTH (ft. BGL)	U.S.C.S.	GRAPHIC LOG	LITHOLOGIC DESCRIPTION	CONTACT DEPTH	WELL DIAGRAM
	11	SS20	X				Same as above	36.0	
	10							38.0	
0	9	SS21	X				Top .5 Same as above. Bottom .4 medium dense, Light olive Brown, SILT w/ little fine sand, wet, poorly graded, (ML).	40.0	
N/A	6							42.0	
	13							44.0	
	7	SS22	X	40			No Recovery.	46.0	
	6								
1	16	SS23	X				Loose, Light olive Brown, SILT w/ some gravel, few clay, wet, well graded, (ML) (TILL).		
	14								
0	13								
	2	SS23	X				Similar too above except, very dense (TILL).		
	2								
	4								
	3								
	23							45	
	30								
	53								
	42								

BORING\_WELL\_P009.GPJ HSI\_MA.GDT 1/11/99



**BORING/WELL CONSTRUCTION LOG**

PROJECT NUMBER P009-001  
 PROJECT NAME Source Control Upper Reach Housatonic River  
 LOCATION Pittsfield, Massachusetts  
 DRILLING METHOD HSA  
 SAMPLING METHOD SS  
 GROUND ELEVATION 991.42  
 TOP OF CASING 993.24  
 LOGGED BY MJJ  
 REMARKS \_\_\_\_\_

BORING/WELL NUMBER E2SC-05  
 DATE DRILLED 10/26/98  
 CASING TYPE/DIAMETER 2" PVC  
 SCREEN TYPE/SLOT 010 Slot 2" PVC  
 GRAVEL PACK TYPE #0 Silica Sand  
 GROUT TYPE/QUANTITY Portland/Volclay  
 DEPTH TO WATER \_\_\_\_\_  
 GROUND WATER ELEVATION \_\_\_\_\_

FID (ppm)	BLOW COUNTS	SAMPLE ID.	EXTENT	DEPTH (ft. BGL)	U.S.C.S.	GRAPHIC LOG	LITHOLOGIC DESCRIPTION	CONTACT DEPTH	WELL DIAGRAM
0.8	2	SS01	X				Loose, Light olive - Moderate Brown, silty SAND w/ some organics, dry, well graded, subround, (SM).	1.0	<p>Portland / Volclay Grout</p> <p>Bentonite Seal</p> <p>#0 Filter Sand</p>
12	6 20 18 50/4'	SS02	X				Medium dense, Light - Moderate olive Brown, SAND w/ some gravel, few fines, dry, well graded, subangular, (SW).	3.0	
0.6	8	SS03	X				Medium dense, Moderate olive Brown, fine SAND w/ little gravel trace fines, dry, well graded, subangular, (SW), (FILL).	5.0	
10.2	5	SS04	X	5			Same as above.	6.0	
4.5	6	SS05	X				Similar to above w/ limestone cobbles.	8.0	
0	10	SS06	X				Medium dense, Light olive Brown, fine SAND w/ some gravel, some fines, dry, well graded, (SW), (FILL).	10.0	
7	7 4 5 5 4	SS07	X	10			Top .1 Same as above, Bottom 1.3 Medium dense, Olive Grey, silty SAND w/ few organics (roots) trace gravel, moist, graded, (SM), (native).	12.0	
8	4	SS08	X				Medium dense, Olive Grey, sandy SILT w/ few clay, trace gravel, moist, well graded, (SM).	14.0	
1.5	4	SS09	X				Medium Dense, Olive Grey, sandy GRAVEL w/ few fines, moist, well graded, faint odor (GM).	15.0	
17	9	SS10	X	15			Medium dense, Olive Grey, sandy GRAVEL w/ trace fines, moist, well graded, subangular, faint odor (GW-SW).	17.0	
13	10	SS11	X				Top .3 Same as above, Bottom 1.0 Olive Grey, gravelly coarse SAND w/ trace fines, moist, well graded, faint odor (SW-GW).	19.0	
18	11	SS12	X				Medium dense, Olive Grey, gravelly coarse SAND, wet, well graded, (SW-GW).	20.0	
15	15	SS13	X	20			Medium dense, Olive Grey, gravelly coarse SAND, wet, well graded, visible NAPL (SW-GW).	22.0	
5.3	9	SS14	X				Similar too above except, no NAPL	24.0	
5.2	10	SS15	X				Dense, Light olive Grey, sandy GRAVEL, wet, well graded, (GW-SW).	26.0	
4.8	11 16 17 20	SS16	X	25			Dense, Olive Grey, medium - fine SAND w/ trace fines, wet, well graded, (SW).	28.0	
3.2	8	SS17	X				Dense, Olive Grey, gravelly medium SAND, wet, well graded, (SW-GW).	30.0	
4.6	15 20 30	SS18	X	30			Medium dense, Olive Grey, medium - fine SAND some gravel, wet, well graded, subangular (SW-GW).	32.0	
2.8	7	SS19	X				Dense, Moderate dark Grey, medium - fine SAND some gravel, trace fines, wet, well graded, subangular (SW-GW).	34.0	
3	11	SS20	X				Medium dense, Dark Brown - Dark Grey, medium SAND	35.0	

BORING\_WELL\_P009.GPJ HSI\_MA\_GDT\_1/17/99

Continued Next Page



**BORING/WELL CONSTRUCTION LOG**

PROJECT NUMBER P009-001 BORING/WELL NUMBER E2SC-05  
 PROJECT NAME Source Control Upper Reach Housatonic River DATE DRILLED 10/26/98

*Continued from Previous Page*

FID (ppm)	BLOW COUNTS	SAMPLE ID.	EXTENT	DEPTH (ft. BGL)	U.S.C.S.	GRAPHIC LOG	LITHOLOGIC DESCRIPTION	CONTACT DEPTH	WELL DIAGRAM
N/A	12 15 10	SS21	X				w/ few gravel, wet, well graded, slight odor (SW).	36.0	<p>.010 Slot 2" PVC Schd 40 Screen</p> <p>1' 2" PVC Schd 40 Sump</p>
1	17 20 18	SS22	X				Medium dense, Olive Grey, SAND w/ some gravel few fines, wet, well graded, visible NAPL (SW-GW).	38.0	
	25 21		X				Top 0.2 Same as above. Bottom 0.3 Dense, Light olive Brown, sandy SILT, wet, poorly graded, (ML).	40.0	
1.2	33 51	SS23	X	40			Very dense, Light olive Brown, fine sandy SILT w/ little gravel, wet, well graded, angular, (ML) (Till).	42.0	



**BORING/WELL CONSTRUCTION LOG**

PROJECT NUMBER P009-001  
 PROJECT NAME Source Control Upper Reach Housatonic River  
 LOCATION Pittsfield, Massachusetts  
 DRILLING METHOD HSA  
 SAMPLING METHOD SS  
 GROUND ELEVATION 990.46  
 TOP OF CASING 992.49  
 LOGGED BY MJJ  
 REMARKS

BORING/WELL NUMBER E2SC-06  
 DATE DRILLED 10/24/98  
 CASING TYPE/DIAMETER 2" PVC  
 SCREEN TYPE/SLOT .010 Slot 2" PVC  
 GRAVEL PACK TYPE #0 Silica Sand  
 GROUT TYPE/QUANTITY Portland/Volclay  
 DEPTH TO WATER \_\_\_\_\_  
 GROUND WATER ELEVATION \_\_\_\_\_

FID (ppm)	BLOW COUNTS	SAMPLE ID.	EXTENT	DEPTH (ft. BGL)	U.S.C.S.	GRAPHIC LOG	LITHOLOGIC DESCRIPTION	CONTACT DEPTH	WELL DIAGRAM
0.2	6	SS01	X				Loose, Moderate olive Brown, SAND w/ some organics, dry, well graded, (SW).	1.0	<p>Portland / Volclay Grout</p> <p>Bentonite Seal</p> <p>#0 Filter Sand</p> <p>.010 Slot 2" PVC Schd 40 Screen</p> <p>1' 2" PVC Schd 40 Sump</p>
0.4	8	SS02	X				Medium dense, Moderate olive Brown, SAND w/ little organics, few slag, few fines, dry, well graded, (SW), (Fill).	3.0	
17	12	SS03	X				Medium dense, Moderate olive Brown, SAND w/ few gravel, trace organics, dry, well graded, (SW), (Fill).	5.0	
15	5	SS04	X	5			Medium dense, Light - Moderate olive Brown, SAND w/ little gravel, few fines, moist, well graded, organic odor (SW).	6.0	
0	10	SS05	X				Medium dense, Moderate olive Brown, SAND w/ some gravel, trace fines, dry, well graded, (SW), (Fill).	8.0	
18	3	SS06	X				Medium dense, Light olive Brown, silty SAND w/ little gravel, wet, well graded, perched water (SW).	10.0	
20	5	SS07	X	10			Medium dense, Light Brown, silty SAND w/ some gravel, wet, graded, sheen (SW).	12.0	
750	3	SS08	X				Top 0.2 Same as above. Middle 0.4 loose, Black, sandy GRAVEL, wet, saturated w/ NAPL (GW-SW). Bottom 0.5 Black, organic peat, saturated w/NAPL, odor.	14.0	
580	4	SS09	X				Same as above (Bottom).	15.0	
410	14	SS10	X	15			Top 0.6 Medium dense, Black - Dark Brown, peat organics (roots), wet, saturated w/ NAPL (PT). Bottom 0.4 sandy GRAVEL, moist, well graded, (GW-SW).	17.0	
180	10	SS11	X				Top 0.3 Black, peat, saturated with NAPL. Middle 0.3 Loose, Olive Grey, clay, moist, poor grading, laminated (CL). Next 0.3 loose, Black - Dark Brown, gravelly SAND, wet, well graded, (SW-GW). Bottom 0.3 loose, Light olive Grey, medium SAND, moist, poorly graded, (SP).	19.0	

BORING\_WELL\_P009.GPJ HSI\_MA\_GDT\_11/1/99



**BORING/WELL CONSTRUCTION LOG**

PROJECT NUMBER P009-001  
 PROJECT NAME Source Control Upper Reach Housatonic River  
 LOCATION Pittsfield, Massachusetts  
 DRILLING METHOD HSA  
 SAMPLING METHOD SS  
 GROUND ELEVATION 989.13  
 TOP OF CASING None  
 LOGGED BY MJJ

BORING/WELL NUMBER E2SC-07  
 DATE DRILLED 10/27/98  
 CASING TYPE/DIAMETER 2" PVC  
 SCREEN TYPE/SLOT .010 Slot 2" PVC  
 GRAVEL PACK TYPE #0 Silica Sand  
 GROUT TYPE/QUANTITY Portland/Volclay  
 DEPTH TO WATER \_\_\_\_\_  
 GROUND WATER ELEVATION \_\_\_\_\_

REMARKS

FID (ppm)	BLOW COUNTS	SAMPLE ID.	EXTENT	DEPTH (ft. BGL)	U.S.C.S.	GRAPHIC LOG	LITHOLOGIC DESCRIPTION	CONTACT DEPTH	WELL DIAGRAM
0.6	3	SS01	X				Loose, Moderate Brown, silty fine SAND w/ some organics trace gravel, dry, well graded, (SW-SM), (soil horizon).	1.0	
0.2	11	SS02	X			Medium dense, Light to Moderate olive Brown, fine SAND w/ some silt, little gravel, trace coal fragments, dry, well graded, (SW-SM), (Fill).	3.0		
1.6	5	SS03	X			Same as above.	5.0		
0	2	SS04	X	5			Loose, Light Brown, fine SAND, dry, poorly graded, (SP).	6.0	
0	3	SS05	X				Loose, Moderate yellowish Brown, fine SAND w/ trace silt, dry, poorly graded, sub-angular (SP).	8.0	
3.8	5	SS06	X				Medium dense, Dusky Yellow - Moderate Brown, interbedded fine SAND w/ trace gravel, dry, well graded, (SW).	10.0	
2	5	SS07	X	10			Loose, Moderate yellowish Brown, gravelly SAND w/ trace fines, dry, well graded, sub-angular (SW).	12.0	
3	5	SS08	X				Similar to above except poor recovery.	14.0	
6	3	SS09	X	15			Loose, Light olive Grey, medium - coarse SAND, moist, graded, faint odor (SP).	15.0	
	3	SS10	X				Loose, Greyish Olive, medium SAND, moist, poorly graded, sub-angular (SP).	17.0	
30	5	SS11	X				Medium dense, Greyish Olive, medium SAND, wet, poorly graded, sub-angular, strong odor, visible NAPL (SP).	19.0	
28	3	SS12	X	20			Top 0.3 loose, Medium - Dark Grey, medium - coarse SAND, wet, poorly graded, sub-angular, visible NAPL (SP). Bottom 0.3 loose, Moderate olive Brown, medium - coarse SAND, wet, poorly graded, sub-angular, no NAPL (SP).	20.0	
15	5	SS13	X				Top 0.2 Same as above (Bottom). Bottom 0.5 medium dense, Light olive Brown, fine SAND w/ some silt, wet, poorly graded, (SP-SM).	22.0	
4	4	SS14	X				Same as above (Bottom).	24.0	
0.7	14	SS15	X	25			Medium dense, Light olive Brown, interbedded SILT - SAND - GRAVEL, wet, wellgraded, sub-angular (GM).	26.0	
6.2	5	SS16	X				Medium dense, Light - Moderate olive Brown, interbedded SILTS - GRAVELS, wet, well graded, sub-angular (GW-GM).	28.0	
3.6	12	SS17	X				Same as above.	30.0	
0	22	SS18	X	30			No Recovery.	32.0	
2.8	10	SS19	X				Medium dense, Moderate olive Brown, medium - fine SAND w/ few silts, wet, poorly graded, sub-angular (SP-ML).	34.0	
0.2	7	SS20	X	35			Dense, Moderate olive Brown, SAND w/ some gravel,		

Continued Next Page

BORING\_WELL\_P009.GPJ HSI\_MA.GDT 1/11/99



**BORING/WELL CONSTRUCTION LOG**

PROJECT NUMBER P009-001 BORING/WELL NUMBER E2SC-07  
 PROJECT NAME Source Control Upper Reach Housatonic River DATE DRILLED 10/27/98

*Continued from Previous Page*

FID (ppm)	BLOW COUNTS	SAMPLE ID.	EXTENT	DEPTH (ft. BGL)	U.S.C.S.	GRAPHIC LOG	LITHOLOGIC DESCRIPTION	CONTACT DEPTH	WELL DIAGRAM
1.2	18 13 14 19	SS21	X				trace fines, wet, well graded, angular, faint staining (SW-GW).	36.0	
0.2	13 14 21 12 16 30 35	SS22	X				Top 0.5 Same as above. Bottom 0.3 medium dense, Light olive Brown, silty fine SAND, wet, poorly graded. (SP-SM).	38.0	
			X	40			Dense, Light olive Brown, silty SAND w/ little gravel, few clay, wet, well graded, angular, (SP_SM) (Till).	40.0	

BORING\_WELL\_P009\_GPJ\_HSI\_MA\_GDT\_1/1/1999



**BORING/WELL CONSTRUCTION LOG**

PROJECT NUMBER P009-001  
 PROJECT NAME Source Control Upper Reach Housatonic River  
 LOCATION Pittsfield, Massachusetts  
 DRILLING METHOD HSA  
 SAMPLING METHOD SS  
 GROUND ELEVATION 986.07  
 TOP OF CASING None  
 LOGGED BY MJJ & BB  
 REMARKS

BORING/WELL NUMBER E2SC-08  
 DATE DRILLED 10/19/98  
 CASING TYPE/DIAMETER None  
 SCREEN TYPE/SLOT None  
 GRAVEL PACK TYPE None  
 GROUT TYPE/QUANTITY Portland/Volclay  
 DEPTH TO WATER \_\_\_\_\_  
 GROUND WATER ELEVATION \_\_\_\_\_

FID (ppm)	BLOW COUNTS	SAMPLE ID.	EXTENT	DEPTH (ft. BGL)	U.S.C.S.	GRAPHIC LOG	LITHOLOGIC DESCRIPTION	CONTACT DEPTH	WELL DIAGRAM
0	8	CS01	X				Loose, Moderate olive Brown, sandy GRAVEL trace fines, moist, well graded, (GW-SW).	1.0	
190	9 14 20 17	SS02	X				Similar to above except wood fragments.	3.0	
70	5 9 50	SS03	X				Loose, Moderate olive Brown, SAND w/ some wood fragments, little fines, well graded, (SW).	5.0	
190	1 6	SS04	X	5			Similar to above (sample recovery poor).	6.0	
62	3 4 3	SS05	X				Loose, Moderate to Dark olive Brown, SAND w/ some gravel, organic fragments (wood), poor recovery, (SW-GW).	8.0	
3.7	4 4 3	SS06	X				Loose, Dark Brown, SAND w/ some organics, moist, well graded, (SW).	10.0	
22	2 1 3	SS07	X	10			Top 0.01 very loose, Moderate - Dark Brown, organics and SAND (SW). Middle 0.01 - 0.9 very loose, Moderate - Dark Brown, fine SAND w/ little silt, moist, heavily stained, petroleum odor (SW). Bottom 0.1 very loose, Moderate - Dark Brown, SILT w/ little sand, moist, heavily stained, petroleum odor (ML).	12.0	
30	7 9 34	SS08	X				Dense, Black, SAND w/ little fines, wet (NAPL), well graded, heavily stained, strong odor (SW).	14.0	
30	5	SS09	X	15			Loose, Light olive Brown, medium - fine SAND, wet, poorly graded, strong odor, sluf is full of NAPL (SP).	15.0	
4.5	3 6 8	SS10	X				Medium dense, Moderate olive Brown, fine SAND few fines, wet, laminations 1-3mm (SP).	17.0	
N/A	7 7	SS11	X				Same as above.	19.0	
N/A	4 3		X				No Recovery.	20.0	
3	4 3 6	SS13	X	20			Loose, Olive gray, fine SAND fines, wet, laminated (SP).	22.0	
2.6	10 6 5	SS14	X				Medium dense, Olive Grey, fine SAND trace gravel and fines, sub-angular (SW).	24.0	
N/A	4 4 6	SS15	X	25			Medium dense, dark olive Gray, subrounded to subangular GRAVEL trace fines, wet, (GM).	26.0	
2.5	6 8 8	SS16	X				Medium dense, Olive Grey, GRAVEL few fines, wet, sub-angular to sub-rounded (GM).	28.0	
N/A	6 8 9		X				No Recovery.	30.0	
N/A	2 1 4		X	30			No Recovery.	32.0	
1	8 9 6	SS19	X				Medium dense, Greyish Olive w/ Greyish Yellow mottling, fine - medium SAND w/ gravel, sub-rounded to sub-angular (SW-GW).	34.0	
N/A	8 6 4	SS20	X				Loose, Greyish Olive, fine - medium SAND and GRAVEL,		

BORING\_WELL\_P009\_GPJ\_HSI\_MA\_GDT\_1/11/99

Continued Next Page





PROJECT NUMBER P009-001

BORING/WELL NUMBER E2SC-08

PROJECT NAME Source Control Upper Reach Housatonic River

DATE DRILLED 10/19/98

*Continued from Previous Page*

FID (ppm)	BLOW COUNTS	SAMPLE ID.	EXTENT	DEPTH (ft. BGL)	U.S.C.S.	GRAPHIC LOG	LITHOLOGIC DESCRIPTION	CONTACT DEPTH	WELL DIAGRAM
0	5	SS21	X				wet, (SW-GW).	36.0	
	4						Top 0.5 loose, Dark yellowish Orange, SAND and GRAVEL trace clays, sub-angular (SW-GW). Bottom 0.25 loose, Brownish Black, GRAVEL trace sand, sub-angular to sub-rounded (GP).	38.0	
0.4	8	SS22	X				Medium dense, Light olive Grey, fine SAND some gravel, some fines, sub-angular (SW-GW).	40.0	
	8								
0.4	10	SS23	X	40			Dense, Light olive Grey, silty SAND w/ little clay and gravel, sub-angular to angular (SW-ML).	42.0	
	15								
N/A	16		X				Same as above.	44.0	
	12		X						
	14		X						
	23		X						
	24		X						
	28		X						
	37		X						
	37		X						
	39		X						

BORING\_WELL\_P009.GPJ HSI\_MA\_GDT 1/11/99



**BORING/WELL CONSTRUCTION LOG**

PROJECT NUMBER P009-001  
 PROJECT NAME Source Control Upper Reach Housatonic River  
 LOCATION Pittsfield, Massachusetts  
 DRILLING METHOD HSA  
 SAMPLING METHOD SS  
 GROUND ELEVATION 983.48  
 TOP OF CASING 984.78  
 LOGGED BY BB

BORING/WELL NUMBER E2SC-09  
 DATE DRILLED 10/21/98  
 CASING TYPE/DIAMETER 2" PVC  
 SCREEN TYPE/SLOT .010 Slot 2" PVC  
 GRAVEL PACK TYPE #0 Silica Sand  
 GROUT TYPE/QUANTITY Portland/Volclay  
 DEPTH TO WATER \_\_\_\_\_  
 GROUND WATER ELEVATION \_\_\_\_\_

REMARKS \_\_\_\_\_

FID (ppm)	BLOW COUNTS	SAMPLE ID.	EXTENT	DEPTH (ft. BGL)	U.S.C.S.	GRAPHIC LOG	LITHOLOGIC DESCRIPTION	CONTACT DEPTH	WELL DIAGRAM
N/A	3	CS01					Very loose, Dark yellowish Brown, clayey SILT, dry, OL.	1.0	<p>Portland / Volclay Grout</p> <p>Bentonite Seal</p> <p>#0 Filter Sand</p>
10	5	SS02				Loose, Greyish Brown, clayey SILT trace pebbels, dry, (OL).	3.0		
0	3	SS03				Loose, Greyish Brown, clayey SILT some gravel, trace sand, dry, (ML-GM).	5.0		
0.2	4	SS04		5		Loose, Brownish Black, sandy clayey SILT trace gravel, coal ash and brick fragments, (ML-SM).	6.0		
6	7	SS05				Loose, Pale Olive, SILT and very fine SAND trace clay, trace gravel root fragments, (ML-SM).	8.0		
36	3	SS06				Loose, Light olive Grey, fine SAND some silt, trace clay root fragments, slight odor (SM).	10.0		
28	2	SS07		10		Top 1.0 Same as above. Middle 0.5 loose, Olive Grey, SILT some sand, (SM) Bottom 0.5 loose, Black, SAND, wet, LNAPL (SW).	12.0		
26	10	SS08				Medium dense, Black, SAND and GRAVEL, wet, odor (SW-GW).	14.0		
6.5	3	SS09				Loose, Black, medium - coarse SAND and GRAVEL, wet, sheen, odor (SW-GW).	15.0		
6	10	SS10		15		Dense, Light olive Grey, SAND and GRAVEL, wet, sub-angular to sub-rounded (SW-GW).	17.0		
16.5	3	SS11				Medium dense, Pale Olive, SAND some gravel, wet to moist, (SW-GW).	19.0		
6	9	SS12				No Recovery.	20.0		
8	5	SS13		20		Medium Dense, Olive Grey, medium - coarse SAND some gravel, wet, (SW-GW).	22.0		
11	11	SS14				Top 0.5 medium dense, Olive Grey, silty SAND trace gravel, (SM). Bottom 0.5 medium dense, GRAVEL and SAND some silt and clay, (SW-GW).	24.0		
6	8	SS15		25		Medium dense, Light Olive, SAND and GRAVEL some clay, (SW-GW).	26.0		
2	28	SS16				Top 0.5 Same as above. Bottom 1.5 Medium dense, Dark yellowish Orange, GRAVEL and SAND trace silt and clay, (SW-GW).	28.0		
25	21	SS17				Dense, Pale Olive w/ Dark Grey staining, GRAVEL w/ silt, (GM).	30.0		
12	8	SS18		30		Dense, Olive Grey w/ layered dark staining, fine SAND and SILT some gravel, (SM).	32.0		
6	27	SS19				Dense, Greyish Yellow w/ black staining, SILT and GRAVEL, slight sheen (GM).	34.0		
7	8	SS20		35		Dense, Grayish Yellow w/ Black staining, SILT and fine			

Continued Next Page

BORING\_WELL\_P009.GPJ HSI\_MA\_GDT 1/11/99



**BORING/WELL CONSTRUCTION LOG**

PROJECT NUMBER P009-001 BORING/WELL NUMBER E2SC-09  
 PROJECT NAME Source Control Upper Reach Housatonic River DATE DRILLED 10/21/98

*Continued from Previous Page*

FID (ppm)	BLOW COUNTS	SAMPLE ID.	EXTENT	DEPTH (ft. BGL)	U.S.C.S.	GRAPHIC LOG	LITHOLOGIC DESCRIPTION	CONTACT DEPTH	WELL DIAGRAM
4	16 25 28 26 36 18	SS21	X				SAND gravel, (SM). Same as above.	36.0	
8	9 19 13 9	SS22	X			Medium dense, Pale Olive, clayey SILT some gravel, Till (ML).	38.0		
1	6 29 49 52 56	SS23	X	40		Very dense, Olive Gray, SILT some clay and gravel, Till (ML).	40.0		
								42.0	



**BORING/WELL CONSTRUCTION LOG**

PROJECT NUMBER P009-001  
 PROJECT NAME Source Control Upper Reach Housatonic River  
 LOCATION Pittsfield, Massachusetts  
 DRILLING METHOD HSA  
 SAMPLING METHOD SS  
 GROUND ELEVATION 989.19  
 TOP OF CASING None  
 LOGGED BY BB  
 REMARKS \_\_\_\_\_

BORING/WELL NUMBER E2SC-10  
 DATE DRILLED 10/20/98  
 CASING TYPE/DIAMETER None  
 SCREEN TYPE/SLOT None  
 GRAVEL PACK TYPE None  
 GROUT TYPE/QUANTITY Portland/Volclay  
 DEPTH TO WATER \_\_\_\_\_  
 GROUND WATER ELEVATION \_\_\_\_\_

FID (ppm)	BLOW COUNTS	SAMPLE ID	EXTENT	DEPTH (ft. BGL)	U.S.C.S.	GRAPHIC LOG	LITHOLOGIC DESCRIPTION	CONTACT DEPTH	WELL DIAGRAM
1	3	CS01	X				Loose, Moderate olive Grey, silty CLAY some clay root fragments, (CH), (top soil).	1.0	
1	5	SS02	X				Loose, Olive Grey, silty SAND trace clay, (SM).	3.0	
36	4	SS03	X				Top 0.25 loose, Dark Grey to Black, organic granular material, no odor. Bottom 2.5 loose, Olive Grey, fine SAND trace clays, laminated (SM).	5.0	
0.3	5	SS04	X	5			Same as above (Bottom).	6.0	
1	3	SS05	X				Top 0.5 Same as above. Bottom 1.5 loose, Light olive Grey (salt and pepper), medium SAND trace fines, dry, (SW).	8.0	
3.8	6	SS06	X				Medium dense, Light olive Grey, fine - medium SAND and GRAVEL, dry, sub-rounded (SW-GW).	10.0	
1	6	SS07	X	10			Same as above.	12.0	
0	5	SS08	X				Medium dense, Light olive Grey (salt and pepper), medium SAND trace gravel, dry, sub-rounded, some Fe stained laminations, (SW).	14.0	
N/A	7	SS09	X				Same as above.	15.0	
1	8	SS10	X	15			Medium dense, Light olive Grey (salt and pepper), medium - coarse SAND trace gravel and qtz cobbles, (SP).	17.0	
0	6	SS11	X				Loose, Light olive Grey, fine - medium SAND some silt, trace clay, wet, laminations (SM).	19.0	
0.5	3	SS12	X				Top 0.5 Same as above. Bottom 0.5 loose, Light olive Grey (salt and pepper), medium SAND, wet, (SW).	20.0	
0.2	5	SS13	X	20			Top 0.5 Same as above (Bottom). Bottom 1.5 loose, Dark yellowish Orange, medium - coarse SAND some gravel, sub-rounded to sub-angular (SW-GW).	22.0	
0.2	3	SS14	X				Top 0.25 Same as above (Bottom). Bottom 1.5 loose, Pale Olive, GRAVEL trace cobbles, sub-rounded to sub-angular (GW).	24.0	
0.5	11	SS15	X	25			Same as above (Bottom).	26.0	
0	15	SS16	X				Top 1 Dense, Olive Grey, GRAVEL some sand and fines, well graded, (GW-SW). Bottom 1 Same but clay inc. trace sand	28.0	
0	26	SS17	X				Dense, Greyish Olive, SILT and CLAY w/ some gravel and cobbles, well graded, (ML), (Till).	30.0	

BORING WELL P009.GPJ HSI MA.GDT 1/11/99



**BORING/WELL CONSTRUCTION LOG**

PROJECT NUMBER P009-001 BORING/WELL NUMBER E2SC-11  
 PROJECT NAME Source Control Upper Reach Housatonic River DATE DRILLED 10/9/98  
 LOCATION Pittsfield, Massachusetts CASING TYPE/DIAMETER None  
 DRILLING METHOD HSA SCREEN TYPE/SLOT None  
 SAMPLING METHOD SS GRAVEL PACK TYPE None  
 GROUND ELEVATION 990.06 GROUT TYPE/QUANTITY Portland/Volclay  
 TOP OF CASING None DEPTH TO WATER \_\_\_\_\_  
 LOGGED BY MJJ GROUND WATER ELEVATION \_\_\_\_\_  
 REMARKS \_\_\_\_\_

FID (ppm)	BLOW COUNTS	SAMPLE ID.	EXTENT	DEPTH (ft. BGL)	U.S.C.S.	GRAPHIC LOG	LITHOLOGIC DESCRIPTION	CONTACT DEPTH	WELL DIAGRAM
0.2	2	SS01	X				Very loose, Moderate to Dark Brown, medium to fine SAND, w/ some organics, moist, poorly graded, (SP).	1.0	<p>Portland / Volclay Grout</p>
0	3	SS02	X			Medium loose, Moderate yellowish Brown, fine SAND, w/ few interbedded medium sand lenses, (SP).	3.0		
0	6	SS03	X			Similar too above except no medium sand lenses, finely laminated, dry.	5.0		
0	6	SS04	X	5		Same as above.	6.0		
0	5	SS05	X			Same as above.	8.0		
0.4	4	SS06	X			Same as above.	10.0		
0.2	4	SS07	X			Similar too above except, few silt lenses.	12.0		
0	4	SS08	X			Similar too above except, moist.	14.0		
0	4	SS09	X			Similar too above except, wet.	15.0		
0.2	18	SS10	X	15		Same as above.	17.0		
0.2	6								
	7								
	7								
	9								
	11								



**HSI  
GEOTRANS**  
A TETRA TECH COMPANY

**BORING/WELL CONSTRUCTION LOG**

PROJECT NUMBER P009-001  
 PROJECT NAME Source Control Upper Reach Housatonic River  
 LOCATION Pittsfield, Massachusetts  
 DRILLING METHOD HSA  
 SAMPLING METHOD SS  
 GROUND ELEVATION 978.87  
 TOP OF CASING None  
 LOGGED BY MJJ  
 REMARKS \_\_\_\_\_

BORING/WELL NUMBER E2SC-12  
 DATE DRILLED 10/19/98  
 CASING TYPE/DIAMETER None  
 SCREEN TYPE/SLOT None  
 GRAVEL PACK TYPE None  
 GROUT TYPE/QUANTITY Portland/Volclay  
 DEPTH TO WATER \_\_\_\_\_  
 GROUND WATER ELEVATION \_\_\_\_\_

FID (ppm)	BLOW COUNTS	SAMPLE ID.	EXTENT	DEPTH (ft. BGL)	U.S.C.S.	GRAPHIC LOG	LITHOLOGIC DESCRIPTION	CONTACT DEPTH	WELL DIAGRAM
N/A	6	CS01	X			[Cross-hatched]	No Recovery (Pavement).	1.0	[Well Diagram: Portland / Volclay Grout]
N/A	5	SS02	X			[Cross-hatched]	No Recovery.	3.0	
0.2	4	SS03	X			[Dotted]	Loose, Moderate olive Brown, SAND w/ little gravel trace fines, dry, well graded, sub-rounded (SW).	4.5	
	5							5.0	
N/A	1	SS04	X	5		[Dotted]	No Recovery.	6.0	
42	1	SS05	X			[Dotted]	Loose, Moderate - Dark Brown, SAND w/ few organic peat and fines, tip of spoon wet, visably discolored (SW).	3	
	3							8.0	
28	1	SS06	X			[Dotted]	Top 0.6 Same as above. Bottom similar except coarse SAND w/ few gravel trace fines, wet, (SW).	2	
	2							10.0	
14	8	SS07	X	10		[Dotted]	Top 0.4 loose, coarse SAND w/ gravel, (SW). Bottom loose, Moderate to Dark olive Brown, fine SAND w/ trace fines, wet, poorly graded, (SM).	2	
	2							12.0	
10	6	SS08	X			[Vertical lines]	Medium dense, Moderate olive Brown, clayey SILT, wet, poorly graded, laminate 1-4mm (ML).	4	
	4							14.0	
	8	SS09	X			[Vertical lines]	Medium dense, Moderate olive grey Brown, silty SAND w/ trace gravel, wet, well graded, interbedded (SM). No Sample Taken	8	
	8							15.0	
4.2	7	SS10	X			[Dotted]	Medium dense, Moderate olive Brown, SAND w/ some gravel trace fines, wet, well graded, sub-rounded (SW-GW).	11	
	7							16.0	
1.8	9	SS11	X			[Dotted]	Top 0.3 Medium dense, Moderate olive Brown, SAND w/ little gravel trace fines, wet, well graded, (SW). Bottom 0.5 Medium dense, Moderate olive Brown, SAND, wet, poorly graded, SW.	6	
	6							18.0	
0.2	12	SS12	X	20		[Dotted]	Medium dense, Light olive Brown, coarse - medium SAND w/ some gravel trace fines, wet, well graded, (SW-GW).	6	
	7							20.0	
N/A	2	SS13	X			[Dotted]	No Recovery.	4	
	4							22.0	
0.4	10	SS14	X			[Dotted]	Medium dense, Greyish Olive, medium - coarse SAND w/ few gravel trace fines, wet, graded, (SW).	4	
	4							24.0	
0.4	12	SS15	X	25		[Dotted]	Medium dense, Moderate olive Brown, silty SAND w/ trace gravel, wet, poorly graded, laminated 1-3mm (SP).	7	
	7							26.0	
0	4	SS16	X			[Vertical lines]	Very dense, Moderate olive Brown, SAND w/ some silt few gravel, wet, well graded, (SM).	4	
	4							28.0	
0.6	17	SS17	X	30		[Vertical lines]	Very Dense, Light olive Brown, SAND w/ little gravel few fines, moist, well graded, (SW), (Till).	8	
	8							30.0	
	58							32.0	
	13								
	17								
	16								
	24								
	76								
	70								

BORING WELL P009.GPJ HSI\_MA.GDT 1/11/99



**HSI  
GEOTRANS**  
A TETRA TECH COMPANY

**BORING/WELL CONSTRUCTION LOG**

PROJECT NUMBER P009-001 BORING/WELL NUMBER E2SC-13  
 PROJECT NAME Source Control Upper Reach Housatonic River DATE DRILLED 10/7/98  
 LOCATION Pittsfield, Massachusetts CASING TYPE/DIAMETER 2" PVC  
 DRILLING METHOD HSA SCREEN TYPE/SLOT 010 Slot 2" PVC  
 SAMPLING METHOD SS GRAVEL PACK TYPE #0 Silica Sand  
 GROUND ELEVATION 988.09 GROUT TYPE/QUANTITY Portland/Volclay  
 TOP OF CASING 989.89 DEPTH TO WATER \_\_\_\_\_  
 LOGGED BY MJJ GROUND WATER ELEVATION \_\_\_\_\_

REMARKS \_\_\_\_\_

FID (ppm)	BLOW COUNTS	SAMPLE ID.	EXTENT	DEPTH (ft. BGL)	U.S.C.S.	GRAPHIC LOG	LITHOLOGIC DESCRIPTION	CONTACT DEPTH	WELL DIAGRAM
0	6	CS01	X				Loose, Moderate yellowish Brown, SAND w/ little fines and gravel, sub-rounded (SW).	1.0	<p>Portland / Volclay Grout</p> <p>Bentonite Seal</p> <p>#0 Filter Sand</p> <p>010 Slot 2" PVC Schd 40 Screen</p>
0	10	SS02	X			Medium dense, Moderate Brown, SAND w/ some gravel trace fines, dry, (SW-GW).	3.0		
0	11	SS03	X			Same as above.	5.0		
0	13		X				6.0		
0	14		X						
0	20	SS04	X	5		Loose, Moderate Brown, SAND w/ some gravel little fines, dry, sub-rounded (SW-GW). No Sample Taken	8.0		
0	7		X				10.0		
0	4		X				12.0		
N/A	3	SS05	X			Loose, Moderate Brown, fine - medium SAND w/ trace fines, moist, poorly graded, (SP).	14.0		
N/A	6		X				16.0		
N/A	4		X				18.0		
0	4	SS06	X	10		No Recovery (Drove cobble).			
0	3		X						
0	2		X						
0	10	SS07	X			Medium dense, Light olive Grey and Light olive Brown, SAND w/ some gravel, moist, laminated fine sand zone, (SW-GW).			
0	12		X						
0	4		X						
0	6	SS08	X			Loose, Light olive Grey, medium SAND, wet, poorly graded, laminated (salt and pepper) (SW).			
0	6		X						
0	5		X						
N/A	3	SS09	X	15					
N/A	2		X						
N/A	2		X						
N/A	1								
N/A	3								
N/A	2								
N/A	2								

BORING\_WELL\_P009.GPJ\_HSI\_MA\_GDT 1/11/99



**BORING/WELL CONSTRUCTION LOG**

PROJECT NUMBER P009-001  
 PROJECT NAME Source Control Upper Reach Housatonic River  
 LOCATION Pittsfield, Massachusetts  
 DRILLING METHOD HSA  
 SAMPLING METHOD SS  
 GROUND ELEVATION 990.19  
 TOP OF CASING 992.25  
 LOGGED BY MJJ  
 REMARKS \_\_\_\_\_

BORING/WELL NUMBER E2SC-14  
 DATE DRILLED 10/8/98  
 CASING TYPE/DIAMETER 2" PVC  
 SCREEN TYPE/SLOT .010 Slot 2" PVC  
 GRAVEL PACK TYPE #0 Silica Sand  
 GROUT TYPE/QUANTITY Portland/Volclay  
 DEPTH TO WATER \_\_\_\_\_  
 GROUND WATER ELEVATION \_\_\_\_\_

FID (ppm)	BLOW COUNTS	SAMPLE ID.	EXTENT	DEPTH (ft. BGL)	U.S.C.S.	GRAPHIC LOG	LITHOLOGIC DESCRIPTION	CONTACT DEPTH	WELL DIAGRAM
0		SS01	X				Loose, Medium to Dark Brown, organic SAND w/ few gravel, moist, (SW), (Top soil/ Fill).	1.0	<p>Portland / Volclay Grout</p> <p>Bentonite Seal</p> <p>#0 Filter Sand</p> <p>.010 Slot 2" PVC Schd 40 Screen</p> <p>Cave in</p>
0		SS02	X				Medium dense, Moderate Brown, SAND w/ little gravel, few fines, moist, (SW).	3.0	
0		SS03	X				Loose, Light to Pale olive Brown, SAND w/ trace fines, moist, poorly graded, (SP).	5.0	
1		SS04	X	5			Loose, Light olive Brown, fine SAND, moist, poorly graded (SP).	6.0	
1.1		SS05	X				Similar too above except, silty SAND.	8.0	
2.3		SS06	X				Similar to above except fine to medium SAND.	10.0	
0		SS07	X	10			Similar too above except, medium SAND.	12.0	
0.7		SS08	X				Loose, Light olive Grey, medium to fine SAND w/ trace fines, moist, poorly graded, brown staining from bottom 0.6 (SP).	14.0	
0.8		SS09	X				Similar too above except, medium SAND, interbedded silt lens .4 to .6	16.0	
10.2		SS10	X				Similar too above except, no silt lens, wet.	18.0	
0		SS11	X				Medium dense, Light olive Grey, clayey SILT, wet, poorly graded, (MH).	20.0	





**BORING/WELL CONSTRUCTION LOG**

PROJECT NUMBER P009-001  
 PROJECT NAME Source Control Upper Reach Housatonic River  
 LOCATION Pittsfield, Massachusetts  
 DRILLING METHOD HSA  
 SAMPLING METHOD SS  
 GROUND ELEVATION 984.34  
 TOP OF CASING N/A  
 LOGGED BY MJJ  
 REMARKS \_\_\_\_\_

BORING/WELL NUMBER E2SC-15  
 DATE DRILLED 10/20/98  
 CASING TYPE/DIAMETER None  
 SCREEN TYPE/SLOT None  
 GRAVEL PACK TYPE None  
 GROUT TYPE/QUANTITY Portland/Volclay  
 DEPTH TO WATER \_\_\_\_\_  
 GROUND WATER ELEVATION \_\_\_\_\_

FID (ppm)	BLOW COUNTS	SAMPLE ID	EXTENT	DEPTH (ft. BGL)	U.S.C.S.	GRAPHIC LOG	LITHOLOGIC DESCRIPTION	CONTACT DEPTH	WELL DIAGRAM
0	3	SS02					Loose, Moderate olive Brown, SAND w/ little gravel, few fines(orgamics), dry, well graded, (SW).	3.0	
	4	SS03					Loose, Moderate olive Brown to Dusk yellow Brown, SAND w/ little gravel, few fines, dry, coal slag fragments (SW), (Fill).	5.0	
1.8	4	SS04		5			Same as above.	6.0	
0	3	SS05					Medium dense, Dark yellowish Brown, fine SAND w/ trace fines and gravel, dry, graded, (SW), (Fill).	8.0	
1.4	6	SS06					Similar to above except wood fragments.	10.0	
0	3	SS07		10			Medium dense, Light olive Grey to Moderate olive Brown, fine SAND w/ few fines, trace organics, poorly graded, Iron staining (SP).	12.0	
5	3	SS08					Loose, Light olive Grey, SAND w/ trace fines interbedded w/ fine - medium sand and trace organics, wet, graded, (SW).	14.0	
0.2	4	SS09		15			Loose, Light olive Grey to Moderate olive Brown, sandy GRAVEL w/ trace organics, wet, well graded, sub-angular (GW-SW).	15.0	
0.4	4	SS10					Same as above	16.0	
0.2	8	SS11					Medium dense, Moderate olive Brown, sandy GRAVEL few fines, wet, well graded, sub-angular (GW-SW).	18.0	
8.2	10	SS12					Top 0.6 Same as above. Bottom 0.5 loose, Light olive Grey, silty SAND, wet, poorly graded, (SP-SM).	20.0	
0	4	SS13		20			Loose, Greyish Olive, silty fine SAND w/ trace clay, wet, poorly graded, laminated 1-3mm (SP-SM).	22.0	
0	3	SS14					Top 0.6 Same as above. Bottom 0.7 Medium dense, Greyish Brown to Moderate olive Brown, medium SAND, wet, poorly graded, top of sand has grayish interval (SW)	24.0	
0.4	6	SS15		25			Same as above (Bottom).	26.0	
0	5	SS16					Top 0.9 Same as above. Bottom 0.2 Dense, Olive Grey, SAND and GRAVEL w/ trace fines, wet, well graded, sub-rounded (SW-GW).	28.0	
0	6	SS17					Dense, Olive Grey to Moderate olive Brown, sandy GRAVEL w/ few fines, wet, well graded, sub-rounded (GW-SW).	30.0	
N/A	10	SS18		30			No Recovery.	32.0	
0	8	SS19					Dense, Light olive Brown, SAND w/ some silt, few gravel, wet, well graded, sub-angular, glacial outwash (SM).	34.0	
0	17	SS20					Very dense. Light olive Brown, silty SAND w/ some gravel		

BORING\_WELL\_P009\_GPJ\_HSI\_MA\_GDT\_1/11/99

Continued Next Page



**BORING/WELL CONSTRUCTION LOG**

PROJECT NUMBER P009-001

BORING/WELL NUMBER E2SC-15

PROJECT NAME Source Control Upper Reach Housatonic River

DATE DRILLED 10/20/98

*Continued from Previous Page*

FID (ppm)	BLOW COUNTS	SAMPLE ID.	EXTENT	DEPTH (ft. BGL)	U.S.C.S.	GRAPHIC LOG	LITHOLOGIC DESCRIPTION	CONTACT DEPTH	WELL DIAGRAM
	78 71		X			▨	few clay, moist, well graded, sub-angular (SM), (Till).	36.0	▨

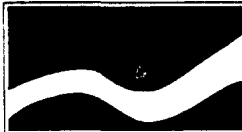

**BORING/WELL CONSTRUCTION LOG**

PROJECT NUMBER P009-001  
 PROJECT NAME Source Control Upper Reach Housatonic River  
 LOCATION Pittsfield, Massachusetts  
 DRILLING METHOD HSA  
 SAMPLING METHOD SS  
 GROUND ELEVATION 985.95  
 TOP OF CASING 987.77  
 LOGGED BY NSB  
 REMARKS \_\_\_\_\_

BORING/WELL NUMBER E2SC-16I  
 DATE DRILLED 11/10/98  
 CASING TYPE/DIAMETER 2" PVC  
 SCREEN TYPE/SLOT 010 Slot 2" PVC  
 GRAVEL PACK TYPE #0 Silica Sand  
 GROUT TYPE/QUANTITY Portland/Volclay  
 DEPTH TO WATER \_\_\_\_\_  
 GROUND WATER ELEVATION \_\_\_\_\_

FID (ppm)	BLOW COUNTS	SAMPLE ID.	EXTENT	DEPTH (ft. BGL)	U.S.C.S.	GRAPHIC LOG	LITHOLOGIC DESCRIPTION	CONTACT DEPTH	WELL DIAGRAM
				5			See Soil Boring "E2SC-16S"		
				10					
				15					
0.4	3 6 8	SS12	X	18.0			Medium dense, Dark Grey, coarse SAND trace fines, wet, well graded, (SW).	18.0	<p>← Portland / Volclay Grout</p> <p>← Bentonite Seal</p>
2	3 5 7	SS13	X	20.0			Similar to above except middle 0.8 light olive gray.	20.0	
15	6 6 10 11	SS14	X	22.0			Top 0.8 Medium dense, Dark Grey to Moderate olive Grey, SAND, wet, poor grading, coarsening downward (SP). Bottom 0.4 Medium dense, Moderate olive Grey, fine SAND, trace silt, wet, well graded, (SW).	22.0	
24	5 8 10 15	SS15	X	24.0			Top 0.2 Medium dense, Dark Grey, fine SAND, wet, well graded, (SW). Bottom 1.0 Light to Moderate olive Grey, fine SAND little silt, wet, well graded, (Sw).	24.0	
16	9 8 10 10	SS16	X	26.0			Medium dense, Moderate olive Grey, fine to medium SAND trace silt, wet, well graded, chunk of metal slag on side of sample (SW).	26.0	
15	3 4 7	SS17	X	28.0			Medium dense, Moderate olive Grey, SAND trace silt and gravel, wet, well graded, (SW).	28.0	
20	5 6 9 11	SS18	X	30.0			Top 0.3 medium dense, Light Grey, fine SAND trace fines, wet, well graded, laminations (SW). Bottom 0.3 Moderate Grey, medium SAND, wet, well graded, (SW).	30.0	
42	8 10 12 11	SS19	X	32.0			Top 0.3 Same as above (Top). Bottom 0.7 Moderate olive Grey, coarse to medium SAND, wet, well graded, (SW).	32.0	
40	4	SS20	X	34.0			Same as above (Bottom).	34.0	
				35					

BORING WELL P009 GPJ HSI\_MA\_GDT 1/11/99

Continued Next Page



**BORING/WELL CONSTRUCTION LOG**

PROJECT NUMBER P009-001

BORING/WELL NUMBER E2SC-161

PROJECT NAME Source Control Upper Reach Housatonic River

DATE DRILLED 11/10/98

Continued from Previous Page

FID (ppm)	BLOW COUNTS	SAMPLE ID.	EXTENT	DEPTH (ft. BGL)	U.S.C.S.	GRAPHIC LOG	LITHOLOGIC DESCRIPTION	CONTACT DEPTH	WELL DIAGRAM
N/A	7 11 11 9	SS21	X			[Dotted pattern]	No Recovery.	36.0	<p>#0 Filter Sand 010 Slot 2" PVC Schd 40 Screen 1' 2" PVC Schd 40 Sump Cave in</p>
130	10 13 10 4	SS22	X			[Dotted pattern]	Medium dense, Moderate olive Grey, SAND w/ few gravel, wet, well graded, sub-angular, visable NAPL (SW).	38.0	
80	5 16 21 18	SS23	X	40		[Dotted pattern]	Same as above except very dense.	40.0	
N/A	35 37 36 14	SS24	X			[Dotted pattern]	No Recovery.	42.0	
5	17 16 33 9	SS25	X	45		[Dotted pattern]	Top 0.8 Medium dense, Moderate olive Brown, SAND w/ little gravel, wet, well graded, sub-rounded, visable NAPL (SW). Bottom 0.2 Dense, Moderate olive Grey to Moderate olive Brown, SILT little gravel, wet, well graded (ML).	44.0	
15	15 25 37	SS26	X			[Diagonal hatching]	Top 0.3 Moderate olive Brown, SAND, wet, well graded, (SW). Bottom 0.3 Moderate olive Grey, gravelly SILT, well graded, (ML), (Till).	46.0	
12		SS27	X			[Diagonal hatching]	Light olive Grey to Yellowish Grey, fine SAND some weathered cobbles little silt, wet, well graded, (SM), (Till).	48.0	
			X			[Diagonal hatching]		50.0	

BORING\_WELL\_P009\_GPJ\_HSI\_MA\_GDT\_1/11/99



**BORING/WELL CONSTRUCTION LOG**

PROJECT NUMBER P009-001 BORING/WELL NUMBER E2SC-16S  
 PROJECT NAME Source Control Upper Reach Housatonic River DATE DRILLED 10/8/98  
 LOCATION Pittsfield, Massachusetts CASING TYPE/DIAMETER 2" PVC  
 DRILLING METHOD HSA SCREEN TYPE/SLOT .010 Slot 2" PVC  
 SAMPLING METHOD SS GRAVEL PACK TYPE #0 Silica Sand  
 GROUND ELEVATION 985.78 GROUT TYPE/QUANTITY Portland/Volclay  
 TOP OF CASING 987.69 DEPTH TO WATER \_\_\_\_\_  
 LOGGED BY MJJ GROUND WATER ELEVATION \_\_\_\_\_

REMARKS

FID (ppm)	BLOW COUNTS	SAMPLE ID.	EXTENT	DEPTH (ft. BGL)	U.S.C.S.	GRAPHIC LOG	LITHOLOGIC DESCRIPTION	CONTACT DEPTH	WELL DIAGRAM
0	7	CS01	X				Medium dense, Medium Brown, organic SAND w/ few gravel, moist, (CL), (Top soil/ Fill).	1.0	<p>Portland / Volclay Grout</p> <p>Bentonite Seal</p> <p>#0 Filter Sand</p> <p>.010 Slot 2" PVC Schd 40 Screen</p>
0	13	SS02	X				Medium dense, Dark Brown to Black, medium SAND w/ few gravel, trace fines, moist, well graded, (SW), (Fill).	3.0	
	7		X						
	6	SS03	X				Dark Brown to Black, medium SAND w/ some cinders and coal ash, moist, (SW), (Fill).	5.0	
	6		X						
	6	SS04	X	5			Same as above.	6.0	
0.8	2	SS05	X				Top Same as above. Bottom 0.4, loose, Olive Brown, medium to course SAND, moist, well graded, (SW).	8.0	
	1		X						
5.5	3	SS06	X				Loose, Interbedded cinders and sand units, (Fill).	10.0	
	3		X						
6	4	SS07	X	10			Medium dense, Black, coal ash and slag, (Fill).	12.0	
	3		X						
6	6	SS08	X				Same as above.	14.0	
5.4	11		X						
	5	SS09	X				Loose, Black, gravelly SAND, moist, well graded, SW, heavily stained, (Fill).	15.0	
71.4	8		X						
0.4	12	SS10	X	15			Loose, Light olive Grey, medium to course SAND, wet, stained, (SW), (native).	17.0	
	7		X						
	4		X						
	4		X						
	2		X						
	2		X						



**BORING/WELL CONSTRUCTION LOG**

PROJECT NUMBER P009-001 BORING/WELL NUMBER E2SC-17  
 PROJECT NAME Source Control Upper Reach Housatonic River DATE DRILLED 10/27/98  
 LOCATION Pittsfield, Massachusetts CASING TYPE/DIAMETER 2" PVC  
 DRILLING METHOD HSA SCREEN TYPE/SLOT .010 Slot 2" PVC  
 SAMPLING METHOD SS GRAVEL PACK TYPE #0 Silica Sand  
 GROUND ELEVATION 983.76 GROUT TYPE/QUANTITY Portland/Volclay  
 TOP OF CASING 985.38 DEPTH TO WATER \_\_\_\_\_  
 LOGGED BY NSB GROUND WATER ELEVATION \_\_\_\_\_  
 REMARKS \_\_\_\_\_

FID (ppm)	BLOW COUNTS	SAMPLE ID	EXTENT	DEPTH (ft. BGL)	U.S.C.S.	GRAPHIC LOG	LITHOLOGIC DESCRIPTION	CONTACT DEPTH	WELL DIAGRAM
0	4	CS01	X				Loose, Black - olive Brown, silty SAND few gravel, dry, well graded, sub-angular, (SW), (soil horizon).	1.0	<p>Portland / Volclay Grout</p> <p>Bentonite Seal</p>
1	5	SS02	X				Loose, Moderate yellowish Brown, fine - medium SAND few fines, trace gravel, dry, well graded, (SW).	3.0	
50	1	SS03	X				Loose, Olive Black, fine SAND few fines coal fragments, dry, well graded, (SW), (Fill).	5.0	
12	2	SS04	X	5			Similar to above w/ few coal slag cobbles.	6.0	
30	2	SS05	X				Medium dense, Olive Black, medium to fine SAND trace fines, some coal fragments, dry, well graded, Fe staining, (SM), (Fill).	8.0	
17	5	SS06	X				Medium dense, Olive Black - Black, coarse SAND some coal fragments, dry, well graded, Fe staining, (SW), (Fill).	10.0	
5	10	SS07	X	10			Top and bottom 0.3 Similar to above w/ same coal fragments, moist, Middle 0.1 Loose, Pale greenish Yellow, coarse SAND, dry, well graded, (SW)	12.0	
7	2	SS08	X				Loose, Black, gravelly coarse SAND, wet well graded, sub-angular (SW-GW).	14.0	
6	1	SS09	X	15			Top 0.8 Very Loose, Olive Brown, coarse SAND, wet, well graded, (SW). Bottom 0.2 Similar to above except fine SAND trace fines	16.0	
25	7	SS11	X				Very loose, Black, silty SAND, wet, well graded, (SW).	16.0	
	9	SS12	X				Medium dense, Light olive Grey, medium SAND trace fines, wet, well graded, laminations 1 - 3mm, (SW).	18.0	
6	5	SS12	X				Same as above.	20.0	
8	4	SS13	X	20			Medium dense, Light olive Grey, fine SAND few fines, wet, well graded, laminated (SW).	22.0	
13	6	SS14	X				Same as above.	24.0	
18	6	SS15	X	25			Medium dense, Light olive Grey, fine SAND some fines, wet, well graded, laminated (SW).	26.0	
15	5	SS16	X				Medium dense, Light olive Grey - Greyish Olive, fine SAND some fines, wet, well graded, laminated (SW).	28.0	
N/A	6		X				No Recovery.	30.0	
N/A	2		X	30			No Recovery.	32.0	
30	11	SS19	X				Top 0.4 dense, Greyish Olive, sandy GRAVEL, wet, well graded, sub-rounded, (GW-SW). Bottom 0.4 dense, Greyish Olive, gravelly SAND, wet, well graded, sub-rounded (SW-GW).	34.0	
16	7	SS20	X	35					

BORING WELL P009 GPJ HSI MA GDT 1/11/99

Continued Next Page



PROJECT NUMBER P009-001

BORING/WELL NUMBER E2SC-17

PROJECT NAME Source Control Upper Reach Housatonic River

DATE DRILLED 10/27/98

*Continued from Previous Page*

FID (ppm)	BLOW COUNTS	SAMPLE ID.	EXTENT	DEPTH (ft. BGL)	U.S.C.S.	GRAPHIC LOG	LITHOLOGIC DESCRIPTION	CONTACT DEPTH	WELL DIAGRAM
N/A	5 10 11 6 4 9	SS24	[X]	40		[Dotted Pattern]	Medium dense, greyish Olive, sandy GRAVEL, wet, well rounded, sub-rounded (GW-SW). No Recovery.	36.0	[Well Diagram: #0 Filter Sand, .010 Slot 2" PVC Schd 40 Screen]
N/A	33 17 11 13						No Recovery.	38.0	
N/A	20 8 18						No Recovery.	40.0	
72	14 18 28 56 78						Very dense, Light olive Grey - Olive Grey, GRAVEL w/ some sand, few fines, wet, well graded, sub-rounded, visable NAPL, outwash (GW-SW).	42.0	
N/A	63 6 100+	SS27	[X]	45		[Dotted Pattern]	No Recovery.	44.8	[Well Diagram: 1' 2" PVC Schd 40 Sump Cave in]
N/A	30 140 16 41 47 43						No Recovery.	46.9	
20						[Hatched Pattern]	Very Dense, Light olive Gray, fine SAND w/ some gravel few fines, weathered cobble, well graded, till, (SM)	49.0	



**BORING/WELL CONSTRUCTION LOG**

PROJECT NUMBER P009-001 BORING/WELL NUMBER E2SC-18  
 PROJECT NAME Source Control Upper Reach Housatonic River DATE DRILLED 12/18/98  
 LOCATION Pittsfield, Massachusetts CASING TYPE/DIAMETER None  
 DRILLING METHOD Direct Push SCREEN TYPE/SLOT None  
 SAMPLING METHOD Direct Push GRAVEL PACK TYPE None  
 GROUND ELEVATION 980.13 GROUT TYPE/QUANTITY \_\_\_\_\_  
 TOP OF CASING None DEPTH TO WATER \_\_\_\_\_  
 LOGGED BY DC GROUND WATER ELEVATION \_\_\_\_\_  
 REMARKS \_\_\_\_\_

FID (ppm)	BLOW COUNTS	SAMPLE ID.	EXTENT	DEPTH (ft. BGL)	U.S.C.S.	GRAPHIC LOG	LITHOLOGIC DESCRIPTION	CONTACT DEPTH	WELL DIAGRAM
		SS01					Top 0.5 Dark yellow Brown to olive Brown TOP SOIL, dry, well graded. Bottom 0.5 Dark yellow Brown to olive Brown TOP SOIL w/ some coarse gravel, dry, well graded. Shake test Negative.	1.0	No Well Installed
		SS02					Dark yellow Brown TOP SOIL w/ some coarse gravel trace organics trace sand, dry, well graded. Shake test Negative.	2.0	
		SS03					Dark yellow Brown TOP SOIL w/ trace gravel, dry, well graded. Shake test Negative.	3.0	
		SS04					Pale yellow Brown fine SAND w/ trace coal ash, dry, well graded. Shake test Negative.	4.0	
		SS05					Pale yellow Brown fine SAND w/ trace coal ash, dry, well graded. Shake test Negative.	5.0	
		SS06		5			Olive Brown, SAND w/ staining on bottom 0.3, moist well graded, ODOR. Shake test Negative.	6.0	





**BORING/WELL CONSTRUCTION LOG**

PROJECT NUMBER P009-001  
 PROJECT NAME Source Control Upper Reach Housatonic River  
 LOCATION Pittsfield, Massachusetts  
 DRILLING METHOD Direct Push  
 SAMPLING METHOD Direct Push  
 GROUND ELEVATION 980.07  
 TOP OF CASING None  
 LOGGED BY DC  
 REMARKS \_\_\_\_\_

BORING/WELL NUMBER E2SC-19  
 DATE DRILLED 12/18/98  
 CASING TYPE/DIAMETER None  
 SCREEN TYPE/SLOT None  
 GRAVEL PACK TYPE None  
 GROUT TYPE/QUANTITY \_\_\_\_\_  
 DEPTH TO WATER \_\_\_\_\_  
 GROUND WATER ELEVATION \_\_\_\_\_

FID (ppm)	BLOW COUNTS	SAMPLE ID.	EXTENT	DEPTH (ft. BGL)	U.S.C.S.	GRAPHIC LOG	LITHOLOGIC DESCRIPTION	CONTACT DEPTH	WELL DIAGRAM
		SS01					Brown, TOP SOIL w/ wood chips, little sand, dry, well graded. Shake test Negative.		No Well Installed
		SS02					Dark yellowish Brown, SAND, dry, well graded. Shake test Negative.	1.0	
		SS03					Top 0.5 Dark yellowish Brown, SAND, dry, well graded. Bottom 0.5 Dark Brown, SAND w/ organics, dry, well graded. Shake test Negative.	2.0	
		SS04					Light olive Gray, weathered GRAVEL w/ SAND and coarse subangular GRAVEL, dry, odorless. Shake test Negative.	3.0	
		SS05						4.0	
		SS06		5			Moderate yellow brown, SAND w/ gravel, dry, well graded. Shake test Negative.	6.0	
		SS07					Light Brown to Grayish Orange, weathered GRAVEL w/ little coarse Gravel, dry, well graded. Shake test Negative.	7.0	
		SS08					Top 0.5 Light Brown to Grayish Orange, weathered GRAVEL w/ little coarse Gravel, dry, well graded, slight ODOR. Bottom 0.5 Olive Gray, SAND w/ some fines, little coarse, moist, strong ODOR. Slight sheen in shake test.	8.0	



**BORING/WELL CONSTRUCTION LOG**

PROJECT NUMBER P009-001 BORING/WELL NUMBER E2SC-20  
 PROJECT NAME Source Control Upper Reach Housatonic River DATE DRILLED 12/18/98  
 LOCATION Pittsfield, Massachusetts CASING TYPE/DIAMETER None  
 DRILLING METHOD Direct Push SCREEN TYPE/SLOT None  
 SAMPLING METHOD Direct Push GRAVEL PACK TYPE None  
 GROUND ELEVATION 980.38 GROUT TYPE/QUANTITY \_\_\_\_\_  
 TOP OF CASING None DEPTH TO WATER \_\_\_\_\_  
 LOGGED BY DC GROUND WATER ELEVATION \_\_\_\_\_  
 REMARKS \_\_\_\_\_

FID (ppm)	BLOW COUNTS	SAMPLE ID.	EXTENT	DEPTH (ft. BGL)	U.S.C.S.	GRAPHIC LOG	LITHOLOGIC DESCRIPTION	CONTACT DEPTH	WELL DIAGRAM
		SS01					Dark olive Gray, fine ORGANICS w/ little sand, dry, medium to well graded. Shake test Negative.	1.0	No Well Installed
		SS02					Dark yellowish Brown, SAND w/ trace gravel, dry, well graded. Shake test Negative.	2.0	
		SS03					Grayish Orange, weathered GRAVEL, poorly graded, dry. Shake test Negative.	3.0	
		SS04					Yellowish Gray, medium to coarse SAND w/ little gravel, little cobbles, dry, well graded. Shake test Negative.	4.0	
		SS05					Medium Brown to Grayish Yellow, medium weathered GRAVEL w/ some cobbles, dry, well graded. Shake test Negative.	5.0	
		SS06	5				Moderate Brown, weathered GRAVEL w/ medium to coarse SAND, moist. Slight sheen in shake test.	6.0	
		SS07					Dark Gray, weathered GRAVEL w/ medium to coarse SAND, moist. Slight sheen in shake test.	7.0	
		SS08					Olive Black, fine SAND w/ some Silt, moist, well graded, strong ODOR. Shake test positive.	8.0	

BORING\_WELL\_P009.GPJ HSI\_MA.GDT 1/9/99

ATTACHMENT B

---

GRAIN SIZE ANALYSES



**SIEVE ANALYSIS**  
ASTM D 422-63 (SOP-S3)

Client: QUANTERRA  
 Client Reference: QUANTERRA C8J150154  
 Project No.: 98275-01  
 Lab ID: 98275-01.001

Boring No.: NA  
 Depth (ft): NA  
 Sample No.: E2SC-04-GS01  
 Soil Color: BROWN

USCS	SIEVE ANALYSIS		HYDROMETER
	gravel	sand	silt and clay

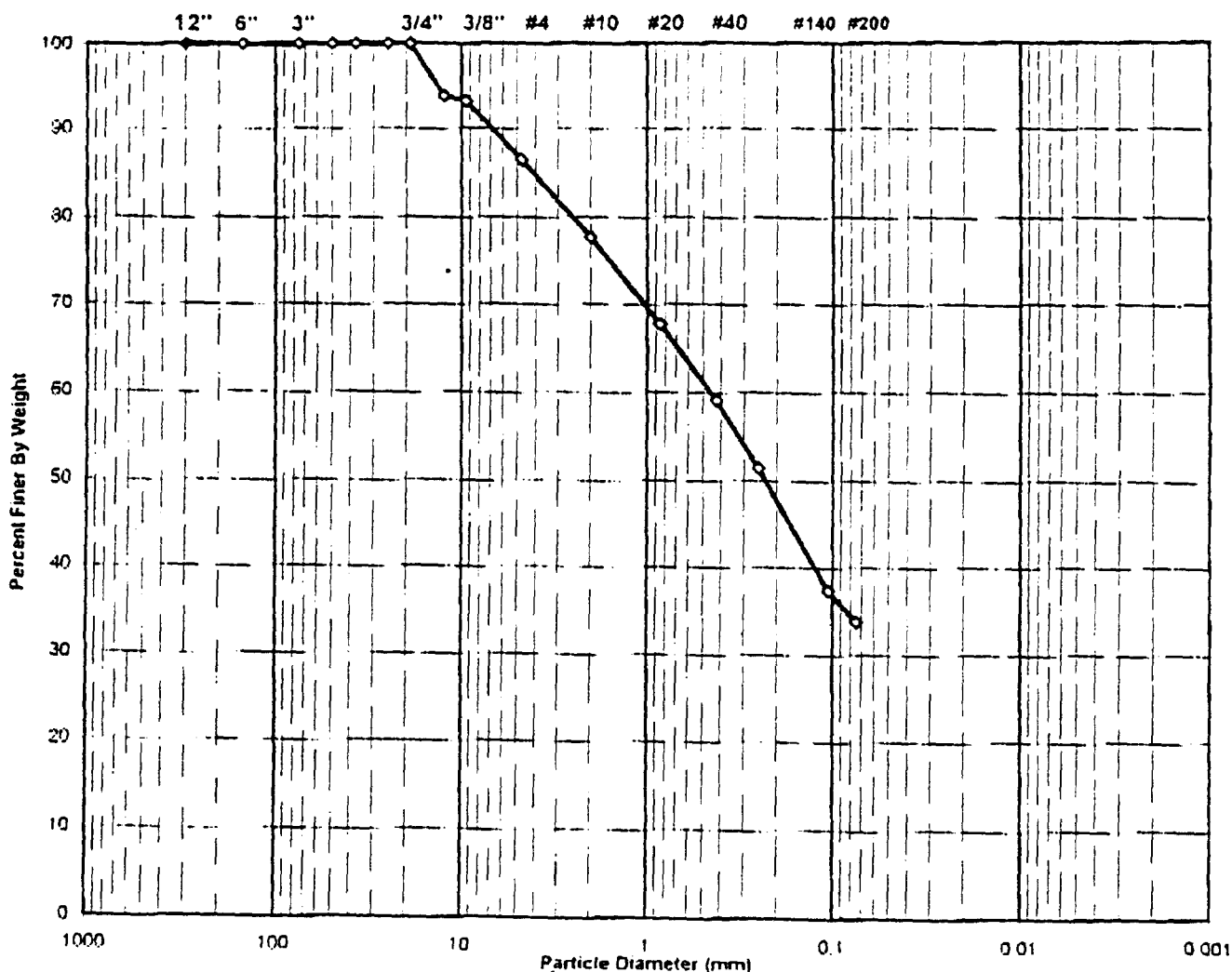

USCS Symbol: **sc, ASSUMED**

USCS Classification: **CLAYEY SAND**

Tested By: JLD Date: 10/19/98 Checked By: *Jem* Date: 10-27-98



**WASH SIEVE ANALYSIS**  
ASTM D 422-63 (SOP-S3)

Client	QUANTERRA	Boring No.	NA
Client Reference	QUANTERRA C8J150154	Depth (ft)	NA
Project No.	98275-01	Sample No	E2SC-04-GS01
Lab ID	98275-01 001	Soil Color	BROWN

Moisture Content of Passing 3/4" Material		Water Content of Retained 3/4" Material	
Tare No.	1718	Tare No.	NA
Wgt. Tare + Wet Specimen (gm)	368.11	Wgt. Tare + Wet Specimen (gm)	NA
Wgt. Tare + Dry Specimen (gm)	332.74	Wgt. Tare + Dry Specimen (gm)	NA
Weight of Tare (gm)	82.43	Weight of Tare (gm)	NA
Weight of Water (gm)	35.37	Weight of Water (gm)	NA
Weight of Dry Soil (gm)	250.31	Weight of Dry Soil (gm)	NA
<b>Moisture Content (%)</b>	<b>14.1</b>	<b>Moisture Content (%)</b>	<b>NA</b>

Wet Weight -3/4" Sample (gm)	NA	Weight of the Dry Specimen (gm)	250.31
Dry Weight - 3/4" Sample (gm)	165.7	Weight of minus #200 material (gm)	84.62
Wet Weight +3/4" Sample (gm)	NA	Weight of plus #200 material (gm)	165.69
Dry Weight + 3/4" Sample (gm)	0.00		
Total Dry Weight Sample (gm)	NA		

Sieve Size	Sieve Opening (mm)	Wgt. of Soil Retained (gm)	Percent Retained (%)	Accumulated Percent Retained (%)	Percent Finer (%)	Accumulated Percent Finer (%)
12"	300	0.00	0.00	0.00	100.00	100.00
6"	150	0.00	0.00	0.00	100.00	100.00
3"	75	0.00	0.00	0.00	100.00	100.00
2"	50	0.00	0.00	0.00	100.00	100.00
1 1/2"	37.5	0.00	0.00	0.00	100.00	100.00
1"	25.0	0.00	0.00	0.00	100.00	100.00
3/4"	19.0	0.00	0.00	0.00	100.00	100.00
1/2"	12.50	15.79	6.31	6.31	93.69	93.69
3/8"	9.50	1.55	0.62	6.93	93.07	93.07
#4	4.75	16.80	6.71	13.64	86.36	86.36
#10	2.00	21.80	8.71	22.35	77.65	77.65
#20	0.850	25.01	9.99	32.34	67.66	67.66
#40	0.425	21.68	8.66	41.00	59.00	59.00
#60	0.250	18.82	7.52	48.52	51.48	51.48
#140	0.106	35.44	14.16	62.68	37.32	37.32
#200	0.075	8.80	3.52	66.19	33.81	33.81
Pan	-	84.62	33.81	100.00	-	-

Tested By JLD Date 10/19/98 Checked By *Jcm* Date 10-27-98



SIEVE ANALYSIS  
ASTM D 422-63 (SOP-S3)

Client QUANTERRA  
Client Reference QUANTERRA C8J150154  
Project No. 98275-01  
Lab ID 98275-01.002

Boring No. NA  
Depth (ft) NA  
Sample No. E2SC-04-GS02  
Soil Color BROWN

USCS	SIEVE ANALYSIS		HYDROMETER
	gravel	sand	silt and clay

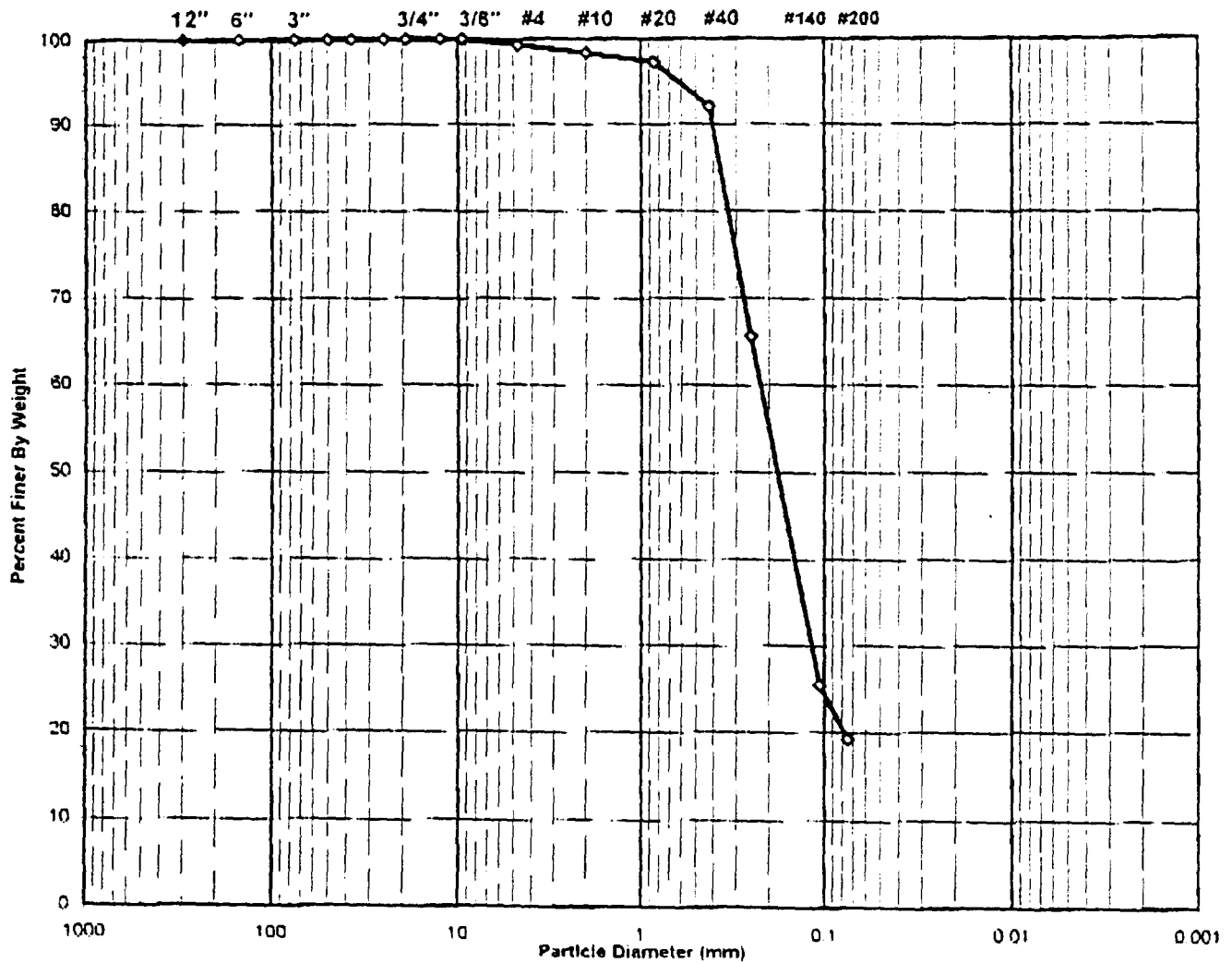

USCS Symbol **sc, ASSUMED**

USCS Classification **CLAYEY SAND**

Tested By JLD Date 10/19/98 Checked By *Jm*

Date 10-27-98



### WASH SIEVE ANALYSIS

ASTM D 422-63 (SOP-S3)

Client	QUANTERRA	Boring No.	NA
Client Reference	QUANTERRA C8J150154	Depth (ft)	NA
Project No.	98275-01	Sample No.	E2SC-04-GS02
Lab ID	98275-01.002	Soil Color	BROWN

Moisture Content of Passing 3/4" Material		Water Content of Retained 3/4" Material	
Tare No.	1719A	Tare No.	NA
Wgt. Tare + Wet Specimen (gm)	381.69	Wgt. Tare + Wet Specimen (gm)	NA
Wgt. Tare + Dry Specimen (gm)	351.85	Wgt. Tare + Dry Specimen (gm)	NA
Weight of Tare (gm)	84.83	Weight of Tare (gm)	NA
Weight of Water (gm)	29.84	Weight of Water (gm)	NA
Weight of Dry Soil (gm)	267.02	Weight of Dry Soil (gm)	NA
<b>Moisture Content (%)</b>	<b>11.2</b>	<b>Moisture Content (%)</b>	<b>NA</b>

Wet Weight - 3/4" Sample (gm)	NA	Weight of the Dry Specimen (gm)	267.02
Dry Weight - 3/4" Sample (gm)	215.7	Weight of minus #200 material (gm)	51.34
Wet Weight + 3/4" Sample (gm)	NA	Weight of plus #200 material (gm)	215.68
Dry Weight + 3/4" Sample (gm)	0.00		
Total Dry Weight Sample (gm)	NA		

Sieve Size	Sieve Opening (mm)	Wgt. of Soil Retained (gm)	Percent Retained (%)	Accumulated Percent Retained (%)	Percent Finer (%)	Accumulated Percent Finer (%)
12"	300	0.00	0.00	0.00	100.00	100.00
6"	150	0.00	0.00	0.00	100.00	100.00
3"	75	0.00	0.00	0.00	100.00	100.00
2"	50	0.00	0.00	0.00	100.00	100.00
1 1/2"	37.5	0.00	0.00	0.00	100.00	100.00
1"	25.0	0.00	0.00	0.00	100.00	100.00
3/4"	19.0	0.00	0.00	0.00	100.00	100.00
1/2"	12.50	0.00	0.00	0.00	100.00	100.00
3/8"	9.50	0.00	0.00	0.00	100.00	100.00
#4	4.75	2.01	0.75	0.75	99.25	99.25
#10	2.00	2.47	0.93	1.68	98.32	98.32
#20	0.850	2.88	1.08	2.76	97.24	97.24
#40	0.425	13.87	5.19	7.95	92.05	92.05
#60	0.250	70.57	26.43	34.38	65.62	66.62
#140	0.106	107.40	40.22	74.60	25.40	25.40
#200	0.075	16.48	6.17	80.77	19.23	19.23
Pan	-	51.34	19.23	100.00	-	-

Tested By JLD Date 10/19/98 Checked By Jern Date 10.27.98



**SIEVE ANALYSIS**  
ASTM D 422-63 (SOP-S3)

Client **QUANTERRA**  
Client Reference **QUANTERRA C8J150154**  
Project No. **98275-01**  
Lab ID **98275-01.003**

Boring No. **NA**  
Depth (ft) **NA**  
Sample No. **E2SC-04-GS03**  
Soil Color **GRAY & BROWN**

USCS	SIEVE ANALYSIS		HYDROMETER
	gravel	sand	silt and clay

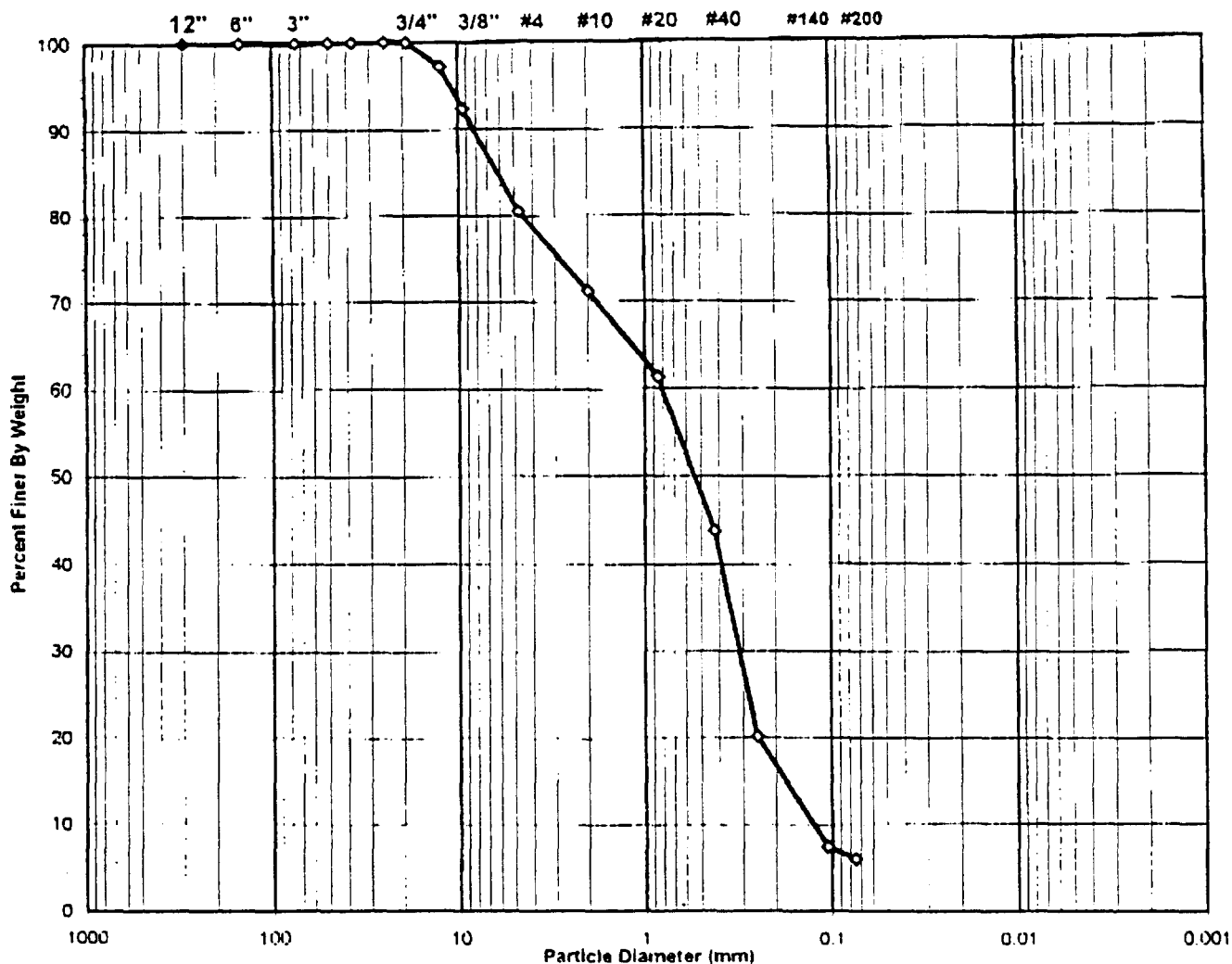

USCS Symbol **sp-sm, ASSUMED**

D60 = 0.8      CC = 1.0

USCS Classification **POORLY GRADED SAND WITH SILT AND GRAVEL**

D30 = 0.3      CU = 6.4

D10 = 0.1

Tested By **JLD**      Date **10/19/98**      Checked By **JLD**      Date **10-27-98**





### WASH SIEVE ANALYSIS

ASTM D 422-63 (SOP-S3)

Client **QUANTERRA**  
 Client Reference **QUANTERRA C8J150154**  
 Project No. **98275-01**  
 Lab ID **98275-01.003**

Boring No. **NA**  
 Depth (ft) **NA**  
 Sample No **E2SC-04-GS03**  
 Soil Color **GRAY & BROWN**

Moisture Content of Passing 3/4" Material		Water Content of Retained 3/4" Material	
Tare No.	598	Tare No.	NA
Wgt. Tare + Wet Specimen (gm)	475.20	Wgt. Tare + Wet Specimen (gm)	NA
Wgt. Tare + Dry Specimen (gm)	423.60	Wgt. Tare + Dry Specimen (gm)	NA
Weight of Tare (gm)	84.79	Weight of Tare (gm)	NA
Weight of Water (gm)	51.60	Weight of Water (gm)	NA
Weight of Dry Soil (gm)	338.81	Weight of Dry Soil (gm)	NA
<b>Moisture Content (%)</b>	<b>15.2</b>	<b>Moisture Content (%)</b>	<b>NA</b>

Wet Weight - 3/4" Sample (gm)	NA	Weight of the Dry Specimen (gm)	338.81
Dry Weight - 3/4" Sample (gm)	318.6	Weight of minus #200 material (gm)	20.19
Wet Weight + 3/4" Sample (gm)	NA	Weight of plus #200 material (gm)	318.62
Dry Weight + 3/4" Sample (gm)	0.00		
Total Dry Weight Sample (gm)	NA		

Sieve Size	Sieve Opening (mm)	Wgt. of Soil Retained (gm)	Percent Retained (%)	Accumulated Percent Retained (%)	Percent Finer (%)	Accumulated Percent Finer (%)
12"	300	0.00	0.00	0.00	100.00	100.00
6"	150	0.00	0.00	0.00	100.00	100.00
3"	75	0.00	0.00	0.00	100.00	100.00
2"	50	0.00	0.00	0.00	100.00	100.00
1 1/2"	37.5	0.00	0.00	0.00	100.00	100.00
1"	25.0	0.00	0.00	0.00	100.00	100.00
3/4"	19.0	0.00	0.00	0.00	100.00	100.00
1/2"	12.50	9.62	2.84	2.84	97.16	97.16
3/8"	9.50	16.46	4.86	7.70	92.30	92.30
#4	4.75	40.41	11.93	19.62	80.38	80.38
#10	2.00	31.20	9.21	28.83	71.17	71.17
#20	0.850	33.63	9.93	38.76	61.24	61.24
#40	0.425	59.59	17.59	56.35	43.65	43.65
#60	0.250	79.72	23.53	79.88	20.12	20.12
#140	0.106	43.18	12.74	92.62	7.38	7.38
#200	0.075	4.81	1.42	94.04	5.96	5.96
Pan	-	20.19	5.96	100.00	-	-

Tested By **JLD** Date **10/19/98** Checked By *Jen*

Date **10-27-98**



SIEVE ANALYSIS  
ASTM D 422-83 (SOP-S3)

Client QUANTERRA  
Client Reference QUANTERRA C8J150154  
Project No. 98275-01  
Lab ID 98275-01.004

Boring No. NA  
Depth (ft) NA  
Sample No. E2SC-04-GS04  
Soil Color BROWN

USCS	SIEVE ANALYSIS		HYDROMETER
	gravel	sand	silt and clay

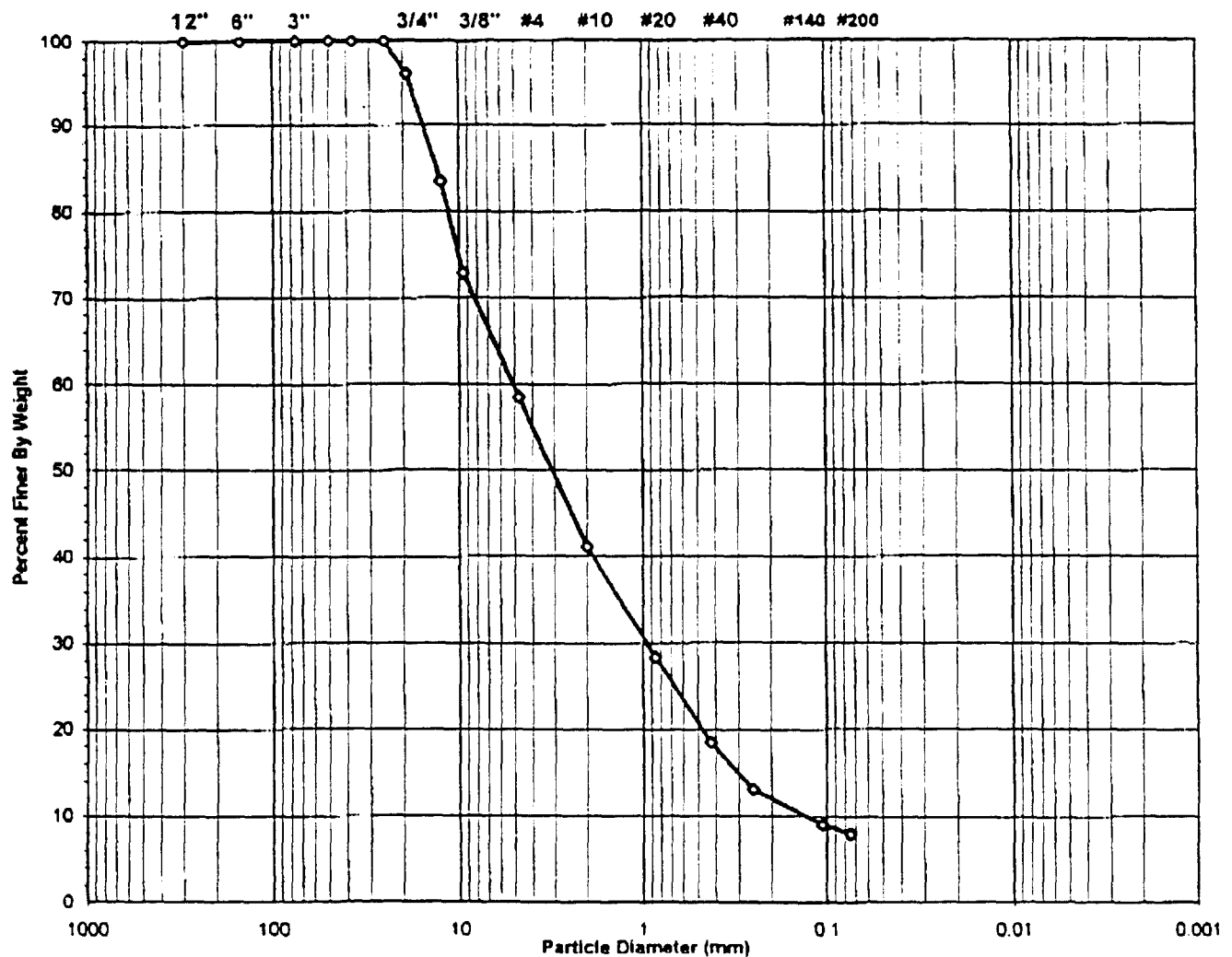

USCS Symbol *sw-sm, ASSUMED*

D60 = 5.1 CC = 1.3

USCS Classification *WELL-GRADED SAND WITH SILT AND GRAVEL*

D30 = 1.0 CU = 38.7

D10 = 0.1

Tested By JLD Date 10/19/98 Checked By *Jam*

Date 10-22-98



### WASH SIEVE ANALYSIS

ASTM D 422-63 (SOP-S3)

Client **QUANTERRA**  
 Client Reference **QUANTERRA C8J150154**  
 Project No. **98275-01**  
 Lab ID **98275-01.004**

Boring No. **NA**  
 Depth (ft) **NA**  
 Sample No. **E2SC-04-GS04**  
 Soil Color **BROWN**

Moisture Content of Passing 3/4" Material		Water Content of Retained 3/4" Material	
Tare No.	585	Tare No.	NA
Wgt. Tare + Wet Specimen (gm)	496.38	Wgt. Tare + Wet Specimen (gm)	NA
Wgt. Tare + Dry Specimen (gm)	469.06	Wgt. Tare + Dry Specimen (gm)	NA
Weight of Tare (gm)	85.64	Weight of Tare (gm)	NA
Weight of Water (gm)	27.30	Weight of Water (gm)	NA
Weight of Dry Soil (gm)	383.42	Weight of Dry Soil (gm)	NA
Moisture Content (%)	7.1	Moisture Content (%)	NA

Wet Weight -3/4" Sample (gm)	NA	Weight of the Dry Specimen (gm)	383.42
Dry Weight - 3/4" Sample (gm)	337.9	Weight of minus #200 material (gm)	30.24
Wet Weight +3/4" Sample (gm)	NA	Weight of plus #200 material (gm)	353.18
Dry Weight + 3/4" Sample (gm)	15.26		
Total Dry Weight Sample (gm)	NA		

Sieve Size	Sieve Opening (mm)	Wgt. of Soil Retained (gm)	Percent Retained (%)	Accumulated Percent Retained (%)	Percent Finer (%)	Accumulated Percent Finer (%)
12"	300	0.00	0.00	0.00	100.00	100.00
6"	150	0.00	0.00	0.00	100.00	100.00
3"	75	0.00	0.00	0.00	100.00	100.00
2"	50	0.00	0.00	0.00	100.00	100.00
1 1/2"	37.5	0.00	0.00	0.00	100.00	100.00
1"	25.0	0.00	0.00	0.00	100.00	100.00
3/4"	19.0	15.26	3.98	3.98	96.02	96.02
1/2"	12.50	48.56	12.66	16.64	83.36	83.36
3/8"	9.50	40.20	10.48	27.13	72.87	72.87
#4	4.75	55.24	14.41	41.54	58.46	58.46
#10	2.00	66.65	17.38	58.92	41.08	41.08
#20	0.850	49.07	12.80	71.72	28.28	28.28
#40	0.425	37.92	9.89	81.61	18.39	18.39
#60	0.250	20.87	5.44	87.05	12.95	12.95
#140	0.106	15.23	3.97	91.02	8.98	8.98
#200	0.075	4.18	1.09	92.11	7.89	7.89
Pan	-	30.24	7.89	100.00	-	-

Tested By **JLD** Date **10/19/98** Checked By *Jcm* Date **10-27-98**



SIEVE ANALYSIS  
ASTM D 422-63 (SOP-S3)

Client QUANTERRA  
Client Reference QUANTERRA C8J150154  
Project No. 98275-01  
Lab ID 98275-01.005

Boring No. NA  
Depth (ft) NA  
Sample No. E2SC-04-GS05  
Soil Color BROWN

USCS	SIEVE ANALYSIS		HYDROMETER
	gravel	sand	silt and clay

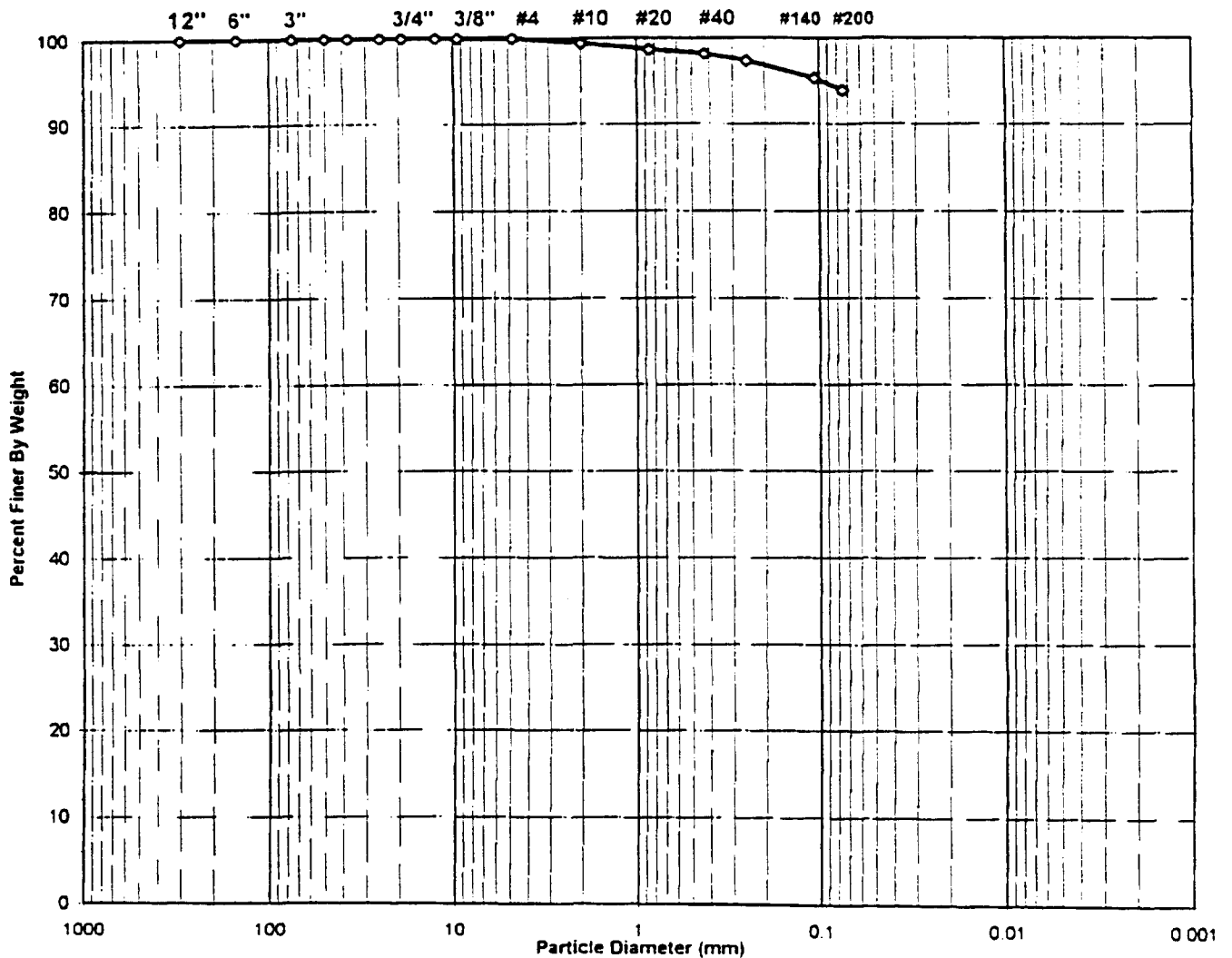

USCS Symbol ML, TESTED

USCS Classification SILT (NON-PLASTIC FINES)

Tested By TO Date 10/27/98 Checked By *Jem*

Date 10-28-98



**WASH SIEVE ANALYSIS**

ASTM D 422-83 (SOP-S3)

Client	QUANTERRA	Boring No.	NA
Client Reference	QUANTERRA C8J150154	Depth (ft)	NA
Project No.	98275-01	Sample No.	E2SC-04-GS05
Lab ID	98275-01.005	Soil Color	BROWN

Moisture Content of Passing 3/4" Material		Water Content of Retained 3/4" Material	
Tare No.	1681	Tare No.	NA
Wgt. Tare + Wet Specimen (gm)	232.08	Wgt. Tare + Wet Specimen (gm)	NA
Wgt. Tare + Dry Specimen (gm)	214.99	Wgt. Tare + Dry Specimen (gm)	NA
Weight of Tare (gm)	103.91	Weight of Tare (gm)	NA
Weight of Water (gm)	17.09	Weight of Water (gm)	NA
Weight of Dry Soil (gm)	111.08	Weight of Dry Soil (gm)	NA
<b>Moisture Content (%)</b>	<b>15.4</b>	<b>Moisture Content (%)</b>	<b>NA</b>

Wet Weight - 3/4" Sample (gm)	NA	Weight of the Dry Specimen (gm)	111.08
Dry Weight - 3/4" Sample (gm)	6.8	Weight of minus #200 material (gm)	104.28
Wet Weight + 3/4" Sample (gm)	NA	Weight of plus #200 material (gm)	6.80
Dry Weight + 3/4" Sample (gm)	0.00		
Total Dry Weight Sample (gm)	NA		

Sieve Size	Sieve Opening (mm)	Wgt. of Soil Retained (gm)	Percent Retained (%)	Accumulated Percent Retained (%)	Percent Finer (%)	Accumulated Percent Finer (%)
12"	300	0.00	0.00	0.00	100.00	100.00
6"	150	0.00	0.00	0.00	100.00	100.00
3"	75	0.00	0.00	0.00	100.00	100.00
2"	50	0.00	0.00	0.00	100.00	100.00
1 1/2"	37.5	0.00	0.00	0.00	100.00	100.00
1"	25.0	0.00	0.00	0.00	100.00	100.00
3/4"	19.0	0.00	0.00	0.00	100.00	100.00
1/2"	12.50	0.00	0.00	0.00	100.00	100.00
3/8"	9.50	0.00	0.00	0.00	100.00	100.00
#4	4.75	0.00	0.00	0.00	100.00	100.00
#10	2.00	0.69	0.62	0.62	99.38	99.38
#20	0.850	0.79	0.71	1.33	98.67	98.67
#40	0.425	0.57	0.51	1.85	98.15	98.15
#60	0.250	0.88	0.79	2.64	97.36	97.36
#140	0.106	2.26	2.03	4.67	95.33	95.33
#200	0.075	1.61	1.45	6.12	93.88	93.88
Pan	-	104.28	93.88	100.00	-	-

Tested By TO Date 10/27/98 Checked By *Em* Date 10.28.98



**ATTERBERG LIMIT**  
ASTM D 4318-96 (SOP - S4)

Client	QUANTERRA	Boring No.	NA
Client Reference	QUANTERRA C8J150154	Depth (ft)	NA
Project No.	98275-01	Sample No.	E2SC-04-GS05
Lab ID	98275-01 005	Visual Description	<b>BROWN SILT</b> ( Minus No. 40 sieve material. Airdried)

**NON - PLASTIC  
MATERIAL**

Tested By TO Date 10/26/98 Checked By Jim Date 10-27-98



SIEVE ANALYSIS  
ASTM D 422-63 (SOP-S3)

Client QUANTERRA  
Client Reference QUANTERRA C8J150154  
Project No. 98275-01  
Lab ID 98275-01 006

Boring No. NA  
Depth (ft) NA  
Sample No. E2SC-04-GS06  
Soil Color BROWN

USCS	SIEVE ANALYSIS		HYDROMETER
	gravel	sand	silt and clay

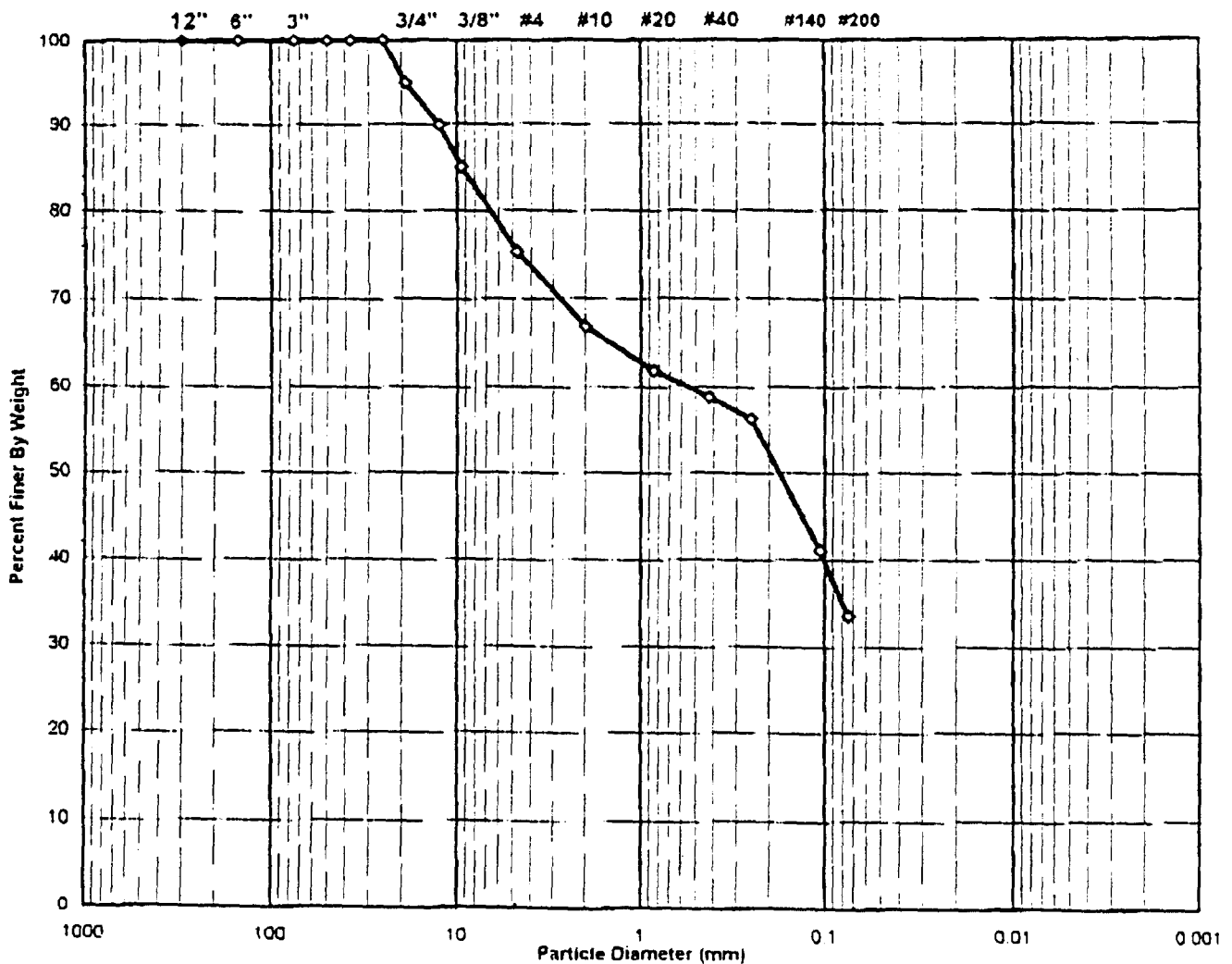

USCS Symbol SM, TESTED

USCS Classification SILTY SAND WITH GRAVEL ( NON-PLASTIC FINDS )

Tested By TO

Date 10/21/98

Checked By *Jan*

Date 10-27-98



**WASH SIEVE ANALYSIS**  
ASTM D 422-83 (SOP-S3)

Client **QUANTERRA**  
 Client Reference **QUANTERRA C8J150154**  
 Project No. **98275-01**  
 Lab ID **98275-01.006**

Boring No. **NA**  
 Depth (ft) **NA**  
 Sample No. **E2SC-04-GS06**  
 Soil Color **BROWN**

Moisture Content of Passing 3/4" Material		Water Content of Retained 3/4" Material	
Tare No.	586	Tare No	NA
Wgt. Tare + Wet Specimen (gm)	477.80	Wgt. Tare + Wet Specimen (gm)	NA
Wgt. Tare + Dry Specimen (gm)	439.70	Wgt. Tare + Dry Specimen (gm)	NA
Weight of Tare (gm)	82.70	Weight of Tare (gm)	NA
Weight of Water (gm)	38.10	Weight of Water (gm)	NA
Weight of Dry Soil (gm)	357.00	Weight of Dry Soil (gm)	NA
<b>Moisture Content (%)</b>	<b>10.7</b>	<b>Moisture Content (%)</b>	<b>NA</b>

Wet Weight - 3/4" Sample (gm)	NA	Weight of the Dry Specimen (gm)	357.00
Dry Weight - 3/4" Sample (gm)	218.9	Weight of minus #200 material (gm)	119.97
Wet Weight + 3/4" Sample (gm)	NA	Weight of plus #200 material (gm)	237.03
Dry Weight + 3/4" Sample (gm)	18.18		
Total Dry Weight Sample (gm)	NA		

Sieve Size	Sieve Opening (mm)	Wgt. of Soil Retained (gm)	Percent Retained (%)	Accumulated Percent Retained (%)	Percent Finer (%)	Accumulated Percent Finer (%)
12"	300	0.00	0.00	0.00	100.00	100.00
6"	150	0.00	0.00	0.00	100.00	100.00
3"	75	0.00	0.00	0.00	100.00	100.00
2"	50	0.00	0.00	0.00	100.00	100.00
1 1/2"	37.5	0.00	0.00	0.00	100.00	100.00
1"	25.0	0.00	0.00	0.00	100.00	100.00
3/4"	19.0	18.18	5.09	5.09	94.91	94.91
1/2"	12.50	18.08	5.06	10.16	89.84	89.84
3/8"	9.50	17.32	4.85	15.01	84.99	84.99
#4	4.75	34.73	9.73	24.74	75.26	75.26
#10	2.00	30.24	8.47	33.21	66.79	66.79
#20	0.850	17.99	5.04	38.25	61.75	61.75
#40	0.425	10.62	2.97	41.22	58.78	58.78
#60	0.250	9.07	2.54	43.76	56.24	56.24
#140	0.106	54.30	15.21	58.97	41.03	41.03
#200	0.075	26.50	7.42	66.39	33.61	33.61
Pan	-	119.97	33.61	100.00	-	-

Tested By **JLD** Date **10/19/98** Checked By *JLD* Date **10-27-98**





**ATTERBERG LIMIT**  
ASTM D 4318-98 (SOP - S4)

Client	QUANTERRA	Boring No.	NA
Client Reference	QUANTERRA C8J150154	Depth (ft)	NA
Project No.	98275-01	Sample No.	E2SC-04-GS06
Lab ID	98275-01.006	Visual Description	<b>BROWN SILT</b> ( Minus No. 40 sieve material. Airdried)

**NON - PLASTIC  
MATERIAL**

Tested By *DBB* Date *10/24/98* Checked By *Jom* Date *10-27-98*

ATTACHMENT C

---

SEISMIC REFRACTION DATA

# Geophysical Applications, Inc.

125 Washington Street - Suite 2  
Foxboro, MA 02035

voice: 508/543-1388 e-mail: geoapp@aol.com fax: 508/543-1019

## Seismic Survey Results Summary

### Vicinity of Hibbard Playground and East Street Area 2 Site

The accompanying figure shows interpreted seismic refraction results from three traverses performed near the Hibbard Playground and the East Street Area 2 site.

Line 11A is located near the playgrounds north edge, parallel to the river. Line 8 crosses the playground, and continues on the north side of the river within East Street Area 2. An extra spread within the playground, denoted Line 15, is also shown oriented towards the northwest.

Lines 8 and 11A indicate unsaturated soil (velocity range of 1,270 to 1,400 ft/sec) above elevation 970 feet or 975 feet. An intermediate layer (velocity range of 3,650 to 4,020 ft/sec) was detected below elevation 970 or 975 feet. This material may include soils that are more dense, or water-saturated, compared to the shallow layer.

The lowermost layer shown on the cross sections exhibits seismic velocity values of 6,000 to 6,400 ft/sec. This material is anticipated to be more dense than the overlying layers, and should produce distinctly higher blow counts during test drilling. A trough in this surface is centered along Line 11A near Station 575. The lowermost layers surface along Line 15 shows more scatter than Lines 8 and 11A, possibly due to side-refractions from the sides of the potential trough.

The intermediate layers velocity value was defined by no more than two points on each seismogram, because the layer is relatively thin. If the intermediate layers velocity is actually higher (e.g., water-saturated sediments typically exhibit seismic velocities of approximately 4,800 ft/sec), then the lowermost layer may be deeper than shown on the cross sections.

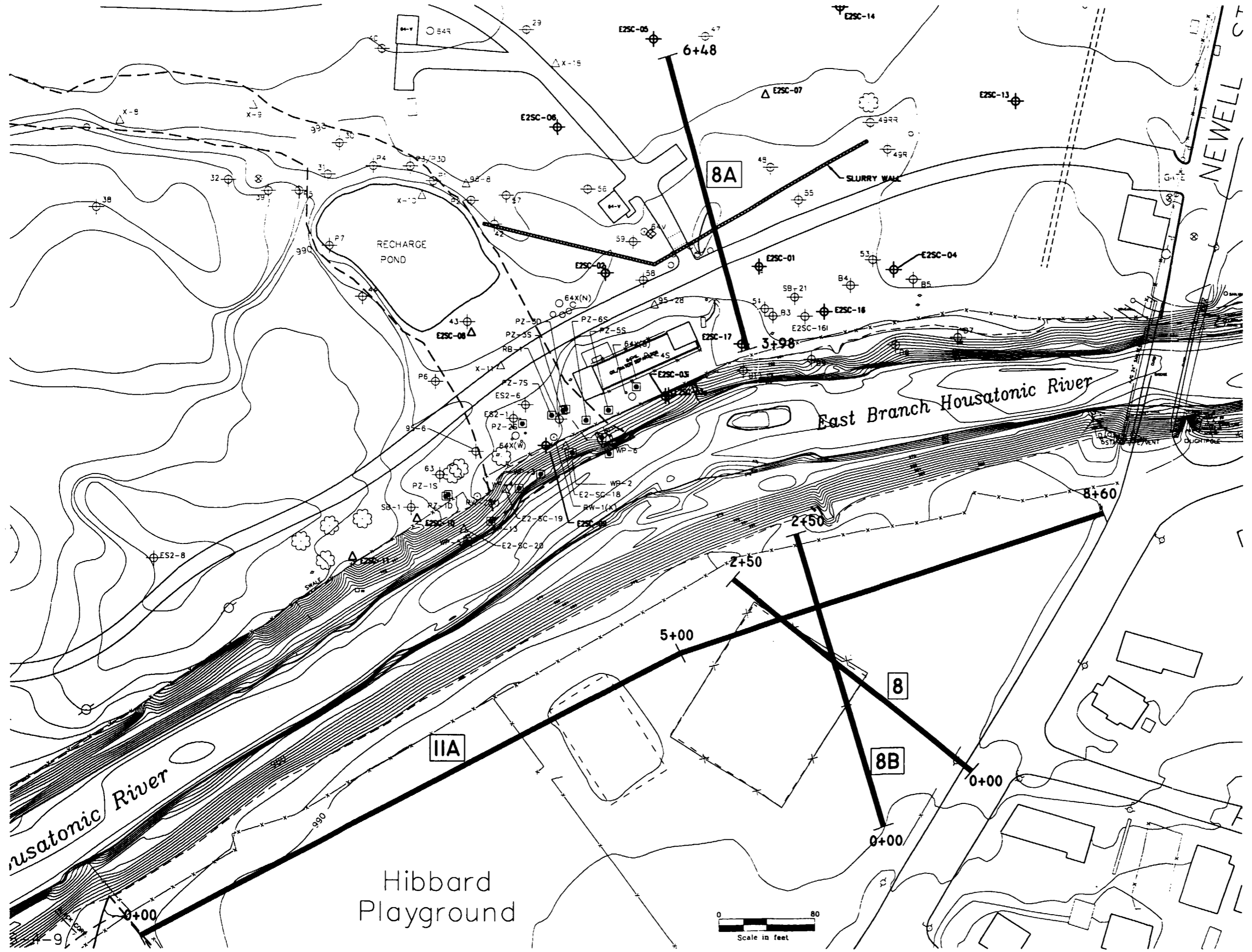

- EXPLANATION**
- SECTION LOCATION**
- APPROXIMATE DELINEATION OF FORMER OUBOW H
  - ES2-1 PREVIOUSLY INSTALLED MONITORING WELL
  - 64X(W) PREVIOUSLY INSTALLED OIL RECOVERY CAISSON
  - RW-1(X) PREVIOUSLY INSTALLED PUMPING WELL
  - X-11 PREVIOUSLY INSTALLED SOIL BORING
  - WP-3 PREVIOUSLY INSTALLED PIEZOMETER
  - E2SC-1 SOURCE CONTROL MONITORING WELL (INSTALLED 1998)
  - E2SC-7 SOURCE CONTROL BORING (INSTALLED 1998)
  - SEISMIC REFRACTION LINE

NOTE: BASE MAP AND ALL DATA LOCATIONS PRIOR TO 1998 PROVIDED BY BLASLAND, BOUCK & LEE. ALL SOURCE CONTROL INVESTIGATION BORINGS AND WELL LOCATIONS PROVIDED BY HILL ENGINEERING.

Figure 1 Seismic Refraction Line Locations



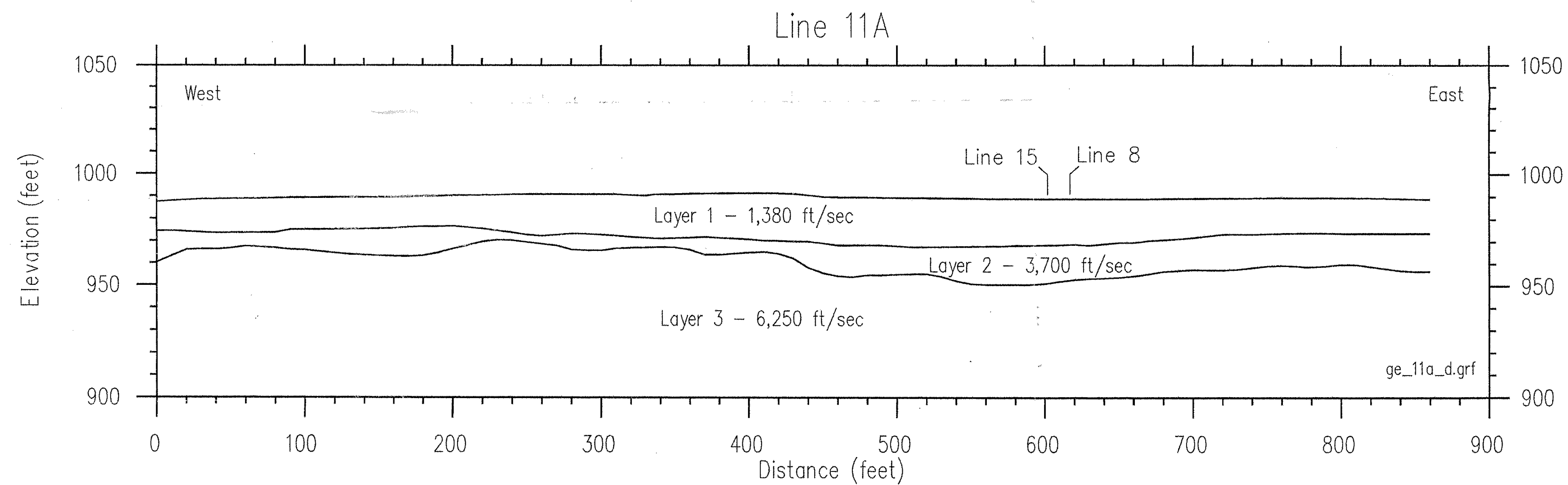
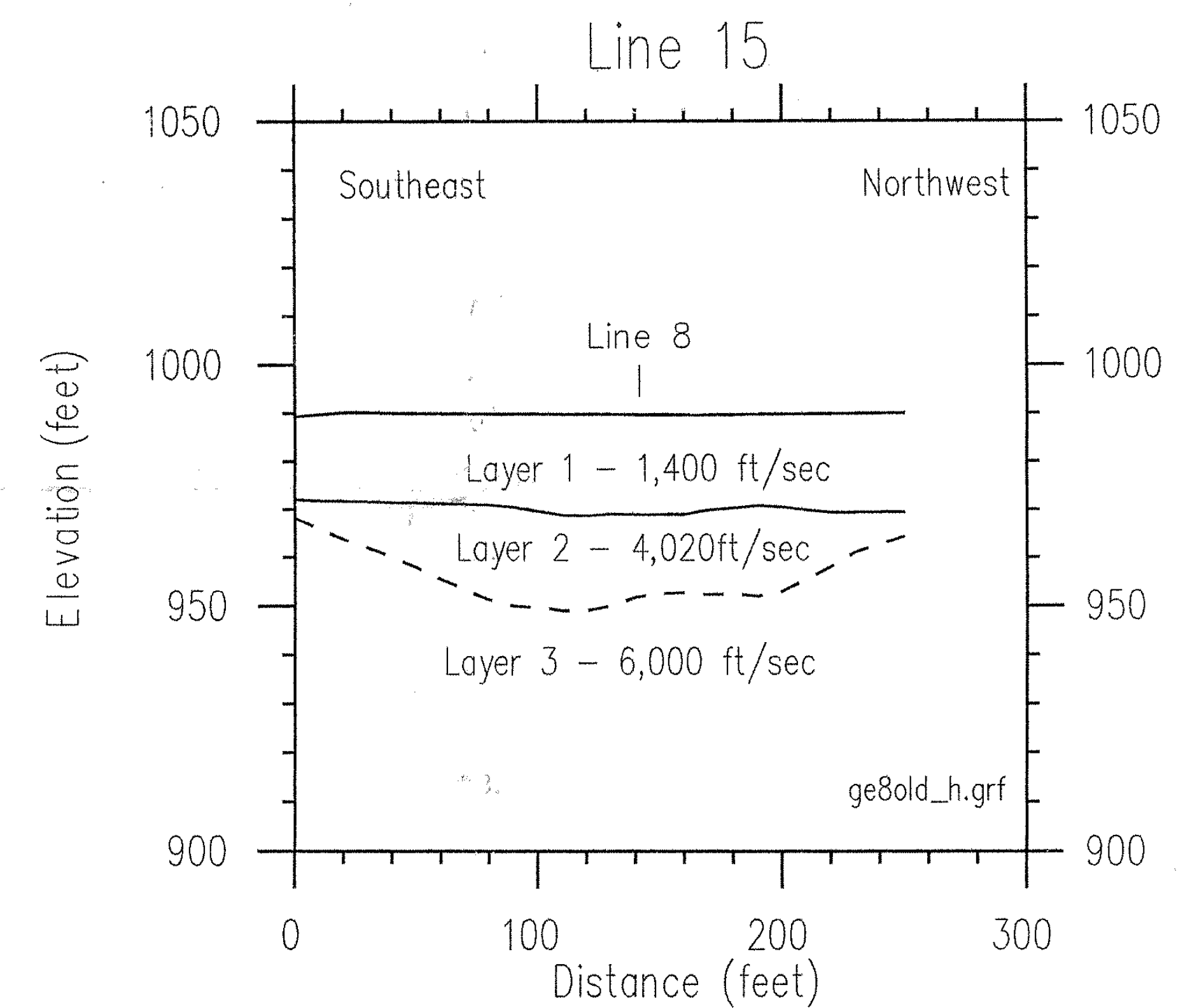
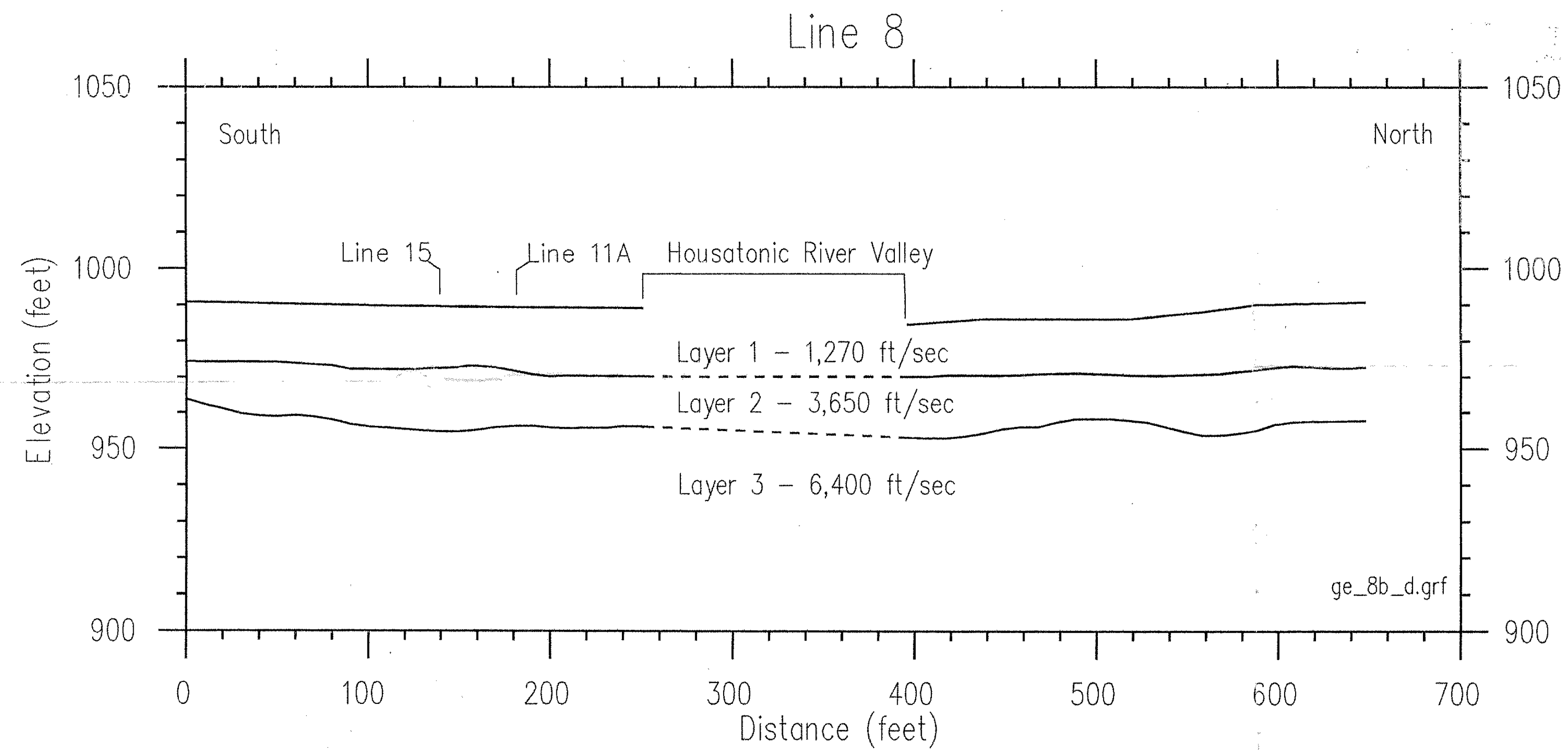

Notes:

- 1) Seismic velocity values are in units of feet per second (ft/sec)
- 2) Vertical exaggeration is 2:1
- 3) Ground elevations are approximate
- 4) Dashed lines represent interfaces with assumed geometry

98239 - 8\_11a\_15.dwg  
last modified 1/8/99

**GEOPHYSICAL  
APPLICATIONS**  
INCORPORATED

Seismic Refraction Cross Sections  
Lines 8, 11A and 15  
Pittsfield, Massachusetts  
prepared for  
GENERAL ELECTRIC COMPANY

# ***Appendix B***

BLASLAND, BOUCK & LEE, INC.  
*engineers & scientists*

---

## ***Groundwater Hydraulic Modeling Results***

**GENERAL ELECTRIC COMPANY  
PITTSFIELD, MASSACHUSETTS  
EAST STREET AREA 2 SOURCE CONTROL**

**GROUNDWATER HYDRAULIC MODELING RESULTS**

**Introduction**

The well-documented Visual MODFLOW™ program was used for the groundwater modeling effort associated with the East Street Area 2 Source Control activities. Visual MODFLOW™ is a proprietary pre- and post-processing program (Waterloo Hydrogeologic, Inc., 1996) formulated to allow quick and efficient model setup and graphical presentation of model results for the publicly available MODFLOW and MODPATH groundwater programs. MODFLOW is a three-dimensional groundwater flow model developed by the USGS to simulate groundwater movement (McDonald and Harbaugh, 1988). MODPATH is a three-dimensional advective particle tracking program designed for use with MODFLOW steady-state flow simulations. MODPATH was also developed by the USGS (Pollock, 1989).

**Model Setup**

The area subject to modeling extends in a north-south direction from East Street to the Housatonic River. In the east-west direction, the model extends from Newell Street to approximately 500 feet west of the recharge pond. Portions of the model grid (Figure 1) that extend beyond these model boundaries (i.e., south of the Housatonic River and north of East Street) are currently set as inactive and are not incorporated in the model calculations. The model grid is designed with 161 rows, 125 columns, and 2 layers. The grid spacing is variable, ranging from 5 to 15 feet, with the smallest grid blocks centered between the recharge pond and the river. Two layers are used to facilitate simulation of the existing slurry wall located southeast of the recharge pond. The base of the top layer (model Layer 1) is set at the approximate elevation of the bottom of the slurry wall. There is no differentiation between the different geologic deposits encountered above the till. Since the till has a substantially lower hydraulic conductivity than the alluvium, it has been modeled as an impermeable surface.

The input required for the model includes: stratigraphic data, groundwater elevations and hydraulic properties for each layer, estimates regarding the amount of water entering and leaving the hydrogeologic system, and model boundary conditions. Layer hydrostratigraphic elevations necessary for this model are selected as the bottom elevation of the existing slurry wall and the top of till elevation. The bottom of the slurry wall is approximately 29 feet below land surface. Land surface elevation contours on the site map range from 988 to 986 feet above mean sea level (amsl) in the vicinity of the slurry wall. The base of Layer 1 is set at a uniform 959.0 feet amsl to correspond with the base of the existing slurry wall.

The base of layer 2 represents the top of till. The top of till elevations used in the model were estimated from borings, supplemented with interpreted geophysical till elevations, which indicate a sloping (from north to south) top of till surface. These till elevations range from 942.0 feet amsl along the Housatonic River to 969.5 feet amsl closer to East Street. The base of Layer 2 therefore slopes up from a low of 942.0 feet at the river until it intersects Layer 1 at elevation 959.0 feet. For simplicity, this is the highest elevation used to represent the till in the model.

The horizontal hydraulic conductivity for all the saturated overburden materials above the till was initially set to  $1.5 \times 10^{-2}$  cm/sec (42.5 feet/day), based on a pumping test performed on recovery well RW-1(X) by Golder

Associates (1993). The vertical conductivity was assumed to be 10 times less than horizontal because of the existence of horizontal (bedding plane) stratification. During the process of calibrating the model, a horizontal hydraulic conductivity of  $1 \times 10^{-2}$  cm/sec (28.35 feet/day) was found to produce better results.

The model input conditions include the: recharge due to precipitation, Housatonic River, recharge pond, till, and regional groundwater flow lines. Recharge due to precipitation was set to 10 inches per year. The eastern and western model boundaries were impermeable or 'no flow' boundaries presumed to correspond with groundwater flow lines. The till also was modeled as a no flow boundary.

Constant heads were used to represent the Housatonic River along the southern edge of the model. A line of constant heads was set at 980.0 feet amsl along the northern model boundary in Layer 1 to allow upgradient inflow of groundwater. This line was generally parallel to the 980.0 foot contour shown on the April 1998 groundwater elevation contour map shown in the *Spring 1998 Semi-Annual Groundwater Monitoring Report* (August 1998, BBL). The recharge pond was simulated with a low permeability pond bottom. The elevation of the recharge pond was set to 983.0 feet amsl and the bottom of the recharge pond (set as 3 feet thick) was assigned conductance values ranging from 3.8 to 7.6  $\text{cm}^2/\text{sec}$  (354 to 708  $\text{feet}^2/\text{day}$ ). These conductance values are reflective of a vertical hydraulic conductivity of approximately  $1 \times 10^{-2}$  cm/sec (28.35 feet/day) applied across the area of the given grid block.

Additional features incorporated into the model include the existing recovery wells, the existing hanging slurry wall, and the proposed sheetpile wall. The recovery wells were set at the locations shown on the site map and were modeled as constant heads. The existing slurry wall was incorporated with the MODFLOW wall option, which was activated only in model Layer 1. The slurry wall was assigned a thickness of 2 feet and a hydraulic conductivity of  $1 \times 10^{-8}$  cm/sec (0.0000284 feet/day). The base of the slurry wall was set at an elevation of 959 feet amsl, which was the base of Layer 1. The proposed sheetpile wall was also incorporated using the MODFLOW wall option. The wall was modeled as a hanging sheetpile wall, i.e. it was only activated in Layer 1 of the model. The thickness of the sheetpile wall was 0.021 feet (0.25 inches) and the hydraulic conductivity was set at  $1 \times 10^{-8}$  cm/sec (0.0000284 feet/day).

Once the model was established, it was calibrated using the observed water elevations in recovery systems RW-1(X), RW-2(X), 64X(W), 64X(S), 64S, 64R, and 64V, along with the observed river elevation during two separate monitoring events. The resulting contours were then compared with water elevations observed in 64X(N), 49R, 53, 54, 58, 42, PZ-2S, PZ-4S, and PZ-5S during the same monitoring events. An overview of this calibration process follows.

### **Calibration Process**

The goal of the calibration process was to simulate the groundwater elevations observed on February 4 and 5, 1998 and May 6 and 7, 1998 (BBL, 1998). The following constant head elevations for the river and the groundwater recovery systems were established based on Spring 1998 Semi-Annual Monitoring Report (August 1998, BBL) and used for calibration purposes:



Location	Date	
	February 4-5, 1998 Water Elevation (feet)	May 6-7, 1998 Water Elevation (feet)
River	971.6	973.2
RW-1(X)	965.1	970.6
RW-2(X)	965.6	970.6
64X(W)	971.6	972.8
64X(S)	971.7	972.8
64S	974.0	974.0
64R	977.0	977.0
64V	965.0	965.0

The model was run with the above input parameters and the resulting equipotential contours were compared to observed water elevations (BBL, 1998). To improve the simulation, the horizontal and vertical hydraulic conductivities were reduced to  $1 \times 10^{-2}$  cm/sec (28.35 feet/day) and  $1 \times 10^{-3}$  cm/sec (2.84 feet/day), respectively. This simulation produced equipotential contours shown on Figures 2 and 3 that better matched the observed elevations in 64X(N), 49R, 53, 54, 58, 42, PZ-2S, PZ-4S, and PZ-5S for both monitoring events (BBL, 1998).

### Hangng Sheetpile Wall Modeling

After calibration of the models, the hanging sheetpile wall was added, and both models were rerun (Figures 4 and 5 for February 1998 and May 1998, respectively). The resulting equipotential and drawdown contours indicate that the groundwater flow is generally the same but the contours deflect slightly at the edge of the sheetpile wall with groundwater elevations typically 0.5 feet to 1 foot higher immediately behind the wall, as compared to the calibrated existing contours (Figures 6 and 7 for February 1998 and May 1998, respectively). This is likely a conservative estimate since the hydraulic heads between the recharge pond and the riverbank are 2-4 feet higher in the model calibration run as compared to the actual hydraulic heads observed. Lowering the recharge pond elevation to 982 feet somewhat reduces this effect (Figures 8 and 9).

Two-dimensional analyses of the riverbank area both without and with the sheetpile wall (Figures 10 and 11, respectively) was conducted to evaluate the potential changes which the sheetpile wall might cause to vertical gradients. This provides further insight into the potential for DNAPL movement by comparing the specific gravity of the DNAPL with the hydraulic gradient. For example, a DNAPL with a specific gravity of 1.08 could potentially be mobilized under a vertical hydraulic gradient greater than 0.08. Based on the two-dimensional analyses performed, vertical gradients were calculated to predict their potential on DNAPL before and after placement of the sheetpile wall (Figures 12 and 13). Although, the vertical gradients may increase slightly after wall placement, they do not approach the levels where potential upward movement is a concern. In the vicinity of the proposed wall itself, the gradients remain at levels at or below 0.01. Under the middle of the river, the vertical gradients may potentially increase to .025 at elevations above 949 amsl. However,

they drop back to levels of 0.01 below 947 amsl which will approximate the simulated vertical gradients which exist near the top of the till prior to placement of the sheetpile. Therefore, upward movement of the DNAPL should not be induced by the installation of the sheetpile barrier.

## ***References:***

---

- Blasland, Bouck & Lee, Inc., *Occurrence of Oil at East Street Area 2/USEPA Area 4 - Spring 1998*, (Syracuse, NY: August 1998).
- Golder Associates, *Evaluation of River Bank Recovery Measures: RW-1(X) System East Street Area 2 Pittsfield Massachusetts*, (Mt. Laurel, NJ: June 1993).
- McDonald, M. G., and Harbaugh, A. W., 1988, A Modular Three-Dimensional Finite-Difference Ground-water Flow Model, Techniques of Water-Resources Investigations of the USGS, Chapter A1, Book 6, Modeling Techniques.
- Pollack, D.W., 1989, Documentation of a Computer Program to Compute and Display Pathlines using Results from the USGS Modular Three-Dimensional Finite-Difference Ground-Water Flow Model, USGS Open-File Report 89-391, 188 p.
- Waterloo Hydrogeologic Software, 1996, Visual MODFLOW User's Manual, The Fully Integrated Modeling Environment for the USGS's MODFLOW and MODPATH, Version VM200.767.

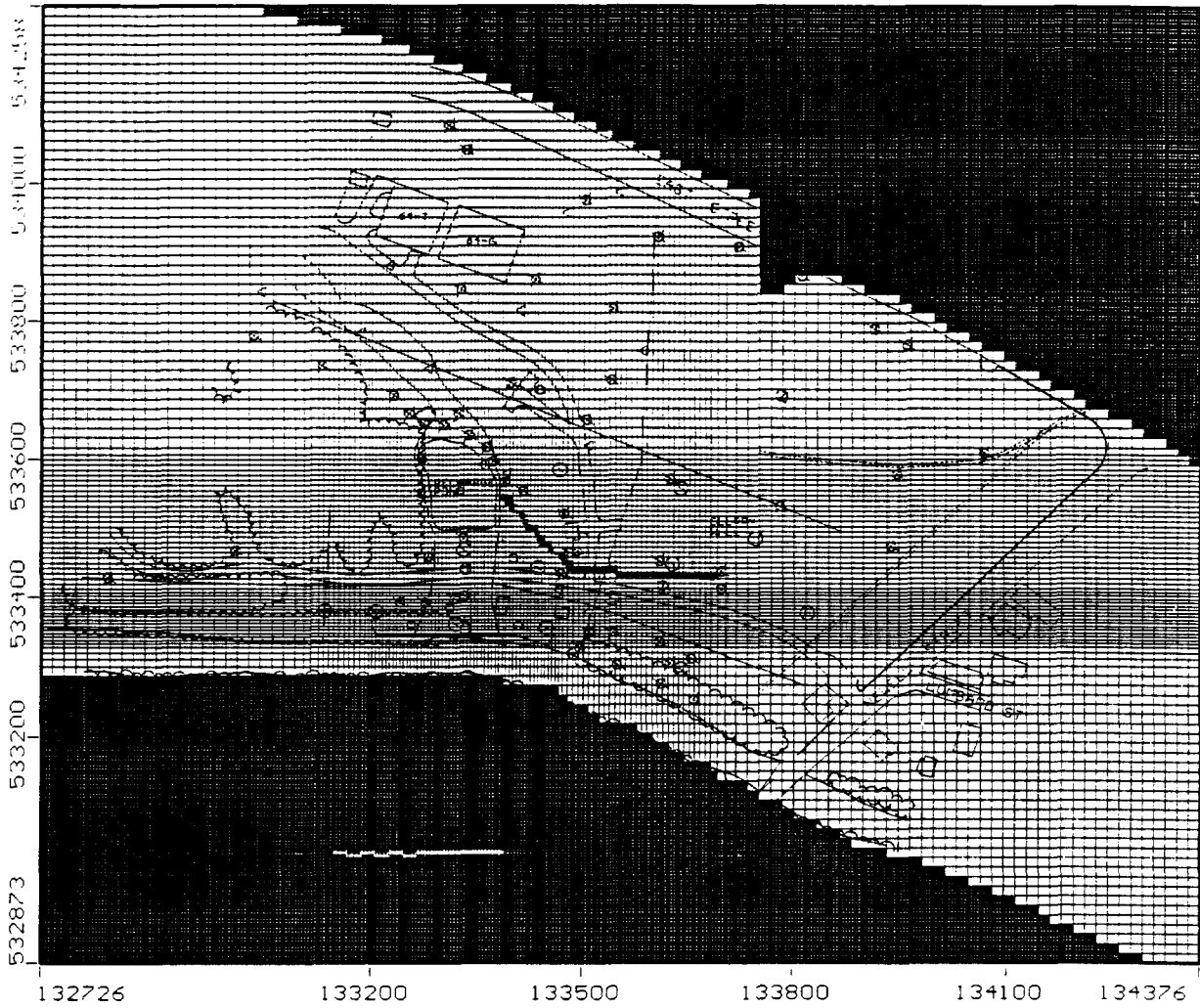

Blasland, Bouck & Lee, Inc. - Syracuse,  
 Project: East Street Area 2

Figure 1 Model Grid

Visual MODFLOW v.2.11, (c) 1995  
 Waterloo Hydrogeologic Software  
 NC: 161 NR: 125 NL: 2  
 Current Layer: 1

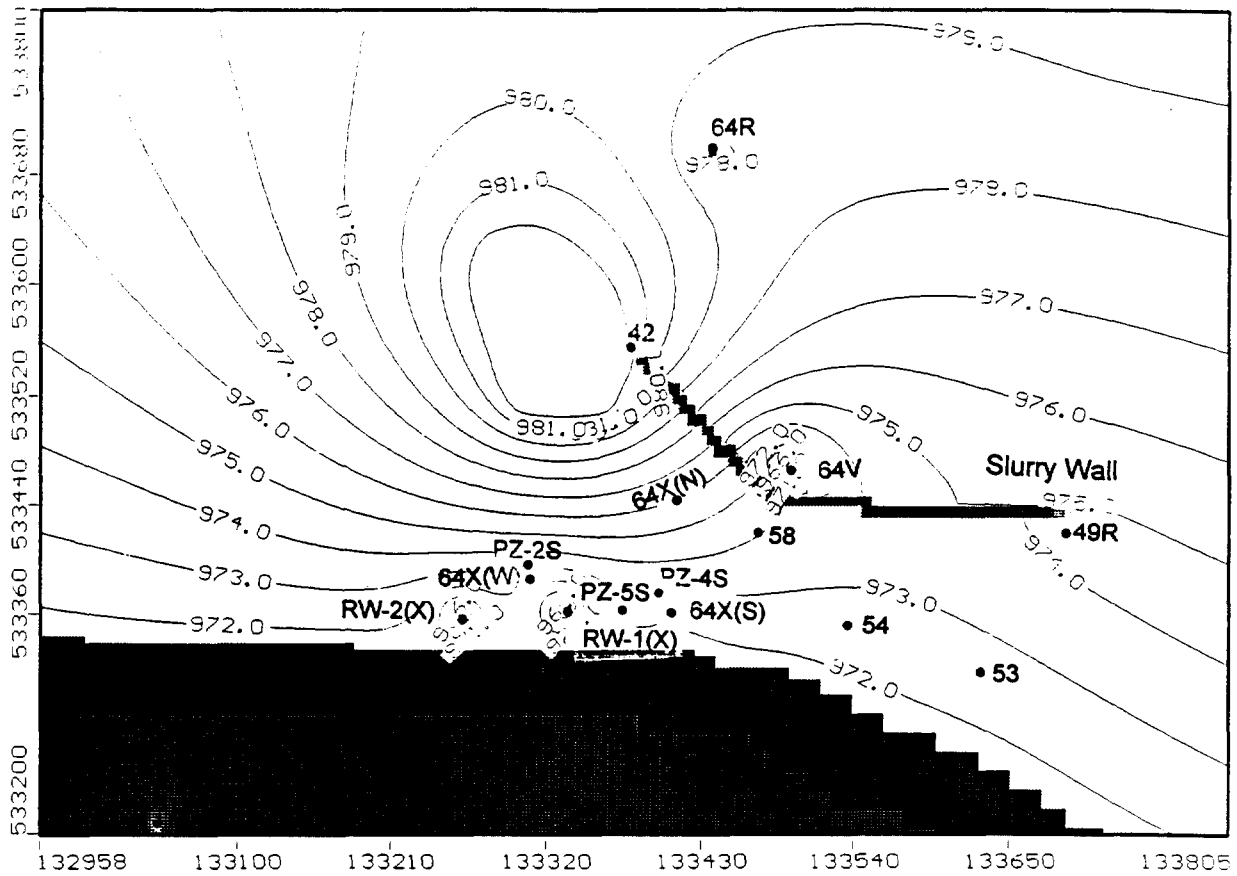

Location	Piezometric Elevation	Location	Piezometric Elevation	Location	Piezometric Elevation
64R	977	42	974.52	RW-1(X)	965.08
64V	965	49R	973.00	RW-2(X)	965.56
64X(W)	971.6	53	972.53	PZ-2S	971.81
64X(S)	971.68	54	972.49	PZ-4S	971.32
64X(N)	972.01	58	972.39	PZ-5S	972.02

Blasland, Bouck & Lee, Inc. - Syracuse,  
Project: East Street Area 2

Figure 2 February 1998 Calibration

Visual MODFLOW v.2.11, (c) 1995  
Waterloo Hydrogeologic Software  
NC: 161 NR: 125 NL: 2  
Current Layer: 1

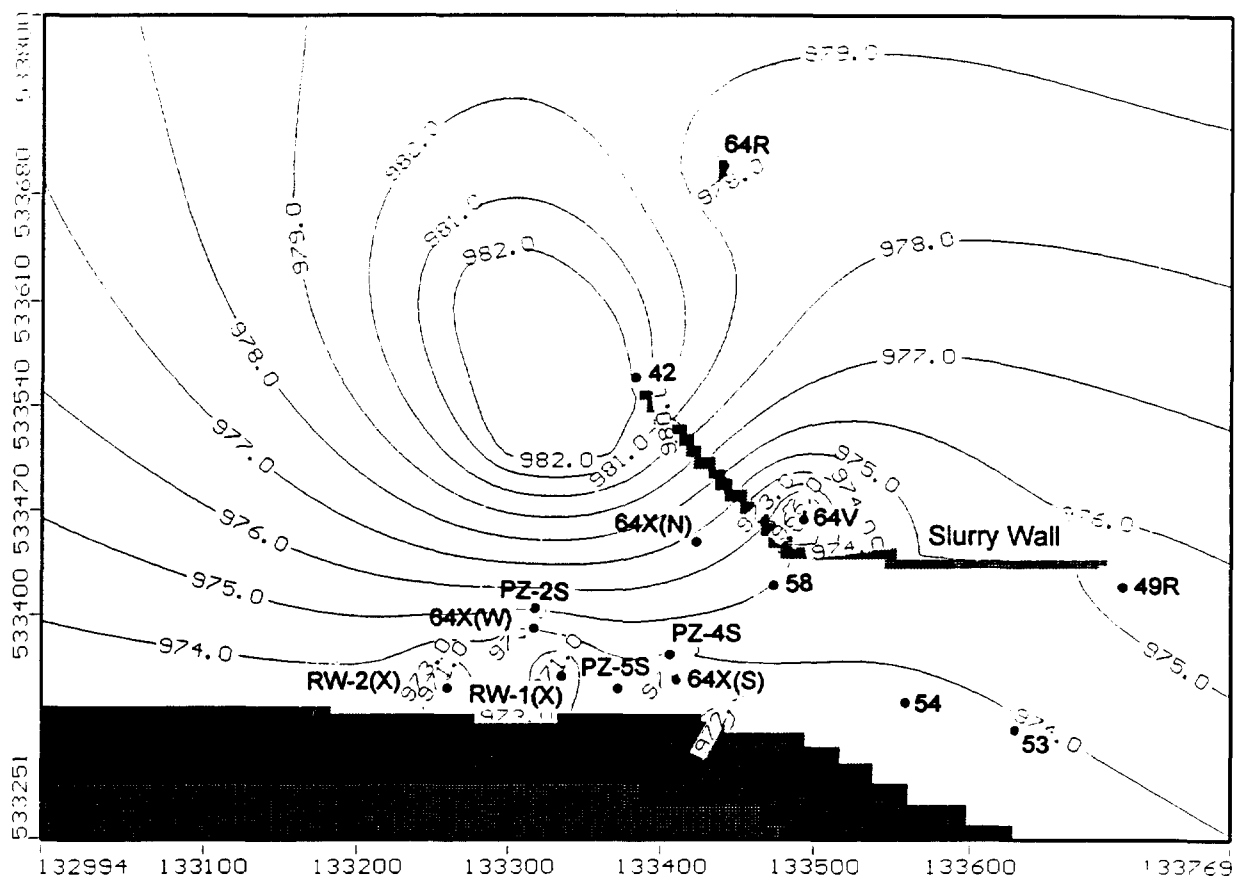

Location	Piezometric Elevation	Location	Piezometric Elevation	Location	Piezometric Elevation
64R	977	42	975.79	RW-1(X)	970.64
64V	965	49R	973.44	RW-2(X)	970.60
64X(W)	971.76	53	973.33	PZ-2S	973.38
64X(S)	972.81	54	973.31	PZ-4S	972.84
64X(N)	972.98	58	972.94	PZ-5S	973.34

Blasland, Bouck & Lee, Inc. — Syracuse,  
 Project: East Street Area 2

Figure 3 May 1998 Calibration

Visual MODFLOW v.2.11, (c) 1995  
 Waterloo Hydrogeologic Software  
 NC: 161 NR: 125 NL: 2  
 Current Layer: 1

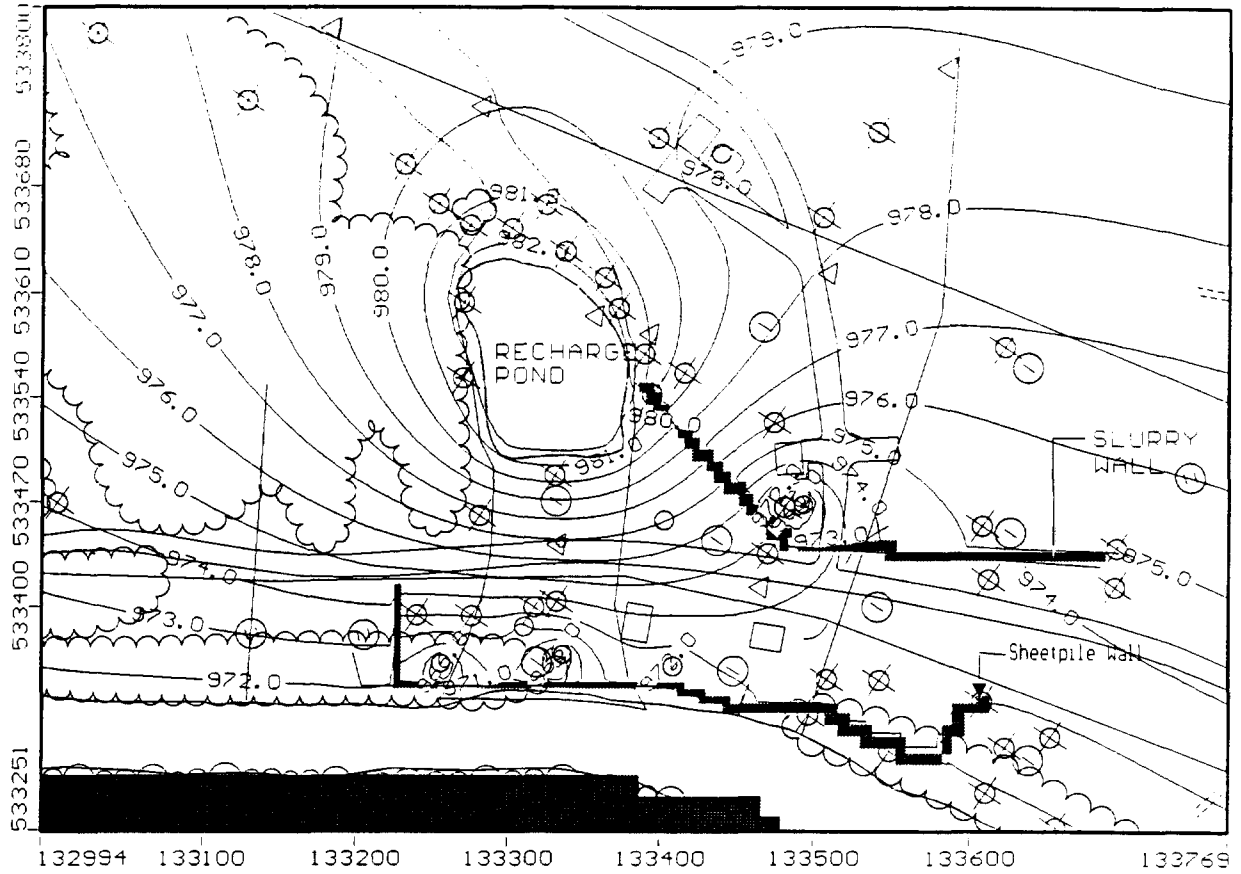

Blasland, Bouck & Lee, Inc. - Syracuse,  
 Project: East Street Area 2

Figure 4 February 1998 Simulation with  
 Containment Barrier

Visual MODFLOW v.2.11, (c) 1995  
 Waterloo Hydrogeologic Software  
 NC: 161 NR: 125 NL: 2  
 Current Layer: 1

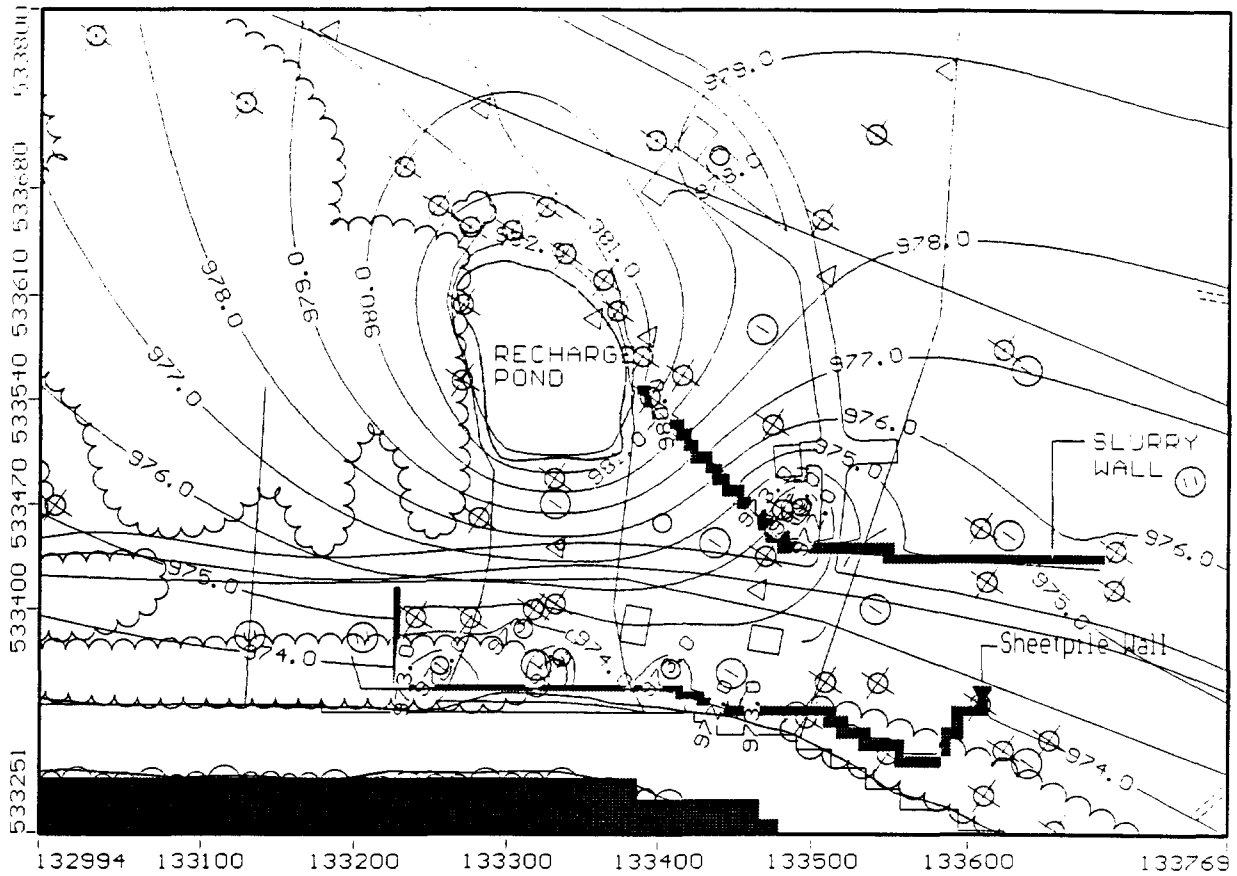

Blasland, Bouck & Lee, Inc. - Syracuse,  
 Project: East Street Area 2

Figure 5 May 1998 Simulation with  
 Containment Barrier

Visual MODFLOW v.2.11, (c) 1995  
 Waterloo Hydrogeologic Software  
 NC: 161 NR: 125 NL: 2  
 Current Layer: 1



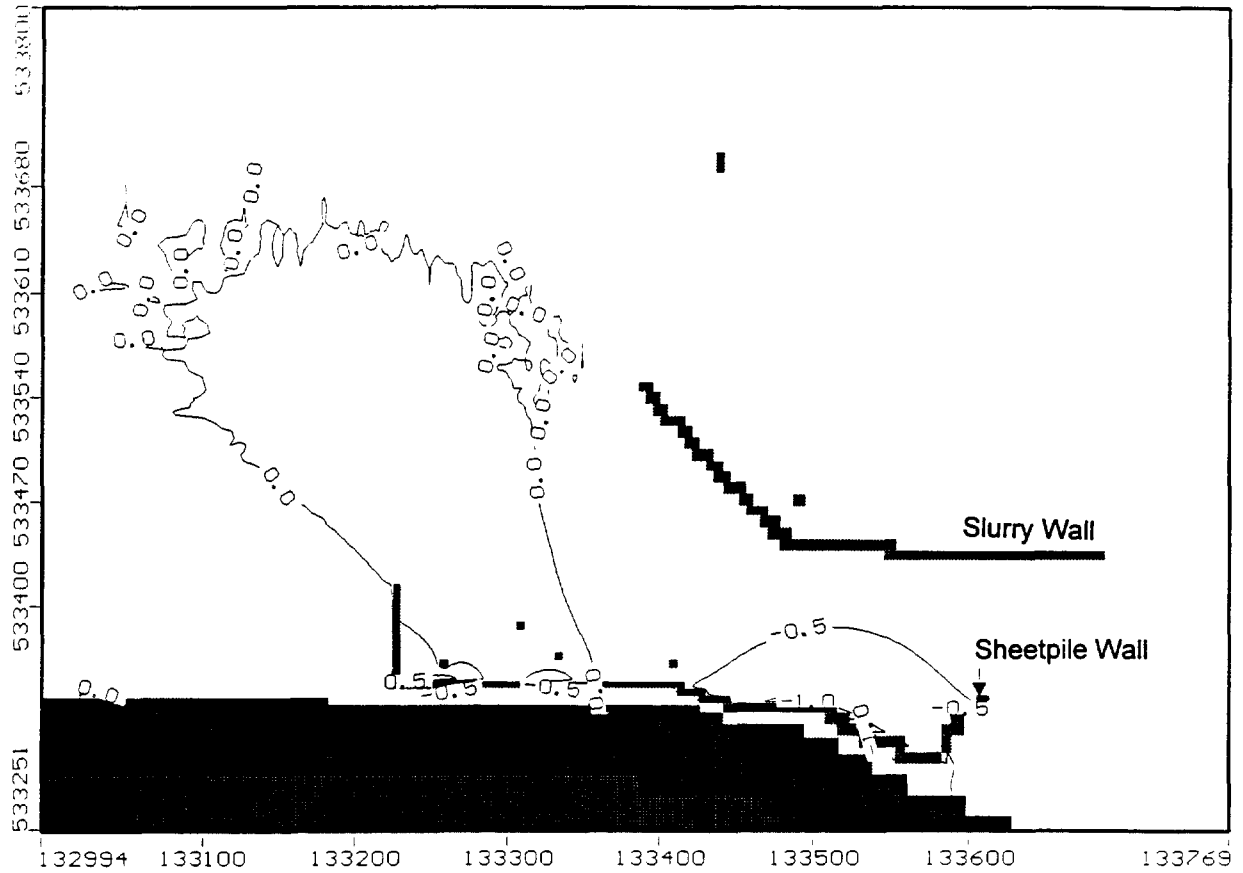

Blasland, Bouck & Lee, Inc. - Syracuse.  
 Project: East Street Area 2

Figure 6 February 1998 Simulation -  
 Hydraulic Head Differential

Visual MODFLOW v.2.11, (c) 1995  
 Waterloo Hydrogeologic Software  
 NC: 161 NR: 125 NL: 2  
 Current Layer: 1

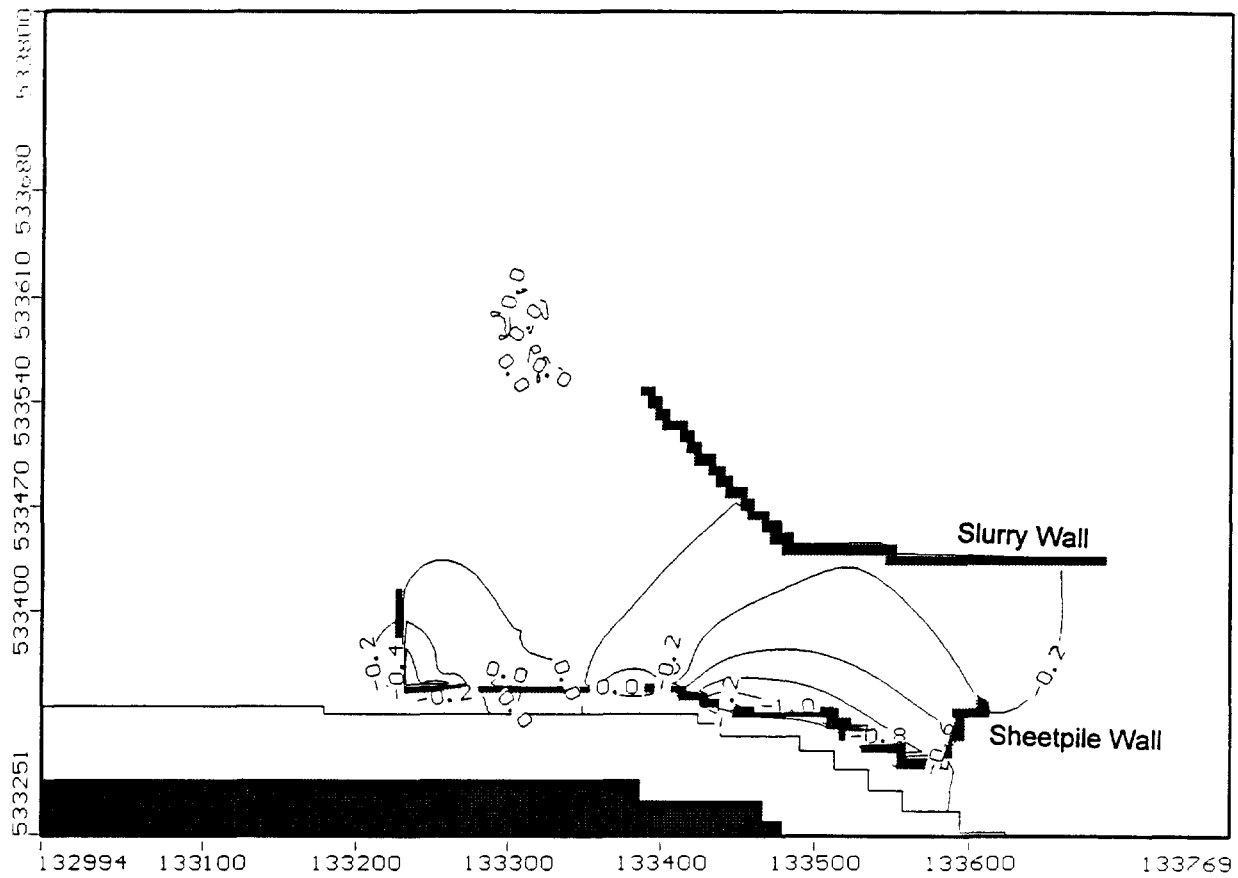

Blasland, Bouck & Lee, Inc. - Syracuse,  
 Project: East Street Area 2

Figure 7 May 1998 Simulation -  
 Hydraulic Head Differential

Visual MODFLOW v.2.11. (c) 1995  
 Waterloo Hydrogeologic Software  
 NC: 161 NR: 125 NL: 2  
 Current Layer: 1

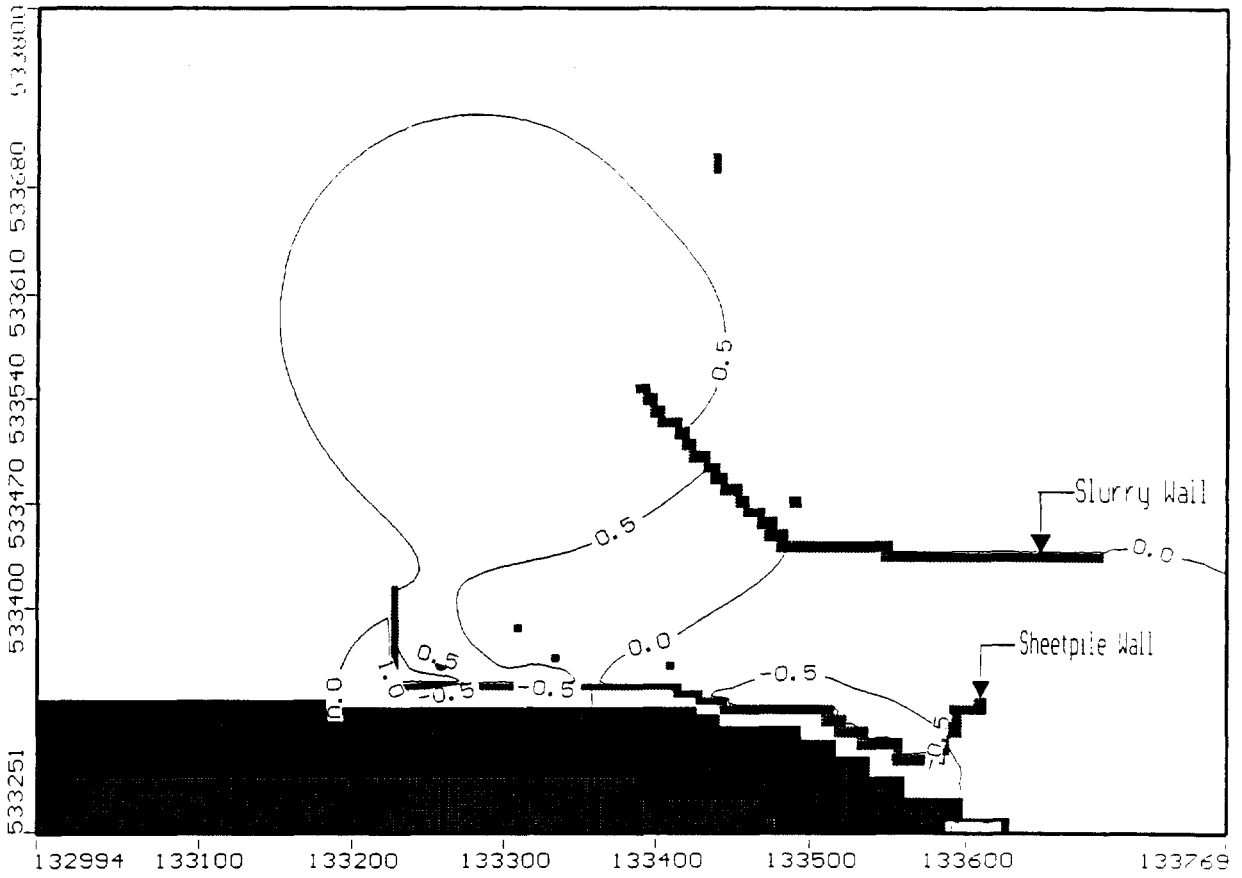

Blasland, Bouck & Lee, Inc. - Syracuse,  
 Project: East Street Area 2

Figure 8 February 1998 Simulation -  
 Recharge Pond Adjustment

Visual MODFLOW v.2.11, (c) 1995  
 Waterloo Hydrogeologic Software  
 NC: 161 NR: 125 NL: 2  
 Current Layer: 1

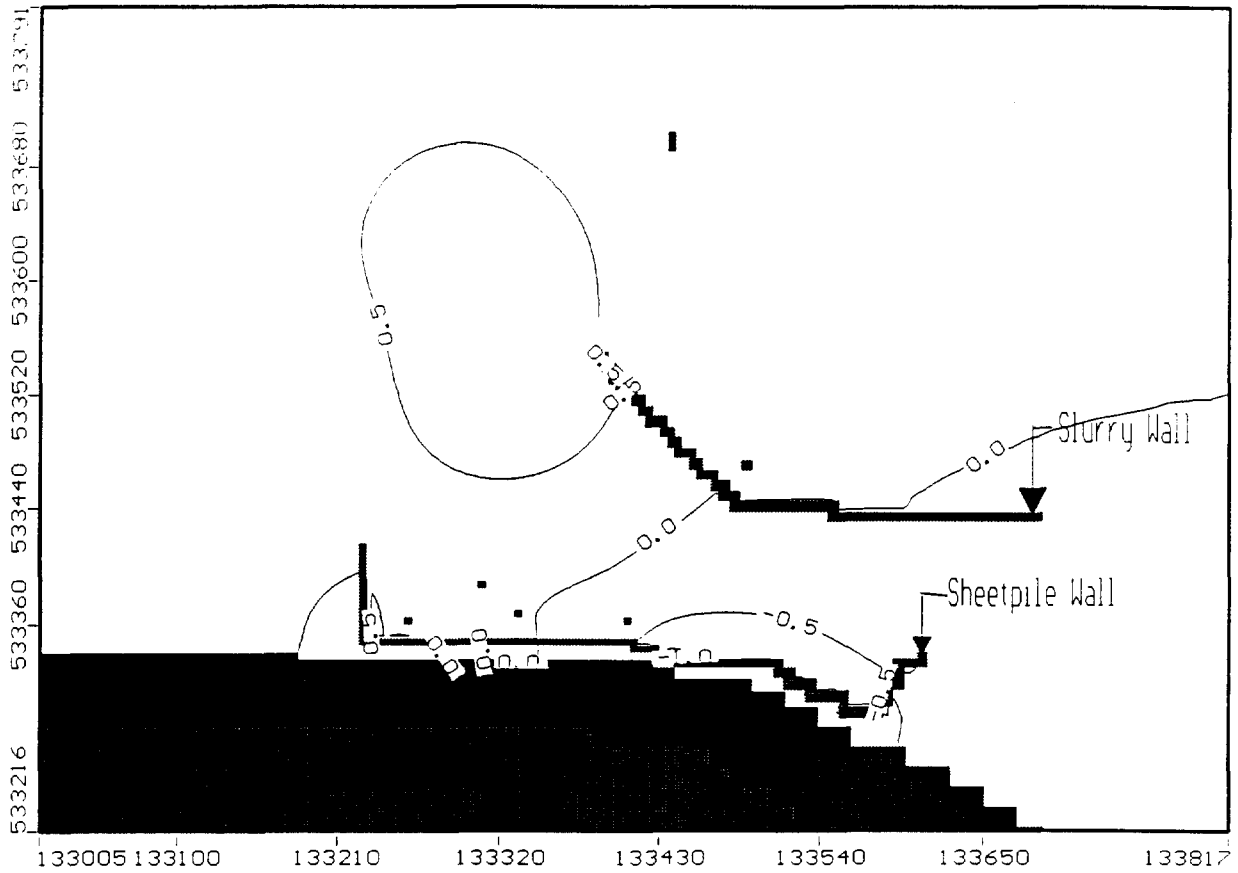

Blasland, Bouck & Lee, Inc. - Syracuse,  
 Project: East Street Area 2

Figure 9 May 1998 Simulation -  
 Recharge Pond Adjustment

Visual MODFLOW v.2.11, (c) 1995  
 Waterloo Hydrogeologic Software  
 NC: 161 NR: 125 NL: 2  
 Current Layer: 1

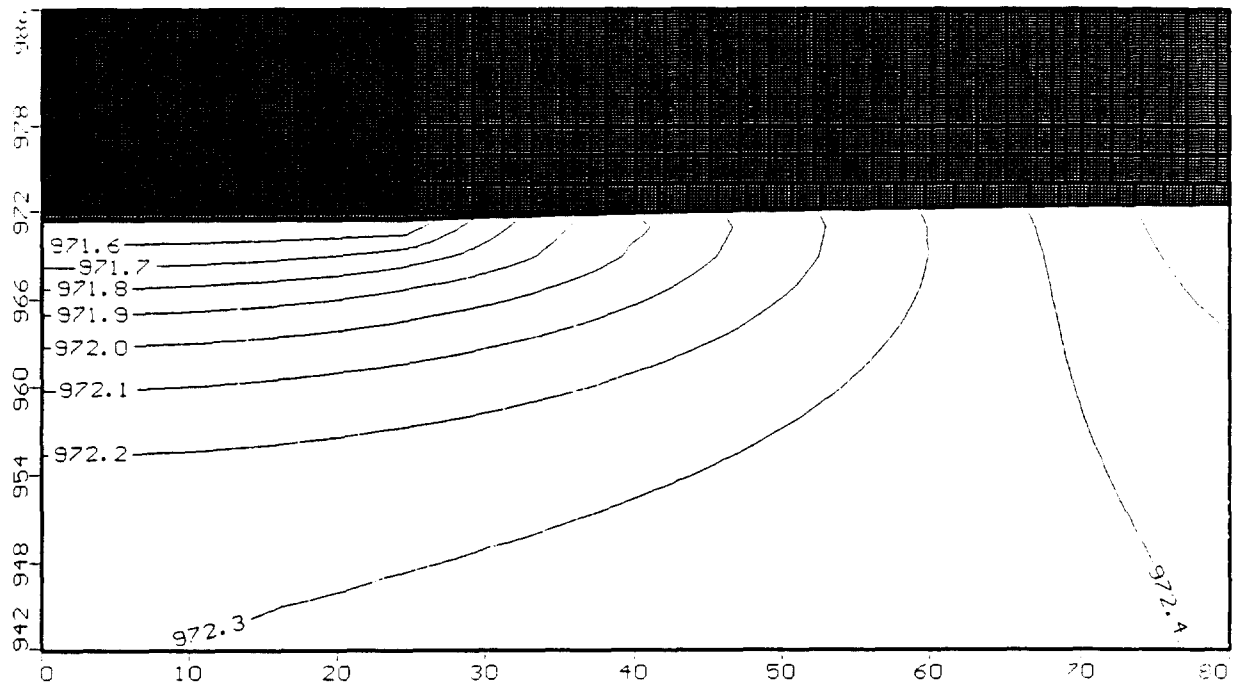

Blasland, Bouck & Lee, Inc. - Syracuse,  
 Project: East Street Area 2

Figure 10 Cross-section

Visual MODFLOW v.2.11, (c) 1995  
 Waterloo Hydrogeologic Software  
 NC: 3 NR: 150 NL: 22  
 Current Column: 2

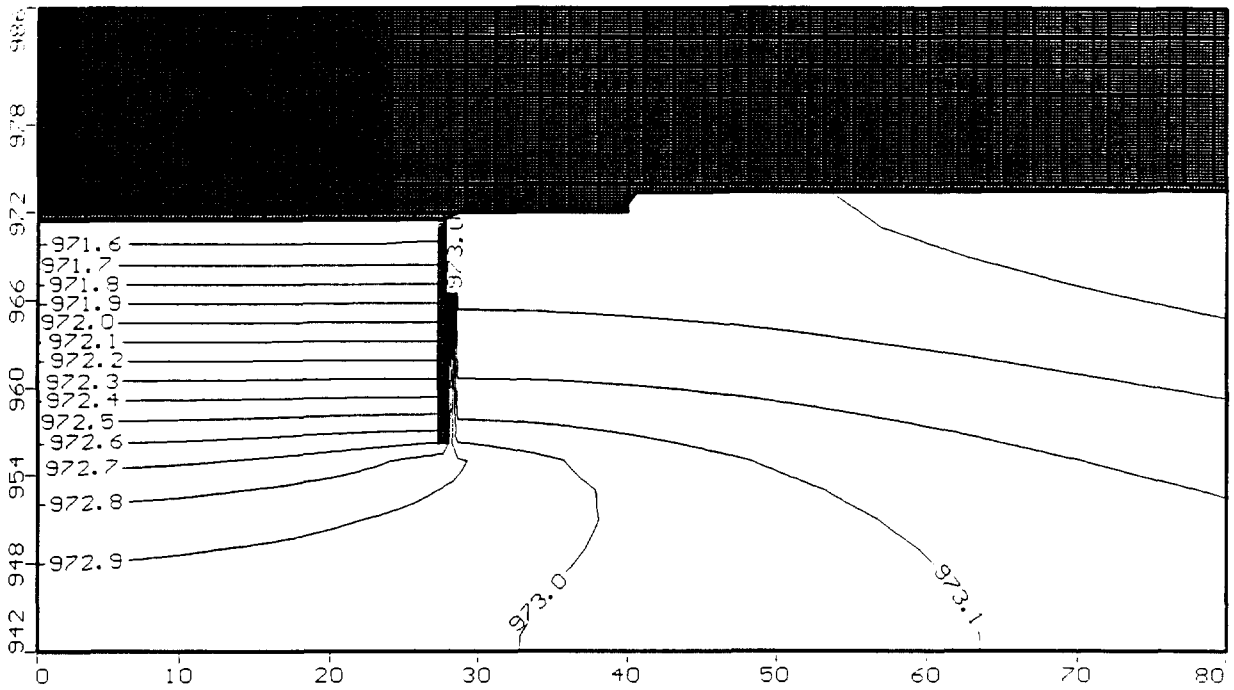

Blasland, Bouck & Lee, Inc. - Syracuse,  
 Project: East Street Area 2

Figure 11 Cross-section with Containment Barrier

Visual MODFLOW v.2.11, (c) 1995  
 Waterloo Hydrogeologic Software  
 NC: 3 NR: 150 NL: 22  
 Current Column: 2

**Figure 12 Simulated Vertical Gradients without Sheetpile Wall**

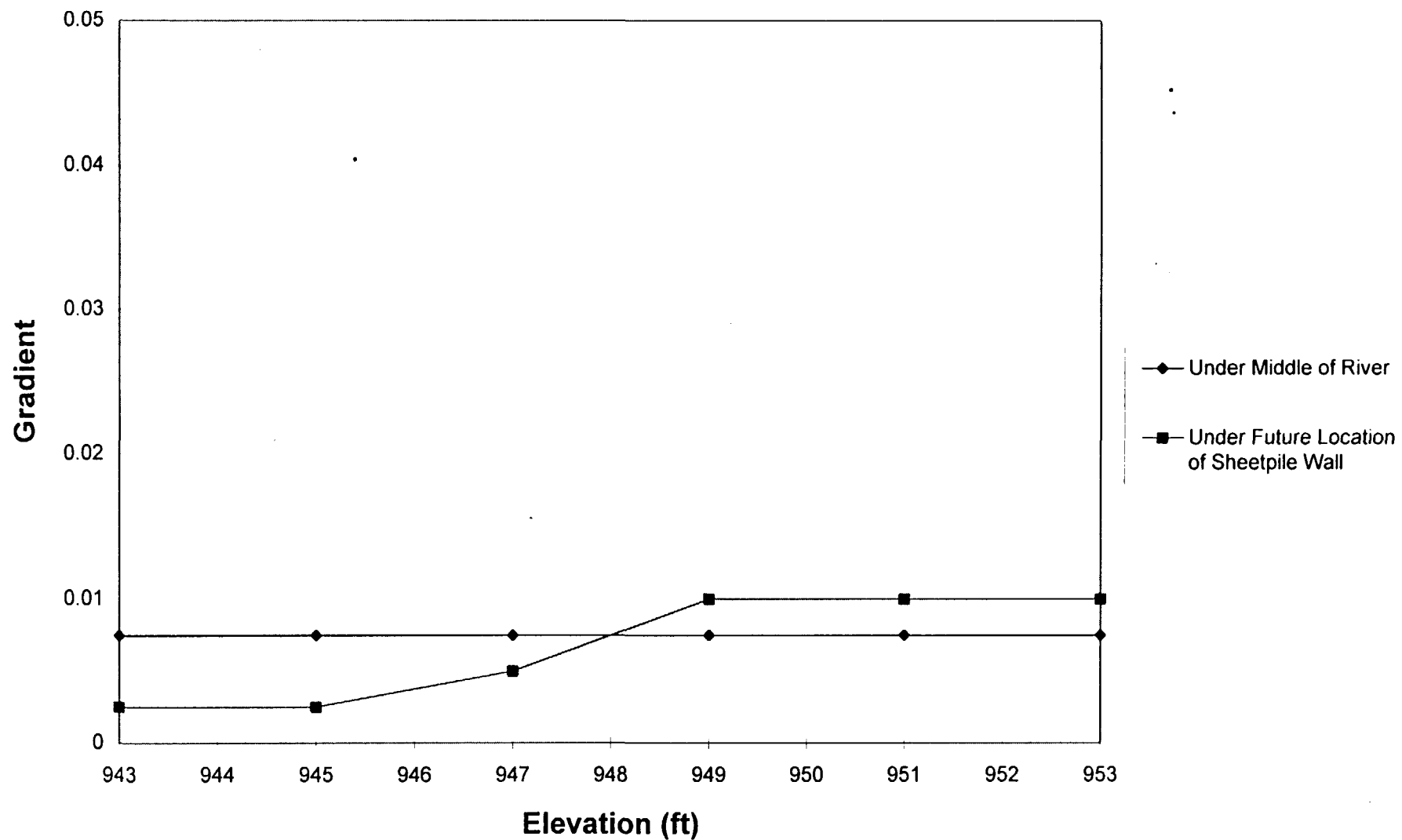

**Figure 13 Simulated Vertical Gradients with Sheetpile Wall**

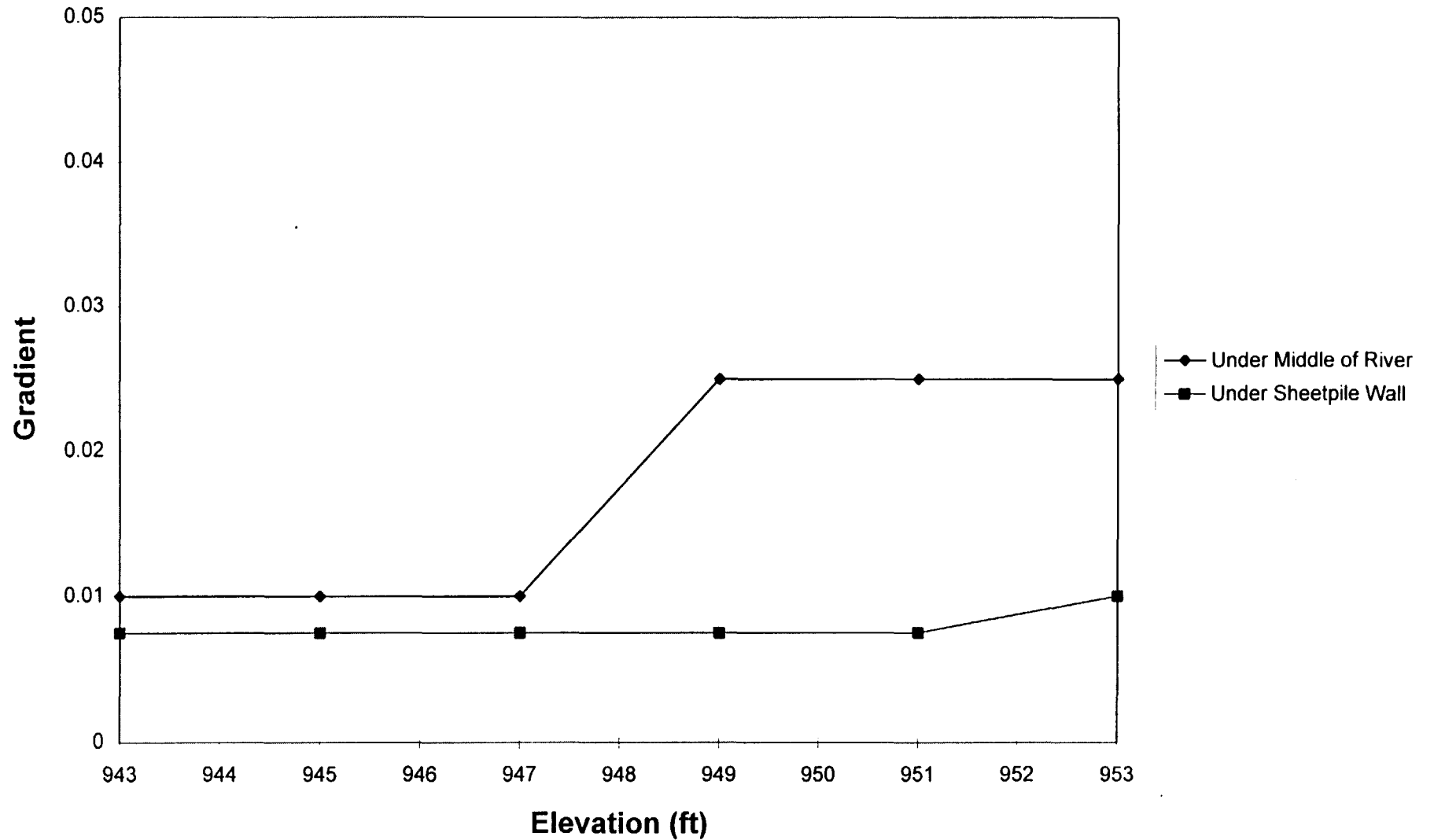



# **Appendix C**

BLASLAND, BOUCK & LEE, INC.  
*engineers & scientists*

---

## ***Sheetpile Geotechnical and Structural Calculations***

CLIENT GE Pittsfield SUBJECT Sheetpile Design Calculation Prepared By YZ Date: 01/07/99  
East Street Area 2 Reviewed By \_\_\_\_\_ Date: \_\_\_\_\_  
PROJECT Source Control Containment Barrier

**TASK:**

To perform a geotechnical/structural calculation for the sheetpile hanging wall design. The sheetpile wall is used to provide excavation stability and to serve as a source control containment barrier.

**REFERENCES:**

1. Blasland, Bouck & Lee, Inc., "Source Control Work Plan - Upper Reach of Housatonic River (First 1/2 Mile)", September, 1998
2. NAVFAC DM-7, March, 1971

**METHODOLOGY:**

This design calculation uses a typical sheetpile configuration based on the site conditions to determine pile penetration depth and the maximum bending moment for the sheetpile design. For the selected sheetpile, factors of safety against both pile toppling and pile break are also calculated. Since the sheetpile joints need to be watertight, potential of grout cracking caused by the pile bending is evaluated by checking grout tensile stress against its strength.

**CALCULATIONS:**

Typical Sheetpile Configuration:

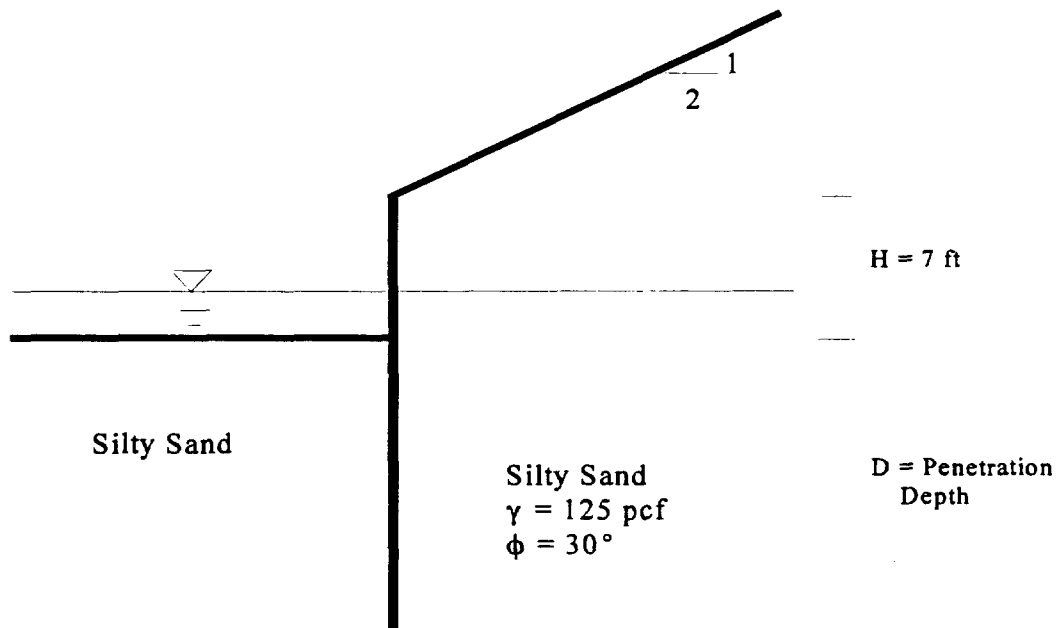

NOTE: WATER LEVELS CAN BE DIFFERENT ON OPPOSITE SIDES DUE TO PUMPING, TIDAL FLUCTUATIONS AND OTHER REASONS.

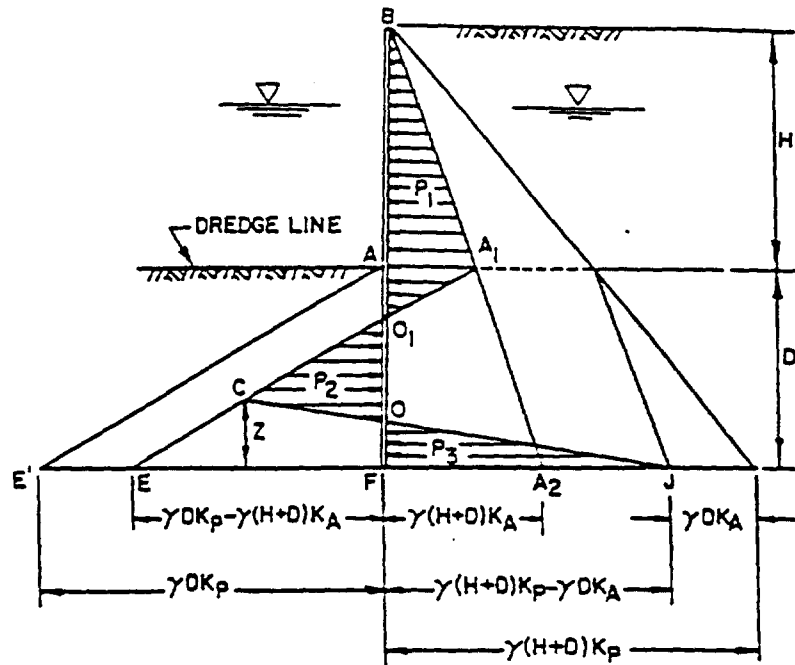

1. Assume a trial depth of penetration, D. This may be estimated from the following approximate correlation.

Standard Penetration Resistance, N Blows/foot	Depth of Penetration*
0 - 4	2.0H
5 - 10	1.5H
11 - 30	1.25H
31 - 50	1.0H
+50	0.75H

\* H = height of piling above dredge line

2. Determine the active and passive lateral pressure using appropriate coefficients of lateral earth pressure. If the Coulomb method is used, it should be used conservatively for the passive pressure.
3. Satisfy the requirements of static equilibrium: the sum of the forces in the horizontal direction must be zero and the sum of the moments about any point must be zero. The sum of the horizontal forces may be written in terms of pressure areas:

$$\Delta(EA_1A_2) - \Delta(FBA_2) - \Delta(ECJ) = 0$$

Solve the above equation for the distance, Z. For a uniform granular soil,

$$Z = \frac{K_p D^2 - K_A (H+D)^2}{(K_p - K_A) (H+2D)}$$

FIGURE 23  
Analysis for Cantilever Wall

4. Take moments about point F. If sum of moments is other than zero, readjust D and repeat calculations until sum of moments around F is zero.
5. Compute maximum moment at point of zero shear.
6. Increase D by 20% - 40% to result in approximate factor of safety of 1.5 to 2.

FIGURE 23 (continued)  
Analysis for Cantilever Wall

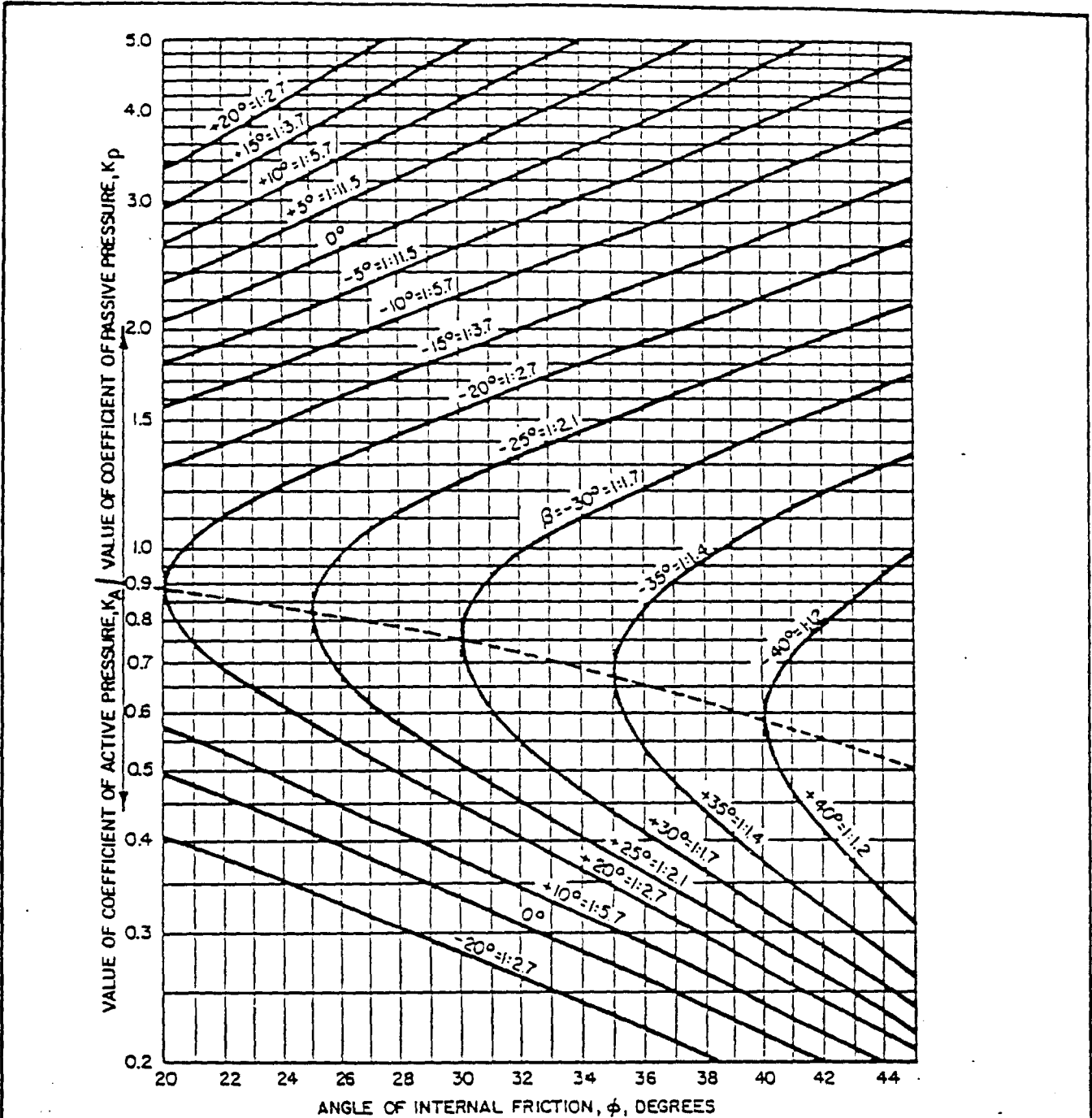

PASSIVE PRESSURE

ACTIVE PRESSURE

$$K_A = \left[ \frac{\cos \phi}{1 + \sqrt{\sin \phi (\sin \phi - \cos \phi \tan \beta)}} \right]^2; \quad K_P = \left[ \frac{\cos \phi}{1 - \sqrt{\sin \phi (\sin \phi + \cos \phi \tan \beta)}} \right]^2$$

$K_A$  &  $K_P$  = COEFFICIENTS FOR COULOMB'S EQUATION FOR ACTIVE AND PASSIVE EARTH PRESSURE (NO SHEAR STRESS ON VERTICAL PLANES).

$P_A$  = ACTIVE RESULTANT       $\phi$  = ANGLE OF INTERNAL FRICTION  
 $P_P$  = PASSIVE RESULTANT     $\beta$  = SLOPE ANGLE  
 $\gamma$  = UNIT WEIGHT OF SOIL  
 $H$  = HEIGHT OF WALL

FIGURE 3  
Active and Passive Coefficients, Sloping Backfill  
(Granular Soils)

CLIENT GE Pittsfield SUBJECT Sheetpile Design Calculation Prepared By YZ Date: 01/07/99  
East Street Area 2 Reviewed By \_\_\_\_\_ Date: \_\_\_\_\_  
 PROJECT Source Control Containment Barrier

**I - Penetration Depth and Pile Selection**

Follow calculation procedures on Sheets 2 and 3.

**1) Determine D**

Penetration depth D is adjusted (Step 4) by computer calculation spreadsheet.

**2) Determine  $K_a$  and  $K_p$**

From Sheet 4, for  $\phi = 30^\circ$  and  $\beta = 26^\circ$  (2H:1V slope),  $K_a = 0.55$ .  $K_p = 3.0$

**3) to 6)**

Detailed calculations are presented on Sheet 6.

In a summary table below, it's assumed that Waterloo WZ75 pile will be used. Allowable section modulus of the pile ( $S_{all}$ ) is 15.9 in<sup>3</sup>/ft. (Sheet 7)

Pile Depth (ft)				Factor of Safety	
H	D	Stick-up	Total	Toppling	Break ( $S_{all}/S$ )
7	12	0	19	1.5	6.9

**II - Bending Deflection and Grout Cracking Evaluation**

Sheetpile bending deflection and grout tensile stress caused by such bending are evaluated using beam theory. The following assumptions were made for the analysis:

1. Loading conditions for the sheetpile is simplified for the calculation. Soil or water reactions resisting the bending deflection are neglected.
2. Concrete-based grout for joint sealing complies with common concrete behavior or properties.
3. The grout core of the sheetpile joint is a circular-shaped cylinder that deforms simultaneously with the sheetpile when subjected to bending.
4. Tensile stress of the grout core is back-calculated from the sheetpile deflection. Loading to the grout to cause the bending deflection is ignored (not deducted from sheetpile loading) in pile structural calculation.

## Cantilever Sheet Pile Design

Top of Sheetpile and Soil = 977 feet: 2:1 Slope

**Trial 1**

H (ft)	D (ft)	Ka	Kp	Density(pcf)	Df
7	7	0.55	3	125	1

EF	1,663	EA1A2	9,188
FA2	963	-FBA2	(6,738)
FJ	4,769	-ECJ	(2,450)
Z	0.76	Total	-4.5475E-13

Mf **(10,626)**

**Trial 2**

H (ft)	D (ft)	Ka	Kp	Density(pcf)	Df
7	10.5	0.55	3	125	1.5

EF	2,734	EA1A2	20,672
FA2	1,203	-FBA2	(10,527)
FJ	5,841	-ECJ	(10,145)
Z	2.37	Total	0

Mf **2,941**

**Trial 3**

H (ft)	D (ft)	Ka	Kp	Density(pcf)	Df
7	10.01	0.55	3	125	1.43

EF	2,584	EA1A2	18,788
FA2	1,169	-FBA2	(9,946)
FJ	5,691	-ECJ	(8,841)
Z	2.14	Total	0

Mf **(4) OK**

AA1	481	AO1	1.57
-----	-----	-----	------

Max. M      6,973 LB-FT  
               83,679 LB-IN

SIGy      36,000    PSI      S      2.32      IN^3

INCREASE D BY 20%      D      12      FT  
 (FS = 1.5)

# WATERLOO BARRIER™

IS AVAILABLE IN TWO DESIGNS.  
THE MEDIUM WALL WZ75 AND  
THE HEAVY WALL WEZ95

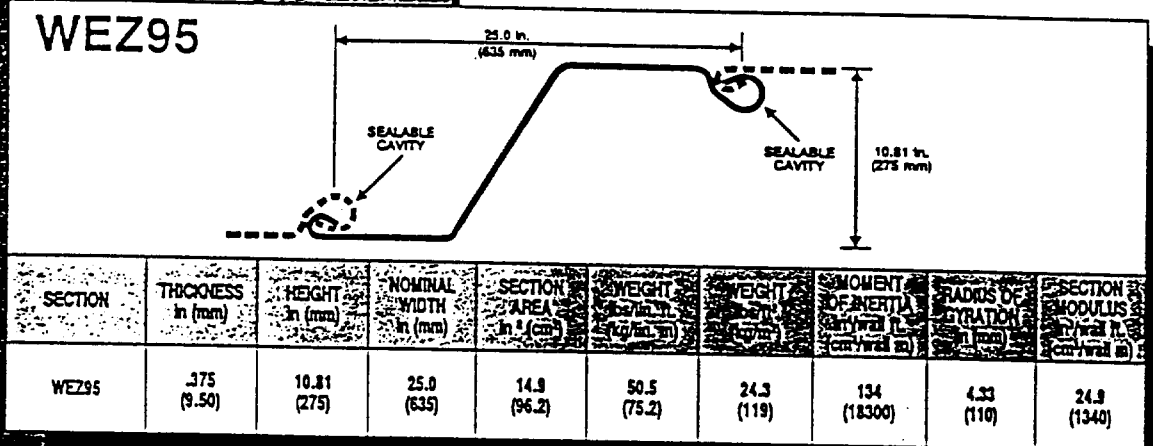
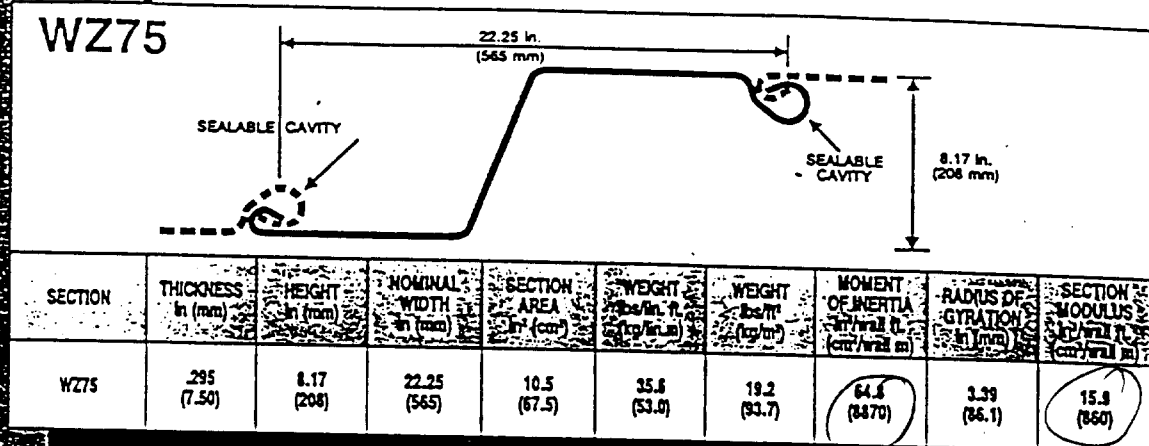

## SPECIFICATIONS:

**RAW MATERIAL:** ASTM A572 GR50  
CSA G40.21 GR 350W

**MANUFACTURING:** ASTM A6  
CSA G40.20

**COATINGS:**

- 1) GALVANIZED ASTM A123, CSA G164
- 2) COAL TAR EPOXY SSPC-16
- 3) FUSION BONDED EPOXY RESIN, MFG'S SPEC.

**ACCESSORIES:** BENDS CAN BE SUPPLIED TO ANY ANGLE.  
T' SECTIONS AND OTHER WELDED  
FABRICATIONS ARE AVAILABLE.



CLIENT GE Pittsfield SUBJECT Sheetpile Design Calculation Prepared By YZ Date: 01/07/99  
East Street Area 2 Reviewed By \_\_\_\_\_ Date: \_\_\_\_\_

PROJECT Source Control Containment Barrier

Typical Sheetpile Bending Sketch:

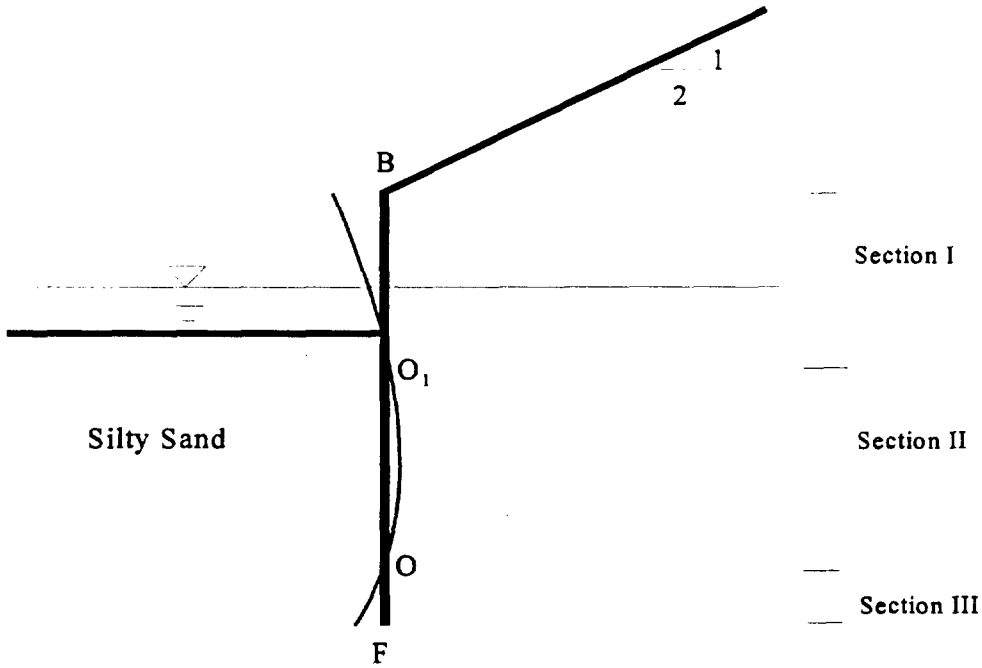

1) Section I

Section I can be simplified as a cantilever beam as sketched below:

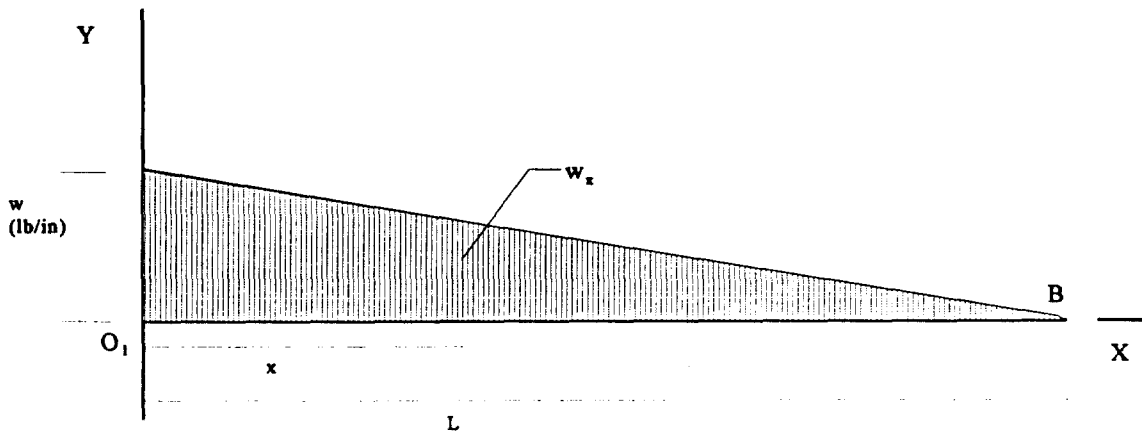

CLIENT GE Pittsfield SUBJECT Sheetpile Design Calculation Prepared By YZ Date: 01/07/99  
East Street Area 2 Reviewed By \_\_\_\_\_ Date: \_\_\_\_\_  
 PROJECT Source Control Containment Barrier

Where :

$$L = H + AO_1 = 7' + 1.57' = 8.57' = 102.8 \text{ in}$$

$$w = \gamma L K_s = 125 \text{ pcf} \times 8.57 \text{ ft} \times 1 \text{ ft} \times 0.55 = 589.19 \text{ lb/ft} = 49.1 \text{ lb/in}$$

From beam theory:

$$EI (dy/dx)^2 = M = -(1/3)(1/2)w_x(L-x)^2 = -(1/6)(w/L)(L-x)^3 \quad (1)$$

Integrating Equation (1) once:

$$EI (dy/dx) = - (1/24)(w/L)(L-x)^4 + C_1$$

Assume  $(dy/dx) = 0$  at  $x = 0$ ,  $C_1 = - (1/24)w L^3$ , we have,

$$EI (dy/dx) = - (1/24)(w/L)(L-x)^4 - (1/24)w L^3 \quad (2)$$

Integrating Equation (2) once:

$$EI y = - (1/120)(w/L)(L-x)^5 - (1/24)w L^3 x + C_2$$

Assume  $y = 0$  at  $x = 0$ ,  $C_2 = (1/120)w L^4$ , we have the deflection equation,

$$EI y = - (1/120)(w/L)(L-x)^5 - (1/24)w L^3 x + (1/120)w L^4 \quad (3)$$

2) Section II

Section II can be simplified as a simple beam as sketched below:

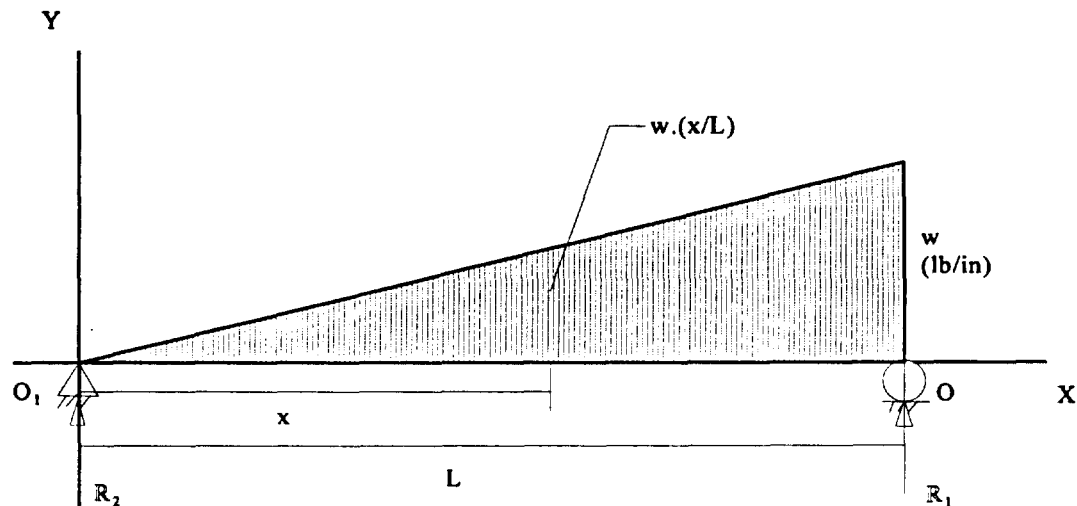

CLIENT GE Pittsfield SUBJECT Sheetpile Design Calculation Prepared By YZ Date: 01/07/99  
East Street Area 2 Reviewed By \_\_\_\_\_ Date: \_\_\_\_\_  
 PROJECT Source Control Containment Barrier

Where :

$$L = OO_1 = D - AO_1 - Z = 10.01' - 1.57' - 2.14' = 6.3' = 75.6 \text{ in}$$

$$w = (OO_1 / O_1F)(EF) = (6.3 / (6.3 + 2.14))(2,584 \text{ lb/ft}) = 1,928.8 \text{ lb/ft} = 160.7 \text{ lb/in}$$

From that sum of vertical forces equals zero, we find:

$$R_1 = (1/3)Lw, \quad R_2 = (1/6)Lw$$

From beam theory:

$$EI (dy/dx)^2 = M = R_2x - (1/2)w(x/L)x(x/3) = (1/6)Lwx - (1/6)(w/L)x^3 \quad (4)$$

Integrating Equation (4) twice:

$$EIy = (w/6)[(1/6)Lx^3 - (1/20)(x^5/L)] + C_2x + C_1$$

Since  $y = 0$  at  $x = 0$  and  $y = 0$  at  $x = L$ , we have,

$$C_2 = 0 \quad \text{and} \quad C_1 = - (7/360)wL^3$$

We have the deflection equation,

$$EIy = (1/4)wL[ - (1/30)(x^5 / L^2) + (1/8)x^3 - (7/90)L^2x] \quad (5)$$

3) Section III

Section III can be simplified as a cantilever beam with reversed triangular loading as compare to Section I, as sketched below:

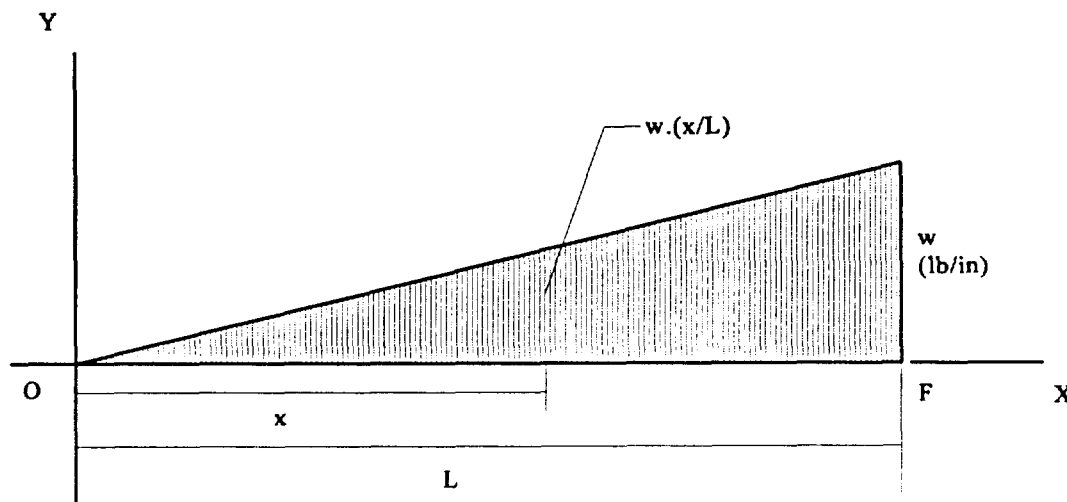

CLIENT GE Pittsfield SUBJECT Sheetpile Design Calculation Prepared By YZ Date: 01/07/99  
East Street Area 2 Reviewed By \_\_\_\_\_ Date: \_\_\_\_\_  
 PROJECT Source Control Containment Barrier

Where,

$$L = OF \approx Z = 2.14 \text{ ft} = 25.7 \text{ in}$$

$$w = FJ = 5,691 \text{ lb/ft} = 474.3 \text{ lb/in}$$

From beam theory,

$$EI (dy/dx)^2 = M = -(\frac{1}{2})(L-x)^2w(x/L) - (\frac{2}{3})(\frac{1}{2})[(w - w(x/L))(L - x)^2]$$

$$= -w/(6L)[3L^2x - 6Lx^2 + 3x^3 + 2(L - x)^3] \tag{6}$$

Integrating Equation (6) once:

$$EI (dy/dx) = -w/(6L)[(\frac{3}{2})L^2x^2 - (\frac{6}{3})Lx^3 + (\frac{3}{4})x^4 + (\frac{2}{4})(L - x)^4] + C_1$$

Assume  $(dy/dx) = 0$  at  $x = 0$ ,  $C_1 = - (1/12)w L^3$ , we have,

$$EI (dy/dx) = -w/(6L)[(\frac{3}{2})L^2x^2 - 2Lx^3 + (\frac{3}{4})x^4 + (\frac{1}{2})(L - x)^4 + (\frac{1}{2})L^4] \tag{7}$$

Integrating Equation (7) once:

$$EI y = -w/(6L)[(\frac{1}{2})L^2x^3 - (\frac{1}{2})Lx^4 + (\frac{3}{20})x^5 + (\frac{1}{10})(L - x)^5 + (\frac{1}{2})L^4x] + C_2$$

Assume  $y = 0$  at  $x = 0$ ,  $C_2 = (1/60)w L^4$ , we have the deflection equation,

$$EI y = -w/(12L)[L^2x^3 - Lx^4 + (\frac{3}{10})x^5 + (\frac{1}{5})(L - x)^5 + L^4x - (\frac{1}{5})L^5] \tag{8}$$

**4) Bending Deflection Calculation**

Bending deflections for the three sections were calculated using computer spreadsheets. For the calculation, steel Young's Modulus E of 30,000,000 psi and sheetpile's Moment of Inertia I of 64.8 in<sup>4</sup>/ft (Sheet 7) were used. Results of the calculations and deflection graphs are presented on Sheets 13 through 21.

**5) Grout Cracking Potential Analysis**

The potential of the grout cracking is assessed by grout tensile stress analysis. If the grout tensile stress caused by the sheetpile bending is less than grout tensile strength, then grout cracking is unlikely. Otherwise, the cracking is likely to occur.

The grout data is shown on Sheet 22. The compressive strength of the WBS301 grout (concrete base) is,

$$f_c' = 60 \text{ Mpa} = 60,000 \text{ Kpa} \times 0.145 \text{ psi/Kpa} = 8,700 \text{ psi}$$

Tensile strength of concrete is usually 7% to 10 % of compressive strength. Use 8.5%:

CLIENT GE Pittsfield SUBJECT Sheetpile Design Calculation Prepared By YZ Date: 01/07/99  
East Street Area 2 Reviewed By \_\_\_\_\_ Date: \_\_\_\_\_  
 PROJECT Source Control Containment Barrier

$$\sigma_t' = 8.5\% \times f_c' = 0.085 \times 8,700 \text{ psi} = 740 \text{ psi}$$

Young's Modulus of the grout is,

$$E = \gamma^{1.5}(33)(f_c')^{0.5} = 130^{1.5}(33)(8,700)^{0.5} = 4,562,350 \text{ psi}$$

Assume the grout core is circular with a diameter of 1.5 in,

$$\text{Moment of Inertia: } I = 0.25\pi r^4 = 0.25\pi(1.5/2)^4 = 0.2485 \text{ in}^4/\text{ft}$$

$$\text{Section Modulus: } S = I/r = 0.2485 \text{ in}^4/\text{ft} / (1.5/2) \text{ in} = 0.3313 \text{ in}^3/\text{ft}$$

From the sheetpile bending deflection results (Sheets 13 through 21), the maximum sheetpile bending curvature (change of slope) occurred in Section III (0.0051%) and Section I (0.0043%). Therefore, both Section III and Section I was used to calculate the grout tensile stress.

The maximum grout tensile stress of Section I is,

$$\sigma_t = M_{\max}/S = (1/6)wL^2/S = (1/6)102.8^2 w/0.3313 \text{ psi}$$

Back-calculation was used to find the loading w that yields deflection of the grout close to that of sheetpile shown on Sheets 13 through 15. The w was found to be (Sheets 23 through 25):

$$w = 0.029 \text{ lb/in}$$

Therefore,

$$\sigma_t = (1/6)102.8^2 w/0.3313 \text{ psi} = (1/6)102.8^2 \times 0.029/0.3313 = 154.2 \text{ psi} < \sigma_t' = 740 \text{ psi, OK, no cracking}$$

The maximum grout tensile stress of Section III is,

$$\sigma_t = M_{\max}/S = (2/6)wL^2/S = (1/3) \times 25.7^2 w/0.3313 \text{ psi}$$

Back-calculation was used to find the loading w that yields deflection of the grout close to that of sheetpile shown on Sheet 20. The w was found to be (Sheet 26):

$$w = 0.28 \text{ lb/in}$$

Therefore,

$$\sigma_t = (1/3) \times 25.7^2 w/0.3313 \text{ psi} = (1/3) \times 25.7^2 \times 0.28 / 0.3313 = 186.1 \text{ psi} < \sigma_t' = 740 \text{ psi, OK, no cracking}$$

## Section I

### Sheet Pile Deflection Estimate by Beam Theory

w (lb/in)	L (in)	E (lb/in <sup>2</sup> )	I (in <sup>4</sup> )
49.1	102.8	30,000,000	64.8

Deflection,  $d = (1/(EI))(D1+D2-D3)$

where,  $D1 = w(L-x)^5/120/L$

$D2 = wL^3x/24$

$D3 = wL^4/120$

x (in)	D1	D2	D3	d (in)	Bending Slope (%)	Change of Slope (%)
0.00				0.0000	0.0000	0.0000
1.00	43,515,705	2,222,540	45,695,423	0.0000	0.0022	0.0022
2.00	41,419,971	4,445,080	45,695,423	0.0001	0.0065	0.0043
3.00	39,405,772	6,667,620	45,695,423	0.0002	0.0107	0.0042
4.00	37,470,704	8,890,160	45,695,423	0.0003	0.0148	0.0041
5.00	35,612,413	11,112,700	45,695,423	0.0005	0.0187	0.0039
6.00	33,828,592	13,335,240	45,695,423	0.0008	0.0226	0.0038
7.00	32,116,978	15,557,780	45,695,423	0.0010	0.0263	0.0037
8.00	30,475,358	17,780,320	45,695,423	0.0013	0.0299	0.0036
9.00	28,901,563	20,002,860	45,695,423	0.0017	0.0334	0.0035
10.00	27,393,468	22,225,400	45,695,423	0.0020	0.0368	0.0034
11.00	25,948,995	24,447,940	45,695,423	0.0024	0.0400	0.0033
12.00	24,566,109	26,670,481	45,695,423	0.0029	0.0432	0.0032
13.00	23,242,820	28,893,021	45,695,423	0.0033	0.0463	0.0031
14.00	21,977,180	31,115,561	45,695,423	0.0038	0.0492	0.0030
15.00	20,767,284	33,338,101	45,695,423	0.0043	0.0521	0.0029
16.00	19,611,272	35,560,641	45,695,423	0.0049	0.0549	0.0028
17.00	18,507,322	37,783,181	45,695,423	0.0055	0.0575	0.0027
18.00	17,453,655	40,005,721	45,695,423	0.0061	0.0601	0.0026
19.00	16,448,535	42,228,261	45,695,423	0.0067	0.0626	0.0025
20.00	15,490,264	44,450,801	45,695,423	0.0073	0.0650	0.0024
21.00	14,577,184	46,673,341	45,695,423	0.0080	0.0674	0.0023
22.00	13,707,679	48,895,881	45,695,423	0.0087	0.0696	0.0022
23.00	12,880,170	51,118,421	45,695,423	0.0094	0.0718	0.0022
24.00	12,093,116	53,340,961	45,695,423	0.0102	0.0738	0.0021
25.00	11,345,016	55,563,501	45,695,423	0.0109	0.0758	0.0020
26.00	10,634,406	57,786,041	45,695,423	0.0117	0.0778	0.0019
27.00	9,959,858	60,008,581	45,695,423	0.0125	0.0796	0.0019
28.00	9,319,983	62,231,121	45,695,423	0.0133	0.0814	0.0018
29.00	8,713,426	64,453,661	45,695,423	0.0141	0.0831	0.0017
30.00	8,138,868	66,676,201	45,695,423	0.0150	0.0848	0.0016
31.00	7,595,028	68,898,741	45,695,423	0.0158	0.0864	0.0016
32.00	7,080,655	71,121,281	45,695,423	0.0167	0.0879	0.0015
33.00	6,594,536	73,343,821	45,695,423	0.0176	0.0893	0.0015
34.00	6,135,491	75,566,361	45,695,423	0.0185	0.0907	0.0014
35.00	5,702,373	77,788,902	45,695,423	0.0194	0.0920	0.0013
36.00	5,294,067	80,011,442	45,695,423	0.0204	0.0933	0.0013
37.00	4,909,492	82,233,982	45,695,423	0.0213	0.0945	0.0012

38.00	4,547,599	84,456,522	45,695,423	0.0223	0.0957	0.0012
39.00	4,207,368	86,679,062	45,695,423	0.0232	0.0968	0.0011
40.00	3,887,813	88,901,602	45,695,423	0.0242	0.0979	0.0011
41.00	3,587,976	91,124,142	45,695,423	0.0252	0.0989	0.0010
42.00	3,306,930	93,346,682	45,695,423	0.0262	0.0999	0.0010
43.00	3,043,779	95,569,222	45,695,423	0.0272	0.1008	0.0009
44.00	2,797,652	97,791,762	45,695,423	0.0282	0.1017	0.0009
45.00	2,567,712	100,014,302	45,695,423	0.0293	0.1025	0.0008
46.00	2,353,146	102,236,842	45,695,423	0.0303	0.1033	0.0008
47.00	2,153,169	104,459,382	45,695,423	0.0313	0.1040	0.0008
48.00	1,967,025	106,681,922	45,695,423	0.0324	0.1048	0.0007
49.00	1,793,984	108,904,462	45,695,423	0.0334	0.1054	0.0007
50.00	1,633,341	111,127,002	45,695,423	0.0345	0.1061	0.0006
51.00	1,484,417	113,349,542	45,695,423	0.0356	0.1067	0.0006
52.00	1,346,560	115,572,082	45,695,423	0.0366	0.1072	0.0006
53.00	1,219,141	117,794,622	45,695,423	0.0377	0.1078	0.0005
54.00	1,101,555	120,017,162	45,695,423	0.0388	0.1083	0.0005
55.00	993,223	122,239,702	45,695,423	0.0399	0.1088	0.0005
56.00	893,586	124,462,242	45,695,423	0.0410	0.1092	0.0004
57.00	802,111	126,684,782	45,695,423	0.0421	0.1096	0.0004
58.00	718,286	128,907,323	45,695,423	0.0432	0.1100	0.0004
59.00	641,620	131,129,863	45,695,423	0.0443	0.1104	0.0004
60.00	571,644	133,352,403	45,695,423	0.0454	0.1107	0.0003
61.00	507,912	135,574,943	45,695,423	0.0465	0.1110	0.0003
62.00	449,995	137,797,483	45,695,423	0.0476	0.1113	0.0003
63.00	397,487	140,020,023	45,695,423	0.0487	0.1116	0.0003
64.00	349,998	142,242,563	45,695,423	0.0498	0.1119	0.0003
65.00	307,161	144,465,103	45,695,423	0.0510	0.1121	0.0002
66.00	268,625	146,687,643	45,695,423	0.0521	0.1123	0.0002
67.00	234,057	148,910,183	45,695,423	0.0532	0.1126	0.0002
68.00	203,144	151,132,723	45,695,423	0.0543	0.1127	0.0002
69.00	175,586	153,355,263	45,695,423	0.0555	0.1129	0.0002
70.00	151,104	155,577,803	45,695,423	0.0566	0.1131	0.0002
71.00	129,432	157,800,343	45,695,423	0.0577	0.1132	0.0001
72.00	110,322	160,022,883	45,695,423	0.0589	0.1133	0.0001
73.00	93,538	162,245,423	45,695,423	0.0600	0.1135	0.0001
74.00	78,862	164,467,963	45,695,423	0.0611	0.1136	0.0001
75.00	66,089	166,690,503	45,695,423	0.0623	0.1137	0.0001
76.00	55,028	168,913,043	45,695,423	0.0634	0.1138	0.0001
77.00	45,499	171,135,583	45,695,423	0.0646	0.1138	0.0001
78.00	37,339	173,358,123	45,695,423	0.0657	0.1139	0.0001
79.00	30,394	175,580,663	45,695,423	0.0668	0.1140	0.0001
80.00	24,523	177,803,203	45,695,423	0.0680	0.1140	0.0001
81.00	19,597	180,025,744	45,695,423	0.0691	0.1141	0.0000
82.00	15,496	182,248,284	45,695,423	0.0703	0.1141	0.0000
83.00	12,112	184,470,824	45,695,423	0.0714	0.1142	0.0000
84.00	9,348	186,693,364	45,695,423	0.0725	0.1142	0.0000
85.00	7,112	188,915,904	45,695,423	0.0737	0.1142	0.0000
86.00	5,327	191,138,444	45,695,423	0.0748	0.1142	0.0000
87.00	3,919	193,360,984	45,695,423	0.0760	0.1143	0.0000
88.00	2,826	195,583,524	45,695,423	0.0771	0.1143	0.0000
89.00	1,992	197,806,064	45,695,423	0.0782	0.1143	0.0000
90.00	1,368	200,028,604	45,695,423	0.0794	0.1143	0.0000
91.00	911	202,251,144	45,695,423	0.0805	0.1143	0.0000
92.00	585	204,473,684	45,695,423	0.0817	0.1143	0.0000
93.00	360	206,696,224	45,695,423	0.0828	0.1143	0.0000

94.00	210	208,918,764	45,695,423	0.0840	0.1143	0.0000
95.00	115	211,141,304	45,695,423	0.0851	0.1143	0.0000
96.00	58	213,363,844	45,695,423	0.0862	0.1143	0.0000
97.00	26	215,586,384	45,695,423	0.0874	0.1143	0.0000
98.00	10	217,808,924	45,695,423	0.0885	0.1143	0.0000
99.00	3	220,031,464	45,695,423	0.0897	0.1143	0.0000
100.00	1	222,254,004	45,695,423	0.0908	0.1143	0.0000
101.00	0	224,476,544	45,695,423	0.0920	0.1143	0.0000
102.00	0	226,699,084	45,695,423	0.0931	0.1143	0.0000
102.80	0	228,477,116	45,695,423	0.0940	0.1143	0.0000



# Sheet Pile Deflection

## Section I

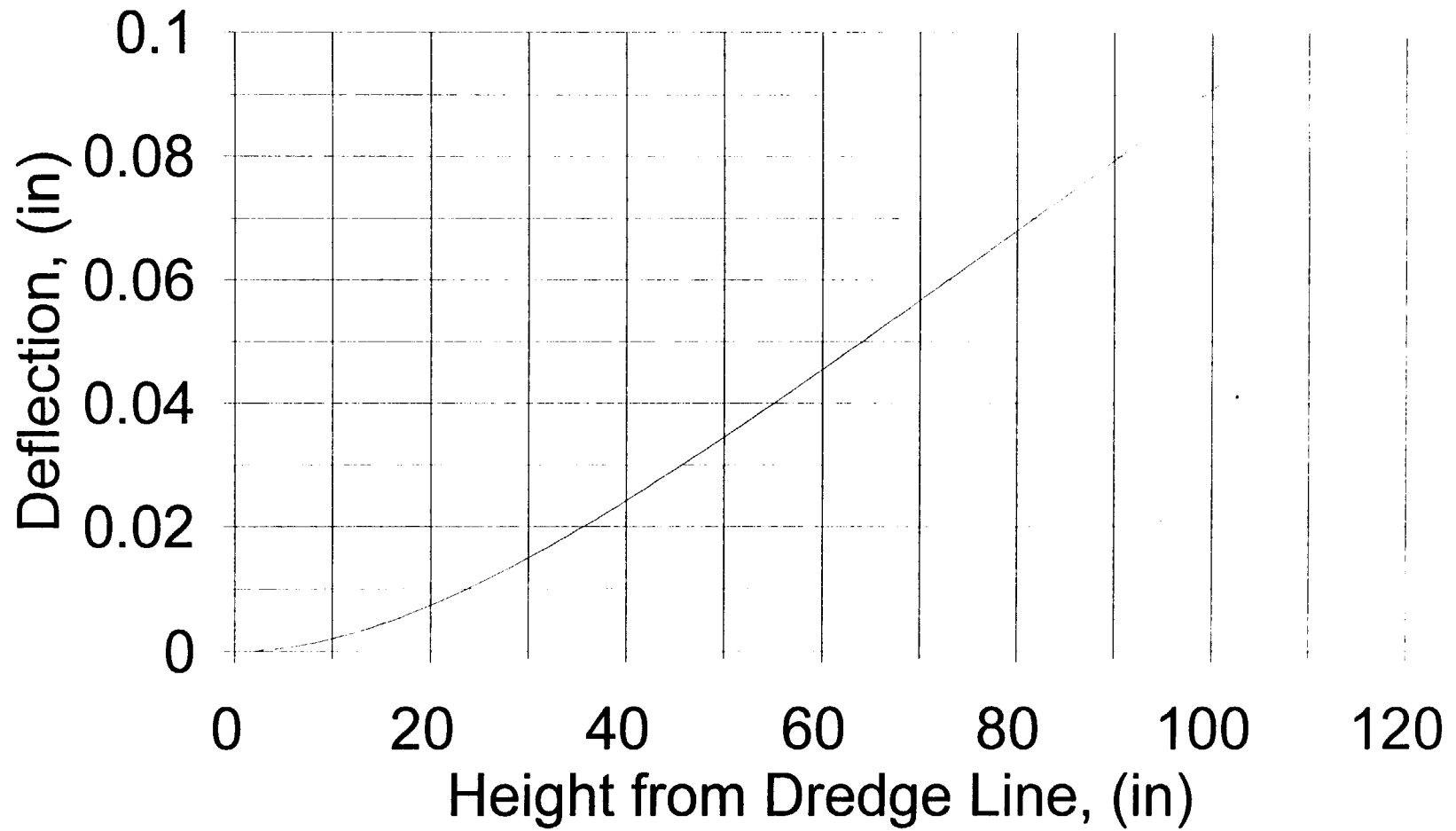

## Section II

### Sheet Pile Deflection Estimate by Beam Theory

w (lb/in)	L (in)	E (lb/in <sup>2</sup> )	I (in <sup>4</sup> )
160.7	75.6	30,000,000	64.8

Deflection,  $d = (1/(EI))(wL/(2))(D1+D2+D3)$

where,  $D1 = -x^5/(60L^2)$                        $D2 = x^3/18$                        $D3 = -7L^2x/180$

x (in)	D1	D2	D3	d (in)	Bending Slope (%)	Change of Slope (%)
0.00				0.0000	0.0000	0.0000
1.00	-0	0	-222	0.0007	0.0694	0.0694
2.00	-0	0	-445	0.0014	0.0693	-0.0001
3.00	-0	2	-667	0.0021	0.0691	-0.0002
4.00	-0	4	-889	0.0028	0.0688	-0.0003
5.00	-0	7	-1,111	0.0035	0.0684	-0.0004
6.00	-0	12	-1,334	0.0041	0.0679	-0.0005
7.00	-0	19	-1,556	0.0048	0.0673	-0.0006
8.00	-0	28	-1,778	0.0055	0.0665	-0.0007
9.00	-0	41	-2,000	0.0061	0.0657	-0.0008
10.00	-0	56	-2,223	0.0068	0.0648	-0.0009
11.00	-0	74	-2,445	0.0074	0.0638	-0.0010
12.00	-1	96	-2,667	0.0080	0.0626	-0.0011
13.00	-1	122	-2,889	0.0087	0.0614	-0.0012
14.00	-2	152	-3,112	0.0093	0.0601	-0.0013
15.00	-2	188	-3,334	0.0098	0.0587	-0.0014
16.00	-3	228	-3,556	0.0104	0.0572	-0.0015
17.00	-4	273	-3,778	0.0110	0.0556	-0.0016
18.00	-6	324	-4,001	0.0115	0.0539	-0.0017
19.00	-7	381	-4,223	0.0120	0.0522	-0.0018
20.00	-9	444	-4,445	0.0125	0.0503	-0.0019
21.00	-12	515	-4,668	0.0130	0.0484	-0.0019
22.00	-15	592	-4,890	0.0135	0.0463	-0.0020
23.00	-19	676	-5,112	0.0139	0.0443	-0.0021
24.00	-23	768	-5,334	0.0143	0.0421	-0.0022
25.00	-28	868	-5,557	0.0147	0.0398	-0.0022
26.00	-35	976	-5,779	0.0151	0.0375	-0.0023
27.00	-42	1,094	-6,001	0.0155	0.0351	-0.0024
28.00	-50	1,220	-6,223	0.0158	0.0327	-0.0025
29.00	-60	1,355	-6,446	0.0161	0.0302	-0.0025
30.00	-71	1,500	-6,668	0.0164	0.0276	-0.0026
31.00	-83	1,655	-6,890	0.0166	0.0249	-0.0026
32.00	-98	1,820	-7,112	0.0168	0.0223	-0.0027
33.00	-114	1,997	-7,335	0.0170	0.0195	-0.0027
34.00	-132	2,184	-7,557	0.0172	0.0167	-0.0028
35.00	-153	2,382	-7,779	0.0173	0.0139	-0.0028
36.00	-176	2,592	-8,002	0.0175	0.0111	-0.0029
37.00	-202	2,814	-8,224	0.0175	0.0082	-0.0029

38.00	-231	3,048	-8,446	0.0176	0.0052	-0.0029
39.00	-263	3,296	-8,668	0.0176	0.0023	-0.0030
40.00	-299	3,556	-8,891	0.0176	-0.0007	-0.0030
41.00	-338	3,829	-9,113	0.0176	-0.0037	-0.0030
42.00	-381	4,116	-9,335	0.0175	-0.0067	-0.0030
43.00	-429	4,417	-9,557	0.0174	-0.0098	-0.0030
44.00	-481	4,732	-9,780	0.0173	-0.0128	-0.0030
45.00	-538	5,063	-10,002	0.0171	-0.0158	-0.0030
46.00	-601	5,408	-10,224	0.0169	-0.0188	-0.0030
47.00	-669	5,768	-10,446	0.0167	-0.0219	-0.0030
48.00	-743	6,144	-10,669	0.0165	-0.0249	-0.0030
49.00	-824	6,536	-10,891	0.0162	-0.0278	-0.0030
50.00	-911	6,944	-11,113	0.0159	-0.0308	-0.0030
51.00	-1,006	7,370	-11,335	0.0155	-0.0337	-0.0029
52.00	-1,109	7,812	-11,558	0.0152	-0.0366	-0.0029
53.00	-1,220	8,271	-11,780	0.0148	-0.0395	-0.0029
54.00	-1,339	8,748	-12,002	0.0144	-0.0423	-0.0028
55.00	-1,468	9,243	-12,225	0.0139	-0.0450	-0.0028
56.00	-1,606	9,756	-12,447	0.0134	-0.0477	-0.0027
57.00	-1,755	10,289	-12,669	0.0129	-0.0504	-0.0026
58.00	-1,914	10,840	-12,891	0.0124	-0.0529	-0.0026
59.00	-2,085	11,410	-13,114	0.0118	-0.0554	-0.0025
60.00	-2,268	12,000	-13,336	0.0113	-0.0578	-0.0024
61.00	-2,463	12,610	-13,558	0.0107	-0.0601	-0.0023
62.00	-2,672	13,240	-13,780	0.0100	-0.0623	-0.0022
63.00	-2,894	13,892	-14,003	0.0094	-0.0645	-0.0021
64.00	-3,131	14,564	-14,225	0.0087	-0.0665	-0.0020
65.00	-3,384	15,257	-14,447	0.0080	-0.0683	-0.0019
66.00	-3,652	15,972	-14,669	0.0073	-0.0701	-0.0018
67.00	-3,937	16,709	-14,892	0.0066	-0.0717	-0.0016
68.00	-4,240	17,468	-15,114	0.0059	-0.0732	-0.0015
69.00	-4,561	18,251	-15,336	0.0051	-0.0746	-0.0014
70.00	-4,901	19,056	-15,558	0.0044	-0.0758	-0.0012
71.00	-5,261	19,884	-15,781	0.0036	-0.0768	-0.0010
72.00	-5,642	20,736	-16,003	0.0028	-0.0777	-0.0009
73.00	-6,045	21,612	-16,225	0.0021	-0.0784	-0.0007
74.00	-6,471	22,512	-16,448	0.0013	-0.0789	-0.0005
75.00	-6,920	23,438	-16,670	0.0005	-0.0792	-0.0003
75.60	-7,201	24,005	-16,803	0.0000	-0.0794	-0.0001

# Sheet Pile Deflection

## Section II

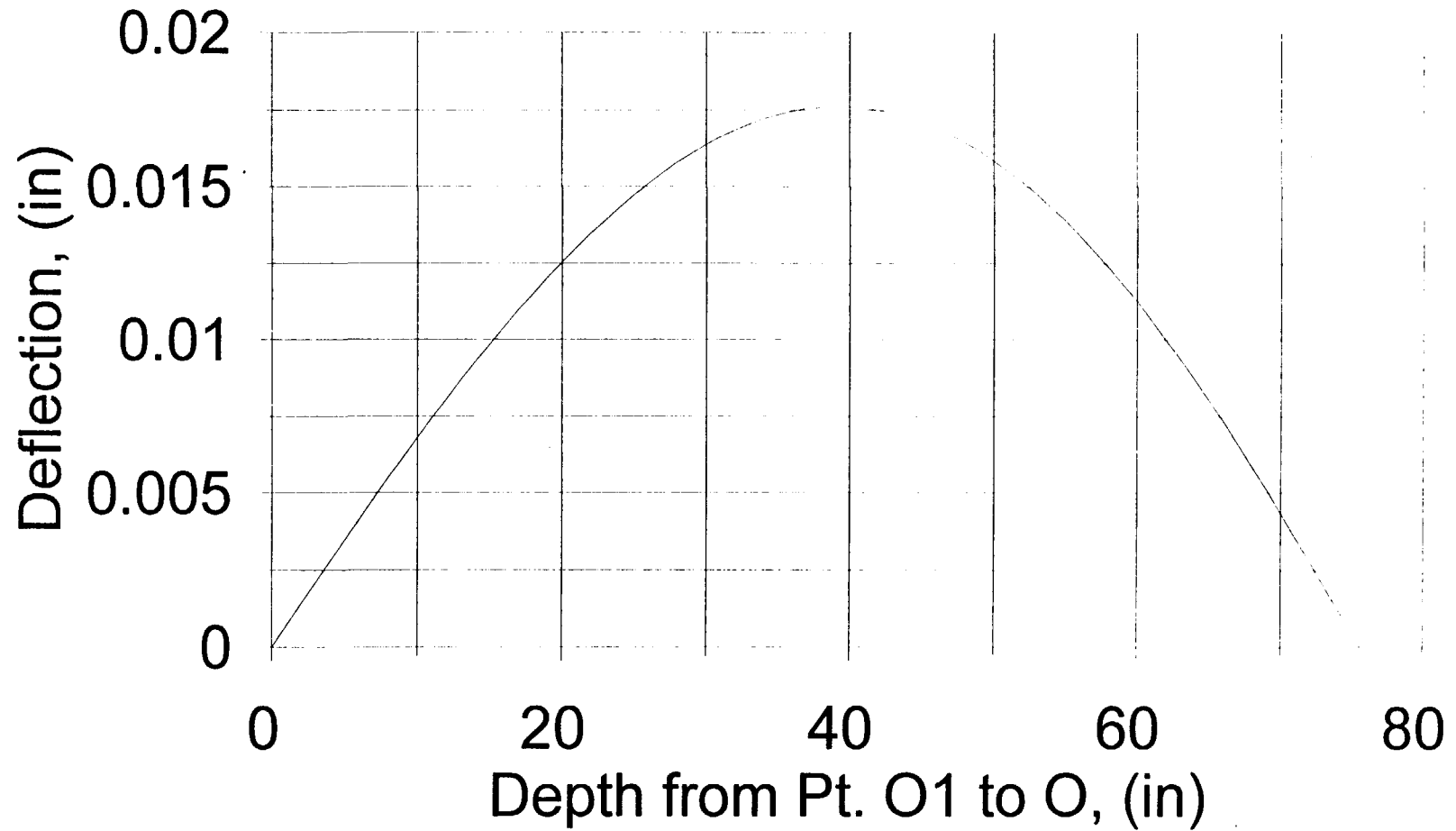

### Section III

## Sheet Pile Deflection Estimate by Beam Theory

w	L	E	I
(lb/in)	(in)	(lb/in <sup>2</sup> )	(in <sup>4</sup> )
474.3	25.7	30,000,000	64.8

Deflection,  $d = (1/(EI))(w/(6L))(D1+D2+D3)$

where,  $D1 = -L^5/10+0.5L^4x$        $D2 = 0.5(L^2x^3-Lx^4)$        $D3 = (3/20)x^5+0.1(L-x)^5$

x	D1	D2	D3	d	Bending Slope	Change of Slope
(in)				(in)	(%)	(%)
0.00				0.0000	0.0000	0.0000
1.00	-903,031	317	919,358	0.0000	0.0026	0.0026
2.00	-684,908	2,436	747,730	0.0001	0.0077	0.0051
3.00	-466,784	7,876	602,775	0.0002	0.0124	0.0047
4.00	-248,661	17,846	481,324	0.0004	0.0169	0.0044
5.00	-30,537	33,249	380,528	0.0006	0.0210	0.0041
6.00	187,586	54,679	297,876	0.0009	0.0248	0.0038
7.00	405,710	82,421	231,190	0.0011	0.0284	0.0035
8.00	623,833	116,452	178,642	0.0015	0.0316	0.0032
9.00	841,957	156,440	138,749	0.0018	0.0345	0.0029
10.00	1,060,080	201,745	110,389	0.0022	0.0372	0.0027
11.00	1,278,204	251,419	92,799	0.0026	0.0396	0.0024
12.00	1,496,327	304,206	85,587	0.0030	0.0417	0.0021
13.00	1,714,451	358,539	88,732	0.0034	0.0436	0.0019
14.00	1,932,574	412,547	102,598	0.0039	0.0453	0.0016
15.00	2,150,698	464,046	127,932	0.0043	0.0467	0.0014
16.00	2,368,821	510,546	165,874	0.0048	0.0479	0.0012
17.00	2,586,945	549,249	217,963	0.0053	0.0489	0.0010
18.00	2,805,068	577,047	286,142	0.0058	0.0497	0.0008
19.00	3,023,192	590,526	372,765	0.0063	0.0504	0.0007
20.00	3,241,316	585,960	480,602	0.0068	0.0509	0.0005
21.00	3,459,439	559,318	612,844	0.0073	0.0512	0.0004
22.00	3,677,563	506,259	773,114	0.0078	0.0515	0.0003
23.00	3,895,686	422,134	965,466	0.0084	0.0516	0.0002
24.00	4,113,810	301,985	1,194,395	0.0089	0.0517	0.0001
25.00	4,331,933	140,547	1,464,844	0.0094	0.0518	0.0000
25.70	4,484,620	0	1,681,732	0.0098	0.0518	0.0000

# Sheet Pile Deflection

## Section III

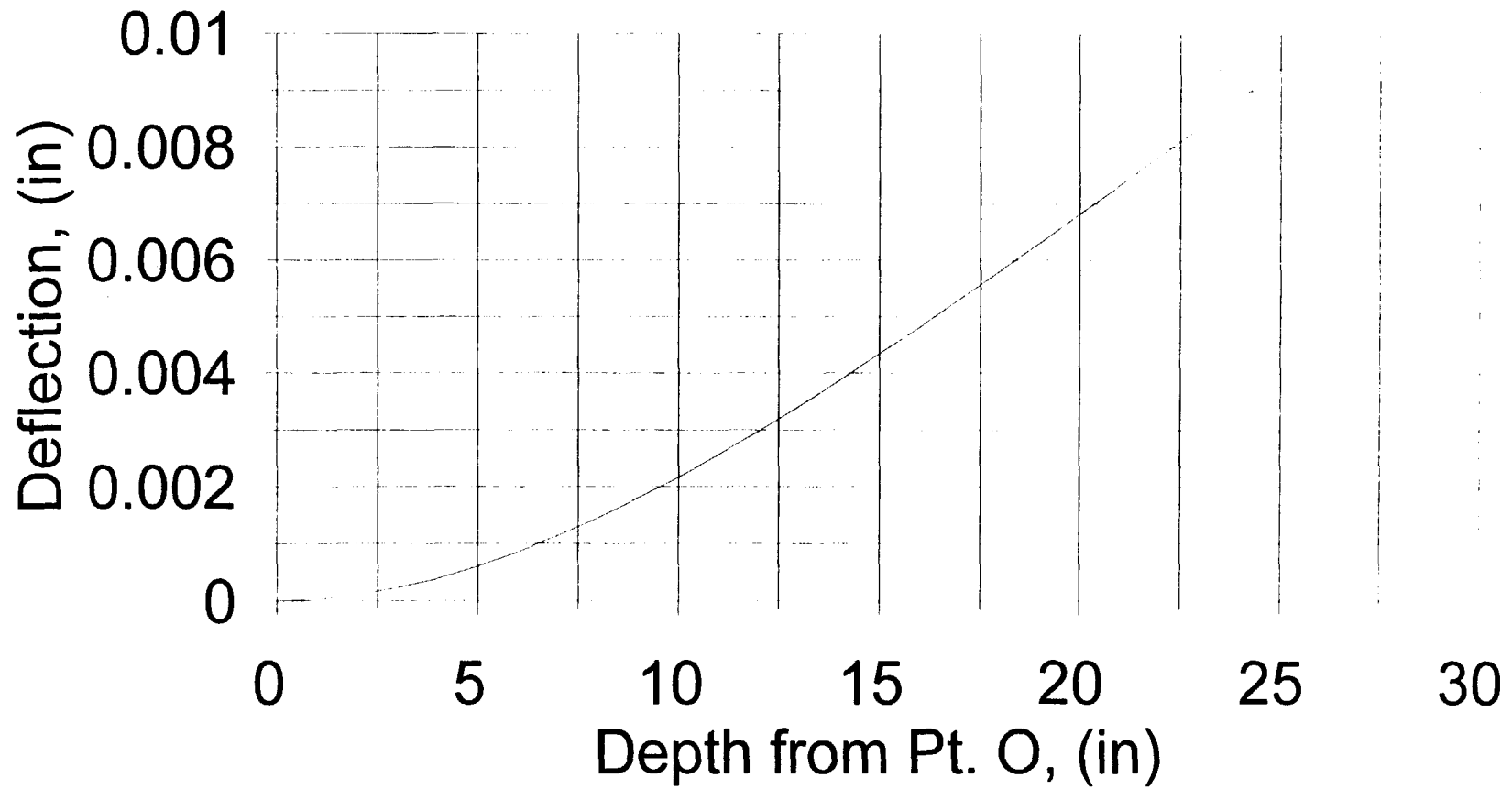

## Section I

### Concrete 1.5" Core Deflection Estimate by Beam Theory

w (lb/in)	L (in)	E (lb/in <sup>2</sup> )	I (in <sup>4</sup> )
0.029	102.8	4,562,350	0.2485

Deflection,  $d = (1/(EI))(D1+D2-D3)$

where,  $D1 = w(L-x)^5/120/L$        $D2 = wL^3x/24$        $D3 = wL^4/120$

x (in)	D1	D2	D3	d (in)	Bending Slope (%)	Change of Slope (%)
0.00				0.0000	0.0000	0.0000
1.00	25,702	1,313	26,989	0.0000	0.0022	0.0022
2.00	24,464	2,625	26,989	0.0001	0.0066	0.0044
3.00	23,274	3,938	26,989	0.0002	0.0109	0.0042
4.00	22,131	5,251	26,989	0.0003	0.0150	0.0041
5.00	21,034	6,564	26,989	0.0005	0.0190	0.0040
6.00	19,980	7,876	26,989	0.0008	0.0229	0.0039
7.00	18,969	9,189	26,989	0.0010	0.0266	0.0038
8.00	18,000	10,502	26,989	0.0013	0.0303	0.0036
9.00	17,070	11,814	26,989	0.0017	0.0338	0.0035
10.00	16,179	13,127	26,989	0.0020	0.0372	0.0034
11.00	15,326	14,440	26,989	0.0024	0.0405	0.0033
12.00	14,510	15,752	26,989	0.0029	0.0437	0.0032
13.00	13,728	17,065	26,989	0.0034	0.0468	0.0031
14.00	12,980	18,378	26,989	0.0039	0.0499	0.0030
15.00	12,266	19,691	26,989	0.0044	0.0528	0.0029
16.00	11,583	21,003	26,989	0.0049	0.0556	0.0028
17.00	10,931	22,316	26,989	0.0055	0.0583	0.0027
18.00	10,309	23,629	26,989	0.0061	0.0609	0.0026
19.00	9,715	24,941	26,989	0.0068	0.0634	0.0025
20.00	9,149	26,254	26,989	0.0074	0.0659	0.0024
21.00	8,610	27,567	26,989	0.0081	0.0682	0.0024
22.00	8,096	28,879	26,989	0.0088	0.0705	0.0023
23.00	7,607	30,192	26,989	0.0095	0.0727	0.0022
24.00	7,143	31,505	26,989	0.0103	0.0748	0.0021
25.00	6,701	32,818	26,989	0.0111	0.0768	0.0020
26.00	6,281	34,130	26,989	0.0118	0.0788	0.0020
27.00	5,883	35,443	26,989	0.0126	0.0806	0.0019
28.00	5,505	36,756	26,989	0.0135	0.0824	0.0018
29.00	5,146	38,068	26,989	0.0143	0.0842	0.0017
30.00	4,807	39,381	26,989	0.0152	0.0859	0.0017
31.00	4,486	40,694	26,989	0.0160	0.0875	0.0016
32.00	4,182	42,006	26,989	0.0169	0.0890	0.0015
33.00	3,895	43,319	26,989	0.0178	0.0905	0.0015
34.00	3,624	44,632	26,989	0.0188	0.0919	0.0014
35.00	3,368	45,945	26,989	0.0197	0.0932	0.0014
36.00	3,127	47,257	26,989	0.0206	0.0945	0.0013
37.00	2,900	48,570	26,989	0.0216	0.0958	0.0012

38.00	2,686	49,883	26,989	0.0226	0.0969	0.0012
39.00	2,485	51,195	26,989	0.0235	0.0981	0.0011
40.00	2,296	52,508	26,989	0.0245	0.0991	0.0011
41.00	2,119	53,821	26,989	0.0255	0.1002	0.0010
42.00	1,953	55,133	26,989	0.0265	0.1011	0.0010
43.00	1,798	56,446	26,989	0.0276	0.1021	0.0009
44.00	1,652	57,759	26,989	0.0286	0.1030	0.0009
45.00	1,517	59,072	26,989	0.0296	0.1038	0.0008
46.00	1,390	60,384	26,989	0.0307	0.1046	0.0008
47.00	1,272	61,697	26,989	0.0317	0.1054	0.0008
48.00	1,162	63,010	26,989	0.0328	0.1061	0.0007
49.00	1,060	64,322	26,989	0.0339	0.1068	0.0007
50.00	965	65,635	26,989	0.0349	0.1074	0.0006
51.00	877	66,948	26,989	0.0360	0.1080	0.0006
52.00	795	68,260	26,989	0.0371	0.1086	0.0006
53.00	720	69,573	26,989	0.0382	0.1091	0.0005
54.00	651	70,886	26,989	0.0393	0.1097	0.0005
55.00	587	72,199	26,989	0.0404	0.1101	0.0005
56.00	528	73,511	26,989	0.0415	0.1106	0.0005
57.00	474	74,824	26,989	0.0426	0.1110	0.0004
58.00	424	76,137	26,989	0.0437	0.1114	0.0004
59.00	379	77,449	26,989	0.0448	0.1118	0.0004
60.00	338	78,762	26,989	0.0460	0.1121	0.0003
61.00	300	80,075	26,989	0.0471	0.1125	0.0003
62.00	266	81,388	26,989	0.0482	0.1128	0.0003
63.00	235	82,700	26,989	0.0493	0.1130	0.0003
64.00	207	84,013	26,989	0.0505	0.1133	0.0003
65.00	181	85,326	26,989	0.0516	0.1136	0.0002
66.00	159	86,638	26,989	0.0528	0.1138	0.0002
67.00	138	87,951	26,989	0.0539	0.1140	0.0002
68.00	120	89,264	26,989	0.0550	0.1142	0.0002
69.00	104	90,576	26,989	0.0562	0.1143	0.0002
70.00	89	91,889	26,989	0.0573	0.1145	0.0002
71.00	76	93,202	26,989	0.0585	0.1147	0.0001
72.00	65	94,515	26,989	0.0596	0.1148	0.0001
73.00	55	95,827	26,989	0.0608	0.1149	0.0001
74.00	47	97,140	26,989	0.0619	0.1150	0.0001
75.00	39	98,453	26,989	0.0631	0.1151	0.0001
76.00	33	99,765	26,989	0.0642	0.1152	0.0001
77.00	27	101,078	26,989	0.0654	0.1153	0.0001
78.00	22	102,391	26,989	0.0665	0.1154	0.0001
79.00	18	103,703	26,989	0.0677	0.1154	0.0001
80.00	14	105,016	26,989	0.0688	0.1155	0.0001
81.00	12	106,329	26,989	0.0700	0.1155	0.0000
82.00	9	107,642	26,989	0.0711	0.1156	0.0000
83.00	7	108,954	26,989	0.0723	0.1156	0.0000
84.00	6	110,267	26,989	0.0735	0.1156	0.0000
85.00	4	111,580	26,989	0.0746	0.1157	0.0000
86.00	3	112,892	26,989	0.0758	0.1157	0.0000
87.00	2	114,205	26,989	0.0769	0.1157	0.0000
88.00	2	115,518	26,989	0.0781	0.1157	0.0000
89.00	1	116,830	26,989	0.0792	0.1157	0.0000
90.00	1	118,143	26,989	0.0804	0.1158	0.0000
91.00	1	119,456	26,989	0.0816	0.1158	0.0000
92.00	0	120,769	26,989	0.0827	0.1158	0.0000
93.00	0	122,081	26,989	0.0839	0.1158	0.0000



94.00	0	123,394	26,989	0.0850	0.1158	0.0000
95.00	0	124,707	26,989	0.0862	0.1158	0.0000
96.00	0	126,019	26,989	0.0873	0.1158	0.0000
97.00	0	127,332	26,989	0.0885	0.1158	0.0000
98.00	0	128,645	26,989	0.0897	0.1158	0.0000
99.00	0	129,957	26,989	0.0908	0.1158	0.0000
100.00	0	131,270	26,989	0.0920	0.1158	0.0000
101.00	0	132,583	26,989	0.0931	0.1158	0.0000
102.00	0	133,896	26,989	0.0943	0.1158	0.0000
102.80	0	134,946	26,989	0.0952	0.1158	0.0000

# Sheet Pile Deflection

## Section I

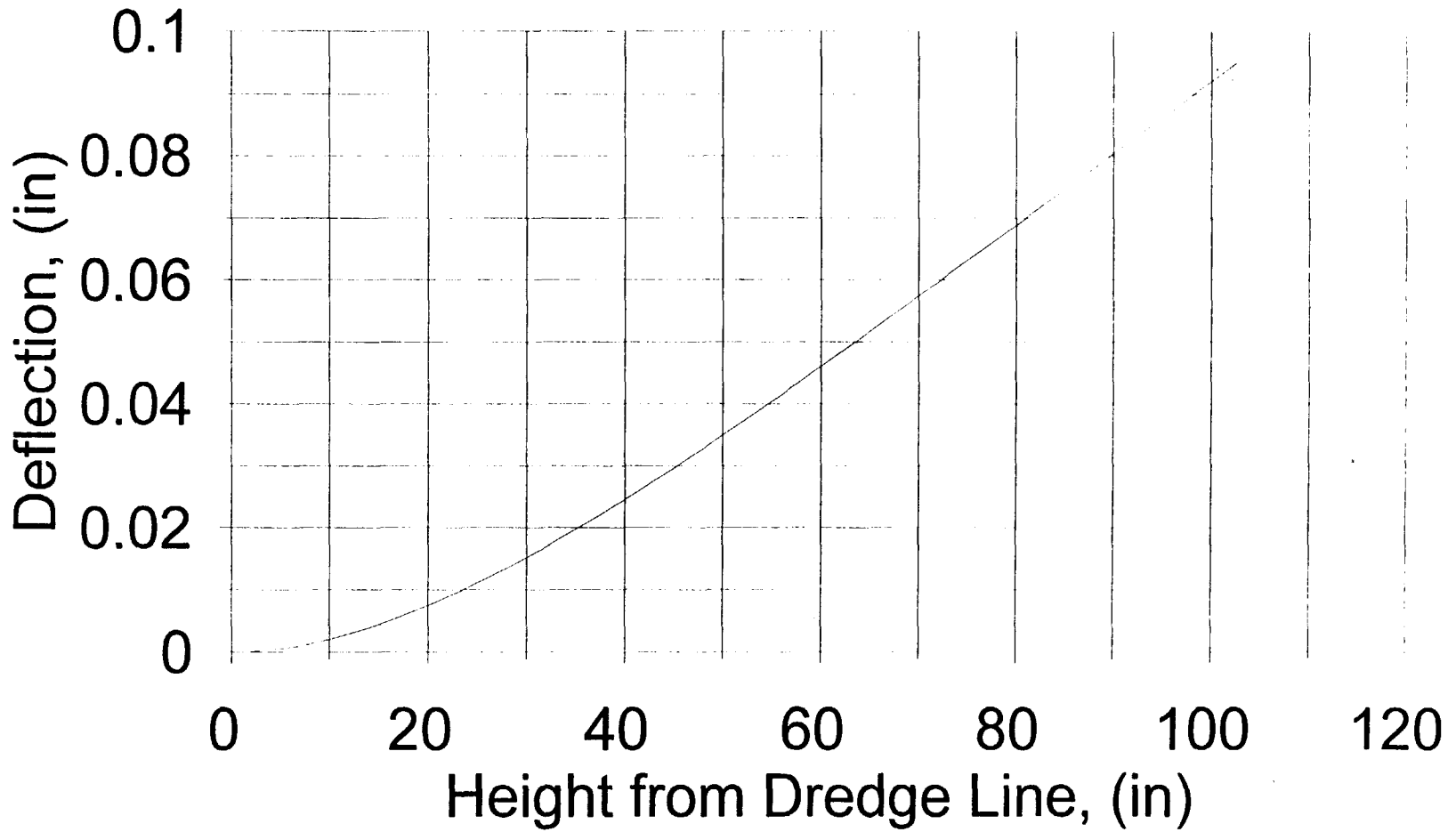

### Section III Concrete 1.5" Core Deflection Estimate by Beam Theory

w (lb/in)	L (in)	E (lb/in <sup>2</sup> )	I (in <sup>4</sup> )
0.28	25.7	4,562,350	0.2485

Deflection, d = (1/(EI))(w/(6L))(D1+D2+D3)

where, D1 = -L<sup>5</sup>/10+0.5L<sup>4</sup>x      D2 = 0.5(L<sup>2</sup>x<sup>3</sup>-Lx<sup>4</sup>)      D3 = (3/20)x<sup>5</sup>+0.1(L-x)<sup>5</sup>  
Change of

x (in)	D1	D2	D3	d (in)	Bending Slope (%)	Slope (%)
0.00				0.0000	0.0000	0.0000
1.00	-903,031	317	919,358	0.0000	0.0027	0.0027
2.00	-684,908	2,436	747,730	0.0001	0.0078	0.0051
3.00	-466,784	7,876	602,775	0.0002	0.0126	0.0048
4.00	-248,661	17,846	481,324	0.0004	0.0171	0.0045
5.00	-30,537	33,249	380,528	0.0006	0.0213	0.0042
6.00	187,586	54,679	297,876	0.0009	0.0251	0.0039
7.00	405,710	82,421	231,190	0.0012	0.0287	0.0036
8.00	623,833	116,452	178,642	0.0015	0.0320	0.0033
9.00	841,957	156,440	138,749	0.0018	0.0350	0.0030
10.00	1,060,080	201,745	110,389	0.0022	0.0376	0.0027
11.00	1,278,204	251,419	92,799	0.0026	0.0401	0.0024
12.00	1,496,327	304,206	85,587	0.0030	0.0422	0.0022
13.00	1,714,451	358,539	88,732	0.0035	0.0441	0.0019
14.00	1,932,574	412,547	102,598	0.0039	0.0458	0.0017
15.00	2,150,698	464,046	127,932	0.0044	0.0472	0.0014
16.00	2,368,821	510,546	165,874	0.0049	0.0485	0.0012
17.00	2,586,945	549,249	217,963	0.0054	0.0495	0.0010
18.00	2,805,068	577,047	286,142	0.0059	0.0503	0.0008
19.00	3,023,192	590,526	372,765	0.0064	0.0510	0.0007
20.00	3,241,316	585,960	480,602	0.0069	0.0515	0.0005
21.00	3,459,439	559,318	612,844	0.0074	0.0518	0.0004
22.00	3,677,563	506,259	773,114	0.0079	0.0521	0.0003
23.00	3,895,686	422,134	965,466	0.0085	0.0523	0.0002
24.00	4,113,810	301,985	1,194,395	0.0090	0.0524	0.0001
25.00	4,331,933	140,547	1,464,844	0.0095	0.0524	0.0000
25.70	4,484,620	0	1,681,732	0.0099	0.0524	0.0000

# Sheet Pile Deflection

## Section III

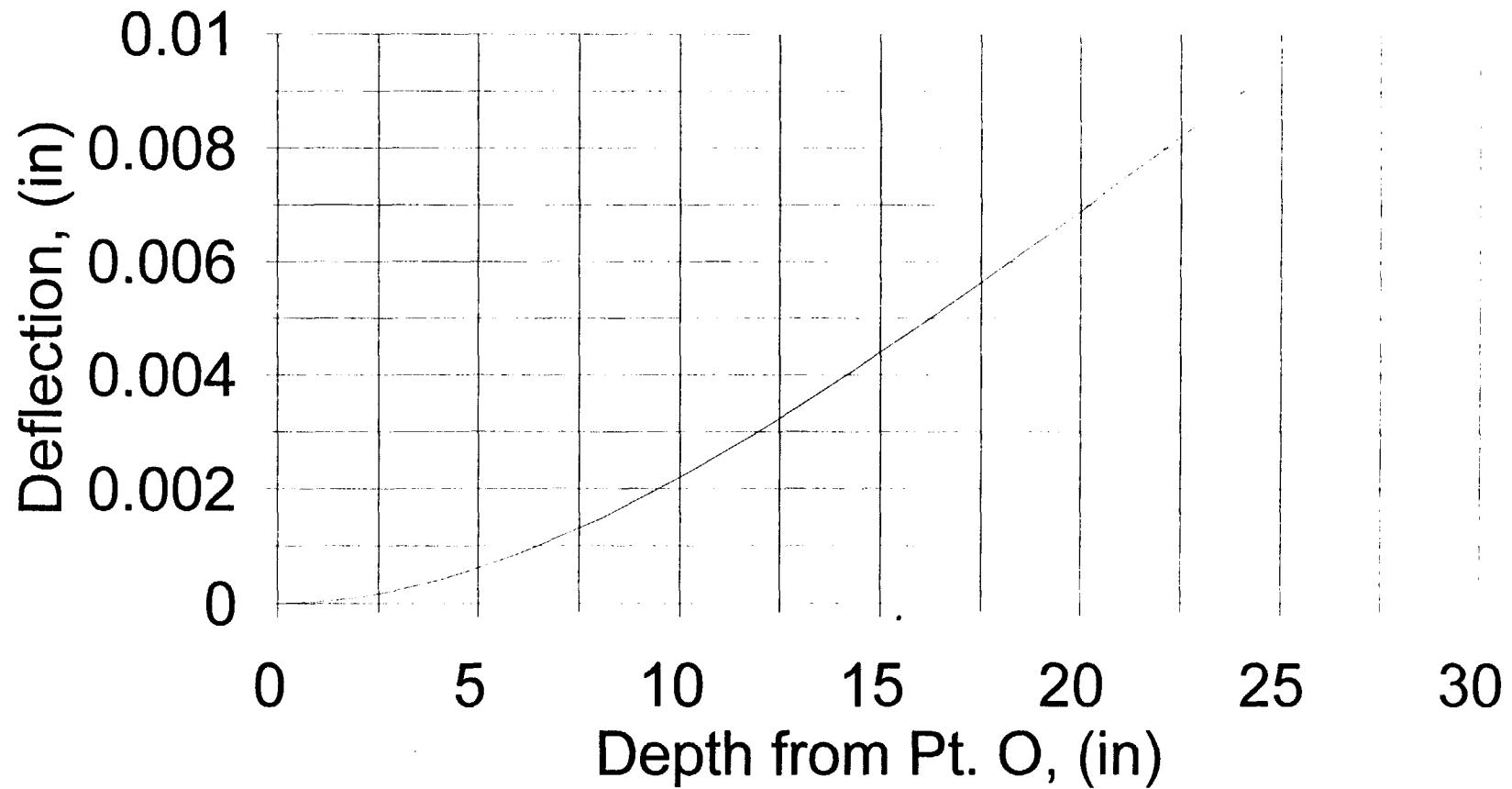

CLIENT GE Pittsfield SUBJECT Sheetpile Design Calculation Prepared By YZ Date: 01/07/99  
East Street Area 2 Reviewed By \_\_\_\_\_ Date: \_\_\_\_\_  
 PROJECT Source Control Containment Barrier

**TASK:**

To perform a geotechnical/structural calculation for the sheetpile hanging wall design. The sheetpile wall is used to provide excavation stability and to serve as a source control containment barrier. This analysis includes a 2.5 foot deep sediment excavation in front of the wall. This will be done in conjunction with bank regrading that will limit backfill behind the sheetpile to elevation 975 feet with a 2H:1V slope to the top of the bank during the excavation period.

**REFERENCES:**

1. Blasland, Bouck & Lee, Inc., "Source Control Work Plan - Upper Reach of Housatonic River (First 1/2 Mile)", September, 1998
2. NAVFAC DM-7, March, 1971

**METHODOLOGY:**

This design calculation uses a typical sheetpile configuration based on the site conditions to determine pile penetration depth and the maximum bending moment for the sheetpile design. For the selected sheetpile, factors of safety against both pile toppling and pile break are also calculated.

**CALCULATIONS:**

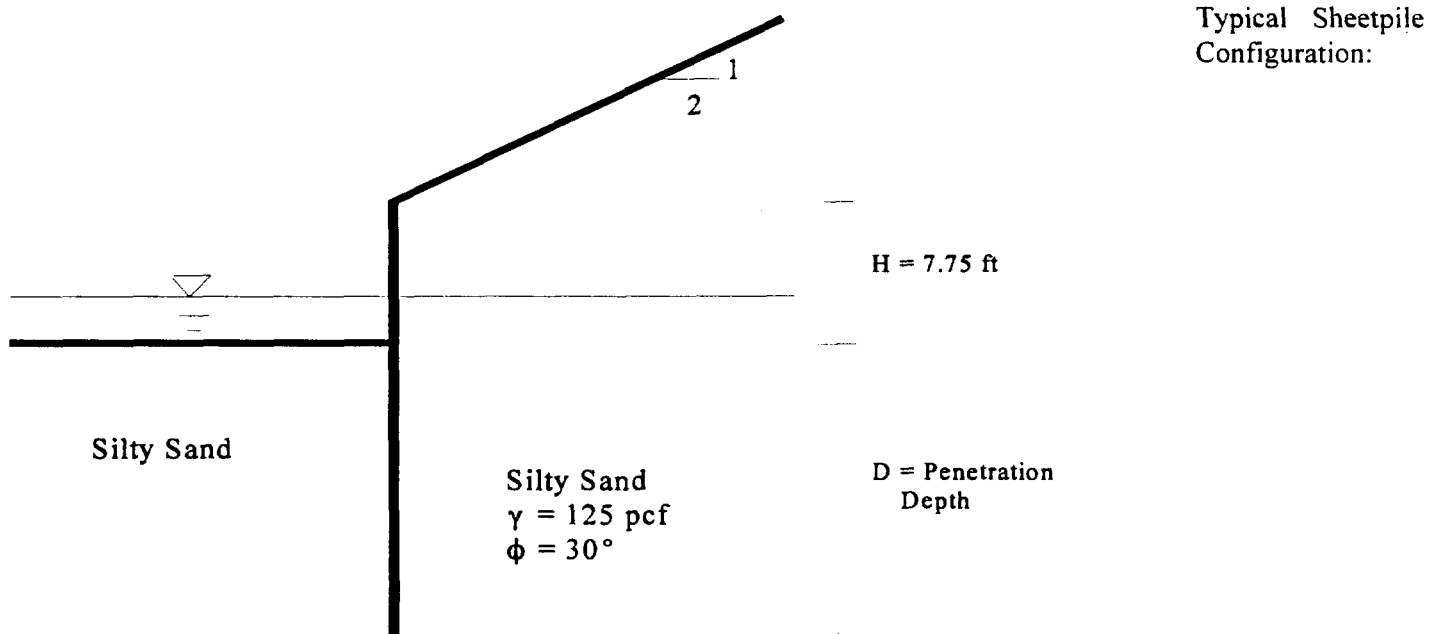

NOTE: WATER LEVELS CAN BE DIFFERENT ON OPPOSITE SIDES DUE TO PUMPING, TIDAL FLUCTUATIONS AND OTHER REASONS.

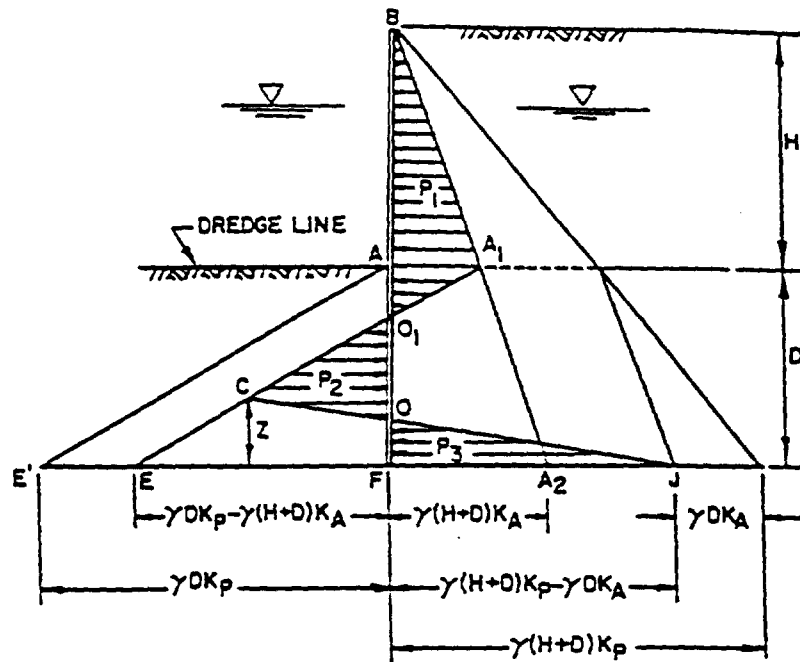

1. Assume a trial depth of penetration, D. This may be estimated from the following approximate correlation.

Standard Penetration Resistance, N Blows/foot	Depth of Penetration*
0 - 4	2.0H
5 - 10	1.5H
11 - 30	1.25H
31 - 50	1.0H
+50	0.75H

\* H = height of piling above dredge line

2. Determine the active and passive lateral pressure using appropriate coefficients of lateral earth pressure. If the Coulomb method is used, it should be used conservatively for the passive pressure.
3. Satisfy the requirements of static equilibrium: the sum of the forces in the horizontal direction must be zero and the sum of the moments about any point must be zero. The sum of the horizontal forces may be written in terms of pressure areas:

$$\Delta(EA_1A_2) - \Delta(FBA_2) - \Delta(ECJ) = 0$$

Solve the above equation for the distance, Z. For a uniform granular soil,

$$Z = \frac{K_p D^2 - K_A (H+D)^2}{(K_p - K_A) (H+2D)}$$

FIGURE 23  
Analysis for Cantilever Wall

- 3
4. Take moments about point F. If sum of moments is other than zero, readjust D and repeat calculations until sum of moments around F is zero.
  5. Compute maximum moment at point of zero shear.
  6. Increase D by 20% - 40% to result in approximate factor of safety of 1.5 to 2.

FIGURE 23 (continued)  
Analysis for Cantilever Wall

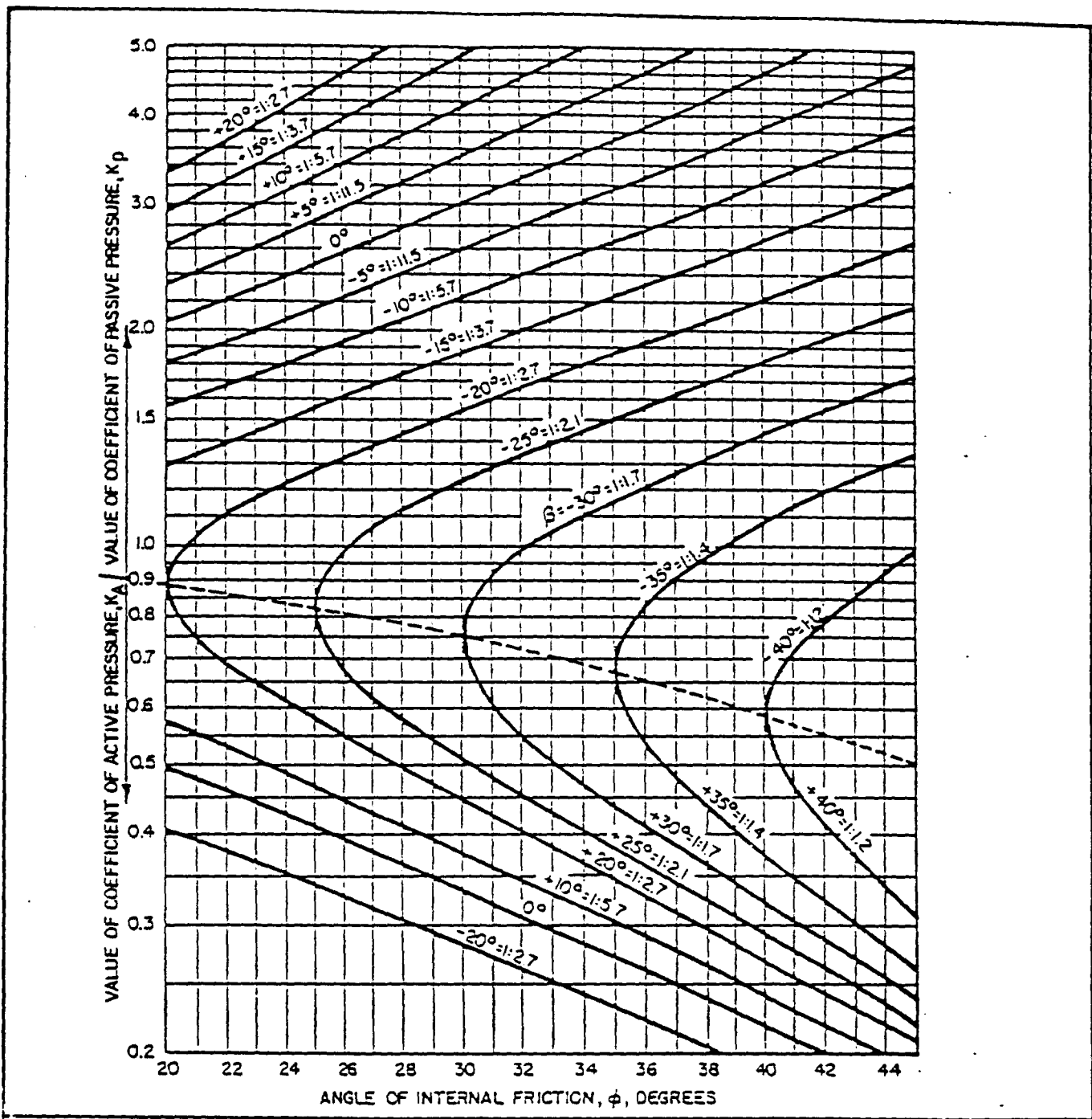

PASSIVE PRESSURE

ACTIVE PRESSURE

$$K_A = \left[ \frac{\cos \phi}{1 - \sqrt{\sin \phi (\sin \phi - \cos \phi \tan \beta)}} \right]^2; \quad K_P = \left[ \frac{\cos \phi}{1 - \sqrt{\sin \phi (\sin \phi + \cos \phi \tan \beta)}} \right]^2$$

$K_A$  &  $K_P$  = COEFFICIENTS FOR COULOMB'S EQUATION FOR ACTIVE AND PASSIVE EARTH PRESSURE (NO SHEAR STRESS ON VERTICAL PLANES).

$P_A$  = ACTIVE RESULTANT       $\phi$  = ANGLE OF INTERNAL FRICTION  
 $P_P$  = PASSIVE RESULTANT     $\beta$  = SLOPE ANGLE  
 $\gamma$  = UNIT WEIGHT OF SOIL  
 $H$  = HEIGHT OF WALL

FIGURE 3  
Active and Passive Coefficients, Sloping Backfill  
(Granular Soils)



CLIENT GE Pittsfield SUBJECT Sheetpile Design Calculation Prepared By YZ Date: 01/07/99  
East Street Area 2 Reviewed By \_\_\_\_\_ Date: \_\_\_\_\_  
 PROJECT Source Control Containment Barrier

**I - Penetration Depth and Pile Selection**

Follow calculation procedures on Sheets 2 and 3.

**1) Determine D**

Penetration depth D is adjusted (Step 4) by computer calculation spreadsheet.

**2) Determine  $K_s$  and  $K_p$**

From Sheet 4, for  $\phi = 30^\circ$  and  $\beta = 26^\circ$  (2H:1V slope),  $K_s = 0.55$ ,  $K_p = 3.0$

**3) to 6)**

Detailed calculations are presented on Sheet 6.

In a summary table below, it's assumed that Waterloo WZ75 pile will be used. Allowable section modulus of the pile ( $S_{all}$ ) is 15.9 in<sup>3</sup>/ft. (Sheet 7)

Pile Depth (ft)				Factor of Safety	
H	D	Stick-up	Total	Toppling	Break ( $S_{all}/S$ )
7.75	12.2	0	20	1.25	5.0

## Cantilever Sheet Pile Design

2.5' Excavation - Top of Soil Temporarily at 975.25'/FS=1.25

<b>Trial 1</b>					
H (ft)	D (ft)	Ka	Kp	Density(pcf)	Df
7.75	7.75	0.55	3	125	1
EF	1,841		EA1A2	11,262	
FA2	1,066		-FBA2	(8,259)	
FJ	5,280		-ECJ	(3,003)	
Z	0.84		Total	4.5475E-13	
Mf	<b>(14,421)</b>				
<b>Trial 2</b>					
H (ft)	D (ft)	Ka	Kp	Density(pcf)	Df
7.75	11.625	0.55	3	125	1.5
EF	3,027		EA1A2	25,339	
FA2	1,332		-FBA2	(12,904)	
FJ	6,466		-ECJ	(12,435)	
Z	2.62		Total	0	
Mf	<b>3,991</b>				
<b>Trial 3</b>					
H (ft)	D (ft)	Ka	Kp	Density(pcf)	Df
7.75	11.0825	0.55	3	125	1.43
EF	2,861		EA1A2	23,029	
FA2	1,295		-FBA2	(12,192)	
FJ	6,300		-ECJ	(10,838)	
Z	2.37		Total	(0)	
Mf	<b>(6)</b>	<b>OK</b>			
AA1	533		AO1	1.74	
Max. M	9,463	LB-FT			
	113,560	LB-IN			
SIGy	36,000	PSI	S	3.15	IN^3
INCREASE D BY 10%			D	12.19	FT
(FS =1.25)					

# WATERLOO BARRIER™

IS AVAILABLE IN TWO DESIGNS.  
THE MEDIUM WALL WZ75 AND  
THE HEAVY WALL WEZ95

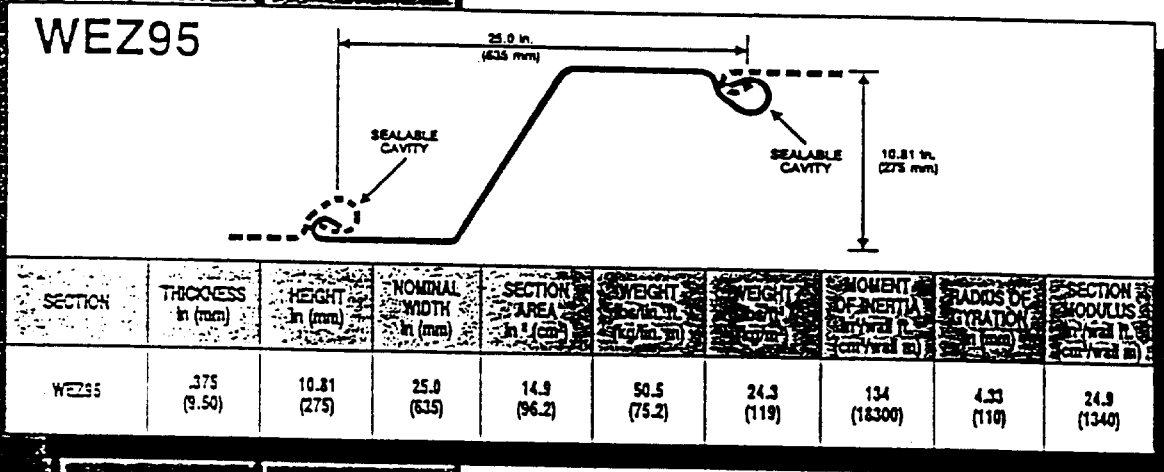
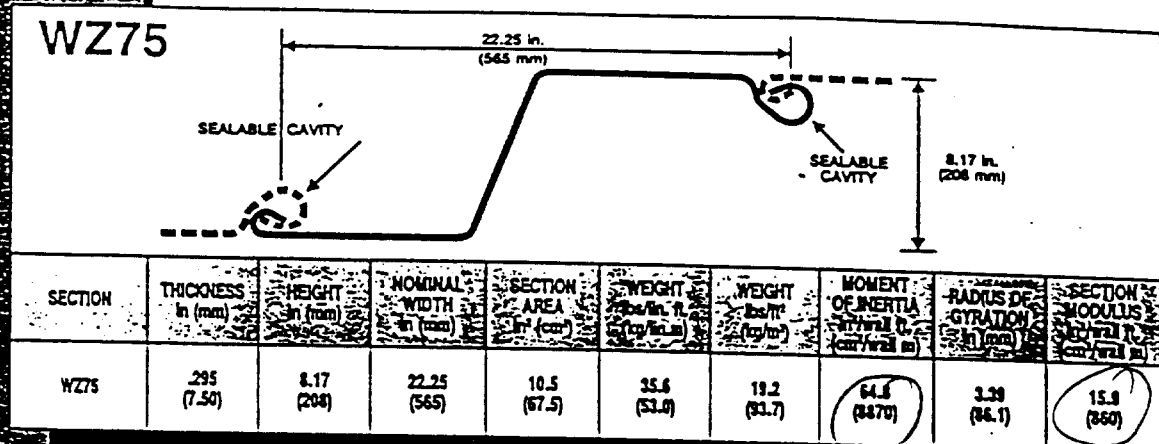

## SPECIFICATIONS:

**RAW MATERIAL:** ASTM A572 GR50  
CSA G40.21 GR 350V1

**MANUFACTURING:** ASTM A6  
CSA G40.20

**COATINGS:**

- 1) GALVANIZED ASTM A123, CSA G164
- 2) COAL TAR EPOXY SSPC-16
- 3) FUSION BONDED EPOXY RESIN, MFG'S SPEC.

**ACCESSORIES:** BENDS CAN BE SUPPLIED TO ANY ANGLE.  
T SECTIONS AND OTHER WELDED  
FABRICATIONS ARE AVAILABLE.

# ***Appendix D***

BLASLAND, BOUCK & LEE, INC.  
*engineers & scientists*

---

## ***Containment Barrier Technical Drawings***

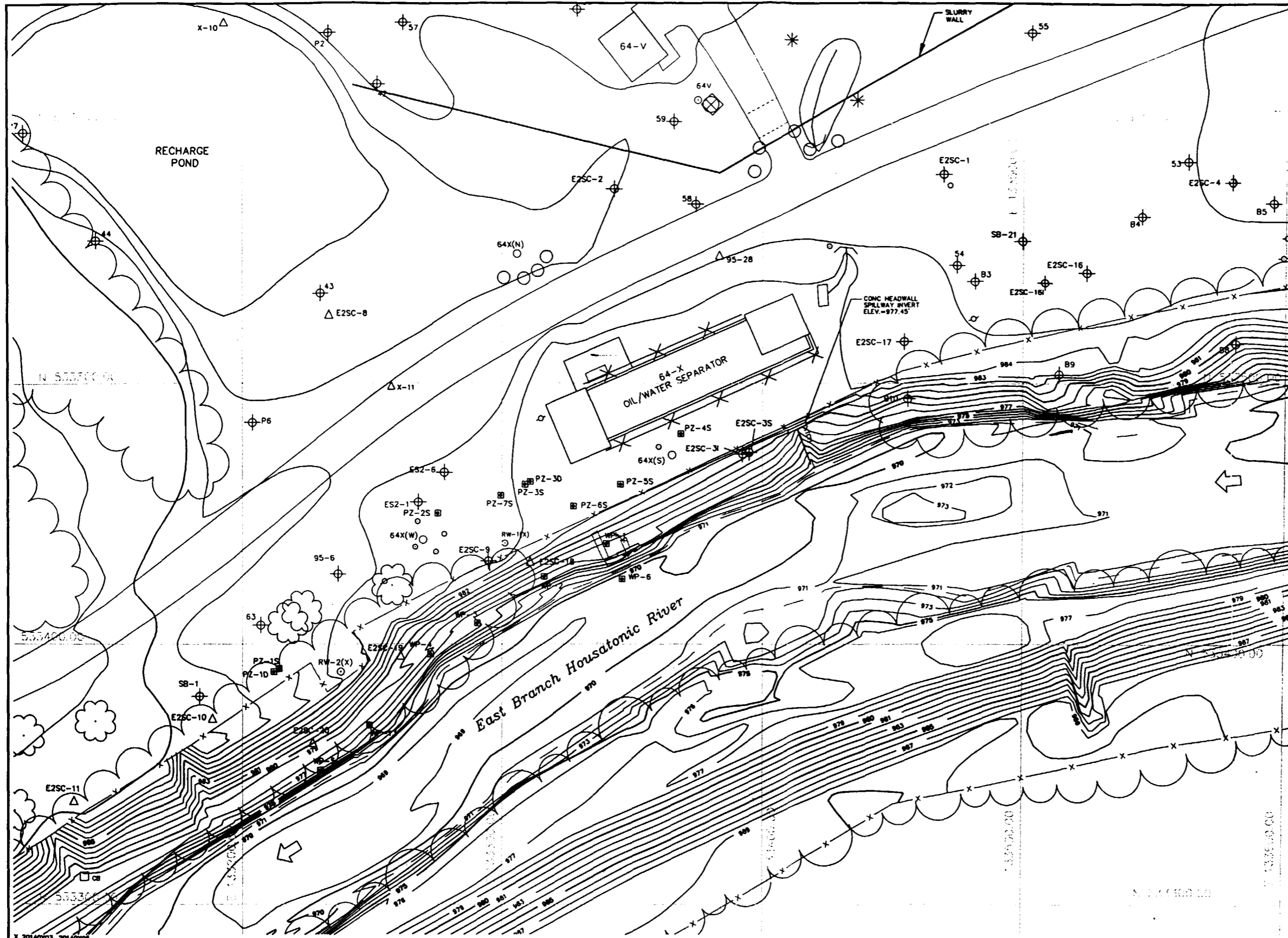

- LEGEND:**
- EXISTING INDEX ELEVATION CONTOUR
  - 980 — EXISTING INTERMEDIATE ELEVATION CONTOUR
  - WATER LINE
  - ☼ DECIDUOUS TREE
  - \* CONIFEROUS TREE
  - ⊗ MANHOLE
  - x—x— CHAIN LINK FENCE
  - POLE (NON-UTILITY)
  - ⊙ POLE (OVERHEAD UTILITY)
  - ⊕ ES2-1 PREVIOUSLY INSTALLED MONITORING WELL
  - ⊙ 64X(W) PREVIOUSLY INSTALLED OIL RECOVERY CAISSON
  - ⊙ RW-1(X) PREVIOUSLY INSTALLED PUMPING WELL
  - △ X-11 PREVIOUSLY INSTALLED SOIL BORING
  - ⊞ PZ-4S PREVIOUSLY INSTALLED PIEZOMETER
  - ⊕ E2SC-1 1998 MONITORING WELLS
  - △ E2SC-8 1998 SOIL BORINGS

- NOTES:**
1. BASE MAP PROVIDED BY LOCKWOOD MAPPING, INC. PREPARED FROM 1990 AERIAL PHOTOGRAPHY. RIVERBANK AND RIVER BED TOPOGRAPHIC INFORMATION PROVIDED BY BBL FROM OCTOBER 12-23, 1998 FIELD SURVEY.
  2. COORDINATE GRID BASED ON 1927 STATE PLANE COORDINATES.
  3. ELEVATION DATUM REFERENCED TO NGVD 1929.
  4. CONTOUR INTERVAL IN THE RIVER AND ON RIVERBANK = 1 FOOT CONTOUR. INTERVAL OUTSIDE RIVERBANK AREA = 2 FEET.
  5. ALL MONITORING WELL, BORING, PUMPING WELL, CAISSON, FENCE, MANHOLE, AND TREE LOCATIONS ARE APPROXIMATE.

**FOR BID ONLY  
NOT FOR CONSTRUCTION**

X 20140003, 20140005  
L: ON=\*, OFF=RET  
P: 20140808.PCP  
1/12/99 5YR-54-DHW AK CMS  
20140003,20140807.DWG



THIS DRAWING IS THE PROPERTY OF BLASLAND, BOUCK & LEE, INC. AND MAY NOT BE REPRODUCED OR ALTERED IN WHOLE OR IN PART WITHOUT THE EXPRESS WRITTEN PERMISSION OF BLASLAND, BOUCK & LEE, INC.

No.	Date	Revisions	Init

Project Mgr. — JML  
Designed by — BDL  
Drawn by — RCA  
Checked by — BDL  
Prof. Eng. —  
PE License —

**BBL**  
BLASLAND, BOUCK & LEE, INC.  
engineers & scientists

GENERAL ELECTRIC COMPANY • PITTSFIELD, MASSACHUSETTS  
EAST STREET AREA 2 SUPPLEMENTAL SOURCE CONTROL CONTAINMENT  
**EXISTING SITE PLAN**  
CONTRACT DRAWINGS

File Number  
201.40.005  
Date  
JANUARY 1999  
Blasland, Bouck & Lee, Inc.  
Corporate Headquarters  
8723 Township Road  
Syracuse, NY 13214  
315-448-9120

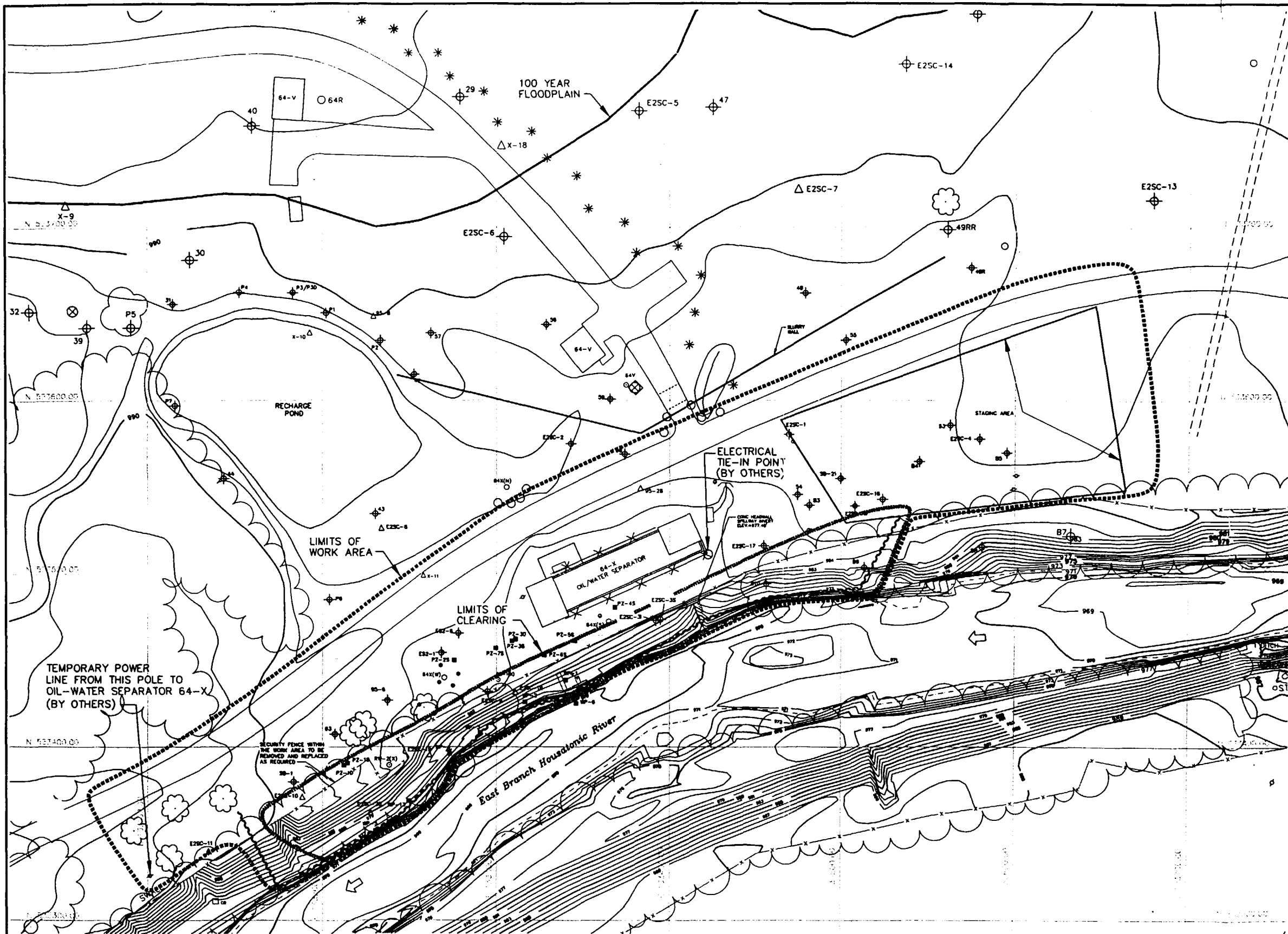

- LEGEND:**
- EXISTING INDEX ELEVATION CONTOUR
  - - - EXISTING INTERMEDIATE ELEVATION CONTOUR
  - - - WATER LINE
  - ☼ DECIDUOUS TREE
  - \* CONIFEROUS TREE
  - ⊙ MANHOLE
  - CHAIN LINK FENCE
  - POLE (NON-UTILITY)
  - ◆ POLE (OVERHEAD UTILITY)
  - ⊕ E2SC-1 PREVIOUSLY INSTALLED MONITORING WELL
  - ⊕ 64(V) PREVIOUSLY INSTALLED OIL RECOVERY CAISSON
  - ⊕ P2-1(1) PREVIOUSLY INSTALLED PUMPING WELL
  - △ X-11 PREVIOUSLY INSTALLED SOIL BORING
  - ⊕ P2-48 PREVIOUSLY INSTALLED PIEZOMETER
  - ⊕ E2SC-1 1998 MONITORING WELLS
  - △ E2SC-8 1998 SOIL BORINGS
  - ~ LOCATION OF CONTAINMENT BARRIER

- NOTES:**
1. BASE MAP PROVIDED BY LOCKWOOD MAPPING, INC. PREPARED FROM 1990 AERIAL PHOTOGRAPHY. RIVERBANK AND RIVER BED TOPOGRAPHIC INFORMATION PROVIDED BY BBL FROM OCTOBER 12-23, 1998 FIELD SURVEY.
  2. COORDINATE GRID BASED ON 1927 STATE PLANE COORDINATES.
  3. ELEVATION DATUM REFERENCED TO NGVD 1929.
  4. CONTOUR INTERVAL IN THE RIVER AND ON RIVERBANK = 1 FOOT CONTOUR. INTERVAL OUTSIDE RIVERBANK AREA = 2 FEET.
  5. ALL MONITORING WELL, BORING, PUMPING WELL, CAISSON, FENCE, MANHOLE, AND TREE LOCATIONS ARE APPROXIMATE.

**FOR BID ONLY  
NOT FOR CONSTRUCTION**

X 20140003, 20140005  
L: CM-\*, OFT-REF  
P: 20140808.PCP  
1/12/98 SYR-54-DWN AK GMS  
20140003, 20140808.DWG

GRAPHIC SCALE  
30' 0 30' 60'  
SCALE (FEET)

No.	Date	Revisions	Init

Project Mgr. — JMN  
Designed by — BDD  
Drawn by — RCA  
Checked by — BDD  
Prof. Eng. —  
PE License —

**BBL**  
BLASLAND, BOUCK & LEE, INC.  
engineers & scientists

GENERAL ELECTRIC COMPANY • PITTSFIELD, MASSACHUSETTS  
EAST STREET AREA 2 SUPPLEMENTAL SOURCE CONTROL CONTAINMENT

**WORK LIMITS**

CONTRACT DRAWINGS

File Number  
201.40.005  
Date  
JANUARY 1999  
Blasland, Bouck & Lee, Inc.  
Corporate Headquarters  
8723 Towpath Road  
Syracuse, NY 13214  
315-445-9120

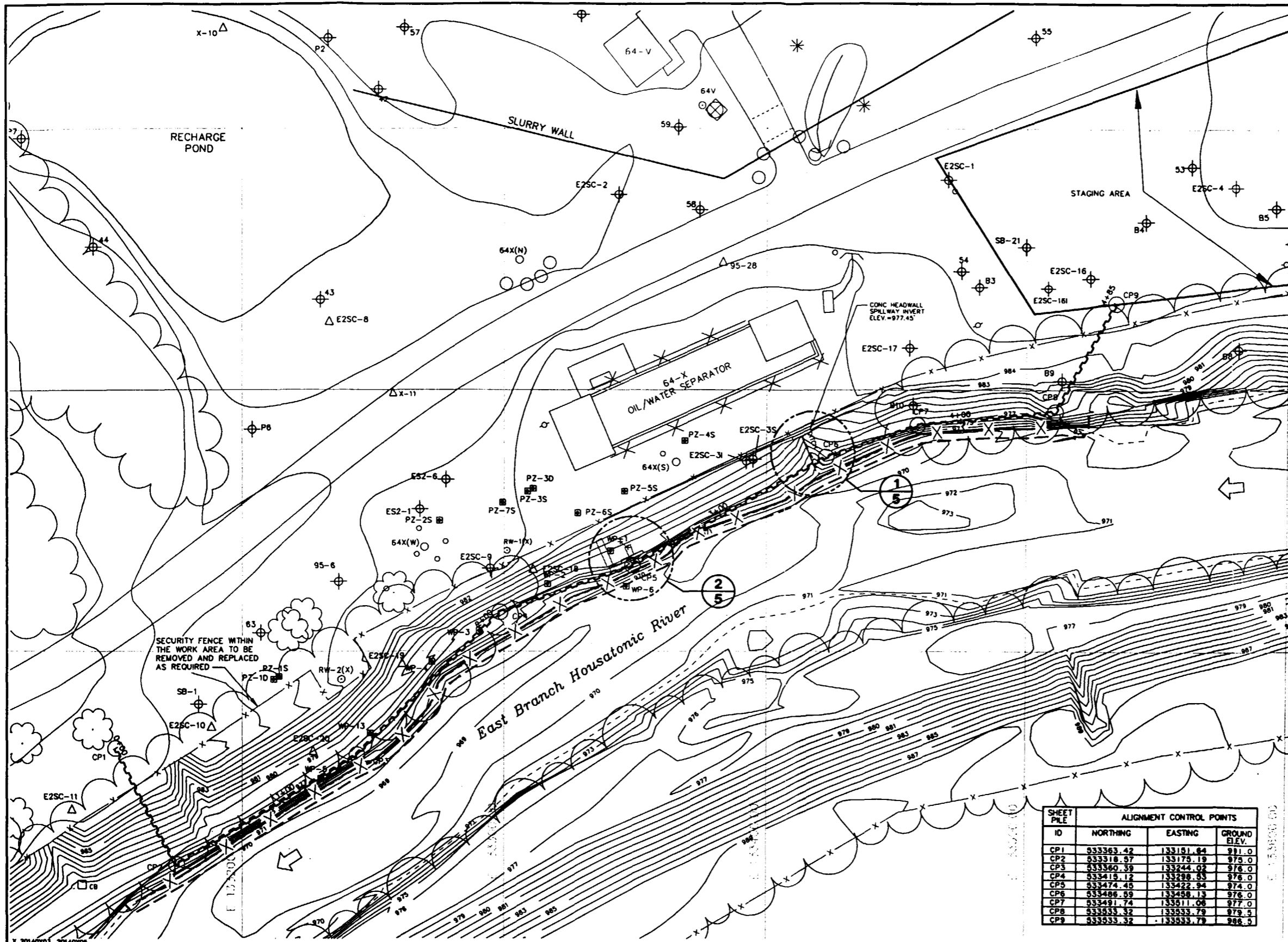

**LEGEND:**

- EXISTING INDEX ELEVATION CONTOUR
- 980- EXISTING INTERMEDIATE ELEVATION CONTOUR
- - - WATER LINE
- ☼ DECIDUOUS TREE
- \* CONIFEROUS TREE
- ⊗ MANHOLE
- X-X- CHAIN LINK FENCE
- POLE (NON-UTILITY)
- ⊙ POLE (OVERHEAD UTILITY)
- ES2-1 ⊕ PREVIOUSLY INSTALLED MONITORING WELL
- 64X(W) ○ PREVIOUSLY INSTALLED OIL RECOVERY CAISSON
- RW-1(X) ⊕ PREVIOUSLY INSTALLED PUMPING WELL
- X-11 ⊕ PREVIOUSLY INSTALLED SOIL BORING
- PZ-45 ⊕ PREVIOUSLY INSTALLED PIEZOMETER
- E2SC-1 ⊕ 1998 MONITORING WELLS
- E2SC-8 ⊕ 1998 SOIL BORINGS
- ~ ~ ~ LOCATION OF CONTAINMENT BARRIER
- CP1 BARRIER ALIGNMENT CONTROL POINT
- X-X- SILT FENCE TO BE INSTALLED ALONG THE WATER LINE (1/8)
- - - SILT CURTAIN (1/8)

**NOTES:**

1. BASE MAP PROVIDED BY LOCKWOOD MAPPING, INC. PREPARED FROM 1990 AERIAL PHOTOGRAPHY. RIVERBANK AND RIVER BED TOPOGRAPHIC INFORMATION PROVIDED BY BBL FROM OCTOBER 12-23, 1998 FIELD SURVEY.
2. COORDINATE GRID BASED ON 1927 STATE PLANE COORDINATES.
3. ELEVATION DATUM REFERENCED TO NGVD 1929.
4. CONTOUR INTERVAL IN THE RIVER AND ON RIVERBANK = 1 FOOT CONTOUR. INTERVAL OUTSIDE RIVERBANK AREA = 2 FEET.
5. ALL MONITORING WELL, BORING, PUMPING WELL, CAISSON, FENCE, MANHOLE, AND TREE LOCATIONS ARE APPROXIMATE.
6. PROFILE OF SHEETPILE WALL ALIGNMENT, INCLUDING SHEETPILE LENGTHS AND CUTOFF ELEVATIONS, SHOWN ON DRAWING 4.
7. CONTRACTOR SHALL BE RESPONSIBLE FOR PROVIDING ADDITIONAL EROSION AND SEDIMENTATION CONTROL MEASURES AS NEEDED DURING CONSTRUCTION.

SHEET PILE ID	ALIGNMENT CONTROL POINTS		
	NORTHING	EASTING	GROUND ELEV.
CP1	533363.42	133151.64	971.0
CP2	533318.97	133175.19	975.0
CP3	533460.39	133244.02	978.0
CP4	533419.12	133228.93	978.0
CP5	533474.46	133222.94	978.0
CP6	533486.89	133458.13	976.0
CP7	533491.74	133611.08	977.0
CP8	533533.32	133533.79	979.5
CP9	533533.32	133533.79	980.5

**FOR BID ONLY  
NOT FOR CONSTRUCTION**

X: 20140005, 20140005  
L: 01-07-REF  
P: STD/PCP-DL  
1/12/99 SYR-54-DMW AK GMS  
20140005, 20140010.DWG

GRAPHIC SCALE  
20' 0 20' 40'  
SCALE (FEET)

THIS DRAWING IS THE PROPERTY OF BLASLAND, BOUCK & LEE, INC. AND MAY NOT BE REPRODUCED OR ALTERED IN WHOLE OR IN PART WITHOUT THE EXPRESS WRITTEN PERMISSION OF BLASLAND, BOUCK & LEE, INC.

No.	Date	Revisions	Init

Project Mgr. — JMB  
Designed by — BDD  
Drawn by — RCA  
Checked by — RDD  
Prof. Eng. —  
PE License —

**BBL**  
BLASLAND, BOUCK & LEE, INC.  
engineers & scientists

GENERAL ELECTRIC COMPANY • PITTSFIELD, MASSACHUSETTS  
EAST STREET AREA 2 SUPPLEMENTAL SOURCE CONTROL CONTAINMENT  
**CONTAINMENT BARRIER PLAN**

CONTRACT DRAWINGS

File Number  
201.40.005  
Date  
JANUARY 1999  
Blasland, Bouck & Lee, Inc.  
Corporate Headquarters  
8723 Towpath Road  
Syracuse, NY 13214  
315-446-9120

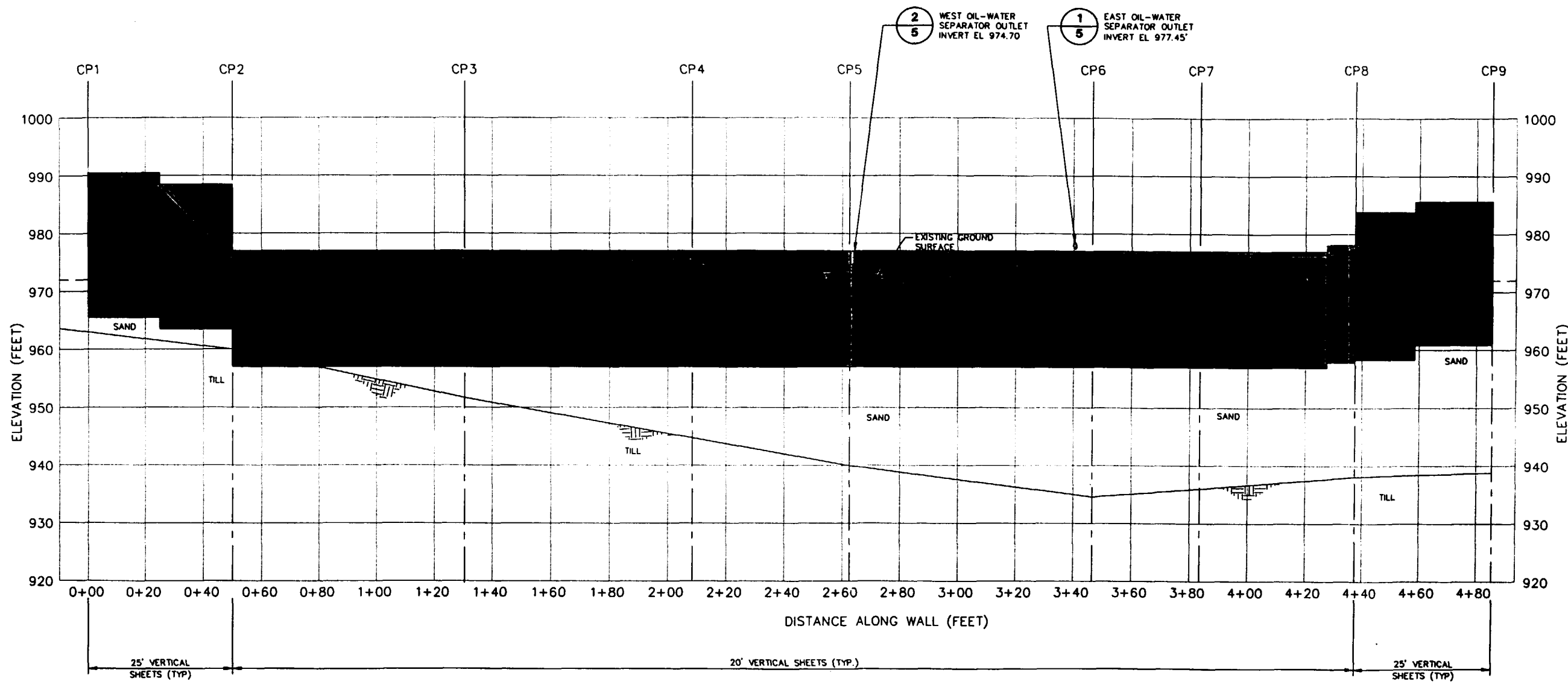

**LEGEND:**

- CP10 SHEET PILE ALIGNMENT CONTROL POINT
- TYPICAL RIVER SURFACE WATER ELEVATION
- █ DEPTH OF THE SHEET PILE

**NOTE:**

1. TOP OF TILL AND GROUND WATER TABLE ARE PROJECTED FROM SECTION A-A' OF FIGURE 3 IN SOURCE CONTROL PROPOSAL.
2. CONTROL POINT COORDINATES SHOWN ON DRAWING 2.
3. INSTALL STEEL SHEET PILE AND JOINT SEALANT IN ACCORDANCE WITH THE PROJECT SPECIFICATIONS.
4. ALL THE DIMENSIONS AND ELEVATIONS ARE APPROXIMATE. FIELD CONDITIONS MAY VARY.
5. CUTOFF SHEETING AT APPROXIMATELY GROUND SURFACE BETWEEN CP1 TO CP2 AND CP8 TO CP9.

**FOR BID ONLY  
NOT FOR CONSTRUCTION**

L: ON=\*, OFF=REF  
P: STD-PCP/DL  
1/11/99 SYR-54-RCA GMS AK  
20140005/20140V04.DWG

10' 0 10' 20'  
VERTICAL SCALE (FEET)  
20' 0 20' 40'  
HORIZONTAL SCALE (FEET)

THIS DRAWING IS THE PROPERTY OF BLASLAND, BOUCK & LEE, INC. AND MAY NOT BE REPRODUCED OR ALTERED IN WHOLE OR IN PART WITHOUT THE EXPRESS WRITTEN PERMISSION OF BLASLAND, BOUCK & LEE, INC.

No.	Date	Revisions	Init

Project Mgr. JML  
Designed by BDD  
Drawn by BDA  
Checked by BDD  
Prof. Eng.    
PE License  



GENERAL ELECTRIC COMPANY • PITTSFIELD, MASSACHUSETTS  
EAST STREET AREA 2 SUPPLEMENTAL SOURCE CONTROL CONTAINMENT  
**CONTAINMENT BARRIER PROFILE**

CONTRACT DRAWINGS

File Number  
201.40.005  
Date  
JANUARY 1999  
Blasland, Bouck & Lee, Inc.  
Corporate Headquarters  
6723 Towpath Road  
Syracuse, NY 13214  
315-446-9120



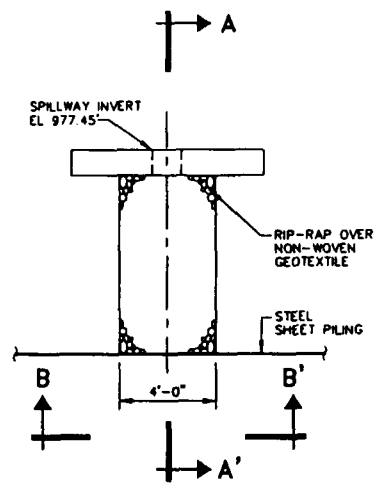

**EAST HEADWALL PLAN 1**  
NOT TO SCALE

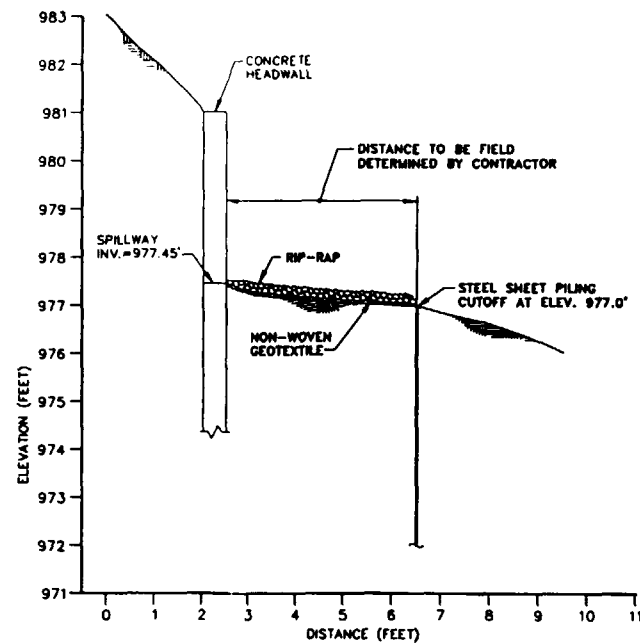

**SECTION A-A' 1**  
SCALE: 1"=2'-0"

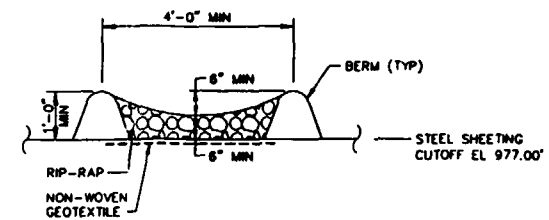

**SECTION B-B' 1**  
NOT TO SCALE

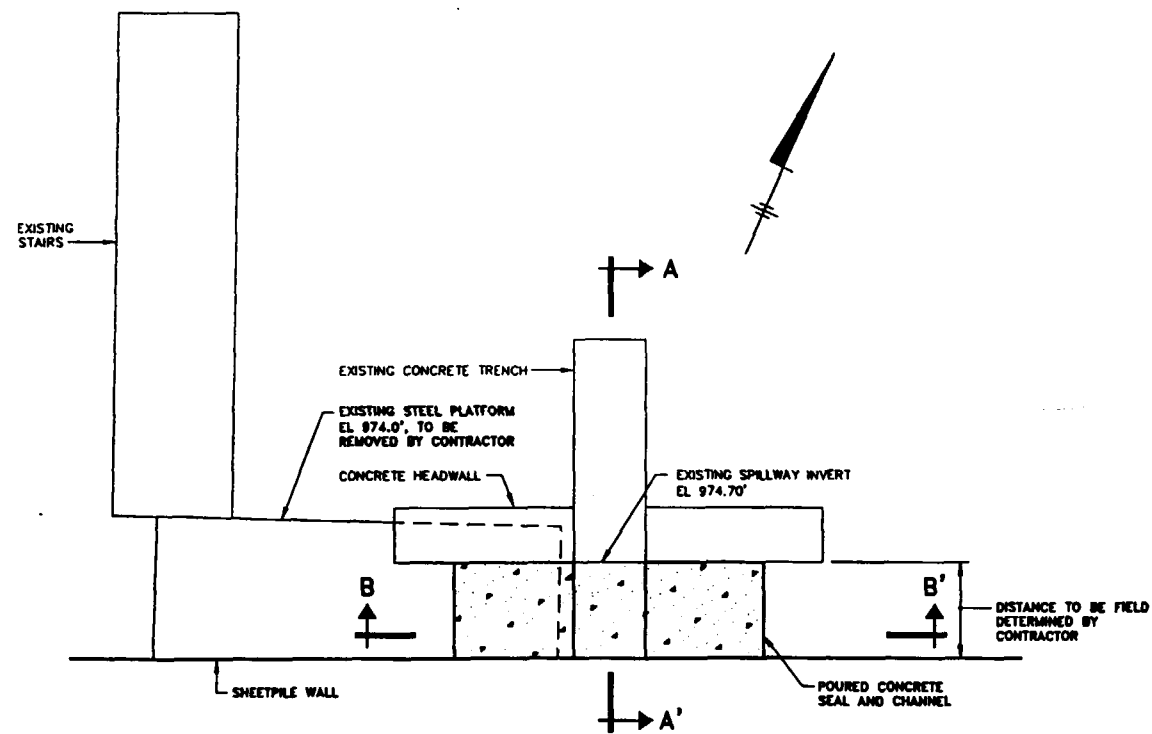

**WEST HEADWALL PLAN 2**  
NOT TO SCALE

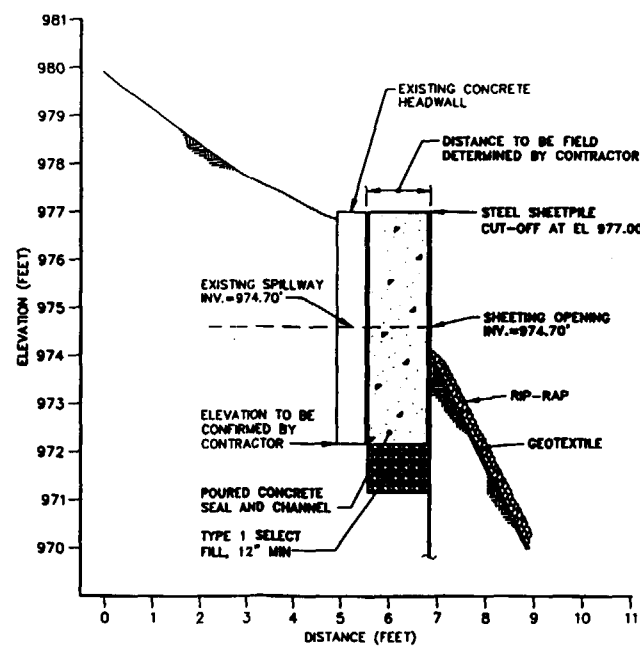

**SECTION A-A' 2**  
SCALE: 1"=2'-0"

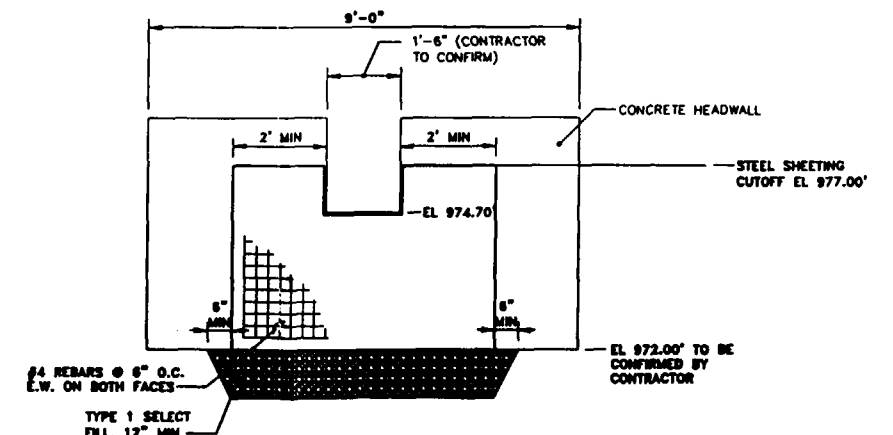

**SECTION B-B' 2**  
NOT TO SCALE

- NOTES:**
- 18" LONG #4 DOWELS DRILLED AND EPOXIED INTO CONCRETE HEADWALL PROTRUDING AT LEAST 8" INTO NEW CONCRETE AT 1' O.C.
  - REBAR MAT TO BE ATTACHED TO STEEL LUGS WELDED TO SHEETPIILING @ 1' O.C.
  - MINIMUM 3" COVER FOR REBAR.
  - CONCRETE SHALL BE 4,000 PSI (MIN) W/ 3%-5% AIR ENTRAINMENT.

**FOR BID ONLY  
NOT FOR CONSTRUCTION**

L: ON=0, OFF=REF  
P: STD-PCP/DL, D2BL  
1/12/99 SYR-54-RCA AK GMS  
20140005\_20140809.DWG

No.	Date	Revisions	Init

Project Mgr. JMN  
Designed by BDD  
Drawn by RCA/GMS  
Checked by BDD  
Prof. Eng. \_\_\_\_\_  
PE License \_\_\_\_\_

**BBL**  
BLASLAND, BOUCK & LEE, INC.  
engineers & scientists

GENERAL ELECTRIC COMPANY • PITTSFIELD, MASSACHUSETTS  
EAST STREET AREA 2 SUPPLEMENTAL SOURCE CONTROL CONTAINMENT

**DETAILS**

CONTRACT DRAWINGS

File Number  
201.40.005  
Date  
JANUARY 1999  
Blasland, Bouck & Lee, Inc.  
Corporate Headquarters  
6723 Towpath Road  
Syracuse, NY 13214  
315-446-9120

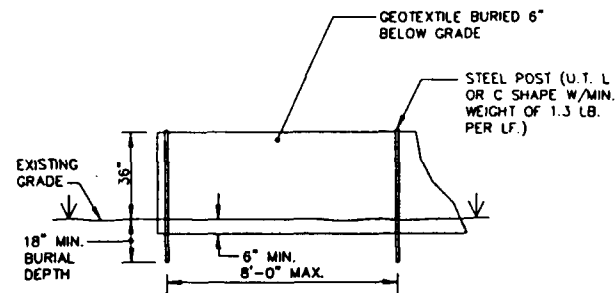

**NOTES:**

1. SEDIMENT DEPOSITS SHALL BE REMOVED WHEN THE DEPOSIT REACHES APPROX. 6 INCHES ABOVE GRADE LEVEL.
2. THE SILT FENCE WILL REMAIN IN PLACE UNTIL A STRONG VEGETATIVE STAND IS ESTABLISHED.
3. THE SILT FENCE WILL BE USED FOR TEMPORARY EROSION AND SEDIMENTATION CONTROL ONLY.

**SILT FENCE DETAIL 1**  
NOT TO SCALE

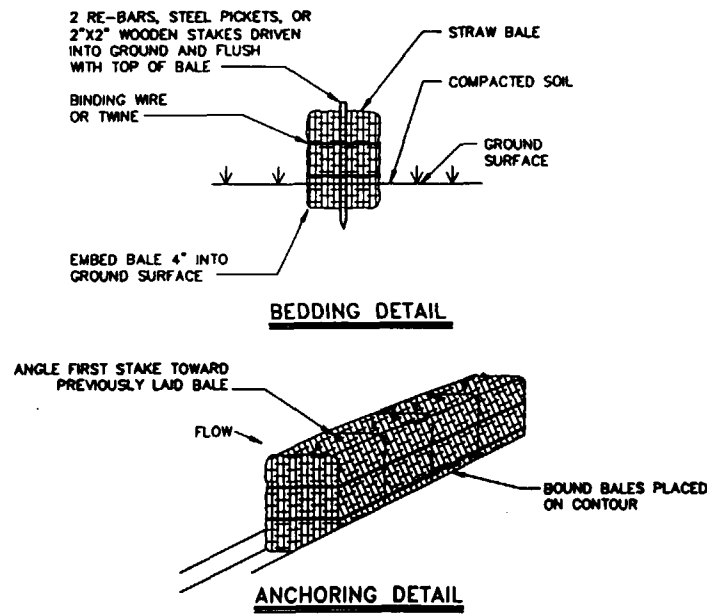

**NOTE:**

1. THE STRAW BALES WILL BE USED FOR TEMPORARY EROSION AND SEDIMENTATION CONTROL ONLY.

**STRAW BALE 2**  
NOT TO SCALE

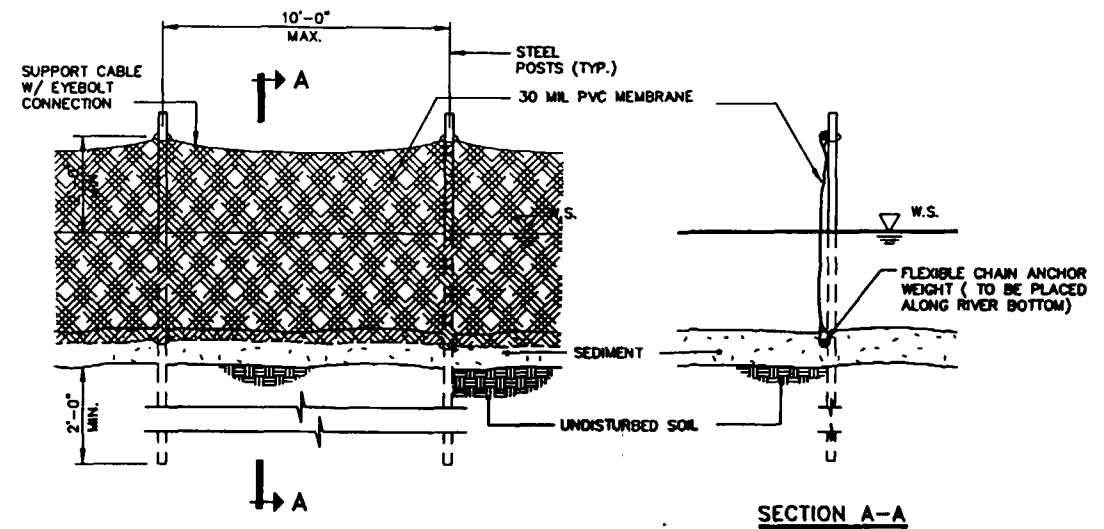

**NOTE:**

1. THE SILT CURTAIN WILL BE USED FOR TEMPORARY EROSION AND SEDIMENTATION CONTROL ONLY.

**SILT CURTAIN DETAIL 3**  
NOT TO SCALE

L: ON=0; OFF=REF  
P: STD-PCP/DL D28L  
1/12/99 SYR-34-NES AK QMS  
20140005\20140811.DWG

THIS DRAWING IS THE PROPERTY OF BLASLAND, BOUCK & LEE, INC. AND MAY NOT BE REPRODUCED OR ALTERED IN WHOLE OR IN PART WITHOUT THE EXPRESS WRITTEN PERMISSION OF BLASLAND, BOUCK & LEE, INC.

No.	Date	Revisions	Init

Project Mgr. --- JML ---  
Designed by --- BDD ---  
Drawn by --- BCB/GMS ---  
Checked by --- BDD ---  
Prof. Eng. ---  
PE License ---

**BBL**  
BLASLAND, BOUCK & LEE, INC.  
engineers & scientists

GENERAL ELECTRIC COMPANY • PITTSFIELD, MASSACHUSETTS  
EAST STREET AREA 2 SUPPLEMENTAL SOURCE CONTROL CONTAINMENT  
**DETAILS**  
CONTRACT DRAWINGS

File Number  
201.48.005  
Date  
JANUARY 1999  
Blasland, Bouck & Lee, Inc.  
Corporate Headquarters  
6723 Towpath Road  
Syracuse, NY 13214  
315-446-9120

**FOR BID ONLY  
NOT FOR CONSTRUCTION**