

**CIVIL ENGINEERING STUDIES**  
Transportation Engineering Series No. 33  
Illinois Cooperative Highway Research Program  
Series No. 191

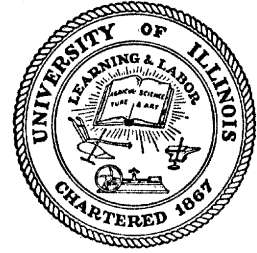

# **REPAIR AND PREVENTATIVE MAINTENANCE PROCEDURES FOR CONTINUOUSLY REINFORCED CONCRETE PAVEMENT**

by  
**MICHAEL I. DARTER  
TERRY L. BARNETT  
DAVID J. MORRILL**

A Report of the Investigation of  
Determination of Optimum Maintenance Procedures  
and Materials for Continuously Reinforced Concrete Pavement  
Project IHR-901  
Illinois Cooperative Highway Research Program

conducted by the  
**TRANSPORTATION RESEARCH LABORATORY  
DEPARTMENT OF CIVIL ENGINEERING  
ENGINEERING EXPERIMENT STATION  
UNIVERSITY OF ILLINOIS  
AT URBANA-CHAMPAIGN**

in cooperation with the  
**STATE OF ILLINOIS  
DEPARTMENT OF TRANSPORTATION**

and  
**THE U.S. DEPARTMENT OF TRANSPORTATION  
FEDERAL HIGHWAY ADMINISTRATION**

**UNIVERSITY OF ILLINOIS  
URBANA, ILLINOIS  
JUNE, 1982**

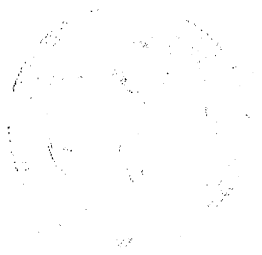

The following information is provided for your information:

1. The information is confidential and should be handled accordingly.

2. The information is for internal use only.

3. The information is not to be distributed outside the organization.

4. The information is not to be used for any other purpose.

5. The information is not to be used for any other purpose.

6. The information is not to be used for any other purpose.

7. The information is not to be used for any other purpose.

8. The information is not to be used for any other purpose.

9. The information is not to be used for any other purpose.

10. The information is not to be used for any other purpose.

REPAIR AND PREVENTATIVE MAINTENANCE PROCEDURES FOR  
CONTINUOUSLY REINFORCED CONCRETE PAVEMENT

by

Michael I. Darter  
Terry L. Barnett  
David J. Morrill

Research Report 901-4  
Illinois Cooperative Highway Research Program

Conducted by

Transportation Research Laboratory  
Department of Civil Engineering  
University of Illinois

in cooperation with

State of Illinois  
Department of Transportation

and the

U.S. Department of Transportation  
Federal Highway Administration

June 1982



1. Report No. FHWA/IL/UI-191		2. Government Accession No.		3. Recipient's Catalog No.	
4. Title and Subtitle Repair and Preventative Maintenance Procedures for Continuously Reinforced Concrete Pavement				5. Report Date June 1981	
				6. Performing Organization Code	
7. Author(s) Michael I. Darter Terry L. Barnett, David J. Morrill				8. Performing Organization Report No. UILU-ENG-81-2016	
9. Performing Organization Name and Address Department of Civil Engineering Engineering Experiment Station University of Illinois at Urbana-Champaign Urbana, Illinois 61801				10. Work Unit No.	
				11. Contract or Grant No. IHR-901	
12. Sponsoring Agency Name and Address Illinois Department of Transportation Bureau of Materials and Physical Research 126 East Ash Street Springfield, Illinois 62706				13. Type of Report and Period Covered Final Report 1978-1981	
				14. Sponsoring Agency Code	
15. Supplementary Notes Study was conducted in cooperation with the U.S. Department of Transportation Federal Highway Administration. Study Title: Determination of Optimum Maintenance Procedures and Material for Continuously Reinforced Concrete Pavement.					
16. Abstract Procedures for permanently patching and for pressure grouting of continuously reinforced concrete pavement have been developed. These procedures have been extensively field tested to ensure their practicality and adequacy. The patching procedures reduce costs and lane closure time by considering the different distress types, different methods of construction, and concrete additive and curing for early opening. The pressure grouting procedures provide for a restoration of support beneath the slab and the prevention of future pumping.					
17. Key Words Pavement, Concrete, Distress, Evaluation, Maintenance, Reinforcement, Construction, Patching, Rehabilitation, Overlay, Deflection, Pressure Grout, CRCP			18. Distribution Statement No restrictions. This document is available to the public through National Technical Information Service, Springfield, Virginia 22161		
19. Security Classif. (of this report) Unclassified		20. Security Classif. (of this page) Unclassified		21. No. of Pages 86	22. Price

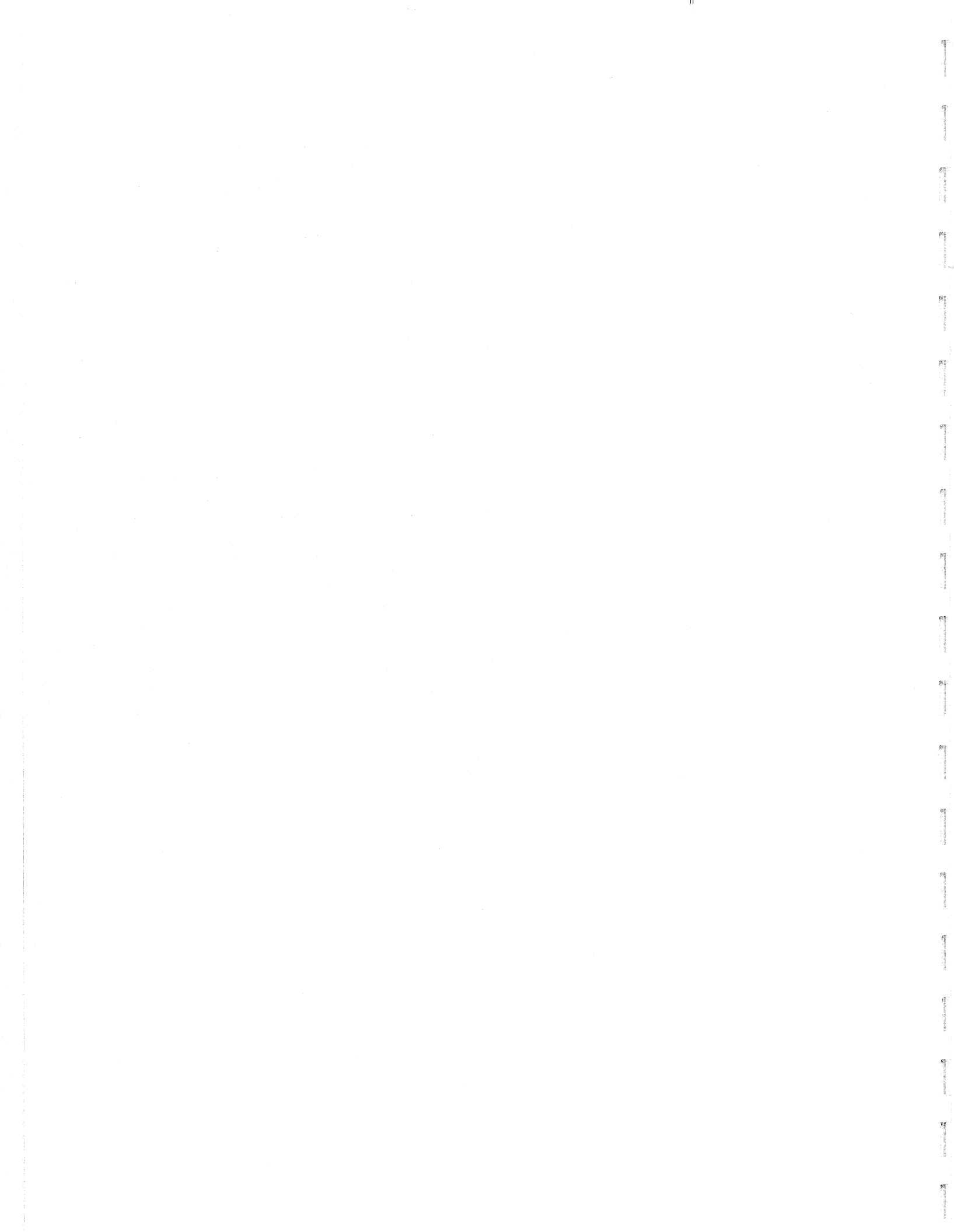

## ACKNOWLEDGMENTS

This report was prepared as a part of the Illinois Cooperative Highway Research Program, Project IHR-901 - Determination of Optimum Maintenance Procedures and Materials for Continuously Reinforced Concrete Pavement, by the Department of Civil Engineering, in the Engineering Experiment Station, University of Illinois at Urbana-Champaign, in cooperation with the Illinois Department of Transportation and the United States Department of Transportation, Federal Highway Administration.

## DISCLAIMER

The contents of this report reflect the views of the authors who are responsible for the facts and the accuracy of the data presented herein. The contents do not necessarily reflect the official views or policies of the Illinois Department of Transportation or the Federal Highway Administration. This report does not constitute a standard, specification, or regulation.





## LIST OF REPORTS

Research Report 901-1, "Performance of Continuously Reinforced Concrete Pavement in Illinois," by Scott A. LaCoursiere, Michael I. Darter, and Scott A. Smiley, describes a comprehensive field evaluation of distress on CRCP on Interstate highways in Illinois, 1978.

Research Report 901-2, "Evaluation of Patching of Continuously Reinforced Concrete Pavement in Illinois," by Darrell J. Maxey, Michael I. Darter, and Scott A. Smiley, evaluates permanent patching procedures and field performance of patches in Illinois, 1979.

Research Report 901-3, "Evaluation of Maintenance Rehabilitation Alternatives For Continuously Reinforced Concrete Pavement," by Terry L. Barnett, Michael I. Darter, and Ned R. Laybourne, describes the construction and evaluation of several experimental maintenance/rehabilitation techniques applied to an Interstate highway in Illinois, 1981.

Research Report 901-4, "Repair and Preventative Maintenance Procedures For Continuously Reinforced Concrete Pavement," by Michael I. Darter, Terry L. Barnett and David J. Morrill provides recommended methods for permanent patching and pressure grouting CRCP, 1981.

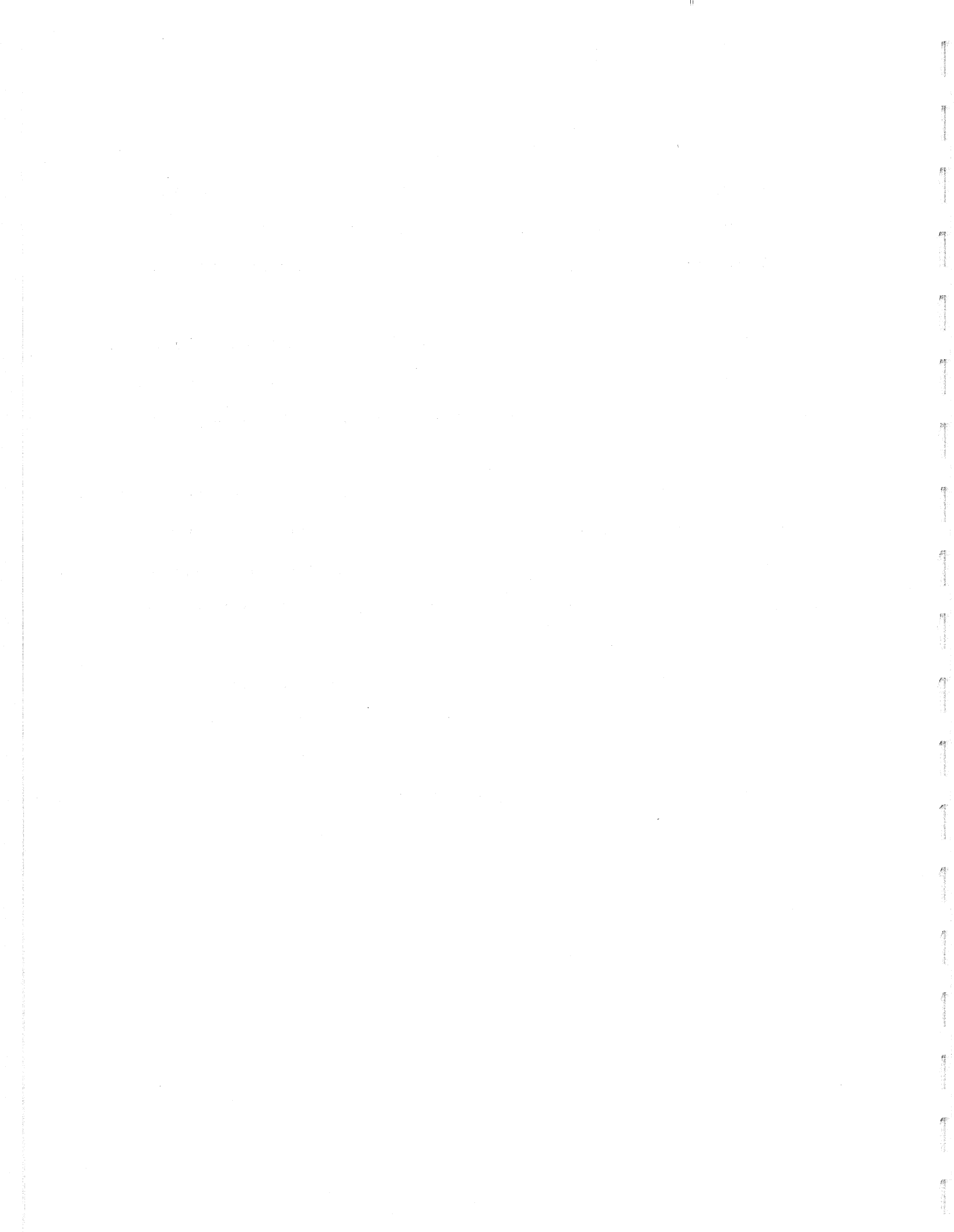

## PREFACE

This is the fourth and final report describing the work accomplished on Project IHR-901 entitled "Determination of Optimum Maintenance Procedures and Materials for Continuously Reinforced Concrete Pavement." Much appreciation is expressed to the following Civil Engineering graduate students who contributed to this study: Darrel J. Maxey, Scott A. Smiley, Scott A. LaCoursiere, Ned R. Laybourne, Terry L. Barnett, and David J. Morrill. Thanks are due to the project advisory committee for guidance and for reviewing this report. The committee includes: H. C. Bankie, B. J. Dempsey, W. L. Gamble, J. Santarelli, D. R. Schwartz, M. F. Thompson, C. P. Alexander, and John Ebers, Jr. Special appreciation is extended to several personnel from the Illinois Department of Transportation, for considerable assistance throughout the study. Appreciation is also expressed to Maggie Ross for typing this report.

June 1982



## TABLE OF CONTENTS

Chapter		Page
1	INTRODUCTION.....	1
2	PERFORMANCE OF CRCP IN ILLINOIS.....	2
3	PERMANENT REPAIR OF CRCP.....	5
	3.1 Variation In Dimensions.....	6
	3.2 Mechanized Equipment & Alternate Concrete Removal Procedures.....	6
	3.3 Shortened Lap Splices.....	7
	3.4 Welded Splice.....	8
	3.5 Other Alternatives.....	10
	3.6 Opening to Traffic.....	13
4	PRESSURE GROUTING OF CRCP.....	29
	4.1 Materials.....	29
	4.2 Equipment.....	30
	4.3 Pressure Grouting Procedures.....	32
	4.4 Typical Pressure Grout Quantities.....	39
5	CONCLUSIONS AND RECOMMENDATIONS.....	40
	REFERENCES.....	39
	APPENDIX A - RECOMMENDED PROCEDURES FOR PATCHING CRCP FOR ILLINOIS DEPARTMENT OF TRANSPORTATION MAINTENANCE CREWS	



## LIST OF TABLES

Table		Page
3.1	Recommended Minimum Time from Placement to Opening to Traffic (all patches contain CaCl).....	27





## LIST OF FIGURES

Figure		Page
2.1	Effect of Traffic Loadings on the Edge Punchouts/Mile of 7, 8, 9 and 10 in. CRCP.....	4
3.1	Example Strength Gain Curves from Beam Breaks.....	15
3.2	Comparison of Beam Strength With and Without CaCl.....	19
3.3	Effect of Superplasticizer (or Water Cement Ratio) on Beam Strength.....	21
3.4	Modulus of Rupture (PSI) - Center Point vs Time Since Placement (HRS).....	22
4.1	Compressive Strength (6 x 12 in. cylinder) vs Time for Cement-Lime Dust Grout Used in Illinois R-R-R Project.....	31
4.2	Illustration of Deflection Profile for Continuously Reinforced Concrete Pavement.....	34
4.3	Hole Pattern Used on a Cement-Lime Dust Grout CRCP Project in Illinois.....	36
4.4	Measurement Device for Determining Lift of Slab During Pressure Grouting Operation.....	37

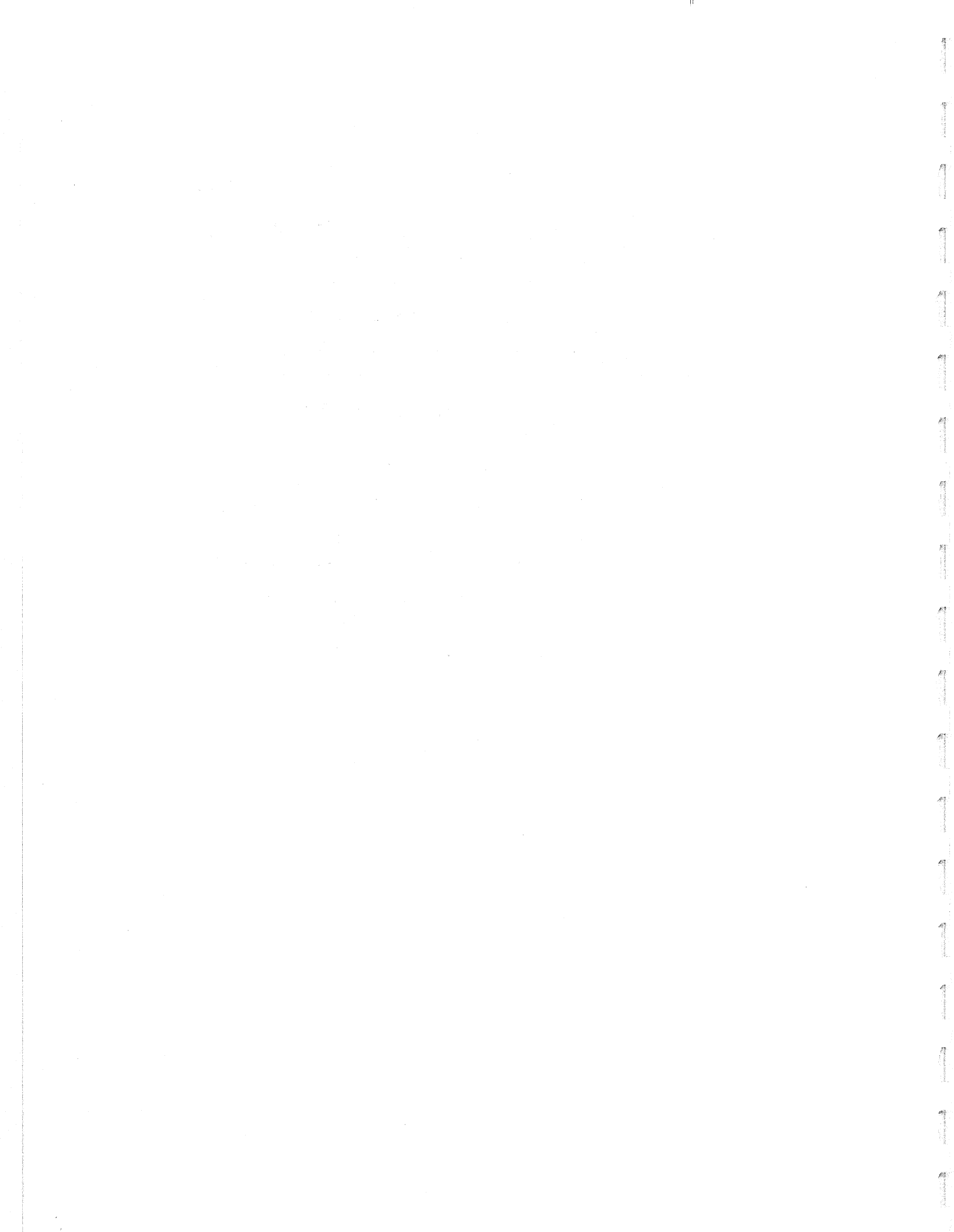

# CHAPTER 1

## INTRODUCTION

A comprehensive study of optimum maintenance procedures and materials for continuously reinforced concrete pavements (CRCP) has been conducted. This included an overall evaluation of the performance of CRCP in Illinois (Ref. 1), an evaluation of current patching procedures (Ref. 3), an evaluation of several maintenance/rehabilitation alternatives (Ref. 6) and the construction and evaluation of many experimental patches.

The result of these studies was the development of recommended permanent patching procedures, and pressure grouting procedures with cement grout to restore slab support and minimize future pumping.

This report presents these procedures and provides background information not provided in previous project reports. The complete detailed patching procedures are given in the Appendix. A slide/script/cassette tape training aid was also prepared for the patching procedures.

This report is presented in the following sequence:

- Chapter 2 - summarizes the performance of CRCP in Illinois.
- Chapter 3 - describes the permanent repair procedures for CRCP.
- Chapter 4 - describes the recommended procedures for pressure grouting CRCP.
- Chapter 5 - presents conclusions and recommendations.
- Appendix - contains the detailed patching procedures.

## CHAPTER 2

### PERFORMANCE OF CRCP IN ILLINOIS

The State of Illinois has constructed over 2700 equivalent 2-lane miles (4320 km) of CRCP. Beginning in 1947-48, a few miles of CRCP were constructed in the Vandalia experimental project, and in 1961-1962 several more miles were constructed on the heavily traveled Dan Ryan Expressway in Chicago. As a result of the good initial performance of the early CRCP in Illinois and other states, an extensive CRCP construction program was initiated in the mid-1960's. A large majority of the Illinois CRCP was built as part of the Interstate highway system which is located on heavy truck routes.

Variations exist in the elements that make up the CRCP structural sections in Illinois. Subgrades for pavements in Illinois are generally composed of fine-grained soils which tend to be quite plastic and practically saturated. Subbases were initially granular, but since 1965 have been stabilized with asphalt, cement, and later with lime and fly ash. The portland cement concrete slabs range in thickness from 7 to 10 inches (18-25 cm). Deformed rebar and deformed welded steel fabric have been used to provide the continuous reinforcement.

An extensive field survey of the Interstate CRCP was conducted in 1977-78 (Ref. 1) to determine the types, causes, and extent of distress. Results showed significant pavement deterioration that was increasing rapidly. Major distress types include the load caused punchout and the materials/climate caused "D" cracking. Other distress includes ruptured steel (wide cracks), pumping of foundation and subbase, longitudinal joint faulting, construction joint failure, blowups, breakup of existing patches

and the surrounding slab, and ramp reflection joint failure (this problem was corrected by a design change in the late 1960's). A detailed analyses of causes is provided in Reference 1, 2 and 3. Far more distress occurred in the thinner slabs (7-8 ins.) than in the thicker slabs (9-10 ins.) as illustrated in Figure 2.1.

Based upon the existing types, causes and extent of distress, it was concluded that a more cost effective permanent repair was needed. It was also believed that a preventative repair was also needed to restore support and minimize future pumping.

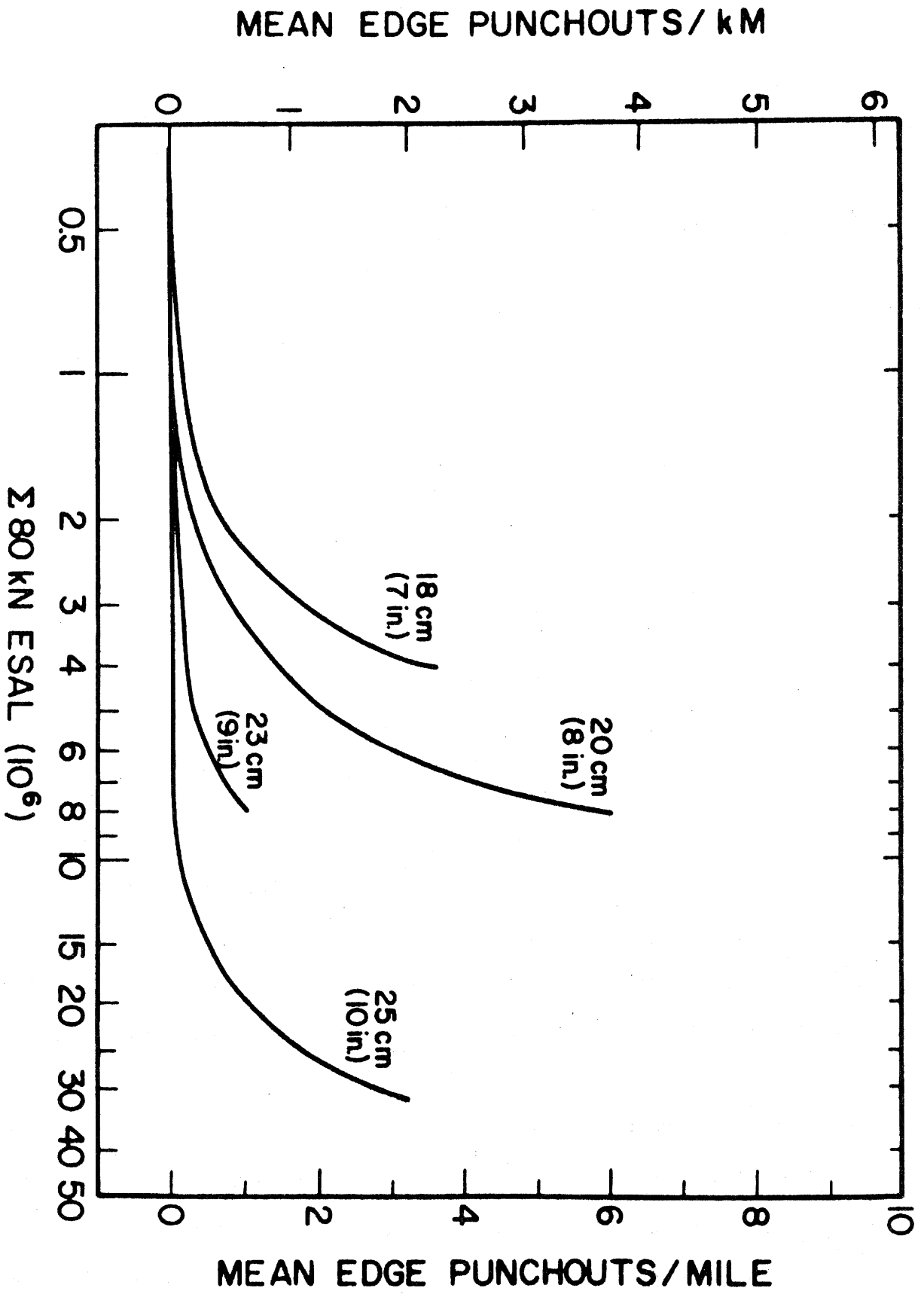

Figure 2.1. Effect of Traffic Loadings on the Edge Punchouts/Mile of 7, 8, 9 and 10 in. CRCP.

CHAPTER 3  
PERMANENT REPAIR OF CRCP

A comprehensive evaluation of existing repair methods in 1977-78 concluded the following (Ref. 3 and 4):

- (1) The existing procedures used by IDOT were technically correct, but there were a number of improvements that would make them more cost effective,
- (2) a wide variation in procedures were actually being performed by state maintenance crews,
- (3) some new patching concepts were suggested that looked promising,
- (4) it was anticipated that in the future a number of large patching contracts would be let to private contractors, and
- (5) many field personnel indicated the need for training in patching CRCP.

A number of improvements were considered for reducing patching costs and lane closure time (Ref. 3). The following were selected and studied in detail in this project:

- (1) Varying the length, width and thickness of the patch depending on the existing distress,
- (2) different methods of construction to account for the varying equipment capabilities of the maintenance crew, and to allow for rapid production oriented patching by contractors.
- (3) Shortening of the length of lap splices and the use of short welded splices, and
- (4) concrete additives and curing for early opening to traffic.

From 1977 to 1980 many experimental patches were placed in the state of Illinois by IDOT Maintenance Crews, Day Labor Crews, and private contractors. Many of these were placed in cooperation with the research staff while others were placed on the initiative of the field engineers and crews.

### 3.1 Variation In Dimensions

Patch dimensions include length, width and thickness. The standard patch consisted of 10 x 12 ft. and equal to CRCP thickness. A field survey of over 60 one-half lane width patches showed that they performed similar to full lane width patches. A number of patches less than 10 ft. long were also observed. Where these patches were placed to repair narrow distress types, they performed similar to larger patches. However, for some narrow patches that did not include the entire underlying deterioration of the foundation, the adjacent CRCP slab had failed. Recommendations for the layout of patches are provided in the Appendix.

One district had placed over 200 extra deep patches that were placed where the subbase and subgrade was poor. Field surveys of these patches revealed excellent performance. Several additional patches were placed in other districts that also performed very well (e.g. no patch breakup at all). Thus where the subbase has disintegrated or disturbed badly during concrete removal, the placement of extra deep concrete provides good performance. The normal steel content is carried through the patch as usual.

### 3.2 Mechanized Equipment & Alternate Concrete Removal Procedures

Field observations of crews using pavement breakers or hydrohammers showed almost twice the productivity as crews without this equipment. Also, crews that were utilizing a loader to lift out the center section rather than breaking it out showed even a higher rate of productivity. For example, one maintenance crew that typically placed one patch per work day using



conventional breakout procedures with jackhammers doubled their production by utilizing the lift out method for the center section (Ref. 5).

During the Manteno experimental project on I-57, the contractor utilized a removal method that resulted in excellent production rates. This method is described in the Appendix as the "Alternate Breakout Method". It is particularly recommended for maintenance crews as it reduces the amount of concrete sawing.

### 3.3 Shortened Lap Splices

The current Illinois Standard Specifications for Road and Bridge Construction requires a 36-inch (91 cm) tied splice for CRCP patches that are 10 feet (3 m) in length or longer. However, in both field and laboratory testing, significantly shorter splices have been successfully used. Patches utilizing splice lengths of 15 to 20 inches (38 to 51 cm) have been used on many patches in Illinois and are performing adequately. These shorter splices save construction time by reducing the length of the end sections which require breakout by hand methods. They also cost less since the overall length of the patch can often be significantly reduced.

The best documented field testing of short length tied splice patches was in the I-57 Manteno project reported in Reference 6. Part of this report covered the construction of experimental patches, including forty 20-inch (51 cm) tied lap splice patches. These patches were closely monitored by on-site personnel, before and after opening to traffic. These patches performed adequately in all stages of evaluation. Additionally, the ensuing cost analysis revealed that the use of these short splice length patches resulted in significant cost savings when compared to standard 36-inch (91 cm) tied lap splice patches. Other patches with lap lengths as short as 15 inches (38 cm) have been studied, and at the time of their survey showed no distress attributable directly to the short splices.

In an attempt to achieve both good performance and optimum savings a final recommendation of an 18-inch (46 cm) end section and a minimum 16-inch (41 cm) tied lap splice (for #5 reinforcement) was reached. Complete details of the patch are given in the Appendix. The 18-inch (46 cm) end section provides adequate length for the existing No. 5 reinforcement to develop its full strength. The end section length will vary for different sizes of reinforcement. The minimum patch length has been set at 4.5 feet (1.4 m). This will allow for two 18-inch (46 cm) end sections and an 18-inch (46 cm) center section.

This patch will save time in construction by significantly shortening the end section breakout area. As previously mentioned, special care must be taken during the end section breakout making it the single most time consuming event of the construction procedure. Also cost savings will be realized due to the decrease in the minimum length of a tied splice patch. When a distress is contained within a short length a minimum length tied splice patch of 4.5 feet (1.4 m) can be used where previously a "standard" 10 foot (3 m) long patch may have been used. Obviously the use of a minimum length patch is restricted to distresses contained in a narrow width of pavement and subgrade .

#### 3.4 Welded Splice

An alternative to the tied splice for steel reinforcement is the welded splice. The current Illinois specification does not allow welding between new and existing reinforcement. However, in both field and laboratory testing welded splice patches have proven to be a viable alternative to tied splice patches.

One district maintenance crew has used the technique of welded splices on hundreds of patches with success comparable to that of tied splice

patches. They make use of a single 6-inch (15 cm) weld to connect each new reinforcement bar to the existing reinforcement at each end of the patch.

The best documented field testing of welded splice patches was also reported in Reference 6. Part of the experimental patching program in this project was the construction of 43 4-inch (10 cm) double weld splice patches. These patches were closely monitored by on-site personnel both before and after opening to traffic. The welded splice patches performed adequately in all stages of evaluation. They also were reported to have contributed to large cost savings over the average costs of "standard" 10 ft. (3 m) patches.

In laboratory tests at the University of Illinois double weld splices with effective lengths greater than 7 in. (18 cm) were able to develop full yield strength and 90% of ultimate strength for Grade 60 reinforcement in static tensile tests. The tests were performed on maintenance crew field welded samples. Double weld splice are defined as two lines of weld, one on each side of the two reinforcing bars.

The recommendation given for welded splices is a 4-inch (10 cm) double weld splice, giving an 8 in. (20 cm) effective weld length. This welded splice should develop the full yield strength and at least 90% of the ultimate strength of the reinforcement. A 16-inch (41 cm) minimum tied splice in the center of the patch is recommended to avoid buckling of the reinforcement during temperature movements of the adjacent pavement before or during concrete placement. Full details of this patch are given in the Appendix.

For maintenance crews possessing welding capabilities the welded splice patch provides the same advantages as the short tied splice patch only to a greater degree. The welded splice will require only an 8-inch (20 cm) end

section breakout area that will more than offset the extra time required for welding. Likewise, the increased cost of labor and equipment for welding will be more than offset by the decrease in the minimum length of a welded splice patch. A welded splice patch will have a minimum length of only 3 ft. (1 m). When a distress is contained in a short length, a 3 ft. (1 m) welded splice patch could be used rather than a "standard" 10 ft. (3 m) patch. If used in the proper situation, for the right distress, the savings could be very significant.

### 3.5 Other Alternatives

Although the majority of the study was aimed at alternative splicing techniques (shorter tied splices and welded splices) other patch design alternatives were studied. These were partial-depth concrete, partial-depth asphalt, full-depth asphalt, and no-steel concrete patches.

Partial-depth concrete patches were considered to be a possible alternative when patching distresses involved the surface concrete, but still left the reinforcement and underlying concrete intact. These surface distresses included poor consolidation or other construction related problems and D-cracking. In theory this alternative appeared to be promising. It would be much less expensive to simply remove the surface distress down to the top of the reinforcement and then fill with concrete than to replace the entire thickness of the pavement with a full depth patch. One district maintenance crew placed a number of partial depth patches in cooperation with the project team on Interstate 74. These partial depth patches were used to repair localized spalling, usually in the wheel paths, caused by "D" cracking. This series of patches did not hold up very well. Many of the patches broke up within 2 to 3 years.

The reason for the poor performance of these patches is probably three fold. First of all the pavement was only a 7 in. (18 cm) thick slab. Therefore most of the patches were only in the range of 2.5 to 3.5 in. (6 to 9 cm) thick. Secondly these thin partial depth patches were placed in "D"-cracked concrete. It is unlikely that the pavement underlying the patches provided adequate support. And finally, many of the patches were placed directly in the wheel path and were quite small, submitting the patches to very high stresses. With this combination of factors it is easy to see why the patches performed poorly.

On the other hand, when partial depth patches were used under different circumstances they proved to be a good choice. On one particular project on I-70 hundreds of partial depth concrete patches were placed in a 9 in. (23 cm) CRCP, suffering from "D"-cracking, prior to resurfacing. In this case the partial depth patches performed well over a one year period before the overlay was placed (and no noticeable problems for two years after the overlay was placed). Therefore, in this instance, the partial depth patch may be a viable alternative due to the thicker slab and the fact that the pavement was resurfaced. The thicker slab allows for thicker partial depth patches and the asphalt overlay would reduce the stresses from traffic. In the right situation the partial depth patches could return uniform support prior to resurfacing for a fraction of the cost of full depth patches.

Many attempts have been made to utilize asphalt as a permanent patch material, either as full depth or partial depth patches. However, after much field testing it is concluded that full depth asphalt patches should only be used on a temporary basis until a permanent concrete patch can be constructed. Observed life for asphalt patches is 1-2 years and much failure occurs in the surrounding CRCP because of no load transfer.

Partial depth asphalt patches have been surveyed in which the reinforcement simply buckled upward during hot weather forcing its way through the asphalt and causing a blowup. Partial depth asphalt patches are not recommended under any circumstances.

Reference 6 reported that full depth asphalt patches placed prior to resurfacing were unable to provide adequate support for the asphalt overlay. The final result was spalled reflective cracking through the overlay at the asphalt patch boundaries. Due to its poor support properties full depth asphalt patches, as stated earlier, are recommended for temporary patching only. Since they provide no shear transfer and break the continuity of the CRCP their use on a permanent basis may result in distress to the adjacent pavement.

The no-steel concrete patch has also been considered as a possible patching alternative. Like the full depth asphalt patch, the no-steel patch does not return continuity to the pavement. The no-steel concrete patch is only recommended when being placed in badly "D"-cracked sections where the expected life of the pavement surrounding the proposed patch is short. There have been a number of patches placed under these circumstances with satisfactory results.

### 3.6 Opening to Traffic

Current practices employed by maintenance crews patching CRCP include opening lanes containing recently placed concrete patches to traffic anywhere between 3 and 72 hours. The result of this inconsistent approach to the application of large repeated loadings is quite surprising. Many patches that were allowed to cure for only three hours performed very well under traffic loadings. On the other hand, there have been several failures of patches that were opened to traffic very early. Since the overall cost of a patch increases as the curing time increases and because of the inconvenience and hazard to motorists during the lane closure, the determination of a safe but yet earliest possible opening time was desirable. Consequently, an extensive field and laboratory study was conducted to determine the optimum length of time between placing a patch and the subsequent opening of the patch to traffic.

The optimum length of time between placing a patch and the subsequent opening of the patch to traffic is hereby defined as the "minimum required curing time" needed for the concrete in the patch to attain a strength which will enable it to resist normal traffic loads. The approach that was taken to determine this strength involved the casting of field concrete beams corresponding to many experimental patches, and laboratory determination of the influence of various factors on the early development of concrete strength.

Concrete beams were cast in the field using standard 6 x 6 x 30 inch steel boxes from a nearby patch as it was being placed. From one to five beams were cast from a given patch. Each beam would then be tested for flexural strength by means of a portable center point loading machine. The 16 inch span between the supports provided for two tests for each 30 in.

beam. By varying the times that each beam was tested, a strength development curve was constructed for each patch. Figure 3.1 shows some example curves for beams cast at different temperatures. By use of this curve, the strength of the concrete at the time of opening was determined for the corresponding patch (actually the strength of the patch was higher as subsequently discussed). Observation of the patch over time would indicate whether the opening strength was sufficient to resist the traffic loads. It was determined that the contraction of the reinforcing steel the first night after placement of a patch will in some cases induce small tension cracks in the concrete. Therefore, a majority of the 74 beams that were cast corresponded to patches not containing reinforcement (which is not the proper CRCP patching method), and nearly all were less than 20 ft. in length.

Several tests were performed in the laboratory in an attempt to discover ways of significantly increasing the early strength development of concrete. Addition of superplasticizers and variation of the cement factor were the two main factors investigated in addition to temperature at placement.

#### Field Testing Procedure

Seventy-four beams were cast at various maintenance projects on two Interstate highways. Observations of the corresponding patches have been recorded over about twelve months. Thirty-eight of the beams were taken from an October 1979 project on Interstates 57 and 74 just west of Champaign, Illinois. Sixty-nine patches without reinforcement were placed. The beams were cast and cured in the field at the side of the highway in the beam boxes and were tested for flexural strength at times ranging from two hours to 28 days. In addition to the daily variations of temperature, wind and sunshine, several experiments were conducted to vary specific strength dependent factors.

One of the experiments was aimed at determining the field effects of using calcium chloride. One patch was placed in the usual manner with



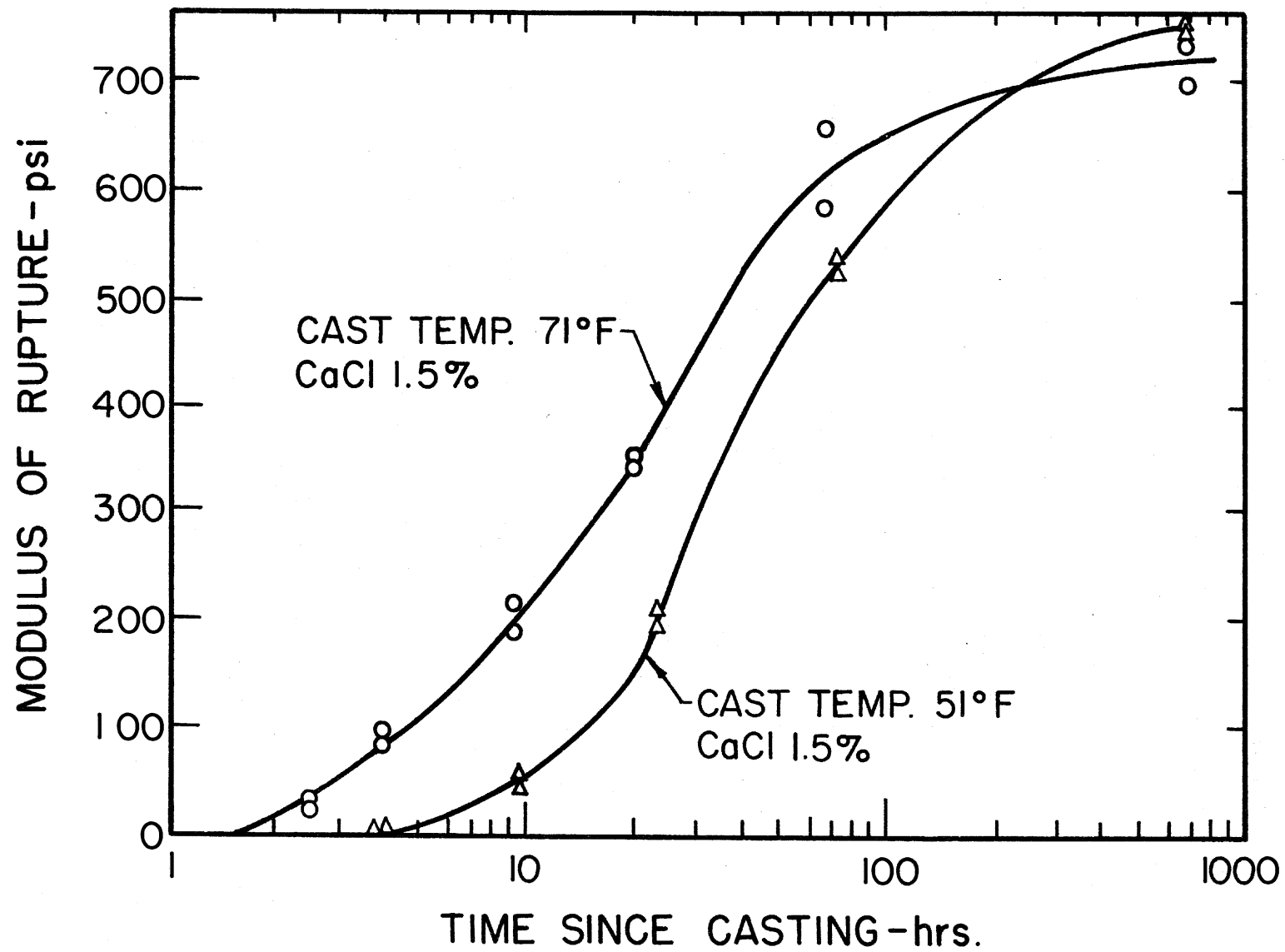

Figure 3.1. Example Strength Gain Curves from Beam Breaks.

concrete that had 1.5% of calcium chloride by weight of cement. A second patch was placed with concrete that did not have calcium chloride. Five beams were taken from each patch.

Another experiment was aimed at observing the effect of using a superplasticizer. One patch was placed in the usual manner which included the use of an air-entraining admixture and the addition of calcium chloride. Another patch was placed with the same mix of concrete except that the water-cement ratio was lowered to produce a lower slump. A sufficient amount of Mighty 150, a superplasticizer, was added at the site to increase the slump to 7 inches which was the slump of the concrete placed in the first patch. Once again five beams were taken from each patch.

A final test was aimed at determining the variations of temperature between the concrete in a patch with insulation, a patch without insulation, the concrete in the beam boxes, and ambient temperature. Thermocouples were placed at the top, center and bottom of the patches and at the center of the beam. One of the patches was covered with a tarp and another with high quality insulation while a third patch and the beam were left exposed as is the usual procedure. Another thermocouple measured the ambient temperature.

The remainder of the beams were taken at various temperatures in an attempt to determine the effects of ambient temperature on the strength development of concrete. The patches varied from 6-12 feet wide, from 3-20 feet long and from 7-11 inches thick. Patches were placed in both the truck and passing lanes.

#### Laboratory Testing Procedures

Two test series were conducted in the laboratory. The first series was to determine the effects of a superplasticizer at various temperatures.

Thirty-six 6 x 12 inch cylinders were cast, twelve cylinders at each of three temperatures. Six of the twelve at each temperature were cast using Mighty 150 and six were cast without the superplasticizer. All of the cylinders had an air entraining admixture and calcium chloride added to the seven bag mix concrete. The concrete for the cylinders without Mighty was designed for a slump of 7 inches and an air content of 4-7%. The concrete for the cylinders with Mighty was designed for a slump of 1 inch and an air content of 4-7%. An additional amount of air-entraining admixture was needed to maintain the desired air content for the mixes with Mighty. Sufficient amounts of Mighty was added to bring the slump to 7 inches. Six cylinders with Mighty and six cylinders without Mighty were cured at 35° F, 75° F and 95° F. The mixing water was brought to the corresponding temperature but all the aggregate was at a uniform temperature of 75° F. Three cylinders from each of the three different temperatures were tested for indirect tensile strength at 3, 6 and 24 hours. It should be noted that the air-entraining admixture, calcium chloride and Mighty were added and thoroughly mixed into the concrete separately in the order listed. In this manner the admixtures did not have direct contact with each other and no unfavorable reactions occurred.

The second laboratory test was designed to observe the effects of the cement factor on early strength development in addition to the effects of Mighty 150 at the different cement factors. A total of fifty-four 6 x 12 inch cylinders were cast. Eighteen cylinders were cast for each of three cement factors and half of the cylinders for each cement factor had Mighty 150 added to increase the slump. The final slump for all cylinders was three inches and the final air content was 4-7% with the addition of an air entraining admixture. Once again, additional air entraining admixture was

needed for the concrete with Mighty 150. Calcium chloride was not used in this test series. Three cylinders from the seven, eight and nine bag mixes, both with and without Mighty, were tested at three different curing times, and the strength development curves were constructed.

### Discussion of Results

The results of the seventy-four beam tests were run through a regression analysis to determine the significance of each factor on the development of concrete strength at any given time. The variables used in the regression were as follows: temperature at placement, wind, sunshine, time of day, slump (indication of w/c ratio), calcium chloride content and consolidation techniques. The results of the regression analysis showed that the temperature at placement was the overwhelmingly largest factor in the development of the concrete strength. The time of day of placement was the only other factor which proved to be of more than minor significance in the development of the concrete strength. The time of day is significant because a patch placed in the morning will be subjected to increasing ambient temperatures for the remainder of the morning and the afternoon whereas a patch placed late in the afternoon will be subjected to decreasing ambient temperatures. Consequently, the most significant factor by far in the normal strength development of concrete placed in the field is the ambient temperature at placement.

The results of the regression analysis are substantiated by other experiments that were conducted in the field and in the lab. The results of the experiment of placing a patch with calcium chloride and comparing it with a patch without calcium chloride showed no significant difference between strengths as illustrated in Figure 3.2. It appears that even though there is substantial amounts of laboratory data which indicates that calcium chloride significantly

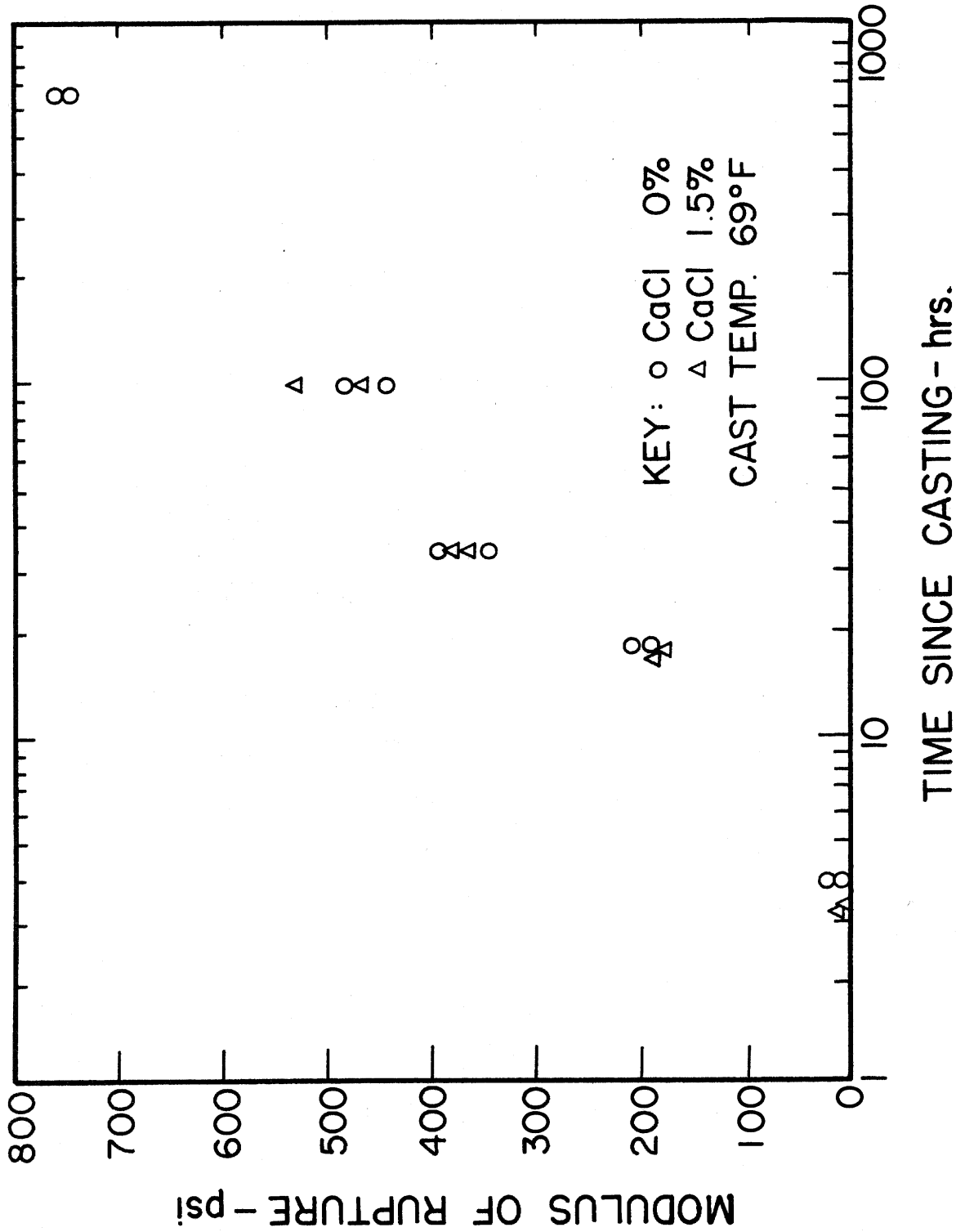

Figure 3.2. Comparison of Beam Strength With and Without CaCl.

increases early concrete strength, when the calcium chloride is added in the field the water-cement ratio is inadvertently increased so as to offset the early strength gain caused by the admixture. It is also interesting to speculate concerning the failure mechanisms. Failure in compression is governed primarily by the strength of the cement paste, while in flexure it is governed mainly by the paste-aggregate bond strength (1). If calcium chloride increases the early strength of only the cement paste, then we would expect an insignificant increase in the early flexural strength. Nevertheless, because calcium chloride decreases the set time, it remains a valuable time saver.

The variation of flexural strength with water-cement ratio had some effect on early strength. It was found that in actual patching operations the water-cement ratio varied between 0.41 and 0.55 depending on the amount of water added at the site by the maintenance crew. The beam data shows that this resulted in a range of flexural strengths at 24 hours from 120 psi to 190 psi which is a maximum difference of 70 psi. Inspection of the beam data at various temperatures shows that a variation in flexural strength of 70 psi can result from a 6° F increase in temperature. Consequently, it is easy to see that the temperature at placement of a patch is the single most important factor in predicting the flexural strength of concrete at early ages. Figure 3.3 shows a comparison of beam strengths with and without superplasticizer and the corresponding difference in w/c ratio.

A plot of center point flexural strength vs time was constructed using the range of temperatures obtained in the field. All beam tests were considered and a variety of graphs developed to arrive at the final relationships. The temperature at placement of the patch (and casting of the beam) was utilized as the temperature value. Figure 3.4 shows the final graph

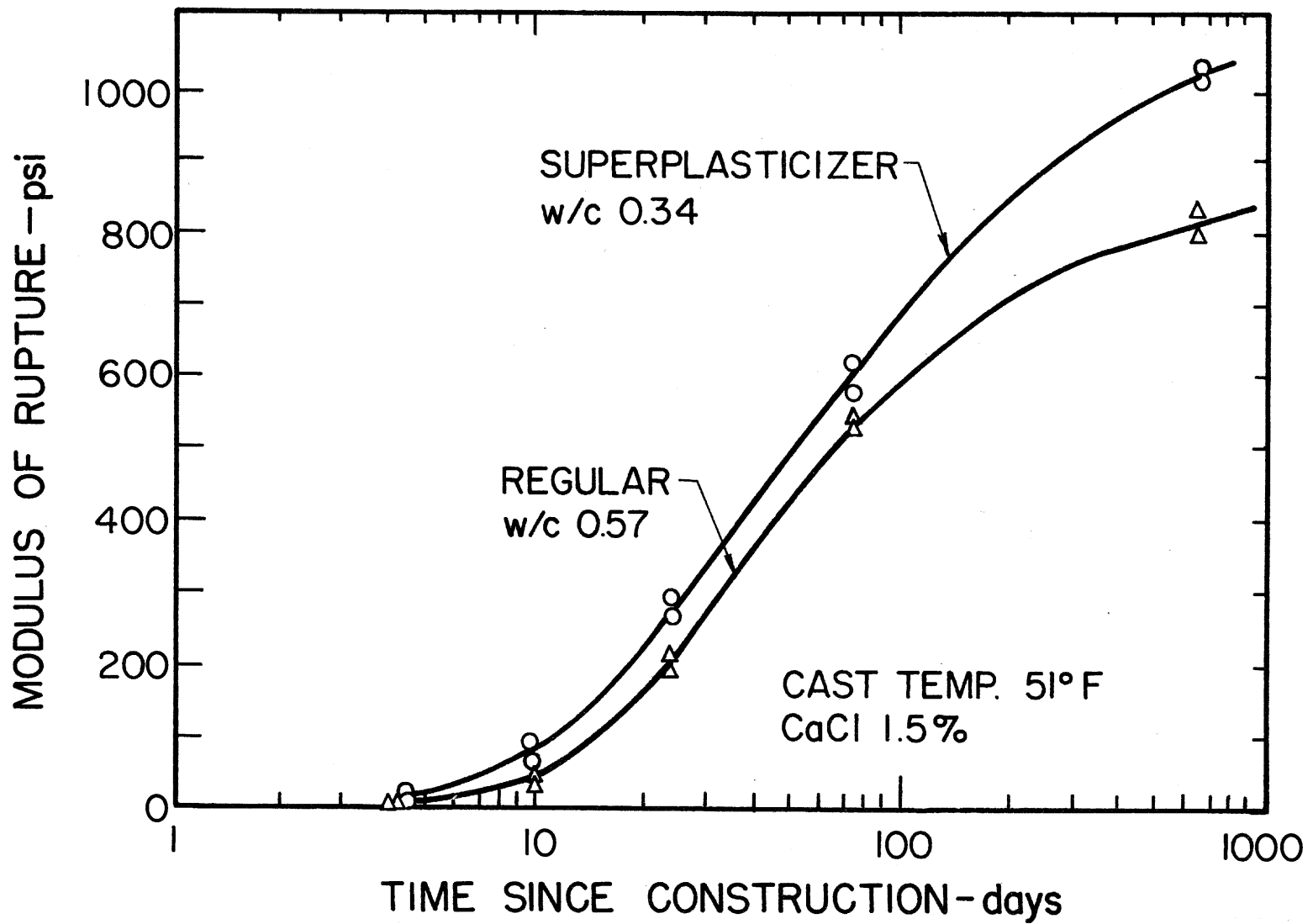

Figure 3.3. Effect of Superplasticizer (or Water Cement Ratio) on Beam Strength.

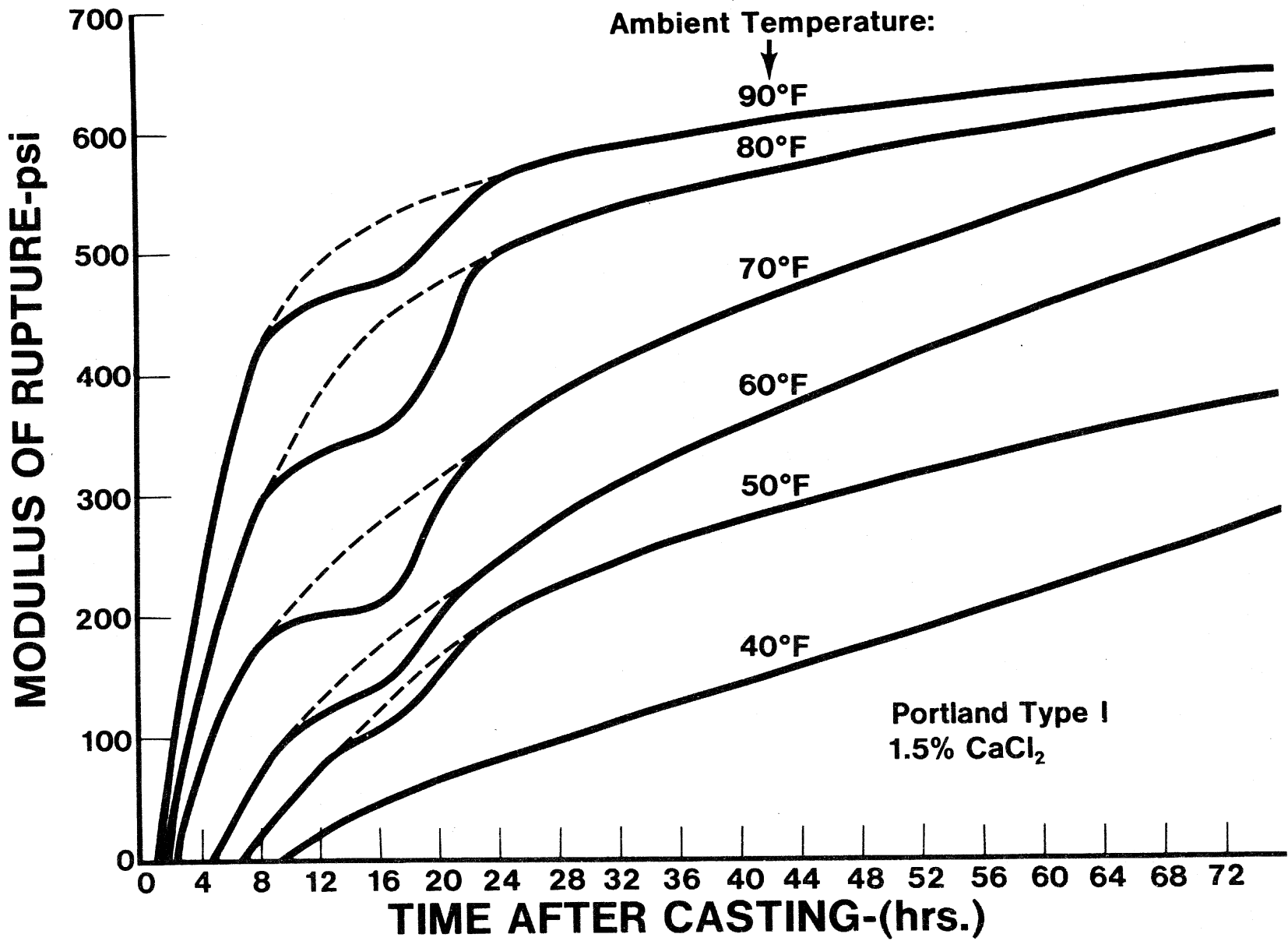

Figure 3.4. Modulus of Rupture (PSI) - Center Point vs Time Since Placement (HRS).



developed from all the data. The modulus of rupture for third point loading was determined by multiplying the center point modulus by 0.84 as determined from PCA results (Ref. 7).

The next task was to determine the strength at which the patches were successfully resisting traffic loadings. An examination of all of the 7 inch thick no steel patches revealed that when they were opened to traffic at a corresponding beam strength of 270 psi or greater, cracking of the concrete did not occur over a 12 month period. Several 7 inch no-steel patches opened to traffic with strengths less than 200 psi cracked within 6 months, apparently from fatigue damage. Several 7 inch thick patches with steel were opened with beam strengths as low as 100 psi and although they cracked, the cracks remained tight and the patches were in good shape after 9 months.

This result must be considered along with results observed on other projects where a very early opening led to cracking and a rapid deterioration of the crack. When concrete cracks early the crack is normally within the mortar and not through the large aggregate. If it is then subjected to heavy loadings the aggregate interlock easily breaks down and the crack spalls even though the steel is still intact. Finally, eight 10 inch thick patches without steel were opened to traffic with beam strengths of about 175 psi and after 6 months (winter and spring), none of them had cracked. Based on these observations it was concluded that a beam center point modulus of rupture of 300 psi or more would provide sufficient strength to resist traffic loadings for patches with thicknesses of 7 inch or more. It is emphasized that this is 300 psi modulus of rupture (center point loading) in a beam cast under the same conditions as that of the patch. The actual strength of the concrete in the patch is much higher because of the higher temperature in the patch due to the heat of hydration. The concrete temperature in the beam was determined to be almost identical to the ambient temperature. It is for this reason that there is a dip in the curves of Figure 3.4

around 16 hours, as the ambient temperature dropped the first night after placement, the strength gains slowed. On the other hand, the temperature at the center of the patch increased to at least 17° F more than that of the beam and thus the patch concrete is much stronger than the corresponding beam.

Using a beam strength of 300 psi, the optimum length of time between placing a patch and the subsequent opening of the patch to traffic (hereafter referred to as "opening time") when the ambient temperature is 50° F at casting would be approximately 54 hours. Because of the problems stated earlier concerning such long opening times, methods of increasing the early strength development were investigated.

Field testing results showed that a patch covered with a tarp had as much as 11° F higher temperature at its center over ambient temperature. A high quality insulation placed over the patch resulted in an increase of 30° F at the center of the patch by the age of 4 hours over ambient temperature. This difference is maintained over several hours. This added temperature in the patch would greatly increase the strength and decrease the opening time.

Results from the laboratory experiment aimed at determining the affect of increased cement factor showed that at 24 hours an increase from a 7 bag mix to a 9 bag mix increases the modulus of rupture by less than 75 psi. The results of a similar test performed by the Illinois DOT in 1976 showed that the increase in modulus of rupture at 24 hours is 100 psi when the cement factor increases from 5.6 to 7.5. Due to the relatively small increases of strength and the fact that the cost per patch and the shrinkage of the concrete increase significantly as the cement factor increases, increasing the cement content above the standard seven bag mix is not recommended.

The use of superplasticizer (Mighty 150) (which resulted in a reduction in the w/c ratio) increased the modulus of rupture at 24 hours 150 psi, 165 psi and 200 psi for the 7, 8, and 9 bag mixes

respectively. Likewise, the IDOT data shows that the use of Mighty 150 increased the modulus of rupture at 24 hours 110 psi for the 5.6 bag mix and 160 psi for the 7.5 bag mix at 75° F. As was previously mentioned, another experiment was conducted which investigated the effects of using Mighty 150 at various temperatures. The results indicate that at 24 hours the use of Mighty increased the modulus of rupture by 115 psi at 75° F and by 185 psi at 95° F, while there is no apparent increase at 35° F. The notion that the use of Mighty 150 detrimentally affects the concrete strength development at 35° F is questioned by an experiment with Mighty performed in the field as was previously described. The field results indicated an increase of strength at 24 hours of 70 psi where the average temperature was 40° F. It appears that the beneficial effects of Mighty decrease somewhat with the temperature. Consequently, it would appear that an increase in the flexural strength of 75 psi at an age of 24 hours for all temperatures would be a viable assumption when Mighty 150 was used. According to the literature from the leading manufacturers of superplasticizers it would appear that the conclusions arrived at with experiments with Mighty 150 are applicable to other brand name superplasticizers. This thought is substantiated by a field experiment performed by Illinois DOT District 3 maintenance crew using WRDA 19, a superplasticizer. Increases of over 200 psi at 48 hours were realized at a temperature of 50° F.

#### Summary of Results

1. A patch can be opened to traffic when the corresponding beam center point modulus of rupture reaches 300 psi. The amount of time to reach this strength is primarily dependent on the ambient temperature at placement and can be determined from Figure 3.4.
2. Increasing the cement factor above the standard 7 bag mix is not considered to be cost and performance effective.

3. The use of high quality insulators to cover a patch can increase the temperature of the patch by 20° F or more at 24 hours.
4. The use of superplasticizers can add at least 75 psi to the flexural strength of concrete at 24 hours. (This increase is due to a lower water cement ratio.)

### Conclusions

In order for the safe opening time of a patch to be readily and easily determined, Table 3.1 was constructed for field usage. These opening times are based on the successful performance of several no steel, 7 inch thick, 7 bag mix patches. The normal variations in water-cement ratio, calcium chloride content, etc. will not jeopardize the successes of these recommendations. Additionally, the presence of steel or an increased slab thickness only increases the factor of safety. Also, a reasonable support condition is assumed (not a wet saturated condition).

The second column of opening times is based on 75 psi additional modulus of rupture at 24 hours from using a superplasticizer. For a given temperature, 75 psi is added at 24 hours and is proportionally decreased at times less than 24 hours. It is assumed that 75 psi is the maximum increase of strength due to a superplasticizer after 24 hours. The increase of 75 psi appears to be the minimum that nearly always will be obtained.

The third column of opening times is based on an increase of 20° F at 24 hours due to the insulation of the patch. This column is calculated by simply adding 20° F to the lowest temperature in any interval and then calculating the opening time. The fact that insulation has been recommended at ambient temperatures up to 90° F has brought up the question of increased shrinkage problems. The Nebraska DOT has been insulating non-steel patches at 90° F for over three years without adverse shrinkage cracking problems. Consequently, it has been concluded that any increased shrinkage does not

Table 3.1. Recommended Minimum Time from Placement to Opening to Traffic (all patches contain CaCl).

Ambient Temperature @ Placement (°F)	MINIMUM NUMBER OF HOURS TO OPENING			
	Regular Patch(1)	Regular Patch With Super Plasticizer(2)	Regular Patch With Insulation(3)	Regular Patch With Super Plasticizer and Insulation(4)
40-42	54	35	26	22
43-45	49	33	23	20
46-48	44	31	21	18
49-51	39	29	19	16
52-54	35	27	16	13
55-57	32	25	14	11
58-60	29	23	11	8
61-63	26	21	9	7
64-66	23	19	9	6
67-69	21	17	8	5
70-72	18	15	7	5
73-75	15	13	6	5
76-78	13	10	5	5
79-81	10	8	5	5
82-84	9	7	5	5
85-87	8	6	5	5
88-90	7	5	5	5
91-93	6	5	5*	5*
Above 93	5	5	5*	5*

\* Do not place insulation when ambient temperature is greater than 90° F.

- (1) See Sections VIII A, B, D in Appendix A.
- (2) See Sections VIII A, B, C, D in Appendix A.
- (3) See Sections VIII A, B, D, X C in Appendix A.
- (4) See Sections VIII A, B, C, D, X C in Appendix A.

seriously reduce the integrity of the patch. This topic needs additional study however.

Finally, the fourth column of Table 3.1 is a simple superposition of techniques used in determining columns 2 and 3.

Table 3.1 can be easily used by maintenance personnel to determine the minimum opening time for concrete patches. This table should be considered as approximate only and will likely be modified with usage. Actually, it has been found that patches can be opened at less than 5 hours under warm temperatures, but 5 hours has been used as the minimum for these recommendations to provide some factor of safety.

## CHAPTER 4

### PRESSURE GROUTING OF CRCP

The loss of support from beneath the CRCP slab has long been recognized as a major factor that accelerates the development of punchouts. The pressure grouting of the slab is recommended as a preventative repair that is a cost effective way of extending pavement life. If significant pumping has occurred and slab support is not re-established, the pavement may continue to show rapid deterioration in the future, particularly in heavily trafficked pavements even if an overlay has been placed.

The term "pressure grouting" is defined as the insertion by pressure of a cement grout mixture beneath the slab and/or subbase to both fill voids and to provide a thin layer that should reduce deflections and resist future pumping action. The purpose of pressure grouting is to stabilize the slab by filling the existing voids with grout, and not to raise the slab. The term "slab jacking" refers to the lifting of the slab at a depression to its original smooth profile. This is also a viable repair method but it is not discussed herein.

The cement grout pressure grouting of CRCP has become a highly specialized operation with specially trained personnel and specifically designed equipment. Grout mixtures, equipment, and construction procedures for pressure grouting are presented. Further details can be found in References 9-19. Pressure grouting was used successfully on the 1978 Manteno I-57 rehabilitation project as described in Reference 6.

#### 4.1 Materials

A variety of grout mixtures have been used for pressure grouting. The materials that make up the grout greatly affects the consistency, strength,

and durability of the mix. The most important requirement is that the grout is very flowable to fill very small voids beneath the slab and sub-base. The grout must also displace free water while ultimately hardening into a structurally strong and non-erodible substance.

The following grout mixes are recommended:

- (a) Cement - Limestone dust slurry
- (b) Cement - Pozzolan (natural or artificial) slurry

Both grouts have been used successfully, but the Pozzolan grout has better flowability due to its fineness and spherical shape.

The grouts normally consist of the following:

- 1 part (by volume) Portland Cement Type I, II or III.
- 3 parts (by volume) Pozzolan or limestone dust
- Water to achieve required fluidity.

Pozzolan includes natural (volcanic ash, diatomaceous earth) and artificial (fly ash) pozzolans. The pozzolan materials should meet the requirements under ASTM C-618. The limestone dust should meet the requirements of AASHTO M-17 for mineral fillers.

Various additives may be used to achieve increased strength and density. These include water reducing agents, fluidifiers, superplasticizers, calcium chloride to accelerate set, etc.

The grout should be the consistency of thick soup. Its consistency can be specified using the flow cone method (Corps of Engineers CRD-C 611-80 with 1/2 in. inside diameter orifice). The time of efflux should be in the range of 10 to 22 seconds. A plot of compressive strength vs time for the grout used on the Manteno project is shown in Figure 4.1.

#### 4.2 Equipment

The following equipment is used during pressure grouting operations:

- (a) Air compressors to drive pneumatic hammers.



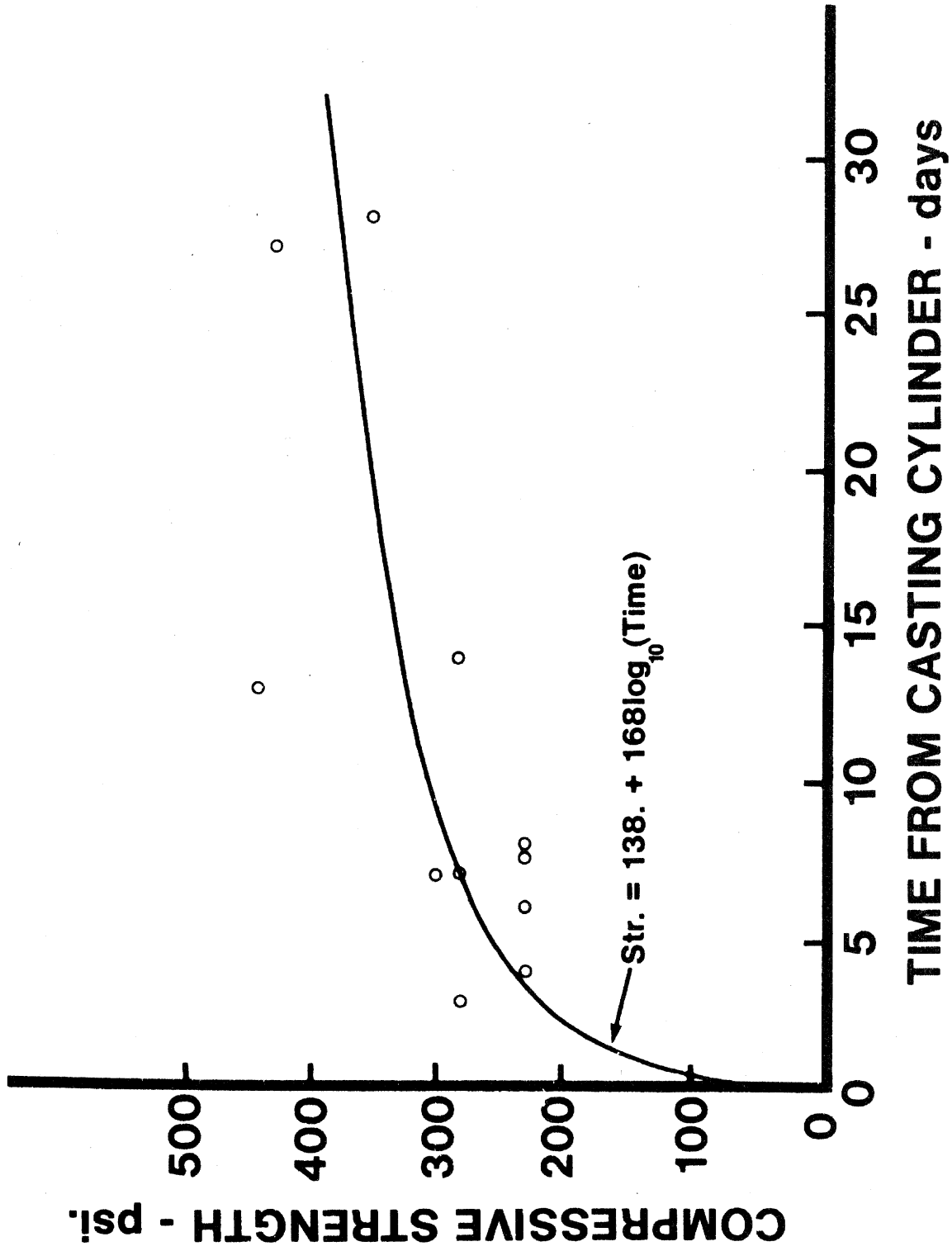

Figure 4.1. Compressive Strength (6 x 12 in. cylinder) vs Time for Cement-Lime Dust Grout Used in Illinois R-R-R Project.

- (b) Pneumatic hammers equipped with drills or other drills that will cut 1-1/2 - 2-1/2 inch (38-64 mm) holes through the concrete slab and steel reinforcement.
- (c) A grout plant that is capable of accurately measuring and proportioning by volume or weight, and mixing the various materials composing the grout. The plant must also contain a positive displacement cement injection pump capable of applying at least 50-250 psi (344-1720 KPa) at the end of the discharge pipe (depending on the application).  
For cement pozzolan mixes it is necessary to use a high speed colloidal mixer operating in a range of 800 to 2000 RPM.
- (d) Cylindrical wooden plugs or other approved plugs that can effectively plug holes until the grout has set.
- (e) Grout packers that can be inserted into the drilled hole and then seal the hole while the grout is being pumped.

#### 4.3 Pressure Grouting Procedures

Although cement grout pressure grouting has been performed for many years (commonly called "mud-jacking"); the past few years has seen a great increase in large project work. There is relatively very little current published information available, and only a few experienced contractors and maintenance crews. Cement grout pressure grouting is very much an art, and its success depends highly upon the experience of the contractor. Thus, there should be an experience clause requiring prior work.

Pressure grouting can be performed in "blanket" coverage over the entire project, or it can be performed only in "localized" areas where pumping and loss of support is more severe.

Pumping can occur anywhere in CRCP but more usually in slight sags or depressions, existing patches, and various load associated distress. It is recommended that pressure grouting be performed in localized areas of high deflection or where pumping can be observed. Of course, if there is visual proof of extensive pumping along the entire project, then most of the project should be considered for blanket pressure grouting.

Pressure grouting should be performed at all existing permanent patches showing any evidence of pumping or settlement. This will extend the life of the patch and the original slab surrounding the patch.

Deflections and visual pumping are the primary criteria that have been used to locate voids beneath slabs. Studies performed in Illinois on CRCP concluded that peak deflections along a profile measured every 5-10 ft. (1.5-3 m) and obviously greater than the general mean should be selected for pressure grouting as illustrated in Figure 4.2.

It is recommended that a heavy load deflection device (having loads approaching that of truck wheel loads) be used for void deflection on concrete pavements such as the Benkleman beam or heavy IDOT Road Rater. This allows a realistic evaluation of foundation support. Some voids may be located below the subbase which can be located with heavy load deflections.

After the specific areas of pressure grouting have been located the actual grouting can begin. Because a large majority of trucks travel in the outer lane, most of the pumping and voids occur in the outer lane. Thus, in this case it is probably cost effective to pressure grout only the outer lane. There certainly are exceptions to this however. The first step is selection of the hole pattern and depth. These will vary depending on type and design of concrete pavement.

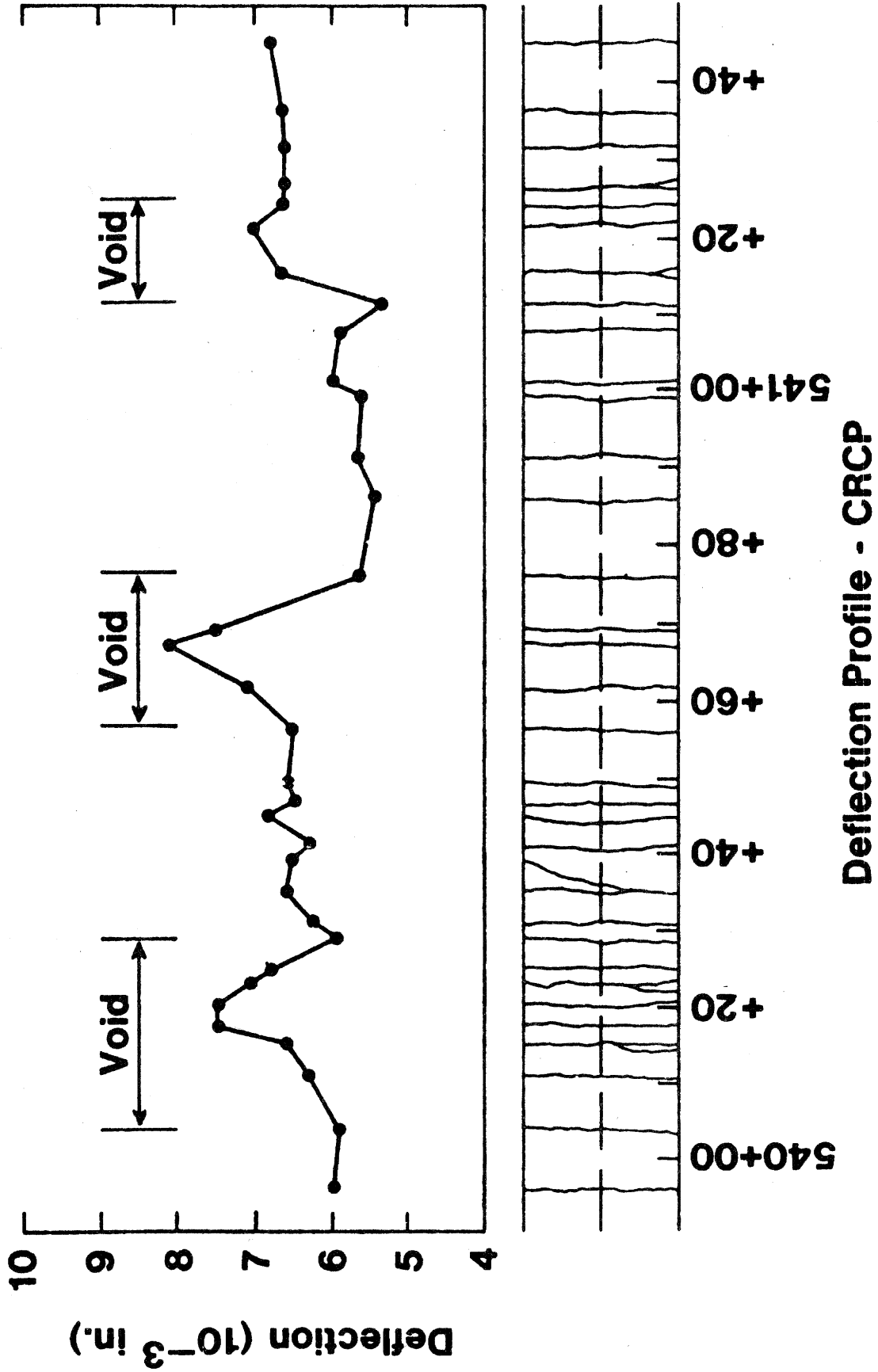

Figure 4.2. Illustration of Deflection Profile for Continuously Reinforced Concrete Pavement.

The hole pattern should vary depending on the results during the job. A typical hole spacing used on a project in Illinois is shown in Figure 4.3. This hole spacing appeared to give good coverage, but better coverage may have been obtained if the longitudinal spacing of the holes were more closely spaced (e.g. 10 ft. (3 m) instead of 14 ft. (4.3 m)). Also, the grouting of the passing lane is not believed necessary in most cases.

The depth to which the grouting hole should be drilled should be at least to the bottom of the concrete slab. If however, the subbase is stabilized, the hole is most often drilled on through the subbase. Voids often exist beneath the stabilized subbase and it is important that these also be filled.

After the holes are drilled, an expanding rubber packer connected to the discharge hose on the pressure grout pump is lowered into the holes. The discharge end of the packer is not extended below the lower surface of the concrete slab.

The actual process of pumping grout varies greatly. Close inspection is required during the pressure grouting process. The purpose is to stabilize the slab by filling existing voids with grout and not to raise the slab above grade. (Small sags may be taken out if desired.)

The project specifications should allow the slab to be lifted no more than 1/8 in. (3.2 mm), therefore a device to monitor lift is a necessity. A modified Benkelman Beam type device can be used which indicates total movement of the slab. One device used to control the amount of pumping that is done in each hole is shown in Figure 4.4. Other factors that are used to determine when to cease pumping are the appearance of grout in adjacent holes, edge joint or cracks and the ejection of grout from under the slab. Another

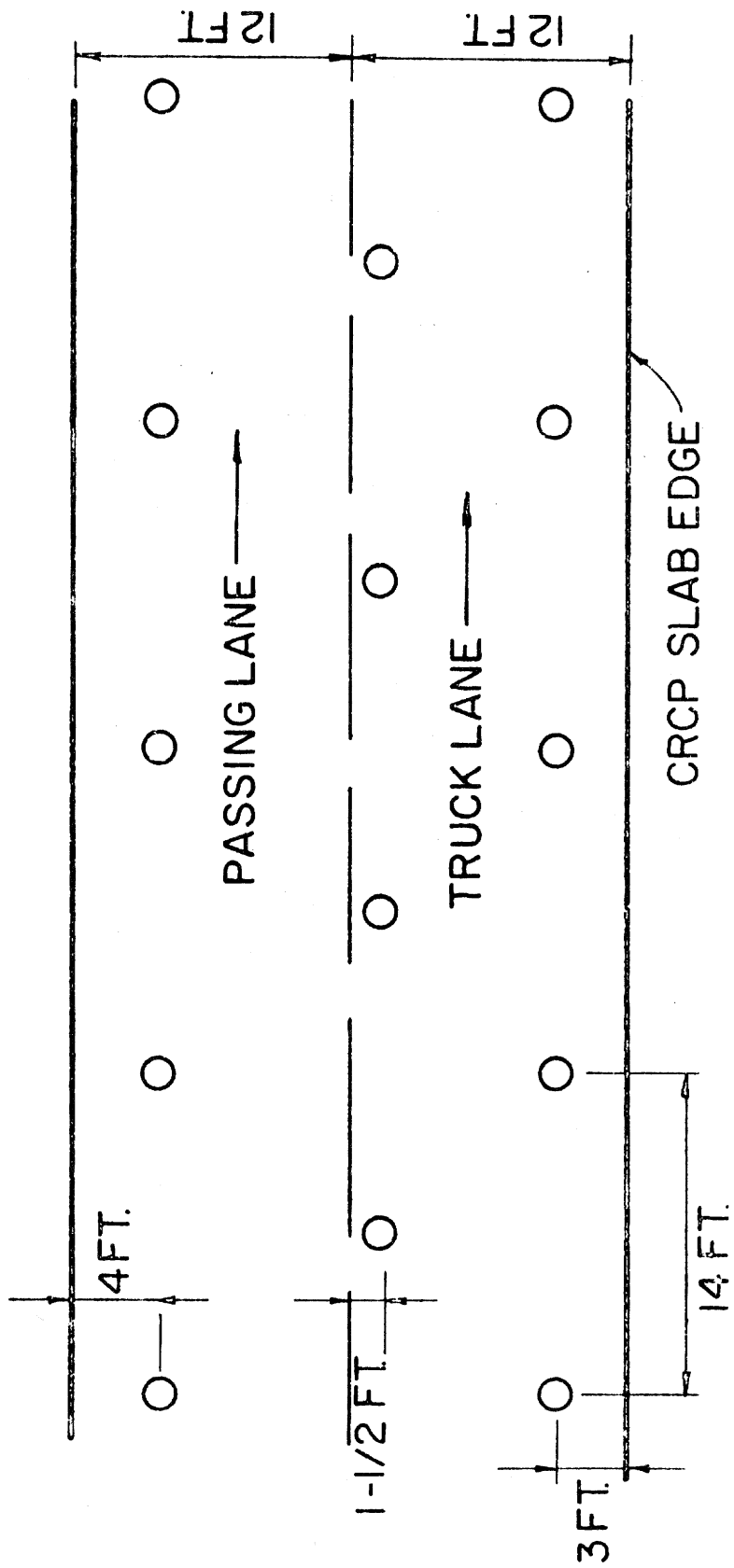

Figure 4.3. Hole Pattern Used on a Cement-Lime Dust Grout CRCP Project in Illinois.

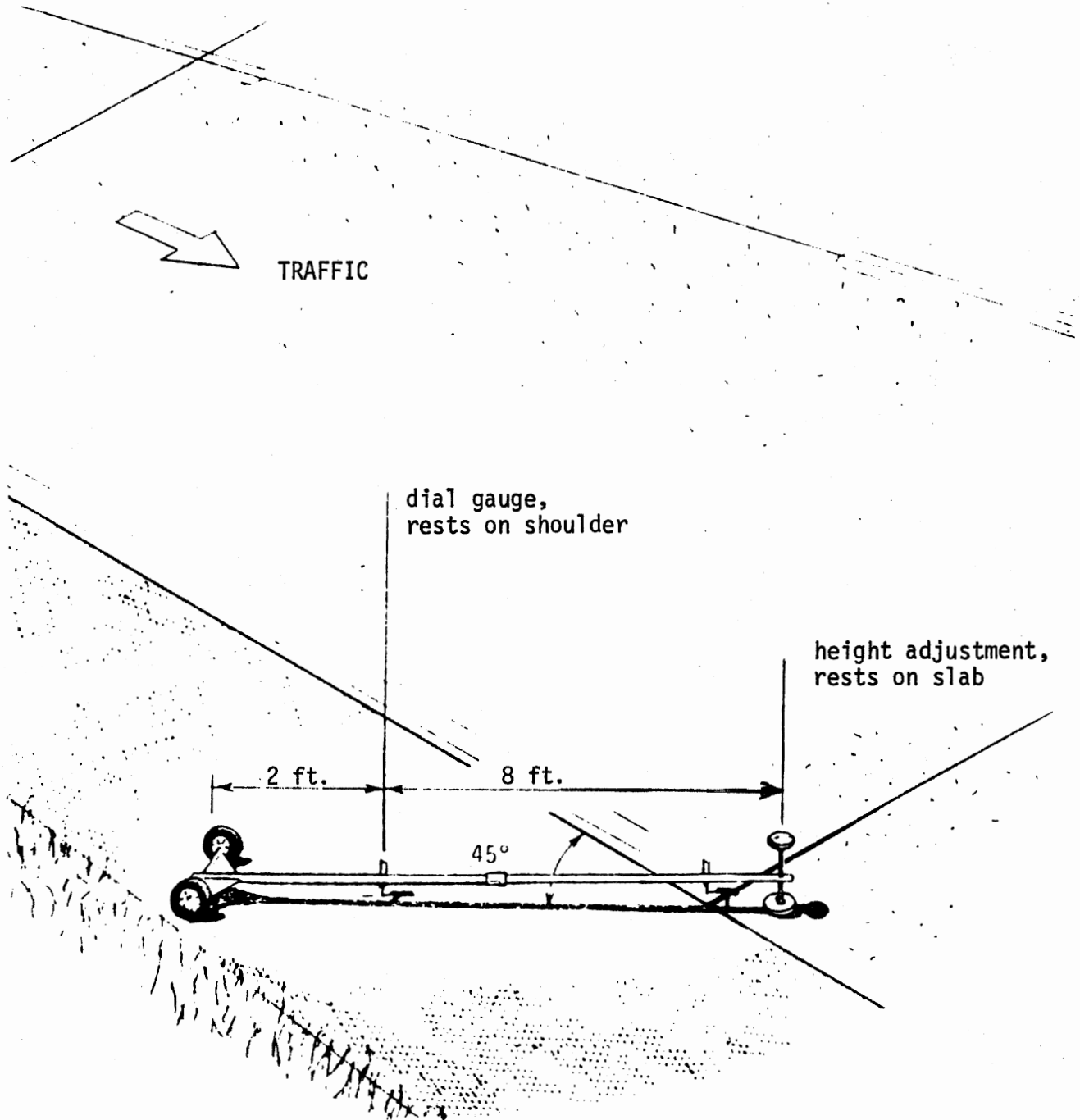

Figure 4.4. Measurement Device for Determining Lift of Slab During Pressure Grouting Operation.

indication that grouting should cease is the pumping time on a hole. When no evidence of grout appears in joints or a hole and no lift is being recorded on the gauge after a reasonable amount of time (e.g. 1 min.) grouting should cease. This is especially true when pumping grout next to an adjacent lane.

Normally, indication that the slab is beginning to rise or the flowing of grout out of an adjacent hole or joint or the edge of the slab is sufficient evidence that all cavities or voids are filled within the range of the hole being grouted, and pumping in such a hole should cease. During pumping, very close attention should be given to prevent any rising other than that necessary to indicate that the slab is or is about to begin rising .

After grouting has been completed in any one hole, the packer is withdrawn from that hole and the hole plugged immediately. Temporary plugs that protrude above the top of the slab should be removed when sufficient time has elapsed to permit the grout to set sufficiently so that back pressure will not force it through the hole, and space occupied by the plug filled with a reasonably stiff grout or an approved concrete mixture, and compacted.

The question of how long traffic should be kept off a grouted slab has not been fully answered yet. Grouts at normal temperatures lose their fluidity within about 20 minutes after placement. Since the grout is well confined it should be able to support loads within at least 1 hour.

The total effectiveness of the pressure grouting can be determined only by monitoring future performance of the pavement. Some agencies attempt to monitor the effectiveness by remeasuring the slab deflection at the same points and determining if it is still above the maximum allowed. If it is high the area is regouted until it is reduced.



#### 4.4 Typical Pressure Grout Quantities

The amount of grout that is required to fill voids and stabilize slabs is of course highly dependent upon the pavement condition, particularly the amount of existing pumping.

Available data obtained from contractors indicate that grout quantities for CRCP may range from 0.2 to 0.4 ft<sup>3</sup>/SY of slab area.

CHAPTER 5  
CONCLUSIONS AND RECOMMENDATIONS

The overall objective of Project IHR-901 was to improve the maintenance procedures and materials for CRCP. The research approach used to accomplish this objective as to (1) conduct a field survey to determine the types of distress occurring and the future maintenance needs (Refs. 1, 2), and (2) conduct an evaluation of existing patching methods, costs, and performance (Refs. 3, 4). Based upon these results, input from the Project Advisory Committee and IDOT maintenance personnel, the most promising procedures and materials were identified for further testing and development. Experimental field and laboratory studies were conducted over three years to provide data for developing improved procedures and materials. Major studies included:

- (1) Short lap tied patches.
- (2) Welded lap patches.
- (3) Extra thick patches.
- (4) Partial depth patches.
- (5) Varying length and width patches.
- (6) Asphalt and no-steel concrete patches.
- (7) Early opening concrete additives and curing procedures.
- (8) Pressure grouting CRCP with cement-grout.
- (9) Pressure grouting CRCP with asphalt cement.
- (10) Epoxying wide cracks.
- (11) Location of voids using NDT.
- (12) Use of mechanized equipment for patching.

Many significant results were obtained as documented in References 6, 8, and this final report.

The final permanent patching techniques are presented in the Appendix of this report. Recommendations for pressure grouting CRCP with cement-grout are given in Chapter 4 of this report. The patching procedures may be used by IDOT maintenance crews, day-labor crews and also utilized to make appropriate modifications to the standard specifications.

A separate audio-visual slide/cassette aid for training purpose was also developed for the patching procedures. This can be used for the training of maintenance crews. Since CRCP patching is a difficult and costly process, a small amount of training will pay significant rewards in productivity and in increased patch life. It is also recommended that IDOT maintenance consider the acquisition of additional mechanized equipment for crews patching CRCP such as lift out capability, hydrammer, etc.

The procedures included herein have been field tested and found to provide excellent performance. They were also found to be much more cost effective than the standard procedures utilized by IDOT over the past decade. It is strongly believed that an effective permanent patching program and also pressure grouting where appropriate will extend the life of a CRCP significantly. This alternative will be much more cost effective than letting the CRCP deteriorate seriously, and then placing a thick overlay.

## REFERENCES

1. LaCoursiere, S. A., M. I. Darter and S. A. Smiley, "Performance of Continuously Reinforced Concrete Pavement in Illinois," Report FHWA-IL-UI-172, Cooperative Research Program between University of Illinois, Illinois Department of Transportation and Federal Highway Administration, 1978.
2. Darter, M. I., S. A. LaCoursiere and S. A. Smiley, "Structural Distress Mechanisms in Continuously Reinforced Concrete Pavement," Transportation Research Record No. 715, Transportation Research Board, 1979, pp. 1-6.
3. Maxey, D. J., M. I. Darter and S. A. Smiley, "Evaluation of Patching of Continuously Reinforced Concrete Pavement in Illinois," Report FHWA/IL/UI-176, Cooperative Research Program between University of Illinois, Illinois Department of Transportation and Federal Highway Administration, 1979.
4. Maxey, D. J., M. I. Darter and S. A. Smiley, "Evaluation of CRCP Patching," Transportation Research Record No. 727, Transportation Research Board, 1979, pp. 9-16.
5. Simonsen, J. E., "Development of Procedures for Replacing Joints in Concrete Pavement," Final Report No. R-1020, Michigan Department of Transportation, 1976.
6. Barnett, T. L., M. I. Darter and N. R. Laybourne, "Evaluation of Maintenance/Rehabilitation Alternatives for CRCP," Report FHWA/IL/UI-185, Cooperative Research Program between University of Illinois, Illinois Department of Transportation and Federal Highway Administration, 1981.
7. "Thickness Design for Concrete Pavements," IS010.03P, Portland Cement Association, 1966.
8. Darter, M. I., "Patching of CRCP," Transportation Research Record No. 800, Transportation Research Board, 1981.
9. "Slabjacking Concrete Pavements," ISO 60.01P, Portland Cement Association, Skokie, Illinois 60076, 1967.
10. "Mud-Jack Contractors Handbook," Koehring PCM Division, Milwaukee, Wisconsin 53201, 1970.
11. \_\_\_\_\_, "A Study of Concrete Slab Jacking Slurries," Implementation Package, Mississippi State Highway Department, 1976.
12. Kawala, E. L., "Slabjacking Art and Science," Concrete Construction, February 1969.
13. Thornton, J. B. and W. Gulden, "Pavement Restoration Measures to Precede Joint Resealing," paper presented at the 1980 Annual Meeting of Transportation Research Board, in press, January 1980.

14. Higgins, C. M., R. W. Kinchen, and J. L. Melancon, "Louisiana Slab-jacking Study," Research Report No. 45, Louisiana Department of Highways, 1970.
15. \_\_\_\_\_, "Engineering Investigation and Evaluation--Grout Subseal on I-10, Colorado County, Texas," Raba-Kistner Consultants, Inc., February 6, 1979.
16. \_\_\_\_\_, "Rigid Pavement Maintenance," AFR-85-8, U.S. Air Force, March, 1977.
17. Del Val, John, "Concrete Jacking and Grout Subsealing Slide and Cassette Presentation," Del Val, Inc., P. O. Box 23594, Portland, Oregon, 1979.
18. Del Val, J., "Grouting--A Handbook of Applications," Del Val, Inc., Portland, Oregon, 1978.
19. Rizzuto, I. F. and J. E. Haviland, "An Investigation of Asphalt Cement Subsealing and Lime-Cement Jacking," Highway Research Circular No. 58, Highway Research Board, 1966.

APPENDIX A

RECOMMENDED PROCEDURES FOR PATCHING CRCP FOR  
ILLINOIS DEPARTMENT OF TRANSPORTATION MAINTENANCE CREWS

Department of Civil Engineering  
University of Illinois  
1 November 1981

## TABLE OF CONTENTS

	Page
LIST OF TABLES .....	ii
LIST OF FIGURES .....	iii
SECTION I. INTRODUCTION .....	1
SECTION II. SELECTION OF PATCH BOUNDARIES .....	3
SECTION III. SAWING OF PATCH .....	7
SECTION IV. REMOVAL OF THE CONCRETE .....	9
SECTION V. EVALUATING THE CONDITION OF THE SUBBASE .....	12
SECTION VI. REPLACING AND SPLICING THE REINFORCING STEEL .....	13
SECTION VII. PREPARING THE PATCH FOR CONCRETE PLACEMENT .....	15
SECTION VIII. PLACING THE CONCRETE IN THE PATCH .....	16
SECTION IX. DATING AND IDENTIFICATION PATCHES .....	20
SECTION X. CURING OF THE PATCH CONCRETE .....	21
SECTION XI. OPENING THE PATCH TO TRAFFIC .....	22

## LIST OF TABLES

Table	Page
1.	Recommended Minimum Time from Placement to Opening to Traffic .23



## LIST OF FIGURES

Figure		Page
1.	Identification of Center and End Sections .....	24
2.	Location of Patch Boundaries .....	25
3a.	Tied Steel Patch Dimensions .....	26
3b.	Welded Steel Patch Dimensions .....	27
4.	Minimum Distance Between Partial Depth Saw Cut and Nearest Transverse Crack .....	28
5.	Typical Partial Lane Patch for a Distressed Area Confined to Less Than Half a Lane .....	29
6a.	Standard Breakout Method. Partial and Full Depth Saw Cuts ...	30
6b.	Standard Breakout Method. Center Section Breakout .....	31
6c.	Standard Breakout Method. End Section Breakout .....	32
7a.	Alternate Breakout Method. Partial Depth Saw Cuts .....	33
7b.	Alternate Breakout Method. End Section Breakout .....	34
7c.	Alternate Breakout Method. Center Section Breakout .....	35
7d.	Alternate Breakout Method. Removal of Remaining Concrete ....	36
8a.	Center Section Lift Out Method. Partial and Full Depth Saw Cuts .....	37
8b.	Center Section Lift Out Method. Removal of Center Section ...	38
8c.	Center Section Lift Out Method. End Section Removal .....	39
9.	Typical Pin and Accessories for Lift Out of Large and Heavy Concrete Slabs .....	40
10.	Tied Steel Lap Length .....	41
11.	Weld Design Used in the Welded Splice Patch .....	42

## LIFT OF FIGURES

Figure		Page
12.	Minimum Center Tied Lap Length For a Welded Patch .....	43
13.	Replacement of Steel Reinforcement With Chairs for Support. Refer to Figures 10 and 11 for Detailed Lap Length Sections for Tied and Welded Patches .....	44
14.	Placement of the Portland Cement Concrete Patch .....	45
15.	Dating and Identifying Patches .....	46

## RECOMMENDED PROCEDURES FOR PATCHING CRCP FOR IDOT MAINTENANCE CREWS

### SECTION I. INTRODUCTION

The purpose of this document is to describe recommended methods of patching continuously reinforced concrete pavements (CRCP) for IDOT maintenance and day labor crews. The procedures are the result of a comprehensive research project conducted at the University of Illinois, Department of Civil Engineering. The procedures reduce costs and lane closure time by considering the several different distress types in CRCP, different methods of construction to account for the varying equipment capabilities of each crew, and concrete additives for early opening. Practical step by step procedures are provided for the efficient and long lasting patching of CRCP.

The various CRCP distress types are as follows:

Edge Punchout - A block of concrete between transverse cracks which has become depressed or punched down relative to the surrounding slab. Located at the edge of the slab, the edge punchout is caused primarily by the deterioration of the subbase from pumping. Repeated heavy truck loading is also an important factor in the progressive development of the distress. The edge punchout is one of the most serious and prevalent CRCP distress type requiring permanent patching.

Wide Cracks - Originally tight transverse cracks which have opened up, faulted, and spalled, often across an entire lane. The opening of the cracks is associated with the loss of aggregate interlock and yielding of the reinforcing steel at the crack. Wide cracks can develop into an edge punchout or a blowup.

Longitudinal Joint Faulting - Faulting and/or separation of one lane relative to another for a distance of 10 to 20 feet (3.05 to 15.24 m) along the centerline joint. In many instances large groups of edge punchouts are found in the area of this distress.

Localized Breakup - A local area of the slab which has broken up into several small pieces. This distress is often located in regions of close, interconnected, crack spacing and is generally associated with construction defects.

Construction Joint Failures - The appearance of punchouts, wide cracks, excessive spalling, or disintegration of the slab, in the region close to a CRCP construction joint. The underlying cause is poor construction techniques.

Blowups - A crushing or buckling of the slab due to thermal and moisture expansive forces. This distress has appeared infrequently in CRCP but the rate of occurrence is increasing significantly. Blowups can be a severe traffic hazard and most often develop at wide cracks or construction joints.

"D" Cracking - A distress which causes the concrete to slowly disintegrate due to freeze-thaw (expansion) action in the large aggregate. Depending on the aggregate properties and local environment, "D" cracking can result in complete disintegration of a pavement in a time span of 8 to 15 years. The close crack spacing of CRCP makes it particularly susceptible to "D" cracking.

In summary, CRCP has about seven different types of distress that are repaired by constructing permanent concrete patches. Most of these distress types are unique to CRCP, so that traditional methods used for identifying and diagnosing distress in plain or reinforced jointed concrete pavements may or may not be applied to CRCP.

It is important that the various distress types be properly identified and diagnosed. To make a good diagnosis of the distress, the mechanisms of development must be understood. Maintenance personnel should have a good idea if the distress is primarily a result of traffic loads, environmental conditions, or is a result of a construction defect. It is especially important that they be aware of the extent of the distress, and how it has affected the slab, reinforcing steel, subbase, and subgrade.

## SECTION II. SELECTION OF PATCH BOUNDARIES

Most of the patches described in this guideline will have three distinct sections simply referred to as the center section and the two end sections as shown in Figure 1. The correct determination of these section boundaries will increase the life of the finished patch and minimize overall annual patching costs.

For example, in most cases the subbase material beneath an edge punchout is disintegrated for some distance on both sides of the distress. Signs of edge pumping or longitudinal joint faulting (settlement) will prove to be a good guide in determining how far from the edge of the visible distress the subbase has been damaged (typically 2-3 feet). Consequently, the overall length of the patch must reflect this deteriorated subbase material. Careful attention must be given to these warning signs around the distressed area and the appropriate steps taken to insure that the deteriorated areas are contained within the patch boundaries as illustrated in Figure 2. If the transverse crack next to the X mark (where the partial depth saw cut will be placed) contains broken or corroded steel, the X mark should be moved at least 18 inches away from the crack to provide an adequate end section length.

Broken reinforcement can be verified by running a thin ruler down through the crack, or any crack that has faulted 0.10 of an inch or more can be assumed to contain broken and/or corroded steel. The patch boundaries cannot be moved too close to the distressed portion because then the possibility exists that all of the deteriorated subbase may not be included, and future failure of the adjacent slab and/or patch will occur.

#### A. Minimum Patch Size

In order to minimize patch size and cost and at the same time provide adequate lap length and allow for cleanout of the center section, the following minimum values for overall patch length should be observed.

1. Patch containing tied steel, 4.5 ft minimum length
2. Patch containing welded steel - 3 ft minimum length

#### B. Tied Steel Patch

A patch containing tied steel can be placed for any distress type.

1. The distressed portions of the CRC slab and base should be incorporated within the center section of the patch.
2. The end sections and the center section of the patch should be a minimum of eighteen (18) inches long. Field and laboratory testing has shown these end and center section lengths to be adequate for typical reinforcement used in Illinois (No. 5 bars and welded deformed steel fabric). (See Figure 3a)

#### C. Welded Steel Patch

A patch containing welded steel can be placed whenever the proper equipment is available (see Figure 3b). This type reduces the length of the end sections and consequently can save a considerable amount of breakout time.

1. The distressed portion of the CRC slab and base should be incorporated within the center section of the patch.
2. The end sections of the patch should be a minimum of eight (8) inches long.

NOTE: A patch containing no steel is recommended only for a badly "D" cracked section of CRCP where the expected life of the pavement surrounding a proposed patch is short.

Rather than place a patch with steel which would have a life many times that of the surrounding pavement, it is much more cost effective to place a concrete patch without steel which would most likely still last longer than the surrounding pavement.

1. The distressed portion of the CRC slab and subbase should be incorporated within the center section of the patch.
2. The end sections of the patch are eliminated.

#### D. Minimum Distance to Crack

Because of the potential of the CRC slab failing between the edge of a patch and the nearest transverse crack in the CRCP, the outer patch boundaries should be located at least eighteen inches from the nearest transverse crack. However, sometimes the crack spacing is very small and in these particular cases it might be necessary to place the boundary closer than eighteen inches to the nearest transverse crack, but not less than 6 inches. If this is necessary, make sure that the cracks are tightly closed and not faulted. (Note: to determine faulting simply run your hand over the crack in the opposite direction of traffic). If a crack that isn't tight or is faulted is within eighteen inches, the patch should be extended to include this crack (see Figure 4). Also, the outer patch boundaries should not cross a transverse crack as this may lead to spalling and breakup in the slab.

#### E. Width of Patch

In most instances the width of the patch will be equal to a full lane width, but this can be reduced under some circumstances.

1. Distress types such as wide cracks, large edge punchouts, blowups and other distresses occurring over more than one-half of the lane should be patched over a full lane width (12 feet).

2. In some cases such as a small edge punchout the width of the patch need not be a full 12 feet (see Figure 5). In these cases, a longitudinal boundary must be established. A minimum patch width of six feet should be used, however, a wider patch can be used as long as the longitudinal boundary is placed between the reinforcement and the joint does not fall in the center of the wheel path.

#### F. Failure Across Two or More Traffic Lanes

Whenever a failure occurs across all tied traffic lanes, a special patching sequencing is required. The typical situation is where a steel rupture (or wide crack) has occurred across both lanes of a four lane divided Interstate highway. There is typically a large amount of movement across this crack during a given 24 hour period. This movement has often badly cracked the first lane patched during the first night (normally the truck lane), and heavy truck loads over the next few weeks cause these cracks to spall and deteriorate until the patch breaks up. The patch placed in the passing lane normally does not crack as badly as the first patch because movement is restrained.

The following procedure has been found to increase the chance of obtaining two good patches:

1. Patch the passing lane first.
2. Next patch the heavy truck lane.

Cracks formed in the passing lane patch will not likely breakdown because of reduced heavy traffic.



## SECTION III. SAWING OF PATCH

Sawing of all outer boundaries of the patch is highly recommended. Experience has shown that the outer boundaries of a patch will undergo spalling if they are created by jackhammers or other breakout equipment, or follow an existing crack. Consequently, the proper sawing equipment should be utilized.

A. Outer Patch Boundary Saw Cut

The outer boundary of the end sections should be a partial depth saw cut 1-1/2 - 2 inches deep that does not cut the reinforcing steel (see Figure 6a).

B. End Section/Center Section Saw Cut

The boundary between the center section and the end section should be a full depth saw cut through the reinforcement, unless the alternative method under item C below is used (see Figure 6a).

NOTE: For a patch with no steel, the transverse outer boundaries of the patch should be sawed to a depth including the reinforcing steel (a full depth saw cut).

C. Alternate to Full Depth Saw Cut

The following alternative to the full depth saw cut may result in a savings of time and cost.

1. The partial depth saw cuts are placed as usual (see Figure 7a). Jackhammers are used to break up the concrete down to the steel where it is cut with a handsaw or with a torch, thus eliminating the full depth saw cut at the boundary between the center and end sections (see Figure 7b).

#### D. Longitudinal Saw Cut

If the width of a patch is less than a full lane, the longitudinal boundary must be sawed (see Figure 5).

1. Patches in CRCP which have the standard reinforcing bars should have a partial depth saw cut along the longitudinal boundary.
2. Patches in CRCP which have welded wire mesh reinforcement should have a full depth saw cut through the reinforcement along the longitudinal boundary. Note that the method described in Section III C.1 can be used here to eliminate the full depth saw cut.

#### E. Saw Cuts and Lift Out

If pins or chains are to be used to lift out the center sections of the patch, the saw cuts must be completely through the CRC slab. If full depth sawing is not possible, an area approximately 5 inches wide can be broken up using a jackhammer along all edges. This will enable the slab to be lifted out without experiencing severe binding. This may be needed in hot weather even if full depth saw cutting is available.

## SECTION IV. REMOVAL OF THE CONCRETE

A. Center Section

Removal of the concrete from the center section can be accomplished by several different methods depending on the equipment available (see Figure 6b and Figure 7c).

1. The most common procedure is to break up the concrete with jackhammers and shovel it out with hand tools. The advantages of this method are that a minimum of equipment is needed and if the work is done carefully, damage to the subbase and the adjacent slab is avoided. Unfortunately, this is the most time consuming man power intensive method, and very expensive.
2. The removal can be shortened by using a pavement breaker and a backhoe. (Note: breaking the concrete by means of a ball breaker should never be permitted as the large shock waves will damage adjacent concrete). The problem with this method is that damage to the subbase material usually occurs.
3. A third method which has been used successfully is lift out by a front end loader or a bulldozer. The common procedure is to break up the concrete with jackhammers on all sides of the center section. The front end loader or bulldozer then lifts up one end of the slab. Chains are then connected to the exposed steel at the other end of the slab and then secured to the bucket. The slab is then lifted out and placed in a truck, or if it is very large, on a flatbed.

This method can be accomplished in a very short period of time and it does not damage the subbase or the adjacent CRCP. The problems lie in the fact that the size of slab that can be lifted depends on the available equipment. Also, this method doesn't work very well in badly "D" cracked material or where bituminous patches are being replaced, and disposal of the slabs can be a problem.

4. A final method involves lift out with pins. This procedure requires at least two drilled holes, two or more lift out pins, and some heavy equipment capable of lifting large loads as shown in Figure 8. First a five inch wide strip of the CRC center section must be broken up and removed down to the reinforcement. The steel must then be cut and taken away. The remainder of the strip down to the subbase must then be broken up and carefully removed by hand methods being careful not to damage the existing subbase.

Figure 9 shows a typical reusable pin that has been used effectively by several states. The holes must be drilled so that the weight of the slab is distributed as evenly as possible. The number of pins used will depend on the size and condition of the slab and on the capacity of the chain. Some contractors have developed equipment that can more rapidly lift out the slabs. This method can be accomplished in a short period of time and normally leaves the base material and adjacent CRC slab undisturbed.

#### B. End Sections

Removal of the concrete from the end sections should only be done in the following manner (see Figure 6c and 7d).

1. Concrete in the two end sections must be carefully removed so as to not damage the reinforcement in the lap area, and to avoid spalling

at the bottom of the joint (beneath the partial depth saw cut). This task can be accomplished by using only jackhammers, prying bars, picks, shovels, and other hand tools.

2. Breaking around the reinforcing steel without nicking, bending, or in any way damaging it is difficult. However, the reinforcement must not be bent up in removal of concrete since the bars cannot be properly straightened out afterward. Bent reinforcement in the patch area will eventually result in spalling of the patch and failure because of the large eccentric stresses carried by the reinforcement.
3. The use of a drop hammer or hydrammer should not be allowed in the end sections because this equipment will typically damage the reinforcement and/or cause serious undercutting beneath the partial depth sawed joint. It may be necessary to limit the size of the jackhammer operating at the joint to minimize undercutting beneath the reinforcement.
4. Any bent reinforcement should be carefully straightened after the breakout of the concrete.

## SECTION V. EVALUATING THE CONDITION OF THE SUBBASE

A. No Damage

If the subbase has not been damaged by construction operations and no standing water or excessive moisture is present, and in general it is in sound condition, then proceed to SECTION VI.

B. Damaged Subbase

All material that has been disturbed or that is loose should be removed and replaced with regular concrete during placement of the patch.

C. Moisture

All excessive free moisture should be removed or dried up if possible before the placing of the concrete.

D. Side Drain

If the subbase and subgrade are saturated, and considerable water is present a side trench or pipe drain should be installed to facilitate drainage. This can be accomplished by cutting a narrow trench through the shoulder. The trench is then back filled with crushed stone and surfaced with asphalt concrete.

## SECTION VI. REPLACING AND SPLICING THE REINFORCING STEEL

### A. Inspection

The reinforcing steel at the patch ends should be inspected for damage. If more than 10% of the steel is visibly damaged or corroded, the ends of the patch should be extended until this situation is rectified over the required lap length.

### B. Type and Clearance

Reinforcement of similar size and strength should be placed in the patch and spliced to the reinforcement at the patch ends by lapping. The required length of embedment of the existing reinforcement into the patch depends on the size and type of the reinforcement. Illinois field tests have shown that an embedment length of 18 ins. is adequate for No. 5 deformed bars and welded deformed steel fabric (dia. = 0.516 ins.) (see Figure 8). This provides an embedment of 29 bar diameters for the No. 5 bar. A No. 6 bar requires 22 ins. embedment for 29 bar diameters. This exceeds the ACI 318 Code for basic development length. Further research may show that a shorter length is adequate (shown in Fig. 10). A minimum 2 inch clearance should be provided between the ends of the new rebars and the existing CRCP slab face to allow for possible expansion. The number and spacing of the new reinforcement should match the reinforcement in the pavement.

### C. Welded Reinforcement

An alternative to splicing by means of tying the reinforcement as described above is to weld the new reinforcement in place (see Fig. 11).

However, in some cases the reinforcement in the patch will have been made from old rails which cannot be easily welded. The origin of the reinforcement should be determined, and if it was made from old rails, welding should not be attempted. All deformed bars furnished with rolled-in markings. These identify the producing mill (usually an initial), the bar size number (e.g. 5 or 6), the type of steel (e.g. N for billet, A for axle, and a rail sign for rail steel), and an additional marking for identifying the higher strength steels (e.g., 60 means 60,000 psi yield steels). Welding guidelines are as follows:

1. 1/4 inch continuous welds should be made.
2. The length of the welds should be four inches and both sides of the bars should be welded. A stacking of the bars on top of each other is recommended. This length of weld develops the full strength of No. 5 bars.
3. Use AWS A5.1 E70XX electrodes.
4. Arc strikes outside of the permanent weld area are to be avoided and tack welding is expressly prohibited.
5. To avoid potential buckling the reinforcement must be lapped at the center of the patch (minimum lap length is 16 inches for all bar sizes) (see Fig. 12).

#### D. Placement

The new reinforcing steel bars shall be placed observing the following conditions (see Fig. 13).

1. Reinforcing steel shall be placed so that a minimum of 2-1/2 inches of cover is provided. If existing cover is less than 2-1/2 inches then place spliced bar under the existing bar.
2. Reinforcing steel shall be placed and supported by chairs or other means available so that the reinforcement will not be permanently bent down during placement of the patch.



## SECTION VII. PREPARING THE PATCH FOR CONCRETE PLACEMENT

A. Side Forms

Wood or steel side forms should be placed along the slab edge to make it possible to form a uniform edge along the slab and to strike off the concrete surface. The existing asphalt shoulder may need to be removed for a width of less than one foot. After removal of the form, the excavated shoulder area must be backfilled using an asphaltic mix and compacted.

B. Bonding

Since concrete bonds better to dry surfaces than to wet surfaces, the ends of the existing CRCP should not be wetted down before concrete placement, nor the surface on which the concrete is to be placed. The application of a neat cement grout (cement plus water) to the joint face immediately before concrete placement will improve bonding.

## SECTION VIII. PLACING THE CONCRETE IN THE PATCH (see Fig. 14)

A. Concrete Mixture

The concrete should be obtained from a nearby IDOT approved ready-mix plant with the following properties:

1. A seven bag mix of portland type I cement. It has been found that the detrimental effects of increased shrinkage and the increase in cost outweigh the increase in strength that a cement factor higher than 7 bags or other types of cement provide.
2. An approved air-entraining agent should be used in amounts such that 4-7% of air is entrained in the concrete.
3. The material proportions should be in accordance with the IDOT approved mix design which has a w/c = .41 and gives a slump of 3-4".

B. Calcium Chloride Additive

Calcium chloride is recommended for use as an accelerator in the patching concrete with the following conditions:

1. The calcium chloride should be added to the ready-mix concrete at the site when the ambient temperature is above 70°F. When the temperature is below 70°F, the calcium chloride can be added at the site, or at the plant as long as the length of time from mixing to delivery is less than 15 minutes.
  - a. When the calcium chloride is added at the site, a standard solution should be prepared in accordance with the "Manual of Instructions for Concrete Proportion Engineering," IDOT.

- b. The ready-mix truck should be mixed an additional 40 revolutions after the addition of the calcium chloride at the site.
2. At all times the percentage of calcium chloride by weight of cement is limited to a maximum of 2%.
    - a. It is recommended that no more than 1% be used when the ambient temperature is above 80<sup>0</sup>F because greater percentages can bring on a flash set.
    - b. It must be noted that on warm days the initial set of the concrete can occur as soon as 30 minutes after the addition of calcium chloride. Consequently, the patch should be placed and finished as quickly as possible.

#### C. Super Plasticizer Additive

On some days, additional early strength could make the difference between opening a patch to traffic at the end of the day or waiting to the next morning (See Table 1). If the engineer foresees this to be the case, an approved super plasticizer may be added to the concrete in order to gain the additional strength. The insulation of the finished patch to increase early strength also is recommended in Section X-C (under certain conditions).

1. When a super plasticizer is to be used, the mix at the ready-mix plant should be altered so as to produce the following:
  - a. a 1" slump concrete
  - b. a concrete with approximately 8% entrained air
2. At all times the super plasticizer should be added at the site.
  - a. If calcium chloride is to be added at the site also, the

calcium chloride should be added according to the provisions of Section VIII B. before the addition of the super plasticizer.

- b. The super plasticizer should be added immediately after the calcium chloride has been thoroughly mixed according to the provisions of Section VIII B. 1. b.
3. The super plasticizer should be added in accordance with the instructions supplied by the manufacturer to provide a 7" slump concrete for easy placement.
  - a. If the concrete begins to stiffen up by the time the second or third patch is to be poured, an additional reduced dose of the super plasticizer may be added. (Note: This can be repeated as many times as is necessary, but never add more than the necessary amount to increase the slump 1 inch at any one time with the obvious exception of the initial dosage.)
  - b. It is recommended that a large plastic container with volume markings along the outside be used to measure the super plasticizer.
  - c. The ready-mix truck should be mixed 2 minutes at high speed after every addition of the super plasticizer (including the initial dosage).

D. Adding Water at Site

The addition of water to the concrete at the site should be avoided unless absolutely necessary because of the detrimental effects this has on the strength development and increased shrinkage.

1. If calcium chloride is being added at the plant and the concrete consistently arrives at the site too stiff, then the calcium chloride should be added at the site.
2. If, after the addition of calcium chloride at the site, the concrete is too stiff, the ready-mix plant operator should be notified to increase the slump an appropriate amount.

#### E. Consolidation of Concrete

The entire patch area should be consolidated by an appropriate sized spud vibrator, particularly around the edges of the patch. The use of a vibrator not only consolidates the concrete, but it also helps in the finishing process, thus avoiding unnecessarily high slumps.

#### F. Strike Off

Special care shall be used in bringing the finished patch concrete to the same grade as the surrounding slab to avoid roughness causing dynamic loads that will foil the patch.

#### G. Identification

The patch shall be dated and identified as in Section IX and shall be broomed.

#### H. Placement of Patch

The casting of patches before noon is not recommended especially during the summer months as this leads to crushing of the patches in the late afternoon.

## IX. DATING AND IDENTIFICATION PATCHES

The dating and identification marks will be placed as indicated in Figure 15. This allows for future performance studies.

1. The date the patch was placed
2. The agency performing the construction of the patch
  - D for day labor crew
  - M for district maintenance crew
  - C for contractors crew
3. The thickness of the patch in inches preceded by a T.
4. The length of the reinforcement lap length in inches preceded by an L. It will be assumed that the lap length number less than 16 will mean that the reinforcement has been welded.  
If the patch does not contain steel write NS.

## X. CURING OF THE PATCH CONCRETE

### A. Curing Compound

A liquid membrane curing compound should be sprayed over the concrete in a uniform manner.

### B. High Wind Speed

On days when the wind speed is in excess of 10 mph, light colored or clear polyethylene sheeting should be placed over the concrete to reduce the amount of moisture loss from the surface. It can be held down along the edges with reinforcing steel or any other similar weight material.

### C. Insulation

The placement of a 4-inch thick insulation over the patch is highly recommended to maintain a high temperature for curing and permit early opening.

1. Polyethylene sheeting should be placed on the concrete before placing the insulation.
2. The insulation should be held down by reinforcing steel or in a similar fashion.

## XI. OPENING THE PATCH TO TRAFFIC

There are many factors which influence the length of time which is necessary for concrete to develop sufficient strength to safely resist traffic loads. As a result of a comprehensive study, the ambient temperature at placement has been found to be by far the most influential factor on the strength development of concrete patches. Consequently, Table 1 gives the minimum number of hours that the concrete must be allowed to cure before it is opened to traffic and it is solely dependent on the ambient temperature at placement. Included in the table are reduced curing times when a super plasticizer, insulation or both are used according to the provision put forth in this guideline.

It is important to emphasize that the values in Table 1 are only applicable when the patch has been constructed in accordance with the provisions of this guideline.



Table 1. Recommended Minimum Time from Placement to Opening to Traffic (all patches contain CaCl).

Ambient Temperature @ Placement (°F)	MINIMUM NUMBER OF HOURS TO OPENING			
	Regular Patch(1)	Regular Patch With Super Plasticizer(2)	Regular Patch With Insulation(3)	Regular Patch With Super Plasticizer and Insulation(4)
40-42	54	35	26	22
43-45	49	33	23	20
46-48	44	31	21	18
49-51	39	29	19	16
52-54	35	27	16	13
55-57	32	25	14	11
58-60	29	23	11	8
61-63	26	21	9	7
64-66	23	19	9	6
67-69	21	17	8	5
70-72	18	15	7	5
73-75	15	13	6	5
76-78	13	10	5	5
79-81	10	8	5	5
82-84	9	7	5	5
85-87	8	6	5	5
88-90	7	5	5	5
91-93	6	5	5*	5*
Above 93	5	5	5*	5*

\* Do not place insulation when ambient temperature's greater than 90° F.

- (1) See Sections VIII A, B, D in Appendix A.
- (2) See Sections VIII A, B, C, D in Appendix A.
- (3) See Sections VIII A, B, D, X C in Appendix A.
- (4) See Sections VIII A, B, C, D, X C in Appendix A.

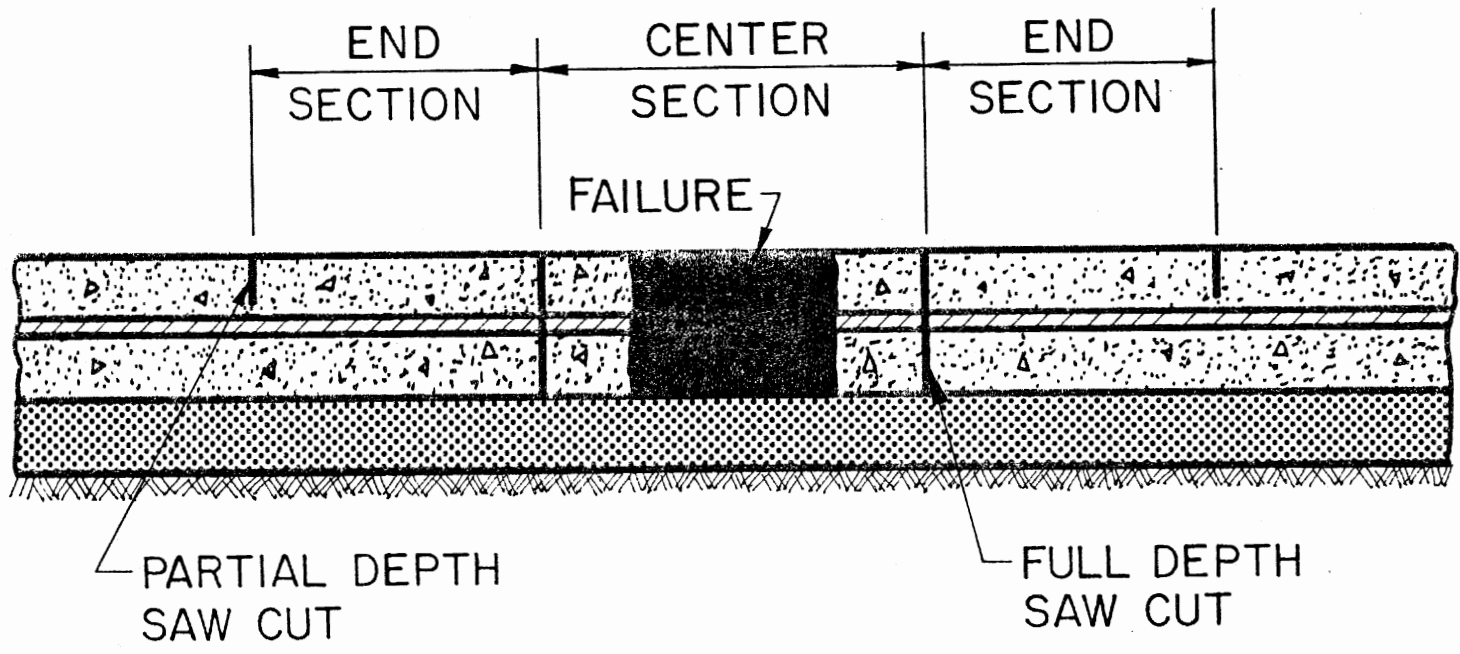

Figure 1. Identification of Center and End Sections.

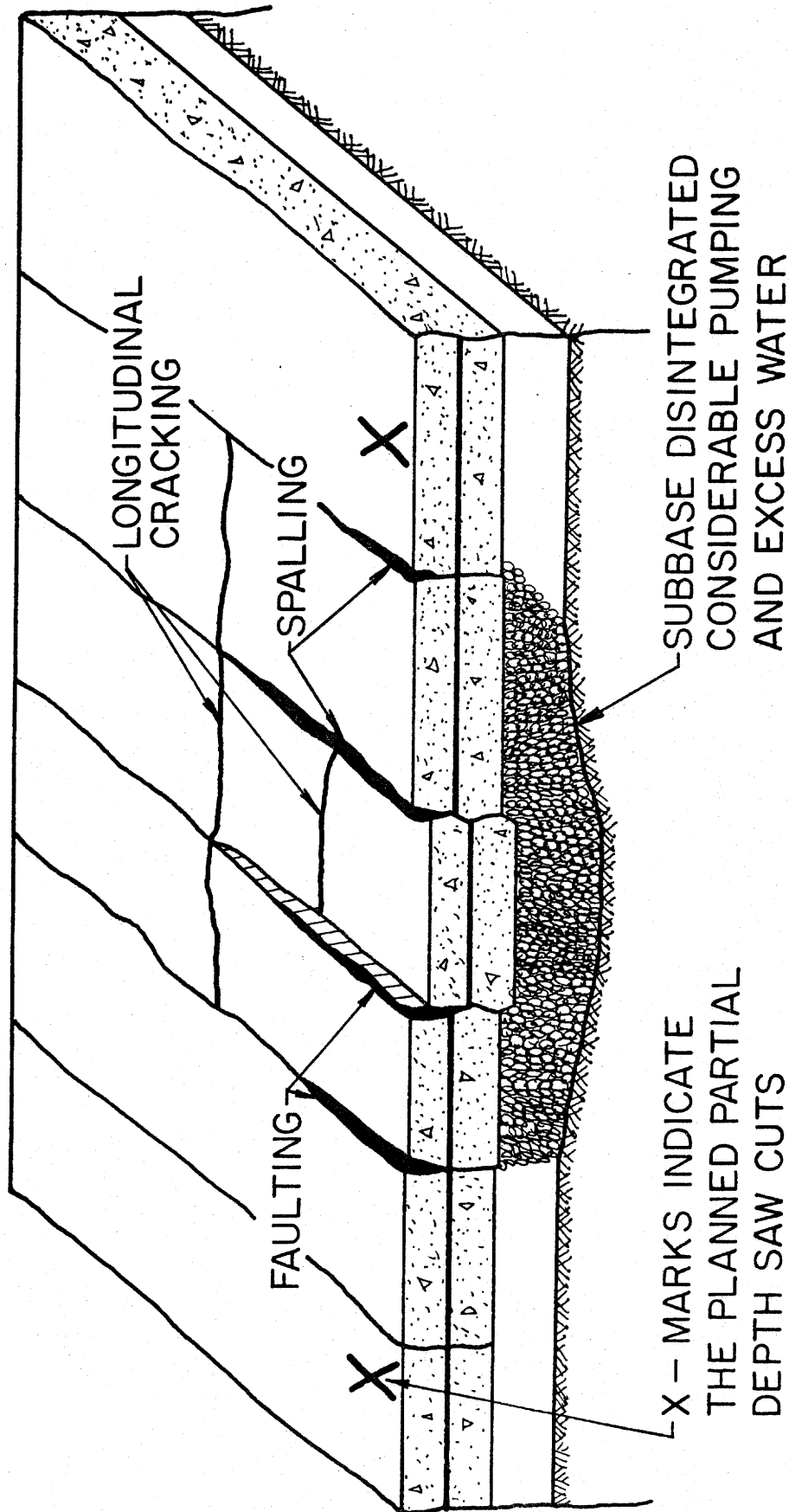

Figure 2. Location of Patch Boundaries.

NOTE: If the transverse crack next to the X mark (where the partial depth saw cut will be placed) contains broken or corroded steel, the X mark should be moved at least 18 inches away from the crack to provide an adequate end section lap length. Broken reinforcement can be verified by running a thin ruler down through the crack, or any crack that has faulted 0.10 of an inch or more can be assumed to contain broken and/or corroded steel. The patch boundaries cannot be moved too close to the distressed portion because the possibility exists that all of the deteriorated subbase may not be included and future failure of the adjacent slab and/or patch will occur.

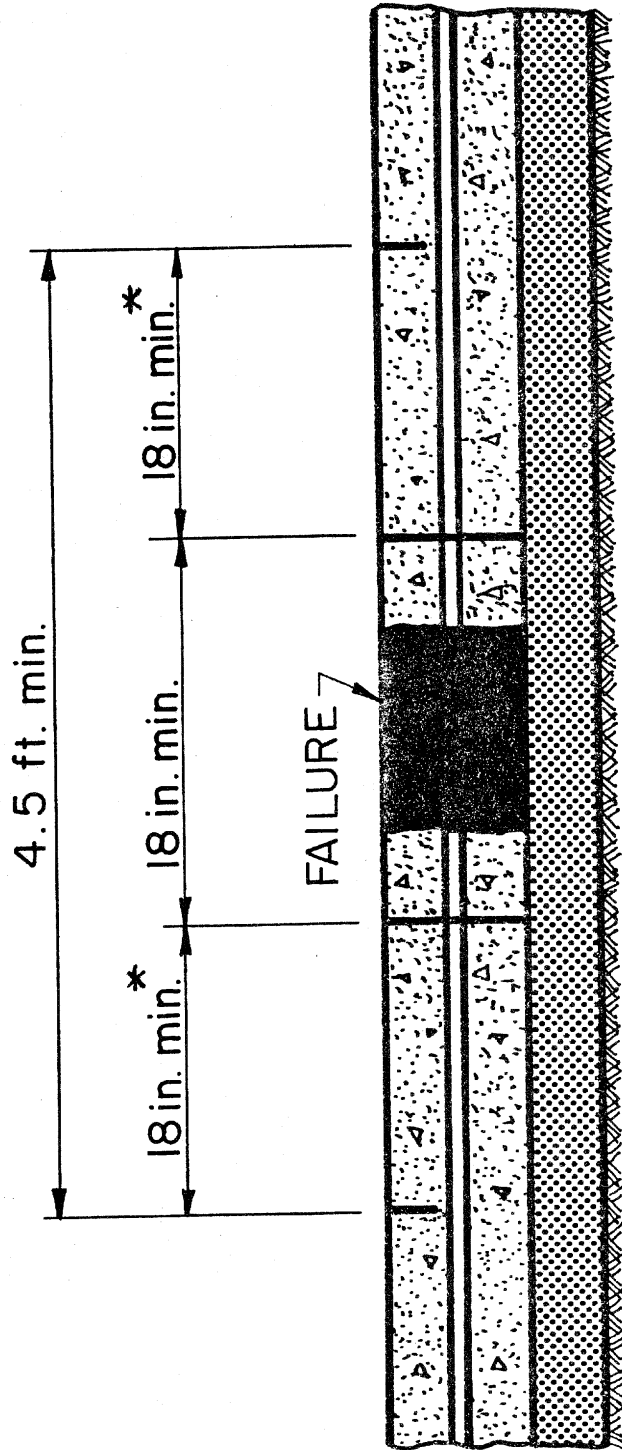

Figure 3a. Tied Steel Patch Dimensions.

\*NOTE: May be varied depending on the size and type of reinforcement in CRCP slab.

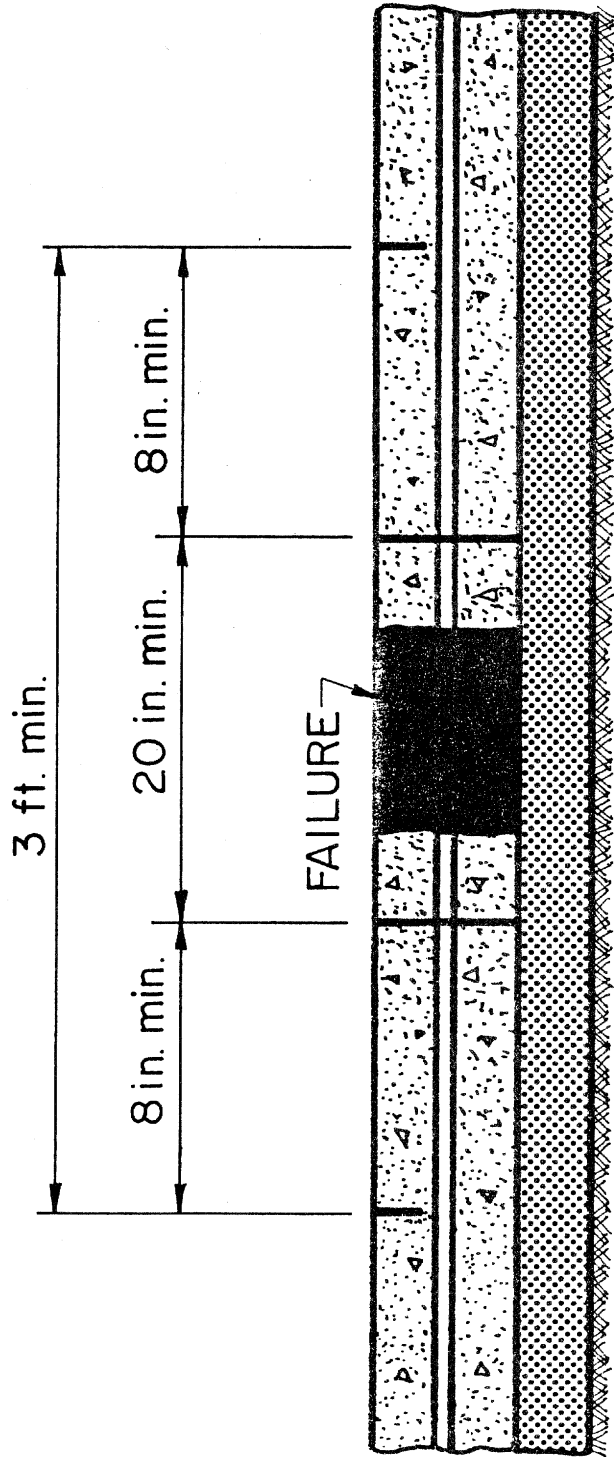

Figure 3b. Welded Steel Patch Dimensions.

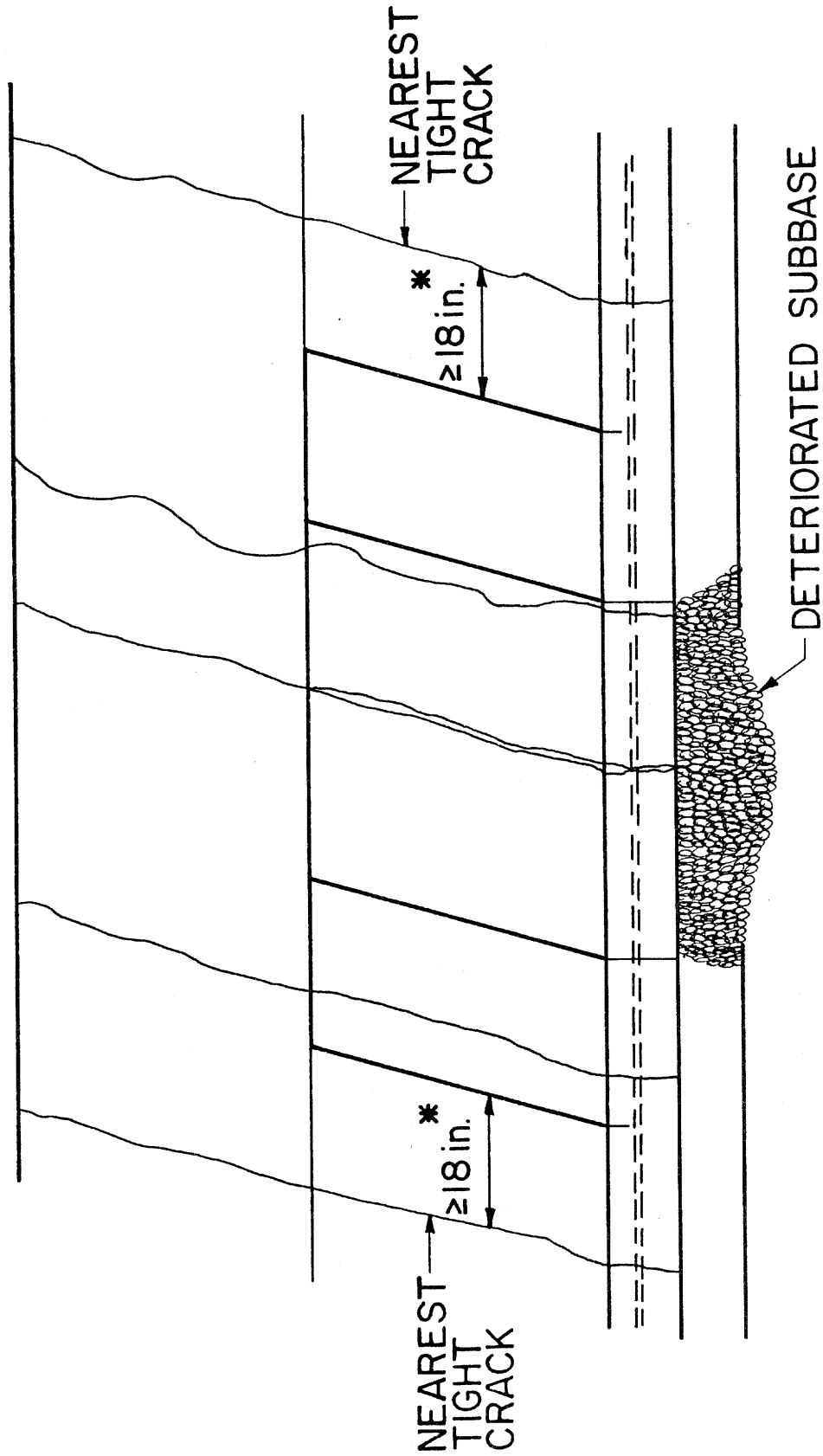

Figure 4. Minimum Distance Between Partial Depth Saw Cut and Nearest Transverse Crack.

\*NOTE: If the requirement for a minimum of 18" clearance between the partial depth saw cut and the nearest transverse crack cannot be met, a shorter distance can be chosen, but the minimum length must not be less than 6 inches.

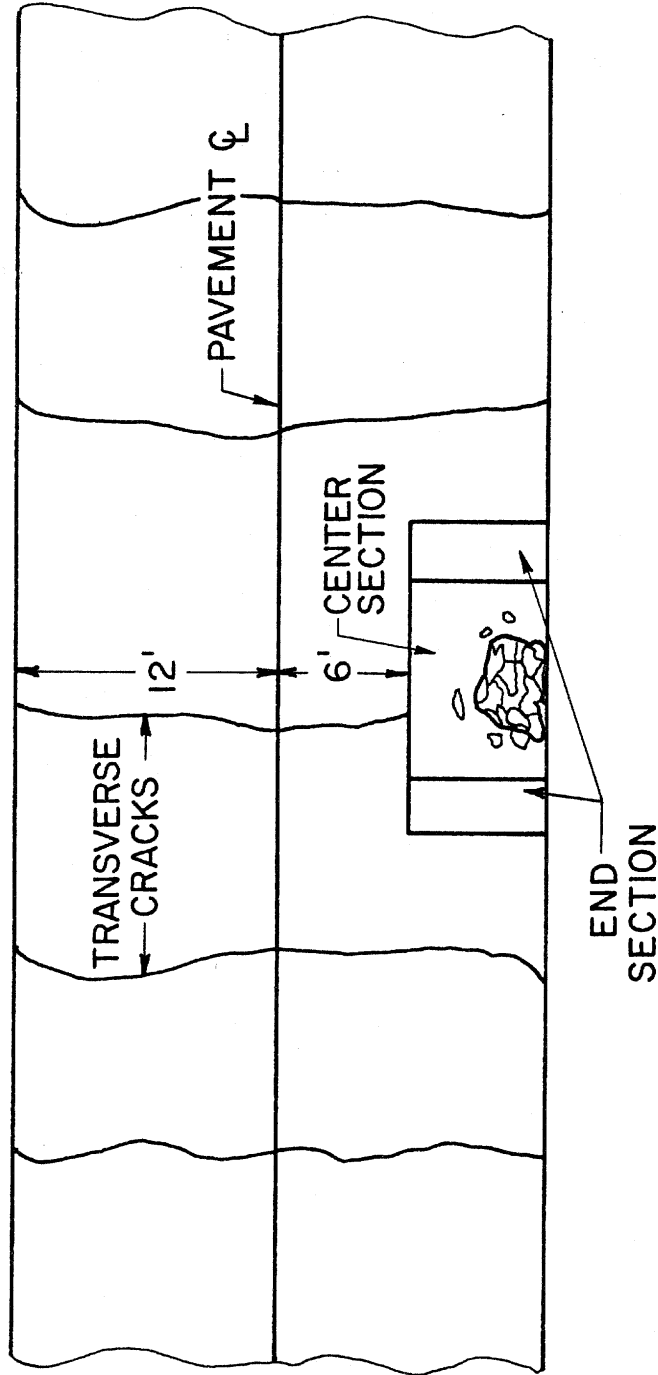
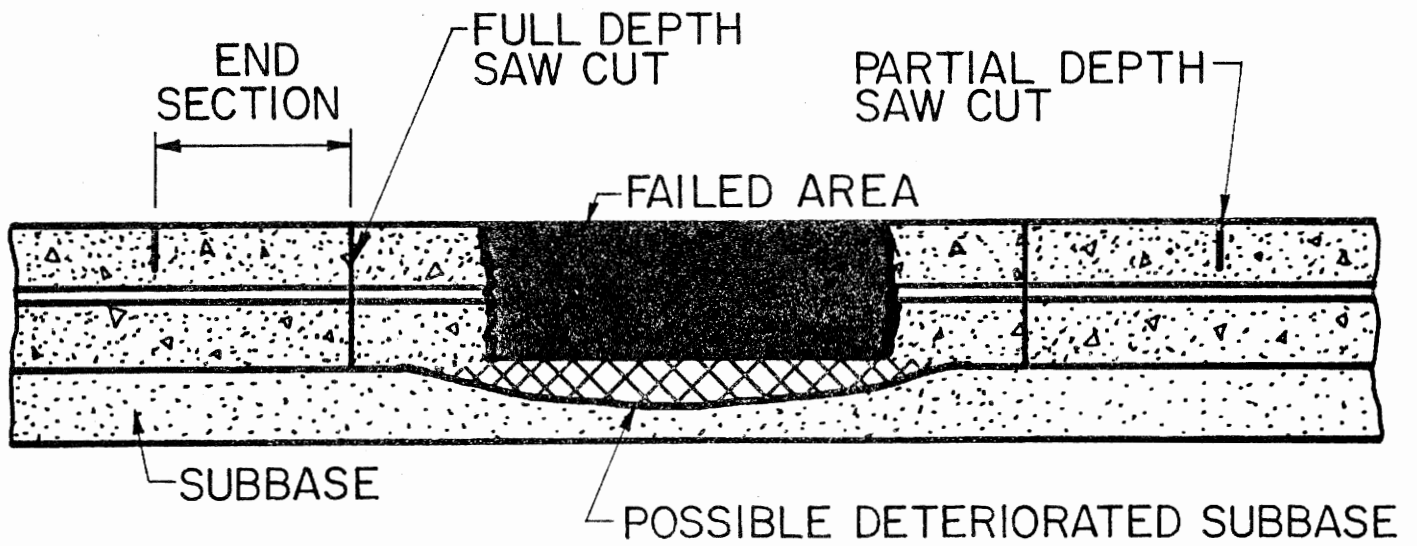

Figure 5: Typical Partial Lane Patch for a Distressed Area Confined to Less Than Half a Lane.



Step 1: Make one partial depth saw cut at the ends of the patch and one full depth saw cut at the proper end section lengths from the edges (18 inches for tied steel patches, 8 inches for welded steel patches).

Figure 6a. Standard Breakout Method. Partial and Full Depth Saw Cuts.



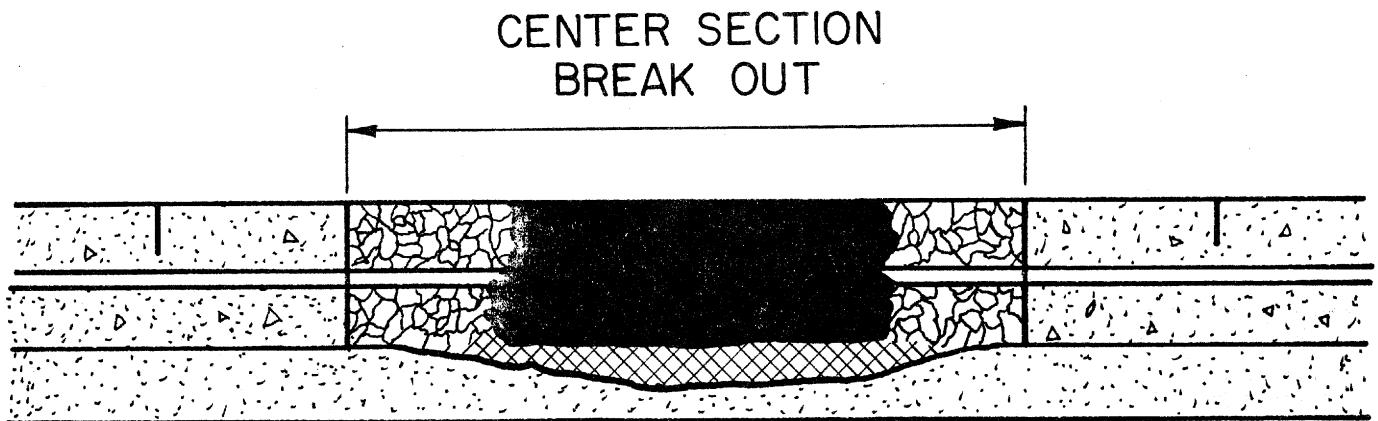

Step 2: Breakout concrete in the center section using jackhammers and remove debris by mechanical methods. Carefully remove the deteriorated subbase, if any exists, making sure not to damage the remaining subbase. The deteriorated area will be filled with Portland Cement Concrete.

Figure 6b. Standard Breakout Method. Center Section Breakout.

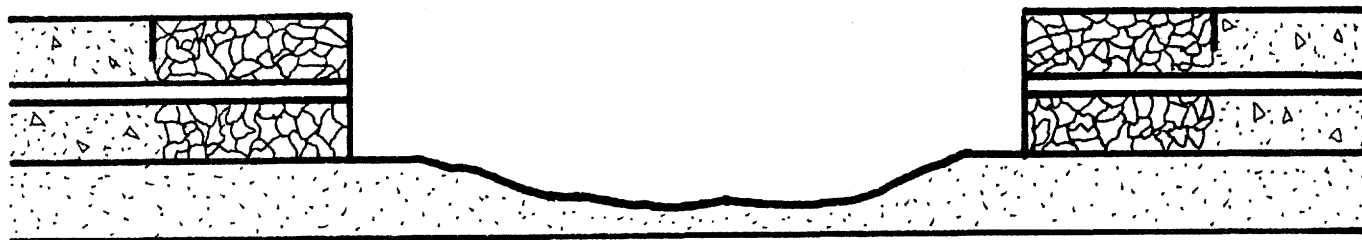

Step 3. Breakup and remove the remaining concrete in the end sections using hand methods being careful not to nick or bend the reinforcement and not to spall the existing CRC slab beneath the reinforcement. The rebar shall not be bent up for the removal of the remaining concrete.

Figure 6c. Standard Breakout Method. End Section Breakout.

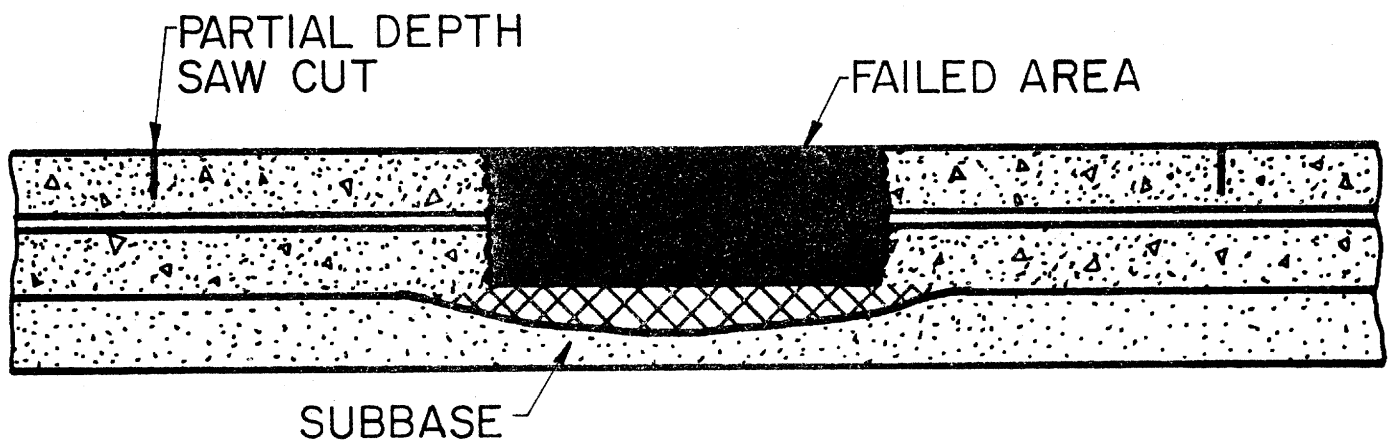

Step 1. Make one partial depth saw cut at the ends of the patch (do not cut steel reinforcement).

Figure 7a. Alternate Breakout Method. Partial Depth Saw Cuts.

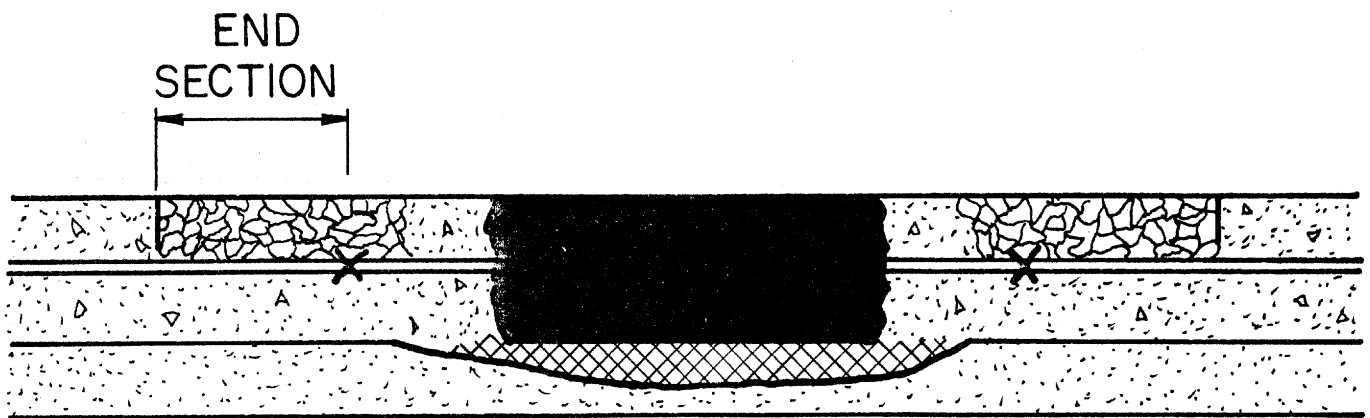

Step 2. Breakout concrete in end sections using jackhammers down to the steel at the proper end section length (18 inches for tied patches, 8 inches for welded patches) and cut the steel.

Figure 7b. Alternate Breakout Method. End Section Breakout.

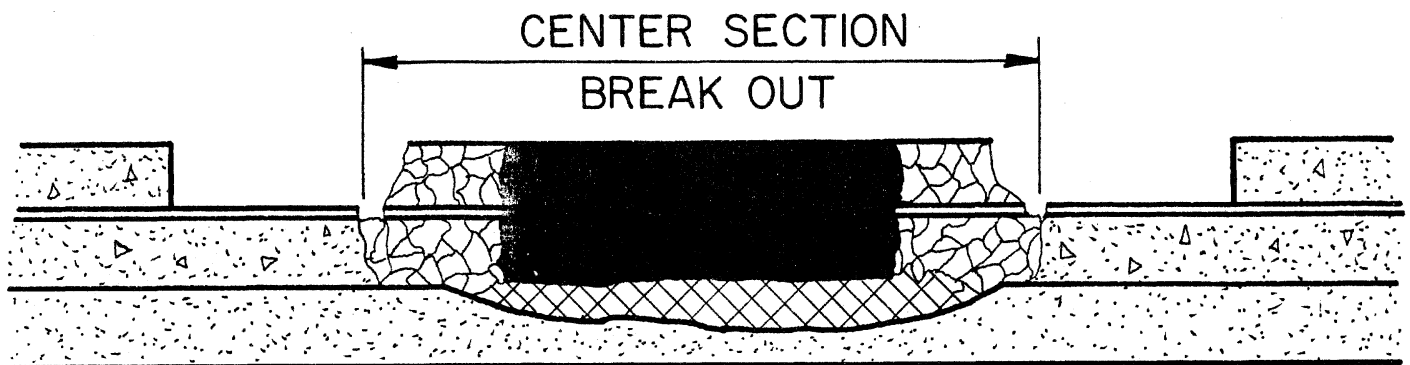

Step 3: Breakup center section using mechanical methods, remove debris in center using mechanical methods if the length allows. Carefully remove the deteriorated subbase, if any exists, making sure not to damage the remaining good subbase. The deteriorated area will be filled with Portland Cement Concrete.

Figure 7c. Alternate Breakout Method. Center Section Breakout.

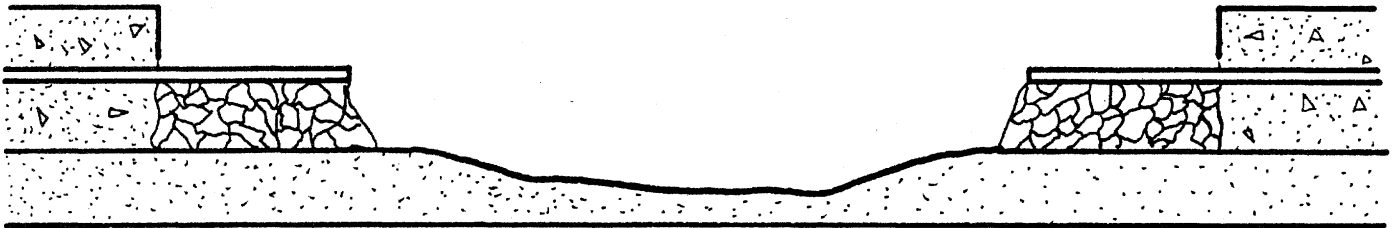

Step 4. Breakup and remove remaining concrete in the end sections using hand methods being careful not to spall existing CRC slab beneath reinforcement and not to nick or bend the reinforcement. The rebar shall not be bent up for removal of the remaining concrete.

Figure 7d. Alternate Breakout Method. Removal of Remaining Concrete.

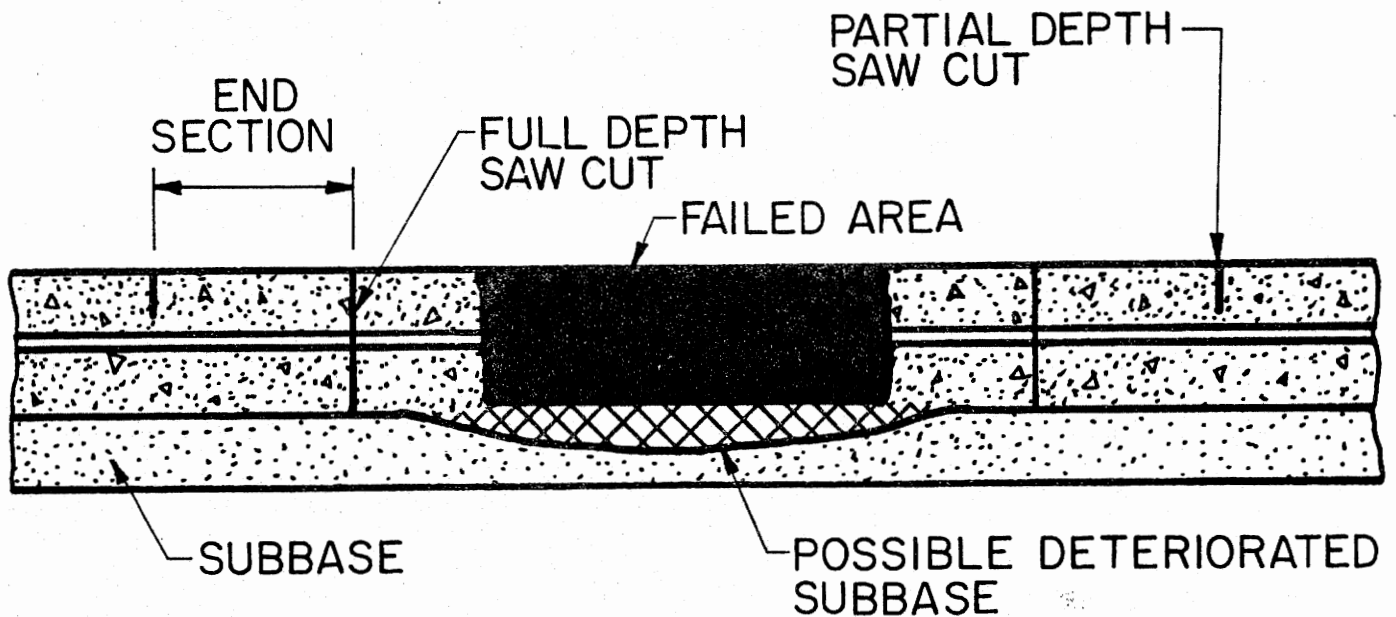

Step 1: Make one partial depth saw cut at the ends of the patch and one full depth saw cut at the proper end section lengths from the edges (18 ins. for tied steel patches, 8 ins. for welded steel patches).

Figure 8a. Center Section Lift Out Method. Partial and Full Depth Saw Cuts.

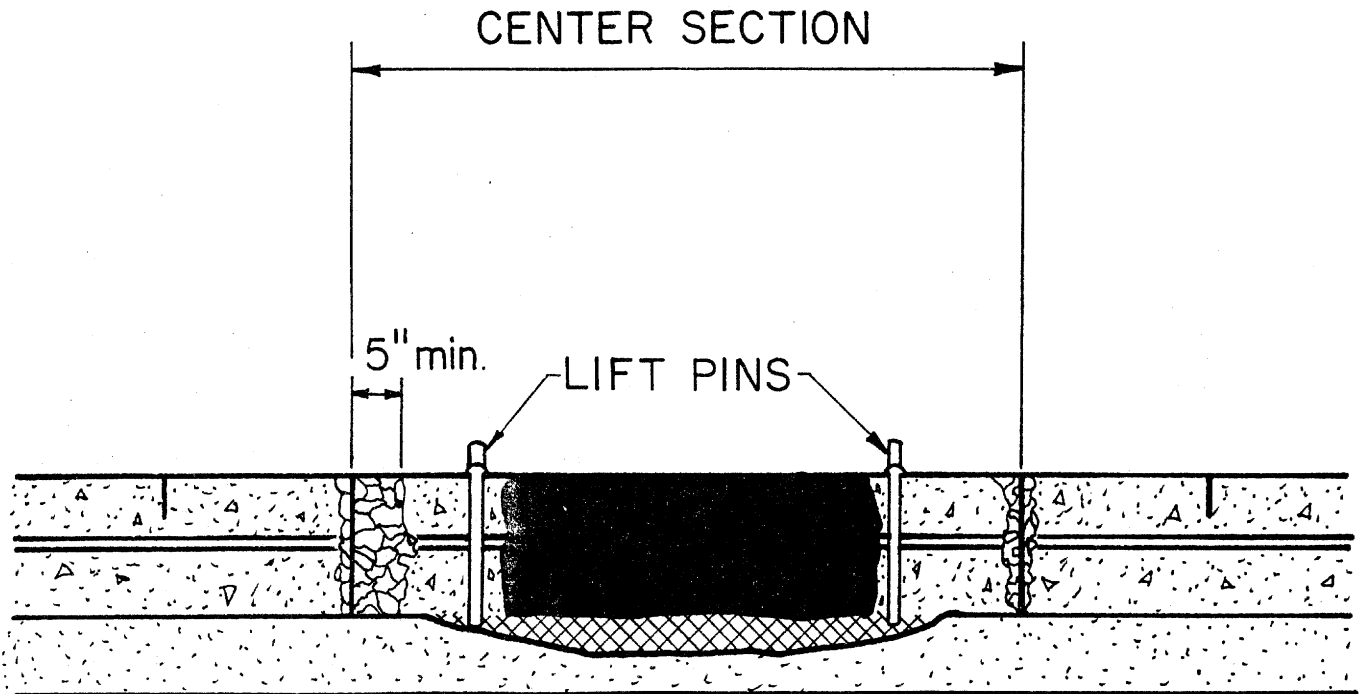

Step 2. Breakup concrete down to the steel in the center section at the full depth saw cuts and on one side extend the breakup at least 5 inches into the center section. Remove debris and cut the steel with a saw and remove. Breakup remaining concrete down to the subbase and remove. Drill the required number of holes and insert the lift pins. Carefully remove the deteriorated subbase, if any exists, making sure not to damage the remaining good subbase. The deteriorated area will be filled with Portland Cement Concrete.

Figure 8b. Center Section Lift Out Method. Removal of Center Section.



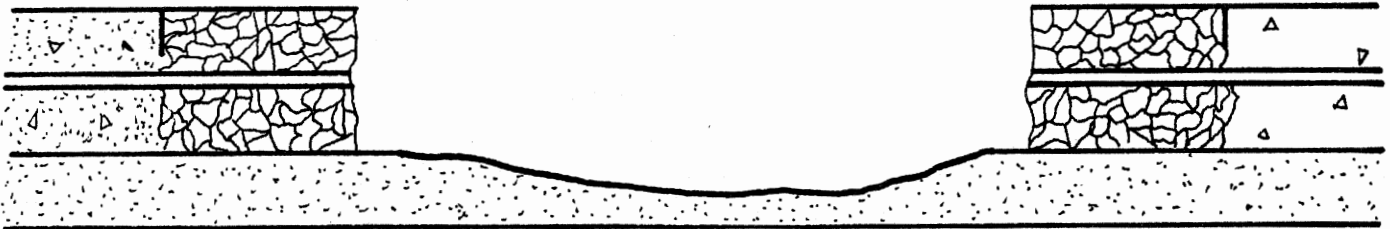

Step 3: Breakup and remove the concrete in the end sections being careful not to nick or bend the steel reinforcement. Use hand methods for breakup and removal. The rebar shall not be bent up for removal of the remaining concrete.

Figure 8c. Center Section Lift Out Method. End Section Removal.

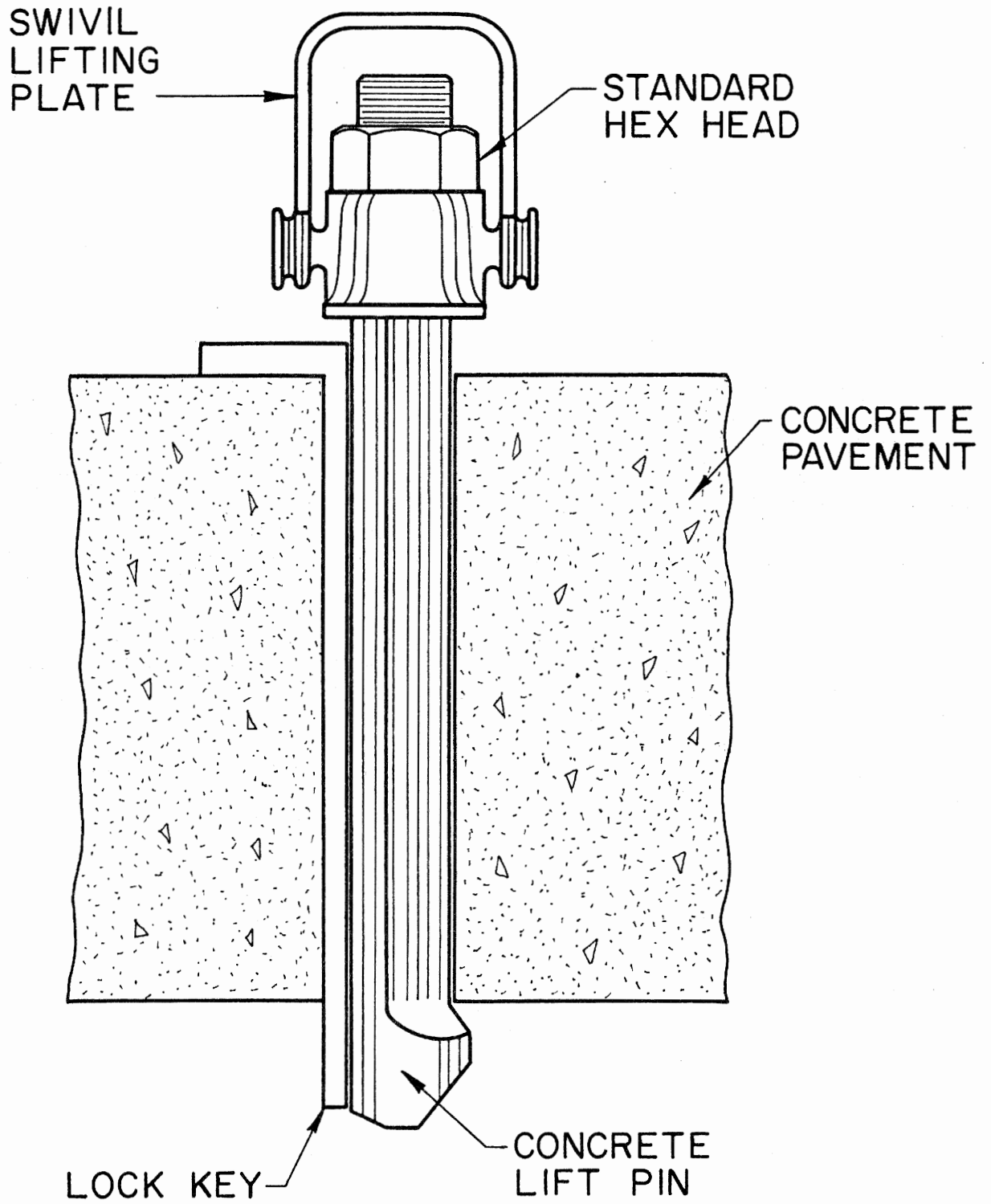

Figure 9. Typical Pin and Accessories for Lift Out of Large and Heavy Concrete Slabs.

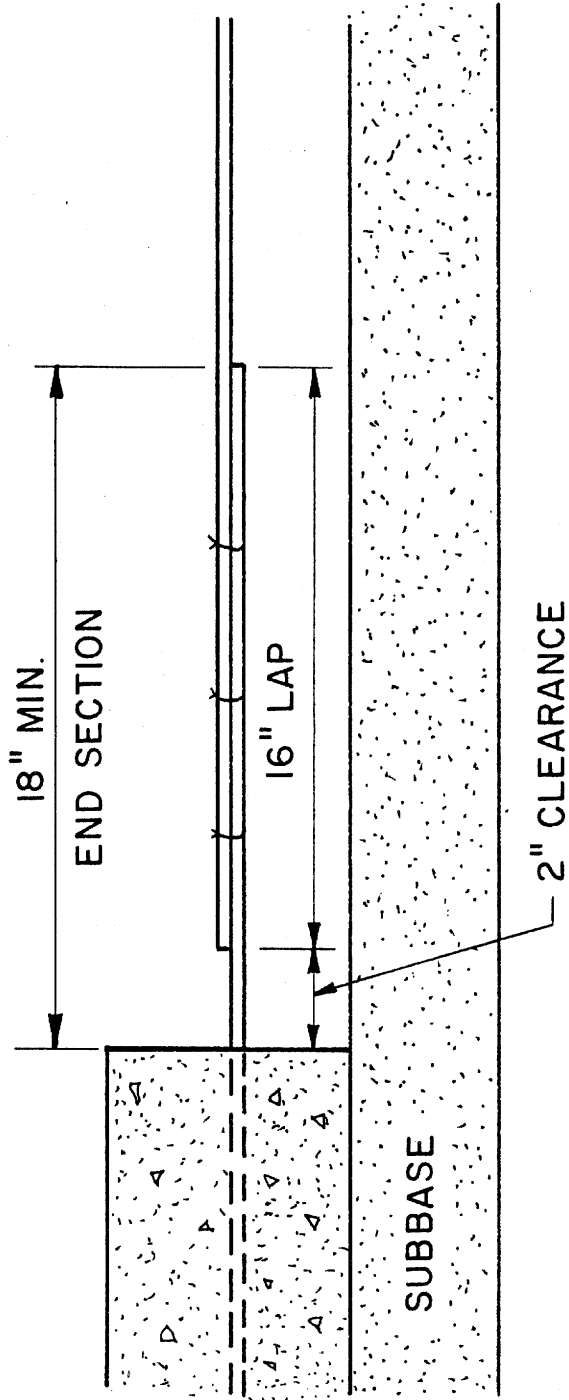
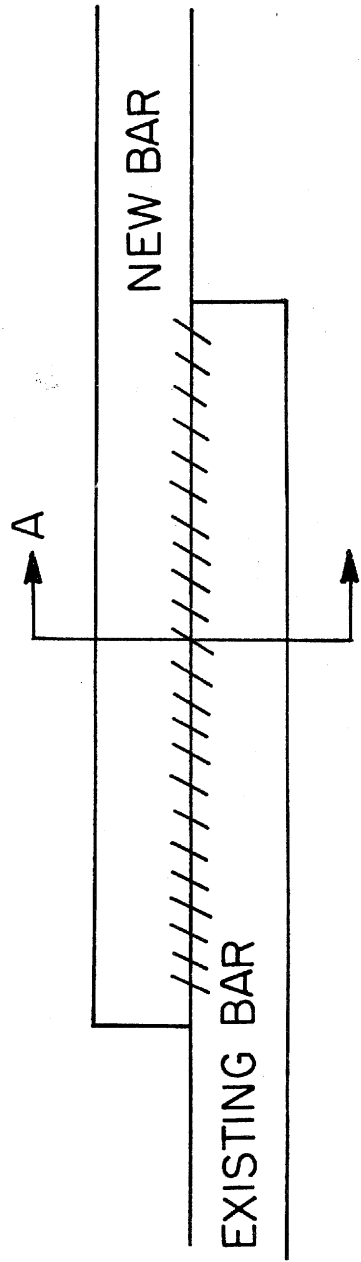

Figure 10. Tied Steel Lap Length.



SECT. A-A

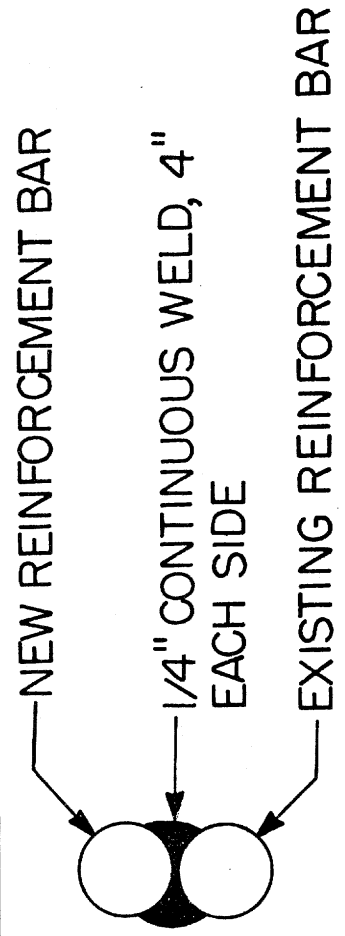

Figure 11. Weld Design Used in the Welded Splice Patch.

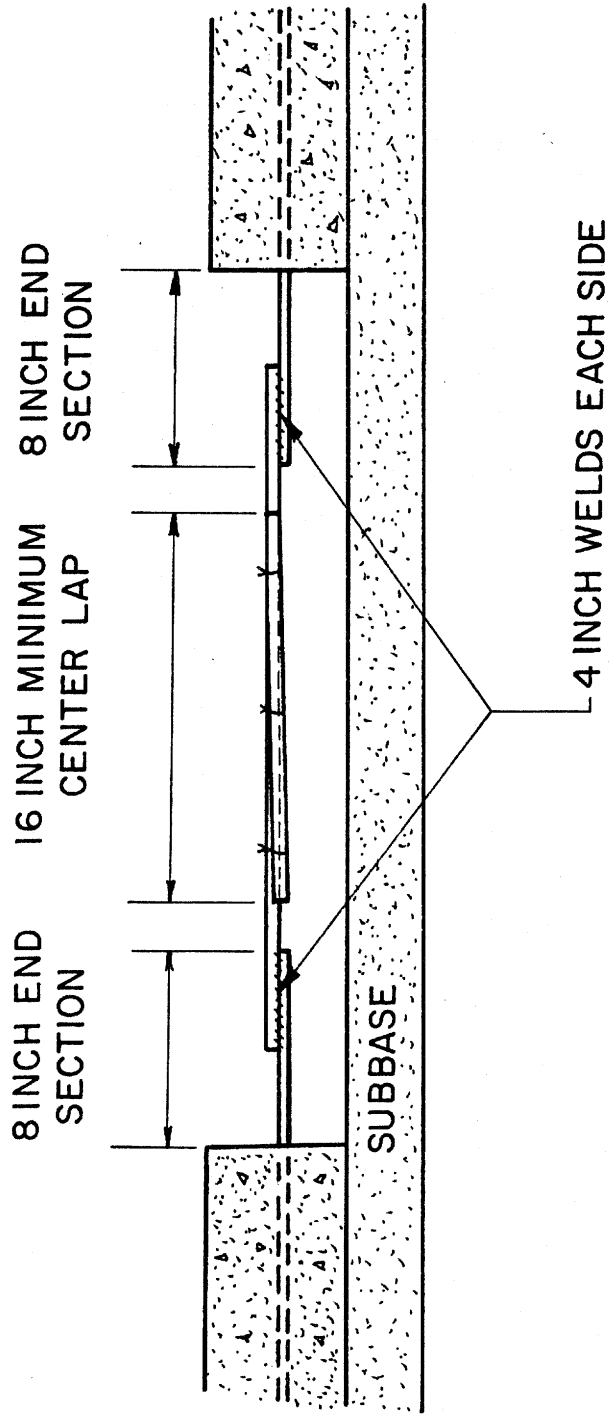

Figure 12. Minimum Center Tied Lap Length For a Welded Patch.

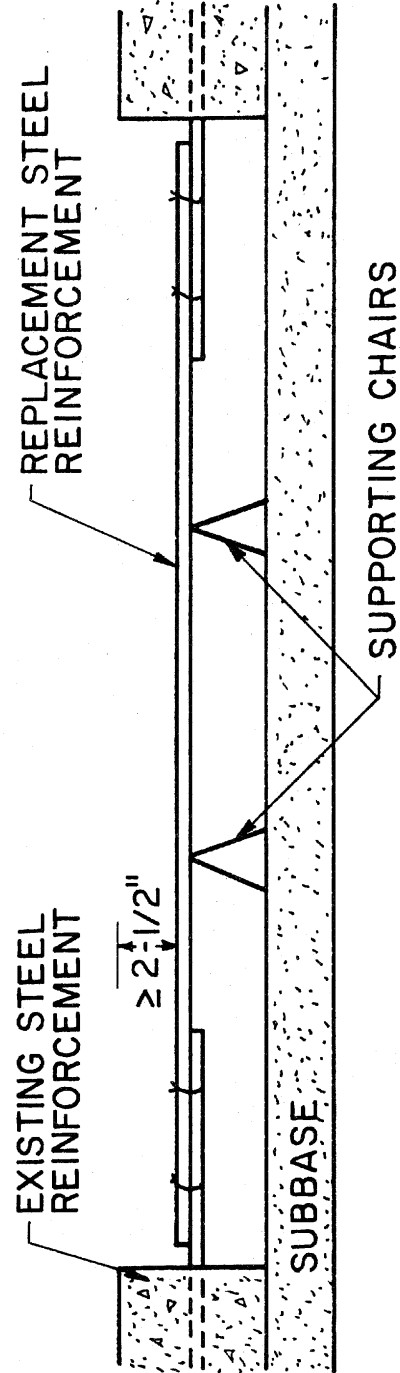

Figure 13. Replacement of Steel Reinforcement With Chairs for Support. Refer to Figures 10 and 11 for Detailed Lap Length Sections for Tied and Welded Patches.

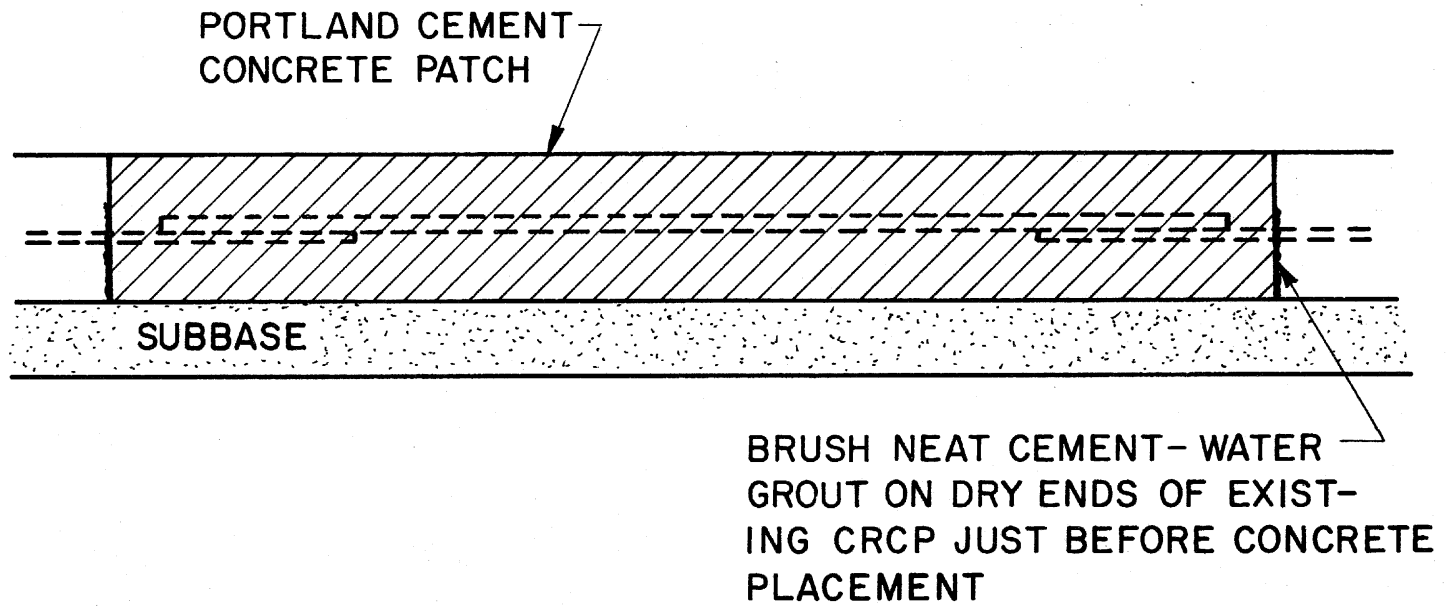

Figure 14. Placement of the Portland Cement Concrete Patch.

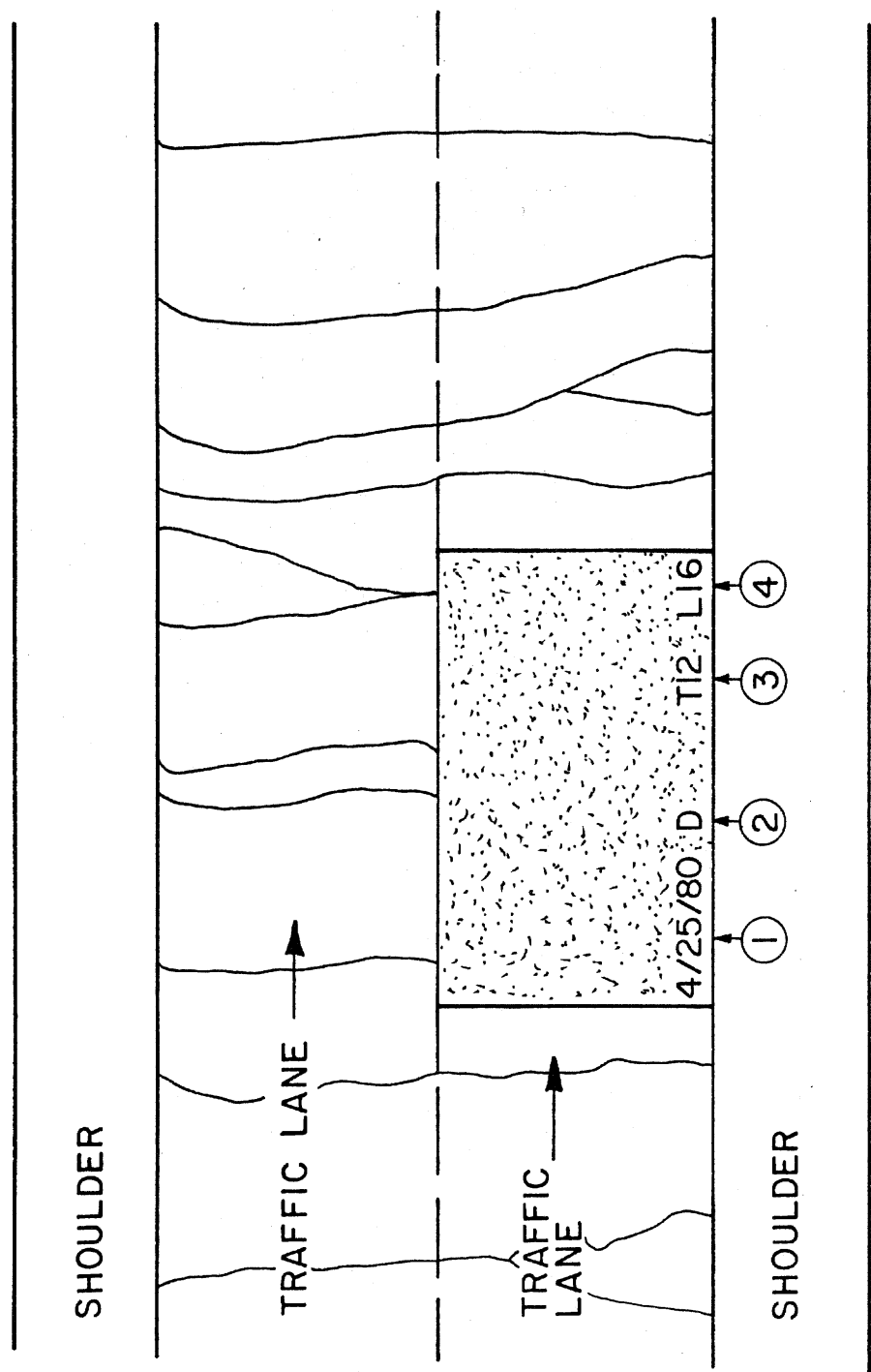

Figure 15. Dating and Identifying Patches.



