

Price List

Notice 123 ■ Effective May 12, 2008

Mailing Services	Page		
First-Class Mail®	2		
First-Class Mail International™	3		
Standard Mail® Letters and Flats	4–6		
Standard Mail Parcels and NFM's	7–8		
Periodicals	9		
Parcel Post®	10–11		
Media Mail® and Library Mail	12		
Bound Printed Matter	13–14		
Shipping Services			
Global Express Guaranteed®	15		
Express Mail®	16		
Express Mail International™	17		
Priority Mail®	18–19		
Priority Mail International™	20		
Parcel Select®	21–23		
Parcel Return Service®	24		
Extra Services			
Domestic	25–27		
International	27		
Reference			
International Price Group Map	28–29		
First-Class Mail International Shape Summary	31		
First-Class Mail Domestic Shape Summary	32		

First-Class Mail	
One Ounce Letter	\$0.42
One Ounce Large Envelope	0.83
One Ounce Parcel	1.17
Additional Ounce	0.17
Postcard	0.27
Priority Mail	
Up to 1 Pound	\$4.80
Flat-Rate Envelope	4.80
Regular Flat-Rate Box	9.80
Large Flat-Rate Box	12.95
delivered to APO/FPO addresses	10.95
Express Mail	
Flat-Rate Envelope	\$16.50

First-Class Mail—Retail

Weight Not Over (ounces)	Letters and Cards ¹	Large Envelopes ²	Packages ³
1	\$0.42	\$0.83	\$1.17
2	0.59	1.00	1.34
3	0.76	1.17	1.51
3.5	0.93 ⁴	1.34	1.68
4	—	1.34	1.68
5	—	1.51	1.85
6	—	1.68	2.02
7	—	1.85	2.19
8	—	2.02	2.36
9	—	2.19	2.53
10	—	2.36	2.70
11	—	2.53	2.87
12	—	2.70	3.04
13	—	2.87	3.21
Postcard ⁵	\$0.27	—	—

- Letters that meet one or more of the nonmachinable characteristics in DMM 101.1.2 are subject to the \$0.20 nonmachinable surcharge.
 - Pieces that are rigid, nonrectangular, or not uniformly thick pay package prices.
 - For keys and identification devices, add \$0.72. If more than 13 ounces, see Priority Mail prices.
 - For weights over 3.5 ounces, see large envelope (flat) prices.
 - The card price applies to each single or double postcard when originally mailed; reply half of double postcard must be designed for reply mail purposes only.
- See page 32 for postcard, letter, large envelope, and package dimensions.

First-Class Mail—Commercial Letters & Cards

Weight Not Over (ounces)	Automation				Nonautomation
	5-Digit	3-Digit	AADC	Mixed AADC	Presorted ¹
1	\$0.324	\$0.346	\$0.351	\$0.369	\$0.394
2	0.449	0.471	0.476	0.494	0.519
3	0.574	0.596	0.601	0.619	0.644
3.5	0.699	0.721	0.726	0.744	0.769 ²
Postcard ³	\$0.199	\$0.210	\$0.213	\$0.223	\$0.242

- Letters that meet one or more of the nonmachinable characteristics in DMM 201.2.1 are subject to the \$0.20 nonmachinable surcharge.
- The maximum weight for machinable letter preparation is 3.3 ounces.
- The card price applies to each single or double postcard when originally mailed; reply half of double postcard must be designed for reply mail purposes only.

First-Class Mail—Commercial Flats

Weight Not Over (ounces) ¹	Automation				Nonautomation
	5-Digit	3-Digit	ADC	Mixed ADC	Presorted
1	\$0.364	\$0.479	\$0.570	\$0.702	\$0.727
2	0.534	0.649	0.740	0.872	0.897
3	0.704	0.819	0.910	1.042	1.067
4	0.874	0.989	1.080	1.212	1.237
5	1.044	1.159	1.250	1.382	1.407
6	1.214	1.329	1.420	1.552	1.577
7	1.384	1.499	1.590	1.722	1.747
8	1.554	1.669	1.760	1.892	1.917
9	1.724	1.839	1.930	2.062	2.087
10	1.894	2.009	2.100	2.232	2.257
11	2.064	2.179	2.270	2.402	2.427
12	2.234	2.349	2.440	2.572	2.597
13	2.404	2.519	2.610	2.742	2.767

- Flat-size pieces with certain characteristics (see DMM 301.1.3 and 1.4) are subject to the parcel prices.

First-Class Mail—Commercial Parcels

Weight Not Over (ounces) ¹				
	5-Digit	3-Digit	ADC	Single-Piece ²
1	\$0.711	\$0.858	\$0.918	\$1.17
2	0.881	1.028	1.088	1.34
3	1.051	1.198	1.258	1.51
4	1.221	1.368	1.428	1.68
5	1.391	1.538	1.598	1.85
6	1.561	1.708	1.768	2.02
7	1.731	1.878	1.938	2.19
8	1.901	2.048	2.108	2.36
9	2.071	2.218	2.278	2.53
10	2.241	2.388	2.448	2.70
11	2.411	2.558	2.618	2.87
12	2.581	2.728	2.788	3.04
13	2.751	2.898	2.958	3.21

- Unless prepared in 5-digit/scheme sacks or paid at the single-piece prices, presorted parcels are subject to a \$0.05 surcharge if any of the following characteristics apply:
 - The parcels weigh less than 2 ounces.
 - The parcels do not bear a UCC/EAN Code 128 or POSTNET barcode for the ZIP Code of the delivery address.
 - The parcels are irregularly shaped, such as rolls, tubes, and triangles.
- Use single-piece price for mixed ADC sortation.

First-Class Mail International Retail Postcards

Canada and Mexico	\$0.72
All other countries	0.94

First-Class Mail International Retail Letters

Weight Not Over (ounces)	Price Groups			
	Canada	Mexico	3-5	6-9
1	\$0.72	\$0.72	\$0.94	\$0.94
2	0.96	1.27	1.74	1.69
3	1.20	1.82	2.54	2.44
3.5	1.44	2.37	3.34	3.19

Letters that meet one or more of the nonmachinable characteristics in IMM 243.23 are subject to the \$0.20 nonmachinable surcharge.

First-Class Mail International Retail Large Envelopes

Weight Not Over (ounces)	Price Groups			
	Canada	Mexico	3-5	6-9
1	\$0.98	\$0.98	\$1.20	\$1.20
2	1.22	1.53	2.00	1.95
3	1.46	2.08	2.80	2.70
4	1.70	2.63	3.60	3.45
5	1.94	3.18	4.40	4.20
6	2.18	3.73	5.20	4.95
7	2.42	4.28	6.00	5.70
8	2.66	4.83	6.80	6.45
12	3.61	6.33	8.45	8.05
16	4.56	7.83	10.10	9.65
20	5.51	9.33	11.75	11.25
24	6.46	10.83	13.40	12.85
28	7.41	12.33	15.05	14.45
32	8.36	13.83	16.70	16.05
36	9.31	15.33	18.35	17.65
40	10.26	16.83	20.00	19.25
44	11.21	18.33	21.65	20.85
48	12.16	19.83	23.30	22.45
52	13.11	21.33	24.95	24.05
56	14.06	22.83	26.60	25.65
60	15.01	24.33	28.25	27.25
64	15.96	25.83	29.90	28.85

Pieces that are rigid, nonrectangular, or not uniformly thick pay package prices.

For a listing of countries by price group, see pages 28 and 29.

For First-Class Mail International retail postcard, letter, large envelope, and package dimensions, see page 31.

First-Class Mail International Retail Packages

Weight Not Over (ounces)	Price Groups			
	Canada	Mexico	3-5	6-9
1	\$1.18	\$1.18	\$1.40	\$1.40
2	1.42	1.73	2.20	2.15
3	1.66	2.28	3.00	2.90
4	1.90	2.83	3.80	3.65
5	2.14	3.38	4.60	4.40
6	2.38	3.93	5.40	5.15
7	2.62	4.48	6.20	5.90
8	2.86	5.03	7.00	6.65
12	3.81	6.53	8.65	8.25
16	4.76	8.03	10.30	9.85
20	5.71	9.53	11.95	11.45
24	6.66	11.03	13.60	13.05
28	7.61	12.53	15.25	14.65
32	8.56	14.03	16.90	16.25
36	9.51	15.53	18.55	17.85
40	10.46	17.03	20.20	19.45
44	11.41	18.53	21.85	21.05
48	12.36	20.03	23.50	22.65
52	13.31	21.53	25.15	24.25
56	14.26	23.03	26.80	25.85
60	15.21	24.53	28.45	27.45
64	16.16	26.03	30.10	29.05

For a listing of countries by price group, see pages 28 and 29.

Standard Mail Regular—Letters Enhanced Carrier Route & Automation

Entry Discount		Enhanced Carrier Route (ECR) ¹			Automation			
		Saturation	High Density	Basic	5-Digit	3-Digit	AADC	Mixed AADC
Letters weighing 3.3 oz. or less	None	\$0.179	\$0.190	\$0.234	\$0.225	\$0.241	\$0.244	\$0.257
	DBMC	0.146	0.157	0.201	0.192	0.208	0.211	0.224
	DSCF	0.137	0.148	0.192	0.183	0.199	0.202	—
	DDU	—	—	—	—	—	—	—
per piece price	None	\$0.604	\$0.604	\$0.635	\$0.733	\$0.733	\$0.733	\$0.733
	DBMC	0.445	0.445	0.476	0.574	0.574	0.574	0.574
	DSCF	0.401	0.401	0.432	0.530	0.530	0.530	—
	DDU	—	—	—	—	—	—	—
more than 3.3 oz.²	None	\$0.604	\$0.604	\$0.635	\$0.733	\$0.733	\$0.733	\$0.733
	DBMC	0.445	0.445	0.476	0.574	0.574	0.574	0.574
	DSCF	0.401	0.401	0.432	0.530	0.530	0.530	—
	DDU	—	—	—	—	—	—	—
per pound price	None	\$0.604	\$0.604	\$0.635	\$0.733	\$0.733	\$0.733	\$0.733
	DBMC	0.445	0.445	0.476	0.574	0.574	0.574	0.574
	DSCF	0.401	0.401	0.432	0.530	0.530	0.530	—
	DDU	—	—	—	—	—	—	—
+ per piece price	None	0.054 ³	0.065 ³	0.103 ³	0.074 ³	0.090 ³	0.093 ³	0.106 ³
	DBMC	0.054 ³	0.065 ³	0.103 ³	0.074 ³	0.090 ³	0.093 ³	0.106 ³
	DSCF	0.054 ³	0.065 ³	0.103 ³	0.074 ³	0.090 ³	0.093 ³	0.106 ³
	DDU	0.054 ³	0.065 ³	0.103 ³	0.074 ³	0.090 ³	0.093 ³	0.106 ³

- ECR letters that are not automation-compatible and barcoded (DMM 201.3) are mailable at the flat-size prices (DMM 243.6). Mailers may not pay ECR flat-size prices and claim DDU discounts for letter-size pieces.
- For pieces weighing more than 3.3 ounces, each piece is subject to both a per piece price and a per pound price. Multiply the number of pieces in the mailing by the per piece price. Multiply the number of pounds in the mailing by the per pound price. Add both totals.
- Per piece price for ECR letters and automation letters that weigh more than 3.3 ounces but less than (or equal to) 3.5 ounces includes a discount that equals the applicable flat-size price (3.3 ounces or less) minus the applicable letter piece price (3.3 ounces or less).

Standard Mail Regular—Letters Nonautomation

Entry Discount		Machinable		Nonmachinable ¹			
		AADC	Mixed AADC	5-Digit	3-Digit	ADC	Mixed ADC
Letters weighing 3.3 oz. or less	None	\$0.258	\$0.260	\$0.343	\$0.438	\$0.461	\$0.561
	DBMC	0.225	0.227	0.310	0.405	0.428	0.528
	DSCF	0.216	—	0.301	0.396	0.419	—
	DDU	—	—	—	—	—	—
per piece price	None	\$0.258	\$0.260	\$0.343	\$0.438	\$0.461	\$0.561
	DBMC	0.225	0.227	0.310	0.405	0.428	0.528
	DSCF	0.216	—	0.301	0.396	0.419	—
	DDU	—	—	—	—	—	—

- For pieces over 3.3 ounces, see Standard Mail Not Flat-Machinable prices.

Standard Mail Nonprofit—Letters Enhanced Carrier Route & Automation

		Enhanced Carrier Route (ECR) ¹			Automation			
		Saturation	High Density	Basic	5-Digit	3-Digit	AADC	Mixed AADC
Letters weighing 3.3 oz. or less	None	\$0.108	\$0.119	\$0.159	\$0.127	\$0.143	\$0.146	\$0.159
	DBMC	0.075	0.086	0.126	0.094	0.110	0.113	0.126
	DSCF	0.066	0.077	0.117	0.085	0.101	0.104	—
	DDU	—	—	—	—	—	—	—
per piece price								
more than 3.3 oz.²	None	\$0.415	\$0.415	\$0.446	\$0.632	\$0.632	\$0.632	\$0.632
	DBMC	0.256	0.256	0.287	0.473	0.473	0.473	0.473
	DSCF	0.212	0.212	0.243	0.429	0.429	0.429	—
	DDU	—	—	—	—	—	—	—
per pound price								
+ per piece price		0.022 ³	0.033 ³	0.067 ³	-0.003 ³	0.013 ³	0.016 ³	0.029 ³

1. ECR letters that are not automation-compatible and barcoded (DMM 201.3) are mailable at the flat-size price (DMM 243.6). Mailers may not pay ECR flat-size prices and claim DDU discounts for letter-size pieces.
2. For pieces weighing more than 3.3 ounces, each piece is subject to both a per piece price and a per pound price. Multiply the number of pieces in the mailing by the per piece price. Multiply the number of pounds in the mailing by the per pound price. Add both totals.
3. Per piece price for ECR letters and automation letters that weigh more than 3.3 ounces but less than (or equal to) 3.5 ounces includes a discount that equals the applicable flat-size price (3.3 ounces or less) minus the applicable letter piece price (3.3 ounces or less).

Standard Mail Nonprofit—Letters Nonautomation

		Machinable		Nonmachinable ¹			
		AADC	Mixed AADC	5-Digit	3-Digit	ADC	Mixed ADC
Letters weighing 3.3 oz. or less	None	\$0.160	\$0.162	\$0.245	\$0.340	\$0.363	\$0.463
	DBMC	0.127	0.129	0.212	0.307	0.330	0.430
	DSCF	0.118	—	0.203	0.298	0.321	—
	DDU	—	—	—	—	—	—
per piece price							

1. For pieces over 3.3 ounces, see Standard Mail Not Flat-Machinable prices.

Standard Mail Regular—Flats

		Enhanced Carrier Route (ECR) ¹			Automation ¹				Nonautomation ¹			
		Entry Discount	Saturation ²	High Density	Basic	5-Digit	3-Digit	ADC	Mixed ADC	5-Digit	3-Digit	ADC
Flats weighing 3.3 oz. or less	None	\$0.191	\$0.210	\$0.255	\$0.339	\$0.400	\$0.436	\$0.489	\$0.366	\$0.451	\$0.483	\$0.553
	DBMC	0.158	0.177	0.222	0.306	0.367	0.403	0.456	0.333	0.418	0.450	0.520
	DSCF	0.149	0.168	0.213	0.297	0.358	0.394	—	0.324	0.409	0.441	—
	per piece price	DDU	0.140	0.159	0.204	—	—	—	—	—	—	—
more than 3.3 oz.³	None	\$0.604	\$0.604	\$0.635	\$0.733	\$0.733	\$0.733	\$0.733	\$0.733	\$0.733	\$0.733	\$0.733
	DBMC	0.445	0.445	0.476	0.574	0.574	0.574	0.574	0.574	0.574	0.574	0.574
	DSCF	0.401	0.401	0.432	0.530	0.530	0.530	—	0.530	0.530	0.530	—
	per pound price	DDU	0.356	0.356	0.387	—	—	—	—	—	—	—
+		+	+	+	+	+	+	+	+	+	+	+
per piece price		0.066	0.085	0.124	0.188	0.249	0.285	0.338	0.215	0.300	0.332	0.402

1. Flat-size pieces with certain characteristics (see DMM 301.1.3 and 1.4) are subject to Not Flat-Machinable or parcel prices.
2. For ECR flats with a detached address label, add \$0.017 per piece.
3. For pieces weighing more than 3.3 ounces, each piece is subject to both a per piece price and a per pound price. Multiply the number of pieces in the mailing by per piece price. Multiply the number of pounds in the mailing by the per pound price. Add both totals.

Standard Mail Nonprofit—Flats

		Enhanced Carrier Route (ECR) ¹			Automation ¹				Nonautomation ¹			
		Entry Discount	Saturation ²	High Density	Basic	5-Digit	3-Digit	ADC	Mixed ADC	5-Digit	3-Digit	ADC
Flats weighing 3.3 oz. or less	None	\$0.118	\$0.137	\$0.185	\$0.206	\$0.267	\$0.303	\$0.356	\$0.233	\$0.318	\$0.350	\$0.420
	DBMC	0.085	0.104	0.152	0.173	0.234	0.270	0.323	0.200	0.285	0.317	0.387
	DSCF	0.076	0.095	0.143	0.164	0.225	0.261	—	0.191	0.276	0.308	—
	per piece price	DDU	0.067	0.086	0.134	—	—	—	—	—	—	—
more than 3.3 oz.³	None	\$0.415	\$0.415	\$0.446	\$0.632	\$0.632	\$0.632	\$0.632	\$0.632	\$0.632	\$0.632	\$0.632
	DBMC	0.256	0.256	0.287	0.473	0.473	0.473	0.473	0.473	0.473	0.473	0.473
	DSCF	0.212	0.212	0.243	0.429	0.429	0.429	—	0.429	0.429	0.429	—
	per pound price	DDU	0.167	0.167	0.198	—	—	—	—	—	—	—
+		+	+	+	+	+	+	+	+	+	+	+
per piece price		0.032	0.051	0.093	0.076	0.137	0.173	0.226	0.103	0.188	0.220	0.290

1. Flat-size pieces with certain characteristics (see DMM 301.1.3 and 1.4) are subject to Not Flat-Machinable or parcel prices.
2. For ECR flats with a detached address label, add \$0.017 per piece.
3. For pieces weighing more than 3.3 ounces, each piece is subject to both a per piece price and a per pound price. Multiply the number of pieces in the mailing by per piece price. Multiply the number of pounds in the mailing by the per pound price. Add both totals.

Standard Mail Regular—Parcels

		Enhanced Carrier Route (ECR)			Machinable ¹			Irregular ¹			
		Saturation ²	High Density	Basic	5-Digit	BMC	Mixed BMC	5-Digit	3-Digit	ADC	Mixed ADC
Parcels weighing 3.3 oz. or less	None	\$0.389	\$0.405	\$0.519	—	—	—	\$0.708	\$0.761	\$1.080	\$1.330
	DBMC	0.356	0.372	0.486	—	—	—	0.675	0.728	1.047	1.297
	DSCF	0.346	0.362	0.476	—	—	—	0.665	0.718	1.037	—
	DDU	0.321	0.337	0.451	—	—	—	0.640	—	—	—
more than 3.3 oz.³	None	\$0.604	\$0.604	\$0.635	\$0.733	\$0.733	\$0.733	\$0.733	\$0.733	\$0.733	\$0.733
	DBMC	0.445	0.445	0.476	0.574	0.574	—	0.574	0.574	0.574	0.574
	DSCF	0.395	0.395	0.426	0.524	—	—	0.524	0.524	0.524	—
	DDU	0.273	0.273	0.304	0.402	—	—	0.402	—	—	—
per piece price		+	+	+	+	+	+	+	+	+	
per piece price		0.264	0.280	0.388	0.400	0.799	1.007	0.557	0.610	0.929	1.179

1. For nonbarcoded parcels, add \$0.05 per piece. The surcharge does not apply to pieces sorted to 5-digit ZIP Codes.
2. For ECR parcels with a detached address label, add \$0.017 per piece.
3. For pieces weighing more than 3.3 ounces, each piece is subject to both a per piece price and a per pound price. Multiply the number of pieces in the mailing by per piece price. Multiply the number of pounds in the mailing by per pound price. Add both totals.

Standard Mail Nonprofit—Parcels

		Enhanced Carrier Route (ECR)			Machinable ¹			Irregular ¹			
		Saturation ²	High Density	Basic	5-Digit	BMC	Mixed BMC	5-Digit	3-Digit	ADC	Mixed ADC
Parcels weighing 3.3 oz. or less	None	\$0.300	\$0.316	\$0.449	—	—	—	\$0.528	\$0.581	\$0.900	\$1.150
	DBMC	0.267	0.283	0.416	—	—	—	0.495	0.548	0.867	1.117
	DSCF	0.257	0.273	0.406	—	—	—	0.485	0.538	0.857	—
	DDU	0.232	0.248	0.381	—	—	—	0.460	—	—	—
more than 3.3 oz.³	None	\$0.415	\$0.415	\$0.446	\$0.633	\$0.633	\$0.633	\$0.633	\$0.633	\$0.633	\$0.633
	DBMC	0.256	0.256	0.287	0.474	0.474	—	0.474	0.474	0.474	0.474
	DSCF	0.206	0.206	0.237	0.424	—	—	0.424	0.424	0.424	—
	DDU	0.084	0.084	0.115	0.302	—	—	0.302	—	—	—
per pound price		+	+	+	+	+	+	+	+	+	
per piece price		0.214	0.230	0.357	0.280	0.679	0.887	0.397	0.450	0.769	1.019

1. For nonbarcoded parcels, add \$0.05 per piece. The surcharge does not apply to pieces sorted to 5-digit ZIP Codes.
2. For ECR parcels with a detached address label, add \$0.017 per piece.
3. For pieces weighing more than 3.3 ounces, each piece is subject to both a per piece price and a per pound price. Multiply the number of pieces in the mailing by per piece price. Multiply the number of pounds in the mailing by per pound price. Add both totals.

Standard Mail Regular—Not Flat-Machinable

		Not Flat-Machinable ¹			
		5-Digit	3-Digit	ADC/ BMC	Mixed ADC/ Mixed BMC
Pieces weighing 3.3 oz. or less	None	\$0.519	\$0.580	\$0.871	\$1.183
	DBMC	0.486	0.547	0.838	1.150
	DSCF	0.476	0.537	0.828	—
	DDU	0.451	—	—	—
per piece price					
more than 3.3 oz.²	None	\$0.733	\$0.733	\$0.733	\$0.733
	DBMC	0.574	0.574	0.574	0.574
	DSCF	0.524	0.524	0.524	—
	DDU	0.402	—	—	—
per pound price					
+		+	+	+	+
per piece price		0.368	0.429	0.720	1.032

1. For nonbarcoded pieces, add \$0.05 per piece. The surcharge does not apply to pieces sorted to 5-digit ZIP Codes or to nonmachinable letters over 3.3 ounces paying NFM prices.
2. For pieces weighing more than 3.3 ounces, each piece is subject to both a per piece price and a per pound price. Multiply the number of pieces in the mailing by the per piece price. Multiply the number of pounds in the mailing by the per pound price. Add both totals.

Standard Mail Nonprofit—Not Flat-Machinable

		Not Flat-Machinable ¹			
		5-Digit	3-Digit	ADC/ BMC	Mixed ADC/ Mixed BMC
Pieces weighing 3.3 oz. or less	None	\$0.353	\$0.414	\$0.705	\$1.017
	DBMC	0.320	0.381	0.672	0.984
	DSCF	0.310	0.371	0.662	—
	DDU	0.285	—	—	—
per piece price					
more than 3.3 oz.²	None	\$0.633	\$0.633	\$0.633	\$0.633
	DBMC	0.474	0.474	0.474	0.474
	DSCF	0.424	0.424	0.424	—
	DDU	0.302	—	—	—
per pound price					
+		+	+	+	+
per piece price		0.222	0.283	0.574	0.886

1. For nonbarcoded pieces, add \$0.05 per piece. The surcharge does not apply to pieces sorted to 5-digit ZIP Codes or to nonmachinable letters over 3.3 ounces paying NFM prices.
2. For pieces weighing more than 3.3 ounces, each piece is subject to both a per piece price and a per pound price. Multiply the number of pieces in the mailing by the per piece price. Multiply the number of pounds in the mailing by the per pound price. Add both totals.

Periodicals

Outside-County

Pound Prices—per pound or fraction

Advertising Portion			Nonadvertising Portion		
Zone	Regular Price	Science-of-Agriculture	Zone	Regular Price	Science-of-Agriculture
DDU	\$0.165	\$0.124	DDU	\$0.137	\$0.137
DSCF	0.215	0.162	DSCF	0.179	0.179
DADC	0.225	0.169	DADC	0.187	0.187
1 & 2	0.246	0.184	Other	0.205	0.205
3	0.265	0.265			
4	0.312	0.312			
5	0.383	0.383			
6	0.459	0.459			
7	0.550	0.550			
8	0.628	0.628			

Preferred Price Discounts: Authorized nonprofit and classroom publications and publications that meet the standards for limited circulation publications receive a discount of 5% off the total Outside-County postage excluding the postage for advertising pounds. The 5% discount does not apply to commingled nonsubscriber or nonrequester copies in excess of the 10% allowance in DMM 707.7.

Ride-Along Price—per piece: \$0.159

Piece Prices—per addressed piece

Bundle Level	Letters		Machinable Flats		Nonmachinable Flats		Parcels
	Barcoded	Nonbarcoded	Barcoded	Nonbarcoded	Barcoded	Nonbarcoded	
5-Digit	\$0.217	\$0.284	\$0.276	\$0.284	\$0.293	\$0.298	\$0.298
3-Digit/SCF	0.283	0.358	0.341	0.358	0.373	0.384	0.384
ADC	0.298	0.381	0.360	0.381	0.424	0.445	0.445
MXD ADC	0.337	0.444	0.416	0.444	0.519	0.550	0.550

All firm bundles—\$0.174

All Carrier Route pieces: Saturation—\$0.135; High Density—\$0.153; Basic—\$0.174

Nonadvertising adjustment factor for each 1% of nonadvertising content: \$0.00094

Bundle Prices—per bundle

Bundle Level	Container Level			
	CR/5-Digit	3-Digit/SCF	ADC	MXD ADC
Firm	\$0.028	\$0.046	\$0.049	\$0.081
Carrier Route	0.040	0.098	0.107	—
5-Digit	0.008	0.086	0.098	0.166
3-Digit/SCF	—	0.040	0.065	0.138
ADC	—	—	0.039	0.133
MXD ADC	—	—	—	0.103

Container Prices—per pallet, sack, or tray

Entry	Pallet			Tray/Sack			
	5-Digit	3-Digit/SCF	ADC	CR/5-Digit	3-Digit/SCF	ADC	MXD ADC
Destination Delivery Unit	\$1.236	—	—	\$0.721	—	—	—
Destination SCF	8.237	\$6.898	—	0.927	\$0.618	—	—
Destination ADC	15.959	12.561	\$9.163	1.338	1.030	\$0.618	—
Destination BMC	18.018	14.826	13.385	1.544	1.236	1.132	—
Origin	27.748	23.660	19.161	2.306	1.956	1.853	\$0.432

In-County

Pound Prices—per pound or fraction

Zone	Price
Destination Delivery Unit	\$0.136
All other zones	0.176

Ride-Along Price—per piece: \$0.159

Piece Prices—per addressed piece

Presort Level	Automation		Nonautomation
	Letters	Flats	Letters, Flats, & Parcels
Carrier Route			
<i>Saturation</i>	—	—	\$0.029
<i>High Density</i>	—	—	0.042
<i>Basic</i>	—	—	0.057
5-Digit	\$0.045	\$0.095	0.101
3-Digit	0.047	0.102	0.113
Basic	0.056	0.110	0.125

Destination delivery unit (DDU) discount for each addressed piece: \$0.008

Parcel Post—Local and Intra-BMC/ASF

Machinable ^{1, 2, 3}					Weight Not Over (pounds)	Nonmachinable ^{1, 2, 3, 4}				
Zone						Zone				
Local	1 & 2	3	4	5		Local	1 & 2	3	4	5
\$3.67	\$4.02	\$4.05	\$4.14	\$4.33	1	\$6.40	\$6.75	\$6.78	\$6.87	\$7.06
4.11	4.50	4.80	4.89	5.16	2	6.84	7.23	7.53	7.62	7.89
4.51	5.00	5.48	5.60	5.97	3	7.24	7.73	8.21	8.33	8.70
4.88	5.70	6.11	6.23	6.71	4	7.61	8.43	8.84	8.96	9.44
5.21	6.29	6.65	6.80	7.40	5	7.94	9.02	9.38	9.53	10.13
5.51	6.67	7.15	7.30	8.01	6	8.24	9.40	9.88	10.03	10.74
5.74	7.03	7.60	7.77	8.60	7	8.47	9.76	10.33	10.50	11.33
5.93	7.61	8.03	8.21	9.13	8	8.66	10.34	10.76	10.94	11.86
6.13	7.93	8.42	8.65	9.62	9	8.86	10.66	11.15	11.38	12.35
6.32	8.27	8.84	9.34	10.08	10	9.05	11.00	11.57	12.07	12.81
6.49	8.56	9.18	9.70	10.50	11	9.22	11.29	11.91	12.43	13.23
6.67	8.87	9.52	10.05	10.90	12	9.40	11.60	12.25	12.78	13.63
6.84	9.07	9.82	10.38	11.28	13	9.57	11.80	12.55	13.11	14.01
7.00	9.24	10.10	10.74	11.62	14	9.73	11.97	12.83	13.47	14.35
7.15	9.41	10.39	11.03	11.94	15	9.88	12.14	13.12	13.76	14.67
7.31	9.57	10.69	11.31	12.26	16	10.04	12.30	13.42	14.04	14.99
7.45	9.77	10.96	11.62	12.54	17	10.18	12.50	13.69	14.35	15.27
7.59	9.91	11.22	11.87	12.81	18	10.32	12.64	13.95	14.60	15.54
7.72	10.07	11.49	12.13	13.07	19	10.45	12.80	14.22	14.86	15.80
7.87	10.24	11.75	12.35	13.30	20	10.60	12.97	14.48	15.08	16.03
7.99	10.36	11.99	12.58	13.53	21	10.72	13.09	14.72	15.31	16.26
8.12	10.53	12.23	12.82	13.74	22	10.85	13.26	14.96	15.55	16.47
8.25	10.64	12.48	13.06	13.97	23	10.98	13.37	15.21	15.79	16.70
8.38	10.79	12.71	13.30	14.16	24	11.11	13.52	15.44	16.03	16.89
8.50	10.91	12.93	13.52	14.36	25	11.23	13.64	15.66	16.25	17.09
8.61	11.06	13.14	13.75	14.52	26	11.34	13.79	15.87	16.48	17.25
8.73	11.18	13.37	13.97	14.69	27	11.46	13.91	16.10	16.70	17.42
8.84	11.29	13.59	14.17	14.88	28	11.57	14.02	16.32	16.90	17.61
8.96	11.42	13.80	14.38	15.10	29	11.69	14.15	16.53	17.11	17.83
9.08	11.54	13.99	14.57	15.30	30	11.81	14.27	16.72	17.30	18.03
9.18	11.66	14.17	14.77	15.52	31	11.91	14.39	16.90	17.50	18.25
9.26	11.78	14.38	14.97	15.70	32	11.99	14.51	17.11	17.70	18.43
9.38	11.89	14.55	15.14	15.90	33	12.11	14.62	17.28	17.87	18.63
9.45	12.00	14.67	15.33	16.09	34	12.18	14.73	17.40	18.06	18.82
9.53	12.10	14.84	15.51	16.27	35	12.26	14.83	17.57	18.24	19.00
					36	12.34	14.93	17.69	18.40	19.18
					37	12.40	15.06	17.82	18.57	19.35
					38	12.46	15.16	17.96	18.74	19.53
					39	12.56	15.27	18.10	18.89	19.69
					40	12.65	15.34	18.21	19.06	19.86
					41	12.74	15.49	18.38	19.16	20.02
					42	12.80	15.55	18.49	19.28	20.17
					43	12.89	15.64	18.61	19.35	20.33
					44	12.99	15.76	18.73	19.44	20.47
					45	13.06	15.83	18.83	19.68	20.61
					46	13.11	15.97	18.96	19.76	20.87
					47	13.21	16.07	19.06	19.84	21.30
					48	13.27	16.14	19.19	19.90	21.75
					49	13.34	16.25	19.30	19.97	22.18
					50	13.41	16.30	19.40	20.03	22.64
					51	13.50	16.43	19.48	20.11	23.10
					52	13.55	16.53	19.64	20.17	23.59
					53	13.63	16.57	19.71	20.21	24.08
					54	13.72	16.65	19.77	20.28	24.58
					55	13.79	16.74	19.84	20.35	24.79
					56	13.83	16.83	19.90	20.43	24.88
					57	13.91	16.93	19.92	20.46	25.03
					58	13.99	17.01	19.99	20.51	25.13
					59	14.06	17.10	20.03	20.57	25.24
					60	14.09	17.19	20.06	20.60	25.36
					61	14.22	17.28	20.13	20.67	25.46
					62	14.25	17.36	20.17	20.75	25.56
					63	14.34	17.44	20.20	20.85	25.65
					64	14.40	17.52	20.23	20.94	25.76
					65	14.46	17.61	20.28	21.03	25.84
					66	14.50	17.71	20.32	21.13	25.96
					67	14.62	17.79	20.35	21.24	26.04
					68	14.68	17.82	20.38	21.29	26.13
					69	14.69	17.93	20.41	21.39	26.22
					70	14.70	18.01	20.46	21.49	26.31
					Oversized	31.56	45.75	46.18	47.10	48.49

For parcels over 35 pounds, use nonmachinable prices.

- For parcels that originate and destinate in the same BMC service area (see DMM 153.1.1).
- Parcels that measure in combined length and girth:
 - More than 84 inches but not more than 108 inches, and weigh less than 20 pounds, use 20-pound price (balloon price).
 - More than 108 inches but not more than 130 inches, use the oversized price regardless of weight.
- Regardless of weight, a parcel that meets any of the criteria in DMM 101.7.2 must pay the nonmachinable prices.
- Prices include the \$2.73 nonmachinable surcharge. The nonmachinable surcharge does not apply to parcels mailed at oversized prices or parcels sent with special handling.

To compute Parcel Post prices, go to Postal Explorer at pe.usps.com and click on "Retail/Single Piece" under Price Calculators in the left frame. For zone charts, click on "Zone Charts."

Parcel Post—Inter-BMC/ASF

Machinable ^{1, 2, 3}							Weight Not Over (pounds)	Nonmachinable ^{1, 2, 3, 4}						
Zone								Zone						
1 & 2	3	4	5	6	7	8	1 & 2	3	4	5	6	7	8	
\$4.55	\$4.55	\$4.55	\$4.55	\$4.55	\$4.55	\$4.55	1	\$8.25	\$8.25	\$8.25	\$8.25	\$8.25	\$8.25	
4.55	4.85	5.35	5.94	6.13	6.35	6.67	2	8.25	8.55	9.05	9.64	9.83	10.05	
5.05	5.70	6.60	6.94	7.22	7.52	8.12	3	8.75	9.40	10.30	10.64	10.92	11.22	
5.75	6.75	7.55	7.88	8.23	8.62	9.38	4	9.45	10.45	11.25	11.58	11.93	12.32	
6.40	7.70	8.37	8.76	9.19	9.67	10.58	5	10.10	11.40	12.07	12.46	12.89	13.37	
7.00	8.60	9.15	9.61	10.11	10.66	11.72	6	10.70	12.30	12.85	13.31	13.81	14.36	
7.55	9.34	9.89	10.42	10.98	11.60	12.81	7	11.25	13.04	13.59	14.12	14.68	15.30	
8.00	9.70	10.61	11.19	11.82	12.51	13.85	8	11.70	13.40	14.31	14.89	15.52	16.21	
8.40	10.06	11.30	11.94	12.63	13.39	14.86	9	12.10	13.76	15.00	15.64	16.33	17.09	
8.80	11.20	11.96	12.66	13.40	14.23	15.83	10	12.50	14.90	15.66	16.36	17.10	17.93	
9.15	11.60	12.60	13.35	14.16	15.04	16.76	11	12.85	15.30	16.30	17.05	17.86	18.74	
9.50	11.90	13.22	14.02	14.88	15.83	17.67	12	13.20	15.60	16.92	17.72	18.58	19.53	
9.90	12.17	13.82	14.67	15.59	16.59	18.55	13	13.60	15.87	17.52	18.37	19.29	20.29	
10.11	12.51	14.41	15.30	16.27	17.33	19.40	14	13.81	16.21	18.11	19.00	19.97	21.03	
10.29	12.79	14.97	15.92	16.93	18.05	20.22	15	13.99	16.49	18.67	19.62	20.63	21.75	
10.44	13.06	15.52	16.51	17.58	18.75	21.03	16	14.14	16.76	19.22	20.21	21.28	22.45	
10.63	13.29	16.06	17.09	18.21	19.43	21.81	17	14.33	16.99	19.76	20.79	21.91	23.13	
10.77	13.54	16.58	17.66	18.82	20.10	22.57	18	14.47	17.24	20.28	21.36	22.52	23.80	
10.96	13.79	17.09	18.21	19.42	20.74	23.32	19	14.66	17.49	20.79	21.91	23.12	24.44	
11.09	14.02	17.59	18.75	20.00	21.37	24.04	20	14.79	17.72	21.29	22.45	23.70	25.07	
11.25	14.26	18.08	19.27	20.57	21.99	24.75	21	14.95	17.96	21.78	22.97	24.27	25.69	
11.38	14.44	18.47	19.79	21.12	22.59	25.44	22	15.08	18.14	22.17	23.49	24.82	26.29	
11.53	14.70	18.80	20.29	21.67	23.18	26.12	23	15.23	18.40	22.50	23.99	25.37	26.88	
11.64	14.89	19.07	20.78	22.20	23.76	26.78	24	15.34	18.59	22.77	24.48	25.90	27.46	
11.79	15.08	19.37	21.26	22.72	24.32	27.43	25	15.49	18.78	23.07	24.96	26.42	28.02	
11.90	15.27	19.64	21.73	23.23	24.87	28.07	26	15.60	18.97	23.34	25.43	26.93	28.57	
12.07	15.46	19.89	22.19	23.73	25.41	28.69	27	15.77	19.16	23.59	25.89	27.43	29.11	
12.16	15.65	20.18	22.64	24.22	25.94	29.30	28	15.86	19.35	23.88	26.34	27.92	29.64	
12.30	15.84	20.44	23.09	24.70	26.46	29.90	29	16.00	19.54	24.14	26.79	28.40	30.16	
12.41	15.99	20.67	23.52	25.17	26.97	30.48	30	16.11	19.69	24.37	27.22	28.87	30.67	
12.55	16.16	20.91	23.95	25.63	27.47	31.06	31	16.25	19.86	24.61	27.65	29.33	31.17	
12.64	16.33	21.15	24.37	26.07	27.97	31.62	32	16.34	20.03	24.85	28.07	29.77	31.67	
12.75	16.50	21.39	24.78	26.50	28.45	32.18	33	16.45	20.20	25.09	28.48	30.20	32.15	
12.88	16.61	21.57	25.18	26.92	28.92	32.72	34	16.58	20.31	25.27	28.88	30.62	32.62	
12.99	16.80	21.80	25.58	27.33	29.39	33.26	35	16.69	20.50	25.50	29.28	31.03	33.09	
For parcels over 35 pounds, use nonmachinable prices.							36	16.79	20.64	25.74	29.67	31.43	33.54	
							37	16.89	20.77	25.90	30.05	31.82	33.99	
							38	16.99	20.95	26.09	30.43	32.21	34.43	
							39	17.11	21.05	26.28	30.80	32.60	34.87	
							40	17.21	21.22	26.49	31.16	32.98	35.30	
							41	17.34	21.36	26.65	31.52	33.35	35.72	
							42	17.43	21.48	26.83	31.87	33.72	36.13	
							43	17.49	21.61	27.02	32.22	34.09	36.54	
							44	17.60	21.71	27.17	32.56	34.45	36.94	
							45	17.70	21.86	27.35	32.90	34.80	37.34	
							46	17.79	21.98	27.53	33.23	35.14	37.72	
							47	17.91	22.12	27.67	33.56	35.49	38.11	
							48	17.99	22.23	27.85	33.88	35.84	38.49	
							49	18.05	22.36	27.99	34.20	36.16	38.86	
							50	18.14	22.45	28.11	34.51	36.50	39.23	
1. For parcels that destinate to a different BMC service area (see DMM 153.1.1).							51	18.26	22.59	28.29	34.82	36.83	39.59	
2. Parcels that measure in combined length and girth:							52	18.33	22.70	28.43	35.13	37.15	39.94	
■ More than 84 inches but not more than 108 inches, and weigh less than 20 pounds, use 20-pound price (balloon price).							53	18.45	22.79	28.52	35.43	37.47	40.30	
■ More than 108 inches but not more than 130 inches, use the oversized price regardless of weight.							54	18.51	22.94	28.70	35.72	37.78	40.64	
3. Regardless of weight, a parcel that meets any of the criteria in DMM 101.7.2 must pay the nonmachinable prices.							55	18.59	22.98	28.84	35.91	38.09	40.99	
4. Prices include the \$3.70 nonmachinable surcharge. The nonmachinable surcharge does not apply to parcels mailed at oversized prices or parcels sent with special handling.							56	18.69	23.15	28.96	36.08	38.40	41.32	
							57	18.78	23.24	29.10	36.22	38.70	41.66	
							58	18.85	23.34	29.22	36.37	39.01	41.99	
							59	18.94	23.44	29.36	36.51	39.31	42.31	
							60	19.03	23.53	29.50	36.65	39.60	42.63	
							61	19.15	23.67	29.60	36.78	39.90	42.95	
							62	19.22	23.74	29.73	36.92	40.18	43.26	
							63	19.27	23.86	29.85	37.04	40.46	43.57	
							64	19.35	23.92	29.95	37.17	40.74	43.87	
							65	19.43	24.04	30.08	37.30	41.02	44.18	
							66	19.54	24.14	30.17	37.41	41.31	44.47	
							67	19.63	24.24	30.30	37.54	41.58	44.77	
							68	19.68	24.33	30.43	37.65	41.85	45.06	
							69	19.75	24.39	30.53	37.77	42.12	45.34	
							70	19.86	24.52	30.64	37.87	42.38	45.63	
To compute Parcel Post prices, go to Postal Explorer at pe.usps.com and click on "Retail/Single Piece" under Price Calculators in the left frame. For zone charts, click on "Zone Charts."							Oversized	54.84	59.88	63.23	75.30	89.24	94.83	120.88

Media Mail

Weight Not Over (pounds)	Single-Piece ¹	5-Digit	Basic ¹
1	\$2.23	\$1.42	\$1.90
2	2.58	1.77	2.25
3	2.93	2.12	2.60
4	3.28	2.47	2.95
5	3.63	2.82	3.30
6	3.98	3.17	3.65
7	4.33	3.52	4.00
8	4.68	3.87	4.35
9	5.03	4.22	4.70
10	5.38	4.57	5.05
11	5.73	4.92	5.40
12	6.08	5.27	5.75
13	6.43	5.62	6.10
14	6.78	5.97	6.45
15	7.13	6.32	6.80
16	7.48	6.67	7.15
17	7.83	7.02	7.50
18	8.18	7.37	7.85
19	8.53	7.72	8.20
20	8.88	8.07	8.55
21	9.23	8.42	8.90
22	9.58	8.77	9.25
23	9.93	9.12	9.60
24	10.28	9.47	9.95
25	10.63	9.82	10.30
26	10.98	10.17	10.65
27	11.33	10.52	11.00
28	11.68	10.87	11.35
29	12.03	11.22	11.70
30	12.38	11.57	12.05
31	12.73	11.92	12.40
32	13.08	12.27	12.75
33	13.43	12.62	13.10
34	13.78	12.97	13.45
35	14.13	13.32	13.80
36	14.48	13.67	14.15
37	14.83	14.02	14.50
38	15.18	14.37	14.85
39	15.53	14.72	15.20
40	15.88	15.07	15.55
41	16.23	15.42	15.90
42	16.58	15.77	16.25
43	16.93	16.12	16.60
44	17.28	16.47	16.95
45	17.63	16.82	17.30
46	17.98	17.17	17.65
47	18.33	17.52	18.00
48	18.68	17.87	18.35
49	19.03	18.22	18.70
50	19.38	18.57	19.05
51	19.73	18.92	19.40
52	20.08	19.27	19.75
53	20.43	19.62	20.10
54	20.78	19.97	20.45
55	21.13	20.32	20.80
56	21.48	20.67	21.15
57	21.83	21.02	21.50
58	22.18	21.37	21.85
59	22.53	21.72	22.20
60	22.88	22.07	22.55
61	23.23	22.42	22.90
62	23.58	22.77	23.25
63	23.93	23.12	23.60
64	24.28	23.47	23.95
65	24.63	23.82	24.30
66	24.98	24.17	24.65
67	25.33	24.52	25.00
68	25.68	24.87	25.35
69	26.03	25.22	25.70
70	26.38	25.57	26.05

1. Machinable parcels may be eligible for the barcoded discount of \$0.03 per parcel (50-piece minimum).

Library Mail

Weight Not Over (pounds)	Single-Piece ¹	5-Digit	Basic ¹
1	\$2.12	\$1.35	\$1.81
2	2.45	1.68	2.14
3	2.78	2.01	2.47
4	3.11	2.34	2.80
5	3.44	2.67	3.13
6	3.77	3.00	3.46
7	4.10	3.33	3.79
8	4.43	3.66	4.12
9	4.76	3.99	4.45
10	5.09	4.32	4.78
11	5.42	4.65	5.11
12	5.75	4.98	5.44
13	6.08	5.31	5.77
14	6.41	5.64	6.10
15	6.74	5.97	6.43
16	7.07	6.30	6.76
17	7.40	6.63	7.09
18	7.73	6.96	7.42
19	8.06	7.29	7.75
20	8.39	7.62	8.08
21	8.72	7.95	8.41
22	9.05	8.28	8.74
23	9.38	8.61	9.07
24	9.71	8.94	9.40
25	10.04	9.27	9.73
26	10.37	9.60	10.06
27	10.70	9.93	10.39
28	11.03	10.26	10.72
29	11.36	10.59	11.05
30	11.69	10.92	11.38
31	12.02	11.25	11.71
32	12.35	11.58	12.04
33	12.68	11.91	12.37
34	13.01	12.24	12.70
35	13.34	12.57	13.03
36	13.67	12.90	13.36
37	14.00	13.23	13.69
38	14.33	13.56	14.02
39	14.66	13.89	14.35
40	14.99	14.22	14.68
41	15.32	14.55	15.01
42	15.65	14.88	15.34
43	15.98	15.21	15.67
44	16.31	15.54	16.00
45	16.64	15.87	16.33
46	16.97	16.20	16.66
47	17.30	16.53	16.99
48	17.63	16.86	17.32
49	17.96	17.19	17.65
50	18.29	17.52	17.98
51	18.62	17.85	18.31
52	18.95	18.18	18.64
53	19.28	18.51	18.97
54	19.61	18.84	19.30
55	19.94	19.17	19.63
56	20.27	19.50	19.96
57	20.60	19.83	20.29
58	20.93	20.16	20.62
59	21.26	20.49	20.95
60	21.59	20.82	21.28
61	21.92	21.15	21.61
62	22.25	21.48	21.94
63	22.58	21.81	22.27
64	22.91	22.14	22.60
65	23.24	22.47	22.93
66	23.57	22.80	23.26
67	23.90	23.13	23.59
68	24.23	23.46	23.92
69	24.56	23.79	24.25
70	24.89	24.12	24.58

1. Machinable parcels may be eligible for the barcoded discount of \$0.03 per parcel (50-piece minimum).

Bound Printed Matter

Commercial Nonpresorted Flats

Weight Not Over (pounds) ¹	Zone						
	1 & 2	3	4	5	6	7	8
1.0	\$1.89	\$1.93	\$1.99	\$2.08	\$2.19	\$2.25	\$2.44
1.5	1.89	1.93	1.99	2.08	2.19	2.25	2.44
2.0	1.98	2.04	2.12	2.24	2.38	2.46	2.72
2.5	2.08	2.15	2.25	2.40	2.58	2.68	3.00
3.0	2.17	2.26	2.38	2.56	2.77	2.89	3.28
3.5	2.27	2.37	2.51	2.72	2.97	3.11	3.56
4.0	2.36	2.48	2.64	2.88	3.16	3.32	3.84
4.5	2.46	2.59	2.77	3.04	3.36	3.54	4.12
5.0	2.55	2.70	2.90	3.20	3.55	3.75	4.40
6.0	2.74	2.92	3.16	3.52	3.94	4.18	4.96
7.0	2.93	3.14	3.42	3.84	4.33	4.61	5.52
8.0	3.12	3.36	3.68	4.16	4.72	5.04	6.08
9.0	3.31	3.58	3.94	4.48	5.11	5.47	6.64
10.0	3.50	3.80	4.20	4.80	5.50	5.90	7.20
11.0	3.69	4.02	4.46	5.12	5.89	6.33	7.76
12.0	3.88	4.24	4.72	5.44	6.28	6.76	8.32
13.0	4.07	4.46	4.98	5.76	6.67	7.19	8.88
14.0	4.26	4.68	5.24	6.08	7.06	7.62	9.44
15.0	4.45	4.90	5.50	6.40	7.45	8.05	10.00

1. For barcode discount, deduct \$0.03 per piece (automation-compatible flats only, 50-piece minimum).

Commercial Nonpresorted Parcels

Weight Not Over (pounds) ¹	Zone						
	1 & 2	3	4	5	6	7	8
1.0	\$2.15	\$2.19	\$2.25	\$2.34	\$2.45	\$2.51	\$2.70
1.5	2.15	2.19	2.25	2.34	2.45	2.51	2.70
2.0	2.24	2.30	2.38	2.50	2.64	2.72	2.98
2.5	2.34	2.41	2.51	2.66	2.84	2.94	3.26
3.0	2.43	2.52	2.64	2.82	3.03	3.15	3.54
3.5	2.53	2.63	2.77	2.98	3.23	3.37	3.82
4.0	2.62	2.74	2.90	3.14	3.42	3.58	4.10
4.5	2.72	2.85	3.03	3.30	3.62	3.80	4.38
5.0	2.81	2.96	3.16	3.46	3.81	4.01	4.66
6.0	3.00	3.18	3.42	3.78	4.20	4.44	5.22
7.0	3.19	3.40	3.68	4.10	4.59	4.87	5.78
8.0	3.38	3.62	3.94	4.42	4.98	5.30	6.34
9.0	3.57	3.84	4.20	4.74	5.37	5.73	6.90
10.0	3.76	4.06	4.46	5.06	5.76	6.16	7.46
11.0	3.95	4.28	4.72	5.38	6.15	6.59	8.02
12.0	4.14	4.50	4.98	5.70	6.54	7.02	8.58
13.0	4.33	4.72	5.24	6.02	6.93	7.45	9.14
14.0	4.52	4.94	5.50	6.34	7.32	7.88	9.70
15.0	4.71	5.16	5.76	6.66	7.71	8.31	10.26

1. For barcode discount, deduct \$0.03 per piece (machinable parcels only, 50-piece minimum).

Bound Printed Matter

Commercial Flats

Each piece is subject to both a piece price and a pound price. ¹		Carrier Route			Presorted ²		
		Price per piece	+	Price per pound	Price per piece	+	Price per pound
Zone	Local 1 & 2	\$1.146	+	\$0.136	\$1.253	+	\$0.136
	3	1.146	+	0.169	1.253	+	0.169
	4	1.146	+	0.209	1.253	+	0.209
	5	1.146	+	0.268	1.253	+	0.268
	6	1.146	+	0.337	1.253	+	0.337
	7	1.146	+	0.380	1.253	+	0.380
	8	1.146	+	0.507	1.253	+	0.507
	<i>Destination Entry</i>						
	1 & 2	\$0.876	+	\$0.098	\$0.983	+	\$0.098
DBMC	3	0.876	+	0.126	0.983	+	0.126
Zone	4	0.876	+	0.174	0.983	+	0.174
	5	0.876	+	0.233	0.983	+	0.233
	DSCF	0.486	+	0.082	0.593	+	0.082
	DDU	0.402	+	0.039	0.509 ³	+	0.039

1. Multiply the number of pounds in the mailing by the price per pound. Multiply the number of pieces in the mailing by the price per piece. Add both totals.
2. For the barcode discount, deduct \$0.03 per piece (automation-compatible flats only). Barcode discount not available for pieces mailed at presorted DDU prices.
3. Each flat must weigh more than 1 pound to be eligible for the presorted DDU price.

Commercial Parcels

Each piece is subject to both a piece price and a pound price. ¹		Carrier Route			Presorted ²		
		Price per piece	+	Price per pound	Price per piece	+	Price per pound
Zone	Local, 1 & 2	\$1.306	+	\$0.137	\$1.413	+	\$0.137
	3	1.306	+	0.170	1.413	+	0.170
	4	1.306	+	0.210	1.413	+	0.210
	5	1.306	+	0.269	1.413	+	0.269
	6	1.306	+	0.338	1.413	+	0.338
	7	1.306	+	0.381	1.413	+	0.381
	8	1.306	+	0.508	1.413	+	0.508
	<i>Destination Entry</i>						
	1 & 2	\$1.032	+	\$0.099	\$1.139	+	\$0.099
DBMC	3	1.032	+	0.127	1.139	+	0.127
Zone	4	1.032	+	0.175	1.139	+	0.175
	5	1.032	+	0.234	1.139	+	0.234
	DSCF	\$0.658	+	\$0.089	\$0.765	+	\$0.089
	DDU	0.487	+	0.039	0.594	+	0.039

1. Multiply the number of pounds in the mailing by the price per pound. Multiply the number of pieces in the mailing by the price per piece. Add both totals.
2. Machinable presorted parcels may be eligible for the barcoded discount of \$0.03 per parcel (50-piece minimum), except for parcels mailed at presorted DDU or DSCF prices.

Global Express Guaranteed

The price for items mailed in USPS-supplied Global Express Guaranteed (GXG) envelopes are based on the weight of the piece. The prices for items not mailed in USPS-supplied GXG envelopes are based on dimensional weight or the actual weight whichever is greater. See the Postage Price Calculator at pe.usps.com.

Commercial Price: Postage paid through Click-N-Ship at www.usps.com or authorized PC Postage vendors is 10% below retail prices.

Global Express Guaranteed Retail Prices

Weight Not Over (pounds)	Price Groups							
	Canada	Mexico	3	4	5	6	7	8
0.5	\$29.95	\$29.95	\$38.95	\$79.95	\$38.95	\$38.95	\$38.95	\$52.95
1	43.50	45.50	52.00	96.00	62.00	58.50	50.00	69.00
2	47.25	51.50	59.50	112.00	70.00	67.50	57.00	86.00
3	51.00	57.50	67.00	128.00	78.00	76.50	64.00	103.00
4	54.75	63.50	74.50	144.00	86.00	85.50	71.00	120.00
5	58.50	69.50	82.00	160.00	94.00	94.50	78.00	137.00
6	62.25	75.50	89.50	176.00	102.00	103.50	85.00	154.00
7	66.00	81.50	97.00	192.00	110.00	112.50	92.00	171.00
8	69.75	87.50	104.50	208.00	118.00	121.50	99.00	188.00
9	73.50	93.50	112.00	224.00	126.00	130.50	106.00	205.00
10	77.25	99.50	119.50	240.00	134.00	139.50	113.00	222.00
11	80.50	103.00	124.25	252.00	139.50	146.75	118.50	233.50
12	83.75	106.50	129.00	264.00	145.00	154.00	124.00	245.00
13	87.00	110.00	133.75	276.00	150.50	161.25	129.50	256.50
14	90.25	113.50	138.50	288.00	156.00	168.50	135.00	268.00
15	93.50	117.00	143.25	300.00	161.50	175.75	140.50	279.50
16	96.75	120.50	148.00	312.00	167.00	183.00	146.00	291.00
17	100.00	124.00	152.75	324.00	172.50	190.25	151.50	302.50
18	103.25	127.50	157.50	336.00	178.00	197.50	157.00	314.00
19	106.50	131.00	162.25	348.00	183.50	204.75	162.50	325.50
20	109.75	134.50	167.00	360.00	189.00	212.00	168.00	337.00
21	113.00	138.00	171.75	372.00	194.50	219.25	173.50	348.50
22	116.25	141.50	176.50	384.00	200.00	226.50	179.00	360.00
23	119.50	145.00	181.25	396.00	205.50	233.75	184.50	371.50
24	122.75	148.50	186.00	408.00	211.00	241.00	190.00	383.00
25	126.00	152.00	190.75	420.00	216.50	248.25	195.50	394.50
26	129.25	155.50	195.50	432.00	222.00	255.50	201.00	406.00
27	132.50	159.00	200.25	444.00	227.50	262.75	206.50	417.50
28	135.75	162.50	205.00	456.00	233.00	270.00	212.00	429.00
29	139.00	166.00	209.75	468.00	238.50	277.25	217.50	440.50
30	142.25	169.50	214.50	480.00	244.00	284.50	223.00	452.00
31	145.50	173.00	219.25	492.00	249.50	291.75	228.50	463.50
32	148.75	176.50	224.00	504.00	255.00	299.00	234.00	475.00
33	152.00	180.00	228.75	516.00	260.50	306.25	239.50	486.50
34	155.25	183.50	233.50	528.00	266.00	313.50	245.00	498.00
35	158.50	187.00	238.25	540.00	271.50	320.75	250.50	509.50
36	161.75	190.50	243.00	552.00	277.00	328.00	256.00	521.00
37	165.00	194.00	247.75	564.00	282.50	335.25	261.50	532.50
38	168.25	197.50	252.50	576.00	288.00	342.50	267.00	544.00
39	171.50	201.00	257.25	588.00	293.50	349.75	272.50	555.50
40	174.75	204.50	262.00	600.00	299.00	357.00	278.00	567.00
41	177.75	207.50	266.50	609.00	304.00	363.50	282.75	576.00
42	180.75	210.50	271.00	618.00	309.00	370.00	287.50	585.00
43	183.75	213.50	275.50	627.00	314.00	376.50	292.25	594.00
44	186.75	216.50	280.00	636.00	319.00	383.00	297.00	603.00

For weights up to 70 pounds, see the International Country Listing or Postage Price Calculator on Postal Explorer at pe.usps.com. Global Express Guaranteed price groups are *not* the same as the price groups on pages 28 and 29.

No Global Express Guaranteed Service

Ascension	Kiribati	Sao Tome and Principe	Turkmenistan
Burma	Korea, Democratic People's	Sierra Leone	Tuvalu
Central African Republic	Republic of (North)	Solomon Islands	Western Samoa
Comoros	Libya	Somalia	
Cuba	Nauru	Sudan	
Equatorial Guinea	Pitcairn Island	Syrian Arab Republic	
Falkland Islands	Saint Helena	Tajikistan	
Guinea-Bissau	Saint Pierre and Miquelon	Tristan da Cunha	
Iran			

Express Mail—Retail

Weight Not Over (pounds)	Zone ¹						
	Local, 1, & 2	3	4	5	6	7	8
0.5	\$12.60	\$14.65	\$17.45	\$18.30	\$18.60	\$19.25	\$19.50
1	14.55	19.00	22.40	22.65	22.90	23.15	23.40
2	15.70	20.15	24.65	24.90	25.15	25.40	25.65
3	16.65	21.35	28.40	28.65	28.90	29.15	29.40
4	17.95	22.75	32.10	32.35	32.60	32.85	33.10
5	18.60	24.35	35.85	36.10	36.35	36.60	36.85
6	21.85	29.25	39.55	39.80	40.05	40.30	40.55
7	25.10	34.15	43.25	43.50	43.75	44.00	44.25
8	26.35	35.15	47.00	47.25	47.50	47.75	48.00
9	27.80	36.65	50.35	50.95	51.20	51.45	51.70
10	28.60	38.10	52.70	53.55	53.80	54.05	54.30
11	32.00	43.00	55.40	56.15	56.40	56.65	56.90
12	32.00	46.00	58.40	58.70	58.95	59.20	59.45
13	32.00	49.00	61.05	61.30	61.55	61.80	62.05
14	33.00	52.00	63.60	63.85	64.10	64.35	64.60
15	35.00	55.00	66.20	66.45	66.70	66.95	67.20
16	36.00	58.00	68.80	69.05	69.30	69.55	69.80
17	38.00	61.00	71.35	71.60	71.85	72.10	72.35
18	40.00	64.00	73.95	74.20	74.45	74.70	74.95
19	41.00	67.00	76.50	76.75	77.00	77.25	77.50
20	43.00	70.00	79.10	79.35	79.60	79.85	80.10
21	44.00	73.00	81.95	82.70	82.95	83.20	83.45
22	46.00	76.00	84.00	85.25	85.50	85.75	86.00
23	47.00	79.00	86.45	87.85	88.10	88.35	88.60
24	49.00	82.00	89.20	90.40	90.65	90.90	91.15
25	51.00	85.00	91.40	93.00	93.25	93.50	93.75
26	52.00	88.00	94.05	95.60	95.85	96.10	96.35
27	54.00	91.00	96.45	98.15	98.40	98.65	98.90
28	55.00	94.00	99.55	100.75	101.00	101.25	101.50
29	57.00	97.00	102.80	103.30	103.55	103.80	104.05
30	59.00	100.00	106.05	106.40	106.65	106.90	107.40
31	60.00	103.00	109.30	109.65	109.90	110.15	110.70
32	62.00	106.00	112.55	112.90	113.15	113.40	114.00
33	63.00	109.00	115.80	116.20	116.45	116.70	117.30
34	65.00	112.00	119.10	119.45	119.70	119.95	120.60
35	66.00	115.00	122.35	122.75	123.00	123.25	123.90
36	68.00	118.00	125.60	126.00	126.25	126.50	127.20
37	70.00	121.00	128.85	129.30	129.55	129.80	130.50
38	71.00	124.00	132.10	132.55	132.80	133.05	133.80
39	73.00	127.00	135.40	135.80	136.05	136.30	137.10
40	74.00	130.00	138.65	139.10	139.35	139.60	140.45
41	76.00	133.00	141.90	142.35	142.60	142.85	143.75
42	78.00	136.00	145.15	145.65	145.90	146.15	147.05
43	79.00	139.00	148.40	148.90	149.15	149.40	150.35
44	81.00	142.00	151.65	152.20	152.45	152.70	153.65
45	82.00	145.00	154.95	155.45	155.70	155.95	156.95
46	84.00	148.00	158.20	158.70	158.95	159.20	160.25
47	85.00	151.00	161.45	162.00	162.25	162.50	163.55
48	87.00	154.00	164.70	165.25	165.50	165.75	166.85
49	89.00	157.00	167.95	168.55	168.80	169.05	170.15
50	90.00	160.00	171.25	171.80	172.05	172.30	173.50
51	92.00	163.00	174.50	175.05	175.30	175.55	176.80
52	93.00	166.00	177.75	178.35	178.60	178.85	180.10
53	95.00	169.00	181.00	181.60	181.85	182.10	183.40
54	97.00	172.00	184.30	184.90	185.15	185.40	186.70
55	98.00	176.00	187.55	188.15	188.40	188.65	190.00
56	100.00	179.00	190.80	191.45	191.70	191.95	193.30
57	101.00	182.00	194.05	194.70	194.95	195.20	196.60
58	103.00	185.00	197.30	197.95	198.20	198.45	199.90
59	104.00	188.00	200.55	201.25	201.50	201.75	203.20
60	106.00	191.00	203.80	204.50	204.75	205.00	206.50
61	108.00	194.00	207.10	207.80	208.05	208.30	209.85
62	109.00	197.00	210.35	211.05	211.30	211.55	213.15
63	111.00	200.00	213.60	214.30	214.55	214.80	216.45
64	112.00	203.00	216.85	217.60	217.85	218.10	219.75
65	114.00	206.00	220.10	220.85	221.10	221.35	223.05
66	116.00	209.00	223.40	224.15	224.40	224.65	226.35
67	117.00	212.00	226.65	227.40	227.65	227.90	229.65
68	119.00	215.00	229.90	230.70	230.95	231.20	232.95
69	120.00	218.00	233.15	233.95	234.20	234.45	236.25
70	122.00	221.00	236.40	237.20	237.45	237.70	239.55

Express Mail Flat-Rate Envelope

The Express Mail retail flat-rate envelope is \$16.50 to any U.S. destination regardless of the actual weight of the piece.



Commercial Prices

The Express Mail commercial flat-rate envelope is \$16.00 to any U.S. destination regardless of the actual weight of the piece.

Postage paid through Click-N-Ship service at www.usps.com, registered end-users of PC Postage products when using a shipping label, and Express Mail Corporate Accounts, or Federal Agency Accounts, receive a 3% price reduction. Additional volume incentives available (see DMM 413.1).

Postage Price Calculator

To compute Express Mail or any postage price, visit www.usps.com and click on "Calculate Postage."

1. For Sunday/holiday delivery, add \$12.50.

Express Mail International

Express Mail International Flat-Rate Envelope

Canada and Mexico	\$23.95
All other countries	25.95

Commercial Price: Postage paid through Click-N-Ship at www.usps.com or authorized PC Postage vendors is 8% below retail prices. Express Mail International commercial volume price incentives available, see IMM 222.13.

Express Mail International Retail Prices

Weight Not Over (pounds)	Price Groups								
	Canada	Mexico	3	4	5	6	7	8	9
0.5	\$23.95	\$23.95	\$25.95	\$25.95	\$25.95	\$25.95	\$25.95	\$25.95	\$25.95
1	27.25	27.00	28.50	28.00	30.50	28.50	32.00	31.50	30.50
2	30.50	31.00	32.75	31.75	34.75	32.25	37.00	36.50	35.00
3	33.75	35.00	37.00	35.50	39.00	36.00	42.00	41.50	39.50
4	37.00	39.00	41.25	39.25	43.25	39.75	47.00	46.50	44.00
5	40.25	43.00	45.50	43.00	47.50	43.50	52.00	51.50	48.50
6	43.40	45.75	50.50	47.00	51.35	48.25	57.15	56.50	53.50
7	46.55	48.50	55.50	51.00	55.20	53.00	62.30	61.50	58.50
8	49.70	51.25	60.50	55.00	59.05	57.75	67.45	66.50	63.50
9	52.85	54.00	65.50	59.00	62.90	62.50	72.60	71.50	68.50
10	56.00	56.75	70.50	63.00	66.75	67.25	77.75	76.50	73.50
11	59.00	59.50	75.50	67.25	70.60	72.50	83.10	81.75	78.75
12	62.00	62.25	80.50	71.50	74.45	77.75	88.45	87.00	84.00
13	65.00	65.00	85.50	75.75	78.30	83.00	93.80	92.25	89.25
14	68.00	67.75	90.50	80.00	82.15	88.25	99.15	97.50	94.50
15	71.00	70.50	95.50	84.25	86.00	93.50	104.50	102.75	99.75
16	74.00	73.25	100.50	88.50	89.85	98.75	109.85	108.00	105.00
17	77.00	76.00	105.50	92.75	93.70	104.00	115.20	113.25	110.25
18	80.00	78.75	110.50	97.00	97.55	109.25	120.55	118.50	115.50
19	83.00	81.50	115.50	101.25	101.40	114.50	125.90	123.75	120.75
20	86.00	84.25	120.50	105.50	105.25	119.75	131.25	129.00	126.00
21	89.00	87.00	125.50	109.75	109.10	125.00	136.60	134.25	131.25
22	92.00	89.75	130.50	114.00	112.95	130.25	141.95	139.50	136.50
23	95.00	92.50	135.50	118.25	116.80	135.50	147.30	144.75	141.75
24	98.00	95.25	140.50	122.50	120.65	140.75	152.65	150.00	147.00
25	101.00	98.00	145.50	126.75	124.50	146.00	158.00	155.25	152.25
26	104.00	100.75	150.50	131.00	128.35	151.25	163.35	160.50	157.50
27	107.00	103.50	155.50	135.25	132.20	156.50	168.70	165.75	162.75
28	110.00	106.25	160.50	139.50	136.05	161.75	174.05	171.00	168.00
29	113.00	109.00	165.50	143.75	139.90	167.00	179.40	176.25	173.25
30	116.00	111.75	170.50	148.00	143.75	172.25	184.75	181.50	178.50
31	119.00	114.50	175.50	152.25	147.60	177.50	190.10	186.75	183.75
32	122.00	117.25	180.50	156.50	151.45	182.75	195.45	192.00	189.00
33	125.00	120.00	185.50	160.75	155.30	188.00	200.80	197.25	194.25
34	128.00	122.75	190.50	165.00	159.15	193.25	206.15	202.50	199.50
35	131.00	125.50	195.50	169.25	163.00	198.50	211.50	207.75	204.75
36	134.00	128.25	200.50	173.50	166.85	203.75	216.85	213.00	210.00
37	137.00	131.00	205.50	177.75	170.70	209.00	222.20	218.25	215.25
38	140.00	133.75	210.50	182.00	174.55	214.25	227.55	223.50	220.50
39	143.00	136.50	215.50	186.25	178.40	219.50	232.90	228.75	225.75
40	146.00	139.25	220.50	190.50	182.25	224.75	238.25	234.00	231.00
41	149.00	141.75	225.50	194.75	186.10	230.00	243.60	239.25	236.25
42	152.00	144.25	230.50	199.00	189.95	235.25	248.95	244.50	241.50
43	155.00	146.75	235.50	203.25	193.80	240.50	254.30	249.75	246.75
44	158.00	149.25	240.50	207.50	197.65	245.75	259.65	255.00	252.00

For weights up to 70 pounds, see the International Country Listing or Postage Price Calculator on Postal Explorer at pe.usps.com.
 For a listing of countries by price group, see pages 28 and 29.

No Express Mail International Service

Afghanistan	Greenland	Saint Helena
Antigua and Barbuda	Iran	Saint Pierre and Miquelon
Ascension	Kiribati	Sao Tome and Principe
British Virgin Islands	Korea, Democratic Peoples	Somalia
Burma	Republic of (North Korea)	Suriname
Comoros	Lebanon	Tonga
Cuba	Libya	Tristan da Cunha
Falkland Islands	Montserrat	Tuvalu
Gambia	Pitcairn Island	Wallis and Futuna Islands
Gibraltar	Reunion	

Maximum weight limit

Country	Maximum weight
Bahamas	22
Namibia	22
Taiwan	33

Priority Mail—Retail

Weight Not Over (pounds)	Zone ^{1, 2, 3}						
	Local, 1, & 2	3	4	5	6	7	8
1	\$4.80	\$4.80	\$4.80	\$4.80	\$4.80	\$4.80	\$4.80
2	4.80	5.05	5.60	6.80	7.20	7.70	8.25
3	5.20	5.95	6.75	8.75	9.55	10.35	11.50
4	5.80	6.80	7.85	10.55	11.60	12.65	14.25
5	6.45	7.75	8.90	12.20	13.45	14.75	16.80
6	7.05	8.65	10.00	13.95	14.40	16.25	17.65
7	7.60	9.40	11.00	15.35	15.80	18.05	20.15
8	8.05	9.75	11.95	16.40	17.15	19.80	22.60
9	8.45	10.45	12.75	17.50	18.55	21.55	25.15
10	8.85	11.25	13.45	18.65	20.10	23.45	27.55
11	9.35	11.75	14.50	19.75	21.75	25.20	29.00
12	9.75	12.35	15.30	20.85	23.45	26.50	30.25
13	10.00	12.65	15.75	22.00	25.15	27.55	31.30
14	10.35	13.20	16.45	23.00	26.50	29.15	32.85
15	10.80	13.80	17.25	23.70	27.10	29.45	33.55
16	11.15	14.25	17.80	24.20	27.70	30.10	34.40
17	11.50	14.75	18.15	24.80	28.45	30.85	35.30
18	11.75	15.20	18.50	25.30	29.00	31.45	36.15
19	12.15	15.55	18.80	25.90	29.70	32.25	37.05
20	12.45	15.80	19.15	26.35	30.25	32.85	37.85
21	12.80	16.00	19.45	26.80	30.75	33.45	38.60
22	13.10	16.30	19.75	27.40	31.45	34.20	39.55
23	13.40	16.50	20.30	27.85	32.00	34.80	40.25
24	13.70	16.70	20.90	28.45	32.65	35.60	41.25
25	14.00	16.95	21.60	28.90	33.15	36.15	41.95
26	14.30	17.15	22.30	29.50	33.90	36.90	43.30
27	14.70	17.40	22.95	29.90	34.40	37.45	44.90
28	15.15	17.60	23.55	30.30	34.85	38.00	46.55
29	15.60	17.80	24.25	30.70	35.30	38.50	48.05
30	16.10	18.05	24.90	31.15	35.80	39.05	49.65
31	16.50	18.20	25.60	31.50	36.25	39.55	51.30
32	16.95	18.65	26.25	31.90	36.75	40.50	52.90
33	17.40	19.15	26.85	32.30	37.20	41.65	54.45
34	17.85	19.65	27.55	33.00	38.30	42.80	56.05
35	18.30	20.15	28.10	33.70	39.35	43.95	57.65
36	18.75	20.65	28.55	34.45	40.35	45.15	59.25
37	19.20	21.10	29.00	35.10	41.40	46.30	60.85
38	19.65	21.60	29.45	35.80	42.55	47.40	62.45
39	20.05	22.05	29.85	36.50	43.60	48.60	64.10
40	20.45	22.50	30.30	37.25	44.60	49.70	65.60
41	20.85	22.95	30.70	37.60	45.65	50.90	67.20
42	21.25	23.40	31.10	38.40	46.65	52.10	68.80
43	21.65	23.80	31.50	39.25	47.80	53.25	70.40
44	22.05	24.25	31.90	40.15	48.80	54.45	72.00
45	22.45	24.70	32.25	41.00	49.85	55.60	73.60
46	22.85	25.15	32.90	41.80	50.90	56.75	75.20
47	23.25	25.60	33.50	42.70	52.05	57.95	76.75
48	23.65	25.95	34.25	43.55	53.10	59.15	78.40
49	24.05	26.25	34.90	44.35	54.05	60.35	79.95
50	24.40	26.50	35.55	45.20	55.10	61.50	81.40
51	24.85	26.75	36.20	46.10	56.15	62.65	82.25
52	25.20	27.00	36.90	46.95	57.30	63.80	83.05
53	25.65	27.25	37.50	47.80	58.30	65.00	83.85
54	26.00	27.45	38.15	48.70	59.30	66.10	84.65
55	26.45	27.70	38.90	49.55	60.35	67.20	85.40
56	26.80	27.90	39.50	50.35	61.50	68.40	86.15
57	27.25	28.15	40.15	51.15	62.50	69.60	86.90
58	27.60	28.35	40.85	52.05	63.55	70.75	87.60
59	28.05	28.55	41.50	52.90	64.55	71.90	88.25
60	28.40	28.75	42.15	53.80	65.65	73.05	88.90
61	28.85	28.95	42.90	54.60	66.50	74.20	90.10
62	29.20	29.20	43.50	55.50	66.95	75.35	91.50
63	29.65	29.65	44.20	56.40	67.35	76.10	92.95
64	30.00	30.00	44.85	57.25	67.75	76.55	94.45
65	30.45	30.45	45.45	57.95	68.10	77.00	95.90
66	30.80	30.80	46.15	58.85	68.50	77.40	97.30
67	31.25	31.25	46.90	59.75	68.85	77.80	98.80
68	31.60	31.60	47.50	60.60	69.15	78.20	100.20
69	32.05	32.05	48.15	61.50	69.50	78.55	101.65
70	32.45	32.45	48.90	61.80	69.80	78.90	103.10

Priority Mail Flat-Rate Envelope

The Priority Mail flat-rate envelope is \$4.80 to any U.S. destination regardless of the actual weight of the piece.



Priority Mail Flat-Rate Boxes

Priority Mail flat-rate boxes are available, regardless of the actual weight of the piece at the following prices:

Priority Mail Regular Flat-Rate Boxes

- \$9.80

Priority Mail Large Flat-Rate Box

- Domestic address: \$12.95
- APO/FPO destination address: \$10.95

1. Parcels addressed for delivery to zones 1–4 (including local) that weigh less than 20 pounds but measure more than 84 inches (but not more than 108 inches) in combined length and girth are charged the applicable price for a 20-pound parcel (balloon price).
2. Parcels addressed for delivery to zones 5–8 that exceed 1 cubic foot (1,728 cubic inches) are charged based on the actual weight or the dimensional weight (as calculated in DMM 123.1.3), whichever is greater.
3. Keys and identification devices that weigh:
 - Up to 13 ounces, refer to First-Class Mail retail package prices.
 - More than 13 ounces but not more than 1 pound, \$5.52.
 - More than 1 pound but not more than 2 pounds, \$6.32.

Priority Mail—Commercial

Weight Not Over (pounds)	Zone ^{1, 2, 3}						
	Local, 1, & 2	3	4	5	6	7	8
1	\$4.75	\$4.75	\$4.75	\$4.75	\$4.75	\$4.75	\$4.75
2	4.75	4.75	5.29	6.46	6.88	7.39	7.96
3	4.86	5.59	6.38	7.79	9.12	9.94	11.10
4	5.42	6.39	7.42	9.50	11.08	12.14	13.75
5	6.03	7.29	8.14	11.11	12.84	14.16	16.21
6	6.59	8.13	9.25	12.84	13.75	15.60	17.03
7	7.11	8.84	10.28	14.28	15.09	17.33	19.44
8	7.53	9.17	11.29	15.42	16.38	19.01	21.81
9	7.73	9.82	12.05	16.63	17.72	20.69	24.27
10	8.18	10.58	12.71	17.72	19.20	22.51	26.59
11	8.74	11.05	13.70	18.76	20.77	24.19	27.99
12	9.12	11.61	14.46	19.81	22.39	25.44	29.19
13	9.35	11.89	14.88	20.90	24.02	26.45	30.20
14	9.68	12.41	15.55	21.85	25.31	27.98	31.70
15	10.10	12.97	16.30	22.52	25.88	28.27	32.38
16	10.43	13.40	16.82	22.99	26.45	28.90	33.20
17	10.75	13.87	17.15	23.56	27.17	29.62	34.06
18	10.99	14.29	17.48	24.04	27.70	30.19	34.88
19	11.36	14.62	17.77	24.61	28.36	30.96	35.75
20	11.64	14.85	18.10	25.03	28.89	31.54	36.53
21	11.97	15.04	18.38	25.46	29.37	32.11	37.25
22	12.25	15.32	18.66	26.03	30.03	32.83	38.17
23	12.53	15.51	19.18	26.46	30.56	33.41	38.84
24	12.81	15.70	19.75	27.03	31.18	34.18	39.81
25	13.09	15.93	20.41	27.46	31.66	34.70	40.48
26	13.37	16.12	21.07	28.03	32.37	35.42	41.78
27	13.74	16.36	21.69	28.41	32.85	35.95	43.33
28	14.17	16.54	22.25	28.79	33.28	36.48	44.92
29	14.59	16.73	22.92	29.17	33.71	36.96	46.37
30	15.05	16.97	23.53	29.59	34.19	37.49	47.91
31	15.43	17.11	24.19	29.93	34.62	37.97	49.50
32	15.85	17.53	24.81	30.31	35.10	38.88	51.05
33	16.27	18.00	25.37	30.69	35.53	39.98	52.54
34	16.69	18.47	26.03	31.35	36.58	41.09	54.09
35	17.11	18.94	26.55	32.02	37.58	42.19	55.63
36	17.53	19.41	26.98	32.73	38.53	43.34	57.18
37	17.95	19.83	27.41	33.35	39.54	44.45	58.72
38	18.37	20.30	27.83	34.01	40.64	45.50	60.26
39	18.75	20.73	28.21	34.68	41.64	46.66	61.86
40	19.12	21.15	28.63	35.39	42.59	47.71	63.30
41	19.49	21.57	29.01	35.72	43.60	48.86	64.85
42	19.87	22.00	29.39	36.48	44.55	50.02	66.39
43	20.24	22.37	29.77	37.29	45.65	51.12	67.94
44	20.62	22.80	30.15	38.14	46.60	52.27	69.48
45	20.99	23.22	30.48	38.95	47.61	53.38	71.02
46	21.36	23.64	31.09	39.71	48.61	54.48	72.57
47	21.74	24.06	31.66	40.57	49.71	55.63	74.06
48	22.11	24.39	32.37	41.37	50.71	56.78	75.66
49	22.49	24.68	32.98	42.13	51.62	57.94	77.15
50	22.81	24.91	33.59	42.94	52.62	59.04	78.55
51	23.23	25.15	34.21	43.80	53.62	60.14	79.37
52	23.56	25.38	34.87	44.60	54.72	61.25	80.14
53	23.98	25.62	35.44	45.41	55.68	62.40	80.92
54	24.31	25.80	36.05	46.27	56.63	63.46	81.69
55	24.73	26.04	36.76	47.07	57.63	64.51	82.41
56	25.06	26.23	37.33	47.83	58.73	65.66	83.13
57	25.48	26.46	37.94	48.59	59.69	66.82	83.86
58	25.81	26.65	38.60	49.45	60.69	67.92	84.53
59	26.23	26.84	39.22	50.26	61.65	69.02	85.16
60	26.55	27.03	39.83	51.11	62.70	70.13	85.79
61	26.97	27.21	40.54	51.87	63.51	71.23	86.95
62	27.30	27.45	41.11	52.73	63.94	72.34	88.30
63	27.72	27.87	41.77	53.58	64.32	73.06	89.70
64	28.05	28.20	42.38	54.39	64.70	73.49	91.14
65	28.47	28.62	42.95	55.05	65.04	73.92	92.54
66	28.80	28.95	43.61	55.91	65.42	74.30	93.89
67	29.22	29.38	44.32	56.76	65.75	74.69	95.34
68	29.55	29.70	44.89	57.57	66.04	75.07	96.69
69	29.97	30.13	45.50	58.43	66.37	75.41	98.09
70	30.34	30.50	46.21	58.71	66.66	75.74	99.49

Commercial Priority Mail includes those pieces bearing postage paid by: customers who use Click-N-Ship at www.usps.com; registered end-users of PC Postage products when using a shipping label; and customers using permit imprint with electronic Confirmation Services (see DMM 423.1).

Priority Mail Flat-Rate Envelope

The Priority Mail flat-rate envelope is \$4.75 to any U.S. destination regardless of the actual weight of the piece.



Priority Mail Flat-Rate Boxes

Priority Mail flat-rate boxes are available, regardless of the actual weight of the piece at the following prices:

Priority Mail Regular Flat-Rate Boxes
 ■ \$9.30

Priority Mail Large Flat-Rate Box
 ■ Domestic address: \$12.50
 ■ APO/FPO destination address: \$10.50

1. Parcels addressed for delivery to zones 1–4 (including local) that weigh less than 20 pounds but measure more than 84 inches (but not more than 108 inches) in combined length and girth are charged the applicable price for a 20-pound parcel (balloon price).
2. Parcels addressed for delivery to zones 5–8 that exceed 1 cubic foot (1,728 cubic inches) are charged based on the actual weight or the dimensional weight whichever is greater.

Priority Mail International

Priority Mail International Flat-Rate Envelope

Canada and Mexico	\$9.95
All other countries	11.95

The maximum weight is 4 pounds.

Commercial Price: Postage paid through Click-N-Ship at www.usps.com or authorized PC Postage vendors is 5% below retail prices.

Priority Mail International Regular Flat-Rate Box

Canada and Mexico	\$23.95
All other countries	38.95

The maximum weight is 20 pounds.

Priority Mail International Large Flat-Rate Box

Canada and Mexico	\$29.95
All other countries	49.95

The maximum weight is 20 pounds.

Priority Mail International Retail Prices

Weight Not Over (pounds)	Price Groups								
	Canada	Mexico	3	4	5	6	7	8	9
1	\$17.00	\$17.00	\$22.50	\$21.50	\$24.00	\$23.00	\$22.00	\$21.00	\$19.50
2	18.40	20.25	27.00	24.75	27.00	27.25	26.50	25.00	23.25
3	19.80	23.50	31.50	28.00	30.50	31.50	31.00	29.00	27.00
4	21.20	26.75	36.00	31.25	34.00	35.75	35.50	33.00	30.75
5	22.60	30.00	40.50	34.50	37.50	40.00	40.00	37.00	34.50
6	24.10	32.40	44.25	37.75	40.50	44.75	44.50	41.35	37.90
7	25.60	34.80	48.00	41.00	43.50	49.50	49.00	45.70	41.30
8	27.10	37.20	51.75	44.25	46.50	54.25	53.50	50.05	44.70
9	28.60	39.60	55.50	47.50	49.50	59.00	58.00	54.40	48.10
10	30.10	42.00	59.25	50.75	52.50	63.75	62.50	58.75	51.50
11	31.70	44.25	63.00	54.50	55.50	68.75	66.85	63.10	54.90
12	33.30	46.50	66.75	58.25	58.50	73.75	71.20	67.45	58.30
13	34.90	48.75	70.50	62.00	61.50	78.75	75.55	71.80	61.70
14	36.50	51.00	74.25	65.75	64.50	83.75	79.90	76.15	65.10
15	38.10	53.25	78.00	69.50	67.50	88.75	84.25	80.50	68.50
16	39.70	55.50	81.75	73.25	70.50	93.75	88.60	84.85	71.90
17	41.30	57.75	85.50	77.00	73.50	98.75	92.95	89.20	75.30
18	42.90	60.00	89.25	80.75	76.50	103.75	97.30	93.55	78.70
19	44.50	62.25	93.00	84.50	79.50	108.75	101.65	97.90	82.10
20	46.10	64.50	96.75	88.25	82.50	113.75	106.00	102.25	85.50
21	47.70	66.75	100.50	92.00	85.50	118.75	110.35	106.60	88.90
22	49.30	69.00	104.25	95.75	88.50	123.75	114.70	110.95	92.30
23	50.90	71.25	108.00	99.50	91.50	128.75	119.05	115.30	95.70
24	52.50	73.50	111.75	103.25	94.50	133.75	123.40	119.65	99.10
25	54.10	75.75	115.50	107.00	97.50	138.75	127.75	124.00	102.50
26	55.70	78.00	119.25	110.75	100.50	143.75	132.10	128.35	105.90
27	57.30	80.25	123.00	114.50	103.50	148.75	136.45	132.70	109.30
28	58.90	82.50	126.75	118.25	106.50	153.75	140.80	137.05	112.70
29	60.50	84.75	130.50	122.00	109.50	158.75	145.15	141.40	116.10
30	62.10	87.00	134.25	125.75	112.50	163.75	149.50	145.75	119.50
31	63.70	89.25	138.00	129.50	115.50	168.75	153.85	150.10	122.90
32	65.30	91.50	141.75	133.25	118.50	173.75	158.20	154.45	126.30
33	66.90	93.75	145.50	137.00	121.50	178.75	162.55	158.80	129.70
34	68.50	96.00	149.25	140.75	124.50	183.75	166.90	163.15	133.10
35	70.10	98.25	153.00	144.50	127.50	188.75	171.25	167.50	136.50
36	71.70	100.50	156.75	148.25	130.50	193.75	175.60	171.85	139.90
37	73.30	102.75	160.50	152.00	133.50	198.75	179.95	176.20	143.30
38	74.90	105.00	164.25	155.75	136.50	203.75	184.30	180.55	146.70
39	76.50	107.25	168.00	159.50	139.50	208.75	188.65	184.90	150.10
40	78.10	109.50	171.75	163.25	142.50	213.75	193.00	189.25	153.50
41	79.70	111.75	175.50	167.00	145.50	218.75	197.35	193.60	156.90
42	81.30	114.00	179.25	170.75	148.50	223.75	201.70	197.95	160.30
43	82.90	116.25	183.00	174.50	151.50	228.75	206.05	202.30	163.70
44	84.50	118.50	186.75	178.25	154.50	233.75	210.40	206.65	167.10

For weights up to 70 pounds, see the International Country Listing or Postage Price Calculator on Postal Explorer at pe.usps.com.

For a listing of countries by price group, see pages 28 and 29.

No Priority Mail International Service

Ascension
 Bolivia (flat-rate envelope only)
 Cuba (flat-rate envelope only)
 Falkland Islands
 Korea, Democratic Peoples Republic of (North Korea)
 Somalia

Maximum weight limit 22 pounds

Anguilla
 Antigua and Barbuda
 Bahamas
 Burma
 Equatorial Guinea
 Jamaica
 Pitcairn Island
 Saint Vincent and the Grenadines
 Tristan da Cunha

Parcel Select BMC and OBMC Presort (Inter-BMC)

Machinable 1, 2, 3, 4, 5							Weight Not Over (pounds)	Nonmachinable 1, 2, 3, 5, 6						
Zone								Zone						
1 & 2	3	4	5	6	7	8	1 & 2	3	4	5	6	7	8	
\$4.55	\$4.55	\$4.55	\$4.55	\$4.55	\$4.55	\$4.55	1	\$8.25	\$8.25	\$8.25	\$8.25	\$8.25	\$8.25	
4.55	4.85	5.35	5.94	6.13	6.35	6.67	2	8.25	8.55	9.05	9.64	9.83	10.05	
5.05	5.70	6.60	6.94	7.22	7.52	8.12	3	8.75	9.40	10.30	10.64	10.92	11.22	
5.75	6.75	7.55	7.88	8.23	8.62	9.38	4	9.45	10.45	11.25	11.58	11.93	12.32	
6.40	7.70	8.37	8.76	9.19	9.67	10.58	5	10.10	11.40	12.07	12.46	12.89	13.37	
7.00	8.60	9.15	9.61	10.11	10.66	11.72	6	10.70	12.30	12.85	13.31	13.81	14.36	
7.55	9.34	9.89	10.42	10.98	11.60	12.81	7	11.25	13.04	13.59	14.12	14.68	15.30	
8.00	9.70	10.61	11.19	11.82	12.51	13.85	8	11.70	13.40	14.31	14.89	15.52	16.21	
8.40	10.06	11.30	11.94	12.63	13.39	14.86	9	12.10	13.76	15.00	15.64	16.33	17.09	
8.80	11.20	11.96	12.66	13.40	14.23	15.83	10	12.50	14.90	15.66	16.36	17.10	17.93	
9.15	11.60	12.60	13.35	14.16	15.04	16.76	11	12.85	15.30	16.30	17.05	17.86	18.74	
9.50	11.90	13.22	14.02	14.88	15.83	17.67	12	13.20	15.60	16.92	17.72	18.58	19.53	
9.90	12.17	13.82	14.67	15.59	16.59	18.55	13	13.60	15.87	17.52	18.37	19.29	20.29	
10.11	12.51	14.41	15.30	16.27	17.33	19.40	14	13.81	16.21	18.11	19.00	19.97	21.03	
10.29	12.79	14.97	15.92	16.93	18.05	20.22	15	13.99	16.49	18.67	19.62	20.63	21.75	
10.44	13.06	15.52	16.51	17.58	18.75	21.03	16	14.14	16.76	19.22	20.21	21.28	22.45	
10.63	13.29	16.06	17.09	18.21	19.43	21.81	17	14.33	16.99	19.76	20.79	21.91	23.13	
10.77	13.54	16.58	17.66	18.82	20.10	22.57	18	14.47	17.24	20.28	21.36	22.52	23.80	
10.96	13.79	17.09	18.21	19.42	20.74	23.32	19	14.66	17.49	20.79	21.91	23.12	24.44	
11.09	14.02	17.59	18.75	20.00	21.37	24.04	20	14.79	17.72	21.29	22.45	23.70	25.07	
11.25	14.26	18.08	19.27	20.57	21.99	24.75	21	14.95	17.96	21.78	22.97	24.27	25.69	
11.38	14.44	18.47	19.79	21.12	22.59	25.44	22	15.08	18.14	22.17	23.49	24.82	26.29	
11.53	14.70	18.80	20.29	21.67	23.18	26.12	23	15.23	18.40	22.50	23.99	25.37	26.88	
11.64	14.89	19.07	20.78	22.20	23.76	26.78	24	15.34	18.59	22.77	24.48	25.90	27.46	
11.79	15.08	19.37	21.26	22.72	24.32	27.43	25	15.49	18.78	23.07	24.96	26.42	28.02	
11.90	15.27	19.64	21.73	23.23	24.87	28.07	26	15.60	18.97	23.34	25.43	26.93	28.57	
12.07	15.46	19.89	22.19	23.73	25.41	28.69	27	15.77	19.16	23.59	25.89	27.43	29.11	
12.16	15.65	20.18	22.64	24.22	25.94	29.30	28	15.86	19.35	23.88	26.34	27.92	29.64	
12.30	15.84	20.44	23.09	24.70	26.46	29.90	29	16.00	19.54	24.14	26.79	28.40	30.16	
12.41	15.99	20.67	23.52	25.17	26.97	30.48	30	16.11	19.69	24.37	27.22	28.87	30.67	
12.55	16.16	20.91	23.95	25.63	27.47	31.06	31	16.25	19.86	24.61	27.65	29.33	31.17	
12.64	16.33	21.15	24.37	26.07	27.97	31.62	32	16.34	20.03	24.85	28.07	29.77	31.67	
12.75	16.50	21.39	24.78	26.50	28.45	32.18	33	16.45	20.20	25.09	28.48	30.20	32.15	
12.88	16.61	21.57	25.18	26.92	28.92	32.72	34	16.58	20.31	25.27	28.88	30.62	32.62	
12.99	16.80	21.80	25.58	27.33	29.39	33.26	35	16.69	20.50	25.50	29.28	31.03	33.09	
							36	16.79	20.64	25.74	29.67	31.43	33.54	
							37	16.89	20.77	25.90	30.05	31.82	33.99	
							38	16.99	20.95	26.09	30.43	32.21	34.43	
							39	17.11	21.05	26.28	30.80	32.60	34.87	
							40	17.21	21.22	26.49	31.16	32.98	35.30	
							41	17.34	21.36	26.65	31.52	33.35	35.72	
							42	17.43	21.48	26.83	31.87	33.72	36.13	
							43	17.49	21.61	27.02	32.22	34.09	36.54	
							44	17.60	21.71	27.17	32.56	34.45	36.94	
							45	17.70	21.86	27.35	32.90	34.80	37.34	
							46	17.79	21.98	27.53	33.23	35.14	37.72	
							47	17.91	22.12	27.67	33.56	35.49	38.11	
							48	17.99	22.23	27.85	33.88	35.84	38.49	
							49	18.05	22.36	27.99	34.20	36.16	38.86	
							50	18.14	22.45	28.11	34.51	36.50	39.23	
							51	18.26	22.59	28.29	34.82	36.83	39.59	
							52	18.33	22.70	28.43	35.13	37.15	39.94	
							53	18.45	22.79	28.52	35.43	37.47	40.30	
							54	18.51	22.94	28.70	35.72	37.78	40.64	
							55	18.59	22.98	28.84	35.91	38.09	40.99	
							56	18.69	23.15	28.96	36.08	38.40	41.32	
							57	18.78	23.24	29.10	36.22	38.70	41.66	
							58	18.85	23.34	29.22	36.37	39.01	41.99	
							59	18.94	23.44	29.36	36.51	39.31	42.31	
							60	19.03	23.53	29.50	36.65	39.60	42.63	
							61	19.15	23.67	29.60	36.78	39.90	42.95	
							62	19.22	23.74	29.73	36.92	40.18	43.26	
							63	19.27	23.86	29.85	37.04	40.46	43.57	
							64	19.35	23.92	29.95	37.17	40.74	43.87	
							65	19.43	24.04	30.08	37.30	41.02	44.18	
							66	19.54	24.14	30.17	37.41	41.31	44.47	
							67	19.63	24.24	30.30	37.54	41.58	44.77	
							68	19.68	24.33	30.43	37.65	41.85	45.06	
							69	19.75	24.39	30.53	37.77	42.12	45.34	
							70	19.86	24.52	30.64	37.87	42.38	45.63	
							Oversized	54.84	59.88	63.23	75.30	89.24	94.83	

For parcels over 35 pounds, use nonmachinable prices.

1. Must be part of a mailing of 50 or more pieces and prepared as an OBMC Presort or BMC Presort mailing.

- For OBMC Presort, deduct \$1.42 per parcel.
- For BMC Presort, deduct \$0.32 per parcel.

2. For parcels that destinate to a different BMC service areas (see DMM 453.3.1).

3. Parcels that measure in combined length and girth:

- More than 84 inches but not more than 108 inches, and the piece weighs less than 20 pounds, use 20-pound prices (balloon price).
- More than 108 inches but not more than 130 inches, use oversized prices (regardless of weight).

4. Machinable parcels may be eligible for a barcoded discount of \$0.03 per parcel.

5. Regardless of weight, a parcel that meets any of the criteria in DMM 401.2.3.2 must pay the nonmachinable prices.

6. Prices include the \$3.70 nonmachinable surcharge. The nonmachinable surcharge does not apply to parcels mailed at oversized prices or parcels sent with special handling.

To compute Parcel Select prices, go to Postal Explorer at pe.usps.com and click on "Commercial" under Price Calculators in the left frame. For zone charts, click on "Zone Charts."

Parcel Select Barcoded Intra-BMC

Parcel Select Barcoded Inter-BMC

Machinable 1, 2, 3, 4, 5					Weight Not Over (pounds)	Machinable 1, 2, 3, 4, 5							
Zone						Zone							
Local	1 & 2	3	4	5		1 & 2	3	4	5	6	7	8	
\$3.64	\$3.99	\$4.02	\$4.11	\$4.30	1	\$4.52	\$4.52	\$4.52	\$4.52	\$4.52	\$4.52	\$4.52	
4.08	4.47	4.77	4.86	5.13	2	4.52	4.82	5.32	5.91	6.10	6.32	6.64	
4.48	4.97	5.45	5.57	5.94	3	5.02	5.67	6.57	6.91	7.19	7.49	8.09	
4.85	5.67	6.08	6.20	6.68	4	5.72	6.72	7.52	7.85	8.20	8.59	9.35	
5.18	6.26	6.62	6.77	7.37	5	6.37	7.67	8.34	8.73	9.16	9.64	10.55	
5.48	6.64	7.12	7.27	7.98	6	6.97	8.57	9.12	9.58	10.08	10.63	11.69	
5.71	7.00	7.57	7.74	8.57	7	7.52	9.31	9.86	10.39	10.95	11.57	12.78	
5.90	7.58	8.00	8.18	9.10	8	7.97	9.67	10.58	11.16	11.79	12.48	13.82	
6.10	7.90	8.39	8.62	9.59	9	8.37	10.03	11.27	11.91	12.60	13.36	14.83	
6.29	8.24	8.81	9.31	10.05	10	8.77	11.17	11.93	12.63	13.37	14.20	15.80	
6.46	8.53	9.15	9.67	10.47	11	9.12	11.57	12.57	13.32	14.13	15.01	16.73	
6.64	8.84	9.49	10.02	10.87	12	9.47	11.87	13.19	13.99	14.85	15.80	17.64	
6.81	9.04	9.79	10.35	11.25	13	9.87	12.14	13.79	14.64	15.56	16.56	18.52	
6.97	9.21	10.07	10.71	11.59	14	10.08	12.48	14.38	15.27	16.24	17.30	19.37	
7.12	9.38	10.36	11.00	11.91	15	10.26	12.76	14.94	15.89	16.90	18.02	20.19	
7.28	9.54	10.66	11.28	12.23	16	10.41	13.03	15.49	16.48	17.55	18.72	21.00	
7.42	9.74	10.93	11.59	12.51	17	10.60	13.26	16.03	17.06	18.18	19.40	21.78	
7.56	9.88	11.19	11.84	12.78	18	10.74	13.51	16.55	17.63	18.79	20.07	22.54	
7.69	10.04	11.46	12.10	13.04	19	10.93	13.76	17.06	18.18	19.39	20.71	23.29	
7.84	10.21	11.72	12.32	13.27	20	11.06	13.99	17.56	18.72	19.97	21.34	24.01	
7.96	10.33	11.96	12.55	13.50	21	11.22	14.23	18.05	19.24	20.54	21.96	24.72	
8.09	10.50	12.20	12.79	13.71	22	11.35	14.41	18.44	19.76	21.09	22.56	25.41	
8.22	10.61	12.45	13.03	13.94	23	11.50	14.67	18.77	20.26	21.64	23.15	26.09	
8.35	10.76	12.68	13.27	14.13	24	11.61	14.86	19.04	20.75	22.17	23.73	26.75	
8.47	10.88	12.90	13.49	14.33	25	11.76	15.05	19.34	21.23	22.69	24.29	27.40	
8.58	11.03	13.11	13.72	14.49	26	11.87	15.24	19.61	21.70	23.20	24.84	28.04	
8.70	11.15	13.34	13.94	14.66	27	12.04	15.43	19.86	22.16	23.70	25.38	28.66	
8.81	11.26	13.56	14.14	14.85	28	12.13	15.62	20.15	22.61	24.19	25.91	29.27	
8.93	11.39	13.77	14.35	15.07	29	12.27	15.81	20.41	23.06	24.67	26.43	29.87	
9.05	11.51	13.96	14.54	15.27	30	12.38	15.96	20.64	23.49	25.14	26.94	30.45	
9.15	11.63	14.14	14.74	15.49	31	12.52	16.13	20.88	23.92	25.60	27.44	31.03	
9.23	11.75	14.35	14.94	15.67	32	12.61	16.30	21.12	24.34	26.04	27.94	31.59	
9.35	11.86	14.52	15.11	15.87	33	12.72	16.47	21.36	24.75	26.47	28.42	32.15	
9.42	11.97	14.64	15.30	16.06	34	12.85	16.58	21.54	25.15	26.89	28.89	32.69	
9.50	12.07	14.81	15.48	16.24	35	12.96	16.77	21.77	25.55	27.30	29.36	33.23	

For nonmachinable parcels, see retail Parcel Post Intra-BMC prices on page 10.

For nonmachinable parcels, see retail Parcel Post Inter-BMC prices on page 11.

- All Parcel Select Barcoded Intra-BMC pieces must be part of a mailing of 50 or more pieces.**
- For parcels that originate and destinate in the same BMC service area (see DMM 453.3.1).
- Parcels that measure in combined length and girth:
 - More than 84 inches but not more than 108 inches, and the piece weighs less than 20 pounds, use 20-pound price (balloon price).
 - More than 108 inches but not more than 130 inches, use oversized prices regardless of weight.
- For nonbarcoded pieces, add \$0.03 per parcel.
- Regardless of weight, a parcel that meets any of the criteria in DMM 401.2.3.2 must pay the retail Parcel Post Intra-BMC price on page 10.

- All Parcel Select Barcoded Inter-BMC pieces must be part of a mailing of 50 or more pieces.**
- For parcels that destinate to a different BMC service area (see DMM 453.3.1).
- Parcels that measure in combined length and girth:
 - More than 84 inches but not more than 108 inches, and the piece weighs less than 20 pounds, use 20-pound price (balloon price).
 - More than 108 inches but not more than 130 inches, use oversized prices regardless of weight.
- For nonbarcoded pieces, add \$0.03 per parcel.
- Regardless of weight, a parcel that meets any of the criteria in DMM 401.2.3.2 must pay the retail Parcel Post Inter-BMC price on page 11.

To compute Parcel Select prices, go to Postal Explorer at pe.usps.com and click on "Commercial" under Price Calculators in the left frame. For zone charts, click on "Zone Charts."

Parcel Return Service

Machinable					Weight Not Over (pounds) ¹	Nonmachinable				
RDU	RBMC Zone					RDU	RBMC Zone			
	1 & 2	3	4	5			1 & 2	3	4	5
\$1.62	\$2.35	\$2.48	\$2.56	\$2.76	1	\$1.62	\$5.08	\$5.21	\$5.29	\$5.49
1.69	3.18	3.22	3.32	3.60	2	1.69	5.91	5.95	6.05	6.33
1.76	3.86	3.91	4.03	4.41	3	1.76	6.59	6.64	6.76	7.14
1.82	4.31	4.54	4.66	5.15	4	1.82	7.04	7.27	7.39	7.88
1.88	4.72	5.08	5.24	5.84	5	1.88	7.45	7.81	7.97	8.57
1.94	5.10	5.59	5.74	6.46	6	1.94	7.83	8.32	8.47	9.19
1.99	5.42	6.04	6.22	7.05	7	1.99	8.15	8.77	8.95	9.78
2.04	6.05	6.47	6.66	7.58	8	2.04	8.78	9.20	9.39	10.31
2.09	6.37	6.86	7.10	8.07	9	2.09	9.10	9.59	9.83	10.80
2.13	6.64	7.28	7.79	8.54	10	2.13	9.37	10.01	10.52	11.27
2.22	6.81	7.62	8.15	8.95	11	2.22	9.54	10.35	10.88	11.68
2.31	7.02	7.96	8.50	9.36	12	2.31	9.75	10.69	11.23	12.09
2.39	7.21	8.27	8.83	9.74	13	2.39	9.94	11.00	11.56	12.47
2.46	7.38	8.55	9.20	10.08	14	2.46	10.11	11.28	11.93	12.81
2.54	7.52	8.84	9.48	10.40	15	2.54	10.25	11.57	12.21	13.13
2.61	7.68	9.14	9.77	10.73	16	2.61	10.41	11.87	12.50	13.46
2.68	7.87	9.42	10.08	11.00	17	2.68	10.60	12.15	12.81	13.73
2.74	7.99	9.68	10.33	11.28	18	2.74	10.72	12.41	13.06	14.01
2.81	8.16	9.94	10.59	11.54	19	2.81	10.89	12.67	13.32	14.27
2.87	8.29	10.15	10.81	11.77	20	2.87	11.02	12.88	13.54	14.50
2.93	8.43	10.35	11.04	12.00	21	2.93	11.16	13.08	13.77	14.73
2.98	8.57	10.52	11.29	12.21	22	2.98	11.30	13.25	14.02	14.94
3.04	8.69	10.75	11.53	12.44	23	3.04	11.42	13.48	14.26	15.17
3.09	8.80	10.90	11.77	12.63	24	3.09	11.53	13.63	14.50	15.36
3.14	8.92	11.08	11.99	12.83	25	3.14	11.65	13.81	14.72	15.56
3.19	9.05	11.23	12.22	12.99	26	3.19	11.78	13.96	14.95	15.72
3.24	9.17	11.41	12.44	13.17	27	3.24	11.90	14.14	15.17	15.90
3.28	9.26	11.57	12.60	13.35	28	3.28	11.99	14.30	15.33	16.08
3.33	9.38	11.75	12.74	13.57	29	3.33	12.11	14.48	15.47	16.30
3.37	9.50	11.88	12.88	13.77	30	3.37	12.23	14.61	15.61	16.50
3.41	9.61	12.00	13.00	13.99	31	3.41	12.34	14.73	15.73	16.72
3.46	9.75	12.16	13.15	14.18	32	3.46	12.48	14.89	15.88	16.91
3.50	9.82	12.30	13.26	14.38	33	3.50	12.55	15.03	15.99	17.11
3.53	9.94	12.41	13.38	14.53	34	3.53	12.67	15.14	16.11	17.26
3.57	10.02	12.56	13.48	14.66	35	3.57	12.75	15.29	16.21	17.39
					36	3.61	12.88	15.45	16.35	17.56
					37	3.64	12.98	15.55	16.44	17.64
					38	3.68	13.04	15.64	16.50	17.70
					39	3.71	13.11	15.75	16.57	17.77
					40	3.74	13.17	15.82	16.61	17.84
					41	3.77	13.27	15.94	16.67	17.91
					42	3.80	13.30	16.02	16.73	17.97
					43	3.83	13.36	16.11	16.80	18.00
					44	3.86	13.43	16.18	16.85	18.04
					45	3.89	13.48	16.25	17.05	18.10
					46	3.92	13.57	16.35	17.10	18.13
					47	3.94	13.63	16.40	17.13	18.17
					48	3.97	13.68	16.50	17.16	18.22
					49	4.00	13.75	16.58	17.20	18.25
					50	4.02	13.76	16.65	17.23	18.30
					51	4.04	13.86	16.70	17.26	18.35
					52	4.07	13.91	16.81	17.31	18.38
					53	4.09	13.93	16.85	17.32	18.43
					54	4.11	13.99	16.88	17.36	18.46
					55	4.13	14.04	16.91	17.39	18.50
					56	4.16	14.09	16.93	17.43	18.55
					57	4.18	14.16	16.93	17.43	18.59
					58	4.20	14.21	16.96	17.45	18.64
					59	4.22	14.26	16.98	17.47	18.68
					60	4.23	14.32	16.99	17.47	18.71
					61	4.25	14.37	17.00	17.50	18.76
					62	4.27	14.41	17.01	17.57	18.79
					63	4.29	14.47	17.01	17.64	18.85
					64	4.31	14.52	17.01	17.67	18.89
					65	4.32	14.56	17.05	17.72	18.92
					66	4.34	14.62	17.05	17.79	18.97
					67	4.35	14.68	17.06	17.87	19.01
					68	4.37	14.68	17.06	17.90	19.04
					69	4.39	14.75	17.06	17.97	19.10
					70	4.40	14.80	17.06	18.02	19.14
					Oversized	7.68	30.05	30.56	31.48	32.88

For parcels over 35 pounds, use nonmachinable prices.

1. Parcels that measure in combined length and girth:
 - Balloon Price: RBMC pieces more than 84 inches but not more than 108 inches, and the piece weighs less than 20 pounds, use 20-pound prices.
 - More than 108 inches but not more than 130 inches, use oversized rates (regardless of weight).

Extra Services and Fees

ADDRESS CORRECTION SERVICE

Per manual notice issued—\$0.50

Per electronic notice (or manual notice for electronic option customers) issued:

First-Class Mail—\$0.08

Other than First-Class Mail—\$0.25

Per automated notice issued:

First-Class Mail letters (first two notices)—\$0.00

First-Class Mail letters (per additional notice)—\$0.06

Standard Mail letters (first two notices)—\$0.03

Standard Mail letters (per additional notice)—\$0.18

ADDRESS SEQUENCING SERVICE

Per card removed by the USPS for an incorrect or undeliverable address or added for a missing or new address—\$0.34

ANNUAL MAILING FEES (per 12-month period)

First-Class Mail Presort, per office of mailing—\$180.00

Standard Mail—\$180.00

Parcel Select (destination entry)—\$180.00

Presorted Media Mail—\$180.00

Presorted Library Mail—\$180.00

Bound Printed Matter (destination entry)—\$180.00

Parcel Return Service—\$180.00

BULK PARCEL RETURN SERVICE

Annual permit fee—\$180.00

Annual account maintenance fee—\$565.00

Per piece returned, regardless of weight—\$2.25

For Standard Mail machinable parcels only.

BUSINESS REPLY AND QUALIFIED BUSINESS REPLY MAIL

Business Reply Mail® (BRM)

	High Volume	Basic
Annual permit fee	\$180.00	\$180.00
Annual account maintenance fee	565.00	None
1-ounce letter price + per piece ¹	0.42 + 0.08	0.42 + 0.72
1-ounce flat price + per piece ¹	0.83 + 0.08	0.83 + 0.72
1-ounce parcel price + per piece ¹	1.17 + 0.08	1.17 + 0.72
Card price + per piece	0.27 + 0.08	0.27 + 0.72

Qualified Business Reply Mail (QBRM)

	High Volume	Basic
Annual permit fee	\$180.00	\$180.00
Annual account maintenance fee	565.00	565.00
Quarterly fee	1,855.00	None
1-ounce letter price + per piece ²	0.397 + 0.006	0.397 + 0.05
Card price + per piece	0.247 + 0.006	0.247 + 0.05

- \$0.17 each additional ounce: use Priority Mail prices for flats and parcels over 13 ounces.
- Second ounce or fraction—\$0.17.

CALLER SERVICE

For each separation provided, per semiannual (6 month) period.
For each reserved call number, per calendar year—\$39.00.

Fee Group	Fee
1	\$644.00
2	562.00
3	495.00
4	487.00
5	476.00
6	425.00
7	379.00

CERTIFIED MAIL

Fee—\$2.70

CERTIFICATE OF MAILING

Individual Pieces	Fee
Individual article (Form 3817)	\$1.10
Firm mailing books (Form 3877), per article listed (min. 3)	0.40
Duplicate copies of Form 3817 or mailing bill, per page	1.10

Bulk Quantities

For first 1,000 pieces (or fraction thereof)	\$6.00
Each additional 1,000 pieces (or fraction thereof)	0.70
Duplicate copy of Form 3606	1.10

COLLECT ON DELIVERY (COD)

Amount to be collected or insurance coverage desired, whichever is higher ¹	Fee
\$0.01 to \$50	\$5.25
50.01 to 100	6.45
100.01 to 200	7.65
200.01 to 300	8.85
300.01 to 400	10.05
400.01 to 500	11.25
500.01 to 600	12.45
600.01 to 700	13.65
700.01 to 800	14.85
800.01 to 900	16.05
900.01 to 1,000	17.25

Restricted delivery ²	\$4.30
Notice of nondelivery	3.70
Alteration of COD charges or designation of new addressee	3.70
Registered Mail COD ³	4.65

- For Express Mail COD shipments valued at \$100 or less, the COD fee charged is based on the amount to be collected. Express Mail insurance automatically provides up to \$100 merchandise insurance.
- Not available with Express Mail COD.
- Maximum amount collectible is \$1,000.

CONFIRM®

Subscription Level	Subscription Fee and Term	Additional ID Code Fee and Term	Additional Scans Fee and Number
Silver	\$2,000 3 months	\$900 each 3 months	\$500 block of 2 million scans
Gold	\$6,500 12 months	\$900 each 3 months \$2,500 annual	\$800 block of 6 million scans
Platinum	\$23,500 12 months	\$900 quarterly \$2,500 annual	NA

CUSTOMIZED MARKETMAIL®

Standard Mail Regular per piece—\$0.460
Standard Mail Nonprofit per piece—\$0.334

DETACHED ADDRESS LABELS

For Standard Mail Enhanced Carrier Route flats and parcels, per detached address label—\$0.017

Extra Services and Fees

DELIVERY CONFIRMATION™		SIGNATURE CONFIRMATION™	
Service	Fee	Service	Fee
First-Class Mail			
Retail (parcels only)	\$0.75	Retail (parcels only)	\$2.20
Electronic	0.18	Electronic	1.80
Priority Mail			
Retail	\$0.65	Retail	\$2.20
Electronic	0.00	Electronic	1.80
Package Services¹			
Retail	\$0.75	Retail	\$2.20
Electronic	0.18	Electronic	1.80
Parcel Select Destination Entry			
Electronic	\$0.00	Electronic	\$1.80
Parcel Select (all other)			
Electronic	\$0.18		
Standard Mail²			
Electronic	\$0.18		

1. Available only for parcels.
2. Available only for Not Flat-Machinables and parcels.

EXPRESS MAIL INSURANCE	
Merchandise Insurance Coverage Desired	Fee
\$0.01 to \$100.00	\$0.00
100.01 to 200.00	0.75
200.01 to 500.00	2.10
500.01 to 5,000.00	\$2.10 plus \$1.35 for each \$500 or fraction over \$500.

Express Mail merchandise maximum coverage: \$5,000.
Document reconstruction maximum liability: \$100.

INSURANCE	
Merchandise Insurance Coverage Desired	Fee ¹
\$0.01 to \$50	\$1.70
50.01 to 100	2.15
100.01 to 200	2.60
200.01 to 300	4.60
300.01 to 400	5.55
400.01 to 500	6.50
500.01 to 600	7.45
600.01 to 5,000	\$7.45 plus \$0.95 for each \$100 or fraction over \$600 in declared value. (maximum liability is \$5,000)

1. Bulk insurance discount \$0.80 per piece (see DMM 503.4.4).

MAILING LIST SERVICE	
For correction of name and address on occupant lists, per name on list—\$0.34. Minimum per list (30 items)—\$10.20	
For sortation of mailing lists on cards by 5-digit ZIP Code, per 1,000 addresses or fraction—\$115.00	
For address changes provided to election boards and voter registration commissions, per Form 3575—\$0.33	

MONEY ORDERS—Domestic	
Service	Fee
\$0.01 to \$500	\$1.05
500.01 to 1,000	1.50
Postal military money order (issued by military facilities)	0.30
Inquiry fee (includes the issuance of a copy of a paid money order)	5.20
Maximum amount per money order: \$1,000	

MERCHANDISE RETURN SERVICE	
Annual permit fee—\$180.00.	
Annual account maintenance fee (for advance deposit account)—\$565.00.	

PARCEL AIRLIFT (PAL)	
Weight Not More Than (pounds)	Fee
2	\$0.50
3	1.05
4	1.50
30	2.05

PARCEL RETURN SERVICE	
Annual Permit fee—\$180	
Annual account maintenance fee—\$565	

PERIODICALS APPLICATION FEES	
Original entry—\$510.00	
Additional entry—\$80.00	
Reentry—\$60.00	
Registration for news agents—\$50.00	

REGISTERED MAIL™		
Declared Value	Fee (in addition to postage) ¹	
\$0.00	\$10.00	
0.01 to \$100	10.80	
100.01 to 500	12.10	
500.01 to 1,000	13.30	
1,000.01 to 2,000	14.50	
2,000.01 to 3,000	15.70	
3,000.01 to 4,000	16.90	
4,000.01 to 5,000	18.10	
5,000.01 to 6,000	19.30	
6,000.01 to 7,000	20.50	
7,000.01 to 8,000	21.70	
8,000.01 to 9,000	22.90	
9,000.01 to 10,000	24.10	
10,000.01 to 11,000	25.30	
11,000.01 to 12,000	26.50	
12,000.01 to 13,000	27.70	
13,000.01 to 14,000	28.90	
14,000.01 to 15,000	30.10	
15,000.01 to 16,000	31.30	
16,000.01 to 17,000	32.50	
17,000.01 to 18,000	33.70	
18,000.01 to 19,000	34.90	
19,000.01 to 20,000	36.10	
20,000.01 to 21,000	37.30	
21,000.01 to 22,000	38.50	
22,000.01 to 23,000	39.70	
23,000.01 to 24,000	40.90	
24,000.01 to 25,000	42.10	

Declared Value	Fee (in addition to postage) ¹
\$25,000.01 to \$15 million	\$42.10 plus \$1.20 handling charge for each \$1,000 or fraction over first \$25,000.
Over \$15 million	\$18,012.10 plus amount determined by USPS based on weight, space, and value.

1. Fees for articles valued over \$25,000 are for handling only. Maximum amount of insurance coverage available is \$25,000.

Additional Services	
Return Receipts	
Requested at time of mailing showing to whom, signature, date of delivery, and addressee's address (if different)—\$2.20	
Requested at time of mailing (receive electronically)—\$1.00	
Requested after mailing showing only to whom and date delivered—\$4.35	
COD Collection Charge —\$4.65 (maximum amount collectible is \$1,000)	
Restricted Delivery —\$4.30	

Extra Services and Fees

PERMIT IMPRINT

Application fee—\$180

PICKUP SERVICE FEE

For Express Mail, Priority Mail, and Parcel Post:
Per Pickup on Demand or Custom Designed delivery stop—\$14.75

POST OFFICE BOX SERVICE

Per Semiannual (6-month) Period

Fee Group	Box Size and Fee				
	1	2	3	4	5
1	\$43.00	\$66.00	\$120.00	\$247.00	\$398.00
2	36.00	56.00	95.00	187.00	333.00
3	29.00	47.00	85.00	153.00	255.00
4	21.00	35.00	53.00	104.00	200.00
5	19.00	27.00	49.00	90.00	151.00
6	13.00	21.00	36.00	63.00	112.00
7	10.00	16.00	29.00	49.00	87.00
E ¹	0	0	0	0	0

1. Eligibility and location determined by USPS.

Deposit per key issued—\$1.00

Key duplication or replacement (after first two keys), each—\$6.00

Post Office box lock replacement, each—\$14.00

PREMIUM FORWARDING SERVICE

Enrollment fee—\$10.00

Weekly reshipment charge—\$11.95

REPOSITIONABLE NOTES

First-Class Mail letters and flats—\$0.005

Periodicals letters and flats—\$0.015

Standard Mail letters and flats—\$0.015

RESTRICTED DELIVERY (In conjunction with another service)

Fee, per item, in addition to postage and other fees—\$4.30

RETURN RECEIPT (In conjunction with another service)

Service	Fee
Requested at time of mailing (Form 3811, receive by mail)	\$2.20
Requested at time of mailing (receive electronically)	1.00
Requested after mailing (Form 3811-A, receive by fax, mail, or e-mail)	4.35

RETURN RECEIPT FOR MERCHANDISE (Form 3804)

Service	Fee
Requested at time of mailing	\$3.60

SHIPPER PAID FORWARDING

Annual account maintenance fee—\$565

For Standard Mail machinable parcels and most Package Service parcels.

SPECIAL HANDLING

Weight	Fee
Not more than 10 pounds	\$7.10
More than 10 pounds	9.90

International Extra Services

CERTIFICATE OF MAILING

Fee—\$1.10

CUSTOMS CLEARANCE AND DELIVERY

Fee—\$5.35

REGISTERED MAIL

Fee—\$10.80

RESTRICTED DELIVERY (In conjunction with another service)

Fee, per item, in addition to postage and other fees—\$4.30

RETURN RECEIPT (In conjunction with another service)

Requested at time of mailing—\$2.20

INTERNATIONAL BUSINESS REPLY CARD

Fee—\$0.95

INTERNATIONAL BUSINESS REPLY ENVELOPE (Up to 2 oz.)

Fee—\$1.45

INTERNATIONAL REPLY COUPONS

Fee—\$2.10

INTERNATIONAL POSTAL MONEY ORDERS

Fee—\$3.85

GLOBAL EXPRESS GUARANTEED INSURANCE

Indemnity Limit Not Over	Fee
\$100	\$0.00
Each additional \$100 or fraction over \$100	1.00
Maximum indemnity varies by country.	

EXPRESS MAIL INTERNATIONAL INSURANCE

Indemnity Limit Not Over	Fee
\$0.01 to \$100	\$0.00
100.01 to 200	0.75
200.01 to 500	2.10
500.01 to 1,000	3.45
1,000.01 to 1,500	4.80
1,500.01 to 2,000	6.15
2,000.01 to 2,500	7.50
2,500.01 to 3,000	8.85
3,000.01 to 3,500	10.20
3,500.01 to 4,000	11.55
4,000.01 to 4,500	12.90
4,500.01 to 5,000	14.25

PRIORITY MAIL INTERNATIONAL INSURANCE

Indemnity Limit Not Over	All Other Countries	
	Canada	Fee
\$50	\$1.70	\$2.45
100	2.15	3.35
200	2.60	4.30
300	4.60	5.25
400	5.55	6.20
500	6.50	7.15
600	7.45	8.10
675	8.40	—
700	N/A	9.05
Each additional \$100 or fraction over \$700	N/A	0.95
Maximum indemnity varies by country.		

Price Groups

Express Mail International
Priority Mail International
First-Class Mail International



Price Group 1	Price Group 2	Price Group 3	Price Group 4	Price Group 5
---------------	---------------	---------------	---------------	---------------

Canada

Mexico

Australia
 China
 Hong Kong
 Japan
 Korea, Republic
 (South Korea)

Albania
 Bosnia-Herzegovina
 Bulgaria
 Croatia
 Cyprus
 Czech Republic
 Estonia
 Hungary
 Latvia
 Macedonia
 Poland
 Romania
 Russia
 Turkey
 Ukraine

Austria
 Belgium
 Denmark
 Finland
 France
 Germany
 Great Britain
 Greece
 Ireland
 Italy
 Netherlands
 Norway
 Spain
 Sweden
 Switzerland

The countries listed are representative of each price group based on mail volume. For a complete country listing, see the International Country listing at pe.usps.com.

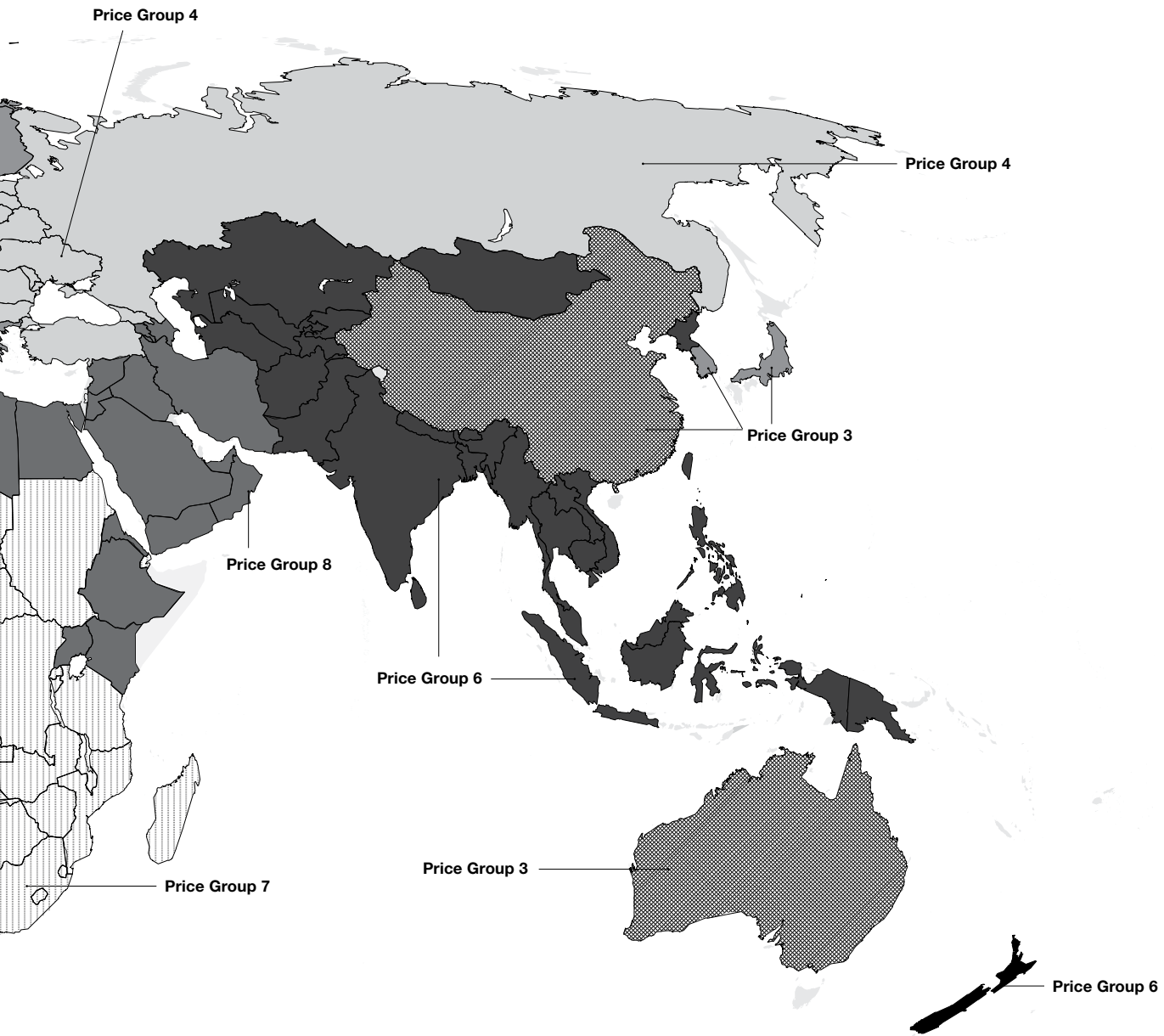

Price Group 6

- Cambodia
- Fiji Islands
- India
- Indonesia
- Malaysia
- New Zealand
- Pakistan
- Philippines
- Singapore
- Sri Lanka
- Taiwan
- Thailand
- Uzbekistan
- Vietnam

Price Group 7

- Botswana
- Congo, Democratic Republic of the
- Cote D'Ivoire
- Ghana
- Kenya
- Malawi
- Mozambique
- Niger
- Nigeria
- South Africa
- Swaziland
- Tanzania
- Uganda

Price Group 8

- Bahrain
- Egypt
- Ethiopia
- Israel
- Kuwait
- Morocco
- Qatar
- Saudi Arabia
- United Arab Emirates

Price Group 9

- Argentina
- Bahamas
- Bermuda
- Brazil
- Chile
- Colombia
- Costa Rica
- Guatemala
- Jamaica
- Panama
- Peru
- Trinidad and Tobago
- Uruguay
- Venezuela

Postal Explorer® *pe.usps.com*

Your source for up-to-date business mailing information.

Publications

Mailing Standards of the United States Postal Service, Domestic Mail Manual (DMM®)

Quick Service Guides

Customer Support Rulings

Notice 123, Price List

Postal Addressing Standards

An Introduction to Mailing for Businesses and Organizations

International Mail Manual (IMM)

DMM Advisory—Message board to keep postal customers informed of changes to mailing standards, services, and prices.

Postage Statements

Price Charts

Retail and Business Price Calculators—calculate domestic and international prices.

Standard Mail Eligibility—Easy-to-use decision tree to help determine Standard Mail eligibility.

Zone Charts—access national Zone Charts.

First-Class Mail International—Retail

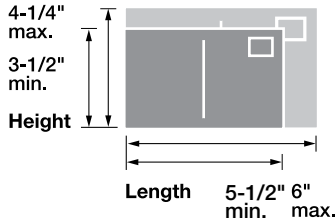
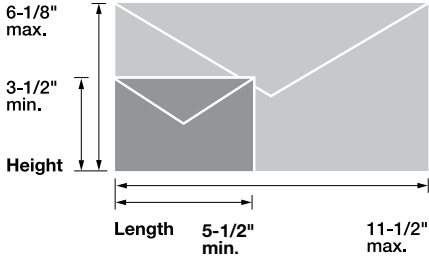
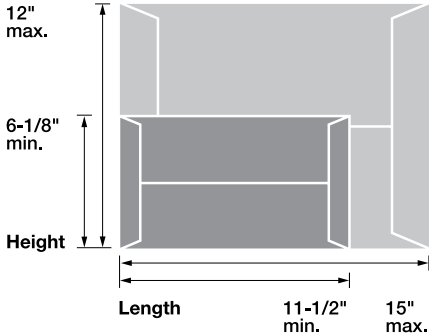
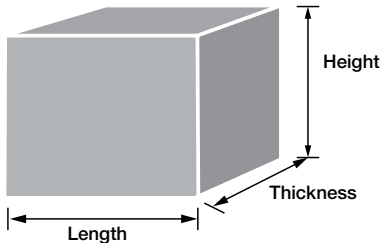
SHAPE	SIZE		PRICE					
Postcards								
 <p>4-1/4" max. 3-1/2" min. Height</p> <p>5-1/2" min. 6" max. Length</p>		minimum	maximum	Prices				
	length	5-1/2 inches	6 inches	Canada and Mexico \$0.72				
	height	3-1/2 inches	4-1/4 inches	All other countries 0.94				
	thickness	0.007 inch	0.016 inch					
Letters								
 <p>6-1/8" max. 3-1/2" min. Height</p> <p>5-1/2" min. 11-1/2" max. Length</p>		minimum	maximum	Weight Not Over (ounces)	Price Groups¹			
	length	5-1/2 inches	11-1/2 inches	1	1	2	3-5	6-9
	height	3-1/2 inches	6-1/8 inches	2	\$0.72	\$0.72	\$0.94	\$0.94
	thickness	0.007 inch	1/4 inch	3	0.96	1.27	1.74	1.69
				3.5	1.20	1.82	2.54	2.44
					1.44	2.37	3.34	3.19
Letters that meet one or more of the nonmachinable characteristics in IMM 243.23 are also subject to the \$0.20 nonmachinable surcharge.								
Large Envelopes (Flats)								
 <p>12" max. 6-1/8" min. Height</p> <p>11-1/2" min. 15" max. Length</p>		minimum*	maximum	Weight Not Over (ounces)	Price Groups¹			
	length	11-1/2 inches	15 inches	1	\$0.98	\$0.98	\$1.20	\$1.20
	height	6-1/8 inches	12 inches	2	1.22	1.53	2.00	1.95
	thickness	1/4 inch	3/4 inch	3	1.46	2.08	2.80	2.70
				4	1.70	2.63	3.60	3.45
				5	1.94	3.18	4.40	4.20
				6	2.18	3.73	5.20	4.95
				7	2.42	4.28	6.00	5.70
				8	2.66	4.83	6.80	6.45
				12	3.61	6.33	8.45	8.05
				16²	4.56	7.83	10.10	9.65
* Flats exceed at least one of these dimensions. Pieces that are rigid, nonrectangular, or not uniformly thick pay package prices.								
Packages								
 <p>Height</p> <p>Thickness</p> <p>Length</p>	Size							
		Maximum length = 24 inches.						
	Maximum length + height + thickness combined = 36 inches.							
				Weight Not Over (ounces)	Price Groups¹			
				1	1	2	3-5	6-9
				2	\$1.18	\$1.18	\$1.40	\$1.40
				3	1.42	1.73	2.20	2.15
				4	1.66	2.28	3.00	2.90
				5	1.90	2.83	3.80	3.65
				6	2.14	3.38	4.60	4.40
				7	2.38	3.93	5.40	5.15
				8	2.62	4.48	6.20	5.90
				12	2.86	5.03	7.00	6.65
				16²	3.81	6.53	8.65	8.25
					4.76	8.03	10.30	9.85

Price Group 1: Canada

Price Group 2: Mexico

Price Groups 3-5: Australia, China, Eastern Europe, Hong Kong, Japan, Russia, South Korea, Turkey, Western Europe

Price Groups 6-9: Africa, Asia (see exceptions in Price Groups 3-5), Central America, Middle East, New Zealand, South America

1. For a country price group map, see pages 28 and 29.

2. For prices up to 64 ounces, see page 3.

First-Class Mail—Retail

SHAPE	SIZE	PRICE
-------	------	-------

Postcards

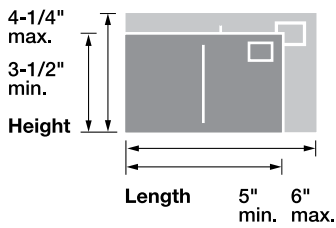

	minimum	maximum
length	5 inches	6 inches
height	3-1/2 inches	4-1/4 inches
thickness	0.007 inch	0.016 inch

Price
\$0.27

Letters

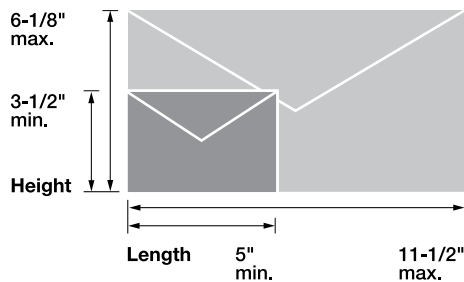

	minimum	maximum
length	5 inches	11-1/2 inches
height	3-1/2 inches	6-1/8 inches
thickness	0.007 inch	1/4 inch

Weight Not Over (ounces)	Price
1	\$0.42
2	0.59
3	0.76
3.5	0.93

Letters that meet one or more of the nonmachinable characteristics in DMM 101.1.2 are also subject to the \$0.20 nonmachinable surcharge.

Large Envelopes (Flats)

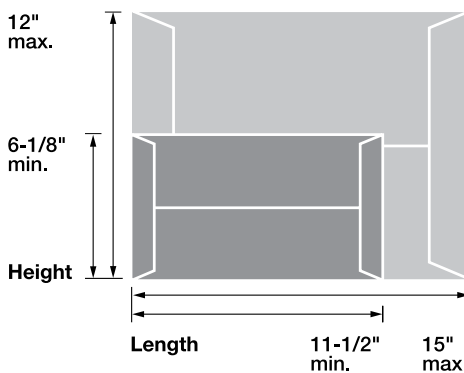

	minimum*	maximum
length	11-1/2 inches	15 inches
height	6-1/8 inches	12 inches
thickness	1/4 inch	3/4 inch

Weight Not Over (ounces)	Price
1	\$0.83
2	1.00
3	1.17
4	1.34
5	1.51
6	1.68
7	1.85
8	2.02
9	2.19
10	2.36
11	2.53
12	2.70
13	2.87

* Flats exceed at least one of these dimensions. Pieces that are rigid, nonrectangular, or not uniformly thick pay package prices.

Packages

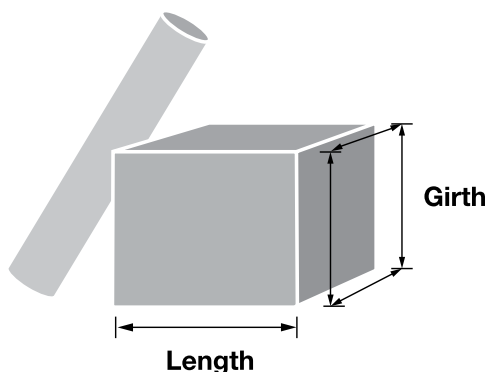

length + girth	length + girth combined cannot exceed 108 inches (Parcel Post cannot exceed 130 inches)
length	the longest side of the package
girth	measurement around the thickest part (perpendicular to the length).

Weight Not Over (ounces)	Price
1	\$1.17
2	1.34
3	1.51
4	1.68
5	1.85
6	2.02
7	2.19
8	2.36
9	2.53
10	2.70
11	2.87
12	3.04
13	3.21