

 **EPA Environmental Technology  
Verification Report**

## Soil Sampling Technology

Geoprobe Systems, Inc.  
Large-Bore Soil Sampler



# **Environmental Technology Verification Report**

## **Soil Sampler**

### **Geoprobe<sup>®</sup> Systems, Inc. Large-Bore Soil Sampler**

Prepared by

Tetra Tech EM Inc.  
591 Camino De La Reina, Suite 640  
San Diego, California 92108

Contract No. 68-C5-0037

Dr. Stephen Billets  
Characterization and Monitoring Branch  
Environmental Sciences Division  
Las Vegas, Nevada 89193-3478

National Exposure Research Laboratory  
Office of Research and Development  
U.S. Environmental Protection



---

## **Notice**

This document was prepared for the U.S. Environmental Protection Agency's (EPA) Superfund Innovative Technology Evaluation Program under Contract No. 68-C5-0037. The work detailed in this document was administered by the National Exposure Research Laboratory—Environmental Sciences Division in Las Vegas, Nevada. The document has been subjected to EPA's peer and administrative reviews, and has been approved for publication as an EPA document. Mention of corporation names, trade names, or commercial products does not constitute endorsement or recommendation for use of specific products.



UNITED STATES ENVIRONMENTAL PROTECTION AGENCY

Office of Research and Development  
Washington, D.C. 20460



ENVIRONMENTAL TECHNOLOGY VERIFICATION PROGRAM  
VERIFICATION STATEMENT

TECHNOLOGY TYPE:	SOIL SAMPLER
APPLICATION:	SUBSURFACE SOIL SAMPLING
TECHNOLOGY NAME:	LARGE-BORE SOIL SAMPLER
COMPANY:	GEOPROBE® SYSTEMS, INC.
ADDRESS:	601 NORTH BROADWAY SALINA, KANSAS 67401
PHONE:	(913) 825-1842

### ETV PROGRAM DESCRIPTION

The U.S. Environmental Protection Agency (EPA) created the Environmental Technology Verification (ETV) Program to facilitate the deployment of innovative technologies through performance verification and information dissemination. The goal of the ETV Program is to further environmental protection by substantially accelerating the acceptance and use of improved and cost-effective technologies. The ETV Program is intended to assist and inform those involved in the design, distribution, permitting, and purchase of environmental technologies. This document summarizes the results of a demonstration of the Geoprobe® Systems, Inc., Large-Bore Soil Sampler.

### PROGRAM OPERATION

Under the ETV Program and with the full participation of the technology developer, the EPA evaluates the performance of innovative technologies by developing demonstration plans, conducting field tests, collecting and analyzing demonstration data, and preparing reports. The technologies are evaluated under rigorous quality assurance (QA) protocols to ensure that data of known and adequate quality are generated and that the demonstration results are defensible. The EPA's National Exposure Research Laboratory, which demonstrates field characterization and monitoring technologies, selected Tetra Tech EM Inc. as the verification organization to assist in field testing various soil and soil gas sampling technologies. This demonstration was conducted under the EPA's Superfund Innovative Technology Evaluation Program.

### DEMONSTRATION DESCRIPTION

In May and June 1997, the EPA conducted a field test of the Geoprobe® Large-Bore Soil Sampler along with three other soil and two soil gas sampling technologies. This verification statement focuses on the Geoprobe® Large-Bore Soil Sampler; similar statements have been prepared for each of the other technologies. The performance of the Large-Bore Soil Sampler was compared to a reference subsurface soil sampling method (hollow-stem auger drilling and split-spoon sampling) in terms of the following parameters: (1) sample recovery, (2) volatile organic compound (VOC) concentrations in recovered samples, (3) sample integrity, (4) reliability and throughput, and (5) cost. Data quality indicators for precision, accuracy, representativeness, completeness, and comparability were also assessed against project-specific QA objectives to ensure the usefulness of the data for the purpose of this evaluation.

The Large-Bore Soil Sampler was demonstrated at two sites: the Small Business Administration (SBA) site in Albert City, Iowa, and the Chemical Sales Company (CSC) site in Denver, Colorado. These sites were chosen because of the wide range of VOC concentrations detected at the sites and because each has a distinct soil type. The VOCs

detected at the sites include cis-1,2-dichloroethene (cis-1,2-DCE); 1,1,1-trichloroethane (1,1,1-TCA); trichloroethene (TCE); and tetrachloroethene (PCE). The SBA site is composed primarily of clay soil, and the CSC site is composed primarily of medium- to fine-grained sandy soil. A complete description of the demonstration, including a data summary and discussion of results, is available in the report titled *Environmental Technology Verification Report: Soil Sampler, Geoprobe® Systems, Inc., Large-Bore Soil Sampler*, EPA 600/R-98/092.

## TECHNOLOGY DESCRIPTION

The Large-Bore Soil Sampler is a single tube-type, solid-barrel, closed-piston device advanced by using direct-push techniques to collect discrete interval samples of unconsolidated materials at depth. The sampler is 24 inches long with a 1.5-inch outside diameter. It is capable of recovering a discrete sample in the form of a 22-inch by 1-1/16-inch core. The sampler can be used with 24-inch long and 1-1/8-inch diameter disposable liners. In some cases, liners may facilitate retrieval of the sample and may be used for sample storage when applicable.

## VERIFICATION OF PERFORMANCE

The demonstration data indicate the following performance characteristics for the Large-Bore Soil Sampler:

**Sample Recovery.** For purposes of this demonstration, sample recovery was defined as the ratio of the length of recovered sample to the length of sampler advancement. Sample recoveries from 42 samples collected at the SBA site ranged from 65 to 100 percent, with an average sample recovery of 98 percent. Sample recoveries from 42 samples collected at the CSC site ranged from 42 to 94 percent, with an average sample recovery of 78 percent. Using the reference method, sample recoveries from 42 samples collected at the SBA site ranged from 40 to 100 percent, with an average recovery of 88 percent. Sample recoveries from the 41 samples collected at the CSC site ranged from 53 to 100 percent, with an average recovery of 87 percent. A comparison of average recovery data from the Large-Bore Soil Sampler and the reference sampler indicates that the Large-Bore Soil Sampler achieved higher sample recoveries in the clay soil at the SBA site and lower recoveries in the sandy soil at the CSC site relative to the sample recoveries achieved by the reference sampling method.

**Volatile Organic Compound Concentrations:** Soil samples collected using the Large-Bore Soil Sampler and the reference sampling method at six sampling depths within nine grids (five at the SBA site and four at the CSC site) were analyzed for VOCs. For 20 of the 23 Large-Bore Soil Sampler and reference sampling method pairs (12 at the SBA site and 11 at the CSC site), a statistical analysis using the Mann-Whitney test indicated no significant statistical difference at the 95 percent confidence level between the VOC concentrations detected in samples collected with the Large-Bore Soil Sampler and those collected with the reference sampling method. A statistically significant difference was identified for three sample pairs: one pair at the SBA site and two pairs at the CSC site. Analysis of the SBA site data, using the sign test, indicated no statistical difference between the data obtained by the Large-Bore Soil Sampler and by the reference sampling method. However, at the CSC site, the sign test indicated that the VOC data (cis-1,2-DCE, 1,1,1-TCA, TCE, and PCE) obtained by the Large-Bore Soil Sampler are statistically significantly different than the data obtained by the reference sampling method, suggesting that the reference method tends to yield higher concentrations in sampling coarse-grain soils than does the Large-Bore Soil Sampler.

**Sample Integrity:** Six integrity samples were collected with the Large-Bore Soil Sampler at each site to determine if potting soil in a lined sampler became contaminated after it was advanced through a zone of high VOC concentrations. Seven integrity samples were collected with the reference sampling method at the SBA site and five integrity samples were collected at the CSC site. For the Large-Bore Soil Sampler, VOCs were detected in five of the 12 integrity samples, all at the SBA site. The range of VOC concentrations detected above the analytical detection limit in the potting soil at the SBA site were: cis-1,2-DCE (3.42 to 295 micrograms per kilogram [Fg/kg]) and TCE (14.4 to 46.3 Fg/kg). These results indicate that the integrity of the lined chamber in the Large-Bore Soil Sampler may not be preserved when the sampler is advanced through highly contaminated soils. Results of sample integrity tests for the reference sampling method indicate no contamination in the potting soil after advancement through a zone of high VOC concentrations. Because potting soil has an organic carbon content many times greater than typical soils, the integrity tests represent a worst-case scenario for VOC absorbance and may not be representative of cross-contamination under normal field conditions.

**Reliability and Throughput** At the SBA site, the Large-Bore Soil Sampler collected a sample from the desired depth on the initial attempt 93 percent of the time. Sample collection in the initial push was achieved 100 percent of the

time at the CSC site. The initial push success rate was less than 100 percent primarily because of refusal due to cobbles. By conducting multiple pushes, the Large-Bore Soil Sampler did collect all of the samples required for this demonstration, yielding a sampling completeness of 100 percent. For the reference sampling method, the initial sampling success rates at the SBA and CSC sites were 90 and 95 percent, respectively. Success rates for the reference sampling method were less than 100 percent due to (1) drilling beyond the target sampling depth, (2) insufficient sample recovery, or (3) auger refusal. The average sample retrieval time for the Large-Bore Soil Sampler to set up on a sampling point, collect the specified sample, grout the hole, decontaminate the sampler, and move to a new sampling location was 27.5 minutes per sample at the SBA site and 15.3 minutes per sample at the CSC site. For the reference sampling technique, the average sample retrieval times at the SBA and CSC sites were 26 and 8.4 minutes per sample, respectively. During the performance range tests at Grid 5 at the CSC site, the Large-Bore Soil Sampler successfully collected all seven soil samples within the saturated zone from 40 feet below ground surface (bgs) at Grid 5; however, the Large-Bore Soil Sampler failed once to collect a sample on the initial attempt from the target depth of 40 feet in Grid 5. This sample was collected on the subsequent push. The reference method collected all seven samples from the saturated zone at 40 feet bgs on the initial attempts. One person collected soil samples using the Large-Bore Soil Sampler at the SBA site (except Grid 1 where a two-person crew was used), and a two-person sampling crew collected soil samples at the CSC site. A three-person sampling crew collected soil samples using the reference method at both sites. One additional person was present at the CSC site to oversee and assist with sample collection using the reference method.

**Cost** Based on the demonstration results and information provided by the vendor, the Large-Bore Soil Sampler and equipment costs ranged from \$1,330 to \$1,450 per day at both sites. Oversight costs for the Large-Bore Soil Sampler ranged from \$1,480 to \$2,510 at the clay soil site and \$1,080 to \$1,860 at the sandy soil site. For this demonstration, reference sampling was procured at a lump sum of \$13,400 for the clay soil site and \$7,700 for the sandy soil site. Oversight costs for the reference sampling method ranged from \$4,230 to \$6,510 at the clay soil site and \$1,230 to \$2,060 at the sandy soil site. A site-specific cost and performance analysis is recommended before selecting a subsurface soil sampling method.

A qualitative performance assessment of the Large-Bore Soil Sampler indicated that (1) the reliability of the sampler was better than the reference sampling method; (2) the sampler is easy to use and requires minimal training to operate; (3) logistical requirements are similar to those of the reference sampling method; (4) sample handling is similar to the reference method; (5) the performance range is primarily a function of the advancement platform; and (6) no drill cuttings are generated when using the Large-Bore Soil Sampler with a push platform.

The demonstration results indicate that the Large-Bore Soil Sampler can provide useful, cost-effective samples for environmental problem-solving. However, in some cases, VOC data collected using the Large-Bore Soil Sampler may be statistically different from VOC data collected using the reference sampling method. Also, the integrity of a lined sample chamber may not be preserved when the sampler is advanced through highly contaminated zones in clay soils. As with any technology selection, the user must determine what is appropriate for the application and project data quality objectives.

Gary J. Foley, Ph.D.  
Director  
National Exposure Research Laboratory  
Office of Research and Development

**NOTICE:** EPA verifications are based on an evaluation of technology performance under specific, predetermined criteria and appropriate quality assurance procedures. EPA makes no expressed or implied warranties as to the performance of the technology and does not certify that a technology will always operate as verified. The end user is solely responsible for complying with any and all applicable federal, state, and local requirements.

---

## Foreword

The U.S. Environmental Protection Agency (EPA) is charged by Congress with protecting the nation's natural resources. Under the mandate of national environmental laws, the Agency strives to formulate and implement actions leading to a compatible balance between human activities and the ability of natural systems to support and nurture life. To meet this mandate, the EPA's Office of Research and Development (ORD) provides data and science support that can be used to solve environmental problems and to build the scientific knowledge base needed to manage our ecological resources wisely, to understand how pollutants affect our health, and to prevent or reduce environmental risks.

The National Exposure Research Laboratory (NERL) is the Agency's center for the investigation of technical and management approaches for identifying and quantifying risks to human health and the environment. Goals of the Laboratory's research program are to (1) develop and evaluate methods and technologies for characterizing and monitoring air, soil, and water; (2) support regulatory and policy decisions; and (3) provide the science support needed to ensure effective implementation of environmental regulations and strategies.

The EPA's Superfund Innovative Technology Evaluation (SITE) Program evaluates technologies for the characterization and remediation of contaminated Superfund and Resource Conservation and Recovery Act sites. The SITE Program was created to provide reliable cost and performance data to speed the acceptance and use of innovative remediation, characterization, and monitoring technologies by the regulatory and user community.

Effective measurement and monitoring technologies are needed to assess the degree of contamination at a site, to provide data that can be used to determine the risk to public health or the environment, to supply the necessary cost and performance data to select the most appropriate technology, and to monitor the success or failure of a remediation process. One component of the EPA SITE Program, the Monitoring and Measurement Technology Program, demonstrates and evaluates innovative technologies to meet these needs.

Candidate technologies can originate from within the federal government or from the private sector. Through the SITE Program, developers are given the opportunity to conduct a rigorous demonstration of their technology under actual field conditions. By completing the evaluation and distributing the results, the Agency establishes a baseline for acceptance and use of these technologies. The Monitoring and Measurement Technology Program is managed by the ORD's Environmental Sciences Division in Las Vegas, Nevada.

Gary Foley, Ph.D.  
Director  
National Exposure Research  
Laboratory  
Office of Research and Development

---

## Contents

Notice . . . . .	ii
Verification Statement . . . . .	iii
Foreword . . . . .	vi
Figures . . . . .	ix
Tables . . . . .	x
Acronyms and Abbreviations . . . . .	xi
Acknowledgments . . . . .	xii
Executive Summary . . . . .	xiii
Chapter 1 Introduction . . . . .	1
Technology Verification Process . . . . .	3
Needs Identification and Technology Selection . . . . .	3
Demonstration Planning and Implementation . . . . .	3
Report Preparation . . . . .	4
Information Distribution . . . . .	4
Demonstration Purpose . . . . .	4
Chapter 2 Technology Description . . . . .	5
Background . . . . .	5
Components and Accessories . . . . .	6
Description of Platforms . . . . .	6
General Operating Procedures . . . . .	8
Other Sampling Tools . . . . .	10
Developer Contact . . . . .	10
Chapter 3 Site Descriptions and Demonstration Design . . . . .	12
Site Selection and Description . . . . .	12
SBA Site Description . . . . .	12
CSC Site Description . . . . .	14
Predemonstration Sampling and Analysis . . . . .	16
Demonstration Design . . . . .	18
Sample Recovery . . . . .	18
Volatile Organic Compound Concentrations . . . . .	18
Sample Integrity . . . . .	24
Reliability and Throughput . . . . .	24
Cost . . . . .	24
Deviations from the Demonstration Plan . . . . .	25
Chapter 4 Description and Performance of the Reference Method . . . . .	26
Background . . . . .	26
Components and Accessories . . . . .	26
Description of Platform . . . . .	26
Demonstration Operating Procedures . . . . .	28
Qualitative Performance Factors . . . . .	30
Reliability and Ruggedness . . . . .	30
Training Requirements and Ease of Operation . . . . .	31



---

## Contents (Continued)

Logistical Requirements . . . . .	31
Sample Handling . . . . .	32
Performance Range . . . . .	32
Investigation-Derived Waste . . . . .	32
Quantitative Performance Factors . . . . .	32
Sample Recovery . . . . .	32
Volatile Organic Compound Concentrations . . . . .	33
Sample Integrity . . . . .	33
Sample Throughput . . . . .	33
Data Quality . . . . .	33
Chapter 5 Technology Performance . . . . .	36
Qualitative Performance Factors . . . . .	36
Reliability and Ruggedness . . . . .	36
Training Requirements and Ease of Operation . . . . .	37
Logistical Requirements . . . . .	37
Sample Handling . . . . .	37
Performance Range . . . . .	38
Investigation-Derived Waste . . . . .	38
Quantitative Performance Assessment . . . . .	38
Sample Recovery . . . . .	38
Volatile Organic Compound Concentrations . . . . .	39
Sample Integrity . . . . .	45
Sample Throughput . . . . .	45
Data Quality . . . . .	46
Macro-Core® Soil Sampler Performance . . . . .	46
Training . . . . .	46
Performance Range, Reliability, and Ruggedness . . . . .	47
Licensing Requirements . . . . .	47
Throughput . . . . .	47
Sample Recovery . . . . .	47
Chapter 6 Economic Analysis . . . . .	48
Assumptions . . . . .	48
Large-Bore Soil Sampler . . . . .	48
Reference Sampling Method . . . . .	50
Chapter 7 Summary of Demonstration Results . . . . .	53
Chapter 8 Technology Update . . . . .	56
Chapter 9 Previous Deployment . . . . .	58
References . . . . .	59
Appendix	
A Data Summary Tables and Statistical Method Descriptions . . . . .	A-1

---

## Figures

2-1.	Large-Bore Soil Sampler Components . . . . .	7
2-2.	Driving and Sampling with the Large-Bore Soil Sampler . . . . .	9
2-3.	Macro-Core® Soil Sampler Assembly . . . . .	11
3-1.	Small Business Administration Site . . . . .	13
3-2.	Chemical Sales Company Site . . . . .	15
3-3.	Typical Sampling Locations and Random Sampling Grid . . . . .	19
3-4.	Sampling Grid with High Contaminant Concentration Variability . . . . .	21
3-5.	Sampling Grid with Low Contaminant Concentration Variability . . . . .	22
4-1.	Split-Spoon Soil Sampler . . . . .	27
4-2.	Typical Components of a Hollow-Stem Auger . . . . .	29
5-1.	Comparative Plot of Median VOC Concentrations for the Large-Bore Soil Sampler and Reference Sampling Method at the SBA and CSC Sites . . . . .	44

---

## Tables

3-1.	Sampling Depths Selected for the Large-Bore Soil Sampler Demonstration . . . . .	17
4-1.	Volatile Organic Compound Concentrations in Samples Collected Using the Reference Sampling Method . . . . .	34
5-1.	Investigation-Derived Waste Generated During the Demonstration . . . . .	38
5-2.	Sample Recoveries for the Large-Bore Soil Sampler and the Reference Sampling Method . . . . .	39
5-3.	Volatile Organic Compound Concentrations in Samples Collected Using the Large-Bore Soil Sampler . . . . .	40
5-4.	Demonstration Data Summary for the Large-Bore Soil Sampler and Reference Sampling Method . . . . .	41
5-5.	Median Volatile Organic Compound Concentrations of Large-Bore Soil Sampler and Reference Sampler Data and Statistical Significance . . . . .	43
5-6.	Sign Test Results for the Large-Bore Soil Sampler and Reference Sampling Method . . . . .	45
5-7.	Average Sample Retrieval Times for the Large-Bore Soil Sampler and the Reference Sampling Method . . . . .	46
6-1.	Estimated Subsurface Soil Sampling Costs for the Large-Bore Soil Sampler . . . . .	49
6-2.	Estimated Subsurface Soil Sampling Costs for the Reference Sampling Method . . . . .	51

---

## Acronyms and Abbreviations

bgs	below ground surface
cc	cubic centimeter
CERCLA	Comprehensive Environmental Response, Compensation, and Liability Act
cis-1,2-DCE	cis-1,2-dichloroethene
CME	Central Mine Equipment
CSC	Chemical Sales Company
CSCT	Consortium for Site Characterization Technology
1,1-DCA	1,1-dichloroethane
E&E	Ecology & Environment
EPA	U.S. Environmental Protection Agency
ETV	Environmental Technology Verification
ETVR	Environmental Technology Verification Report
g	gram
GC	gas chromatography
i.d.	inside diameter
IDW	investigation-derived waste
LCS	laboratory control samples
MC	Geoprobe® Systems Macro-Core® sampler
mg/kg	milligrams per kilogram
mL	milliliter
MS/MSD	matrix spike/matrix spike duplicate
Fg/kg	micrograms per kilogram
NERL	National Exposure Research Laboratory
o.d.	outside diameter
OSHA	Occupational Safety and Health Administration
OU	operable unit
PCE	tetrachloroethene
QA/QC	quality assurance/quality control
RCRA	Resource Conservation and Recovery Act
RI/FS	remedial investigation/feasibility study
RPD	relative percent difference
SBA	Small Business Administration
SITE	Superfund Innovative Technology Evaluation
SMC	Superior Manufacturing Company
1,1,1-TCA	1,1,1-trichloroethane
TCE	trichloroethene
UST	underground storage tank
VOC	volatile organic compound

---

## **Acknowledgments**

This report was prepared for the U.S. Environmental Protection Agency's (EPA) Environmental Technology Verification Program under the direction of Stephen Billets, Brian Schumacher, and Eric Koglin of the EPA's National Exposure Research Laboratory—Environmental Sciences Division in Las Vegas, Nevada. The project was also supported by the EPA's Superfund Innovative Technology Evaluation (SITE) Program. The EPA wishes to acknowledge the support of Janice Kroone (EPA Region 7), Joe Vranka (Colorado Department of Public Health and the Environment), Armando Saenz (EPA Region 8), Sam Goforth (independent consultant), Alan Hewitt (Cold Regions Research Engineering Laboratory), Bob Siegrist (Colorado School of Mines), and Ann Kern (EPA SITE Program). In addition, we gratefully acknowledge the collection of soil samples using the Large-Bore Soil Sampler by Wes Chandler and Mike Carlin (Geoprobe® Systems, Inc.), collection of soil samples using hollow-stem auger drilling and split-spoon sampling by Michael O'Malley, Bruce Stewart, and Clay Schnase (Geotechnical Services), implementation of this demonstration by Eric Hess, Patrick Splichal, and Andy Mazzeo (Tetra Tech); editorial and publication support by Butch Fries, Jennifer Brainerd, and Stephanie Anderson (Tetra Tech); and technical report preparation by Ron Ohta, Roger Argus, and Ben Hough (Tetra Tech).

---

## Executive Summary

In May and June 1997, the U.S. Environmental Protection Agency sponsored a demonstration of the Geoprobe® System, Inc., Large-Bore Soil Sampler, three other soil sampling technologies, and two soil gas sampling technologies. This Environmental Technology Verification Report presents the results of the Large-Bore Soil Sampler demonstration; similar reports have been published for each of the other soil and soil gas sampling technologies.

The Large-Bore Soil Sampler is a sampling tool capable of collecting unconsolidated subsurface material at depths that depend on the capability of the advancement platform. The Large-Bore Soil Sampler can be advanced into the subsurface with direct-push platforms, drill rigs, or manual methods.

The Large-Bore Soil Sampler was demonstrated at two sites: the Small Business Administration (SBA) site in Albert City, Iowa, and the Chemical Sales Company (CSC) site in Denver, Colorado. These sites were chosen because each has a wide range of volatile organic compound (VOC) concentrations and because each has a distinct soil type. The VOCs detected at the sites include 1,1,1-trichloroethane; cis-1,2-dichloroethene; trichloroethene; and tetrachloroethene. The SBA site is composed primarily of clay soil, and the CSC site is composed primarily of medium- to fine-grained sandy soil.

The Large-Bore Soil Sampler was compared to a reference method (hollow-stem auger drilling and split-spoon sampling) in terms of the following parameters: (1) sample recovery, (2) VOC concentrations in recovered samples, (3) sample integrity, (4) reliability and throughput, and (5) cost. The demonstration data indicate the following performance and cost characteristics:

- C Compared to the reference method, average sample recoveries for the Large-Bore Soil Sampler were higher in clay soil and lower in sandy soil.
- C A significant statistical difference between the VOC concentrations measured was detected for one of 12 Large-Bore Soil Sampler and reference sample method pairs at the SBA site and for two of 11 pairs at the CSC site. The data also suggest that the reference method tends to yield higher concentrations than the Large-Bore Soil Sampler in sampling coarse-grained soils.
- C In five of the 12 integrity test samples, the integrity of the lined chamber of the Large-Bore Soil Sampler was not preserved when the sampler was advanced through highly contaminated soils.
- C The reliability of the Large-Bore Soil Sampler to collect a sample in the first attempt was higher than that of the reference sampling method in both clay and sandy soils. The average sample retrieval time for the Large-Bore Soil Sampler was slower than the retrieval time for the reference method in both clay and sandy soil.
- C For both clay soil and sandy soil sites, the range of costs for the Large-Bore Soil Sampler was lower than the reference method. The actual cost depends on the number of samples required, the sample retrieval time, soil type, sample depth, and the cost for disposal of drill cuttings.

In general, results for the data quality indicators selected for this demonstration met the established quality assurance objectives and support the usefulness of the demonstration results in verifying the Large-Bore Soil Sampler's performance.

---

## **Chapter 1 Introduction**

Performance verification of innovative and alternative environmental technologies is an integral part of the U.S. Environmental Protection Agency's (EPA) regulatory and research mission. Early efforts focused on evaluating technologies that supported implementation of the Clean Air and Clean Water Acts. To meet the needs of the hazardous waste program, the Superfund Innovative Technology Evaluation (SITE) Program was established by the EPA Office of Solid Waste and Emergency Response (OSWER) and Office of Research and Development (ORD) as part of the Superfund Amendments and Reauthorization Act of 1986. The primary purpose of the SITE Program is to promote the acceptance and use of innovative characterization, monitoring, and treatment technologies.

The overall goal of the SITE Program is to conduct research and performance verification studies of alternative or innovative technologies that may be used to achieve long-term protection of human health and the environment. The various components of the SITE Program are designed to encourage the development, demonstration, acceptance, and use of new or innovative treatment and monitoring technologies. The program is designed to meet four primary objectives: (1) identify and remove obstacles to the development and commercial use of alternative technologies, (2) support a development program that identifies and nurtures emerging technologies, (3) demonstrate promising innovative technologies to establish reliable performance and cost information for site characterization and cleanup decision-making, and (4) develop procedures and policies that encourage the selection of alternative technologies at Superfund sites, as well as other waste sites and commercial facilities.

The intent of a SITE demonstration is to obtain representative, high quality, performance and cost data on innovative technologies so that potential users can assess a given technology's suitability for a specific application. The SITE Program includes the following elements:

- C Monitoring and Measurement Technology (MMT) Program** — Evaluates technologies that detect, monitor, sample, and measure hazardous and toxic substances. These technologies are expected to provide better, faster, and more cost-effective methods for producing real-time data during site characterization and remediation studies
  
- C Remediation Technologies** — Conducts demonstrations of innovative treatment technologies to provide reliable performance, cost, and applicability data for site cleanup
  
- C Technology Transfer Program** — Provides and disseminates technical information in the form of updates, brochures, and other publications that promote the program and the technology. Provides technical assistance, training, and workshops to support the technology

---

The MMT Program provides developers of innovative hazardous waste measurement, monitoring, and sampling technologies with an opportunity to demonstrate a technology's performance under actual field conditions. These technologies may be used to detect, monitor, sample, and measure hazardous and toxic substances in soil, sediment, waste materials, and groundwater. Technologies include chemical sensors for *in situ* (in place) measurements, groundwater sampling devices, soil and core sampling devices, soil gas samplers, laboratory and field-portable analytical equipment, and other systems that support field sampling or data acquisition and analysis.

The MMT Program promotes the acceptance of technologies that can be used to accurately assess the degree of contamination at a site, provide data to evaluate potential effects on human health and the environment, apply data to assist in selecting the most appropriate cleanup action, and monitor the effectiveness of a remediation process. Acceptance into the program places high priority on innovative technologies that provide more cost-effective, faster, and safer methods than conventional technologies for producing real-time or near-real-time data. These technologies are demonstrated under field conditions and results are compiled, evaluated, published, and disseminated by ORD. The primary objectives of the MMT Program are the following:

- C Test field analytical technologies that enhance monitoring and site characterization capabilities
- C Identify the performance attributes of new technologies to address field characterization and monitoring problems in a more cost-effective and efficient manner
- C Prepare protocols, guidelines, methods, and other technical publications that enhance the acceptance of these technologies for routine use

The SITE MMT Program is administered by ORD's National Exposure Research Laboratory (NERL-LV) at the Environmental Sciences Division in Las Vegas, Nevada.

In 1994, the EPA created the Environmental Technology Verification (ETV) Program to facilitate the deployment of innovative technologies in other areas of environmental concern through performance verification and information dissemination. As in the SITE Program, the goal of the ETV Program is to further environmental protection by substantially accelerating the acceptance and use of improved and cost-effective technologies. The ETV Program is intended to assist and inform those involved in the design, distribution, permitting, and purchase of various environmental technologies. The ETV Program capitalizes on and applies the lessons learned in implementing the SITE Program.

For each demonstration, the EPA draws on the expertise of partner "verification organizations" to design efficient procedures for conducting performance tests of environmental technologies. The EPA selects its partners from both the public and private sectors, including federal laboratories, states, universities, and private sector entities. Verification organizations oversee and report verification activities based on testing and quality assurance (QA) protocols developed with input from all major stakeholder and customer groups associated with the technology area. For this demonstration, the EPA selected Tetra Tech EM Inc. (Tetra Tech; formerly PRC Environmental Management, Inc.) as the verification organization.

In May and June 1997, the EPA conducted a demonstration, funded by the SITE Program, to verify the performance of four soil and two soil gas sampling technologies: SimulProbe® Technologies, Inc., Core Barrel Sampler; Geoprobe® Systems, Inc., Large-Bore Soil Sampler; AMS™ Dual Tube Liner



---

Sampler; Clements Associates, Inc., Environmentalist's Subsoil Probe; Quadrel Services, Inc., EMFLUX® Soil Gas Investigation System; and W.L. Gore & Associates GORE-SORBER® Soil Gas Sampler. This environmental technology verification report (ETVR) presents the results of the demonstration for one soil sampling technology, the Geoprobe® Systems, Inc., Large-Bore Soil Sampler. Separate ETVRs have been published for the remaining soil and soil gas sampling technologies.

### **Technology Verification Process**

The technology verification process is designed to conduct demonstrations that will generate high-quality data that the EPA and others can use to verify technology performance and cost. Four key steps are inherent in the process: (1) needs identification and technology selection, (2) demonstration planning and implementation, (3) report preparation, and (4) information distribution.

#### ***Needs Identification and Technology Selection***

The first aspect of the technology verification process is to identify technology needs of the EPA and the regulated community. The EPA, the U.S. Department of Energy, the U.S. Department of Defense, industry, and state agencies are asked to identify technology needs for characterization, sampling, and monitoring. Once a technology area is chosen, a search is conducted to identify suitable technologies that will address that need. The technology search and identification process consists of reviewing responses to *Commerce Business Daily* announcements, searches of industry and trade publications, attendance at related conferences, and leads from technology developers. Selection of characterization and monitoring technologies for field testing includes an evaluation of the candidate technology against the following criteria:

- C Designed for use in the field or in a mobile laboratory
- C Applicable to a variety of environmentally contaminated sites
- C Has potential for resolving problems for which current methods are unsatisfactory
- C Has costs that are competitive with current methods
- C Performs better than current methods in areas such as data quality, sample preparation, or analytical turnaround time
- C Uses techniques that are easier and safer than current methods
- C Is commercially available

#### ***Demonstration Planning and Implementation***

After a technology has been selected, the EPA, the verification organization, and the developer agree to a strategy for conducting the demonstration and evaluating the technology. The following issues are addressed at this time:

- C Identifying and defining the roles of demonstration participants, observers, and reviewers

- 
- C Identifying demonstration sites that provide the appropriate physical or chemical attributes in the desired environmental media
  - C Determining logistical and support requirements (for example, field equipment, power and water sources, mobile laboratory, or communications network)
  - C Arranging analytical and sampling support
  - C Preparing and implementing a demonstration plan that addresses the experimental design, the sampling design, quality assurance/quality control (QA/QC), health and safety, field and laboratory operations scheduling, data analysis procedures, and reporting requirements

### ***Report Preparation***

Each of the innovative technologies is evaluated independently and, when possible, against a reference technology. The technologies are usually operated in the field by the developers in the presence of independent observers. These individuals are selected by the EPA or the verification organization and work to ensure that the technology is operated in accordance with the demonstration plan. Demonstration data are used to evaluate the capabilities, performance, limitations, and field applications of each technology. After the demonstration, all raw and reduced data used to evaluate each technology are compiled into a technology evaluation report as a record of the demonstration. A verification statement and detailed evaluation narrative of each technology are published in an ETVR. This document receives a thorough technical and editorial review prior to publication.

### ***Information Distribution***

The goal of the information distribution strategy is to ensure that ETVRs are readily available to interested parties through traditional data distribution pathways, such as printed documents. Related documents and technology updates are also available on the World Wide Web through the ETV Web site (<http://www.epa.gov/etv>) and through the Hazardous Waste Clean-Up Information Web site supported by the EPA OSWER Technology Innovation Office (<http://clu-in.org>). Additional information on the SITE Program can be found on ORD's web site (<http://www.epa.gov/ORD/SITE>).

### ***Demonstration Purpose***

The primary purpose of a soil sampling technology is to collect a sample from a specified depth and return it to the surface with minimal changes to the chemical concentration or physical properties of the sample. This report documents the performance of the Geoprobe® Systems, Inc., Large-Bore Soil Sampler relative to the hollow-stem auger drilling and split-spoon sampling reference method.

This document summarizes the results of an evaluation of the Geoprobe® Systems, Inc., Large-Bore Soil Sampler in comparison to the reference sampling method in terms of the following parameters: (1) sample recovery, (2) volatile organic compound (VOC) concentrations in recovered samples, (3) sample integrity, (4) reliability and throughput, and (5) cost. Data quality measures of precision, accuracy, representativeness, completeness, and comparability were also assessed against established QA objectives to ensure the usefulness of the data for the purpose of this verification.

---

## **Chapter 2**

### **Technology Description**

This chapter describes the Geoprobe® Large-Bore Soil Sampler, including its background, components and accessories, sampling platform, and general operating procedures. The text in this chapter was provided by the developer and was edited for format and relevance.

#### **Background**

In the late 1980s, Geoprobe® began development of percussion-probing (direct-push) techniques. One of the first soil samplers designed for percussion probing was a simple closed-barrel, piston-type sampler called the Kansas Sampler. This sampler allowed the operator to collect a soil core approximately 1 foot in length and 1 inch in diameter. However, this sample must be extruded from the lined sample barrel. The need in the environmental industry for larger sample volumes, collection of samples in liners to minimize sample handling, and replaceable cutting shoes to reduce equipment costs led to the development of the Large-Bore Soil Sampler.

The Large-Bore Soil Sampler is designed to collect core samples of unconsolidated materials such as soils, sediments, and waste materials or mixtures of these materials. This sampling device has been used in medium- to fine-grained, cohesive materials such as silty clay soils or sediments, and has also been used in sampling medium- to coarse-grained, sandy materials with some fine gravels. This sampling device is not designed for sampling consolidated bedrock, strongly cemented soils or sediments, or materials rich in coarse gravels, cobbles, or boulders.

When appropriate sampler liner materials are used and the Large-Bore Soil Sampler is properly operated, soil samples can be collected for most environmental analytes of interest.

Additional developer claims for the performance of the Large-Bore Soil Sampler are that it:

- C Collects samples representative of the chemical and physical characteristics of the interval sampled
- C Preserves sample integrity
- C Can sample discrete depths accurately
- C Works in most soil textures
- C Requires no specialized training to operate

---

C Produces very little investigation-derived waste (IDW) consisting primarily of soil from unused samples and decontaminating fluids

C Can be used at depths in excess of 100 feet in favorable soils and geologic settings

During the demonstration, the developer's claims regarding the performance of the Large-Bore Soil Sampler were evaluated with the exception of the performance range of the Large-Bore Soil Sampler being in excess of 100 feet.

### **Components and Accessories**

The Large-Bore Soil Sampler is a single tube-type, solid-barrel, closed-piston device advanced by using direct-push techniques to collect discrete interval samples of unconsolidated materials at depth. The sampler is 24 inches long with a 1.5-inch outside diameter (o.d.). It is capable of recovering a discrete sample in the form of a 22-inch by 1-1/16-inch core. The sampler can be used with a disposable liner, which measures 24 inches by 1-1/8 inches. Liners facilitate retrieval of the sample and may be used for storage when applicable.

The components of the Large-Bore Soil Sampler are shown in Figure 2-1. The sampler has seven basic components: piston tip, piston rod, drive head, stop-pin, sample tube, cutting shoe, and sample liner. The liners are available in clear plastic (cellulose acetate butyrate [acetate]), brass, stainless steel, and Teflon™ to meet the sample collection requirements and data quality objectives of a specific project. The fully assembled sampler weighs approximately 7.2 pounds.

The Large-Bore Soil Sampler can be driven to depth manually or with a Geoprobe® Systems percussion-probing machine. A sufficient number of probe rods (3- or 4-foot lengths) are required to advance the sampler to the target depth. Extension rods with connectors are needed to insert through the hollow probe rods and retrieve the piston stop-pin before the sample can be collected.

Tools such as pipe wrenches, vise grips (large and small), and a large-bore shoe wrench may be needed for disassembly. A manual extruder is available to extrude samples from the brass or stainless-steel liners. Geoprobe® has developed grouting equipment that allows for bottom-up re-entry grouting of the probe holes and meets American Society for Testing and Materials and state requirements.

### **Description of Platforms**

The Large-Bore Soil Sampler can be used with all the variations of platforms that Geoprobe® Systems manufactures. The Large-Bore Soil Sampler can also be used with other direct-push platforms with the proper adapters. During the SITE demonstration, the Geoprobe® Model 5400 platform was used, the most powerful soil probing machine Geoprobe® manufactures. The 1,680-pound machine was mounted and enclosed in a three-quarter-ton pickup truck, and the truck engine supplied the power to the probe hydraulics. It can exert up to 18,000 pounds of downward force and 25,000 pounds of upward force. Equipped with the GH-40 hammer system, the probing mast has a 5.4-foot total stroke and a maximum height of approximately 10 feet. The platform is capable of moving laterally 23.5 inches when extended for operation. This feature allows for rapid repositioning to sample proximal locations.

The standard 48-inch-long Geoprobe® B-threaded hollow rods used during the demonstration have an o.d. of 1.25 inches and an inside diameter (i.d.) of 0.625 inches. One and a quarter-inch drive caps

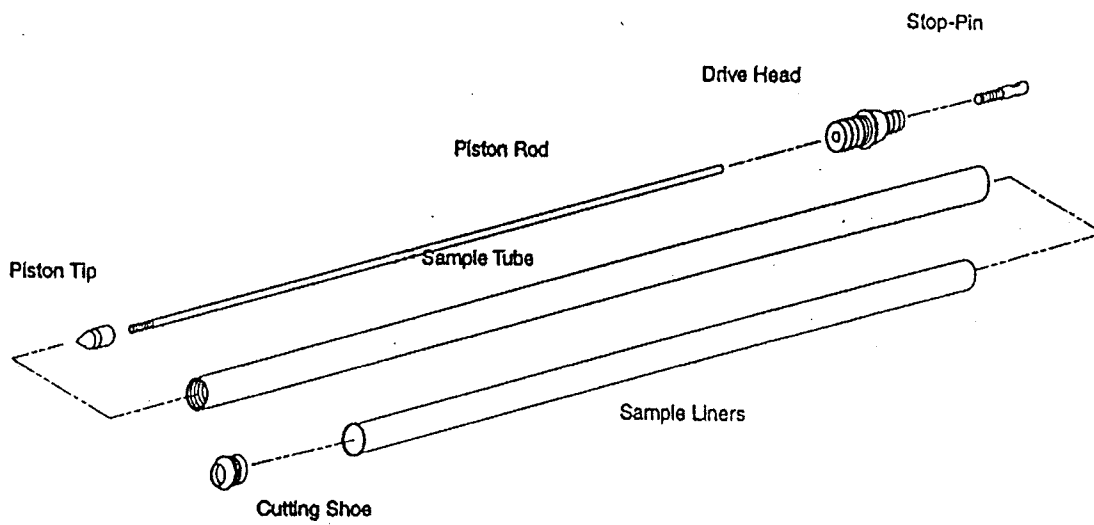

Figure 2-1. Large-Bore Soil Sampler Components (modified from Geoprobe®, 1997)

---

are needed to advance the sampler, and a recently developed accessory called the rod grip puller was used to retract the rods, replacing the need for the pull cap. The rod grip puller can be used to extract the probe rods from the ground by gripping the rod and applying adequate pressure against the rod. Another accessory used during the demonstration was the rod wiper. The rod wiper is a platform with a hole and series of rubber wipers that clean the probe rods as they are extracted from the ground.

### **General Operating Procedures**

Before use and between each sample collected during the demonstration, the Large-Bore Soil Sampler and any supporting equipment that may come in contact with the sample should be cleaned and decontaminated to meet the project-specific data quality objectives. The Large-Bore Soil Sampler is assembled according to the following protocol.

First, the liner (acetate during the demonstration) is fitted over the bottom of the cutting shoe. One end of the commonly used acetate liners is expanded, which facilitates fitting the liner over the edge of the cutting shoe. Next, the cutting shoe and liner assembly are threaded onto the sample tube (either end) until tight. The piston tip and piston assembly should be tightly threaded and then inserted into the top end of the sample tube so that the tip is exposed beneath the cutting shoe. The drive head is then threaded onto the sample tube on top of the sampler, over the extruding piston. The stop-pin is then reverse-threaded into the drive head; all threading may be tightened by hand except for the stop-pin, which may require use of small vise grips or a wrench. This tightening is a crucial step in the procedure because it ensures that the piston tip and sample tube are properly sealed to minimize the possibility that contaminants could enter the sampler before the sample is collected.

The assembled sampler is connected to the leading end of a probe rod by the drive head and driven into the subsurface using a percussion-probing machine. Additional probe rods are connected in succession to advance the sampler to depth. The sampler remains sealed (closed) by the piston tip as it is driven. When the sampler tip has reached the top of the desired sampling interval, a series of extension rods, adequate to reach the required depth, are coupled together and lowered down the inside of the probe rods. Once the extension rods contact the stop-pin, the extension rods are rotated clockwise using a handle on the topmost extension rod. The male threads on the leading end of the extension rods engage the female threads on the top end of the stop-pin, and the pin is removed. After the extension rods and stop-pin have been removed, the sampler is advanced a maximum of 24 inches. The piston is displaced inside the sampler body by the soil as the sampler is advanced.

The sampler is retrieved from the hole with the pull cap or rod grip puller, and the liner containing the soil sample is removed. To remove the liner, the sample tube is placed in a vise, and the drive head is manually unthreaded. Next, the cutting shoe is unthreaded. The liner that is still attached to the cutting shoe is then removed from the sample tube (Figure 2-2).

Health and safety considerations for operating the Geoprobe® platform and collecting soil samples with the Large-Bore Soil Sampler include applicable Occupational Safety and Health Administration (OSHA) hazardous waste operation training and eye, ear, head, hand, and foot protection. The percussion hammer of the Geoprobe® poses a threat of hearing loss and requires adequate hearing protection.

The many moving parts pose a risk of injury to the head, eyes, and feet, which can be protected with hard helmet, safety glasses, and steel-toed boots. Leather gloves, and in some cases a chemically protective overglove (depending on the nature and concentration of the contaminants), are

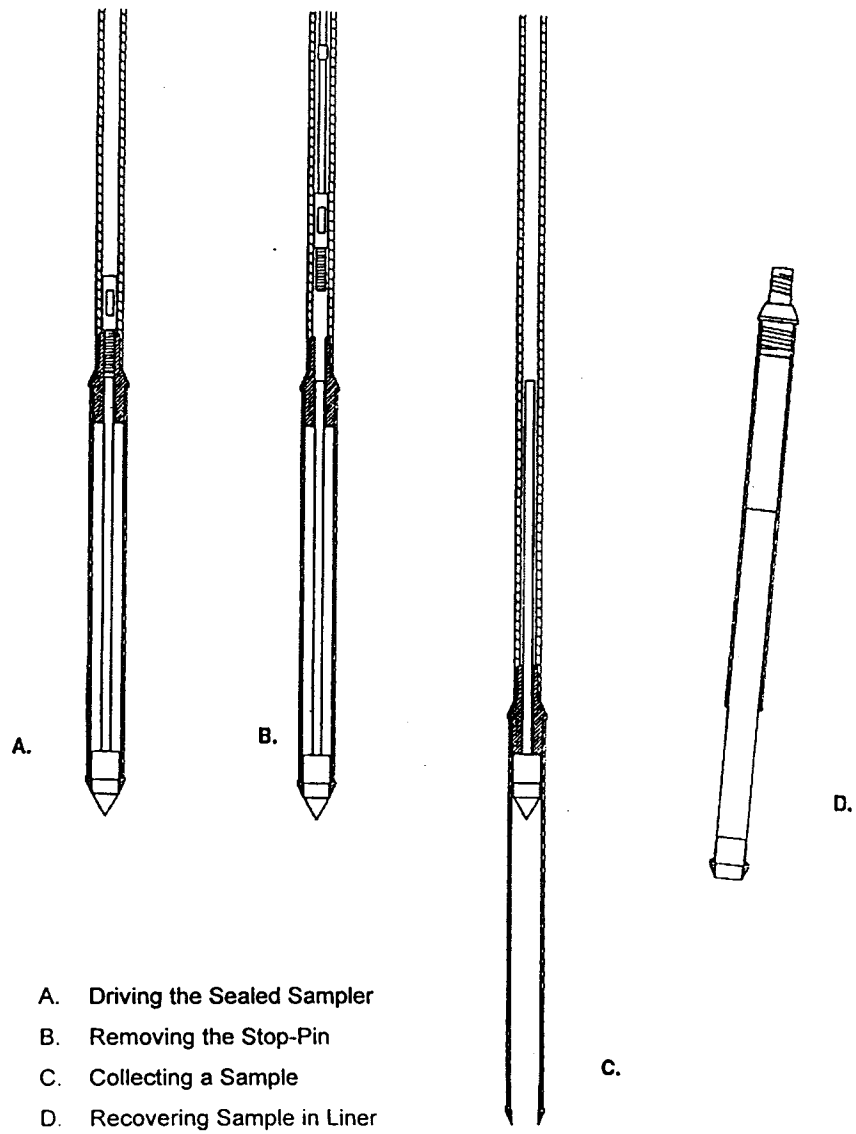

Figure 2-2. Driving and Sampling with the Large-Bore Soil Sampler (modified from Geoprobe®, 1997)

---

recommended for physical and chemical protection during operation of the Geoprobe® platform and sampling apparatus.

### **Other Sampling Tools**

Geoprobe® Systems has developed another soil sampler tool called the Macro-Core® Soil Sampler. The Macro-Core® Soil Sampler is similar in design and function to the Large-Bore Soil Sampler, except that it provides a larger sample. This sampler was demonstrated only in the continuous sampling mode at one location at the Chemical Sales Company (CSC) site in this demonstration. Its continuous sampling capability was compared to continuous sampling using a hollow-stem auger drill rig with a 24-inch split-spoon sampler. This comparison is presented in Chapter 5.

The Macro-Core® Soil Sampler can be used to collect core samples of unconsolidated materials in 4-foot increments from ground surface to depth. The sampler can be operated as an open-tube sampler or as a closed-piston sampler. The sampler measures 48 inches long and has a 2-inch o.d. The Macro-Core® Soil Sampler is capable of recovering a sample in the form of a 45-inch by 1.5-inch core. The samples are recovered in a liner inserted inside the Macro-Core® sample tube. Liners are 46 inches long and 1.5 inches in diameter and are available in stainless steel, Teflon™, polyvinyl chloride, and polyethylene triglycerate. The components of the Macro-Core® Soil Sampler are shown on Figure 2-3. The open-tube system has only five basic parts. These parts are the sample tube, drive head, cutting shoe, sample liner, and either a spacer ring or a core catcher. The closed-piston system operates with these same basic parts, but includes the closed-piston assembly. The fully assembled Macro-Core® Soil Sampler weighs approximately 14.1 pounds.

The Macro-Core® Soil Sampler can be driven to depth with the Geoprobe® percussion-probing machine, similar direct-push machine, or by manual methods. When operating the closed-piston system, the Macro-Core® release rod and extension rods with connectors are needed to insert through the hollow drive rods to release the locked closed-piston assembly. Drive caps and pull caps or the rod grip puller are needed to advance and then retract the sampler. Hand tools, including the Macro-Core® combination wrench, may be needed for assembly and disassembly after use.

### **Developer Contact**

For more developer information on the Large-Bore Soil Sampler and Macro-Core® sampler, please refer to Chapters 8 and 9 of this ETVR or contact the developer at:

Mr. Wes McCall  
Geoprobe® Systems, Inc.  
601 North Broadway  
Salina, Kansas 67401  
Telephone: (913) 825-1842  
Facsimile: (913) 825-2097  
E-mail: mcallw@geoprobessystem.com



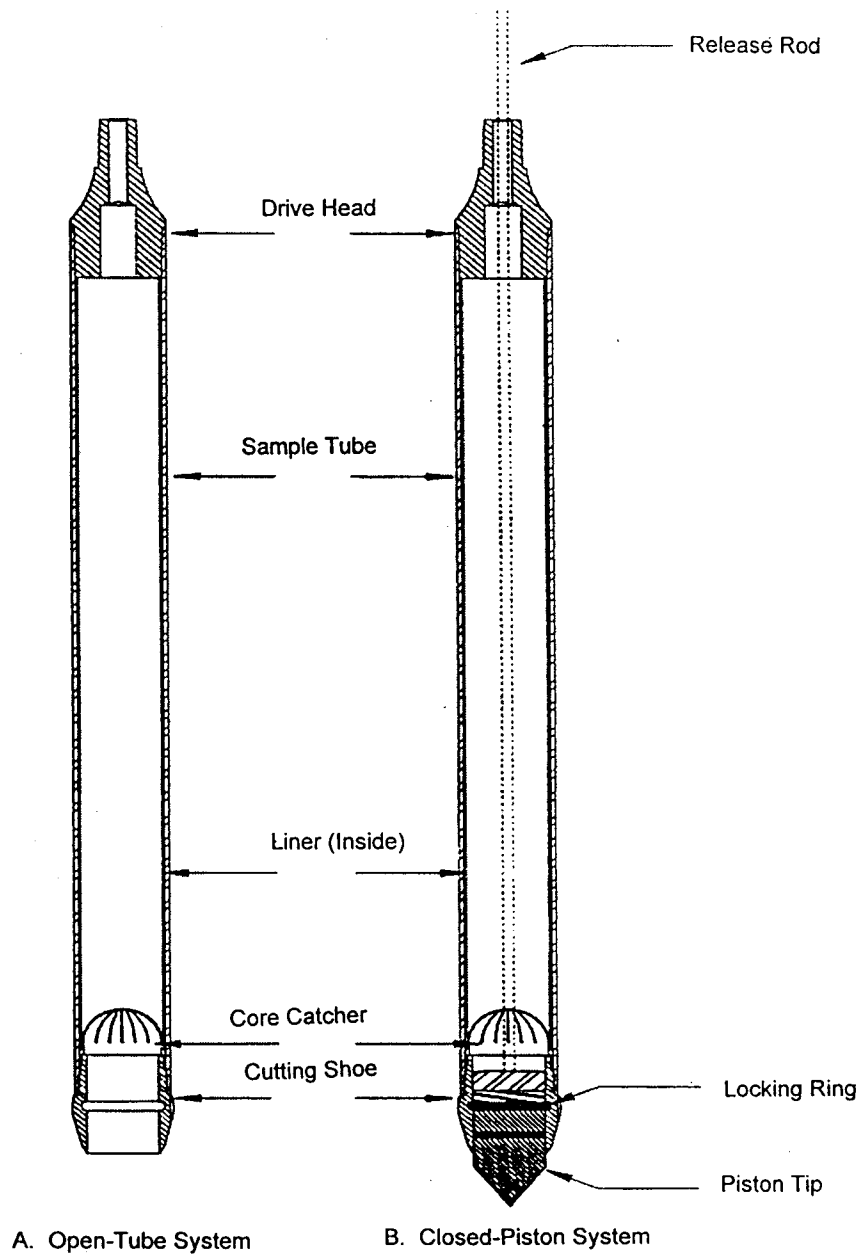

Figure 2-3. Macro-Core® Soil Sampler Assembly (modified from Geoprobe® Systems, 1997)

---

## **Chapter 3**

### **Site Descriptions and Demonstration Design**

This chapter describes the demonstration sites, predemonstration sampling and analysis, and the demonstration design. The demonstration was conducted in accordance with the “Final Demonstration Plan for the Evaluation of Soil Sampling and Soil Gas Sampling Technologies” (PRC, 1997).

#### **Site Selection and Description**

The following criteria were used to select the demonstration sites:

- C Unimpeded access for the demonstration
- C A range (micrograms per kilogram [Fg/kg] to milligrams per kilogram [mg/kg]) of chlorinated or aromatic VOC contamination in soil
- C Well-characterized contamination
- C Different soil textures
- C Minimal underground utilities
- C Situated in different climates

Based on a review of 48 candidate sites, the Small Business Administration (SBA) site in Albert City, Iowa, and the CSC site in Denver, Colorado, were selected for the demonstration.

#### ***SBA Site Description***

The SBA site is located on Orchard Street between 1st and 2nd Avenues in east-central Albert City, Iowa (Figure 3-1). The site is the location of the former Superior Manufacturing Company (SMC) facility and is now owned by SBA and B&B Chlorination, Inc. SMC manufactured grease guns at the site from 1935 until 1967. Metal working, assembling, polishing, degreasing, painting, and other operations were carried out at the site during this period. The EPA files indicate that various solvents were used in manufacturing grease guns and that waste metal shavings coated with oil and solvents were placed in a waste storage area. The oil and solvents were allowed to drain onto the ground, and the metal waste was hauled off site by truck (Ecology & Environment [E&E], 1996).

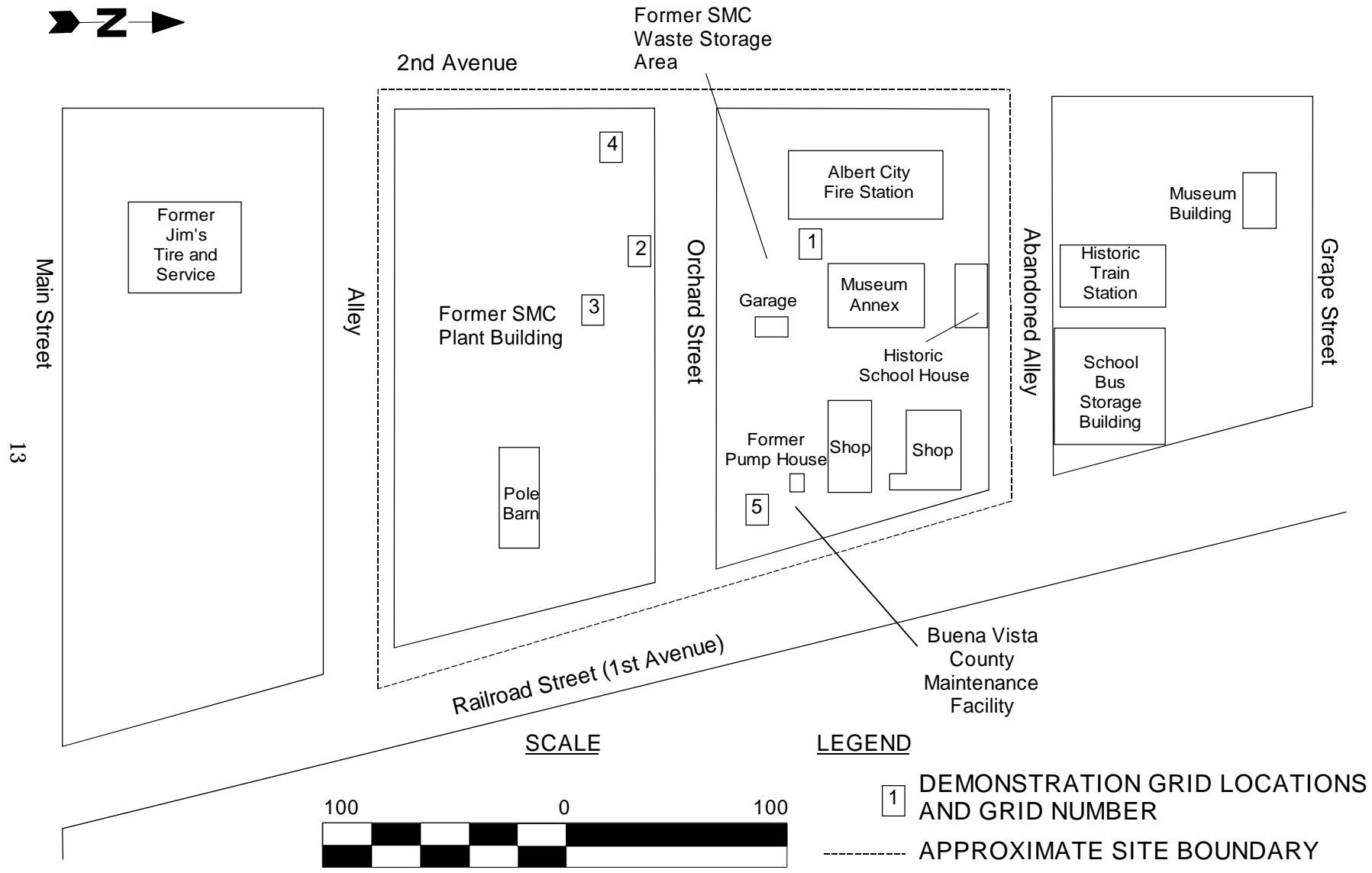

Figure 3-1. Small Business Administration Site

---

The site consists of the former SMC plant property and a waste storage yard. The SMC plant property is currently a grass-covered, relatively flat, unfenced open lot. The plant buildings have been razed. A pole barn is the only building currently on the plant property. Several buildings are present in the waste storage yard, including three historic buildings: a garage, a museum, and a school house.

Poorly drained, loamy soils of the Nicollet series are present throughout the site area. The upper layer of these soils is a black loam grading to a dark gray loam. Below this layer, the soils grade to a friable, light clay loam extending to a depth of 60 inches. Underlying these soils is a thick sequence (400 feet or more) of glacial drift. The lithology of this glacial drift is generally a light yellowish-gray, sandy clay with some gravel, pebbles, or boulders. The sand-to-clay ratio is probably variable throughout the drift. Groundwater is encountered at about 6 to 7 feet below ground surface (bgs) at the SBA site (E&E, 1996).

Tetrachloroethene (PCE), trichloroethene (TCE), cis-1,2-dichloroethene (cis-1,2-DCE), and vinyl chloride are the primary contaminants detected in soil at the site. These chlorinated VOCs have been detected in both surface (0 to 2 feet deep) and subsurface (3 to 5 feet deep) soil samples. TCE and cis-1,2-DCE are the VOCs usually detected at the highest concentrations in both soil and groundwater. In past site investigations, TCE and cis-1,2-DCE have been detected in soils at 17 and 40 mg/kg, respectively, with vinyl chloride present at 1.4 mg/kg. The areas of highest contamination have been found near the center of the former SMC plant property and near the south end of the former SMC waste storage area (E&E, 1996).

### ***CSC Site Description***

The CSC site is located in Denver, Colorado, approximately 5 miles northeast of downtown Denver. From 1962 to 1976, a warehouse at the site was used to store chemicals. The CSC purchased and first occupied the facility in 1976. The CSC installed aboveground and underground storage tanks and pipelines at the site between October 1976 and February 1977. From 1976 to 1992, the facility received, blended, stored, and distributed various chemicals and acids. Chemicals were transported in bulk to the CSC facility by train, and were unloaded along railroad spurs located north and south of the CSC facility. These operations ceased at the CSC site in 1992.

The EPA conducted several investigations of the site from 1981 through 1991. Results of these investigations indicated a release of organic chemicals into the soil and groundwater at the site. As a result of this finding, the CSC site was placed on the National Priorities List in 1990. The site is divided into three operable units (OU). This demonstration was conducted at OU1, located at 4661 Monaco Parkway in Denver (Figure 3-2). In September 1989, EPA and CSC entered into an Administrative Order on Consent requiring CSC to conduct a remedial investigation/feasibility study (RI/FS) for CSC OU1. The RI/FS was completed at OU1 in 1991 (Engineering-Science, Inc., 1991).

The current site features of OU1 consist of the warehouse, a concrete containment pad with a few remaining tanks from the aboveground tank farm, another smaller containment pad with aboveground tanks north of a railroad spur, and multiple areas in which drums are stored on the west side of the warehouse and in the northwest corner of the property. The warehouse is currently in use and is occupied by Steel Works Corporation.

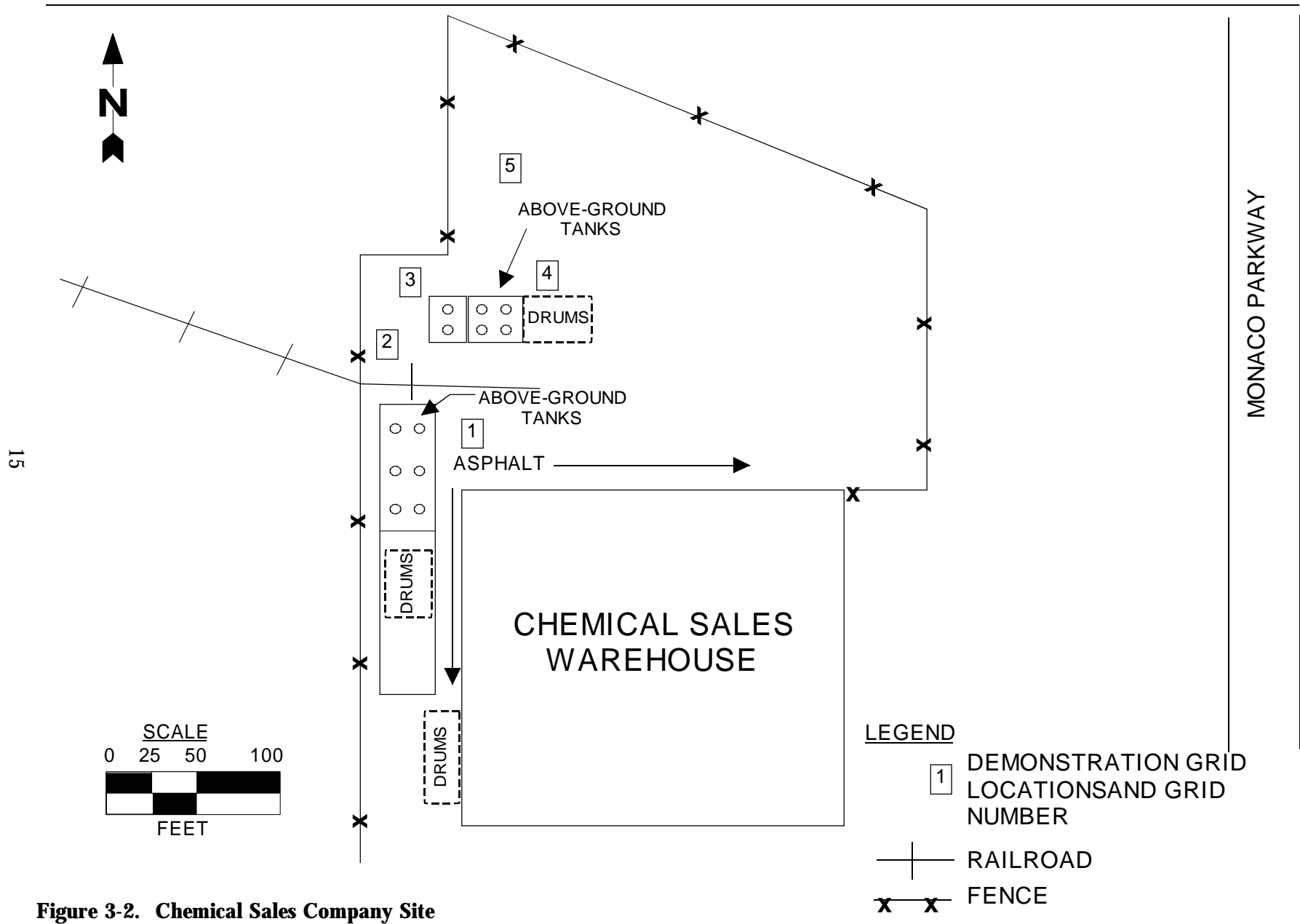

**Figure 3-2. Chemical Sales Company Site**

---

The topography, distribution of surficial deposits, and materials encountered during predemonstration sampling suggest that the portion of OU1 near the CSC warehouse is a terrace deposit composed of Slocum Alluvium beneath aeolian sand, silt, and clay. The terrace was likely formed by renewed downcutting of a tributary to Sand Creek. Borings at the CSC property indicate that soils in the vadose zone and saturated zone are primarily fine- to coarse-grained, poorly sorted sands with some silts and clays. The alluvial aquifer also contains some poorly sorted gravel zones. The depth to water is about 30 to 40 feet bgs near the CSC warehouse.

During previous soil investigations at the CSC property, chlorinated VOC contamination was detected extending from near the surface (less than 5 feet bgs) to the water table depth. The predominant chlorinated VOCs detected in site soils are PCE, TCE, 1,1,1-trichloroethane (1,1,1-TCA), and 1,1-dichloroethane (1,1-DCA). The area of highest VOC contamination is north of the CSC tank farm, near the northern railroad spur. The PCE concentrations detected in this area measure as high as 80 mg/kg, with TCE and 1,1,1-TCA concentrations measuring as high as 1 mg/kg.

### **Predemonstration Sampling and Analysis**

Predemonstration sampling and analysis were conducted to establish the geographic location of sampling grids, identify target sampling depths, and estimate the variability of contaminant concentrations exhibited at each grid location and target sampling depth. Predemonstration sampling was conducted at the SBA site between April 1 and 11, 1997, and at the CSC site between April 20 and 25, 1997. Ten sampling grids, five at the SBA site and five at the CSC site, were investigated to identify sampling depths within each grid that exhibited chemical concentration and soil texture characteristics that met the criteria set forth in the predemonstration sampling plan (PRC, 1997) and would, therefore, be acceptable for the Large-Bore Soil Sampler demonstration.

At each of the grids sampled during the predemonstration, a single continuous core was collected at the center of the 10.5- by 10.5-foot sampling area. This continuous core was collected to a maximum depth of 20 feet bgs at the SBA site and 28 feet bgs at the CSC site. Analytical results for this core sample were used to identify target sampling depths and confirm that the target depths exhibited the desired contaminant concentrations and soil type. After the center of each grid was sampled, four additional boreholes were advanced and sampled in each of the outer four corners of the 10.5- by 10.5-foot grid area. These corner locations were sampled at depth intervals determined from the initial coring location in the center of the grid, and were analyzed for VOCs and soil texture.

During predemonstration sampling, ten distinct target depths were sampled at five grids at the SBA site: three depths at Grid 1, two depths at Grid 2, one depth at Grid 3, two depths at Grid 4, and two depths at Grid 5. Five of the target depths represented intervals with contaminant concentrations in the tens of mg/kg, and five of the target depths represented intervals with contaminant concentrations in the tens of Fg/kg. As expected, the primary VOCs detected in soil samples were vinyl chloride, cis-1,2-DCE, TCE, and PCE. TCE and cis-1,2-DCE were detected at the highest concentrations. Because the soil texture was relatively homogeneous for each target sampling depth, soil sampling locations for the demonstration were selected based on TCE and cis-1,2-DCE concentration variability within each grid. A depth was deemed acceptable for the demonstration if (1) individual TCE and cis-1,2-DCE concentrations were within a factor of 5, (2) the relative standard deviations for TCE and cis-1,2-DCE concentrations were less than 50 percent, and (3) the soil texture did not change in dominant grain size.

During predemonstration sampling, 12 distinct target depths were sampled at the five grids at the CSC site: two depths at Grid 1, three depths at Grid 2, three depths at Grid 3, two depths at Grid 4, and two depths at Grid 5. Two of the target depths represented intervals with contaminant concentrations greater than 200 Fg/kg, and 10 of the target depths represented intervals with contaminant concentrations less than 200 Fg/kg. The primary VOCs detected in soil at the CSC site were 1,1,1-TCA, TCE, and PCE.

Of the 22 distinct target depths sampled during predemonstration activities at the SBA and CSC sites, seven sampling depths in 10 grids were selected for the demonstration. Six sampling depths within nine grids at the SBA and CSC sites (a total of 12 grid-depth combinations) were chosen to meet the contaminant concentration and soil texture requirements stated above. One sampling depth at one grid (40 feet bgs at Grid 5) at the CSC site was selected to evaluate the reliability and sample recovery of the Large-Bore Soil Sampler in saturated sandy soil. The sampling depths and grids selected for the Large-Bore Soil Sampler demonstration at the SBA and CSC sites are listed in Table 3-1. The locations of the sampling grids are shown in Figures 3-1 and 3-2.

**Table 3-1. Sampling Depths Selected for the Large-Bore Soil Sampler Demonstration**

Site	Grid	Concentration Zone	Depth (feet)
SBA (Clay Soil)	1	High	9.5
		High	13.5
	2	Low	3.5
	3	High	9.5
	4	Low	9.5
CSC (Sandy Soil)	1	High	3.0
		Low	6.5
	2	High	3.0
	3	High	3.0
		Low	7.5
	4	Low	6.5
	5 <sup>a</sup>	Low	40.0 <sup>a</sup>

<sup>a</sup> Performance test sampling location only; samples collected but not analyzed. Sampling location selected to evaluate the reliability and sample recovery of the Large-Bore Soil Sampler in saturated sandy soil.

---

## **Demonstration Design**

The demonstration was designed to evaluate the Large-Bore Soil Sampler in comparison to the reference sampling method in terms of the following parameters: (1) sample recovery, (2) VOC concentration in recovered samples, (3) sample integrity, (4) reliability and throughput, and (5) cost. These parameters were assessed in two different soil textures (clay soil at the SBA site and sandy soil at the CSC site), and in high- and low-concentration areas at each site. The demonstration design is described in detail in the demonstration plan (PRC, 1997) and is summarized below.

Predemonstration sampling identified 12 grid-depth combinations (See Table 3-1) for the demonstration that exhibited consistent soil texture, acceptable VOC concentrations, and acceptable variability in VOC concentrations. One additional grid-depth combination was selected for the demonstration to evaluate the performance of the Large-Bore Soil Sampler in saturated sandy soil. Each grid was 10.5 feet by 10.5 feet in area and was divided into seven rows and seven columns, producing 49, 18- by 18-inch sampling cells (Figure 3-3). Each target depth was sampled in each of the seven columns (labeled A through G) using the Large-Bore Soil Sampler and the reference sampling method. The cell that was sampled in each column was selected randomly. The procedure used to collect samples using the Large-Bore Soil Sampler is described in Chapter 2, and the procedure used to collect samples using the reference sampling method is described in Chapter 4. In addition, Chapters 4 and 5 summarize the data collected at each grid for the reference method and Large-Bore Soil Sampler.

### ***Sample Recovery***

Sample recoveries for each Large-Bore Soil Sampler and reference method sample were calculated by comparing the length of sampler advancement to the length of sample core obtained for each attempt. Sample recovery is defined as the length of recovered sample core divided by the length of sampler advancement, and is expressed as a percentage. In some instances, the length of recovered sample was reported as greater than the length of sampler advancement. In these cases, sample recovery was reported as 100 percent. Sample recoveries were calculated to assess the recovery range and mean for both the Large-Bore Soil Sampler and the reference sampling method.

### ***Volatile Organic Compound Concentrations***

Once a sample was collected, the soil core was exposed and a subsample was collected at the designated sampling depth. The subsample was used for on-site VOC analysis according to either a low-concentration or a high-concentration method using modified SW-846 methods. The low-concentration method was used for sampling depths believed to exhibit VOC concentrations of less than 200 Fg/kg. The high-concentration method was used for sampling depths believed to exhibit concentrations greater than 200 Fg/kg. The method detection limits for the low- and high-concentration methods were 1 Fg/kg and 100 Fg/kg, respectively. Predemonstration sampling results were used to classify target sampling depths as low or high concentration. Samples for VOC analysis were collected by a single sampling team using the same procedures for both the Large-Bore Soil Sampler and reference sampling method.

Samples from low-concentration sampling depths were collected as two 5-gram (g) aliquots. These aliquots were collected using a disposable 5-cubic centimeter (cc) syringe with the tip cut off and the rubber plunger tip removed. The syringe was pushed into the sample to the point that 3 to 3.5 cc of soil was contained in the syringe. The soil core in the syringe was extruded directly into a 22-milliliter



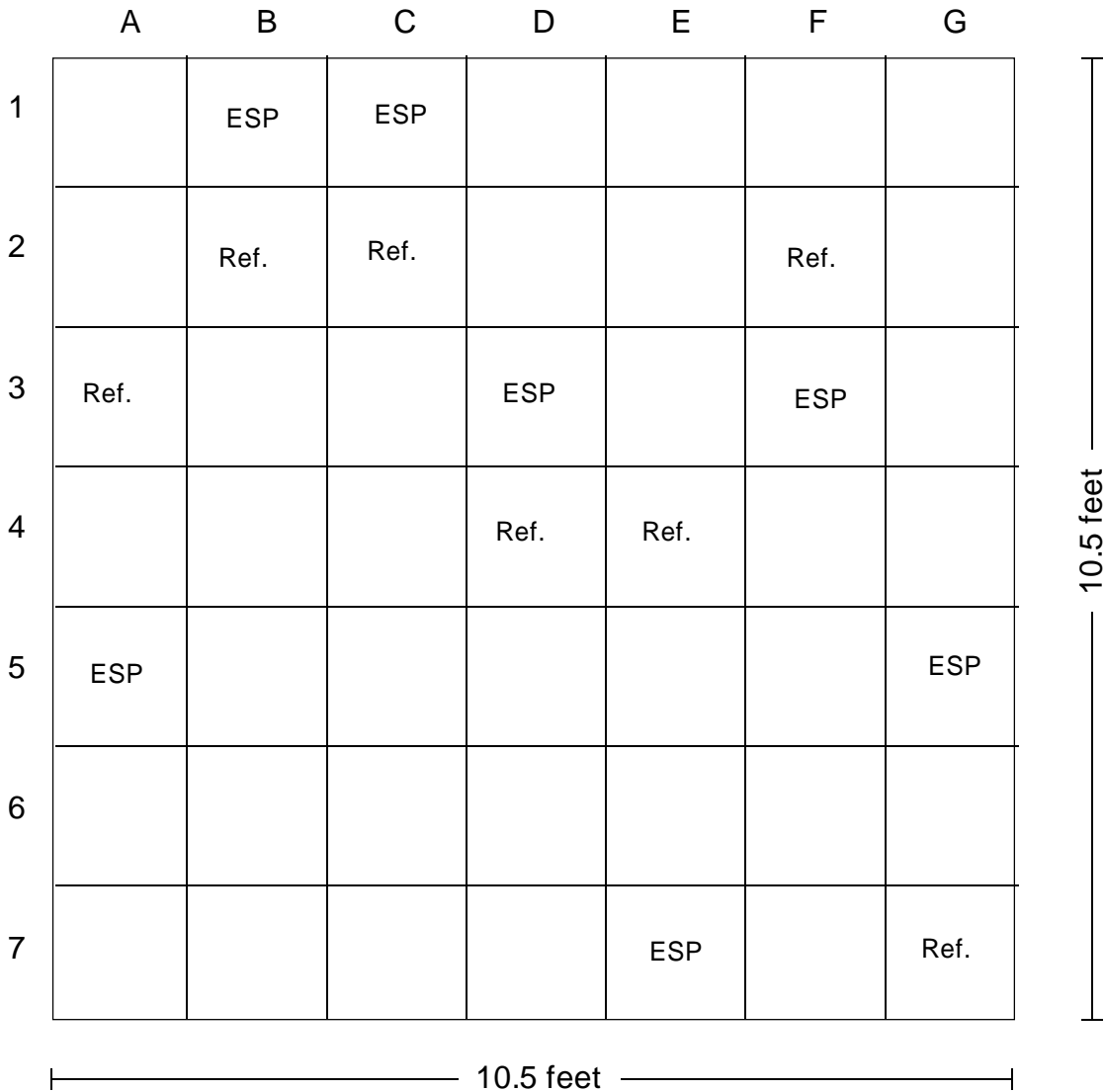

ESP JMC Environmentalist's Subsoil Probe Sampling Location

Ref. Reference Sampling Method Location

**Figure 3-3. Typical Sampling Locations and Random Sampling Grid**

---

(mL) headspace vial, and 5.0 mL of distilled water was added immediately. The headspace vial was sealed with a crimp-top septum cap within 5 seconds of adding the organic-free water. The headspace vial was labeled according to the technology, the sample grid and cell from which the sample was collected, and the sampling depth. These data, along with the U.S. Department of Agriculture soil texture, were recorded on field data sheets. For each subsurface soil sample, two collocated samples were collected for analysis. The second sample was intended as a backup sample for reanalysis or in case a sample was accidentally opened or destroyed prior to analysis.

Samples from high-concentration sampling depths were also collected with disposable syringes as described above. Each 3 to 3.5 cc of soil was extruded directly into a 40-mL vial and capped with a Teflon™-lined septum screw cap. Each vial contained 10 mL of pesticide-grade methanol. The 40-mL vials were labeled in the same manner as the low-concentration samples, and the sample number and the U.S. Department of Agriculture soil texture were recorded on field data sheets. For each soil sample, two collocated samples were collected.

To minimize VOC loss, samples were handled as efficiently and consistently as possible. Throughout the demonstration, sample handling was timed from the moment the soil sample was exposed to the atmosphere to the moment the sample vials were sealed. Sample handling times ranged from 40 to 60 seconds for headspace sampling and from 30 to 47 seconds for methanol flood sampling.

Samples were analyzed for VOCs by combining automated headspace sampling with gas chromatography (GC) analysis according to the standard operating guidelines provided in the demonstration plan (PRC, 1997). The standard operating guideline incorporates the protocols presented in SW-846 Methods 5021, 8000, 8010, 8015, and 8021 from the EPA Office of Solid Waste and Emergency Response, "Test Methods for Evaluating Solid Waste" (EPA, 1986). The target VOCs for this demonstration were vinyl chloride, cis-1,2-DCE, 1,1,1-TCA, TCE, and PCE. However, during the demonstration, vinyl chloride was removed from the target compound list because of resolution problems caused by coelution of methanol.

To report the VOC data on a dry weight basis, samples were collected to measure soil moisture content. For each sampling depth, a sample weighing approximately 100 g was collected from one of the reference method subsurface soil samples. The moisture samples were collected from the soil core within 1 inch of the VOC sampling location using a disposable steel teaspoon.

An F test for variance homogeneity was run on the VOC data to assess their suitability for parametric analysis. The data set variances failed the F test, indicating that parametric analysis was inappropriate for hypothesis testing. To illustrate this variability and heterogeneity of contaminant concentrations in soil, predemonstration and demonstration soil sample results (obtained using the reference sampling method for a grid depth combination with high variability and a grid depth combination with low variability) are provided as Figures 3-4 and 3-5 respectively.

Because the data set variance failed the F test, a nonparametric method, the Mann-Whitney test, was used for the statistical analysis. The Mann-Whitney statistic was chosen because (1) it is historically acceptable, (2) it is easy to apply to small data sets, (3) it requires no assumptions regarding normality, and (4) it assumes only that differences between two reported data values, in this case the reported chemical concentrations, can be determined. A description of the application of the Mann-Whitney test and the conditions under which it was used is presented in Appendix A1. A statistician should be consulted before applying the Mann-Whitney test to other data sets.

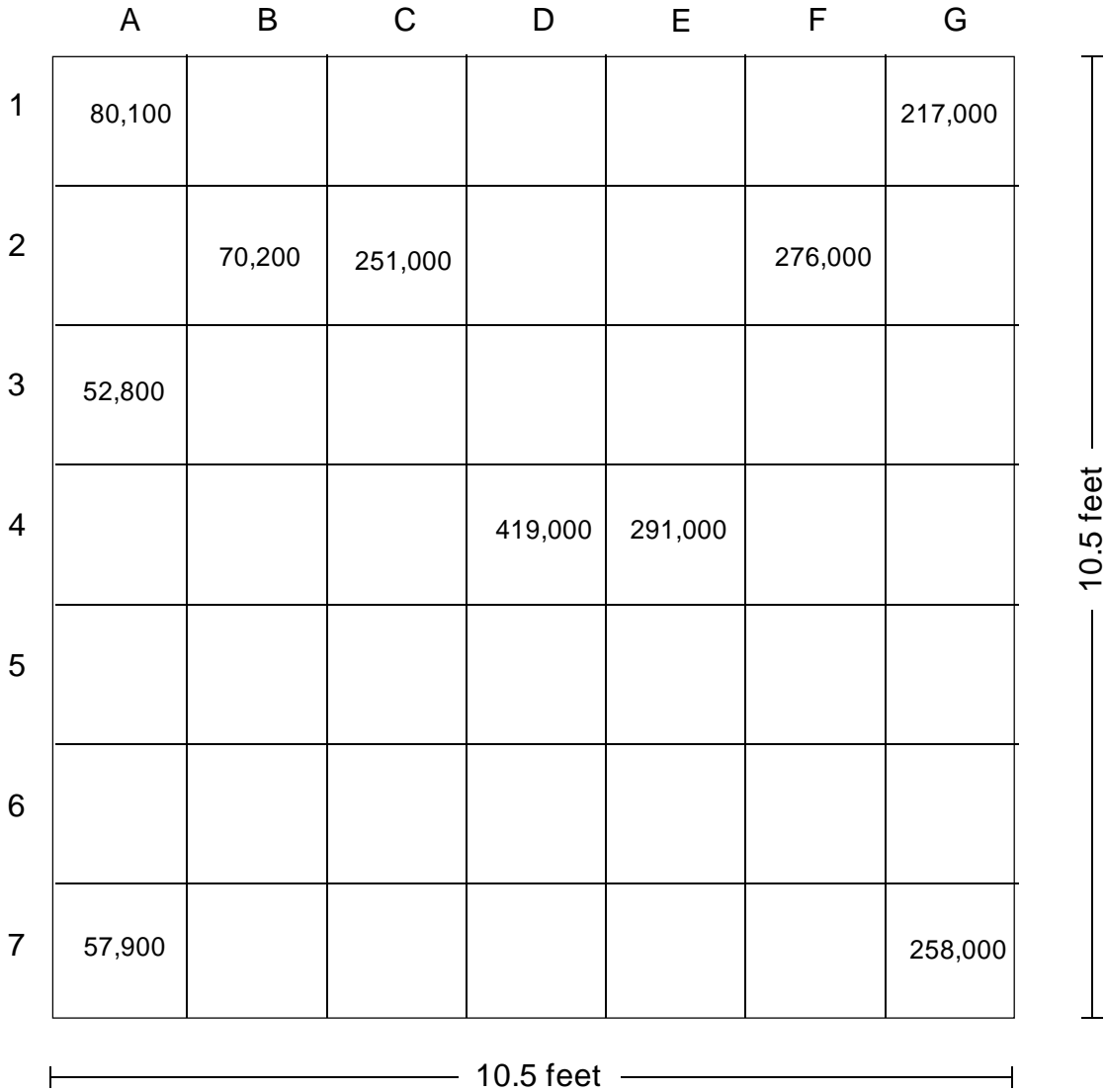

Units - micrograms per kilogram

**Figure 3-4. Sampling Grid with High Contaminant Concentration Variability**

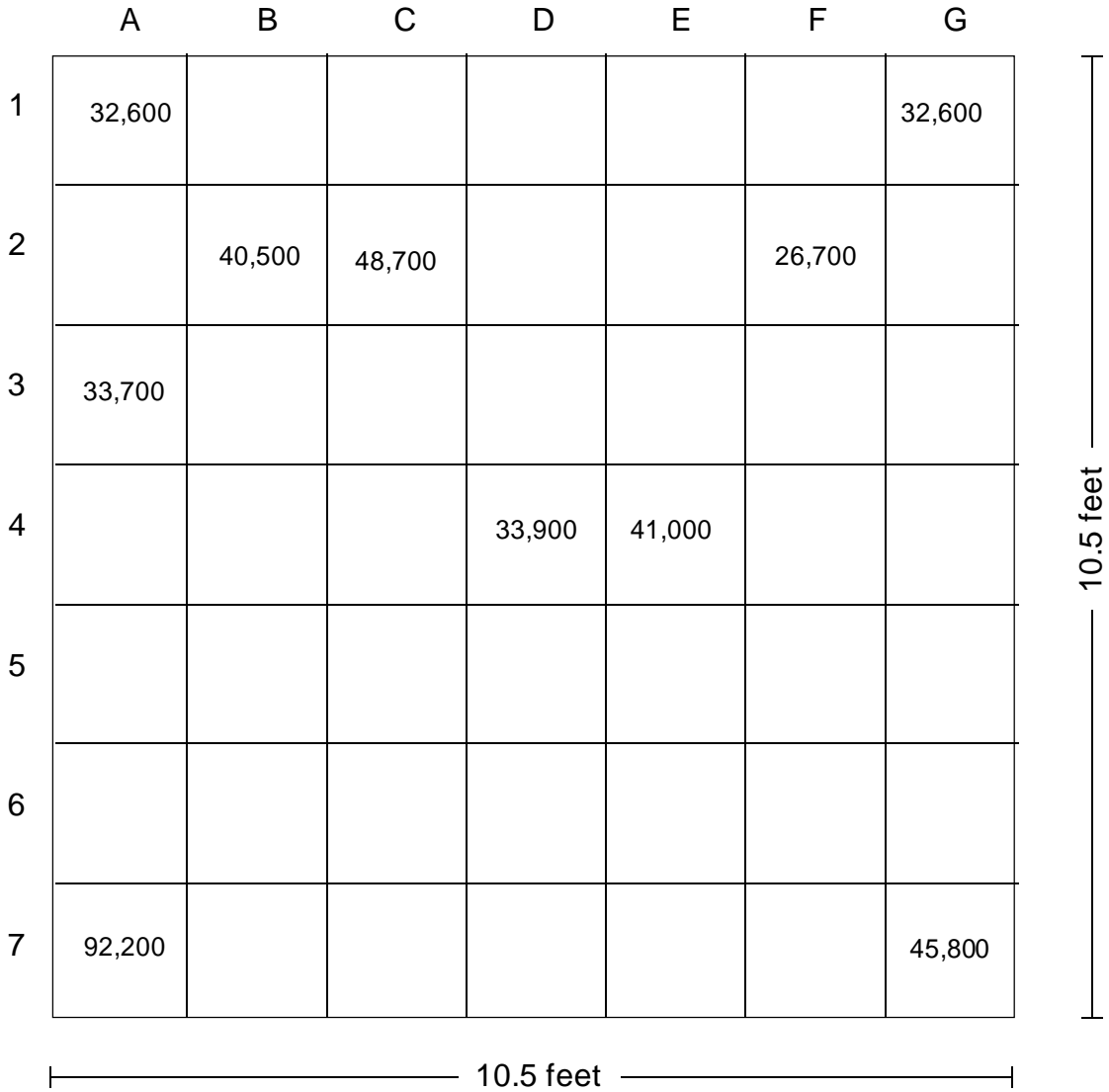

Units - micrograms per kilogram

**Figure 3-5. Sampling Grid with Low Contaminant Concentration Variability**

---

The Mann-Whitney statistical evaluation of the VOC concentration data was conducted based on the null hypothesis ( $H_0$ ) that there is no difference between the median contaminant concentrations obtained by the Large-Bore Soil Sampler and the reference sampling method. A two-tailed 95 percent confidence limit was used. The calculated two-tailed significance level for the null hypothesis thus becomes 5 percent ( $p \neq 0.05$ ). A two-tailed test was used because there is no reason to suspect *a priori* that one method would result in greater concentrations than the other.

Specifically, the test evaluates the scenario wherein samples (soil samples, in this instance) would be drawn from a common universe with different sampling methods (reference versus Large-Bore Soil Sampler). If, in fact, the sampling universe is uniform and there is no sampling bias, the median value (median VOC concentration) for each data set should be statistically equivalent. Sampling, however, is random; therefore, the probability also exists that dissimilar values (particularly in small data sets) may be “withdrawn” even from an identical sampling universe. The 95 percent confidence limit used in this test was selected such that differences, should they be inferred statistically, should occur no more than 5 percent of the time.

Additionally, the sign test was used to examine the potential for sampling and analytical bias between the Large-Bore Soil Sampler and the reference sampling method. The sign test is nonparametric and counts the number of positive and negative signs among the differences. The differences tested, in this instance, were the differences in the median concentrations of paired data sets (within a site, within a grid, at a depth, and for each analyte). From the data sets, counts were made of (1) the number of pairs in which the reference sampling method median concentrations were higher than the Large-Bore Soil Sampler median concentrations and (2) the number of pairs in which the Large-Bore Soil Sampler median concentrations were higher than the reference sampling method median concentrations. The total number of pairs in which the median concentrations were higher for the Large-Bore Soil Sampler was then compared to the total number of pairs in which the median concentrations were higher for the reference sampling method. If no bias is present in the data sets, the probability of the total number of pairs for one or the other test method being higher is equivalent; that is, the probability of the number of pairs in which the median concentrations in the Large-Bore Soil Sampler are higher is equal to the probability of the number of pairs in which the median concentrations in the reference sampling method are higher. To determine the exact probability of the number of data sets in which the median concentrations in the Large-Bore Soil Sampler and reference sampling method were higher, a binomial expansion was used. If the calculated probability is less than 5 percent ( $p < 0.05$ ), then a significant difference is present between the Large-Bore Soil Sampler and reference sampling method.

The sign test was chosen because it (1) reduces sensitivity to random analysis error and matrix variabilities by using the median VOC concentration across each grid depth, (2) enlarges the sample sizes as compared to the Mann-Whitney test, and (3) is easy to use. A description of the application of the sign test and the conditions under which it was used is presented in Appendix A1.

For the demonstration data, certain VOCs were not detected in some, or all, of the samples in many data sets. There is no strict guidance regarding the appropriate number of values that must be reported within a data set to yield statistically valid results. Therefore, and for the purposes of this demonstration, the maximum number of “nondetects” allowed within any given data set was arbitrarily set at three. That is, there must be at least four reported values within each data set to use the Mann-Whitney and sign tests.

---

### ***Sample Integrity***

The integrity tests were conducted by advancing a sampler filled with uncontaminated potting soil into a zone of grossly contaminated soil. The potting soil was analyzed prior to use and no target VOCs were detected. Potting soil has an organic carbon content many times greater than typical soils, 0.5 to 5 percent by weight (Bohn and George, 1979), representing a worst-case scenario for VOC absorbance. The integrity samples were advanced through a contaminated zone that was a minimum of 2 feet thick and exhibited VOC contamination in the tens of thousands of mg/kg. All of the integrity samples were packed to approximately the same density. The samplers filled with the uncontaminated potting soil were advanced 2 feet into the contaminated zone and left in place for approximately 2 minutes. The samplers were then withdrawn and the potting soil was sampled and analyzed for VOCs. In each case, the sampling team collected the potting soil samples for analysis from approximately the center of the potting soil core.

Six integrity samples were collected with the Large-Bore Soil Sampler at each site to determine if potting soil in an unlined sampler interior became contaminated after it was advanced through a zone of high VOC concentrations. Additionally, seven integrity samples were collected with the reference sampling method at the SBA site and five integrity samples at the CSC site. Sample liners were used during collection of all the integrity samples using the Large-Bore Soil Sampler and reference sampling method. All integrity samples were collected from Grid 1 at both the SBA and CSC sites, because Grid 1 was the most contaminated grid at each site. The sample integrity data were used to directly indicate the potential for cross-contamination of the soil sample during sample collection.

### ***Reliability and Throughput***

Reliability was assessed by documenting the initial sampling success rate and the number of sampling attempts necessary to obtain an adequate sample from that depth. The cause of any failure of initial or subsequent sampling attempts was also documented. Throughput was assessed by examining sample retrieval time, which was measured as the time required to set up on a sampling point, collect the specified sample, grout the hole, decontaminate the sampler, and move to a new sampling location. In addition, a performance test was conducted in Grid 5 at the CSC site to evaluate the ability of the sampling methods to collect samples in saturated sandy material at a depth of 40 feet bgs.

### ***Cost***

The cost estimate focused on the range of costs for using the Large-Bore Soil Sampler and reference split-spoon sampler to collect 42 subsurface soil samples at a clay soil site (similar to the SBA site) and a sandy soil site (similar to the CSC site). The cost analysis is based on results and experience gained from the demonstration and on cost information provided by Geoprobe®. Factors that could affect the cost of operating the Large-Bore Soil Sampler and the reference split-spoon sampler include:

- C Equipment costs
- C Operating costs
- C Oversight costs
- C Disposal costs
- C Site restoration costs

---

### ***Deviations from the Demonstration Plan***

Six project-wide deviations from the approved demonstration plan are described below: (1) the nonparametric Mann-Whitney test was used instead of ANOVA to determine whether there is a statistical difference between the VOC concentrations from the Large-Bore Soil Sampler and the reference sampling method; (2) the nonparametric sign test was used to assess potential bias between VOC concentrations determined from the Large Bore Soil Sampler and the reference sampling method; (3) vinyl chloride was eliminated from the target compound list because of a coelution problem with methanol; (4) the drill rig, large tools, and augers were decontaminated between each grid instead of between each boring; (5) 24-inch split spoon samplers instead of 18-inch samplers were used and were driven 15 to 20 inches during sample collection; and (6) the split-spoon sampler was used with and without acetate liners. Cases where the performance of a sampling technology caused it to deviate from the demonstration plan are discussed on a technology-specific basis in Chapters 4 (reference method) and 5 (Large Bore Soil Sampler) of this ETVR.

---

## **Chapter 4**

### **Description and Performance of the Reference Method**

This chapter describes the reference soil sampling method, including background information, components and accessories, platform description, demonstration operating procedures, qualitative performance factors, quantitative performance factors, and data quality. The reference method chosen for this demonstration was hollow-stem auger drilling and split-spoon sampling.

#### **Background**

Several drilling methods have evolved to accommodate various stratigraphic conditions and the end use of the boring. Although there is no single preferred drilling method for all stratigraphic conditions and well installations, the hollow-stem auger method has become the most popular and widely used for environmental drilling and sampling. Hollow-stem augers have also been used extensively in the environmental field because soil samples can readily be collected and monitoring wells can easily be installed with this equipment (EPA, 1987). Use of hollow-stem augers as a method of drilling boreholes for soil investigations, installing groundwater monitoring wells, and completing other geotechnical work is widely accepted by federal, state, and local regulators. Because hollow-stem augers are the most commonly used drilling equipment for environmental applications, this method was selected as the reference drilling method for this demonstration.

#### **Components and Accessories**

The most common sampler used with hollow-stem augers for environmental applications is the split-spoon. The split-spoon sampler is a thick-walled steel tube that is split lengthwise (Figure 4-1). The split-spoon samplers used for this demonstration measured 24 inches long with an internal diameter of 2 inches and an external diameter of 2.5 inches. A cutting shoe is attached to the lower end, and the upper end contains a check valve and is connected to the drill rods. Split-spoon samplers are typically driven 18 to 24 inches beyond the auger head into the formation by a hammer drop system. The split-spoon sampler is used to collect a sample of material from the subsurface and to measure the resistance of the material to penetration by the sampler in the standard penetration test. The degree of soil compaction can be determined by counting the number of blows of the drop weight required to drive the split spoon a distance of 1 foot. A weight of 140 pounds and a height of fall of 30 inches are considered standard (Terzaghi and Peck, 1967).

#### **Description of Platform**

Hollow-stem augers are typically used with a truck- or trailer-mounted drill rig that is either mechanically or hydraulically powered. Trucks, vans, all-terrain vehicles, and crawler tractors are



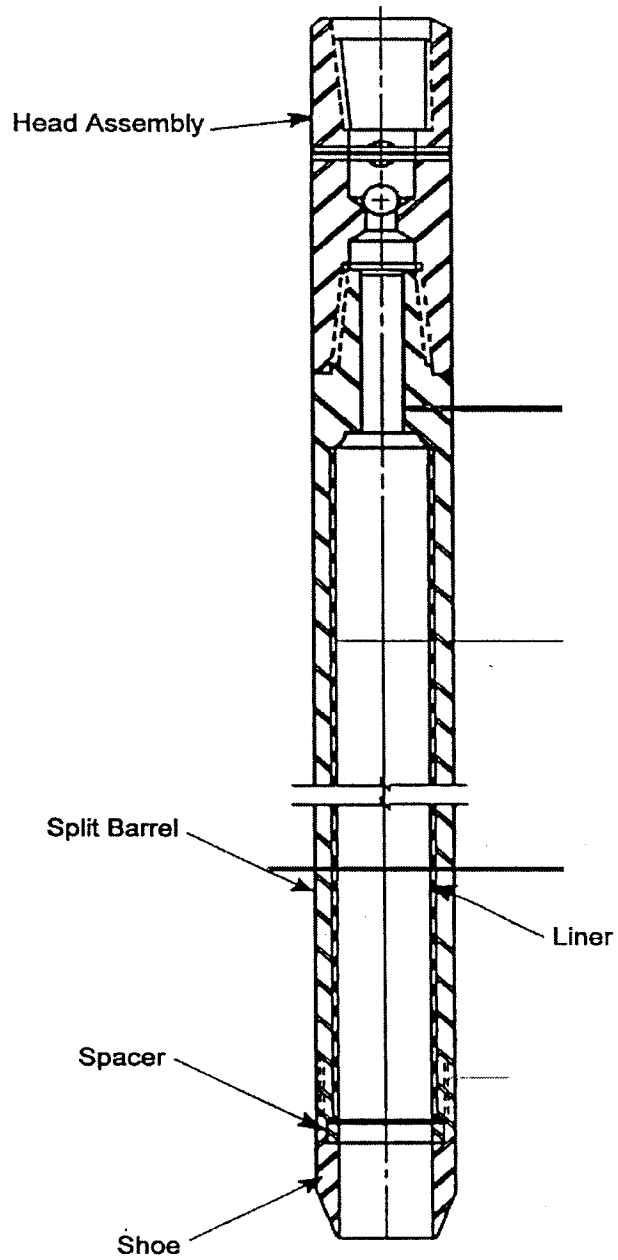

Figure 4-1. Split-Spoon Soil Sampler (Central Mine Equipment Co., 1994)

---

often used as the transport vehicle because of their easy mobilization. A variety of drill rig specifications are available based on the project-specific operation requirements and the geological conditions anticipated (EPA, 1987).

Hollow-stem auger drilling is accomplished by using a series of interconnected auger sections with a cutting head at the lowest end. The hollow-stem auger consists of (1) a section of seamless steel tube with a spiral flight attached to a carbide-tooth auger head at the bottom and an adapter cap at the top, and (2) a center drill stem composed of drill rods attached to a center plug with a drag bit at the bottom and an adapter at the top. The center of the core of augers is open, but can be closed by the center plug attached to the bottom of the drill rods. As the hole is drilled, additional lengths of hollow-stem flights and center stem are added. The center stem and plug may be removed at any time during drilling to permit sampling below the bottom of the cutter head. Typical components of a hollow-stem auger are shown in Figure 4-2 (Central Mine Equipment Company [CME], 1994).

The dimensions of hollow-stem auger sections and the corresponding auger head used with each lead auger section are not standardized among the various auger manufacturers. Drilling at the SBA site was accomplished with a Mobile B-47 drill rig using 3.25-inch inside-diameter and 6.25-inch outside-diameter CME hollow-stem augers. Drilling at the CSC site was accomplished with a Mobile D-5 and a Mobile B-47 drill rig using 3.25-inch inside-diameter and 6.25-inch outside-diameter CME hollow-stem augers. The Mobile B-47 used a pulley assembly to operate the hammer that drove the split-spoon samplers, and the Mobile D-5 used an automatic hydraulic hammer to drive the split-spoon samplers. The Mobile D-5 drill rig was used at the CSC site because the Mobile B-47 drill rig experienced mechanical problems en route to the CSC site, delaying its arrival at the site. The same drill crew operated both drill rigs; the use of the two drill rigs at the CSC site is not expected to affect the results of the demonstration.

### **Demonstration Operating Procedures**

To collect the samples for this demonstration, the hollow-stem augers were first rotated and advanced to 9 inches above the target sampling depth. As the augers were rotated and pressed downward, the cutting teeth on the auger head broke up the formation materials, and the cuttings were rotated up the continuous flights to the ground surface, where they were stored in drums as investigation-derived waste (IDW). At the point 9 inches above the sampling depth, the drill rods and the attached center plug were removed, and the split-spoon samplers were placed on the lower end of the drill rods and lowered through the hollow-stem augers to the bottom of the borehole. The split-spoon sampler was then driven approximately 18 inches to collect a soil sample, with the target sampling depth positioned in the center of the soil core. The loaded sampler and sampling rod were removed from the auger column. If a lower depth was to be sampled, the pilot assembly and center rod were reinserted.

During the demonstration, split-spoon samplers were used with and without acetate liners because formations that are weakly cohesive or hard commonly produce poor recovery with liners. Several boreholes were initially installed at each site to determine whether liners would be used, based on the driller's experience and the cohesiveness of the soil. Liners were used at SBA site Grid 1 and half of the cells at Grid 3. Liners were also used for target sampling depths at half of the 3-foot depth intervals at CSC site Grid 1, and at the 7.5-foot sampling depth at Grid 3. Overall, sample liners were used during collection of about one-third of the reference method samples, including all samples collected to evaluate sample integrity.

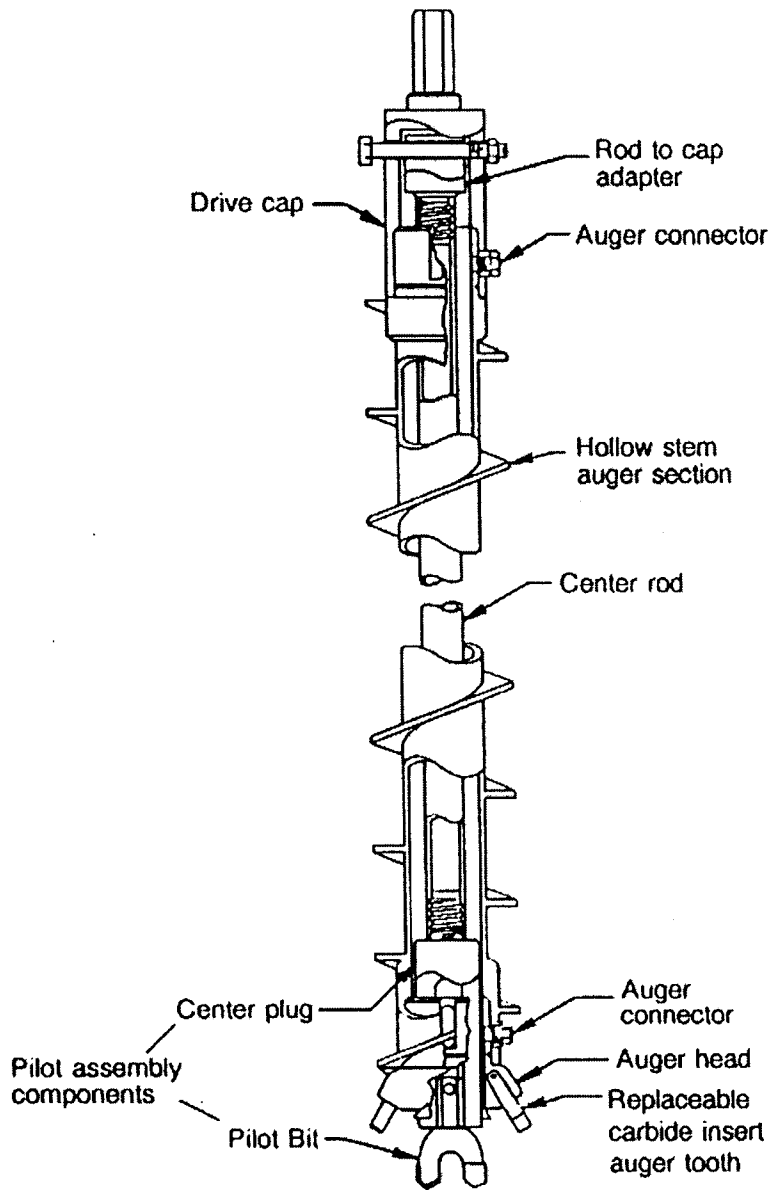

Figure 4-2. Typical Components of a Hollow-Stem Auger (Central Mine Equipment Co., 1994)

---

Once a split-spoon sampler was retrieved from the borehole, the drive head and cutting shoe were loosened. If the sampler contained a liner, the liner was removed, capped, and taken directly to the sample preparation table for subsampling and sample packaging. If the split spoon did not contain a liner, the sampler was taken directly to the sample preparation table and opened for immediate subsampling and sample packaging.

Split-spoon samplers were decontaminated before each use by scrubbing the disassembled sampler parts with a stiff-bristle brush in a phosphate-free soap and water solution. This process was intended to remove the residual soil as well as chemical contaminants. After washing, the sampler parts were rinsed in potable water and reassembled for use at the next sampling point. Augers, larger tools, and the drill rig were decontaminated between each grid with a high-pressure hot water wash.

### **Qualitative Performance Factors**

The following qualitative performance factors were assessed for the reference sampling method: (1) reliability and ruggedness under the test conditions, (2) training requirements and ease of operation, (3) logistical requirements, (4) sample handling, (5) performance range, and (6) quantity of IDW generated during the demonstration.

#### ***Reliability and Ruggedness***

Overall, the initial sampling success rate for the reference sampling method, defined as the rate of success in obtaining a sample on the initial attempt, was 93 percent. At the SBA site, the reference sampling method did not collect a sample on the initial drive in four of 42 attempts, resulting in an initial sampling success rate of 90 percent. At this site, two of the samples had insufficient recovery; one sample was not collected because drilling refusal was encountered above the target sampling depth, and one sample was not collected because the boring was drilled beyond the target sampling depth. At the CSC site, the reference sampling method did not collect a sample on the initial drive in two of 41 attempts, resulting in an initial sampling success rate of 95 percent. At this site, two samples were not collected because the borings were drilled beyond the target sampling depth. Drilling beyond the target depth is considered an operator error and was not caused by the sampling tool. Target sampling depths were determined by measuring the height of the auger above the ground surface, and subtracting the measured value from the total length of augers in use. During the saturated sand recovery test at Grid 5 at the CSC site, the reference method collected all seven samples on the initial try.

During the sampling at the SBA and CSC sites, the driller attempted sampling with and without sample liners to optimize soil sample recovery. Generally, the greatest sample recovery was obtained without the use of liners.

Sampling downtime occurred three times during the demonstration. Each of these events occurred at the SBA site; the three events are as follows:

1. The main hydraulic cylinder on the drill rig began to leak at the start of drilling at Grid 5, resulting in the loss of less than 1 quart of hydraulic oil. The hose was repaired by a local farm implement dealer soon after it was removed from the rig. This breakdown resulted in approximately 2.5 hours of sampling downtime.

- 
2. Drilling at Grid 5 was conducted with the mast down due to the proximity of overhead power lines. This arrangement prohibited the use of the drill rig winches to remove the augers and drill rod from the boring. While lifting out the center plug and attaching the drill rod, the rod fell back into the hole. The top of the fallen rod was well below the open end of the auger string. The drillers required approximately 10 minutes to retrieve the fallen drill rod.
  3. During drilling at one sampling cell, material entered the auger bit and caused the center plug to jam. Drilling proceeded to the target depth, but the drillers required several minutes to free the center plug.

As discussed above, the Mobile B-47 drill rig experienced mechanical problems en route to the CSC site, delaying its arrival at the site. Because of this delay, a Mobile D-5 drill rig was obtained from a local drilling company and was used to advance soil borings and collect soil samples until the Mobile B-47 arrived. Although drilling startup was delayed a half day because of the last-minute change in drill rigs, no sampling downtime occurred during drilling and no additional drilling costs were incurred.

### ***Training Requirements and Ease of Operation***

Operation of the drill rig requires training and experience. The lead driller for this project had 17 years of environmental drilling experience and was a licensed driller in the states of Iowa and Colorado. Although the various drill rig manufacturers offer training in specific drilling techniques, much of a driller's training is obtained on the job, in a fashion similar to an apprenticeship. The state licenses require the driller to pass a written test and to renew the drilling license periodically.

The moving parts of a drill rig pose a risk of injury to the head, eyes, and feet, which can be protected with hard hat, safety glasses, and steel-toed boots. Leather gloves facilitate the safe assembly and disassembly of the split-spoon sampler. Additional personal protective equipment may be required in accordance with site-specific health and safety requirements.

### ***Logistical Requirements***

Some states require licenses for personnel conducting subsurface sampling. The sampler or equipment operator must contact appropriate state or local agencies to determine the applicability of any license or permit requirements. Additionally, underground utility clearances are usually needed before sampling with any intrusive subsurface equipment.

The augers created 6.25-inch-diameter boreholes, which were filled using neat-Portland cement grout at the SBA site and dry granular bentonite at the CSC site. Demonstration drilling generated 15 drums of soil cuttings at the SBA site and three drums of soil cuttings at the CSC site.

The drill rigs used in the demonstration were powered by an on-board engine and needed no external power source (other than fuel). Decontamination water can be carried on the truck, but a support truck with a 250-gallon tank was used to transport, store, and provide water for decontamination for the demonstration. Small tools and split-spoon samplers were decontaminated in a steel stock tank, while augers and drill rods were decontaminated in an on-site decontamination containment area with a high-pressure hot water washer.

---

### ***Sample Handling***

During the demonstration, liners were not used in the collection of approximately two-thirds of the split-spoon samples. This method allowed easy access to the sample by removing the drive head and cutting shoe and separating the two halves of the sampler. Liners were used in noncohesive soils because opening the split spoon without a liner would have allowed the sample core to collapse and disrupt sample integrity. After the liner was removed from the split spoon, it was capped and taken immediately to the sample packaging area for processing. Prior to sampling, the liner was split open to allow access to the soil for subsampling.

### ***Performance Range***

The depth limitations of the reference method are based on the torque provided by the drill rig, the strength of the augers, the diameter of the augers, and the textures of the formations penetrated. During the demonstration, samples were collected from a maximum depth of 40 feet bgs in Grid 5 at the CSC site. However, depths of 300 feet or more have been drilled with high-torque drill rigs using high-strength augers. This drilling and sampling method is inappropriate for unconsolidated formations containing large cobbles or boulders. In addition, the use of this method below the water table in sandy, noncohesive formations generally leads to sand heave into the augers, making borehole advancement and sampling difficult.

### ***Investigation-Derived Waste***

The IDW for the reference method primarily consisted of decontamination fluids and soil cuttings. Approximately 100 gallons of decontamination wastewater was generated at the SBA site, and approximately 50 gallons of decontamination wastewater was generated at the CSC site.

Soil cuttings were also generated during advancement of the boreholes. Eighteen 55-gallon drums of soil cuttings were generated during this demonstration: three at the CSC site and 15 at the SBA site. Fewer drums were generated at the CSC site due to the shallower sampling depths and the noncohesive nature of the soil. Reverse rotation during auger withdrawal allowed most of the sand to travel down the auger flights and back into the borehole at the CSC site. In addition to decontamination fluids and soil cuttings, sample liners and other materials were generated as IDW.

### ***Quantitative Performance Factors***

The following quantitative performance indicators were measured for the reference sampling method: (1) sample recovery, (2) VOC concentrations in recovered samples, (3) sample integrity, and (4) sample throughput.

### ***Sample Recovery***

Sample recoveries for the reference sampling method were calculated by comparing the length of sampler advancement to the length of sample core obtained for each attempt. Sample recovery is defined as the length of recovered sample core divided by the length of sampler advancement and is expressed as a percentage. At the SBA site, sample recoveries ranged from 40 percent to 100 percent, with an average of 88 percent. At the CSC site, recoveries ranged from 53 percent to 100 percent,

---

with an average of 87 percent. Sample recovery data for each sample collected are summarized in Appendix A2, Table A2.

### ***Volatile Organic Compound Concentrations***

Samples were collected using the reference method at each sampling depth, as described in Chapter 3. Samples were analyzed for VOCs by combining headspace sampling with GC analysis according to the standard operating procedure (SOP) provided in the demonstration plan (PRC, 1997). Table 4-1 presents the range and median VOC concentrations for samples collected using the reference method. The VOC results for each sample collected are summarized in Appendix A3, Table A3. For seven of the 12 sampling grid-depth combinations, VOC data for some samples collected are not available due to laboratory error; in these cases, the range and median were calculated from the remaining sample data.

Data are reported on a dry-weight basis. Chapter 5 presents a statistical comparison of the analytical results obtained using the reference method to those obtained using the Large-Bore Soil Sampler.

### ***Sample Integrity***

Seven integrity samples were collected using the reference sampling method in Grid 1 at the SBA site, and five integrity samples were collected using the reference sampling method in Grid 1 at the CSC site. No VOCs were detected in any of the integrity samples collected using the reference sampling method (the method detection limit for these analyses was 1 Fg/kg). Sample liners were used during collection of the integrity samples at both the SBA and CSC sites, but liners were not used in collecting approximately two-thirds of the soil samples collected during the demonstration. Because of this sampling deviation, the integrity of all samples collected using the reference method cannot be verified.

### ***Sample Throughput***

The average sample retrieval time for the reference sampling method was 26 minutes per sample for the SBA site and 8.4 minutes per sample for the CSC site. Sample retrieval time was measured as the amount of time per sample required to set up at a sampling point, collect the specified sample, grout the hole, decontaminate the sampling equipment, and move to a new sampling location. A three-person sampling crew collected soil samples using the reference sampling method at both sites. One additional person was present at the CSC site to direct drilling operations and assist with demonstration sampling, as necessary. The large discrepancy in the sample retrieval time between the SBA and CSC sites is due in part to the difference in average sampling depth (10 feet at the SBA site versus 5 feet at the CSC site) and soil type (clay versus sandy soil).

### ***Data Quality***

Data quality was assessed throughout this demonstration by implementing an approved quality assurance project plan (PRC, 1997). The QA/QC procedures included the consistent application of approved methods for sample collection, chemical analysis, and data reduction. Based on the intended use of the data, QA objectives for precision, accuracy, representativeness, comparability, and completeness were established and QC samples were collected to assess whether the QA objectives were met. Based on the results of a field audit conducted by the EPA and a detailed validation of the demonstration data by Tetra Tech, the data have been deemed acceptable for use as described in the demonstration design (Chapter 3). The results of the QC indicators used for this demonstration for

**Table 4-1. Volatile Organic Compound Concentrations in Samples Collected Using the Reference Sampling Method**

		Concentration (Fg/kg)							
Site	Grid - Depth	cis-1,2-DCE		1,1,1-TCA		TCE		PCE	
		Range	Median	Range	Median	Range	Median	Range	Median
SBA	1 - 9.5 feet	49,700 - 147,000	86,700	< 100	NC	52,800 - 419,000	276,000	< 100 - 4,510	1,630
SBA	1 - 13.5 feet	1,360 - 44,900	14,500	< 100	NC	26,700 - 433,000	40,500	< 100 - 2,400	NC
SBA	2 - 3.5 feet	< 1 - 2.18	NC	< 1	NC	22.6 - 88.8	56.9	< 1	NC
SBA	3 - 9.5 feet*	796 - 1,460	903	< 100	NC	34,100 - 63,700	38,500	< 100	NC
SBA	4 - 9.5 feet	6.68 - 22.1	13.2	< 1	NC	847 - 2,080	1,710	< 1	NC
SBA	5 - 13.5 feet <sup>†</sup>	33.7 - 147	93.6	< 1	NC	< 1 - 138	21.0	< 1	NC
CSC	1 - 3.0 feet <sup>†</sup>	< 100	NC	< 100 - 659	NC	< 100	NC	1,880 - 6,220	2,530
CSC	1 - 6.5 feet <sup>†</sup>	< 1 - 5.81	2.20	13.1 - 54.6	26.0	3.47 - 22.4	6.45	58.5 - 848	112
CSC	2 - 3.0 feet	< 100	NC	< 100 - 984	NC	< 100 - 435	126	1,560 - 2,910	2,000
CSC	3 - 3.0 feet <sup>†</sup>	< 100	NC	< 100 - 313	NC	< 100	NC	1,030 - 2,110	1,480
CSC	3 - 7.5 feet*	< 1 - 7.35	4.12	3.81 - 21.9	13.9	2.48 - 31.7	14.9	21.1 - 177	73.0
CSC	4 - 6.5 feet <sup>††</sup>	< 1 - 5.72	NC	< 1 - 51.4	8.09	< 1 - 43.3	2.37	5.55 - 749	50.3

Fg/kg Micrograms per kilogram  
 cis-1,2-DCE cis-1,2-Dichloroethene  
 1,1,1-TCA 1,1,1-Trichloroethane  
 CSC Chemical Sales Company site  
 \* VOC data for only four samples are available  
 † VOC data for only six samples are available  
 †† VOC data for only five samples are available  
 NC No median calculated because at least half the reported values were below the method detection limit.



---

both the reference sampling method and Large-Bore Soil Sampler are provided in the technology evaluation report for this demonstration (Tetra Tech, 1997) and are summarized here.

The VOC data quality was assessed through the incorporation of QC samples into the analytical process for each sample delivery group, and through a full data validation review on 20 percent of the samples. Specific QC samples that were processed to assess precision and accuracy included matrix spike/matrix spike duplicates (MS/MSDs), laboratory control samples (LCSs), and method blanks. Additionally, surrogate spikes were used in all samples.

The LCSs and matrix spikes were analyzed at frequencies of 8.3 percent and 3.9 percent, respectively. With few exceptions, the QA objective of 50 to 150 percent recovery was met for LCS and MS samples, indicating that acceptable accuracy was achieved. The few exceptions to meeting this objective were primarily for vinyl chloride; these exceptions are attributable to the high volatility of vinyl chloride and apparently result from vaporization during the analytical process.

Surrogate spike recoveries were also used to evaluate accuracy. Surrogate recoveries were problematic for the methanol flood method for high-concentration samples, indicating a reduced accuracy for these samples. Surrogate recoveries were consistently within the QA objective of 50 percent to 150 percent recovery for low-concentration samples.

Seventeen MS/MSD pairs, representing a 3.6 percent frequency, were analyzed to assess the precision of the analytical method. The relative percent differences (RPDs) of the duplicate results were consistently less than the QA objective of 50 percent; only a few exceptions were noted. Thus, method precision appeared to be adequate for the intended use of the data.

Analysis of method blanks revealed only occasional contamination with low part-per-billion levels of chlorinated hydrocarbons. The frequency and levels of these contaminants were not judged to be sufficient to significantly affect data quality except for those results at or near the detection limit in the specific sample delivery group.

The data validation review noted chromatographic separation and coelution problems for vinyl chloride. As a result, all vinyl chloride data were rejected. Other analytes were flagged as having data quality problems in isolated instances and in response to specific exceptions to the QA objectives, as described generally above. Details of these and all other data quality issues can be found in the technology evaluation report for this demonstration (Tetra Tech, 1997).

---

## **Chapter 5**

### **Technology Performance**

This chapter describes the performance of the Geoprobe® Large-Bore Soil Sampler and assesses qualitative and quantitative performance factors. A description of the Large-Bore Soil Sampler is provided in Chapter 2 of this ETVR. This chapter also briefly describes the performance of the Geoprobe® Macro-Core® Sampler.

#### **Qualitative Performance Factors**

The following qualitative performance factors were assessed for the Large-Bore Soil Sampler: (1) reliability and ruggedness under the test conditions, (2) training requirements and ease of operation, (3) logistical requirements, (4) sample handling, (5) performance range, and (6) quantity of IDW generated during the demonstration.

#### ***Reliability and Ruggedness***

Overall, the initial sampling success rate for the Large-Bore Soil Sampler, defined as the ratio of the number of successful sampling attempts (sample obtained on the initial attempt) to the total number of sampling attempts, was 97 percent. At the SBA site, the Large-Bore Soil Sampler did not collect a sample on the initial push in three of 42 attempts, resulting in an initial sampling success rate of 93 percent. One of the three instances was attributable to refusal from cobbles or boulders. A second instance resulted when clay in the liner expanded, which prevented the removal of the acetate liner from the sample tube. The third instance occurred when the stop pin could not be retrieved from the drive head. As a result, the piston tip could not be released from its closed position, preventing subsequent collection of the sample. By conducting multiple pushes, the Large-Bore Soil Sampler collected all samples required for this demonstration, yielding a sampling completeness of 100 percent.

At the CSC site, the Large-Bore Soil Sampler collected all samples required for chemical analysis during the initial push in Grids 1 through 4, resulting in an initial sampling success rate of 100 percent. The Large-Bore Soil Sampler was subjected to an additional evaluation at Grid 5 at the CSC site to assess the efficiency of the sampler in collecting samples in saturated sand. During the performance range tests at Grid 5 at the CSC site, the Large-Bore Soil Sampler successfully collected all seven soil samples within the saturated zone from 40 feet bgs at Grid 5; however, the Large-Bore Soil Sampler failed once to collect a sample on the initial attempt from the target depth of 40 feet bgs in Grid 5. This sample was collected on the subsequent push, yielding a sampling completeness of 100 percent. This failure occurred when the stop-pin fractured, preventing its removal from the drive head and subsequent collection of the sample. The fracture of the stop-pin was attributed to equipment failure

---

due to a manufacturing defect. Data from Grid 5 were only used to assess the performance range of the Large-Bore Soil Sampler.

The Geoprobe® Model 5400 probe and GH-40 hammer were successful in advancing the sampler to a maximum depth of 13.5 feet bgs in the clay soils at the SBA site and to a depth of 40 feet bgs in the sandy soils at the CSC site. Constant hammering was required only in the initial portion of the push from the ground surface to approximately 2 feet bgs at most sampling locations, a function of both the lithology and force exerted by the downward motion of the mast. No other problems with either the sampler components or the platform were noted during the demonstration. With the exception of the stop-pin, no components were replaced during the demonstration due to excessive wear.

### ***Training Requirements and Ease of Operation***

No specialized training or education is required to operate the Large-Bore Soil Sampler. Assembly and operation of the sampler are simple and can be learned within 1 hour. The Geoprobe® percussion-probing machine that advances the sampler minimizes labor but requires training to learn its proper operation. The many moving parts pose a risk of injury to the head, eyes, and feet, which can be protected with hard hat, safety glasses, and steel-toed boots. Leather gloves, and potentially a latex overglove (depending on the nature and concentration of potential contaminants), are recommended for physical and chemical protection during operation of the Large-Bore Soil Sampler and sampling apparatus. Additional personal protective equipment may be necessary in accordance with site-specific health and safety requirements.

### ***Logistical Requirements***

Some states require licenses for personnel conducting subsurface sampling. The sampler or equipment operator must contact appropriate state or local agency to assess any license or permit requirements. Additionally, utility clearances are needed before sampling with any intrusive subsurface equipment.

The physical impact of demonstration sampling on the site was minimal. The Model 5400 Geoprobe® platform used to push the Large-Bore Soil Sampler during the demonstration was mounted on a three-quarter ton pickup truck. The sampler left approximately 2-inch-diameter holes, which were grouted with neat Portland cement at the SBA site and with dry granular bentonite at the CSC site. No drill cuttings were generated during use of the Large-Bore Soil Sampler.

No additional power requirements are necessary for operation of either the platform or the Large-Bore Soil Sampler. Only a limited amount of water (about 7 gallons per day) and a containment area were necessary for adequate sampler decontamination.

### ***Sample Handling***

Acetate liners were used during the demonstration as described in Chapter 2. Once the liner was removed from the sample tube in accordance with the disassembly protocol, the ends were immediately capped to prevent volatile constituents from escaping the core. The liner was subsequently opened with a razor blade for subsampling.

---

### **Performance Range**

The performance range of the Large-Bore Soil Sampler depends in part on the capability of the platform advancing the sampler. During the demonstration, the Large-Bore Soil Sampler successfully collected samples at depths of up to 13.5 feet bgs. Additionally, the Large-Bore Soil Sampler attempted to collect samples from up to 40 feet bgs in Grid 5 at the CSC site. Because the sampler was not depth-limited in the clay soils at the SBA site or sandy soils at the CSC site, no performance limit has been postulated. Additionally, based on the push refusal described above, this sampling method is likely inappropriate for unconsolidated formations containing large cobbles.

### **Investigation-Derived Waste**

Minimal IDW was generated by the Large-Bore Soil Sampler during the demonstration. The direct-push and retraction of the Geoprobe® platform used during the demonstration generated no soil cuttings; the only waste created was soil remaining in the sampler after the subsample was collected. Approximately 18 gallons of soil was generated at each site by the Large-Bore Soil Sampler.

Decontamination of the Large-Bore Soil Sampler generated approximately 7 gallons of wastewater per day. This quantity was sufficient to decontaminate all sampler components in both Alconox® mixture and rinse water for an 8-hour sampling period. At the SBA site, slightly more water was used when the sampler encountered a zone of saturated clay and oily product.

Table 5-1 presents a comparison of the IDW generated by the Large-Bore Soil Sampler and the reference sampling method during this demonstration.

**Table 5-1. Investigation-Derived Waste Generated During the Demonstration**

<b>Sampler</b>	<b>Sampling Platform</b>	<b>Soil Generated</b>	<b>Wastewater Generated</b>
Large-Bore Soil Sampler	Push	18 Gallons	35 Gallons
Reference Sampler	Drilling	990 Gallons	150 Gallons

### **Quantitative Performance Assessment**

Quantitative measures of the Large-Bore Soil Sampler performance included (1) sample recovery, (2) VOC concentrations in recovered samples, (3) sample integrity, and (4) sample throughput.

#### **Sample Recovery**

Sample recoveries for the Large-Bore Soil Sampler were calculated by comparing the length of sampler advancement to the length of sample core obtained for each attempt. Sample recovery is defined as the length of recovered sample core divided by the length of sampler advancement and is expressed as a percentage. At the SBA site, sample recoveries ranged from 65 percent to 100 percent, with an average of 98 percent. At the CSC site, recoveries ranged from 42 percent to 94 percent, with an

average of 78 percent. In addition, sample recovery data for each sample collected are summarized in Appendix A2, Table A2. During the performance range test in Grid 5 at the CSC site, the recoveries in the saturated soil for the Large-Bore Soil Sampler ranged from 68 percent to 100 percent with an average of 89 percent.

Table 5-2 presents a comparison of sample recoveries achieved by the Large-Bore Soil Sampler and the reference sampling method during this demonstration.

**Table 5-2. Sample Recoveries for the Large-Bore Soil Sampler and the Reference Sampling Method**

Sampler	Site	Sample Recovery (percent)	
		Range	Average
Large-Bore Soil Sampler	SBA	65 to 100	98
Reference Sampler	SBA	40 to 100	88
Large-Bore Soil Sampler	CSC	42 to 94	78
Reference Sampler	CSC	53 to 100	87
Large-Bore Soil Sampler	CSC - Grid 5	68 to 100	89
Reference Sampler	CSC - Grid 5	22 to 100	75

Average sample recoveries for the Large-Bore Soil Sampler were greater than the reference sampling method at the SBA site because the clay soils helped to hold the soil in the sampler. The Large-Bore Soil Sampler was less successful in filling or holding the less-cohesive, sandy soils at the CSC site.

### ***Volatile Organic Compound Concentrations***

Samples were collected with the Large-Bore Soil Sampler at each sampling grid-depth combination as described in Chapter 3. Samples were analyzed for VOCs by combining headspace sampling with gas chromatography analysis according to the SOP provided in the demonstration plan (PRC, 1997). Table 5-3 presents the range and median VOC concentrations for samples collected using the Large-Bore Soil Sampler. Data are reported on a dry-weight basis. For six of the 12 sampling grid-depth combinations, VOC data are not available for all seven samples collected due to laboratory error; in these cases, the range and median were calculated from the remaining sample data. A summary of the number of samples collected and analyzed for each analyte at each site is presented in Table 5-4.

As described in Chapter 3, two statistical evaluations of the VOC concentration data were conducted: one using the Mann-Whitney test and the other using the sign test. Table 5-4 lists the number of analyte values used in the statistical evaluations. For the Mann-Whitney test, a statistical evaluation of the VOC concentration data was conducted based on the null hypothesis that there is no difference between the median contaminant concentrations obtained by the Large-Bore Soil Sampler and the reference sampling method described in Chapter 4. In addition, statistical evaluations using the

**Table 5-3. Volatile Organic Compound Concentrations in Samples Collected Using the Large-Bore Soil Sampler**

		Concentration (Fg/kg)							
Site	Grid - Depth	cis-1,2-DCE		1,1,1-TCA		TCE		PCE	
		Range	Median	Range	Median	Range	Median	Range	Median
SBA	1 - 9.5 feet	26,100 - 128,000	83,300	< 100	NC	69,500 - 542,000	200,000	< 100 - 2,720	574
SBA	1 - 13.5 feet	165 - 27,000	8,660	< 100	NC	11,200 - 664,000	55,500	< 100 - 3,320	NC
SBA	2 - 3.5 feet	< 1	NC	< 1	NC	45.4 - 177	124	< 1	NC
SBA	3 - 9.5 feet <sup>†</sup>	< 100 - 1,090	561	< 100	NC	18,800 - 282,000	24,900	< 100 - 473	NC
SBA	4 - 9.5 feet	8.13 - 52.7	14.6	< 1	NC	983 - 2,700	1,590	< 1 - 3.34	NC
SBA	5 - 13.5 feet*	1 - 230	77.0	< 1	NC	< 1 - 127	6.57	< 1	NC
CSC	1 - 3.0 feet <sup>†</sup>	< 100	NC	< 100	NC	< 100	NC	532 - 2,660	615
CSC	1 - 6.5 feet*	< 1 - 3.12	NC	6.78 - 42.3	25.1	< 1 - 5.19	3.28	24.9 - 115	71.7
CSC	2 - 3.0 feet*	< 100	NC	< 100	NC	< 100	NC	< 100 - 1,520	494
CSC	3 - 3.0 feet*	< 100 - 283	NC	< 100 - 859	579	< 100	NC	347 - 1,880	589
CSC	3 - 7.5 feet	< 1	NC	< 1 - 43.1	8.99	< 1 - 12.5	7.14	11.2 - 86.9	58.9
CSC	4 - 6.5 feet	< 1	NC	< 1 - 7.07	3.87	< 1 - 3.19	NC	5.93 - 40.8	18.0

Fg/kg Micrograms per kilogram PCE Tetrachloroethene  
 cis-1,2-DCE cis-1,2-Dichloroethene SBA Small Business Administration site  
 1,1,1-TCA 1,1,1-Trichloroethane TCE Trichloroethene  
 CSC Chemical Sales Company site † VOC data are available for only six samples  
 \* VOC data are available for only five samples NC No median calculated because at least half the reported values were below the method detection limit.

**Table 5-4. Demonstration Data Summary for the Large-Bore Soil Sampler and Reference Sampling Method**

Site	Grid	Depth (feet)	Number of Samples Analyzed	Number of Data Points Above the Method Detection Limit			
				cis-1,2-DCE	1,1,1-TCA	TCE	PCE
SBA	<b>Large-Bore Soil Sampler</b>						
	1	9.5	7	7	0	7	4
	1	13.5	7	7	0	7	1
	2	3.5	7	0	0	7	0
	3	9.5	6	5	0	6	1
	4	9.5	7	7	0	7	1
	5	13.5	7	6	0	5	0
	<b>Reference Sampling Method</b>						
	1	9.5	7	7	0	7	6
	1	13.5	7	7	0	7	1
	2	3.5	7	1	0	7	0
	3	9.5	4	4	0	4	0
	4	9.5	7	7	0	7	0
	5	13.5	6	6	0	5	0
CSC	<b>Large-Bore Soil Sampler</b>						
	1	3.0	7	0	0	0	7
	1	6.5	5	1	5	4	5
	2	3.0	5	0	0	0	4
	3	3.0	5	1	4	0	5
	3	7.5	7	0	6	6	7
	4	6.5	7	0	5	1	7
	<b>Reference Sampling Method</b>						
	1	3.0	6	0	3	0	6
	1	6.5	6	4	6	6	6
	2	3.0	7	0	3	4	7
	3	3.0	6	0	1	0	6
	3	7.5	4	3	4	4	4
4	6.5	5	2	4	3	5	

Note: Medians were not calculated when at least half of the reported values within a data set were below the method detection limit.

---

Mann-Whitney and sign tests were conducted only when at least half of the reported values for the grid, depth, and analyte combination were above the method detection limit.

The two-tailed significance level for this null hypothesis was set at 5 percent (2.5 percent for one-tailed); that is, if a two-tailed statistical analysis indicates a probability of greater than 5 percent that there is no significant difference between data sets, it will be concluded that there is no significant difference between the data sets. Because the data are not normally distributed, the Mann-Whitney test, a nonparametric method, was used to test the statistical hypothesis for VOC concentrations. The Mann-Whitney test makes no assumptions regarding normality and assumes only that the differences between the medians of two independent random samples may be determined—in this case, the reported chemical concentrations of soils collected by two different sampling systems. The Mann-Whitney test was used because of its historical acceptability and ease of application to small data sets.

Table 5-5 lists the median VOC concentrations calculated from data for samples collected with the Large-Bore Soil Sampler and the reference sampling method. The table also indicates whether there is a significant difference ( $p \leq 0.05$ ) in VOC data sets for each sampling grid and depth for each analyte based on the Mann-Whitney test. A comparative summary of the Mann-Whitney statistics for the Large-Bore Soil Sampler and reference sampling method is presented in Appendix A4, Table A4. A total of 48 grid, depth, and analyte combination pairs were collected during the demonstration. Of the 48 pairs, only 23 data sets were obtained: 12 from the SBA site and 11 from the CSC site. A statistical comparison could not be made for the remaining data sets because at least half of the reported values from the Large-Bore Soil Sampler or reference sampling method were below the method detection limit. According to the Mann-Whitney test, there is a statistically-significant difference in the data sets collected using the Large-Bore Soil Sampler and the reference sampling method in three of 23 cases. The statistically significant differences involve data collected from the SBA site, Grid 2 at the 3.5-foot sampling depth for the analyte TCE, and from the CSC site, Grids 1 and 2 at the 3-foot sampling depth for the analyte PCE. Figure 5-1 presents a graphic representation of median VOC concentrations of the Large-Bore Soil Sampler versus the median VOC concentrations of the reference sampling method for each contaminant at each depth.

To test potential bias between the data sets, a statistical analysis using the sign test was conducted. As discussed in Chapter 3, the sign test is a nonparametric statistical method that counts the number of positive and negative signs among the differences. The differences tested, in this instance, were the differences in the medians of paired data sets (within a site, within a grid, at a depth, and for each analyte). From the data sets, counts were made of (1) the number of pairs in which the reference sampling method median concentrations were higher than the Large-Bore Soil Sampler median concentrations and (2) the number of pairs in which the Large-Bore Soil Sampler median concentrations were higher than the reference sampling method median concentrations. The total number of pairs in which the median concentrations were higher with the Large-Bore Soil Sampler was then compared with the total number of pairs in which the median concentrations were higher with the reference sampling method. If no bias is present in the data sets, the probability of the total number of pairs for one or the other test method being higher is equivalent; that is, the probability of the number of pairs in which the median concentrations in the Large-Bore Soil Sampler are higher is equal to the probability of the number of pairs in which the median concentrations for the reference sampling method are higher. A binomial expansion was used to determine the exact probability of the number of data sets in which the median concentrations in the Large-Bore Soil Sampler and reference sampling method were higher. If the calculated probability is less than 5 percent ( $p < 0.05$ ), then a significant difference is present between the Large-Bore Soil Sampler and reference sampling method.

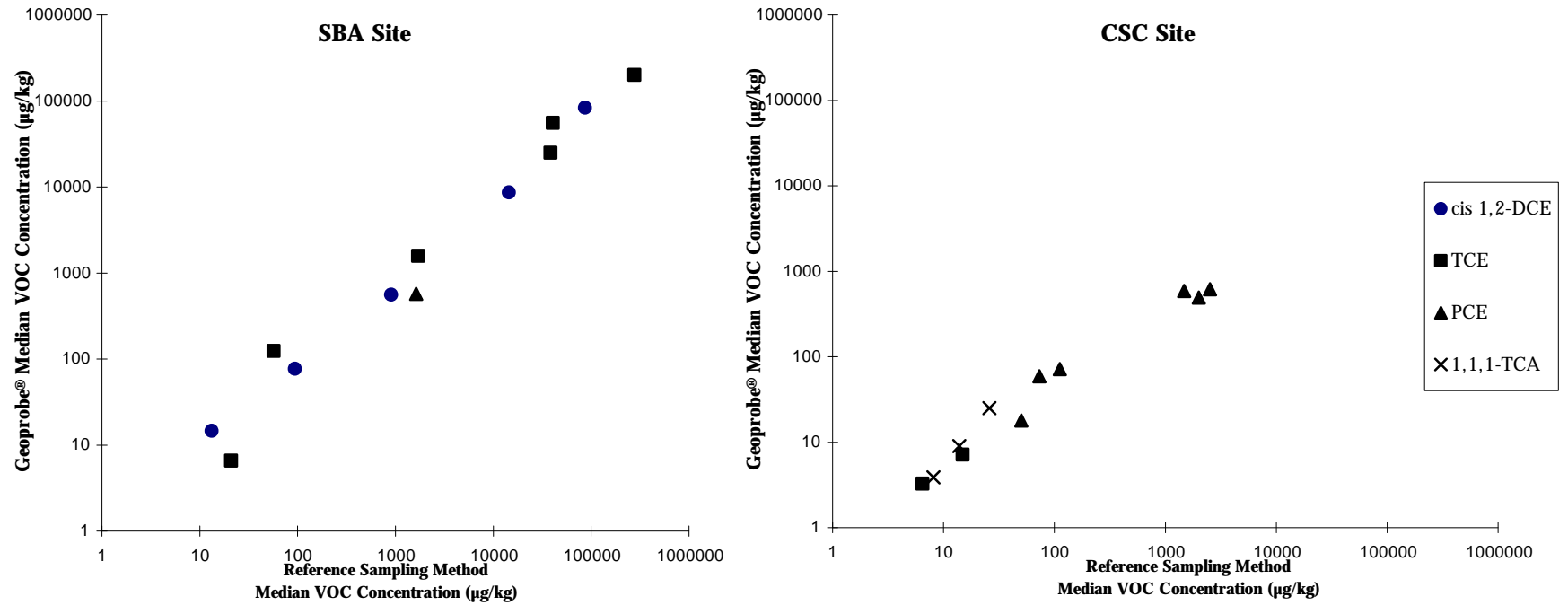

**Table 5-5. Median Volatile Organic Compound Concentrations of Large-Bore Soil Sampler and Reference Sampler Data and Statistical Significance**

Median Concentration (Fg/kg) and Significance													
Site	Grid - Depth	cis-1,2-DCE			1,1,1-TCA			TCE			PCE		
		LBS	Ref.	Sign.	LBS	Ref.	Sign.	LBS	Ref.	Sign.	LBS	Ref.	Sign.
SBA	1 - 9.5 feet	83,300	86,700	No	NC	NC	*	200,000	276,000	No	574	1,630	No
SBA	1 - 13.5 feet	8,660	14,500	No	NC	NC	*	55,500	40,500	No	NC	NC	*
SBA	2 - 3.5 feet	NC	NC	*	NC	NC	*	124	56.9	Yes	NC	NC	*
SBA	3 - 9.5 feet	561	903	No	NC	NC	*	24,900	38,500	No	NC	NC	*
SBA	4 - 9.5 feet	14.6	13.2	No	NC	NC	*	1,590	1,710	No	NC	NC	*
SBA	5 - 13.5 feet	77.0	93.6	No	NC	NC	*	6.57	21.0	No	NC	NC	*
CSC	1 - 3.0 feet	NC	NC	*	NC	NC	*	NC	NC	*	615	2,530	Yes
CSC	1 - 6.5 feet	NC	2.20	*	25.1	26.0	No	3.28	6.45	No	71.7	112	No
CSC	2 - 3.0 feet	NC	NC	*	NC	NC	*	NC	126	*	494	2,000	Yes
CSC	3 - 3.0 feet	NC	NC	*	579	NC	*	NC	NC	*	589	1,480	No
CSC	3 - 7.5 feet	NC	4.12	*	8.99	13.9	No	7.14	14.9	No	58.9	73.0	No
CSC	4 - 6.5 feet	NC	NC	*	3.87	8.09	No	NC	2.37	*	18.0	50.3	No

Fg/kg Micrograms per kilogram  
 cis-1,2-DCE cis-1,2-Dichloroethene  
 1,1,1-TCA 1,1,1-Trichloroethane  
 TCE Trichloroethene  
 SBA Small Business Administration site  
 \* A statistical comparison could not be made because an insufficient number

PCE Tetrachloroethene  
 LBS Large-Bore Soil Sampler  
 Ref. Reference sampling method  
 Sign. Significance  
 CSC Chemical Sales Company site  
 NC No median calculated because at least half the reported values were below the method detection limit of VOC concentrations were detected



Note:  $\mu\text{g}/\text{kg}$  = micrograms per kilogram

**Figure 5-1. Comparative Plot of Median VOC Concentrations for the Large-Bore Soil Sampler and Reference Sampling Method at the SBA and CSC Sites**

The sign test data are provided in Table 5-6 and are summarized in Appendix A5, Table A5. At the SBA site, the calculated probability is greater than 0.05; therefore, the difference is not statistically significant. However, the calculated probability at the CSC site is less than 0.05, indicating that the Large-Bore Soil Sampler yielded results that, statistically, were significantly different than the reference sampling method (probability of 0.049 percent). This result suggests that, in sampling coarse-grained soils for VOC analysis (DCE, TCA, TCE, and PCE), the reference sampling method tends to yield higher concentrations than does the Large-Bore Soil Sampler.

**Table 5-6. Sign Test Results for the Large-Bore Soil Sampler and the Reference Sampling Method**

<b>Sampler</b>	<b>Number of Pairs in Which the Median Concentration is Higher than Other Method</b>	
	<b>SBA Site</b>	<b>CSC Site</b>
Reference Sampler	9	11
Large-Bore Soil Sampler	3	0
Total Comparisons	12	11
Calculated Probability	0.054	0.00049

### ***Sample Integrity***

Six integrity samples were collected with the Large-Bore Soil Sampler in Grid 1 at each site, as described in Chapter 3, to determine if potting soil in a lined sampler interior became contaminated after it was advanced through a zone of high VOC concentrations. VOCs were detected in five of the 12 integrity samples collected using the Large-Bore Soil Sampler; all VOCs were detected in samples collected at the SBA site. The range of VOC concentrations detected above the analytical method detection limit in potting soil at the SBA site were: cis-1,2-DCE (3.42 to 295 Fg/kg) and TCE (14.4 to 46.3 Fg/kg). These results indicate that the integrity in a lined chamber of the Large-Bore Soil Sampler may not be preserved when the sampler is advanced through highly contaminated soils. The results of sample integrity tests for the reference method indicate no contamination in the potting soil after advancement through a zone of high VOC concentrations. Because potting soil has an organic carbon content many times greater than typical soils, the integrity tests represent a worst-case scenario for VOC absorbance and may not be representative of cross-contamination under normal conditions.

### ***Sample Throughput***

Sample retrieval time was measured as the amount of time required to set up at a sampling point, collect the specified sample, grout the hole, decontaminate the sampling equipment, and move to a new sampling location. The average sample retrieval time for the Large-Bore Soil Sampler was 27.5 minutes per sample for the SBA site and 15.3 minutes per sample for the CSC site. At the SBA site, a two-person sampling crew collected samples using the Large-Bore Soil Sampler at Grid 1; one person collected soil samples from the remaining grids at the SBA site. A two-person sampling crew collected

**Table 5-7. Average Sample Retrieval Times for the Large-Bore Soil Sampler and the Reference Sampling Method**

Sampler	Average Sample Retrieval Time (minutes per sample)	
	SBA Site	CSC Site
Large-Bore Soil Sampler	27.5	15.3
Reference Sampling Method	26	8.4

Note: One person collected soil samples using the Large-Bore Soil Sampler at the SBA site, except at Grid 1 where a two-person sampling crew was used. A two-person sampling crew collected soil samples using the Large-Bore Soil Sampler at the CSC sites. A three-person drilling and sampling crew collected soil samples using the reference sampling method at both sites. One additional person was present at the CSC site to direct drilling operations and assist with demonstration sampling, as necessary.

soil samples using the Large-Bore Soil Sampler at the CSC. Table 5-7 presents a comparison of the average sample retrieval times for the Large-Bore Soil Sampler and the reference sampling method. The reference method was quicker than the Large-Bore Soil Sampler at both sites.

**Data Quality**

Data quality was assessed throughout this demonstration by implementing an approved quality assurance project plan (PRC, 1997). The QA/QC procedures included the consistent application of approved methods for sample collection, chemical analysis, and data reduction. Based on the intended use of the data, QA objectives for precision, accuracy, representativeness, comparability, and completeness were established and QC samples were collected to assess whether the QA objectives were met. Based on the results of a field audit conducted by the EPA and a detailed validation of the demonstration data by Tetra Tech, the data have been deemed acceptable for use as described in the demonstration design (Chapter 3). The results of the QC indicators used for this demonstration for both the Large-Bore Soil Sampler and reference sampling method are provided in the Technology Evaluation Report for this demonstration (Tetra Tech, 1997) and are summarized in the data quality section of Chapter 4 of this ETVR.

**Macro-Core® Soil Sampler Performance**

The following subsections briefly discuss qualitative and quantitative performance factors for the Geoprobe® Systems Macro-Core® Soil Sampler as used in the continuous sampling mode.

**Training**

Training requirements for the Macro-Core® Soil Sampler are the same as for the Large-Bore Soil Sampler.

---

### ***Performance Range, Reliability, and Ruggedness***

The Macro-Core® Sampler was used during this demonstration to collect samples of unconsolidated materials to a depth of 39 feet bgs. The depth reached with the sampler is a function of the methods used to advance the sampler (manual, static vehicle weight, or percussion probing), the formation penetrated, and operator experience. The Macro-Core® closed-piston sampler is not designed to be driven to depth. Instead, soil is first removed to the sampling depth with an open-tube sampler, or a pilot hole may be made to sampling depth with a Macro-Core® Pre-Probe.

During the demonstration, no downtime was incurred due to equipment failure. Continuous coring at Grid 5 of the CSC site was completed by the Macro-Core® Soil Sampler and the reference method. Using the Macro-Core® Soil Sampler, Geoprobe® completed this task to a depth of 39 feet bgs before the hex drive on the GH-40 hammer failed. The hex drive failure was believed to result from hammering without the assistance of downward force of the mast, which applied excess pressure to the lower portion of the hammer where the hex drive stem is positioned.

### ***Licensing Requirements***

Currently, most state and local agencies do not require licensing or permits to collect soil samples with the Macro-Core® Sampler. Some states impose depth limits on operation without a license or permit, and some states limit sampling to depths above the water table unless a licensed operator or registered geologist is present. The operator must contact the appropriate state or local agencies to identify any license or permit requirements.

### ***Throughput***

The throughput calculation included only the time required for collection of the continuous cores to a depth of 39 feet bgs. Decontamination or grout installation time were not considered. Overall, the Macro-Core® Soil Sampler performed similarly to the reference method in sample retrieval time. The Macro-Core Sampler collected a continuous core to 39 feet bgs with a 48-inch-long sampler in 190 minutes, while the reference method collected a continuous core to 42 feet using 24-inch-long samplers in 170 minutes. The sample throughputs calculated for the two methods were similar, although the reference method was slightly quicker. However, a two-person sampling crew collected soil samples using the Macro-Core® Soil Sampler and a three-person drilling and sampling crew was used to collect soil samples using the reference sampling method.

### ***Sample Recovery***

The average sample recovery for the Macro-Core® Soil Sampler was 81 percent versus 87 percent for the reference method. However, data suggest that recovery for the Macro-Core® Soil Sampler decreased with depth. Because of the direct-push nature of the Macro-Core® Soil Sampler, it generates no cuttings, similar to the Large-Bore Soil Sampler. Conversely, the reference method generated one 55-gallon drum of cuttings.

---

## **Chapter 6**

### **Economic Analysis**

The Large-Bore Soil Sampler was demonstrated at two sites that varied geologically and were contaminated with VOCs at a range of concentrations. This chapter presents an economic analysis for applying the Large-Bore Soil Sampler at sites similar to those used in this demonstration. The demonstration costs for the reference sampling method are also provided.

This economic analysis estimates the range of costs for using a Geoprobe® Systems, Inc., Large-Bore Soil Sampler to collect 42 subsurface soil samples at a clay soil site (400 feet total depth, similar to the SBA site) and a sandy soil site (200 feet total depth, similar to the CSC site). The analysis is based on the results and experience gained from this demonstration and on costs provided by Geoprobe® Systems, Inc., and vendors supplying Geoprobe® sampling equipment and services. To account for variability in cost data and assumptions, the economic analysis is presented as a list of cost elements and a range of costs for collecting samples using the Large-Bore Soil Sampler.

#### **Assumptions**

Several factors affect the cost of subsurface soil sampling. Wherever possible, these factors are identified so that decision makers can independently complete a site-specific economic analysis. For example, this cost estimate is based on collecting soil samples from clay and sandy soil sites at sampling depths ranging from 3 feet bgs to 13.5 feet bgs and using the average sample retrieval times calculated during the demonstrations of 27.5 minutes per sample for the clay soil site and 15.3 minutes per sample at the sandy soil site. This cost estimate also assumes that a direct-push platform is used to advance the Large-Bore Soil Sampler and that a hollow-stem auger drilling platform is used to advance the reference method sampler.

#### **Large-Bore Soil Sampler**

The costs for collecting soil samples using the Large-Bore Soil Sampler are presented in two categories: (1) sampling and equipment costs, which include costs for a vendor to supply and operate a Large-Bore Soil Sampler and push platform, and (2) oversight costs, which include labor costs for sampling oversight and other direct costs such as supplies and IDW disposal.

The cost categories and associated cost elements are defined and discussed below and serve as the basis for the estimated cost ranges presented in Table 6-1.

*Sampling and Equipment Costs.* At a rental rate ranging from \$1,330 to \$1,450 per day, the total vendor cost for the clay soil site is estimated to range from \$3,990 to \$4,350 and the sandy soil site

**Table 6-1. Estimated Subsurface Soil Sampling Costs for the Large-Bore Soil Sampler**

<b>Sampling and Equipment Costs</b>			
Large-Bore Soil Sampler and Sample Collection = \$1,330 to \$1,450 per day			
<b>Oversight Costs</b>			
<b>Clay Soil Site</b>		<b>Sandy Soil Site</b>	
Total Sampling Time = 19 to 23 hours (3 days)		Total Sampling Time = 11 to 13 hours (2 days)	
Total Samples Collected = 42		Total Samples Collected = 42	
Total Sample Depth = 400 feet		Total Sample Depth = 200 feet	
Sampling Crew Size = 2 People		Sampling Crew Size = 2 People	
<b>Labor Costs</b>		<b>Labor Costs</b>	
Mobilization/Demobilization	\$300 - \$500	Mobilization/Demobilization	\$300 - \$500
Travel	\$6 - \$30	Travel	\$6 - \$30
Per Diem	0 - \$450	Per Diem	0 - \$300
Sampling Oversight	\$950 - \$1,150	Sampling Oversight	\$550 - \$650
<b>Other Direct Costs</b>		<b>Other Direct Costs</b>	
Supplies	\$25 - \$75	Supplies	\$25 - \$75
IDW Disposal	\$200 - \$300	IDW Disposal	\$200 - \$300
<b>Range of Oversight Costs*</b>	<b>\$1,480 - \$2,510</b>		<b>\$1,080 - \$1,860</b>

\* The range of Oversight Costs is rounded to the nearest tens of dollars and does not include Sampling and Equipment Costs.

from \$2,660 to \$2,900. These costs are based on vendor-supplied price quotes for daily use of the sampler and push platform for 3 days at a clay soil site and 2 days at a sandy soil site. The vendor price quotes included the following operating costs:

- C Mobilization and demobilization
- C Use of a push platform and Large-Bore Soil Sampler to collect soil samples
- C Labor costs for a two-person field crew (8 to 10 hours per day)
- C Grouting boreholes and grout
- C Waste collection and containerization
- C Decontamination time
- C Site restoration and cleanup

Additional mobilization/demobilization and per diem costs will apply if travel greater than 100 miles is required by the push platform operator.

*Oversight Costs.* Oversight costs are presented as a range to provide an estimate of oversight costs that may be incurred. Costs for overseeing sampling using the Large-Bore Soil Sampler are segregated into labor costs and other direct costs, as shown below.

---

Labor costs include mobilization/demobilization, travel, per diem, and sampling oversight costs.

- C Mobilization/Demobilization Labor Costs — This cost element includes the time for one person to prepare for and travel to each site, set up and pack up equipment, and return from the field and includes 6 to 10 hours for one person at a rate of \$50 per hour.
- C Travel Costs — Travel costs for each site are limited to round-trip mileage costs and are estimated to be between 20 to 100 miles at a rate of \$0.30 per mile.
- C Per Diem Costs — This cost element includes food, lodging, and incidental expenses, and is estimated to range from zero (for a local site) to \$150 per day per person for one person for 3 days at the clay soil site (3 days for sample collection, mobilization/demobilization, and site restoration), and for 2 days at the sandy soil site (2 days for sample collection, mobilization/demobilization, and site restoration).
- C Sampling Oversight Labor Costs — On-site labor, often a registered geologist, is required to oversee sample collection. This cost element does not include the push crew, which is covered in the lump sum Large-Bore Soil Sampler and push platform operating costs. Based on the average demonstration sample retrieval times, sampling oversight labor times are estimated to be 19 to 23 hours for one person at the clay soil site, and 11 to 13 hours for one person at the sandy soil site. Labor rates are estimated at \$50 per hour.

Other direct costs include supplies and IDW disposal.

- C Supplies — This cost element includes decontamination supplies, such as buckets, soap, high-purity rinse water, and brushes, as well as personal protective equipment (Level D, the minimum level of protection, is assumed). Supplies are estimated to cost between \$25 and \$75.
- C IDW Disposal — Disposal costs for each site are limited to the cost of disposing of one 55-gallon drum of IDW for \$200 to \$300 (typically, the minimum IDW disposal unit is one 55-gallon drum). Limited volumes of IDW were generated during the demonstration using the Large-Bore Soil Sampler because of the direct-push nature of the sampler advancement unit. No costs are included for wastewater disposal.

### **Reference Sampling Method**

The costs for implementing the reference sampling method during the demonstration include driller's costs and oversight costs, as presented in Table 6-2 and discussed below.

*Driller's Costs.* Total lump sum driller's cost was \$13,400 for the clay soil site and \$7,700 for the sandy soil site and included:

- C Mobilization and demobilization (\$2,700 per site)
- C Drilling footage (\$7 per linear foot)
- C Split-spoon sampling (\$45 per sample)
- C Grouting boreholes (\$3 per linear foot)
- C Waste collection and containerization (\$45 per drum)



**Table 6-2. Estimated Subsurface Soil Sampling Costs for the Reference Sampling Method**

<b>Driller's Costs</b>			
Lump Sum = \$21,100 (\$13,400 for the clay soil site and \$7,700 for the sandy soil site)			
<b>Oversight Costs</b>			
<b>Clay Soil Site</b>		<b>Sandy Soil Site</b>	
Total Sampling Time = 18 to 22 hours (2 days)		Total Sampling Time = 6 to 8 hours (1 day)	
Total Samples Collected = 42		Total Samples Collected = 42	
Total Sample Depth = 400 feet		Total Sample Depth = 200 feet	
Sampling Crew Size = 3 People		Sampling Crew Size = 3 People	
<b>Labor Costs</b>		<b>Labor Costs</b>	
Mobilization/Demobilization	\$300 - \$500	Mobilization/Demobilization	\$300 - \$500
Travel	\$6 - \$30	Travel	\$6 - \$30
Per Diem	0 - \$300	Per Diem	0 - \$150
Sampling Oversight	\$900 - \$1,100	Sampling Oversight	\$300 - \$400
<b>Other Direct Costs</b>		<b>Other Direct Costs</b>	
Supplies	\$25 - \$75	Supplies	\$25 - \$75
IDW Disposal	\$3,000 - \$4,500	IDW Disposal	\$600 - \$900
<b>Range of Oversight Costs*</b>	<b>\$4,230 - \$6,510</b>		<b>\$1,230 - \$2,060</b>

\* The range of Oversight Costs is rounded to the nearest tens of dollars and does not include Driller's Costs.

- C Standby time (\$80 per hour)
- C Decontamination time (\$80 per hour)
- C Drum moving time (\$80 per hour)
- C Difficult move time (\$80 per hour)
- C Site restoration and cleanup (\$50 per hour)
- C Per diem for the drilling crew (3 people)
- C Drilling crew labor costs (3 people)

These rates are based on the demonstration data and vendor-supplied information for collecting soil samples at clay soil and sandy soil sites similar to the SBA and CSC sites.

*Oversight Costs.* Oversight costs are presented as ranges to provide an estimate of oversight costs that may be incurred at other sites. Costs for overseeing the reference sampling method are segregated into labor costs and other direct costs, as shown below.

Labor costs include mobilization/demobilization, travel, per diem, and sampling oversight costs.

- 
- C Mobilization/Demobilization Labor Costs — This cost element includes the time for one person to prepare for and travel to each site, set up and pack up equipment, and return from the field and includes 6 to 10 hours for one person at a rate of \$50 per hour.
  - C Travel Costs — Travel costs for each site are limited to round-trip mileage costs and are estimated to be between 20 to 100 miles at a rate of \$0.30 per mile.
  - C Per Diem Costs — This cost element includes food, lodging, and incidental expenses, and is estimated to range from zero (for a local site) to \$150 per day per person for one person for 2 days at the clay soil site (2 days for sample collection, mobilization/demobilization, and site restoration), and one person for 1 day at the sandy soil site (1 day for sample collection, mobilization/ demobilization, and site restoration).
  - C Sampling Oversight Labor Costs — On-site labor, often a registered geologist, is required to oversee sample collection. This cost element does not include the drill crew, which is covered in the lump sum driller's cost. Based on the average demonstration sample retrieval times, oversight labor times are estimated to be 18 to 22 hours for one person at the clay soil site and 6 to 8 hours for one person at the sandy soil site. Labor rates are estimated at \$50 per hour.

Other direct costs include supplies and IDW disposal.

- C Supplies — This cost element includes personal protective equipment (Level D, the minimum level of protection, is assumed) and other miscellaneous field supplies. Supplies are estimated to cost between \$25 and \$75.
- C IDW Disposal — Disposal costs for each site are limited to the cost of disposing of 15, 55-gallon drums for the clay soil site and three 55-gallon drums for the sandy soil site at a cost of \$200 to \$300 per drum.

---

## **Chapter 7**

### **Summary of Demonstration Results**

This chapter summarizes the technology performance results. The Large-Bore Soil Sampler was compared to a reference subsurface soil sampling method (hollow-stem auger drilling and split-spoon sampling) in terms of the following parameters: (1) sample recovery, (2) VOC concentrations in recovered samples, (3) sample integrity, (4) reliability and throughput, and (5) cost.

The demonstration data indicate the following performance characteristics for the Geoprobe® Systems, Inc., Large-Bore Soil Sampler:

- C **Sample Recovery:** The ratio of the length of recovered sample to the length of sampler advancement was calculated for samples collected at both the SBA and CSC sites. Sample recoveries from 42 samples collected at the SBA site ranged from 65 to 100 percent, with an average sample recovery of 98 percent. Sample recoveries from 42 samples collected at the CSC site ranged from 42 to 94 percent, with an average sample recovery of 78 percent. The ranges of sample recoveries for 42 samples collected with the reference method at the SBA site and 41 samples collected with the reference method at the CSC site were 40 to 100 percent and 53 to 100 percent, respectively. Average recoveries for the reference sampling method at the SBA and CSC sites were 88 and 87 percent, respectively. A comparison of recovery data from the Large-Bore Soil Sampler and the reference sampler indicates that the Large-Bore Soil Sampler achieved higher sample recoveries in the clay soil at the SBA site and lower recoveries in the sandy soil at the CSC site relative to sample recoveries by the reference sampling method.
  
- C **Volatile Organic Compound Concentrations:** Soil samples collected using the Large-Bore Soil Sampler and the reference sampling method at six sampling depths within nine grids (five at the SBA site and four at the CSC site) were analyzed for VOCs. For 20 of the 23 Large-Bore Soil Sampler and reference sampling method pairs (12 at the SBA site and 11 at the CSC site), a statistical analysis using the Mann-Whitney test indicated no significant statistical difference at the 95 percent confidence level between the VOC concentrations detected in samples collected with the Large-Bore Soil Sampler and those collected with the reference sampling method. A statistically significant difference was identified for three sample pairs: one pair at the SBA site and two pairs at the CSC site. Analysis of the SBA site data, using the sign test, indicated no statistical difference between the data obtained by the Large-Bore Soil Sampler and by the reference sampling method. However, at the CSC site, the sign test indicated that the VOC data (cis-1,2-DCE, 1,1,1-TCA, TCE, and PCE) obtained by the Large-Bore Soil Sampler are statistically significantly different than the data obtained by the reference

---

sampling method, suggesting that the reference method tends to yield higher concentrations in sampling coarse-grain soils than does the Large-Bore Soil Sampler.

- C **Sample Integrity:** Six integrity sampling tests were conducted with the Large-Bore Soil Sampler at each site to determine if potting soil in a lined sampler interior became contaminated after it was advanced through a zone of high VOC concentrations. Additionally, seven and five integrity sampling tests were conducted with the reference sampling method at the SBA and CSC sites, respectively. For the Large-Bore Soil Sampler, VOCs were detected in five of the 12 integrity samples, all at the SBA site. The range of VOC concentrations detected above the analytical detection limit in the potting soil at the SBA site were: cis-1,2-DCE (3.42 to 295 Fg/kg) and TCE (14.4 to 46.3 Fg/kg). These results indicate that the integrity of a lined chamber in the Large-Bore Soil Sampler may not be preserved when the sampler is advanced through highly contaminated soils. Results of sample integrity tests for the reference sampling method indicate no contamination in the potting soil after it was advanced through a zone of high VOC concentrations. Because potting soil has an organic carbon content many times greater than typical soils, the integrity tests represent a worst-case scenario for VOC absorbance and may not be representative of cross-contamination under normal field conditions.
- C **Reliability and Throughput:** At the SBA site, the Large-Bore Soil Sampler collected a sample from the desired depth on the initial attempt 93 percent of the time. Sample collection in the initial push was achieved 100 percent of the time at the CSC site. The initial push success rate was less than 100 percent primarily because of refusal due to cobbles. By conducting multiple pushes, the Large-Bore Soil Sampler did collect all of the samples required for this demonstration, yielding a sampling completeness of 100 percent. For the reference sampling method, the initial sampling success rates at the SBA and CSC sites were 90 and 95 percent, respectively. Success rates for the reference sampling method were less than 100 percent due to (1) drilling beyond the target sampling depth, (2) insufficient sample recovery, or (3) auger refusal. The average sample retrieval time for the Large-Bore Soil Sampler to set up on a sampling point, collect the specified sample, grout the hole, decontaminate the sampler, and move to a new sampling location was 27.5 minutes per sample at the SBA site and 15.3 minutes per sample at the CSC site. For the reference sampling technique, the average sample retrieval times at the SBA and CSC sites were 26 and 8.4 minutes per sample, respectively. During the performance range tests at Grid 5 at the CSC site, the Large-Bore Soil Sampler successfully collected all seven soil samples within the saturated zone from 40 feet below ground surface (bgs) at Grid 5; however, the Large-Bore Soil Sampler failed once to collect a sample on the initial attempt from the target depth of 40 feet in Grid 5. This sample was collected on the subsequent push. The reference method collected all seven samples from the saturated zone at 40 feet bgs on the initial attempts. One person collected soil samples using the Large-Bore Soil Sampler at the SBA site (except Grid 1 where a two-person crew was used), and a two-person sampling crew collected soil samples at the CSC site. A three-person sampling crew collected soil samples using the reference method at both sites. One additional person was present at the CSC site to oversee and assist with sample collection using the reference sampling method.
- C **Cost:** Based on the demonstration results and information provided by the vendor, the Large-Bore Soil Sampler and equipment costs ranged from \$1,330 to \$1,450 per day at both sites. Oversight costs for the Large-Bore Soil Sampler ranged from \$1,480 to \$2,510 at the clay soil site and \$1,080 to \$1,860 at the sandy soil site. For this demonstration, reference sampling

---

was procured at a lump sum of \$13,400 for the clay soil site and \$7,700 for the sandy soil site. Oversight costs for the reference sampling method ranged from \$4,230 to \$6,510 at the clay soil site and \$1,230 to \$2,060 at the sandy soil site. A site-specific cost and performance analysis is recommended when selecting a subsurface soil sampling method.

A qualitative performance assessment of the Large-Bore Soil Sampler indicated that (1) the reliability of the sampler was better than the reference sampling method; (2) the sampler is easy to use and requires minimal training to operate; (3) logistical requirements are similar to those for the reference sampling method; (4) sample handling is similar to the reference method; (5) the performance range is primarily a function of the advancement platform; and (6) no drill cuttings are generated when using the Large-Bore Soil Sampler with a push platform.

The demonstration results indicate that the Large-Bore Soil Sampler can provide useful, cost-effective samples for environmental problem-solving. However, in some cases, VOC data collected using the Large-Bore Soil Sampler may be statistically different from VOC data collected using the reference sampling method. Also, the integrity of a lined sample chamber may not be preserved when the sampler is advanced through highly contaminated soils.

---

## **Chapter 8 Technology Update**

Geoprobe® Systems has helped to advance, improve, and greatly lower the costs required to conduct many routine site investigations with the development of the Geoprobe® hydraulic machine and supporting tools and equipment. Geoprobe® designs and manufactures many tools, machines, and direct sensing devices for the geo-environmental industry. The Large-Bore Soil Sampler is only one of the many direct push sampling tools specifically designed for the industry. Geoprobe® also manufactures soil gas sampling equipment, groundwater sampling and monitoring equipment, and “direct sense” logging devices. The logging devices include the Direct Image® Electrical Conductivity logging (E-logging) system and the Membrane Interface Probe (MIP) system designed specifically for direct push applications. The E-logging system provides detailed electrical logs of unconsolidated formations to provide lithologic information for geologic mapping with minimal soil sampling. The MIP system provides a vertical log of volatile organic contaminant concentrations using a semipermeable membrane on a heated probe. Both the MIP and E-log probes are driven directly into virgin materials without the need for a pre-existing borehole or well. Both of these systems are laptop computer based and provide onscreen-live time data as logging is conducted in the field.

Both the Direct Image® Electrical Conductivity logging system and the Geoprobe®’s Screen Point 15 groundwater sampler (SP-15) were used at Grid 5 at the CSC site in Denver (Figure 3-2). The E-log, along with verification of the water level with the Screen Point 15 groundwater sampler, quickly identified the saturated sands below 37 feet.

Last year Geoprobe® Systems introduced its new, heavier duty 1.25-inch o.d. probe rods for direct push sampling and logging applications. These probe rods have an inside diameter of 0.625 inches, which is one-eighth of an inch larger i.d. than the original 1.0-inch o.d. by 0.5-inch i.d. probe rods. This larger probe rod design has enabled Geoprobe® to increase the diameter of both the stop-pin and piston rod of the original Large-Bore Soil Sampler that was used in the SITE demonstration. In the last few years, increasing numbers of direct push operators have been collecting soil and sediment samples at much greater depths. Several years ago, collecting a soil sample at 20 to 30 foot depths with direct push methods was considered exceptional, but now sampling to depths consistently over 50 feet

Chapter 8 was written solely by Geoprobe® Systems, Inc. The statements presented in this chapter represent the vendor’s point of view and summarize the claims made by the vendor regarding the Large-Bore Soil Sampler. Publication of this material does not represent the EPA’s approval or endorsement of the statements made in this chapter; results of the performance evaluation of the Large-Bore Soil Sampler are discussed in other chapters of this report.

---

has become routine. The smaller, original design stop-pin and piston rod were showing increased evidence of wear and damage and need for replacement when used repeatedly for sampling at these greater depths. This was especially true under difficult driving conditions such as those encountered at the CSC site in Denver during the SITE demonstration.

The newly designed Large-Bore Soil Sampler, with larger stop pin and piston rod, makes the sampler even more rugged and reliable than the earlier model. This more durable construction increases the sampler life span and enables more consistent sampling at greater depths under comparable conditions. Of course, some soils and subsurface conditions (bedrock or glacial till with boulders) are not suitable conditions for direct push applications and other alternatives may need consideration.

The Geoprobe® Systems Macro-Core® (MC) sampler was also used during the SITE demonstration at the CSC Site in Denver. This sampler is used for continuous coring from ground surface to depth in unconsolidated materials. The MC recovers a sample approximately 4 feet in length and 1.5 inches in diameter. This sampler was operated with the Locking Piston mechanism at the CSC site to assure that borehole wall slough was not recovered in the sample. The Locking Piston allows the operator to collect representative, high-integrity samples for geo-environmental investigations. During the demonstration at the CSC site, the MC sampler and the reference sampling method were used to collect continuous samples to a depth of 40 feet. The Geoprobe® two-person team was able to collect the samples in slightly less time than the three-person reference sampling method drilling team. The drilling generated almost two drums of cuttings while collecting the samples; the Geoprobe® and MC generated no excess cuttings.

Since the completion of the SITE demonstration, Geoprobe® Systems has also engineered a new Macro-Core® Soil Sampler design. This design uses a piston stop-pin and piston rod similar to the Large-Bore Soil Sampler design. This is a simpler, more rugged and robust design than the earlier MC Locking Piston Assembly. This simpler design will make operation of the sampler more user friendly and increase efficiency. The new MC design is still recommended only for continuous sampling operations, not discrete intervals at depth. Under ideal conditions, depth-discrete sampling may be achieved but is not recommended due to increased possibility of sampler damage. The unit cost will also be somewhat lower than that of the original MC design.

Currently, the Large-Bore Soil Sampler is not equipped with a sampler catcher to enhance sample recovery in poorly cohesive soils. The MC sampler can be equipped with a catcher when needed to assist in recovery of poorly cohesive soils (such as saturated sands). If time and finances permit, and the need demands, a catcher for the Large-Bore Soil Sampler may be designed in the not too distant future.

Chapter 8 was written solely by Geoprobe® Systems, Inc. The statements presented in this chapter represent the vendor's point of view and summarize the claims made by the vendor regarding the Large-Bore Soil Sampler. Publication of this material does not represent the EPA's approval or endorsement of the statements made in this chapter; results of the performance evaluation of the Large-Bore Soil Sampler are discussed in other chapters of this report.

---

## **Chapter 9**

### **Previous Deployment**

The Geoprobe® hydraulically powered direct push machines and Large-Bore Soil Samplers have been used to collect thousands of soil samples at hundreds of Comprehensive Environmental Response, Compensation, and Liability Act (CERCLA), Resource Conservation and Recovery Act (RCRA), and underground storage tank (UST) sites across the United States and in many other countries. The low cost of this sampling method and the high-quality, high-integrity samples provided have been recognized in the geo-environmental industry. The Large-Bore Soil Sampler has been found to be rugged and reliable for use in sampling unconsolidated materials. Another important advantage to the direct push soil sampling method with the Geoprobe® and Large-Bore Soil Sampler is that essentially no drill cuttings are generated. This eliminates as much as 25 percent to 50 percent of the cost of soil sampling compared to using traditional rotary drilling techniques when sampling at contaminated sites. The lack of drill cuttings using the direct push method greatly reduces the potential chemical exposure hazards to the site workers, local residents, and the environment when compared to traditional sampling methods.

Chapter 9 was written solely by Geoprobe® Systems, Inc. The statements presented in this chapter represent the vendor's point of view and summarize the claims made by the vendor regarding the Large-Bore Soil Sampler. Publication of this material does not represent the EPA's approval or endorsement of the statements made in this chapter; results of the performance evaluation of the Large-Bore Soil Sampler are discussed in other chapters of this report.



---

## References

- Bohn, H., Brian, M., and George, O. 1979. *Soil Chemistry*. John Wiley & Sons.
- Central Mine Equipment Company. 1994. Augers Brochure. St. Louis, Missouri.
- Ecology & Environment. 1996. "Expanded Site Inspection for the Albert City, SBA Site, Albert City, Iowa." July.
- Engineering-Science, Inc. 1991. "Remedial Investigation/Feasibility Report for the Chemical Sales Company Superfund Site, OU1, Leyden Street Site."
- GeoProbe® Systems. 1997. Product Schematics.
- PRC Environmental Management, Inc. 1997. "Final Demonstration Plan for Soil Sampling and Soil Gas Sampling Technologies."
- Rohlf, F. James and Robert R. Sokal. 1969. *Statistical Tables*. W. H. Freeman and Company. Table CC. Critical values of the Mann-Whitney statistic, page 241.
- Terzaghi, Karl, and Ralph B. Peck. 1967. *Soil Mechanics in Engineering Practice*. John Wiley & Sons. New York, New York.
- Tetra Tech EM Inc. 1997. "Soil and Soil Gas Technology Evaluation Report."
- U.S. Environmental Protection Agency (EPA). 1986. *Test Methods for Evaluating Solid Waste. SW-846. Third Edition*.
- EPA. 1987. "A Compendium of Superfund Field Operations Methods." Office of Emergency and Remedial Response. Washington, DC. EPA 540-P-87 001. December.

---

**APPENDIX A**

**DATA SUMMARY TABLES AND STATISTICAL METHOD  
DESCRIPTIONS**

**FOR THE**

**GEOPROBE® SYSTEMS, INC.  
LARGE-BORE SOIL SAMPLER**

---

**APPENDIX A1**

**STATISTICAL METHOD DESCRIPTIONS**

**MANN-WHITNEY TEST AND SIGN TEST**

---

## MANN-WHITNEY TEST

A statistical evaluation of the volatile organic compound (VOC) concentration data was conducted based on the null hypothesis that there is no difference between the median contaminant concentrations obtained by the Large-Bore Soil Sampler and the reference sampling method. The two-tailed significance level for this null hypothesis was set at a probability of 5 percent ( $p \leq 0.05$ ) (2.5 percent for a one-tailed); that is, if a two-tailed statistical analysis indicates a probability of greater than 5 percent that there is no significant difference between data sets, then it will be concluded that there is no significant difference between the data sets. A two-tailed test was used because no information was available to indicate *a priori* that one method would result in greater concentrations than the other method was known. Because the F test for homogeneity of variances failed, a parametric analysis of variance could not be used to test the hypothesis. Therefore, a nonparametric method, the Mann-Whitney test, was used to test the statistical hypothesis for VOC concentrations. The Mann-Whitney statistic makes no assumptions regarding normality and assumes only that the differences between two values, in this case the reported chemical concentrations, can be determined. Other assumptions required for use of the Mann-Whitney test are that samples are independent of each other and that the populations from which the samples are taken differ only in location. The Mann-Whitney test was chosen because of its historical acceptability and ease of application to small data sets.

To use the Mann-Whitney test, all of the data within two data sets which are to be compared are ranked without regard to the population from which each sample was withdrawn. The cis-1,2-dichloroethene (DCE) data from the SBA site are provided as an example in Table A1. The combined data from both data sets are ranked from the lowest value to the highest. Next, the sum of ranks within a sample set is determined by adding the assigned rank values. In the example provided in Table A1, the sum of ranks is 50.5 for the Large-Bore Soil Sampler data and 54.5 for the reference sampling method data.

A Mann-Whitney statistic is then calculated for each data set as follows:

$$\text{Mann-Whitney}_1 = N_1N_2 + \frac{N_1(N_1 + 1)}{2} - \text{sum of ranks value for the first data set}$$

and

$$\text{Mann-Whitney}_2 = N_1N_2 + \frac{N_2(N_2 + 1)}{2} - \text{sum of ranks value for the second data set}$$

Where

$N_1$  is the number of values in data set 1  
 $N_2$  is the number of values in data set 2

**Table A1. Mann-Whitney Test Rank of cis-1,2-DCE Data from the 9.5 Foot Depth of Grid 1 at the SBA Site**

<b>Sampler</b>	<b>Sample Location</b>	<b>cis-1,2-DCE Concentration (mg/kg)</b>	<b>cis-1,2-DCE Concentration Rank</b>	<b>Median Value Rank</b>
Large-Bore Soil Sampler	A6	83.3	7	4
Large-Bore Soil Sampler	B5	109	11.5	6
Large-Bore Soil Sampler	C5	66.0	5	3
Large-Bore Soil Sampler	D2	128	13	7
Large-Bore Soil Sampler	E3	92.6	9	5
Large-Bore Soil Sampler	F5	58.9	4	2
Large-Bore Soil Sampler	G4	26.1	1	1
Reference	A3	49.7	2	1
Reference	B2	86.7	8	4
Reference	C2	109	11.5	6
Reference	D4	147	14	7
Reference	E4	67.1	6	3
Reference	F2	98.4	10	5
Reference	G7	50.2	3	2
Sum of Large-Bore Soil Sampler Ranks (7+ 11.5+ 5+ 13+ 9+ 4+ 1 = 50.5)			50.5	
Sum of Reference Sampler Ranks (2+ 8+ 11.5+ 14+ 6+ 10+ 3 = 54.5)			54.5	
Mann-Whitney <sub>1</sub> Statistic			26.5	
Mann-Whitney <sub>2</sub> Statistic			22.5	
Critical Mann-Whitney Value (for N <sub>1</sub> = 7, N <sub>2</sub> = 7, p= 0.05)			41	
Significance (Mann-Whitney Statistic > 41 ?)			no	

---

For the example provided in Table A1, the equations become:

$$\text{Mann-Whitney}_1 = (7)(7) + \frac{7(7+1)}{2} - 50.5$$

$$\text{Mann-Whitney}_1 = 49 + 28 - 50.5$$

$$\text{Mann-Whitney}_1 = 26.5$$

and

$$\text{Mann-Whitney}_2 = (7)(7) + \frac{7(7+1)}{2} - 54.5$$

$$\text{Mann-Whitney}_2 = 49 + 28 - 54.5$$

$$\text{Mann-Whitney}_2 = 22.5$$

To determine the significance of the calculated Mann-Whitney value, a table of critical values for the Mann-Whitney statistic is consulted. For the case of 7 samples in each data set, the Mann-Whitney statistic value for  $N_1=7$  and  $N_2=7$  is of interest. For a two-tailed test with a significance level of 0.05, the Mann-Whitney statistic value is 41 (Rohlf and Sokal, 1969). Therefore, when the Mann-Whitney statistic value is greater than 41, a significance level of  $p < 0.05$  has been realized, and the null hypothesis is rejected; that is, the two data sets are statistically different. The example comparison provided in Table A1 yielded a maximum Mann-Whitney statistic of 26.5, which is less than 41; therefore, there is no statistically significant difference between the two data sets and the null hypothesis is accepted.

The question of data points with equal values may be easily addressed with the Mann-Whitney statistic. When two values (contaminant concentrations in this instance) are equivalent, the median rank is assigned to each. For instance, if the initial two values in the rank series are equivalent (regardless of which data set they were derived from) they would be assigned a median rank of 1.5  $([1+2]/2 = 1.5)$ . For three equivalent ranks, the assigned rank for each value would be 2  $([1+2+3]/3 = 2)$ . This approach is also applied to data points where contaminant concentrations are reported as below the method detection limit.

For the demonstration data, certain VOCs were not detected in some, or all, of the samples for many data sets. There is no strict guidance regarding the appropriate number of values which must be reported within a data set to yield statistically valid results. Therefore, and for the purposes of this statistical analysis, the maximum number of "nondetects" allowed within any given data set has been set at three. That is, there must be at least four reported values above the method detection limit within each data set to perform the Mann-Whitney test.

---

## **SIGN TEST**

The sign test was used to examine the potential for sampling and analytical bias between the Large-Bore Soil Sampler and the reference sampling method. The sign test is nonparametric and counts the number of positive and negative signs among the differences. The differences tested, in this instance, were the differences in the median concentrations of paired data sets (within a site, within a grid, within a depth, and within an analyte). From the data sets, counts were made of the number of pairs in which (1) the reference sampling method median concentrations were higher than the Large-Bore Soil Sampler median concentrations and (2) the number of pairs in which the Large-Bore Soil Sampler median concentrations were higher than the reference sampling method median concentrations were counted. The total number of pairs in which the median concentrations were higher in Large-Bore Soil Sampler was then compared with the total number of pairs in which the median concentrations were higher in the reference sampling method. If no bias is present in the data sets, the probability that the total number of pairs for one or the other test method is higher is equivalent. That is, the probability of the number of pairs in which the median concentrations in the Large-Bore Soil Sampler are higher is equal to the probability of the number of pairs in which the median concentrations in the reference sampling method are higher. A binomial expansion was used to determine the exact probability of the number of data sets in which the median concentrations in the Large-Bore Soil Sampler and reference sampling method were higher. If the calculated probability is less than 5 percent ( $p < 0.05$ ), then a significant difference is present between the Large-Bore Soil Sampler and reference sampling method.

The sign test was chosen because it (1) reduces sensitivity to random analysis error and matrix variabilities by using the median VOC concentration across each grid depth, (2) enlarges the sample sizes as compared to the Mann-Whitney test, and (3) is easy to use.

For the demonstration data, certain VOCs were not detected in some, or all, of the samples for many data sets. There is no strict guidance regarding the appropriate number of values that must be reported within a data set to yield statistically valid results. Therefore, and for the purposes of the statistical analysis, the maximum number of “nondetects” allowed within any given data set has been set at three. That is, there must be four reported values within each data set to perform the sign test.



**APPENDIX A2**  
**SAMPLE RECOVERY TEST DATA**



**TABLE A2a. LARGE-BORE SOIL SAMPLER RECOVERY TEST DATA  
SBA SITE**

<b>Sample Number</b>	<b>Sample Location</b>	<b>Soil Type</b>	<b>Reported Length Pushed (in.)</b>	<b>Reported Length Recovered (in.)</b>	<b>Sample Recovery (%)</b>
GEOAG1B509.5	B5	Fine	18.0	24.0	100.0% <sup>a</sup>
GEOAG1A609.5	A6	Fine	24.0	24.0	100.0%
GEOAG1C509.5	C5	Fine	18.0	24.0	100.0% <sup>a</sup>
GEOAG1D209.5	D2	Fine	18.0	24.0	100.0% <sup>a</sup>
GEOAG1E309.5	E3	Fine	18.0	24.0	100.0% <sup>a</sup>
GEOAG1F509.5	F5	Fine	18.0	24.0	100.0% <sup>a</sup>
GEOAG1G409.5	G4	Fine	18.0	24.0	100.0% <sup>a</sup>
GEOAG1A613.5	A6	Fine	18.0	24.0	100.0% <sup>a</sup>
GEOAG1B513.5	B5	Fine	18.0	24.0	100.0% <sup>a</sup>
GEOAG1C513.5	C5	Fine	18.0	24.0	100.0% <sup>a</sup>
GEOAG1D213.5	D2	Fine	18.0	24.0	100.0% <sup>a</sup>
GEOAG1E313.5	E3	Fine	18.0	24.0	100.0% <sup>a</sup>
GEOAG1F513.5	F5	Fine	18.0	24.0	100.0% <sup>a</sup>
GEOAG1G413.5	G4	Fine	18.0	24.0	100.0% <sup>a</sup>
GEOAG2A103.5	A1	Fine	24.0	24.0	100.0%
GEOAG2B203.5	B2	Fine	24.0	24.0	100.0%
GEOAG2C403.5	C4	Fine	24.0	23.0	95.8%
GEOAG2D303.5	D3	Fine	24.0	23.0	95.8%
GEOAG2E203.5	E2	Fine	24.0	22.0	91.7%
GEOAG2F703.5	G2	Fine	24.0	23.0	95.8%
GEOAG2G203.5	G2	Fine	24.0	22.0	91.7%
GEOAG4A209.5	A2	Fine	18.0	21.0	100.0% <sup>a</sup>
GEOAG4B709.5	B7	Fine	20.0	13.0	65.0%
GEOAG4C709.5	C7	Fine	18.0	21.0	100.0% <sup>a</sup>
GEOAG4D409.5	D4	Fine	18.0	23.0	100.0% <sup>a</sup>
GEOAG4E509.5	E5	Fine	18.0	23.0	100.0% <sup>a</sup>
GEOAG4F409.5	F4	Fine	18.0	15.0	83.3%
GEOAG4G709.5	G7	Fine	18.0	22.0	100.0% <sup>a</sup>
GEOAG3A309.5	A3	Fine	18.0	23.0	100.0% <sup>a</sup>
GEOAG3D109.5	D1	Fine	20.0	23.0	100.0% <sup>a</sup>
GEOAG3B709.5	B7	Fine	24.0	22.0	91.7%
GEOAG3C609.5	C6	Fine	24.0	24.0	100.0%
GEOAG3E209.5	E2	Fine	18.0	18.0	100.0%
GEOAG3F609.5	F6	Fine	20.0	23.0	100.0% <sup>a</sup>
GEOAG3G509.5	G5	Fine	18.0	16.0	88.9%
GEOAG5A513.5	A5	Fine	18.0	24.0	100.0% <sup>a</sup>
GEOAG5B7013.5	B7	Fine	18.0	22.0	100.0% <sup>a</sup>
GEOAG5C513.5	C5	Fine	18.0	24.0	100.0% <sup>a</sup>
GEOAG5D113.5	D1	Fine	18.0	24.0	100.0% <sup>a</sup>
GEOAG5E513.5	E5	Fine	18.0	19.0	100.0% <sup>a</sup>
GEOAG5F413.5	F4	Fine	18.0	24.0	100.0% <sup>a</sup>
GEOAG5G613.5	G6	Fine	18.0	24.0	100.0% <sup>a</sup>

<sup>a</sup> Sample recovery is reported as 100 percent when length recovered is greater than length pushed.

Average: 97.6%  
Range: 65.0 - 100%  
Total # Samples: 42

**TABLE A2b. LARGE-BORE SOIL SAMPLER RECOVERY TEST DATA  
CSC SITE**

<b>Sample Number</b>	<b>Sample Location</b>	<b>Soil Type</b>	<b>Reported Length Pushed (in.)</b>	<b>Reported Length Recovered (in.)</b>	<b>Sample Recovery (%)</b>
GEOCG1A403.0	A4	Coarse	24.0	18.0	75.0%
GEOCG1B503.0	B5	Coarse	27.0	21.0	77.8%
GEOCG1C703.0	C7	Coarse	30.0	24.0	80.0%
GEOCG1D603.0	D6	Coarse	30.0	24.0	80.0%
GEOCG1E503.0	E5	Coarse	30.0	24.0	80.0%
GEOCG1F403.0	F4	Coarse	30.0	21.5	71.7%
GEOCG1G503.0	G5	Coarse	30.0	23.0	76.7%
GEOCG1A406.5	A4	Coarse	24.0	19.0	79.2%
GEOCG1B506.5	B5	Coarse	27.0	25.5	94.4%
GEOCG1C706.5	C7	Coarse	30.0	20.0	66.7%
GEOCG1D606.5	D6	Coarse	30.0	24.0	80.0%
GEOCG1E506.5	E5	Coarse	30.0	23.0	76.7%
GEOCG1F406.5	F4	Coarse	30.0	24.0	80.0%
GEOCG1G506.5	G5	Coarse	30.0	19.0	63.3%
GEOCG2A603.0	A6	Coarse	30.0	21.5	71.7%
GEOCG2B503.0	B5	Coarse	30.0	25.0	83.3%
GEOCG2C203.0	C2	Coarse	30.0	24.0	80.0%
GEOCG2D503.0	D5	Coarse	30.0	24.0	80.0%
GEOCG2E203.0	E2	Coarse	30.0	24.0	80.0%
GEOCG2F603.0	F6	Coarse	30.0	24.0	80.0%
GEOCG2G303.0	G3	Coarse	30.0	24.0	80.0%
GEOCG3A303.0	A3	Coarse	29.0	23.0	79.3%
GEOCG3B703.0	B7	Coarse	30.0	23.0	76.7%
GEOCG3C103.0	C1	Coarse	30.0	24.0	80.0%
GEOCG3D403.0	D4	Coarse	27.0	24.0	88.9%
GEOCG3E503.0	E5	Coarse	30.0	24.0	80.0%
GEOCG3F103.0	F1	Coarse	30.0	24.0	80.0%
GEOCG3G603.0	G6	Coarse	27.0	24.0	88.9%
GEOCG3A307.5	A3	Coarse	30.0	24.0	80.0%
GEOCG3B707.5	B7	Coarse	27.0	24.0	88.9%
GEOCG3C107.5	C1	Coarse	27.0	24.0	88.9%
GEOCG3D407.5	D4	Coarse	27.0	24.0	88.9%
GEOCG3E507.5	E5	Coarse	27.0	23.0	85.2%
GEOCG3F107.5	F1	Coarse	27.0	24.0	88.9%
GEOCG3G607.5	G6	Coarse	30.0	24.0	80.0%
GEOCG4A506.5	A5	Coarse	30.0	17.0	56.7%
GEOCG4B706.5	B7	Coarse	30.0	12.5	41.7%
GEOCG4C306.5	C3	Coarse	30.0	21.0	70.0%
GEOCG4D206.5	D2	Coarse	30.0	22.5	75.0%
GEOCG4E606.5	E6	Coarse	30.0	24.0	80.0%
GEOCG4F706.5	F7	Coarse	27.0	21.0	77.8%
GEOCG4G206.5	G2	Coarse	24.0	19.0	79.2%

Average: 78.4%  
Range: 41.7-94.4%  
Total # Samples: 42

**TABLE A2c. REFERENCE SAMPLING METHOD RECOVERY TEST DATA  
SBA SITE**

<b>Sample Number</b>	<b>Sample Location</b>	<b>Soil Type</b>	<b>Reported Length Pushed (in.)</b>	<b>Reported Length Recovered (in.)</b>	<b>Sample Recovery (%)</b>
REFAG1A309.5	A3	Fine	18.0	13.5	75.0%
REFAG1A313.5	A3	Fine	19.0	17.0	89.5%
REFAG1B209.5	B2	Fine	18.0	17.0	94.4%
REFAG1B213.5	B2	Fine	18.0	19.0	100.0% <sup>a</sup>
REFAG1C209.5	C2	Fine	18.0	16.0	88.9%
REFAG1C213.5	C2	Fine	18.0	11.0	61.1%
REFAG1D409.5	D4	Fine	18.0	16.0	88.9%
REFAG1D413.5	D4	Fine	18.0	17.5	97.2%
REFAG1E409.5	E4	Fine	18.0	17.0	94.4%
REFAG1E413.5	E4	Fine	18.0	17.0	94.4%
REFAG1F209.5	F2	Fine	18.0	16.0	88.9%
REFAG1F213.5	F2	Fine	18.0	17.0	94.4%
REFAG1G709.5	G7	Fine	18.0	18.0	100.0%
REFAG1G713.5	G7	Fine	18.0	16.0	88.9%
REFAG2A203.5	A2	Fine	18.0	18.0	100.0%
REFAG2B403.5	B4	Fine	18.0	14.0	77.8%
REFAG2C103.5	C1	Fine	18.0	12.0	66.7%
REFAG2D603.5	D6	Fine	18.0	9.0	50.0%
REFAG2E503.5	E5	Fine	18.0	16.0	88.9%
REFAG2F103.5	F1	Fine	18.0	18.0	100.0%
REFAG2G403.5	G4	Fine	18.0	17.0	94.4%
REFAG3A209.5	A2	Fine	15.0	20.0	100.0% <sup>a</sup>
REFAG3B609.5	B6	Fine	15.0	18.0	100.0% <sup>a</sup>
REFAG3C409.5	C4	Fine	15.0	6.0	40.0%
REFAG3D609.5	D6	Fine	15.0	13.0	86.7%
REFAG3E109.5	E1	Fine	15.0	16.5	100.0% <sup>a</sup>
REFAG3F309.5	F3	Fine	15.0	21.0	100.0% <sup>a</sup>
REFAG3G609.5	G6	Fine	18.0	24.0	100.0% <sup>a</sup>
REFAG4A109.5	A1	Fine	18.0	16.5	91.7%
REFAG4B309.5	B3	Fine	18.0	18.0	100.0%
REFAG4C309.5	C3	Fine	18.0	16.0	88.9%
REFAG4D609.5	D6	Fine	18.0	17.0	94.4%
REFAG4E709.5	E7	Fine	18.0	17.0	94.4%
REFAG4F209.5	F2	Fine	18.0	15.0	83.3%
REFAG4G209.5	G2	Fine	18.0	17.5	97.2%
REFAG5A213.5	A2	Fine	18.0	18.0	100.0%
REFAG3B113.5	B1	Fine	18.0	18.0	100.0%
REFAG5C213.5	C2	Fine	18.0	15.5	86.1%
REFAG5D613.5	D6	Fine	18.0	17.0	94.4%
REFAG5E313.5	E3	Fine	18.0	11.0	61.1%
REFAG5F313.5	F3	Fine	18.0	12.0	66.7%
REFAG5G413.5	G4	Fine	18.0	17.0	94.4%

<sup>a</sup> Sample recovery is reported as 100 percent when length recovered is greater than length pushed.

Average: 88.4%  
Range: 40.0-100.0%  
Total # Samples: 42

**TABLE A2d. REFERENCE SAMPLING METHOD RECOVERY TEST DATA  
CSC SITE**

<b>Sample Number</b>	<b>Sample Location</b>	<b>Soil Type</b>	<b>Reported Length Pushed (in.)</b>	<b>Reported Length Recovered (in.)</b>	<b>Sample Recovery (%)</b>
REFCG1A303.0	A3	Coarse	18.0	12.0	66.7%
REFCG1A306.5	A3	Coarse	18.0	16.0	88.9%
REFCG1B303.0	B3	Coarse	18.0	10.0	55.6%
REFCG1B306.5	B3	Coarse	18.0	14.0	77.8%
REFCG1C303.0	C3	Coarse	18.0	15.0	83.3%
REFCG1C306.5	C3	Coarse	18.0	13.0	72.2%
REFCG1D503.0	D5	Coarse	18.0	16.0	88.9%
REFCG1D506.5	D5	Coarse	18.0	14.0	77.8%
REFCG1E103.0	E1	Coarse	18.0	20.0	100.0% <sup>a</sup>
REFCG1E106.5	E1	Coarse	18.0	11.5	63.9%
REFCG1F103.0	F1	Coarse	18.0	14.5	80.6%
REFCG1F106.5	F1	Coarse	18.0	15.0	83.3%
REFCG1G703.0	G7	Coarse	18.0	14.0	77.8%
REFCG1G706.5	G7	Coarse	18.0	15.0	83.3%
REFCG2A103.0	A1	Coarse	18.0	13.0	72.2%
REFCG2B603.0	B6	Coarse	18.0	19.0	100.0% <sup>a</sup>
REFCG2C103.0	C1	Coarse	18.0	16.0	88.9%
REFCG2D603.0	D6	Coarse	18.0	18.0	100.0%
REFCG2E303.0	E3	Coarse	18.0	19.5	100.0% <sup>a</sup>
REFCG2F503.0	F5	Coarse	18.0	18.5	100.0% <sup>a</sup>
REFCG2G103.0	G1	Coarse	19.0	19.0	100.0%
REFCG3A203.0	A2	Coarse	18.0	17.5	97.2%
REFCG3A207.5	A2	Coarse	18.0	12.0	66.7%
REFCG3B103.0	B1	Coarse	18.0	17.0	94.4%
REFCG3B107.5	B1	Coarse	18.0	12.0	66.7%
REFCG3C203.0	C2	Coarse	18.0	18.0	100.0%
REFCG3C207.5	C2	Coarse	18.0	9.5	52.8%
REFCG3D603.0	D6	Coarse	19.0	18.0	94.7%
REFCG3D607.5	D6	Coarse	20.0	20.0	100.0%
REFCG3E603.0	E6	Coarse	18.0	18.0	100.0%
REFCG3E607.5	E6	Coarse	18.0	18.0	100.0%
REFCG3F603.0	F6	Coarse	18.0	18.0	100.0%
REFCG3F607.5	F6	Coarse	No data	No data	-
REFCG3G403.0	G4	Coarse	18.0	17.0	94.4%
REFCG3G407.5	G4	Coarse	18.0	18.0	100.0%
REFCG4A706.5	A7	Coarse	18.0	18.0	100.0%
REFCG4B606.5	B6	Coarse	18.0	13.0	72.2%
REFCG4C706.5	C7	Coarse	18.0	17.0	94.4%
REFCG4D306.5	D3	Coarse	18.0	17.0	94.4%
REFCG4E506.5	E5	Coarse	18.0	18.0	100.0%
REFCG4F306.5	F3	Coarse	18.0	18.0	100.0%
REFCG4G506.5	G5	Coarse	18.0	11.5	63.9%

<sup>a</sup> Sample recovery is reported as 100 percent when length recovered is greater than length pushed.

Average:	86.7%
Range:	52.8-100.0%
Total # Samples:	41

**TABLE A2e. GRID 5 PERFORMANCE TEST RESULTS - LARGE-BORE SOIL SAMPLER AND  
REFERENCE SAMPLING METHOD RECOVERY TEST DATA  
CSC SITE**

<b>Sample Number</b>	<b>Sample Location</b>	<b>Soil Type</b>	<b>Reported Length Pushed (in.)</b>	<b>Reported Length Recovered (in.)</b>	<b>Sample Recovery (%)</b>
GEOAG5A7042	A7	Coarse	24.0	20.0	83.3%
GEOAG5B3040	B3	Coarse	24.0	22.0	91.7%
GEOAG5C5040	C5	Coarse	24.0	21.5	89.6%
GEOAG5D3040	D3	Coarse	24.0	16.4	68.3%
GEOAG5E3040	E3	Coarse	24.0	24.0	100.0% <sup>a</sup>
GEOAG5F2040	F2	Coarse	24.0	22.5	93.8%
GEOAG5G5040	G5	Coarse	24.0	23.5	97.9%
				Average:	89.2%
				Range:	68.3 - 100%
				Total # Samples:	7
REFAG5A2040	A2	Coarse	18.0	14.0	77.8%
REFAG5B1040	B1	Coarse	18.0	12.5	69.4%
REFAG5C1040	C1	Coarse	18.0	4.0	22.2%
REFAG5D4040	D4	Coarse	18.0	18.0	100.0%
REFAG5E1040	E1	Coarse	18.0	14.0	77.8%
REFAG5F6040	F6	Coarse	18.0	14.5	80.5%
REFAG5G2040	G2	Coarse	18.0	18.0	100.0%
				Average:	75.4%
				Range:	22.2 - 100%
				Total # Samples:	7



**APPENDIX A3**  
**VOLATILE ORGANIC COMPOUND CONCENTRATIONS**

**TABLE A3a. VOLATILE ORGANIC COMPOUND CONCENTRATIONS  
FOR LARGE-BORE SOIL SAMPLER AND REFERENCE SAMPLING METHOD  
SBA SITE - GRID 1 - 9.5 FEET**

Sample Name	Sample Location	Soil Type	Concentration Zone	Contaminant Concentration (mg/kg)			
				cis-1,2-DCE	1,1,1-TCA	TCE	PCE
<b>LARGE-BORE SOIL SAMPLER DATA</b>							
GEOAG1A609.5	A6	Fine	High	83,323	100	167,368	100
GEOAG1B509.5	B5	Fine	High	108,928	100	69,516	100
GEOAG1C509.5	C5	Fine	High	66,019	100	133,197	574
GEOAG1D209.5	D2	Fine	High	128,280	100	532,755	2,123
GEOAG1E309.5	E3	Fine	High	92,612	100	284,855	830
GEOAG1F509.5	F5	Fine	High	58,929	100	542,298	2,719
GEOAG1G409.5	G4	Fine	High	26,083	100	200,091	100

Range:                    26,100 - 128,000    100    69,500 - 542,000    100 - 2,720

Median:                    83,300                    NC                    200,000                    574

<b>REFERENCE SAMPLING METHOD DATA</b>							
REFAG1A309.5	A3	Fine	High	49,671	100	52,846	100
REFAG1B209.5	B2	Fine	High	86,749	100	70,217	669
REFAG1C209.5	C2	Fine	High	108,582	100	251,269	2,012
REFAG1D409.5	D4	Fine	High	147,042	100	418,733	4,511
REFAG1E409.5	E4	Fine	High	67,126	100	290,739	1,534
REFAG1F209.5	F2	Fine	High	98,437	100	276,149	1,720
REFAG1G709.5	G7	Fine	High	50,237	100	289,330	1,625

Range:                    49,700 - 147,000    100    52,800 - 419,000    100 - 4,510

Median:                    86,700                    NC                    276,000                    1,630

Note:                    Values reported as "100" are nondetects with a detection limit of 100.  
 NC =                    No medians calculated because at least half the reported values were below  
                               the method detection limit.  
 µg/kg =                Micrograms per kilogram.

**TABLE A3b. VOLATILE ORGANIC COMPOUND CONCENTRATIONS  
FOR LARGE-BORE SOIL SAMPLER AND REFERENCE SAMPLING METHOD  
SBA SITE - GRID 1 - 13.5 FEET**

Sample Name	Sample Location	Soil Type	Concentration Zone	Contaminant Concentration (mg/kg)			
				cis-1,2-DCE	1,1,1-TCA	TCE	PCE
<b>LARGE-BORE SOIL SAMPLER DATA</b>							
GEOAG1A613.5	A6	Fine	High	6,741	100	78,946	100
GEOAG1B513.5	B5	Fine	High	21,878	100	663,533	3,322
GEOAG1C513.5	C5	Fine	High	8,661	100	55,450	100
GEOAG1D213.5	D2	Fine	High	27,025	100	48,887	100
GEOAG1E313.5	E3	Fine	High	25,848	100	57,790	100
GEOAG1F513.5	F5	Fine	High	1,534	100	27,278	100
GEOAG1G413.5	G4	Fine	High	165	100	11,179	100

Range:                    165 - 27,000      100      11,200 - 664,000    100 - 3,320

Median:                    8,660                    NC                    55,500                    NC

<b>REFERENCE SAMPLING METHOD DATA</b>							
REFAG1A313.5	A3	Fine	High	6,762	100	33,736	100
REFAG1B213.5	B2	Fine	High	14,453	100	40,511	100
REFAG1C213.5	C2	Fine	High	20,362	100	48,730	100
REFAG1D413.5	D4	Fine	High	44,929	100	432,508	2,405
REFAG1E413.5	E4	Fine	High	12,343	100	40,984	100
REFAG1F213.5	F2	Fine	High	15,415	100	26,652	100
REFAG1G713.5	G7	Fine	High	1,356	100	39,138	100

Range:                    1,360 - 44,900      100      26,700 - 433,000    100 - 2,410

Median:                    14,500                    NC                    40,500                    NC

Note:                    Values reported as "100" are nondetects with a detection limit of 100.  
 NC =                    No medians calculated because at least half the reported values were below  
                               the method detection limit.  
 µg/kg =                Micrograms per kilogram.



**TABLE A3c. VOLATILE ORGANIC COMPOUND CONCENTRATIONS  
FOR LARGE-BORE SOIL SAMPLER AND REFERENCE SAMPLING METHOD  
SBA SITE - GRID 2 - 3.5 FEET**

Sample Name	Sample Location	Soil Type	Concentration Zone	Contaminant Concentration (mg/kg)			
				cis-1,2-DCE	1,1,1-TCA	TCE	PCE
<b>LARGE-BORE SOIL SAMPLER DATA</b>							
GEOAG2A103.5	A1	Fine	Low	1	1	45.4	1
GEOAG2B203.5	B2	Fine	Low	1	1	68.2	1
GEOAG2C403.5	C4	Fine	Low	1	1	136	1
GEOAG2D303.5	D3	Fine	Low	1	1	177	1
GEOAG2E203.5	E2	Fine	Low	1	1	124	1
GEOAG2F703.5	F7	Fine	Low	1	1	148	1
GEOAG2G203.5	G2	Fine	Low	1	1	74.8	1

Range:                    1                    1                    45.4 - 177                    1

Median:                    NC                    NC                    124                    NC

<b>REFERENCE SAMPLING METHOD DATA</b>							
REFAG2A203.5	A2	Fine	Low	1	1	22.6	1
REFAG2B403.5	B4	Fine	Low	1	1	58.2	1
REFAG2C103.5	C1	Fine	Low	1	1	29.3	1
REFAG2D603.5	D6	Fine	Low	1	1	43.5	1
REFAG2E503.5	E5	Fine	Low	1	1	56.9	1
REFAG2F103.5	F1	Fine	Low	1	1	78.6	1
REFAG2G403.5	G4	Fine	Low	2.18	1	88.8	1

Range:                    1 - 2.18                    1                    22.6 - 88.8                    1

Median:                    NC                    NC                    56.9                    NC

Note:                    Values reported as "1" are nondetects with a detection limit of 1.  
 NC =                    No medians calculated because at least half the reported values were below  
                                  the method detection limit.  
 µg/kg =                    Micrograms per kilogram.

**TABLE A3d. VOLATILE ORGANIC COMPOUND CONCENTRATIONS  
FOR LARGE-BORE SOIL SAMPLER AND REFERENCE SAMPLING METHOD  
SBA SITE - GRID 3 - 9.5 FEET**

Sample Name	Sample Location	Soil Type	Concentration Zone	Contaminant Concentration (mg/kg)			
				cis-1,2-DCE	1,1,1-TCA	TCE	PCE
<b>LARGE-BORE SOIL SAMPLER DATA</b>							
GEOAG3A309.5	A3	Fine	High	591	100	18,770	100
GEOAG3B709.5	B7	Fine	High	531	100	29,074	100
GEOAG3C609.5	C6	Fine	High	646	100	22,729	100
GEOAG3E209.5	E2	Fine	High	1,086	100	25,864	100
GEOAG3F609.5	F6	Fine	High	100	100	23,993	100
GEOAG3G509.5	G5	Fine	High	461	100	282,083	473

Range:                    100 - 1,090            100            18,800 - 282,000    100 - 473

Median:                    561                    NC                    24,900                    NC

<b>REFERENCE SAMPLING METHOD DATA</b>							
REFAG3A209.5	A2	Fine	High	796	100	34,069	100
REFAG3B609.5	B6	Fine	High	1,007	100	34,420	100
REFAG3C409.5	C4	Fine	High	1,455	100	63,740	100
REFAG3D609.5	D6	Fine	High	799	100	42,502	100

Range:                    796 - 1,460            100            34,100 - 63,700            100

Median:                    903                    NC                    38,500                    NC

Note:                    Values reported as "100" are nondetects with a detection limit of 100.  
 NC =                    No medians calculated because at least half the reported values were below  
                               the method detection limit.  
 $\mu\text{g}/\text{kg}$  =                    Micrograms per kilogram.

**TABLE A3e. VOLATILE ORGANIC COMPOUND CONCENTRATIONS  
FOR LARGE-BORE SOIL SAMPLER AND REFERENCE SAMPLING METHOD  
SBA SITE - GRID 4 - 9.5 FEET**

Sample Name	Sample Location	Soil Type	Concentration Zone	Contaminant Concentration (mg/kg)			
				cis-1,2-DCE	1,1,1-TCA	TCE	PCE
<b>LARGE-BORE SOIL SAMPLER DATA</b>							
GEOAG4A209.5	A2	Fine	Low	52.7	1	2,698	3.34
GEOAG4B709.5	B7	Fine	Low	18.8	1	1,939	1
GEOAG4C709.5	C7	Fine	Low	14.6	1	1,446	1
GEOAG4D409.5	D4	Fine	Low	8.13	1	1,266	1
GEOAG4E509.5	E5	Fine	Low	14.8	1	1,586	1
GEOAG4F409.5	F4	Fine	Low	14.0	1	1,632	1
GEOAG4G709.5	G7	Fine	Low	11.5	1	983	1

Range:                    8.13 - 52.7            1            983 - 2,700    1 - 3.34

Median:                    14.6                    NC            1,590            NC

<b>REFERENCE SAMPLING METHOD DATA</b>							
REFAG4A109.5	A1	Fine	Low	7.15	1	847	1
REFAG4B309.5	B3	Fine	Low	6.68	1	966	1
REFAG4C309.5	C3	Fine	Low	21.2	1	1,709	1
REFAG4D609.5	D6	Fine	Low	13.2	1	1,834	1
REFAG4E709.5	E7	Fine	Low	12.1	1	1,306	1
REFAG4F209.5	F2	Fine	Low	22.1	1	2,084	1
REFAG4G209.5	G2	Fine	Low	19.2	1	1,870	1

Range:                    6.68 - 22.1            1            847 - 2,080    1

Median:                    13.2                    NC            1,710            NC

Note:                    Values reported as "1" are nondetects with a detection limit of 1.  
 NC =                    No medians calculated because at least half the reported values were below  
                               the method detection limit.  
 µg/kg =                Micrograms per kilogram.

**TABLE A3f. VOLATILE ORGANIC COMPOUND CONCENTRATIONS  
FOR LARGE-BORE SOIL SAMPLER AND REFERENCE SAMPLING METHOD  
SBA SITE - GRID 5 - 13.5 FEET**

Sample Name	Sample Location	Soil Type	Concentration Zone	Contaminant Concentration (mg/kg)			
				cis-1,2-DCE	1,1,1-TCA	TCE	PCE
<b>LARGE-BORE SOIL SAMPLER DATA</b>							
GEOAG5A513.5	A5	Fine	Low	230	1	127	1
GEOAG5B713.5	B7	Fine	Low	158	1	66.0	1
GEOAG5C513.5	C5	Fine	Low	164	1	86.8	1
GEOAG5D113.5	D1	Fine	Low	77.0	1	6.57	1
GEOAG5E513.5	E5	Fine	Low	1	1	1	1
GEOAG5F413.5	F4	Fine	Low	38.4	1	1	1
GEOAG5G613.5	G6	Fine	Low	36.7	1	4.93	1

Range:                    1 - 230                    1                    1 - 127                    1

Median:                    77.0                    NC                    6.57                    NC

<b>REFERENCE SAMPLING METHOD DATA</b>							
REFAG5A213.5	A2	Fine	Low	81.2	1	23.3	1
REFAG5C213.5	C2	Fine	Low	118	1	58.0	1
REFAG5D613.5	D6	Fine	Low	147	1	138	1
REFAG5E313.5	E3	Fine	Low	106	1	18.7	1
REFAG5F313.5	F3	Fine	Low	59.5	1	3.23	1
REFAG5G413.5	G4	Fine	Low	33.7	1	1	1

Range:                    33.7 - 147                    1                    1 - 138                    1

Median:                    93.6                    NC                    21.0                    NC

Note:                    Values reported as "1" are nondetects with a detection limit of 1.  
 NC =                    No medians calculated because at least half the reported values were below  
                               the method detection limit.  
 µg/kg =                    Micrograms per kilogram.

**TABLE A3g. VOLATILE ORGANIC COMPOUND CONCENTRATIONS  
FOR LARGE-BORE SOIL SAMPLER AND REFERENCE SAMPLING METHOD  
CSC SITE - GRID 1 - 3.0 FEET**

Sample Name	Sample Location	Soil Type	Concentration Zone	Contaminant Concentration (mg/kg)			
				cis-1,2-DCE	1,1,1-TCA	TCE	PCE
<b>LARGE-BORE SOIL SAMPLER DATA</b>							
GEOCG1A403.0	A4	Coarse	High	100	100	100	615
GEOCG1B503.0	B5	Coarse	High	100	100	100	2,657
GEOCG1C703.0	C7	Coarse	High	100	100	100	532
GEOCG1D603.0	D6	Coarse	High	100	100	100	704
GEOCG1E503.0	E5	Coarse	High	100	100	100	589
GEOCG1F403.0	F4	Coarse	High	100	100	100	567
GEOCG1G503.0	G5	Coarse	High	100	100	100	819

Range:                    100                    100                    100                    532 - 2,660

Median:                    NC                    NC                    NC                    615

<b>REFERENCE SAMPLING METHOD DATA</b>							
REFCG1B303.0	B3	Coarse	High	100	256	100	5,742
REFCG1C303.0	C3	Coarse	High	100	659	100	1,881
REFCG1D503.0	D5	Coarse	High	100	100	100	6,217
REFCG1E303.0	E3	Coarse	High	100	644	100	2,166
REFCG1F103.0	F1	Coarse	High	100	100	100	2,895
REFCG1G703.0	G7	Coarse	High	100	100	100	1,887

Range:                    100                    100 - 659                    100                    1,880 - 6,220

Median:                    NC                    NC                    NC                    2,530

Note:                    Values reported as "100" are nondetects with a detection limit of 100.  
 NC =                    No medians calculated because at least half the reported values were below  
                               the method detection limit.  
 µg/kg =                    Micrograms per kilogram.

**TABLE A3h. VOLATILE ORGANIC COMPOUND CONCENTRATIONS  
FOR LARGE-BORE SOIL SAMPLER AND REFERENCE SAMPLING METHOD  
CSC SITE - GRID 1 - 6.5 FEET**

Sample Name	Sample Location	Soil Type	Concentration Zone	Contaminant Concentration (mg/kg)			
				cis-1,2-DCE	1,1,1-TCA	TCE	PCE
<b>LARGE-BORE SOIL SAMPLER DATA</b>							
GEOCG1A406.5	A4	Coarse	Low	1	25.1	3.64	115
GEOCG1B506.5	B5	Coarse	Low	1	22.1	2.24	56.7
GEOCG1D606.5	D6	Coarse	Low	1	6.78	1	24.9
GEOCG1E506.5	E5	Coarse	Low	3.12	42.3	5.19	108
GEOCG1G506.5	G5	Coarse	Low	1	34.9	3.28	71.7

Range:                    1 - 3.12      6.78 - 42.3      1 - 5.19      24.9 - 115

Median:                    NC                    25.1                    3.28                    71.7

<b>REFERENCE SAMPLING METHOD DATA</b>							
REFCG1A306.5	A3	Coarse	Low	2.03	32.1	6.46	107
REFCG1B306.5	B3	Coarse	Low	1	14.0	3.47	58.5
REFCG1C306.5	C3	Coarse	Low	2.36	54.6	22.4	848
REFCG1D506.5	D5	Coarse	Low	1	13.1	4.18	109
REFCG1F106.5	F1	Coarse	Low	5.81	19.8	8.39	114
REFCG1G706.5	G7	Coarse	Low	3.08	36.3	6.44	256

Range:                    1 - 5.81      13.1 - 54.6      3.47 - 22.4      58.5 - 848

Median:                    2.20                    26.0                    6.45                    112

Note:                    Values reported as "1" are nondetects with a detection limit of 1.  
 NC =                    No medians calculated because at least half the reported values were below  
                              the method detection limit.  
 µg/kg =                    Micrograms per kilogram.

**TABLE A3i. VOLATILE ORGANIC COMPOUND CONCENTRATIONS  
FOR LARGE-BORE SOIL SAMPLER AND REFERENCE SAMPLING METHOD  
CSC SITE - GRID 2 - 3.0 FEET**

Sample Name	Sample Location	Soil Type	Concentration Zone	Contaminant Concentration (mg/kg)			
				cis-1,2-DCE	1,1,1-TCA	TCE	PCE
<b>LARGE-BORE SOIL SAMPLER DATA</b>							
GEOCG2A603.0	A6	Coarse	High	100	100	100	100
GEOCG2B503.0	B5	Coarse	High	100	100	100	494
GEOCG2D503.0	D5	Coarse	High	100	100	100	1,481
GEOCG2F603.0	F6	Coarse	High	100	100	100	1,518
GEOCG2G303.0	G3	Coarse	High	100	100	100	157

Range:                    100            100            100            100 - 1,520

Median:                    NC            NC            NC            494

<b>REFERENCE SAMPLING METHOD DATA</b>							
REFCG2A103.0	A1	Coarse	High	100	100	126	1,830
REFCG2B603.0	B6	Coarse	High	100	100	100	1,615
REFCG2C103.0	C1	Coarse	High	100	100	100	2,003
REFCG2D603.0	D6	Coarse	High	100	100	100	1,556
REFCG2E303.0	E3	Coarse	High	100	984	435	2,905
REFCG2F503.0	F5	Coarse	High	100	320	375	2,149
REFCG2G103.0	G1	Coarse	High	100	273	355	2,282

Range:                    100            100 - 984    100 - 435    1,560 - 2,910

Median:                    NC            NC            126            2,000

Note:                    Values reported as "100" are nondetects with a detection limit of 100.  
 NC =                    No medians calculated because at least half the reported values were below  
                               the method detection limit.  
 µg/kg =                Micrograms per kilogram.

**TABLE A3j. VOLATILE ORGANIC COMPOUND CONCENTRATIONS  
FOR LARGE-BORE SOIL SAMPLER AND REFERENCE SAMPLING METHOD  
CSC SITE - GRID 3 - 3.0 FEET**

Sample Name	Sample Location	Soil Type	Concentration Zone	Contaminant Concentration (mg/kg)			
				cis-1,2-DCE	1,1,1-TCA	TCE	PCE
<b>LARGE-BORE SOIL SAMPLER DATA</b>							
GEOCG3A303.0	A3	Coarse	High	283	802	100	444
GEOCG3B103.0	B1	Coarse	High	100	491	100	970
GEOCG3C103.0	C1	Coarse	High	100	859	100	1,879
GEOCG3E503.0	E5	Coarse	High	100	579	100	589
GEOCG3G603.0	G6	Coarse	High	100	100	100	347

Range:                    100 - 283      100 - 859            100            347 - 1,880

Median:                    NC                    579                    NC                    589

<b>REFERENCE SAMPLING METHOD DATA</b>							
REFCG3A203.0	A2	Coarse	High	100	313	100	2,105
REFCG3B103.0	B1	Coarse	High	100	100	100	1,597
REFCG3C203.0	C2	Coarse	High	100	100	100	2,067
REFCG3D603.0	D6	Coarse	High	100	100	100	1,372
REFCG3E603.0	E6	Coarse	High	100	100	100	1,027
REFCG3F603.0	F6	Coarse	High	100	100	100	1,056

Range:                    100                    100 - 313            100            1,030 - 2,110

Median:                    NC                    NC                    NC                    1,480

Note:                    Values reported as "100" are nondetects with a detection limit of 100.

NC =                    No medians calculated because at least half the reported values were below the method detection limit.

µg/kg =                    Micrograms per kilogram.



**TABLE A3k. VOLATILE ORGANIC COMPOUND CONCENTRATIONS  
FOR LARGE-BORE SOIL SAMPLER AND REFERENCE SAMPLING METHOD  
CSC SITE - GRID 3 - 7.5 FEET**

Sample Name	Sample Location	Soil Type	Concentration Zone	Contaminant Concentration (mg/kg)			
				cis-1,2-DCE	1,1,1-TCA	TCE	PCE
<b>LARGE-BORE SOIL SAMPLER DATA</b>							
GEOCG3A307.5	A3	Coarse	Low	1	1	1	11.2
GEOCG3B707.5	B7	Coarse	Low	1	43.1	12.5	66.7
GEOCG3C107.5	C1	Coarse	Low	1	8.57	7.14	66.8
GEOCG3D407.5	D4	Coarse	Low	1	8.47	3.40	37.0
GEOCG3E507.5	E5	Coarse	Low	1	14.1	8.08	58.9
GEOCG3F107.5	F1	Coarse	Low	1	8.99	5.88	49.0
GEOCG3G607.5	G6	Coarse	Low	1	12.9	10.5	86.9

Range:                    1                    1 - 43.1                    1 - 12.5                    11.2 - 86.9

Median:                    NC                    8.99                    7.14                    58.9

<b>REFERENCE SAMPLING METHOD DATA</b>							
REFCG3A207.5	A2	Coarse	Low	1	3.81	2.48	21.1
REFCG3D607.5	D6	Coarse	Low	7.35	21.9	31.7	177
REFCG3E607.5	E6	Coarse	Low	5.69	13.5	19.6	98.7
REFCG3G407.5	G4	Coarse	Low	2.55	14.3	10.2	47.3

Range:                    1 - 7.35                    3.81 - 21.9                    2.48 - 31.7                    21.1 - 177

Median:                    4.12                    13.9                    14.9                    73.0

Note:                    Values reported as "1" are nondetects with a detection limit of 1.  
 NC =                    No medians calculated because at least half the reported values were below the method detection limit.  
 µg/kg =                    Micrograms per kilogram.

**TABLE A3I. VOLATILE ORGANIC COMPOUND CONCENTRATIONS  
FOR LARGE-BORE SOIL SAMPLER AND REFERENCE SAMPLING METHOD  
CSC SITE - GRID 4 - 6.5 FEET**

Sample Name	Sample Location	Soil Type	Concentration Zone	Contaminant Concentration (mg/kg)			
				cis-1,2-DCE	1,1,1-TCA	TCE	PCE
<b>LARGE-BORE SOIL SAMPLER DATA</b>							
GEOCG4A506.5	A5	Coarse	Low	1	7.07	1	32.7
GEOCG4B706.5	B7	Coarse	Low	1	1	1	5.93
GEOCG4C306.5	C3	Coarse	Low	1	7.02	3.19	40.8
GEOCG4D206.5	D2	Coarse	Low	1	3.87	1	18.0
GEOCG4E606.5	E6	Coarse	Low	1	1	1	14.2
GEOCG4F706.5	F7	Coarse	Low	1	2.17	1	24.5
GEOCG4G206.5	G2	Coarse	Low	1	4.76	1	8.34

Range:                    1                    1 - 7.07                    1 - 3.19                    5.93 - 40.8

Median:                    NC                    3.87                    NC                    18.0

<b>REFERENCE SAMPLING METHOD DATA</b>							
REFCG4B606.5	B6	Coarse	Low	5.72	51.4	43.3	749
REFCG4C706.5	C7	Coarse	Low	1	8.09	2.37	24.8
REFCG4D306.5	D3	Coarse	Low	1	3.54	1	50.3
REFCG4F306.5	F3	Coarse	Low	2.10	12.9	4.39	59.7
REFCG4G506.5	G5	Coarse	Low	1	1	1	5.55

Range:                    1 - 5.72                    1 - 51.4                    1 - 43.3                    5.55 - 749

Median:                    NC                    8.09                    2.37                    50.3

Note:                    Values reported as "1" are nondetects with a detection limit of 1.  
 NC =                    No medians calculated because at least half the reported values were below  
                                  the method detection limit.  
 $\mu\text{g}/\text{kg}$  =                    Micrograms per kilogram.

**TABLE A3m. VOLATILE ORGANIC COMPOUND CONCENTRATIONS IN INTEGRITY SAMPLES  
FOR LARGE-BORE SOIL SAMPLER AND REFERENCE SAMPLING METHOD  
SBA SITE**

Sample Name	Sample Location	Soil Type	Concentration Zone	Contaminant Concentration (mg/kg)			
				cis-1,2-DCE	1,1,1-TCA	TCE	PCE
<b>LARGE-BORE SOIL SAMPLER DATA</b>							
GEOAG1A60INT	A6	Fine	Low	33.1	1	1	1
GEOAG1B50INT	B5	Fine	Low	295	1	46.3	1
GEOAG1C50INT	C5	Fine	Low	108	1	14.4	1
GEOAG1D20INT	D2	Fine	Low	3.42	1	1	1
GEOAG1F50INT	F5	Fine	Low	1	1	1	1
GEOAG1G40INT	G4	Fine	Low	8.79	1	24.7	1

Range:                    1 - 295                    1                    1 - 46.3                    1

Median:                    20.9                    NC                    7.70                    NC

<b>REFERENCE SAMPLING METHOD DATA</b>							
REFAG1A30INT	A3	Fine	Low	1	1	1	1
REFAG1B20INT	B2	Fine	Low	1	1	1	1
REFAG1C20INT	C2	Fine	Low	1	1	1	1
REFAG1D40INT	D4	Fine	Low	1	1	1	1
REFAG1E40INT	E4	Fine	Low	1	1	1	1
REFAG1F20INT	F2	Fine	Low	1	1	1	1
REFAG1G70INT	G7	Fine	Low	1	1	1	1

Range:                    1                    1                    1                    1

Median:                    NC                    NC                    NC                    NC

Note:                    Values reported as "1" are nondetects with a detection limit of 1.  
 NC =                    No medians calculated because at least half the reported values were below  
                               the method detection limit.  
 µg/kg =                    Micrograms per kilogram.

**TABLE A3n. VOLATILE ORGANIC COMPOUND CONCENTRATIONS IN INTEGRITY SAMPLES  
FOR LARGE-BORE SOIL SAMPLER AND REFERENCE SAMPLING METHOD  
CSC SITE**

Sample Name	Sample Location	Soil Type	Concentration Zone	Contaminant Concentration (mg/kg)			
				cis-1,2-DCE	1,1,1-TCA	TCE	PCE
<b>LARGE-BORE SOIL SAMPLER DATA</b>							
GEOCG1B50INT	B5	Coarse	Low	1	1	1	1
GEOCG1C70INT	C7	Coarse	Low	1	1	1	1
GEOCG1D60INT	D6	Coarse	Low	1	1	1	1
GEOCG1E50INT	E5	Coarse	Low	1	1	1	1
GEOCG1F40INT	F4	Coarse	Low	1	1	1	1
GEOCG1G50INT	G5	Coarse	Low	1	1	1	1

Range:                    1                    1                    1                    1

Median:                    NC                    NC                    NC                    NC

<b>REFERENCE SAMPLING METHOD DATA</b>							
REFCG1A30INT	A3	Coarse	Low	1	1	1	1
REFCG1B30INT	B3	Coarse	Low	1	1	1	1
REFCG1D50INT	D5	Coarse	Low	1	1	1	1
REFCG1E10INT	E1	Coarse	Low	1	1	1	1
REFCG1G70INT	G7	Coarse	Low	1	1	1	1

Range:                    1                    1                    1                    1

Median:                    NC                    NC                    NC                    NC

Note:                    Values reported as "1" are nondetects with a detection limit of 1.  
 NC =                    No medians calculated because at least half the reported values were below  
                               the method detection limit.  
 µg/kg =                    Micrograms per kilogram.



**APPENDIX A4**  
**STATISTICAL SUMMARY OF MANN-WHITNEY TEST**

**TABLE A4a. COMPARATIVE SUMMARY OF MANN-WHITNEY STATISTICS FOR THE LARGE-BORE SOIL SAMPLER AND CONVENTIONAL SAMPLING METHOD**

<b>Site Description</b>	<b>cis-1,2-DCE</b>	<b>1,1,1-TCA</b>	<b>TCE</b>	<b>PCE</b>
Site: <b>SBA</b> Grid: <b>1</b> Depth: <b>9.5 feet</b> Soil Type: <b>Fine</b> Concentration: <b>High</b>	NO	NC (ALL ND)	NO	NO
Site: <b>SBA</b> Grid: <b>1</b> Depth: <b>13.5 feet</b> Soil Type: <b>Fine</b> Concentration: <b>High</b>	NO	NC (ALL ND)	NO	NC (2)
Site: <b>SBA</b> Grid: <b>2</b> Depth: <b>3.5 feet</b> Soil Type: <b>Fine</b> Concentration: <b>Low</b>	NC (1)	NC (ALL ND)	<b>YES</b>	NC (ALL ND)
Site: <b>SBA</b> Grid: <b>3</b> Depth: <b>9.5 feet</b> Soil Type: <b>Fine</b> Concentration: <b>High</b>	NO	NC (ALL ND)	NO	NC (1)
Site: <b>SBA</b> Grid: <b>4</b> Depth: <b>9.5 feet</b> Soil Type: <b>Fine</b> Concentration: <b>Low</b>	NO	NC (ALL ND)	NO	NC (1)
Site: <b>SBA</b> Grid: <b>5</b> Depth: <b>13.5 feet</b> Soil Type: <b>Fine</b> Concentration: <b>Low</b>	NO	NC (ALL ND)	NO	NC (ALL ND)
Site: <b>CSC</b> Grid: <b>1</b> Depth: <b>3.0 feet</b> Soil Type: <b>Coarse</b> Concentration: <b>High</b>	NC (ALL ND)	NC (3)	NC (ALL ND)	<b>YES</b>

**TABLE A4a. COMPARATIVE SUMMARY OF MANN-WHITNEY STATISTICS FOR THE LARGE-BORE SOIL SAMPLER AND REFERENCE SAMPLING METHOD (continued)**

<b>Site Description</b>	<b>cis-1,2-DCE</b>	<b>1,1,1-TCA</b>	<b>TCE</b>	<b>PCE</b>
Site: <b>CSC</b> Grid: <b>1</b> Depth: <b>6.5 feet</b> Soil Type: <b>Coarse</b> Concentration: <b>Low</b>	NC (5)	NO	NO	NO
Site: <b>CSC</b> Grid: <b>2</b> Depth: <b>3.0 feet</b> Soil Type: <b>Coarse</b> Concentration: <b>High</b>	NC (ALL ND)	NC (3)	NC (4)	<b>YES</b>
Site: <b>CSC</b> Grid: <b>3</b> Depth: <b>3.0 feet</b> Soil Type: <b>Coarse</b> Concentration: <b>High</b>	NC (1)	NC (5)	NC (ALL ND)	NO
Site: <b>CSC</b> Grid: <b>3</b> Depth: <b>7.5 feet</b> Soil Type: <b>Coarse</b> Concentration: <b>Low</b>	NC (3)	NO	NO	NO
Site: <b>CSC</b> Grid: <b>4</b> Depth: <b>6.5 feet</b> Soil Type: <b>Coarse</b> Concentration: <b>Low</b>	NC (2)	NO	NC (4)	NO

**Notes:**

- NC No medians calculated because at least half the reported values were below the method detection limit.
- (ALL ND) Level of contaminants in all samples tested were below the method detection limits.
- (X) Number of samples in which some level of contamination was detected. The number of samples containing some contaminants in the referenced test series was deemed too low for statistical analysis (that is, there were too many "0" values).
- NO Level of difference between tested populations was not statistically significant.
- YES Level of significance between tested populations was  $p \leq 0.10$ .

**TABLE A4b. COMPARATIVE MANN-WHITNEY STATISTICS FOR THE LARGE-BORE SOIL SAMPLER AND REFERENCE SAMPLING METHOD  
SBA SITE**

Site: **SBA**  
 Grid: **1**  
 Depth: **9.5 feet**  
 Soil Type: **Fine**  
 Concentration: **High**

**Sum of Rank Statistics**

	N	cis-1,2-DCE	1,1,1-TCA	TCE	PCE
Geoprobe (1)	7	51		53	42.25
Reference (2)	7	54		52	59.75
$N1N2 + [N1(N1 + 1)]/2$		77		77	77
$N1N2 + [N2(N2 + 1)]/2$		77		77	77
Mann-Whitney 1		26		24	34.75
Mann-Whitney 2		23		25	17.25
Mann-Whitney > 41?		NO		NO	NO

Site: **SBA**  
 Grid: **1**  
 Depth: **13.5 feet**  
 Soil Type: **Fine**  
 Concentration: **High**

**Sum of Rank Statistics**

	N	cis-1,2-DCE	1,1,1-TCA	TCE	PCE
Geoprobe (1)	7	50		60	
Reference (2)	7	55		45	
$N1N2 + [N1(N1 + 1)]/2$		77		77	
$N1N2 + [N2(N2 + 1)]/2$		77		77	
Mann-Whitney 1		27		17	
Mann-Whitney 2		22		32	
Mann-Whitney > 41?		NO		NO	



**TABLE A4b. COMPARATIVE MANN-WHITNEY STATISTICS FOR THE LARGE-BORE SOIL SAMPLER AND REFERENCE SAMPLING METHOD  
SBA SITE (continued)**

Site: **SBA**  
 Grid: **2**  
 Depth: **3.5 feet**  
 Soil Type: **Fine**  
 Concentration: **Low**

**Sum of Rank Statistics**

	N	cis-1,2-DCE	1,1,1-TCA	TCE	PCE
Geoprobe (1)	7			69	
Reference (2)	7			36	
$N_1N_2 + [N_1(N_1 + 1)]/2$				77	
$N_1N_2 + [N_2(N_2 + 1)]/2$				77	
Mann-Whitney 1				8	
Mann-Whitney 2				41	
Mann-Whitney > 41?				<b>YES</b>	

Site: **SBA**  
 Grid: **3**  
 Depth: **9.5 feet**  
 Soil Type: **Fine**  
 Concentration: **High**

**Sum of Rank Statistics**

	N	cis-1,2-DCE	1,1,1-TCA	TCE	PCE
Geoprobe (1)	6	24		25	
Reference (2)	4	31		30	
$N_1N_2 + [N_1(N_1 + 1)]/2$		45		45	
$N_1N_2 + [N_2(N_2 + 1)]/2$		34		34	
Mann-Whitney 1		21		20	
Mann-Whitney 2		3		4	
Mann-Whitney > 22?		NO		NO	

**TABLE A4b. COMPARATIVE MANN-WHITNEY STATISTICS FOR THE LARGE-BORE SOIL SAMPLER AND REFERENCE SAMPLING METHOD  
SBA SITE (continued)**

Site: **SBA**  
 Grid: **4**  
 Depth: **9.5 feet**  
 Soil Type: **Fine**  
 Concentration: **Low**

**Sum of Rank Statistics**

	N	cis-1,2-DCE	1,1,1-TCA	TCE	PCE
Geoprobe (1)	7	55		54	
Reference (2)	7	50		51	
$N1N2 + [N1(N1 + 1)]/2$		77		77	
$N1N2 + [N2(N2 + 1)]/2$		77		77	
Mann-Whitney 1		22		23	
Mann-Whitney 2		27		26	
Mann-Whitney > 41?		NO		NO	

Site: **SBA**  
 Grid: **5**  
 Depth: **13.5 feet**  
 Soil Type: **Fine**  
 Concentration: **Low**

**Sum of Rank Statistics**

	N	cis-1,2-DCE	1,1,1-TCA	TCE	PCE
Geoprobe (1)	7	50		48	
Reference (2)	6	41		43	
$N1N2 + [N1(N1 + 1)]/2$		70		70	
$N1N2 + [N2(N2 + 1)]/2$		63		63	
Mann-Whitney 1		20		22	
Mann-Whitney 2		22		30	
Mann-Whitney > 36?		NO		NO	

**TABLE A4c. COMPARATIVE MANN-WHITNEY STATISTICS FOR THE LARGE-BORE SOIL SAMPLER AND REFERENCE SAMPLING METHOD  
CSC SITE**

Site: **CSC**  
 Grid: **1**  
 Depth: **3.0 feet**  
 Soil Type: **Coarse**  
 Concentration: **High**

**Sum of Rank Statistics**

	N	cis-1,2-DCE	1,1,1-TCA	TCE	PCE
Geoprobe (1)	7				31
Reference (2)	6				60
$N_1N_2 + [N_1(N_1 + 1)]/2$					70
$N_1N_2 + [N_2(N_2 + 1)]/2$					63
Mann-Whitney 1					39
Mann-Whitney 2					3
Mann-Whitney > 36?					<b>YES</b>

Site: **CSC**  
 Grid: **1**  
 Depth: **6.5 feet**  
 Soil Type: **Coarse**  
 Concentration: **Low**

**Sum of Rank Statistics**

	N	cis-1,2-DCE	1,1,1-TCA	TCE	PCE
Geoprobe (1)	5		30	18	22
Reference (2)	6		36	48	44
$N_1N_2 + [N_1(N_1 + 1)]/2$			45	45	45
$N_1N_2 + [N_2(N_2 + 1)]/2$			51	51	51
Mann-Whitney 1			15	27	23
Mann-Whitney 2			15	3	7
Mann-Whitney > 27?			NO	NO	NO

**TABLE A4c. COMPARATIVE MANN-WHITNEY STATISTICS FOR THE LARGE-BORE SOIL SAMPLER AND REFERENCE SAMPLING METHOD  
CSC SITE (continued)**

Site: **CSC**  
 Grid: **2**  
 Depth: **3.0 feet**  
 Soil Type: **Coarse**  
 Concentration: **High**

**Sum of Rank Statistics**

	N	cis-1,2-DCE	1,1,1-TCA	TCE	PCE
Geoprobe (1)	5				15
Reference (2)	7				63
$N_1N_2 + [N_1(N_1 + 1)]/2$					50
$N_1N_2 + [N_2(N_2 + 1)]/2$					63
Mann-Whitney 1					35
Mann-Whitney 2					0
Mann-Whitney > 29?					<b>YES</b>

Site: **CSC**  
 Grid: **3**  
 Depth: **3.0 feet**  
 Soil Type: **Coarse**  
 Concentration: **High**

**Sum of Rank Statistics**

	N	cis-1,2-DCE	1,1,1-TCA	TCE	PCE
Geoprobe (1)	5				19
Reference (2)	6				47
$N_1N_2 + [N_1(N_1 + 1)]/2$					45
$N_1N_2 + [N_2(N_2 + 1)]/2$					51
Mann-Whitney 1					26
Mann-Whitney 2					4
Mann-Whitney > 36?					NO

**TABLE A4c. COMPARATIVE MANN-WHITNEY STATISTICS FOR THE LARGE-BORE SOIL SAMPLER AND REFERENCE SAMPLING METHOD  
CSC SITE (continued)**

Site: **CSC**  
 Grid: **3**  
 Depth: **7.5 feet**  
 Soil Type: **Coarse**  
 Concentration: **Low**

**Sum of Rank Statistics**

	N	cis-1,2-DCE	1,1,1-TCA	TCE	PCE
Geoprobe (1)	7		38	36	39
Reference (2)	4		28	30	27
$N_1N_2 + [N_1(N_1 + 1)]/2$			56	56	56
$N_1N_2 + [N_2(N_2 + 1)]/2$			38	38	38
Mann-Whitney 1			18	20	17
Mann-Whitney 2			10	8	11
Mann-Whitney > 25?			NO	NO	NO

Site: **CSC**  
 Grid: **4**  
 Depth: **6.5 feet**  
 Soil Type: **Coarse**  
 Concentration: **Low**

**Sum of Rank Statistics**

	N	cis-1,2-DCE	1,1,1-TCA	TCE	PCE
Geoprobe (1)	7		38		37
Reference (2)	5		40		41
$N_1N_2 + [N_1(N_1 + 1)]/2$			63		63
$N_1N_2 + [N_2(N_2 + 1)]/2$			50		50
Mann-Whitney 1			25		26
Mann-Whitney 2			10		9
Mann-Whitney > 30?			NO		NO

Note: (N > xx) **Mann-Whitney** value must be greater than the given value to be significant at the 0.05 level of statistical significance. This is a two-tailed test.

**Statistical Source:**

Rohlf, F. James and Robert R. Sokal. 1969. Statistical Tables. W. H. Freeman and Company.  
Table CC. Critical values of the Mann-Whitney statistic, page 241.



**APPENDIX A5**  
**STATISTICAL SUMMARY OF SIGN TEST**

**TABLE A5a. SIGN TEST SUMMARY  
COMPARISON OF MEDIAN VOC CONCENTRATIONS FOR LARGE-BORE SOIL  
SAMPLER AND REFERENCE SAMPLING METHOD  
SBA SITE**

<b>Site Description</b>	<b>Technology</b>	<b>Median cis-1,2- DCE</b>	<b>Median 1,1,1- TCA</b>	<b>Median TCE</b>	<b>Median PCE</b>
Site: <b>SBA</b> Grid: <b>1</b> Depth: <b>9.5 feet</b> Concentration: <b>High</b>	Reference Sampling Method	86,700	ALL ND	276,000	1,630
	Large Bore Sampler	83,300	ALL ND	200,000	574
Site: <b>SBA</b> Grid: <b>1</b> Depth: <b>13.5 feet</b> Concentration: <b>High</b>	Reference Sampling Method	14,500	ALL ND	40,500	NC(1)
	Large Bore Sampler	8,660	ALL ND	55,500	NC(1)
Site: <b>SBA</b> Grid: <b>2</b> Depth: <b>3.5 feet</b> Concentration: <b>Low</b>	Reference Sampling Method	NC(1)	ALL ND	56.9	ALL ND
	Large Bore Sampler	ALL ND	ALL ND	124	ALL ND
Site: <b>SBA</b> Grid: <b>3</b> Depth: <b>9.5 feet</b> Concentration: <b>High</b>	Reference Sampling Method	903	ALL ND	38,500	ALL ND
	Large Bore Sampler	561	ALL ND	24,900	NC(1)
Site: <b>SBA</b> Grid: <b>4</b> Depth: <b>9.5 feet</b> Concentration: <b>Low</b>	Reference Sampling Method	13.2	ALL ND	1,710	ALL ND
	Large Bore Sampler	14.6	ALL ND	1,590	NC(1)
Site: <b>SBA</b> Grid: <b>5</b> Depth: <b>13.5 feet</b> Concentration: <b>Low</b>	Reference Sampling Method	93.6	ALL ND	21.0	ALL ND
	Large Bore Sampler	77.0	ALL ND	6.57	ALL ND
Number of pairs in which Reference Sampling Method median is higher		4	0	4	1
Number of pairs in which Large Bore Sampler median is higher		1	0	2	0

**Notes:**

NC No medians calculated because at least half the reported values were below the method detection limit.  
 ALL ND Level of contaminants in all samples tested were below the method detection limits.  
 (X) Number of samples in which some level of contamination was detected. The number of samples containing some contaminants in the referenced test series was deemed too low for statistical analysis (that is, there were too many "0" values).



**TABLE A5b. SIGN TEST SUMMARY  
COMPARISON OF MEDIAN VOC CONCENTRATIONS FOR LARGE-BORE SOIL  
SAMPLER AND REFERENCE SAMPLING METHOD  
CSC SITE**

<b>Site Description</b>	<b>Technology</b>	<b>Median cis-1,2-DCE</b>	<b>Median 1,1,1- TCA</b>	<b>Median TCE</b>	<b>Median PCE</b>
Site: <b>CSC</b> Grid: <b>1</b> Depth: <b>3.0</b> Concentration: <b>High</b>	Reference Sampling Method	ALL ND	NC(3)	ALL ND	2,530
	Large Bore Sampler	ALL ND	ALL ND	ALL ND	615
Site: <b>CSC</b> Grid: <b>1</b> Depth: <b>6.5 feet</b> Concentration: <b>Low</b>	Reference Sampling Method	2.20	26.0	6.45	112
	Large Bore Sampler	NC (1)	25.1	3.28	71.7
Site: <b>CSC</b> Grid: <b>2</b> Depth: <b>3.0 feet</b> Concentration: <b>High</b>	Reference Sampling Method	ALL ND	NC(3)	126	2,000
	Large Bore Sampler	ALL ND	ALL ND	ALL ND	494
Site: <b>CSC</b> Grid: <b>3</b> Depth: <b>3.0 feet</b> Concentration: <b>High</b>	Reference Sampling Method	ALL ND	NC(1)	ALL ND	1,480
	Large Bore Sampler	NC (1)	579	ALL ND	589
Site: <b>CSC</b> Grid: <b>3</b> Depth: <b>7.5 feet</b> Concentration: <b>Low</b>	Reference Sampling Method	4.12	13.9	14.9	73.0
	Large Bore Sampler	ALL ND	8.99	7.14	58.9
Site: <b>CSC</b> Grid: <b>4</b> Depth: <b>6.5 feet</b> Concentration: <b>Low</b>	Reference Sampling Method	NC(2)	8.09	2.37	50.3
	Large Bore Sampler	ALL ND	3.87	NC (1)	18.0
Number of pairs in which Reference Sampling Method median is higher		0	3	2	6
Number of pairs in which Large Bore Sampler median is higher		0	0	0	0

**Notes:**

NC No medians calculated because at least half the reported values were below the method detection limit.  
 ALL ND Level of contaminants in all samples tested were below the method detection limits.  
 (X) Number of samples in which some level of contamination was detected. The number of samples containing some contaminants in the referenced test series was deemed too low for statistical analysis (that is, there were too many "0" values).