

7

CURB RAMPS

CHAPTER

Curb Ramps

According to the Title II implementing regulations, priorities for the installation of curb ramps in existing facilities should include access to government facilities, transportation, public accommodations, and for employees to their place of employment (U.S. Department of Justice, 1991a).

7.1 The impact of curb ramps

Curb ramps provide access for people who use wheelchairs, who would otherwise be excluded from the sidewalk because of the barrier created by the curb. However, curb ramps can create major information barriers for people with vision impairments who rely on the curb to identify the transition point between the sidewalk and the street. The following section evaluates the impact of curb ramps on these two user groups and provides design strategies to enhance the benefits of curb ramps for people with mobility impairments while minimizing the drawbacks for people with vision impairments.

Curb ramps are critical to providing access between the sidewalk and the street for people who use wheelchairs. Curb ramps are most commonly found at intersections, but they may also be used at other locations such as on-street parking, loading zones, bus stops, and midblock crossings. The implementing regulations under Title II of the ADA specifically identify curb ramps as requirements for existing facilities, as well as all new construction. Curb ramps for existing facilities must be included in Transition Plans.



Figure 7-1. Curb ramps should be designed to provide access to people with mobility limitations and vision impairments.

7

CURB RAMPS

CHAPTER

7.1.1 Impact of curb ramps on people with mobility impairments

Curb ramps are designed to provide access to people who use wheeled forms of mobility. Without curb ramps, people who use wheelchairs would not be able to independently access the sidewalk and street. However, not all wheelchairs perform the same on a curb ramp. Common types of wheeled mobility devices include manual and powered wheelchairs, as well as powered scooters. Each type of technology will benefit from different aspects of the curb ramp design. For example, most powered mobility devices are maneuverable in small spaces due to their short wheelbase. Scooters have a longer wheelbase but have manual steering, and most can perform a three-point turn in tight spaces. Manual wheelchairs can turn on their own wheelbase but are difficult to steer on a cross slope as they tend to turn downhill.

For many people with mobility impairments, curb ramps are not critical to access. In fact, in some situations curb

ramps make it more difficult for some people with mobility impairments to navigate. Crutches and canes are sized to fit the individual user so that the energy required for ambulation is minimized on a hard, level surface. Use of these types of walking aids is more difficult on sloped surfaces such as curb ramps. Cane, walker, or crutch users must lower their body forward when going downhill. On uphill slopes, the cane or crutch must be lifted higher and placed on the surface. The user must have the strength to lift his or her body up over the supporting device. Widening the crosswalk to allow people to use either the curb or the curb ramp will enhance access for cane and crutch users who are not comfortable traveling on a sloped surface.

7.1.2 Impact of curb ramps on people with vision impairments

The curb is the most reliable cue that people with vision impairments use to identify the transition between the sidewalk and the street. The installation

7

CURB RAMPS

CHAPTER

of curb ramps removes this cue and replaces it with a ramp which is much more difficult to detect. Therefore, it is important that as curb ramps are installed to create access for people who use wheelchairs, they are installed in such a way as to maximize detectability for people with vision impairments. Where gradual slopes are desirable for people who use wheelchairs, a detectable warning at the bottom of the curb ramp can provide the information blind pedestrians can rely on. Some localities have installed 12.3 mm (1/2 in) unbeveled lips at the bottom of curb cuts as an information cue for blind pedestrians. This is not reliable information because it is not discernable from cracks, seams, and defects in the pedestrian environment. Also, ADAAG does not allow 12.3 mm (1/2 in) unbeveled changes in level because of the climbing difficulty for wheelchairs.

7.1.3 Ideal design characteristics

An accessible connection between the sidewalk and the street can be provided

through a variety of curb ramp designs (see Section 7.2). Designers who have a clear understanding of the needs of pedestrians, with and without disabilities, will be better positioned to select appropriate curb ramp types and locations within the existing site constraints. To maximize accessibility and safety for all pedestrians, curb ramp designs should attempt to meet all of the best practices for curb ramp design shown in Table 7-1. Depending on site constraints, it may not be possible to incorporate all of the best practices within each curb ramp. However, the remainder of this chapter will identify the best curb ramp designs to meet the needs of a broad range of people with disabilities under a variety of site conditions. In addition, mitigating solutions will be provided to improve existing scenarios that hinder access.

7.2 Curb ramp types

Curb ramps are usually categorized by their structural design and how it is positioned relative to the sidewalk or

7

CURB RAMPS

CHAPTER

Table 7-1. Best Practices for Curb Ramp Design

Best Practice	Rationale
Provide a level maneuvering area or landing at the top of the curb ramp.	Landings are critical to allow wheelchair users space to maneuver on or off of the ramp. Furthermore, people who are continuing along the sidewalk will not have to negotiate a surface with a changing grade or cross slope.
Clearly identify the boundary between the bottom of the curb ramp and the street with a detectable warning.	Without a detectable warning, people with vision impairments may not be able to identify the boundary between the sidewalk and the street.
Design ramp grades that are perpendicular to the curb.	Assistive devices for mobility are unstable if one side of the device is lower than the other or if the full base of support (e.g., all four wheels on a wheelchair) are not in contact with the surface. This commonly occurs when the bottom of a curb ramp is not perpendicular to the curb.
Place the curb ramp within the marked crosswalk area.	Pedestrians outside of the marked crosswalk are less likely to be seen by drivers because they are not in an expected location.
Avoid changes of grade that exceed 11 percent over a 610 mm (24 in) interval.	Severe or sudden grade changes may not provide sufficient clearance for the frame of the wheelchair causing the user to tip forward or backward.
Design the ramp that doesn't require turning or maneuvering on the ramp surface.	Maneuvering on a steep grade can be very hazardous for people with mobility impairments.
Provide a curb ramp grade that can be easily distinguished from surrounding terrain; otherwise, use detectable warnings.	Gradual slopes make it difficult for people with vision impairments to detect the presence of a curb ramp.
Design the ramp with a grade of 7.1 ± 1.2 percent. [Do not exceed 8.33 percent (1:12).]	Shallow grades are difficult for people with vision impairments to detect but steep grades are difficult for those using assistive devices for mobility.
Design the ramp and gutter with a cross slope of 2.0 percent.	Ramps should have minimal cross slope so users do not have to negotiate a steep grade and cross slope simultaneously.
Provide adequate drainage to prevent the accumulation of water or debris on or at the bottom of the ramp.	Water, ice, or debris accumulation will decrease the slip resistance of the curb ramp surface.
Transitions from ramps to gutter and streets should be flush and free of level changes.	Maneuvering over any vertical rise such as lips and defects can cause wheelchair users to propel forward when wheels hit this barrier.
Align the curb ramp with the crosswalk, so there is a straight path of travel from the top of the ramp to the center of the roadway to the curb ramp on the other side.	Where curb ramps can be ahead, people using wheelchairs often build up momentum in the crosswalk in order to get up the curb ramp grade (i.e., they "take a run at it"). This alignment may be useful for people with vision impairments.
Provide clearly defined and easily identified edges or transitions on both sides of the ramp to contrast with sidewalk.	Clearly defined edges assist users with vision impairments to identify the presence of the ramp when it is approached from the side.

7

CURB RAMPS

CHAPTER

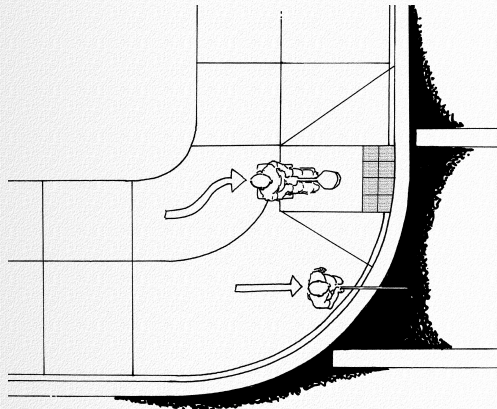
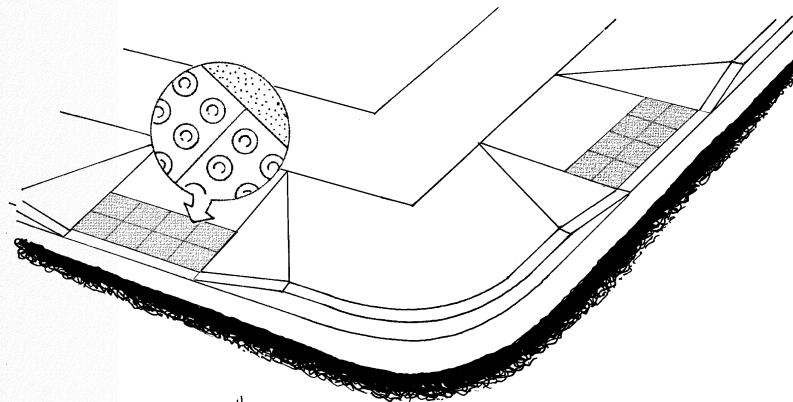

Figure 7-2. GOOD DESIGN: When a portion of the curb is included in the crosswalk, it is easier for people with vision impairments to detect the transition between the sidewalk and the street.

Figure 7-3. GOOD DESIGN: A level landing of at least 1.220 m (48 in) and a 610 mm (24 in) strip of detectable warnings should be installed at the bottom of a perpendicular curb ramp.



street. The structure of a curb ramp is determined by how the components, such as ramps and flares, are assembled. The type of curb ramp and the installation site will determine its accessibility and safety for pedestrians with and without disabilities. The following types of curb ramps will be reviewed in this guidebook:

- Perpendicular curb ramps;
- Diagonal curb ramps;
- Parallel curb ramps;

- Combination curb ramps;
- Built-up curb ramps; and
- Depressed corners.

Each type of curb ramp has advantages and disadvantages. Some advantages and disadvantages are fundamental to the type of curb ramp. Others result from changes to the configuration of the components within each type or the curb ramp placement on the site. To help designers and engineers sort through the large quantity of potential designs, each type of curb ramp will be described, its advantages and disadvantages discussed, and key issues related to accessibility highlighted through the accompanying illustrations.

7.2.1 Perpendicular curb ramps

A perpendicular curb ramp is one that is aligned so that:

- The ramp is generally perpendicular to the curb, and

7

CURB RAMPS

CHAPTER

Level landings:

If it is not possible to provide a top level landing, perpendicular curb ramps should not be installed.

- Users will generally be traveling perpendicular to vehicular traffic when they enter the street at the bottom of the ramp.

Whenever possible, the ramp path should also be aligned with the crosswalk. However, this is difficult to do at intersections with wide turning radii.

Perpendicular curb ramps are easier to design if the sidewalk corridor is wide because the curb ramp can be contained within the furniture zone. This design strategy allows the pedestrian zone to

remain unobstructed. For example, if the curb height is 101 mm (4 in), the ramp slope is 7.1 percent, and the sidewalk has a 2 percent cross slope towards the street, the installation of a perpendicular curb ramp requires a planter/furniture zone that is a minimum of 1.98 m (78 in) wide. If the curb was higher, additional right-of-way would be needed and the curb ramp might have to extend into the pedestrian zone. For details on determining ramp length, refer to Section 7.3.3.

If possible, perpendicular curb ramps should be located outside of the pedestrian walkway, such as in a planting strip or similar location where pedestrians would not normally walk. Placing the curb ramp outside of the pedestrian path of travel allows the flares to be replaced with returned curbs. Returned curbs are more detectable to people with vision impairments than flares (Section 7.3.11). Perpendicular curb ramps within the pedestrian walkway should have flared sides.

All perpendicular curb ramps should include a 610 mm (24 in) detectable

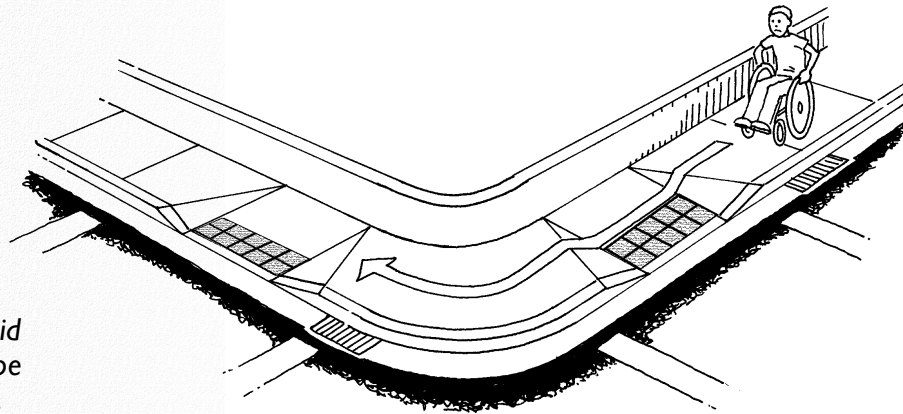

Figure 7-4.

PROBLEM:

Perpendicular curb ramps without level landings are not allowed because they cause severe cross slopes and rapid changes in cross slope over short distances.

7

CURB RAMPS

CHAPTER

warning (Section 6.3). In addition, all perpendicular curb ramps should be installed with level landings at the top of the ramp. Landings allow pedestrians to move completely off the curb ramp before turning to proceed along the sidewalk. Perpendicular curb ramps without landings create barriers because they force people to travel over the ramp flares. The path across the flares is not accessible because it creates a severe change in cross slope for a pedestrian on the sidewalk. Wheelchair users and others are very unstable on surfaces with changing cross slopes. Chapter 5 on Driveway Crossings contains additional information on rapidly changing cross slopes.

If it is not possible to provide a level landing of at least 915 mm (36 in), perpendicular curb ramps should not be installed. New construction should always provide adequate right of way for perpendicular curb ramps. If a sidewalk is too narrow for a perpendicular curb ramp to be installed with a landing, a curb extension should be installed or additional

right-of-way should be secured around the curb ramp to create a jogged landing. (See Figures 4-1 and 5-6 for example of jogged space.) A parallel curb ramp may be necessary on very narrow sidewalks with limited row.

At the bottom of a perpendicular curb ramp, the slope of the gutter should not exceed 5 percent. A level landing is not necessary at the bottom of a perpendicular curb ramp for the following reasons:

- No turning is required because users will be oriented in the desired direction of travel (i.e., perpendicular to vehicular traffic) when they enter the street; and
- The bottom of the ramp is contained within the crosswalk. This ensures that the user is not required to maneuver immediately upon entering the street. Placing the curb ramp within the crosswalk will also help people with vision impairments determine the crossing location. Pedestrians with vision

7

CURB RAMPS

CHAPTER

impairments will only be able to rely on this information if curb ramps are consistently located within the crosswalk.

The following lists summarize the advantages and disadvantages of perpendicular curb ramps:

Advantages of perpendicular curb ramps

- Are aligned perpendicular to vehicular traffic;
- Provide a straight path of travel on tight radius corners;
- Are aligned with the crossing direction on tight radius corners;
- Are usually positioned within crosswalk; and
- Are at the expected crossing location for all pedestrians.

Disadvantages of perpendicular curb ramps

- Are more expensive than a single diagonal curb ramp;
- Do not provide a straight path of travel on large radius corners;
- Require a level landing that takes up additional right-of-way; and
- Require a wide sidewalk corridor or a curb extension to accommodate the curb ramp and the level landing.

7.2.2 Diagonal curb ramps

A diagonal curb ramp is a single curb ramp that is located at the apex of the corner at an intersection. It is aligned so that:

- A straight path of travel down the ramp will lead diagonally into the center of the intersection;

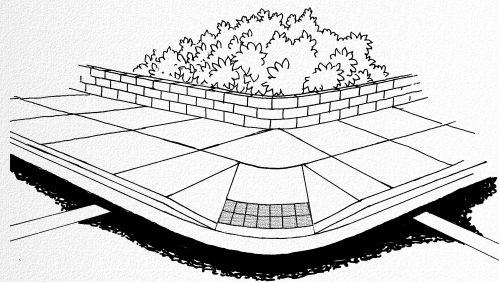

Figure 7-5. When designed to promote access, diagonal curb ramps include a detectable warning, a clear space of at least 1.220 m (48 in) within the crosswalk, and a level maneuvering area at the street/gutter approach.

7

CURB RAMPS

CHAPTER

Figure 7-6. PROBLEM: If a diagonal curb ramp is located at a corner with a tight turning radius, it may not be possible to provide a 1.22 m (48 in) clear space.

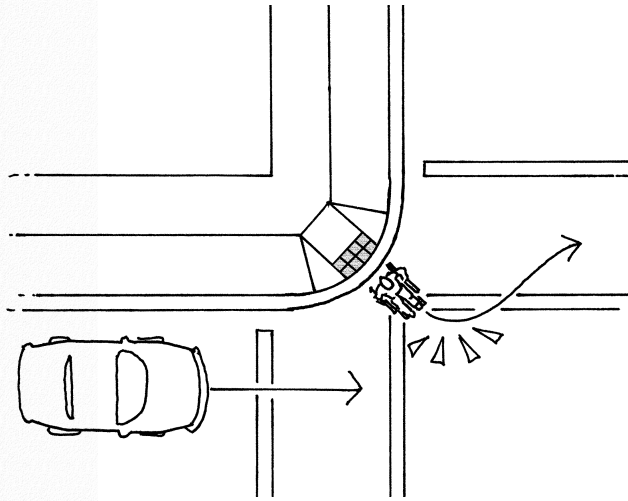
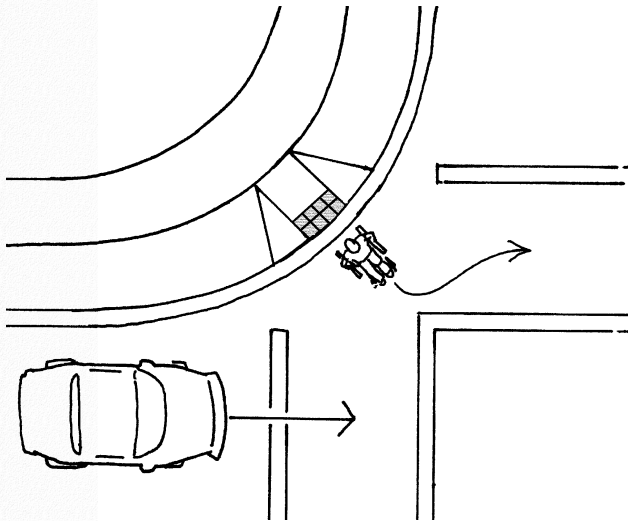

Figure 7-7. ACCEPTABLE DESIGN: Although diagonal curb ramps are never ideal at a corner with a wide turning radius, users have enough room to maneuver towards the direction of the crosswalk. There must be a 1.22 m x 1.22 m (48 in x 48 in) bottom level landing.



- The ramp is diagonal to the users' path of travel; and
- Users will be traveling diagonal to the vehicular traffic when they enter the street at the bottom of the ramp.

The structure of diagonal curb ramps is usually similar to that of perpendicular curb ramps, but diagonal curb ramps can also have the structure of a parallel or combined curb ramp (Section 7.2.3 and 7.2.4). Because these ramps are diagonal to the path of travel, they are only accessible if a level landing or maneuvering space (e.g., 2.0 percent in any direction) is provided at the top and bottom of the ramp.

In many situations, diagonal curb ramps are not recommended. Diagonal curb ramps force pedestrians descending the ramp to proceed into the intersection before turning to the left or right to cross the street. This problem is worse at intersections with a tight turning radius and without on-street parking because wheelchair users are exposed to moving traffic at the bottom of the curb ramp. Furthermore, diagonal

7

CURB RAMPS

CHAPTER

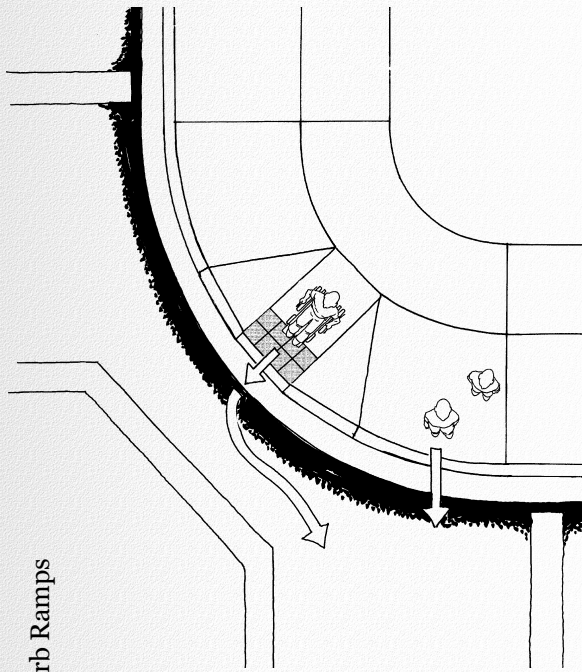

Chapter 7. Curb Ramps

Figure 7-8. When a single diagonal curb ramp is provided, wheelchair users cross in a different location than other pedestrians.

curb ramps can make it more difficult for individuals with vision impairments to determine the correct crossing location and direction.

When designed to promote access, diagonal curb ramps include at least 1.22 m (48 in) of clear space at the bottom of the curb ramp. However, providing 1.22 m (48 in) of clear space is often not possible at intersections with tight turning radii without exposing the pedestrian to vehicular traffic. In addition, the clear space should be level with a slope that is not more than 2.0 percent in any direction. The level area is necessary so users are not required to turn on a sloped surface. For existing facilities, designing a level landing at the bottom of a curb ramp is difficult because the cross slope of the gutter and the roadway usually exceed 2.0 percent. Limiting the slope of the gutter and roadway to 2.0 percent may interfere with the proper operation of drainage structures and will complicate street resurfacing. If creating level landings is too difficult or a 1.220 m (48 in) clear space cannot be provided,

diagonal curb ramps should not be considered.

The following lists summarize the advantages and disadvantages of diagonal curb ramps:

Advantages of diagonal curb ramps

- Require less space because there is only one curb ramp per corner;
- Are less expensive for alterations because there is only one curb ramp per corner; and
- Allow a pedestrian's normal path of travel to intersect a curb rather than a curb ramp, which enhances detectability of the intersection by people with vision impairments who use the curb to identify the transition from the sidewalk to the street. Street furniture and vegetation should be kept out of this area.

7

CURB RAMPS

CHAPTER

Disadvantages of diagonal curb ramps

- Put pedestrians into a potential area of conflict with motorists who are traveling straight and turning;
- Require turning at the top and bottom of the ramp;
- Provide no alignment with the proper crossing direction, which is difficult for most people with disabilities;
- Make the essential level maneuvering area difficult to achieve at the bottom of the curb ramp; and
- Can cause a person with a vision impairment to mistake a diagonal curb ramp for a perpendicular curb ramp and unintentionally travel into the middle of the intersection due to the lack of, or ambiguous, audible cues from the surge of traffic.

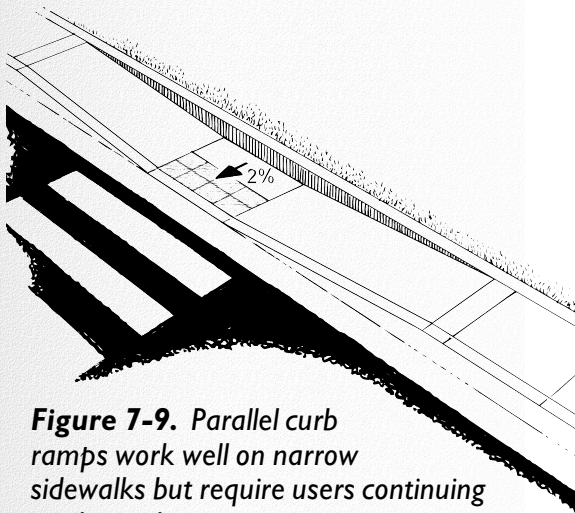

Figure 7-9. Parallel curb ramps work well on narrow sidewalks but require users continuing on the pathway to negotiate two ramp grades.

7.2.3 Parallel curb ramps

A parallel curb ramp has two ramps leading down towards a center level landing at the bottom between both ramps with a level landing at the top of each ramp. A parallel curb ramp is one that is oriented so that the path of travel on the ramp is parallel to the:

- Vehicular path of travel on the adjacent street; and
- Users' path of travel on the sidewalk.

Parallel ramps can be installed on very narrow sidewalks because the landing at the top of the ramp does not require additional right-of-way. Parallel curb ramps are also effective on steep terrain and locations with high curbs because the ramps can easily be lengthened to reduce the grades. The landing at the bottom of a parallel curb ramp is essentially at street level and must be sloped towards the street to limit ponding and poor drainage. Detectable warnings on parallel

7

CURB RAMPS

CHAPTER

curb ramps should be contained within the lower landing and should border the roadway. Detectable warnings should not be placed at the bottom of each ramp.

Parallel curb ramps are usually designed across the full width of the sidewalk and do not require returned curbs or flares. This eliminates rapid

grade and cross slope changes that are potentially difficult for pedestrians. Parallel curb ramps require people continuing along the sidewalk to travel down one ramp and up the other ramp. For this reason, parallel curb ramps should not be installed on sites where it is possible to install two well-designed perpendicular curb ramps.

The following lists summarize the advantages and disadvantages of parallel curb ramps:

Advantages of parallel curb ramps

- Require minimal right-of-way;
- Enhance the detectability of the boundary between the curb ramp and the roadway because the ramp ends at a landing, not in the street;
- Allow ramps to be extended to reduce ramp grades;
- Does not require turning or maneuvering on the ramp;

Figure 7-10. At intersections with narrow sidewalks and wide turning radii, two parallel curb ramps should be considered.

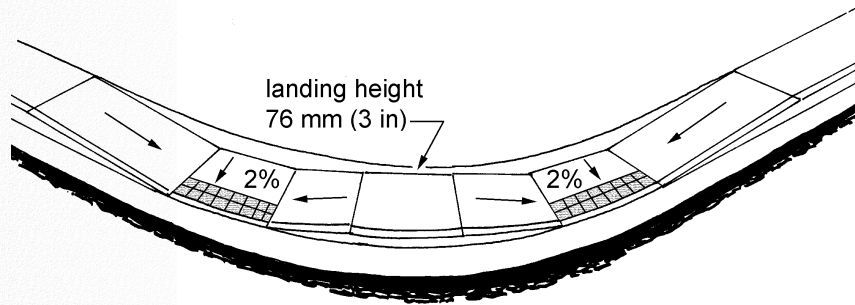
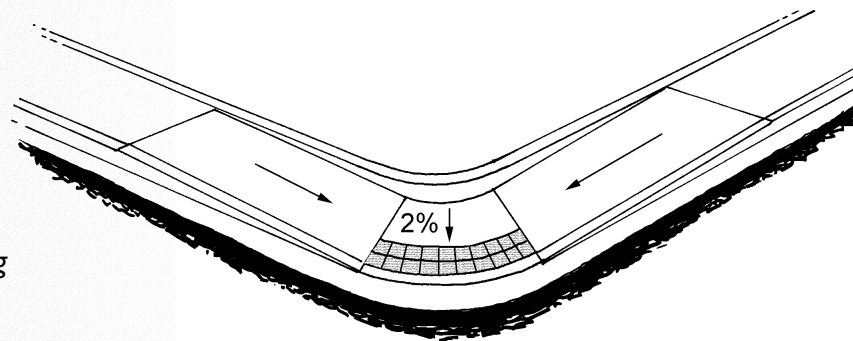

Figure 7-11. On narrow sidewalks with tight turning radii, a single parallel curb ramp may be considered.



7

CURB RAMPS

CHAPTER

- Provide the connection to the street within the crosswalk;
- Provide a level maneuvering area at the top and bottom of the ramp; and
- Provide edges on the sides of the ramp that are clearly defined for people with visual impairments.

Disadvantages of parallel curb ramps

- Require users continuing along the sidewalk to negotiate two ramp grades; and

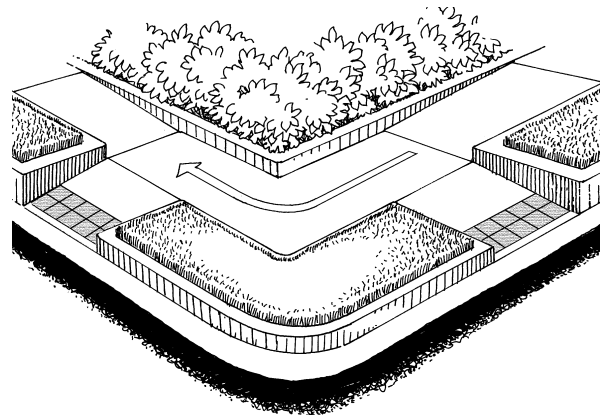

Figure 7-12. Combined parallel and perpendicular curb ramps lowers the elevation of level landings while bridging the remaining elevation gap. This recommended design is very accessible but can be expensive to install in some retrofit installations.

- Require careful attention to the construction of the landing at the bottom of the ramp in order to limit the accumulation of water and/or debris.

7.2.4 Combined parallel and perpendicular curb ramp

A combined parallel and perpendicular curb ramp utilizes the best characteristics of both parallel and perpendicular curb ramps. A combined curb ramp uses the concept of the parallel ramp to lower the elevation level of the landing and then uses a perpendicular ramp to bridge the remaining elevation gap between the landing and the street. This design is particularly helpful for enhancing access in problematic situations where the sidewalk is narrow, has a steep grade, or a high curb.

Combined ramps may be more expensive to install during an alteration than other types of ramps because they require more of the existing sidewalk to be replaced. Combined curb ramps on setback

7

CURB RAMPS

CHAPTER

sidewalks can be designed with returned curbs because the ramps are out of the pedestrian path of travel.

The following lists are intended to summarize the advantages and disadvantages of combination curb ramps:

Advantages of combined parallel and perpendicular curb ramps

- Do not require turning or maneuvering on the ramp surface;
- Provide the connection to the street within the marked crosswalk;
- Are aligned with the proper crossing direction;
- Provide level maneuvering areas at the top and bottom of the ramps; and
- They provide adequate drainage to limit the accumulation of water or debris.

Disadvantages of combined parallel and perpendicular curb ramps

- Generally require more space than a parallel curb ramp;
- Require more extensive alterations for installation in retrofit situations; and
- Require users continuing along the sidewalk to negotiate the parallel ramps.

7.2.5 Built-up curb ramps

Built-up curb ramps are curb ramps that project from the curb into the gutter and street. They are usually oriented in the same direction as perpendicular curb ramps.

Built-up curb ramps are not commonly installed on sidewalks but are frequently installed in parking lots, but they are not permitted in the access isles of accessible parking spaces. If it is not desired to have the entire built-up curb ramp in the roadway, a partial built-up curb ramp may be used.

7

CURB RAMPS

CHAPTER

A partial built-up curb ramp begins sloping within the sidewalk corridor but only extends to the end of the gutter.

There are a number of maintenance, design and pedestrian safety problems with the installation of built-up curb ramps. They should not be the first choice of curb ramp application and various considerations should be examined before installing built-up ramps. Curb extensions are more appropriate curb ramp applications, and built-up curb ramps should be used when other applications will not work such as parallel curb ramps.

Disadvantages of built-up curb ramps

- Users are more exposed to cars in the roadway;
- No clear boundary exists between the ramp and the street;
- Adequate drainage may be difficult to achieve or may require more extensive alteration to the gutter and street;

- Must be protected by a parking lane, while protecting the exposed pedestrian to cars parking (bollards and concrete curbing should be placed around the curb ramp flares);
- Must not intrude on space for bicyclists nor interfere with bicycle travel; and
- If flares are built-up, they can require more maintenance, especially if driven over by cars parking.

Design recommendations for built-up curb ramps

- Drop the sidewalk and/or elevate the roadway at the ramp to minimize the grade, length of ramp, and the need for steep flares;
- Blend the flares into the gutter and roadway to minimize the dropoff at the ramp;

7

CURB RAMPS

CHAPTER

- If possible, keep the ramp inside the edge of gutter to decrease the exposure of users in the roadway;
- Use a high contrast, non-slip material, such as inlaid reflective tape, to outline the edges of the ramp and flares in the roadway to alert pedestrians, bicyclists, and motorists;
- Allocate additional roadway space for bicyclists if the curb ramp is placed where bicyclists would ride; and
- Align the ramp with the pedestrian crossing direction.

Consider marked crosswalks

- Allow 1.22 m (48 in) or more for the width of the ramp to prevent users from traveling over flares and ending up in the street; and
- Do not place ramps where motorists are able to drive over them; a protective parking lane should be part of the roadway design.

7.2.6 Depressed corners

Depressed corners gradually lower the level of the sidewalk, through an almost undetectable change in slope, to meet the grade of the street. Depressed corners are often designed as an expanded diagonal curb ramp that extends around the entire corner at the intersection. In addition, a decorative pattern is often used in downtown urban areas to visually blend the sidewalk and the street, giving the effect of one smooth pathway.

Although depressed corners eliminate the need for a curb ramp, there are very significant drawbacks to the use of depressed corners by pedestrians. Typically, depressed corners:

Advantages of depressed corners

- Give children and people with cognitive impairments the illusion that the sidewalk and street are a unified pedestrian space (i.e., safe).

7

CURB RAMPS

CHAPTER

Figure 7-13. PROBLEM: Decorative patterns used at depressed corners, such as this brick pattern, create a continuous pathway. People with vision and cognitive impairments have difficulty detecting where the street begins and ends.

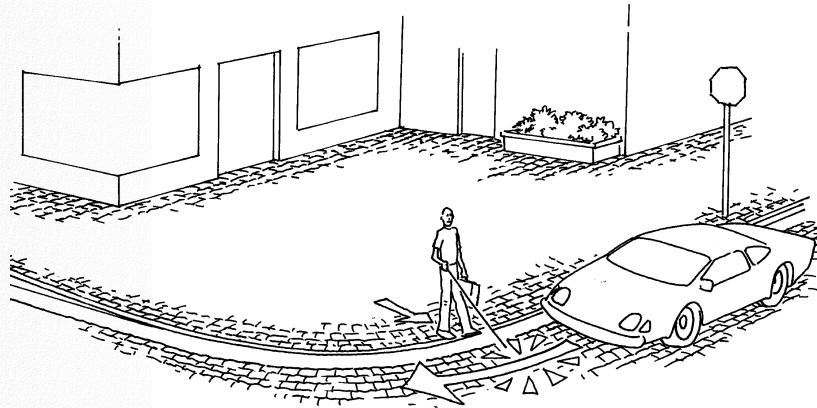
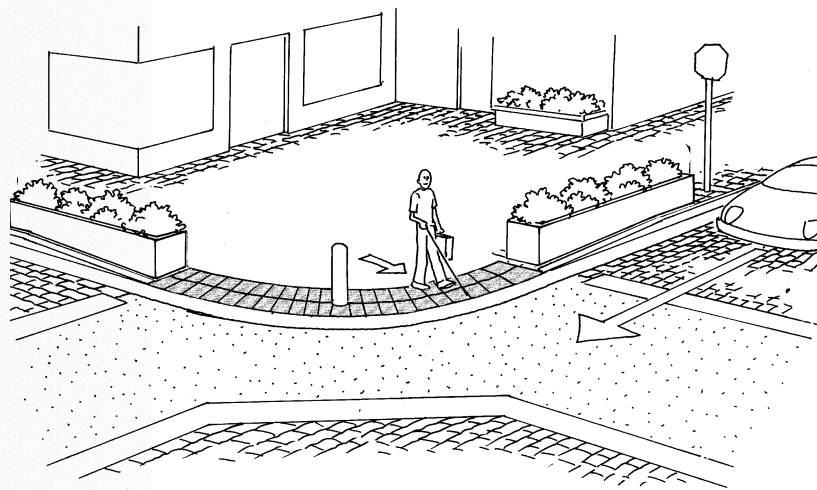

Figure 7-14. Detectable warnings, contrasting surface materials, and barrier posts are measures that can be utilized to convey the transition between the street and sidewalk at depressed corners. This corner would be a good location for accessible signals.



Disadvantages of depressed corners

- Enable large trucks to travel onto the sidewalk to make tight turns, which puts pedestrians at risk;
- Make it much more difficult to detect the boundary between the sidewalk and the street for persons with vision impairments;
- Guide animals may not distinguish the boundary and continue walking; and
- May encourage motorists to drive on the sidewalk, enabling them to turn at higher speeds and making it less likely that they will notice or be able to quickly stop for pedestrians on the sidewalk or in the crosswalk.

Given the significant amount of potential problems with depressed corners, this design is not recommended in new construction. If a depressed curb already exists, the following steps should

7

CURB RAMPS

CHAPTER

be taken to improve pedestrian access and safety:

- Install detectable warnings at the edge of the sidewalk to clearly identify the pedestrian/vehicular boundary;
- Use distinct colors and materials to outline or edge the crosswalk, the sidewalk, and the roadway; and
- Add intermittent barriers, such as planting boxes or bollards, next to the curb to prevent cars from traveling onto the sidewalk when turning the corner. Space the barriers at least 915 mm (36 in) apart to permit wheelchair users to pass. If bollards are used, they should be installed from the centerline out to encourage pedestrian directional flow and to prevent pedestrian congestion. See Section 12.6.3.2.1 in Chapter 12 for more information on installing bollards.

7.2.7 Recommendations for selecting a curb ramp design

Determining which curb ramp is most appropriate depends on the exact conditions of the site. Designers that understand the advantages and disadvantages of each type of curb ramp are best qualified to make this decision. A general set of recommendations is contained in Table 7-2 to assist sidewalk developers in their decisionmaking process.

7.3 Curb ramp specifications

There are a variety of curb ramp designs, and designers can work with the various features to maximize access. Most curb ramps contain combinations of the following features:

- Ramp grade;
- Ramp cross slope;
- Ramp length;
- Ramp width;

7

CURB RAMPS

CHAPTER

Table 7 - 2. Curb Ramps: Perpendicular

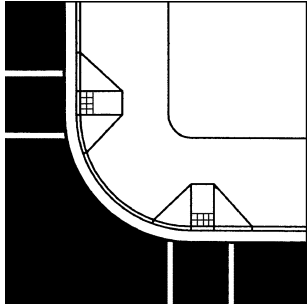
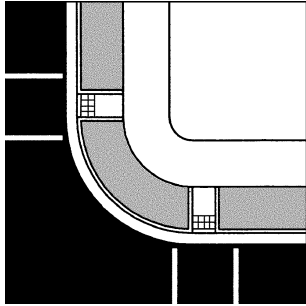
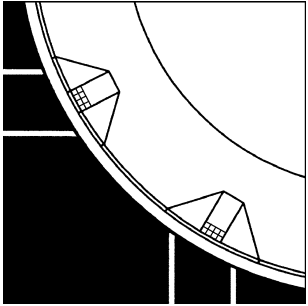
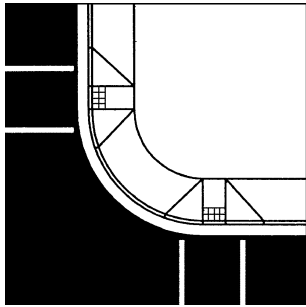
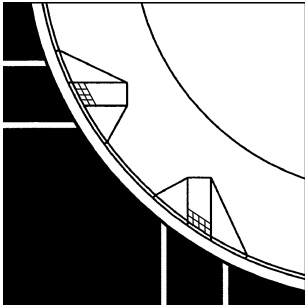
<p>Good Design: Perpendicular curb ramps with flares and a level landing</p> 	<p>Good Design: Perpendicular curb ramps with returned curbs and a level landing</p> 	<p>Inaccessible: Perpendicular curb ramps without a landing</p> 
<p>Design Specifications: Ramp slope = 7.1 ± 1.2 percent Gutter slope = 5% maximum Changes in level = flush Ramp width = 1.22 m (48 in) recommended minimum Landing width = 1.22 m (48 in) recommended minimum Flare slope = 10 percent maximum Cross slope = 2 percent maximum Truncated Domes = 610 mm (24 in)</p> <p>Recommendations: Perpendicular curb ramps require wide sidewalks that permit a level landing; consider using in the following situations:</p> <ol style="list-style-type: none"> 1. In new construction; 2. In urban areas; 3. At signalized intersections; or 4. On arterials and other roads with moderate to heavy traffic volumes 	<p>Recommendations: Returned curbs should only be installed on sidewalks with wide plant-ing strips. Otherwise, this design is similar to two perpendicular curb ramps on a wide sidewalk.</p> <hr/> <p>Acceptable Design: Perpendicular curb ramps designed perpendicular to the curb on a corner with a wide turning radius</p>  <p>Recommendations: This design should be used at corners with wide turning radii and wide sidewalks. Wide turning radii are sometimes necessary but are never ideal for pedestrians.</p>	<p>Recommendations: Perpendicular curb ramps without level landings should not be installed and existing curb ramps should be replaced.</p> <hr/> <p>Inaccessible: On a corner with a wide turning radius, curb ramps are aligned parallel with the crosswalk.</p>  <p>Recommendations: On corners with wide turning radii, curb ramps that are not perpendicular to the curb create problems for wheelchair users because they require users to negotiate rapid changes in grade and cross slope with two wheels leaving the ground. A wider ramp will allow a wheelchair user to turn onto the landing while traveling over less of the flare.</p>

7

CURB RAMPS

CHAPTER

Table 7 - 2. Curb Ramps: Diagonal

Acceptable Design:

Diagonal curb ramp with flares and a level landing, in addition to at least 1.22 m (48 in) of clear space.

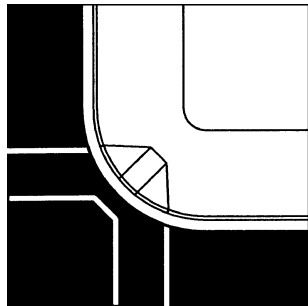

Design Specifications:

Ramp slope = 8.33 percent

Gutter slope = 2.0 percent maximum

Changes in level = none

Ramp width = 1.22 m (48 in) recommended minimum

Landing width = 1.22 m (48 in) recommended minimum

Flare slope = 10 percent maximum

Cross slope = 2 percent maximum

Truncated domes = 610 mm (24 in)

Clear space = 1.22 m (48 in) minimum

Recommendations:

Diagonal curb ramps are never ideal and should be avoided in new construction. They should only be considered during retrofitting where the following circumstances apply:

1. Where utilities prevent the installation of two perpendicular ramps;
2. At intersections that are not signalized; or
3. In some residential areas, where traffic volumes are very low.

Acceptable Design:

Diagonal curb ramp with returned curbs, a level landing, and sufficient clear space in the crosswalk.

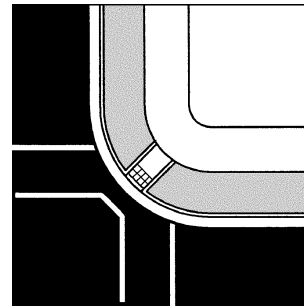

Recommendations:

Returned curbs should only be installed on sidewalks with wide planting strips. Otherwise, this design is similar to a diagonal curb ramp with a level landing.

Acceptable Design:

Single parallel curb ramp with at least 1.22 m (48 in) clear space.

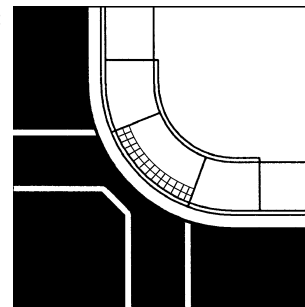

Recommendations:

If a diagonal curb ramp is warranted and the sidewalk width is limited, a single parallel curb ramp should be considered.

Inaccessible:

Diagonal curb ramp with no clear space or no level area at the bottom of the curb ramp.

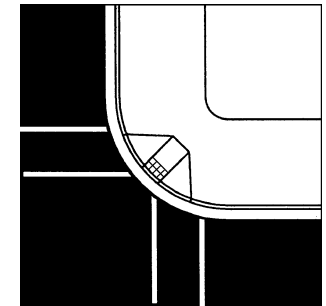

Recommendations:

If a level landing or a clear space of 1.22 m (48 in) cannot be provided at the bottom of the curb ramp, a diagonal curb ramp should not be installed.

Inaccessible:

Diagonal curb ramps without a level landing.

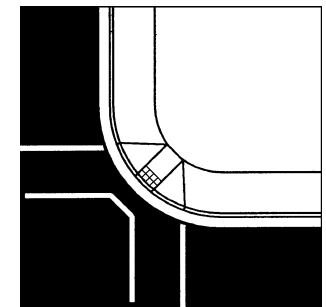

Recommendations:

Diagonal curb ramps without level landings should be replaced because they force users to travel over flares.

7

CURB RAMPS

CHAPTER

Table 7 - 2. Curb Ramps: Parallel and Combination

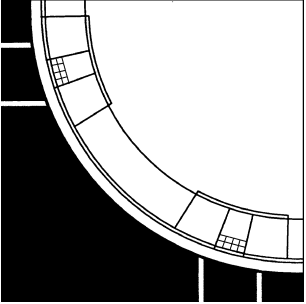
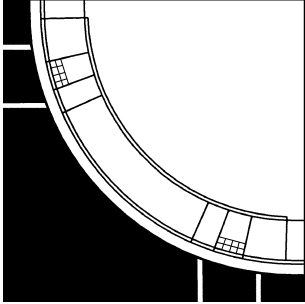
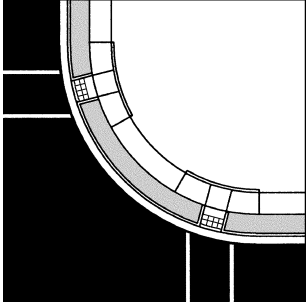
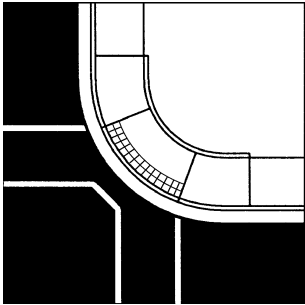
<p>Good Design: Two parallel curb ramps on a wide turning radius.</p> 	<p>Good Design: Two parallel curb ramps with a lowered curb.</p> 	<p>Good Design: Two combination curb ramps on a corner with a wide turning radius.</p> 
<p>Design Specifications: Ramp slope = 7.1 percent Gutter slope = 5 percent maximum Changes in level = none Ramp width = 1.22 m (48 in) recommended minimum Landing width = 1.22 m (48 in) recommended minimum Landing slope = 2 percent maximum towards the gutter Cross slope = 2 percent maximum Truncated domes = 610 mm (24 in)</p>	<p>Recommendations: If the curb between the two parallel curb ramps is lowered, the length or slope of the inside ramps can be reduced because of the reduced elevation change between the sidewalk and the street.</p>	<p>Design Specifications: Ramp slope = 7.1 percent Gutter slope = 5 percent maximum Changes in level = none Ramp width = 1.22 m (48 in) recommended minimum Landing width = 1.22 m (48 in) recommended minimum Landing slope = 2 percent maximum towards the gutter Cross slope = 2 percent maximum Detectable warning = 610 mm (24 in)</p>
<p>Recommendations: Parallel curb ramps are a good design on narrow sidewalks and on sidewalks where a longer ramp length is needed, such as on sidewalks with high curbs. Two parallel curb ramps are less desirable than two perpendicular curb ramps because people traveling around the corner have to travel over four ramps. The landing should be sloped 2.0 percent towards the gutter.</p>	<p>Acceptable Design: Single parallel curb ramp with at least 1.22 m (48 in) clear space.</p>  <p>Recommendations: If the sidewalk is narrow and has a tight turning radius, there may not be room for two parallel curb ramps. In this situation, a single parallel curb ramp should be considered.</p>	<p>Recommendations: A combined curb ramp uses the concept of the parallel ramp to lower the elevation level of the landing and then uses a perpendicular ramp to bridge the remaining elevation gap. This ramp works well on narrow sidewalks because each ramp is relatively short. Combination curb ramps are sometimes designed as a single ramp at the corner if the turning radius of the corner is small.</p>

7

CURB RAMPS

CHAPTER

Table 7 - 2. Curb Ramps: Curb Extensions and Built-up

Good Design:
A curb extension with two perpendicular curb ramps with returned curbs and level landings.

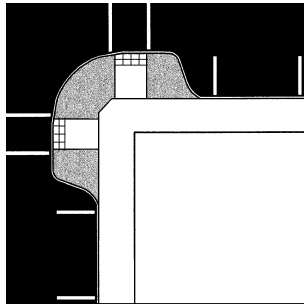

Design Specifications:
Ramp slope = 7.1 ± 1.2 percent
Gutter slope = 5 percent maximum
Changes in level = flush
Ramp width = 1.22 m (48 in) recommended minimum
Landing width = 1.22 m (48 in) recommended minimum
Flare slope = 10 percent maximum
Cross slope = 2 ± 0.9 percent maximum
Detectable warning = 610 mm (24 in)

Recommendations:
Two perpendicular curb ramps built on a curb extension should be installed whenever possible. The curb extension provides additional room for a level landing, increases pedestrian visibility, and reduces motorist turning speeds. Curb extensions also prevent parked cars from blocking the curb ramp.

Acceptable Design:
Two built-up curb ramps.

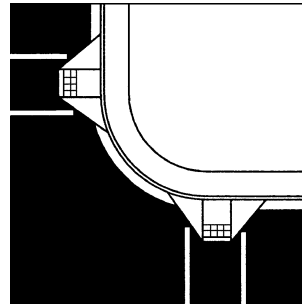

Design Specifications:
Ramp slope and roadway = 8.33 percent
Gutter slope = 2 percent maximum
Changes in level = flush
Ramp width = 1.22 m (48 in) recommended minimum
Landing width = 1.22 m (48 in) recommended minimum
Flare slope = 10 percent maximum
Cross slope = 2 percent maximum
Detectable warning = 610 mm (24 in)

Recommendations:
Two built-up curb ramps work well on narrow sidewalks when parallel ramps and curb extensions will not work. However, the pedestrian is more exposed and less visible to motorists. If built-up curb ramps are used, they should only be installed on streets with a parking lane and must not interfere with bicycle travel. More designing and retrofitting of this curb ramp style may be required, such as dropping the sidewalk, building up the crosswalk area, and blending the flares into the gutter area.

Acceptable Design:
Partially built-up curb ramps.

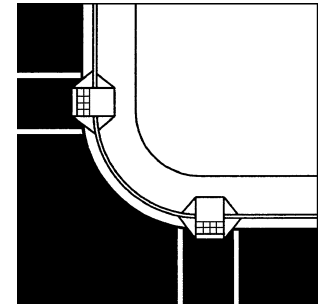

Design Specifications:
Ramp slope and roadway = 8.33 percent
Gutter slope = 2 percent maximum
Changes in level = flush
Ramp width = 1.22 m (48 in) recommended minimum
Landing width = 1.22 m (48 in) recommended minimum
Flare slope = 10 percent maximum
Cross slope = 2 percent maximum
Detectable warning = 610 mm (24 in)

Recommendations:
Partial built-up curb ramps are similar to built-up curb ramps, but the ramp is installed partially on the sidewalk and partially in the gutter. This type of ramp is primarily recommended for use on sidewalks where available space is lacking and a slightly longer ramp is needed.

7

CURB RAMPS

CHAPTER

Good Design:

A curb extension with two perpendicular curb ramps with returned curbs and level landings.

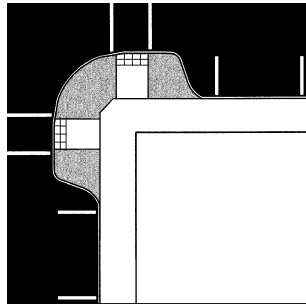

Design Specifications:

Ramp slope = 7.1 percent

Gutter slope = 5 percent maximum

Changes in level = none

Ramp width = 1.22 m (48 in) recommended minimum

Landing width = 1.22 m (48 in) recommended minimum

Flare slope = 10 percent maximum

Cross slope = 2 percent maximum

Detectable warning = 610 mm (24 in)

Recommendations:

Two perpendicular curb ramps built on a curb extension should be installed whenever possible. The curb extension provides additional room for a level landing. The bottom of the ramp is often in a more level landing area, increases pedestrian visibility, and reduces motorist turning speeds. Curb extensions also prevent parked cars from blocking the curb ramp.

- Gutter slope;
- Truncated domes;
- Curb height;
- Change of grade;
- Sidewalk approach width;
- Landing dimension and slope; and
- Flare slope.

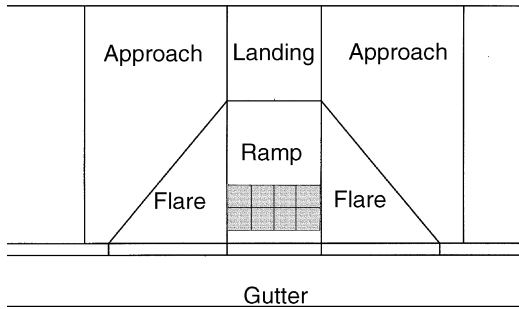

Figure 7-15. Curb ramp components.

The slopes, dimensions, and location of a curb ramp significantly impact the ability of people with disabilities to use the sidewalk independently. The following section describes the recommendations for designing accessible curb ramps. It also discusses potential barriers to pedestrian access that can result when dealing with problematic design situations.

7.3.1 Ramp grade

Steep grades are difficult for people who use walking aids and manual wheelchairs to negotiate because significantly more energy is needed to begin and travel on sloped surfaces. In outdoor environments, wearing heavy winter clothes or carrying packages are frequent activities that further limit an individual's ability to negotiate steep grades. Conversely, gradual grades are problematic for people with vision impairments because the transition between the sidewalk and the street is difficult to detect.

For new construction, ADAAG 4.7 permits a maximum curb ramp slope

7

CURB RAMPS

CHAPTER

of 8.3 percent. However, in practice, 8.3 percent is rarely treated as a maximum but is used as the design standard that does not allow for construction tolerances. Therefore, rather than using 8.3 percent for designing curb ramp grade, a grade of 7.1 percent is recommended to allow a construction tolerance.

In some retrofitting situations, it may not be possible to design a curb ramp with a slope less than 8.3 percent.

In order to address this problem, there is an exception in ADAAG 4.1.6(3)(a) that applies only to the alteration of existing facilities that cannot meet the new construction requirements. The steeper slope specifications should also not be used for alterations where an alternate curb ramp design, such as a parallel curb ramp, would enable the ramp to be installed with a grade of less than 8.3 percent. For alterations only, ADAAG specifies that the following slopes are acceptable but only for short distances (ADAAG, U.S. Access Board, 1991):

- A slope between 8.3 percent and 10 percent is permitted for a maximum rise of 152 mm (6 in);
- A slope between 10 percent and 12.5 percent is permitted for a maximum rise of 76 mm (3 in); and
- A slope steeper than 12.5 percent should be avoided regardless of the length of the ramp.

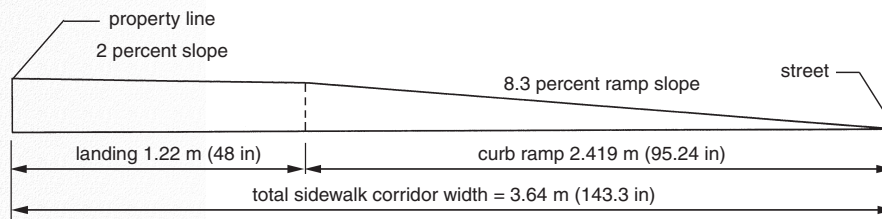
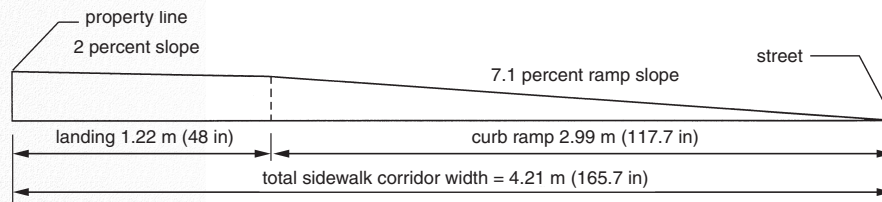

Figure 7-16. A wider sidewalk corridor is needed to design a perpendicular curb ramp with a 7.1 percent slope than an 8.3 percent slope.

7

CURB RAMPS

CHAPTER

These specifications for steeper curb ramps should not be used in new construction.

7.3.2 Ramp cross slope

A curb ramp allows people who use wheelchairs and other wheeled devices to negotiate the elevation change between the roadway and the sidewalk without having to negotiate the curb. People with mobility impairments often have difficulty negotiating a grade and cross slope simultaneously. Since the grade of the ramp will be significant, the cross slope should be minimized. The design specification for cross slope on the ramp should not exceed 2.0 percent.

7.3.3 Ramp length

Curb ramp length is determined by the vertical change in elevation between the roadway and the sidewalk. The greater the vertical change, the longer the ramp will have to be in order to meet

the recommended grade specification. Lower curb heights enable shorter curb ramps to be used. However, if a curb height is less than the standard 152 mm (6 in), there is the potential for water to rise above the level of the curb up onto the sidewalk. Drainage inlets may have to be modified to take in more water or may need to be installed more frequently to prevent water from flowing onto the sidewalk with lower curb heights.

Table 7-3 calculates the minimum ramp length required for a 7.1 percent and an 8.3 percent ramp, based on the height of the required vertical change. The vertical change is determined as the difference between the level of the roadway and the level of the sidewalk and includes any elevation gain that occurs on the sidewalk corridor. Assuming the cross slope of the sidewalk corridor is constant at 2 percent, the formula for determining ramp length is:

$$\text{ramp length} = \frac{\text{curb height}}{(\text{ramp slope} - \text{sidewalk corridor cross slope})}$$

7

CURB RAMPS

CHAPTER

In a retrofit situation, the cross slope of the sidewalk corridor should be measured using a digital inclinometer. Once the cross slope is known, the length needed for the ramp can be accurately

determined. If the desired ramp slope is 7.1 percent and the cross slope of the sidewalk is 2 percent, the length of the ramp can be determined by the following simplified formula:

$$\text{ramp length} = \text{curb height} \times 19.6$$

If the desired ramp slope is 8.3 percent and the cross slope of the sidewalk is 2 percent, the length of the ramp can be determined as follows:

$$\text{ramp length} = \text{curb height} \times 15.9$$

Table 7-3. Ramp length for perpendicular curb ramps based on ramp slope

Change in Elevation	Ramp Length for 7.1 Percent Slope	Ramp Length for 8.3 Percent Slope
203 mm (8 in)	3.99 m (13.1 ft)	3.23 m (10.7 ft)
178 mm (7 in)	3.48 m (11.4 ft)	2.82 m (9.3 ft)
152 mm (6 in)	3.00 m (9.8 ft)	2.42 m (7.9 ft)
127 mm (5 in)	2.49 m (8.2 ft)	2.01 m (6.6 ft)
101 mm (4 in)	1.98 m (6.5 ft)	1.60 m (5.3 ft)

Table 7-3 assumes a 2 percent cross slope for the sidewalk corridor, however, the actual cross slope of the sidewalk corridor will vary between sites. The table also assumes that the sidewalk is not on a hill. For steep terrain, if the curb ramp and landing are not level, the grade of the sidewalk will increase the length of the ramp. For more information about designing curb ramps on steep terrain, see Section 7.4.6.

This table assumes that the sidewalk corridor has a 2 percent slope and that the corner is level.

7

CURB RAMPS

CHAPTER

7.3.4 Ramp width

The recommended minimum curb ramp width is 1.22 m (48 in). Where space is restricted, the width of the ramp can be reduced to 915 mm (36 in). Curb ramp width should never be less than 915 mm (36 in) because there is not enough space for people using assistive devices (e.g., wheelchairs, scooters, and crutches) to travel.

7.3.5 Gutter slope

The gutter is the trough or dip that is provided for drainage purposes between the edge of the street and the curb or curb ramp. The drainage slope of the gutter is the slope parallel to the curb and roadway. The purpose of the drainage slope is to channel water down the street. Because pedestrians generally enter the roadway by crossing perpendicularly over the gutter, pedestrians experience the drainage slope of the gutter as a cross slope. Likewise, after pedestrians go down the curb ramp towards the street, they experience the cross slope of the

gutter as an uphill grade that often continues until the middle of the street because of the crown of the roadway.

If the drainage slope of the gutter is too steep, pedestrians will be required to negotiate a surface with a steep cross slope as they transition from the curb ramp to the roadway. Therefore, the drainage slope of the installed gutter should not exceed 2 percent. The cross slope of the gutter should also be considered in relation to the installation of curb ramps. If the gutter cross slope is significant, the change of grade experienced by pedestrians as they travel from the downhill slope of the curb ramp to the uphill slope of the gutter will be problematic for wheelchair users (see Section 7.3.7). On most curb ramps, to avoid rapidly changing grades, the cross slope of the street and gutter approach to the curb ramp should not exceed 5 percent.

7.3.5.1 Gutter slope at diagonal curb ramps

At the bottom of a diagonal curb ramp, the slope of the gutter and adjoining roadway should not exceed 2 percent in

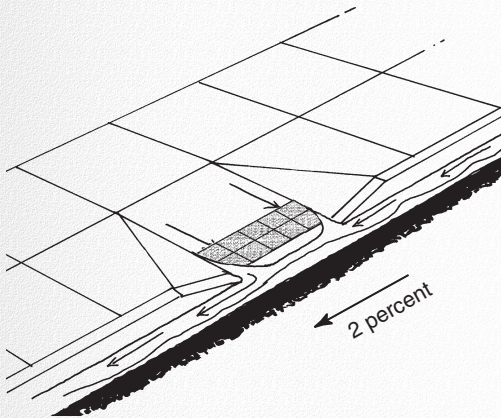

Figure 7-17. The gutter slope should be designed to direct water across rather than towards the bottom of the curb ramp.

7

CURB RAMPS

CHAPTER



Figure 7-18. Detectable warnings at the bottom of curb ramps enhance access for people with vision impairments (Austin, Texas).

Case Study 7-1

Austin, Texas, has a long standing commitment to installing detectable warnings on the surface of curb ramps.

any direction. The level area should extend for a minimum distance of 1.22 m (48 in) in all directions to provide adequate maneuvering space. The difficulty of achieving a level area at the bottom of a diagonal curb ramp is one of the primary reasons that this design does not work well in many pedestrian environments.

7.3.6 Transition detection

Steep ramp grades are difficult for people with mobility impairments to negotiate. However, gradual grades make it more difficult for people with vision impairments to detect the transition between the sidewalk and the street. Research to determine the impact of curb ramps on people with vision impairments has shown that on ramps that comply with ADAAG 4.7 (i.e., have a maximum grade of 8.3 percent), 48 percent of people with vision impairments cannot reliably detect the ramp to street transition (Bentzen and Barlow, 1995). For this reason, a 610 mm (24 in) detectable warning (see Section 7.3) across the bottom of the curb

ramp, at the boundary between the ramp and the street, is recommended on all curb ramps. Detection of the curb ramp by people with visual impairments can be further enhanced if the change of grade between the sidewalk and ramp is abrupt, but this is not a reliable detection tool and can cause hazardous tipping for wheelchair users. However, designers should take care to ensure that the change of grade between the sidewalk and the ramp does not exceed 11 percent. See Section 7.3.7 for additional information on change of grade.

7.3.7 Change of grade

A change of grade is an abrupt difference between the grade of two adjacent surfaces or planes. When considering the needs of pedestrians, change of grade can be evaluated over a 610 mm (24 in) interval, which represents the approximate length of a single walking pace and the base of support of assistive devices such as wheelchairs or walkers.

In the sidewalk environment, the change of grade can be determined by:

7

CURB RAMPS

CHAPTER

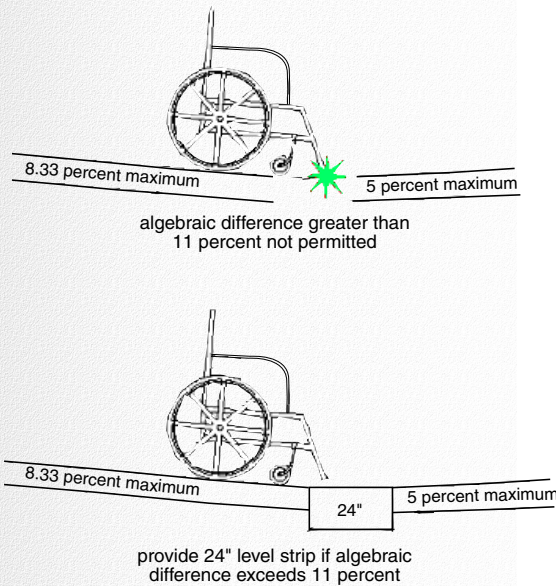
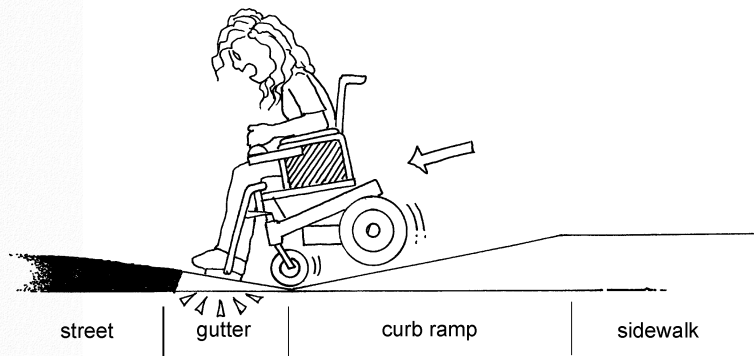

Figure 7-19. Change of grade. Transitions should have minimum grade changes (less than 11%) for a gradual transition for wheelchair users.

Figure 7-20. Grade changes that happen over a short interval, such as between the gutter and ramp, can cause wheelchair users to fall forward.



- Adding the two grades together if the pre- and post-transition grades are in opposite directions (e.g., one uphill and one downhill). For example, if the slope of the curb ramp is 7 percent and the inward slope of the gutter is 3 percent, the change of grade is 10 percent ($7 + 3 = 10$).
- Subtracting one grade from the other if the pre- and post-transition grades are in the same direction (e.g., an uphill followed by a significantly steeper uphill). For example, if a curb ramp with an 8 percent grade leads up to a

sidewalk with a 15 percent grade, the change of grade is 7 percent ($15 - 8 = 7$).

7.3.7.1 Impacts of change of grade on people who use wheelchairs

A rapid change of grade, such as what might be found between the base of a curb ramp and the gutter, may be difficult to negotiate because the wheelchair's footrests or anti-tip wheels cannot clear the ground surface. In general, footrests are positioned low to the ground and extend beyond the front casters. Anti-tip wheels are placed on the back of some wheelchairs, behind the rear axle, to improve stability. Both the footrests and anti-tip wheels limit the clearance height of the wheelchair. Clearance may be a particular problem at an abrupt change of grade because the footrests or anti-tip wheels extend beyond the wheelbase of the wheelchair and therefore may contact the surface across the transition point from where the wheels are located.

7

CURB RAMPS

CHAPTER

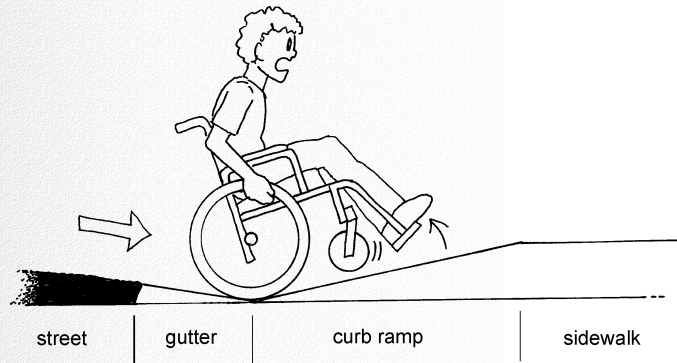

Figure 7-21. Grade changes that happen over a short interval, such as between the gutter and ramp, can cause wheelchairs to flip over backwards.

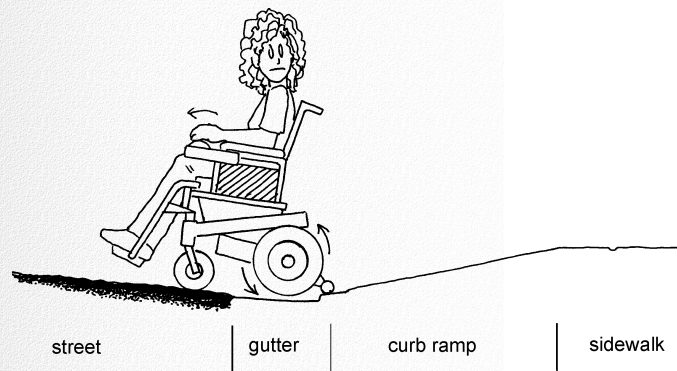

Figure 7-22. Anti-tip wheels and devices in the back bottom of the wheelchair can get caught when traveling over a significant change in grade.

A further complication associated with severe changes in grade is the increased risk of tipping if the wheelchair user is traveling with speed such as when going down the slope of a curb ramp. If the footrests catch on the ground, the wheelchair will come to an abrupt stop; the forward momentum of the individual and wheelchair is interrupted and can cause the wheelchair user's upper body to fall forward or can cause the user and the wheelchair to tip forward.

If the user moves quickly through the change in grade, without compromising the ground clearance of the wheelchair, the dynamic stability of the wheelchair may still be compromised. Dynamic stability can be compromised because the momentum of the wheelchair will rotate backwards as the

wheelchair climbs up the gutter slope. If there is a severe change in grade, this may cause the wheelchair to tip over backwards. Any amount of height transition such as lips between the curb ramp and the gutter can further contribute to the stability problems experienced by wheelchair users (Section 7.3.8).

7.3.7.2 Recommendations for maximum change in grade

In order to avoid difficult or potentially hazardous changes in grade, sidewalks and curb ramps should be designed with gradual grade changes whenever possible. Where abrupt changes are required, the difference in grade between adjacent surfaces should be minimized. The exact change of grade that will be problematic varies among wheelchair users and is dependent on a variety of factors including the design of the wheelchair and the speed at which the user is traveling. Additional research is needed to provide a more comprehensive evaluation of the impact of change of grade on wheelchair users.

7

CURB RAMPS

CHAPTER

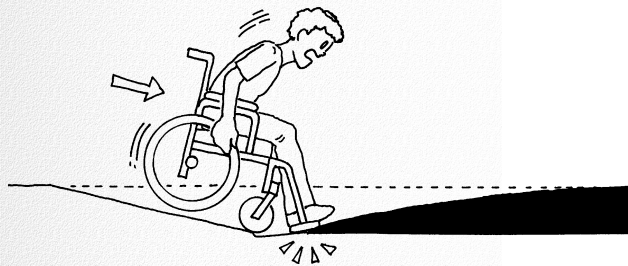

Figure 7-23. Overlaying existing asphalt without milling away the old asphalt can create steep slopes on either side of the centerline.

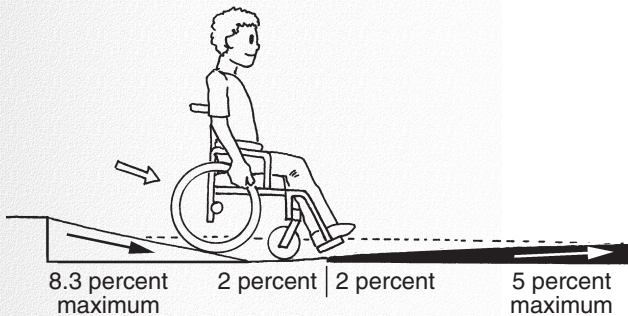

Figure 7-24. Milling away asphalt before resurfacing results in a smooth transition between curb ramps, gutters, and streets.

The maximum recommended change of grade is 11 percent. Whenever possible, sidewalks and curb ramps should be designed with a maximum grade change that is less than 11 percent to ensure that the maximum grade change between the installed surfaces will remain less than 11 percent after street resurfacing or other roadway maintenance activities. Change of grade can be minimized by an addition of 2.75 m (9 in) of 2 percent ramp and 2.75 m (9 in) of 2 percent gutter. The 5.50 m (18 in) of gradual change of grade can prevent wheelchair users from flipping forward or backward.

7.3.7.3 Street resurfacing

The manner in which streets are maintained significantly impacts the slope of the curb ramp approach from the street. Asphalt is an economical and

durable material used to pave most roads. In the past, repairing damage to asphalt roads typically entailed overlaying the existing pavement with more asphalt. Then, as the asphalt layers built up, the roadway crown created steep slopes on either side of the centerline. This also created an abrupt transition between the gutter and the asphalt surface. These slopes significantly exaggerate the intended change of grade.

Recent advances in street repaving allow recycled asphalt to be used in new resurfacing projects. To take advantage of the old material, roads are milled before being resurfaced. Milling should be completed from gutter to gutter. Furthermore, if the road has maintained its original crown, the amount of asphalt removed from the road for recycling should equal the amount of asphalt being added to the road for resurfacing. However, if the road has not been milled during past resurfacing, it may be necessary to remove more asphalt than is being added to restore the crown to its original slope.

7

CURB RAMPS

CHAPTER

When resurfacing is done to a road, access improvements must be made to the curb ramp and driveway crossings that are adjacent to the roadway surface. The Department of Justice mandates that “resurfacing beyond normal maintenance is an alteration” (U.S. Department of Justice, 1994a). In contrast to maintenance activities, alterations such as resurfacing trigger the requirements to provide accessibility improvements such as curb ramps.

likelihood of problems for individuals with balance limitations.

Transition points found within the curb ramp area include:

- Street and gutter;
- Gutter and ramp;
- Ramp and landing; and
- Landing and sidewalk approach.

The two most problematic transition points occur between the street and the gutter and the gutter and the curb ramp. In these situations, it is critical that the combination of change in grade and transition height be minimized. In addition to contributing to a user’s dynamic instability, curb ramp lips will also change the angle of the wheelchair, as if the wheelchair were on an increased grade. For example, if a ramp is designed with an 8.3 percent slope and has a 19 mm (0.75 in) lip at the bottom of the ramp, the actual grade the wheelchair user has to negotiate is 11.6 percent. Curb ramp lips are not allowed by ADAAG.

7.3.8 Transition height

Transition points between adjacent curb ramp surfaces should be flush. Even a 13 mm (0.5 in) change in level combined with a change in grade can complicate access for wheelchair users. If the change in grade is significant, a height transition may also increase the

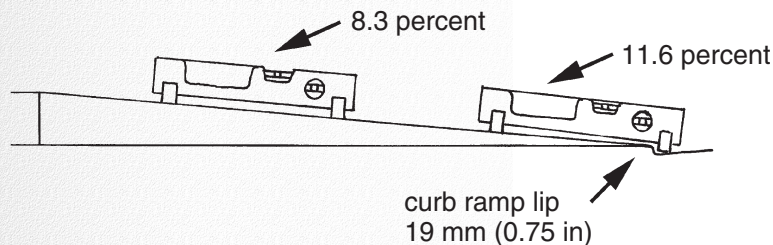

Figure 7-25. The actual slope a wheelchair user will have to negotiate on an 8.3 percent slope with a 0.75 mm lip is 11.6 percent.

7

CURB RAMPS

CHAPTER

7.3.9 Sidewalk approach width

Sidewalk approaches are the sections of sidewalk to the right and left of the landing of a curb ramp. The sidewalk approach should reflect the same design qualities as the sidewalk corridor leading up to it. At a minimum, the approach should have at least 915 mm (36 in) of clear space. If the approach is not clear of obstacles, the curb ramp may be rendered useless to people with mobility impairments. If included as part of a combination curb ramp, the approach may be slightly graded because the level landing is below the elevation of the adjoining sidewalk.

7.3.10 Landing dimension and slope

A landing is the level area that allows users to maneuver on and off of the curb ramp. The provision of a landing is also important for people who are continuing along the sidewalk and do not want to cross the street. On a perpendicular or diagonal curb ramp, a landing is located at the top of the ramp facing the ramp path.

On a diagonal curb ramp, a level maneuvering area should also be located in the roadway at the bottom of the ramp. When a parallel curb ramp design is used, landings are located within the sidewalk at the top of each ramp and at street level between the two ramps.

When installed, the slope of a landing should not exceed 2 percent in any direction because of the maneuvering required on the landing. Furthermore, the landing should extend at least 1.22 m (48 in) minimum beyond the top of the curb ramp to allow people to maneuver off of the ramp and onto the path of travel within the pedestrian zone. If space is limited and a 1.22 m (48 in) landing absolutely cannot be provided, the landing length and space should be as large as possible, with an absolute minimum width of 915 mm (36 in). If the width of the landing is reduced to 915 mm (36 in), wheelchair users may have to travel over a portion of the flare in order to move off of the ramp and onto the sidewalk. To compensate, the slope at the top of the flare should be blended to allow for easier

7

CURB RAMPS

CHAPTER

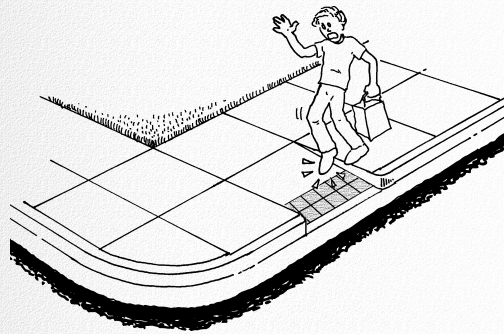

Figure 7-26. Returned curbs become a tripping hazard when located in the pedestrian path of travel.

travel across the flare surface (see Section 7.3.11), and the width of the curb ramp should be widened up to 1.22 m (48 in) to maneuver a wheelchair over a smaller portion of the flare (see Figure 7-32).

7.3.11 Returned curbs and flares

A returned curb or flare is the transition area between the curb ramp and the sidewalk. A returned curb is the preferred transition because:

- The edges of the curb ramp are more clearly delineated;
- It enables the posts for pedestrian signals to be positioned closer to the curb ramp;
- The sides of the curb ramp are easier to detect by people with vision impairments who use a long white cane for navigation;
- The returned curb channels water and debris to the bottom of the curb ramp more effectively; and
- A returned curb is less expensive and easier to construct.

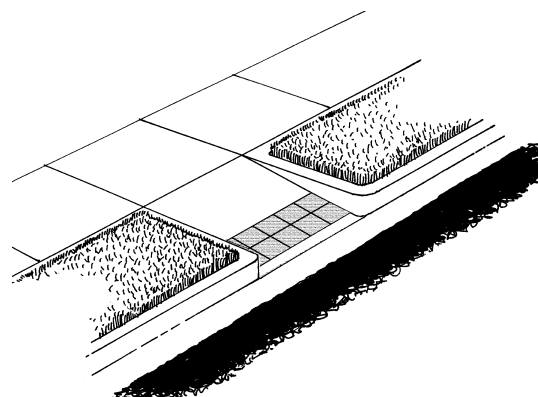
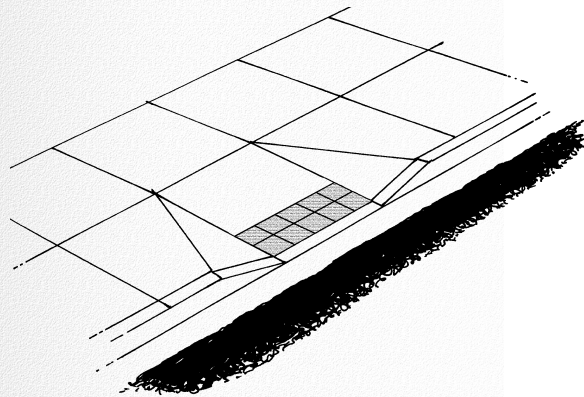

Figure 7-27. Flares provide a gradual transition between the sidewalk and the ramp. Returned curbs transition much more abruptly and should only be used in areas that pedestrians would not normally travel such as planting strips.

Returned curbs should only be used where pedestrians cannot or do not have to walk across the ramp. For example, when the curb ramp is located in a planting strip or the clear path of travel is not adjacent to the side of the ramp (e.g., if a traffic signal is in front of the returned curb).

In areas where there is a potential for pedestrians to travel across the curb

7

CURB RAMPS

CHAPTER

ramp, a flare should be used instead of a returned curb. The flare provides a gradual transition between the curb ramp and the sidewalk so that the tripping hazard for pedestrians is minimized. Although some pedestrians may choose to travel over the flare, it should not be considered part of the pedestrian's path of travel because of the severe change of cross slope.

Improving detectability for people with vision impairments is another reason to design with returned curbs rather than flares. At the sidewalk-to-flare transition, it is difficult for some users to determine if they are at the beginning of a flare or at the top of a curb ramp. If the user mistakes the flare for the ramp, he or she will travel down the sloped surface and reach the curb ramp mistakenly thinking he or she is at the street. The lack of traffic immediately adjacent to the individual standing at the ramp is not always a clear indication of the user's location because a similar situation would occur at the edge of a roadway with a parking lane adjacent to the curb. Skillful blind travelers understand this dilemma,

but distinguishing the landing/ramp from the ramp/roadway remains difficult.

If a flare is provided, the following recommendations should be applied:

- If the landing is at least 1.22 m (48 in), the flares should have a maximum slope of 10 percent;
- If the landing is between 915 mm (36 in) and 1.22 m (48 in), the maximum slope of the flares should be 8.3 percent because wheelchair users may have to travel over a small portion of the flare to maneuver onto the narrow landing; and
- Landings should not be narrower than 915 mm (36 in).

7.4 Design considerations for curb ramp installation

The conditions at the intersection often have a significant influence on the type of curb ramp that is most appropriate. The following sections examine a range of installation considerations including:

7

CURB RAMPS

CHAPTER

- Curb ramp placement at an intersection;
- Influence of turning radii on curb ramp design;
- Determining sidewalk width at pedestrian crossings;

- Curb ramps at high curbs;
- Curb ramps on narrow sidewalks; and
- Curb ramps on steep terrain.

7.4.1 Curb ramp placement at an intersection

Curb ramp placement should be determined by the design constraints of the sidewalk, street, and intersection. The preferred design is to have a separate curb ramp aligned with each crossing direction to allow all pedestrians to cross at the same location. When pedestrians using a curb ramp are forced to cross at a different location, it makes them less visible to drivers and increases the potential for vehicle contact. At most intersections, a pair of perpendicular curb ramps placed at 90 degree angles to one another is the optimal design for meeting these criteria.

The design requirements of diagonal curb ramps, such as providing a level

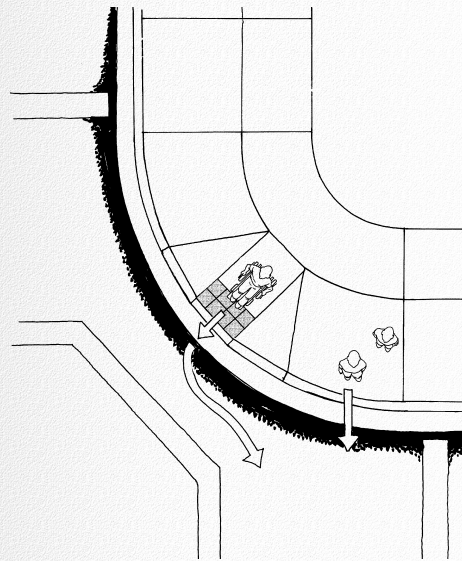

Figure 7-28. When a single diagonal curb ramp is provided, wheelchair users cross in a different location than other pedestrians and are vulnerable to turning traffic.

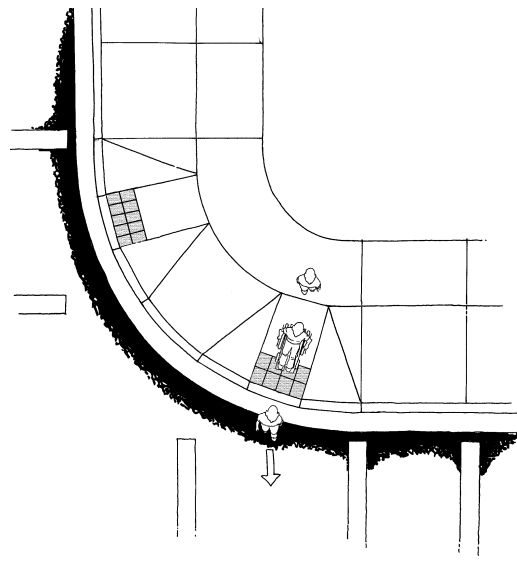

Figure 7-29. When two perpendicular curb ramps are provided, all users cross in the same location as shown here.

7

CURB RAMPS

CHAPTER

area at the bottom of the ramp, are often difficult to achieve. Furthermore, a single diagonal curb ramp at the apex of each corner creates a variety of problems because pedestrians using the ramp are directed towards the center of the intersection. Pedestrians using the ramp must maneuver at the bottom of the ramp to cross in the proper direction.

People with vision impairments are trained (or learn from experience) not to rely on the direction of the curb ramp as a cue for determining the direction of the destination curb because of the abundance of curb ramps that are not aligned with the crosswalk. Instead they align themselves with their destination curb using traffic sounds and other clues. Nevertheless, if they are standing on a curb ramp that slopes toward the center of the intersection, they may still veer towards the center of the intersection while completing their crossing. This situation is most likely to occur if the pedestrian with a vision impairment is distracted, new to an area, or inexperienced with his or her impairment.

In new construction, the installation of two ramps should be the norm. Two curb ramps should also be the norm when alterations are performed:

- In urban areas;
- At signalized intersections;
- On arterials and other roads with moderate to heavy traffic volumes; and
- Where the placement of utilities does not interfere with the installation of two curb ramps.

A diagonal curb ramp or a single parallel curb ramp may be acceptable in retrofitting situations to help conserve resources. For example, if sidewalk width is limited, a single parallel curb ramp will often be the best design. Situations in which diagonal curb ramps may be considered include:

- Some residential areas, where traffic volumes are very low and

7

CURB RAMPS

CHAPTER

Figure 7-30. The 1.22 m (48 in) width of this curb ramp provides sufficient turning space for this wheelchair user. The maximum slope of the flares at this curb ramp should be 10 percent.

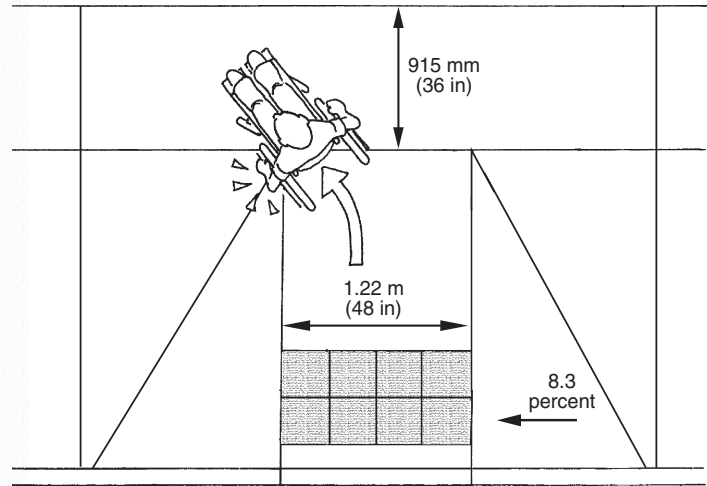
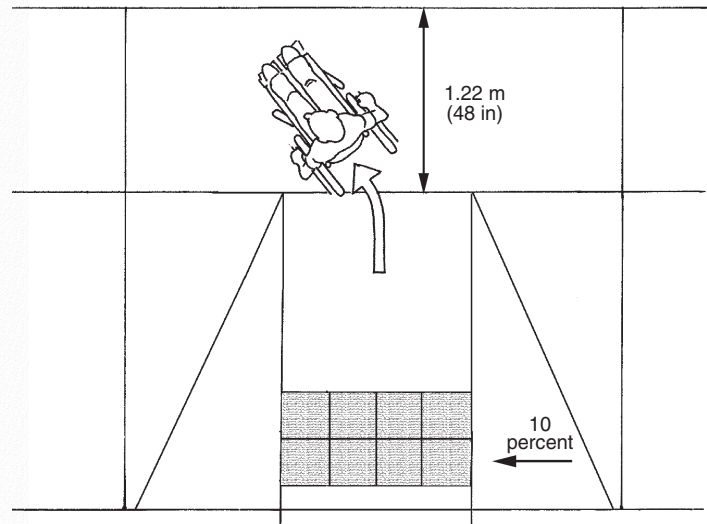

Figure 7-31. The 915 mm (36 in) width of this landing forces this wheelchair user to travel over a portion of the flare to maneuver onto the narrow landing. For this reason, the maximum slope of the flare should not exceed 8.3 percent and should be blended at the top apex. The ramp width should be widened up to 1.22 m (48 in) to allow for a tighter turn onto the landing.



intersections do not require signalization; and

- Where utilities prevent the installation of two perpendicular curb ramps.

7.4.2 Influence of turning radii on curb ramp design

Curb ramps should be built so that the beginning of the sloped area is perpendicular to the user's path of travel. At a corner with a tight turning radius, the ramp of a perpendicular curb ramp will be at a 90 degree angle to the curb and will be oriented parallel to the crosswalk. This is helpful to users because they can follow the ramp path directly across the street. Curb ramps aligned with the crosswalk also minimize the maneuvering that wheelchair users must perform to use the ramp.

At corners with larger turning radii, the curb ramp cannot always be parallel to the direction of the crosswalk while the ramp slope is perpendicular to the curb. In this situation, priority should

7

CURB RAMPS

CHAPTER

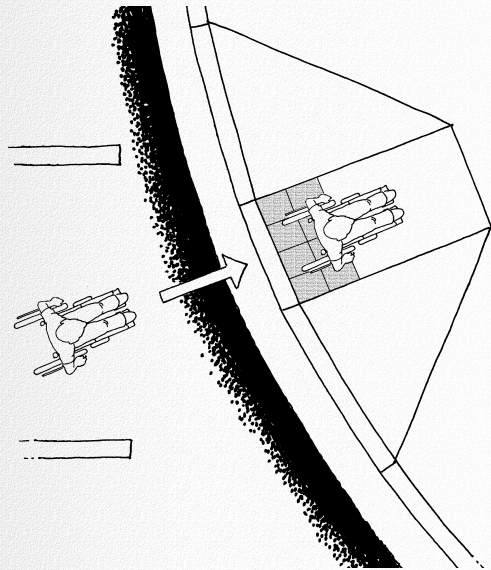

Figure 7-32. Sidewalks are easier for wheelchair users to travel on if the ramp slope is perpendicular to the curb because the chair does not become unstable as it does when one front wheel strikes a curb ramp before the other.

be given to ensuring that the ramp slope is perpendicular to the curb. However, because the curb ramp is not aligned with the crosswalk, the crosswalk must be sufficiently wide enough to allow the user to line up with the curb ramp while still in the street.

If the ramp slope is not perpendicular to the curb, wheelchair users either have to:

- Negotiate changing cross slopes and changing grades simultaneously since one side of the chair will be in the gutter while the other is still on the ramp; or

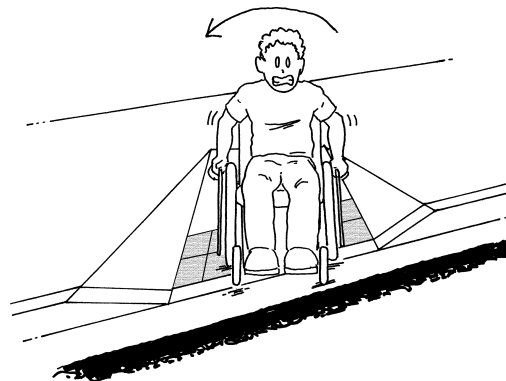

Figure 7-33. PROBLEM: Wheelchair users can be very unstable when traveling down a narrow ramp with a slope that is not perpendicular to the curb, because all four wheels are not touching the ground at all times.

- Turn on the ramp in order to have both wheels move from the ramp to the gutter at the same time. When traveling down a curb ramp, the turn must be completed while on a significant grade and within a narrow space.

Both of these situations significantly reduce the accessibility of the curb ramp for wheelchair users.

In some cities, designers have chosen to align curb ramps on large radii curves parallel to the crosswalk, even though the curb ramp is not perpendicular to the curb. As a result, the change of grade between the ramp and street becomes skewed relative to the path of travel. The theoretical advantage of this design is that people with vision impairments could use the path of the curb ramp to direct them across the street. However, this benefit has limited impact because people with vision impairments tend not to rely on curb ramps for directional information due to the abundance of curb ramps that are not aligned with the proper crossing direction.

7

CURB RAMPS

CHAPTER

7.4.3 Determining sidewalk width at pedestrian crossings

A wider sidewalk corridor is often needed at a pedestrian crossing than at other locations. For this reason, the width of the sidewalk corridor at the pedestrian crossing should be determined separately from the width of the sidewalk corridor at other locations. The width required at the pedestrian crossing will depend on the:

- Type of crossing;
- Curb ramp design;
- Elevation change between the roadway and sidewalk;
- Terrain on the site; and
- Volume of pedestrian traffic.

Each of these factors should be carefully considered when making a decision on the width of the sidewalk corridor at a pedestrian crossing. In addition, conditions on the site, such as utilities or buildings, will also influence

the width of the sidewalk corridor during alterations to existing facilities. Making an isolated decision on one factor may unnecessarily restrict the options available for other factors. For example, selecting a narrow corridor width based on a low volume of pedestrian traffic may limit the types of curb ramps that will fit within the sidewalk corridor.

7.4.3.1 Type of crossing

The width of the sidewalk corridor will depend on the type of pedestrian crossing. At a midblock crossing, traffic volumes are generally less. At a corner intersection, pedestrian traffic volumes are generally higher, and two ramps should be provided at each corner. Therefore, depending on the other factors at the site, a corner intersection will generally require more right-of-way than a midblock crossing.

7.4.3.2 Curb ramp design

In new construction, curb ramp design is a primary factor in determining the width required for the sidewalk

7

CURB RAMPS

CHAPTER

corridor at a pedestrian crossing. Each type of curb ramp will require a different width, depending on the slope of the ramp and the width needed for a landing (see Section 7.2). For example, a perpendicular curb ramp with a landing will require a wider sidewalk corridor than a parallel curb ramp. In existing facilities, the selection of curb ramp design is often constrained by the width of the available right-of-way.

If perpendicular curb ramps are being installed, the length of the ramp significantly impacts the width of the pedestrian corridor. The elevation change between the roadway and the sidewalk is primarily determined by the height of the curb. However, the cross slope of the sidewalk corridor should also be included in elevation calculations. Consider this example of a perpendicular curb installed at an intersection with a standard curb height of 152 mm (6 in) and a sidewalk corridor cross slope of 2 percent. The sidewalk corridor will have to be approximately 4.22 m (13.8 ft) wide to install a ramp with a 7.1 percent slope

and a 1.22 m (48 in) landing. For more information on determining ramp length, see Section 7.3.3.

7.4.3.3 Steep terrain

If a perpendicular curb ramp is used on a steep sidewalk, the terrain will also influence the width of the sidewalk corridor at the pedestrian crossing. If the terrain slopes steeply up from the street, the vertical change between the sidewalk and street will be much larger and therefore the curb ramp will need to be longer. This design problem can be avoided if the sidewalk grade is slightly increased to allow the curb ramp and landing area to be level. Section 7.4.6 contains additional information on designing curb ramps on steep slopes.

7.4.3.4 Volume of pedestrian traffic

The anticipated volume of pedestrian traffic must also be considered when determining the width of the sidewalk corridor at a pedestrian crossing. Areas with higher volumes of pedestrian traffic

7

CURB RAMPS

CHAPTER

Case Study 8-3

To mitigate tall curbs built for flash flooding, the town of Silver City, New Mexico installed a unique combination of short steps and long, parallel ramps to meet the needs of both wheelchair users and walking pedestrians.

will require wider ramps and larger landings to enable a continuous, two-way flow of traffic and provide sufficient space for pedestrians to collect while waiting to cross. Additional information about pedestrian capacity should be obtained from the Highway Capacity Manual (Transportation Research Board, 2000).

7.4.4 Curb ramps at high curbs

In some areas of the United States, flash floods and heavy rains add an additional challenge for sidewalk

designers. To prevent water from coming up onto the sidewalk, high curbs are often installed. When high curbs are used, it is difficult to build curb ramps that are not excessively steep or long.

In areas with curbs that are higher than the standard 152 mm (6 in), a combined parallel and perpendicular curb ramp may be a viable option. The parallel ramps gradually slope down as they approach the pedestrian

crossing so that the vertical change between the sidewalk and street is reduced. This reduction in vertical change enables the installation of a shorter perpendicular curb ramp than would otherwise be required for a curb of the same height (see Section 7.1.3). The addition of a partially built-up curb ramp in the gutter area can also be used to increase the length of the curb ramp resulting in a more gradual slope.

In a response to the problem of very steep curbs, Silver City, New Mexico, created the following solution:

- Short stairs were installed at the apex of the corner for most pedestrians who can negotiate short steps more easily than ramps; and
- Side ramps similar to the ramps used in front of buildings were installed with hand railings.

If the Silver City model is followed, a level landing should be provided at intervals of not more than 9.14 m (30 ft). In addition, the landing dimensions should



Figure 7-34. High curbs should be designed to provide access for both walking pedestrians and wheelchair users.

7

CURB RAMPS

CHAPTER

be a minimum of 1.525 m x 1.525 m (60 in x 60 in) where there is a significant change in direction, such as at the apex of a switchback (ADAAG 4.8). State or local regulations may require a larger landing. For example, California requires a minimum landing dimension of 1.830 m x 1.830 m (72 in x 72 in) for a change in direction greater than 30 degrees. In general, the landing dimensions for a switch back are larger than the landing dimensions of a standard curb ramp because the T-shaped intersection that is traditionally found between the sidewalk and the curb ramp is not available.

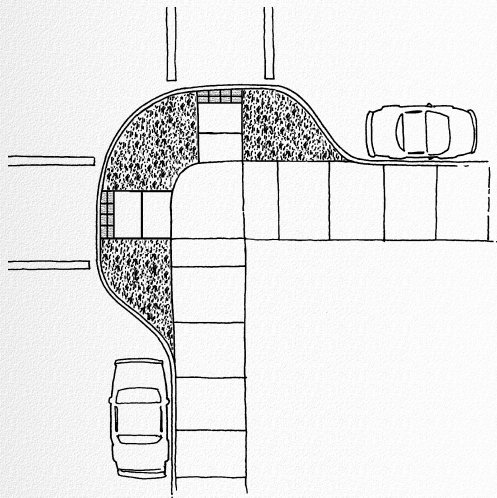

Figure 7-35. Curb extensions extend corners into parking lanes and provide space for curb ramps.

7.4.5 Curb ramps on narrow sidewalks

Narrow sidewalk corridors are problematic because the preferred design of two perpendicular curb ramps cannot be provided in conjunction with level landings within the available space. In new construction, curb ramps at all pedestrian crossings must be considered when determining the width of the sidewalk corridor.

To retrofit narrow sidewalks with accessible curb ramps, designers should consider the following solutions:

SOLUTION 1 — Add curb extensions to extend the corner to the outer edge of the parking lane.

The curb extension is an excellent design strategy for providing additional space to enable the installation of perpendicular curb ramps while maintaining a level path of travel on the sidewalk that also serves as a landing. The curb extension provides pedestrians more protection from vehicular traffic than that of a built-up curb ramp. Furthermore, if a curb extension is installed on an existing road, the height of the curb can be significantly reduced due to the crown of the road that causes the edge of the curb extension to be at a higher elevation than the edge of the sidewalk. A lower curb at the corner is beneficial because it allows for the installation of shorter curb ramps. Depending on the slope of the roadway crown, the curb may be totally eliminated, creating a raised crosswalk. Detectable

7

CURB RAMPS

CHAPTER

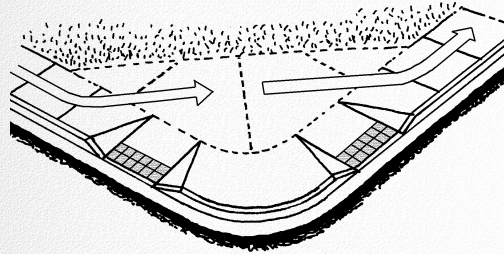

Figure 7-36. Additional right-of-ways to widen sidewalks can be obtained either through purchase, an easement, or donation of fee title.



Figure 7-37. Parallel curb ramps work well on narrow sidewalks but require users continuing on the pathway to negotiate two ramp grades.

warnings are critical at raised crosswalks. For more information about curb extensions, see Section 8.9.

SOLUTION 2 — Widen the entire sidewalk either by securing additional right-of-way from the adjacent property owner or by taking right-of-way from the roadway.

Widening the entire sidewalk corridor is an effective solution because it allows the most direct path of travel for pedestrians traveling along the sidewalk. If widening the entire sidewalk corridor is not possible, securing additional right-of-way only at the corner will enable the installation of a jogged landing at the curb ramp. For additional information about widening sidewalks, refer to Section 4.1.4 on improving access on narrow sidewalks.

SOLUTION 3 — Install a parallel curb ramp or a combined parallel and perpendicular curb ramp.

Because the ramps are parallel to the sidewalk, these designs permit an increase in the length of the ramp without having to increase the width of the sidewalk corridor. See Sections 7.2.3 and 7.2.4 for more information about parallel or combined curb ramps in solution 2.

SOLUTION 4 — Manipulate the height of the curb for a short distance on either side of the curb ramp.

Lowering the curb height and the area for curb ramp placement from the standard 152 mm (6 in) height to a 75 mm (3 in) height, for example, would significantly reduce the space required to install a perpendicular curb ramp. If the curb height and ramp replacement area are lowered, careful planning is needed to ensure that there is adequate drainage so that water does not flood onto the sidewalk at the point where the curb

7

CURB RAMPS

CHAPTER

height is reduced. To prevent ponding, drainage inlets along the gutter should be located on either side of the curb ramp and uphill of the area with a reduced curb height.

7.4.6 Curb ramps on steep terrain

Sidewalks built on steep terrain make access difficult for people with mobility impairments. Although some design strategies can be employed to improve access, steep grades will always present difficulties for people with mobility impairments and should be avoided whenever possible. In the past, some designers have decided not to provide curb ramps on steep sidewalks because of the

erroneous assumption that individuals with mobility impairments could not travel on significant grades. However, even if the terrain is extremely steep, curb ramps should be provided so individuals using powered mobility devices (e.g., a scooter) or traveling with assistance will be able to access the sidewalk.

When addressing steep grades at an intersection, it is best to extend the level area of the intersection to include the curb ramp and the landing. Although this significantly increases the grade of the path leading toward or away from the intersection, it is recommended because it enables people to cross the roadway and transition from the roadway to the sidewalk on a level surface. If this segment of the sidewalk corridor is not level, the problems caused by steep terrain are often magnified because:

- The slope of the curb ramp is compounded by the slope of the sidewalk; and
- The steep slope of the curb ramp, which people with vision

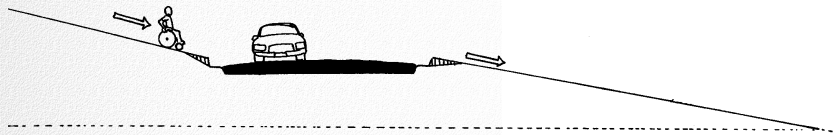

Figure 7-38. POTENTIAL PROBLEM: When the curb ramp section of the sidewalk corridor is not level, curb ramp grades are significantly increased and users cannot quickly move out of the street.

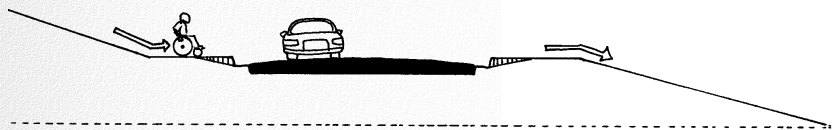

Figure 7-39. GOOD DESIGN: The level area of an intersection should be extended to include the curb ramps and the level landings above them.

7

CURB RAMPS

CHAPTER

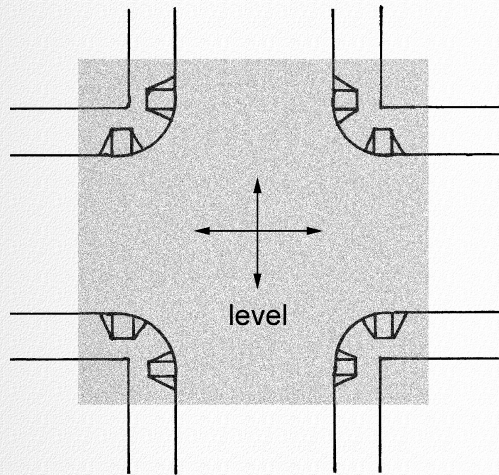

Figure 7-40. The shaded area represents the portion of the intersection that should be level for pedestrian travel.

impairments would normally be able to detect, may become “invisible” in relation to the generally steep terrain.

In addition to providing well-designed curb ramps, extending the level area of the street intersection into the crosswalk areas will also ensure that the crosswalks are level. If the grade of the street slopes up or down, the slope of the street becomes a cross slope for pedestrians (in the crosswalk).

In a retrofit situation, where only the roadway is level, curb extensions can be used to ensure that the sidewalk to roadway transition area (e.g., curb and ramp) is not located on a steep slope. When designing curb extensions, it is preferable to include landscaping, such as grass, to make the location of the curb ramp easier to detect (see Figure 7-38). The width of the curb ramp can also be expanded so that all pedestrians use the ramp instead of traveling on the landscaped areas of the curb extension. Flares should be used only in situations where the entire surface of the curb extension is paved.

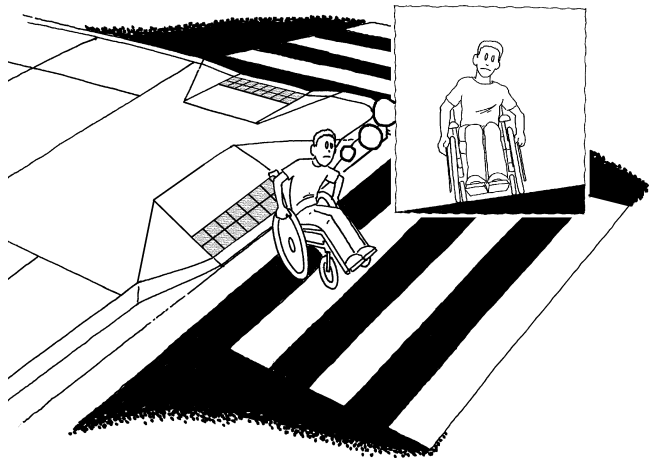

Figure 7-41. If intersections are not level, the slope of the roadway translates into a difficult cross slope for wheelchair users to travel across.

7.5 Curb ramp drainage

Poor drainage at the bottom of a curb ramp is inconvenient to all pedestrians. It is a particular nuisance for people who rely on the curb ramp for access and who will, therefore, not be able to avoid the area. When the water eventually dries up, debris, which further impedes access, is usually left at the base of the ramp.

7

CURB RAMPS

CHAPTER

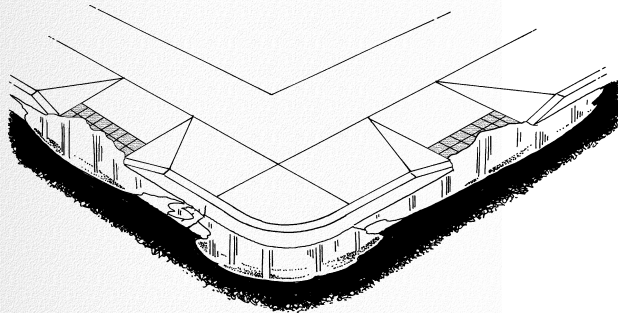

Figure 7-42. POTENTIAL PROBLEM: Curb ramps that are susceptible to pond formation are inconvenient and unsafe (especially when water freezes) for all sidewalk users.

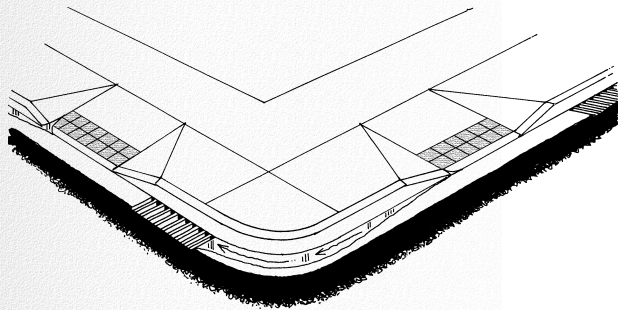

Figure 7-43. GOOD DESIGN: Locating drainage inlets uphill from curb ramps prevents puddles and debris from blocking the path of travel.

In cold-weather locations, water that does not drain away can turn into slush or ice, creating a more hazardous situation.

Most drainage systems focus on channeling water to the corner of the street. However, care must be taken in development of the grading plan to ensure that drainage off the sidewalk is directed across and down towards the bottom of a curb ramp and away from curb ramp. The grading plan should specify:

- Dimensioned distances, elevations, and inlet/catch basin locations;
- Curb/gutter elevation (the ends, center, and quarter points are normally needed in each curve); and
- Sidewalk, pavement, ramp, and gutter slopes.

Designers, surveyors, contractors, and construction inspectors all have a role in ensuring adequate drainage at the bottom of all curb ramps. The following design strategies are recommended:

- Drainage inlets should be located adjacent to the uphill side of a curb ramp;
- Gutter slopes should be designed to guide water flow away from the curb ramp;
- The gutter should be smooth with a continuous slope to prevent water from ponding on more level areas;
- Maintenance programs should be established to periodically remove gutter debris;
- The installed slope of the gutter around the base of the curb ramp should be a minimum of 0.5 percent

7

CURB RAMPS

CHAPTER

and a maximum of 2 percent. A pedestrian experiences the slope of the gutter as a cross slope. This range of slopes is designed to ensure adequate drainage on a paved surface but still allow as level a surface as possible for pedestrians

who will be negotiating a change in grade in addition to the cross slope at the gutter; and

- Height transitions associated with cracks or expansion joints should be avoided.