

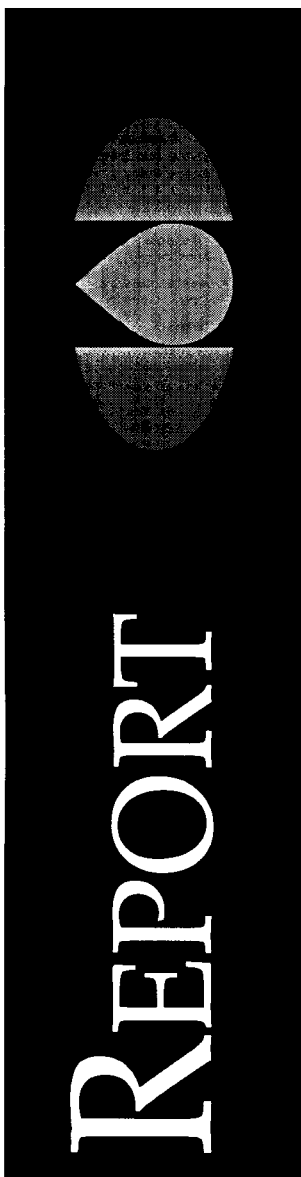

EPA/OSHA JOINT CHEMICAL ACCIDENT INVESTIGATION REPORT

**Surpass Chemical Co., Inc.
Albany, NY**



The EPA/OSHA Accident Investigation Program

Under a Memorandum of Understanding (MOU), EPA and OSHA are working together to investigate certain chemical accidents. The fundamental objective of this joint effort is to determine and report to the public the facts, conditions, circumstances, and causes or probable causes of any chemical accident that results in a fatality, serious injury, substantial property damage, or serious off-site impact, including a large scale evacuation of the general public. The ultimate goal is to determine the root causes in order to reduce the likelihood of recurrence, minimize the consequences associated with accidental releases, and to make chemical production, processing, handling, and storage safer. Reports, such as this one, are issued by the agencies to describe the accident, discuss the root causes and contributing factors, and summarize the findings and recommendations.

Prior to releasing investigation reports, OSHA and EPA must ensure that the report contains no confidential business information. The Freedom of Information Act (FOIA), the Trade Secrets Act, and Executive Order 12600 require federal agencies to protect confidential business information from public disclosure. To meet these provisions, OSHA and EPA have established a clearance process in which the companies mentioned in the report are provided a portion of the draft report. This portion contains only the factual details related to the investigation (not the findings, the conclusions nor the recommendations). Companies are asked to review this factual portion to confirm that the draft report contains no confidential business information (CBI). As part of this clearance process, companies often will provide to OSHA and EPA additional factual information. In preparing the final report, OSHA and EPA consider and evaluate any such additional factual information for possible inclusion in the final report.

Chemical accidents investigated by EPA Headquarters are conducted by the Chemical Accident Investigation Team (CAIT) located in the Chemical Emergency Preparedness and Prevention Office (CEPPO) at 401 M Street SW, Washington, DC 20460, 202-260-8600. More information about CEPPO and the CAIT may be found at the CEPPO Homepage on the Internet at "www.epa.gov/ceppo". Accidents investigated by OSHA Headquarters are conducted by the Chemical Accident Response Team (CART) located in the U.S. Department of Labor - OSHA, Directorate of Compliance Programs, Washington, DC 20210, 202-219-8118. More information about OSHA may be found at the OSHA Homepage on the Internet at "www.osha.gov".

At the time that EPA and OSHA decide to jointly investigate an accident under the MOU, an investigation team is formed consisting of representatives of both EPA's CAIT and OSHA's CART. This team is referred to as the Joint Chemical Accident Investigation Team (JCAIT).

U.S. Chemical Safety and Hazard Investigation Board (CSB)

In 1990, the U.S. Chemical Safety and Hazard Investigation Board (CSB) was created as an independent board in the amendments to the Clean Air Act. Modeled after the National Transportation Safety Board (NTSB), the CSB was directed by Congress to conduct investigations and report on findings regarding the causes of any accidental chemical releases resulting in a fatality, serious injury, or substantial property damages. In October 1997, Congress authorized initial funding for the CSB. The CSB started its operations in January 1998, and has begun several chemical accident investigations. More information about CSB may be found at the CSB Homepage on the Internet at “www.chemsafety.gov”.

For those joint investigations begun by EPA and OSHA under the previously mentioned MOU and prior to the initial funding of the CSB, the agencies have committed to completing their ongoing investigations and issuing public reports. Under their existing authorities, both EPA and OSHA will continue to have roles and responsibilities in responding to and investigating chemical accidents. The CSB, EPA, and OSHA (as well as other agencies) are developing approaches for coordinating efforts to support accident prevention programs and to minimize potential duplication of activities.

Basis of Decision to Investigate

On Tuesday, April 8, 1997, a 5,700-gallon hydrochloric acid (HCl) storage tank ruptured while being filled at the Surpass Chemical Co., Inc. The spill of HCl, a corrosive and toxic chemical, resulted in injuries to employees and members of the public, as well as public evacuations. EPA and OSHA considered the impacts of the tank failure with respect to the MOU criteria and the potential for lessons-learned and decided to initiate a joint investigation. The scope of the investigation was to determine the immediate and root causes of the tank failure and to make recommendations that could assist Surpass and others to prevent similar accidents from occurring in the future.

Accident Investigation Report
Surpass Chemical Company, Inc., Albany, New York, April 8, 1997

Executive Summary

On Tuesday, April 8, 1997, at approximately 8:59 a.m., a 5,700-gallon hydrochloric acid (HCl) storage tank ruptured during filling at the Surpass Chemical Co., Inc. (Surpass), in Albany, New York. The failure of the HCl tank caused a significant portion of its liquid contents (which totaled about 4,800 gallons of 31% HCl) to suddenly surge over the secondary containment. The force of the liquid also caused a break in the secondary containment wall. Witnesses described seeing greenish-yellow fumes drifting offsite as well as liquid material running offsite and along the street curb to the storm drains. As a consequence of the incident, 8 workers and 32 others were taken to the hospital. A 10-block area, including nearby businesses and residences, was evacuated.

Based on the impacts of the incident and the potential for lessons-learned, EPA and OSHA decided to undertake a joint chemical accident investigation to determine the immediate and root causes of the HCl tank failure and to make recommendations to Surpass, government, industry, and others that could assist in preventing similar incidents from occurring in the future.

The Joint Chemical Accident Investigation Team (JCAIT) determined that the immediate cause of the incident was the overpressurization of the HCl tank. The team identified the root causes as:

- ▶ Modifications to the venting of the HCl tank were not within the tank manufacturer's specifications for emergency venting.
- ▶ No hazard analysis of the modifications to the venting of the HCl tank was performed.
- ▶ Inadequate preventive maintenance of the scrubber system.

Additionally, the JCAIT identified the following contributing factor:

- ▶ Lack of a written standard operating procedure (SOP) for air off-loading of deliveries to the HCl tank, including an inadequate method for determining that the delivery was complete.

The JCAIT has developed recommendations that address the root causes and contributing factors in order to prevent a similar event:

- ▶ Surpass and other facilities should ensure that modifications to their equipment, in

this case for the purposes of environmental control, do not create new hazards or compromise safety.

- ▶ Surpass and other facilities should maintain environmental control systems to ensure continuous reliability and effective operation.
- ▶ Surpass should develop written standard operating procedures (SOPs) related to the use of air pressure for off-loading HCl and maintenance of the scrubber system, including consideration of human factors such as adequate measuring devices to reduce the chances of errors in determining the completion of the delivery.
- ▶ EPA and OSHA should develop an alert to raise awareness about the need for thorough consideration of safety when designing equipment or processes for environmental control.

In addition to the root causes and contributing factors associated with the HCl tank failure, the JCAIT identified other potential problem areas that may have contributed to the consequences of the incident. These issues included the location of incompatible materials (HCl and sodium hypochlorite) near each other and the need for periodic inspection of storage tanks. As appropriate, these issues will be addressed in any alerts that EPA and OSHA develop.

Also, Surpass is a member of the National Association of Chemical Distributors (NACD) and participates in the NACD Responsible Distribution Process program, which encourages continuous improvement in the safe handling of chemicals. A timely and thorough implementation of the Responsible Distribution Process program by Surpass may have led to improvements in Surpass's system to manage health, safety, and environmental concerns.

Another issue identified by the JCAIT is the listing of HCl solutions under the Risk Management Program (RMP) Rule. Under a recent modification to the list of regulated substances for the RMP Rule, only anhydrous hydrogen chloride and HCl solutions of 37% or greater will be covered (62 FR 45130, August 25, 1997). As this incident demonstrates, solutions with HCl concentrations below 37% may pose potential hazards to human health or the environment. The circumstances of this incident should be considered in any future evaluation of how to list HCl solutions for the RMP Rule.

Table of Contents

1.0	Introduction	1
1.1	Description of the Event	1
1.2	Scope of Investigation	1
1.3	Structure of Report	1
2.0	Background	2
2.1	Facility Information	2
2.2	Process Information	2
2.3	Chemical Information	9
3.0	Description of the Incident	11
3.1	Chronology of Events	11
3.2	Consequences of the Incident	13
3.3	Description of the Emergency Response	16
4.0	Analysis and Significant Facts	16
4.1	Significant Facts	17
4.2	Analysis	20
5.0	Conclusions	25
5.1	Causes	25
5.2	Root Causes and Contributing Factors	25
6.0	Recommendations	27
7.0	Other Findings	28
	References	30

Appendices

A	Joint Chemical Accident Investigation Team (JCAIT) Members	31
B	Industry Codes	32
C	Other Accidents Involving Atmospheric Pressure FRP Tanks	33
D	Modeling of Venting System	34

List of Figures

Figure 1	Layout of Tank Area (Top view)	4
Figure 2	Representation of Offloading Operation	5
Figure 3	Diffuser Section of Vent System	6
Figure 4	Separation of HCl Tank	14
Figure 5	Top of HCl Tank	14
Figure 6	Closeup of Bottom of HCl Tank	15
Figure 7	Closeup of Top of HCl Tank	15
Figure 8	Scrubber Tank	19
Figure 9	Diffuser Section of Vent System	19
Figure 10	Modeled HCl Storage Tank Pressure, Scenario: No Fouling of Diffuser Openings	23
Figure 11	Modeled HCl Storage Tank Pressure, Scenario: 84% Reduction in the Area of Diffuser Openings	24

1.0 Introduction

1.1 Description of the Event

On Tuesday, April 8, 1997, at approximately 8:59 a.m., a 5,700-gallon hydrochloric acid (HCl) storage tank ruptured during filling at the Surpass Chemical Co., Inc. (Surpass) in Albany, New York. The failure of the HCl tank caused its liquid contents (about 4,800 gallons of 31% HCl) to suddenly surge over the secondary containment. The force of the liquid also caused a break in the secondary containment wall. Witnesses described seeing greenish-yellow fumes drifting offsite as well as liquid material running offsite and along the street curb to the storm drains.

Local, state, and federal officials responded. As a consequence of the incident, 8 workers and 32 members of the public were taken to the hospital, treated, and released. A 10-block area, including nearby businesses and residences, was evacuated. Surpass and its contractor remediated the spill in coordination with local, state, and federal officials.

1.2 Scope of Investigation

At the conclusion of the emergency response and remedial actions, EPA and OSHA initiated an investigation by a Joint Chemical Accident Investigation Team (JCAIT). The JCAIT was directed to determine the immediate and root causes of the HCl tank failure and to make recommendations to Surpass, government, and industry that could assist in preventing similar incidents from occurring in the future. The investigation was to be concurrent with the OSHA compliance investigation. This report represents the conclusion of the JCAIT's investigation.

1.3 Structure of Report

This report summarizes the findings, conclusions, and recommendations of the JCAIT. Section 2 presents background information on the facility and the HCl storage and filling operations. Section 3 describes the incident, including the chronology of events, the consequences of the failure of the tank, and the emergency response. Section 4 describes the investigation and the technical and causal analyses of the facts. Section 5 describes the JCAIT's conclusions about the immediate cause, the root causes, and the contributing factors that led to the incident. Section 6 summarizes the JCAIT's recommendations to Surpass, government, and industry for chemical accident prevention, and Section 7 covers other problem areas identified in the course of the investigation of the HCl tank failure.

2.0 Background

2.1 Facility Information

Surpass is located at 1254 Broadway in Albany, New York, about 1.75 miles northeast of the downtown area. The company manufactures pool chemicals and repackages chemicals and detergents. The Broadway facility is located in a light business area at the edge of a residential neighborhood.

2.2 Process Information

At the Broadway facility, Surpass repackaged 31% HCl onsite in a bottling operation into one-gallon bottles for sale as a treatment for swimming pools. In the spring, Surpass typically started receiving HCl shipments more frequently to meet demands for the swim season. Based on production reports for April, 1997, Surpass repackaged up to 12,000 gallons of HCl April 1 through April 7.

Based on purchase order records for 1995 through early 1997, Surpass received tank truck deliveries of HCl at an average rate of one to two shipments per month, with some variability due to seasonal demand. During the same period, shipments generally ranged from 4,600 gallons to 5,200 gallons (nominally 5,000-gallon orders) and were ordered from either of two suppliers, Reagent Chemical and Research, Inc. (Reagent), Middlesex, New Jersey, or PVS Chemicals, Inc.(PVS), Buffalo, New York. In April, Surpass had received two deliveries prior to the day of the incident– 5,060 gallons on April 2 from Reagent and 4,600 gallons on April 4 from PVS. Reagent was making a delivery of 4,950 gallons on the day of the incident, April 8.

(a) HCl Storage Tank

A 5,700-gallon (working capacity) fiberglass reinforced plastic (FRP)¹ atmospheric pressure storage tank was used for the bulk storage of 31% HCl at ambient temperature. The HCl storage tank was 7½ feet in diameter and 18 feet high. The tank was manufactured by Owens-Corning (model 86 MACS) and purchased by Surpass in 1978. As originally designed, the top of the HCl tank had two 3-inch diameter nozzles, a 2-inch diameter nozzle, and a 22-inch diameter manway. A 3-inch diameter nozzle was installed on the side of the tank, about 7 inches from the bottom of the tank. The manufacturer's design specifications included a caution that, if the tank was to be air loaded, it had to be vented with a minimum 22-inch diameter opening during the filling period. The manufacturer also specified that the tank pressure was not to

¹ Reinforced plastics are composites in which a resin (in this case, a phenolic resin) is combined with a reinforcing agent (in this case, glass fiber) to improve one or more properties of the plastic matrix. FRP combines the corrosion resistance of plastic with the strength of glass fiber. FRP tanks are widely used to store corrosive materials (Lees, 1996).

exceed 10 inches of water, equivalent to about 0.4 pounds per square inch gauge (psig).²

The tank was put into service in 1979 or 1980 and used for HCl storage until about 1985. It was originally located on the west side of the building and elevated about 2 to 3 feet above grade, supported by a steel stand, to permit gravity discharge of its contents. The HCl tank was splash filled from the top through the 2-inch diameter nozzle. One nozzle on the top was fitted with a vacuum breaker and the other was not in use. The tank did not have any gauge for measuring volume; the method of measuring the liquid level at that time is not known by the JCAIT. At that time, the tank had no controls for the HCl vapors. Surpass reported that the manway was loose-bolted and HCl fumes could escape through the manway. In 1985, the tank was taken out of service because fumes escaping from the tank were irritating to those downwind of the tank, and there was corrosion around the manway.

In 1988, Surpass contracted with Empire Fiberglass Products, Inc., Little Falls, New York, to make repairs, seal the manway closed (in anticipation of adding a system to control fuming), and add a 2-inch diameter nozzle in the side wall about 2 inches from the bottom of this HCl tank (in anticipation of adding a gauge). In 1989, the tank was placed back in service and installed on the southeastern side of the building, within a newly built secondary containment area. (See **Figure 1** for a schematic of the storage tank area.) The building provided two walls of containment. A dike, 4 blocks high and reinforced with steel bar, provided the other two walls. The HCl tank was elevated 8 feet above ground level, supported by a steel platform, to permit gravity discharge of its contents. Nearby, in a separate diked area, three other tanks were used for bulk storage. At the time of the incident, two of these were used to store 13% sodium hypochlorite (NaOCl). Further information on the working capacities or the inventories of these tanks was not collected by the JCAIT.

At the time of re-installation, Surpass made two additions to the HCl tank, a scrubber system and a pressure gauge adapted to indicate volume. The scrubber system was intended to reduce the quantity of HCl fumes escaping into the environment. Acid vapors generated during the filling operation were vented through two lines-- 2 and 3 inches in diameter-- that intersected at a tee and continued as a single 3-inch diameter vent line. This vent line ran from above the top of the tank and extended vertically below the HCl tank into a scrubber tank. (See **Figure 2** for a schematic of the HCl tank.) The end of the vent line was fitted with a diffuser section consisting of a connection, a 90° elbow, and an 18-inch length of 3-inch diameter plastic pipe which had been drilled with 36 holes, each 5/8-inch in diameter, and fitted with an end cap with 3 holes drilled into it (a total of 39 holes). (See **Figure 3** for a schematic of the diffuser section.)

The diffuser sat in a 50-gallon, loosely-covered plastic drum referred to as the scrubber tank. (The scrubber system is shown in **Figure 2**.) Initially, the tank was filled with sodium

²This design pressure is consistent with the design pressures commonly found for atmospheric tanks; for example, "[m]ost storage tanks are designed to withstand a gauge pressure of only 8 inches of water (0.3 psi) and will burst at about three times this pressure." (Kletz, p 91.)

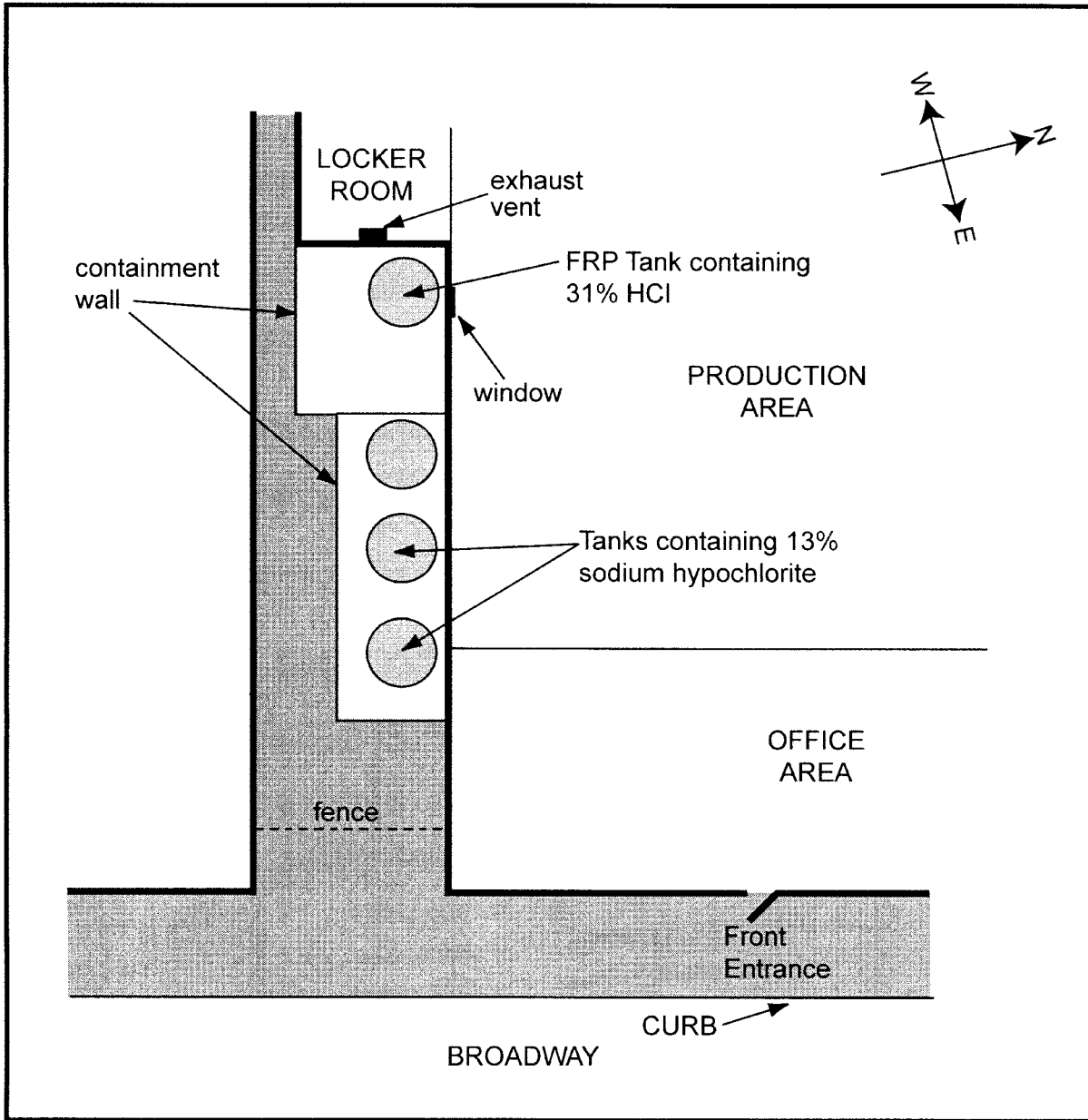

Figure 1: Layout of Tank Area (Topview)

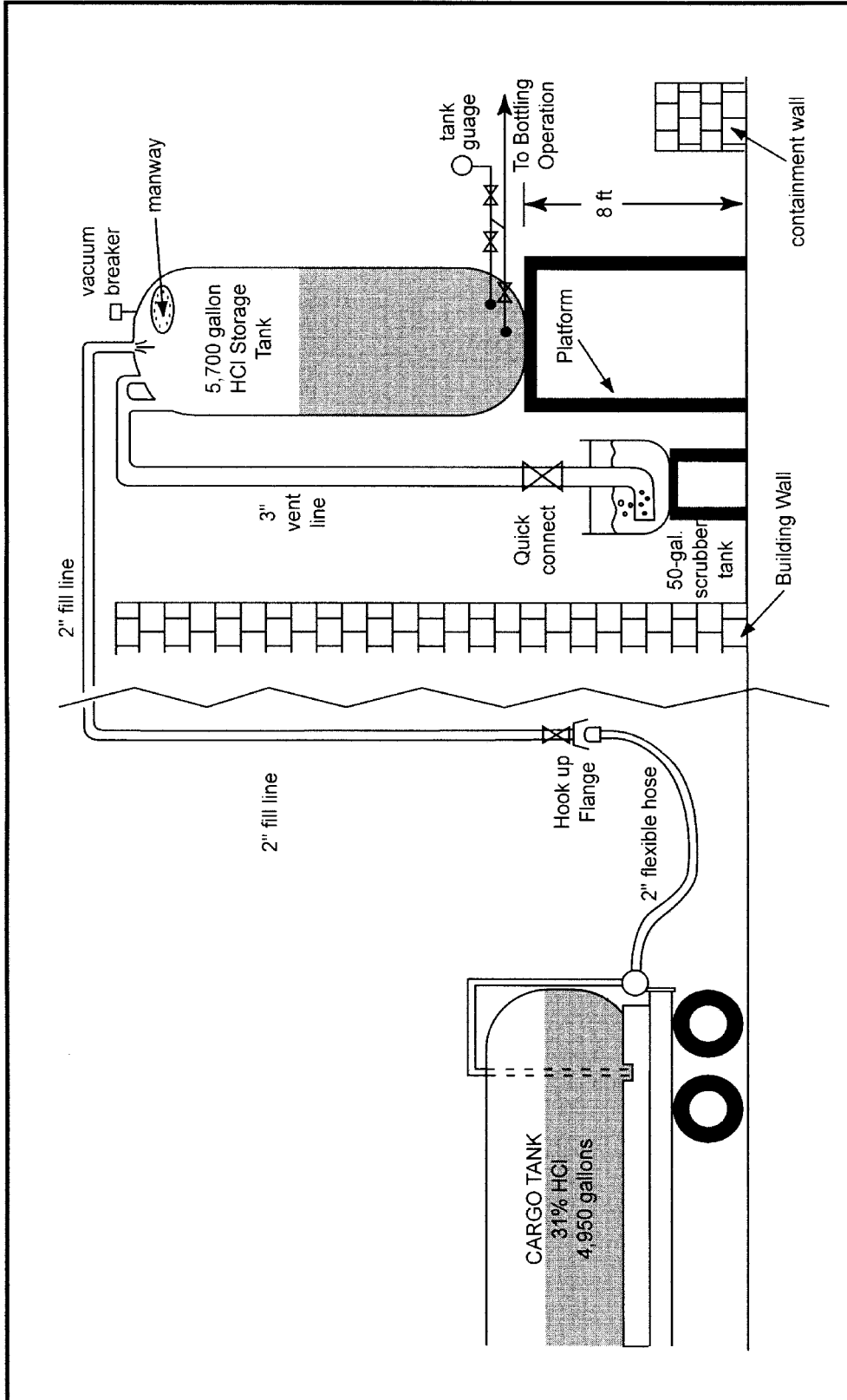

Figure 2: Representation of Offloading Operation
(not to scale)

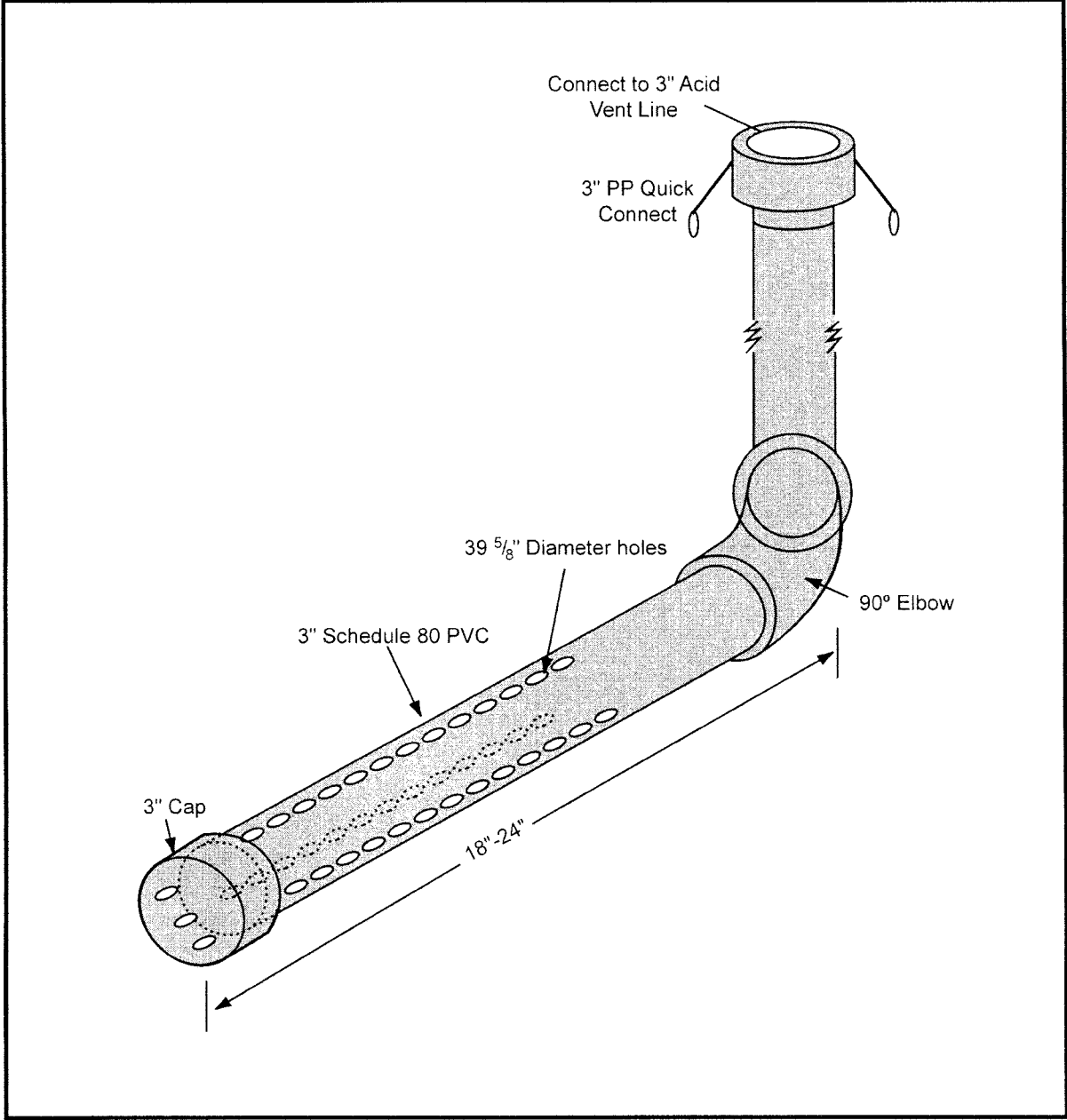

Figure 3: Diffuser Section of Vent System
(not to scale)

carbonate (Na_2CO_3) for the intended purpose of neutralizing the vented HCl acid vapors. The neutralization reaction between the Na_2CO_3 and HCl was expected to form sodium chloride (NaCl), carbon dioxide (CO_2), and water. To attain a lower freezing point in the scrubber solution, the sodium carbonate was replaced with sodium hydroxide (NaOH). A similar neutralization reaction between NaOH and HCl was expected to produce NaCl and water. Other chemical reactions in such a scrubber system are also possible. For example, carbon dioxide (CO_2) from air may react with NaOH to form Na_2CO_3 .

At the time of the incident, a NaOH caustic solution was being used in the scrubber tank. Based on interviews, the scrubber system had been last disassembled and emptied in November, 1996. At that time, Surpass reports that the scrubber solution was replaced with 15 to 20 gallons of 18% concentration NaOH.

There were no written standard operating procedures for the maintenance of the scrubber system. Maintenance required the periodic removal of NaCl, a by-product of the reaction between the HCl and NaOH, as well as monitoring of the pH of the solution to maintain basic (high pH) conditions. The general procedure for monitoring the pH of the scrubber solution was to test the solution using litmus paper following each acid delivery. If the pH was found to be below 9, one-quart bottles of either 50% or 18% NaOH were added to raise the pH. No written records of the pH monitoring were kept by Surpass. No written records were kept of the caustic additions, and it is not known how many, if any, additions were made between November 1996 and April 1997.

Surpass had little documentation on the design of the venting and scrubber system. According to interviews, the vent line was sized using a rule of thumb that the area of the discharge (outlet) vent should be at least twice the area of the inlet vent.

At the time that the HCl tank was re-installed, a pressure gauge also was installed on the HCl tank for the purpose of measuring the liquid level in the tank. The gauge was installed on the 2-inch diameter line near the bottom of the tank and was protected from corrosion by a diaphragm system. The pressure gauge measured the pressure head of liquid above the tank bottom, using a scale reportedly ranging from 0 to 15 psig. Surpass performed theoretical calculations relating the pressure head to the height of liquid in the tank and the density of HCl to develop a template displaying volume in gallons that was overlaid on the dial face. The scale ranged from 0 to 6,120 gallons and was marked off in 360 gallon increments. Surpass made a final calibration of the gauge with the first HCl delivery. Surpass believed the gauge to accurately reflect delivery amounts by plus or minus 100 gallons. Over time, the gauge was not recalibrated, as the volume readings were generally in agreement with the expected quantities of the deliveries.

To supply the bottling operation, HCl was gravity-fed from the HCl tank to a float tank in the production area that served as a reservoir for the bottling operation. The HCl tank was equipped with an air inlet check valve to allow air into the tank as it was emptied and thereby

prevent a vacuum. The original design specified that the vacuum should not exceed 4 inches of water.

(b) Off-loading Operation

A standard HCl tanker delivered the HCl shipment to Surpass. The working capacity of the cargo tank was reported to be up to 52,000 pounds, equivalent to 5,380 gallons. The bill of lading for the April 8 delivery showed that the truck contained 47,840 pounds, about 4,950 gallons of 31% HCl. To ensure that the truck is empty at the end of the off-loading operation, the cargo tank is designed with a 4-inch diameter dip tube that goes down into a sump in the bottom, rear of the cargo tank.

The tank truck used air pressure to unload the cargo tank. The use of air to off-load HCl is relatively common; one chemical supplier estimated that air off-loading is used at about 90% of its customer facilities. The cargo tank was designed for a maximum allowable working pressure of 35 psig and equipped with a pressure relief valve set at 32 psig.³ The truck was equipped with a compressor to pressurize the cargo tank. An air hose was used to connect the compressor to the air line, which was connected to the trailer tank. The air line was equipped with a pressure gauge to measure pressure on the cargo tank.

To make a delivery, the truck backed into an area on the northwest side of the building. A 2-inch diameter flexible hose was used to hook up the product discharge valve on the truck to the facility's hook-up flange for the fill line. The 2-inch diameter fill line ran vertically to the roof top and across the roof to the top of the HCl storage tank. (**Figure 2** shows the delivery set-up.)

Surpass had no written operating procedure for the off-loading of the HCl to this storage tank. By tradition, the procedure was for the facility operator, known as the unloading supervisor, to check that the HCl tank was empty and ensure that all discharge valves on the HCl tank were closed. The unloading supervisor would show the truck driver the correct hook-up flange and instruct the driver to use between 20 and 25 psig of pressure to off-load. Once the transfer began, the unloading supervisor would visually check the scrubber system for percolation, an indication to him that air was flowing through the diffuser. The unloading supervisor would periodically check the HCl tank gauge, which was calibrated for volume, and monitor the off-loading procedure. When the gauge read "5,040 gallons," the unloading supervisor would instruct the driver to shut off the compressor. The bleed-off pressure from the cargo tank would be used to push the remainder of HCl from the truck to the HCl storage tank. As the remaining liquid HCl was pushed out and replaced with air, the hose would surge or "kick," indicating that

³The U.S. Department of Transportation (DOT) regulates the transportation of hazardous materials, including the specifications for design and construction of HCl cargo tanks. Examples of these design specifications include requirements for maximum allowable working pressure; material and thickness of material; pumps, piping, hoses, and connections; and pressure relief. Title 49 of the Code of Federal Regulations (CFR) details the requirements for hazardous materials transportation.

all of the liquid had been transferred. The unloading supervisor relied solely on this hose kick as an indication that the liquid delivery was completed.

Reagent had a written standard operating procedure (SOP) for driver unloading. This procedure included having the customer identify the correct hook-up flange; hooking up the flexible hose from the cargo tank to the hook-up flange; opening the facility's product valve; pressurizing the cargo tank to about 10 psig; and opening the product discharge valve. During the unloading, the driver is expected to monitor the tank pressure using the gauge. The SOP warns that tank pressure is not to exceed 30 psig at any time during transfer. When the tanker is empty, the driver is expected to ensure that the hose is clear of material. The driver is also expected to check with the facility as to the procedure for bleeding off the pressure from the tanker.

2.3 Chemical Information

The chemicals involved in the April 8th release were hydrochloric acid (HCl) in aqueous solution, sodium hypochlorite (NaOCl), also in aqueous solution, and chlorine, generated by the reaction between HCl and NaOCl. Information on each of these substances is presented below.

Hydrochloric acid

Aqueous HCl is a solution of hydrogen chloride (a gas under ambient conditions). Aqueous HCl is a strong acid. It is corrosive and can cause severe eye and skin burns. Hydrogen chloride fumes can be released from aqueous HCl; the amount of fuming depends on the concentration of the solution and conditions such as temperature. The fumes are irritating to the skin, eyes, and respiratory system.

HCl is a versatile chemical that has a number of different industrial uses, including production of chlorides, ore refining, as a laboratory reagent, as a catalyst in chemical production, and etching and cleaning metals.

The most generally shipped solutions of HCl are 20 degrees Baume' ($^{\circ}\text{Be}'$)⁴, equivalent to 31.45% HCl; 22 $^{\circ}\text{Be}'$ (35.21% HCl) and 23 $^{\circ}\text{Be}'$ (37.14% HCl) (Chlorine Institute, 1996). The solution shipped to Surpass for repackaging was 20 $^{\circ}\text{Be}'$. The density of 20 $^{\circ}\text{Be}'$ HCl is approximately 9.671 pounds per gallon at 60°F.

Aqueous HCl is reactive with a number of substances. It reacts with most metals to

⁴The Baume' hydrometer scale is a calibration scale for indicating the specific gravity at 60 °F (15.6 °C) of some liquids in commerce. Baume' is abbreviated as Be', and the reading on the scale is degrees Be' ($^{\circ}\text{Be}'$). For liquids heavier than water, 0 $^{\circ}\text{Be}'$ corresponds to a specific gravity of 1.000 (i.e., the density is equal to the density of water). Specific gravity is calculated as $145/(145 - ^{\circ}\text{Be}')$ at 15.6°C. 20 $^{\circ}\text{Be}'$ corresponds to a specific gravity of 1.16 (Handbook of Chemistry and Physics, 1989).

release flammable hydrogen gas, and it reacts with strong oxidizers to release toxic chlorine.

Sodium hypochlorite

NaOCl is a solid in pure form, but is not very stable as a solid; it is generally produced and used in water solution. Aqueous solutions of NaOCl are used as bleach or disinfectant. The aqueous NaOCl solution stored onsite at Surpass was 13.25% concentration.

Aqueous solutions of NaOCl are fairly stable, but are subject to some decomposition, depending on factors such as concentration, pH, temperature, light, and impurities. The major decomposition products are oxygen and chlorate ion (ClO_3^-). If NaOCl is mixed with acid, hypochlorous acid (HOCl) is formed. HOCl is much less stable than NaOCl and will undergo decomposition reactions forming oxygen, chloric acid (HClO_3), and chlorine. Decomposition to chlorine involves a reversible reaction between HOCl and HCl (an intermediate decomposition product). If HOCl is mixed with large amounts of HCl, the reaction will proceed primarily in the direction of chlorine formation, and chlorine will be generated (Kirk-Othmer, 1993).

NaOCl is a strong oxidizer. NaOCl solutions are corrosive, and exposure to solutions can cause irritation to the eyes, mucous membranes, and skin.

Chlorine

Chlorine, which was produced in the reaction between HCl and NaOCl, is greenish-yellow gas with a suffocating odor. It is poisonous and corrosive. Exposure to relatively low concentrations may cause stinging or burning of the eyes, nose, throat, and chest. Exposure to high concentrations can result in death.

3.0 Description of the Incident

3.1 Chronology of Events

- ◆ 1978 HCl tank was purchased by Surpass.
- ◆ 1979 (estimated) HCl tank was installed at original location.
- ◆ 1985 (estimated) HCl tank was taken out of service.
- ◆ 1988 HCl tank was repaired and modified under contract to Empire Fiberglass Products, Inc. in order that Surpass could place it back into service. At this time, the 22-inch diameter manway was permanently bolted closed.
- ◆ Spring 1989 The HCl tank was installed in the spring. A pressure gauge, modified to read volume by affixing a template on the dial, was installed on HCl tank for the purpose of monitoring the liquid level in the tank. (See Section 2 of this report for additional details.) Additionally, a scrubber system was added to reduce HCl fumes.
- ◆ November 1996 Based on interviews, the scrubber system was cleaned out in November and the solution replaced with 15 to 20 gallons of 18% NaOH.
- ◆ Nov. 1996 to April 1997 5,000-gallon deliveries of 31% HCl were received by Surpass at a rate of 1-2 deliveries per month.
- ◆ April 7 1997
 - 6:30 a.m. Started bottling HCl from the storage tank. Time based on production report.
 - (time not known) The bottling operator drew off HCl from the lowest nozzle on the storage tank until no more product would gravity feed. The volume gauge also read zero.
 - (time not known) To continue with the bottling operation, Surpass ordered a 5,000-gallon shipment of 31% HCl from Reagent for delivery the next day.
 - 4:50 p.m. The Reagent tanker was loaded at Standard Chlorine of Delaware, Inc. The bill of lading stated that 47,840 pounds of 31% HCl were

loaded. Time is based on bill of lading.

◆ April 8 1997

- 7:15 a.m. The tank truck arrived at Surpass to deliver 47, 840 pounds (equivalent to 4,950 gallons). Time based on witness interview.
- 7:30 a.m. This was the truck driver's first delivery to Surpass. The driver asked about unload air pressure. The unloading supervisor stated that unload pressure should be 20 to 25 psig. Unloading supervisor also told driver that it would take approximately 1½ hours to unload, including hooking up and disconnecting the product hose. Time is estimated.
- (time not known) The unloading supervisor reportedly walked to the HCl tank and checked that the discharge valves on the HCl tank were closed.
- 7:40 a.m. The unloading supervisor reportedly walked back to the truck. Tanker started off-loading HCl to the storage tank using air compressor. Time based on witness interview.
- (time not known) The unloading supervisor reported that he checked scrubber tank and observed percolating in the scrubber, an indication to him that the vent line and diffuser were open and operating.
- 7:50 a.m. The unloading supervisor told bottling operator that he could start drawing off HCl. Per the bottling production report, the bottling operator began drawing off HCl from the HCl storage tank to the reservoir for the bottling operation. The bottling operation continued until the HCl tank failed. Time is based on production report.
- 8:55 a.m. The unloading supervisor noted that the volume gauge read 5,040 gallons and reported this to the driver. According to the truck driver, the compressor for the tank truck was turned off about 1 hour and 15 minutes into the delivery. At the time that the compressor was stopped, the pressure gauge on the cargo tank was reported to have read 20 psig. Both the unloading supervisor and the driver reported picking up the product hose line after the compressor was turned off and that the hose felt heavy, indicating to each of them that liquid was still in the line. Within 1-2 minutes, it was reported that the pressure in the cargo tank of the truck drops to about 18 psig. Time is estimated based on witness

recollections of how long after these events the rupture occurred.

8:59 a.m. Approximate time of vessel rupture.

The unloading supervisor instructed the truck driver to shut the unloading valve on the tank truck. Truck driver reported that the pressure gauge on the cargo tank read 16 psig after the rupture.

9:01 a.m. First of several emergency 911 phone calls was placed.

3.2 Consequences of the Incident

The HCl tank head separated at a point about 5 feet from the top of the tank and flew about 15 feet west to the roof of an adjacent building. **Figure 4** shows the separated tank after the incident, and **Figure 5** shows the top of the tank. The bottom of tank failed in the knuckle area where the cylindrical part of the HCl tank meets the flat bottom, as shown in **Figure 6**. The tank bottom remained on the platform. The cylindrical part of the fiberglass shell began to unwind itself at the top edge (see **Figures 4 and 5**). The shell also remained on the platform but collapsed, leaning toward the west building wall (see **Figure 6**). The scrubber tank was not affected by the tank failure; it was found intact in its original position after the incident, as shown in **Figure 7**.

At the time of rupture, the HCl tank contained about 4,800 gallons of material. The failure of the HCl tank caused a sudden surge of liquid over the secondary containment wall. The force of the liquid also caused a break in the masonry of the secondary containment wall. Surpass has estimated that as a result of this release, about 150 gallons were absorbed by soil within the property boundary and about 2,300 gallons entered storm drains located on Broadway. The storm drains emptied into an underground stream, the Patroon Creek, a tributary of the Hudson River. Surpass also estimated that 1,900 gallons were contained within the secondary containment dike and that 400 gallons entered a nearby building through a window in the north wall and through an exhaust fan in the west wall.

During the event, a 2-inch diameter NaOCl line that was located in proximity to the HCl tank was broken, and an estimated 200 gallons of NaOCl was released into the secondary containment. The JCAIT believes that a reaction occurred between the two chemicals, causing the generation of chlorine gas. Witnesses described seeing greenish-yellow fumes (assumed to be chlorine) drifting offsite, as well as liquid material running offsite and along the street curb to the storm drains.

As a consequence of the incident, 8 workers and 32 members of the public were taken to the hospital, treated, and released. A ten-block area, including nearby businesses and residences, was evacuated.

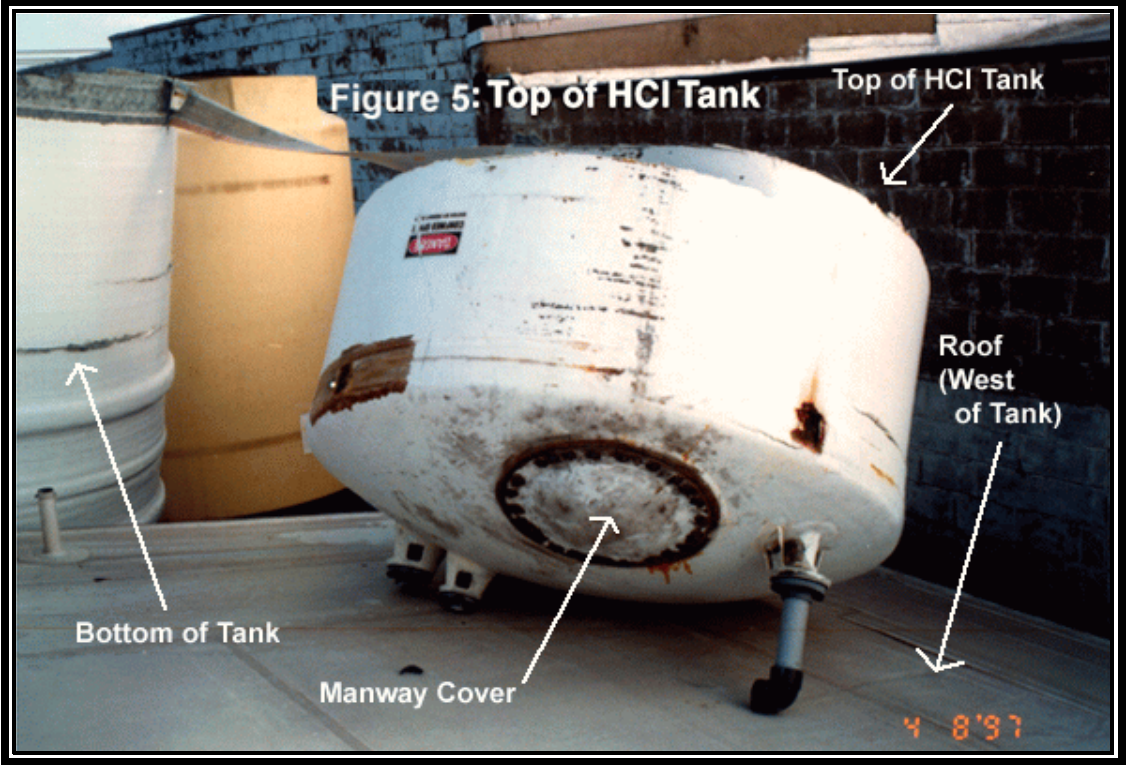
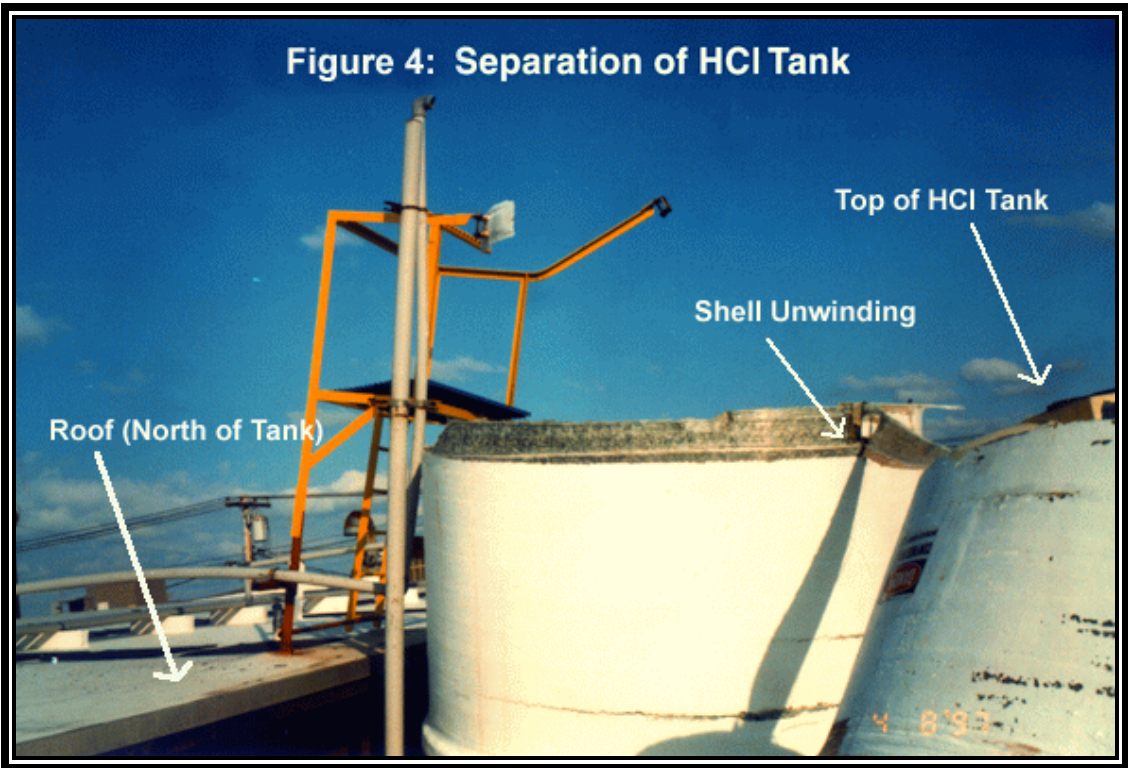

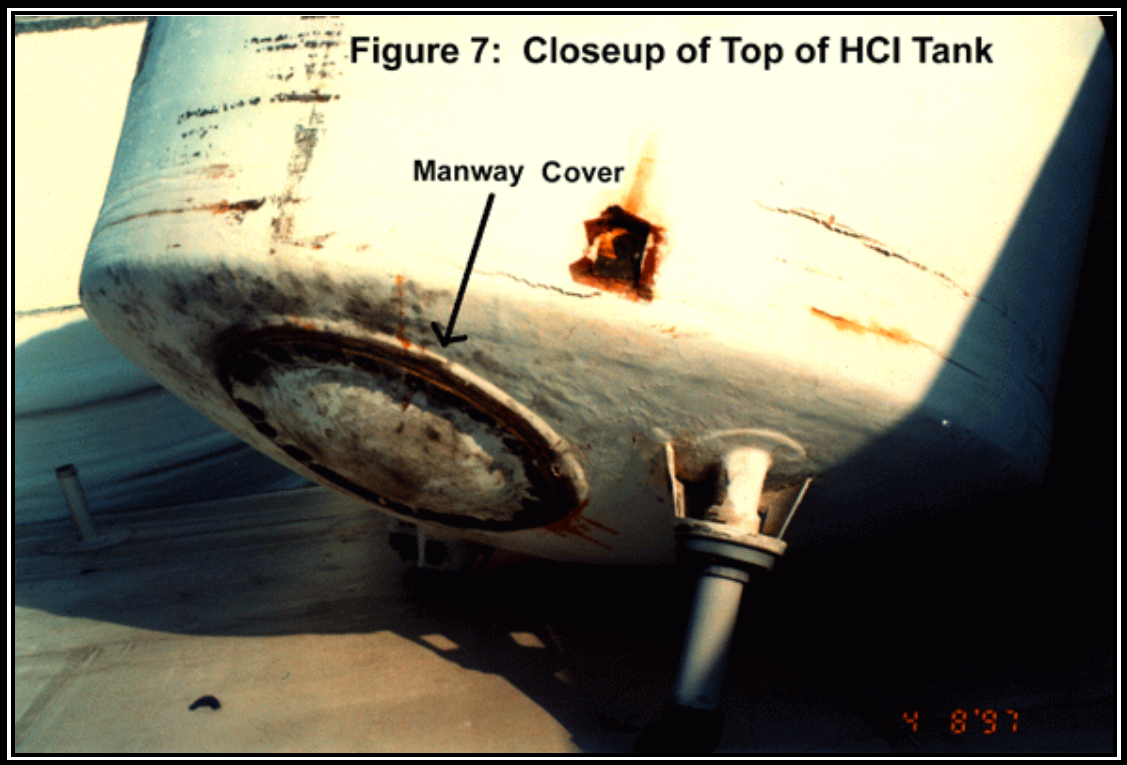
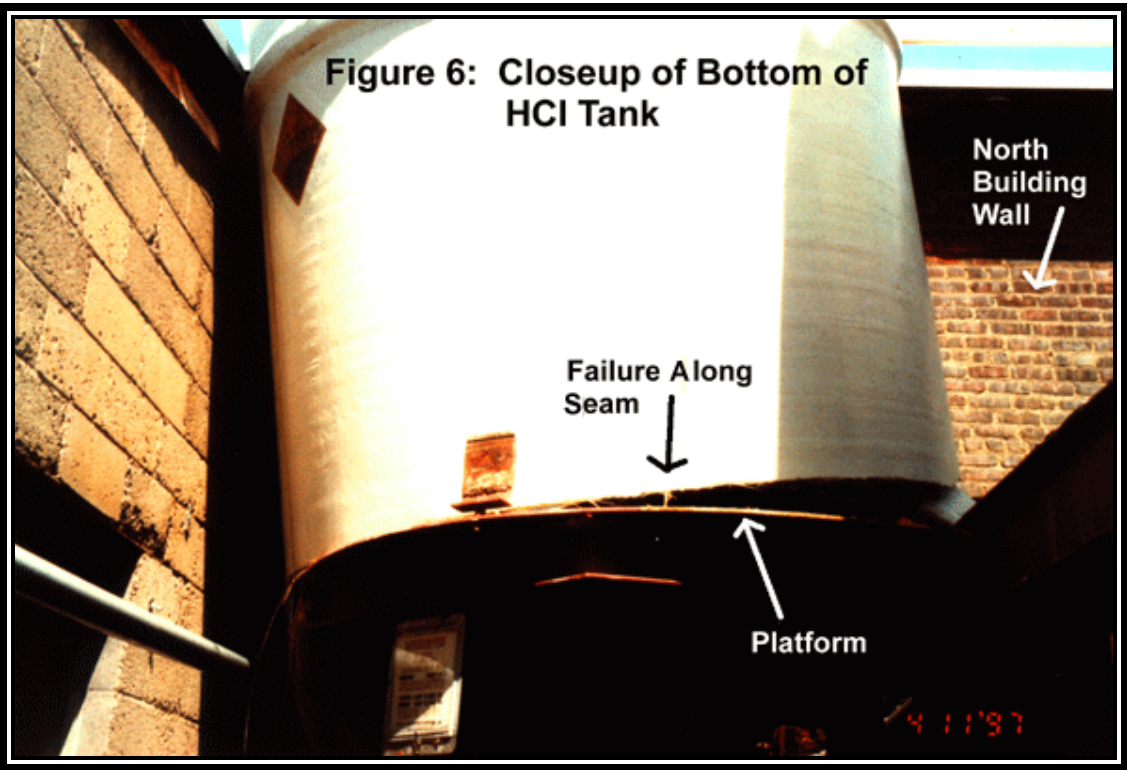

3.3 Description of the Emergency Response

The JCAIT did not collect in-depth details about or evaluate the emergency response actions, but a brief overview is provided here.

Employees from Surpass's Broadway facility, where the incident occurred, and another Surpass facility on Bridge Street, Albany, New York, responded to the incident. The Albany Fire Department and other local and state officials responded to the emergency. The local sewer authority tested the pH at the confluence of the stream and the Hudson River.

Federal officials, including representatives from OSHA's Albany, New York, Area Office and U.S. EPA Region 2, responded by afternoon on the day of the incident. The OSHA compliance officers entered areas of the facility where the HCl had been released to collect samples and gather preliminary information from the employees and managers. The EPA on-scene coordinator also entered areas of the facility where chemicals had been released to assess the extent of the release, to take photographs, and to monitor the response and recovery activities performed by contractors hired by Surpass.

4.0 Analysis and Significant Facts

On April 21, 1997, the JCAIT formally met with the OSHA compliance team to begin collaborating on the collection of evidence, the formal request for documents, interviews of employees and managers, and other field work. Additionally, the JCAIT arranged for a demonstration of the off-loading procedures by the chemical supplier as part of the field work to support the investigation.

At this preliminary stage of the investigation, the main failure scenarios considered by the JCAIT were (1) overfilling with liquid; (2) overpressurization due to a blockage in the vent line or diffuser; and (3) overpressurization due to undersizing of the vent to handle the pressure bleed-down of the tanker.

A material balance based on company records was consistent with testimony that the HCl tank was essentially empty prior to the delivery and the empty tank had the volume capacity to receive the delivery. Additionally, the failure mode of the tank, the force associated with the damage, and witness accounts are consistent with a pneumatic failure. Thus, the JCAIT focused on overpressurization of the HCl tank and the role of the venting/scrubber system in the event. The JCAIT did not consider material failure of the HCl tank given the circumstances of the incident and the force associated with the failure mode.

4.1 Significant Facts

The facts considered by the JCAIT in determining the causes of the incident are listed below:

- The HCl tank truck that arrived at Surpass to make a delivery had a shipment of 4,950 gallons. The bill of lading for the delivery stated that 47,840 pounds of 31% HCl, equivalent to 4,950 gallons, were loaded onto the tank truck on April 7.
- On the morning of the incident, before the off-loading of the tank truck began, the HCl storage tank was empty, as indicated by the following:
 - The inventory at the end of March indicated that the HCl tank contained approximately 2,300 gallons. During April, prior to the day of the incident, Surpass received 9,660 gallons of HCl and bottled 11,680 gallons. The accumulation in the storage tank based on these values is 280 gallons. Within the accuracy of the gauge readings, this would indicate that the tank was empty.
 - The bottling operator reported drawing down the tank on April 7 to empty it by opening both the 3-inch diameter and the 2-inch diameter discharge lines located near the bottom of the tank.
- The HCl tank had a working capacity of 5,700 gallons.
- The heel in the empty HCl tank has been calculated by Surpass to be in the range of 75 to 100 gallons.⁵
- According to the bottling production report, 288 gallons of HCl were bottled on the morning of the incident, during the period of time between the beginning of the delivery and the HCl tank rupture.
- Prior to the rupture, pressurized air was entering the HCl tank from the pressure bleed-off of the tanker, as indicated by the following:
 - One witness reported that after the incident, while the truck was still at the site, he opened the manway on the top of the truck to look inside and observed that the cargo tank was “bone dry.” Reagent also reported that the truck was empty. This indicates that the entire delivery of 4,950 gallons was transferred out of the tanker and into the HCl storage tank.

⁵The heel is the amount of residual that cannot be withdrawn from the bottom of the tank by normal emptying procedures. The estimate of the volume of the heel is based on the cross-sectional area of the HCl tank and the height of the lowest product discharge nozzle.

- The vertical hard piping from the tank truck hook-up to the storage tank was inspected by OSHA after the incident and found to be essentially empty, indicating that the last material through the hard piping was air and further supporting the finding that all of the HCl had been transferred into the storage tank prior to the rupture.
- The pressure gauge on the tanker was reading accurately. The tank truck was inspected by New York State Department of Transportation (DOT) on April 9, 1997, and OSHA verified that the reading on the truck's pressure gauge was reading accurately.
- The HCl tank ruptured into three pieces, as described in Section 3.2.
- The manway on the tank top was sealed shut, and the only way for vapor to escape from the tank was through the vent line. (See **Figure 7**.)
- The scrubber tank was not affected by the tank failure; it was found intact in its original position after the incident. (See **Figure 8**.)
- After the incident, the diffuser in the scrubbing tank was removed by disconnecting the vent line quick connect and removing the lid from the scrubber tank. The holes in the diffuser were found to be clogged with a white crystalline substance, as shown in **Figure 9**. This substance was sodium chloride, according to laboratory analysis.
- A layer of white crystalline material was also found in the bottom of the scrubber tank. This substance also was sodium chloride, according to laboratory analysis.

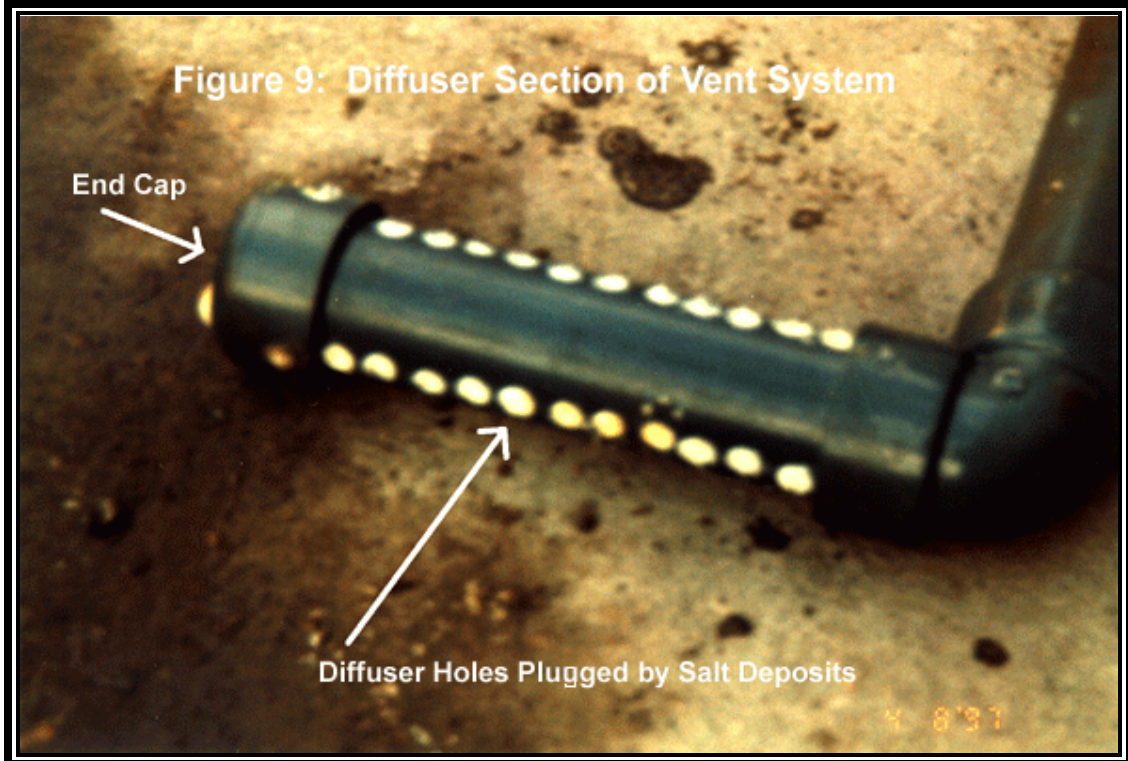
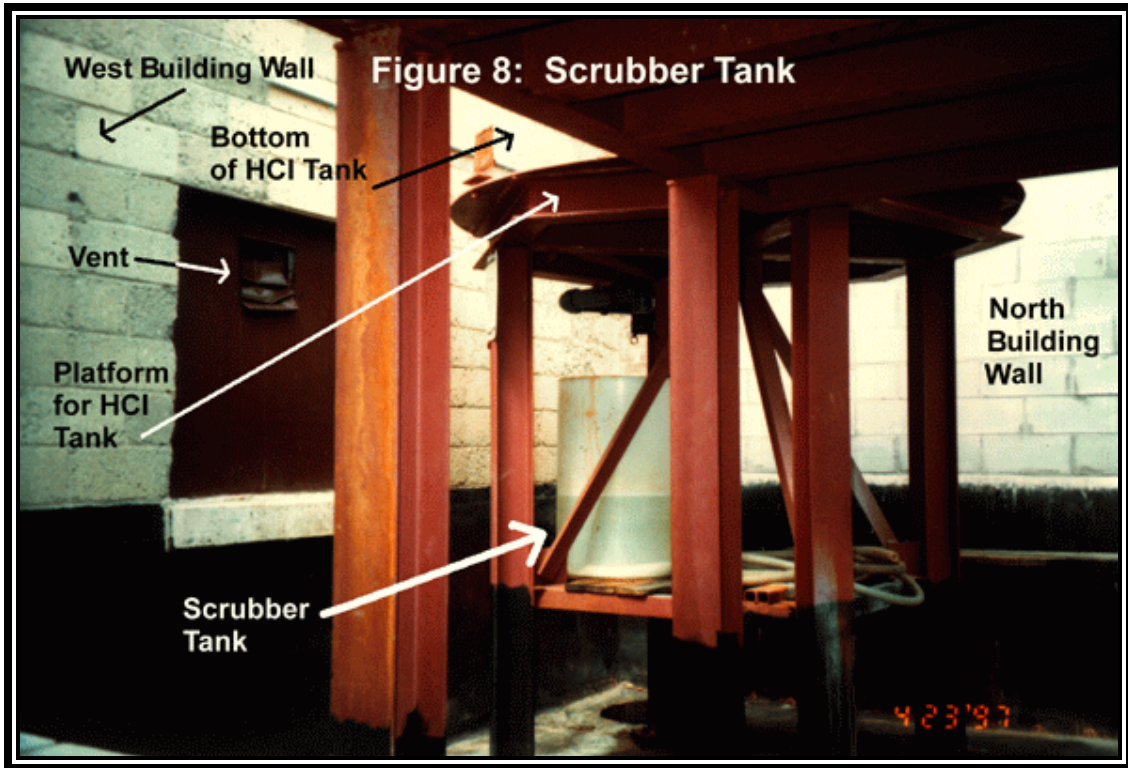

4.2 Analysis

Based on visual observations of the fragmentation of the HCl tank and consideration of the force that would be required to cause the observed damage, the JCAIT determined that the tank failure was due to overpressurization with compressed air rather than to overfilling with liquid. Failure from overpressurization involves a higher energy release than failure from overfilling with liquid, and the damage resulting from the failure of the tank is consistent with higher energy release. In addition, the tank was empty before the delivery of the HCl began and had sufficient capacity to contain the delivery, therefore, overfilling with liquid is unlikely. Given the circumstances of the incident, the JCAIT believes that the failure of the HCl tank was not due to age, wear, or defective materials.

4.2 (a) Venting System Calculations

As discussed above, the JCAIT decided to focus on the overpressurization of the HCl tank and the role of the venting/scrubber system in the event. The JCAIT believed that overpressurization was due to either blockage of the diffuser openings with NaCl or to undersizing of the vent. In order to predict whether blockage in the diffuser or undersizing of the vent was the more likely cause of the overpressurization, the JCAIT's contractor developed a profile describing the change in pressure in the space above the liquid in the storage tank during the HCl delivery operation. Based on the analyses, the JCAIT found that the configuration of the vent/scrubber system, including the sealing of the manway, led to the operation of the HCl tank above the manufacturer's design specifications during the normal air off-loading of deliveries. The fouling of the diffuser over time led to the further increase in tank pressure and ultimately to the failure of the tank. The analysis is summarized here; the consultant's report, describing the analysis in detail, appears in **Appendix D**.

General Description

In general, when liquids are transferred into atmospheric storage tanks fitted with an open vent, the volume of the head space above the liquid level is reduced, increasing the tank pressure momentarily. The increased pressure causes the displacement or flow of vapor from the storage tank to the atmosphere in order to equalize the tank pressure with atmospheric pressure. The liquid fill rate and the vapor flow rate must be equal to ensure that negligible tank pressure builds over time.

In this case, however, the storage tank was not fitted with an open vent to the atmosphere. Instead, the vent line ran to a diffuser that was submerged in an NaOH solution in a scrubber tank. The hydrostatic pressure of the solution in the scrubber tank created a backpressure, which prevented displaced vapors from flowing through the diffuser until the tank pressure exceeded the hydrostatic head. For a period of time while liquid was being transferred, pressure built up in the HCl tank. Once the tank pressure exceeded the hydrostatic head, vapor flow out of the diffuser began. The flow rate of vapor was a function of the tank pressure, the backpressure from the

scrubber solution, and any pressure losses (for example, friction losses in piping or resistance in fittings).

The rate of liquid flow into the tank was a function of the pressure in the cargo tank of the truck, the differential pressure head created by pumping liquid from the truck to the top of the HCl tank, the backpressure created by the pressure within the HCl tank, and the dimensions (length and inner diameter) of the fill line and hose.

At the end of the transfer, as the cargo tank was emptied of liquid, a point was reached at which pressurized air from the cargo tank of the truck flowed into the HCl storage tank.

Modeling

A computer model was created to analyze the pressure profile of the HCl tank during the off-loading operation and to evaluate the effects of the HCl tank's design features on the pressure within the tank. (See **Appendix D** for details.) The analysis of the pressure in the HCl tank is based on an unsteady state mass balance calculation routine.

To bracket the potential peak pressure in the HCl tank during the off-loading, two scenarios were modeled:

- (1) Unrestricted flow, assuming no fouling of the 5/8-inch diameter diffuser openings; and
- (2) Restricted flow, assuming that all of the diffuser openings are reduced to a 1/4-inch diameter because of fouling (about 84% reduction in the cross-sectional area).

The HCl tank pressure as a function of time, calculated by the model, is presented in **Figure 10** (for unrestricted flow) and in **Figure 11** (for restricted flow).

The model assumes that the HCl storage tank was at atmospheric pressure prior to the off-loading of the HCl. The submersion of the diffuser in the scrubber solution resulted in a backpressure equal to the hydrostatic pressure of the solution, estimated to be 0.6 psig. It was assumed that no vapor flow occurred out of the diffuser until the pressure within the HCl storage tank exceeded this superimposed backpressure.

As the off-loading began, delivery of the liquid into the HCl tank pressure decreased the tank's void volume. The combined effect of no vapor flow out through the diffuser and the decreased void volume was to increase the HCl tank pressure. The model predicts that the HCl tank pressure increased until it exceeded 0.6 psig. Note that this is above the design pressure of 0.4 psig for the tank. Once the backpressure was exceeded, vapor flow out of the diffuser would have begun. This point is marked as point A on **Figures 10 and 11**. The rate of liquid flow into the HCl tank determined how quickly the tank pressure rose from atmospheric to the predicted value of 0.6 psig. For both scenarios, the rate of liquid flow into the HCl tank was the same since

the parameters of the off-loading are fixed by the known facts and circumstances of the off-loading operation on April 8, namely, that 4,950 gallons of HCl were delivered; the HCl delivery took approximately 80 minutes; the fill line and the flexible hose were 2 inches in diameter (nominal); and that the pressure on the cargo tank of the truck was up to 25 psig. (These parameters have been previously discussed in sections 2.2(a) and 3.1 of this report.)

Assuming that both the cargo tank pressure and the diffuser backpressure remain relatively constant, the pressure in the HCl tank remains constant at a predicted value of 0.6 psig throughout the delivery of liquid.

Throughout the delivery of the liquid to the HCl tank, the pressure of the liquid discharged to the top of the HCl tank is reduced below the pressure of the cargo tank by both the line pressure drop and, more significantly, the change in the liquid head. At the end of the delivery, as all the liquid in the cargo tank is evacuated, the effect of the change in the liquid head is quickly eliminated as the liquid in the line is evacuated and displaced with vapor. At this point (labeled B on **Figures 10 and 11**), the HCl tank pressure is predicted to increase rapidly as the pressure within the cargo tank is relieved into the HCl tank. The net pressure in the tank is a function of the flow of pressurized air into the tank and the rate of vapor flow out of the diffuser.

The rate of vapor flow out of the tank through the diffuser was modeled as a function of tank pressure and the diffuser backpressure and represented by flow calculations for compressible fluids through an orifice. The pressure drop associated with the flow of the vapor through the 3-inch diameter vent line would have further restricted flow, however, this factor was considered negligible for the purposes of this modeling. The difference in the two scenarios becomes evident in this portion of the pressure profile because the assumed available flow area through the diffuser differs. The peak pressure in the HCl tank is dependent on the flow area of the diffuser.

For the unrestricted scenario, of unobstructed flow through the diffuser, the HCl tank pressure is predicted to peak at 3.4 psig. For the restricted flow scenario, assuming fouling of the diffuser openings, the pressure could have peaked as high as 12 psig. These peaks are represented as point C on **Figures 10 and 11**.

4.2(b) Tank Failure Pressure

The exact pressure that caused the tank failure was not estimated. Because FRP composite structures are not homogenous; the design and manufacture of tanks varies with the manufacturer; and the original design calculations were not available, the exact pressure at which the tank would have failed cannot be readily predicted from the known facts. The modeling of the pressure profile in the HCl tank predicted a peak pressure of 3.4 psig during the off-loading, under normal operation of the scrubber. Although this predicted value is significantly above the design specifications of the HCl tank, the prior use of the tank in this service indicates that it did not exceed the yield point for the tank. Additionally, the diffuser was found to be plugged, potentially raising the pressure to 12 psig, well beyond the normal operation peak.

Figure 10
 Modeled HCl Storage Tank Pressure
 Scenario: No Fouling of Diffuser Openings

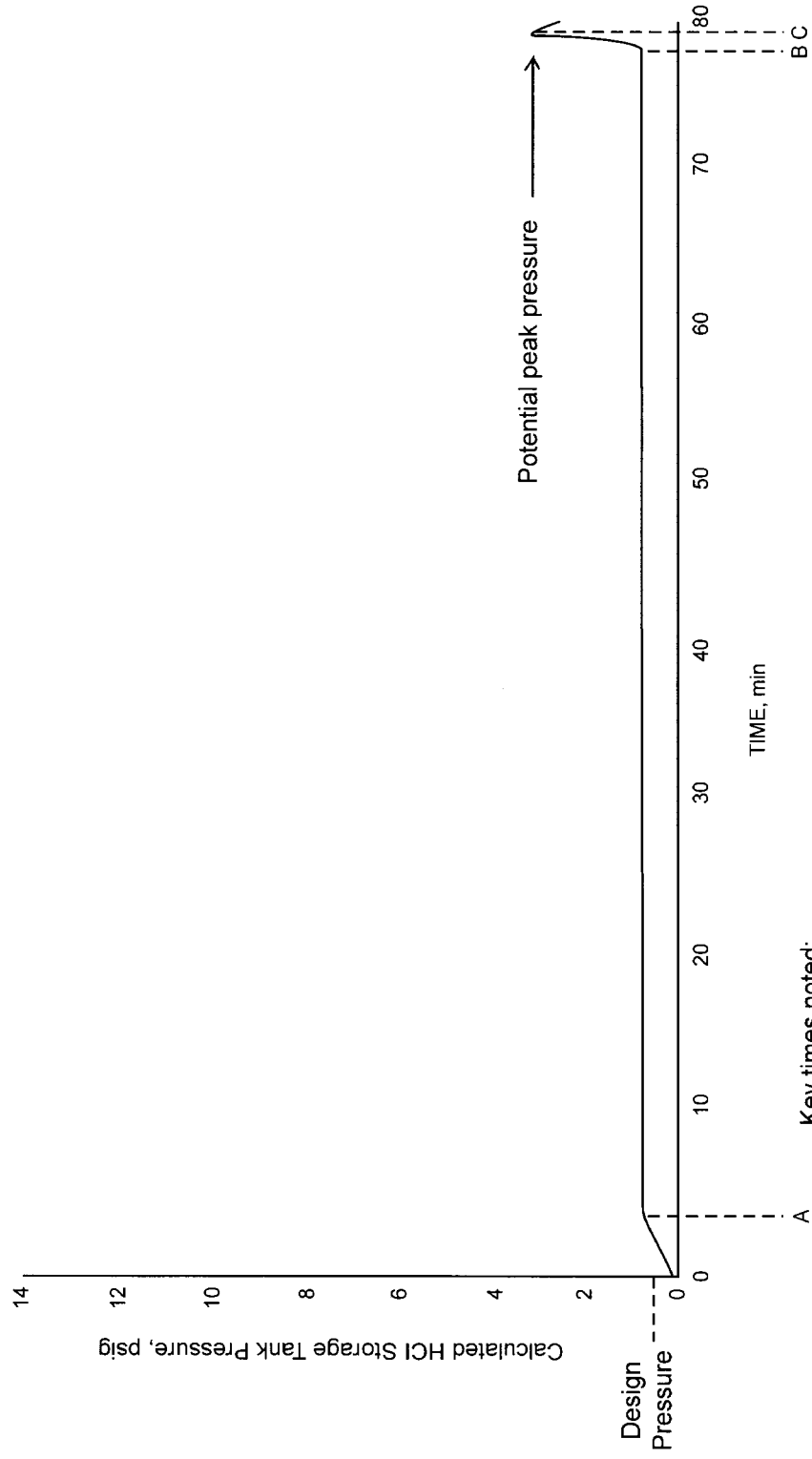

Key times noted:
 A - HCl storage tank pressure exceeds hydrostatic pressure of solution in scrubber tank.
 B - Pressurized air from truck's cargo tank flows into HCl tank.
 C - Potential peak pressure as modeled for scenario.

Figure 11
 Modeled HCl Storage Tank Pressure
 Scenario: 84% Fouling of Diffuser Openings

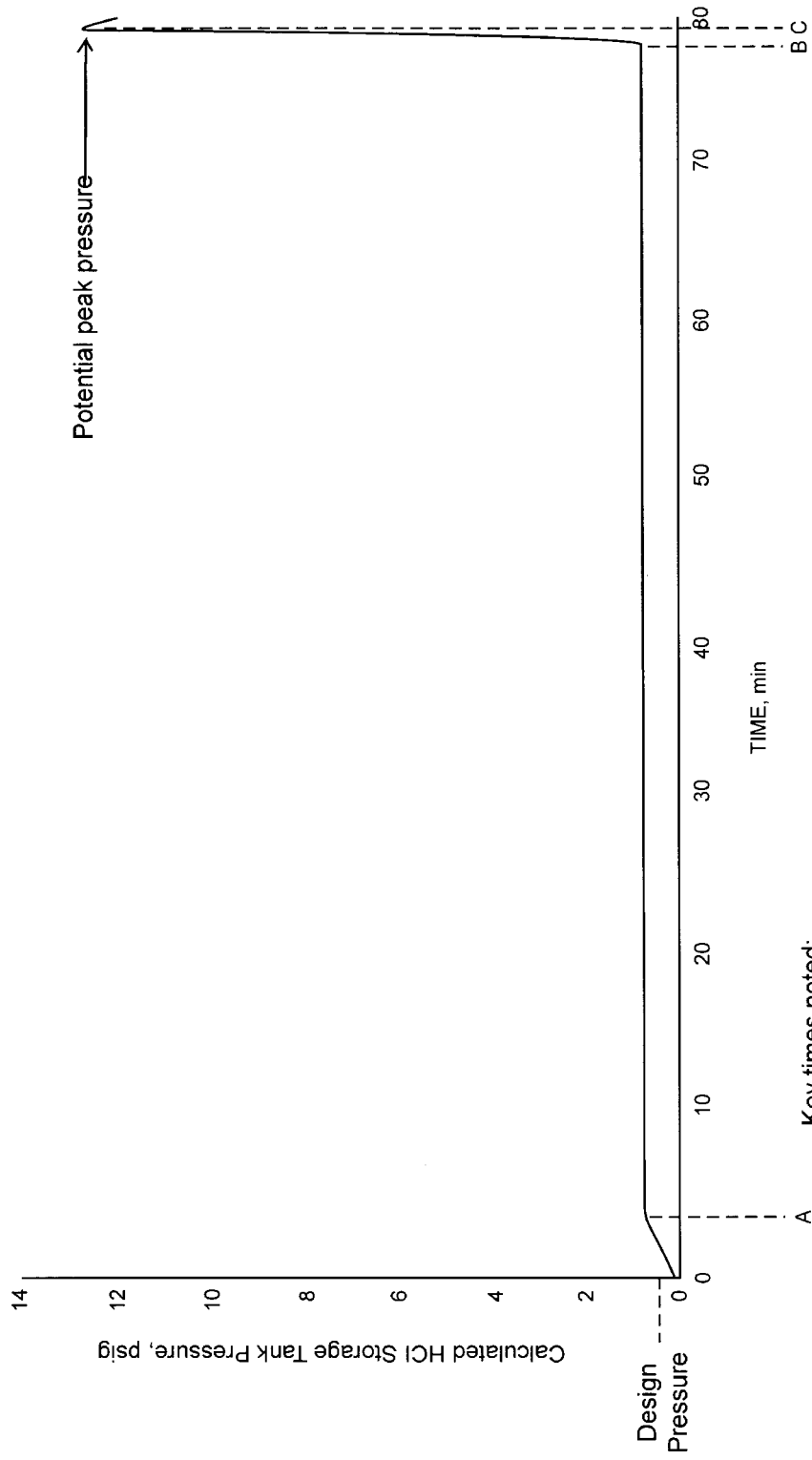

Key times noted:
 A - HCl storage tank pressure exceeds hydrostatic pressure of solution in scrubber tank.
 B - Pressurized air from truck's cargo tank flows into HCl tank.
 C - Potential peak pressure as modeled for scenario.

5.0 Conclusions

For the purpose of maximizing the lessons learned, the JCAIT considered both the root causes and contributing factors in developing the recommendations. Root causes as defined in the EPA/OSHA memorandum of understanding (MOU) are the underlying prime reasons, such as failure of particular management systems, that allow faulty design, inadequate training, or deficiencies in maintenance, which in turn lead to an unsafe act or condition and result in an incident. Contributing factors are reasons that, by themselves, do not lead to the conditions that ultimately caused the event; however, these factors facilitated the occurrence of the event.

The JCAIT developed an events and causal factors chart (that is the basis of the chronology presented in Section 2) and used a root cause tree approach that covered both the equipment and human performance root causes. This type of methodology provides a standard set of root causes for investigators to evaluate and provides for a consistent and methodical approach to be used by all the investigators.

5.1 Causes

The configuration of the vent/scrubber system, including the sealing of the manway, led to the operation of the HCl tank above the manufacturer's design specifications during the normal air off-loading of deliveries. The fouling of the diffuser over time led to the further increase in tank pressure and ultimately to the failure of the tank.

5.2 Root Causes and Contributing Factors

The JCAIT concludes that the root causes of the incident are:

- Modifications (the sealing of the manway and the addition of the scrubber system) to the venting of the HCl tank were not within the tank manufacturer's specifications for venting.

These modifications provided inadequate venting for the air off-loading according to the tank manufacturer's original design specifications, and eliminated any emergency relief of the vessel in the event that it was overpressurized.

- No hazard analysis of the modifications to the venting of the HCl tank was performed.

Surpass did not review the design of the modifications for the venting of the tank (sealing the manway and adding the scrubber) to assess whether these changes would lead to an overpressurization. An evaluation of the changes in the design of the HCl tank using tools such as management of change (MOC) would likely have identified the hazard of overpressuring the tank during air off-loading of HCl

deliveries under normal or expected conditions. The air pressure capability of the tanker far exceeded the design pressure of the HCl tank. A formal analysis of the process hazards would have identified the need to ensure that the pressure from the tanker was not directly delivered to the HCl tank.

- Inadequate preventive maintenance of the scrubber system.

Inadequate maintenance permitted the diffuser section to become clogged with solids, further reducing the scrubber's capacity to vent the pressure buildup in the HCl tank. Surpass had no written procedure for maintaining or inspecting the scrubber system. Maintenance procedures would have been improved by developing detailed procedures for testing and adjusting the scrubber solution-- including the frequency of tests, the parameters (pH, specific gravity, etc.) to be measured, and the acceptable range of those parameters. Maintenance results should be documented in order to provide a historical basis for revising the procedures.

The JCAIT concludes that the contributing cause to the incident is:

- Lack of a written standard operating procedure (SOP) for air off-loading of deliveries to the HCl tank, including an inadequate method for determining that the delivery was complete.

Surpass had no written procedure for off-loading material from the delivery truck to the HCl tank. While Surpass has procedures that have evolved over time based on the experience of its employees, documenting those procedures in writing will ensure that all employees perform similar tasks and procedures in a consistently safe manner. Additionally, written procedures can be made available for ready reference and can be used in the training of new employees.

The written procedure should include the elements of the non-written, traditional procedure such as step-by-step descriptions of tasks, definitions of the safe operating limits, and additional precautions. The SOP would be improved by addressing certain elements in more detail including, the pressure bleed-off of the cargo tank; checking the operation of the scrubber system; and the issue of simultaneous filling and drawing off to the production area. As part of the SOP, clear and definitive process displays must be used so that the operator can easily recognize system errors.

Surpass's reliance on informal methods of determining that the HCl delivery was complete could permit errors by the operators. The operator relied on a pressure gauge modified to read volume to monitor the end of the delivery. The device did not readily permit the operator to detect a potential error, such as

overpressurization of the tank and an inaccurate volume reading. The operator also looked for the hose kick as an indicator that the liquid delivery was complete. The hose kick is a transient occurrence (on the order of seconds) that could be overlooked. Instruments or devices that give a clear, understandable indication to the operator (for example, a sight glass) would reduce the possibilities of errors. A written SOP for off-loading deliveries to the HCl tank should include procedures for determining when the delivery is complete.

6.0 Recommendations

Based on the root causes and contributing factors of the HCl tank failure, the JCAIT has developed the following recommendations:

Surpass and other facilities should ensure that modifications to their equipment, in this case for the purposes of environmental control, do not create new hazards or compromise safety. Before modifying equipment, Surpass and similar facilities should thoroughly review and approve changes prior to implementation to ensure safe operation. Results of the review should be documented. One way to do this is by using formal management of change procedures for any processes which involve the handling of hazardous materials.

Surpass and other facilities should maintain environmental control systems to ensure continuous reliability and effective operation. Based on the system design, the known failure history, and engineering judgement, Surpass and similar facilities should evaluate how long the scrubber solution can be used before it needs to be replaced; develop detailed procedures for inspecting, testing, and adjusting the scrubber solution-- including the frequency of tests, the parameters (pH, specific gravity, etc.) to be measured, and the acceptable range of those parameters; and establish control mechanisms to ensure that preventive maintenance is performed correctly. Maintenance procedures should be written. Maintenance results should be documented in order to provide a historical basis for revising the procedures.

Surpass should develop written standard operating procedures (SOPs) related to the HCl off-loading and maintenance of the scrubber system. SOPs should be written in simple and understandable language, reviewed for safety issues, and validated for accuracy. Procedures should include details of the task to be performed; the types and frequency of instrument readings and samples to be taken; safety precautions; critical parameters and safe operating limits. Additionally, human factors such as communication issues; operator/equipment interfaces for displays; and adequate measuring devices should be incorporated along with the procedures to reduce the chances of errors.

EPA and OSHA should develop an alert to raise awareness about the need for thorough consideration of safety when designing equipment or processes for environmental control. As part of their ongoing effort to prevent chemical accidents, EPA and OSHA jointly issue alerts to increase awareness of potential hazards. In recent months, EPA and OSHA have investigated

several accidents related to the design and/or operation of control devices for air pollution. Because of these accidents, the agencies are considering developing an alert to highlight the need to consider safety prior to implementing changes, such as addition of end of the pipe devices, to ensure that the devices are designed, maintained, and operated safely and integrated with the rest of the process to ensure that it is not adversely affected.

7.0 Other Findings

While investigating the HCl tank failure, the JCAIT identified other potential problem areas that may have contributed to the consequences of the incident. These issues are listed below:

- Although the HCl storage tank was located in a separate diked area from the NaOCl storage tanks, the NaOCl storage tank discharge lines ran nearby to the HCl tank, contributing to the hazard created by the incident. Due to their proximity, the NaOCl lines were broken when the HCl tank ruptured. Incompatible substances (HCl and NaOCl) were mixed together when they were accidentally released, resulting in a reaction that produced a hazardous substance (chlorine). The generation of chlorine added to the hazard posed by the hydrogen chloride fumes that were generated from the spill of aqueous HCl. Adequate separation distances for chemicals that are incompatible because of reactivity are site-specific. Facilities should evaluate their site layout for potential chemical incompatibilities. One way to do this is to perform a process hazard analysis and an off-site consequence analysis (for example, dispersion modeling) to evaluate the potential risks. The results of such analysis should be documented and specific actions taken, such as relocating tanks or installing safety measures or barriers in situations where there are incompatibility problems.
- The design of the secondary containment was not adequate to withstand the sudden surge of liquid over the dike wall. Similar instances have been cited in the literature. For example, Lees suggests that the tidal wave of liquid resulting from the catastrophic failure of an FRP tank is capable of demolishing a dike wall, or, if the tank is indoors, a building wall (Lees, 1996, p. 22/65).
- As part of a facility's mechanical integrity program, storage tanks should be periodically inspected for parameters such as wall thickness, defects, surface hardness, and strain measurement. The parameters to be tested, the type of testing, and the frequency schedule should be determined as part of the facility's mechanical integrity program based on known failure history, the manufacturer's recommendations, and engineering judgement. In 1995, Owens-Corning sent a letter to all of its former customers recommending that they have their FRP tanks inspected annually by qualified fiberglass chemical equipment process experts. This type of information should have been incorporated by Surpass into a mechanical integrity program.

- Surpass is a member of the National Association of Chemical Distributors (NACD). NACD members have developed a program, called the Responsible Distribution Process, which outlines guiding principles and elements to improve the safe handling of chemicals. Commitment to the NACD Responsible Distribution Process is a condition of continued membership. Although the JCAIT understood that Surpass had not yet completed its program, the JCAIT found several deficiencies in Surpass's management system, such as undocumented standard operating procedures and lack of process hazard analysis. A timely and thorough implementation of the Responsible Distribution Process program by Surpass may have uncovered these deficiencies and led to improvements in Surpass's system to manage health, safety, and environmental concerns.
- The Clean Air Act requires a periodic (every 5 year) review of the list of substances covered under the Risk Management Program (RMP) Rule. Under a recent modification to the list of regulated substances for the RMP Rule, only anhydrous hydrogen chloride and HCl solutions of 37% or greater will be covered (62 FR 45130, August 25, 1997). As this incident demonstrates, solutions with HCl concentrations below 37% may pose potential hazards to human health or the environment. The circumstances of this incident should be considered in any future evaluation of how to list HCl solutions for the RMP Rule.

References

The Chlorine Institute, Inc. *Pamphlet 150: Hydrochloric Acid Tank Motor Vehicle Loading/Unloading*. Edition 1. 1996.

CRC Handbook of Chemistry and Physics 1988-89, 69th edition. Boca-Raton: CRC Press. 1988.

Kirk-Othmer Encyclopedia of Chemical Technology, 4th Ed., vol 5, "Chlorine Oxygen Acids and Salts; Dichlorine Monoxide, Hypochlorous Acid, and Hypochlorites," p. 932ff. New York: John Wiley & Sons, 1993.

Kletz, T. *What Went Wrong? Case Histories of Process Plant Disasters*. 3rd Ed. Houston: Gulf Publishing. 1994.

Lees, F. *Loss Prevention in the Process Industries; Volume 2*. 2nd ed. Oxford: Butterworth-Heinemann. 1996.

Appendix A
Joint Chemical Accident Investigation Team (JCAIT) members

OSHA personnel who participated in the accident investigation and development of the accident report include:

Mike Marshall	OSHA National Office
Kay Coffey	OSHA Albany, NY Area Office
Margaret Rawson	OSHA Albany, NY Area Office

EPA personnel who participated in the accident investigation and development of the accident report include:

Breeda Reilly	U.S. EPA Headquarters
Ellen Banner	U.S. EPA Region II
Dilshad Perera	U.S. EPA Region II
Mohan Hede	U.S. EPA Region II

Appendix B Industry Codes

These codes are listed for informational purposes.

D 4097-88 Standard Specification for Contact-Molded Glass-Fiber-Reinforced Thermoset Resin Chemical-Resistant Tanks, 1995 Annual Book of ASTM Standards, Section 8 Plastics, ASTM 1916 Race Street, Philadelphia, PA. This standard includes requirements for materials, properties, design, construction, dimensions, tolerances, workmanship and appearance for atmospheric pressure above-ground cylindrical tanks fabricated by contact molding.



D 3299-88 Standard Specification for Filament-Wound Glass-Fiber-Reinforced Thermoset Resin Chemical-Resistant Tanks, 1995 Annual Book of ASTM Standards, Section 8 Plastics, ASTM 1916 Race Street, Philadelphia, PA. This standard includes requirements for materials, properties, design, construction, dimensions, tolerances, workmanship and appearance for atmospheric pressure above-ground cylindrical tanks fabricated by filament winding. This standard covers both tanks vented directly to the atmosphere and to tanks vented into a fume conservation system.



Pamphlet 150: Hydrochloric acid tank motor vehicle loading/unloading; Edition 1; June 1996, The Chlorine Institute. This code presents guidance for the safe transportation, handling, and receipt of HCl in tank motor vehicles.

Appendix C

Other Accidents Involving Atmospheric Pressure FRP Tanks

Collapse of FRP Tank at Wastewater Treatment Facility

In May, 1995, at a government-owned, contractor-operated facility outside of Cincinnati, Ohio, a 16,900-gallon fiberglass reinforced plastic tank failed and collapsed. Personnel were preparing the tank for testing and water was being added to fill the tank to 94% capacity. There were no personnel injured nor environmental impacts. A large portion of the waste water treatment system was damaged and repairs were estimated at \$393,000 and required over a month to complete.

The tank ruptured at its base and collapsed. Investigators found that the tank was overfilled and estimated that the combined air and water pressure in the tank at the time of the rupture was greater than 70 psig-- approximately ten times the design pressure. The direct cause of the accident was found to be a design error in the tank overflow line. The root cause was an inadequate design review. Other contributing factors were also uncovered.

Reference: DOE (1995). *Type B Investigation Report Collapse of Tank 343 Advanced Wastewater Treatment Facility*, DOE-FN-0001-95, May 20, 1995.

Appendix D
Modeling of Venting System



MATRIX Engineering, Inc.

170 Highway 35, Red Bank, NJ 07701 Phone: (732) 747-9111 Fax: (732) 741-5553

February 6, 1998

Ms. Breeda Reilly
US Environmental Protection Agency
Mail Code 5104
401 M Street, SW
Washington, DC 20460

Re: Surpass Chemical Tank Failure

Dear Breeda:

Presented herein is my report of findings concerning the referenced matter. This report is based on the documents reviewed to date and the computer modeling of the tank failure scenario. This report may be supplemented or amended subject to review of additional documents or other materials relevant to the case.

Surpass Chemical Company is a repackager and marketer of muriatic acid. As part of their operation, Surpass historically received tankwagon loads of 20 Bé muriatic acid for repackaging. The deliveries were received into a fiberglass reinforced plastic (FRP) tank by pressuring the tankwagon to 22 to 25 psig (36.7 to 39.7 psia). On March 8, 1997, during the receipt of a load of muriatic acid, the FRP tank failed leading to the release of approximately 5000 gallons of acid.

The tank was manufactured by Owens-Corning and is shown on the design drawings to be 7'-7" in diameter and approximately 18' straight side with a dome roof. The design specification indicates that the tank was rated for a maximum 10" WC operating pressure and was supplied with a 24" diameter hinged vent at the top for vapor relief.

The filling line leading to the tank to which the tankwagon connected was a 2" diameter PVC line discharging to the top of the tank. The 24" diameter vent had been modified by Surpass to control the release of acid fumes during delivery. The 24" hinged opening was bolted closed and a 3" diameter vent line was mounted on the top of the tank and routed to near grade where it discharged into a caustic solution in a 50 gallon drum. The purpose of the caustic solution was ostensibly to scrub the acid fumes to eliminate an environmental or personnel exposure concern. The drum was reportedly filled with approximately 20 gallons of solution which was manually blended to 18 wt% using 50 wt% NaOH solution.

Environmental Compliance Design Project Management Safety

The 3" diameter vent line was terminated within the scrubber drum by fitting a custom fabricated diffuser. The diffuser was fabricated from PVC pipe by drilling approximately 36 holes, each 5/8" diameter. After the accident, the diffuser holes were found to be fouled with a crystalline solid.

The results of the initial accident investigation documented a timeline of events which indicated that the delivery of muriatic acid totaled 47840 lbs. (4950± gals) and that approximately 80 minutes after the start of the off-loading, the FRP tank failed and released its contents. Other subsequent consequences of the accident led to the release of chlorine gas from a mixture of the muriatic acid with sodium hypochlorite.

As a result of the failure of the tank, the roof and a 5 foot section of the shell of the tank separated and flew 15 to 20 feet to the top of the adjacent building indicating that the tank had been overpressured. A computer model was created to analyze the pressure profile of the tank during the delivery and to evaluate the effect of the tank's design features on the pressure within the tank. The analysis of the pressure in the tank is based on an unsteady state mass balance calculation routine. The parameters used in the calculations are discussed below.

The tank pressure is at atmospheric pressure before the beginning of the muriatic acid off-loading. The submerged diffuser within the scrubber solution resulted in a backpressure during receiving operations equal to the hydrostatic pressure of the solution within the scrubber drum. Therefore, no vapor flow occurred out of the tank until the pressure within the tank exceeded this superimposed backpressure. Based on the report of 20 gallons of solution in the 50 gallon drum, the maximum backpressure created by this solution is calculated to be 16" WC (0.6 psig = 15.3 psia).

The delivery of the liquid into the tank caused an increase in the tank pressure due to the reduction in the void volume of the tank. As the tank pressure increased above the diffuser backpressure, vapor flow out of the tank began. The tank pressure at any time was dependent on the rate of liquid flow into the tank and the rate of vapor flow out of the tank.

The rate of vapor flow out of the tank is a function of the tank pressure and the diffuser backpressure and was calculated using an orifice flow calculation method for compressible flow. The pressure drop associated with the flow of the vapor through the 3" vent line would further restrict flow, however, this factor was considered negligible and was ignored in the modeling effort.

The rate of liquid flow into the tank is a function of the pressure in the tankwagon, the differential head caused by the liquid being pumped to the top of the tank, the backpressure created by the pressure within the tank and the

dimensions of the delivery line and hose. The record indicated that the average rate of liquid flow into the tank was approximately 60+ gpm based on 4947 gallons delivered in 80 minutes.

The computer modeling on this basis indicates that the tank pressure first increased to overcome the diffuser backpressure and thereafter to establish a sufficient vapor flow to equal the inlet liquid flow. During the liquid delivery the tank pressure was calculated to reach approximately 15.3 psia (16"WC gauge). This is more than the rated pressure for the tank but, nonetheless, failure of the tank did not occur at this time.

Throughout the delivery of the liquid to the tank, the pressure of the liquid discharged to the top of the tank is reduced below the pressure of the tankwagon by both the line pressure drop and the change in liquid head. The latter is the more significant factor. At the end of the delivery, as all liquid in the tankwagon and line is vacated, the effect of the change in the liquid head is quickly eliminated as the liquid in the line is evacuated and displaced with vapor. At this point, the tank pressure increased sharply as the pressure within tankwagon is relieved into the tank. The net pressure in the tank is the result of the flow of pressured air into the tank which is only slightly offset by the continued flow of vapors out of the tank through the diffuser.

At this point in the delivery process, the tank pressure quickly rises from its pressure during liquid transfer. The peak pressure in the tank is dependent on the available flow area of the diffuser. Two scenarios were evaluated to demonstrate the effect of fouling of the diffuser holes. The first scenario is based on no fouling. The second scenario assumes that the diameter of the 36 holes in the diffuser had been uniformly reduced to 1/4" from 5/8". Graphs of the predicted pressure profiles of the tank under these conditions are presented in the attachments.

Under conditions of no fouling the tank pressure at the end of the delivery process was predicted to peak at 3.4 psig. Although this is significantly above the recommended pressure limit for the tank, the prior use of the tank in this service indicates that this did not exceed the yield point for the tank. In the second scenario where the diameter was assumed to be reduced to 1/4", the tank pressure peaks at approximately 12 psig.

The exact pressure which caused the tank failure was not predicted. However, the configuration of the vent/scrubber system led to the operation of the tank under routine operations outside the specifications of the manufacturer. The fouling of the diffuser over time led to the further increase in the tank pressure which eventually led to failure. The fundamental cause of this accident was the improper design of the vent/scrubber system to control the maximum pressure within the tank under foreseeable operating conditions.

If you have any questions on this analysis, please contact me at your convenience.

Very truly yours,



J. David Calvert, PE, CSP

Attachments

cc: Tom Uden - ICF Kaiser

