

Bird and bat behavior and mortality at a northern Iowa windfarm

by

Aaftab Ashok Jain

A thesis submitted to the graduate faculty
in partial fulfillment of the requirements for the degree of
MASTER OF SCIENCE

Major: Ecology and Evolutionary Biology

Program of Study Committee:
Rolf Koford, Major Professor
Phillip Dixon
James Miller

Iowa State University

Ames, Iowa

2005

Graduate College
Iowa State University

This is to certify that the master's thesis of
Aaftab Ashok Jain
has met the thesis requirements of Iowa State University

Major Professor

For the Major Program

To Anne Slattery

TABLE OF CONTENTS

| | |
|--|----|
| CHAPTER 1. GENERAL INTRODUCTION | 1 |
| Introduction | 1 |
| Thesis Organization | 2 |
| CHAPTER 2. BIRD ACTIVITY AND COLLISION MORTALITY AT A NORTHERN IOWA WINDFARM | 4 |
| Abstract | 4 |
| Introduction | 4 |
| Study Area | 5 |
| Methods | 7 |
| Results | 14 |
| Discussion | 20 |
| Acknowledgements | 24 |
| References | 25 |
| Figures and Tables | 29 |
| CHAPTER 3. BAT MORTALITY AND ACTIVITY AT A NORTHERN IOWA WINDFARM | 42 |
| Abstract | 42 |
| Introduction | 42 |
| Study Area | 43 |
| Methods | 44 |
| Results | 50 |
| Discussion | 53 |
| Acknowledgements | 59 |
| Literature Cited | 60 |
| Figures and Tables | 66 |
| CHAPTER 4. CANADA GOOSE FORAGING AND VIGILANCE BEHAVIOR AT A NORTHERN IOWA WINDFARM | 71 |
| Abstract | 71 |
| Introduction | 72 |
| Methods | 73 |
| Results | 76 |
| Discussion | 79 |
| Acknowledgements | 82 |
| Literature Cited | 83 |
| Figures and Tables | 86 |
| CHAPTER 5. GENERAL CONCLUSIONS | 92 |
| General Discussion | 92 |
| Future Research Questions | 98 |

| | |
|-----------------------------|-----|
| APPENDIX A | 99 |
| APPENDIX B | 103 |
| ADDITIONAL LITERATURE CITED | 105 |
| ACKNOWLEDGEMENTS | 108 |

Chapter 1: General Introduction

Introduction

Wind power is widely held to be an environmentally friendly source of energy with few negative impacts. However, the siting of large manmade structures in regions with large numbers of birds and bats causes inevitable collision mortality. There are concerns that this mortality could be substantial in some areas (Orloff and Flannery 1992, Erickson *et al.* 2002, Johnson *et al.* 2003). The Top of Iowa wind resource area (WRA) is located near three large wildlife management areas (WMA) that are complexes of wetland, grassland and forest habitats important for neotropical migrants and migrating and resident waterfowl. Local bat populations also make use of these WMA's and the agricultural land that surrounds them. While recent studies have found little or no evidence for population level effects on birds, higher rates of mortality have been reported for bats at WRA's in the U.S. (Fiedler *et al.* 2002, Kerns and Kerlinger 2004,)

Ideally, pre-construction surveys of sensitive species should be contrasted with a post-construction survey, to estimate the impact of construction and operation of the WRA. This study began post-construction, and thus has limited ability to estimate behavioral impacts on wildlife. However, these limitations do not apply to estimating the impact of the WRA in terms of kills per tower per year. Mortality searches under towers are an effective tool in estimating the total number of birds and bats killed per year. Search efficiency,

scavenging rates and search probability were estimated and corrected for, to estimate the total mortality and its variance.

While the bird and bat activity data that we collected cannot be compared with measurements made before construction, local patterns can be correlated with the presence of wind towers. 100m fixed radius point count surveys (Ralph *et al.* 1995) were used to estimate bird activity levels and flight habits at wind tower sites, and contrast them with non-tower sites both on and off the windfarm. Bat acoustic surveys were conducted on the windfarm, at tower and paired non-tower sites. Fall Canada Goose (*Branta canadensis*) foraging behavior was observed to compare vigilance levels between fields with and without wind towers. Finally, we surveyed geese foraging in fields, to construct a model to estimate the effect of wind towers on the presence/absence of geese foraging in fields.

Broad objectives of this study were to: 1) Assess bird and bat collision mortality, 2) examine bird and bat activity and behavior and 3) examine Canada Goose foraging and behavior at the Top of Iowa WRA.

Thesis Organization

This thesis follows the guidelines for the alternate format and consists of three papers that have been written for submission to separate journals for publication. The first chapter provides estimates of avian species composition, activity and mortality. The second provides estimates of bat species composition, activity and mortality. The third is an analysis of Canada Goose foraging habits and vigilance behavior. All three chapters are intended for submission to peer-reviewed journals. Aaftab Jain helped design the studies, conduct the field work and all the data analysis and is the principal author of each paper. Dr. Rolf Koford

assisted in the studies completion through advising, securing funding for Aaftab Jain, and editing the papers. Guy Zenner and Alan Hancock of the Iowa Department of Natural Resources conceived of and created the original project and study design and were integral to all the subsequent phases of the project. Ivan Ramler and Philip Dixon provided statistical guidance. Following the papers are general conclusions and appendices containing information on methods and data supplemental to the chapters. Literature cited in the first and last chapter is listed at the end of the thesis.

CHAPTER 2. BIRD ACTIVITY AND COLLISION MORTALITY AT A NORTHERN

IOWA WINDFARM

A paper to be submitted to the journal *Biological Conservation*

Aaftab Jain, Rolf Koford, Alan Hancock, Guy Zenner

Abstract

We examined bird collision mortality, activity and species composition, at an 89-tower wind resource area (WRA) in north-central Iowa, from April 15, 2003 to December 15, 2003 and March 15, 2004 to December 15, 2004. We found 2 birds in 2003 and 5 birds in 2004, in search transects and gravel access areas under towers. We adjusted for search probability, search efficiency and scavenging rate and estimated total bird mortality at 39.47 ± 4.60 (95% CI) in 2003 and 85.38 ± 7.78 (95% CI) in 2004. Bird abundance did not differ significantly between tower and non-tower sites. Bird flight close to the tower at rotor height was rare. There was a general trend, across species, of avoidance of the 0-30m zone closest to towers. These behaviors possibly reduce the risk of collision mortality. The Top of Iowa WRA had minimal impact on birds in the region.

1. Introduction

Wind power is a financially competitive source of renewable energy in the U.S. that is generally viewed as having few negative effects on the environment. However, there are concerns that bird mortality resulting from collisions with wind turbines could be substantial

in some areas (Orloff and Flannery, 1992; Erickson et al., 2001). Research has suggested that wind farms may indirectly affect bird populations by influencing habitat use in the vicinity of the wind farm. Researchers at the Buffalo Ridge WRA (Wind Resource Area) in Minnesota concluded that, in addition to direct mortality, the presence of wind turbines adversely affected local bird populations by decreasing the area of habitat the birds used (Leddy et al., 1999). In Denmark, researchers studying the effects of wind farms on foraging behavior of pink-footed geese (*Anser brachyrhynchus*) concluded that wind farms caused a direct loss of habitat as well as an additional loss due to habitat fragmentation (Larsen and Madsen, 2000).

Construction on the 89-tower Top of Iowa Wind Farm, near Joice in Worth County, Iowa, was completed in December 2001. Turbines are located on private land in an area comprising about 2,137 ha. We conducted a study from March 15 to December 15, 2003 and 2004 to evaluate the effect of the presence of the wind turbines on the birds in the region. One phase of this study was to estimate the mortality of birds caused by collisions with towers. Another phase was to document the flight patterns of birds using the cropland encompassed by the wind turbines, in order to quantify flight in the collision-risk zone and to estimate the effect of wind turbines on habitat use in and around the WRA.

2. Study Area

The Top of Iowa Wind Farm is located in an area between three large wildlife management areas (WMA) that historically has had very high bird use (G. Zenner, Iowa Dept. of Natural Resources, pers. comm.) The primary vegetation types in the study area were cultivated cropland (primarily corn and soybeans). Minor habitat types included hay,

Conservation Reserve Program (CRP) grassland and deciduous woodlots associated with farmsteads. However, the three WMA's are complexes of wetland, grassland and forest habitat (Fig.1). The close proximity of these WMA's provides attractive habitat on a large scale for wetland and grassland birds and offers islands of strategic habitat. Additionally, part of the wind farm is contained within an area that has been closed to Canada goose hunting for 30 years, and two of the adjacent WMA's contain inviolate waterfowl refuges that attract large numbers of waterfowl each year. Given the proximity of these WMA's, there are few other existing wind farms in Iowa with higher potential bird use.

All the wind turbines were mounted on 71.6 m (235 ft) high tubular towers and turned by three 25.9 m (85 ft) rotors with a 2,107.69 m² (22,690 ft²) sweep area (Fig. 2). All structural components of the towers were painted white. Forty-six towers were lit at the turbine level with Federal Aviation Administration non-pulsating red beacons. Thirty-seven towers situated on the periphery of the windfarm had pulsating red beacons. Due to proximity to the Lake Mills Municipal Airport, six towers in the northwest of the windfarm had a combination of pulsating white beacons and non-pulsating red beacons. In addition to wind towers, there are two (71.6 m high) meteorological towers on site, supported by guy wires, which gather weather data for the Top of Iowa WRA.

3. Methods

3.1. Mortality Monitoring

We looked for evidence of collision-induced mortality under 26 of 89 wind towers. Our sampling design ensured geographic distribution of mortality study sites throughout the windfarm. Of the 35 sections (1 square mile each), that the windfarm occupies, 29 sections contained more than one tower. These were divided into 14 pairs of adjacent sections. Two towers were selected at random from the towers in each of these 14 section-pairs. One additional section was chosen to have two tower sites, making a total of 30 selected tower sites. We received landowner permission for 26 of these 30 sites. In 2003, a tenant farmer revoked permission for one tower, two months into the study. We selected a substitute tower in a neighboring section and set up sampling within a month.

We kept six randomly placed, 3m-wide transects, free of vegetation by using herbicides and manual weeding (Hancock and Zenner, pers. comm.), on each of the 76m x 76m (5776m²) search plots that was centered on the 26 selected towers (Fig. 3). Transects ran parallel to existing corn/soybean rows and were located at random distances from the base of the tower. Access roads and construction pads under the selected towers were also searched. The average total area searched under each tower was 1,742m² which was about 30% of the 5,776m² plot. Standardized searches of all mortality transects began April 15, 2003. Initially, each tower was searched once every three days. After June 12, 2003, the search frequency was increased to once every two days, and remained that way until the end of the study. In 2004, searches of all mortality transects began on March 24. At each of the

26 towers searched, we recorded the location of each carcass and its distance to the tower using Global Positioning System coordinates. All carcasses found were collected and frozen for later species identification and necropsy at the Veterinary Diagnostic Laboratory at Iowa State University, to detect signs of collision trauma. Carcasses were frozen within 3 hours of detection, but the state of preservation was subject to the 2 day search frequency. Carcasses were also examined for additional evidence of fitness such as muscle mass, fat reserves and presence of food in the gut.

Carcasses found at other times (when visiting tower sites for other phases of the project) and found while walking between search transects were also collected, but not used to estimate total mortality at the windfarm because the detection area associated with these carcasses was unknown. In 2004 we also searched under the two meteorological towers operated by the windfarm. We searched 3.05m wide transects on either side of the guy wires, from the base of the tower to the point where the guy wires anchored in the ground. The total area searched under each meteorological tower was 881.76m² (Fig. 4).

3.2. Adjusting for Search Probability, Scavenger Efficiency, Search Efficiency and Proportion of Towers Searched

We made the following adjustments to extrapolate the mortality counts to estimated mortality for the entire wind farm. We adjusted the number of carcasses found (μ_c) in a two-step process.

The number of carcasses found in searched area under transects (μ_c) was initially adjusted for Search Probability (S_p). As the distribution of fallen carcasses may not have

been uniform over the entire 5,776m² search area, we defined 6 concentric buffers of 10m width, centered on each tower. The smallest buffer was a circle (10-meter radius), centered on the tower. The largest buffer was a ring ranging from 50 to 60m from the center of the tower. We adjusted the number of carcasses in each buffer for the average proportion, over all 26 towers, of each buffer searched, (S_p). A mortality estimate (t) was created for each buffer where $t = (\mu_c/S_p)$. We calculated the variance of this estimate for each of the 26 towers searched, using standard methods (assuming normal distribution). We summed the estimates and variances of t for each tower, to produce an estimate (T), the search-probability-adjusted estimate of kills for all searched towers, and its variance.

In the next step, we adjusted the estimate (T) for scavenger efficiency (R), search efficiency (E) and the proportion of towers searched to the total number of towers on the windfarm (P).

a) Percent of test carcasses left by scavengers within the search period (R).

Scavenger efficiency (R) was measured during spring, summer, and fall of both years by placing birds of three sizes, house sparrow (*Passer domesticus*), mallard (*Anas platyrhynchos*) and Canada goose, on mortality transects under each of the 26 monitored wind towers. Over the 6 seasonal tests (3 tests per year), 157 carcasses were placed in predetermined positions on mortality transects, so that there would be no confusion between test carcasses and other carcasses found on transects. We monitored carcasses daily for two weeks for evidence of scavenging. The status of each carcass was reported as intact, partially scavenged, or completely removed. After a two-week period, all remaining carcasses were collected.

- b) Percent of carcasses missed by observers in the search efficiency trials (E).

Search efficiency trials were conducted for each observer by having an independent Department of Natural Resources (DNR) wildlife technician place small birds, such as house sparrows, on transects without the knowledge of the searchers. The field assistants recorded all carcasses that they discovered, including carcasses planted by the wildlife technician. Planted evidence of collisions was later removed from the database and a mean search efficiency rate (E) was calculated by dividing the number of successfully found carcasses by the total number of carcasses planted.

- c) Finally, we adjusted the estimate for the proportion of towers that we searched under relative to the total number of towers on the windfarm (P).

$$\text{Thus, } \hat{C} = \frac{T}{R \times E \times P}$$

Where \hat{C} = Adjusted total number of kills estimated at the windfarm.

The variance of T was calculated per tower using standard methods and then combined as previously described. Then, we calculated the variance due to the correction factors R , E , and P , using the variance of a product formula (Goodman, 1960). The variance of the product of R , E and P is:

$$\text{Var}(\hat{C}) = \hat{C}^2 \times \left[\frac{\text{var } T}{T^2} + \frac{\text{var}(R \times E \times P)}{(R \times E \times P)^2} \right]$$

3.3. Point Count Site Selection

We estimated relative avian abundance and activity using fixed radius (100m) point counts (Ralph et al., 1995). To ensure that the point count sites were distributed across the windfarm, we established geographic blocks. Each block was to have at least two potential tower sites and one potential non-tower site at least 200m from a wind tower. We systematically divided the 29 sections of the windfarm that contained more than one tower into 14 blocks of 2 adjacent sections and 1 block containing the odd (29th) section. In each of the 15 blocks, we randomly chose two tower sites for fixed-radius point counts. These were designated site-types A and B. Site-type B in each block was also used in the mortality search phase of the project, to test for potential differences in bird abundance caused by vegetation-free mortality transects. Of the quarter sections in each block that did not contain wind towers one was chosen at random for the non-tower site (Site-type C). Sites that encompassed woodlots or sloping lands with considerable erosion-control plantings were excluded from the selection process to ensure that the presence or absence of a wind tower was the primary difference between two sites that were compared for bird abundances and flight characteristics. Thus, the bird abundances for the windfarm reflect point counts conducted in the centers of corn and soybean crop fields and away from non-crop vegetation and man-made structures. However, fixed-radius point counts did encompass grassy field edges and terraces with some shrub-like vegetation. We received permission to conduct point counts in sites in 13 out of the 15 blocks that we selected.

We also conducted point counts in crop fields in an area approximately 4 miles southwest of the windfarm, defined as off-windfarm locations (Site-type D) (Fig. 5), to contrast bird activity within the windfarm to similar sites off the windfarm. Off-windfarm fields were selected on the basis of permission granted by farmers or renters. Each field was

divided into parcels of roughly equal area that could encompass a 100m radius point count. We chose 14 point count sites at random from these parcels. As was done on the windfarm, sites that contained woodlots or considerable erosion-control plantings were replaced with a site chosen at random from the remaining available parcels.

3.4. Point count procedures

We conducted fixed-radius (100 m) point counts (Ralph et al., 1995) at these windfarm and off-windfarm sites from May 1, 2003 to December 1, 2003 and from March 24, 2004 to December 14, 2004. During each 10 minute point count, we identified all birds seen (with binoculars) and heard, within 100m of the observer. For each bird or group of birds we recorded (1) number of birds, (2) distance from the observer (0-30m, 30-60m or 60-100m), and (3) estimated flight height above the ground (Low, Medium or High), corresponding to flight height below (Low), at the same level as (Medium) and above the sweep of the tower rotors (High). Distances were initially estimated using range finders (Ranging ® 200, American Visionwear) until observers were comfortable with the three defined zones of detection around the center of the point count.

Point counts were conducted in the morning (one-half hour after sunrise until 4 hours after sunrise), during mid-day (11 a.m. to 2:00 p.m.), in the evening (3.5 hours before sunset to half an hour before sunset), and at night (half an hour before sunset to an hour and a half after sunset). In each time period (morning, midday, evening and night), we conducted point counts in the three site types in each block surveyed, in random order. Each site was visited

approximately once every 6 days for each of the four time periods. Due to low bird activity in the fall, sites were visited less often (\approx once every 8 days).

3.5 Abundance

While abundance data were collected for all four periods of the day, only morning point counts were analyzed to test for differences in abundance, since bird activity is highest at that time (Ralph et al., 1995). We divided the point-count data by species and season, i.e. Summer and Fall 2003 and Spring, Summer and Fall 2004, and analyzed each species-season combination separately. We analyzed data from the seven most common bird species observed. Abundance data were analyzed with ANOVAs, using PROC GLM (SAS Institute Inc, 2001). We compared the relative avian abundance between wind tower sites (A) and adjacent non-tower sites (B and C), and between wind tower sites and the off-windfarm sites (A and D, respectively).

3.6. Flight

Flight data from all four observation periods (morning, midday, evening and night) were examined. Analyses were partitioned by species and season. Observations from all four count periods were combined to obtain a sample size sufficient to test for differences in rare flights in the collision-risk zone and avoidance behavior. We used the normal approximation to a binomial distribution (Ramsey and Schafer, 2002) to estimate the difference between the proportion of flights in the collision risk zone (within 30m of the tower and at rotor height,

46m to 98m above the ground) between site-types tower sites (A) and adjacent non-tower sites (C).

3.7. Avoidance

Flight data were combined with abundance data (ground-level activity) and defined as bird-use. Using PROC UNIVARIATE (SAS Institute Inc., 2001), t-tests were performed to detect whether the proportion of birds that used the (0-30m) zone to the (0-100m) zone differed at tower (A) and non-tower (C) sites, to detect avoidance behavior, if any.

4. Results

4.1. Mortality

We found the carcasses/partial remains of 2 birds in 2003 (a yellow-throated vireo, *Vireo flavifrons*, and a tree swallow, *Tachycineta bicolor*) and 5 birds in 2004 (a red-tailed hawk, *Buteo jamaicensis*, a golden-crowned kinglet, *Regulus satrapa*, and three unidentifiable small birds) in our designated search area. In 2004, we also found 5 birds incidentally (not within the search area or under one of the two meteorological towers operated by the windfarm). These were a yellow-headed blackbird, *Xanthocephalus xanthocephalus*, a red-tailed hawk, a mourning dove, *Zenaida macroura*, a dark-eyed junco, *Junco hyemalis* and a brown creeper, *Certhia americana*.

Collision trauma observed upon necropsy at the Veterinary Diagnostic Laboratory was typically bone fractures and hemorrhaging. Both birds found in 2003 showed signs of collision trauma. In 2004, one of the five bird carcasses was too severely scavenged to determine cause of death. All the remaining four carcasses showed obvious signs of trauma upon necropsy. For the scavenged carcass where mortality could not be attributed to collision, no other obvious cause of mortality could be detected. Given the lack of alternate causes of death, and the poor condition of this carcass, we decided to attribute mortality to tower collision.

We pooled data from spring, summer and fall scavenging trials as the scavenge rate did not differ significantly between seasons, (Pearson $\chi^2 = 1.77$, $df = 78$, $p = 0.41$) in 2003 and (Pearson $\chi^2 = 2.26$, $df = 77$, $p = 0.32$) in 2004. Scavengers left an average of 95% and 92% of carcasses within the interval between searches (2 days) in this study, in 2003 and 2004 respectively. Observer efficiency trials for mortality transect searches indicated that, as a group, observers found 71% (27/38) and 74% (26/35) of bird carcasses, in 2003 and 2004 respectively. The ratios of the area searched in transects and gravel areas under the 26 towers to the total searchable area (S_P), for buffers 1-6 were 0.26, 0.30, 0.29, 0.27, 0.25 and 0.14 in 2003 and 0.24, 0.33, 0.30, 0.26, 0.22, 0.10 in 2004.

Mortality estimates adjusted for the entire windfarm indicate an estimated 39.47 ± 4.60 (95% CI) birds died as a result of collisions with the wind towers between April 15 and December 15, 2003 and an estimated 85.38 ± 7.78 (95% CI) birds died as a result of collisions with the wind towers between March 24 and December 15, 2004.

4.2. Point Counts (Abundance)

Because we started point counts in May 2003, spring migration was missed. In the summer of 2003, we completed 436 morning point counts on and off windfarm and recorded 4,487 birds (10.3 birds/count). In the fall of 2003, we completed 317 morning point counts on and off windfarm and recorded 10,342 birds (32.6 birds/count). In the spring of 2004, we completed 299 morning point counts on and off windfarm and recorded 3,678 birds (12.3 birds/count). In the summer of 2004, we completed 416 morning point counts on and off windfarm and recorded 4,217 birds (10.1 birds/count). In the fall of 2004, we completed 385 morning point counts on and off windfarm and recorded 13,043 total # of birds (33.9 birds/count). In both years, rare observations of very large mixed blackbird flocks accounted for the high fall totals.

We compared avian abundance between point count sites under wind towers (A), wind towers with mortality transects under them (B) and adjacent crop fields without wind towers (C) for the 5 most commonly seen species in each season (Table 1). Only one of the 17 species-season analyses varied among A, B and C. The rest of the analyses had $p > 0.12$ ($df = 2, 22$). Horned larks (*Eremophila alpestris*), in Summer 2004, were observed in significantly greater numbers ($p = 0.02$) at wind towers without mortality transects than at those with mortality transects. Due to extremely low avian abundance in the fall of both years, only common grackles (*Quiscalus quiscula*) were observed in sufficient numbers for meaningful analysis.

When comparing avian abundance between point count sites under wind towers (A) and off-windfarm sites (D) in the area southwest of the windfarm, out of 17 species-season analyses (Table 2), the abundance of three species, red-winged blackbirds (*Agelaius*

phoeniceus) in Summer 2003 and common grackles and song sparrows (*Melospiza melodia*) in Summer 2004, varied between A and D in different directions (p values < 0.05 , $df = 2, 22$). For all other analyses, p values > 0.29 ($df = 2, 22$).

In addition to morning point counts, we conducted 586 mid-day, 621 evening and 262 night point counts in summer and fall of 2003. In summer, over all four time periods, we saw 9,657 birds (6.7 birds/count) of 40 species. In fall, over all four time periods, we saw 31,617 birds (40.0 birds/count) of 39 species. For both seasons combined, common grackles were the most commonly observed species (23%), followed by brown-headed cowbirds, *Molothrus ater* (6%), European starlings, *Sturnus vulgaris* (4%), vesper sparrows, *Pooecetes gramineus* (4%) and horned larks (3%). Raptors made up 0.14% of birds observed, and waterfowl made up 2%. The average number of birds seen per observation time in 2003 was as follows: 33.43 birds/morning count, 12.53 birds/mid-day count, 13.39 birds/evening count and 1.68 birds/night count.

In addition to morning point counts, we conducted 693 mid-day, 683 evening and 457 night point counts, in spring, summer and fall of 2004. In spring, over all four time periods, we saw 5,709 birds (6.4 birds/count) of 49 species. In summer, over all four time periods, we saw 9,421 birds (8.1 birds/count) of 57 species. In fall, over all four time periods, we saw 16,790 birds (19.1 birds/count) of 46 species. For all seasons combined, red-winged blackbirds were the most common species seen (30%), followed by common grackles (23%), brown-headed cowbirds (8%), horned larks (7%) and European starlings (7%). Raptors made up 0.2% of birds observed, and waterfowl made up 4.3%. The average number of birds seen per observation time in 2004 was as follows: 19.03 birds/morning count, 5.38 birds/mid-day count, 8.80 birds/evening count and 2.77 birds/night count.

4.3. Point Counts (Flight)

Bird flight characteristics were summarized with the same combinations of species and seasons as the abundance comparisons. However, data collected from all four time periods were used to determine flights in the collision-risk zone. The combined proportion of all birds for all seasons flying in the collision-risk zone was very low (0.043%) for the duration of the two-year field season. Most birds flew below tower height and avoided the 0-30 m zone close to the towers. It was our aim to test if birds flew in the collision-risk zone in the same proportion at wind towers and in adjacent fields. Due to the rarity of this behavior, tests of significant difference of proportion of birds flying in this zone could not be carried out for most species. However, by combining data for all species and pooling over all 13 blocks of the study, we were able to test for differences in zone use for three of the five seasons. In summer 2003, there was no significant difference in proportions of birds observed using the collision-risk zone around wind towers and the same airspace at non-tower sites (Z statistic= 1.40, p values = 0.16). However, in the fall of both years, birds were observed using the collision-risk zone around wind towers in significantly lower proportions than the same airspace at non-tower sites (Z statistics > 4.12, p values < 0.000037) (Table 3). This same pooling procedure allowed us to conduct the same test for the Common Grackle, the most common bird using the WRA, for one of the five seasons. In fall of 2003, common grackles were observed using the collision-risk zone around wind towers in significantly lower proportion than the same airspace at a non-tower site (Z statistic = 6.10, p values = 0.0000001).

4.4. Point Counts (Avoidance)

We separated our analyses of avoidance data by season and species. Results presented are of all species that were found in the 0-30m zone around the towers at more than two blocks per season (Tables 4-8). Results for rare species had comparatively low degrees of freedom, as these species did not appear in all the blocks. Where data violated the assumption of a normal distribution, p values were not reported, but t-statistics were included to show that the direction of the trend was largely negative, indicating that proportionately fewer birds used the 0-30m zone at tower sites when compared to non-tower sites. There were a total of 67 species-season analyses, of which 64 showed this negative trend. Out of these 64 analyses, 24 showed a significant negative difference and a normal distribution ($p \leq 0.05$, p normality ≥ 0.05). The three results that did not show a negative trend were non-significant, with p values > 0.47 .

5. Discussion:

5.1. Study limitations and scope of inference

The Top of Iowa WRA is located in cropland, which is not nesting habitat for most grassland birds. Wind farms in this habitat may be less harmful to birds than other energy industries or other human-made structures such as power lines (Osborn et al., 1998, 2000). However, large numbers of neotropical migrants and waterfowl move through the region (Guy Zenner, Iowa DNR, pers. comm.). The construction of the windfarm in close proximity to three WMA's, without a pre-construction survey, reduces our ability to assess its indirect impacts. Results from this paper are primarily compared with results from other studies conducted in agricultural land in the western and midwestern U.S. (Usgaard et al., 1997; Osborn et al., 1998, 2000; Johnson et al., 2002; Erickson et al., 2004). For a thorough review on avian collision mortalities with manmade structures in Northern America, see Erickson et al. (2002).

5.2. Mortality

Avian mortality at the Top of Iowa WRA was low in both 2003 and 2004, estimated to be 0.38 and 0.76 birds/tower/year after correcting for search efficiency, scavenging and search probability. The direct impact of the WRA on avian collision mortality appears negligible and much lower than other causes of avian collision mortality (Erickson et al.,

2001). The Top of Iowa WRA cannot be said to affect avian populations significantly. Due to the small numbers of fatalities in each year, it was not possible to determine if any particular species or group of birds (e.g. raptors, waterfowl) was more susceptible to tower collisions than others. Studies at WRA's in California (Orloff and Flannery, 1992; Thelander and Rugge, 2000) found that raptors were disproportionately susceptible to tower collisions, with large numbers of red-tailed hawks killed. Two red-tailed hawks were determined to have been killed by tower collisions at the Top of Iowa WRA, in 2004. The design of the tower may have helped prevent raptor deaths. Unlike many older lattice towers in California, the tubular towers at this study discouraged raptors from perching or nesting on them. Raptors were observed perching on utility poles, fences and in trees, but never on wind towers. Though large numbers of Canada geese use the surrounding WMA's in the fall, and we observed Canada geese flying in between, around and above wind towers in the section of the WRA that is closed to Canada goose hunting, we did not find any dead geese under towers. Of the recognizable bird carcasses we found, three were of species that may have been resident (a juvenile tree swallow, a dark-eyed junco and a mourning dove). However, three were migrants (a yellow-throated vireo, a yellow-headed blackbird and a brown creeper) found under both meteorological and wind towers.

Our overall avian mortality estimate is within the range of mortality at several other studies in the region. Mortality at WRA's in the western and mid-western states ranges from <1 birds/tower/year to 2.83 birds/tower/year (Osborn et al., 2000; Erickson et al., 2002, 2004; Johnson et al., 2002; Young et al., 2003). While our search methods differed from these studies (bare ground transects as opposed to uncleared plots) we searched the gravel pad immediately at the base of the tower and adjusted for the area searched to the total area

within which birds may have fallen. Our search transects were distributed to sample an area of at least 38m radius from the base of the tower. Johnson et al. (2002) found all birds within 33m of towers that attained a maximum blade height of 73m. The Top of Iowa WRA towers had a maximum blade height of 98m. It is possible that a small percentage of carcasses landed farther from towers than we searched, making our overall mortality estimate conservative. Our higher search frequency, however, lowered the possibilities of scavenging and also meant that birds were not missed due to decomposition (Osborn et al., 2000; Kostecke et al., 2001).

Bad weather and visibility have been associated with bird collisions with tall structures in previous studies, but the data are equivocal (Taylor and Anderson, 1973; Avery et al., 1977). There was no major weather event in the inter-search period before any of the birds was found in 2003 or 2004. Tower lighting has also been implicated in bird deaths (Cochrane and Graber, 1958; Avery et al., 1976). All towers at the Top of Iowa WRA had red pulsating or non-pulsating beacons, or white strobe lights combined with red non-pulsating beacons. Low numbers of birds found at the WRA precluded any tests for relationship between lighting and mortality.

Our results indicate that avian mortality in a cropland landscape is smaller than other causes of avian mortality (Erickson et al., 2001). However, the spread of wind resource areas across the United States may have a cumulative impact on birds.

5.3. *Abundance:*

Unlike Erickson et al. (2002, 2004), where avian density was found to have a linear relationship with distance from wind towers, we did not find a clear pattern of significant differences in avian activity between tower and non-tower sites, as indicated by point counts. In addition, no clear pattern of significant differences was found between windfarm sites and sites in an adjacent area approximately 2 miles to the southwest of the farm. This may have been due to the homogeneity of the sites, (primarily corn and soybean fields) and the low number of birds using the region.

5.4. Flight and Avoidance:

Avian flight in the collision-risk zone was very rare across seasons. Where data were sufficient to test for differences, birds were observed using the collision-risk zone around wind towers in lower numbers than the same airspace at non-tower sites. Further, a clear trend across almost all species showed that birds were observed to avoid the 0-30m zone around the towers when compared to the same zone at non-tower sites. These avoidance results are at a smaller scale than those found by avian surveys at the Buffalo Ridge WRA (Usgaard et al., 1997; Osborn et al., 1998) which found that birds avoided the windfarm in favor of adjacent land. While our results may indicate a loss of habitat for birds, it may also be one reason why resident birds are not killed in higher numbers throughout the breeding and post-breeding season. While this study did not estimate avian density, its findings agree with those of Leddy et al. (1999) which recommended that wind towers should be placed within cropland habitats that support lower densities of grassland passerines than those found in Conservation Reserve Program (CRP) grasslands.

5.5. Conclusions

The Top of Iowa WRA has a low avian collision mortality rate and bird activity surveys do not demonstrate large-scale habitat loss. This may be due to the low number of birds using the agricultural land in which the towers are situated, and the avoidance of the 0-30m zone around the towers. While Canada geese used the fields in high numbers during the Fall, no dead geese were found under towers in both 2003 and 2004. It is our conclusion that the Top of Iowa WRA had minimal impact on birds in the region. However, with the rapid expansion of wind power across the United States, future research should explore the landscape level and cumulative impacts of WRA operation on general migration and staging habits of birds.

Acknowledgements

We thank P. Dixon, and J. Miller for critical comments on earlier drafts of this manuscript.

Funding for this study was provided by the Iowa Cooperative Fish and Wildlife Research Unit, Northern Iowa Windpower LLC, and by a US Fish and Wildlife Service State Wildlife Grant (T-1-R-3), through the Iowa Department of Natural Resources. We thank J.

Bockenstedt, P. Brandon, B. Carter, I. Foster, D. Goshorn, K. Kuennen, J. Makosky, R.

Miller, and M. Piorkowski for their hard work in the field and laboratory. We thank I. Ramler and P. Dixon for statistical support, and M. Yeager for carcass necropsy work. Research was conducted under a permit issued by the Iowa State University COAC #9-03-5524-Q.

References

- Anderson, R., Morrison, M., Sinclair, K. and Strickland, D., 1999. Studying wind energy/bird interactions: A guidance document. National Wind Coordinating Committee.
(<http://www.nationalwind.org/publications/avian.htm>). Accessed July 11, 2005
- Avery, M., Springer, P.F., and Cassel, J.F., 1976. The effects of a tall tower on nocturnal bird migration - A portable ceilometer study. *Auk* 93, 281-291.
- Avery, M., Springer, P.F. and Cassel, J.F., 1977. Weather influences on nocturnal bird mortality at a North Dakota tower. *The Wilson Bulletin* 89(2), 291-299.
- Buckland, S.T., Anderson, D.R., Burnham, K.P., Laake, J.L., Borchers, D.L. and Thomas, L., 2001. *Introduction to Distance Sampling: Estimating abundance of biological populations*. Oxford University Press.
- Cochran, W.W. and Graber, R.R., 1958. Attraction of nocturnal migrants by lights on a television tower. *Wilson Bulletin* 70, 378-380.
- Erickson, W. P., Johnson, G.D., Strickland, M.D., Young, Jr. D.P., Sernka, K.J. and Good, R.E., 2001. Avian collisions with wind turbines: A summary of existing studies and comparisons to other sources of avian collision mortality in the United States. National Wind Coordinating Committee.
(<http://www.nationalwind.org/publications/avian.htm>). Accessed July 11, 2005.
- Erickson, W.P., Johnson, G.D., Young, D.P., Strickland, M.D., Good, R.E., Bourassa, M., Bay, K., Sernka, K., 2002. Synthesis and comparison of baseline avian and bat use,

- raptor nesting and mortality information from proposed and existing wind developments. WEST, Inc. 2003 Central Ave. Cheyenne, WY 82001
- Erickson, W.P., Jeffrey, J., Kronner, K., and Bay, K., 2004. Stateline Wind Project wildlife monitoring final report. 2003. WEST, Inc. 2003 Central Ave. Cheyenne, WY 82001
- Goodman, L. A., 1960. On the exact variance of products. *Journal of the American Statistical Association*. 55, 708-713.
- Johnson, G.D. Erickson, W.P., Strickland, M.D., Shepherd, M.F., Shepherd, D.A. and Sarappo, S.A., 2002. Collision mortality of local and migrant birds at a large-scale wind-power development on Buffalo Ridge, Minnesota. *Wildlife Society Bulletin* 30(3), 879-887.
- Johnson, G.D., Erickson W.P., Strickland, M.D., Shepherd M.F. and Shepherd D.A., 2003. Mortality of bats at a large-scale wind power development at Buffalo Ridge, Minnesota. *American Midland Naturalist* 150, 332–342.
- Kostecke, R.M., Linz, G.M. and Bleier, W.J., 2001. Survival of avian carcasses and photographic evidence of predators and scavengers. *Journal of Field Ornithology* 72(3), 439-447.
- Larsen, J.K. and Madsen J., 2000. Effects of wind turbines and other physical elements on field utilization by pink-footed geese (*Anser brachyrhynchus*): A landscape perspective. *Landscape Ecology* 15, 755-764.
- Leddy, K.L., Higgins K.F. and Naugle D.E., 1999. Effects of wind turbines on upland nesting birds in conservation reserve program grasslands. *Wilson Bulletin* 111(1), 100-104.

- Orloff, S. and Flannery, A., 1992. Wind turbine effects on avian activity, habitat use, and mortality in Altamont Pass and Solano County Wind Resource Areas, 1989-1991. Final Report to the California Energy Commission, Sacramento Calif. 150 pp.
- Osborn, R.G., Dieter C.D., Higgins K.F. and Usgaard R.E., 1998. Bird flight characteristics near wind turbines in Minnesota. *The American Midland Naturalist* 139, 29-38.
- Osborn, R.G., Higgins, K.F., Usgaard, R.E., Dieter, C.D. and Neiger, R.D., 2000. Bird mortality associated with wind turbines at the Buffalo Ridge Wind Resource Area, Minnesota. *American Midland Naturalist* 143, 41-52.
- Ralph, C. J., Sauer, J. R., and Droege, S., 1995. Monitoring bird populations by point counts. U.S. Forest Service General Technical Report PSW-GTR-149, Albany, California.
- Ramsey, F.L., and Schafer D.W., 2002. *The statistical sleuth: a course in methods of data analysis*. 2nd Edition. Duxbury, Pacific Grove, CA 93950 USA.
- SAS System for Windows, Version 8.2. Copyright © 2001 SAS Institute Inc. SAS and all other SAS Institute Inc. product or service names are registered trademarks or trademarks of SAS Institute Inc., Cary, NC, USA.
- Sauer, J.R., Fallon, J.E., Johnson, R., 2003. Use of North American breeding bird survey data to estimate population change for bird conservation regions. *Journal of Wildlife Management* 67(2), 372-389.
- Taylor, W.K., and Anderson, B.H., 1973. Nocturnal migrants killed at a central Florida TV tower: Autumns 1969-1971. *The Wilson Bulletin* 85(1), 42-51.

- Thelander, C.G. and Rugge, L., 2000. Avian risk behavior and fatalities at the Altamont Wind Resource Area. National Renewable Energy Laboratory, 1617 Cole Blvd. Golden, CO. (http://www.nrel.gov/wind/avian_lit.html). Accessed July 11, 2005.
- Usgaard, R.E., Naugle, D.E., Osborn, R.G., and Higgins, K.F., 1997. Effects of wind turbines on nesting raptors at Buffalo Ridge in southwestern Minnesota. Proceedings of the South Dakota Academy of Science 76, 113-117.
- Young, Jr., D.P., W.P. Erickson, R.E. Good, M.D. Strickland, and G.D. Johnson. 2003. Final report avian and bat mortality associated with the initial phase of the Foote Creek Rim Windpower Project, Carbon County, Wyoming, November 1998 - June 2002. WEST, Inc. 2003 Central Ave. Cheyenne, WY 82001

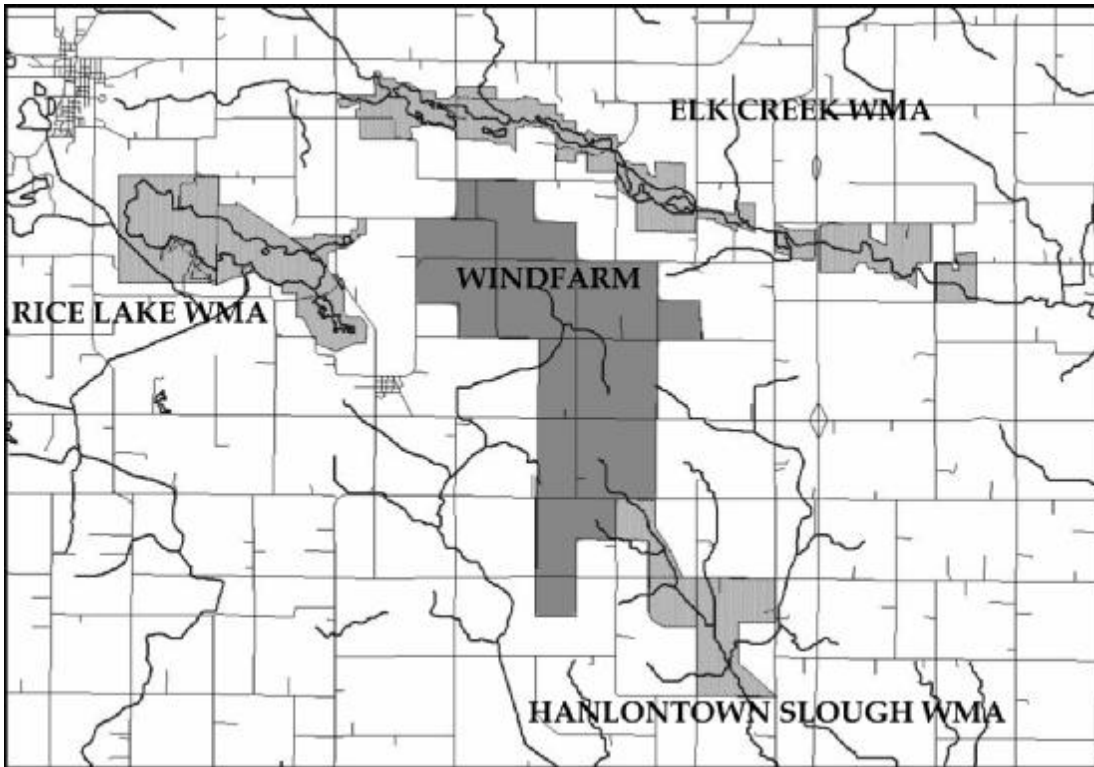

Fig. 1. Location of the Top of Iowa Windfarm relative to Wildlife Management Areas, Worth County, Iowa.

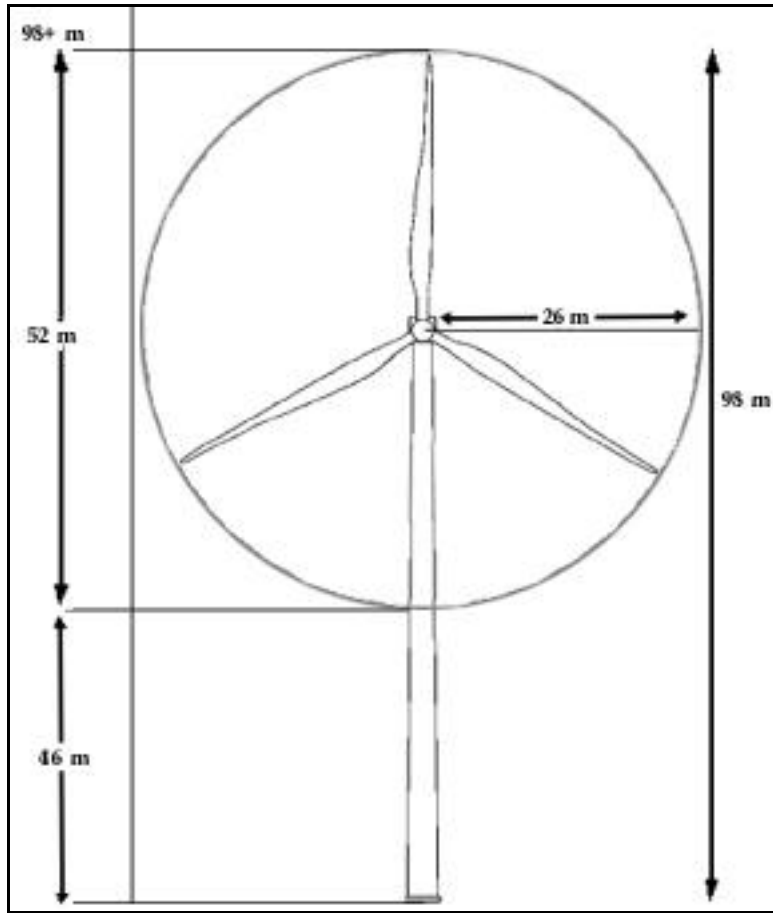

Fig. 2. Schematic diagram of a wind tower at the Top of Iowa WRA.

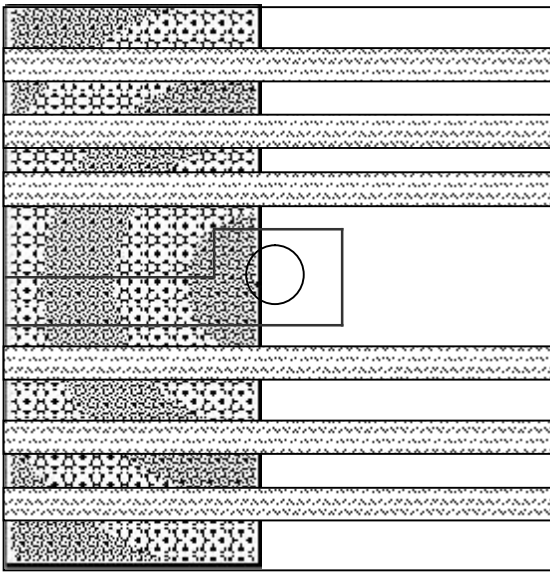

Fig. 3. Mortality transects, gravel pad and access road at the base of a tower (overhead view), with concentric rings.

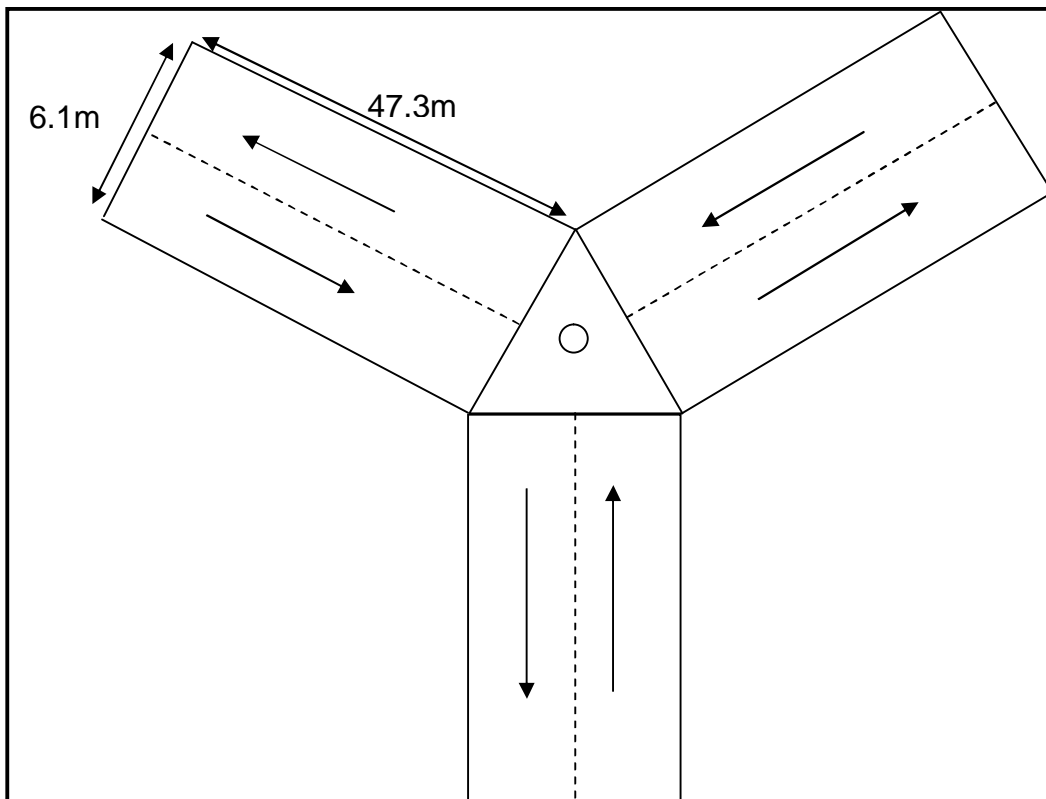

Fig. 4. Overhead view of area searched under both meteorological towers at the Top of Iowa WRA, comprising two transects adjacently located under each of the three sets of guy wires.

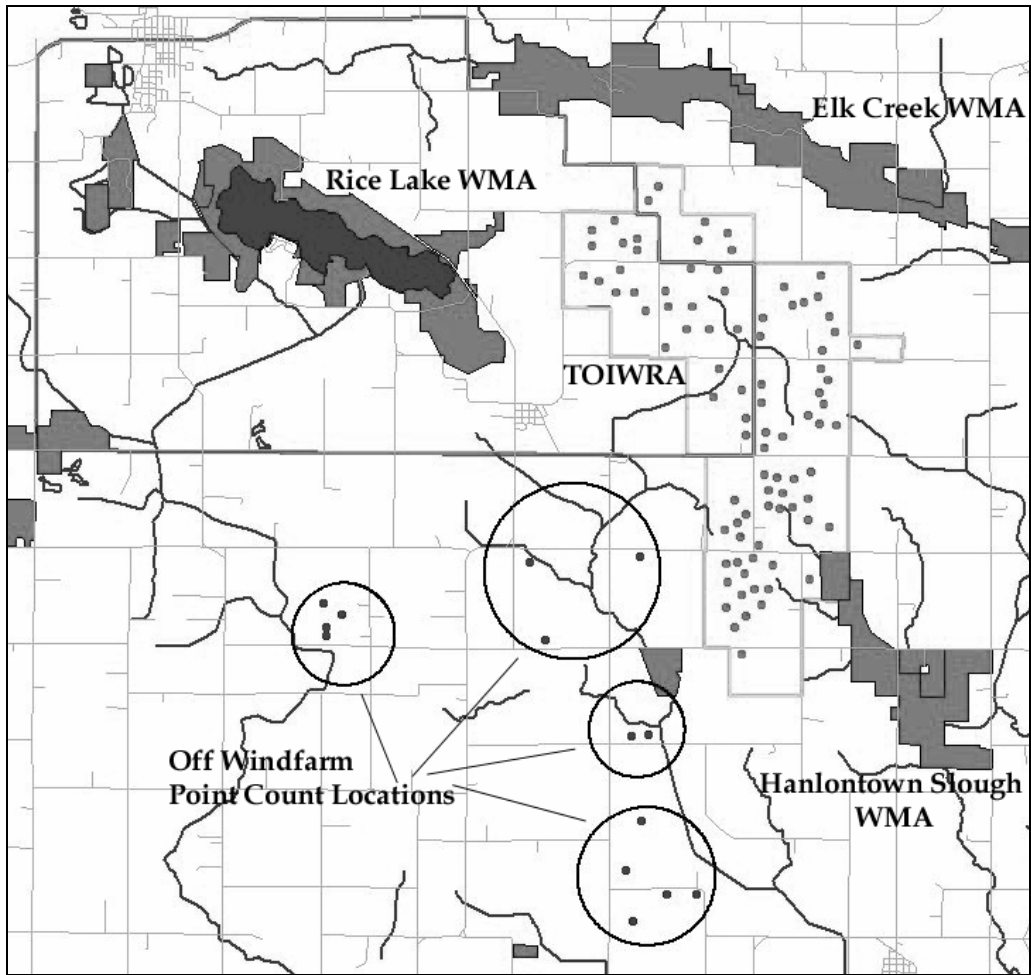

Fig. 5. Off windfarm point count locations (southwest of the Top of Iowa WRA).

Table 1. Comparison of bird abundance among point count sites, under wind towers (A), under wind towers with mortality transects (B) and in adjacent fields without wind towers (C).

| Season | Species | <i>p</i> | Direction |
|--------------------|--|-------------|---------------|
| Summer 2003 | Common Grackle | 0.67 | N/A |
| Summer 2003 | Red-winged Blackbird | 0.13 | N/A |
| Summer 2003 | Vesper Sparrow | 0.68 | N/A |
| Summer 2003 | Brown-headed Cowbird | 0.84 | N/A |
| Summer 2003 | Horned Lark | 0.52 | N/A |
| Spring 2004 | American Robin (<i>Turdus migratorius</i>) | 0.26 | N/A |
| Spring 2004 | Brown-headed Cowbird | 0.10 | N/A |
| Spring 2004 | Horned Lark | 0.62 | N/A |
| Spring 2004 | Red-winged Blackbird | 0.57 | N/A |
| Spring 2004 | Common Grackle | 0.13 | N/A |
| Summer 2004 | Brown-headed Cowbird | 0.16 | N/A |
| Summer 2004 | Red-winged Blackbird | 0.14 | N/A |
| Summer 2004 | Song Sparrow | 0.37 | N/A |
| Summer 2004 | Common Grackle | 0.47 | N/A |
| Summer 2004 | Horned Lark | 0.05 | A>B |
| Fall 2003 | Common Grackle | 0.3 | N/A |
| Fall 2004 | Common Grackle | 0.38 | N/A |

Table 2. Comparison of bird abundance among point count sites, under wind towers (A) and Off-windfarm sites (D).

| Season | Species | <i>p</i> | Direction |
|--------------------|-----------------------------|--------------|---------------|
| Summer 2003 | Brown-headed Cowbird | 0.74 | N/A |
| Summer 2003 | Common Grackle | 0.42 | N/A |
| Summer 2003 | Horned Lark | 0.94 | N/A |
| Summer 2003 | Red-winged Blackbird | 0.048 | D>A |
| Summer 2003 | Vesper Sparrow | 0.74 | N/A |
| Spring 2004 | American Robin | 0.52 | N/A |
| Spring 2004 | Brown-headed Cowbird | 0.73 | N/A |
| Spring 2004 | Common Grackle | 0.69 | N/A |
| Spring 2004 | Horned Lark | 0.43 | N/A |
| Spring 2004 | Red-winged Blackbird | 0.33 | N/A |
| Summer 2004 | Brown-headed Cowbird | 0.21 | N/A |
| Summer 2004 | Common Grackle | 0.02 | A>D |
| Summer 2004 | Horned Lark | 0.34 | N/A |
| Summer 2004 | Red-winged Blackbird | 0.31 | N/A |
| Summer 2004 | Song Sparrow | 0.01 | A>D |
| Fall 2003 | Common Grackle | 0.47 | N/A |
| Fall 2004 | Common Grackle | 0.46 | N/A |

Table 3. Proportions of all species using the collision-risk zone at point count sites Under wind towers (A) and in adjacent fields without wind towers (C).
(Common Grackle = Common Grackle species only).

| Season | A | C | Z-Statistic | <i>p</i> |
|----------------------------|----------|----------|--------------------|-----------------|
| Summer 2003 | 0.0050 | 0.01 | 1.40 | 0.16 |
| Fall 2003 | 0.0001 | 0.03 | 14.66 | 0.0000001 |
| Fall 2004 | 0.0000 | 0.01 | 4.12 | 0.000037 |
| Common Grackle (Fall 2004) | 0 | 0.08 | 6.10 | 0.0000001 |

Table 4. Summer 2003 species-season analyses: Difference in proportion of birds using (0-30m) zone to birds using (0-100m) zone at point count sites under wind towers (A) versus point count sites in adjacent fields without wind towers (Proportion A- Proportion C)

* indicates no test due to non-normality of data.

| Species | <i>n</i> | T-Statistic | <i>p</i> (T-Stat) | <i>p</i> (Normality) |
|---|----------|-------------|-------------------|----------------------|
| Rock Pigeon (<i>Columbia livia</i>) | 3 | -2.86 | 0.10 | 0.86 |
| Brown-headed Cowbird | 12 | -0.03 | 0.98 | 0.71 |
| Mourning Dove | 12 | -0.17 | 0.87 | 0.69 |
| Horned Lark | 9 | -1.48 | 0.18 | 0.63 |
| European Starling | 9 | -1.77 | 0.12 | 0.55 |
| Barn Swallow (<i>Hirundo rustica</i>) | 12 | -3.87 | 0.00 | 0.40 |
| American Robin | 8 | -2.00 | 0.09 | 0.36 |
| Killdeer (<i>Charadrius vociferous</i>) | 10 | -2.99 | 0.02 | 0.31 |
| Common Grackle | 13 | -4.28 | 0.00 | 0.19 |
| Song Sparrow | 7 | -2.69 | 0.04 | 0.13 |
| Vesper Sparrow | 11 | -0.32 | 0.75 | 0.11 |
| Yellow-headed Blackbird | 4 | -4.59 | 0.02 | 0.10 |
| Canada Goose | 5 | -2.07 | 0.11 | 0.05 |
| Red-winged Blackbird | 8 | -0.65 | * | 0.03 |
| Tree Swallow | 6 | -3.01 | * | 0.00 |
| House Sparrow (<i>Passer domesticus</i>) | 4 | -7.00 | * | 0.00 |
| American Goldfinch (<i>Carduelis tristis</i>) | 5 | -12.33 | * | 0.00 |

Table 5. Fall 2003 Species-season analyses: Difference in proportion of birds using (0-30m) zone to birds using (0-100m) zone at point count sites under wind towers (A) versus point count sites in adjacent fields without wind towers (Proportion A- Proportion C)

* indicates no test due to non-normality of data.

| Species | <i>n</i> | T-Statistic | <i>p</i> (T-Stat) | <i>p</i> (Normality) |
|----------------------|-----------------|--------------------|--------------------------|-----------------------------|
| Mourning Dove | 8 | -13.12 | 0.00 | 0.44 |
| Vesper Sparrow | 5 | -1.52 | 0.20 | 0.44 |
| Canada Goose | 3 | -1.26 | 0.34 | 0.30 |
| Common Grackle | 13 | -4.63 | 0.00 | 0.06 |
| Brown-headed Cowbird | 5 | -2.31 | * | 0.01 |
| European Starling | 5 | -1.65 | * | 0.01 |
| Horned Lark | 6 | -4.59 | * | 0.00 |
| Barn Swallow | 4 | -3.00 | * | 0.00 |

Table 6. Spring 2004 species-season analyses: Difference in proportion of birds using (0-30m) zone to birds using (0-100m) zone at point count sites under wind towers (A) versus point count sites in adjacent fields without wind towers (Proportion A- Proportion C)

* indicates no test due to non-normality of data.

| Species | <i>n</i> | T-Statistic | <i>p</i> (T-Stat) | <i>p</i> (Normality) |
|--|----------|-------------|-------------------|----------------------|
| Northern Flicker (<i>Colaptes auratus</i>) | 2 | -5.00 | 0.13 | 1.00 |
| Mallard (<i>Anas platyrhynchos</i>) | 2 | -3.00 | 0.20 | 1.00 |
| Common Grackle | 13 | -3.07 | 0.01 | 0.77 |
| Brown-headed Cowbird | 13 | 0.10 | 0.92 | 0.41 |
| Canada Goose | 4 | -2.55 | 0.08 | 0.37 |
| American Robin | 7 | -1.74 | 0.13 | 0.36 |
| Barn Swallow | 6 | -5.49 | 0.00 | 0.24 |
| Killdeer | 9 | -5.65 | 0.00 | 0.23 |
| Red-winged Blackbird | 8 | -2.99 | 0.02 | 0.13 |
| Vesper Sparrow | 8 | -3.24 | 0.01 | 0.09 |
| Horned Lark | 8 | -3.75 | 0.01 | 0.06 |
| Mourning Dove | 7 | -10.83 | * | 0.03 |
| Song Sparrow | 4 | -7.00 | * | 0.00 |
| American Goldfinch | 3 | -1.25 | * | 0.00 |

Table 7. Summer 2004 species-season analyses: Difference in proportion of birds using (0-30m) zone to birds using (0-100m) zone at point count sites under wind towers (A) versus point count sites in adjacent fields without wind towers (Proportion A- Proportion C)

* indicates no test due to non-normality of data.

| Species | <i>n</i> | T-Statistic | <i>p</i> (T-Stat) | <i>p</i> (Normality) |
|---|----------|-------------|-------------------|----------------------|
| Red-tailed Hawk | 2 | -3.00 | 0.20 | 1.00 |
| Rock Pigeon | 2 | 0.49 | 0.71 | 1.00 |
| Killdeer | 7 | -7.39 | 0.00 | 0.88 |
| American Goldfinch | 4 | -3.23 | 0.05 | 0.83 |
| Vesper Sparrow | 10 | -2.42 | 0.04 | 0.76 |
| Red-winged Blackbird | 13 | -3.06 | 0.01 | 0.74 |
| Horned Lark | 12 | -2.22 | 0.05 | 0.67 |
| European Starling | 4 | -3.93 | 0.03 | 0.64 |
| Common Grackle | 13 | 0.75 | 0.47 | 0.52 |
| Brown-headed Cowbird | 13 | -0.44 | 0.67 | 0.42 |
| American Robin | 11 | -3.36 | 0.01 | 0.32 |
| Song Sparrow | 10 | -6.66 | 0.00 | 0.23 |
| Barn Swallow | 11 | -2.44 | 0.03 | 0.21 |
| Mourning Dove | 13 | -2.24 | * | 0.02 |
| Tree Swallow | 4 | -15.00 | * | 0.00 |
| Cliff Swallow (<i>Petrochelidon pyrrhonota</i>) | 3 | -9.00 | * | 0.00 |

Table 8. Fall 2004 species-season analyses: Difference in proportion of birds using (0-30m) zone to birds using (0-100m) zone at point count sites under wind towers (A) versus point count sites in adjacent fields without wind towers (Proportion A- Proportion C)

* indicates no test due to non-normality of data.

| Species | <i>n</i> | T-Statistic | <i>p</i> (T-Stat) | <i>p</i> (Normality) |
|----------------------|-----------------|--------------------|--------------------------|-----------------------------|
| Canada Goose | 3 | -0.36 | 0.75 | 1 |
| Rock Pigeon | 2 | -2.33 | 0.26 | 1 |
| Red-winged Blackbird | 7 | -4.42 | 0 | 0.67 |
| Common Grackle | 10 | -2.24 | 0.05 | 0.4 |
| Mourning Dove | 6 | -2.52 | 0.05 | 0.39 |
| American Goldfinch | 4 | -2.33 | 0.1 | 0.22 |
| Horned Lark | 11 | -4.97 | * | 0.05 |
| Brown-headed Cowbird | 10 | -4.22 | * | 0.03 |
| American Robin | 5 | -2.98 | * | 0.03 |
| European Starling | 6 | -1.64 | * | 0.01 |
| Barn Swallow | 12 | -2.27 | * | 0 |
| Song Sparrow | 4 | -1.4 | * | 0 |

CHAPTER 3: BAT MORTALITY AND ACTIVITY AT A NORTHERN IOWA WINDFARM

A paper to be submitted to *The Journal of Wildlife Management*

Aaftab Jain, Rolf Koford, Alan Hancock, Guy Zenner

Abstract: We examined bat collision mortality, activity and species composition at an 89 tower wind resource area (WRA) in north-central Iowa from April 15, 2003 to December 15, 2003 and March 15, 2004 to December 15, 2004. We found 30 bats in 2003 and 45 bats in 2004, on search transects and gravel access areas under towers. We adjusted for search probability, search efficiency and scavenging rate and estimated total bat mortality at 587.78 ± 28.95 (95% CI) in 2003 and 785.87 ± 40.00 (95% CI) in 2004. While carcasses were most often migratory species, we found a considerable proportion of non-migratory little brown bats (*Myotis lucifugus*). We recorded 1465 bat calls at tower sites ($\bar{x} = 34.88/\text{detector-night}$) and 1536 bat calls at adjacent non-tower sites ($\bar{x} = 36.57/\text{detector-night}$). Bat activity did not differ significantly between tower and non-tower sites. Bat calls were determined to be made mostly by little brown bats. There was no relationship between types of tower lights and collision mortality or activity. July and August had both the highest bat activity and the highest collision mortality. More research should be conducted on the behavior of bats while engaged in collision-prone flight at rotor heights.

INTRODUCTION

Wind power is a financially competitive source of renewable energy in the U.S. that is generally viewed as having few negative effects on the environment. Earlier wind farm

studies found that, in comparison to birds, bat collisions with wind towers appeared to be rare (Howell 1997, Orloff and Flannery 1992, Thelander and Ruge 2000), though few investigators had studied bat use and mortality associated with wind towers (Osborn et al. 1996). However, more recent studies have found larger numbers of bats killed than expected (Fiedler et al. 2002, Kerns and Kerlinger 2004). In north-central Iowa, observations by wind farm employees at the Cerro Gordo County Wind Farm suggested that bats suffer fatal collisions with wind towers (G. Zenner, Iowa Dept. of Natural Resources, pers. comm.). The Top of Iowa Wind Resource Area (WRA) was constructed in December 2001 in Worth County in north-central Iowa. We conducted a study from March 15 to December 15, 2003 and 2004, to assess the collision mortality of bats at the Top of Iowa WRA and to characterize bat activity in the region. Study objectives included estimating the number of bat fatalities due to tower collisions, comparing bat activity between wind towers and adjacent crop fields, and describing any trends in bat activity and mortality due to seasonal, weather and habitat related factors.

STUDY AREA

Construction on the 89-tower Top of Iowa Wind Resource Area (WRA) near Joice in Worth County, Iowa was completed in December 2001. Towers were located on private land in an area comprising about 2,137 ha. The primary vegetation types in the study area were cultivated crops (primarily corn and soybeans). Other habitat types included hay, Conservation Reserve Program (CRP) grassland and deciduous woodlots associated with farmsteads. The WRA was located between 3 large wildlife management areas (WMA) that were complexes of wetland, grassland and forest habitat (Fig. 1). While no data are available on historical bat use of the WMA's, the close proximity of these 3 WMA's provided habitat

for tree-dwelling bats, while the nearby town of Joice and the farmsteads on and around the WRA provided habitat for structure dwelling bats. The wind turbines were mounted on 71.6 m (235 ft) high tubular towers and turned by 3 25.9m (85ft) rotors with a $2,107.69\text{m}^2$ ($22,690\text{ft}^2$) sweep area (Fig. 2). Forty-six towers were lit at the turbine level with Federal Aviation Administration (FAA) non-pulsating red beacons. Thirty-seven towers on the periphery of the windfarm had pulsating red beacons. Due to proximity to the Lake Mills Municipal Airport, 6 towers in the northwest of the WRA had a combination of pulsating white beacons and non-pulsating red beacons. In addition to wind towers, 2 guy wire supported meteorological towers (71.6m high), were located on the WRA to gather weather data.

METHODS

Mortality

We looked for evidence of collision-induced mortality under 26 of 89 wind towers. During the second year of the study, we also conducted searches under the 2 meteorological towers on the WRA. Bats found under the meteorological towers were treated separately from carcasses found under wind towers, as were any bats found outside our prescribed search areas.

Our sampling design ensured geographic distribution of mortality study sites through the windfarm. Of the 35 1 sq mile sections that the WRA occupies, 29 contained more than 1 tower. These were grouped into 14 pairs of adjacent sections. Two towers were selected at random from the towers in each of these 14 paired section and one additional section was chosen to have 2 tower sites, for a total of 30 selected tower sites. Landowner permission was received for 26 out of these 30 sites.

We kept 6 3m-wide transects free of vegetation by using herbicides and manual weeding (Hancock and Zenner, pers. comm.) within each 76m x 76m (5776 m²) search area under each of the 26 selected towers (Fig.3). Transects ran parallel to existing corn/soybean rows, and were located at random distances from the base of the tower. Transect locations were randomly selected in both years. We also searched access roads and construction pads under towers. The average area searched under each tower was 1742m², which was about 30% of the 5,776m² search area. Standardized searches of all mortality transects began April 15, 2003. Initially, we searched each tower once every 3 days. After June 12, 2003, the search frequency was increased to once every 2 days, until the end of the season, December 15, 2003. Starting March 15, 2004, the mortality study sites were set up again, and standardized searches of all mortality transects began on March 24, 2004. At each of the 26 towers searched, we recorded the location of each carcass and its distance to the tower using Global Positioning System coordinates. We searched each tower once every 2 days. We collected and froze all bat carcasses found for necropsy at the Veterinary Diagnostic Laboratory at Iowa State University, to detect signs of collision trauma. Carcasses were frozen within 3 hours of detection, but the state of preservation was subject to the 2 days search frequency. Carcasses were also examined for additional evidence of fitness such as muscle mass, fat reserves and presence of food in the gut.

We also collected carcasses found at other times (e.g. when visiting tower sites for other phases of the project, and while walking between search transects etc. but did not use them to estimate total mortality because they were not found as part of the systematic searches. In 2004, we also searched under the 2 meteorological towers operated by the windfarm. We searched 3.05m wide transects on either side of the guy wires, from the base

of the tower to the point where the guy wires anchored in the ground. The total area searched under each meteorological tower was 881.76m^2 (Fig. 4).

Adjusting for Search Probability, Scavenger Removal Rate, Search Efficiency and Proportion of Towers Searched.--

We made the following adjustments to extrapolate the mortality counts to estimated mortality for the entire wind farm. We adjusted the number of carcasses found (μ_c) in a two-step process.

The number of carcasses found in the searched area on transects or gravel (μ_c) was adjusted for Search Probability (S_p). As the distribution of fallen carcasses may not have been uniform over the entire $5,776\text{m}^2$ search area, we defined 6 concentric buffers of 10m width, centered on each tower. The smallest buffer was a circle (10-meter radius), centered on the tower. The largest buffer was a ring ranging from 50 to 60m from the center of the tower. We adjusted the number of carcasses in each buffer for the average proportion, over all 26 towers, of each buffer searched, (S_p). A mortality estimate (t) was created for each buffer where $t = (\mu_c/S_p)$. We calculated the variance of this estimate for each of the 26 towers searched, using standard methods (assuming normal distribution). We summed the estimates and variances of t for each tower, to produce an estimate (T), the search-probability-adjusted estimate of kills for all searched towers, and its variance.

In the next step, we adjusted the estimate (T) for scavenger efficiency (R), search efficiency (E) and the proportion of towers searched to the total number of towers on the windfarm (P).

a) Percent of test carcasses left by scavengers within the search period (R).

Scavenger efficiency (R) was measured during spring, summer, and fall of 2003 and 2004

by placing small birds, of house sparrow (*Passer domesticus*) size, on mortality transects under each of the 26 monitored wind towers. Over 6 seasonal tests (3 tests per year), 55 carcasses were placed in predetermined positions in mortality transects, so that there would be no confusion between test carcasses and other carcasses found on transects. We monitored carcasses daily for two weeks for evidence of scavenging. We recorded the status of each carcass as intact, partially scavenged, or completely removed. After the two-week period, we collected and disposed of all remaining carcasses.

- b) Percent of carcasses missed by observers in the search efficiency trials (E).

Search efficiency trials were conducted for each observer by having an independent Iowa Department of Natural Resources (DNR) wildlife technician place small birds, such as house sparrows, on transects without the searchers knowledge. The field assistants recorded all carcasses that they discovered, including carcasses planted by the wildlife technician. Planted carcasses were later removed from the database and a search efficiency rate (E) calculated by dividing the number of successfully found carcasses by the total number of carcasses planted.

- c) We adjusted the estimate for the proportion of towers that we searched under relative to the total number of towers on the windfarm (P).

$$\text{Thus, } \hat{C} = \frac{T}{R \times E \times P}$$

Where \hat{C} = Adjusted total number of kills estimated at the windfarm.

The variance of the number of kills found and the search probability was first calculated per tower using standard methods and then combined. Then, we calculated the

variance due to the correction factors R , E , and P , using the variance of a product formula (Goodman, 1960). The variance of the product of R , E and P is:

$$\text{Var}(C) = C^2 \times \left[\frac{\text{var } T}{T^2} + \frac{\text{var}(R \times E \times P)}{(R \times E \times P)^2} \right]$$

Bat Activity

We used 2 Anabat II ® Bat detectors (Title Electronics Pty. Ltd., NSW, Australia) attached to Anabat Compact Flash Storage Zero-Crossings Analysis Interface Modules (ZCAIM) to collect ultrasonic bat calls at the bases of wind tower sites as well as in adjacent fields without wind towers. The detector sends data to the ZCAIM on detecting ultrasonic vibrations. The ZCAIM stores this information digitally, in individual files, distinguished by intervening periods of no ultrasonic detection. We counted each file as a separate bat call. We used the bat detectors to monitor bat activity from September 4, 2003 to October 9, 2003 and from May 26, 2004 to September 24, 2004. We waterproofed the detectors for passive monitoring (O'Farrell 1998) and set them to record activity from sunset to sunrise at each site. We systematically chose 13 out of the 26 towers (every second tower) searched for collision mortality evidence to monitor for bat activity. Each detector-night, we set 1 bat detector at the base of a wind tower, away from the electric transformer at the tower base, and pointed it upward (30 degrees from the horizontal) and away from the towers. We placed the second detector at the edge of an adjacent field, in a paired design. We used field edges rather than locations in the centers of fields to ensure that farming activity did not damage equipment. We downloaded the collected data (in a digital format) each day.

Tower versus Non-tower Activity.--

We analyzed differences between total calls recorded at tower sites versus adjacent non-tower sites with a paired t-test using PROC GLM (SAS Institute Inc, 2001). Using software programs Analook (O'Farrell et al. 1999) and Analyze (Jolly 1997), we used the digital information to estimate relative bat activity and species on the windfarm.

We counted each file that the CFZCAIM software defined (Britzke et al. 1999) as a unit of activity. This method led to the inclusion of a large number of call fragments. However, this method was adequate for the purpose of determining relative activity. We used a species identification key (Karen Francl, Univ. of Notre Dame pers. comm.) to identify a subset of bat calls recorded from late spring (May 5 to May 26, 2004) and late summer/early fall (July 29 to August 26, 2004). For qualitative analysis, we discarded calls if they contained fewer than 2 individual pulses (Britzke et al. 1999). Where possible, calls were identified to species.

Distance to nearest woodlot.--

Using ArcView 3.3 (Copyright © 1992-2002 Environmental Systems Research Institute, Inc.), we estimated the distance of the nearest woodlot to each monitored tower using 2002 infrared ortho-photos at 1 m² resolution. We examined the relationship between bat activity and distance to nearest woodlot and to the nearest WMA using a multiple linear regression model in which the number of passes was the response and the distances to the nearest woodlot and WMA's were the explanatory variables.

Tower Lights.--

We examined the relationship between bat activity and the tower lights. Four tower sites with red pulsating beacons were among the 13 sites monitored for bat activity. Eight tower sites with non- pulsating red beacons were also monitored. As an artifact of sampling from the

mortality phase of the project, only 1 tower of the third light type (red non- pulsating and white-dual pulsating lights) was sampled for bat activity. Data from this site were not included in the analysis. We used ANOVA to test for a difference between bat activity at towers of red pulsating and non- pulsating beacon types (PROC GLM, SAS Institute Inc, 2001). We also used ANOVA to test for a difference between the numbers of bat carcasses found under towers of each beacon type (PROC GLM, SAS Institute Inc, 2001). Data was log transformed for this purpose. We conducted mortality searches under 13 towers that were lit with flashing red beacons, 4 towers with dual red beacons and flashing white beacons and 9 with steady glowing red beacons.

RESULTS

Mortality

We searched for evidence of mortality from April 15, 2003 to December 15, 2003, and found the remains of 30 bats within the designated search area. (11 hoary, *Lasiurus cinereus*, 9 little brown, *Myotis lucifugus*, 6 eastern red, *L. borealis*, 3 big brown, *Eptesicus fuscus* and 2 silver-haired bats *Lasionycteris noctivagans*). An additional eastern red bat was found incidentally, between transects. Other than 1 silver-haired bat that we found in the spring (April), all bats were found in the fall, from June to October 2003 (Fig. 6.). When searching from April 1 2004 to December 10, 2004, we found the remains of 45 bats (10 hoary, 13 eastern red, 9 little brown, 5 big brown, 7 silver-haired and 1 eastern pipistrelle bat (*Pipistrellus subflavus*). An additional eastern red bat was found incidentally, under a tower that did not have a designated search area. We found all carcasses in the fall, from June to September 2004. We did not find any bats under the meteorological towers in 2004.

Collision trauma observed upon necropsy at the Veterinary Diagnostic Laboratory was typically bone fractures and hemorrhaging. Of 30 bat carcasses in 2003, 23 were in good enough physical condition to necropsy. 19 (~83%) showed obvious signs of trauma and 4 carcasses (~17%) did not. However, of these 4, the veterinary doctor performing the necropsy rated 2 carcasses in poor/marginal state of preservation. Of the 45 bat carcasses found in 2004, 33 carcasses were in good enough physical condition to necropsy. Twenty-two (~67%) showed obvious signs of trauma, and 11 carcasses (~33%) did not. However, most (7) of the carcasses which did not show apparent cause of death were rated in poor state of preservation in the necropsy report, which could detect only the most dramatic traumatic lesions. (Dr. M Yaeger, personal comm.) While we searched sites approximately once every 2 days, small body size, warm temperatures and insect activity quickly reduced the physical condition of the bats. For all carcasses where mortality could not be attributed to collision, no other obvious cause of mortality could be detected. Given the lack of alternate causes of death we decided to attribute all mortality to tower collisions.

Adjusting for Scavenge Rate, Search Efficiency, and Probability.--

We pooled data from spring, summer and fall scavenging trials as the scavenge rate did not differ significantly between seasons, in 2003 (Pearson $\chi^2 = 2.34$, $df = 25$, $p = 0.31$) and (Pearson $\chi^2 = 0.35$, $df = 26$, $p = 0.84$) in 2004. Spring, summer and fall scavenging trials indicated scavengers left an average of 93% and 82% of small bird carcasses within the interval between searches in this study, in 2003 and 2004 respectively. Observer efficiency trials for mortality transect searches indicated that, as a group, observers found 71% (27/38) and 74% (26/35) of small bird carcasses, in 2003 and 2004 respectively. The ratios of the area searched in transects and gravel areas under the 26 towers to the total searchable area

(S_p), for buffers 1-6 were 0.26, 0.30, 0.29, 0.27, 0.25 and 0.14 in 2003 and 0.24, 0.33, 0.30, 0.26, 0.22, and 0.10 in 2004.

Mortality estimates adjusted for the entire WRA indicate an estimated 587.78 ± 28.95 (95% CI) bats died as a result of collisions with the wind towers between April 15 and December 15, 2003 and 785.87 ± 40.00 (95% CI) bats died as a result of collisions with the wind towers between March 24 and December 15, 2004.

Tower Lights.--

No significant difference in bat mortality was observed between towers with the 3 different types of FAA lighting, ($F = 1.42$, $P = 0.26$, $df = 2, 23$).

Bat Activity

We recorded bat activity for a total of 84 detector-nights. We detected 1465 bat calls at tower sites ($\bar{x} = 34.88$ calls/detector-night) and 1536 bat calls at non-tower sites ($\bar{x} = 36.57$ calls/detector-night). We recorded calls at 100% of both the tower and non-tower sites monitored. The maximum number of calls recorded in 1 night at 1 detector was 245 on September 12, at a non-tower site and 195 on June 29 at a tower site. Bat activity, measured by the number of calls per night, peaked in July (99.5 calls/detector-night) and August 2004 (56.44 calls/detector-night). Bat activity was lower in September (10.5 calls/detector-night) and had mostly ceased by October, when detection was curtailed. This followed a trend similar to mortality which was also highest in July and August (Fig. 5.)

The 2003 pilot study (September to October) using Anabat ultrasonic bat detectors indicated there was no significant difference between bat activity at wind tower sites and adjacent crop fields without towers ($F = 0.24$, $df = 1, 12$, $P = 0.63$). The 2004 study (May to September) also found no significant difference between bat activity at wind tower sites and

adjacent crop fields without towers ($F = 0.07$, $df = 1, 70$, $P = 0.78$). Analysis of the 2004 data showed no significant effect of distance to nearest woodlot ($t = 0.86$, $df = 1, 10$, $P = 0.41$), or WMA ($t = -0.97$, $P = 0.035$, $df = 1, 10$) on bat activity. There was also no significant difference between the number of calls recorded at towers with red blinking and non-blinking beacons ($F = 0.07$, $df = 1, 10$, $P = 0.79$). There was no significant relationship between bat activity and bat mortality at towers ($F = 0.18$, $P = 0.68$, $df = 1, 11$).

Qualitative Analysis.--

We were able to differentiate calls of *Myotis* spp. (presumed to be little brown bats) from calls of other species. In the late spring/early summer calls analyzed, we identified 44% of calls as little brown bats (Of a total of 45 calls recorded in 9 detector-nights). Of 595 calls recorded over 11 detector-nights in the fall, we identified 40% as little brown bat calls.

DISCUSSION

As the impacts of WRA's are likely to vary by region, comparisons between studies must consider regional uniqueness of habitat, wildlife abundance and behavior, and differences between study methods. Mortality results from this study are primarily compared with results from other studies conducted in agricultural land in the western and midwestern United States. Our estimated mortality rates, 6.44 bats/tower/year in 2003 and 9.24 bats/tower/year in 2004, were high compared to those of other WRA studies in the Midwest (Osborn et al. 1996, Johnson et al. 2003, 2004, Howe et al. 2002). However, as comparable studies have adjusted for search efficiency and scavenging rates, we think our data reflects a real difference in mortality rate at the Top of Iowa WRA. Although high, our estimates of bat fatalities are not the greatest reported in the literature. Kerns and Kerlinger (2004) estimated fatalities of 47.53 bats/tower/year in a study in West Virginia. Fiedler et al. (2002) estimated

mortality at 10.33 bats/turbine/year in Tennessee. However, both these studies were in mountainous regions, with habitats possibly more suitable to bats than northern Iowa.

Higher mortality rates may be due to differences in search rate and the condition of the ground searched at different WRA's. We used small bird carcasses to estimate search efficiency and scavenge rates, as bat carcasses were not available. Johnson (2002, 2004) reported higher search efficiencies for bats than small birds ($\approx 30\%$ for small birds and $\approx 47\%$ for bats), but search efficiency varied among the substrates searched in those studies. We believe that the bare ground transects maintained in our study would reduce the differences between search efficiency for small birds and bats. Johnson (2002, 2004) reported that bats were scavenged at a slower rate than small birds. As the scavenge rate for small birds was already low in our study, bat scavenge rates were probably not substantially different from small birds. Finally, our search transects were designed to sample an area of at least 38m radius from the base of the tower. Johnson et al. (2003) found only 0.5% of bat carcasses beyond 33m of towers that attained a maximum blade height of 73m. The Top of Iowa WRA towers reached a maximum blade height of 98m. It is possible that a small percentage of carcasses landed farther from towers than we searched, which would make our overall mortality estimate slightly conservative.

Several factors may cause bats to be susceptible to wind tower collision; local and regional habitat, population levels, flight height, weather and visibility conditions, tower lighting and use of habitats immediately around the towers.

Flight Height.--

While bats are thought to fly most often at heights below rotor sweep of the wind towers (Zinn and Baker 1979, LaVal et al. 1977), Hecker and Brigham (1999) recorded bat calls in

forest canopy at 65 to 90m above ground level in British Columbia, Canada,. That region was populated by *Myotis* spp., hoary bats, silver-haired bats, and big brown bats, which are all found at the Top of Iowa WRA. LaVal et al. (1977) also described hoary bats flying high above trees and pastures. Bats are capable of complex flight through aerial obstacles (Vaughn 1970). However, this ability is not infallible. For a thorough review on bat collision mortalities with manmade structures such as television and communication towers, large buildings, power lines and wind towers in Northern America, see Erickson et al. (2002).

It is possible that bat activity at the Top of Iowa WRA was influenced by nearby habitat, namely the three WMA's that surround the windfarm. Data collected while testing the bat detectors in June and July of 2003 showed that bat activity at the Elk Creek WMA (north of the WRA) was easily detectable. Similarly bat activity was easily detectable during the summer, on the western edge of the WRA, in the town of Joice. Considering the wooded habitat and likely food resources in Joice, as well as nearby woodlots and farmsteads, these areas provide adequate habitat for bats (Barbour and Davis 1969, Mager and Nelson 2001). However, we are unsure how bat densities on our study area compare to other regions. Anabat detectors placed below towers did record a higher frequency of bat passes (34.88 calls/detector-night) at this WRA than was recorded at the Buffalo Ridge WRA (1-2 calls/detector-night). However, the CFZCAIM software definition of bat calls included many call fragments, which is roughly equivalent to the number of bat passes (Britzke et al. 1999). For consistent activity comparisons between tower and non-tower sites, we did not remove these call fragments. Due to the low detection range of the equipment (approximately 25m), this is an underestimate of the bat activity in the region. However, other WRA studies may have eliminated call fragments (O'Farrell and Gannon, 1999), leading reports of lower

numbers of calls/detector-night (Johnson et al. 2004). Thus, our data reflect relative activity at the Top of Iowa WRA and should be used cautiously when comparing abundance data with studies using different classifications of bat calls.

Unlike researchers at the Buffalo Ridge WRA (Johnson et al. 2004), we did not find a negative relationship between distance to nearest woodlot and bat activity, nor did we find a significant relationship between distance to nearest WMA and bat activity. Further, bat activity did not differ between tower and non-tower sites, so we have no evidence that the presence of the wind tower was associated with avoidance behavior.

Species Composition.--

Previous studies in the Midwest have hypothesized that hoary, eastern red and silver-haired bats were more likely to strike towers due to their long-range migratory behavior (Erickson et al. 2002, Johnson et al. 2003, 2004). Erickson et al. (2002) reported that other studies in the United States found that approximately 68% of bats killed by towers were hoary bats. Whereas hoary bats were killed in the greatest numbers in both 2003 and 2004 on our study area, they comprised only 28% (21/75) of the total kills over both years. In addition, little brown bats were reported to be 2.8% of kills found at other midwestern WRA studies, whereas 24% (18/75) of carcasses found at this study were little brown bats. Little brown bats do exhibit some migratory behavior, traveling to hibernacula up to 150-450 km away from their summer roosts (Barbour And Davis 1969). Acoustic surveys during both spring and summer at the Top of Iowa WRA revealed that little brown bat calls were the most commonly recorded species. The local abundance of this species may have contributed to a higher collision rate.

Tower Lighting.--

Some species of bats are known to forage for insects that are attracted to artificial lights (McClure 1939, 1942, Acharya and Fenton 1999). As all the towers at the Top of Iowa WRA had FAA lights, we could not test for differences in mortality or activity between lit and unlit towers. However, we found no effect of the type of tower lighting (red pulsating and non-pulsating beacons and white strobe lights) on mortality or activity, consistent with Johnson et al. (2004).

Weather.--

No mortality events coincided with major storms or unusually high winds in either 2003 or 2004. As all but 1 bat fatality occurred in the fall, high winds were not considered to be a cause of mortality. Kerns and Kerlinger (2004), Johnson et al. (2004) found no correlation between weather events and bat collision mortality.

Meteorological towers.--

We did not find any dead bats under either of the two meteorological towers in 2004. Similar studies of towers (guyed and unguyed) at other WRA's also found no bat fatalities at meteorological towers (Erickson et al. 2003, Young et al. 2003, Kerns and Kerlinger 2004). Bats may be colliding with rotors, rather than nonmoving structures such as towers or guy wires.

Seasonal Trends.--

While specific towers in this study did not show a relationship between mortality and ultrasonic activity, the seasonal increase in bat activity closely coincided with the overall incidence of mortality. The timing also corresponded with the post-breeding southward migration for hoary, eastern red and silver-haired bats (Cryan 2003), as well as the movement of big brown, little brown and eastern pipistrelle bats from summer breeding areas to

hibernacula (Barclay 1984, Genter and Jurist, 1995). Movement into new areas during late summer and early autumn may be partially the result of exploratory activity (Cryan 2003). Thus, the temporal pattern of bat collisions in the region may simply be related to increased bat activity prior to and during migration.

The link between mortality and migration could be complex. Physical limitations of echolocating (atmospheric absorption, spreading loss) suggest that high-flying bats may not be able to use that ability for long distance migration (Griffin 1970). Homing experiments have also indicated that vision plays an important part in bat movements across distances greater than a few miles (Williams and Williams 1967, 1970). Thus, bats may not be using echolocation exclusively during migration. The extent of echolocating behavior during migration may have implications for future WRA mitigation and siting analyses. Future research in this area should try to quantify the relationship between bat activity at various altitudes and determine how often bats echolocate while migrating. While Anabat detectors at the base of towers (Johnson et al. 2004, this study) and mist-netting (Johnson et al. 2004, Gruver 2002) can help describe the relationship between activity and mortality, extreme caution must be used in extrapolating data collected from ground level to flight behavior at higher altitudes. It is important to collect information on the behavior of bats when they are at greatest risk of colliding with towers, i.e. at heights beyond the range of bat call detectors placed at ground level (Furlonger et al. 1987). Conventional research methods such as ground level mist-netting and acoustic monitoring are thus inadequate (Menzel et al. 1999). If resident bats rarely hit towers during non-migratory periods (Johnson et al. 2004, this study) then the increase in ultrasonic activity detected at ground level must either reflect a change in behavior of residents, an increased use of local habitat by migrants, or an increase

in local populations due to newly volant juveniles. If the coincidence of ground-level acoustic activity and mortality is taken as evidence that migrant bats are at greatest risk of tower collision, then tower collision may not occur as a result of migratory flight per se, but rather as a result of increased foraging activity to sustain energy levels. Such activities would bring migrant bats in range of detectors.

Winkelman (1994) observed that the turbulence in the wake of wind towers was powerful enough to sweep birds out of the sky, at the Oosterbierum WRA, in the Netherlands. Bats may also be susceptible to flight disruptions from turbulence. A recent report from the Mountaineer WRA in West Virginia showed thermal images of bats being buffeted by the rotor wake (Horn 2004). A study that collects ultrasonic bat data and thermal images at ground and rotor blade levels in grassland and agricultural land could serve to describe which bat species use the area around wind towers and how bats use echolocation to navigate in those situations.

There is a lack of adequate background data on bat populations and habits. While migrant species are most often killed at WRA's, mortality at the Top of Iowa WRA included comparatively greater proportions of non-migrating species. When siting new WRA's, multiple season studies on both local and migrant bat populations and their flight patterns should be conducted. Finally, more research must be conducted on the behavior of bats while engaged in collision-prone flight at rotor heights.

ACKNOWLEDGEMENTS

We thank P. Dixon, and J. Miller for critical comments on earlier drafts of this manuscript. Funding for this study was provided by The Iowa Cooperative Fish and Wildlife Research Unit, Northern Iowa Windpower LLC, and by a US Fish and Wildlife Service State Wildlife

Grant (T-1-R-3), through the Iowa Department of Natural Resources. Guy Zenner and Alan Hancock provided invaluable help in procuring funding, designing the project and supervising data collection during the academic year. We thank J. Bockenstedt, P. Brandon, B. Carter, I. Foster, D. Goshorn, K. Kuennen, J. Makosky, R. Miller, and M. Piorkowski for their hard work in the field and laboratory. R. Benedict, D. Howell and A. Slattery identified bat species. We thank I. Ramler and P. Dixon for statistical support, and M. Yeager for carcass necropsy work. We conducted research under a permit issued by the Iowa State University COAC # 9-03-5524-Q.

LITERATURE CITED

- ACHARYA, L, AND F.M. BROCK. 1999. Bat attacks and moth defensive behaviour around street lights. *Canadian Journal of Zoology* 77(1): 27-33.
- ANDERSON, R., M. MORRISON, K. SINCLAIR, AND D. STRICKLAND. 1999. Studying wind energy/bird interactions: A guidance document. National Wind Coordinating Committee. <<http://www.nationalwind.org/publications/avian.htm>>. Accessed 2005 July 11.
- ARCVIEW 3.3 © 1992-2002. Environmental Systems Research Institute, Inc.
- BARBOUR, R.A, AND W.H. DAVIS. 1969. *Bats of America*. University of Kentucky, Lexington.
- BARCLAY, R.M.R. 1984. Observations on the migration, ecology and behaviour of bats at Delta Marsh, Manitoba. *Canadian Field-Naturalist* 98:331-336.
- BRITZKE, E.R., K.L. MURRAY, B.M. HADLEY, AND L.W. ROBBINS. 1999. Measuring bat activity with the Anabat II system. *Bat Research News* 40 (1): 1-3.
- CRYAN, P., 2003. Seasonal distribution of migratory tree bats (*Lasiurus* and *Lasionycteris*) in North America. *Journal of Mammalogy*. 84 (2): 579–593.

- ERICKSON, W.P., G.D. JOHNSON, D.P. YOUNG, M.D. STRICKLAND, R.E. GOOD, M. BOURASSA, K., BAY, AND K. SERNKA. 2002. Synthesis and comparison of baseline avian and bat use, raptor nesting and mortality information from proposed and existing wind developments. WEST, Inc. 2003 Central Ave. Cheyenne, WY 82001.
- , K. KRONNER, AND B. GRITSKI. 2003. Nine Canyon Wind Power Project avian and bat monitoring report. Prepared for: Nine Canyon Technical Advisory Committee and Energy Northwest. WEST, Inc. 2003 Central Ave. Cheyenne, WY 82001.
- , JEFFREY, J., KRONNER, K., AND BAY, K. 2004. Stateline Wind Project wildlife monitoring final report. 2003. WEST, Inc. 2003 Central Ave. Cheyenne, WY 82001
- FIEDLER, J.K., C.P. NICHOLSON, N.S. NICHOLAS, D.A. BUEHLER, G. MCCrackEN, AND K.H. BRADEN. 2002. Bat activity and mortality at Buffalo Mountain Windfarm, Eastern Tennessee. Special Issue: Abstracts of Papers Presented at the 32nd Annual North American Symposium on Bat Research Held November 6-9, 2002, in Burlington, Vermont. *Bat Research News* 43(4):147-148.
- FURLONGER, C.L., H.J. DEWAR, AND M.B. FENTON. 1987. Habitat use by foraging insectivorous bats. *Canadian Journal of Zoology* 65: 284-288.
- GENTER, D.L., AND K.A. JURIST. 1995. Bats of Montana. Montana Natural Heritage Program. Helena, USA.
- GOODMAN, L. A. 1960. On the exact variance of products. *Journal of the American Statistical Association* 55:708-713.
- GRIFFIN, D.R. 1970. Migrations and homing of bats. Pages 233-264 *in* W.A. Wimsatt, ed. *Biology of bats*. Volume 1. Academic Press, New York, USA.

- GRUVER, J.C. 2002. Assessment of bat community structure and roosting habitat preferences for the hoary bat (*Lasiurus cinereus*) near Foote Creek Rim, Wyoming. Thesis, University of Wyoming, Laramie, USA.
- HECKER, K.R., AND M.R. BRIGHAM. 1999. Does moonlight change vertical stratification of activity by forest dwelling insectivorous bats? *Journal of Mammalogy* 80(4): 1196-1202.
- HORN, J. 2004. Bats and wind turbines: infrared analysis of abundance, flight patterns and avoidance behavior. *Proceedings Onshore Wildlife Interactions with Wind Developments: Research Meeting V. National Wind Coordinating Committee* <<http://www.nationalwind.org/publications/avian.htm>>. Accessed 2005 July 11.
- HOWE, R.W., W. EVANS, AND A.T. WOLF. 2002. Effects of wind turbines on birds and bats in northeastern Wisconsin. Wisconsin Public Service Corporation, Madison, Wisconsin.
- HOWELL, J.A. 1997. Bird mortality at rotor swept area equivalents, Altamont Pass and Montezuma Hills, California. *Transactions of the Western Section of the Wildlife Society* 33: 24-29.
- JOHNSON, G.D., W.P. ERICKSON, M.D. STRICKLAND, M.F. SHEPHERD, D.A. SHEPHERD, AND S.A. SARAPPO. 2002. Collision mortality of local and migrant birds at a large-scale wind-power development on Buffalo Ridge, Minnesota. *Wildlife Society Bulletin* 30(3): 879-887.
- , -----, -----, -----, AND ----- . 2003 Mortality of bats at a large-scale wind power development at Buffalo Ridge, Minnesota. *American Midland Naturalist* 150:332–342.

- , M.K. PERLIK, W.P. ERICKSON, AND M.D. STRICKLAND. 2004. Bat activity, composition, and collision mortality at a large wind plant in Minnesota. *Wildlife Society Bulletin* 32(4): 1278-1288.
- JOLLY, S. 1997. Analysis of bat echolocation calls recorded by Anabat bat detectors. Thesis. Department of Computer and Mathematical Sciences, Victoria University of Technology. Melbourne, Australia.
- JONES, J., AND C.M. FRANCIS. 2003. The effects of light characteristics on avian mortality at lighthouses. *Journal of Avian Biology* 34: 328–333.
- KERNS, J., AND P. KERLINGER. 2004. A study of bird and bat collision fatalities at the Mountaineer Wind Energy Center, Tucker County, West Virginia. Annual Report for 2003. Curry and Kerlinger LLC, Cape May Point, New Jersey, USA.
- LAVAL, R.K., R.L. CLAWSON, M.L. LAVAL, AND W. CAIRE. 1977. Foraging behavior and nocturnal activity patterns of Missouri bats, with emphasis on the endangered species *Myotis grisescens* and *Myotis sodalis*. *Journal of Mammalogy* 58:592-599.
- MAGER, K.J., AND T.A. NELSON. 2001. Roost-site Selection by eastern red bats (*Lasiurus borealis*). *American Midland Naturalist* 145:120–126.
- MCCLURE, H.E. 1939. Red Bats at Lewis, Iowa. *Journal of Mammalogy* 20: 501.
- , 1942. Summer activities of bats (Genus *Lasiurus*) in Iowa. *Journal of Mammalogy* 23(4): 430-434.
- MCCRACKEN, G.F. 1996. Bats Aloft: A Study of High-Altitude Feeding. *Bats* 14(3): 7-10.
- MENZEL, M.A., J.M. MANESS, G.F. MCCRACKEN, J.W. EDWARDS, AND B.R. CHAPMAN. 1999. A comparison of bat activity above and below the forest canopy. *Bat Research News* 40(4):181.

O'FARRELL, M.J. 1998. A passive monitoring system for Anabat II using a laptop computer.

Bat Research News 39(4): 147-150.

-----, AND W.L. GANNON. 1999. A comparison of acoustic versus capture techniques for the inventory of bats. *Journal of Mammalogy* 80(1): 24-30.

-----, B.W. MILLER, AND W.L. GANNON. 1999. Qualitative identification of free-flying bats using the Anabat detector. *Journal of Mammalogy* 80(1): 11-23.

ORLOFF, S., AND A. FLANNERY. 1992. Wind turbine effects on avian activity, habitat use, and mortality in Altamont Pass and Solano County Wind Resource Areas, 1989-1991.

Final Report to the California Energy Commission, Sacramento, USA.

OSBORN, R.G., K.F. HIGGINS, C.D. DIETER, AND R.E. USGAARD. 1996. Bat collisions with wind turbines in southwestern Minnesota. *Bat Research News* 37:105-108.

REYNOLDS, D.S. 2004. Draft study proposal for bat activity monitoring survey Laurel hill wind project, Lycoming County, Pennsylvania. North East Ecological Services.

Prepared For: Catamount Energy Corporation, Rutland, Vermont, USA.

SAS SYSTEM FOR WINDOWS, VERSION 8.2. Copyright © 2001 SAS Institute Inc. SAS and all other SAS Institute Inc. product or service names are registered trademarks or trademarks of SAS Institute Inc., Cary, NC, USA.

SAUNDERS, W.E. 1930. Bats in migration. *Journal of Mammalogy* 11:225.

TITLEY ELECTRONICS PTY. LTD., NSW, Australia. <<http://www.titley.com.au>>

TRAVIS, L., AND C. RICH. 2004. Conflicting data on fast-vs. slow flying bats? *Frontiers in Ecology and the Environment* 2(4): 191-198.

VAUGHN, T. 1970. Flight patterns and aerodynamics, Pages 195-216 in W.A. Wimsatt, editor. *Biology of bats*, Volume 1. Academic Press, New York.

WILLIAMS, T.C., AND J.M. WILLIAMS. 1967. Radio tracking of homing bats, *Science* 155: 1435-1436.

-----, AND -----. 1970. Radio tracking of homing and feeding flights of a neotropical bat. *Animal Behavior* 18:302-309.

YOUNG, JR., D.P., W.P. ERICKSON, R.E. GOOD, M.D. STRICKLAND, AND G.D. JOHNSON. 2003. Final report avian and bat mortality associated with the initial phase of the Foote Creek Rim Windpower Project, Carbon County, Wyoming, November 1998 - June 2002. WEST, Inc. 2003 Central Ave. Cheyenne, WY 82001

ZINN, T.L., AND W.W. BAKER. 1979. Seasonal migration of the hoary bat, *Lasiurus cinereus*, through Florida. *Journal of Mammalogy* 60:634-635.

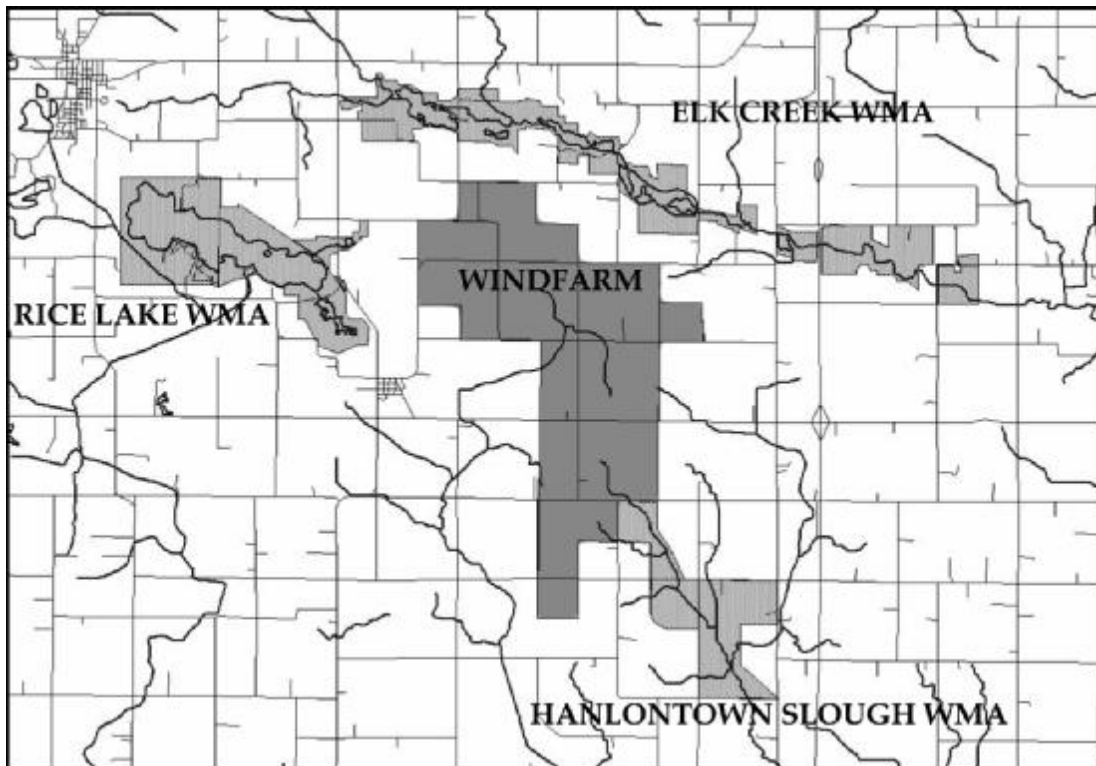

Fig.1. Position of the Top of Iowa Wind Resource Area (Worth County, Iowa) relative to Wildlife Management Areas.

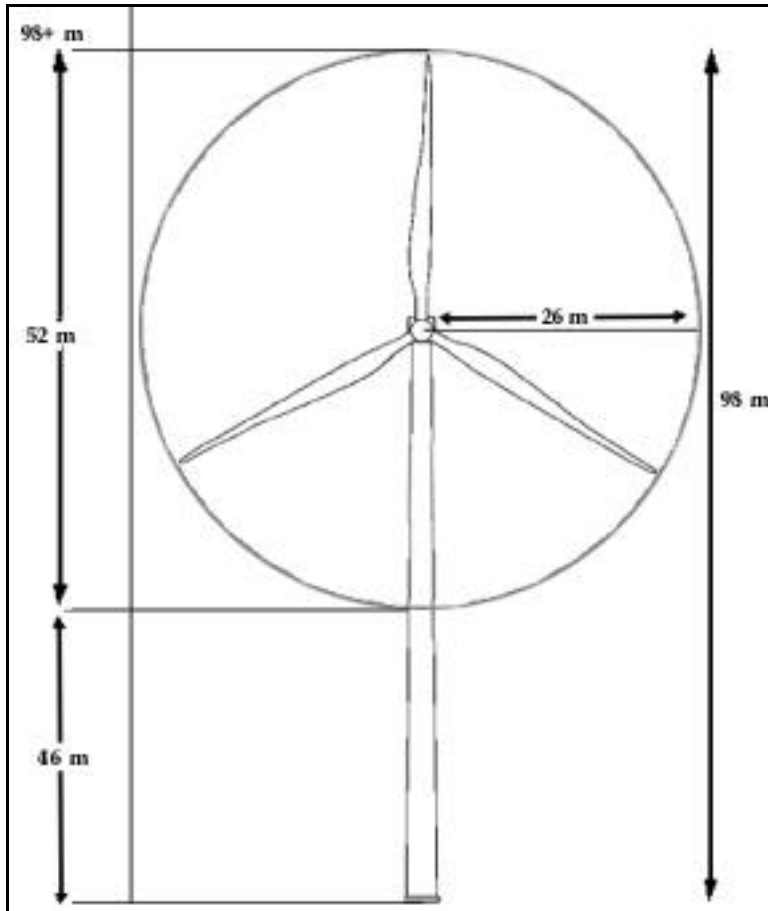

Fig.2. Schematic diagram of a wind tower at the Top of Iowa WRA.

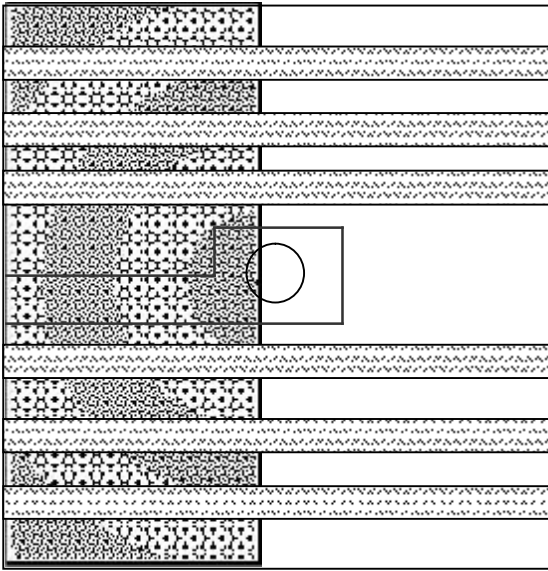

Fig. 3. Mortality transects, gravel pad and access road at the base of a tower (overhead view), with concentric rings.

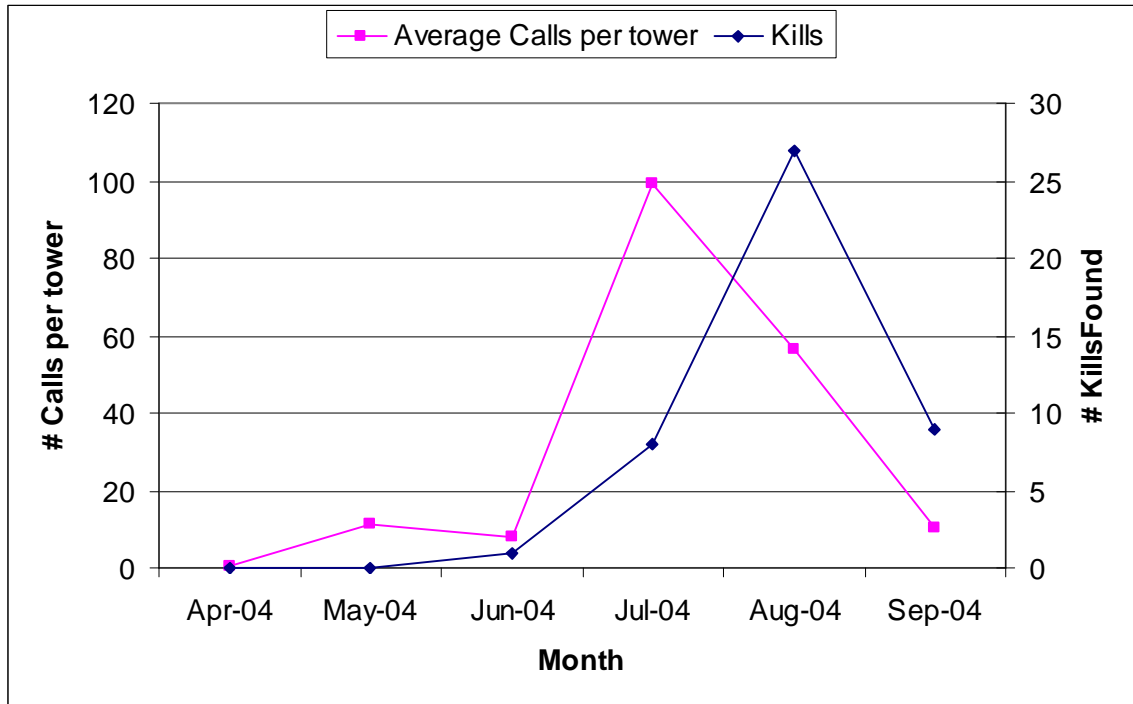

Fig 5. Average bat calling activity per tower-night and bat mortality during the active season (2004).

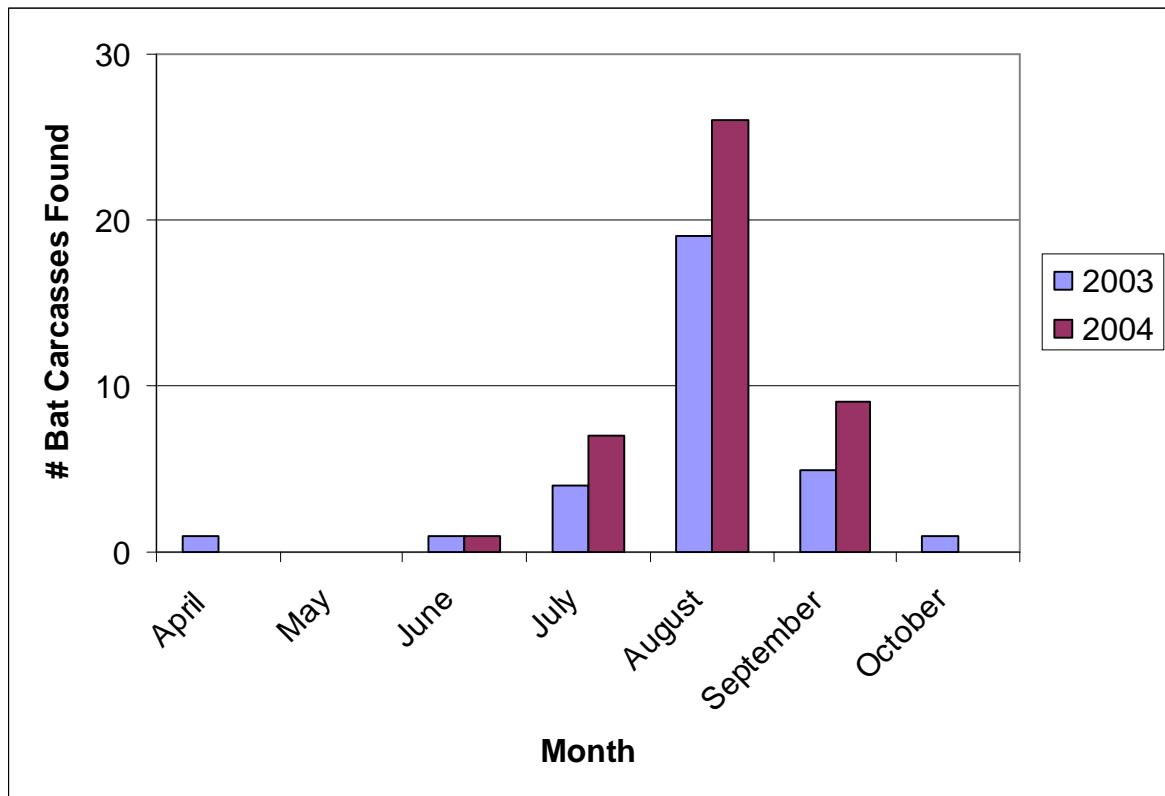

Fig.6. Distribution of bat mortality over both years.

CHAPTER 4. CANADA GOOSE FORAGING AND VIGILANCE BEHAVIOR AT A NORTHERN IOWA WINDFARM

A paper to be submitted to the journal *Condor*

Aaftab Jain, Rolf Koford, Alan Hancock, Guy Zenner

Abstract. We examined Canada Goose (*Branta canadensis*) foraging activity and vigilance behavior on and around an 89 tower wind resource area (WRA) in north-central Iowa from September 15 to December 25, 2003 and from September 27 to December 22, 2004. The northwest portion of the WRA was constructed in an area closed to Canada Goose hunting. We recorded approximately 1.2 million and 904,200 goose-use days (goose observed on a given survey) in fall 2003 and 2004, respectively, in three wetland management areas (WMA) in close proximity to the WRA. We created a model to estimate the effect of the presence of a wind tower in a field on the use of that field by geese. In 2003 and 2004, our models found no evidence that the towers affected goose field choices. We also monitored vigilance behavior to determine if it differed between flocks foraging in WRA fields and non-WRA fields within the area closed to Canada Goose hunting. We found no significant difference between vigilance levels ($F = 0.01$, $df = 1, 59$, $P = 0.92$) in WRA fields and non-WRA fields.

INTRODUCTION

Wind power is a financially competitive source of renewable energy in the U.S. that is generally viewed as having few negative effects on the environment. However, there are concerns that bird mortality resulting from collisions with wind turbines could be substantial in some areas (Orloff and Flannery 1992, Erickson et al. 2002, Barrios and Rodriguez 2004). Other studies have found low numbers of collision mortalities (Byrne 1983, Winkelman 1985, Young et al. 2003). Research has suggested that wind farms may indirectly impact bird populations by influencing habitat use in the vicinity of the wind farm. Researchers at the Buffalo Ridge WRA (Wind Resource Area) in Minnesota concluded that, in addition to direct mortality, the presence of wind turbines adversely affected local bird populations by decreasing the area of habitat the birds were willing to use (Leddy et al. 1999). In Denmark, researchers studying the effects of wind farms on foraging behavior of Pink-footed Geese (*Anser brachyrhynchus*) concluded that wind farms caused a direct loss of habitat as well as an additional loss due to habitat fragmentation (Larsen and Madsen 2000). Other studies have found that waterfowl avoid towers by varying distances (Erickson 2002, Winkelman 1994)

Construction on the 89-turbine Top of Iowa Wind Farm near Joice in Worth County, Iowa was completed in December 2001. Turbines are located on private land in an area comprising about 2,137 ha. We conducted a study from March 15 to December 15, 2003 and 2004 to evaluate the effect of the presence of the wind turbines on the birds and bats in the region. One phase of this study was to determine the use of crop fields by Canada Geese (*Branta canadensis*) in the area closed to Canada Goose hunting, (Closed Zone), both within and outside the windfarm. Another aspect of the study was to determine if vigilance and foraging behavior differed with the presence/absence of wind towers.

METHODS

STUDY AREA

The Top of Iowa Wind Farm is located in an area between three large wildlife management areas (WMA) that historically has had very high bird use (G. Zenner, Iowa Dept. of Natural Resources, pers. comm.) The primary vegetation types in the study area were cultivated cropland (primarily corn and soybeans). Other habitat types included hay, Conservation Reserve Program (CRP) grassland and deciduous woodlots associated with farmsteads. The three WMA's are complexes of wetland, grassland and forest habitat. (Fig.1) The close proximity of these three large WMA's provides attractive habitat on a large scale, for north-central Iowa, and offers islands of strategic habitat (G. Zenner, Iowa Dept. of Natural Resources, pers. comm.) Additionally, part of the WRA is contained within an area that has been closed to Canada Goose hunting since 1972 to increase Canada Goose use in the area, and two of the adjacent WMA's also contain inviolate refuges that attract large numbers of waterfowl each year. There is no other existing wind farm in Iowa with higher potential waterfowl use (G. Zenner, Iowa Dept. of Natural Resources, pers. comm.).

All the wind turbines were mounted on 71.6m (235ft) high tubular towers and turned by three 25.9m (85ft) rotors with a 2107.69m² (22690ft²) sweep area. (Fig. 2) All structural components of the towers were painted white. Forty-six towers were lit at the turbine level with Federal Aviation Administration (FAA) non-pulsating red beacons. Thirty-seven towers situated on the periphery of the windfarm had pulsating red beacons. Due to proximity to the Lake Mills Municipal Airport, six towers in the northwest of the windfarm had a

combination of pulsating white beacons and non-pulsating red beacons. These six towers were all in the Closed Zone.

DATA COLLECTION

Waterfowl activity was monitored, from September 15 to December 25, 2003 and September 27 to December 22, 2004. Waterfowl use of all crop fields within the Closed Zone around Rice Lake was surveyed twice weekly, between 8 and 10 a.m. Observations were made from vehicles using a spotting scope (60 X Bushnell) to keep disturbance to a minimum. We created models of goose use of fields. The response variable was presence/absence of geese over the entire season. If geese were observed using the field during any of the surveys, the response variable for that field was 'present.' The following parameters were included in the model: Cropping (corn/soybeans) and tillage practices (chisel plowing/moldboard plowing) and Post_Harvest_Days (days from harvest to the end of that field season). Other variables that were extracted using ArcView 3.3 (2002) software: Field Area (FA), Distance from Rice Lake (Dist) and Presence/Absence of wind towers in each field (Tower). We ran all subsets of the global model to determine the model that best fit the data (lowest AICc) for each year (Burnham and Anderson 2002), and then forced the class variable 'Tower' into that model. We then made comparisons between the AICc values of the best model with and without the variable 'Tower,' and also looked at the odds ratio associated with 'Tower.'

While our model examined goose foraging from an end-of-season perspective, we also made qualitative and quantitative assessments of the distribution of Canada Geese as observed each week, in order to rule out a shift in foraging behavior mid-season. We looked for a trend in the weekly proportion of goose flocks foraging on the WRA to goose flocks

foraging in the total Closed Zone. We also tested the hypothesis that there was no difference in the number of days from field harvest date to the date geese foraged in them, between WRA and non-WRA fields in the Closed Zone. We used PROC GLM (SAS Institute, Inc. 2001).

27 harvested fields in 2003 and 37 fields in 2004, (with and without wind towers in the Closed Zone) were sampled for waste grain each year to estimate the relative amounts of grain available for foraging waterfowl. This was done to determine if the fields with wind towers had similar amounts of waste grain in them as fields without wind towers. Most fields were sampled within one day of harvest measure available waste grain before Canada Goose foraging occurred but we sampled all fields within 3 days of harvest. Eight 1-meter hoop grain samples were sampled for waste grain per field. Corn fields were also sampled for whole cobs on four transects 33.22m long and 6.1m wide (Area = 202.6 m²). We dried all samples for 24 hours at 105 degrees C. We determined that subsequent drying did not result in further weight loss by drying 32 samples for a further 24 hours. We weighed all samples immediately after drying. All kernels were removed from cob samples and then weighed. We standardized weights for area sampled between hoop and cob samples. We used ANOVA's to test for differences in relative weights of grains sampled from fields on and off the windfarm, analyzing corn and soybean fields separately, with PROC GLM (SAS Institute, Inc. 2001). We also documented farming practices for sampled fields.

Canada Goose behavior was observed during morning and evening foraging periods. We conducted morning surveys beginning half an hour after sunrise for a period of two hours and evening surveys from 45 minutes before sunset until geese could no longer be observed

with a spotting scope. We noted time spent foraging (stationary or mobile) versus time spent vigilant (stationary or mobile) using scan sampling techniques (Altmann 1974). A flock was scanned 4-6 times for 2 minutes each, and each bird visible from the shoulder up was assigned a behavior (foraging, vigilant, mobile, stationary, resting, and other). This prevented an overestimate of vigilant (head-up) geese. The average number of geese in a flock observed vigilant over all scans was an estimate of the vigilance level of the flock. We also estimated the size of the flock: small (< 50 individuals), medium (between 50 and 200 individuals) and large (> 200 individuals). We made observations from a vehicle using a spotting scope in a manner similar to the field-use study. Location of the field (On versus Off WRA, Fig. 3) was noted, and we estimated differences between the proportion of vigilance levels of flocks at the two types of location with ANOVAs, using Proc GLM (SAS Institute, 2001)

In addition, we estimated numbers of waterfowl using Rice Lake, Elk Creek and Hanlontown Slough twice weekly between 10:00 a.m. and 2:00 p.m. to get a relative estimate of waterfowl use of the WMA's adjacent to the wind farm in 2003 and 2004. These counts were conducted in a manner similar to past waterfowl counts (Guy Zenner, IA Dept. of Natural Resources, pers. comm.), thereby providing indices that were comparable to previous years.

RESULTS

DESCRIPTION OF GOOSE FLIGHTS

Geese appeared to make feeding flights based on daylight intensity. Flights from Rice Lake into the Closed Zone crop fields began around sunrise. When skies were overcast, flights

were delayed by half an hour to 45 minutes. Geese usually returned to Rice Lake after 1-2 hours of feeding. Geese usually flew out a second time less than an hour before sunset and returned after dusk. On heavily overcast days, flights times were distributed throughout the day. Geese flew over a landscape intersected by roads with varying traffic intensity, windbreaks (either coniferous or deciduous trees in lines) and telephone and high-power lines.

WATERFOWL USE OF REGION

We recorded approximately 1.2 million goose-use days and 194,000 duck-use days from September 15 to December 25, 2003 (Fig. 4) and approximately 904,200 goose-use days and 66,300 duck-use days from September 27 to December 22, 2004 for the adjacent Rice Lake, Elk Creek and Hanlontown Slough WMA complex (Fig. 5). Waterfowl use of the adjacent WMA's was below long-term averages for both ducks and geese in 2003 and 2004 due to a late summer drought in 2003 and an unusual migration in 2004 (Guy Zenner, IA Dept. of Natural Resources, pers. comm.).

FORAGING MODEL

We sampled 17 of 70 corn fields and 10 of 70 soybean fields for waste grains in 2003, and 20 of 79 corn fields and 17 of 68 soybean fields in 2004, to determine whether waste grain availability was greater in fields on versus off the WRA. In 2003, waste corn availability was greater ($t = 3.15$, $df = 16$, $P < 0.01$) in on-WRA sites ($\bar{x} = 19.45 \text{ gm/m}^2$) than off the WRA ($\bar{x} = 12.35 \text{ gm/m}^2$). There was, however, no significant difference between soybean availability in fields sampled on ($\bar{x} = 8.67 \text{ gm/m}^2$) versus off ($\bar{x} = 8.37 \text{ gm/m}^2$) the WRA ($t = 0.16$, $df = 9$, $P = 0.88$). In 2004, there was no significant difference ($t = -0.07$, $df = 19$, $P = 0.94$) between waste corn availability in fields sampled on ($\bar{x} = 16.55 \text{ gm/m}^2$) versus off ($\bar{x} =$

16.62 gm/m²) the WRA, within the Closed Zone. There was, however, some evidence for greater soybean availability in fields sampled off the WRA ($\bar{x} = 18.28$ gm/m²) versus on ($\bar{x} = 12.86$ gm/m²) the WRA, ($t = -2.79$, $df = 16$, $P = 0.06$).

We observed 447 and 587 flocks of geese foraging in fields with and without wind towers in 2003 and 2004, respectively. In the final model (best model plus ‘Tower’) in 2003 (Table.1), the odds of observing Canada Geese forage in a field with a wind tower against a field without a tower was 0.928 (Wald CI: 0.229 to 3.765). In 2004, the final model (Table.1) indicated that the odds of observing Canada Geese forage in a field with a wind tower to observing Canada Geese in a field without a tower was 0.767 (Wald CI: 0.213 to 2.765). Since the confidence intervals for these odds ratios include one, the effects of ‘Tower’ are considered negligible.

WEEKLY FORAGING PATTERNS

Weekly thunderstorm maps of Canada Goose foraging data (Appendix B) did not reveal any distinct shift in foraging patterns when qualitatively analyzed.

In 2003 and 2004, the weekly proportion of goose flocks foraging on the WRA to goose flocks foraging in the total Closed Zone did not change qualitatively in any clear direction (Fig 5, 6). Further, in 2003, there was no significant difference in the number of days from field harvest date to the date geese foraged in the field, between WRA ($\bar{x} = 18.75$) and non-WRA ($\bar{x} = 16.19$ days) fields in the Closed Zone ($F = 0.27$, $df = 1, 91$, $P = 0.61$). In 2004, the number of days from field harvest date to the date geese foraged in the field was significantly greater at WRA fields ($\bar{x} = 36.00$) than at non-WRA fields ($\bar{x} = 14.89$) in the Closed Zone ($F = 8.49$, $df = 1, 74$, $P = 0.0047$).

VIGILANCE

Due to the late onset of winter in 2004, the number of geese foraging in the Closed Zone was very low for most of the season (19 flocks). We combined behavioral data from 2003 and 2004 to increase sample size, while including years, as fixed effects, in the model, as year effects were only marginally significant ($F = 3.85$, $df = 1$, 59 , $P = 0.055$) We also included flock size, as vigilance is known to vary with flock size. We found no significant difference in vigilance behavior between flocks of geese foraging on versus off the WRA ($F = 0.01$, $df = 1$, 59 , $P = 0.92$).

DISCUSSION

The effect of the WRA on avian mortality (Chapter 1) is negligible and presumably much lower than other causes of avian mortality. Though large numbers of Canada Geese used the surrounding WMA's in the fall, and Canada Geese were observed flying between, around and above wind towers in the portion of the WRA that is closed to Canada Geese hunting, no geese were found dead under towers. Results from analysis of goose foraging distribution are less definite. Without a pre-construction survey, we have reduced ability to assess the effects of the Top of Iowa WRA on goose activity. Ideally, the distribution of foraging flocks of geese, on and off the WRA, would be compared before and after construction (BACI design, Andersen et al. 1999). The total number of geese using the Canada Goose Closed Zone, however, varied from one year to the next, primarily due to the late onset of winter in 2004. If the distribution of foraging flocks is based on competition for waste grain, such fluctuations can reduce the efficacy of the BACI design. A modeling approach where the presence or absence of geese in a field can be predicted based on measured field characteristics allows us to estimate the effect of the presence of towers on Canada Geese.

In both years of the study, our model found negligible negative effects of towers on goose use of fields. Further, qualitative analysis of goose distributions (Appendix B) did not show any clear patterns in distribution that could be missed by the foraging model. While in 2004, the number of days from field harvest date to the date geese foraged in the field was significantly greater at WRA fields, this pattern could also be due to the greater distance between WRA fields and Rice Lake than non-WRA fields (Fig. 1). Waste grain availability varied between the two years and crop types, and did not appear to influence choice of fields with or without towers.

Larsen and Madsen (2000) examined the effects of a medium sized WRA and several smaller groups of towers on Pink-footed Geese (*Anser brachyrhynchus*) in a Danish farmland landscape. They found that geese entirely avoided foraging in the area within the WRA cluster. All towers, regardless of configuration, were avoided by at least 100m. Canada Geese may be less sensitive to disturbance than Pink-footed Geese. While our study did not measure average foraging distance to towers, we examined the feasibility of visually observing geese fly past wind towers in the Closed Zone. However, several days of initial observation revealed that geese flying from Rice Lake were not visibly alarmed by the presence of a tower. In most cases, geese changed height and orientation enough to avoid the towers by 40-50m and continued flying through the WRA. The average distance between a tower and its nearest neighbor was 350m, and the closest towers were at least 200m apart. In the study by Larsen and Madsen (2000), distance between towers was ≈ 200 m. The greater distance between towers may explain why the geese flew through the Top of Iowa WRA and landed in crop fields with towers in them. Another effect noted by Larsen and Madsen (2000) was that, besides habitat loss, towers caused a fragmentation effect, reducing the effective

available area in a field. The variable FA (field area) appeared in 3 out of our 4 competing models for both 2003 and 2004. However, the distribution of our data did not allow effective analysis of count data. We were unable to detect if the presence of towers affected the number of geese using a field.

Erickson (2002) summarized studies of waterfowl at WRA's in the U.S., stating that occasional waterbird/waterfowl mortality had been documented in Wisconsin and Minnesota. Several WRA's in the western and mid-western United States (San Geronio, CA, Buffalo Ridge, MN, Zintel Canyon, WA and Klondike, OR) had moderate to high seasonal waterfowl activity. Only one Canada Goose, however, has been found dead under a wind tower at these sites. Winkelman (1995) summarized European WRA studies, reported an avoidance distance of 100-250m for Mallards (*Anas platyrhynchos*) at Oosterbierum and Urk WRA's in the Netherlands. Further, changes in flight patterns of waterbirds and passerines occurred more frequently when towers were less than 100m apart.

The same factors that may cause geese to avoid towers (obstructed vision, increased noise levels, takeoff obstacles) might cause behavioral changes. While foraging for waste grain, waterfowl are less able to perceive threats due to their lowered head position (Lima and Bednekoff 1999). Vigilance may be increased in response to perceived threats (Guillemain et al. 2001), which results in less time available for foraging. This could potentially impact the fitness of the individual. Canada Geese at the Top of Iowa WRA did not show increased vigilance levels in the presence of wind towers. Thus there was no evidence to indicate that Canada Geese perceived the towers as a threat or a hindrance to foraging.

Wetland-grassland complexes that are maintained in their natural state are extremely rare on the Iowa landscape. Bishop (1981) estimated that over 95% of the wetlands in the Prairie Pothole Region of north-central and northwest Iowa were drained by 1975. Ironically, the topographic features that attract wind farm developers to an area are the same features that make land attractive for wetland/grassland restoration. The glacial moraines found throughout north-central Iowa enhance prevailing wind speeds and make wind farm development economical. These same moraines also contain the knob and kettle landscape features that compromise agricultural drainage and farming practices and make alternative land uses, such as enrolling the land in the Conservation Reserve Program (CRP) or the Wetland Reserve Program (WRP), attractive to landowners. While avian mortality due to collision with wind towers remains the primary concern, a thorough understanding of the impacts wind farms have on avian behavior is important, particularly in areas with limited natural habitat complexes. The Top of Iowa WRA did not appear to affect Canada Goose use of the area. Our ability to understand this impact, however, is reduced due to the lack of a pre-construction study, which should be a requirement at sites intended for future WRA construction. Furthermore, with the rapid expansion of wind power across the United States, future research should explore the landscape level and cumulative impacts of WRA operation on general migration and staging habits of birds.

ACKNOWLEDGEMENTS

We thank P. Dixon and J. Miller for critical comments on earlier drafts of this manuscript. Funding for this study was provided by the Iowa Cooperative Fish and Wildlife Research Unit, Northern Iowa Windpower LLC, and by a US Fish and Wildlife Service State Wildlife

Grant (T-1-R-3), through the Iowa Department of Natural Resources. We thank J. Bockenstedt, P. Brandon, B. Carter, I. Foster, D. Goshorn, K. Kuennen, J. Makosky, R. Miller, and M. Piorkowski for their hard work in the field and laboratory. We thank I. Ramler and P. Dixon for statistical support, and M. Yeager for carcass necropsy work. Research was conducted under a permit issued by the Iowa State University COAC #9-03-5524-Q.

LITERATURE CITED

- Altmann, J. 1974. Observational study of behavior: sampling methods. *Behaviour*. 49: 227-267
- Andersen, D.R., W.A. Link, D.H. Johnson, and K.P. Burnham, Suggestions for presenting the results of data analyses. *Journal of Wildlife Management* 65(3):373-378.
- Anderson, R., M. Morrison, K. Sinclair, and D. Strickland. [online]. 1999. Studying wind energy/bird interactions: A guidance document. National Wind Coordinating Committee. < <http://www.nationalwind.org/publications/avian.htm>> (11 July 2005).
- ArcView 3.3 © 1992-2002 Environmental Systems Research Institute, Inc.
- Barbour, R.A., and W.H. Davis. 1969. *Bats of America*. University of Kentucky, Lexington.
- Barrios, L., and A. Rodriguez. Behavioural and environmental correlates of soaring bird mortality at on-shore wind turbines. 2004. *Journal of Applied Ecology* 41: 72–81.
- Bishop, R. A. 1981. Iowa's wetlands. *Proceedings of the Iowa Academy of Science* 88:11-16.
- Burnham, K. P., and D.R. Anderson. 2002. *Model selection and multimodel inference : a practical information-theoretic approach*. New York: Springer, c2002.
- Byrne, S. 1983. Bird movements and collision mortality at a large horizontal axis wind turbine. *Cal-Neva Wildlife Transactions*. 1983: 76–83.

- Erickson, W.P., G.D. Johnson, D.P. Young, M.D. Strickland, R.E. Good, M. Bourassa, K., Bay, and K. Sernka. 2002. Synthesis and comparison of baseline avian and bat use, raptor nesting and mortality information from proposed and existing wind developments. WEST, Inc. 2003 Central Ave. Cheyenne, WY 82001.
- Evans, M.D., and K.R. Day. 2001. Does shooting disturbance affect diving ducks wintering on large shallow lakes? A case study on Lough Neagh, Northern Ireland. *Biological Conservation* 98: 315-323.
- Guillemain, M., P. Duncan, and H. Fritz. 2001. Switching to a feeding method that obstructs vision increases head-up vigilance in dabbling ducks. *Journal of Avian Biology* 32: 345–350.
- Larsen, J.K., and J. Madsen. 2000. Effects of wind turbines and other physical elements on field utilization by pink-footed geese (*Anser brachyrhynchus*): A landscape perspective. *Landscape Ecology* 15: 755-764.
- Leddy, K.L., K.F. Higgins, and D.E. Naugle. 1999. Effects of wind turbines on upland nesting birds in conservation reserve program grasslands. *Wilson Bulletin*, 111(1): 100-104.
- Lima, S. L., and P.A. Bednekoff. 1999. Back to the basics of antipredatory vigilance: can nonvigilant animals detect attack? *Animal Behaviour* 58: 537–543.
- Orloff, S., and A. Flannery. 1992. Wind turbine effects on avian activity, habitat use, and mortality in Altamont Pass and Solano County Wind Resource Areas, 1989-1991. Final Report to the California Energy Commission, Sacramento Calif. 150 pp.

SAS System for Windows, Version 8.2. Copyright © 2001 SAS Institute Inc. SAS and all other SAS Institute Inc. product or service names are registered trademarks or trademarks of SAS Institute Inc., Cary, NC, USA.

Sauer, J.R., J.E. Fallon, and R. Johnson. 2003. Use of North American breeding bird survey data to estimate population change for bird conservation regions. *Journal of Wildlife Management* 67(2): 372-389.

Winkelman, J.E. 1985. Bird impact by middle-sized wind turbines on flight behavior, victims, and disturbance. *Limosa*, 58: 117-121.

Winkelman, J. E. 1995. Bird/wind turbine investigations in Europe. Proceedings of National Avian-Wind Planning Meeting, Denver, CO, July 1994. Pg. 110-119.

Young, Jr., D.P., W.P. Erickson, R.E. Good, M.D. Strickland, and G.D. Johnson. 2003. Final report avian and bat mortality associated with the initial phase of the Foote Creek Rim Windpower Project, Carbon County, Wyoming, November 1998 - June 2002. WEST, Inc. 2003 Central Ave. Cheyenne, WY 82001

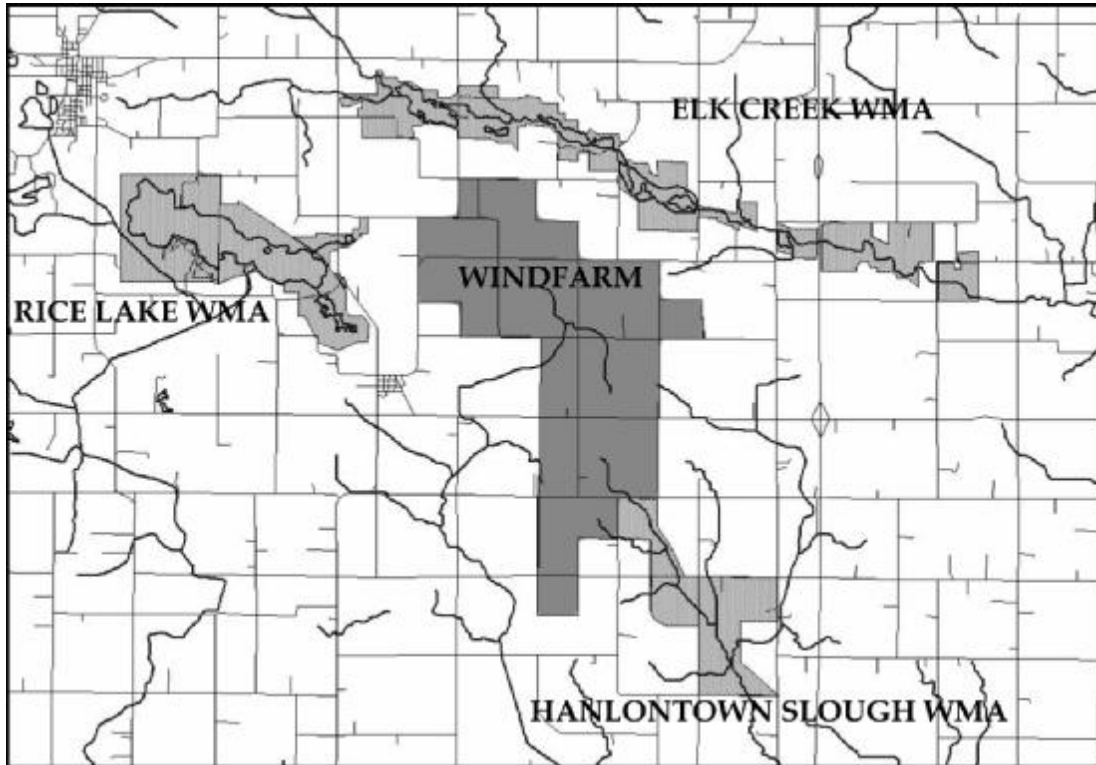

Fig 1. Position of the Top of Iowa WRA relative to Wildlife Management Areas, Worth County, Iowa.

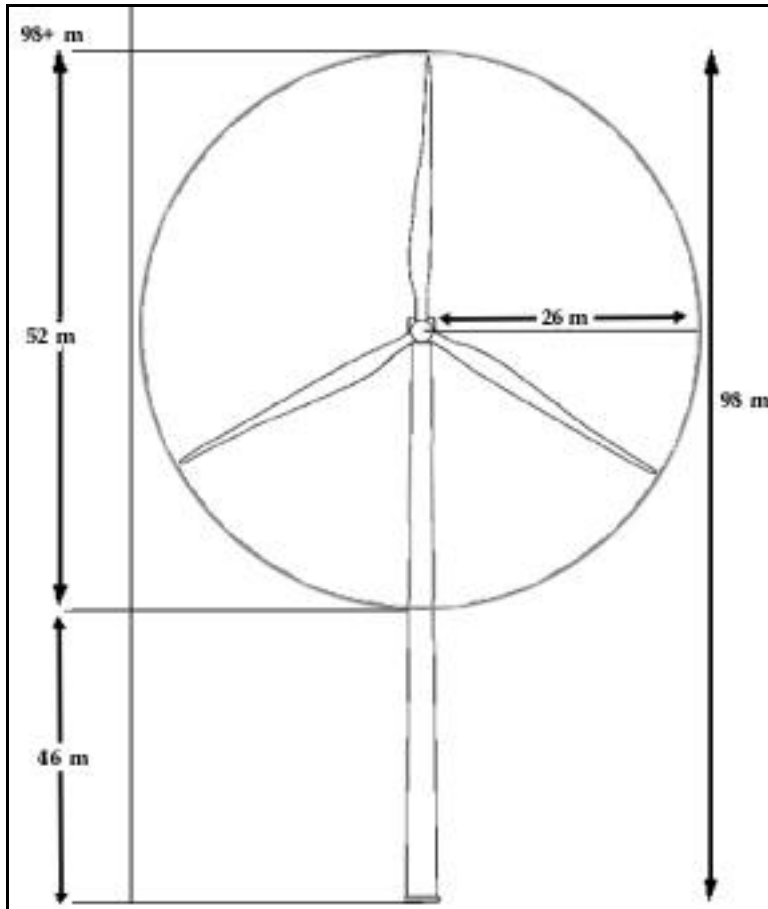

Fig 2. Schematic diagram of a wind tower at the Top of Iowa Wind Resource Area.

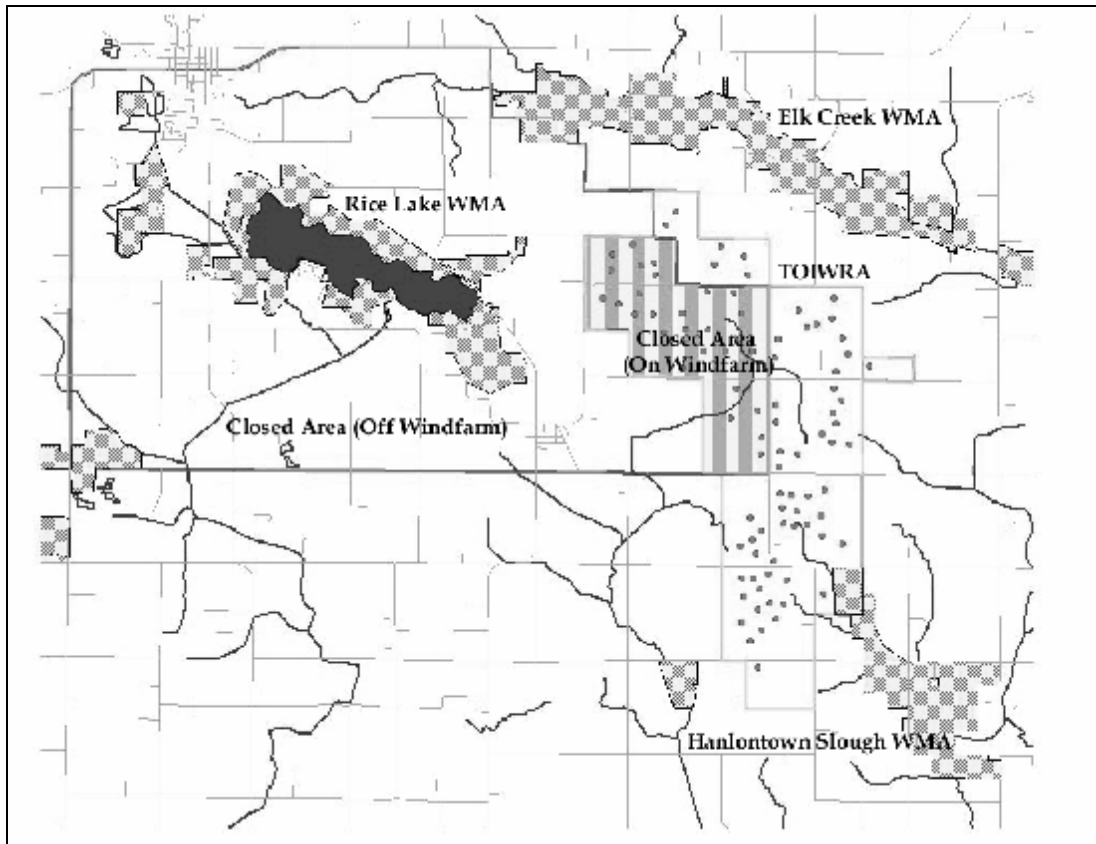

Fig. 3. The north-west section (shaded) of the Top of Iowa Wind Resource Area included land closed to Canada Goose hunting (Closed Zone) that centered on the Rice Lake Wildlife Management Area (WMA).

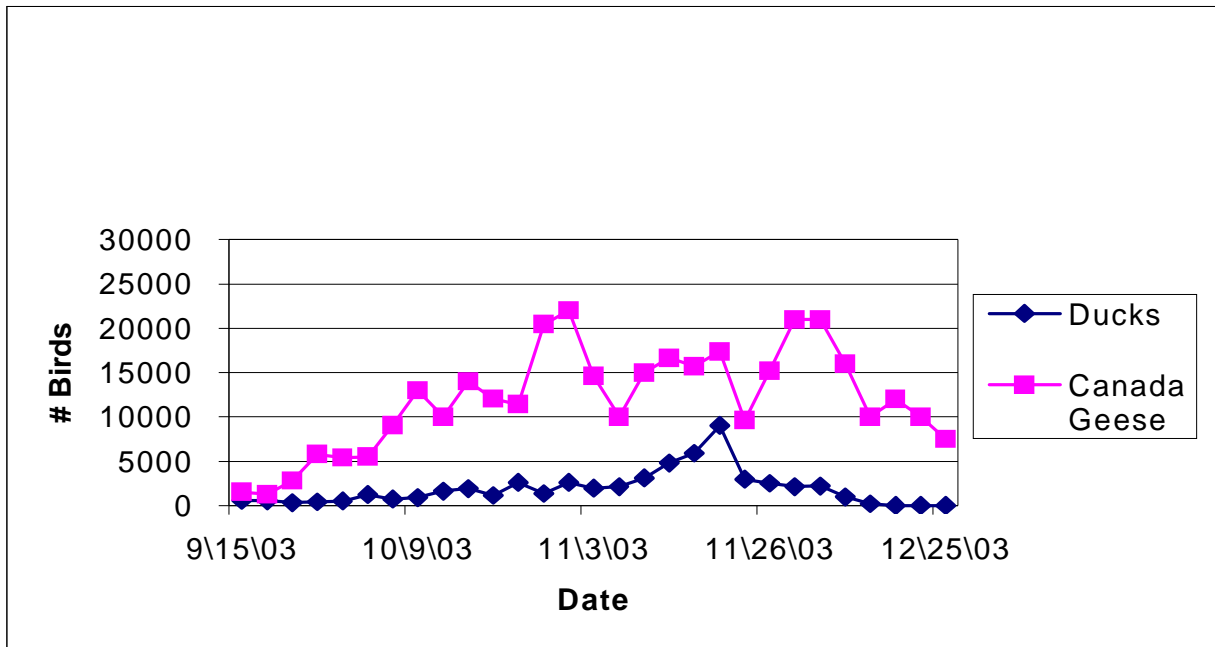

Fig. 4. Bi-weekly counts of Canada geese and ducks using Rice Lake, Hanlontown Slough and Elk Creek Wildlife Management Areas (2003).

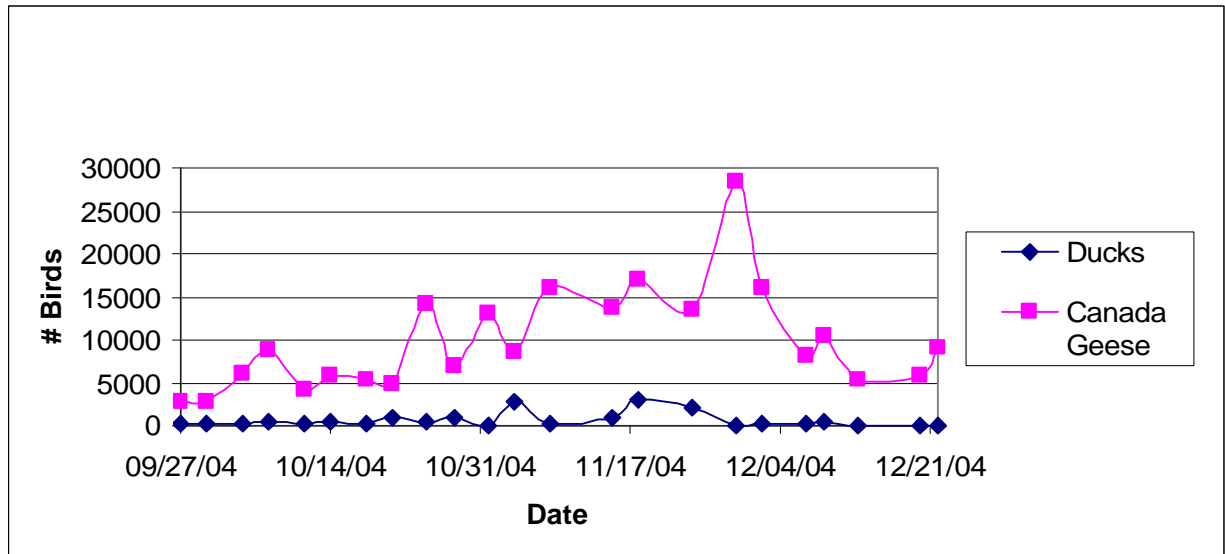

Fig. 5. Bi-weekly counts of Canada geese and ducks using Rice Lake, Hanlontown Slough and Elk Creek Wildlife Management Areas (2004).

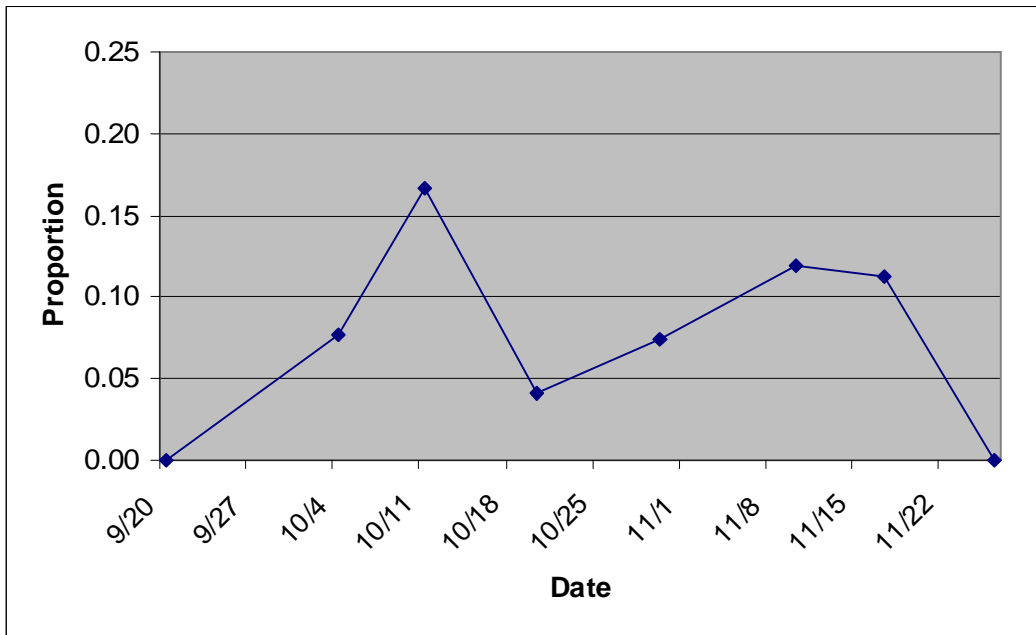

Fig. 6. Weekly proportions of the number of goose flocks observed in the WRA part of the Closed Zone to the total number of goose flocks observed in the Closed Zone.(2003)

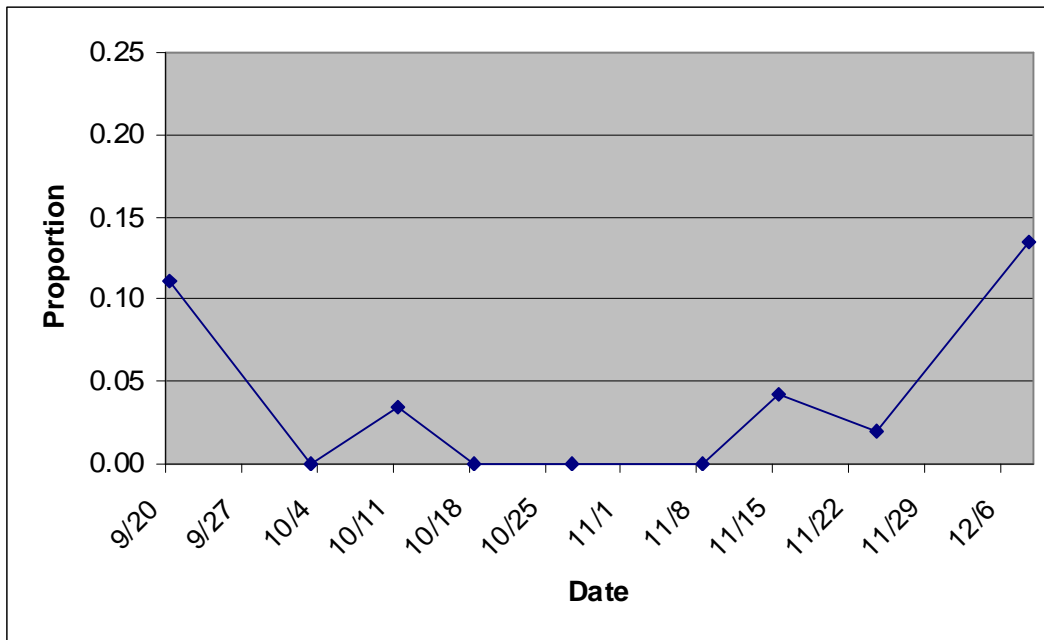

Fig. 6. Weekly proportions of the number of goose flocks observed in the WRA part of the Closed Zone to the total number of goose flocks observed in the Closed Zone.(2004)

Table 1. Best Canada Goose foraging models for 2003 and 2004 ($\Delta AIC_c < 2$). In both years, model 1 was a subset of the competing model (2), and had a lower AIC_c . The variable 'Tower' was forced into model 1 in each year. AIC_c = Akaike Information Criterion. K = Number of parameters + 1.

| Year | Model Choice | Best Models | K | AIC_c | ΔAIC_c | AIC_c Weight |
|-------------|------------------------------|--|----------|---------------------------|----------------------------------|----------------------------------|
| 2003 | 1 | Post_Harvest_Days, Corn/Soy, Dist | 4 | 137.73 | 0 | 0.34 |
| 2003 | 2 | Post_Harvest_Days, Corn/Soy, Dist, FA | 5 | 139.71 | 1.98 | 0.13 |
| 2003 | Best model (1) + Tower | Post_Harvest_Days, Corn/Soy, Dist, Tower | 5 | 139.87 | 2.14 | 0.12 |
| 2004 | 1 | Post_Harvest_Days, Corn/Soy, Dist, FA | 5 | 144.88 | 0 | 0.50 |
| 2004 | 2 | Post_Harvest_Days, Corn/Soy, Dist, FA, Dist ² | 6 | 146.49 | 1.79 | 0.20 |
| 2004 | Best model (1) + Tower | Post_Harvest_Days, Corn/Soy, Dist, FA, Tower | 6 | 146.72 | 2.01 | 0.18 |

CHAPTER 5. GENERAL CONCLUSIONS

The Top of Iowa WRA is located in cropland, in habitat not ideally suited for grassland birds. Wind farms in this habitat may be less harmful to birds than other energy industries or other human-made structures such as power lines (Osborn et al. 1998, 2000). However, neotropical migrants and waterfowl move through the region in large numbers.

Further, bat populations make use of the WMA's, woodlots and farmsteads in the region. Without a pre-construction survey, we have reduced ability to assess its indirect impacts. However, the direct impact due to collision mortality can be estimated.

Avian mortality at the top of Iowa WRA was low in both 2003 and 2004, estimated to be 0.38 and 0.76 birds/tower/year after correcting for search efficiency, scavenging and area searched. The direct impact of the WRA on avian mortality is negligible and much lower than other causes of avian mortality. The Top of Iowa WRA cannot be said to affect avian populations significantly. Studies at WRA's in California (Orloff and Flannery 1992, Thelander and Rugge 2000) found that raptors were disproportionately susceptible to tower collisions, with large numbers of Red-tailed Hawks killed. Two Red-tailed Hawks were determined to have been killed by tower collisions at the Top of Iowa WRA, in 2004, even though raptor numbers were low in the Top of Iowa region.

Our overall avian mortality estimate is lower than several other studies in the region (Erickson *et al.* 2002). While our search methods differed from these studies (bare ground transects as opposed to uncleared plots) we searched the gravel pad immediately at the base of the tower and adjusted for the area searched to the total area within which birds may have

fallen. Further, our higher search frequency lowered the possibilities of scavenging and also meant that birds were not missed due to decomposition (Osborn *et al.* 2000, Kostecke *et al.* 2001).

Unlike Erickson *et al.* (2002, 2004), where avian density was found to have a linear relationship with distance from wind towers, we did not find a clear pattern of significant differences in avian activity between tower and non-tower sites. In addition, no clear pattern of significant differences was found between WRA sites and sites in an adjacent area approximately 2 miles to the southwest of the farm.

Avian flight in the risky zone was very rare across seasons. Where data were sufficient to test for differences, birds were observed using the collision-risk zone around wind towers in lower numbers than the same airspace at non-tower sites. Further, a clear trend across almost all species showed that birds were observed to avoid the 0-30m zone around the towers when compared to the same zone at non-tower sites. These avoidance results are at a smaller scale than those found by avian surveys at the Buffalo Ridge WRA (Usgaard *et al.* 1997, Osborn *et al.* 1998) which found birds to avoid the WRA in favor of adjacent land. While our results may indicate a loss of habitat for birds, it may also be one reason why resident birds are not killed in higher numbers throughout the breeding and post-breeding season.

Unlike birds, our estimated bat mortality rates, 6.44 bats/tower/year in 2003 and 9.24 bats/tower/year in 2004, were high compared to those of other WRA studies in the Midwest (Howe *et al.* 2002, Johnson *et al.* 2003). Higher mortality rates may be due to differences in search technique (twice-daily searches in bare ground plots) as opposed to one search every 14 days in uncleared land. Our search efficiency was estimated by the use of small birds, as

bat carcasses were not available. However, comparable studies have adjusted for search efficiency and scavenging rates. Thus, we think our data reflects a real difference in mortality rate at the Top of Iowa WRA. Although high, our estimates are not the greatest reported bat fatalities at a WRA. Kerns and Kerlinger (2004) estimated a high mortality rate (47.53 bats/tower/year) at an ongoing study in West Virginia.

It is possible that bat activity at the Top of Iowa WRA was affected by better bat habitat nearby, namely the three WMA's that surround the WRA. Anecdotal data from June and July of 2003, collected while testing the bat detectors, showed that bat activity at the Elk Creek WMA (north and northwest of the WRA) and the town of Joice (west of the WRA) was easily detectable. Unlike researchers at the Buffalo Ridge WRA (Johnson *et al.* 2004), we did not find a negative relationship between distance to nearest woodlot and bat activity. Further, bat activity did not differ at tower and non-tower sites, so we have no evidence that the presence of the wind tower was associated with avoidance behavior. The proportion of kills by species also differed between the Top of Iowa WRA and comparable sites. Erickson *et al.* (2002) reported that previous studies in the United States found that approximately 68% of bats killed by towers were Hoary Bats. While Hoary Bats at this WRA were killed in the greatest numbers in both 2003 and 2004, they composed only 28% (21/75) of the total kills over both years. In addition, Little Brown Bats were reported to be 2.8% of kills found at other Midwestern WRA studies, whereas 24% (18/75) of carcasses found at this study were Little Brown Bats. Acoustic surveys during both spring and summer at the Top of Iowa WRA revealed that Little Brown Bat calls were the most commonly recorded species. The local abundance of this species may have contributed to a higher collision rate.

We found no effect of the type of tower lighting (red pulsating and non-pulsating beacons and white strobe lights) on mortality or activity. Johnson *et al.* (2004) also did not find a significant difference in mortality between lit and unlit towers. It is not known if bats are confused by this lighting when migrating. Avian studies have suggested that pulsating/strobe lights have less of an effect on migrating birds and may result in lower numbers of collisions (Jones and Francis 2003). No individual mortality event coincided with a major storm or unusually high winds, in either 2003 or 2004. No dead bats were found under either of the two meteorological towers in 2004.

Seasonal Trends:

While specific towers in this study did not show a significant relationship between mortality and ultrasonic activity, the seasonal increase in bat activity closely coincided with the overall incidence of mortality. The timing also corresponded with the post-breeding southward migration for Hoary, Eastern Red and Silver-haired Bats (Cryan 2003), as well as the timing of movement from summer breeding areas to hibernacula for Big Brown, Little Brown and Eastern Pipistrelle Bats (Barclay 1984, Genter and Jurist, 1995). The temporal pattern of bat collision mortality in the region may be related to increased bat activity prior to and during migration, with corresponding increases in risky flying behavior (Cryan 2003). Increased mortality during this period might also be related to the reduced echolocation and flight capabilities of juvenile bats. While we did not determine whether bat carcasses found at this WRA were juveniles or adults, Johnson *et al.* (2004) found that most bats that collided with wind towers in the Buffalo Ridge WRA were adults.

Extreme caution must be used in extrapolating acoustic data collected from ground level to risky flight behavior at higher altitudes. It is important to collect detailed data on the

behavior of bats when they are at greatest risk of colliding with towers, i.e. mostly at heights beyond the range of bat call detectors placed on the ground (Furlonger *et al.* 1987).

Conventional research methods such as ground-level mist-netting and acoustic monitoring are thus inherently biased (Menzel *et al.* 1999). If resident bats rarely hit towers during non-migratory periods (Johnson *et al.* 2004, this study) then the increase in ultrasonic activity detected at ground level must either reflect a change in behavior of residents, an increased use of local habitat by migrants, or an increase in local populations due to newly volant juveniles. Tower collision may not occur as a result of migratory flight per se, but rather as a result of increased activity related to migration and dispersal such as staging to renew energy levels.

The impact of the WRA on avian mortality is negligible and much lower than other causes of avian mortality. Though large numbers of Canada Geese use the surrounding WMA's in the fall, and Canada Geese were observed flying in between, around and above wind towers in the section of the WRA that is closed to Canada Geese hunting, no birds of that species were found dead under towers. However, our results from analysis of goose foraging distribution are less definite. Without a pre-construction survey, we have reduced ability to assess the behavioral impacts on geese. A modeling approach where the presence or absence of geese in a field can be predicted based on measured field characteristics allows us to estimate the effect the presence of towers on Canada Geese. In both years of the study, our model found negligible negative effects of geese in fields with wind towers. Other studies, in Europe and the United States, have found that waterfowl behavior may be affected by towers, but this effect may not be important enough to affect population levels. Larsen and Madsen (2000) examined the effects of a medium sized WRA and several smaller groups of towers

on Pink-footed Geese (*Anser brachyrhynchus*) in a Danish farmland landscape. They found that geese entirely avoided foraging in the area within the WRA cluster. All towers, regardless of configuration, were avoided by at least 100m. While our study did not measure average foraging distance to towers, we examined the feasibility of visually observing geese fly past wind towers in the Closed Zone. However, initial observations found that geese were not visibly alarmed by the presence of a tower. In most cases, geese changed height and orientation and continued flying through the WRA. The distance between a tower and its nearest neighbor was great enough to allow large flocks of geese to maneuver between towers.

The same reasons that may cause geese to avoid towers (obstructed vision, increased noise levels, obstructed takeoff trajectories) might cause behavioral changes. While foraging for waste grain, waterfowl are less able to perceive threats due to their lowered head position (Lima and Bednekoff 1999). Vigilance may be increased in response to perceived threats (Guillemain *et al.* 2001), which results in less time available for foraging, and impacts the fitness of the individual. However, Canada Geese at the Top of Iowa WRA did not show increased vigilance levels in the presence of wind towers. Thus there was no evidence to indicate that Canada Geese perceived the towers as a threat or a hindrance to foraging.

Future Research Questions

The Top of Iowa WRA appears to cause low avian mortality and small changes in behavior which are unlikely to cause population level declines. However, the short duration of the study (two years), and the lack of preconstruction data limits our ability to ascertain any changes in behavior and habitat use caused by the towers. Further, it is not known what long-term effects the presence of the towers might have on birds and bats using the region. Similar surveys should be carried out, in subsequent years, in order to detect population trends of species using both the WMA's and the cropland around the towers.

While bat behavior also appears unaffected, bat mortality is high, and should be a source for concern. There is a lack of adequate background data on bat populations and habits. While siting new WRA's, multiple year studies on local bat populations and flight patterns remain necessary. However, if the number of bat collisions is unrelated to local bat populations, as this and recent studies of bat mortality at wind towers have shown, more research must be conducted on the behavior of migrating bats while engaged in collision-prone flight at rotor heights.

APPENDIX A

Bat Identification Key:

Key to the calls of bats of Iowa
(using programs Analyze and Analook) *

- | | | |
|----|--|-------------|
| 1. | Call sequence contains ≥ 3 or more pulses of high quality | 2 |
| | Call sequence contains < 3 pulses of high quality | NOID |
| 2. | Minimum call frequency typically < 25 kHz | LACI |
| | Minimum call frequency typically ≥ 25 kHz | 3 |
| 3. | Minimum call frequency typically ≤ 31 kHz | 4 |
| | Minimum call frequency typically > 31 kHz | 5 |
| 4. | Curvature value of call typically ≥ 3 | LANO |
| | Curvature value of call typically < 3 | EPFU |
| 5. | Minimum call frequency 31-40 kHz and average call frequency < 43 kHz | NYHU |
| | Minimum call frequency ≥ 40 kHz or average frequency ≥ 43 kHz | 6 |
| 6. | Call shaped like "A" with an average frequency typically 49-53 kHz, a minimum frequency commonly 39-40 kHz, and curvature values typically ≤ 2 . Curvature values ≥ 3 are rare | 7 |
| | Call shaped like "B" with an average frequency typically ca. 45 kHz, a minimum frequency commonly ≥ 41 and curvature values typically > 2 . Curvature values ≥ 3 are common | LABO/PISU** |
| | **bottom of J consistent in PISU | |

A) A straight, slightly curving line

B) A hook at the end, making it look like a backwards "J"

- | | | |
|----|---|------|
| 7. | In Analook, Slope > 200 (up to 1000) | MYSE |
| | Slope < 200 , typically < 110 | MYLU |
| | Press V key to see slope values. Look at lowest portion of the slope on the Y axis. | |

Relative abundance of bats (to be filled in during Summer 2003 surveys):

LACI (*Lasiurus cinereus*): Hoary Bat

LANO (*Lasionycteris noctivagans*) Silver-haired Bat

EPFU (*Eptesicus fuscus*) Big Brown Bat

NYHU (*Nycticeus humeralis*) (Evening Bat)

LABO (*Lasiurus borealis*) Eastern Red Bat

PISU (*Pipistrellus subflavus*) Eastern Pipistrelle

MYSE (*Myotis septentrionalis*) Northern Myotis Bat

MYLU (*Myotis lucifugus*) Little Brown Bat

**Modified from M. Alex Menzel's Key to the WV bats.*

Indiana bats, if present, usually falls in between MYLU and MYSE in terms of slope (110-200). But in cluttered habitats, MYLU can have higher slopes, upwards of 300-500; MYSE is usually upwards of 500-1000 slope in cluttered habitats...but it's not exact.

APPENDIX B

Fig. 1. Locations of Canada goose flocks observed foraging in the Rice Lake Canada goose closed hunting zone by weekly periods during September 29 – December 8, 2003.

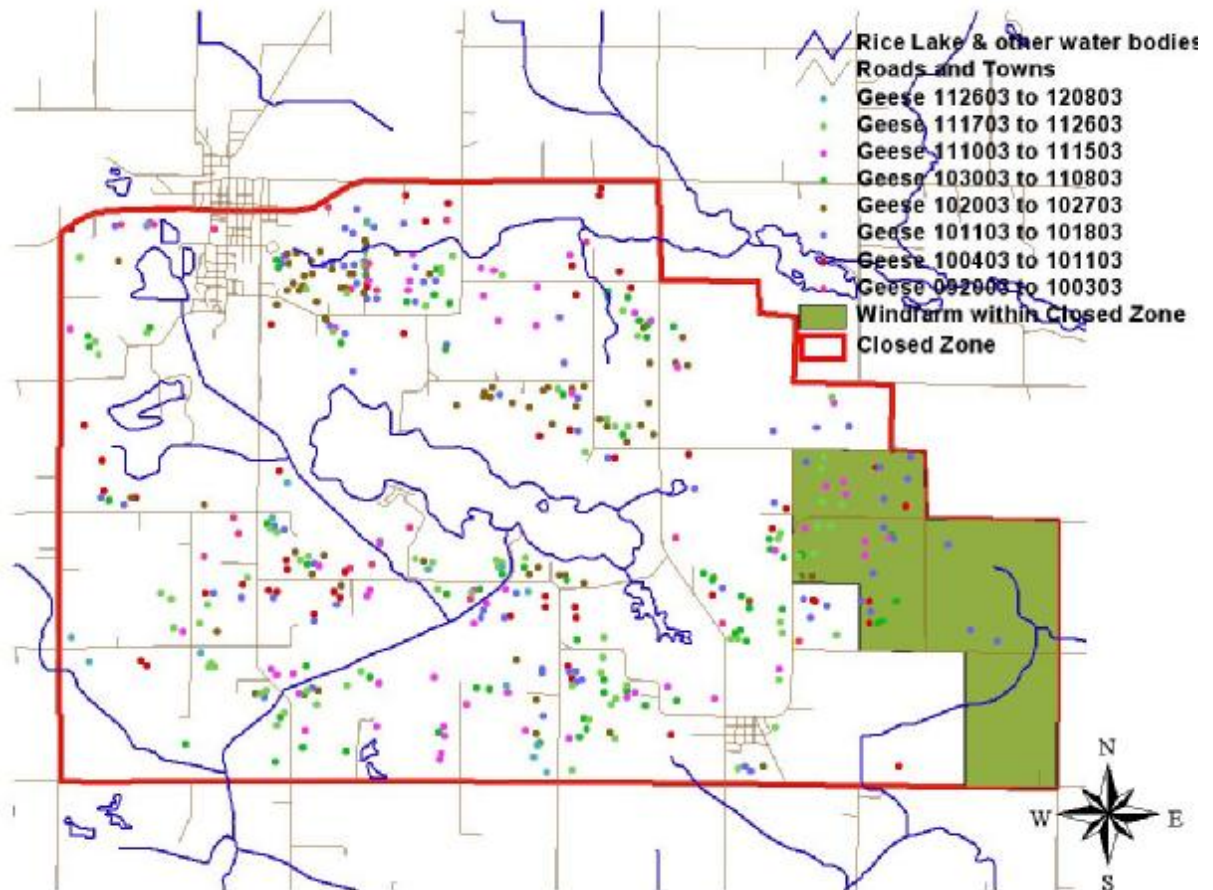
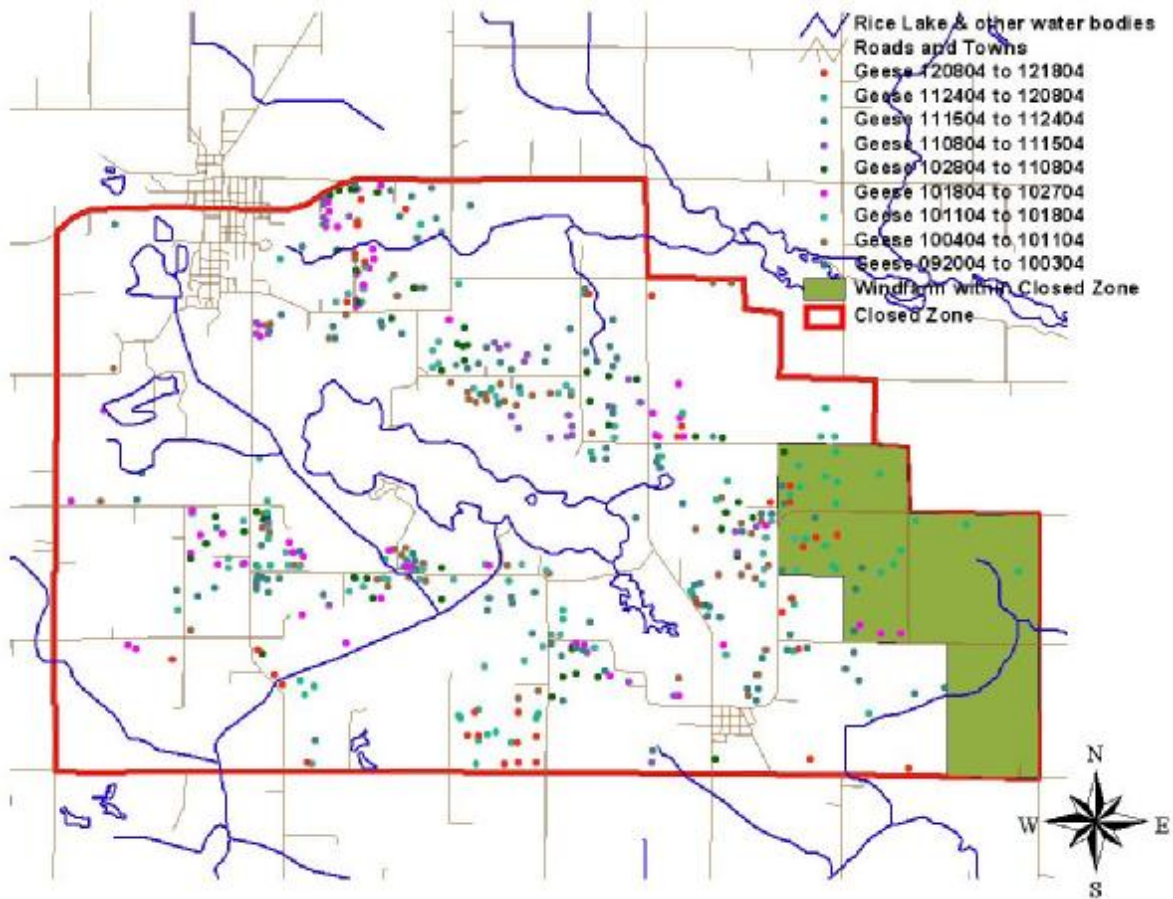

Fig. 2. Locations of Canada goose flocks observed foraging in the Rice Lake Canada goose closed hunting zone by weekly periods during September 20 – December 18, 2004.



ADDITIONAL LITERATURE CITED:

- Barclay, R.M.R. 1984. Observations on the migration, ecology and behaviour of bats at Delta Marsh, Manitoba. *Canadian Field-Naturalist* 98:331-336.
- Erickson, W.P., Johnson, G.D., Young, D.P., Strickland, M.D., Good, R.E., Bourassa, M., Bay, K., Sernka, K. 2002. Synthesis and comparison of baseline avian and bat use, raptor nesting and mortality information from proposed and existing wind developments. WEST, Inc. 2003 Central Ave. Cheyenne, WY 82001.
- Erickson, W.P., Jeffrey, J., Kronner, K., and Bay, K. 2004. Stateline Wind Project wildlife monitoring final report. WEST, Inc. 2003 Central Ave. Cheyenne, WY 82001.
- Fiedler, J.K., Nicholson, C.P., Nicholas, N.S., Buehler, D.A., McCracken, G., Braden, K.H. 2002. Bat activity and mortality at Buffalo Mountain Windfarm, Eastern Tennessee. Special Issue: Abstracts of Papers Presented at the 32nd Annual North American Symposium on Bat Research Held November 6-9, 2002, in Burlington, Vermont. *Bat Research News* 43(4):147-148.
- Furlonger, C.L., Dewar, H.J., Fenton, M.B. 1987. Habitat use by foraging insectivorous bats. *Canadian Journal of Zoology* 65: 284-288.
- Genter, D.L. and Jurist, K.A. 1995. *Bats of Montana* Book 11 p.; 28 cm. Helena, Mont. Montana Natural Heritage Program.
- Guillemain, M., Duncan, P. and Fritz, H. 2001. Switching to a feeding method that obstructs vision increases head-up vigilance in dabbling ducks. *Journal of Avian Biology* 32: 345–350.
- Howe, R.W., W. Evans, and A.T. Wolf. 2002. Effects of wind turbines on birds and bats in northeastern Wisconsin. Wisconsin Public Service Corporation, Madison, Wisconsin.

- Johnson, G.D., Erickson W.P., Strickland, M.D., Shepherd M.F. and Shepherd D.A. 2003. Mortality of Bats at a Large-scale Wind Power Development at Buffalo Ridge, Minnesota. *Midland Naturalist* 150:332–342.
- Johnson, G.D., Perlik, M.K., Erickson, W.P., Strickland, M.D. 2004. Bat activity, composition, and collision mortality at a large wind plant in Minnesota. *Wildlife Society Bulletin* 32(4): 1278-1288.
- Jones, J. and Francis, C.M. 2003. The effects of light characteristics on avian mortality at lighthouses. *Journal of Avian Biology* 34: 328–333.
- Kerns, J., and Kerlinger P. 2004. A study of bird and bat collision fatalities at the Mountaineer Wind Energy Center, Tucker County, West Virginia. Annual Report for 2003, Prepared by Curry and Kerlinger LLC. Cape May Point, NJ 08212.
- Kostecke, R.M., Linz, G.M. and Bleier, W.J. 2001. Survival of avian carcasses and photographic evidence of predators and scavengers. *Journal of Field Ornithology* 72(3): 439-447.
- Larsen, J.K. and Madsen J. 2000. Effects of wind turbines and other physical elements on field utilization by pink-footed geese (*Anser brachyrhynchus*): A landscape perspective. *Landscape Ecology* 15: 755-764.
- Lima, S. L. & Bednekoff P.A. 1999. Back to the basics of antipredatory vigilance: can nonvigilant animals detect attack? *Animal Behaviour* 58: 537–543.
- Menzel, M.A., Maness, J.M., McCracken, G.F., Edwards, J.W., Chapman, B.R. 1999. A comparison of bat activity above and below the forest canopy. *Bat Research News* 40(4):181.

- Orloff, S. and Flannery A. 1992. Wind turbine effects on avian activity, habitat use, and mortality in Altamont Pass and Solano County Wind Resource Areas, 1989-1991. Final Report to the California Energy Commission, Sacramento Calif. 150 pp.
- Osborn, R.G., Dieter C.D., Higgins K.F. and Usgaard R.E 1998. Bird flight characteristics near wind turbines in Minnesota. *The American Midland Naturalist* 139: 29-38.
- Osborn, R.G., Higgins, K.F., Usgaard, R.E., Dieter, C.D. and Neiger, R.D. 2000. Bird mortality associated with wind turbines at the Buffalo Ridge Wind Resource Area, Minnesota. *American Midland Naturalist* 143: 41-52.
- Ralph, C. J., J. R. Sauer, and S. Droege. 1995. Monitoring bird populations by point counts. U.S. Forest Service General Technical Report PSW-GTR-149, Albany, California.
- Thelander, C.G. and Rugge, L., 2000. Avian risk behavior and fatalities at the Altamont Wind Resource Area. National Renewable Energy Laboratory, 1617 Cole Blvd. Golden, CO. (http://www.nrel.gov/wind/avian_lit.html).
- Usgaard, R.E., Naugle, D.E., Osborn, R.G., and Higgins, K.F. 1997. Effects of wind turbines on nesting raptors at Buffalo Ridge in southwestern Minnesota. *Proceedings of the South Dakota Academy of Science* 76: 113-117.

ACKNOWLEDGEMENTS

Funding for this study was provided by the Iowa Cooperative Fish and Wildlife Research Unit, The Top of Iowa Windfarm, and by a US Fish and Wildlife Service State Wildlife Grant (T-1-R-3), through the Iowa Department of Natural Resources. Ivan Ramler and Philip Dixon provided statistical guidance. Guy Zenner and Alan Hancock of the Iowa DNR conceived of the project, helped procure funding and provided logistical support from conception to end. Pamela Brandon, Inga Foster, Kristin Kuennen, Jennifer Makosky, Randy Miller, Brandi Carter and Martin Piorkowski put in many hours of fieldwork. Jessica Bockenstedt, Dawn Goshorn and Zachary Ripperger provided supplemental assistance. Dr. Russell Benedict (Central College) and Daryl Howell (Iowa Department of Natural Resources) identified bat species. Anne Slattery helped identify bat calls. Research was conducted under a permit issued by the Iowa State University COAC #9-03-5524-Q. I am grateful to my advisor, Dr. Rolf Koford, for providing guidance, careful criticism and much support throughout my time at Iowa State University. I thank fellow graduate students, Embere Hall, Ryan Harr, Tracy Walker and Nicole Davros for providing a great atmosphere of friendship, camaraderie and scientific discussion. Finally, I thank my family for all their love and support.