

# PREFABRICATED VERTICAL DRAINS

Research, Development,  
and Technology  
Turner-Fairbank Highway  
Research Center  
6300 Georgetown Pike  
McLean, Virginia 22101-2296



U.S. Department  
of Transportation

**Federal Highway  
Administration**

## Vol. I: Engineering Guidelines

Report No.  
FHWA/RD-86/168

Final Report  
August 1986

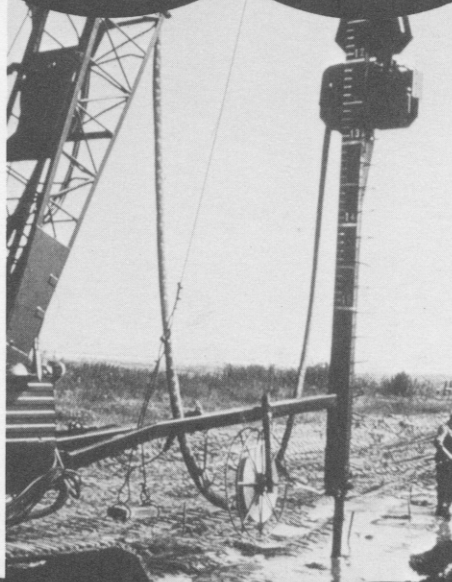

## FOREWORD

This report presents the results of a comprehensive investigation of the use of prefabricated vertical drains to accelerate the consolidation of soft, wet clays beneath embankments. Design and construction guidelines for using prefabricated vertical drains as a ground improvement technique are presented along with detailed specifications, design examples, and cost data. This report will be of interest to bridge engineers, roadway design specialists, construction and geotechnical engineers concerned with foundation settlement problems.

Sufficient copies of the report are being distributed by FHWA Bulletin to provide a minimum of two copies to each FHWA regional and division office, and three copies to each State highway agency. Direct distribution is being made to division offices.



Richard E. Hay, Director  
Office of Engineering and Highway  
Operations Research and Development

## NOTICE

This document is disseminated under the sponsorship of the Department of Transportation in the interest of information exchange. The United States Government assumes no liability for its contents or use thereof.

The contents of this report reflect the views of the contractor, who is responsible for the accuracy of the data presented herein. The contents do not necessarily reflect the official policy of the Department of Transportation.

This report does not constitute a standard, specification, or regulation.

The United States Government does not endorse products or manufacturers. Trade or manufacturers' names appear herein only because they are considered essential to the object of this document.

1. Report No. FHWA/RD-86/168		2. Government Accession No. PB87-154993/AS		3. Recipient's Catalog No.																
4. Title and Subtitle Prefabricated Vertical Drains Vol. I, Engineering Guidelines				5. Report Date September 1986																
				6. Performing Organization Code																
				8. Performing Organization Report No.																
7. Author(s) J.J. Rixner, S.R. Kraemer and A.D. Smith.																				
9. Performing Organization Name and Address Haley & Aldrich, Inc. 238 Main Street Cambridge, Massachusetts 02142				10. Work Unit No. (TRAIS) FCP35P2-032																
				11. Contract or Grant No. DTFH61-83-C-00101																
				13. Type of Report and Period Covered Final Report September 1983 - August 1986																
12. Sponsoring Agency Name and Address Office of Engineering and Highway Operations Research and Development Federal Highway Administration 6300 Georgetown Pike, McLean, Virginia 22101-2296				14. Sponsoring Agency Code CME/0237																
15. Supplementary Notes FHWA contract manager (COTR): A.F. DiMillio (HNR-30)																				
16. Abstract This volume presents procedures and guidelines applicable to the design and installation of prefabricated vertical drains to accelerate consolidation of soils. The contents represent the Consultant's interpretation of the state-of-the-art as of August 1986. The volume is intended to provide assistance to engineers in determining the applicability of PV drains to a given project and in the design of PV drain systems. The information contained herein is intended for use by civil engineers familiar with the fundamentals of soil mechanics and the principles of precompression.  The volume includes descriptions of types and physical characteristics of PV drains, discussion of design considerations, recommended design procedures, guideline specifications and comments pertaining to installation guidelines, construction control, and performance evaluation.  This volume is the first in a series. The others in the series are:																				
<table border="1"> <thead> <tr> <th><u>FHWA No.</u></th> <th><u>Vol. No.</u></th> <th><u>Title</u></th> </tr> </thead> <tbody> <tr> <td>RD-86/169</td> <td>II</td> <td>Prefabricated Vertical Drains: Summary of Research Effort</td> </tr> <tr> <td>RD-86/170</td> <td>III</td> <td>Prefabricated Vertical Drains: Laboratory Data Report</td> </tr> <tr> <td>RD-86/171</td> <td>I</td> <td>Geocomposite Drains: Engineering Assessment and Preliminary Guidelines</td> </tr> <tr> <td>RD-86/172</td> <td>II</td> <td>Geocomposite Drains: Laboratory Data Report</td> </tr> </tbody> </table>						<u>FHWA No.</u>	<u>Vol. No.</u>	<u>Title</u>	RD-86/169	II	Prefabricated Vertical Drains: Summary of Research Effort	RD-86/170	III	Prefabricated Vertical Drains: Laboratory Data Report	RD-86/171	I	Geocomposite Drains: Engineering Assessment and Preliminary Guidelines	RD-86/172	II	Geocomposite Drains: Laboratory Data Report
<u>FHWA No.</u>	<u>Vol. No.</u>	<u>Title</u>																		
RD-86/169	II	Prefabricated Vertical Drains: Summary of Research Effort																		
RD-86/170	III	Prefabricated Vertical Drains: Laboratory Data Report																		
RD-86/171	I	Geocomposite Drains: Engineering Assessment and Preliminary Guidelines																		
RD-86/172	II	Geocomposite Drains: Laboratory Data Report																		
17. Key Words Vertical drains, prefabricated vertical drains, wick drains, precompression			18. Distribution Statement No restrictions. This document is available to the public through the National Technical Information Services, Springfield, Virginia 22161																	
19. Security Classif. (of this report) Unclassified		20. Security Classif. (of this page) Unclassified		21. No. of Pages 117	22. Price															

# METRIC CONVERSION FACTORS

## APPROXIMATE CONVERSIONS FROM METRIC MEASURES

SYMBOL   WHEN YOU KNOW   MULTIPLY BY   TO FIND   SYMBOL

### LENGTH

in	inches	2.5	centimeters	cm
ft	feet	30	centimeters	cm
yd	yards	0.9	meters	m
mi	miles	1.6	kilometers	km

### AREA

in <sup>2</sup>	square inches	6.5	square centimeters	cm <sup>2</sup>
ft <sup>2</sup>	square feet	0.09	square meters	m <sup>2</sup>
yd <sup>2</sup>	square yards	0.6	square meters	m <sup>2</sup>
mi <sup>2</sup>	square miles	2.6	square kilometers	km <sup>2</sup>
	acres	0.4	hectares	ha

### MASS (weight)

oz	ounces	28	grams	g
lb	pounds	0.45	kilograms	kg
	short tons (2000 lb)	0.9	tonnes	t

### VOLUME

tsp	teaspoons	5	milliliters	ml
tbsp	tablespoons	15	milliliters	ml
fl oz	fluid ounces	30	milliliters	ml
c	cups	0.24	liters	l
pt	pints	0.47	liters	l
qt	quarts	0.95	liters	l
gal	gallons	3.8	liters	l
ft <sup>3</sup>	cubic feet	0.03	cubic meters	m <sup>3</sup>
yd <sup>3</sup>	cubic yards	0.76	cubic meters	m <sup>3</sup>

### TEMPERATURE (exact)

°F	Fahrenheit temperature	5/9 (after subtracting 32)	Celsius temperature	°C
----	------------------------	----------------------------	---------------------	----

## APPROXIMATE CONVERSIONS FROM METRIC MEASURES

SYMBOL   WHEN YOU KNOW   MULTIPLY BY   TO FIND   SYMBOL

### LENGTH

mm	millimeters	0.04	inches	in
cm	centimeters	0.4	inches	in
m	meters	3.3	feet	ft
m	meters	1.1	yards	yd
km	kilometers	0.6	miles	mi

### AREA

cm <sup>2</sup>	square centimeters	0.16	square inches	in <sup>2</sup>
m <sup>2</sup>	square meters	1.2	square yards	yd <sup>2</sup>
km <sup>2</sup>	square kilometers	0.4	square miles	mi <sup>2</sup>
ha	hectares (10,000m <sup>2</sup> )	2.5	acres	

### MASS (weight)

g	grams	0.035	ounces	oz
kg	kilograms	2.2	pounds	lb
t	tonnes (1000kg)	1.1	short tons	

### VOLUME

ml	milliliters	8.03	fluid ounces	fl oz
l	liters	2.1	pints	pt
l	liters	1.06	quarts	qt
l	liters	0.26	gallons	gal
m <sup>3</sup>	cubic meters	36	cubic feet	ft <sup>3</sup>
m <sup>3</sup>	cubic meters	1.3	cubic yards	yd <sup>3</sup>

### TEMPERATURE (exact)

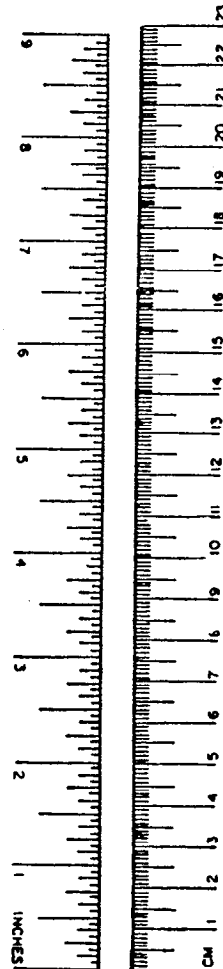
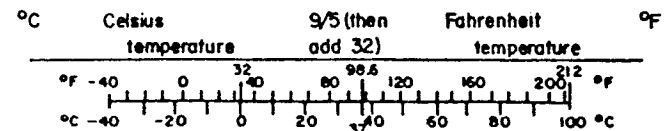



## TABLE OF CONTENTS

<u>Section</u>	<u>Page</u>
INTRODUCTION	
1. Purpose and Scope of Guidelines. . . . .	1
2. Assumptions and Limitations. . . . .	1
BACKGROUND	
1. Basic Principles of Precompression . . . . .	3
2. Purpose and Application of Vertical Drains . . . . .	6
3. History of Vertical Drains . . . . .	8
4. Characteristics of PV Drains . . . . .	9
DESIGN CONSIDERATIONS	
1. Objectives . . . . .	17
2. Design Equations . . . . .	18
3. The Ideal Case . . . . .	21
4. The General Case . . . . .	24
5. Design Approach. . . . .	30
EVALUATION OF DESIGN PARAMETERS	
1. Objectives . . . . .	33
2. Soil Properties ( $c_h, k_h, k_s$ ) . . . . .	33
3. Drain Properties ( $d_w, q_w$ ). . . . .	37
4. Disturbed Soil Zone ( $d_s$ ) . . . . .	39
5. Drain Influence Zone (D) . . . . .	41
DRAIN DESIGN AND SELECTION	
1. Objectives . . . . .	44
2. Selection of PV Drain Type . . . . .	45
3. Other Design Considerations. . . . .	47
4. Drain Spacing and Length . . . . .	52
5. Drainage Blankets. . . . .	55
6. Design Procedure . . . . .	56
7. Design Example . . . . .	59
8. Specifications . . . . .	59

TABLE OF CONTENTS (Continued)

<u>Section</u>	<u>Page</u>
INSTALLATION	
1. Introduction . . . . .	61
2. Site Preparation . . . . .	61
3. Installation Equipment . . . . .	62
4. Installation Procedures. . . . .	63
5. Contractor Interaction . . . . .	64
CONSTRUCTION MONITORING	
1. Introduction . . . . .	68
2. Familiarity with Design. . . . .	68
3. Site Preparation . . . . .	68
4. Drain Installation Equipment and Materials . . . . .	69
5. Drain Installation . . . . .	70
6. Drainage Blanket . . . . .	70
7. Geotechnical Instrumentation . . . . .	71
COSTS	
1. Introduction . . . . .	72
2. Cost Factors . . . . .	72
BIBLIOGRAPHY. . . . .	74
APPENDIX A: Design Equations . . . . .	77
APPENDIX B: Effects of Soil Disturbance. . . . .	81
APPENDIX C: Design Example . . . . .	83
APPENDIX D: Specifications . . . . .	94

## LIST OF TABLES

	<u>Page</u>
Table 1 - Common types of vertical drains.....	8
Table 2 - Some technical advantages of PV drains compared to sand drains.....	10
Table 3 - Typical PV drains available in the United States.....	14
Table 4 - Functions of PV drain jacket and core.....	16
Table 5 - Representative ratios of $k_h/k_v$ for soft clays.....	35
Table 6 - Methods for measurement of $c_h$ and $k_h/k_v$ .....	36
Table 7 - Summary of general product information provided by distributors/manufacturers.....	50
Table 8 - Summary of jacket and core information provided by distributors/manufacturers.....	51

## LIST OF FIGURES

Figure 1 Idealized types of settlement.....	5
Figure 2 Typical vertical drain installation for a highway embankment.....	6
Figure 3 Typical highway applications of PV drains.....	11
Figure 4 Consolidation due to vertical and radial drainage.....	19
Figure 5 Schematic of PV drain with drain resistance and soil disturbance.....	22
Figure 6 Equivalent diameter of a PV drain.....	23
Figure 7 Relationship of $F(n)$ to $D/d_w$ for "ideal case.".....	25
Figure 8 Example curves for "ideal case.".....	26
Figure 9 Disturbance factor ( $F_s$ ) for typical parameters.....	27
Figure 10 Estimation of an average drain resistance factor ( $F_r'$ )..	29
Figure 11 Example of parameter effects on $t_{90}$ .....	31
Figure 12 Typical values of vertical discharge capacity.....	38
Figure 13 Typical PV drain installation equipment.....	40
Figure 14 Approximation of the disturbed zone around the mandrel..	42
Figure 15 Relationship of drain spacing ( $S$ ) to drain influence zone ( $D$ ).....	43
Figure 16 Photographs of typical PV drain products.....	48
Figure 17 Effective confining pressure on a PV drain.....	53
Figure 18 Horizontal drainage blankets.....	57
Figure 19 Typical PV drain installation procedure.....	65
Figure 20 Typical PV drain splicing procedure.....	66

## LIST OF SYMBOLS

The following is a listing of the symbols and their respective definitions:

<u>SYMBOL</u>	<u>TERM</u>
$a$	= width of a band-shaped drain cross section
$A$	= cross-sectional area of drainage blanket removing the discharge of one row of drains
$A_w$	= the free surface area of a drain per unit length
$b$	= thickness of a band-shaped drain cross section
$b'$	= distance between two drains
$c_v$	= coefficient of consolidation for vertical drainage
$c_h$	= coefficient of consolidation for horizontal (or radial) drainage
$CR$	= virgin compression ratio
$C_\alpha$	= coefficient of secondary compression
$d$	= diameter of a circular drain
$d_m$	= equivalent diameter of mandrel (diameter of circle with an equal cross-sectional area)
$d_w$	= equivalent diameter; diameter of a circular drain which is functionally equivalent to the given band-shaped drain
$d_s$	= diameter of the idealized disturbed zone around the drain
$D$	= diameter of the cylinder of influence of the drain (drain influence zone)
$F(n)$	= drain spacing factor
$F_r$	= factor for drain resistance
$F_r'$	= average factor for drain resistance

LIST OF SYMBOLS (continued)

$F_s$	=	factor for soil disturbance
$h$	=	total head required to conduct water from centerline to point $y$
$h_b$	=	total head loss in the drainage blanket
$H_d$	=	length of longest drainage path (thickness of compressible layer when one way drainage occurs; half thickness of compressible layer when two way drainage occurs)
$H_p$	=	height of preload
$i$	=	hydraulic gradient
$k$	=	coefficient of permeability
$k_h$	=	coefficient of permeability in the horizontal direction in the undisturbed soil
$k_s$	=	coefficient of permeability in the horizontal direction in the disturbed soil
$k_v$	=	coefficient of permeability in the vertical direction
$k_w$	=	equivalent coefficient of permeability of the drain material along the axis of the drain
$K_0$	=	at rest lateral stress ratio
$L$	=	effective drain length; (length of drain when drainage occurs at one end only; half length of drain when drainage occurs at both ends)
$m_v$	=	coefficient of volume change
$n$	=	$D/d_w$
$N$	=	number of drains on one side of centerline
$P$	=	applied load
$P_{vm}$	=	maximum past pressure



LIST OF SYMBOLS (continued)

$q_d$	=	rate of discharge from a single drain
$q_w$	=	discharge capacity of the drain (at gradient = 1.0)
$r$	=	radius
$r_e$	=	radius of influence of drain well (D/2)
$r_m$	=	radius of circle with an area equal to the mandrel's cross sectional area.
$r_w$	=	radius of drain well ( $d_w/2$ )
$r_s$	=	radius defining boundary of disturbed zone
RR	=	recompression ratio
S	=	drain spacing
s	=	$r_s/r_w$ = ratio of radius of disturbed zone to equivalent radius of drain
$T_H$	=	nondimensional time factor for horizontal consolidation
$T_V$	=	nondimensional time factor for vertical consolidation
t	=	time
$t_p$	=	time to complete primary consolidation
$t_{sec}$	=	time at end of interval during which secondary compression is of interest
$t_{sr}$	=	time at surcharge removal
$u_e$	=	hydrostatic excess pore pressure, or excess pore water pressure, at a point
$u_v$	=	hydrostatic excess pore pressure with vertical drainage
$\bar{U}$	=	average degree of consolidation due to simultaneous vertical and horizontal drainage

LIST OF SYMBOLS (continued)

$\bar{U}_h$	=	average degree of consolidation due to horizontal drainage
$\bar{U}_v$	=	average degree of consolidation due to vertical drainage
$V$	=	volume
$y$	=	distance from the centerline to a given point
$z$	=	distance below top surface of the compressible soil layer
$\gamma_w$	=	unit weight of water
$\rho_v$	=	settlement
$\rho_c$	=	consolidation settlement
$\rho_{cf}$	=	final primary consolidation settlement
$\rho_f$	=	final consolidation settlement
$\rho_i$	=	initial settlement
$\rho_s$	=	settlement due to secondary compression
$\rho_t$	=	total settlement
$\bar{\sigma}_c$	=	effective confining pressure
$\bar{\sigma}_{v0}$	=	initial effective vertical stress
$\bar{\sigma}_{vf}$	=	final effective vertical stress

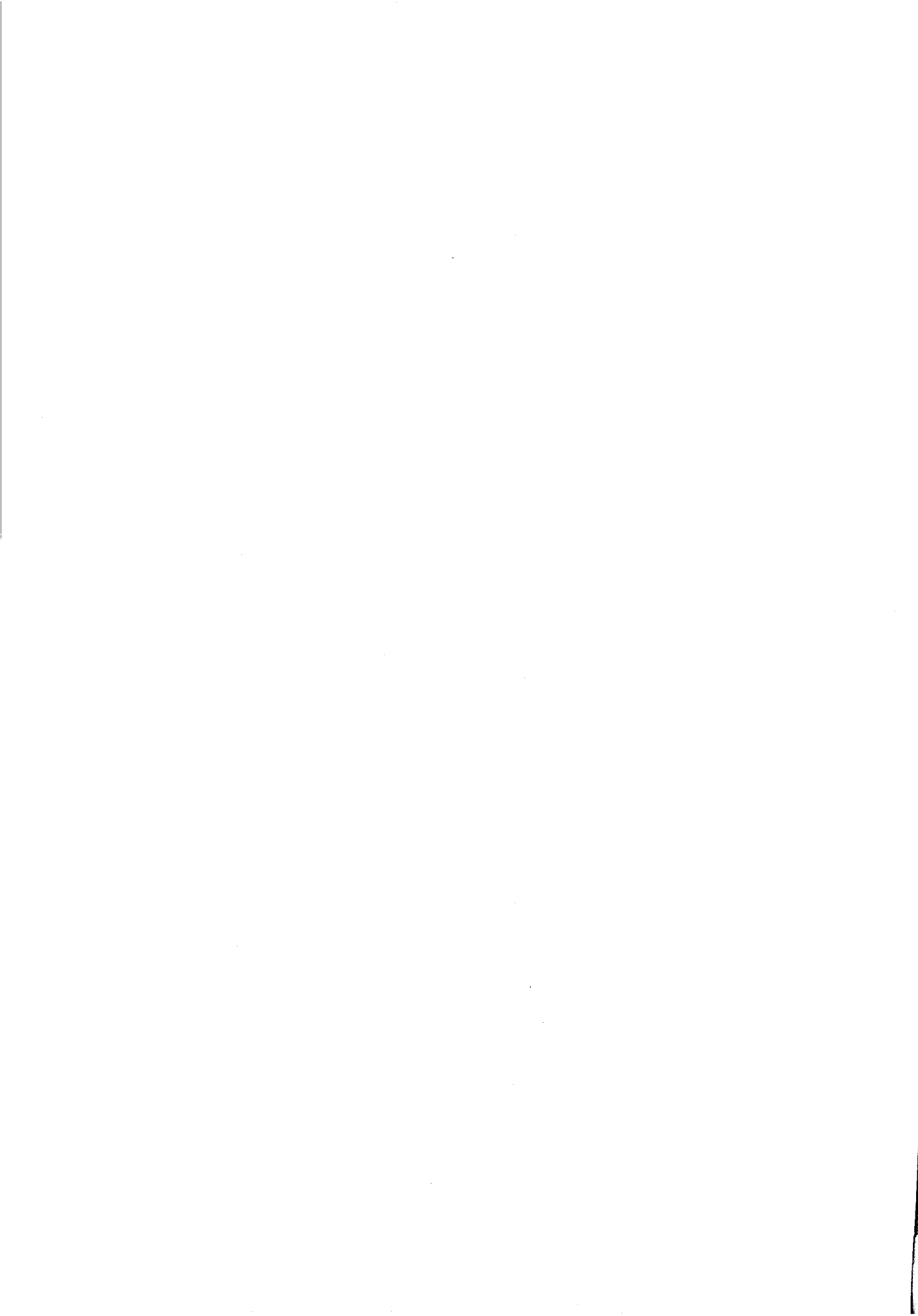

## INTRODUCTION

### 1. Purpose and Scope of Guidelines

The increased use of prefabricated vertical (PV) drains, or "wick" drains, on highway projects has illustrated the need for design and construction guidelines to assist the design engineer. Recognizing the need, the Federal Highway Administration (FHWA) has funded research to develop this manual. It is the specific purpose of this manual to summarize the Consultant's interpretation of the state-of-the-art in PV drain design and installation and to provide design engineers with practical guidelines for the evaluation, design and construction of PV drain projects.

This manual is intended to provide criteria to guide design engineers in evaluating the applicability of PV drains for a given project, and to provide an approach for designing the PV drain component of a precompression project.

The scope of this manual includes:

- Background information on the purpose, history, types and characteristics of PV drains,
- A recommended design equation including a nomograph solution,
- A discussion of pertinent soil parameters and methods for their evaluation,
- Recommended design procedures including a design example,
- Guideline specifications,
- Comments pertaining to drain installation, installation effects on soil properties, construction control, performance evaluations and cost considerations.

The design guidelines are intended to be applicable to commercially available band-shaped PV drains. The currently available products are characterized by a channeled or studded plastic core wrapped with a geotextile. The aspect ratio (width/thickness) is typically 25 to 30, and the surface area which will permit seepage into the drain is commonly 0.2 to 0.3 in<sup>2</sup> (150 to 200 mm<sup>2</sup>) per 0.4 in (1 mm) length. Although intended for use with band-shaped drains, various aspects of the guidelines may also be applicable to other PV drain types.

### 2. Assumptions and Limitations

This guideline manual is intended to be used by civil engineers who are knowledgeable about soil mechanics fundamentals and soil

precompression principles. Information contained herein is generally limited to that which is applicable to the use of PV drains in connection with precompression of soils beneath highway structures and embankments. For considerations of other important factors including the evaluation of stability, calculation of ultimate settlements, procedures for performing specific in-situ or laboratory tests, selection of soil properties, determination of the desirability of precompression and the proper use of field instrumentation, the engineer is directed to other available references.

As used herein, design of a PV drain system refers to the selection of drain type, spacing, length and installation method to achieve a desired degree of consolidation within a given time period. Based on the selected PV drain system, the relative economics and other factors pertaining to the precompression scheme can be evaluated to arrive at an appropriate precompression design.



## BACKGROUND

### 1. Basic Principles of Precompression

Precompression refers to the process of compressing foundation soils under an applied vertical stress (preload) prior to placement or completion of the final permanent construction load. If the temporary applied load exceeds the final loading, the amount in excess is referred to as a surcharge.

Precompression can be used to eliminate all or a portion of the anticipated postconstruction settlements caused by primary consolidation of most compressible foundation soils. By surcharging, the technique can accelerate the precompression and can also reduce settlements due to secondary compression.

When an embankment or other area load is applied rapidly to a deposit of saturated, cohesive soils, the resulting settlement can be divided into three idealized components:

- Initial (or "immediate") settlement occurs during application of the load as excess pore pressures develop in the underlying soil. If the soil has a low permeability and is relatively thick, the excess pore pressures are initially undrained. The foundation soil deforms due to the applied shear stresses with essentially no volume change, such that vertical compression is accompanied by lateral expansion.
- Primary consolidation settlement develops with time as drainage allows excess pore pressures to dissipate. Volume changes, and thus settlement, occur as stresses are transferred from the water (pore pressures) to the soil skeleton (effective stresses). The rate of primary consolidation is governed by the rate of water drainage out of the soil under the induced hydraulic gradients. The drainage rate depends upon the volume change and permeability characteristics of the soil as well as the location and continuity of drainage boundaries.
- Secondary compression settlement is the continuing, long-term settlement which occurs after the excess pore pressures are essentially dissipated and the effective stresses are practically constant. These further volume changes and increased settlements are due to drained creep, and are often characterized by a linear relationship between settlement and logarithm of time.

For purposes of analysis it is usually assumed that these three components occur as separate processes, in the order given. Experience has shown that the actual deformation behavior of soft foundation soils under embankment loadings is more complex than this simplified representation. In some cases the magnitude of one or more of these components may be insignificant. However, in most cases this simplifying assumption is reasonable and designs developed accordingly are appropriate. Figure 1 illustrates a general relationship of the three components of settlement with time.

The relative importance and magnitude of each type of settlement depends on many factors such as: the soil type and compressibility characteristics, its stress history, the magnitude and rate of loading, and the relationship between the area of loading and the thickness of compressible soil. However, for precompression projects it can be generally stated that<sup>(13)</sup>:

- Initial settlements are seldom of much practical concern, except for loadings on thick plastic or organic soils having marginal stability wherein large shear deformations may continue to develop due to undrained creep.<sup>(7)</sup> The initial settlements which occur during the application of the preload generally do not adversely affect the performance of a permanent embankment since additional fill can be placed if necessary to compensate for the settlement.
- Primary consolidation settlements generally predominate and for many precompression projects are the only settlements considered in the preload design.
- Secondary compression settlements are usually of greatest significance with highly organic soils (especially peats), and when primary consolidation occurs rapidly relative to the structure design life, such as can occur with vertical drain installations.

When designing precompression schemes, it is important to consider the deviations from the idealized assumptions of sequential settlements. Effects such as creep movements and lack of agreement between consolidation settlement and dissipation of excess pore pressures can invalidate the applicability of conventional linear consolidation theory for prediction or evaluation of precompression performance.

Discussions of these limitations have been given elsewhere<sup>(12,18)</sup> and are beyond the scope of this manual. Recognition of such limitations can, however, aid the engineers' design judgement and interpretation of results.

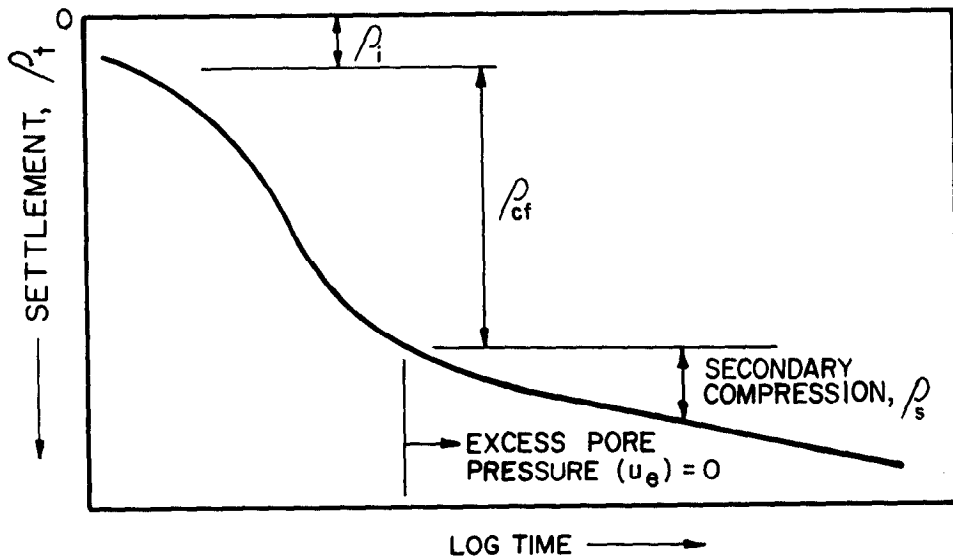
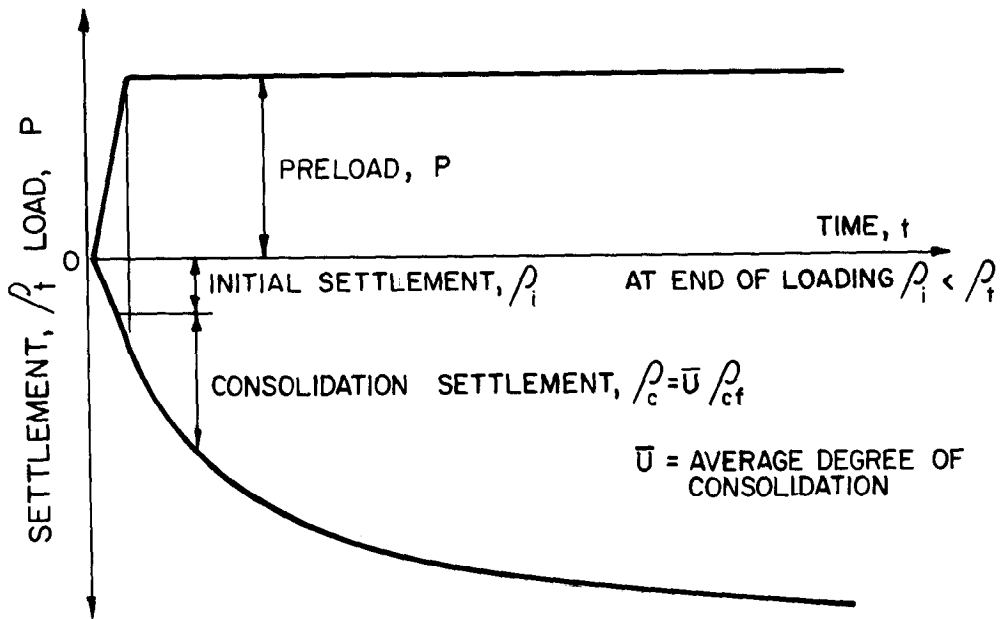

Figure 1 Idealized types of settlement.

If the foundation soils are weak relative to the shear stresses imposed by the embankment, the design of a precompression scheme must also consider overall embankment and foundation stability. Special measures such as flattening side slopes or use of stabilizing "toe" berms, possibly in conjunction with controlled rates of filling to permit an increase in shear strength due to consolidation, may be appropriate when marginal stability conditions exist. Assessment of the safety against instability is beyond the scope of this manual. Some of the important considerations relative to this topic are reviewed by Ladd<sup>(13)</sup>

## 2. Purpose and Application of Vertical Drains

Vertical drains are artificially-created drainage paths which can be installed by one of several methods and which can have a variety of physical characteristics. The use of vertical drains along with precompression has the sole purpose of shortening the drainage path (distance to a drainage boundary) of the pore water, thereby accelerating the rate of primary consolidation. Figure 2 illustrates a typical vertical drain installation for highway embankments.

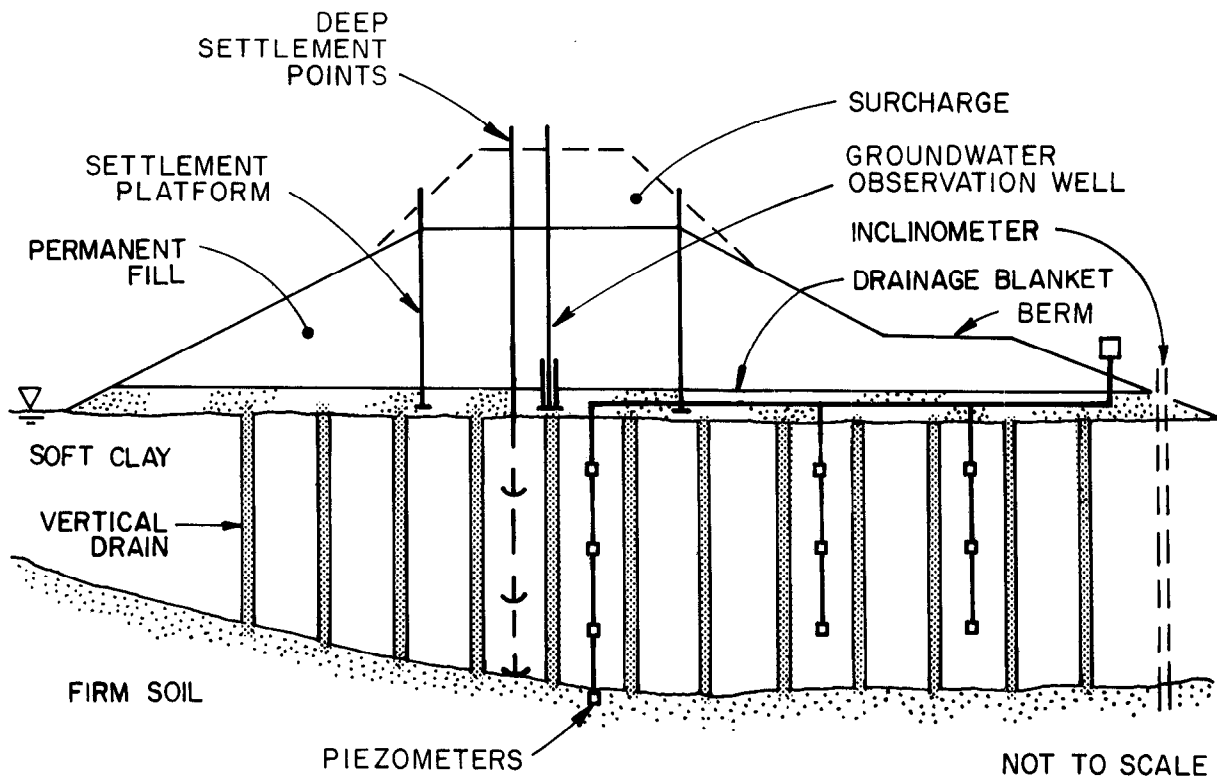

Figure 2 Typical vertical drain installation for a highway embankment.

When used in conjunction with precompression, the principal benefits of a vertical drain system (i.e., of accelerated consolidation) are:

- To decrease the overall time required for completion of primary consolidation due to preloading,
- To decrease the amount of surcharge required to achieve the desired amount of precompression in the given time,
- To increase the rate of strength gain due to consolidation of soft soils when stability is of concern.

Vertical drains can also be used as pressure relief wells to reduce pore pressures due to seepage, such as below natural slopes, and to improve the effectiveness of natural drainage layers below loaded areas.

Vertical drains can be classified into one of three general types: sand drains, fabric encased sand drains, and prefabricated vertical (PV) drains. Each of the general types can be further divided into subtypes as shown in Table 1. Although the scope of this manual is limited to PV drains, references to sand drains and fabric-encased sand drains are included where appropriate.

Under certain conditions the characteristics of the particular site, the subsurface profile and/or the proposed construction may impose limitations on the use of PV drains. If the compressible layer is overlain by dense fill or sands, very stiff clay or other obstructions, drain installation could require predrilling, jetting, and/or use of a vibratory hammer, or may not be feasible. Under such conditions, general pre-excavation can be performed, if practical. Where sensitive soils are present or where stability is of concern, disturbance of the soil due to drain installation may not be tolerable. In such cases, sand drains installed by non-displacement methods or an alternate soil improvement technique may be more appropriate.

Subject to the previously noted factors, consolidation with PV drains is feasible under most conditions for projects which can benefit from vertical drains. Use of PV drains is applicable for soils which: 1) are moderately to highly compressible under static loading, and 2) compress very slowly under natural drainage conditions due to low soil permeability and relatively great distance between natural drainage boundaries. Soils with these characteristics are almost exclusively cohesive, fine grained soils, either organic or inorganic. Soil types for which use of PV drains is ordinarily applicable include:



Table 1 Common types of vertical drains  
(after (13)).

<u>General Type</u>	<u>Sub-Types</u>	<u>Remarks</u>
SAND DRAINS	Closed end mandrel	Maximum displacement
	Screw type auger	Limited experience
	Continuous flight hollow stem auger	Limited displacement
	Internal jetting	Difficult to control
	Rotary jet	Can be non-displacement
	Dutch jet-bailer	Can be non-displacement
FABRIC ENCASED SAND DRAIN	Sandwich, Pack Drain, Fabridrain	Full displacement of relatively small volume
PREFABRICATED VERTICAL DRAIN	Cardboard drain	Full displacement of small volume
	Fabric covered plastic drain	Full displacement of small volume
	Plastic drain without jacket	Full displacement of small volume

inorganic silts and clays of low to moderate sensitivity; organic silts and clays; varved cohesive deposits; and decomposed peat or "muck". Use of PV drains is ordinarily not appropriate in highly pervious or granular soils.

### 3. History of Vertical Drains

Early applications of vertical drains in the U.S. to accelerate soil consolidation below highway fills utilized vertical sand drains. A U.S. patent for a sand drain system was granted in 1926. The California Division of Highways, Materials and Research Department conducted laboratory and field tests on vertical sand drain performance as early as 1933. Since that time, sand drains have been used successfully on a large number of highway projects across the country.

Despite the proven success of sand drains to accelerate consolidation, the method can have performance and environmental drawbacks which were first reported in Europe. In the late 1930's Walter Kjellman, then Director of the Swedish Geotechnical Institute, developed a prefabricated band-shaped vertical drain made of a cardboard core and paper filter jacket which was installed into the ground with a mechanical "stitcher". Kjellman's drain, which had a width of 3.94 in (100 mm) and a thickness of 0.16 in (4 mm), proved to have economic and environmental advantages over sand drains, and became widely used in Europe and Japan during the 1940's.

Development of plastics during and after World War II prompted development of a variety of PV drains having either rectangular (band shape) or circular cross sections composed entirely of plastic. At present, it is reported that over 50 types of PV drains are available worldwide.

The use of PV drains has largely replaced vertical sand drains for most applications. Table 2 lists several technical advantages of PV drains compared to conventional sand drains. The most important advantages are economic competitiveness, less disturbance to the soil mass compared to displacement sand drains, and the speed and simplicity of installation. One additional advantage of PV drains is their feasibility to be installed in a nonvertical orientation. This can be a decided advantage in certain circumstances, but is not specifically addressed in this manual.

PV drains are also relatively adaptable and can be used in a variety of commonly-encountered field conditions. Figure 3 illustrates typical applications of PV drains on highway projects.

#### 4. Characteristics of PV Drains

A PV drain can be defined as any prefabricated material or product having the following characteristics:

- Ability to be installed vertically into compressible subsurface soil strata under field conditions,
- Ability to permit porewater in the soil to seep into the drain,
- A means by which the collected porewater can be transmitted up and down the length of the drain.

The most commonly used PV drains in the U.S. are band-shaped (rectangular cross section) consisting of a synthetic geotextile "jacket" surrounding a plastic core. The jackets are commonly made of commercially available non-woven polyester or polypropylene geotextiles.

Table 2 Some technical advantages of PV drains compared to sand drains (after (13)).

<u>SAND DRAIN TYPE</u>	<u>ADVANTAGES OF PV DRAINS</u>
Displacement	<p>Considerably less disturbance of cohesive soils during installation due to: smaller physical displacement by mandrel and tip, and typically static push rather than driving.</p> <p>Installation equipment usually lighter, more maneuverable on site.</p> <p>Do not require abundant source of water for jetting.</p>
Non-Displacement	<p>Do not require control, processing and disposal of jetted spoil materials; fewer environmental control problems.</p> <p>Field control and inspection not as critical.</p> <p>Definite potential for cost economy.</p> <p>Eliminate cost of sand backfill of drains, quality control problems and related truck traffic.</p> <p>Job control and inspection requirements are reduced due to simplicity of installation procedures.</p>
All	<p>There is greater assurance of a permanent, continuous vertical drainage path; no discontinuities due to installation problems.</p> <p>PV drains can withstand considerable lateral displacement or buckling under vertical or horizontal soil movements.</p> <p>Faster rate of installation possible.</p> <p>Where very rapid consolidation is required, it is practical to install PV drains at close spacing.</p> <p>PV drains can be installed underwater and in a non-vertical orientation more conveniently.</p>

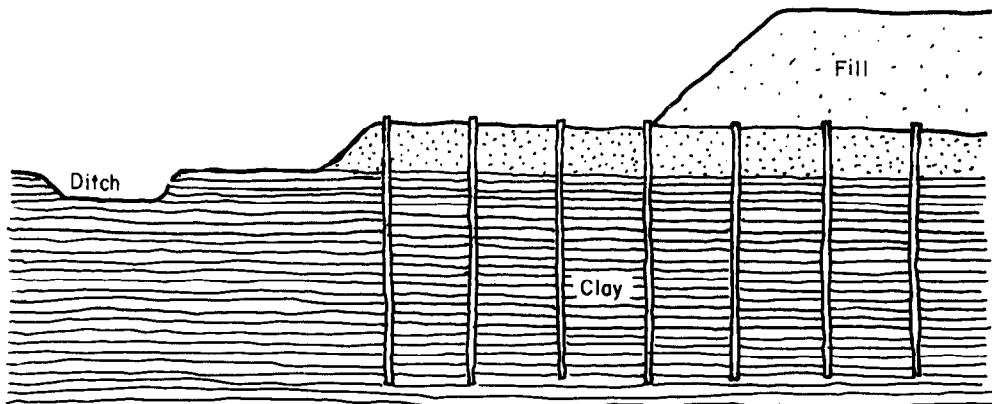

(A) HIGHWAY EMBANKMENT WITH BERM

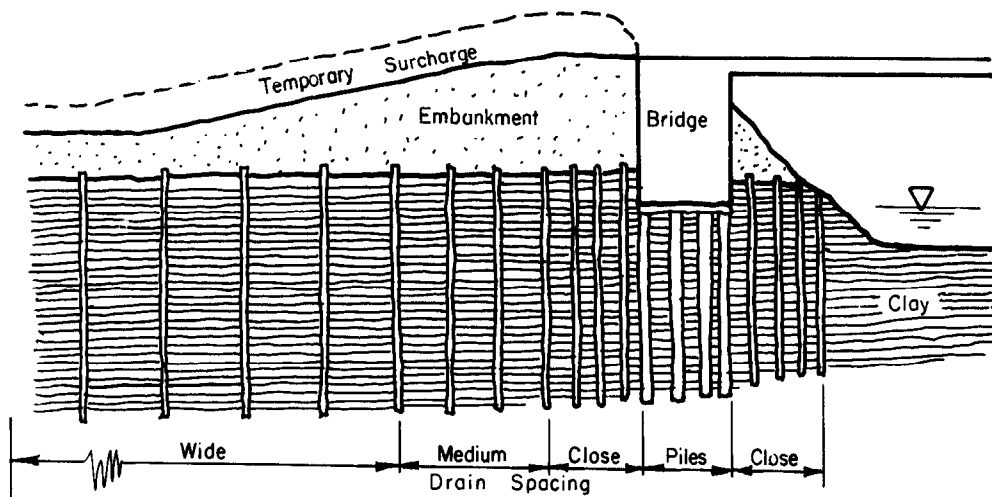

(B) BRIDGE APPROACH WITH TEMPORARY SURCHARGE

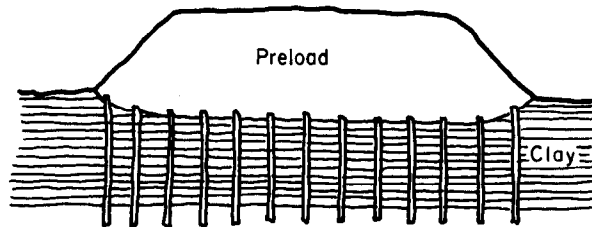

(C) HIGHWAY EMBANKMENT PRELOAD

Figure 3 Typical highway applications of PV drains (after Mebradrain promotional literature).

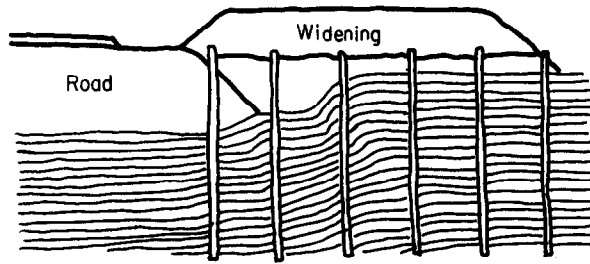

(D) WIDENING OF EXISTING HIGHWAY

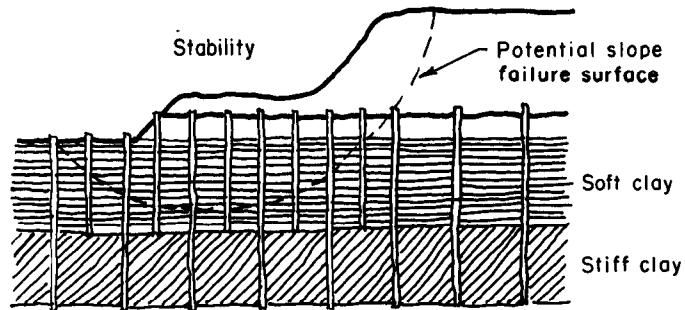

(E) IMPROVED STABILITY DUE TO STRENGTH GAIN WITH CONSOLIDATION

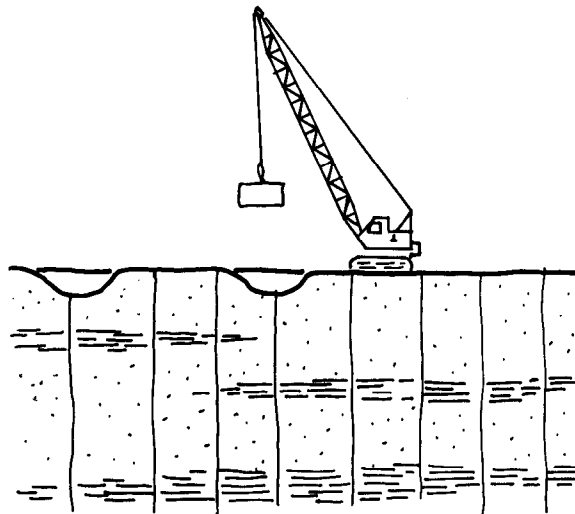

(F) RELIEVE EXCESS PORE PRESSURES DUE TO DYNAMIC CONSOLIDATION

Figure 3 Typical highway applications of PV drains (after Mebradrain promotional literature) (continued).



The plastic core serves two vital functions: to support the filter fabric, and to provide longitudinal flow paths along the drain length. Cores typically consist of grooved channels, a pattern of protruding studs, or mesh-type materials. The jacket material is a physical barrier separating the core flow channels from the surrounding fine grained soils and a "filter" to limit the passage of fine grained soil into the core area.

Most band-shaped drains are manufactured to dimensions similar to the original Kjellman drain, approximately 3.94 in (100 mm) wide by 0.16 in (4 mm) thick. Variations in these dimensions occur in some drains and at least one band-shaped drain has a width of 11.8 in (300 mm).

Table 3 lists typical band-shaped PV drains identified to be presently available in the U.S. Product names and information given in Table 3 and elsewhere in the manual are provided for general reference and are not intended to be all inclusive. This information does not constitute an endorsement of any kind by either the Consultant or the FHWA. In fact, some of the drain products listed in Table 3 are not acceptable to state highway departments and other agencies that have developed preapproved product lists. Several other PV drain types have been used outside the United States including circular sandfilled fabric tubes, fabric covered plastic or metal spirals or pipe cores, and drains consisting only of filter fabric strips.

The primary functions of a conventional PV drain filter jacket and core are given in Table 4. The jacket and core must perform a variety of interrelated functions. The applicability of any given drain type for a particular project will depend on the drain's performance of these functions under in-situ soil and loading conditions.

For a particular soil or project, many factors influence the capability of any given drain to perform the above functions. These factors are of two types: those intrinsic to the drain geometry and material properties and their relationship to the soil characteristics, and those related to the methods and equipment used during installation. Criteria for selection of PV drain type and characteristics are provided in Section 2 of DRAIN SELECTION AND DESIGN. Installation is discussed in Sections 3 and 4 of INSTALLATION.

Table 3 Typical PV drains available  
in the United States.

<u>Product Name</u>	<u>Manufacturer (M)/US Distributor (D)</u>	
Alidrain, Alidrain S Hitek Flodrain	M	Burcan Industries, Ltd. and Burcan Manufacturing Inc. Suite 17, 111 Industrial Drive Whitby, Ontario, Canada L1N 5Z9
	D	Drainage & Ground Improvement, Inc. P. O. Box 13222 Pittsburgh, Pennsylvania 15243 (412)257-2750
	D	Geosystems, Inc. P. O. Box 618 Sterling, Virginia 22170 (703) 430-5444
Amerdrain 307 and 407	M,D	American Wick Drain Co. 301 Warehouse Drive Matthews, North Carolina 28105 1-800-438-9281
Bando Drain	M	Bando Chemical Company, Inc. Isobe, Japan
	D	Fukuzawa & Associates, Inc. 6129 Queenridge Drive Rancho Palos Verdes, CA 90274 (213)377-4735
Castle Drain Board	M	Kinjo Rubber Co., Ltd. Atobe Kitamomachi Yao City, Osaka, Japan
	D	Harquim International Corporation 3112 Los Feliz Boulevard Los Angeles, California 90039 (213)669-8332

Table 3 Typical PV drains available in the United States (continued).

<u>Product Name</u>	<u>Manufacturer (M)/US Distributor (D)</u>	
Colbond CX-1000	M	Colbond BV Velperweg 76 6824 BM Amhen, Holland
	D	BASF Corporation Fibers Division Geomatrix Systems Enka, North Carolina 28728 (704)667-7713
Desol	M	Soletanche 6 rue de Watford F-92005 Nanterre, France
	D	Recosol Incorporated Rosslyn Center 1700 North Moore Street Suite 2200 Arlington, Virginia 22209 (703)524-6503
Mebradrain MD7007	M	Geotechnics Holland, BV Baambrugse Zuwe 212 III Vinkeveen, Holland
	D	L. B. Foster Company 415 Holiday Drive Pittsburgh, Pennsylvania 15220 (415)262-3900
Sol Compact	M	Rhone-Poulenc Paris, France
	D	Moretrench American Corporation 100 Stickle Avenue Rockaway, New Jersey 07866 (201)627-2100
Vinylex	M,D	Vinylex Corporation P. O. Box 7187 Knoxville, Tennessee 37921 (615)690-2211

Table 4 Functions of PV drain jacket and core  
(after (13)).

Functions of Drain Jacket

- Form a surface which allows a natural soil filter to develop to inhibit movement of soil particles while allowing passage of water into the drain
- Create the exterior surface of the internal drain flow paths
- Prevent closure of the internal drain flow paths under lateral soil pressure

Functions of Drain Core

- Provide internal flow paths along the drain
- Provide support of the filter jacket
- Maintain drain configuration and shape
- Provide resistance to longitudinal stretching as well as buckling of the drain

## DESIGN CONSIDERATIONS

### 1. Objectives

The principal objective of soil precompression, with or without PV drains, is to achieve a desired degree of consolidation within a specified period of time. The design of precompression with PV drains requires the evaluation of drain and soil properties (both separately and as a system) as well as the effects of installation.

For one-dimensional consolidation without drains, only consolidation due to one dimensional (vertical) seepage to natural drainage boundaries is considered. The degree of consolidation can be measured by the ratio of the settlement at any time to the total primary settlement that will (or is expected to) occur. This ratio is referred to as  $\bar{U}$ , the average degree of consolidation.

By definition, one-dimensional consolidation is considered to result from vertical drainage only, but consolidation theory can be applied to horizontal or radial drainage as well. Depending on the boundary conditions consolidation may occur due to concurrent vertical and horizontal drainage. The average degree of consolidation,  $\bar{U}$ , can be calculated for the vertical, horizontal or combined drainage depending on the situation considered.

With vertical drains the overall average degree of consolidation,  $\bar{U}$ , is the result of the combined effects of horizontal (radial) and vertical drainage. The combined effect is given by:

$$\bar{U} = 1 - (1 - \bar{U}_h)(1 - \bar{U}_v) \quad (\text{Eq. 1})$$

where

$\bar{U}$  = overall average degree of consolidation

$\bar{U}_h$  = average degree of consolidation due to horizontal (or radial) drainage

$\bar{U}_v$  = average degree of consolidation due to vertical drainage.

Considerations for evaluation of  $\bar{U}_v$  are described in most soil mechanics textbooks. Therefore, the case of consolidation due to vertical drainage only is not discussed separately herein. This manual is directed to the assessment of consolidation due to radial

drainage and the combined effects of vertical and radial drainage. A comparison of one-dimensional consolidation due to vertical drainage and due to radial drainage is presented in Figure 4.

## 2. Design Equations

The design of a PV drain system requires the prediction of the rate of dissipation of excess pore pressures by radial seepage to vertical drains as well as evaluating the contribution of vertical drainage.

The first comprehensive treatment (in English) of the radial drainage problem was presented by Barron<sup>(2)</sup> who studied the theory of vertical sand drains. Barron's work was based on simplifying assumptions of Terzaghi's one-dimensional linear consolidation theory. Appendix A includes a discussion of Barron's analysis and an explanation of the resulting simplified equation. The most widely-used simplified solution from Barron's analysis (see Appendix A) provides the following relationship among time, drain diameter and spacing, coefficient of consolidation and the average degree of consolidation:

$$t = (D^2/8c_h) F(n) \ln(1/(1-\bar{U}_h)) \quad (\text{Eq. 2})$$

where

$t$  = time required to achieve  $\bar{U}_h$

$\bar{U}_h$  = average degree of consolidation due to horizontal drainage

$D$  = diameter of the cylinder of influence of the drain (drain influence zone)

$c_h$  = coefficient of consolidation for horizontal drainage

$F(n)$  = drain spacing factor

$$= \ln(D/d) - 3/4 \quad (\text{simplified}) \quad (\text{Eq. 3})$$

$d$  = diameter of a circular drain

In addition to the one-dimensional theory assumptions, this equation further assumes that:

- the drain itself has infinite permeability (i.e., no drain resistance)

(A) VERTICAL DRAINAGE ONLY

(B) RADIAL DRAINAGE ONLY

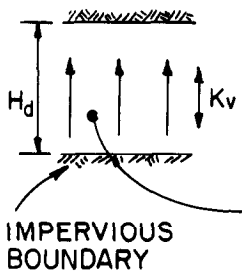

$$t = \frac{T_v (H_d)^2}{c_v}$$

$$\bar{U}_v = f(T_v)$$

VERTICAL SEEPAGE ONLY

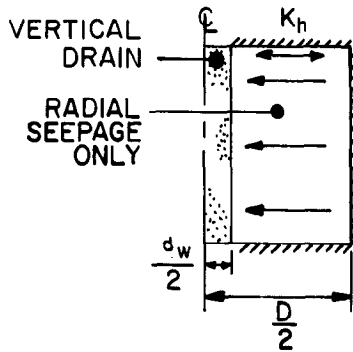

$$t = \frac{T_h D^2}{c_h}$$

$$\bar{U}_h = f\left(T_h, \frac{D}{d_w}\right)$$

$$n = \frac{D}{d_w}$$

COMBINED VERTICAL AND RADIAL DRAINAGE



RADIAL AND VERTICAL SEEPAGE

$$\bar{U} = 1 - (1 - \bar{U}_v)(1 - \bar{U}_h)$$

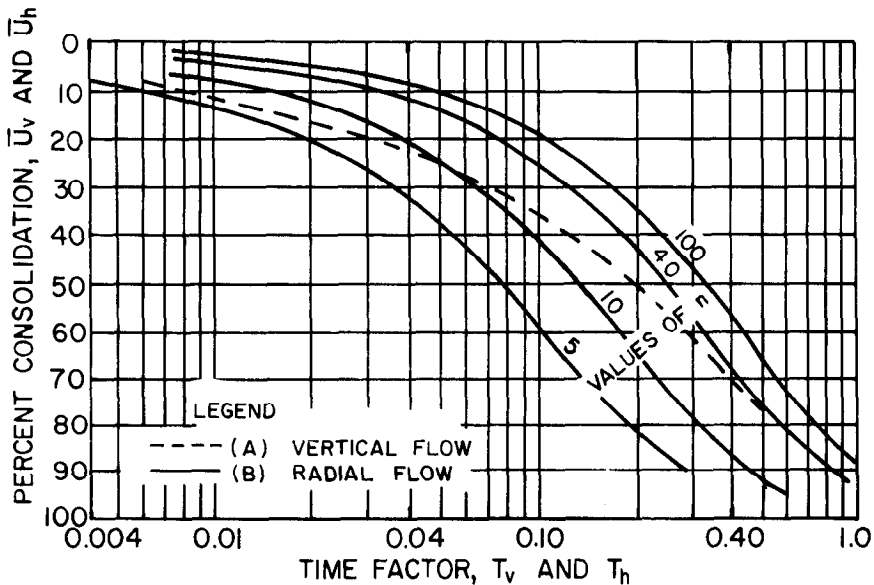

AVERAGE CONSOLIDATION RATES

- (A) FOR VERTICAL FLOW IN A CLAY STRATUM OF THICKNESS H DRAINED ON BOTH UPPER AND LOWER SURFACES
- (B) FOR RADIAL FLOW TO AXIAL DRAIN WELLS IN CLAY CYLINDERS HAVING VARIOUS VALUES OF n
- (AFTER BARRON, 1948)

Figure 4 Consolidation due to vertical and radial drainage.

- there are no adverse effects on soil permeability and consolidation properties due to drain installation (i.e., no disturbance)

Equation 2 was modified by Hansbo<sup>(9)</sup> to be applied to band-shaped PV drains and to include consideration of disturbance and drain resistance effects. Hansbo's derivation and terms are based on a theoretical analysis (See Appendix A for a summary of Hansbo's modifications). The resulting general equation is:

$$t = (D^2/8c_h)(F(n) + F_S + F_R) \ln(1/(1-\bar{U}_h)) \quad (\text{Eq. 4})$$

where

$$t = \text{time required to achieve } \bar{U}_h$$

$$\bar{U}_h = \text{average degree of consolidation at depth } z \text{ due to horizontal drainage}$$

$$D = \text{diameter of the cylinder of influence of the drain}$$

$$c_h = \text{coefficient of consolidation for horizontal drainage}$$

$$F(n) = \text{drain spacing factor}$$

$$= \ln(D/d_w) - 3/4 \quad (\text{Eq. 5})$$

$$d_w = \text{equivalent diameter (See detailed discussion in later section)}$$

$$F_S = \text{factor for soil disturbance}$$

$$= ((k_h/k_S) - 1) \ln(d_S/d_w) \quad (\text{Eq. 6})$$

$$k_h = \text{the coefficient of permeability in the horizontal direction in the undisturbed soil}$$

$$k_S = \text{the coefficient of permeability in the horizontal direction in the disturbed soil}$$

$$d_S = \text{diameter of the idealized disturbed zone around the drain}$$

$$F_R = \text{factor for drain resistance}$$

$$= \pi z (L - z)(k_h/q_w) \quad (\text{Eq. 7})$$



- z = distance below top surface of the compressible soil layer
- L = effective drain length; length of drain when drainage occurs at one end only; half length of drain when drainage occurs at both ends
- q<sub>w</sub> = discharge capacity of the drain (at gradient = 1.0)

The variables of Equation 4 are shown in Figure 5 and discussed in the following sections.

### 3. The Ideal Case

Equation 4 can be simplified to the "ideal case" by ignoring the effects of soil disturbance and drain resistance (i.e.,  $F_s = F_r = 0$ ). The resulting ideal case equation is equivalent to Barron's solution:

$$t = (D^2/8c_h) F(n) \ln(1/(1-\bar{U}_h)) \quad (\text{Eq. 8})$$

In the ideal case, the time for a specified degree of consolidation simplifies to be a function of soil properties ( $c_h$ ), design requirements ( $\bar{U}_h$ ) and design variables ( $D, d_w$ ).

The theory of consolidation with radial drainage assumes that the soil is drained by a vertical drain with a circular cross section. The radial consolidation equations include the drain diameter,  $d$ . A band-shaped PV drain must therefore be assigned an "equivalent diameter,"  $d_w$ . The equivalent diameter of a band-shaped drain is defined as the diameter of a circular drain which has the same theoretical radial drainage performance as the band-shaped drain. Under most conditions  $d_w$  can be assumed to be independent of subsurface conditions, soil properties and installation effects. It can be assumed to be a function of the drain geometry and configuration only.

For design purposes, it is reasonable to calculate the equivalent diameter as<sup>(9)</sup>:

$$d_w = (2(a+b)/\pi) \quad (\text{Eq. 9})$$

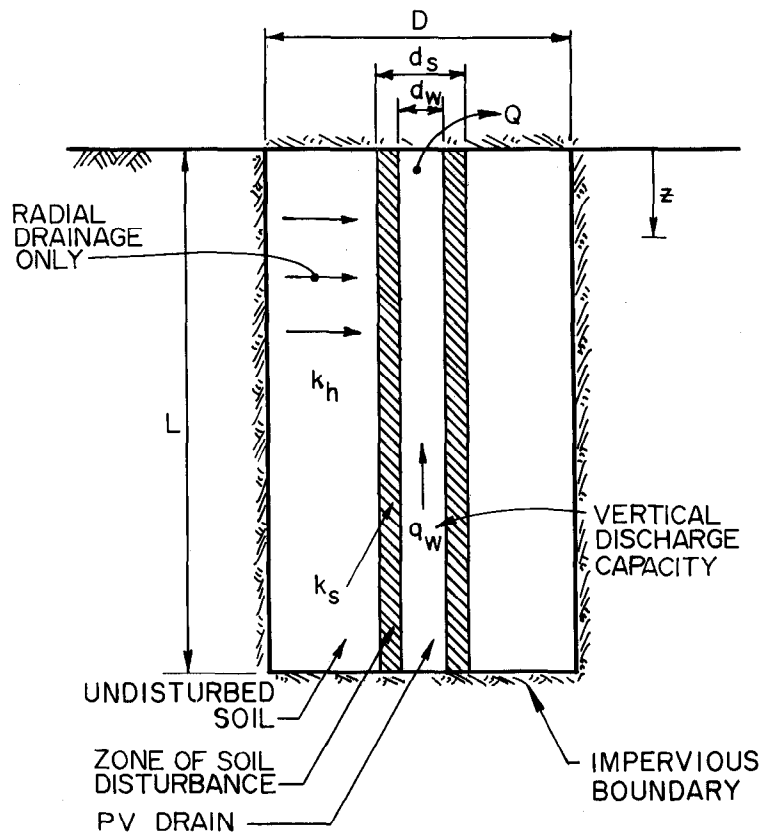

Figure 5 Schematic of PV drain with drain resistance and soil disturbance.

where:

- a = width of a band-shaped drain cross section
- b = thickness of a band-shaped drain cross section

Equation 9 is based on the assumption that circular and band-shaped drains will, for practical purposes, result in the same consolidation performance if their circumferences are the same (see Figure 6). Equation 9 also assumes that the core does not significantly impede seepage into the drainage channels. Impedance can occur if the core openings to the drainage channels are very small and/or widely spaced, or if a high percentage of the jacket area is in direct contact with the core. Based on initial research performed to prepare this manual, Equation 9 was found to be generally valid when the portion of the perimeter area of the band-shaped drain which permits inflow

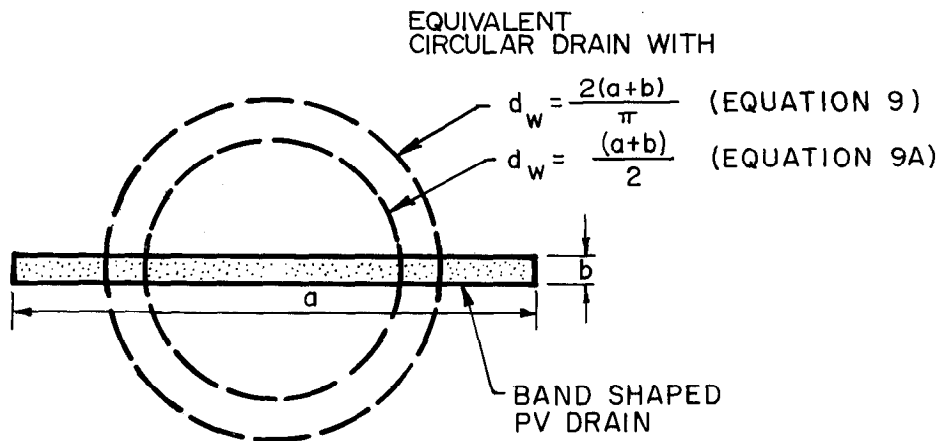

Figure 6 Equivalent diameter of a PV drain.

(not obstructed by the drain core) exceeds approximately 10 to 20 percent of the total perimeter. For most types of PV drains, this condition is easily met. Also, seepage in the plane of the jacket, between openings to the drainage channels, will tend to reduce the theoretical impedance caused by core blockage.

Subsequent finite element studies performed during preparation of this manual<sup>(8)</sup> suggest that it may be more appropriate to modify Equation 9 to:

$$d_w = (a+b)/2 \quad (\text{Eq. 9A})$$

This conclusion is supported by other published studies.<sup>(27)</sup> Equation 9A is considered to be appropriate for design use for conventional band-shaped drains having the ratio  $a/b$  of approximately 50 or less.

In practice the equivalent diameter calculated using Equation 9 is often arbitrarily reduced in recognition of the uncertainties involved in determining the equivalent diameter of a band-shaped drain. This practice is considered unnecessary if Equation 9A is used.

The ideal case equation is commonly used for preliminary designs and in some cases even for final designs. Appropriate design equations to be used for typical design conditions are discussed in later sections of the manual.

Figure 7 shows the relationship of  $F(n)$  to  $D/d_w$  for the ideal case. Within a typical range of  $D/d_w$ ,  $F(n)$  ranges from approximately 2 to 3. Figure 8 is a series of design curves for the ideal case.

#### 4. The General Case

In some situations it is appropriate to consider the effects of drain resistance and/or soil disturbance. Depending on the project conditions, these effects may or may not be significant. The general equation (Equation 4) includes factors for drain resistance and soil disturbance.

$$t = (D^2/8c_h)(F(n) + F_S + F_R) \ln(1/(1-\bar{U}_h)) \quad (\text{Eq. 4})$$

The assumed conditions used to model soil disturbance and drain resistance are shown in Figure 5.

In Equation 4 the effects of soil disturbance ( $F_S$ ) and drain resistance ( $F_R$ ) are additive (i.e., both tend to retard the rate of consolidation). As discussed below, it is apparent from theoretical parametric studies that the drain spacing effect ( $F(n)$ ) is always an important factor, the soil disturbance effect ( $F_S$ ) can be of approximately the same or slightly more significance than  $F(n)$ , and the drain resistance effect ( $F_R$ ) is typically of minor importance.

- Soil Disturbance

For the case with soil disturbance (no drain resistance) Equation 4 simplifies to:

$$t = (D^2/8c_h) (F(n) + F_S) \ln(1/(1-\bar{U}_h)) \quad (\text{Eq. 10})$$

where

$$F_S = ((k_h/k_s) - 1) \ln(d_s/d_w) \quad (\text{Eq. 6})$$

Figure 9 illustrates the relative magnitude of  $F_S$  for a range of soil parameters and  $d_s/d_w$  ratios. For typical values of  $F(n)$  the ratio of  $F_S/F(n)$  might range from approximately 1 to 3. This means that the effect of disturbance on reducing the rate of consolidation could theoretically be up to 3 times as great as the effect of drain spacing.

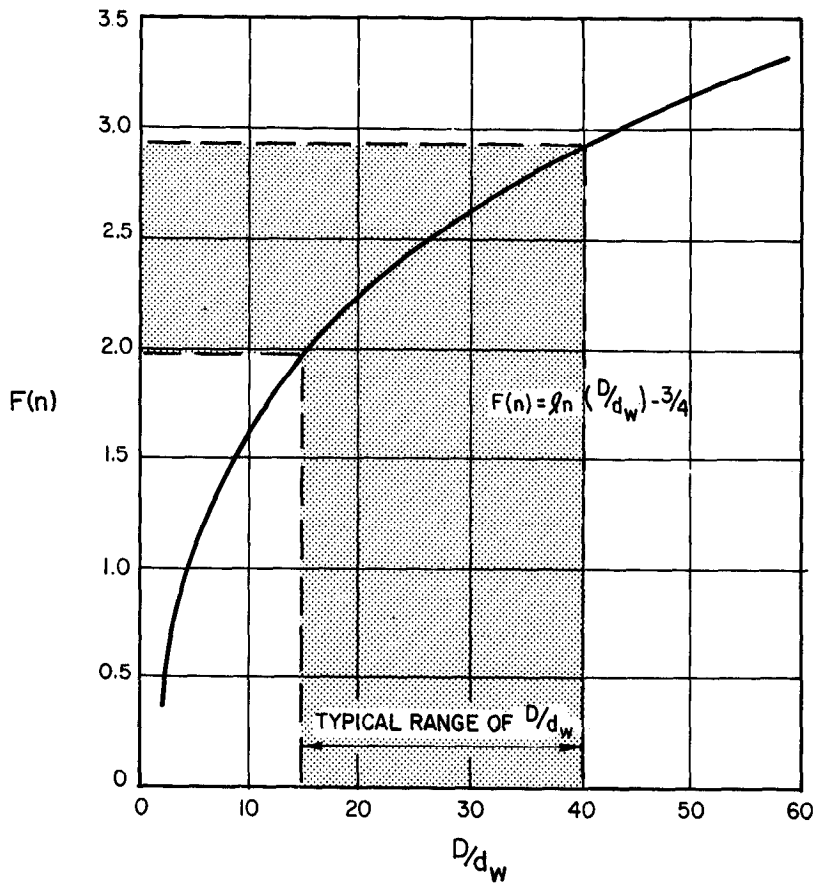

FOR THE IDEAL CASE (no soil disturbance or drain resistance)

$$t = \frac{D^2 F(n)}{8 c_h} \ln \frac{1}{(1-U_h)} \quad (\text{EQUATION 8})$$

$$F(n) = \ln \left( \frac{D}{d_w} \right) - 3/4 \quad (\text{EQUATION 5})$$

Figure 7 Relationship of  $F(n)$  to  $D/d_w$  for "ideal case".

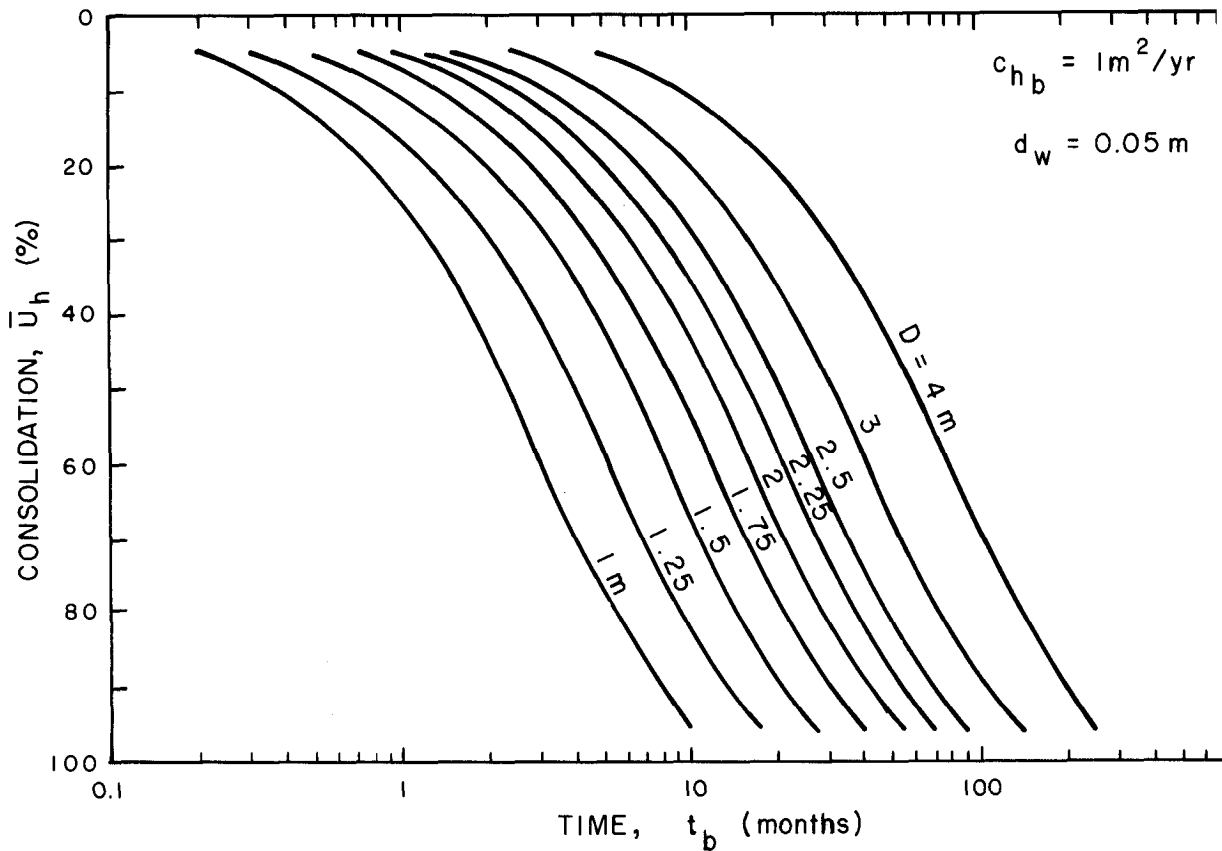

$$t = \frac{D^2}{8c_h} \left[ \ln \frac{D}{d_w} - \frac{3}{4} \right] \ln \left[ \frac{1}{1 - \bar{U}_h} \right] \quad (\text{Equation 2})$$

For other values of  $c_h$  (assuming  $d_w = 0.05 \text{ m}$ )

$$t = \frac{c_{hb}}{c_h} t_b$$

Example

Given:  $c_h = 1.9 \text{ m}^2/\text{yr}$ ,  $d_w = 0.05 \text{ m}$

$t$  for  $\bar{U}_h = 90\% = 20 \text{ months}$

Find: required  $D$

Solution:  $t_b = \frac{1.9 \text{ m}^2/\text{yr}}{1 \text{ m}^2/\text{yr}} (20 \text{ months}) = 38 \text{ months}$

$D = 1.85 \text{ m}$      $w/d_w = 0.05 \text{ m}$

Figure 8 Example design curves for "ideal case".

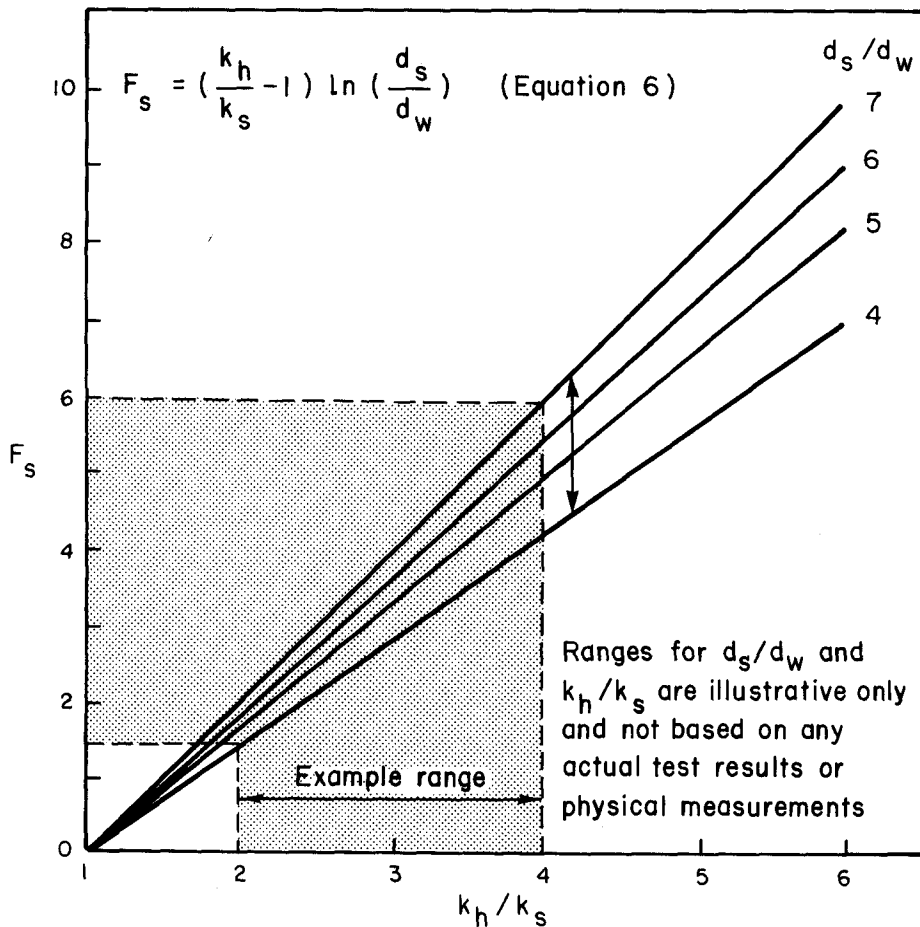

Figure 9 Disturbance factor ( $F_s$ ) for typical parameters.

As part of the research for preparing this manual, the soil disturbance due to mandrel insertion and withdrawal was studied with emphasis on analytical techniques developed since the work by Barron<sup>(2)</sup> and Hansbo<sup>(9)</sup>. A summary of the results of this research is presented in Appendix B along with a framework for predicting installation disturbance effects. Full development of the framework is beyond the research scope; however with development, the proposed framework promises to provide a more analytically sound approach to estimating soil disturbance effects than the current state-of-the-practice which is to use the methods proposed by Barron<sup>(2)</sup> and Hansbo<sup>(9)</sup>, or to ignore the effects altogether.

- Drain Resistance (without disturbance)

For the case with drain resistance (no disturbance) Equation 4 simplifies to:

$$t = (D^2/8c_h)(F(n) + F_r) \ln(1/(1-\bar{U}_h)) \quad (\text{Eq. 11})$$

where

$$F_r = \pi z(L - z)(k_h/q_w) \quad (\text{Eq. 7})$$

$F_r'$  = an average value of  $F_r$  (see explanation below)

It can be seen from Equations 7 and 11 that  $\bar{U}_h$  varies with depth if there is drain resistance (i.e.,  $F_r$  not equal to zero) but is constant with depth if there is no well resistance ( $F_r$  equals zero). If an average value of  $F_r$  ( $F_r'$ ) is entered into Equation 11,  $\bar{U}_h$  can be considered to be the average degree of consolidation for the entire layer.

One approach to the averaging process (presented in Figure 10) results in the following:

One way drainage:

$$F_r' = (2\pi/3)(L^2)(k_h/q_w) \quad (\text{Eq. 7a})$$

Two way drainage:

$$F_r' = (\pi/6)(L^2)(k_h/q_w) \quad (\text{Eq. 7b})$$

With typical values the ratio of  $F_r'/F(n)$  is generally less than 0.05. Therefore, typically the theoretical effect of drain resistance is significantly less than the effect of drain spacing or soil disturbance.

- Combined Soil Disturbance and Drain Resistance

For the combined case of combined soil disturbance and drain resistance, Equation 4 applies.

$$t = (D^2/8c_h) (F(n) + F_s + F_r) \ln(1/(1-\bar{U}_h)) \quad (\text{Eq. 4})$$



$$F_r = \pi z(L-z) \frac{k_h}{q_w} \quad (\text{EQUATION 7})$$

L is the length of the drain

$$L = H_d \quad \text{for 1 way drainage}$$

$$L = 2H_d \quad \text{for 2 way drainage}$$

TWO WAY DRAINAGE

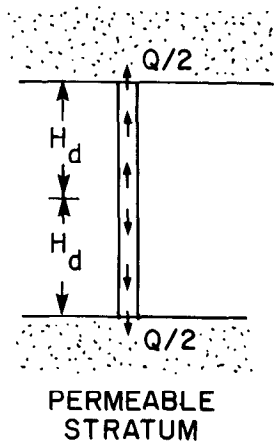

$$F_r = \pi z(L-z) \frac{k_h}{q_w} = \pi \frac{k_h}{q_w} (zL - z^2) = \pi \frac{k_h}{q_w} f_r(z)$$

$$F_r' = \frac{1}{L} \left( \pi \frac{k_h}{q_w} \int_0^L f_r(z) dz \right) = \frac{\pi k_h}{L q_w} \left( \frac{z^2 L}{2} - \frac{z^3}{3} \right) \Big|_0^L$$

$$F_r' = \frac{\pi L^2}{6} \frac{k_h}{q_w} \quad (\text{EQUATION 7a})$$

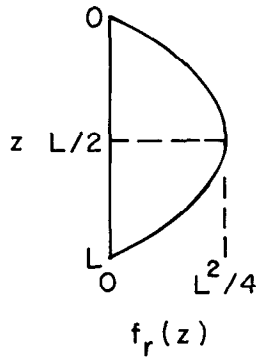

ONE WAY DRAINAGE

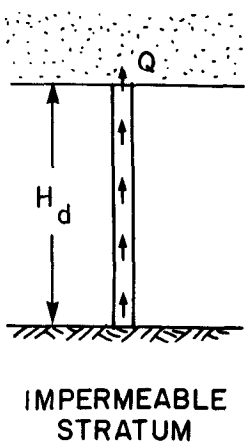

$$F_r = \pi z \left( \frac{L}{2} - z \right) \frac{k_h}{q_w} = \pi \frac{k_h}{q_w} \left( \frac{2L}{2} z - z^2 \right) = \pi \frac{k_h}{q_w} f_r'(z)$$

$$F_r' = \frac{1}{L} \left( \pi \frac{k_h}{q_w} \int_0^L f_r'(z) dz \right) = \frac{\pi k_h}{L q_w} \left( z^2 L - \frac{z^3}{3} \right) \Big|_0^L$$

$$F_r' = \frac{2\pi}{3} L^2 \frac{k_h}{q_w} \quad (\text{EQUATION 7b})$$

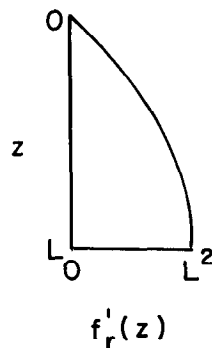

Figure 10 Estimation of an average drain resistance factor ( $F_r'$ ).

where

$$F(n)+F_r+F_s = (\ln(D/d_w) - 3/4) + ((k_h/k_s)-1) \ln(d_s/d_w) + \pi z(L-z)(k_h/q_w) \quad (\text{Eq. 12})$$

Equations 4 and 12 represent the general case for PV drains with consideration of drain spacing, soil disturbance and drain resistance. Figure 11 demonstrates the relative effects of key parameters in Equations 4 and 12 for a given base case situation. It should be noted from Figure 11 that the greatest potential effect on  $t_{90}$  is due to changes in  $c_h$  and  $D$ . The value of  $c_h$ , which can easily vary by a factor of 10, has the most dominant influence on  $t_{90}$ .  $D$ , which can vary by a factor of about 2 to 3, has a considerable influence due to the  $D^2$  term. The influence of the properties of the disturbed zone ( $k_s$  and  $d_s$ ), although much more difficult to quantify, can also be very significant. The equivalent diameter,  $d_w$ , has only a minimal influence on  $t_{90}$ .

## 5. Design Approach

Design of a preloading scheme utilizing PV drains should include the following main steps:

- a. Evaluation of the project time requirements and the establishment of tolerable amounts of postconstruction settlement.
- b. Subsurface investigations and laboratory soil testing program to provide detailed information on site soil and drainage conditions and high-quality data on pertinent engineering properties of the compressible soils.
- c. Predictions of the total anticipated settlements at representative locations due to primary consolidation and secondary compression.
- d. Predictions of the rate of primary consolidation ( $t$  vs.  $\bar{U}_v$ ) at representative locations for the case without drains and for cases with PV drains at several spacings.
- e. Evaluation of stability to establish safe heights of filling and the possible need for berms and/or staged construction.
- f. Evaluations of the relative economic and technical merits of additional surcharging versus drain spacings where it is determined that the rate of primary consolidation settlement must be accelerated to meet the project schedule.

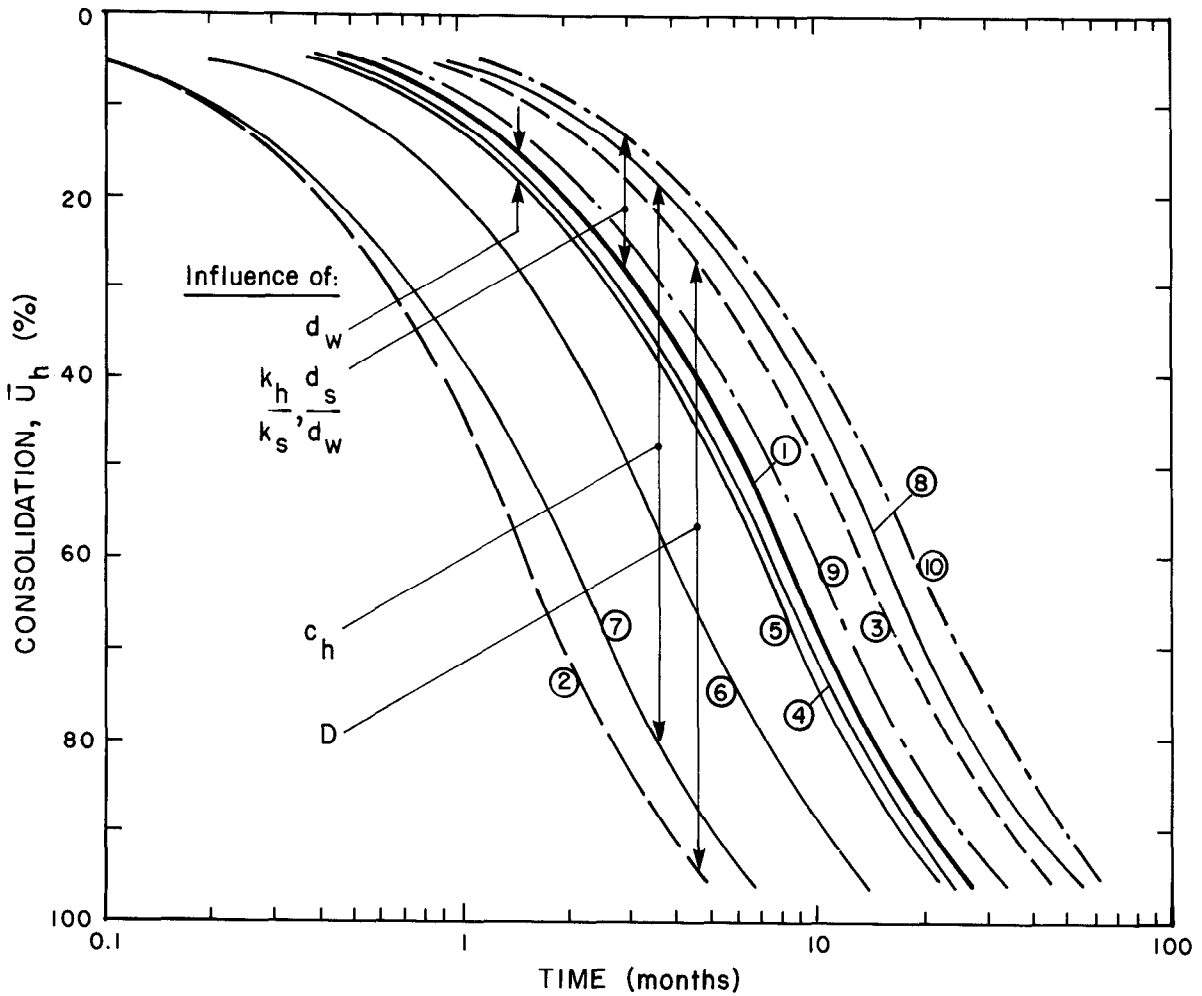

$$t = \frac{D^2}{8 c_h} \left[ \left[ \ln \left( \frac{D}{d_w} \right) - \frac{3}{4} \right] + \left( \frac{k_h}{k_s} - 1 \right) \ln \left( \frac{d_s}{d_w} \right) \right] \ln \left( \frac{1}{1 - \bar{U}_h} \right) \quad (\text{EQUATION 10})$$

CASE	$c_h$ ( $m^2/yr$ )	$D$ (m)	$d_w$ (m)	$k_h/k_s$	$d_s/d_w$	$t_{90}$ (months)	$\frac{t_{90} \text{ Case } i}{t_{90} \text{ Case } 1}$
1	2	2	0.05	1	1	20.3	1.00
2	2	1	0.05	1	1	3.9	0.19
3	2	2.5	0.05	1	1	34.1	1.68
4	2	2	0.06	1	1	19.0	0.94
5	2	2	0.07	1	1	18.0	0.87
6	4	2	0.05	1	1	10.2	0.50
7	8	2	0.05	1	1	5.1	0.25
8	1	2	0.05	1	1	40.6	2.00
9	2	2	0.05	2	2	25.1	1.24
10	2	2	0.05	4	4	49.0	2.41

Figure 11 Example of parameter effects on  $t_{90}$ .

The above approach requires knowledge of design procedures for PV drains, geotechnical engineering experience and judgement. If there are errors or unrealistic assumptions made in any of the above stages, then the success of the project (in terms of preventing stability failures and limiting postconstruction settlements to within the allowable limits) may be adversely affected even though the PV drains may perform in accordance with theoretical predictions.

The design process for PV drains is iterative by nature. The general approach given above is listed in steps which are highly interrelated. The following chapters discuss the key parameters in PV drain design individually with discussions of interrelation between parameters.

## EVALUATION OF DESIGN PARAMETERS

### 1. Objectives

The design of a PV drain project requires evaluation of design parameters including soil and drain properties as well as the effects of installation. The appropriate level of effort involved in the evaluation of each parameter will depend in part on the overall relative size and complexity of the project. Project categories are presented below as an expedient to the following summary discussion on the evaluation of design parameters.

<u>Project Category</u>	<u>Description</u>
A	Basically uniform soil (no varving, low to moderate sensitivity) Simple construction (no staged loading) PV drains (few in number, length less than about 60 ft (18m))
B	Generally similar to Category A although with an increased degree of complexity - intermediate between categories A and C.
C	One or more of the following: Unusual soils (varved, or high sensitivity) Staged loading or other construction complications PV drains (numerous or length greater than about 60 ft (18m))

### 2. Soil Properties ( $c_h$ , $k_h$ , $k_s$ )

The application of the general equation (Eq. 4) requires an evaluation of soil properties  $c_h$ ,  $k_h$ , and  $k_s$ . In general, it is considered appropriate to use soil property values evaluated at the maximum vertical effective stress to be applied to the compressible soil in the field.

#### a. Coefficient of Consolidation for Horizontal Drainage ( $c_h$ ) and Coefficient of Permeability for Horizontal Seepage ( $k_h$ )

The coefficient of consolidation for horizontal drainage,  $c_h$ , can be evaluated using the following relationship:

$$c_h = (k_h/k_v) c_v \quad (\text{Eq. 13})$$

The techniques used to evaluate  $c_h$  depend on the project complexity (Category A, B or C). On a Category A project  $c_h$  can usually be conservatively estimated as being equal to  $c_v$  measured in the laboratory (i.e.,  $k_h/k_v = 1$ ) from one-dimensional consolidation tests (ASTM D2435) which would be performed on any project (Category A, B or C) involving vertical drains. The ratio of permeability can be approximated using Table 5 as a preliminary guide or preferably from available data on the soil in question. Field and/or laboratory measurements should be made for comparison with the estimate. Proper application of Equation 13 requires an awareness of the basic assumptions used and the potential ramifications of soil macrofabric on the ratio of  $k_h/k_v$ .

On Category C and possibly Category B projects,  $c_h$  and the ratio of  $k_h/k_v$  can be more accurately estimated using the methods described in Table 6. In-situ piezometer probes and analysis of pore pressure dissipation curves can also be used to evaluate  $c_h$  and  $k_h$ . These techniques are reviewed by Jamiolkowski et al.<sup>(12)</sup> In-situ determination of  $k_h$  by small-scale pumping tests in piezometers or by self-boring permeameters can be used with laboratory  $m_v$  values to calculate  $c_h$  using the relationship:

$$c_h = k_h / (m_v \gamma_w) \quad (\text{Eq. 14})$$

where

$\gamma_w$  = unit weight of water

$m_v$  = coefficient of volume change

Use of the specialized in-situ techniques requires a thorough understanding of soil consolidation theory in order to properly analyze the results. Consequently the generally recommended approach is to employ conventional consolidation tests to measure  $c_v$  combined with field and laboratory investigations to estimate  $k_h/k_v$  and then evaluate  $c_h$  using Equation 13<sup>(13)</sup>.

Table 5 Representative ratios of  $k_h/k_v$  for soft clays.\*

	$k_h/k_v$
1. No evidence of layering (Partially dried clay has completely uniform appearance)**	$1.2 \pm 0.2$
No or only slightly developed macrofabric (e.g. sedimentary clays with discontinuous lenses and layers of more permeable soil)***	1 to 1.5
2. Slight layering (e.g. sedimentary clays with occasional silt dustings to random silty lenses)**	2 to 5
Fairly well to well developed macrofabric (e.g. sedimentary clays with discontinuous lenses and layers of more permeable material)***	2 to 4
3. Varved clays in Northeastern US **	$10 \pm 5$
Varved clays and other deposits containing embedded and more or less continuous permeable layers***	3 to 15

Notes:

\* Soft clay is defined as a clay with an undrained shear strength of less than 1,000 psf.

\*\* Reference: (13)

\*\*\* Reference: (11)

These ratios are provided for general information purposes only. Designers should verify the actual properties of any given soil.

Table 6 Methods for measurement of  $c_h$  and  $k_h/k_v$  (after (14)).

<u>Method and Parameter</u>	<u>Remarks</u>	<u>References</u>
Laboratory consolidometer test on horizontal sample ( $c_h$ )	Wrong $m_v$ Sample size influences results	(21)
Laboratory consolidometer test with radial drainage to sides ( $c_h$ )	May have problems with side friction and scale effects	(17)
Laboratory consolidometer test with radial drainage to vertical sand drain ( $c_h$ )	Large sample recommended to minimize scale effects	(22,25)
Laboratory permeability tests on vertical and horizontal samples ( $c_h$ )	Problem with variability when using different samples	(24)
Laboratory permeability tests on cubic sample ( $k_h/k_v$ )	Better than No. 4; large large (10 cm) samples recommended	(6,16)
Field constant head flow tests with hydraulic piezometer ( $c_h, k_h$ )	Method of installation important Need to consider length to diameter ratio	(19)
Field pumping test from vertical sand drain ( $k_h$ )	Method of installation important Pervious layers can have important effect	(3)
Field falling head tests in piezometers ( $k_h$ ) and piezocone pore pressure dissipation ( $c_h$ )	Pervious layers can have important effect	(13)



b. Coefficient of Permeability in the Horizontal Direction in the Disturbed Soil ( $k_s$ )

Evaluation of the general equation requires an estimate of  $k_h/k_s$ . Very little published guidance is available to the design engineer. However, the ratio of  $k_h/k_s$  is generally considered to range from 1 to 5 at strain levels anticipated within the disturbed soil. The ratio of  $k_h/k_s$  can be expected to vary with soil sensitivity and the presence or absence of soil macrofabric. Careful consideration, engineering judgement and possibly special testing are necessary to make realistic assessments of  $k_h/k_s$  for particular project conditions.

3. Drain Properties ( $d_w$ ,  $q_w$ )

Equivalent diameter ( $d_w$ ) and discharge capacity ( $q_w$ ) are drain properties required to use the general equation (Equation 4).

a. Equivalent Diameter ( $d_w$ )

Equivalent diameter for conventional band-shaped drains should be calculated as:

$$d_w = ((a+b)/2) \quad (\text{Eq. 9A})$$

For commonly used band-shaped PV drains,  $d_w$  ranges from about 2 in (50mm) to 3 in (75 mm).

b. Discharge Capacity ( $q_w$ )

The discharge capacity of a PV drain is required to analyze the drain resistance factor, which is almost always less significant than the drain spacing and disturbance factors. Accurate measurement of drain discharge capacity is time consuming and requires relatively sophisticated laboratory testing. Therefore, discharge capacity is not normally measured by the engineer as part of the PV drain design process but rather is obtained from published results.

Vertical discharge capacities are often reported by the drain manufacturers. Unfortunately, several different test configurations (confining media, drain sample size, etc.) are used to obtain these values. Results of vertical discharge capacity tests performed as part of this research and those performed by others are shown in Figure 12. These results demonstrate the major influence of confining pressure.

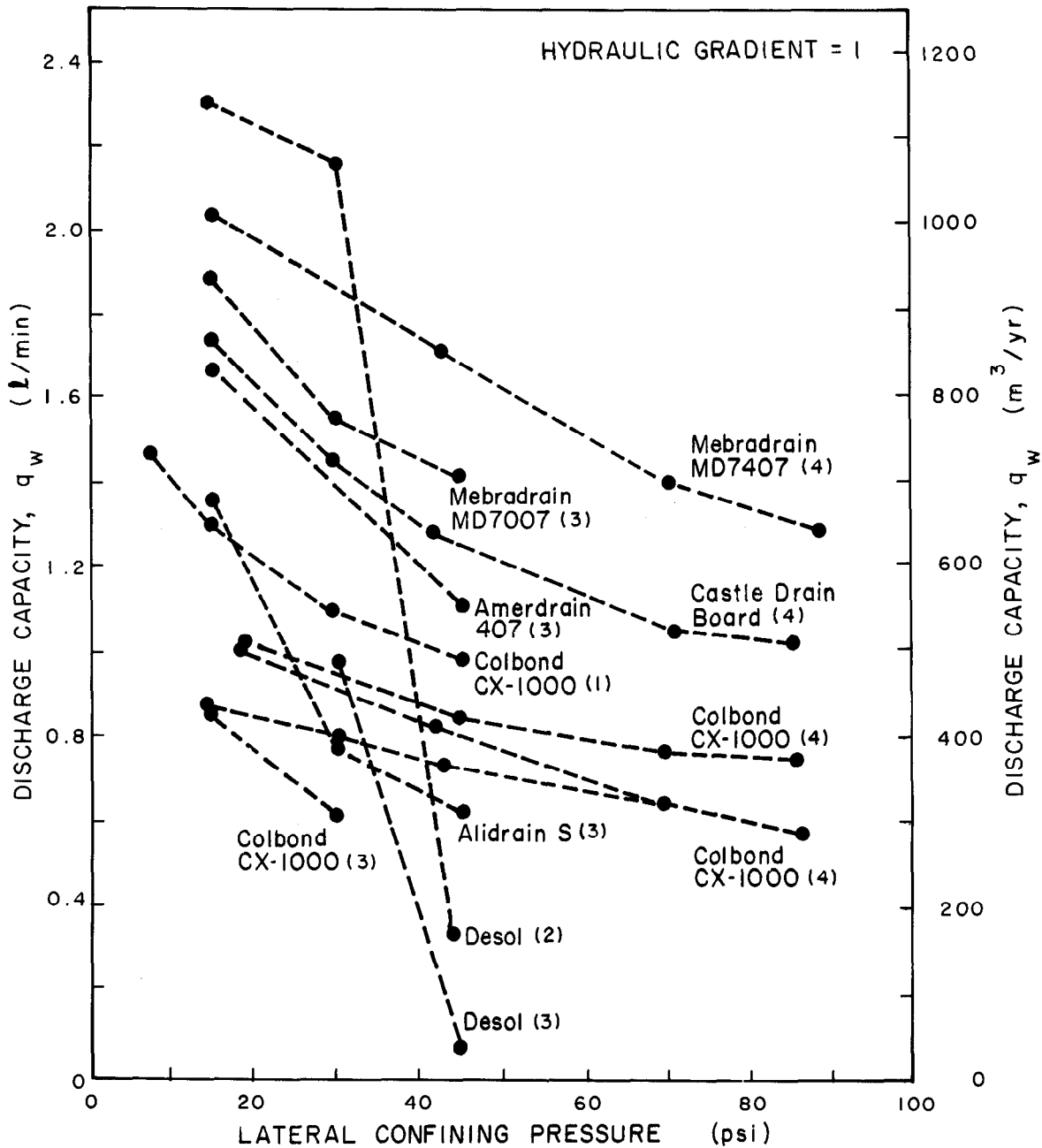

Note: Data from sources other than (3) not verified. Test methods vary. Data Sources - (1) Colbond promotional literature; (2) Desol internal report; (3) Reference 8; (4) Jamiolkowski and Lancellotta, unpublished.

Figure 12 Typical values of vertical discharge capacity.

Vertical discharge capacity is also influenced by the effects of vertical compression on the shape of the drain. Buckling or crimping of the drain has been observed in both laboratory and field testing. The potential reduction on vertical discharge is very difficult to accurately estimate. However, van de Griend<sup>(26)</sup> observed reductions of 10 to 90 percent in vertical discharge capacity at vertical compression of about 20 percent in laboratory consolidation tests. van de Griend concluded that a rigid drain will experience a greater reduction since buckling begins at a lower value of relative compression.

In lieu of specific laboratory test data, discharge capacity can be conservatively assumed to be 3500 ft<sup>3</sup>/yr (100 m<sup>3</sup>/yr) for currently available band-shaped drains with the only known exception of the Desol drain when exposed to horizontal confining stress in excess of 40 psi (276 kPa).

#### 4. Disturbed Soil Zone (d<sub>g</sub>)

PV drains are typically installed using equipment similar to that shown in Figure 13. PV drain installation results in shear strains and displacement of the soil surrounding the drain. The shearing is accompanied by increases in total stress and pore pressure. The PV drain is protected by the mandrel during installation. Since the area of the mandrel is greater than that of the drain, there is the possibility that an annular space is created around the drain which is present after the mandrel is removed. The installation results in disturbance to the soil around the drain.

Evaluation of the disturbance effects is very complex. The present understanding is that disturbance, as it relates to drain performance, is most dependent upon:

- Mandrel size and shape. Generally disturbance increases with larger total mandrel cross sectional area. The mandrel cross sectional area should be as close to that of the drain as possible to minimize displacement; while at the same time, adequate stiffness of the mandrel (dependent on cross sectional area and shape) is required to maintain vertical alignment. Although little data are available to assess shape effects, it is believed that the shape of the mandrel tip and anchor should be as tapered as possible.
- Soil macrofabric (soil layering). For soils with pronounced macrofabric, the ratio  $k_H/k_V$  can be very high, possibly up to 10. However, within the remolded zone, the beneficial effects of soil stratification (and hence greater horizontal permeability) can be reduced or completely eliminated.

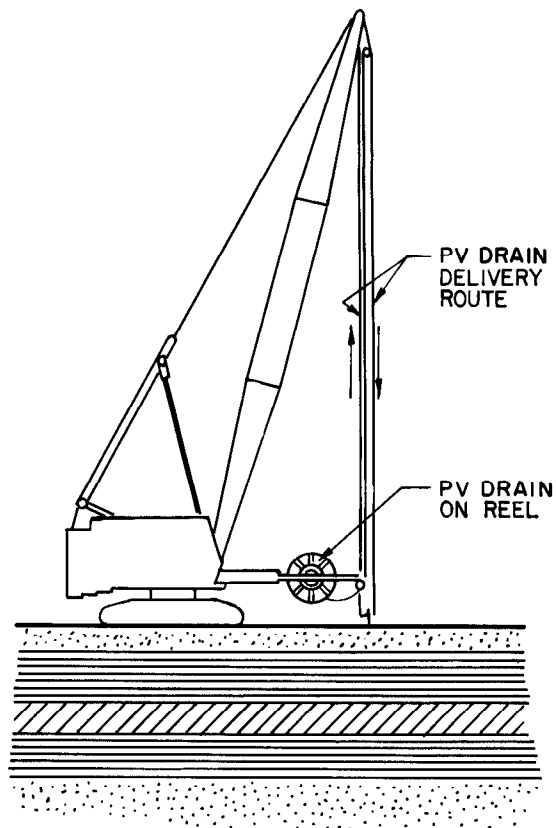

(A) INSTALLATION RIG

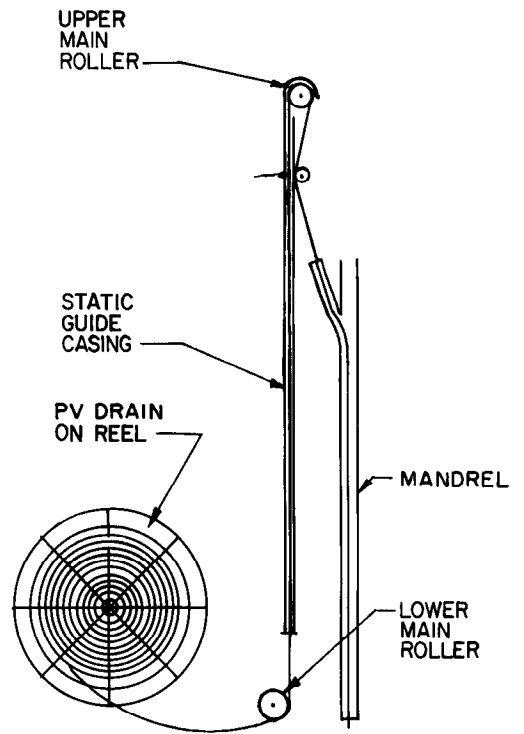

(B) DRAIN DELIVERY ARRANGEMENT

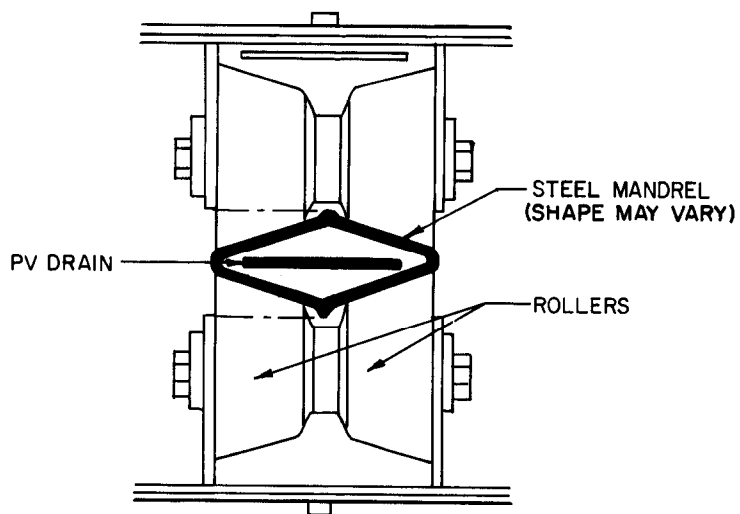

(C) CROSS SECTION OF MANDREL AND DRAIN

Figure 13 Typical PV drain installation equipment.

Smearing of pervious layers with less pervious soil can retard the lateral seepage of porewater from the pervious layers into the drain, thereby reducing the effective  $k_h/k_v$ .

- Installation Procedure. No conclusive data are available on the effects of varying the installation procedure. However, static pushing is thought to be preferred to driving or vibrating the mandrel especially in sensitive soils. It is not known whether drain performance is sensitive to the rate of mandrel penetration. Buckling or "wobbling" of the mandrel can cause added disturbance. The penetration rate and mandrel stiffness should be selected to limit wobbling. The effect of penetration rate on wobbling should be observed during installation. If necessary, the rate should be controlled to limit wobbling.

For design purposes, it has been recommended by others that when disturbance is to be considered,  $d_s$  should be evaluated as<sup>(10)</sup>:

$$d_s = (5 \text{ to } 6)r_m \quad (\text{Eq. 15})$$

where  $r_m$  is the radius of a circle with an area equal to the mandrel's greatest cross sectional area, or cross sectional area of the anchor or tip, whichever is greater. For design purposes it is currently assumed that within the disturbed zone, complete soil remolding occurs (see Figure 14). Research performed as part of the development of this manual (see Figure 14 and Appendix B) indicates the theoretical distribution of shear strain with radial distance from a circular mandrel. At the distance  $d_s$  from Equation 15 the theoretical shear strain is approximately 5 percent. The effects of a 5 percent shear strain on critical soil properties, such as  $c_h$ , are not known at this time.

## 5. Drain Influence Zone (D)

The time to achieve a given percent consolidation is a function of the square of the diameter of the influence cylinder (D). D is a variable in the drain spacing factor,  $F(n)$ , which is used in both the general and ideal cases. Unlike the other parameters discussed above with the exception of  $d_w$ , D is a controllable variable since it is a function of drain spacing only. Vertical drains are commonly installed in square or triangular patterns (see Figure 15). It is the distance between the drains (S) that establishes D through the following relationships:

PHYSICAL CONDITIONS

IDEALIZED CONDITIONS

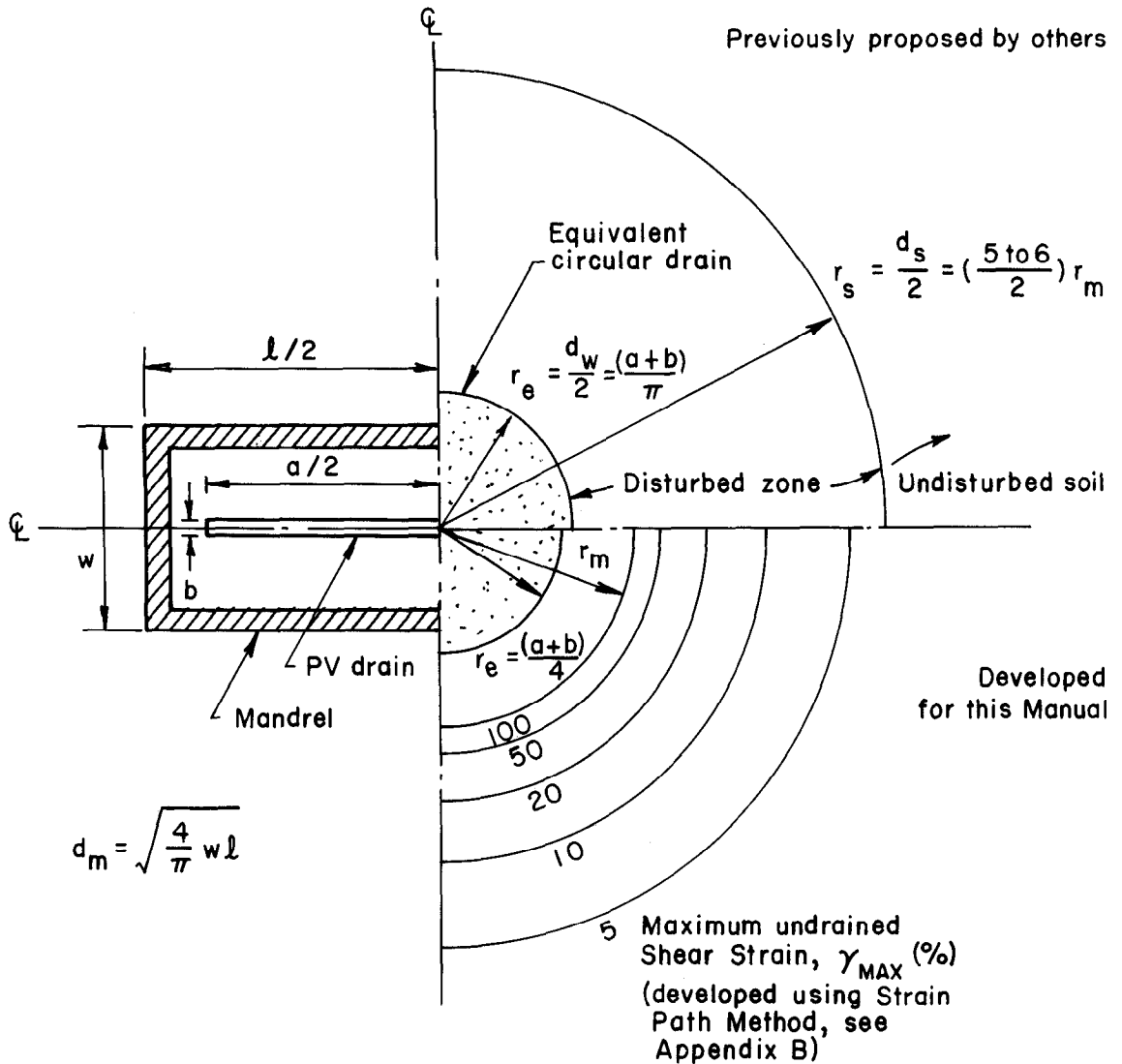
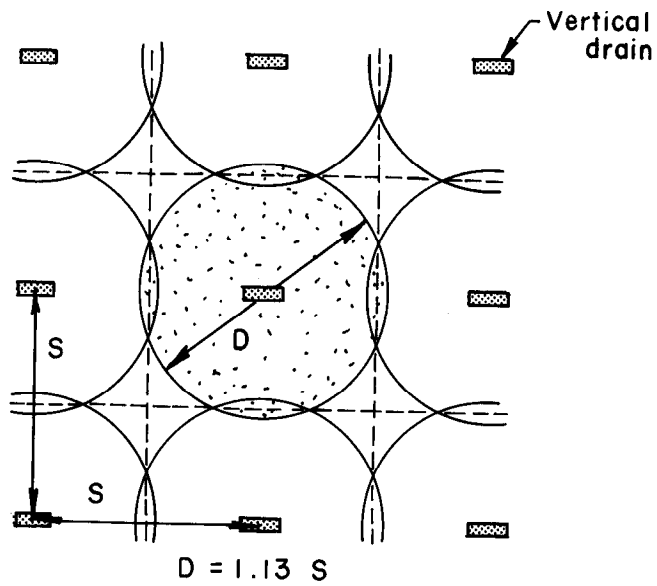

Figure 14 Approximation of the disturbed zone around the mandrel.

Pattern	D as a function of S*	
Square	$D = 1.13S$	(Eq. 16)
Triangular	$D = 1.05S$	(Eq. 17)

A square pattern may be easier to lay out and control in the field, particularly for sites where surveying is difficult. A triangular pattern is usually preferred, however since it provides more uniform consolidation between drains than does an equivalent square pattern.

\* For constant site plan area per drain.



SQUARE PATTERN

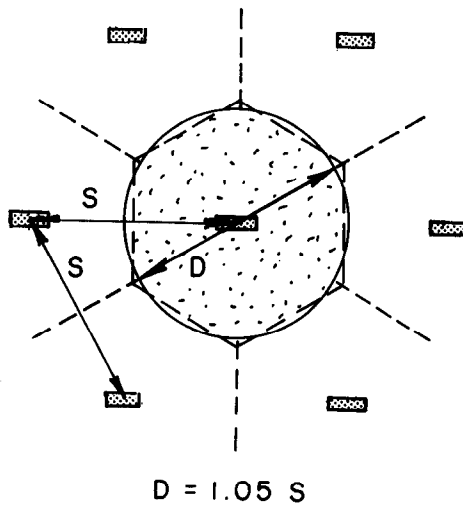

TRIANGULAR PATTERN

Note: Plan area per drain is  $\pi D^2/4$  for both patterns

Figure 15 Relationship of drain spacing (S) to drain influence zone (D).

## DRAIN DESIGN AND SELECTION

### 1. Objectives

The principal objective of a PV drain design is to select the type, spacing, and length of a PV drain to accomplish a required degree of consolidation within a specified time. The PV drain design is one step in the iterative process of developing a cost-effective precompression scheme. The design guidelines recommended in this manual address only those issues pertaining to the design of the PV drain system. The example given in Appendix C illustrates how the PV drain design fits into the framework of the precompression scheme.

PV drain design procedures have evolved from procedures used successfully in the design of sand drains. However, in some cases sand drain installations may have been designed with conservatism due to the inability of the design methods and previous experience to reasonably account for the uncertainties of variables like installation effects and limited drain discharge. Extending the same design methods to PV drains, without a more thorough study of the underlying mechanisms, would perpetuate similar design uncertainties.

Traditionally, drain disturbance effects have been accounted for by using "effective" values of  $c_h$  which were intended to represent a weighted average of the disturbed and undisturbed zones. With this approach, "effective"  $c_h$  would vary with drain diameter, drain type (displacement, nondisplacement) and spacing. This approach introduces complications to the determination of  $c_h$  and the evaluation of disturbance effects. Effects of discharge capacity were usually ignored. This may or may not be a reasonable assumption, since  $q_w$  for a typical 12 in (30 cm) sand drain could be less than 3500 ft<sup>3</sup>/yr (100 m<sup>3</sup>/yr) and center-to-center drain spacing often exceeded  $\delta$  ft (2 m).

With the increasing number of projects using vertical drains and the development and popularity of PV drains with relatively small equivalent diameters, the importance of more rational methods to evaluate  $c_h$ , discharge capacity and disturbance becomes apparent. Procedures are given herein which represent current typical practice for designing PV drains. The design engineer should evaluate the applicability of the procedures for any given project.

Assessing the need for vertical drains is the first step on projects where precompression is determined to be a viable approach to improving the foundation soils. One of the most important factors in the assessment is the stress history of the soil. For example, if the soil has been precompressed so that the soil will still be over-consolidated after consolidating under the preload, PV drains are probably not required.



Another approach involves calculation of the final effective stress at the end of time available for preloading for the case without vertical drains. If dissipation of the remaining positive excess pore pressure would result in a calculated settlement exceeding the tolerable value, then either the use of drains and/or greater surcharge is required.

On some projects it is necessary to accelerate the rate of soil shear strength increase, by accelerating the rate of increase in effective stress. The need for drains in this case can be assessed by comparing the time to achieve the stress increase without drains to the available time. If the necessary time is greater than the available time, drains are likely required.

Economic comparisons between amount of surcharge versus quantity (spacing and length) of PV drains should also be made prior to selection of final drain design. The design example (Appendix C) illustrates a procedure for maximizing the efficiency of the surcharge/PV drain design.

## 2. Selection of PV Drain Type

Selection of a PV drain type(s) for a specific project should be an objective process including experience on similar projects, review of pertinent case histories, and an evaluation of different properties of the candidate drains. The primary concerns in the selection of type of PV drain for a particular project include:

- Equivalent diameter
- Discharge capacity
- Jacket filter characteristics and permeability
- Material strength, flexibility and durability

Each of these factors is discussed in the following sections and criteria for their evaluation are given.

### a. Equivalent diameter, $d_w$

Equivalent diameter should be calculated using Equation 9A. For common PV drains,  $d_w$  ranges from 2 to 3 in (50 to 75 mm). In general, it is probably inappropriate to use a drain with an equivalent diameter of less than 2 in (50 mm).

### b. Discharge capacity, $q_w$

Discharge capacity is seldom an important consideration for PV drains. However,  $q_w$  should be known for the selected drain and its effect should be checked using procedures given

in Section 4 of DESIGN CONSIDERATIONS. Typical values of  $q_w$  are given in Figure 12. In general, the selected drain should have a vertical discharge capacity of at least 3500 ft<sup>3</sup>/yr (100 m<sup>3</sup>/yr) measured under a gradient of one while confined by the maximum in-situ effective horizontal stress.

c. Jacket filter characteristics

The PV drain jacket is exposed to groundwater and remolded soil at the completion of drain installation. Therefore, at least initially the jacket serves as a "filter" when the preloading increases pore pressures and the pore water seeps horizontally into the drain core. The potential exists for the jacket to cake or clog due to the mobility of fines in the remolded soil. The caking and clogging of PV jackets is a topic of recent research<sup>(28)</sup>. To date the available results of such research are not conclusive with regard to the mechanism of clogging. However, design criteria which can be applied in general to PV drains are presented by Christopher and Holtz<sup>(6)</sup>.

d. Jacket permeability

The jacket permeability can retard consolidation if it is not equal to or greater than the permeability of the surrounding soil. Most currently available PV drains have greater jacket permeability than required to pass water into the drain. Some drains may have jackets with a permeability so high that they are not effective in preventing fines from passing into the core. For most soil types, the jacket filter characteristics are presently considered to be more important than permeability.

In order to determine the permeability of PV jackets or any other geotextile, it is necessary to estimate the fabric thickness which is a function of confining pressure. This is very difficult and represents a major drawback to using permeability. It may be better to compare geotextiles using permittivity, which is defined as the volumetric flow rate per unit area under a given hydraulic head.

e. Material strength, flexibility and durability

The stress-strain characteristics of the jacket and core should be compatible. The drain (core or jacket) must not break when subjected to handling and installation stresses, which are typically higher than the in-situ stresses (if subgrade stability is not an issue). A relatively high rupture strain is more important than very high tensile strength.

It is generally considered preferable that the core be free to slip within the jacket to reduce the possible adverse effects of crimping during consolidation.

Durability of synthetic woven or non-woven geotextile jackets throughout the consolidation period is usually not a concern for cases of non-polluted groundwater. If groundwater is suspected to contain solvents or other chemical contamination, the possible effects on drain integrity should be checked. Deterioration, microbial degradation and very low wet strength are concerns with paper jackets. For this reason, PV drains having synthetic jackets should be used.

The selected PV drain should have characteristics such that the system will achieve the desired consolidation within the specified time. Individual drain characteristics may represent tradeoffs, and no single characteristic may be sufficient to disqualify its use. For example, a given drain may have relatively low discharge capacity or jacket permeability, but may have sufficiently large equivalent diameter to offset adverse characteristics. Relative hydraulic properties of alternate drain types, if known, can be evaluated by use of the design equation. Other properties such as clogging potential or crimping are not explicitly accounted for in the current design equations.

There are numerous PV drains available for the design engineer to evaluate and select for a specific project. During the preparation of this manual, the U.S. representatives for various PV drain products were contacted and asked to submit detailed product information. The product information that was received for 10 PV drain distributors/manufacturers is summarized in Tables 7 and 8. The information provided in these tables is included in this manual for general reference. The design engineer should verify this information and obtain similar updated information prior to recommending or specifying a particular PV drain.

Photographs of 12 representative PV drain samples available at the time this manual was prepared are shown in Figure 16. These photographs are included to give the design engineer a perspective on the variety of band shaped PV drains available.

### 3. Other Design Considerations

Consideration should be given to other factors including the following:

- a. The practical minimum drain spacing is usually about 3 ft (1m) center to center. Disturbance effects may eliminate any theoretical benefit of significantly closer spacing.

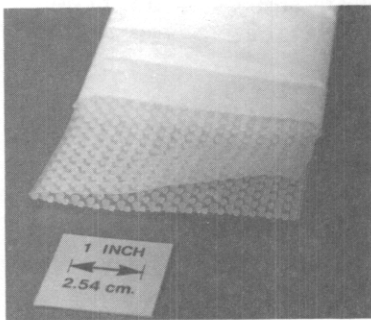

a. Alidrain

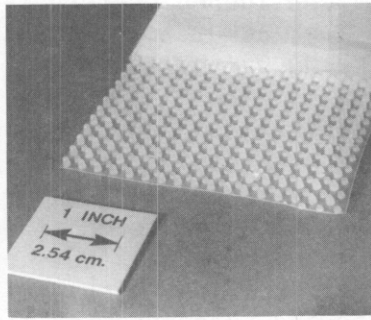

b. Alidrain S

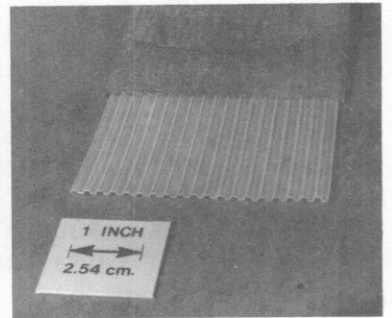

c. Amerdrain 307

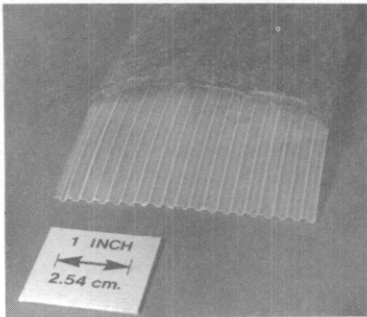

d. Amerdrain 407

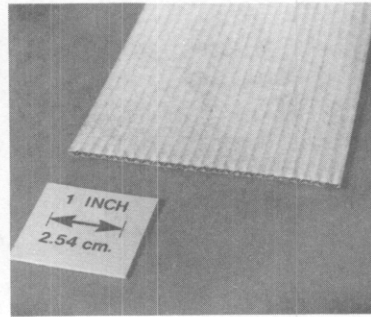

e. Bando

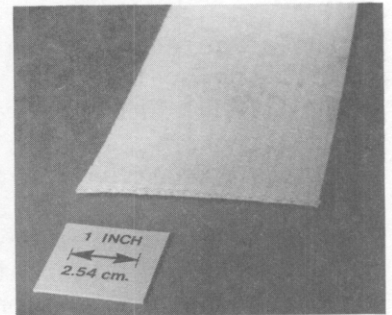

f. Castle Drain Board

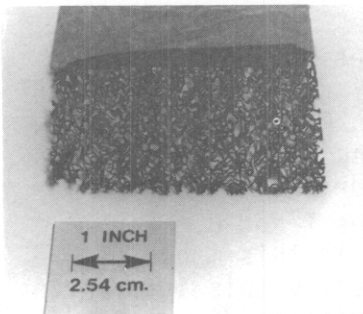

g. Colbond CX-1000

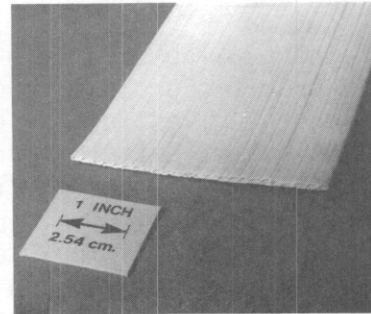

h. Desol

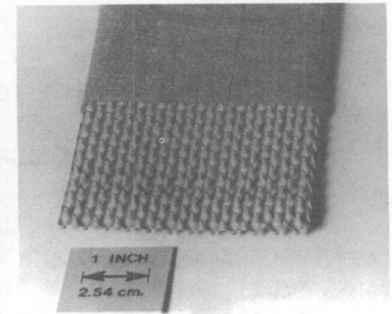

i. Hitek Flodrain

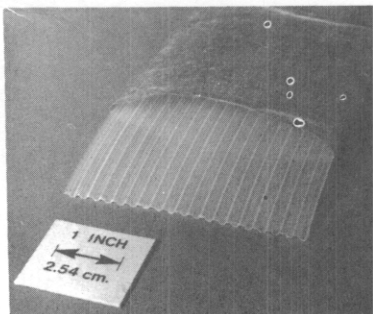

j. Mebradrain MD 7007

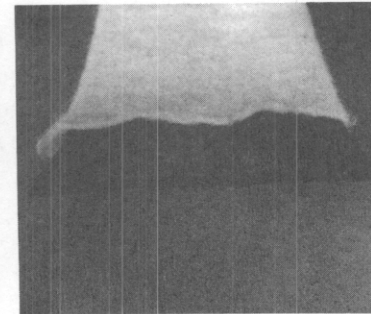

k. Sol Compact

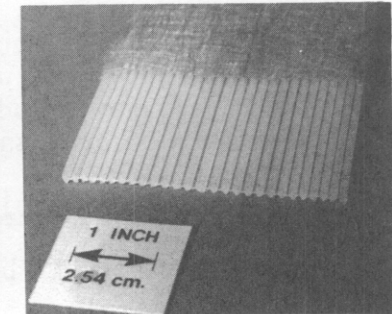

l. Vinyltex

Figure 16 Photographs of typical PV drain products.

- b. Drain length should be sufficient to consolidate the deposit or portions of the deposit to the extent necessary to achieve the design objectives. In some cases, it may not be necessary to fully penetrate the compressible stratum to achieve the necessary shear strength gain or amount of consolidation. Theoretical analyses of partial penetration have been developed<sup>(23)</sup>. Also, as drain length becomes very large (say greater than 80 ft (25m)), additional length may not improve the consolidation rate due to the effects of drain resistance.
- c. The cross-sectional area of the mandrel affects the volume of soil displaced by the mandrel during installation. The amount of soil displacement is intuitively a major factor in the resulting effects of soil disturbance. Typically the cross-sectional area of the mandrel is less than 10 in<sup>2</sup> (65 cm<sup>2</sup>).
- d. Drain installation disturbs the soil and may reduce the shear strength of the deposit. Where overall stability is a problem, effects of disturbance on overall stability should be evaluated. Shear strength can be adversely affected by the soil remolding and excess pore pressures caused by insertion of the mandrel. Vibratory installation may cause a greater increase in pore pressures than static pushing; however, the available information is inconclusive regarding the possible detrimental effects of vibratory installation.
- e. Drain layout is typically a triangular or square pattern, with center to center spacings of 3 to 9 ft (1 to 3m).
- f. Sites having more than one compressible stratum can be analyzed by treating each layer independently if drain discharge capacity does not retard consolidation.
- g. Evaluation of soil properties is the most difficult step in drain designs. The evaluation should include:
- stress history -
    - effective stress profile ( $\bar{\sigma}_{v0}$ );
    - maximum past pressure profile ( $\bar{\sigma}_{vm}$ ).
  - compressibility of soil (RR, CR,  $C_\alpha$ ).
  - coefficient of consolidation ( $c_v$  and  $c_h$ ) -
    - evaluated at maximum effective stress.
  - drainage boundaries -
    - top, bottom and intermediate drainage layers.

Table 7 Summary of general product information provided by distributors/manufacturers.

PV Drain	Width, a (mm)	Thickness, b (mm)	Weight (g/m)	Free Surface (mm <sup>2</sup> )	Free Volume (mm <sup>3</sup> /mm)
Alidrain	100	7	160	180	470
Alidrain S	100	4	90	100	260
Amerdrain 307	100	3	93	200	250
Amerdrain 407	100	3	93	200	250
Bando	(96)	(2.9)	(70)	-	(150)
Castle Drain Board	96±2	2.6	90	-	(108)
Colbond CX-1000	100	3.5	90	-	(152)
Desol	95	2	50	77*	146*
Hitek Flodrain	100	8	90	200	500
Mebradrain MD7007	100	3	92	200	180
Sol Compact	100*	5*	98*	-	-
Vinylex	95	4	93	137	-
Range	95-100	2-7	50-160	77-200	108-470
Median	100	3	92	190	215

Notes:

- (1) Information given was provided by the manufacturer/distributor unless designated by ( ) indicating it was supplied by others and verified by measurement or \* indicating it was determined using information supplied by the distributor/manufacturer.
- (2) Free surface is defined as the distance around the drain perimeter that is not obstructed to flow by the core structure.
- (3) Free volume is defined as the total cross sectional area of the drain minus the cross sectional area of the core (i.e., the open cross sectional area of the drain).
- (4) This information is provided for general information purposes only. Designers should verify the actual properties of any given PV drain.

Table 8 Summary of jacket and core information provided by distributors/manufacturers.

PV Drain	Core/Jacket Connection	Jacket				Core	
		Polymer**	Trade Name	Weight (oz.)	Permeability ( $\times 10^{-4}$ cm/sec)	Polymer**	Geometry
Alidrain	none	P	Chicopee	3.5	3	PE	studded both sides
Alidrain S	none	P	Chicopee	3.5	3	PE	studded one side
Amerdrain 307	none	PP	DuPont Typar	3	300	PP	channels
Amerdrain 407	none	PP	DuPont Typar	4	200	PP	channels
Bando	bonded	*	*	*	*	*	channels
Castle Drain Board	bonded	R	*	*	200	PO	channels
Colbond CX-1000	none	P	Colbond	5.8	1,000	P	filaments
Desol	-	-	No Jacket		-	PO	channels
Hitek Flodrain	none	PP	DuPont Typar	4	200	PE	dimpled
Mebradrain MD7007	none	PP	DuPont Typar	4	500	PP	channels
Sol Compact	none	*	DuPont Typar or Bidim	*	*	*	channels
Vinylex	none	PP	DuPont Typar	4	200	PE	continuous ribs

\* Information not provided by U.S. distributor.

\*\* P - polyester; PE - polyethylene; PO - polyolefin; PP - polypropylene; R - Rayon.

Notes:

- (1) Information shown was provided by the product manufacturer/distributor and is provided for general information purposes only. Designers should verify the actual properties of any given PV drain.
- (2) Permeability test method generally not specified.

- shear strength profile
    - initial in-situ profile;
    - estimated strength gain with consolidation.
  - settlement/stability analysis.
- n. Drain effectiveness can be affected by increasing horizontal confining stress. Figure 17 illustrates that increased confining stress can be a result of increased depth below the ground surface and increased preload or surcharge. The engineer should be aware of potential changes in the performance properties of the PV drain as a result of the horizontal confining pressure. Also, the drain discharge capacity will tend to decrease with time due the possible effects of creep. These effects are partially offset by the fact that the volume flow through the drain is highest during the initial stages of consolidation and the fact that the discharge capacity of most PV drains currently available is in excess of the recommended minimum of 3500 ft<sup>3</sup>/yr (100 m<sup>3</sup>/yr).

#### 4. Drain Spacing and Length

The drain spacing and length are determined using the basic design approach given in Section 3 of DESIGN CONSIDERATIONS. The effort level applied to the various investigations and design steps must be decided on a project by project basis.

For "simple" projects (Category A as described above; simple, small in size, non-sensitive soil, drain length less than about 60 ft (18 m)), the following is suggested:

- Neglect effects of discharge capacity and disturbance, but specify  $q_w \geq 3500 \text{ ft}^3/\text{yr}$  (100 m<sup>3</sup>/yr) at the maximum effective horizontal stress.
- Assume  $c_h = c_v$  obtained from good quality conventional laboratory consolidation tests at maximum effective stress level.
- Design the PV drain system using the ideal case equation (Equation 8).
- If time is critical, reduce drain spacing  $S$  to compensate for uncertainty.

In this case, a reasonable (possibly conservative) design will likely result since using  $c_h = c_v$  will usually be sufficiently conservative to offset disturbance effects. Costs for subsurface investigations, laboratory testing and PV drain design should be



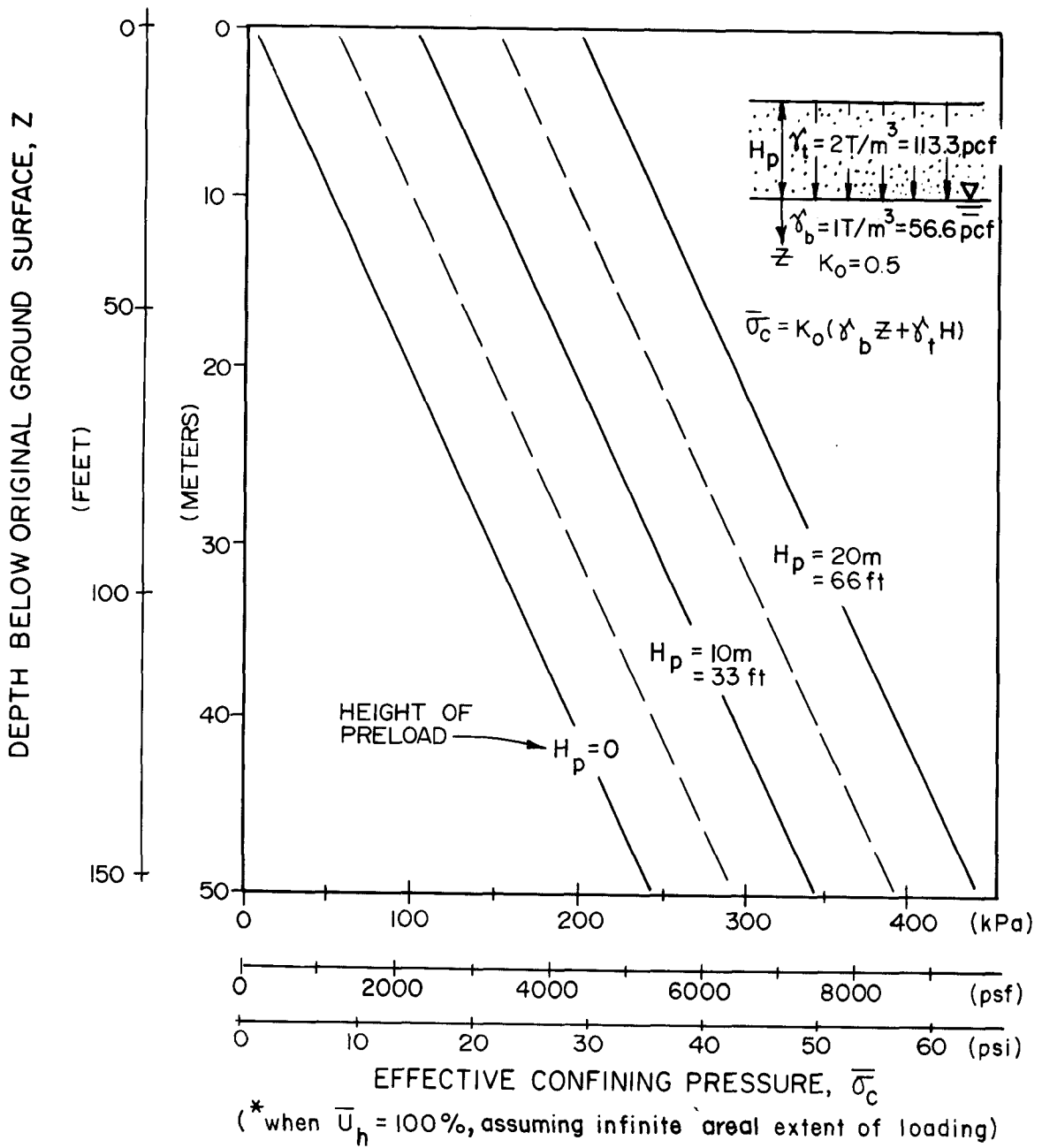

Figure 17 Effective confining pressure on a PV drain.

reasonable compared with the overall project cost. The expense of added engineering effort will probably not result in a significant reduction in overall drain system costs.

For "intermediate" projects (Category B as described above; time very important, conservative design not sufficient), the following is suggested:

- Determine  $c_{\bar{n}}$  using methods described in Table 6, piezometer probe pore pressure decay curves which requires consideration of the over consolidation ratio, or by adjusting  $c_v$  (lab) to obtain  $c_{\bar{n}}$  according to the ratio of horizontal to vertical permeability by:

$$c_{\bar{n}} = c_v(k_h/k_v) \quad (\text{Eq. 13})$$

- Determine  $k_h/k_v$  by one or more of following methods:
  - a. Published  $k_h/k_v$  values such as given in Table 5.
  - b. Measure  $k_v$  and  $k_h$  in lab in oriented k-tests, k-tests in triaxial cell or consolidation tests.
  - c. Measure  $k_v$  and  $k_h$  using in-situ permeability test recognizing the required assumptions regarding boundary and flow conditions.
- Include consideration of possible effects of disturbance and drain resistance using the general design equation (Equation 4).
  - a. Estimate the extent of the disturbed zone using Equation 15, and therefore, obtain an estimate of  $d_s/d_w$ .
  - b. Estimate  $k_h/k_s$  which is influenced by the initial permeability anisotropy and varies with the level of soil disturbance (i.e., radial distance from the mandrel). See Reference 8 for guidance.
  - c. Evaluate the discharge capacity of the drain using available manufacturer's literature and published research test results.

For "major/complex" projects (Category C as described above; critical to have state-of-the-art prediction of time-rate of consolidation, drains more than about 60 feet long, large quantities of drains), the following is suggested:

- Use sophisticated in-situ and/or laboratory testing procedures to obtain best estimates of  $c_h$  and  $k_h$  (see Section 2 above).
- Estimate the  $d_s$  and  $k_s$  parameters using the procedures given under Category B.
- Consider use of trial embankment to observe actual performance. On major projects, properly-instrumented trial embankments are often appropriate to check design assumptions and/or permit revisions to the design prior to production installation of the drains.
- Obtain consultation from a geotechnical engineer who is experienced in the evaluation of soil and system parameters for PV drain design.
- Include consideration of effects of soil disturbance and drain resistance using the general design equation (Equation 4) and consideration of the discussion in Appendix B.

In addition to determining the required drain spacing and length, the design engineer must also determine the required areal limits of the PV drains. The drains should penetrate any compressible soils where accelerated consolidation is necessary to accomplish the design objectives. Depending on the purpose of the desired consolidation (e.g., reduced post construction settlement or increased stability due to shear strength gain), the areal limits of the drains may extend beyond the plan area of the embankment or other structure.

## 5. Drainage Blankets

The water seeping from the drains should be discharged out from beneath the preload or surcharge area. In most cases this is accomplished using a drainage blanket constructed between the subgrade and the fill. If the surficial subgrade material is granular and permeable, a drainage blanket may be of little or no benefit. However, elimination of the drainage blanket should be considered very carefully because it may have a severe impact on the efficiency of the drain system.

When designing the drainage blanket, the design engineer should consider head losses which may occur in blankets or drainage mats which collect the water from the drains and discharge it to the side of fills. Therefore, for PV drains to produce maximum benefits, all of the water seeping out of the drain should be discharged by the outlet blankets or outlet drains, without excessive head losses.

Cedergren<sup>(4)</sup> discusses an idealized drainage system as illustrated in Figure 18. The total head required to conduct the escaping water is:

$$h = (q_d y^2) / (2kAb') \quad (\text{Eq. 18})$$

where

$h$  = total head required to conduct water from centerline to point  $y$ .

$y$  = distance from the centerline to a given point

$k$  = coefficient of permeability of the drainage blanket

$A$  = cross-sectional area of blanket removing the discharge of one row of drains ( $A = b' \times$  blanket thickness)

$b'$  = the distance between drains

$q_d$  = rate of discharge from a single drain

Total head loss in the drainage blanket is:

$$h_b = (q_d b' N^2) / (2kA) \quad (\text{Eq. 19})$$

where

$N$  = number of drains on one side of the centerline

The total head loss in the blanket ( $h_b$ ) can be used to evaluate the suitability of the proposed drainage blanket design and to evaluate the merits of alternative designs. The use of pipe drains to increase the drainage capacity of the blanket is fairly common.

## 6. Design Procedure

The PV drain system design parameters are as follows:

### Given or Selected Design Criteria

$\bar{U}$  Average degree of consolidation due to simultaneous vertical and horizontal drainage

$t$  Available time to achieve  $\bar{U}$

### Soil Parameters Required

$P_{vm}$  Maximum effective stress to which the soil deposit has been previously consolidated (maximum past pressure), evaluated over the entire thickness of the layer

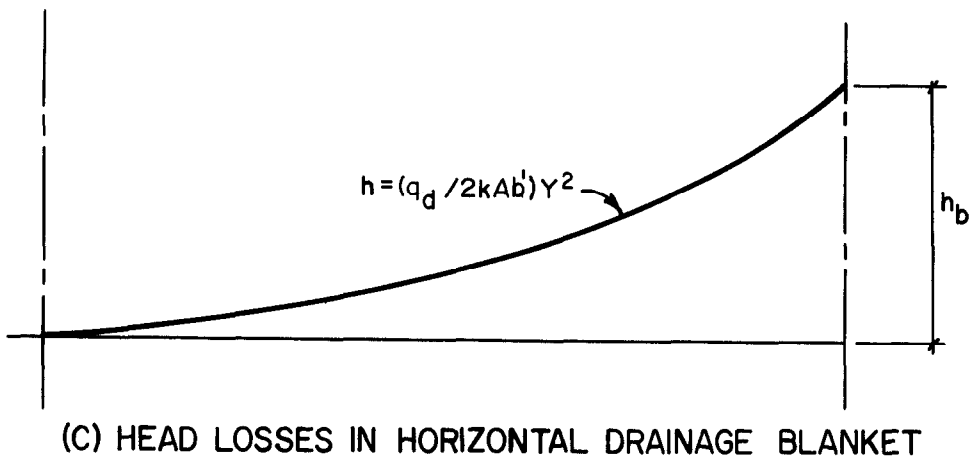
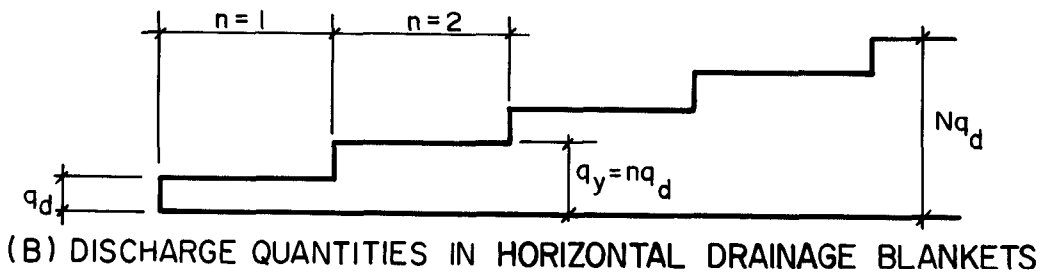
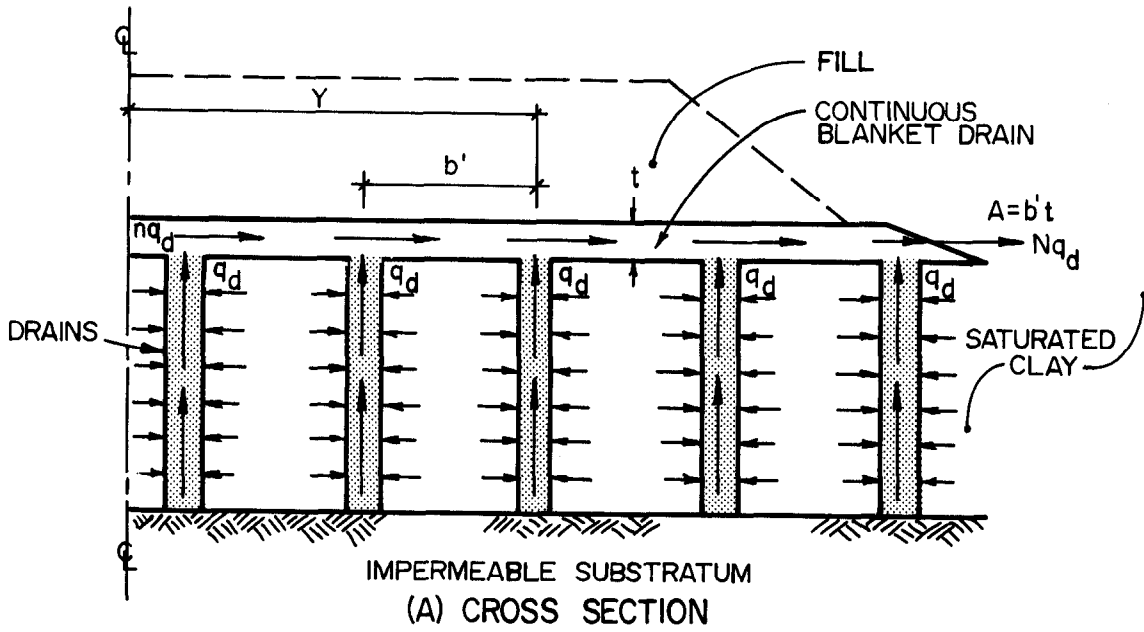

Figure 18 Horizontal drainage blankets.

$c_h, c_v$	Coefficient of consolidation for radial and vertical drainage for undisturbed soil
$k_h/k_s$	Ratio of coefficient of horizontal permeability in the horizontal direction for undisturbed soil to that for disturbed soil
$RR, CR, C_\alpha$	Recompression ratio, virgin compression ratio, coefficient of secondary compression
$H_d$	Length of longest drainage path; (thickness of compressible layer when one way drainage; half thickness of compressible layer when two way drainage)
$\bar{\sigma}_{v0},$ $\bar{\sigma}_{vf}$	Initial and final effective stress profiles

#### System Parameters Required

$d_w, q_w$	Equivalent diameter and discharge capacity for the selected PV drain
$D$	Diameter of the cylinder drained by a single PV drain
$d_s$	Diameter of disturbed zone of soil caused by drain installation
$L$	Length of single drain
$S$	Center to center spacing of PV drains where: $S = D/1.05$ for triangular pattern $S = D/1.13$ for square pattern
$k_h/q_w$	Ratio of coefficient of horizontal permeability for undisturbed soil to discharge capacity of the drain.

The general design approach (to determine  $S$  and  $L$ ) consists of:

1. Select a PV drain type and installation procedure considering the site conditions, project objectives and criteria contained in EVALUATION OF DESIGN PARAMETERS and DRAIN SELECTION AND DESIGN.
2. Determine the required soil parameters using an appropriate combination of in-situ and laboratory investigations and testing.

3. Estimate  $d_s$  based on probable installation procedures, soil type and other considerations discussed in EVALUATION OF DESIGN PARAMETERS.
4. Select a trial drain length based on load configuration, layer thickness and consolidation requirements. In most cases, L is selected to fully penetrate the consolidating stratum.
5. Calculate required  $\bar{U}_h$  knowing  $\bar{U}_v$  and  $\bar{U}$  using Eq. (1).
6. Select a trial value of D and calculate t using Eq. (2).
7. Compare calculated time to available time. If the calculated time exceeds that which is available, adjust D. Iterate until calculated time is less than or equal to available time.
8. Evaluate appropriateness of trial L (particularly if drains only partially penetrate the consolidating layer).
9. Incorporate the resulting drain design and cost into the overall evaluation of the preload/surcharge scheme.

(The above design approach should normally be conducted in two phases. Steps 1 through 4 in particular require considerable judgement and understanding of soil mechanics, and should be performed by an experienced geotechnical engineer).

## 7. Design Example

A design example is given in Appendix C to illustrate the use of the design equations in BACKGROUND and the design considerations in EVALUATION OF DESIGN PARAMETERS.

## 8. Specifications

The design engineer should consider the preparation of PV drain specifications to be part of the PV drain design process. Preparation of PV drain specifications requires careful consideration of the site soil properties, the requirements for an acceptable PV drain product and design, and the probable effects of the installation process.

A typical PV drain specification could include the following major components:

- 1.0 Description
- 2.0 Definitions

- 3.0 Materials
  - 3.1 General
  - 3.2 Jacket
  - 3.3 Core
  - 3.4 Assembled Drain
  - 3.5 Quality Control
- 4.0 Installation Equipment
- 5.0 Installation Procedures
- 6.0 Measurement of Quantities
- 7.0 Basis of Payment

The extent to which each of the major categories is detailed will depend on several factors including:

- the size of the project
- the degree of design sophistication
- the sensitivity of the soil parameters to installation effects
- the specified PV drain(s) (if any)

A "generic" (product independent) specification is given in Appendix D as a guide to preparation of PV drain specifications for projects. This specification is very detailed and includes requirements for parameters, such as discharge capacity, which are currently being researched. Where appropriate, commentary is included in the specification to provide guidance in its use.

The design engineer should exercise prudent judgement regarding the level of detail required in the specifications. For example, small or relatively straight forward projects (i.e., Category A as defined in Section 1 of EVALUATION OF DESIGN PARAMETERS) would not merit the level of detail included in the generic specifications in Appendix D.



## INSTALLATION

### 1. Introduction

The major steps in PV drain installation include site preparation, construction of a drainage blanket and/or working mat, and drain installation. Procedures vary with the site conditions, the particular contractor installing the drains, the installation equipment and in some cases with the type of PV drain being installed. It is important for the design engineer to anticipate procedures and installation or site conditions that might adversely affect the performance of the drain. This section presents a qualitative discussion of installation aspects that impact drain performance.

For discussion purposes the installation aspects have been grouped in the major areas of site preparation including drainage blanket construction, drain installation and contractor selection.

### 2. Site Preparation

Prior to PV drain installation, it is usually necessary to perform at least some general site work. Depending on the site conditions, the necessary site work may include the following:

- a. Excavation: Removing that vegetation, surficial debris, dense soil, soil containing cobbles, or other material (frozen soil, construction rubble, etc.) which would impede the installation of the PV drains.
- b. Site Grading: Establishing and maintaining a reasonably level site grade to aid proper installation of PV drains and as may be necessary for the drainage blanket to function as designed. Ground that slopes as little as 2 to 5 percent can present some installation difficulties. Most installation equipment used in PV drain installation cannot compensate for a more steeply sloping surface without loss of production efficiency. The relative cost of regrading should be compared to the potential cost of reduced production efficiency.
- c. Construct a Working Mat and Drainage Blanket: Depending on the site conditions and the type of installation equipment, it may be necessary to construct a working mat to support the construction traffic and installation rig loads. In most cases the working mat can later serve as the drainage blanket or the drainage blanket can be incorporated into the working mat. If the drainage layer is installed prior to the drains or as part of the working mat, the drainage layer must be protected from freezing and contamination.

It may be important to minimize the disturbance of near-surface soils due to the operation of construction equipment. If the surficial soils are excessively disturbed, the PV drains may be displaced or damaged at the surface, resulting in inadequate connection with the drainage blanket. Continuity between the drains and drainage blanket should be considered in the design of the working mat and/or drainage blanket.

### 3. Installation Equipment

Although there are numerous variations in installation equipment most of the equipment has fairly common features, some of which can directly influence PV drain performance. A typical band-shaped drain installation rig is shown in Figure 13. The installation rigs are usually track mounted boom cranes, or rubber-tired rigs for smaller projects.

Aspects of the installation equipment that the design engineer should consider include the following:

- Mandrel: The mandrel protects the PV drain during installation and creates the space for the drain by displacing soil during penetration. The displacement of soil results in remolding which is usually detrimental to radial consolidation.

The cross sectional area of many mandrels is about 10 in<sup>2</sup> (65 cm<sup>2</sup>) although the area may range from 5 to more than 20 in<sup>2</sup> (32 to 129 cm<sup>2</sup>). The desire to reduce the area of the mandrel and the resulting displacement must be balanced by the need to have a stiff mandrel to permit penetration through dense soils and to maintain vertical alignment.

The shape of the mandrel is typically rectangular or rhombic. The effect of shape on the amount of disturbance resulting from mandrel penetration is not yet known.

- Penetration Method: The mandrel is penetrated into the compressible soils using either static or vibratory force. The static force is applied using the weight of the mandrel in combination with a dead weight at the top of the mandrel or the weight of the installation rig. Vibration is applied using large construction type vibrators similar to those used to install piles or sheet-piling.

The penetration force required is typically estimated by the contractor based on his experience with similar penetration depths in similar soils. The design engineer should consider the magnitude of the force as being secondary to the decision

of whether static and/or vibratory penetration should be specified.

The use of vibratory force should be carefully considered if detrimental property changes (reduced permeability or increased remolding) are anticipated as a result of vibration. Possibly susceptible soils may include sensitive soils and those with macrofabric (varves, sand/silt lenses, etc.). On a large and/or critical project a test section may be constructed using different penetration methods to evaluate the effects.

- Equipment Weight: If stability of the subgrade/working mat is in question, the design engineer may limit the overall weight or bearing pressure of the installation equipment in an attempt to limit possible construction problems. Determination of the maximum acceptable equipment weight and/or bearing pressure is difficult because the engineer does not want to be needlessly restrictive with respect to construction equipment. At the same time, the design engineer should be aware that instability may result from other factors, such as equipment traffic patterns, which are not normally specified in the contract documents.

#### 4. Installation Procedures

The locations of the PV drains may be predrilled to penetrate obstructing materials (debris, frozen soil, soil with cobbles, or very dense soil). Predrilling techniques include the use of jetting, augers, or a hydraulic hammer.

The typical installation sequence (shown in Figure 19) is as follows:

- The installation rig is positioned with the mandrel above a drain location.
- An anchor is placed on the end of the PV drain (Figure 19a).
- The mandrel is penetrated into the ground to the desired depth (Figure 19b).
- The mandrel is withdrawn.
- The drain material is cut above the drainage blanket or above the working mat leaving extra length for the drainage blanket (Figure 19c).

Regardless of the site preparation and installation equipment, there are installation procedures that can influence drain performance. A discussion of some of these procedures and the possible ramifications follows:

- Rate of Mandrel Advance: The rate of mandrel advance should be controlled to avoid significant bending or deflection from vertical. Penetration should be uninterrupted and typical rates are approximately 0.5 to 2 feet per second (0.15 to 0.60 m/sec).
- Splicing: At the end of a roll of drain material it is common practice to splice the remainder to a new roll to save on material wastage. Splicing is not necessarily objectionable if the splice is made properly. Preferably the splice should be made prior to initiation of mandrel penetration so that the penetration is not interrupted to make a splice.

Typical splicing procedures are shown in Figure 20. The primary requirement in splicing is that the integrity of the drain, both in strength and hydraulic properties, be maintained. The core and jacket should be spliced by overlapping about 6 inches. With nonbonded drains, the core sections should be in direct contact when the splice is completed.

- Verticality: Proper performance of the PV drain system with respect to the assumptions of the design equation is dependent on the drains being vertically installed. Deviation from vertical may result in nonuniform settlement magnitude and rate due to drain spacing variations with depth. The drains should be installed with a straight mandrel deviating a maximum of about 0.2 ft (0.06m) from vertical over 10 ft (3m) of length.
- Anchor: It is common practice to use an anchor at the bottom tip of the PV drain. The anchor may be a piece of rebar or pipe, or a specially made plate. The relative size, shape, and stiffness of the anchor compared to the mandrel will impact the amount of disturbance around the mandrel. The anchor should be configured so as to represent the smallest cross section consistent with the needs and/or difficulty of anchoring. Ideally the anchor should be sized to be slightly larger than the mandrel, but small enough that it does not contribute needlessly to soil disturbance.

## 5. Contractor Interaction

Contracts for PV drains usually provide the use of several alternative drain products installed by a specialty contractor. Since many of the drains are proprietary products, each alternative drain may be installed by a different specialty subcontractor.

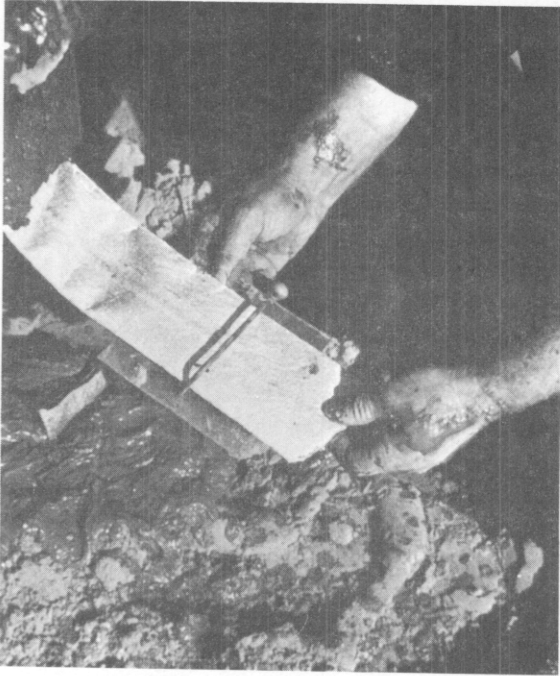

a. Placing the anchor on the drain

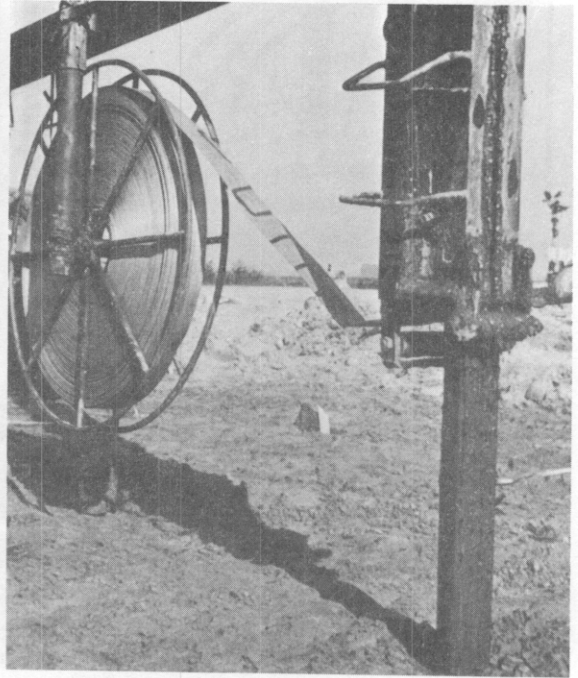

b. Inserting the mandrel into the ground



c. Cutting the drain after withdrawing the mandrel

Figure 19

Typical PV drain installation procedure (photographs provided by Geotechnics Holland, BV).

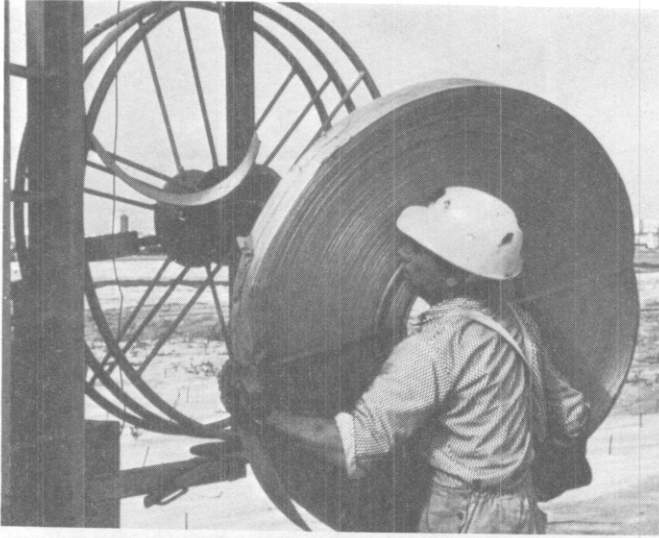

a. Placing the new roll on the drain roller

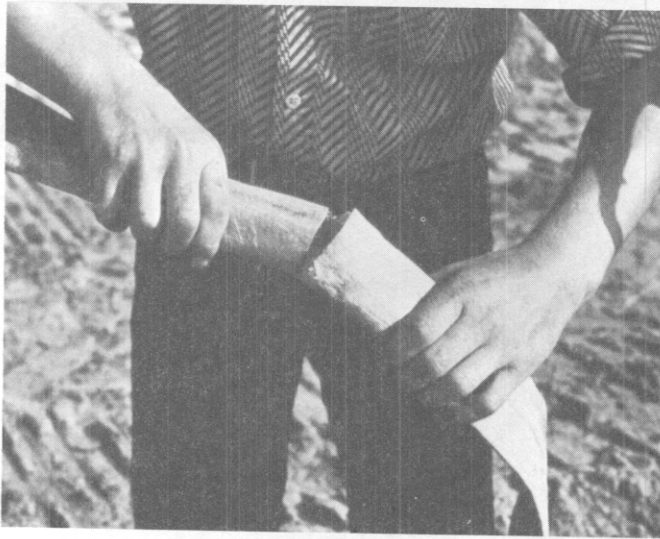

b. Inserting the drain core within the jacket to maintain continuity

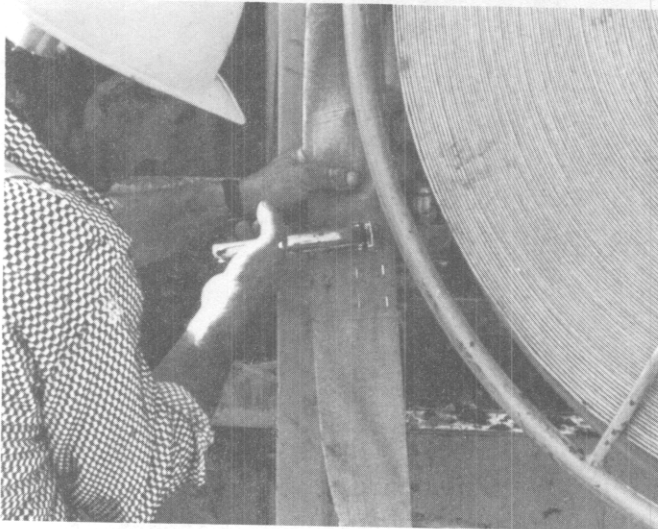

c. Stapling the drain splice

Figure 20 Typical PV drain splicing procedure (photographs provided by Geotechnics Holland, BV).

Usually a general highway construction contract is bid and the potential general contractors will request bids or negotiate with several PV drain specialty subcontractors. This system results in a competitive environment both for price and for substitution of alternative PV drain products.

The design engineer should:

- Thoroughly research alternate, available PV drain products during the design phase.
- Select the acceptable alternative drain types after careful consideration.
- Educate the general contractors regarding the need for quality workmanship and/or previous experience for those installing the drains.
- Consider using specialty contractors with proven, documented experience in PV drain installation where drain installation is critical.

Depending on the complexity of the PV drain project, the design engineer should also consider the following procedures:

- Prequalification of PV drain contractors: Since PV drain installation is typically performed by specialty contractors with experience, prequalification is not usually necessary. However, on a complex project where the drain performance is critical or in cases where the drains are to be installed by the general contractor, the design engineer should consider requiring prequalification of the PV drain contractor to avoid problems with a less experienced contractor.
- Prebid meeting: Most large projects have prebid meetings to discuss project details and to answer questions prior to bidding. Prebid meetings are recommended on projects involving PV drains because a prebid meeting is the appropriate time for the design engineer to state the criteria that will be used to evaluate any alternative drain products if, in fact, alternates will be accepted.
- Preconstruction meeting: A preconstruction meeting is recommended on PV drain projects so that the design engineer, general contractor and PV drain subcontractor can discuss details of the test drains (if any) and production drain installation process prior to mobilizing equipment and materials to the site.

## CONSTRUCTION MONITORING

### 1. Introduction

For PV drains to perform as designed, the drains must be installed in accordance with the contract drawings and specifications. It is important that field monitoring personnel know the correct installation procedures and the possible ramifications of deviations from those procedures. This section presents a discussion of construction monitoring procedures that should be considered for any PV drain project.

### 2. Familiarity with Design

The construction monitoring personnel should be thoroughly familiar with the contract drawings, specifications, and any appropriate addenda. This familiarity should extend beyond the PV drain specifics to include site preparation, geotechnical instrumentation, fill placement, and any other contract items that influence or are influenced by the drains.

In addition to knowing the requirements of the contract drawings and specifications, the field personnel should be aware of the design intent and the possible implications if the field procedures deviate from design. In order to provide continuity of design intent, the design engineer should remain personally involved during the PV drain system construction and subsequent monitoring.

### 3. Site Preparation

Site preparation including any excavation and regrading, can influence drain performance in several ways. The field personnel should observe the following:

- a. The site should be graded to comply with the grades shown on the contract drawings. The ground surface may be graded to be level or pitched depending on the site and/ or the desired drainage conditions. If the ground surface is improperly graded, the drainage blanket may not perform adequately.
- b. The soil conditions exposed during site work should be observed to determine whether they are consistent with the conditions encountered in test borings or test pits and assumed in design. Field observations should be discussed with the design engineer.



- c. The field survey procedure for staking the drain locations should be monitored. Although it is typically the contractor's responsibility to properly position the drains, the field personnel should verify that a proper control point is used and that the staked locations agree with the contract drawings. In critical cases this may require a check survey to be performed by the engineer.
- d. During the construction of a working mat or drainage blanket, the field monitoring personnel should be watching for any indicators of disturbance (pumping, heaving, lateral displacement, etc.) of the near-surface soils.
- e. Predrilling, if required, should be closely monitored to verify that the predrilling is performed carefully, to the required depth, to the correct diameter, and in a manner which does not cause excessive soil disturbance or blanket contamination. The field monitoring personnel should keep accurate and detailed records of the predrilling at each drain location (observations of cuttings and groundwater conditions, etc.).

#### 4. Drain Installation Equipment and Materials

The field monitoring personnel should determine whether or not the equipment and materials that the contractor proposes to use do in fact comply with the contract documents. Some of the important items to be checked include:

- a. Equipment
  - penetration method (static or vibratory)
  - mandrel size, shape, and stiffness
  - anchor size, shape, type
  - means to verify penetration depth
  - equipment weight
- b. Materials
  - drain name and model number
  - drain dimensions (width and thickness)
  - comparison with drain samples submitted with the contractor's bid
  - examples of proposed splice
  - anchor

## 5. Drain Installation

Installation of trial drains to evaluate the installation equipment and general procedures is recommended on most projects. The design engineer and field personnel should be present during trial drain installation. The same personnel (construction and monitoring) should observe both the trial drain and production drain installation.

Variations in installation procedures, particularly the adequacy of predrilling and penetration force and methods of handling possible obstructions, should be evaluated during the trial program. If the trial drains indicate that vibratory force is necessary, the trial program should be used to evaluate the minimum amount of vibration (intensity and depth) that is needed. Obstructions, if encountered, may be handled by predrilling or if the obstructions are isolated, by installing another drain at a slight offset to the obstructed location.

If the conditions vary from the design assumptions, the adequacy of the design may be affected. During drain installation, the field monitoring personnel should observe the procedures to evaluate conformance with contract specifications regarding horizontal location, mandrel stability and penetration rate, depth of installation, verticality, splicing and cutoff of the drains.

In addition to the factors discussed above, the field monitoring personnel should be aware of and observe other potential problems including:

- inaccuracy of the depth calibration on the rig.
- problems/short cuts with anchoring
- bowing or flexing of the mandrel
- integrity (tearing, ripping, etc.) of the drain product
- proper storage of drain materials before use (especially protection from sunlight and freezing temperatures).

### o. Drainage Blanket

The primary design purpose of the drainage blanket is to conduct the expelled water away from the drains. Also common is the use of the drainage blanket as a working mat. Field conditions and the construction activities may adversely affect the drainage blanket. Factors affecting the proper functioning of the drainage blanket include:

- infiltration of fine grained subsurface soils or other contaminating materials into the coarse grained blanket which can impede drainage.

- freezing of the top of the drains, and/or the blanket which can impede drainage.
- large deviation of the drainage blanket/subsurface soil interface from the design slope which can alter the drainage.

The field monitoring personnel should observe any indicators of the above or similar potentially adverse conditions and report them to the design engineer.

## 7. Geotechnical Instrumentation

A critical element of any project involving the consolidation of fine grained soils is measurement of the actual degree of consolidation under the actual field load. This is typically performed using geotechnical instrumentation, some of which is installed prior to installing the drains and the remainder prior to the fill placement. Settlement devices and piezometers are used to measure settlement and the dissipation of excess pore pressure, respectively.

Design engineers should use other available references(14,15) to develop appropriate instrumentation programs for a specific project. As a general guideline the instrumentation should include the following:

- A combination of groundwater observation wells and piezometers to provide a complete pore pressure profile prior to drain installation. Most of the observation wells and piezometers should be installed prior to the drains to monitor the effects of drain installation.
- Settlement platforms or points should be installed at the bottom of the drainage blanket and at intermediate depths and the "bottom" of the compressible layer prior to installing the drains.
- Sufficient instrumentation should be installed to anticipate malfunctioning (particularly with piezometers) and/or vandalism/damage throughout the settlement period.

The analysis of the pore pressure data is particularly sensitive to the location of the piezometers relative to adjacent drains. Piezometers and ground water observation wells should be installed equidistant from adjacent drains. It is very important that the adjacent drains be as vertical as possible.

## COSTS

### 1. Introduction

The number of alternative PV drains presently available and the rate at which new products are being introduced are good indicators of the competitive nature of the PV drain market. The competitive nature of the market in general and the various conditions of each individual project can in some cases make it difficult to estimate drain costs; however, the factors discussed in the following section can be considered in evaluation of overall PV drain system costs.

### 2. Cost Factors

As part of the PV drain design process, the design engineer should consider the following factors that may influence project costs:

- a. Site work: The need for site work as discussed in Section 2 of INSTALLATION.
- b. PV drain materials: Although PV drains can be substantially cheaper than sand drains, the material costs are significant. On a typical project the PV drain material costs are currently approximately 40 to 50 percent of the installed cost per unit length. Since the market is highly competitive, the material costs are nearly the same for many of the available products.
- c. Spacing and length: Once the working mat is in place and production drain installation begins, the cost of the PV drains will depend primarily on drain spacing and length. Installations typically have spacings of about 3 to 9 ft (1 to 3 m) and lengths of about 30 to 60 ft (10 to 20m). Other spacings and lengths may be feasible given project geometries and conditions.
- d. Surface soil conditions: The need to predrill can result in a substantial cost increase. The design engineer should evaluate the available geotechnical data to anticipate predrilling and to develop a reasonable estimate of the required depth and cost of predrilling.

From Equations 8, 16 and 17, it can be seen that for all else equal, the quantity of PV drains required (i.e., cost of accelerating consolidation using PV drains) is:

- inversely proportional to  $S^2$
- inversely proportional to  $c_h$
- inversely proportional to  $t$  allowed
- proportional to  $\ln(1/(1-\bar{U}_h))$

The objective of a PV drain design is to create the lowest cost system that meets the project design requirements. As with any design, there are some factors that can be controlled and others over which only limited control is possible. It is important for the design engineer to consider as many of the controllable factors as possible to develop the most cost effective design.

The drain spacing is the major controllable factor that influences the actual design cost of the PV drain installation. Since the relative cost of accelerating the consolidation is inversely proportional to  $S^2$ , small increases in the spacing can result in substantially lower costs. The other variables ( $c_h$ ,  $t$  and  $\bar{U}_h$ ) influence the drain spacing.

The time available for consolidation is a major factor that may or may not be controllable depending on specific project constraints. If possible, the time for consolidation should be as long as feasible within the overall project time frame. The cost of accelerating consolidation is inversely proportional to the time available and therefore, increased time for consolidation to occur will result in direct cost savings.

The required average degree of consolidation ( $\bar{U}_h$ ) is a major design variable. However, the time for consolidation and therefore, the relative cost of accelerating the consolidation is proportional to the natural logarithm of the inverse of  $(1-\bar{U}_h)$ . Therefore, small changes in the required  $\bar{U}_h$  result in only marginal changes in the cost.

In 1986 installed PV drains cost \$0.75 to \$1.00 per lineal foot without a drainage blanket, work mat, mobilization/demobilization, predrilling, or any other "extra" costs, and assuming that the length and number of drains on the project is sufficient to create a competitive bidding environment. This cost range is provided for general reference only. The actual cost of PV drains on a given project is closely related to other factors discussed in Section 2 above.

## BIBLIOGRAPHY

1. Baligh, M.M., 1985, "Strain Path Method", JGE, ASCE, Vol. III, No. 9, September, pp. 1108-1136.
2. Barron, R.A., 1948, "Consolidation of Fine-Grained Soils by Drain Wells", ASCE Trans, Paper 2346, V. 113, pp. 718-724.
3. Casagrande, L. and Poulos, S., 1969, "On the Effectiveness of Sand Drains", Canadian Geotechnical Journal, Vol. 6, No. 3, pp. 287-326.
4. Cedergren, H.R., 1977, Seepage, Drainage, and Flow Nets, Second Edition, John Wiley and Sons, New York, New York, 534 p.
5. Chan, H.T. and Kenney, T.C., 1973, "Laboratory Investigation of Permeability Ratio of New Liskeard Varved Soil", Canadian Geotechnical Journal, Vol. 10, No. 3, pp. 453-472.
6. Christopher, B.R., and Holtz, R.D., 1984, Geotextile Engineering Manual, prepared for Federal Highway Administration, National Highway Institute, Washington, D.C., DTFH61-80-C-00094.
7. Foott, R. and Ladd, C.C., 1981, "Undrained Settlement of Plastic and Organic Clays", JGED ASCE FT8, pp. 1079-1094.
8. Haley & Aldrich, Inc., 1986, "Prefabricated Vertical Drains: Vol. 2, Summary of Research Effort", (FHWA/RD-86/169).
9. Hansbo, S., 1979, "Consolidation of Clay by Band-Shaped Prefabricated Drains", Ground Engineering, Vol. 12, No. 5, pp. 21-25.
10. Jamiolkowski, M. and Lancellotta, R., 1981, "Consolidation by Vertical Drains - Uncertainties Involved in the Prediction of Settlement Rates", Panel Discussion, Proc. X ICSMFE, Stockholm.
11. Jamiolkowski, M., Lancellotta, R. and Wolski, W., 1983, "Precompression and Speeding Up Consolidation", Proc. VIII ECSMFE, Helsinki.
12. Jamiolkowski, M. et al., 1985, "New Developments in Field and Laboratory Testing of Soils," Proc. XI ICSMFE, San Francisco, Vol. 1, pp. 57-154.
13. Ladd, C.C., 1986, "Stability Evaluation During Staged Construction", Terzaghi Lecture, ASCE Boston Convention, October.

## BIBLIOGRAPHY (continued)

14. Ladd, C.C. and Foott, R., 1977, Foundation Design of Embankments on Varved Clays, U.S. Department of Transportation, FHWA-TS-77-214.
15. Ladd, C.C., Rixner, J.J. and Gifford, D.G. (1972), "Performance of Embankments with Sand Drains on Sensitive Clay", Proc. ASCE Spec. Conf. on Performance of Earth and Earth-Supported Structures, V 1, Part 1, Purdue University, pp. 211-242.
16. Ladd, C.C. and Wissa, A.E.Z., 1970, "Geology and Engineering Properties of Connecticut Valley Varved Clays with Special Reference to Embankment Construction", Dept. of Civil Engr. Research Report R70-56, Soils Publ. No. 264, M.I.T.
17. McKinley, D.G., 1961, "A Laboratory Study of Rates of Consolidation in Clays with Particular Reference to Conditions of Radial Porewater Drainage," Proc., V ICSMFE, Paris, pp. 225-228.
18. Mesri, G., and Choi, A.M., 1985, "Settlement Analysis of Embankments on Soft Clays", JGED ASCE GT4, pp. 441-464.
19. Mitchell, J.K. and Gardner, W.S., 1975, "In Situ Measurement of Volume Change Characteristics", State-of-the-Art Report, Proc. ASCE Spec. Conf. on In Situ Measurements of Soil Properties, North Carolina State Univ., Raleigh.
20. Poulos, H.G., and Davis, E.H., 1974, Elastic Solutions for Soil and Rock Mechanics, John Wiley & Sons, Inc., New York, 411 pp.
21. Rowe, P.W., 1959, "Measurement of the Coefficient of Consolidation of Lacustrine Clay," Geotechnique, V9, No. 3, pp. 107-118.
22. Rowe, P.W. and Barber, L., 1966, "A New Consolidation Cell," Geotechnique, V16, No. 2, p. 162.
23. Runesson, K., Hansbo, S., and Wiberg, N.E., 1985, "The Efficiency of Partially Penetrating Vertical Drains", Geotechnique 35, No. 4, pp. 511-516.
24. Saxena, S.K., Hedberg, J. and Ladd, C.C., 1974, "Results of Special Laboratory Testing Program on Hackensack Valley Varved Clay", Dept. of Civil Engr. Research Report R74-66, Soils Publ. No. 31, M.I.T.
25. Shields, D.H. and Rowe, P.W., 1965, "A Simple Shear Test for Saturated Cohesive Soils", Symposium on Vane Shear and Cone Penetration Resistance Testing of In-Situ Soils, ASTM, STP No. 339, pp. 39-47.

## BIBLIOGRAPHY (continued)

26. van de Griend, A.A., 1984, "Research into the Influence of Relative Compression of a Soil Layer and the Drain Deformation on the Discharge Capacity of a Number of Vertical Plastic Drains", thesis for the Delft Technical University Specialist Group for Geotechnology.
27. Van del Elzen, L.W.A., and Atkinson, M.S., 1980, "Accelerated Consolidation of Compressible Low Permeability Subsoils by Means of Colbond Drains", Arnheim, Colbond b. v.
28. Vreeken, C., van den Berg, F., and Loxham, M., 1983, "The Effect of Clay-Drain Interface Erosion on the Performance of Band-Shaped Vertical Drains", 8th ECSMFE, Helsinki, pp. 713-716.



## APPENDIX A: Design Equations

### 1. The General Design Equation for Vertical Drains

The rate of consolidation in precompression is generally analyzed using the theory of consolidation for one dimensional drainage proposed by Terzaghi. The pertinent equations are:

$$\rho_t/\rho_f = \bar{U}_v \quad (\text{Eq. 20})$$

where  $\bar{U}_v$  = average degree of consolidation for vertical drainage, and  $\rho_t$  and  $\rho_f$  are the consolidation settlement at any intermediate time and the final consolidation settlement, respectively.  $\bar{U}_v$  is related to a dimensionless time factor  $T_v$ , which is:

$$T_v = (c_v t)/(H_d)^2 \quad (\text{Eq. 21})$$

where  $c_v$  = coefficient of consolidation for vertical drainage

$t$  = time

$H_d$  = length of the vertical drainage path.

Figure 4 shows the relationship of  $T_v$  and  $\bar{U}_v$  as well as the assumed one-dimensional drainage condition. The Terzaghi theory applies to primary consolidation only and is based on several assumptions including:

- 1) The soil is saturated and homogeneous.
- 2) The flow and compression are one dimensional.
- 3)  $c_v$ ,  $m_v$  and  $k$  remain constant during consolidation.
- 4) The vertical strains are small.
- 5) The load is applied instantaneously.

Consolidation theory for vertical drains was developed by Barron (2) to analyze the performance of sand drains. For the case of radial drainage only, Barron's solution is:

$$\bar{U}_h = 1 - \exp(-8T_h/F(n)) \quad (\text{Eq. 22})$$

where

$$\bar{U}_h = 1 - (u/u_0) \quad (\text{Eq. 23})$$

$u$  = average excess pore pressure throughout the soil mass at time  $t$  ( $u_0$  at time  $t=0$ ).

$$F(n) = (n^2/(n^2-1)) \ln(n) - (3n^2-1)/(4n^2) \quad (\text{Eq. 24})$$

$$n = (r_e/r_w) = D/d_w, \text{ the spacing ratio} \quad (\text{Eq. 25})$$

$$T_h = c_{ht}/D^2, \text{ the horizontal time factor} \quad (\text{Eq. 26})$$

$c_h$  = coefficient of consolidation for horizontal drainage

$D$  = the diameter of the cylinder of influence for the drain

Barron used the following basic assumptions:

- 1) The clay is saturated and homogeneous.
- 2) All compressive strains within the soil mass occur in a vertical direction.
- 3) No vertical pore water flow.
- 4) Validity of Darcy's law of permeability. The permeability coefficient  $k$  is independent of location.
- 5) The pore water and the mineral grains are incompressible in comparison with the clay skeleton.
- 6) The load increment is initially carried by excess pore water pressure  $u$ .
- 7) No excess pressure in the drain.
- 8) The zone of influence of each drain is a cylinder.

Barron also extended Equation 22 to include the effects of soil disturbance around the drain and drain resistance. The resulting equations are not given here, but the simplified versions are presented below.

## 2. Modification of the General Design Equation

Hansbo<sup>(9)</sup> modified the equations developed by Barron for PV drain applications. Using the same theoretical approach as Barron, Hansbo's modifications dealt mainly with simplifying assumptions due to the physical dimensions and characteristics of PV drains.

### a. Drain Spacing

Equation 24 can be simplified as follows:

$$F(n) = (n^2/(n^2-1))\ln(n) - (3n^2-1)/(4n^2) \quad (\text{Eq. 24})$$

$$F(n) = (n^2/(n^2-1))\ln(n) - 3/4 - (1/4n^2) \quad (\text{Eq. 27})$$

assuming that  $1/n^2 = 0$ , since  $n$  is typically 20 or more, and that  $(n^2/(n^2-1)) = 1$ , then Equation 27 simplifies to:

$$F(n) = \ln(n) - 3/4 \quad (\text{Eq. 28})$$

### a. Drain Resistance

Realizing that the PV drains do not have infinite permeability in the longitudinal direction (i.e., they have limited vertical discharge capacity), Hansbo developed a drain resistance factor ( $F_r$ ) assuming that Darcy's law applied to flow along the vertical axis of the drain. The resulting equation is:

$$F_r = \pi z(L - z)(k_h/q_w) \quad (\text{Eq. 29})$$

where

$z$  = distance from the drainage end of the drain

$L$  = length of the drain when drainage occurs at one end only;  
half length of the drain when drainage occurs at both ends.

$k_h$  = coefficient of permeability in the horizontal  
direction in the undisturbed soil

$q_w$  = discharge capacity of the drain (defined using  
a hydraulic gradient of 1)

If the drain has a finite permeability (i.e., limited vertical discharge capacity), the drain resistance factor (Equation 29) is a function of depth and therefore,  $U_h$  is not constant with depth.

### c. Soil Disturbance

Barron (2) developed an equation to account for the effects of soil disturbance during installation by introducing a zone of disturbance with a reduced permeability. The resulting disturbance factor,  $F_S$ , when combined with  $F(n)$  and  $F_r$  is

$$F(n)+F_r+F_S = (\ln(D/d_w) - 3/4) + ((k_h/k_S)-1) \ln(d_S/d_w) + \frac{\pi z(L-z)(k_h/q_w)}{\dots} \quad (\text{Eq. 30})$$

where:

$d_S$  = diameter of the disturbed zone around the drain

$d_w$  = equivalent diameter of the band-shaped drain

$k_S$  = coefficient of permeability in the horizontal direction in the disturbed soil

## APPENDIX B: Effects of Soil Disturbance

Evaluating the effects of installation disturbance is a very complex soil mechanics problem for which a comprehensive solution was beyond the scope of the design guideline manual. Also, the current design equation<sup>(9)</sup> provides only a very simplistic approach to accounting for disturbance. However, it was believed that guidelines and additional data could be developed to aid the design engineer in evaluating disturbance effects.

The design equation accommodates disturbance in the ratios  $d_s/d_w$  and  $k_h/k_s$ . Insight into  $d_s$  can be obtained from prior research on effects of penetration of piles and cone penetrometers on the surrounding soils. The "Strain Path Method"<sup>(1)</sup> can be used to develop recommendations on optimal mandrel shapes and sizes. Based on this research, ranges of  $d_s$  can be recommended for various mandrel configurations and installation methods.

The major objective of the research on soil disturbance was to provide a more rational approach to the overall evaluation of disturbance effects. In order to achieve this objective, Dr. Mohsen M. Baligh, Professor of Civil Engineering at the Massachusetts Institute of Technology, was retained as a Special Consultant. Dr. Baligh developed the Strain Path Method for determining the state of soil disturbance due to the installation of piles.

Complete copies of Dr. Baligh's reports, summarizing studies for the subject research, are included in Prefabricated Vertical Drains: Vol. 2, Summary of Research Effort (FHWA/RD-86/169)<sup>(8)</sup>. Specifically, these reports address the following important aspects of PV drain installation:

### 1) Effects of Mandrel Penetration

The radius of the soil zone around the drain that is affected by mandrel penetration and the distribution of excess pore pressure within this radius depend on the soil characteristics, mandrel geometry and the penetration conditions. The radius and the distribution of excess pore pressures as well as the drainage characteristics of the soil (permeability and consolidation properties) affect subsequent consolidation rates.

### 2) Effects of Mandrel Withdrawal

Withdrawal of the mandrel causes additional changes in the soil conditions and the pore pressures around the drain.

### 3) Rates of Soil Consolidation

Estimates of soil consolidation rates after mandrel withdrawal taking into consideration installation disturbances (straining and excess pore pressures) as well as surcharge loading are required in order to determine installation effects on drain efficiency.

The general conclusions regarding soil disturbance of the report(8) are as follows:

- 1) Drain installation causes disturbance of the soil that can reduce drain effectiveness.
- 2) Retardation in soil consolidation rates due to installation disturbances is principally caused by undrained soil straining (or distortions at constant volume) due to mandrel penetration.
- 3) Undrained shearing of slightly overconsolidated clays causes a reduction in effective confining (or octahedral) stresses,  $\bar{\sigma}_C$ , and an increase in compressibility as expressed by  $m_v$ . These two factors tend to decrease the coefficient of consolidation and hence delay the dissipation of excess pore pressure and reduce drain effectiveness.
- 4) Susceptibility of soils to installation disturbances can therefore be estimated from the reduction in  $\bar{\sigma}_C$  and the increase in  $m_v$  they undergo due to undrained shearing.
- 5) Based on the above, it is believed that clay sensitivity,  $S_t$ , is a good measure of susceptibility to installation disturbances. Undrained shearing of sensitive soils causes significant reductions in  $\bar{\sigma}_C$  and increases in  $m_v$ . The Liquidity Index, LI, provides a good measure of clay sensitivity.

## APPENDIX C: Design Example.

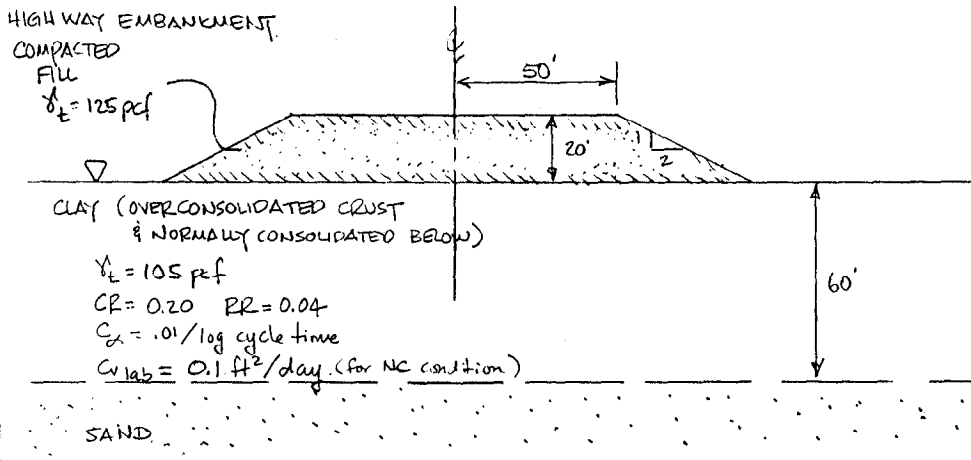
GIVEN:

FIND: A PRELIMINARY PV DRAIN DESIGN TO ACHIEVE THE PRIMARY CONSOLIDATION PLUS 1 LOG CYCLE OF SECONDARY COMPRESSION RESULTING FROM THE HIGHWAY EMBANKMENT LOADING, WITHIN 24 MONTHS OF THE COMPLETION OF THE FILL

DESIGN ASSUMPTIONS:

1. Embankment and surcharge loadings occur instantaneously for purposes of settlement calculations.
2. Stability of the embankment (i.e., staged loading, toe berms, etc.) is considered in separate analysis not presented here.

DESIGN METHODOLOGY:

- 1 Evaluate the Effects of the Proposed Embankment
  - 1A. Calculate Effective Stress Increases Under Centerline Due to Embankment
  - 1B. Develop Stress History and Stress Change Profile
  - 1C. Predict Total Settlement Due to Embankment Loads.
  - 1D. Consider Time Rate of Settlement
2. Consider Surcharge.
3. Evaluate the Required Surcharge.
  - 3A. Estimate the Required Height of Surcharge
  - 3B. Predict Primary Consolidation Due to Embankment and Surcharge.
  - 3C. Calculate Required  $\bar{U}_h$
  - 3D. Check "Ideal Case" for Approximate Drain Spacing
- 4 Comment on Other Design Aspects.
  - 4A. Soil Disturbance.
  - 4B. Drain Resistance.
  - 4C. Drainage Blanket.



1. Evaluate the Effects of the Proposed Embankment

1A Calculate Effective Stress Increases Under Centerline Due to Embankment:

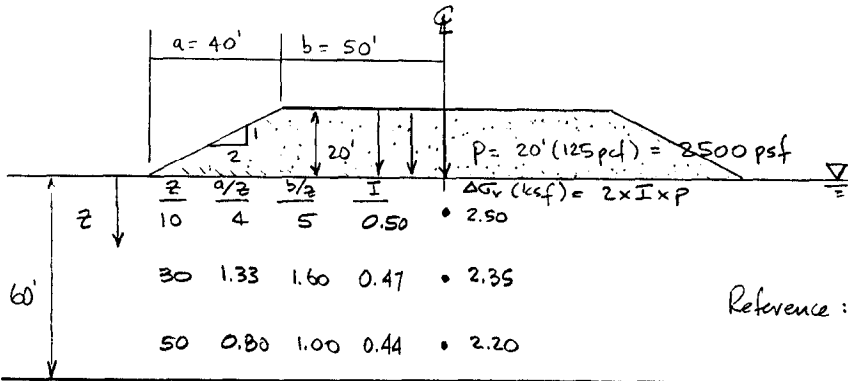

Reference: Elastic Solutions for Soil and Rock Mechanics

byoulos and Davis.  
(p. 40)

1B. Develop Stress History and Stress Change Profile.

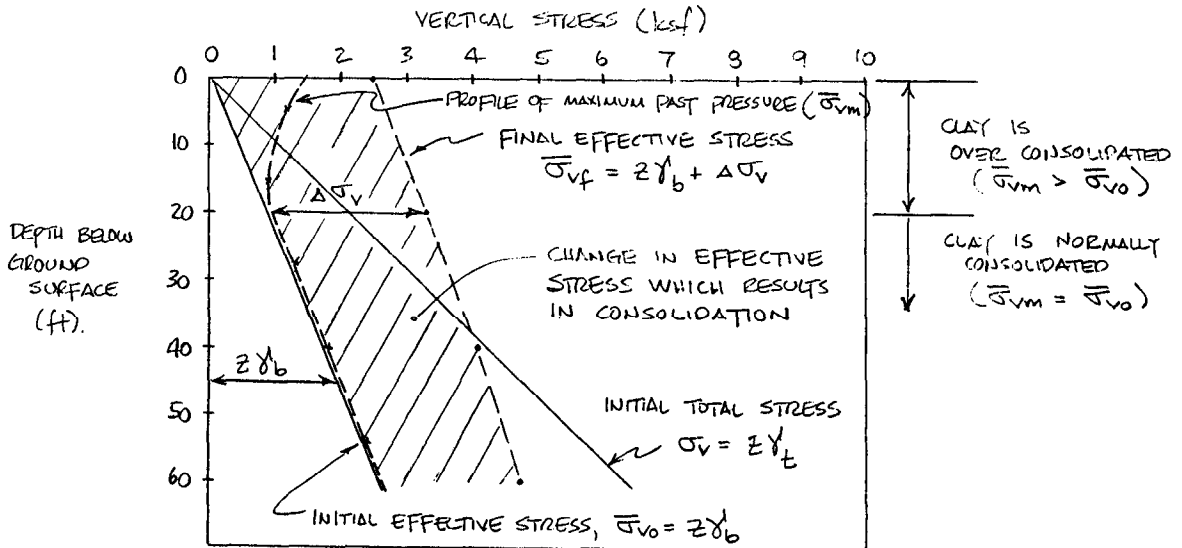

1c Predict Total Settlement Due to Embankment Loads

1. Initial undrained settlement - does not affect PV drains.  
assume  $p_i = 0$
2. Primary consolidation -

$$p_c = RR H \log \left[ \frac{\bar{\sigma}_{vm}}{\bar{\sigma}_{vo}} \right] + CR H \log \left[ \frac{\bar{\sigma}_{vf}}{\bar{\sigma}_{vm}} \right]$$

Depth Interval (ft)	Stress at mid-depth			$H_i$ (ft)	CR	RR	$p_c$ (ft)	
	$\bar{\sigma}_{vo}$ (ksf)	$\bar{\sigma}_{vm}$ (ksf)	$\bar{\sigma}_{vf}$ (ksf)					
0-20'	0.43	1.00	2.93	20	0.20	0.04	2.16	
20-40'	1.28	1.28	3.64	20	0.20	0.04	1.82	
40-60'	2.13	2.13	4.35	20	0.20	0.04	1.24	
							$p_c =$	<u>5.22'</u>

3. Secondary settlement -

$$p_s = H C_\alpha \log \left( \frac{t_f}{t_p} \right)$$

$$p_s = (60')(0.01) \log \left( \frac{10t_p}{t_p} \right) \quad p_s = 0.60'$$

4. Total settlement (primary plus 1 cycle of secondary).

$$p_t = p_p + p_s = 5.22' + 0.60' = 5.82'$$

1D. Consider Time Rate of Settlement1. Check feasibility of 2 way vertical drainage only.

$$\bar{U} = 1 - (1 - \bar{U}_v)(1 - \bar{U}_h)$$

$$\bar{U}_h = 0 \quad \therefore \quad \bar{U} = \bar{U}_v$$

consider case of  $\bar{U}_v = 90\%$  ( $T = 0.848$ )

$$t = \frac{TH^2}{c_v} = \frac{(0.848) \left(\frac{60'}{2}\right)^2}{0.1 \text{ ft}^2/\text{day}} = 3816 \text{ days} \gg 730 \text{ days}$$

$\therefore$  need to consider other options.

2. Calculate  $\bar{U}_v$  that will occur in design period of 2 yrs.

$$t = 2 \text{ yrs} = 730 \text{ days}$$

$$T = \frac{t c_v}{H^2} = \frac{(730 \text{ days})(0.1 \text{ ft}^2/\text{day})}{(60'/2)^2} = 0.08 \Rightarrow \bar{U}_v = 32\%$$

Comment: Need for surcharge is obvious since design requirement is to achieve primary consolidation plus 1 cycle of secondary compression within time,  $t < 10t_p$ .

2. Consider Surcharge

Review advantages of surcharge.

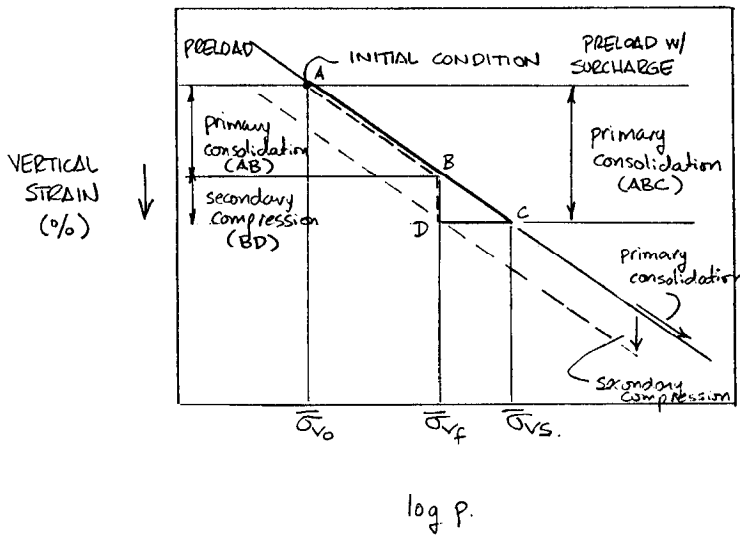

PATH

COMMENTS

- ABD PRELOAD (EMBANKMENT - APPROXIMATELY 10 yrs. TO MOVE FROM A TO B. ONE LOG CYCLE OF TIME TO MOVE FROM B TO D.)  
 ONLY, WITHOUT VERTICAL DRAINS)
- ABCD PRELOAD w/ SURCHARGE (EMBANKMENT w/ SURCHARGE) - APPROX. 2YRS. TO MOVE FROM A TO C. REMOVE SURCHARGE (MOVE FROM C TO D)

3. Evaluate the Required Surcharge.3A. Estimate the Required Height of Surcharge

$$\bar{U} = 1 - (1 - \bar{U}_v)(1 - \bar{U}_h)$$

$$\bar{U}_v = 0.32 \text{ from page 5, assume } \bar{U}_h = 0.85$$

$$\bar{U} = 1 - (1 - 0.32)(1 - 0.85) = 0.90 \quad (\text{which is reasonable value for design}).$$

$$\therefore \text{ in 24 months if } \bar{U} = \frac{P_c}{P_{cf}} = 0.90 \text{ and } P_c = 5.82'$$

$$P_{cf} = 6.47'$$

$$P_{cf} = RR H \log \left[ \frac{\bar{\sigma}_{vm}}{\bar{\sigma}_{vo}} \right] + CR H \log \left[ \frac{\bar{\sigma}_{vf}}{\bar{\sigma}_{vm}} \right] + CR H \log \left[ \frac{\bar{\sigma}_{vs}}{\bar{\sigma}_{vf}} \right] = 6.47'$$

from page 4 first two terms equals 5.22', therefore

$$CR H \log \left[ \frac{\bar{\sigma}_{vs}}{\bar{\sigma}_{vf}} \right] = 6.47 - 5.22' = 1.25'$$

where  $\bar{\sigma}_{vs}$  is the effective vertical stress due to the surcharge.

$$\log \left[ \frac{\bar{\sigma}_{vs}}{\bar{\sigma}_{vf}} \right] = \frac{1.25'}{0.2(60')} = 0.104$$

$$\left[ \frac{\bar{\sigma}_{vs}}{\bar{\sigma}_{vf}} \right] = 1.27 \quad \text{on average throughout } 60' \text{ thickness.}$$

As a minimum the surcharge height should be  $(1.27 - 1)(20') = 5.4'$

Assuming that the intention is to allow entire embankment section to settle and not to re-shape side slopes, etc. after settlement, try using a surcharge of 8'.

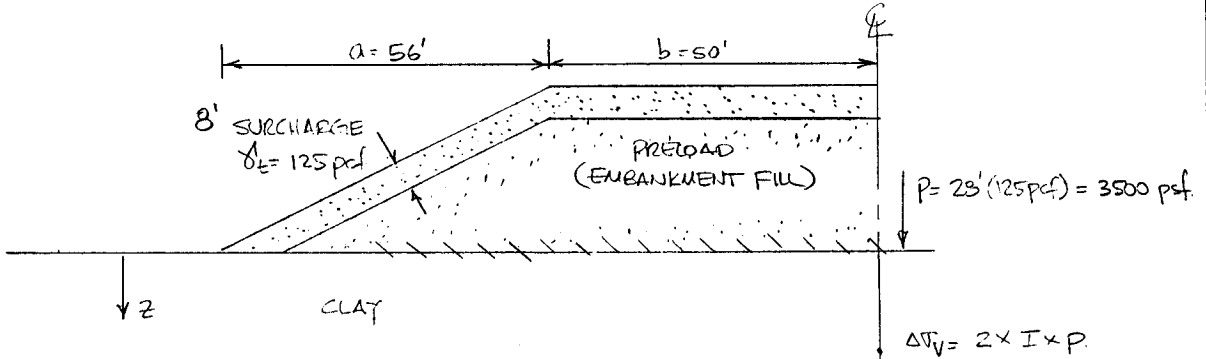

$z$	$a/z$	$b/z$	$I$	$\Delta \bar{\sigma}_v$ (ksf)
10	5.6	5	.50	3.50
30	1.87	1.67	.49	3.43
50	1.12	1	.47	3.29

Reference: Elastic Solutions for Soil and Rock Mechanics  
byoulos and Davis (p.40)

3B Predict Primary Consolidation Due to Embankment and Surcharge

$$P_{cf} = RR \cdot H \log \left[ \frac{\bar{\sigma}_{vm}}{\bar{\sigma}_{vo}} \right] + CR \cdot H \log \left[ \frac{\bar{\sigma}_{vs}}{\bar{\sigma}_{vm}} \right]$$

Depth Interval (ft)	$\bar{\sigma}_{vo}$ (ksf)	$\bar{\sigma}_{vm}$ (ksf)	$\bar{\sigma}_{vs} = \bar{\sigma}_{vo} + \Delta \bar{\sigma}_v$ (ksf)	$H_i$ (ft)	CR	RR	$P_{ci}$ (ft)
0-20'	0.43	1.00	3.93	20	0.20	0.04	2.67
20-40'	1.28	1.28	4.71	20	0.20	0.04	2.26
40-60'	2.13	2.13	5.42	20	0.20	0.04	1.62

$$P_{cf} = 6.55'$$

$$\text{Check } \bar{U} = \frac{R_c}{R_{cf}} = \frac{5.82'}{6.55'} = 0.89 \quad \text{ok}$$

3C. Calculate required  $\bar{U}_h$

$$\bar{U} = 1 - (1 - \bar{U}_v)(1 - \bar{U}_h)$$

$$\bar{U}_h = 1 - \frac{(1 - \bar{U})}{(1 - \bar{U}_v)} = 1 - \frac{(1 - 0.89)}{(1 - 0.32)}$$

$$\bar{U}_h = 0.84$$

3D. Check "Ideal Case" for Approximate Drain Spacing.

$$t = \frac{D^2}{8c_h} \left[ \ln \left( \frac{D}{d_w} \right) - \frac{3}{4} \right] \ln \left( \frac{1}{1 - \bar{U}_h} \right)$$

assume

$$d_w = 0.05 \text{ m} = 0.16 \text{ ft}$$

$$c_h = c_{v \text{ lab}} = 0.1 \text{ ft}^2/\text{day}$$

with  $t = 730$  days (maximum)

$$\bar{U}_h = 0.84$$

$$t = \frac{D^2}{8(0.1 \text{ ft}^2/\text{day})} \left[ \ln \left( \frac{D}{0.16 \text{ ft}} \right) - \frac{3}{4} \right] \ln \left( \frac{1}{1 - 0.84} \right)$$

$$t = \frac{2.29}{\text{ft}^2/\text{day}} D^2 \left[ \ln \left( \frac{D}{0.16 \text{ ft}} \right) - \frac{3}{4} \right]$$

<u>D (ft)</u>	<u>t (days)</u>	
10	775	> 730 N.G.
9	608	< 730 ok, but could increase D.
9.5	689	≈ 730 OK.

For the "ideal case" (no soil disturbance or drain resistance).

PV drains w/  $D = 9.5'$  are adequate based on preliminary design calculations.

#### 4 Comment on Other Design Aspects.

##### 4A. Soil Disturbance

Use of  $c_h = c_{v \text{ lab}}$  in the preliminary design partially compensates for the effects of soil disturbance. More detailed analysis should be performed in the final design to evaluate  $c_h$  and also, the effects of soil disturbance.

##### 4B. Drain Resistance

Drain resistance was not considered due to the relative short length of drain (60 ft.) and two way drainage.



4C Drainage Blanket

Due to the presence of clay at the ground surface and the width of the embankment, final design should include a drainage blanket to be placed as part of the embankment fill to serve as a working mat for the drain installation and after drain installation to function as a collection system for the water seeping out of the drains.

## APPENDIX D: Specifications

The following generic guideline specification for prefabricated vertical (PV) drains includes comments, as well as detailed specifications, that may not apply to all projects depending on the complexity of the project. The design engineer should use these guideline specifications as a tool to aid in the development of the materials and construction control specifications for a particular project. Specifications that would usually be "optional" or be used at the discretion of the design engineer are enclosed in brackets.

- 1.0 Description
- 2.0 Definitions
- 3.0 Materials
  - 3.1 General
  - 3.2 Jacket
  - 3.3 Core
  - 3.4 Assembled Drain
  - 3.5 Quality Control
- 4.0 Installation Equipment
- 5.0 Installation Procedures
- 6.0 Measurement of Quantities
- 7.0 Basis of Payment

### 1.0 DESCRIPTION

Under these items, the Contractor shall furnish all necessary plant, labor, equipment and materials and perform all operations for the installation of prefabricated vertical (PV) drains in accordance with the details shown on the plans and with the requirements of these specifications. The drains shall consist of a band-shaped plastic core enclosed in a suitable jacket material and shall be spaced and arranged as shown on the plans or as otherwise directed by the Engineer.

Comment: The requirement for a suitable jacket material excludes the currently available Desol drain product.

## 2.0 DEFINITIONS

Comment: The Engineer should include any specific definitions of terms that may be necessary for clarity of the specifications. Necessary definitions may include: jacket, core, discharge capacity, permittivity, equivalent diameter, and free volume.

## 3.0 MATERIALS

### 3.1 General

3.1.1 The PV drain shall be of newly-manufactured materials and shall consist of a core enclosed in or integrated with a jacket. The jacket shall allow free passage of pore water to the core without loss of soil material or piping. The core shall provide continuous vertical drainage.

[3.1.2] The drain shall be band-shaped with an aspect ratio (width divided by thickness) not exceeding 50.

### 3.2 Jacket

3.2.1 The jacket shall be a synthetic non-woven geotextile capable of resisting all bending, punching and tensile forces imposed during installation and during the design life of the drain.

3.2.2 The jacket material shall not be subject to localized damage (e.g., punching through the filter by sand/gravel particles).

3.2.3 The jacket material shall be sufficiently rigid to withstand lateral earth pressures due to embedment and surcharge so that the vertical flow capacity through the core will not be adversely affected.

3.2.4 The jacket material shall be sufficiently flexible to bend smoothly during installation and induced consolidation settlement without damage.

3.2.5 Jacket material shall not undergo cracking and peeling during installation of the drain.

3.2.6 The jacket material shall conform to the following specifications:

<u>Test Item</u>	<u>Requirement Designation</u>	<u>(Minimum Roll Value)*</u>
Grab Tensile (1975)	ASTM D1682-64	80 lbs.
Trapezoidal Tear	ASTM D2263-68	25 lbs.
Puncture Strength	ASTM D751-73	50 lbs.
Burst Strength	ASTM D774-46	130 psi

- \* The jacket material shall be tested in saturated and dry condition. These requirements apply to the lower of the two tested conditions.

Comment: The appropriate minimum requirements have been established by reviewing specifications in use at the time of preparing the manual. The design engineer should review the items, test designations, and required minimums for each project. The designer is referred to Christopher and Holtz (1984) for guidance.

Comment: Requirement for test data on mechanical properties for the jacket cited above may be waived by the Engineer for PV drains that have integrated structures (i.e., the core and jacket are integral and cannot be tested separately).

[3.2.7] The jacket shall have a minimum permittivity of \_\_\_\_\_ gal/min/ft<sup>2</sup> when tested according to the ASTM Suggested Test Method for Permeability and Permittivity of Geotextiles.

Comment: The role of permittivity on the satisfactory performance of a PV drain is not fully understood. The present perception is that a jacket should have a minimum permeability equal to or greater than the permeability of the adjacent soil in order to function properly. The design engineer should decide on a minimum permittivity acceptable on the given project. (See Section 2 of DRAIN SELECTION AND DESIGN) of text.

### 3.3 Core

- 3.3.1 The core shall be a continuous plastic material fabricated to promote drainage along the axis of the vertical drain.

Comment: The Engineer may limit the acceptable core materials and drainage channel geometries depending on the particular job conditions. The Engineer may also specify core material physical properties if appropriate.

### 3.4 Assembled Drain

- 3.4.1 The mechanical properties (strength and modulus) of the assembled PV drain shall equal or exceed those specified for the component jacket and core.

3.4.2 The assembled drain shall be resistant against wet rot, mildew, bacterial action, insects, salts in solution in the groundwater, acids, alkalis, solvents, and any other significant ingredients in the site groundwater.

[3.4.3] One single type of assembled drain shall be used on the project unless otherwise specified or approved by the Engineer.

[3.4.4] The assembled drain shall have a minimum discharge capacity of 3500 ft<sup>3</sup>/yr when measured under a gradient of one at the maximum effective stress that the drain will experience.

Comment: Discharge capacity is a function of drain type, confining pressure, and hydraulic gradient as well as possibly being dependent on the test apparatus, test procedure, and confining medium. The Engineer should decide whether a specified minimum value is necessary and if so what the minimum should be (See Section 3 of EVALUATION OF DESIGN PARAMETERS of text). If a minimum discharge capacity is specified, the Engineer must also define the general test method to be used (confining pressure, confining media, length of sample, etc.).

3.4.5 The assembled drain shall have a minimum equivalent diameter of \_\_\_\_\_ using the following definition of equivalent diameter:  $d_w = (a+b)/2$

$d_w$  = diameter of a circular drain equivalent to the band shaped drain

a = width of a band shaped drain

b = thickness of a band shaped drain

Comment: The design engineer should determine a minimum equivalent diameter for the drains on a specific project. Alternatively, the equivalent diameter requirement can be restated by specifying a minimum thickness and width for the band shaped drain. (See Section 3 of EVALUATION OF DESIGN PARAMETERS of text.)

3.4.6 PV drain materials shall be labeled or tagged in such a manner that the information for sample identification and other quality control purposes can be read from the label. As a minimum, each roll shall be identified by the manufacturer as to lot or control numbers, individual roll number, date of manufacture, manufacturer and product identification of the jacket and core.

3.4.7 During shipment and storage, the drain shall be wrapped in heavy paper, burlap or similar heavy duty protective covering. The drain shall be protected from sunlight, mud, dirt, dust, debris and other detrimental substances during shipping and on-site storage.

3.4.8 All material which is damaged during shipment, unloading, storage, or handling and/or which does not meet the minimum requirements of the drain material shall be rejected by the Engineer. No payment of any kind shall be made for rejected material.

[3.4.9] Prefabricated vertical drains preapproved for use on this project are as follows:

Comment: The design engineer may want to preapprove drains to expedite the bid preparation process. The design engineer should list only those drains he considers acceptable on the specific project. The following list does not constitute acceptance by FHWA or the Consultant of any of the drains for any specific purpose or project. Two currently available drain products (Sol Compact and Desol) are not included in the list because laboratory test data is either not available (Sol Compact) or observed critical properties were judged to be below current standards (Desol, which also does not have any jacket).

Alidrain  
Alidrain S  
Hitek Flodrain

Drainage & Ground Improvement, Inc.  
P.O. Box 13222  
Pittsburgh, PA 15243  
(412) 257-2750

Geosystems, Inc.  
P.O. Box 168  
Sterling, VA 22170  
(703) 430-5444

Amerdrain 307, 407

International Construction  
Equipment, Inc.  
301 Warehouse Drive  
Mathews, NC 28105  
(800) 438-9281

Bando

Fukuzawa & Associates, Inc.  
6129 Queenridge Drive  
Rancho Palos Verdes, CA 90274  
(213) 377-4735

Castle Drain  
Board

Harquim International Corp.  
3112 Los Feliz Boulevard  
Los Angeles, CA 90039  
(213) 669-8332

Colbond CX-1000

BASF Corporation, Fibers Division  
Geomatrix Systems  
Enka, NC 28728  
(704) 667-7713

Mebradrain MD 7007

L.B. Foster Company  
415 Holiday Drive  
Pittsburgh, PA 15220  
(412) 262-3900

Vynlex

Vynlex Corporation  
P.O. Box 7187  
Knoxville, TN 37921  
(615) 690-2211

### 3.5 Quality Control

- 3.5.1 The actual type of PV drain installed will be at the option of the Contractor subject to the approval of the Engineer.
- 3.5.2 If the Contractor intends to use a PV drain that is on the preapproved list supplied by the Engineer, the Contractor shall submit written notice to the Engineer at least 28 days prior to the installation of any drains and submit to the Engineer for testing 3 samples of any proposed splices at least 21 days prior to the installation of any drains. Samples of the spliced drain shall be long enough to include the splice plus 2 feet of unspliced drain on both sides of the splice.
- 3.5.3 If the Contractor intends to install a drain that is not on the preapproved list supplied by the Engineer, the Contractor shall:
- submit to the Engineer for testing a sample of the unspliced PV drain to be used, and 3 samples of any proposed splices, at least 28 days prior to the installation of any drains. The sample of unspliced drain shall be at least 10 feet long. Samples of spliced PV drain shall be long enough to include the splice plus 2 feet of unspliced drain on both sides of the splice.
  - submit to the Engineer manufacturer's literature documenting the physical and mechanical properties of the drain (as a minimum those properties required by the specifications) and other similar projects where the same drain has been installed including details on prior performance on these projects, at least 14 days prior to installation.
  - install one of the preapproved drain types if the proposed drain is disallowed by the Engineer.

3.5.4 The Contractor shall indicate the proposed source of the materials prior to delivery to the site. The Contractor shall also retain a supplier's purchase certificate to verify the type and physical characteristics of the drain to be used.

[3.5.5] During construction, individual test samples shall be cut from at least one roll selected at random to represent each shipment or 200,000 linear feet, whichever is less. Individual samples shall be no less than 10 ft in length and shall be full width. Samples submitted for tests shall indicate the linear feet of drain represented by the sample. The total footage represented by the sample shall not be used until the Engineer has accepted the sample (verified physical dimensions, manufacturer, drain designation, and manufacturer's certification of physical and chemical properties).

[3.5.6] Should any individual sample selected at random fail to meet any specification requirement, then that roll shall be rejected and two additional samples shall be taken at random from two other rolls representing the shipment or 200,000 linear feet, whichever is less. If either of these two additional samples fail to comply with any portion of the specification, then the entire quantity of vertical drain represented by the sample shall be rejected.

#### 4.0 INSTALLATION EQUIPMENT

##### 4.1 General

4.1.1 PV drains shall be installed with approved modern equipment of a type which will cause a minimum of disturbance of the sub-soil during the installation operation and maintain the mandrel in a vertical position.

4.1.2 Drains shall be installed using a mandrel or sleeve which shall be inserted (i.e., pushed or vibrated) into the soil. The mandrel or sleeve shall protect the drain material from tears, cuts, and abrasion during installation, and shall be retracted after each drain is installed.

[4.1.3] To minimize disturbance of the subsoil, the mandrel or sleeve shall have a maximum cross-sectional area of          in<sup>2</sup>. The mandrel or sleeve shall be sufficiently stiff to prevent wobble or deflection during installation.



Comment: The design engineer should select a maximum area based on an evaluation of disturbance effects, and in particular,  $d_s$ , the diameter of the disturbed zone. It is typical for the maximum cross-sectional area to be  $10 \text{ in}^2$  ( $65 \text{ cm}^2$ ).

- 4.1.4 The mandrel or sleeve shall be provided with an anchor plate or similar arrangement at the bottom to prevent the soil from entering the bottom of the mandrel during the installation of the drain and to anchor the drain tip at the required depth at the time of mandrel withdrawal. The dimensions of the anchor shall conform as closely as possible to the dimensions of the mandrel so as to minimize soil disturbance. The Engineer shall determine the acceptability of the anchorage system and procedure.

## 5.0 INSTALLATION PROCEDURES

### 5.1 General

- 5.1.1 \_\_\_\_\_ weeks prior to the beginning of trial PV drain installation, the Contractor shall submit full details on the materials, equipment, sequence and method proposed for PV drain installation to the Engineer for review and approval. Approval by the Engineer of installation sequence and methods shall not relieve the Contractor of its responsibility to install drains in accordance with the plans and specifications.
- 5.1.2 Prior to the installation of production PV drains, the Contractor shall demonstrate that its equipment, methods, and materials produce a satisfactory installation in accordance with these specifications. For this purpose, the Contractor will be required to install \_\_\_\_\_ trial drains totalling approximately \_\_\_\_\_ linear feet at locations designated by the Engineer.
- 5.1.3 Approval by the Engineer of the method or equipment used to install the trial drains shall not constitute, necessarily, acceptance of the method for the the remainder of the project. If, at any time, the Engineer considers that the method of installation does not produce satisfactory PV drains, the Contractor shall alter his method and/or equipment as necessary to comply with these specifications.

### 5.2 Installation

- 5.2.1 PV drains shall be located, numbered and staked out by the Contractor using a baseline and benchmark provided by the Engineer. The Contractor shall take all reasonable precautions to preserve the stakes and is responsible for

any necessary re-staking. The as-installed location of the PV drains shall not vary by more than six (6) inches from the plan locations designated on the drawings.

- 5.2.2 PV drains that are more than six (6) inches from design plan location or are damaged or improperly installed, will be rejected and abandoned in place.
- 5.2.3 PV drains shall be installed from the working surface to the depth shown on the drawings, or to such depth as directed by the Engineer. The Engineer may vary the depths, spacings, or the number of drains to be installed, and may revise the plan limits for this work as necessary.
- 5.2.4 During PV drain installation, the Contractor shall provide the Engineer with suitable means of determining the depth of the advancing drain at any given time and the length of drain installed at each location.
- 5.2.5 The Contractor shall supply to the Engineer at the end of each working day a summary of the PV drains installed that day. The summary shall include drain type, locations and length (to nearest 0.1 ft.) quantity of PV drain installed at each location.
- 5.2.6 Equipment for installing PV drains shall be plumbed prior to installing each drain and shall not deviate from the vertical more than 0.2-feet in 10 feet during installation of any drain.
- 5.2.7 PV drains shall be installed using a continuous push using static weight or vibration.
- 5.2.8 Installation techniques requiring driving will not be permitted. Jetting techniques will be permitted only after receiving written approval from the Engineer.
- 5.2.9 The installation shall be performed, without any damage to the drain during advancement or retraction of the mandrel. In no case will alternate raising or lowering of the mandrel during advancement be permitted. Raising of the mandrel will only be permitted after completion of a drain installation.
- [5.2.10] The mandrel penetration rate should be between 1/2 and 2 feet per second.
- 5.2.11 The completed PV drain shall be cut off neatly 1 foot above the working grade, or as otherwise specified on the contract drawings.

5.2.12 The Contractor shall observe precautions necessary for protection of any field instrumentation devices. The Contractor shall replace, at his own expense, any instrumentation equipment that has been damaged or become unreliable as a result of his operations prior to continuing with drain installation or other construction activities.

### 5.3 Preaugering/Obstructions

Comment: If the design engineer anticipates any obstructions (dense soils, building rubble, gravel or stone, etc.) based on the results of the subsurface explorations or other information, the contract documents should include provisions for acceptable obstruction removal techniques and payment for obstruction clearance.

Comment: If the design engineer does not anticipate any obstructions, the following specification sections 5.3.1 through 5.3.3 should be used as a guide and modified as appropriate.

5.3.1 The Contractor shall be responsible for penetrating any overlying material as necessary to install the drains.

5.3.2 Where obstructions are encountered below the working surface which cannot be penetrated by the drain installation equipment, the Contractor shall complete the drain from the elevation of the working surface to the obstruction and notify the Engineer prior to installing any more drains. At the direction of the Engineer and under his review, the Contractor shall attempt to install a new drain within two (2) feet horizontally from the obstructed drain. A maximum of two attempts shall be made as directed by the Engineer. If the drain still cannot be installed to the design tip elevation, the drain location shall be abandoned and the installation equipment shall be moved to the next location, or other action shall be taken as directed by the Engineer.

5.3.3 If permitted by the Engineer, the Contractor may use augering, spudding, or other methods to loosen the soil and clear obstructions, providing the augering does not penetrate more than two feet into the underlying compressible soil.

Comment: If the design engineer anticipates obstructions that can be cleared using augering or spudding, the following specification sections 5.3.4 through 5.3.8 should be used as a guide and modified as appropriate.

5.3.4 The Contractor shall be responsible for penetrating overlying fill material as necessary to satisfactorily

install the PV drains. Satisfactory installation may require clearing obstructions defined as any man-made or natural object or strata that prevents the proper insertion of the mandrel and installation of the PV drain.

- 5.3.5 The Contractor may use augering, spudding, or other approved methods to loosen the soil and any obstruction material prior to the installation of PV drains. The obstruction clearance procedure is subject to the approval of the Engineer; however, such approval shall not relieve the Contractor of his responsibility to clear obstructions in accordance with these specifications.
- 5.3.6 If augering is the selected method, the augers shall have a minimum outside diameter equal to the largest horizontal dimension of the mandrel, shoe or anchor, whichever is greatest. The maximum outside diameter of the auger shall be no more than three inches greater than the minimum outside diameter.
- 5.3.7 Obstruction clearance procedures shall be kept to a minimum. The augering or other obstruction removal techniques shall not penetrate more than two feet into the underlying compressible soil.
- 5.3.8 Where obstructions are encountered, the following procedure shall be implemented in the listed sequence:
  - 1. The Contractor shall immediately notify the Engineer prior to completing the drain and prior to installing any other drains.
  - 2. The Contractor shall then attempt to install drains adjacent to the obstructed location. Based upon the results of these installations and at the direction of the Engineer and under his review, the Contractor shall:
    - a) attempt to install an offset drain within two feet horizontally of the obstructed drain, or
    - b) implement obstruction clearance procedures and install the drain at the design location. Obstruction clearance procedures shall be used only as directed by the Engineer.

#### 5.4 Splicing

- 5.4.1 Splicing of PV drain material shall be done by stapling in a workmanlike manner and so as to insure structural and hydraulic continuity of the drain.

[5.4.2] A maximum of 1 splice per drain installed will be permitted, without specific permission from the Engineer.

5.4.3 The jacket and core shall be overlapped a minimum of 6 inches at any splice.

## 6.0 MEASUREMENT OF QUANTITIES

### 6.1 Mobilization and Demobilization

6.1.1 This item shall include the furnishing of all supervision, equipment, crews, tools, required permits, survey stake out of drain locations, special insurance, and other equipment and materials as necessary to properly execute the work.

### 6.2 PV Drains

6.2.1 PV drains shall be measured to the nearest whole foot. The length of PV drain to be paid for shall be the distance the installation mandrel tip penetrates below the working grade plus the required cut off length above the working grade. Payment will not be made for drains which are not anchored to the required depth.

6.2.2 PV drains placed in excess of the length designated on the contract drawings shall not be paid for unless the additional length was authorized by the Engineer in writing prior to or during the drain installation.

### 6.3 Obstructions

6.3.1 Obstruction clearance by augering or spudding method shall be measured by the linear foot. The length of obstruction clearance to be paid for shall be the length from the working surface at the time of installation to the depth penetrated by the auger or spud, or to a depth two (2) feet into the underlying compressible soil, whichever is the lesser depth. The obstruction clearance depth is subject to verification by the Engineer.

6.3.2 Obstruction clearance by other methods shall be measured on a time and materials basis, subject to the prior approval of the Engineer.

6.3.3 Obstruction clearance shall not be paid for unless the use of the necessary equipment is authorized by the Engineer prior to its use, and the Engineer verifies the penetration length.

## 7.0 BASIS OF PAYMENT

### 7.1 Mobilization and Demobilization

- 7.1.1 Payment for work under this item will be made at the contract price for Mobilization and Demobilization. Payment for Mobilization and Demobilization will constitute full compensation for expenses for such performance, notwithstanding increases or decreases in quantities of the other contract items.

### 7.2 PV Drains

- 7.2.1 Payment for PV drains shall be made at the contract unit price per linear foot for acceptable drains, which price shall be full compensation for the cost of furnishing the full length of PV drain material, installing the PV drain, altering of the equipment and methods of installation in order to produce the required end result in accordance with the contract drawings and specifications, and shall also include the cost of furnishing all tools, materials, labor, equipment and all other costs necessary to complete the required work.
- 7.2.2 No direct payment shall be made for PV drains, or for any delays or expenses incurred through changes necessitated by improper material or equipment. The costs of such shall be included in the unit price bid for this work.
- 7.2.3 Payment for trial drains shall be at the bid price per linear foot for the PV drains.
- 7.2.4 No direct payment will be made for constructing any work platform other than that shown on the contract drawings. The cost of such shall be included in the unit price bid for PV drains or in the lump sum bid for mobilization/demobilization.

### 7.3 Obstructions

- 7.3.1 Payment for obstruction clearance using augering or spudding shall be made at the contract unit price per linear foot, which price shall be full compensation for the cost of preaugering, spudding, or performing other acceptable methods to clear obstructions and to satisfactorily install the PV drains, including the cost of disposal of any surplus preaugered or obstruction clearance materials. The contract unit price shall also include furnishing all tools, materials, labor, equipment, permits if required, and all other costs necessary to complete the required work.

7.3.2 Payment for the removal of obstructions using methods other than augering or spudding shall be on a time and materials basis.

7.3 Payment Items

7.3.1 Payment will be made under the following items.

<u>Pay Item No.</u>	<u>Item</u>	<u>Pay Unit</u>
1	Mobilization and Demobilization	lump sum
2	Prefabricated Vertical (PV) Drain	per linear ft
3	Obstruction Clearance (Augering or Spudding)	per linear ft
4	Obstruction Clearance (Other Means)	per hour plus materials









# FEDERALLY COORDINATED PROGRAM (FCP) OF HIGHWAY RESEARCH, DEVELOPMENT, AND TECHNOLOGY

The Offices of Research, Development, and Technology (RD&T) of the Federal Highway Administration (FHWA) are responsible for a broad research, development, and technology transfer program. This program is accomplished using numerous methods of funding and management. The efforts include work done in-house by RD&T staff, contracts using administrative funds, and a Federal-aid program conducted by or through State highway or transportation agencies, which include the Highway Planning and Research (HP&R) program, the National Cooperative Highway Research Program (NCHRP) managed by the Transportation Research Board, and the one-half of one percent training program conducted by the National Highway Institute.

The FCP is a carefully selected group of projects, separated into broad categories, formulated to use research, development, and technology transfer resources to obtain solutions to urgent national highway problems.

The diagonal double stripe on the cover of this report represents a highway. It is color-coded to identify the FCP category to which the report's subject pertains. A red stripe indicates category 1, dark blue for category 2, light blue for category 3, brown for category 4, gray for category 5, and green for category 9.

## *FCP Category Descriptions*

### **1. Highway Design and Operation for Safety**

Safety RD&T addresses problems associated with the responsibilities of the FHWA under the Highway Safety Act. It includes investigation of appropriate design standards, roadside hardware, traffic control devices, and collection or analysis of physical and scientific data for the formulation of improved safety regulations to better protect all motorists, bicycles, and pedestrians.

### **2. Traffic Control and Management**

Traffic RD&T is concerned with increasing the operational efficiency of existing highways by advancing technology and balancing the demand-capacity relationship through traffic management techniques such as bus and carpool preferential treatment, coordinated signal timing, motorist information, and rerouting of traffic.

### **3. Highway Operations**

This category addresses preserving the Nation's highways, natural resources, and community attributes. It includes activities in physical

maintenance, traffic services for maintenance zoning, management of human resources and equipment, and identification of highway elements that affect the quality of the human environment. The goals of projects within this category are to maximize operational efficiency and safety to the traveling public while conserving resources and reducing adverse highway and traffic impacts through protections and enhancement of environmental features.

### **4. Pavement Design, Construction, and Management**

Pavement RD&T is concerned with pavement design and rehabilitation methods and procedures, construction technology, recycled highway materials, improved pavement binders, and improved pavement management. The goals will emphasize improvements to highway performance over the network's life cycle, thus extending maintenance-free operation and maximizing benefits. Specific areas of effort will include material characterizations, pavement damage predictions, methods to minimize local pavement defects, quality control specifications, long-term pavement monitoring, and life cycle cost analyses.

### **5. Structural Design and Hydraulics**

Structural RD&T is concerned with furthering the latest technological advances in structural and hydraulic designs, fabrication processes, and construction techniques to provide safe, efficient highway structures at reasonable costs. This category deals with bridge superstructures, earth structures, foundations, culverts, river mechanics, and hydraulics. In addition, it includes material aspects of structures (metal and concrete) along with their protection from corrosive or degrading environments.

### **9. RD&T Management and Coordination**

Activities in this category include fundamental work for new concepts and system characterization before the investigation reaches a point where it is incorporated within other categories of the FCP. Concepts on the feasibility of new technology for highway safety are included in this category. RD&T reports not within other FCP projects will be published as Category 9 projects.

