

Appendix D

pH Titration and Constituent Leaching as a Function of pH (SR002 test results)

<u>Fly Ash Comparisons</u>	D-1
pH titration	D-2
Mercury	D-3
Aluminum	D-4
Antimony	D-5
Arsenic	D-6
Barium	D-7
Boron	D-8
Cadmium	D-9
Chromium	D-10
Cobalt	D-11
Lead	D-12
Molybdenum	D-13
Selenium	D-14
Thallium	D-15
<u>Gypsum Comparisons</u>	D-16
pH titration	D-17
Mercury	D-18
Aluminum	D-19
Antimony	D-20
Arsenic	D-21
Barium	D-22
Boron	D-23
Cadmium	D-24
Chromium	D-25
Cobalt	D-26
Lead	D-27
Molybdenum	D-28
Selenium	D-29
Thallium	D-30

<u>Scrubber Sludge Comparisons</u>	D-31
pH titration	D-32
Mercury	D-33
Aluminum	D-34
Antimony	D-35
Arsenic	D-36
Barium	D-37
Boron	D-38
Cadmium	D-39
Chromium	D-40
Cobalt	D-41
Lead	D-42
Molybdenum	D-43
Selenium	D-44
Thallium	D-45
<u>Fixated Stabilized Sludge Comparisons</u>	D-46
pH titration	D-47
Mercury	D-49
Aluminum	D-51
Antimony	D-53
Arsenic	D-55
Barium	D-57
Boron	D-59
Cadmium	D-61
Chromium	D-63
Cobalt	D-65
Lead	D-67
Molybdenum	D-69
Selenium	D-71
Thallium	D-73
<u>Table of Outliers</u>	D-75

Fly Ash Comparisons (FA)

Facility A

Coal: low sulfur bituminous
APC: NO+SNCR+FF

CFA
(SNCR Off)

AFA
(SNCR On)

Facility B

Coal: low sulfur bituminous
APC: NO+SCR+ESP(CS) [Mg lime]

DFA
(SCR Off)

BFA
(SCR On)

Facility K

Coal: sub- bituminous
APC: NO+SCR+ESP(CS) [Mg lime]

KFA
(SCR On)

Fly Ash Comparisons

Off

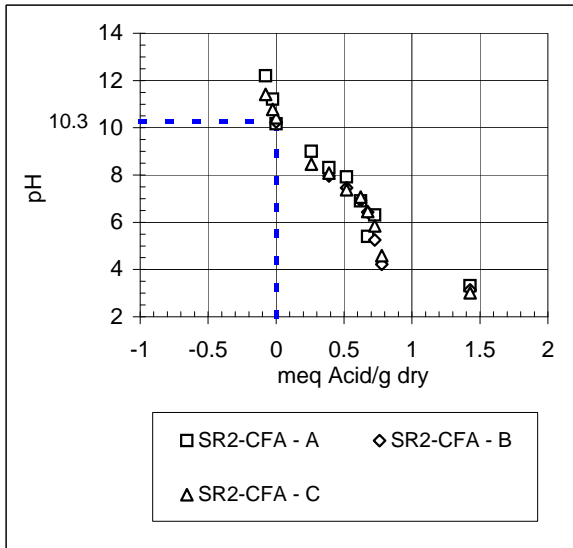

On

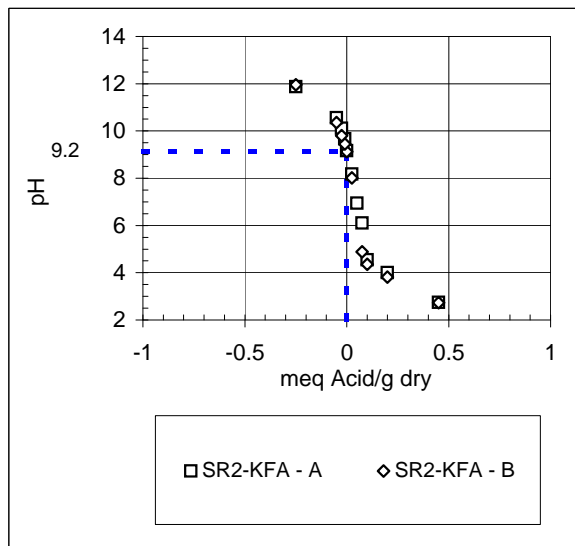
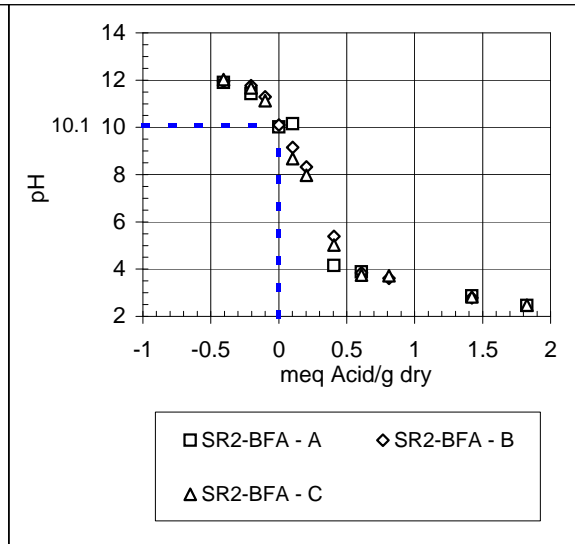
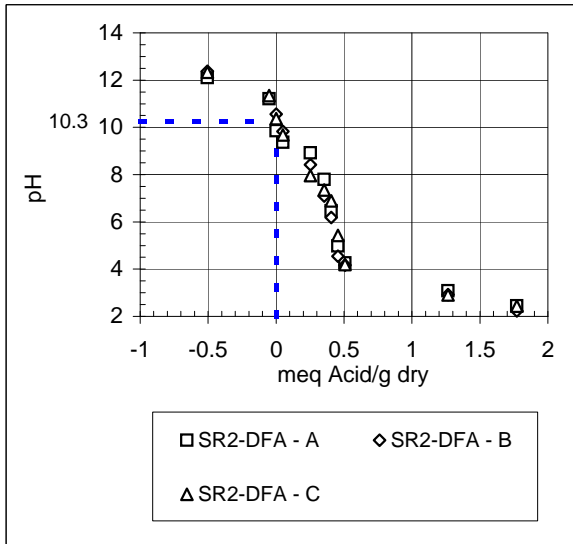
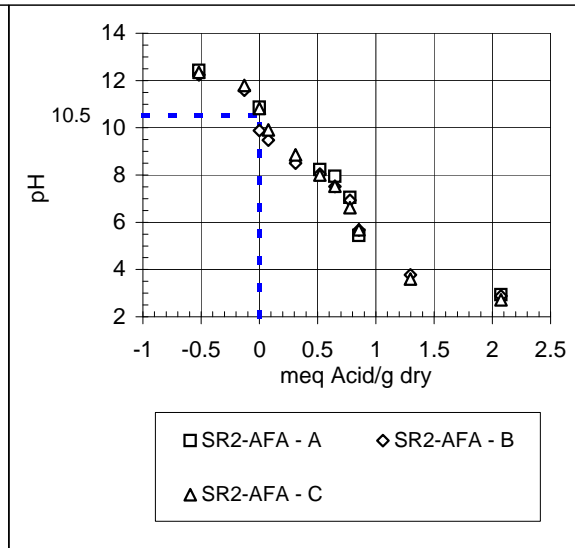

Off

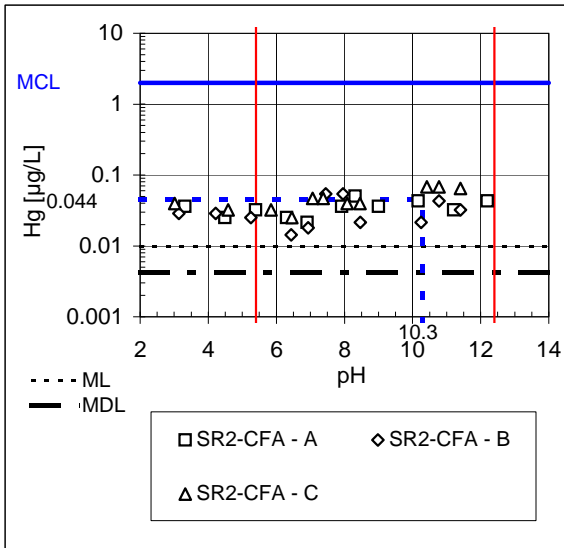

On

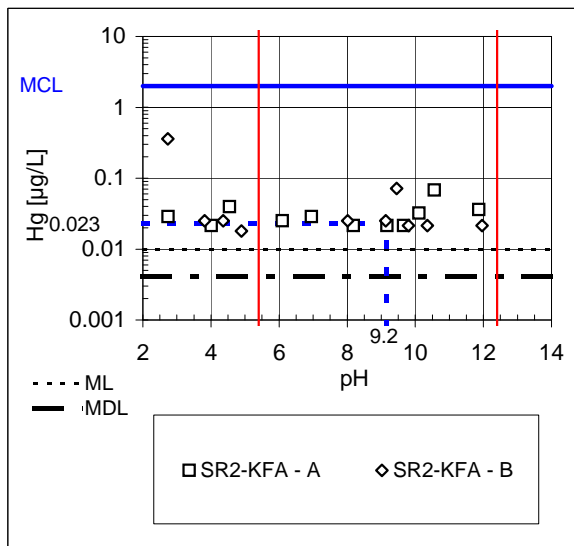
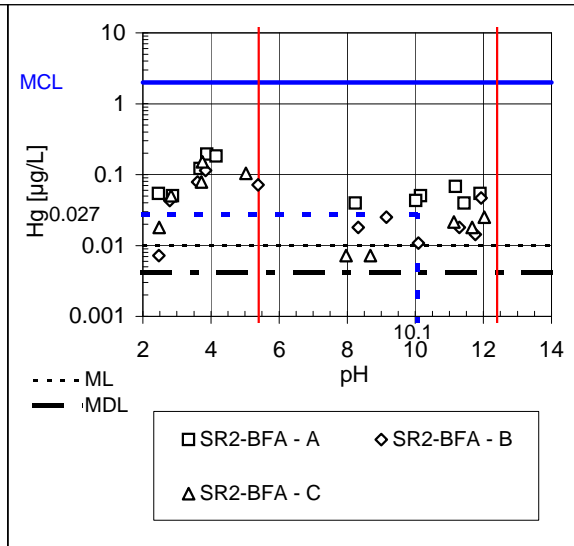
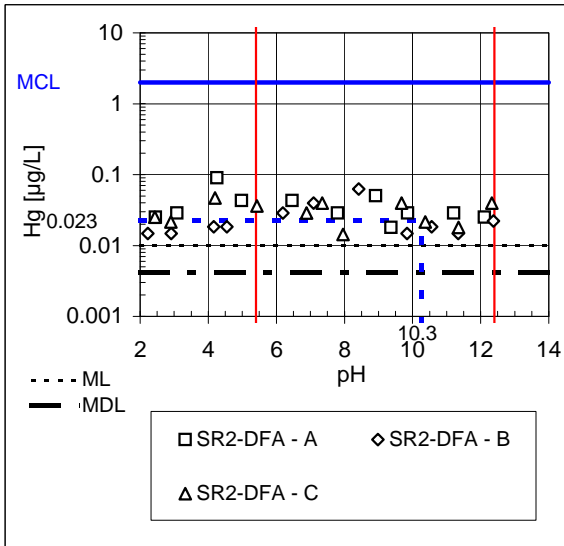
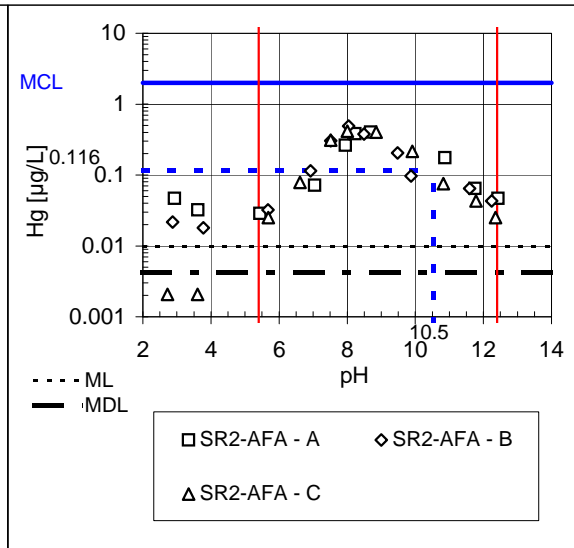

Off

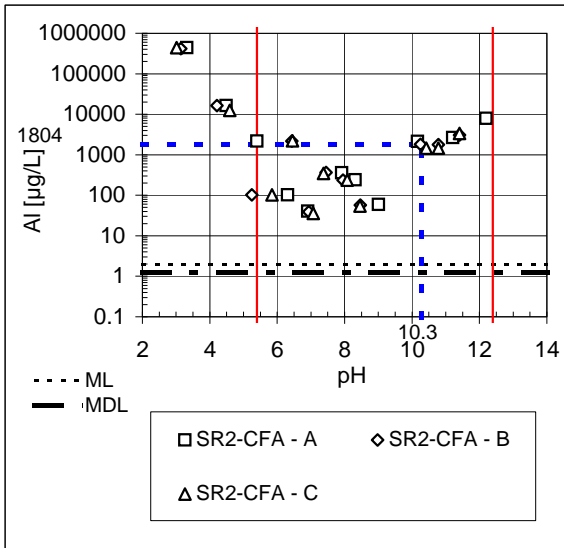

On

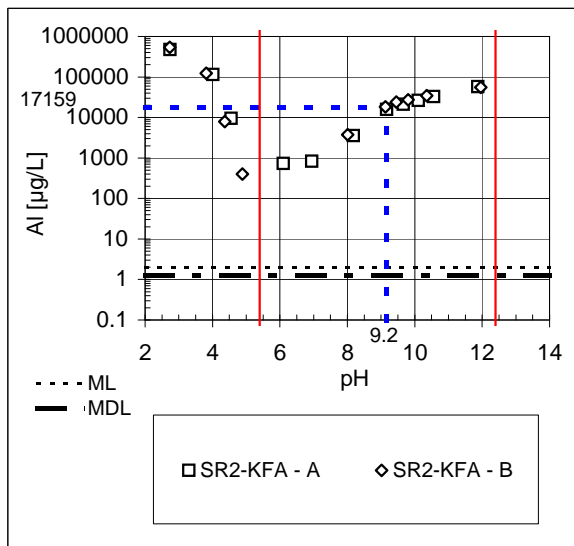
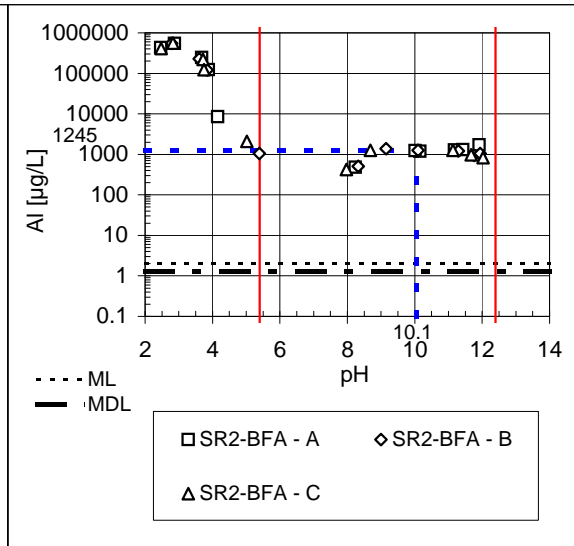
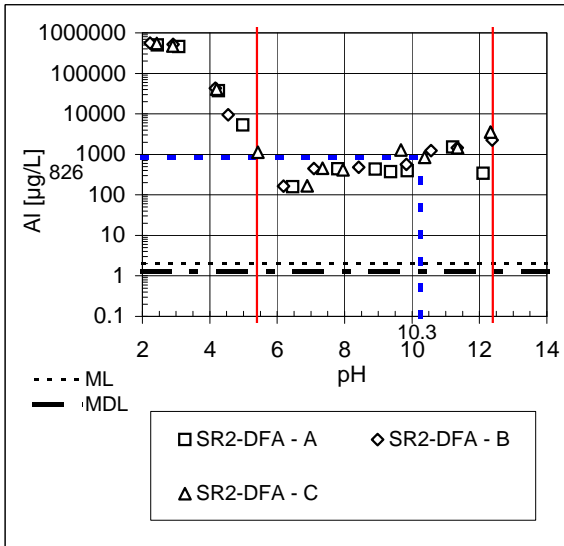
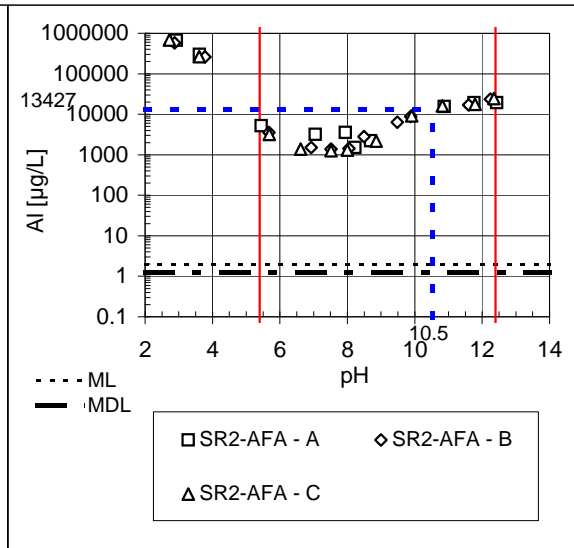

Off

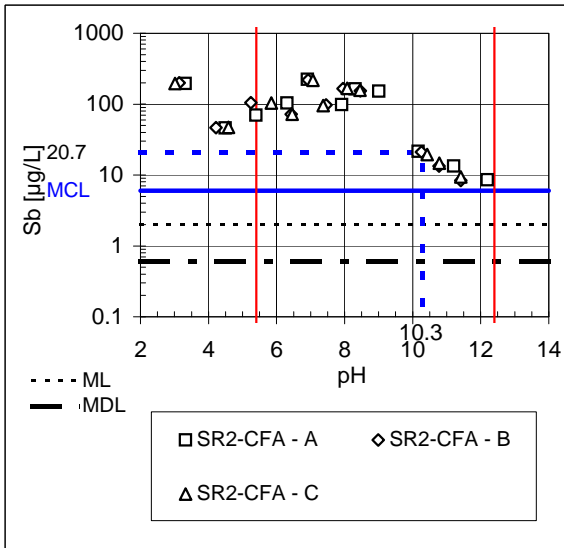

On

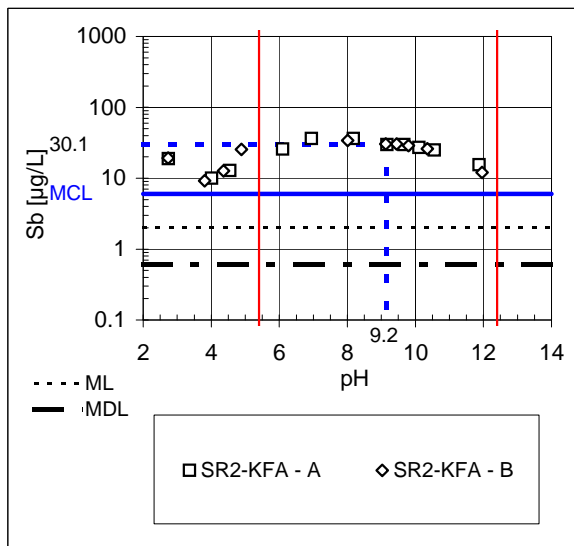
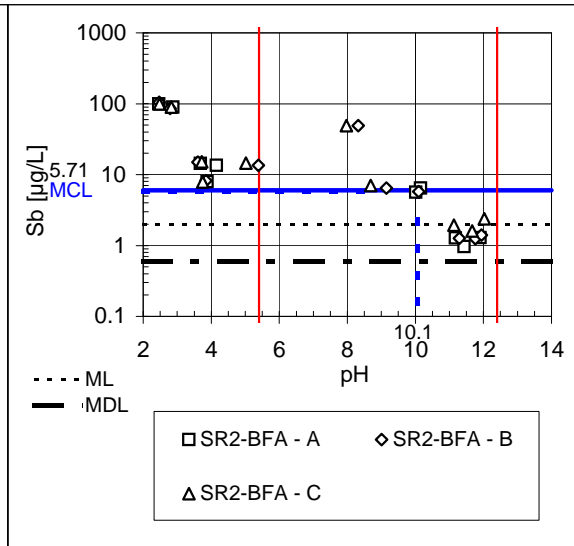
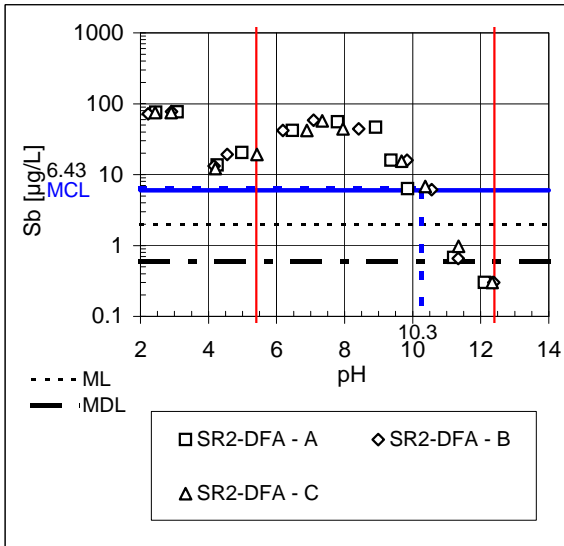
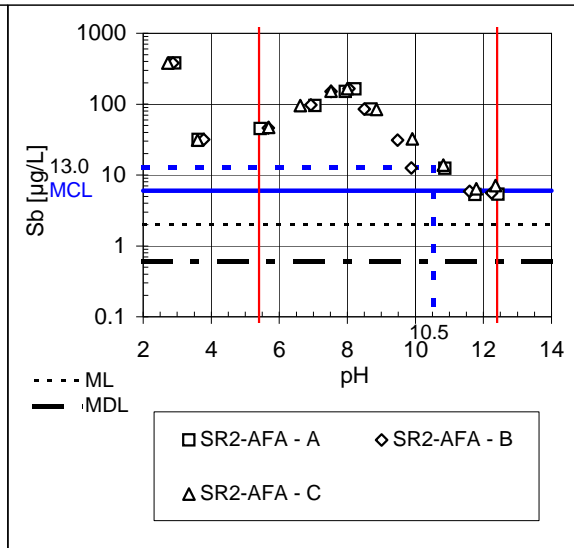

Off

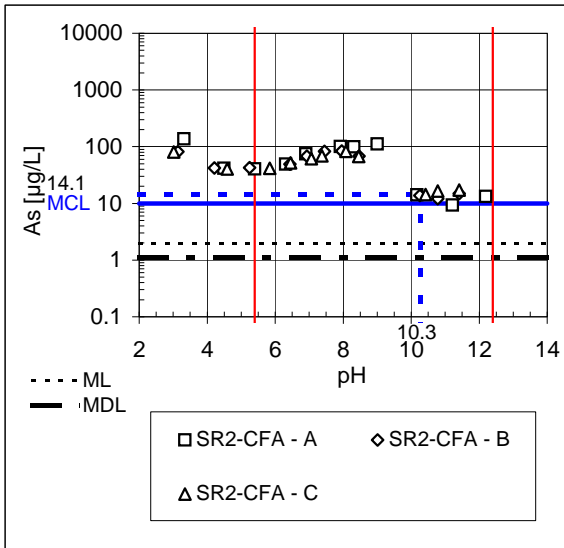

On

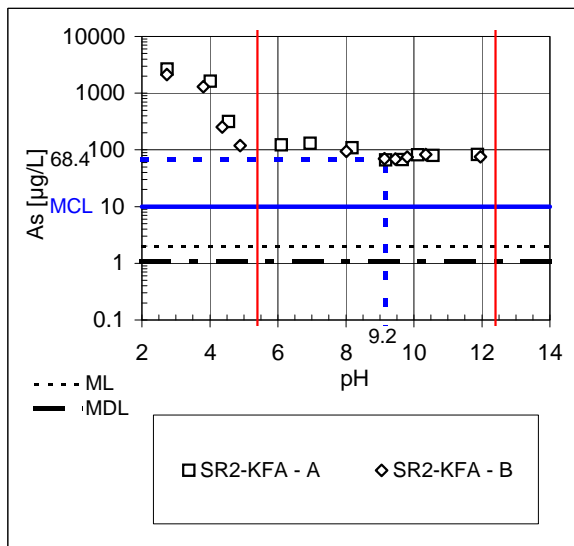
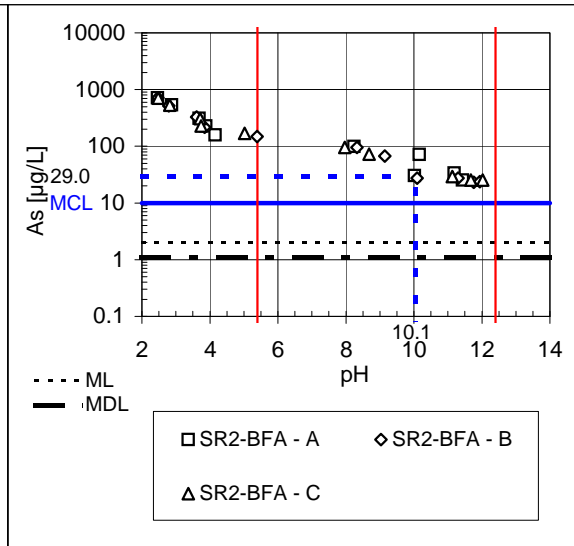
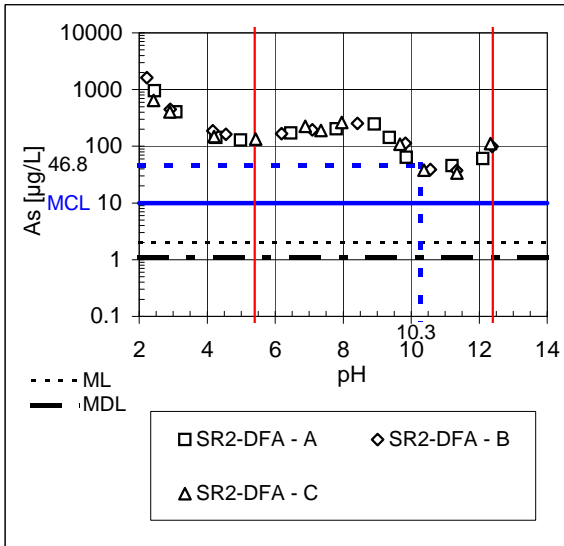
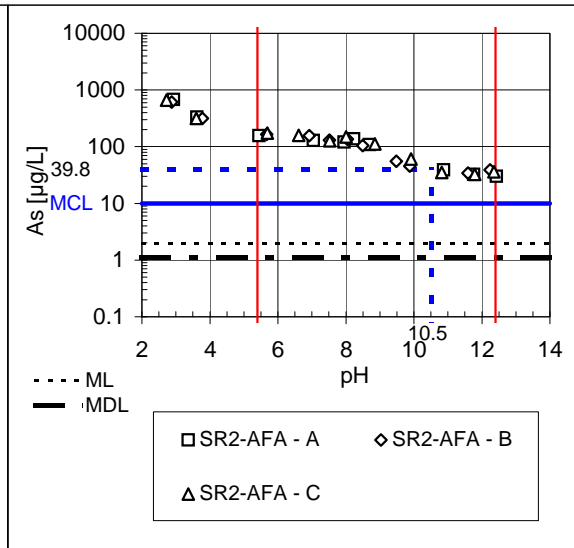

Off

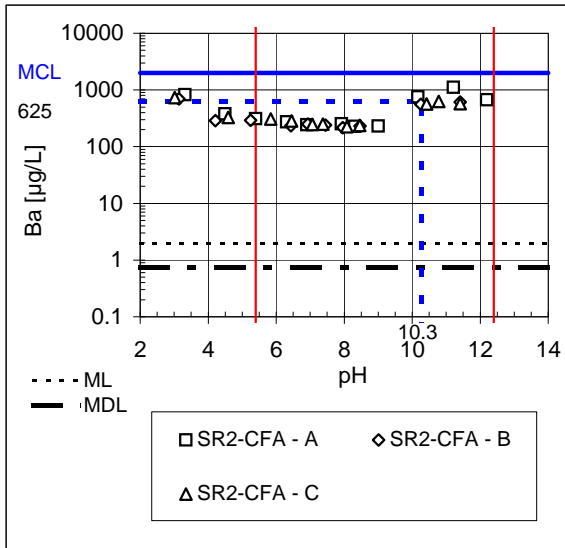

On

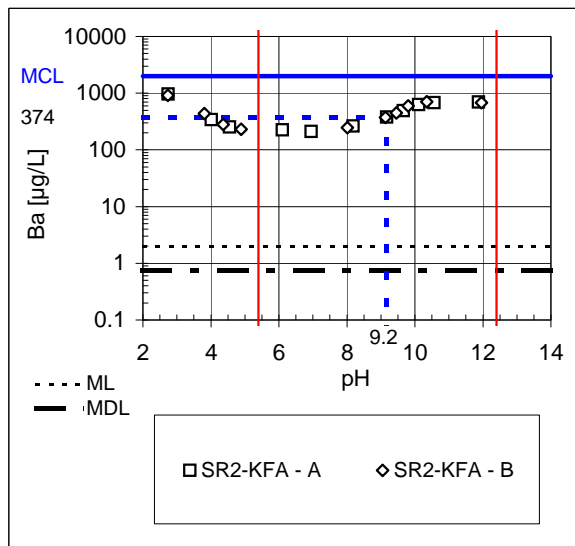
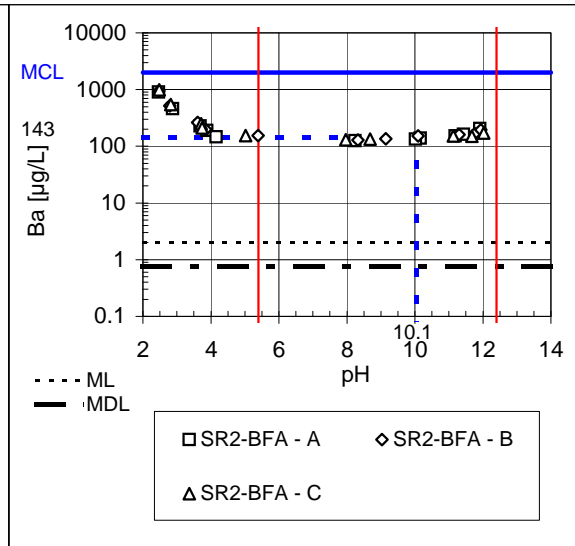
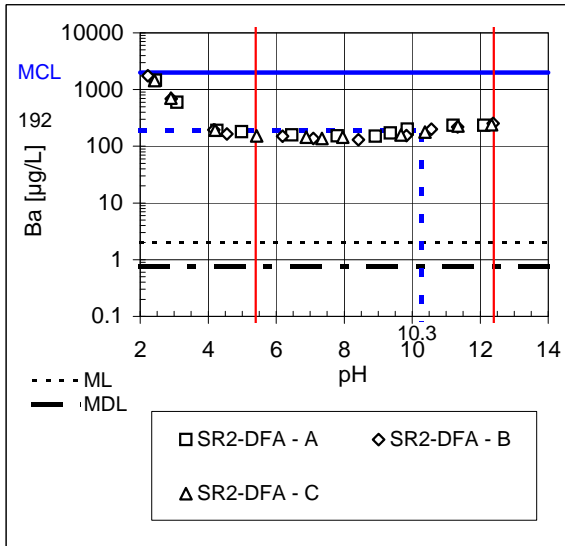
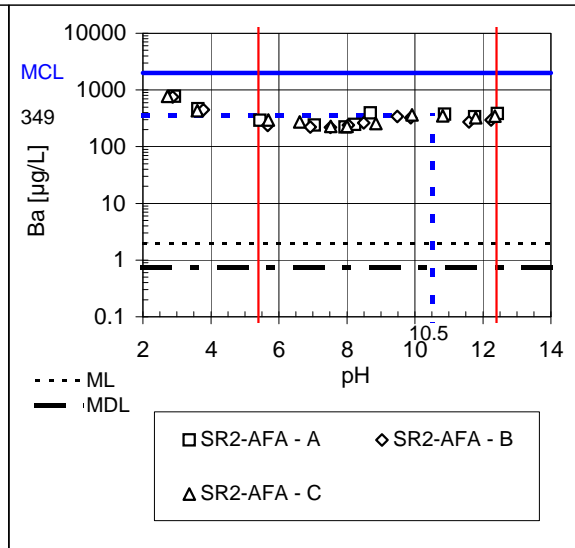

Off

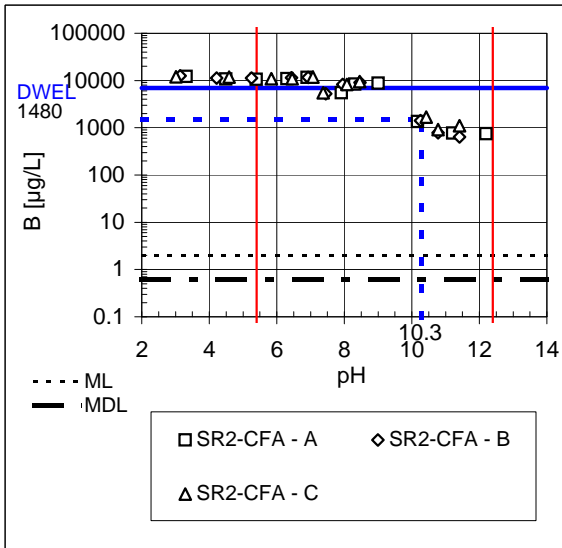

On

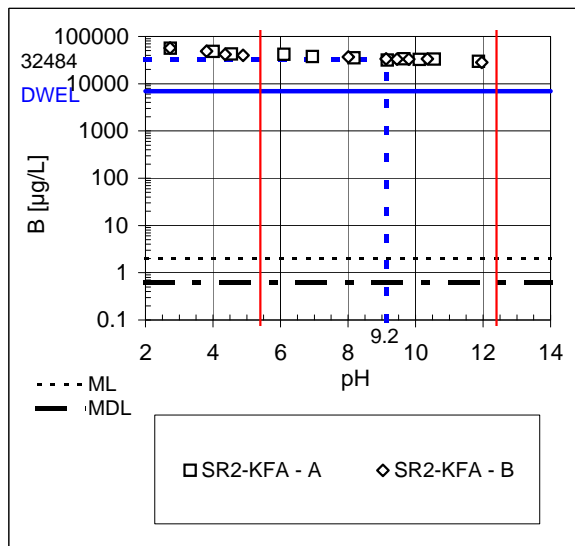
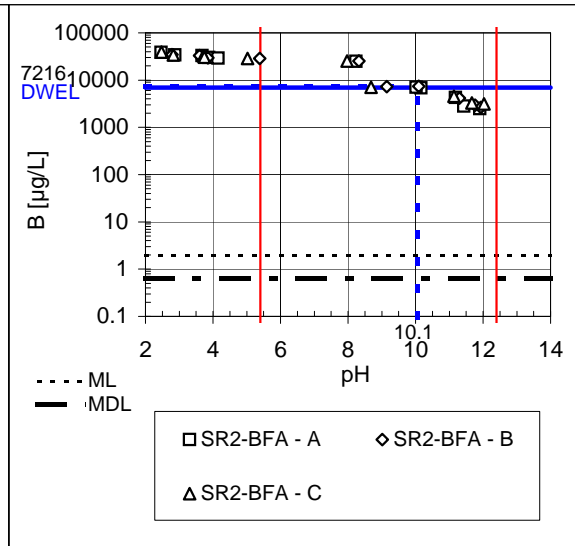
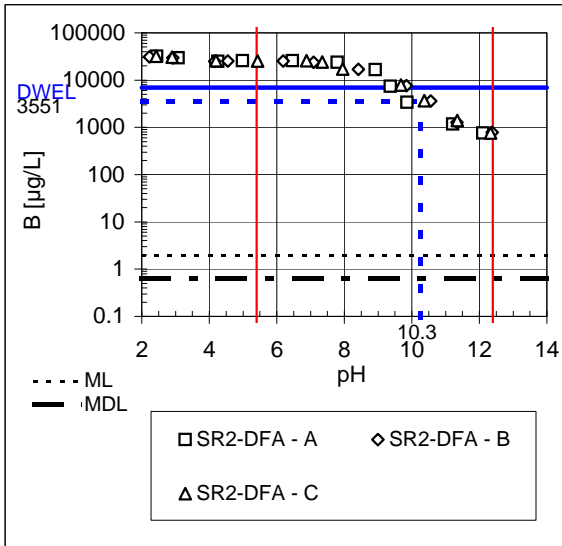
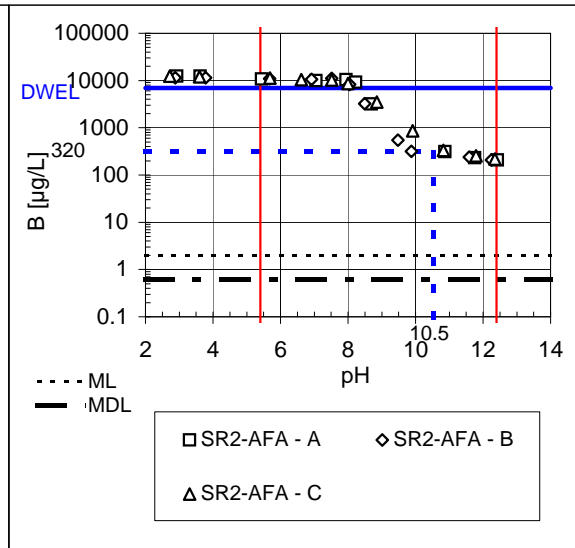

Off

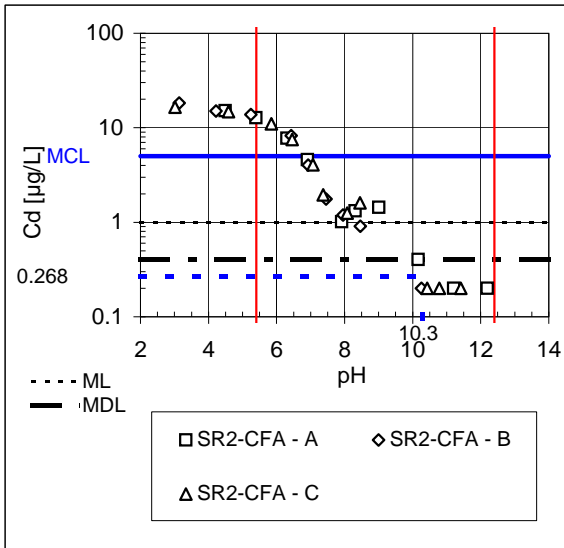

On

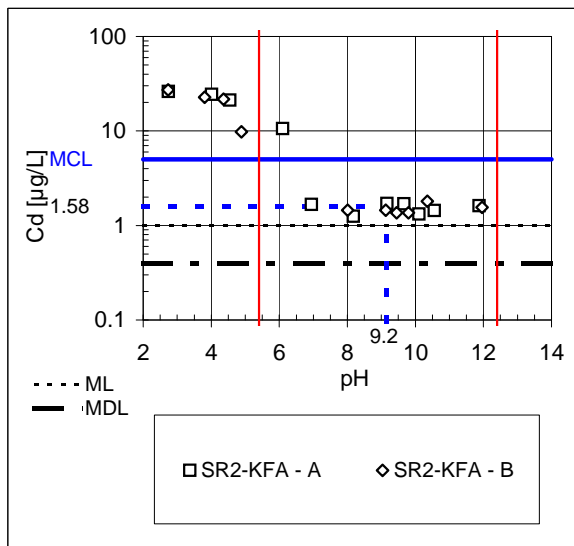
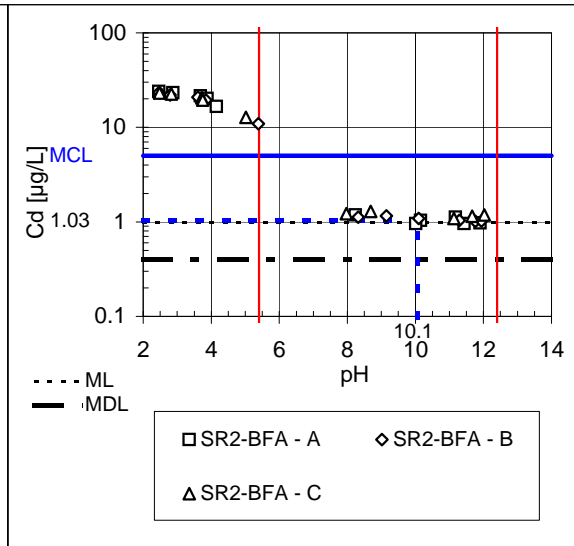
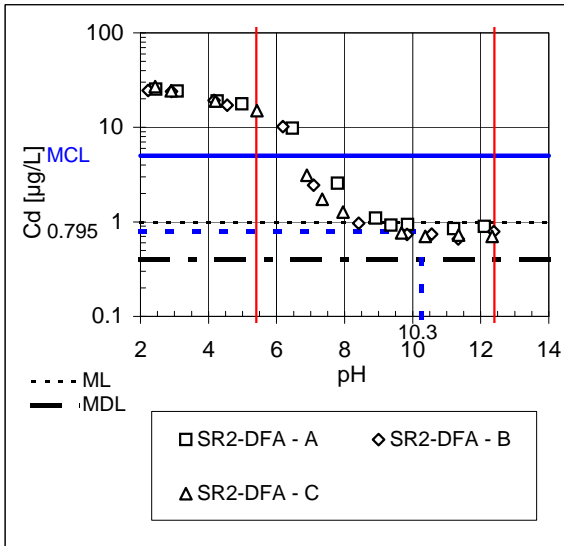
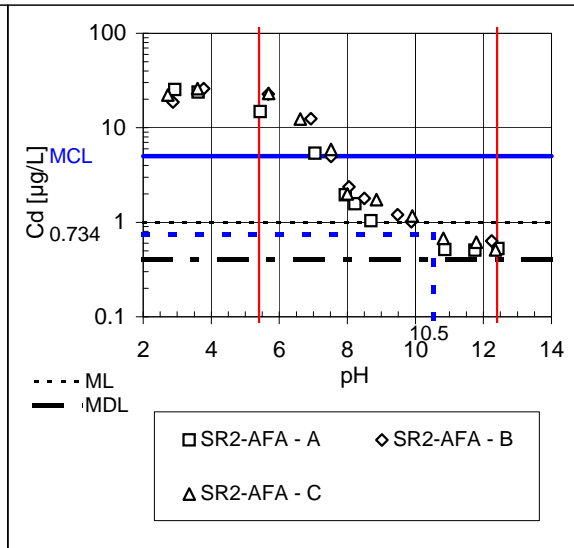

Off

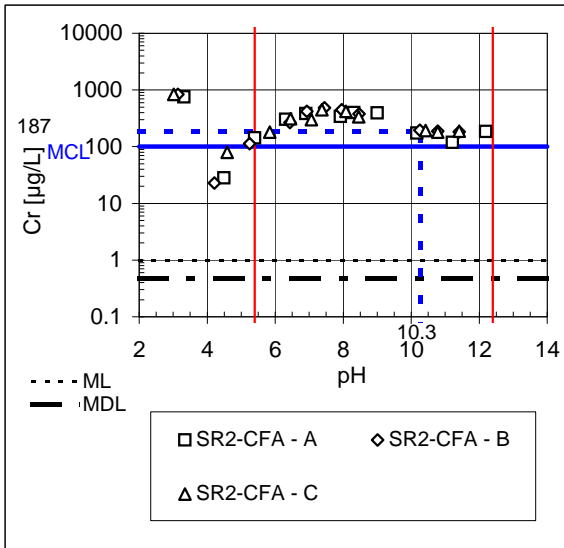

On

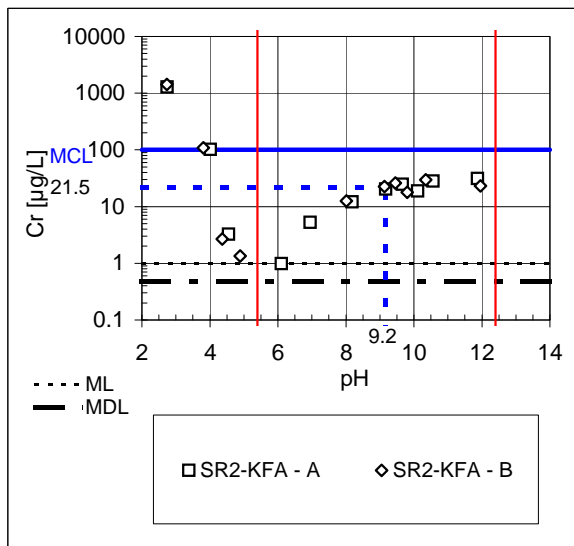
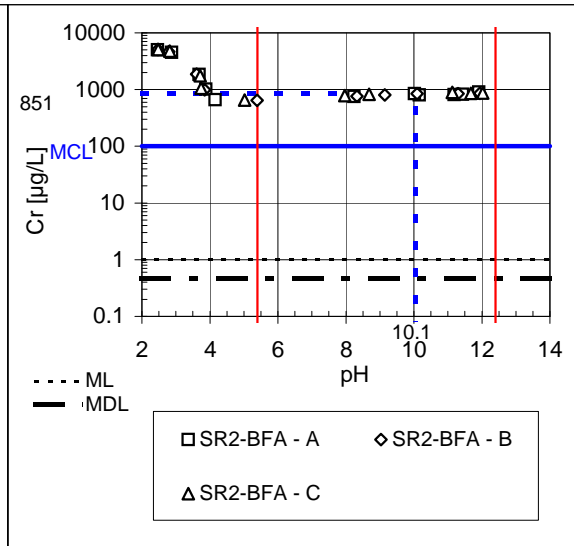
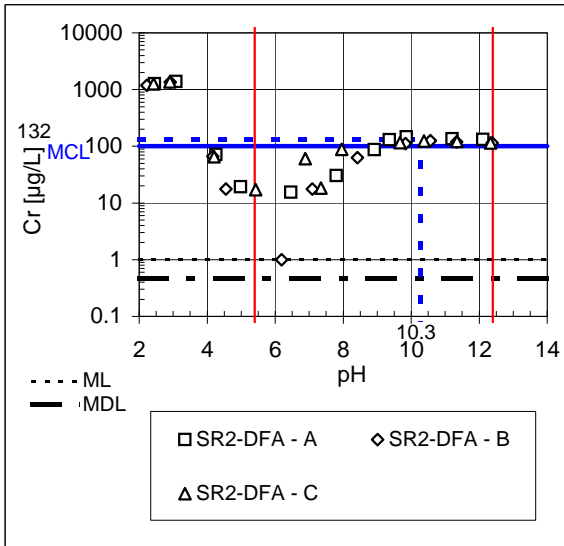
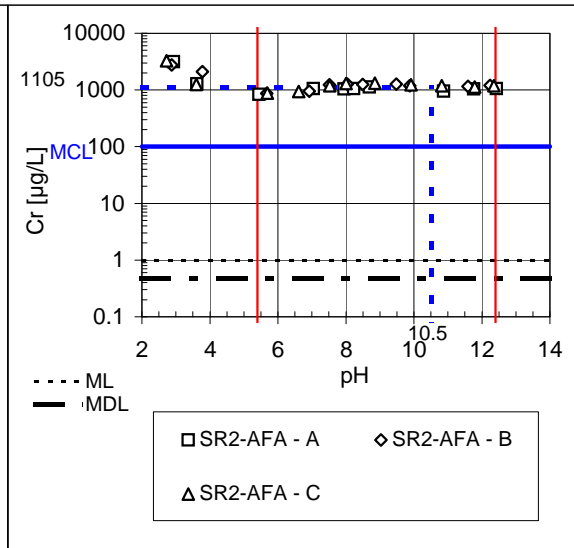

Off

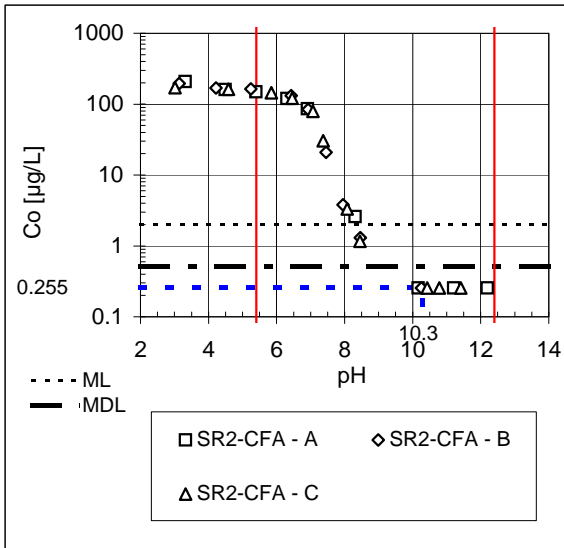

On

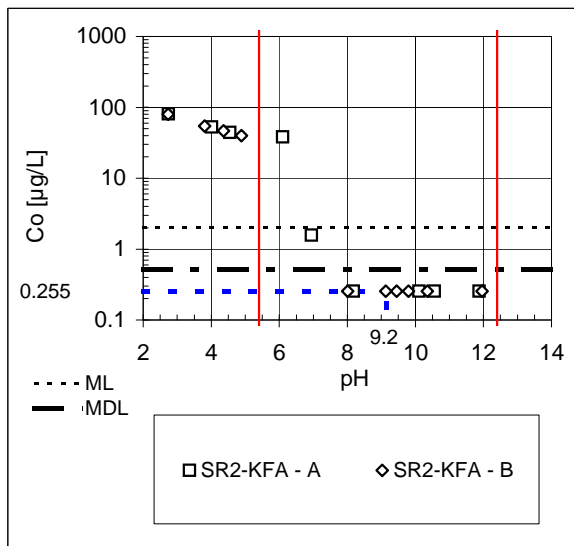
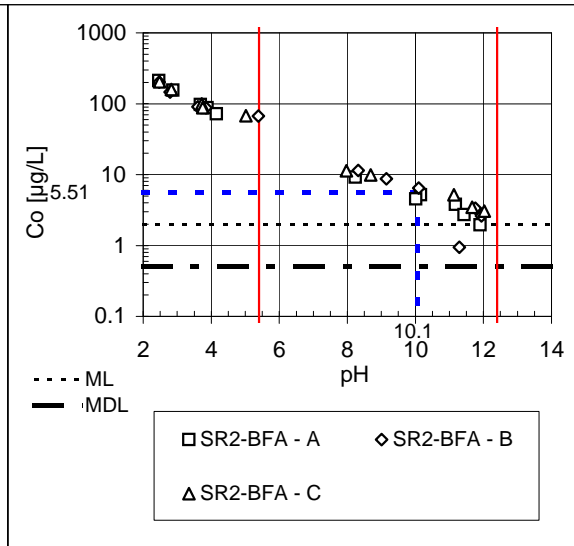
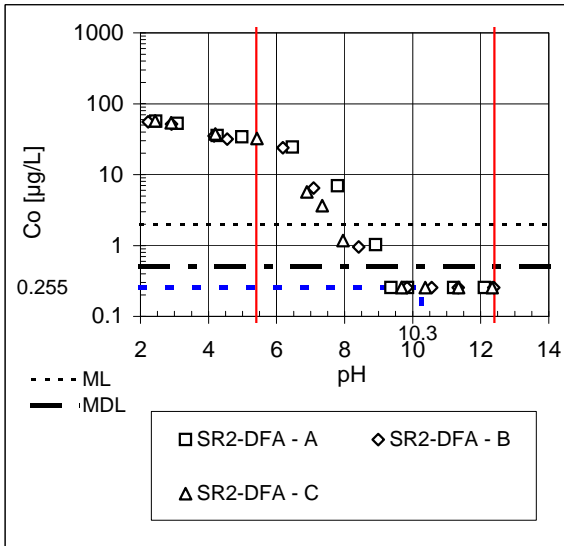
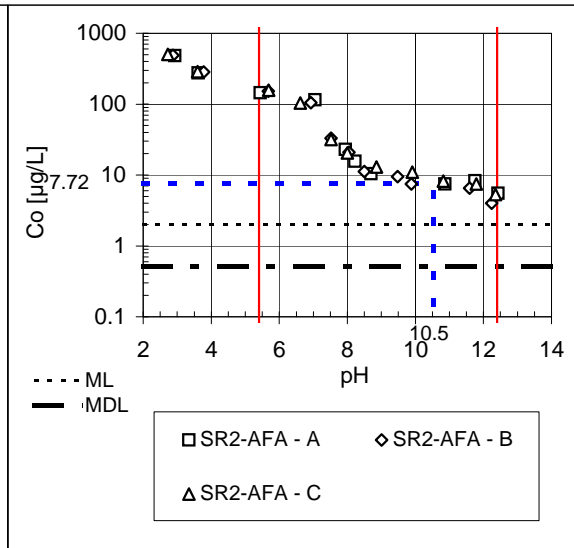

Off

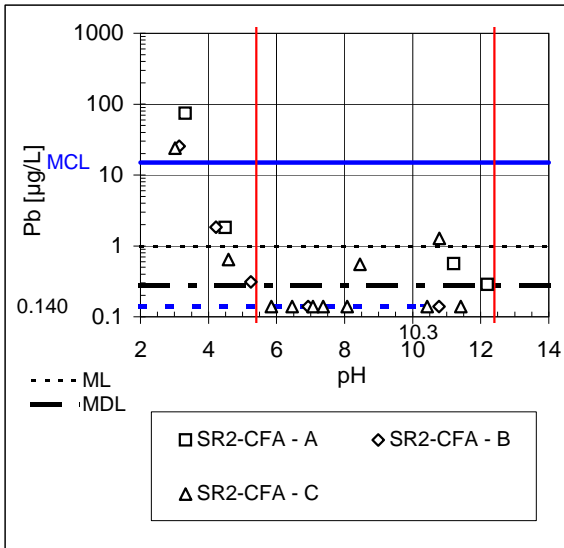

On

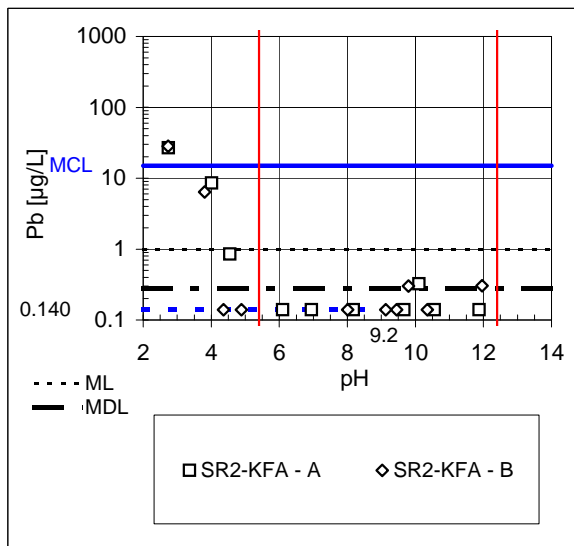
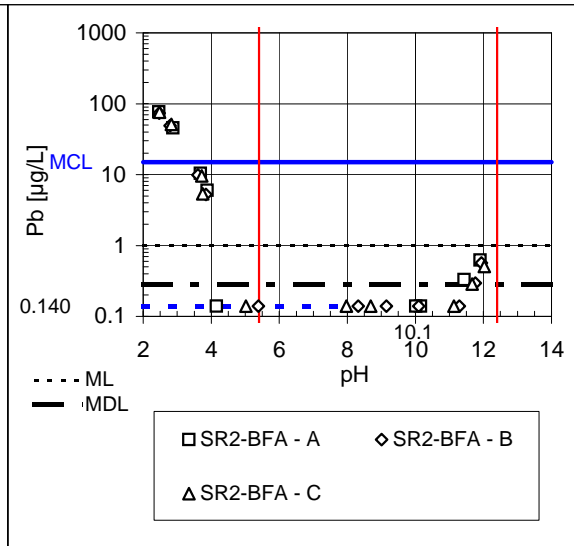
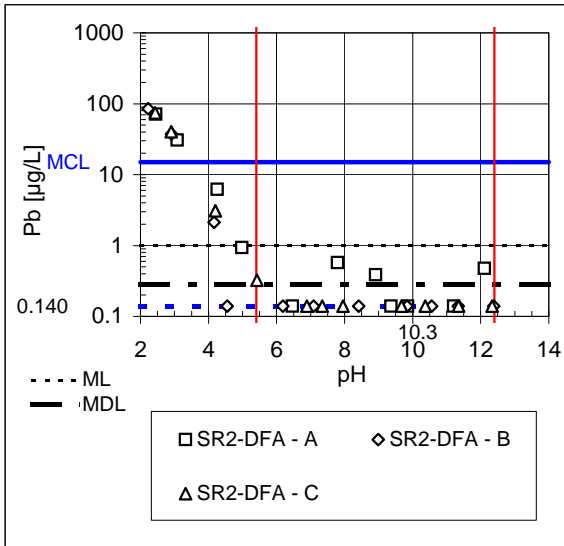
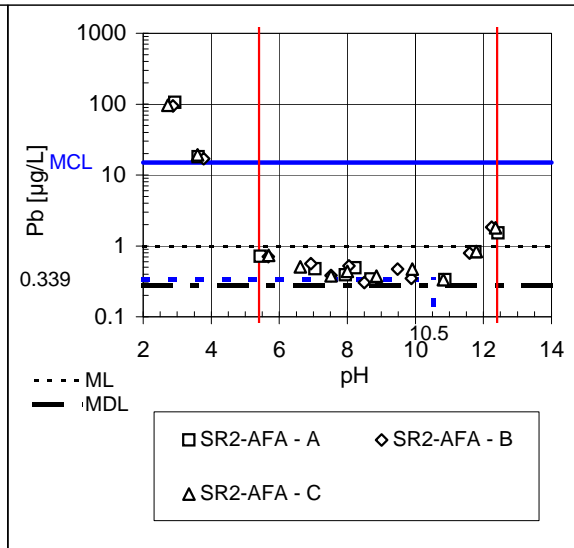

Off

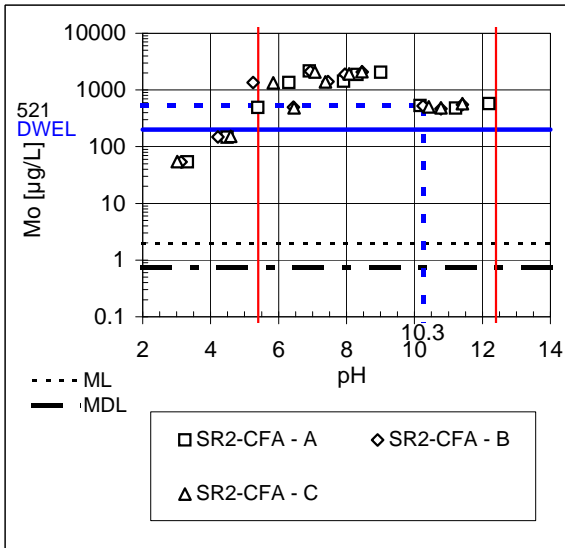

On

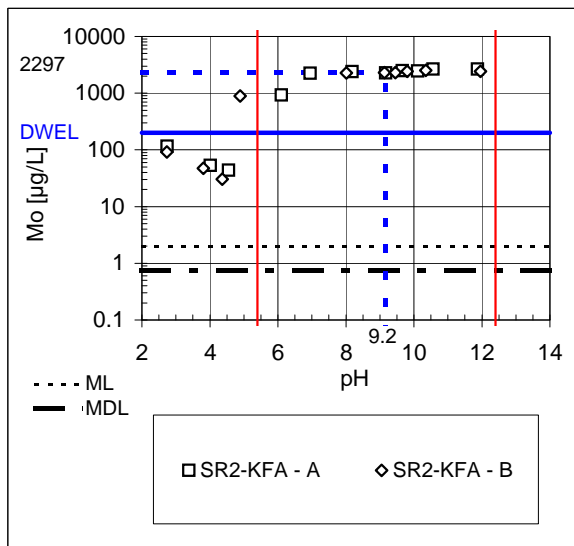
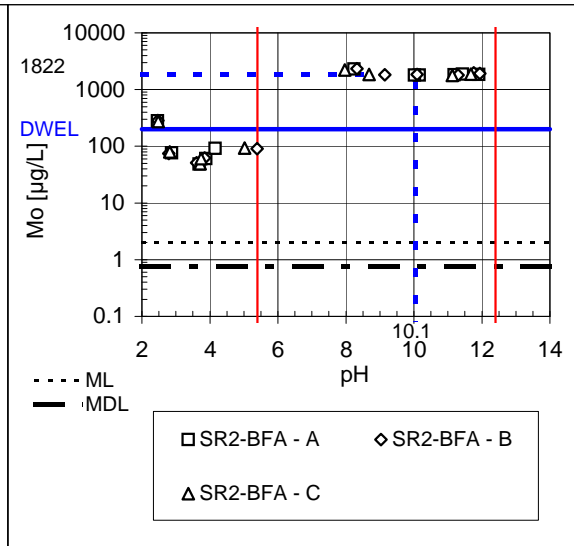
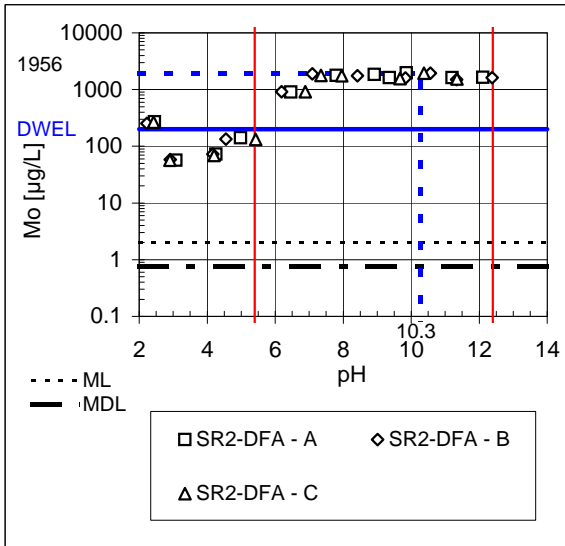
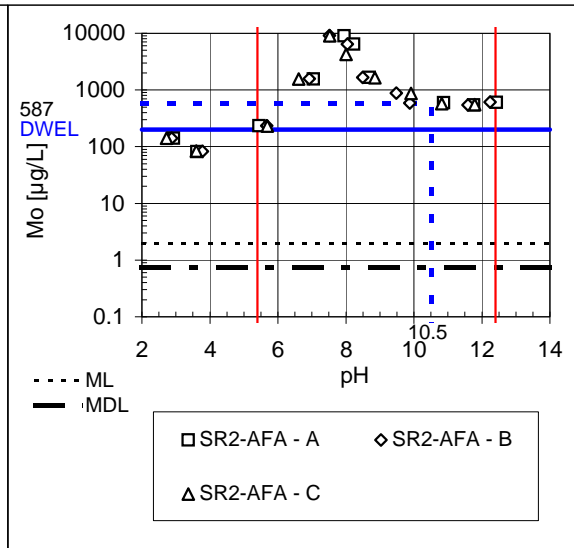

Off

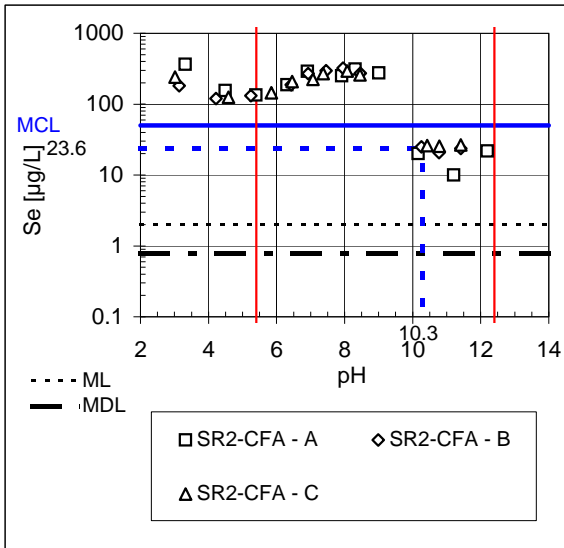

On

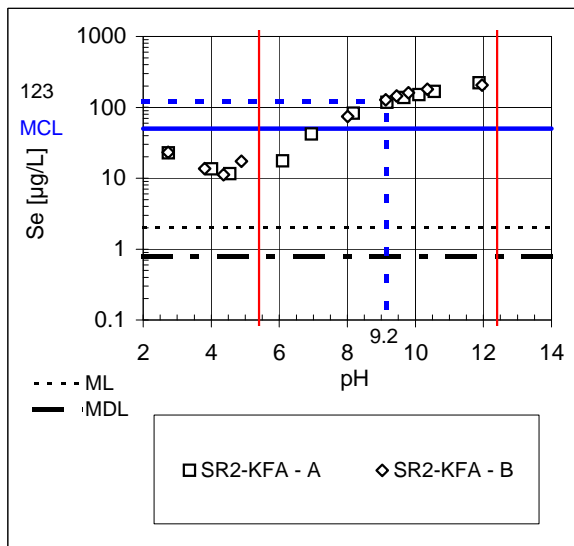
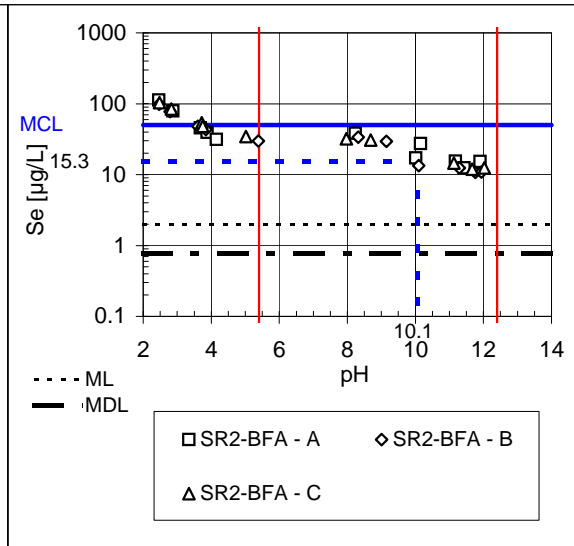
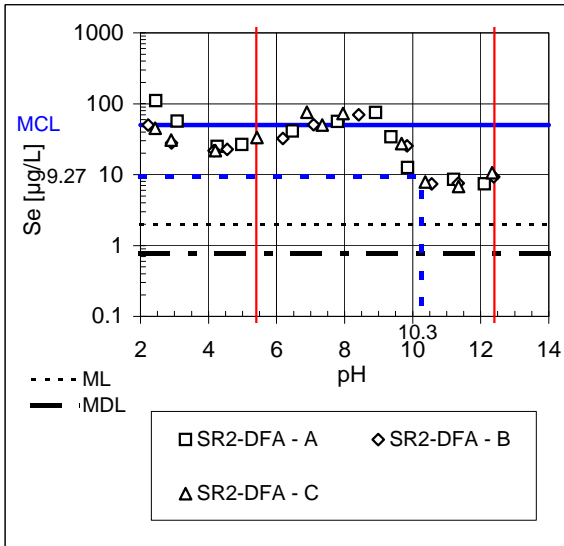
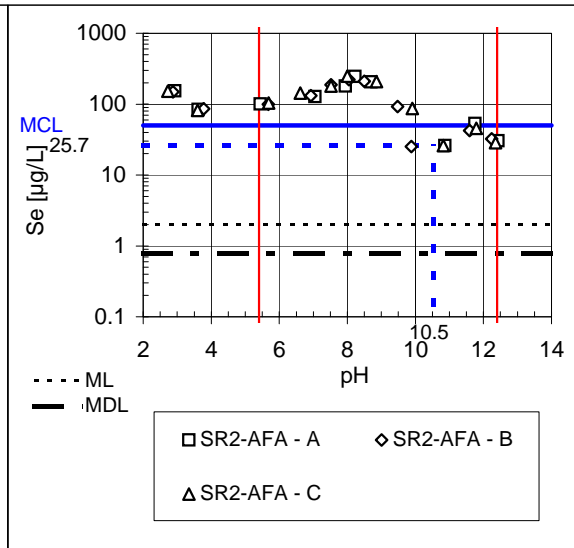

Off

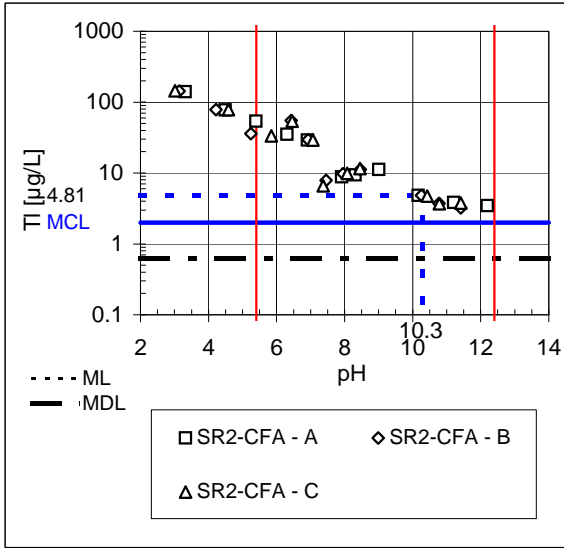

On

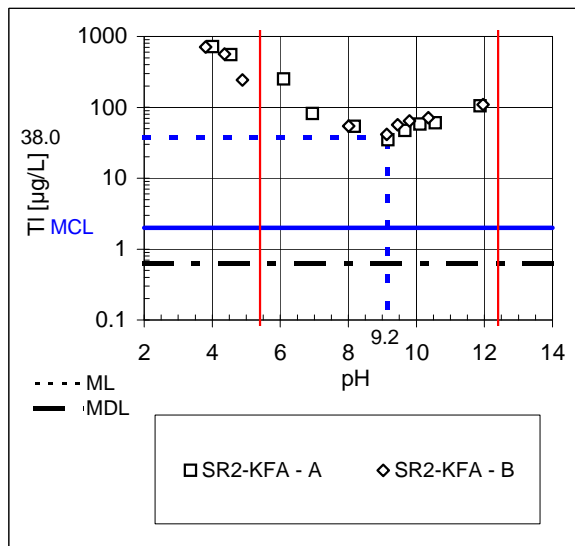
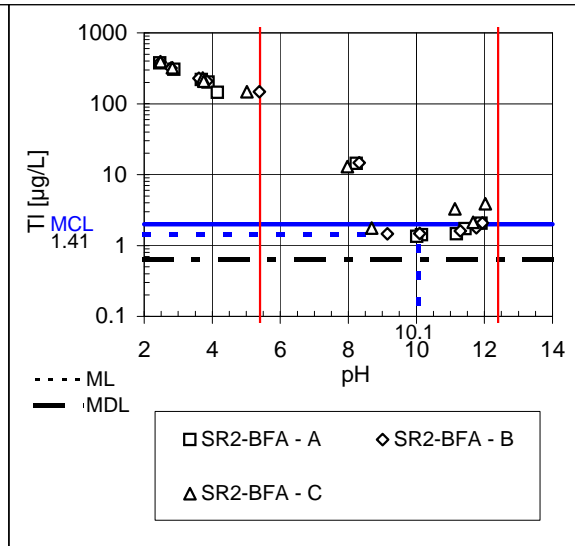
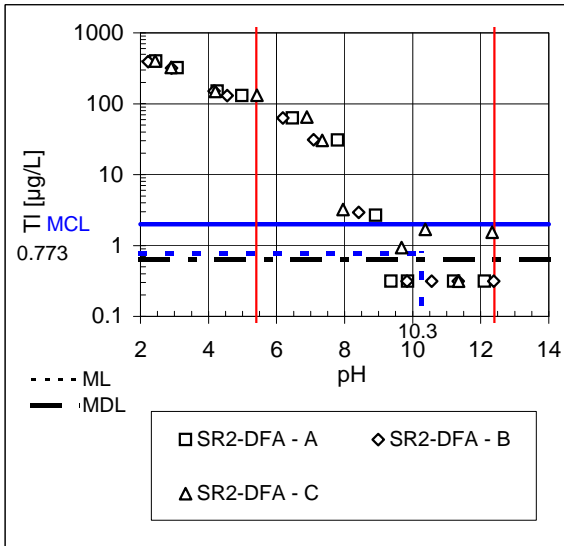
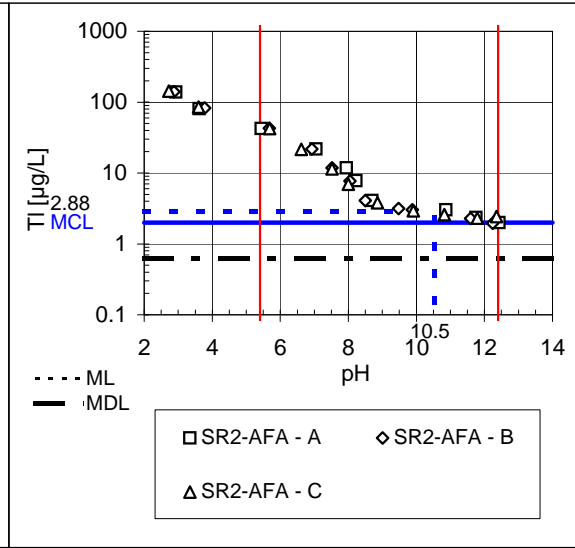

Gypsum (Gyp-U, Gyp-W) Comparisons

Facility N

Coal: bituminous

APC: FO+SCR+ESP(CS)

Gyp-U

Gyp-W

NAU
(unwashed)

NAW
(washed)

Facility O

Coal: bituminous

APC: FO+SCR+ESP(CS)

OAU
(unwashed)

OAW
(washed)

Facility P

Coal: bituminous

APC: FO+ SCR & SNCR +ESP(CS)

PAD (U)
(unwashed)

QAU
(unwashed)

Facility Q

Coal: sub-bituminous

APC: FO+SCR+ESP(CS)



Gypsum Comparison

Gyp-U

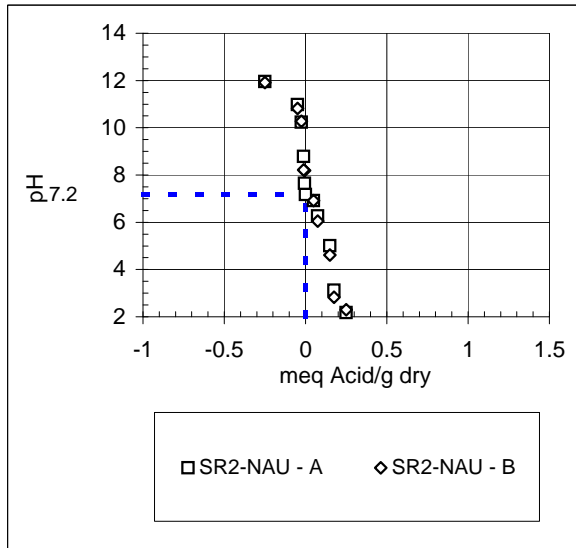

Gyp-W

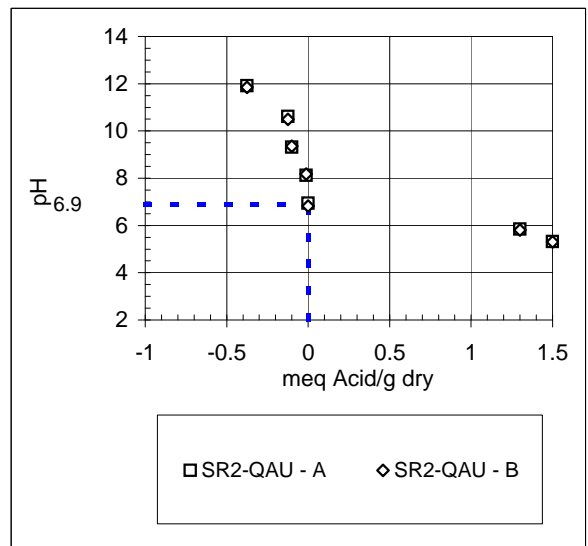
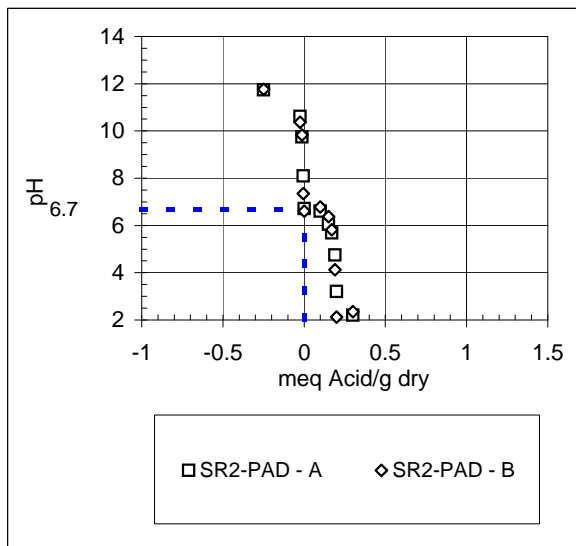
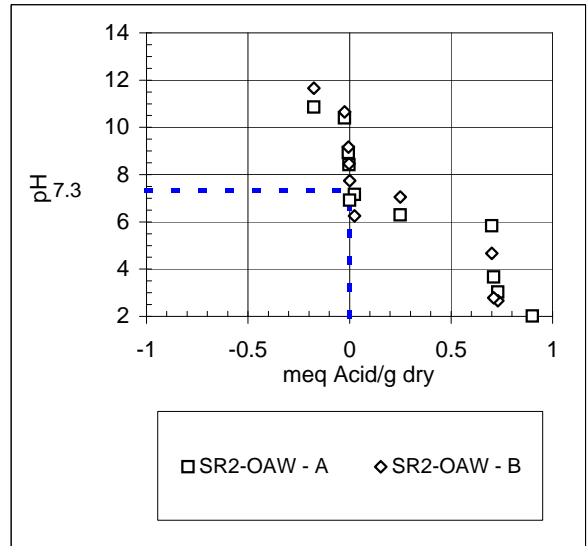
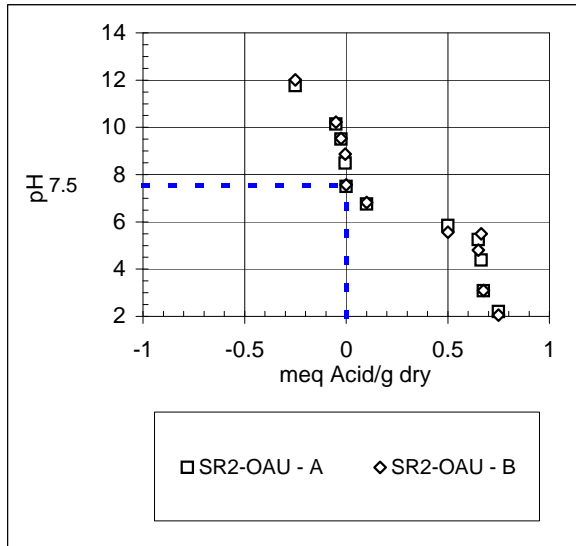
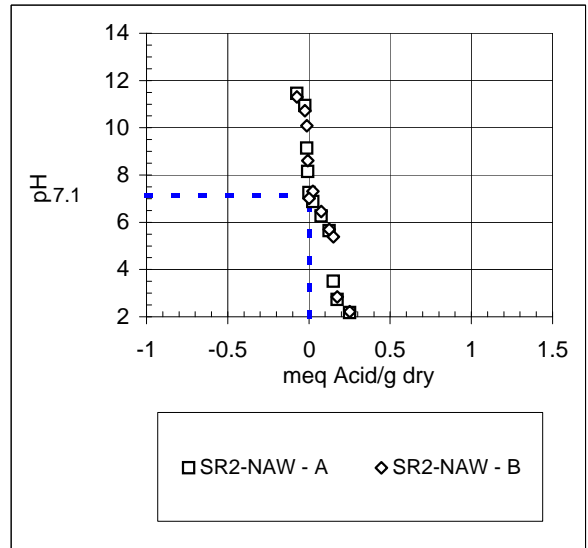

Gyp-U

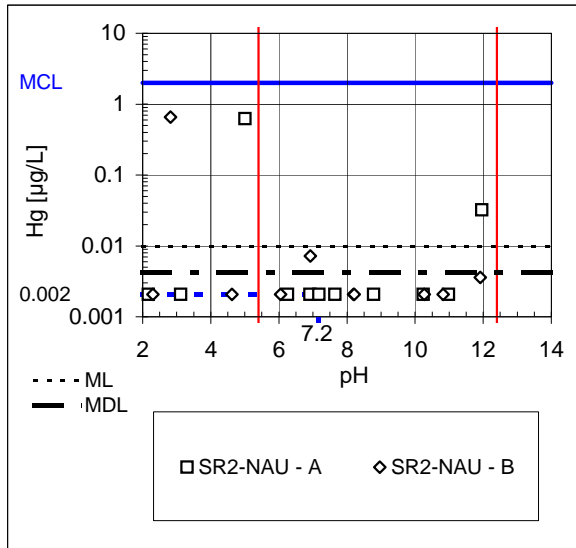

Gyp-W

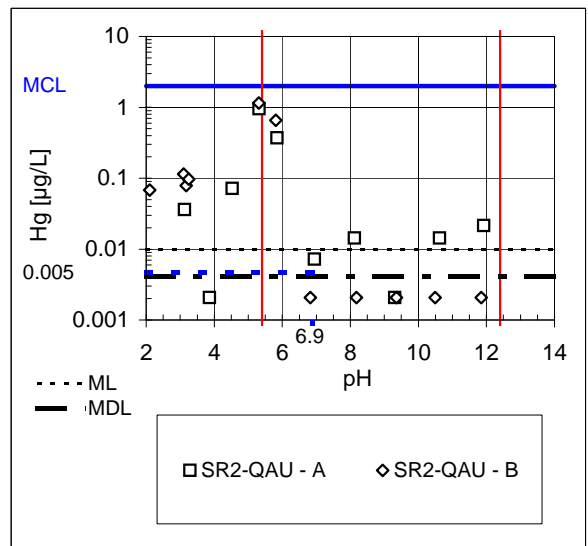
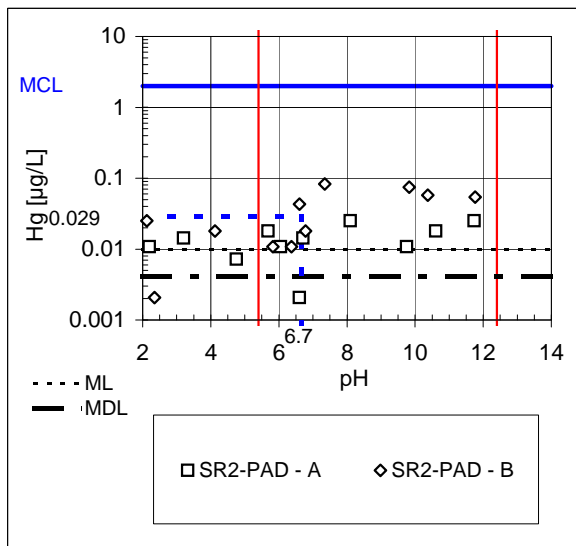
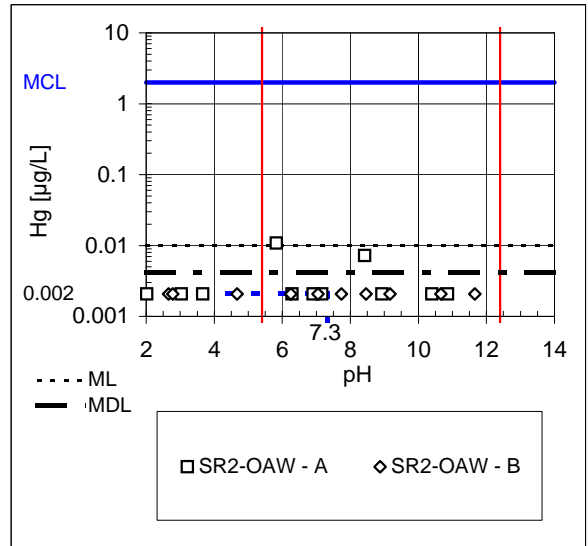
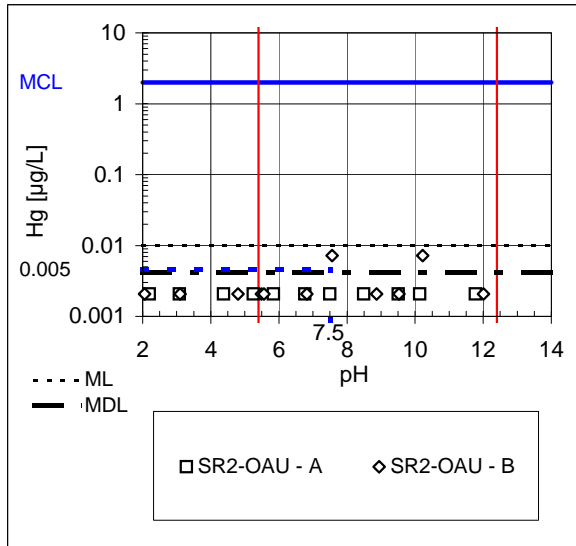
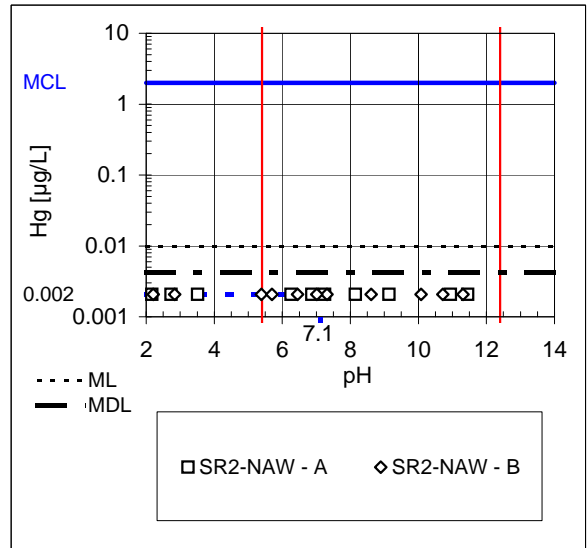

Gyp-U

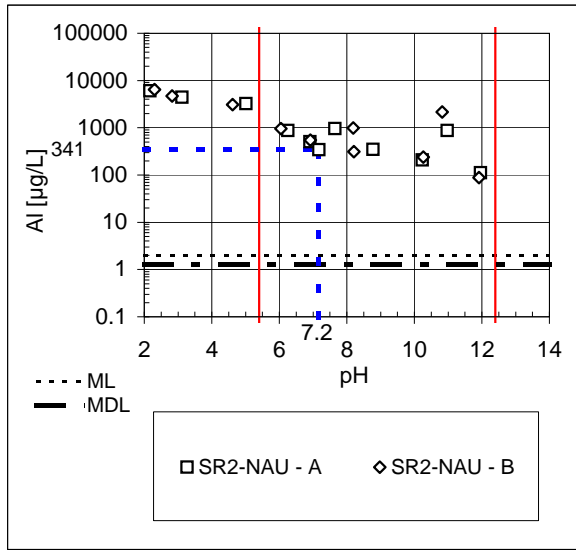

Gyp-W

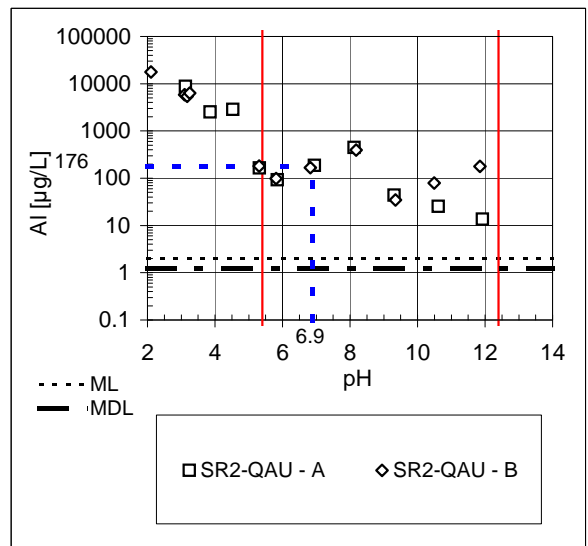
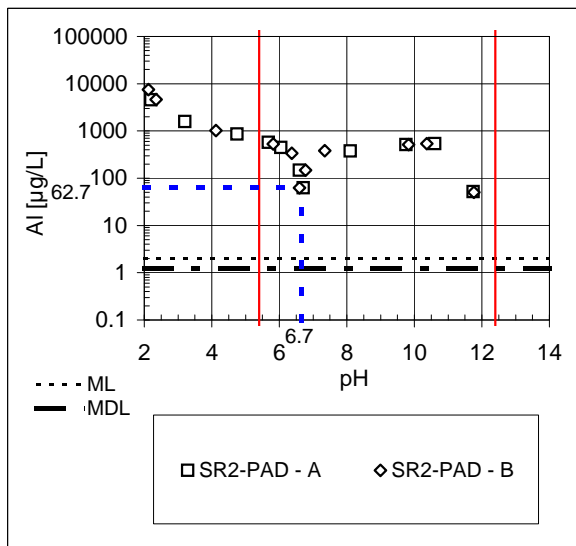
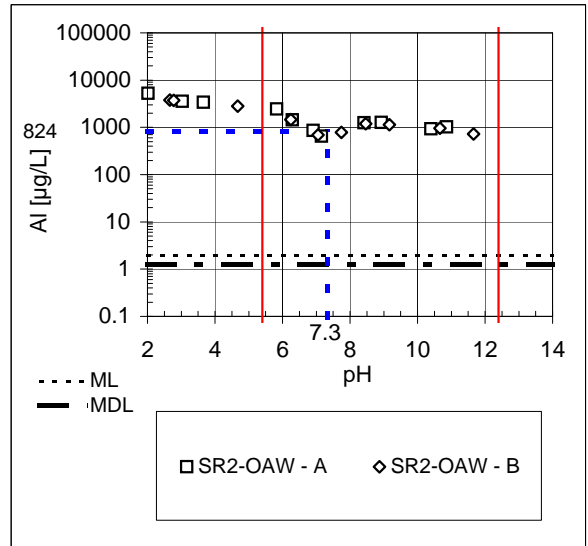
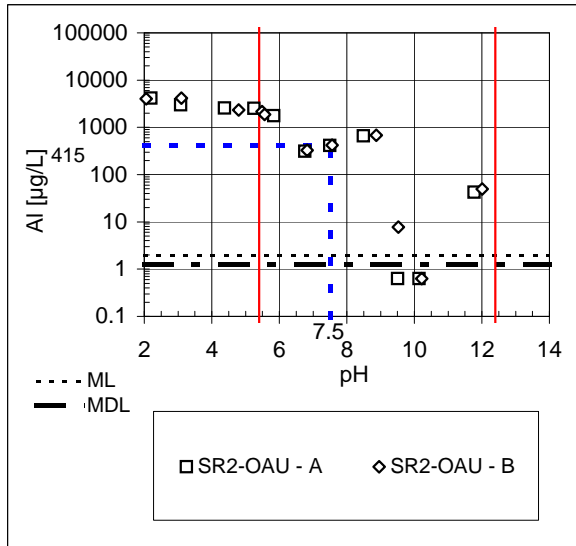
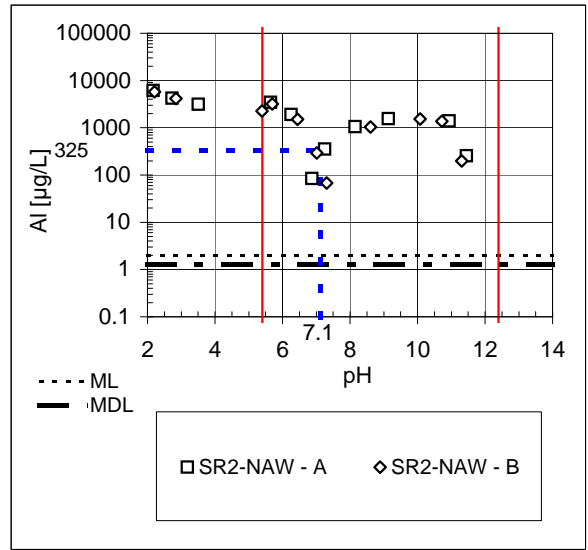

Gyp-U

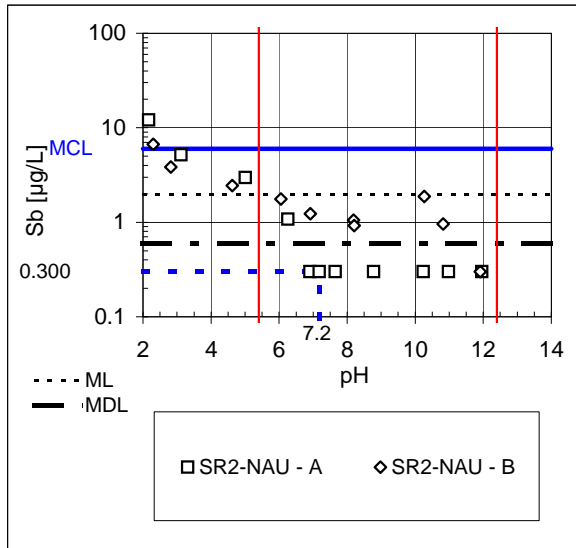

Gyp-W

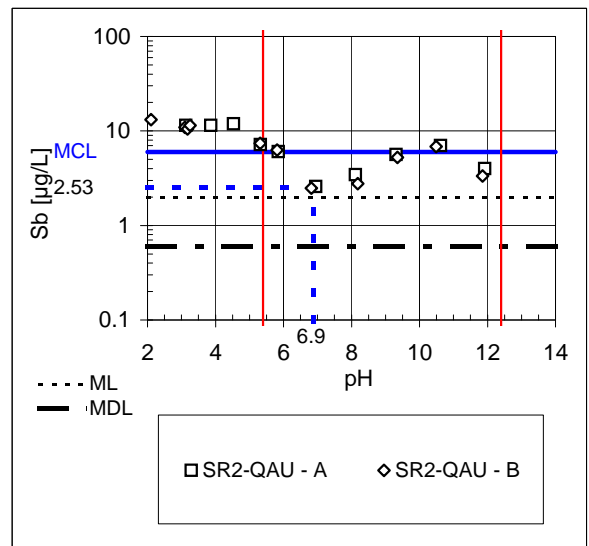
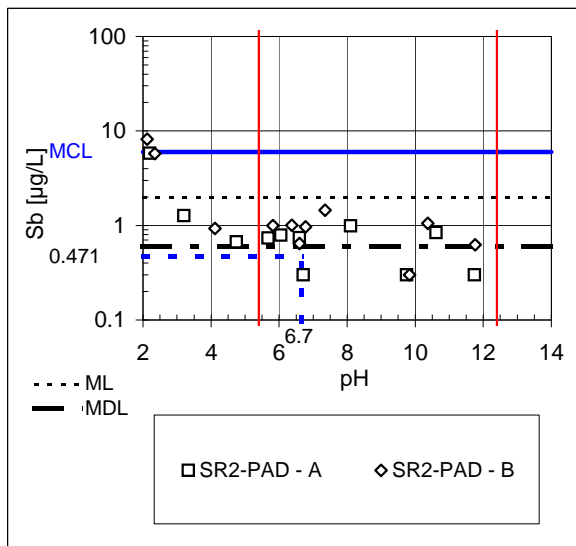
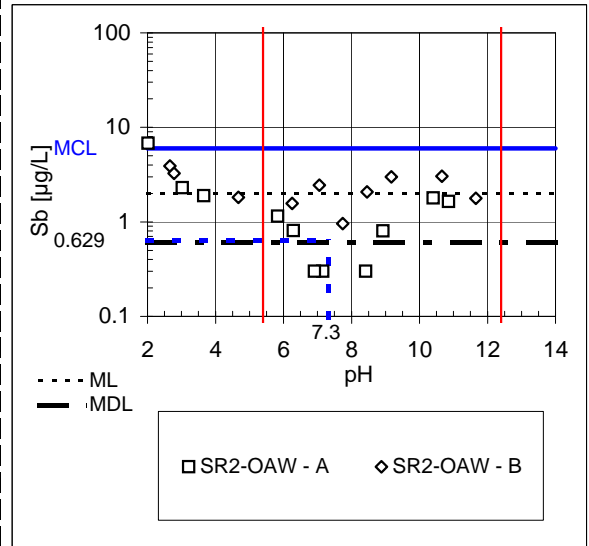
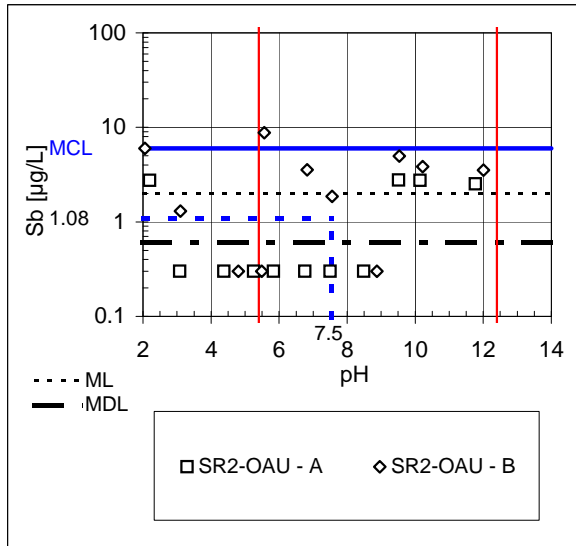
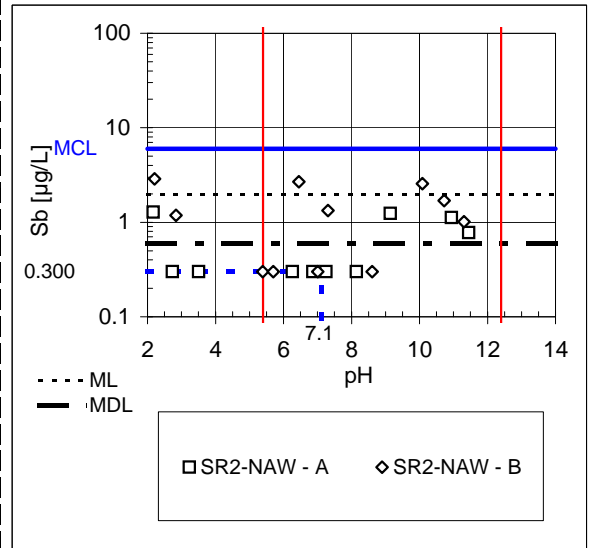

Gyp-U

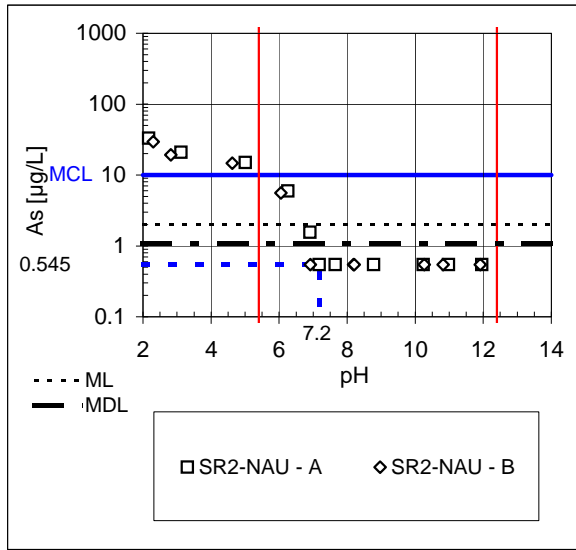

Gyp-W

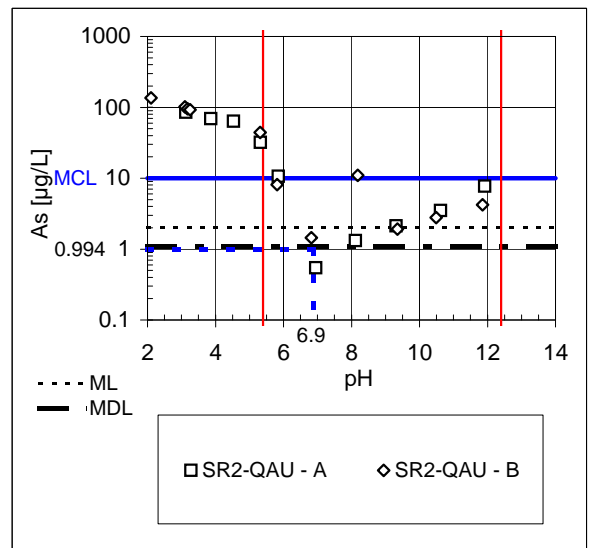
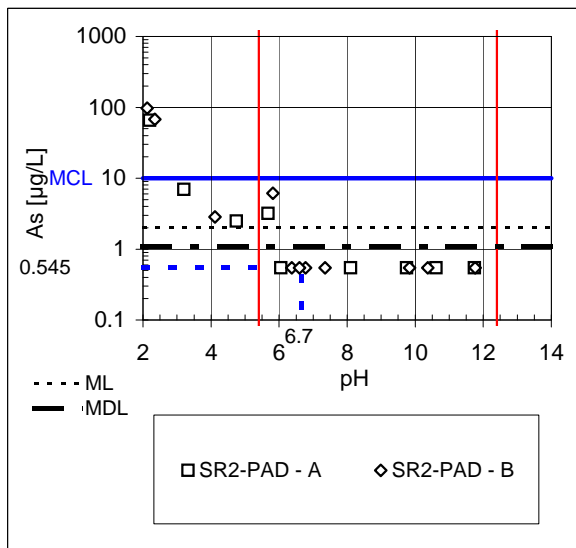
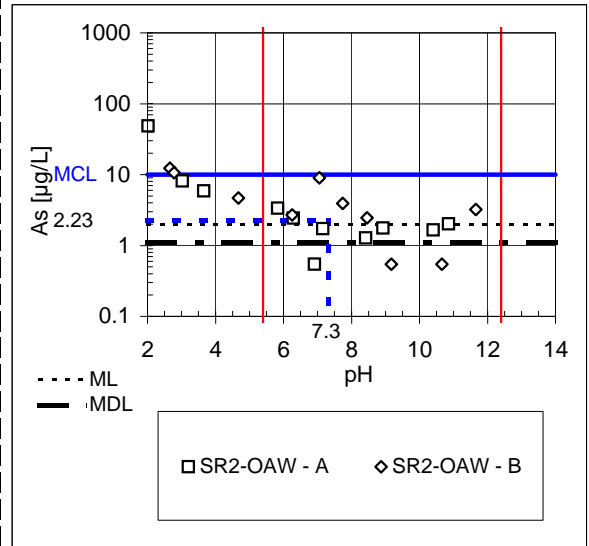
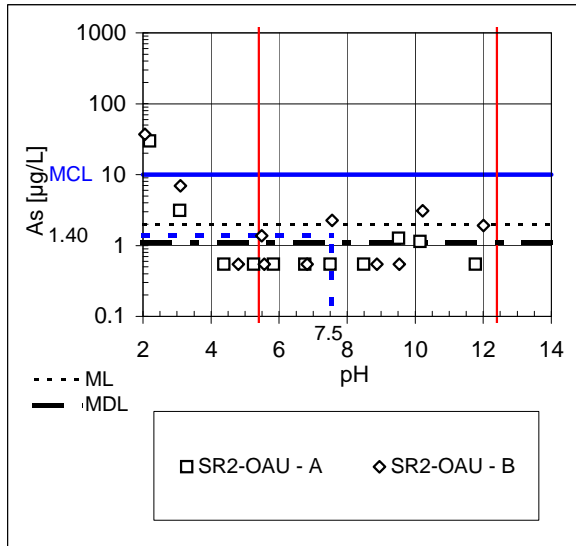
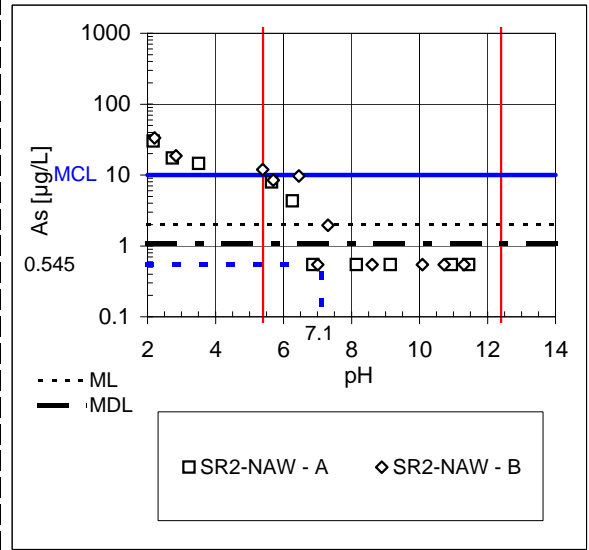

Gyp-U

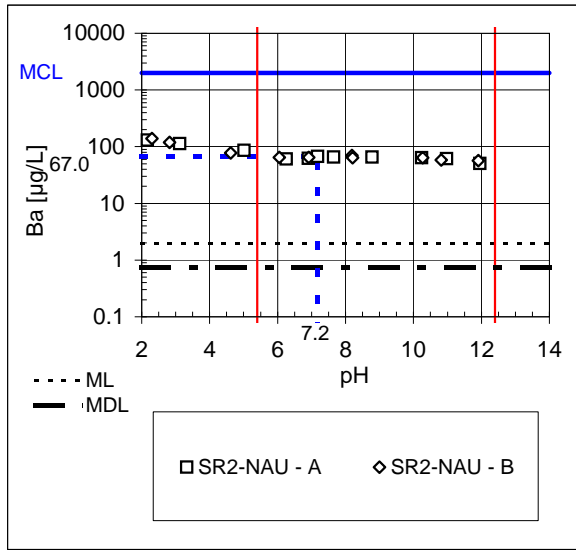

Gyp-W

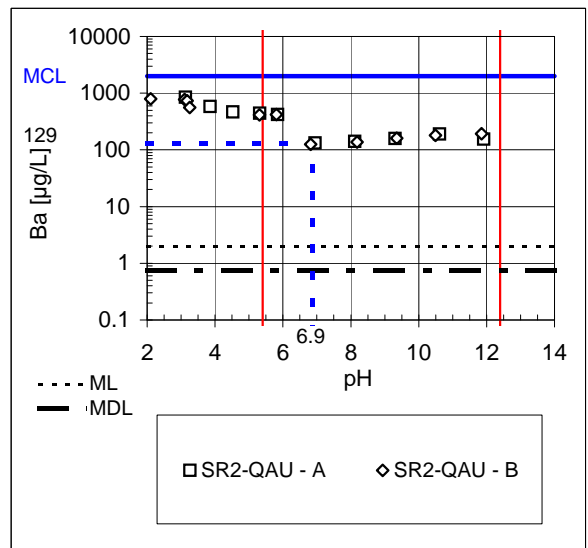
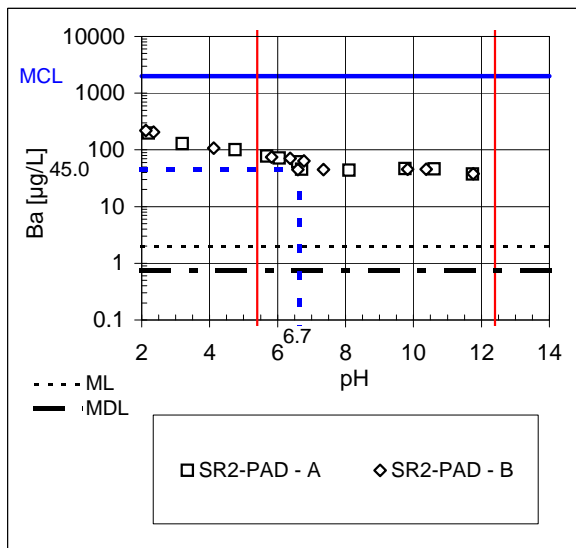
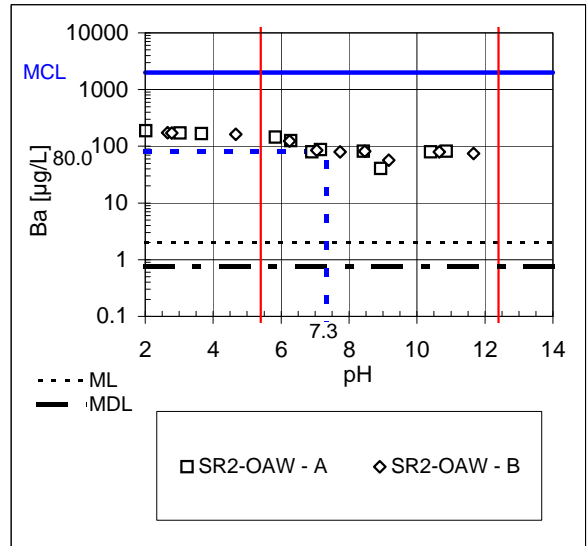
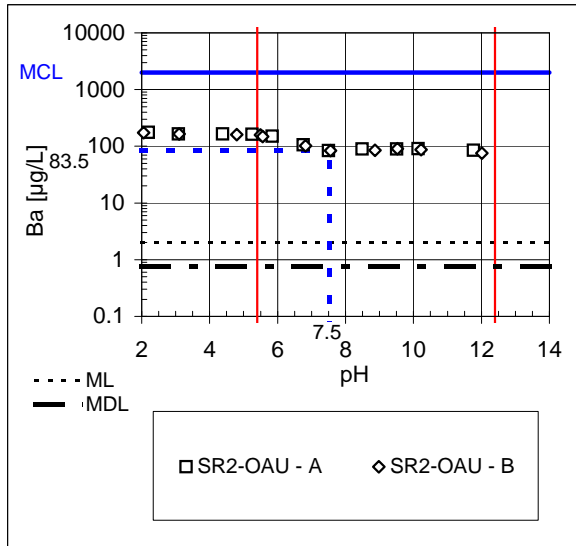
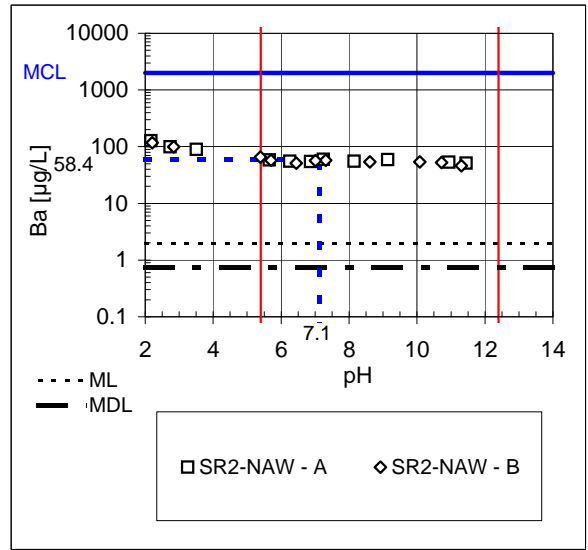

Gyp-U

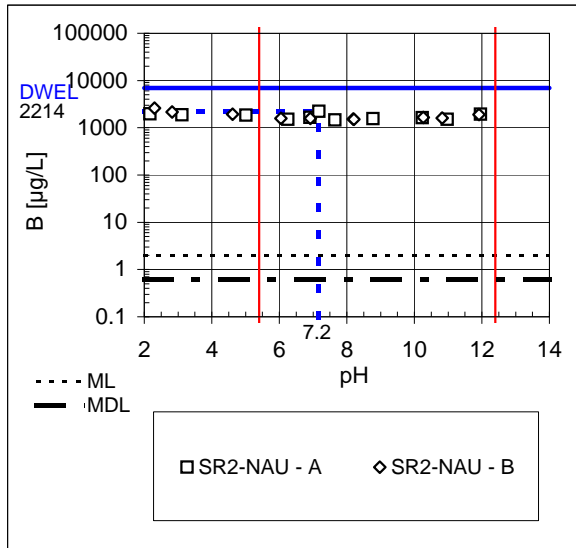

Gyp-W

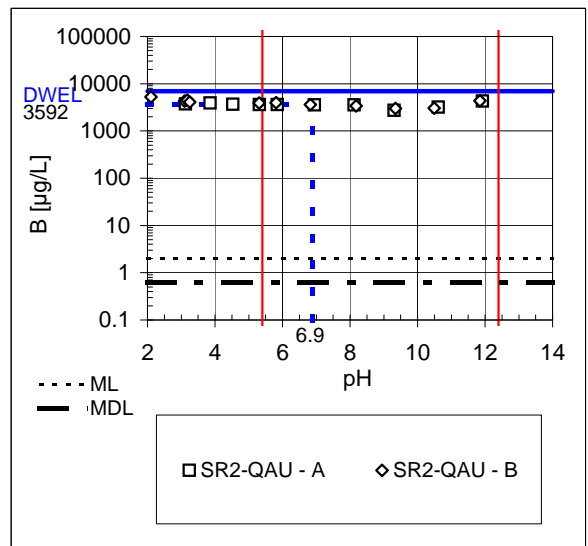
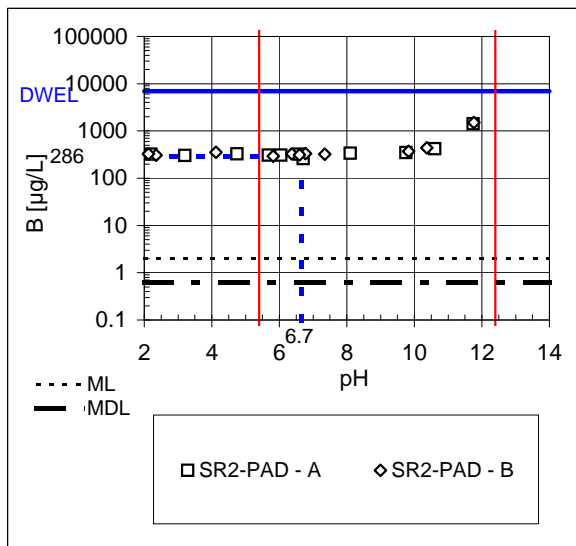
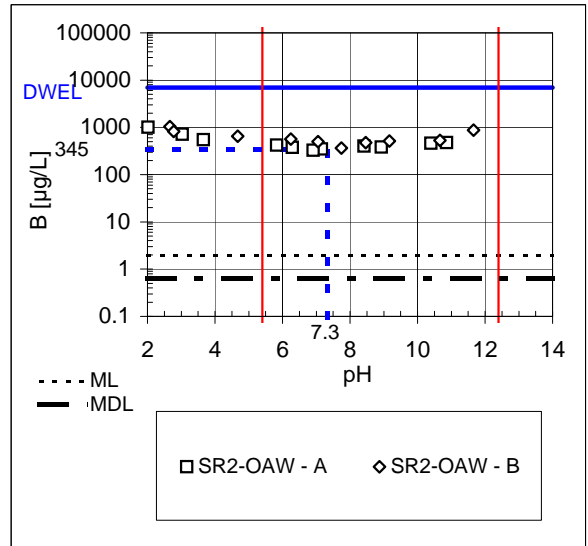
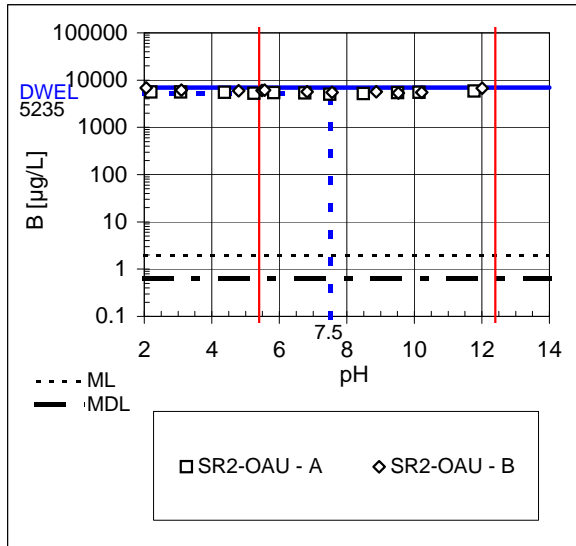
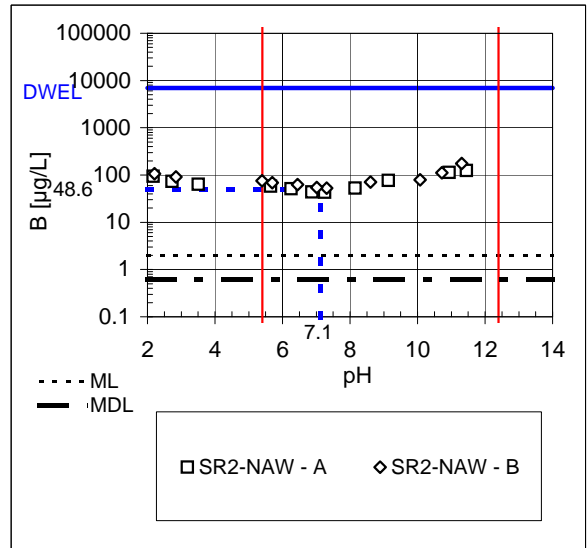

Gyp-U

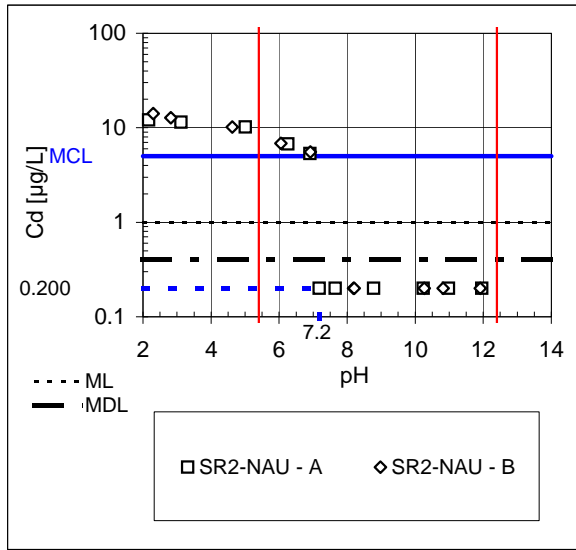

Gyp-W

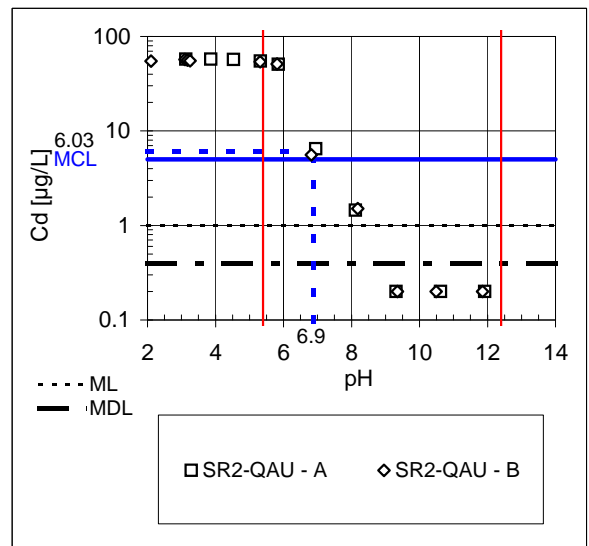
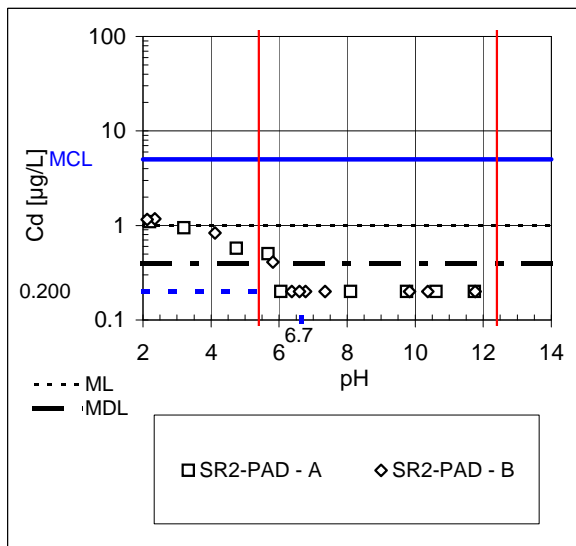
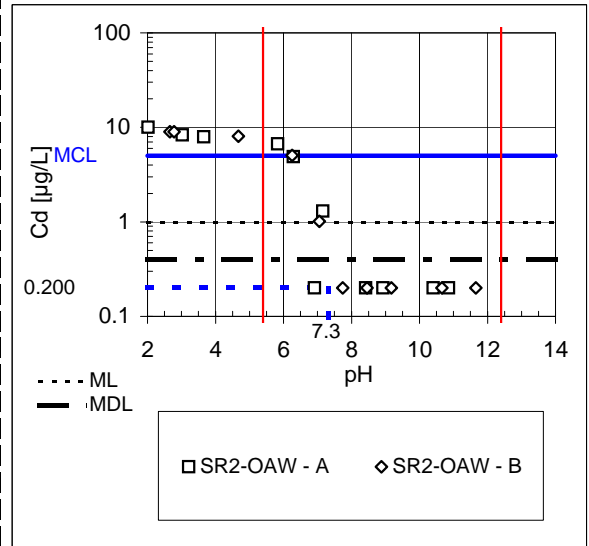
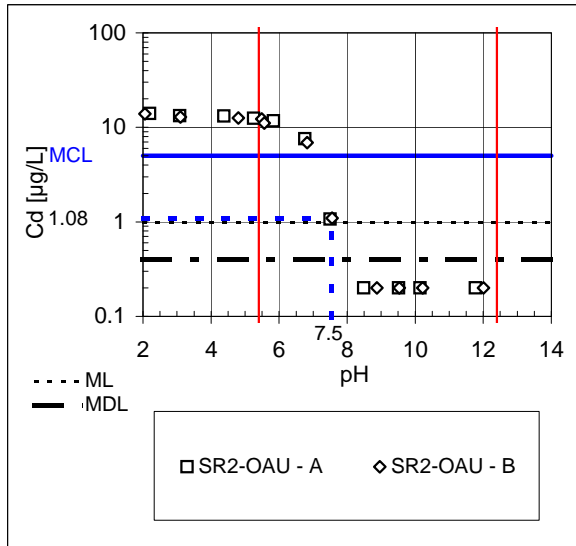
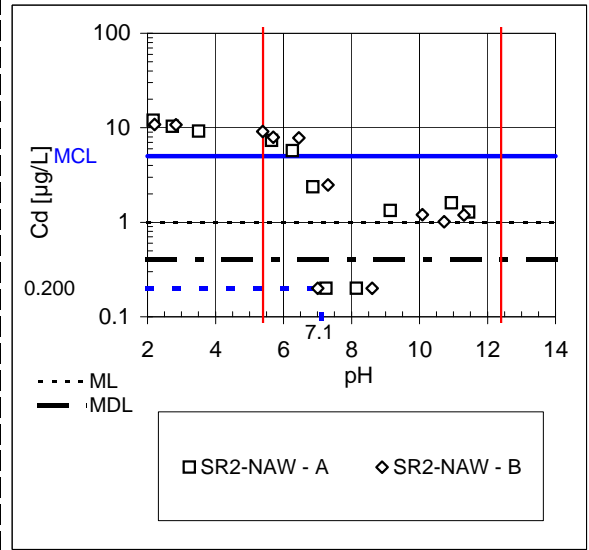

Gyp-U

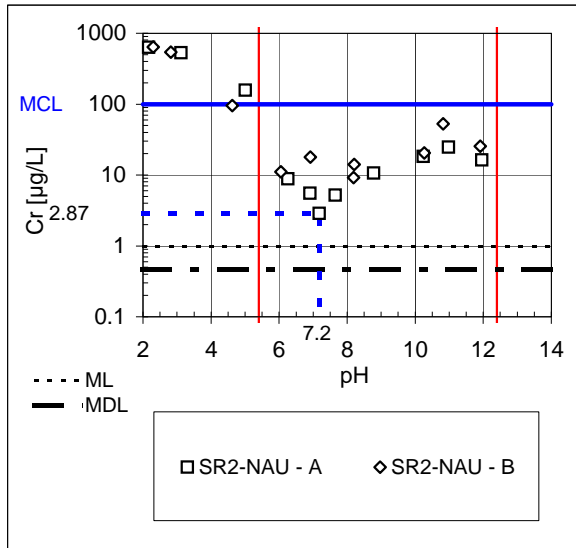

Gyp-W

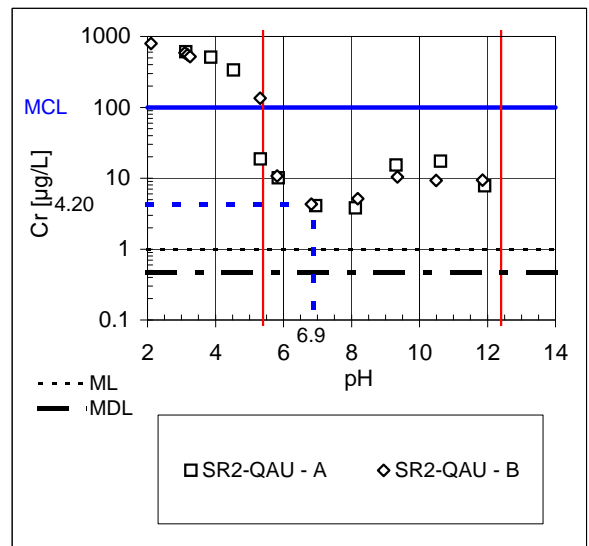
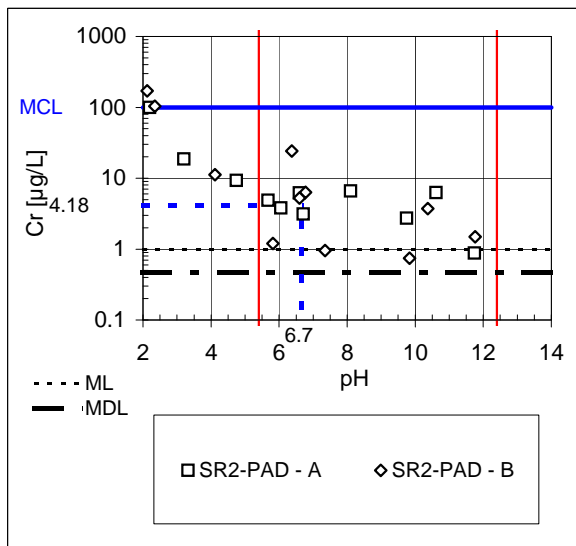
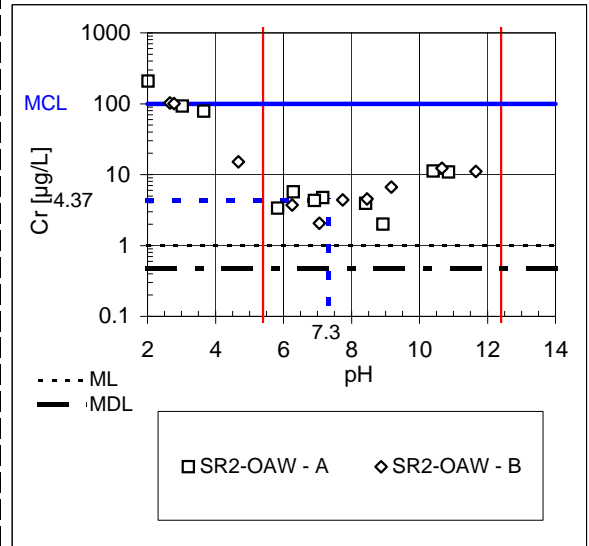
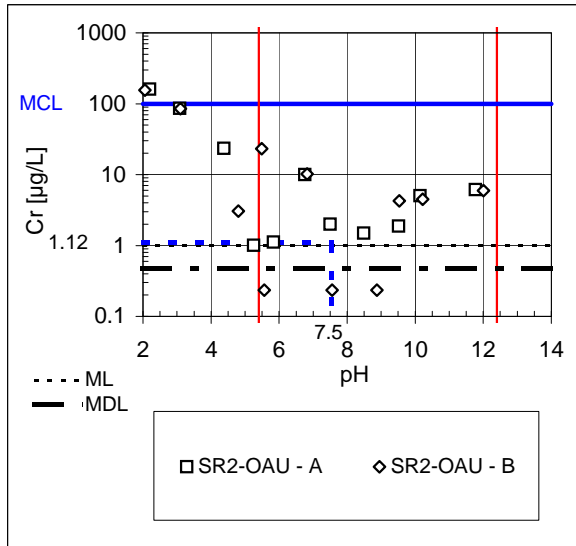
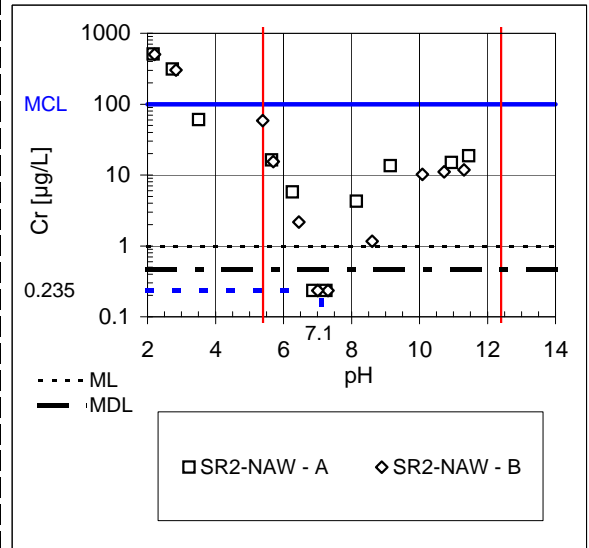

Gyp-U

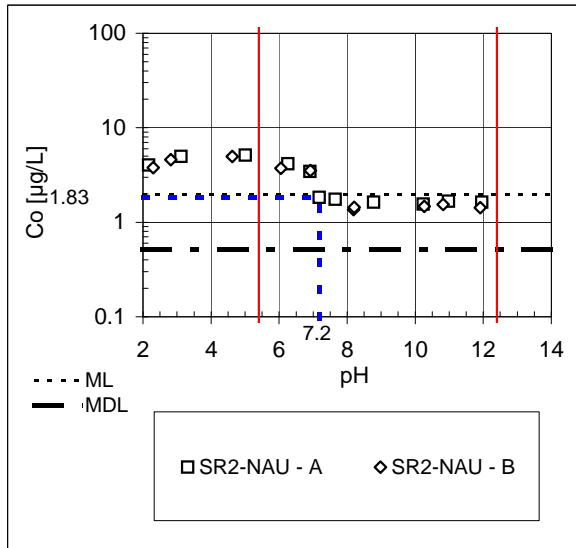

Gyp-W

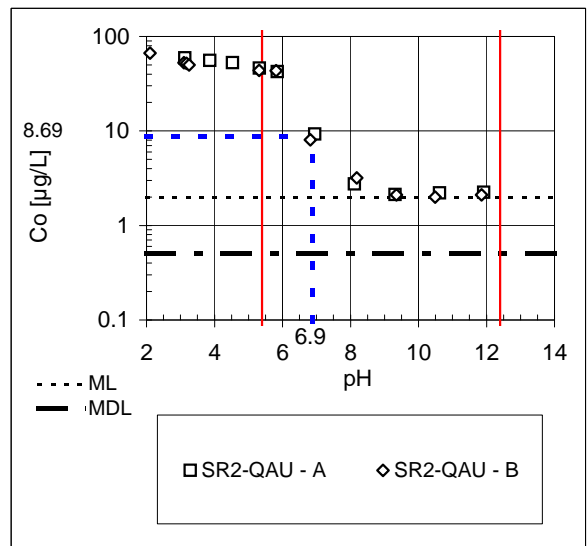
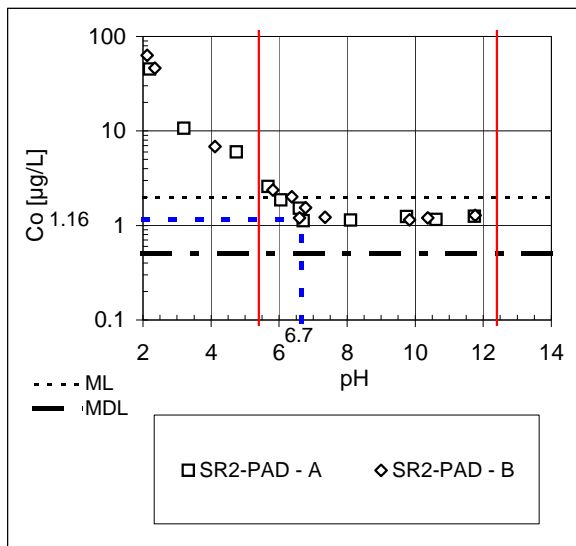
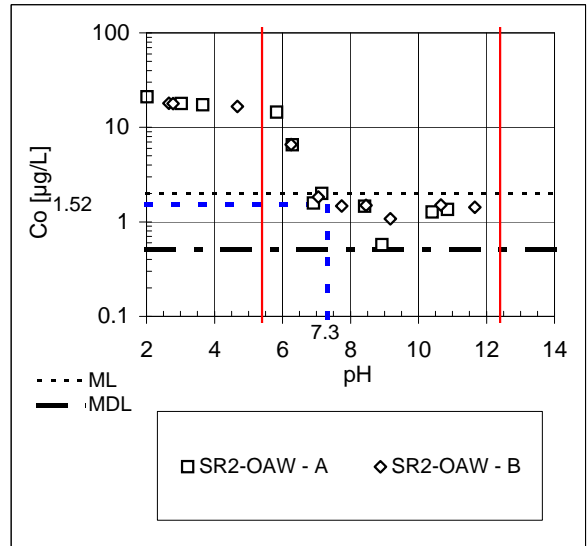
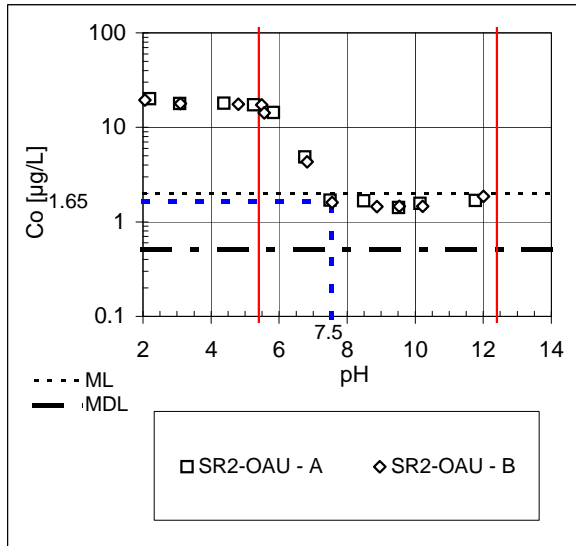
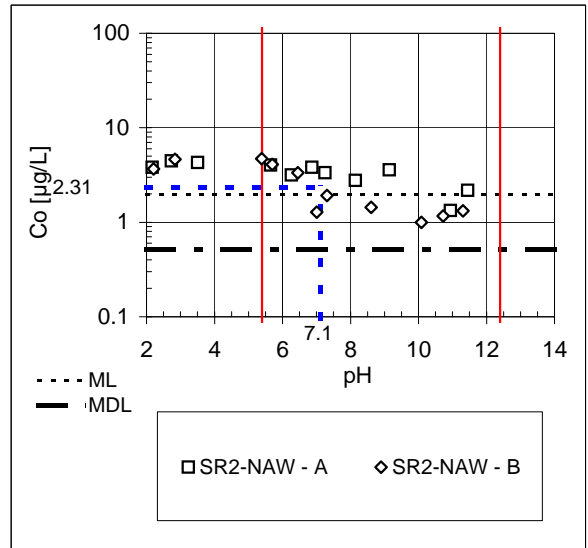

Gyp-U

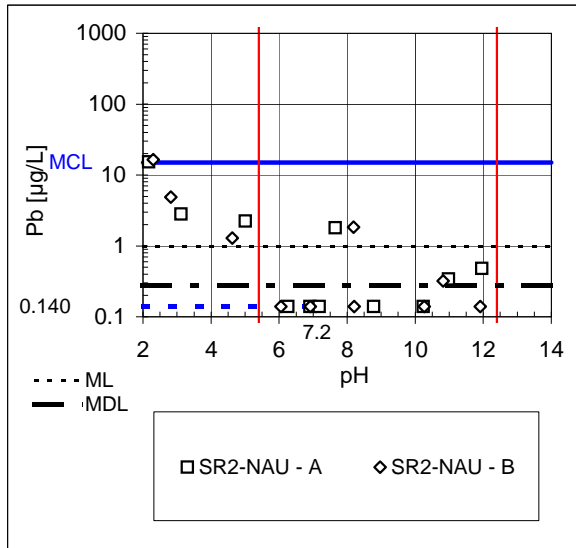

Gyp-W

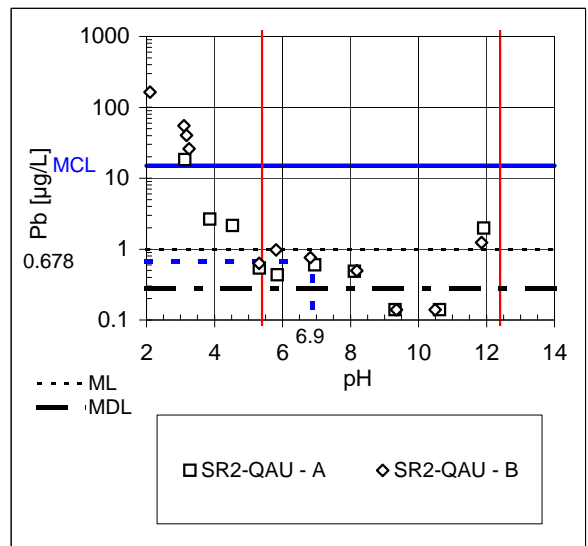
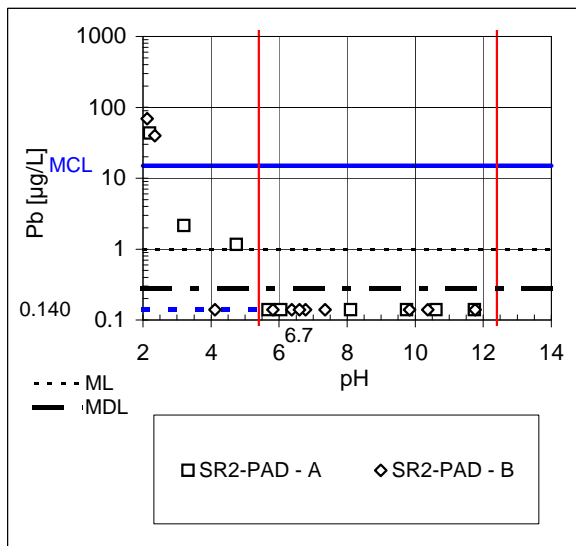
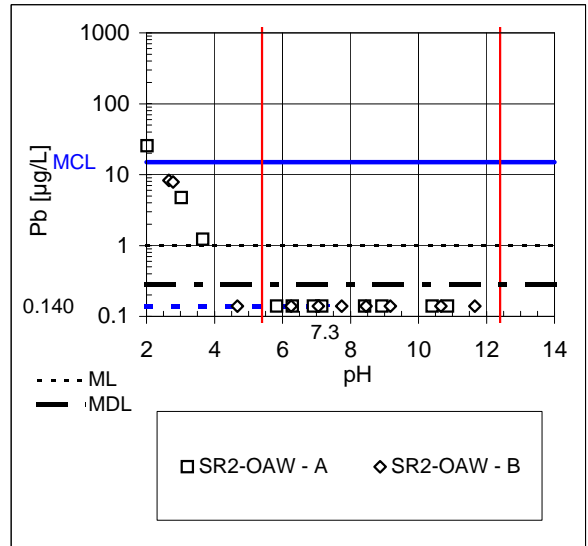
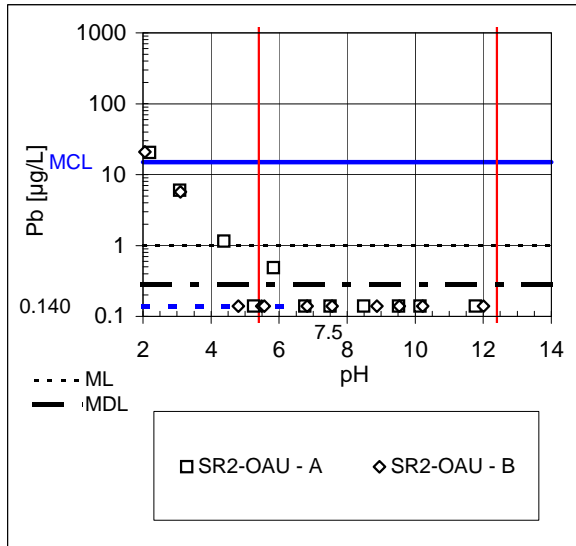
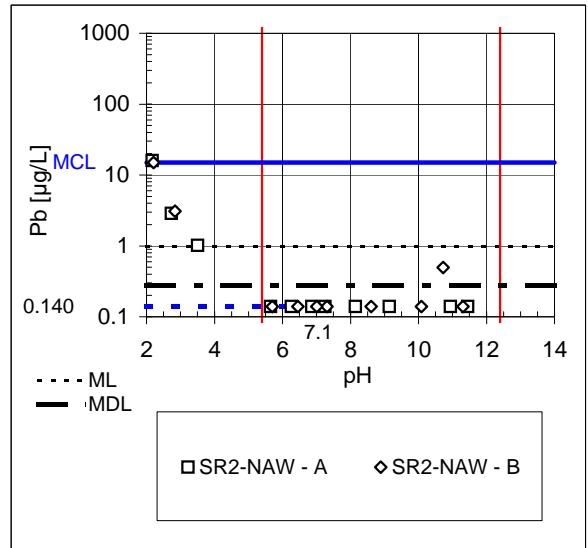

Gyp-U

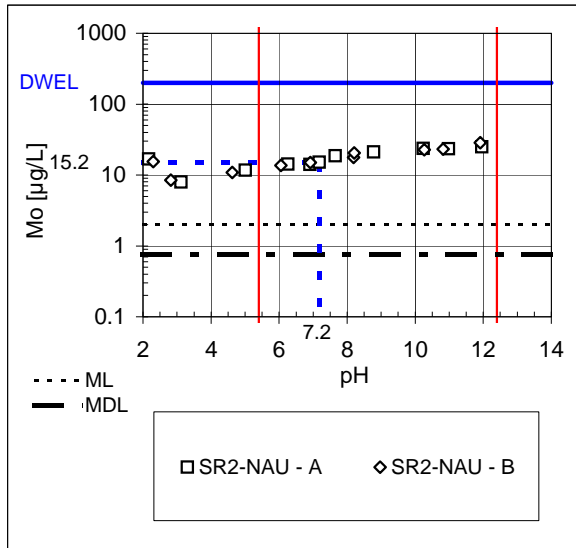

Gyp-W

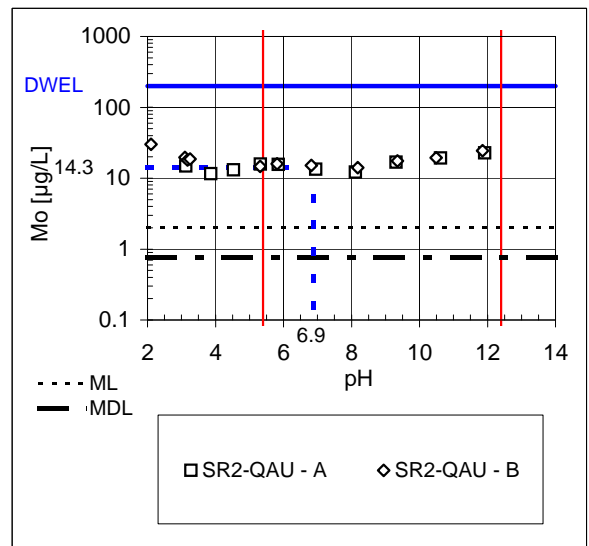
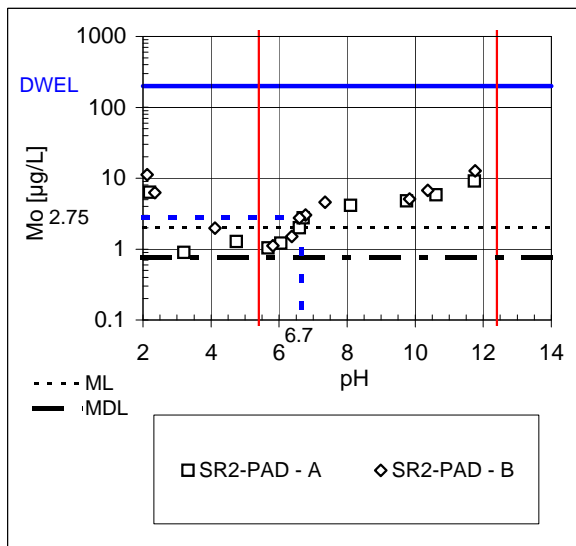
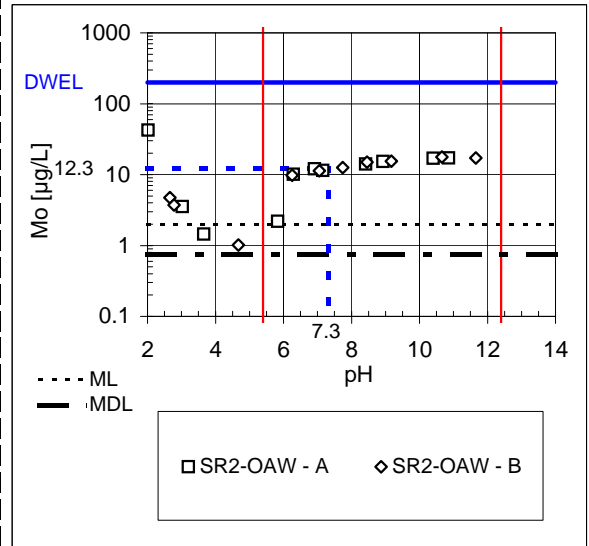
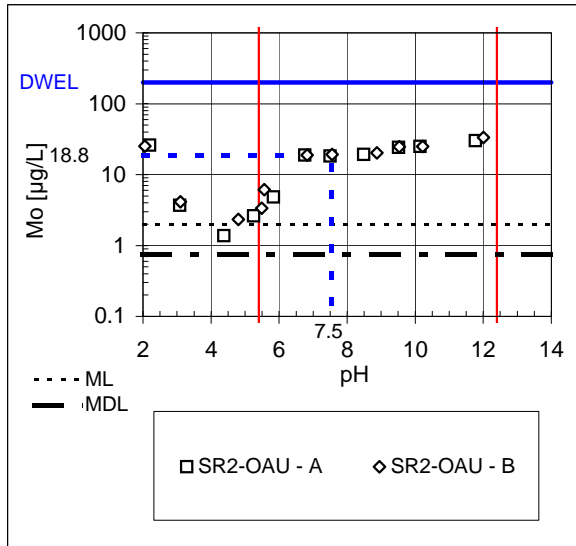
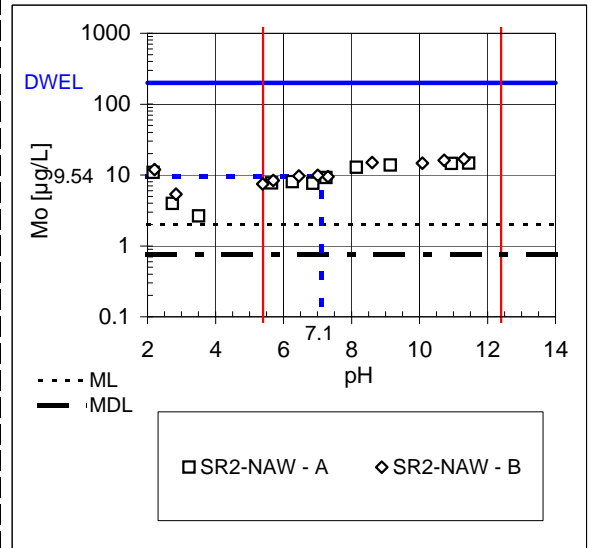

Gyp-U

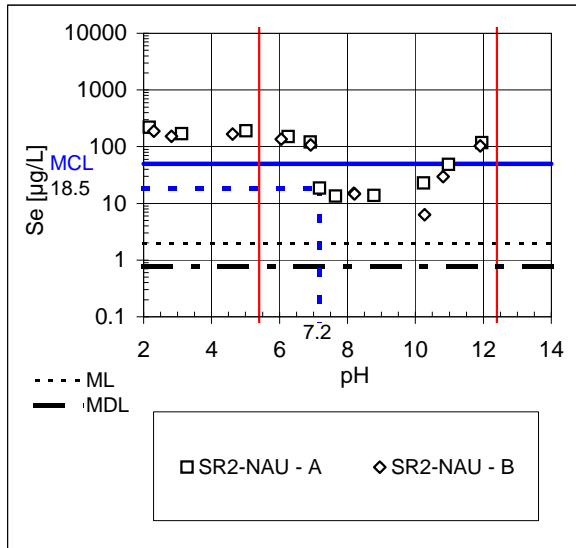

Gyp-W

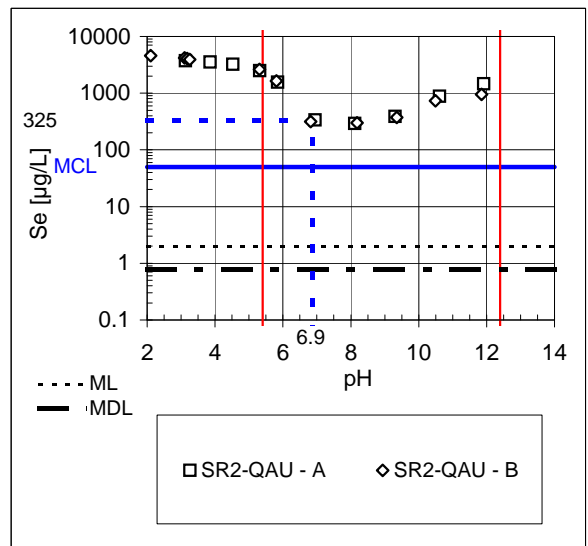
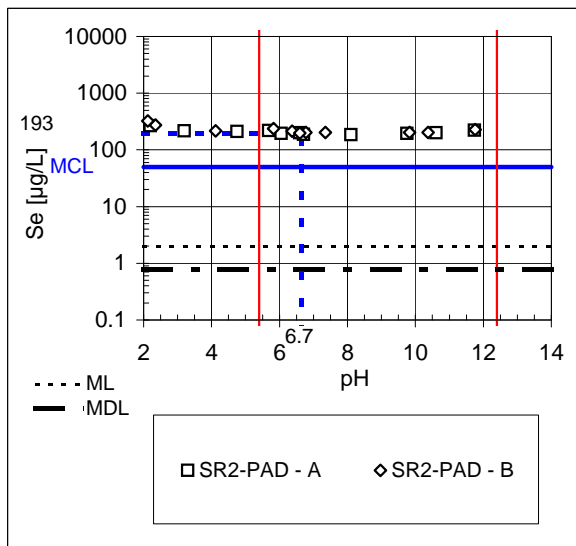
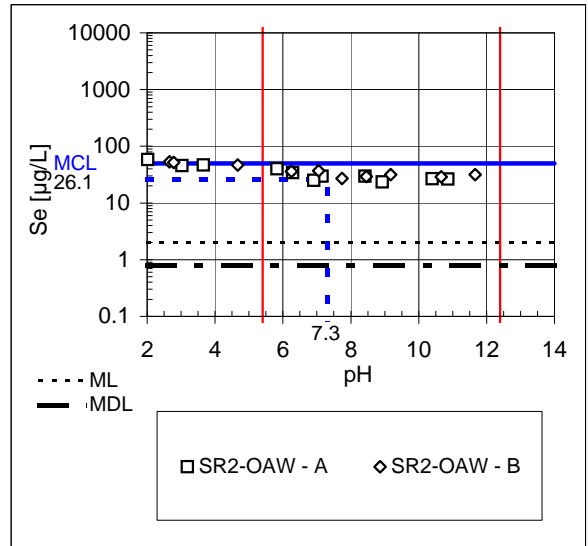
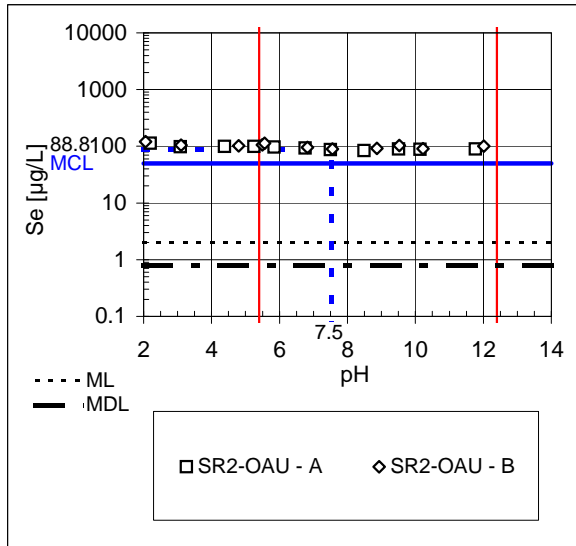
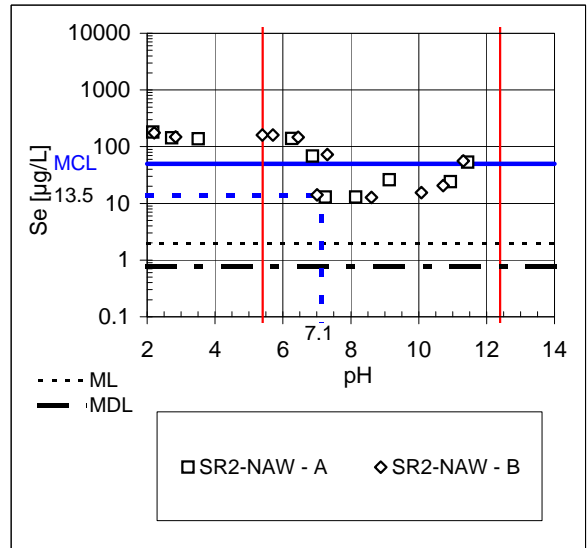

Gyp-U

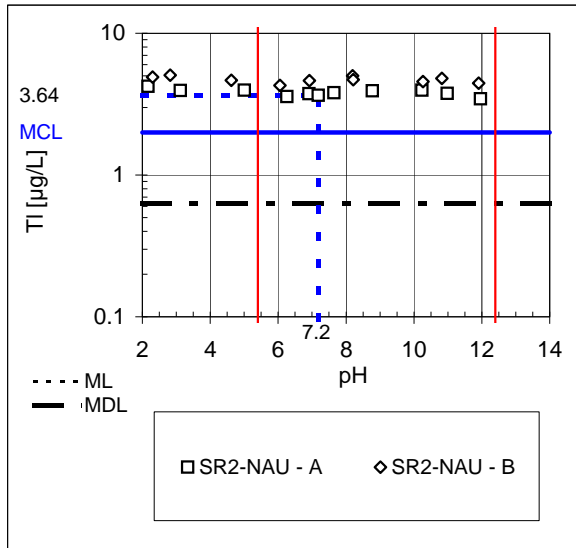

Gyp-W

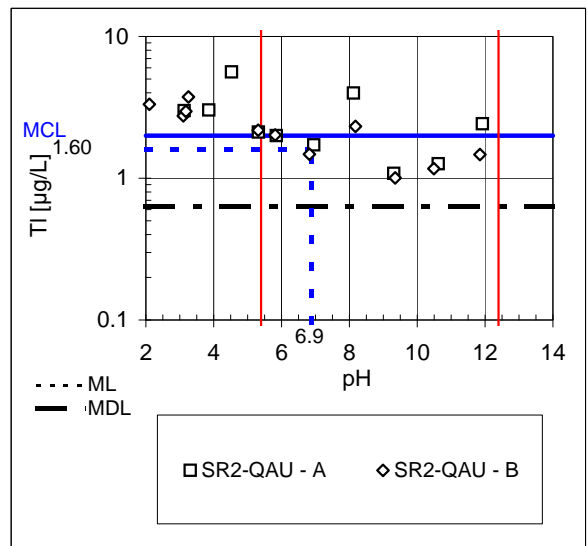
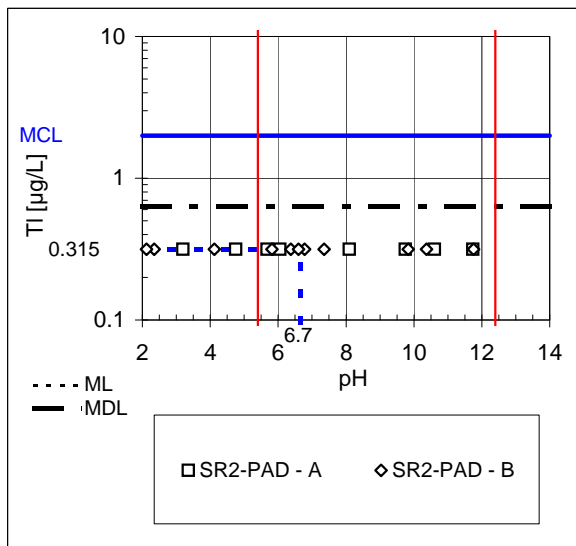
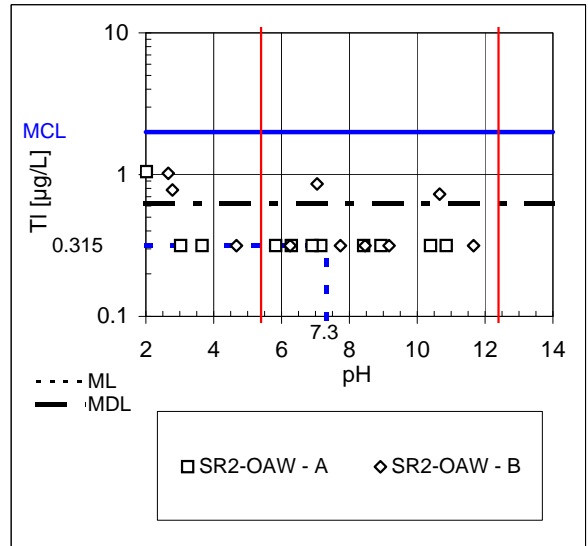
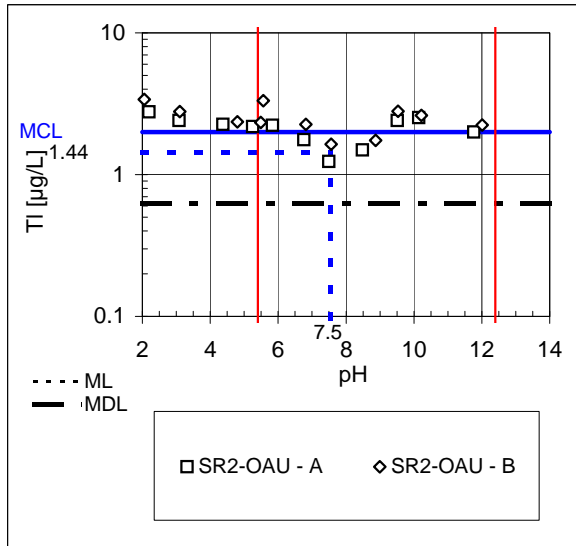
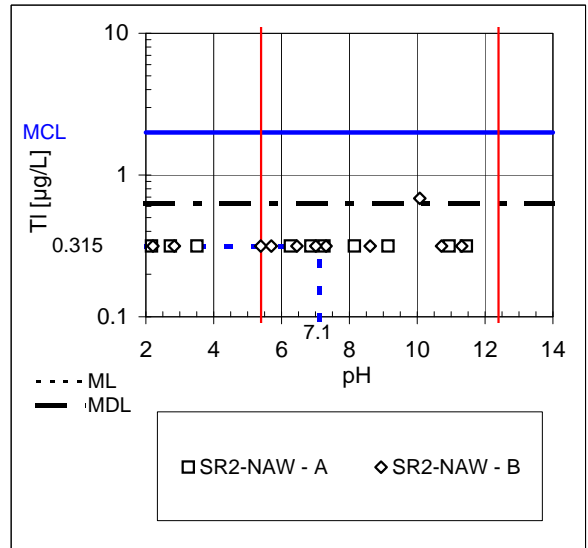

Scrubber Sludge (ScS) Comparisons

Facility A

Coal: low sulfur bituminous

APC: NO+SNCR+FF

CGD
(SNCR Off)

AGD
(SNCR On)

Facility B

Coal: low sulfur bituminous

APC: NO+SCR+ESP(CS) [Mg lime]

DGD
(SCR Off)

BGD
(SCR On)

Facility K

Coal: sub- bituminous

APC: NO+SCR+ESP(CS) [Mg lime]

KGD
(SCR On)

Scrubber Sludge Comparisons

Off

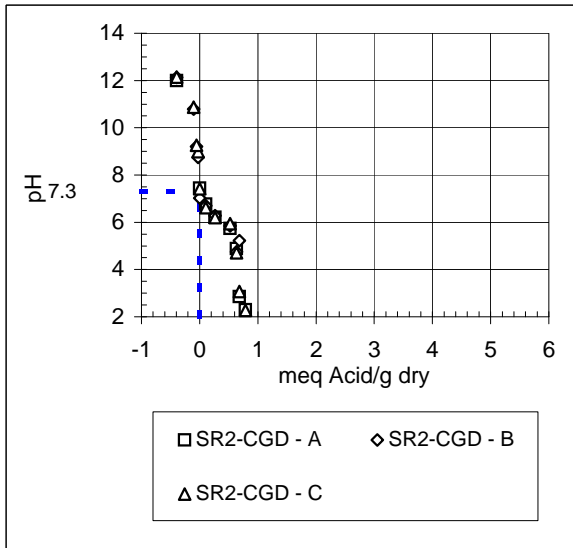

On

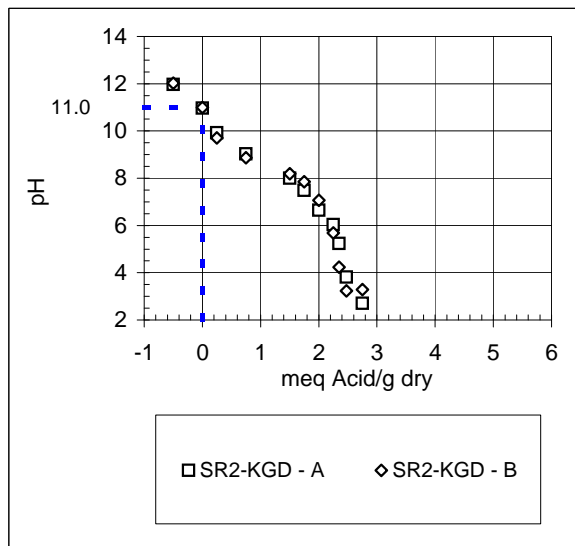
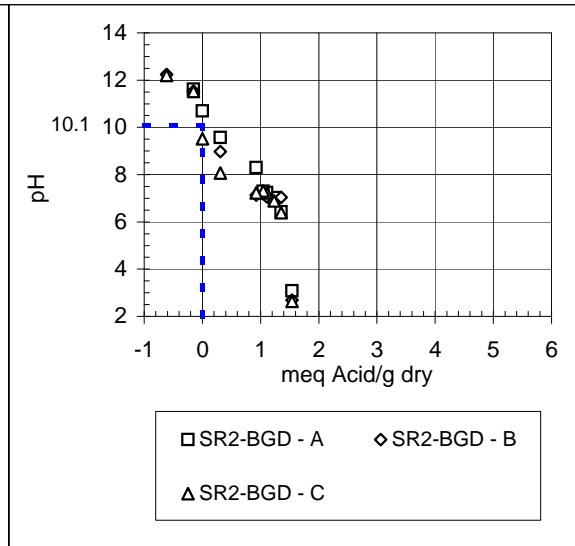
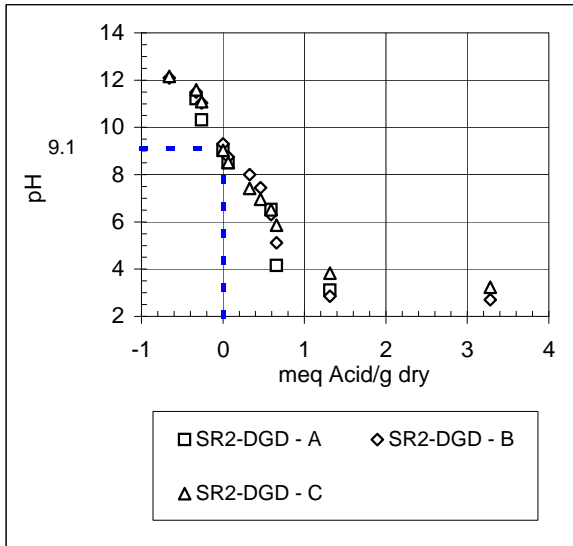
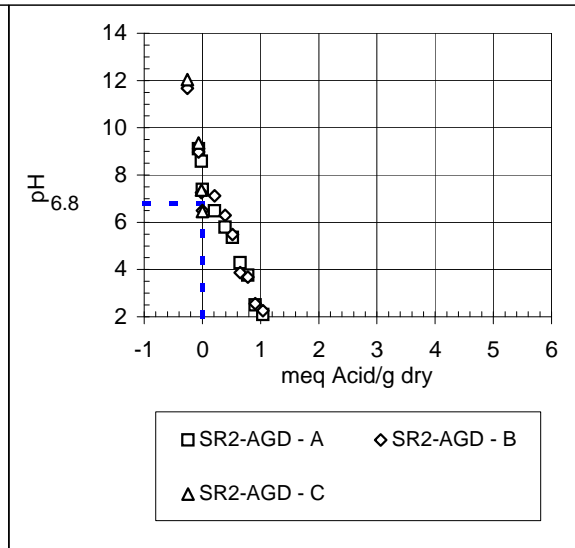

Off

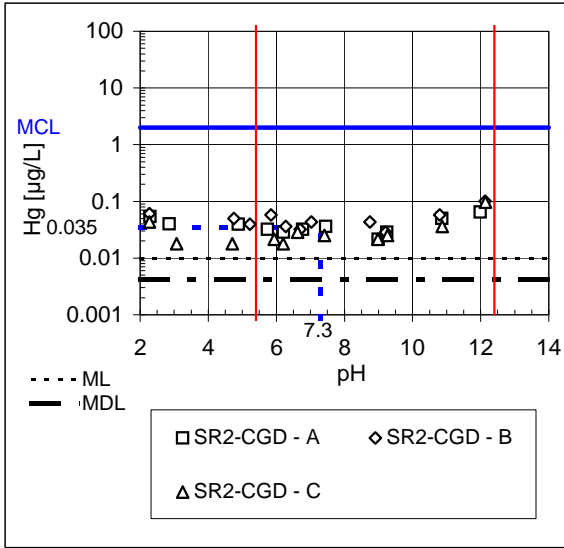

On

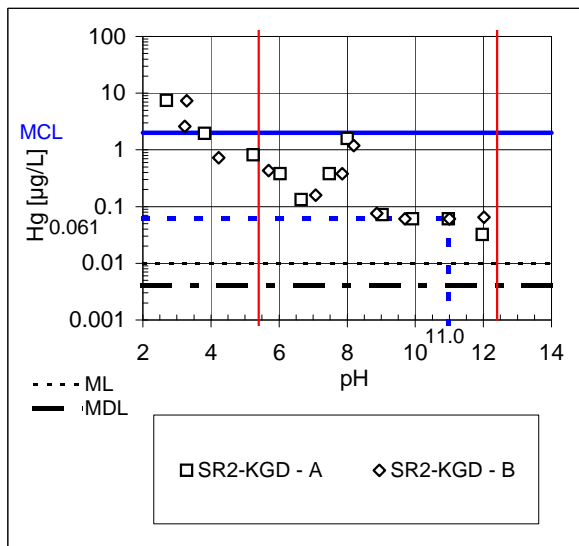
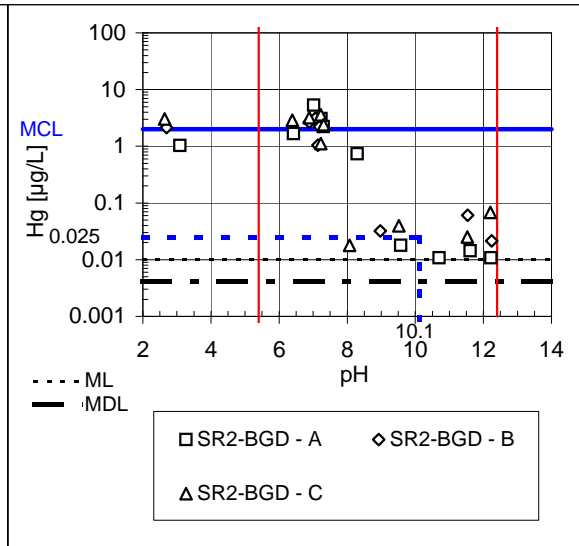
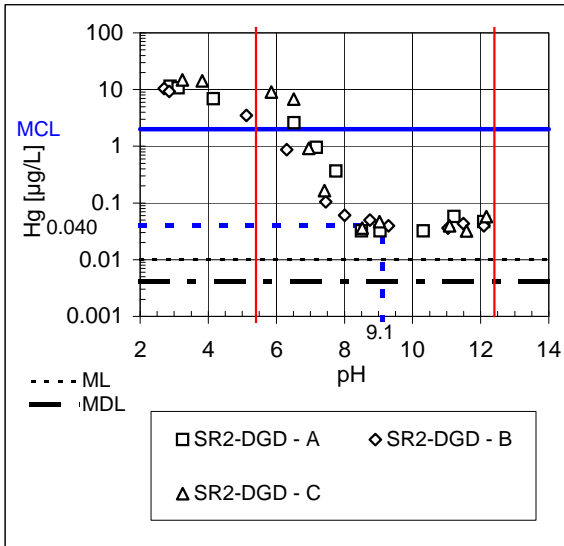
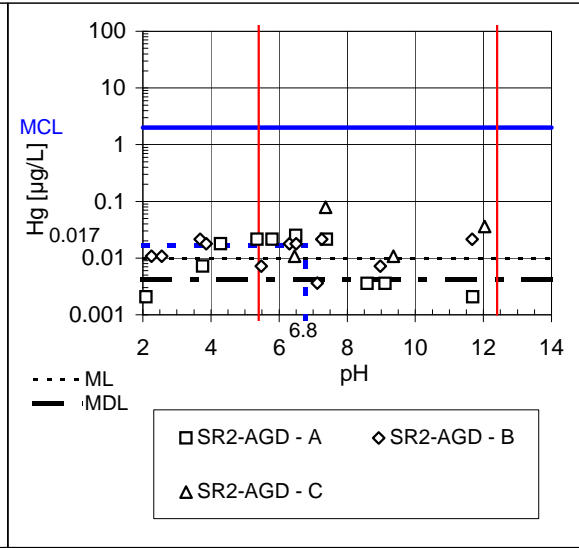

Off

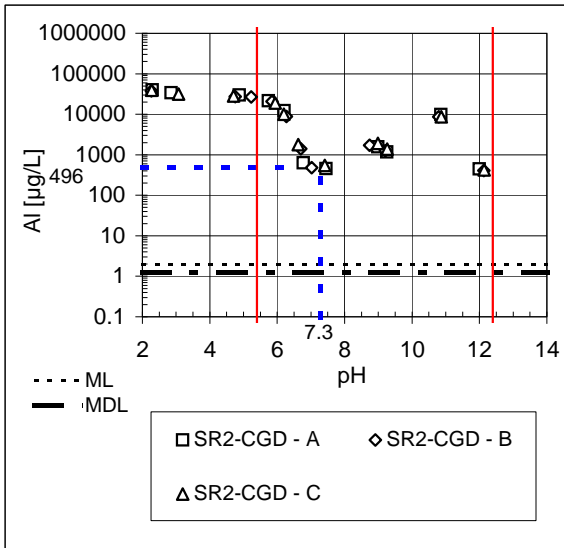

On

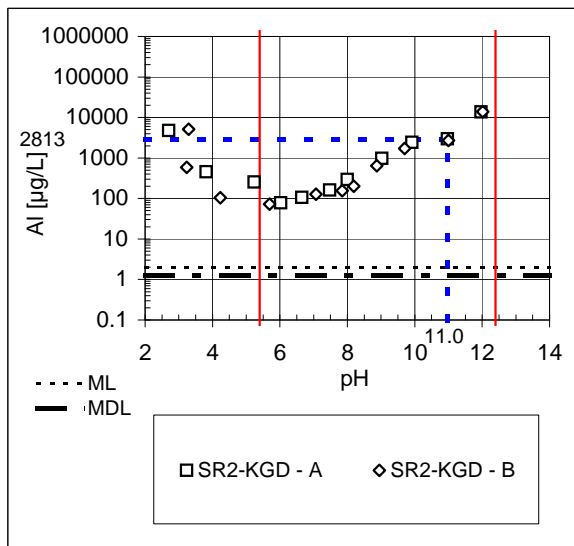
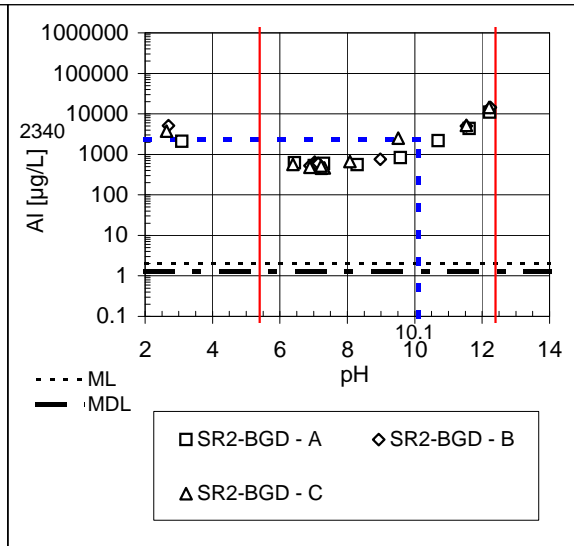
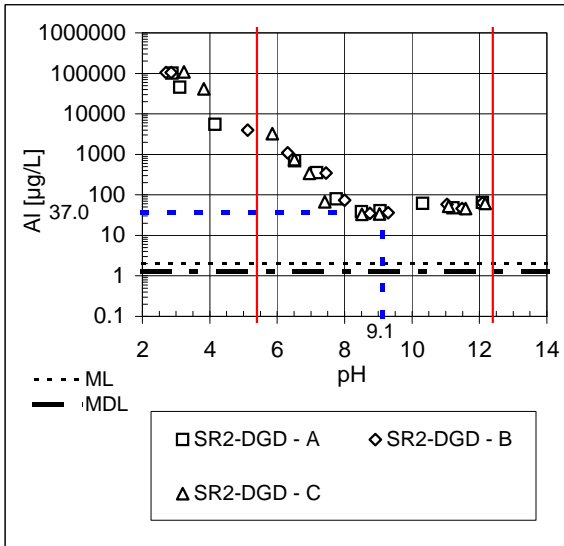
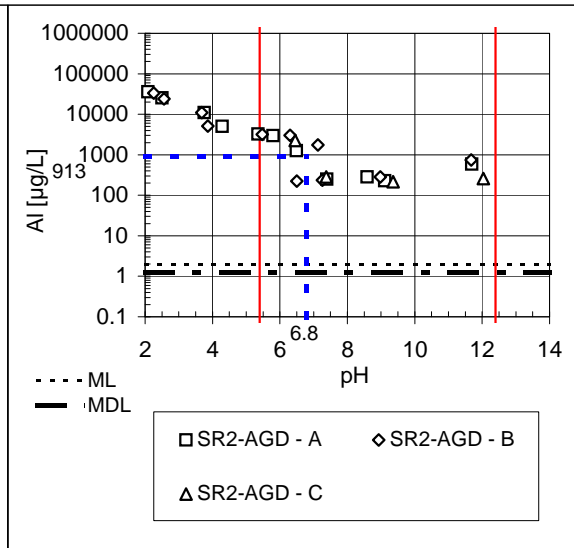

Off

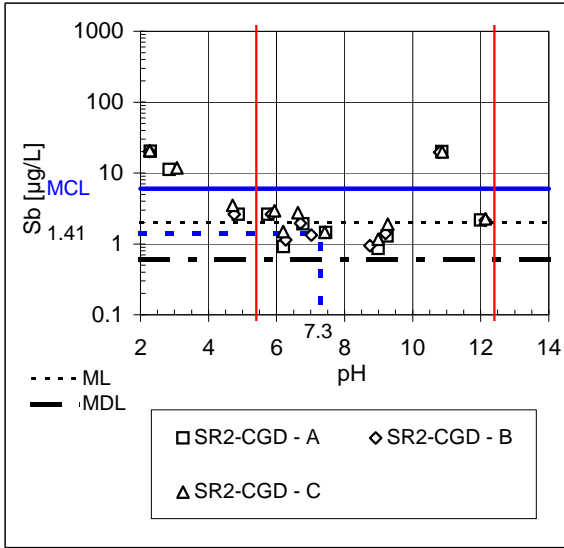

On

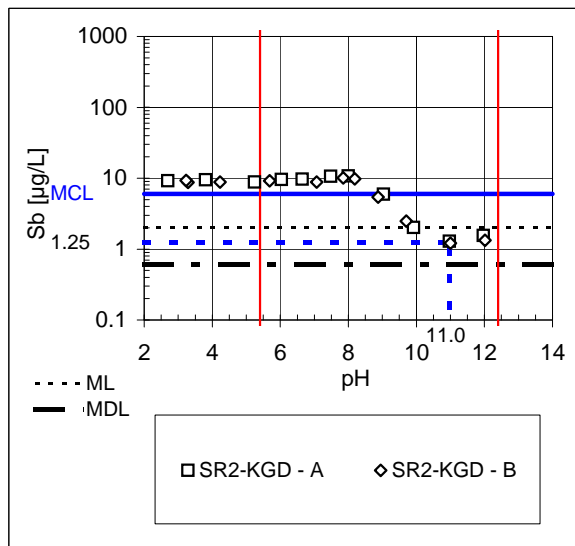
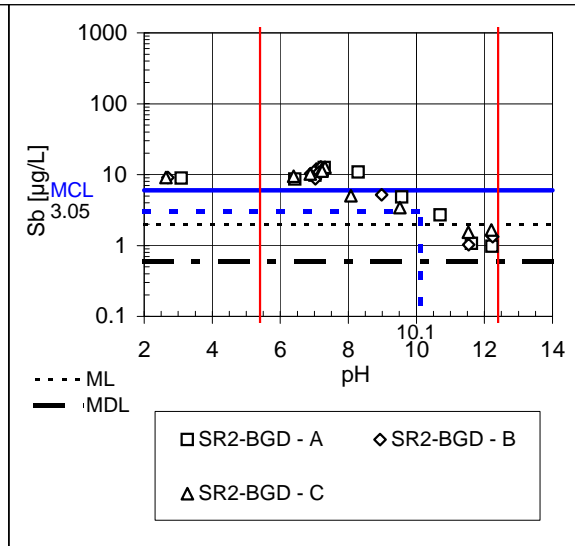
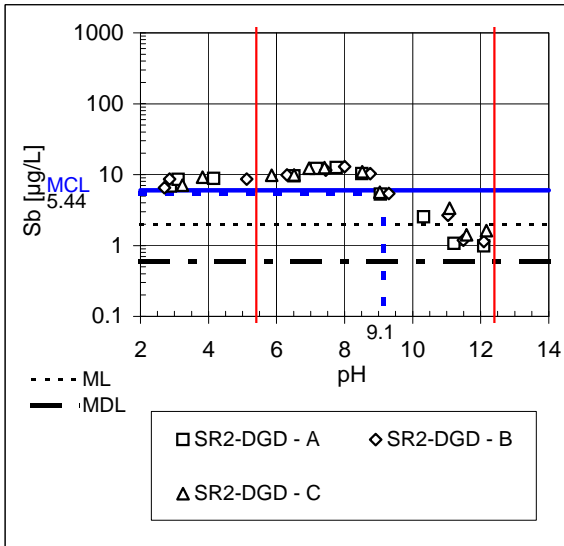
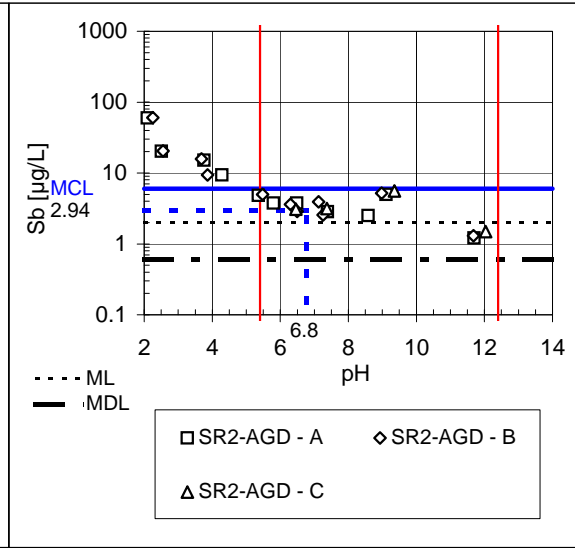

Off

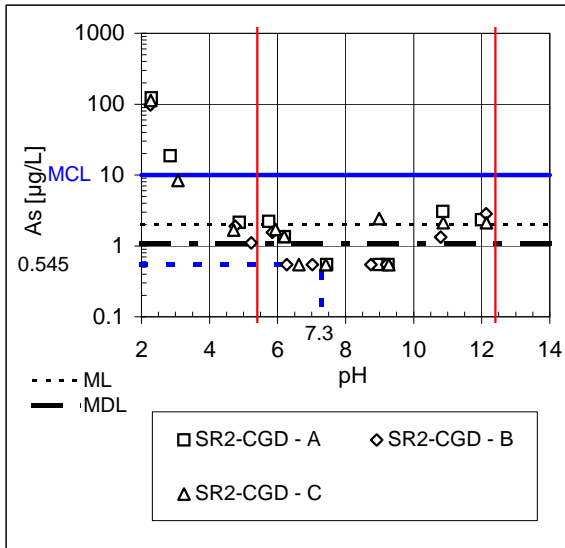

On

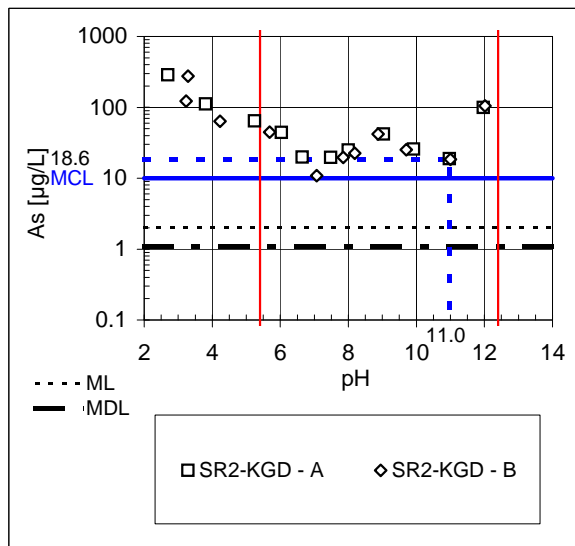
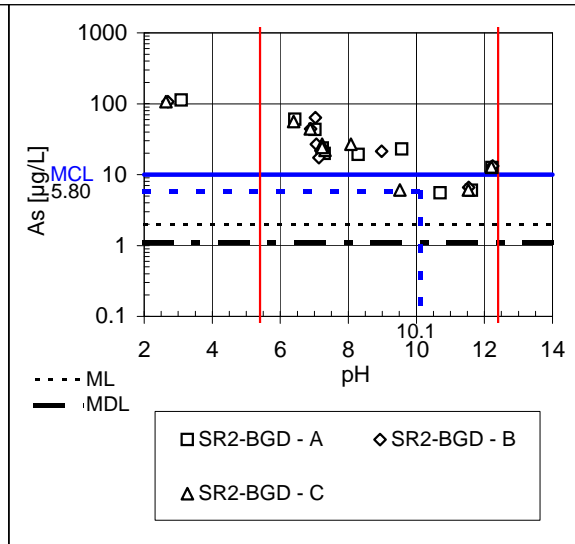
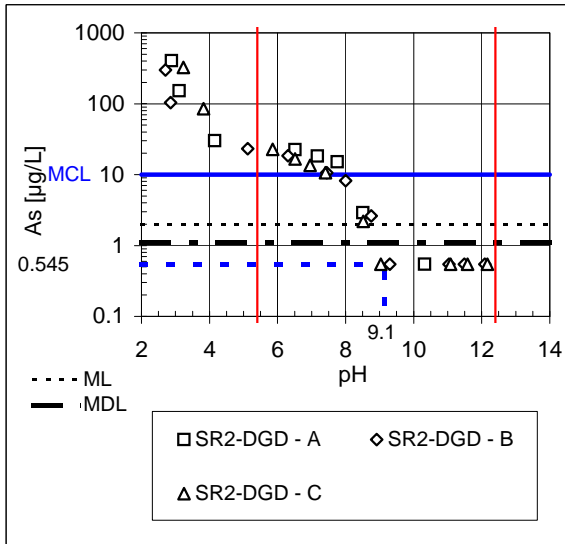
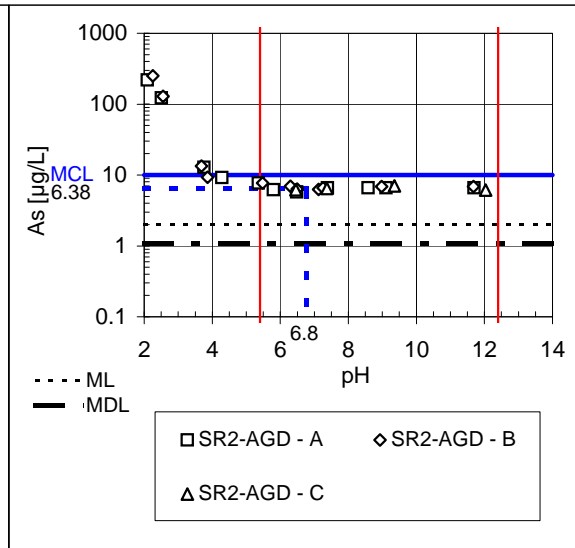

Off

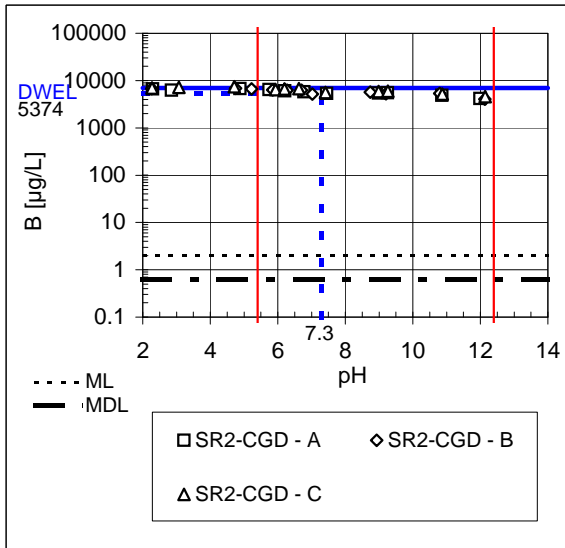

On

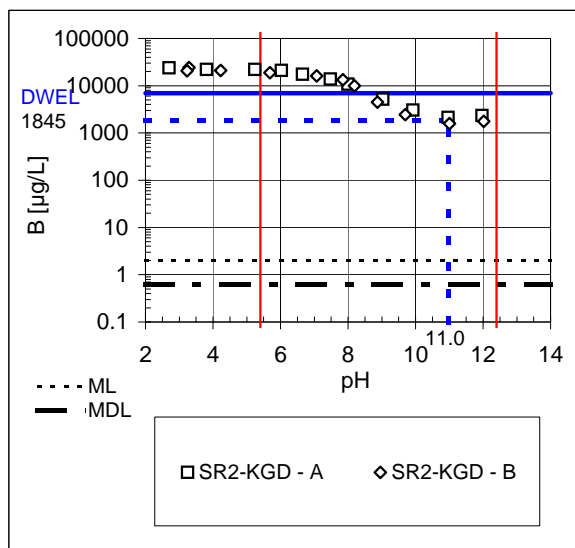
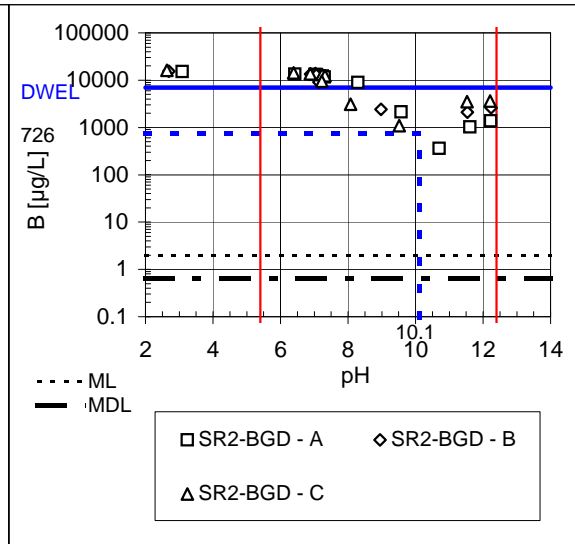
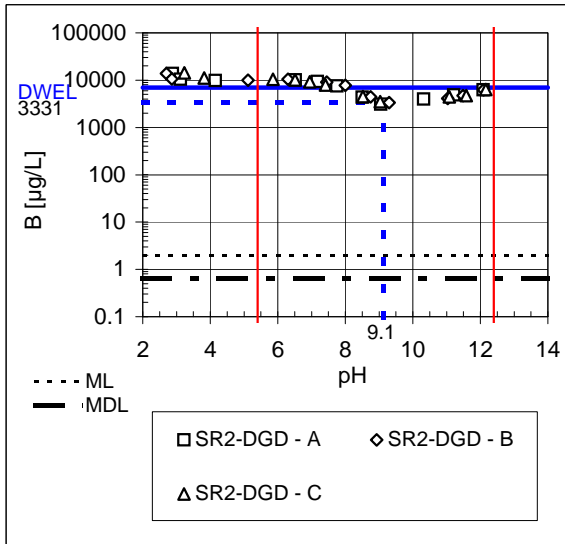
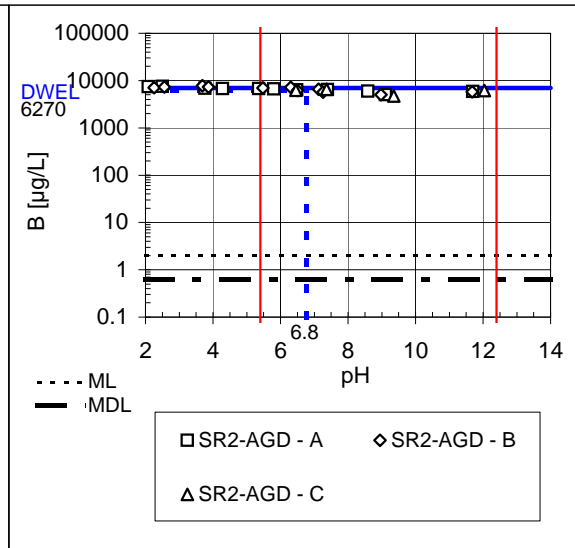

Off

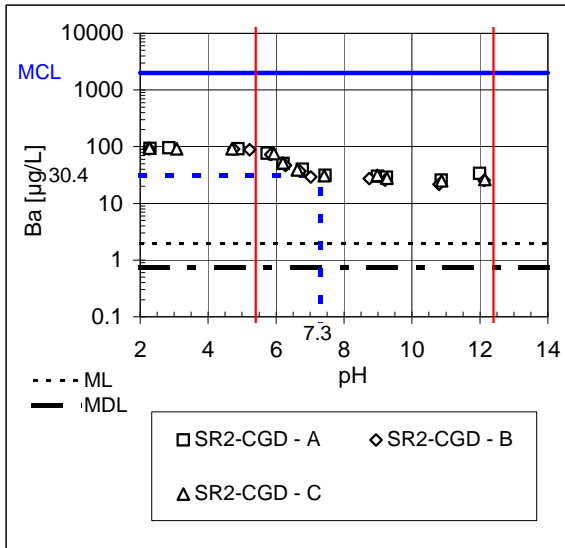

On

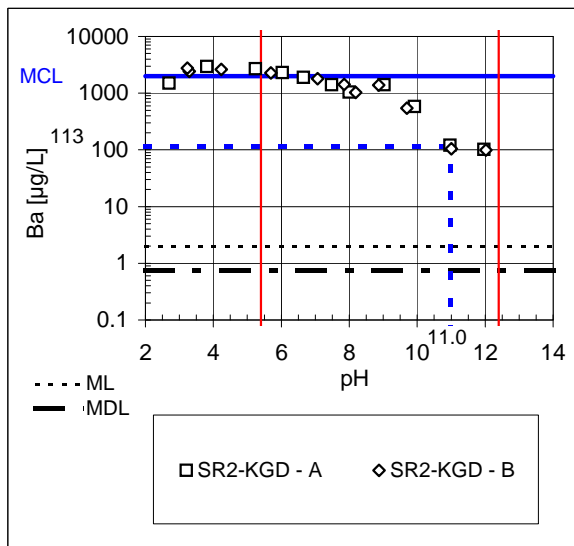
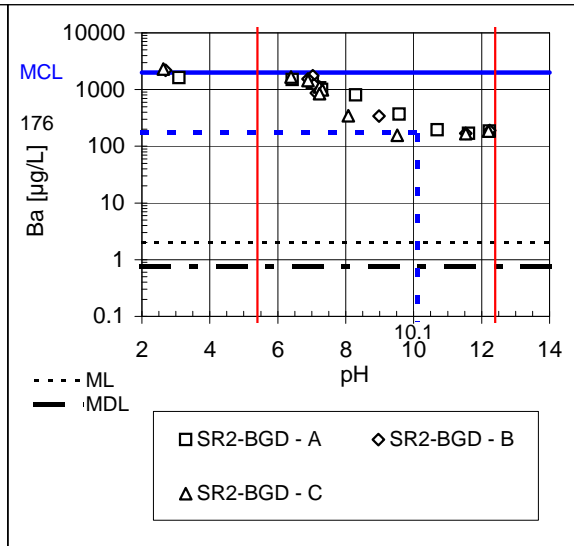
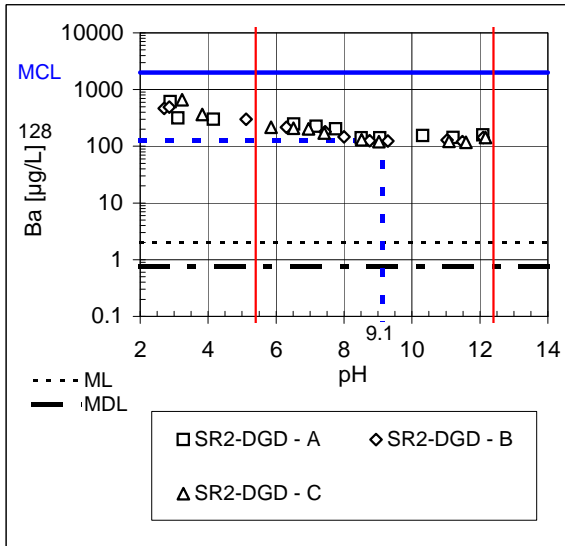
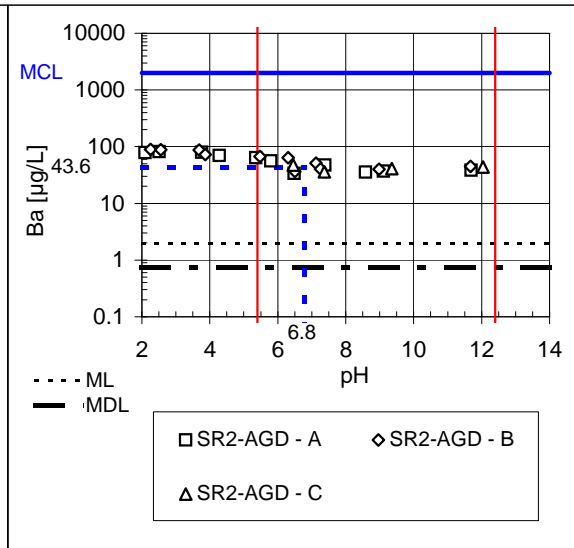

Off

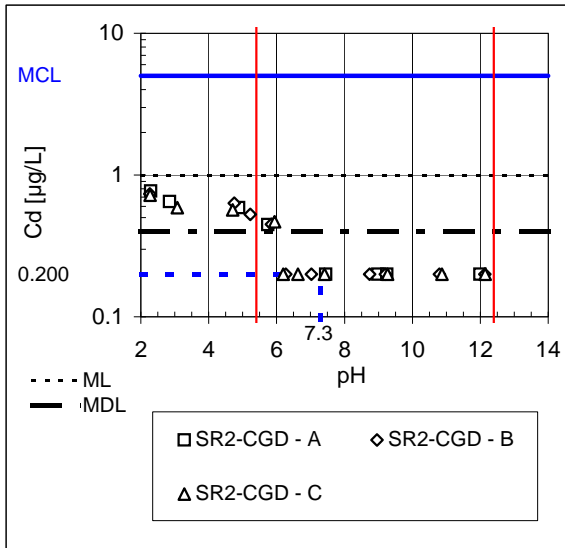

On

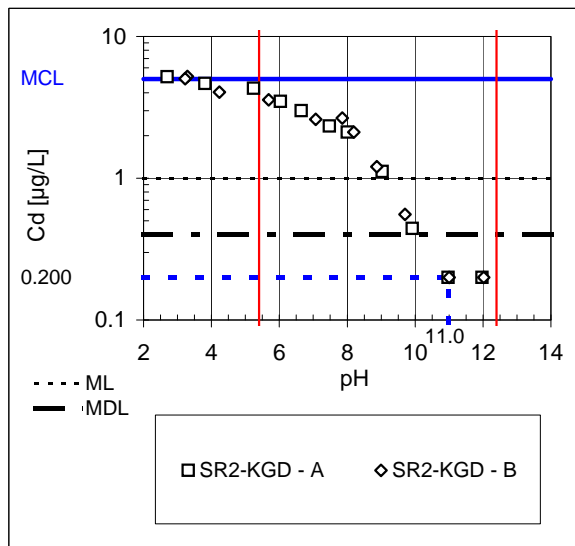
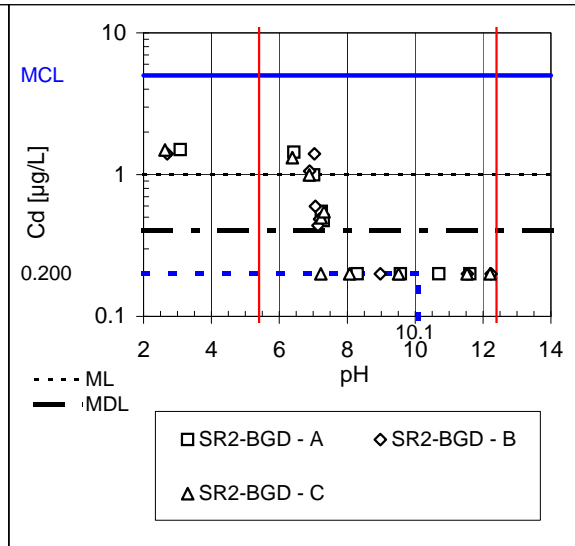
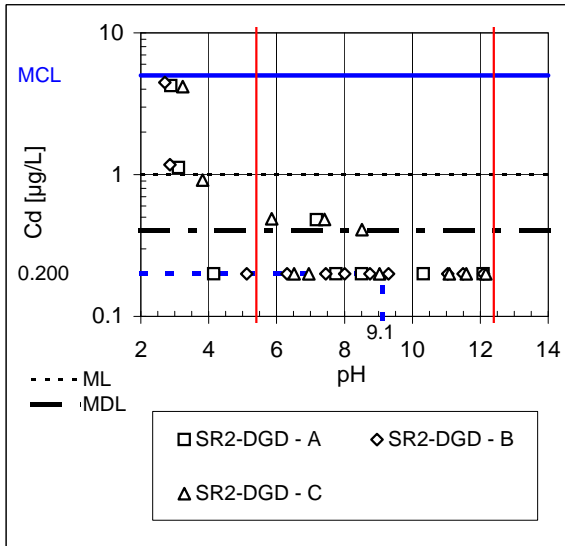
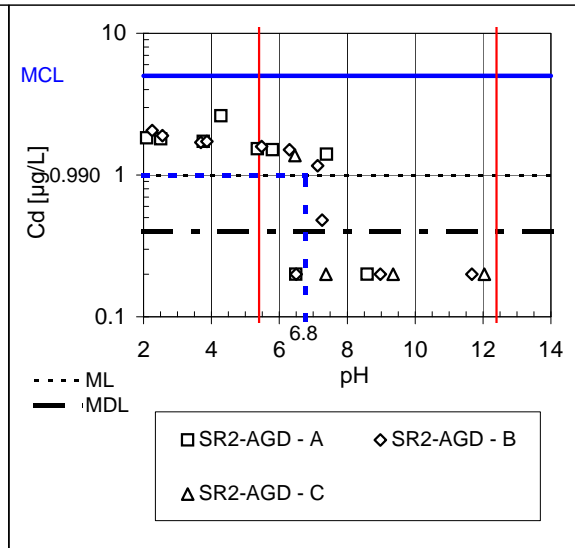

Off

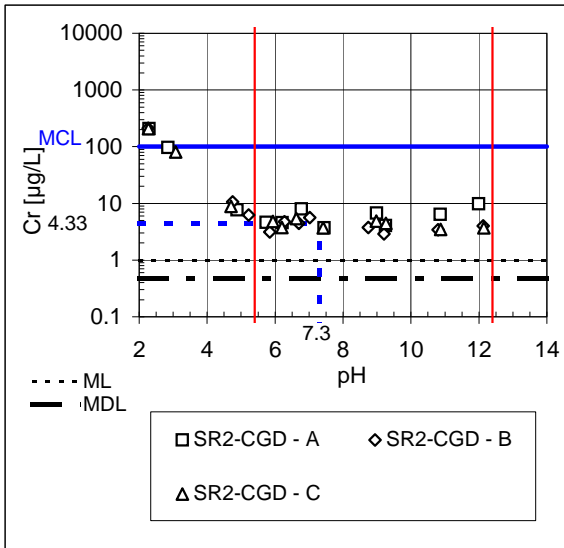

On

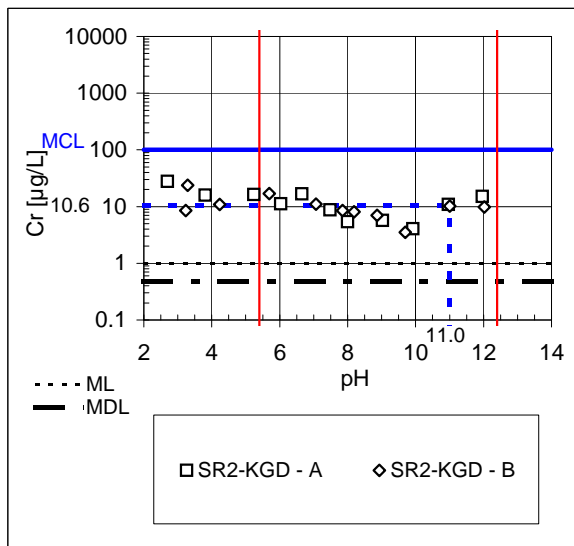
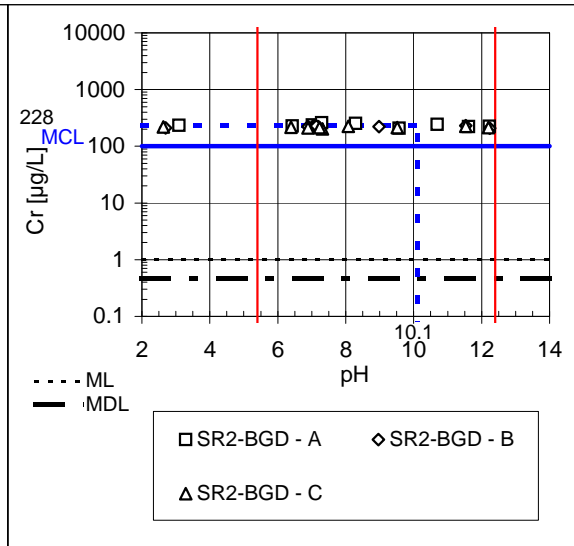
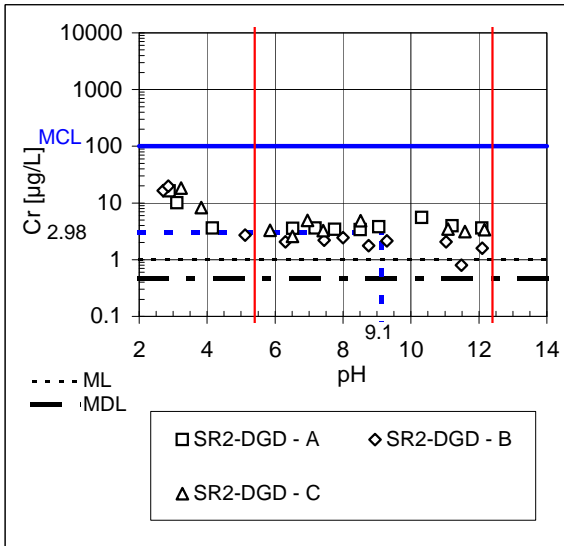
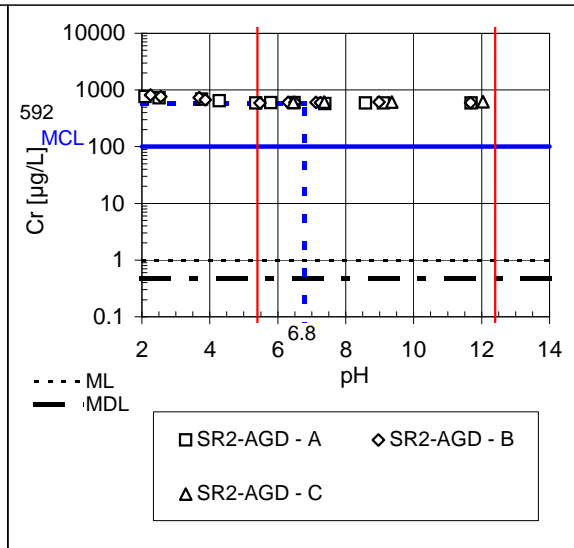

Off

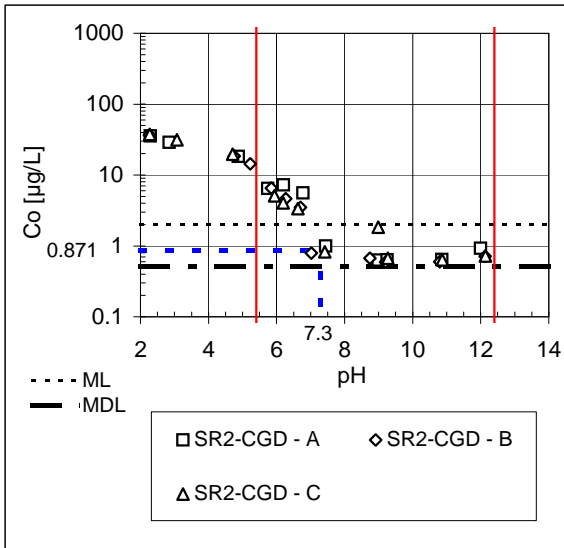

On

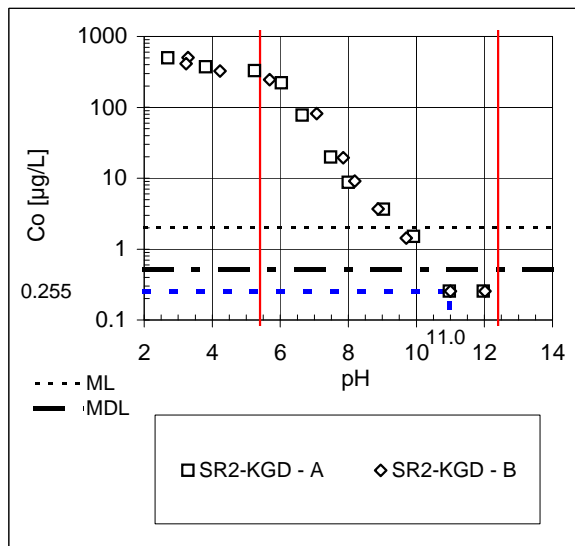
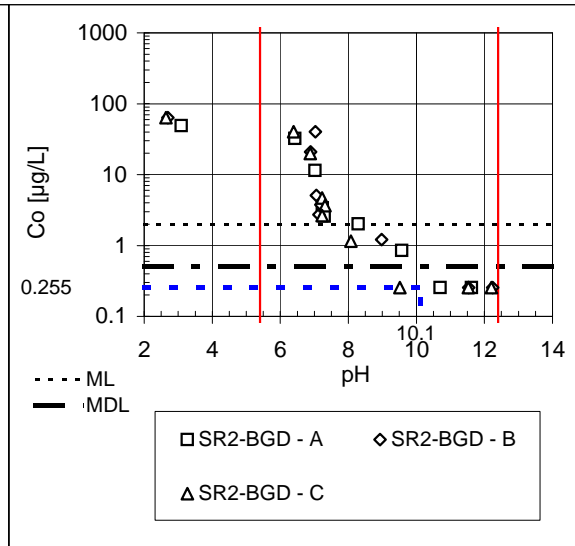
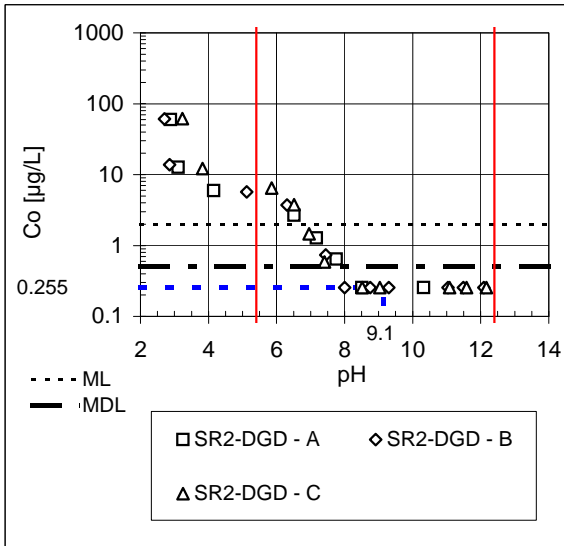
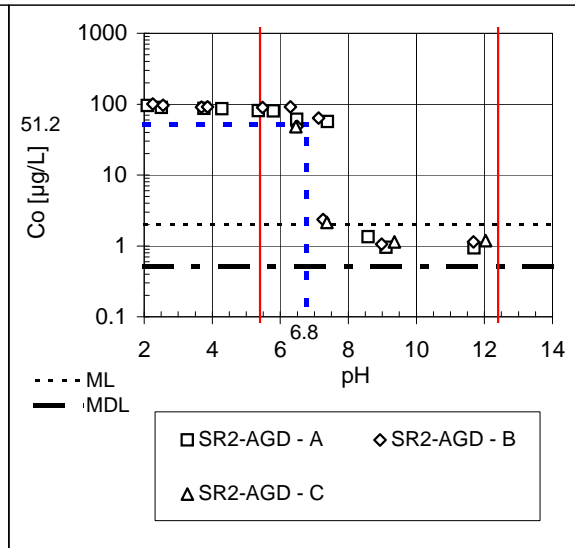

Off

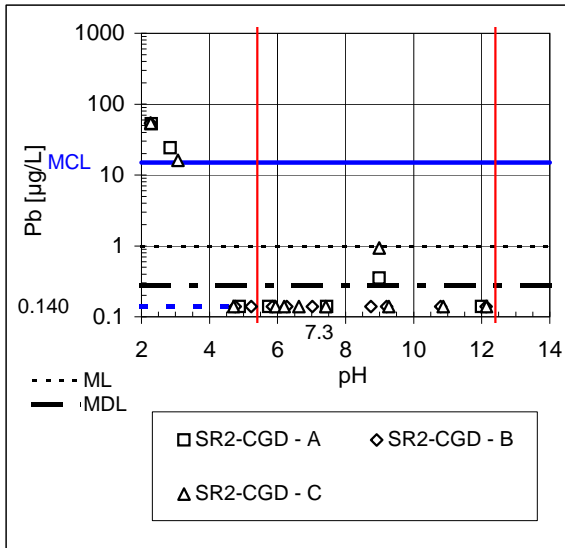

On

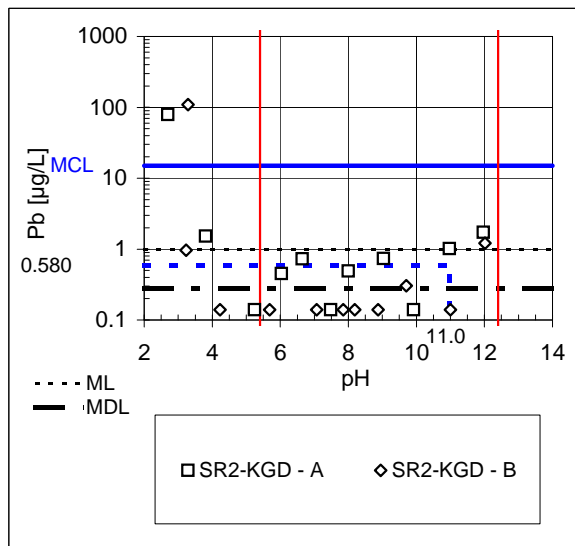
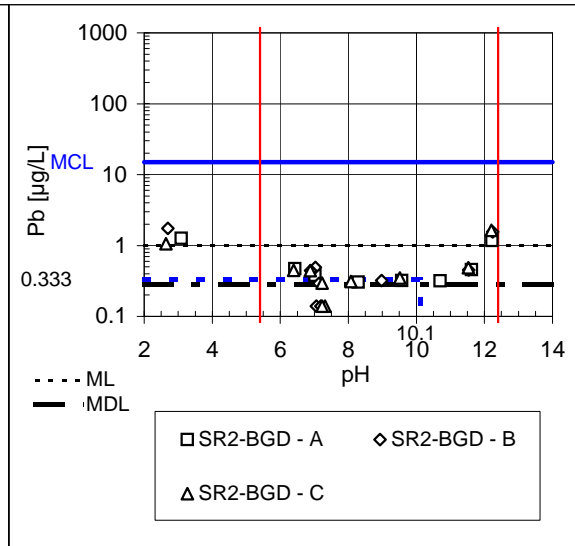
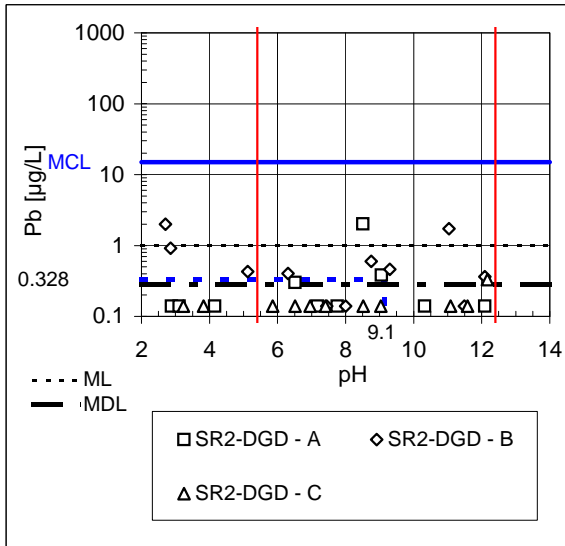
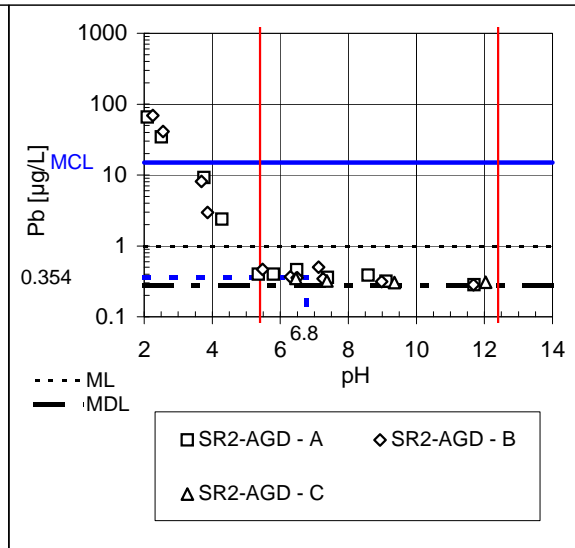

Off

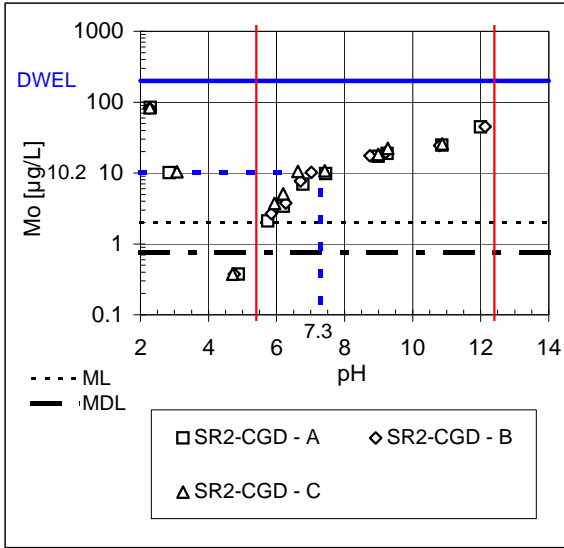

On

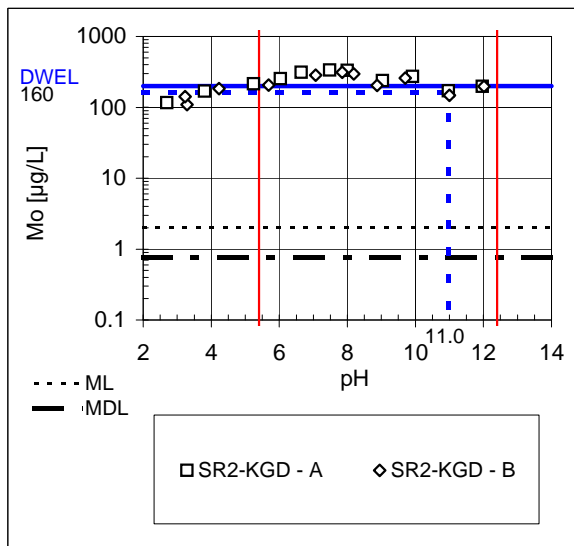
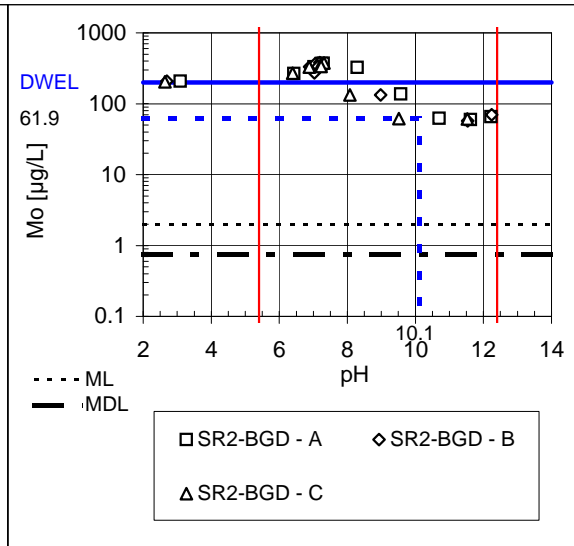
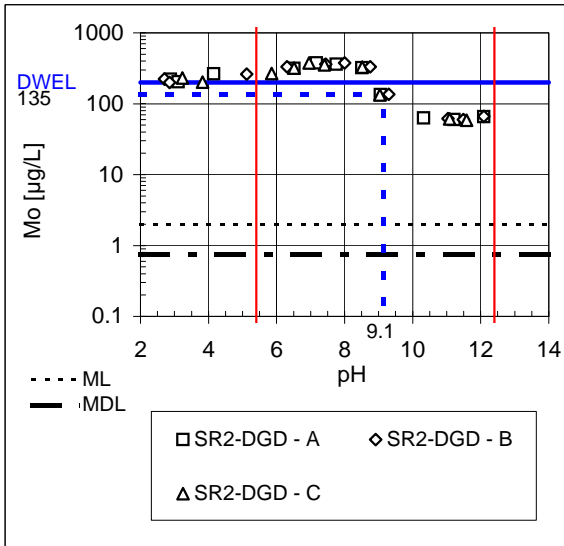
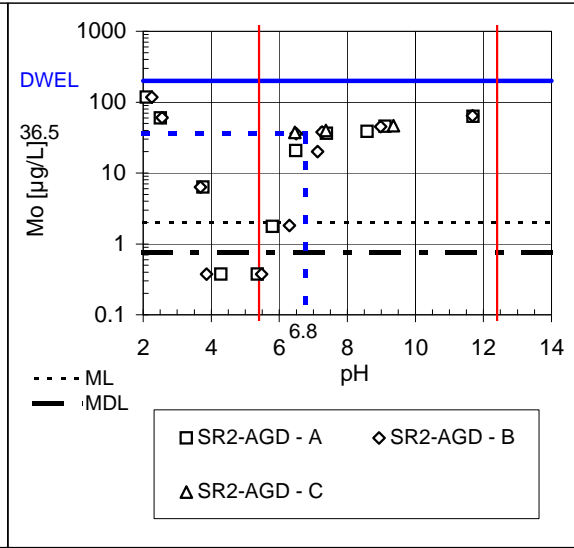

Off

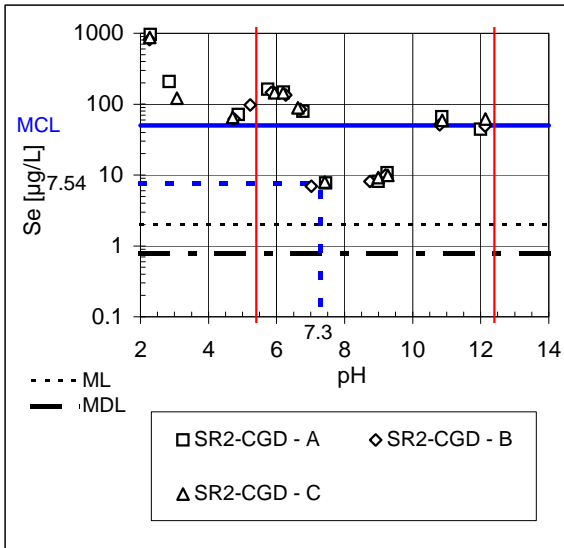

On

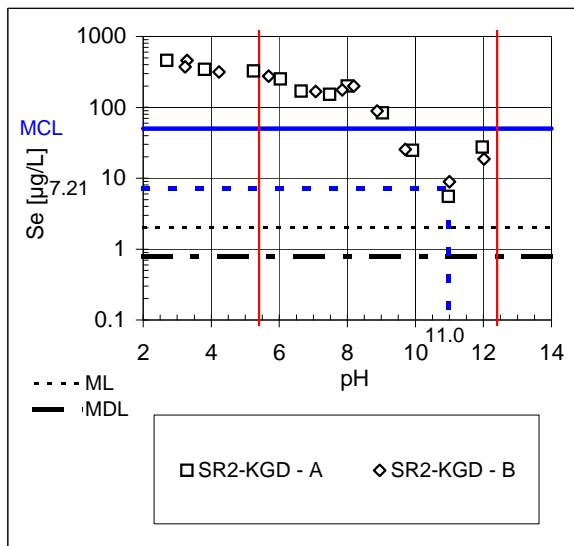
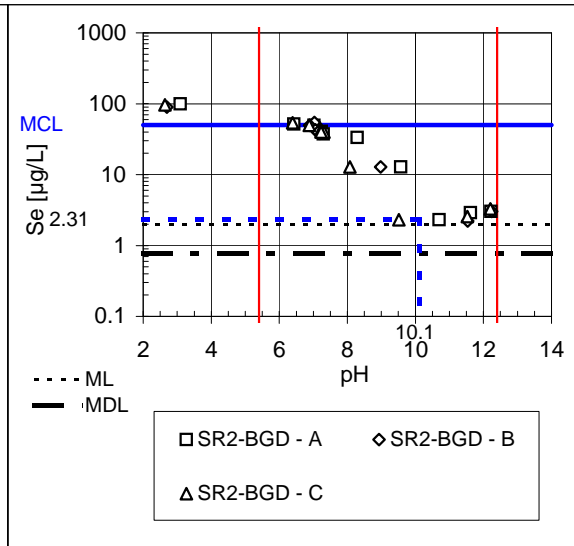
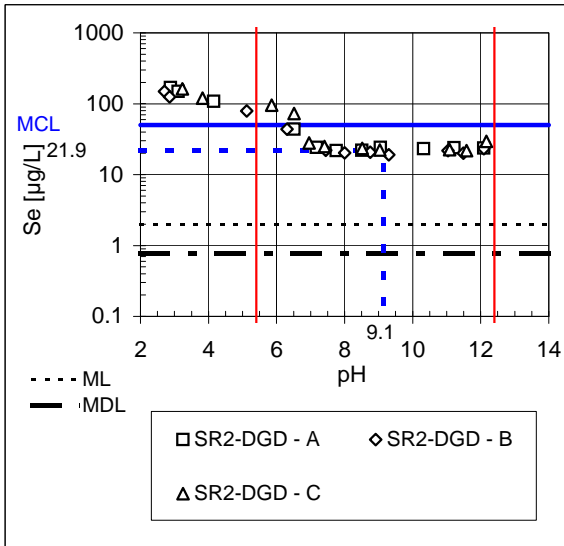
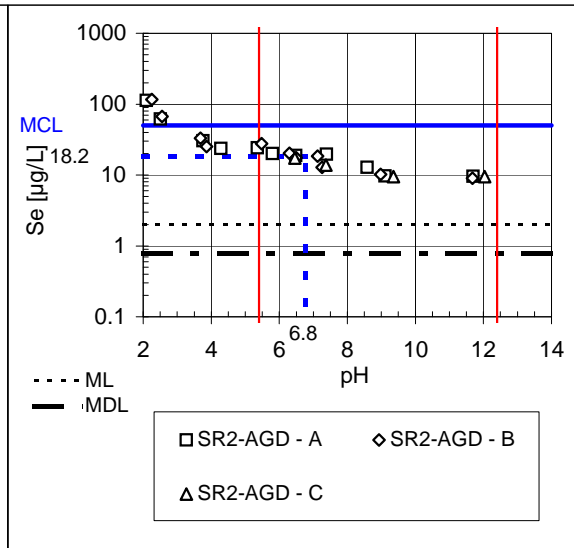

Off

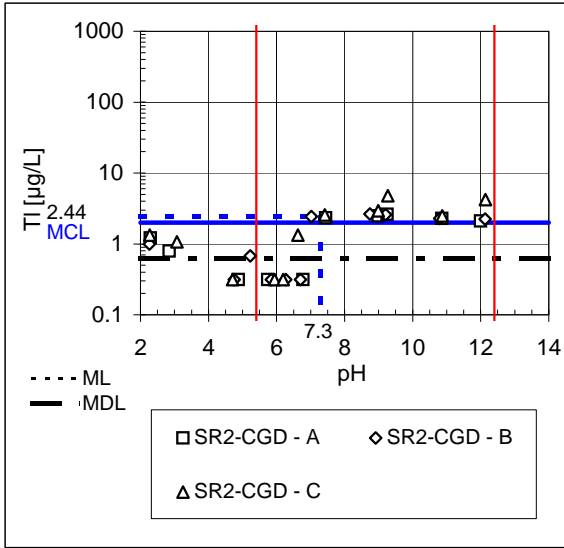

On

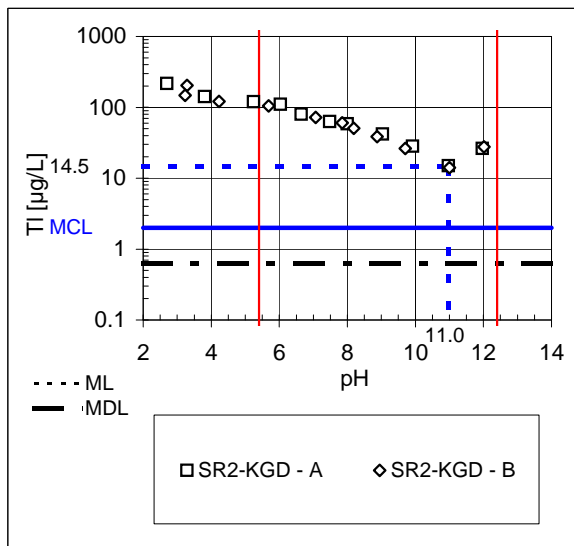
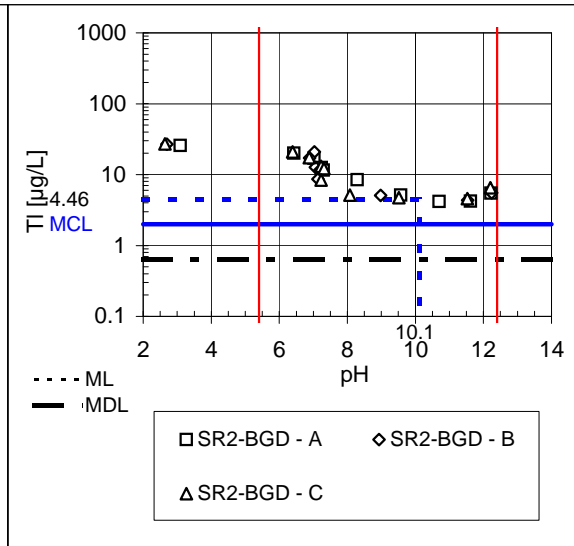
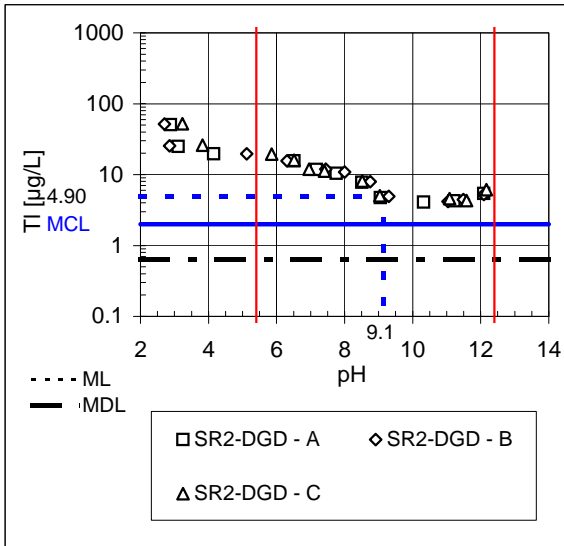
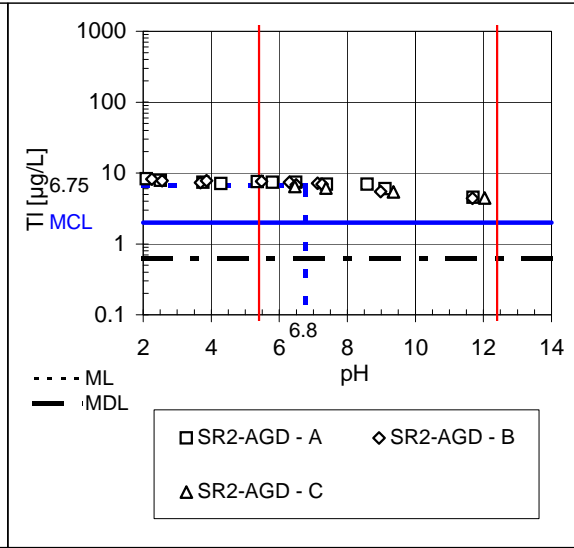

Fixated Scrubber Sludge (FSS, FSSL) Comparisons

FSS: Fly Ash + Scrubber Sludge (FA+ScS)

Facility A (FSS)

Coal: low sulfur bituminous

APC: NO+SNCR+FF

CCC
(SNCR Off)

ACC
(SNCR On)

page break

FSSL: Fly Ash + Scrubber Sludge + Lime (FA+ScS+lime)

Facility B (FSSL)

Coal: low sulfur bituminous

APC: NO+SCR+ESP(CS) [Mg lime]

DCC
(SCR Off)

BCC
(SCR On)

Facility K (FSSL)

Coal: sub-bituminous

APC: NO+SCR+ESP(CS) [Mg lime]

KCC
(SCR On)

Facility M (FSSL)

Coal: bituminous

APC: IO+SCR+ESP(CS)

MAD
(SCR Off)

MAS
(SCR On)

Fixated Scrubber Sludge Comparisons

Off

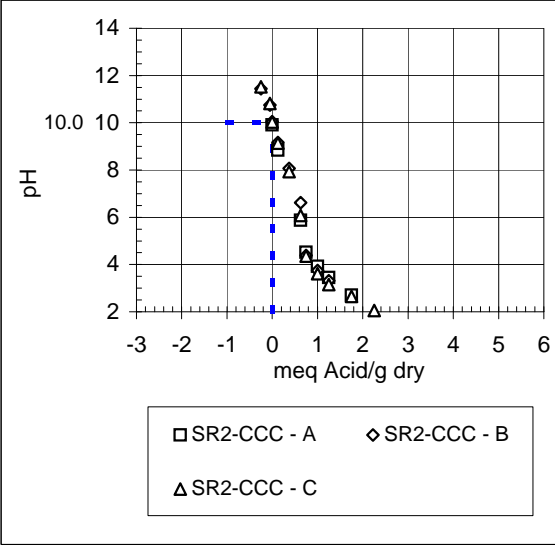

On

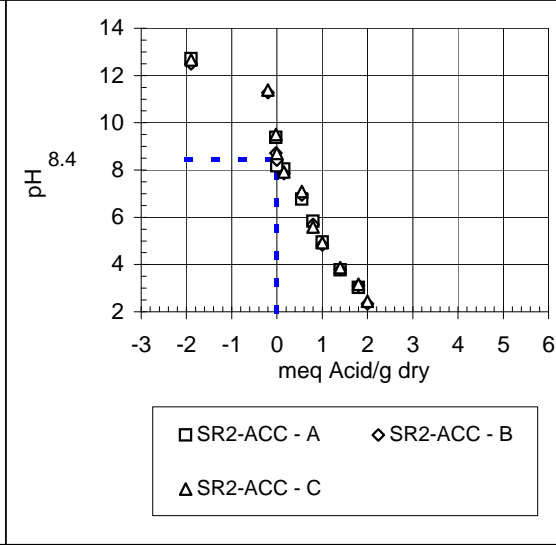

Fixated Scrubber Sludge Comparisons

Off

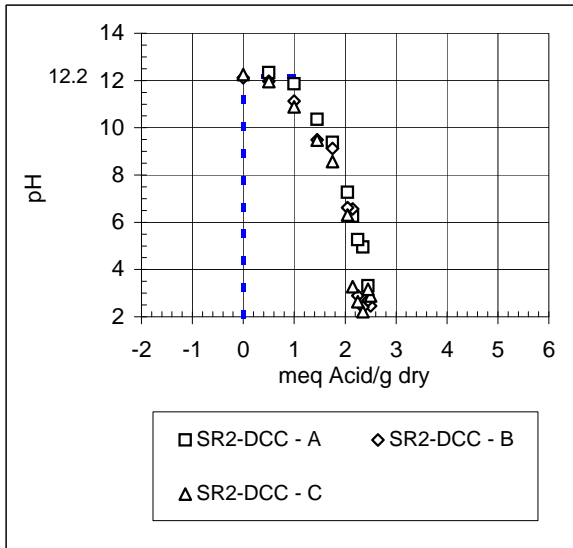

On

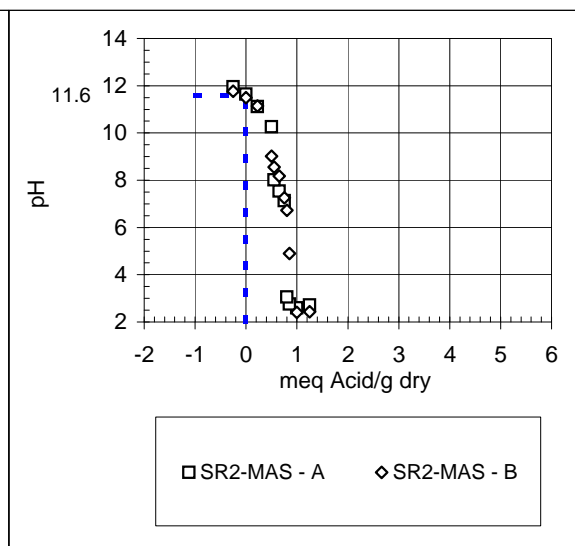
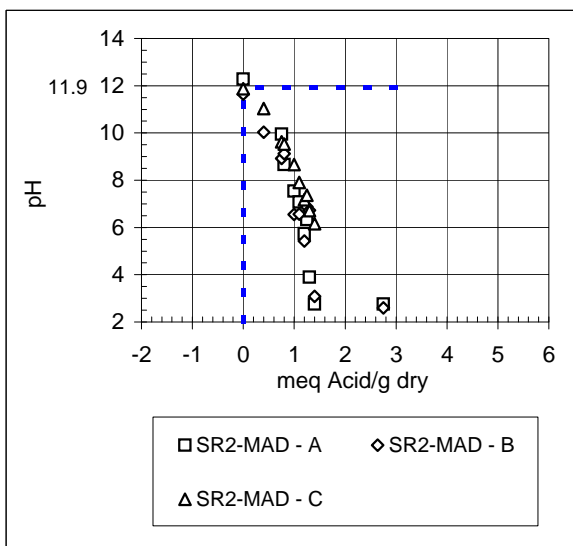
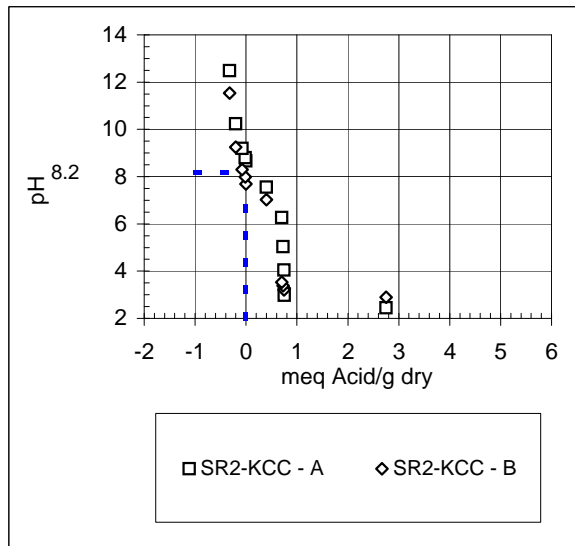
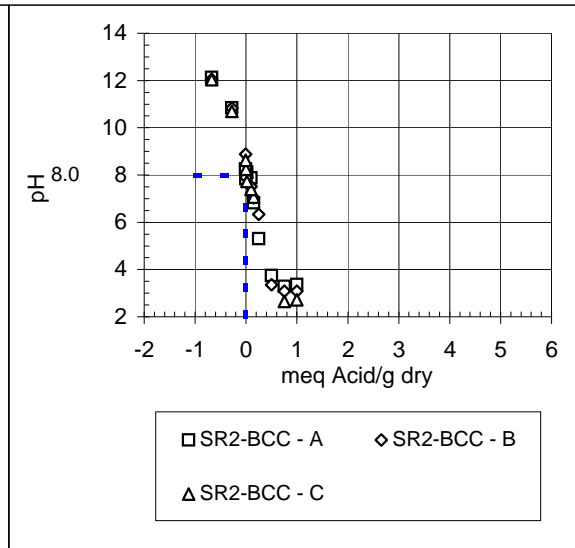

Off

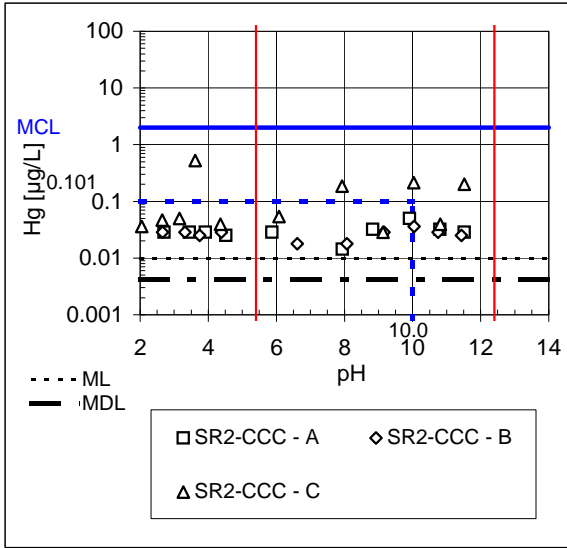

On

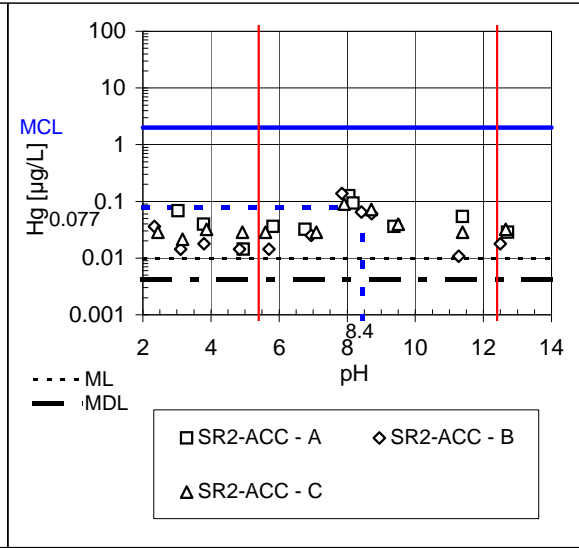

Off

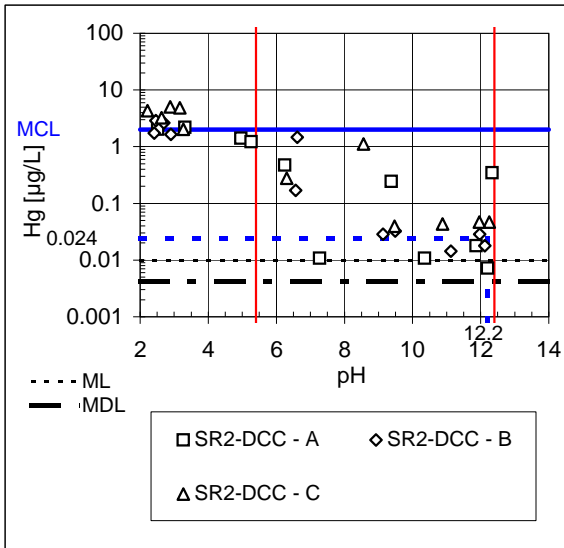

On

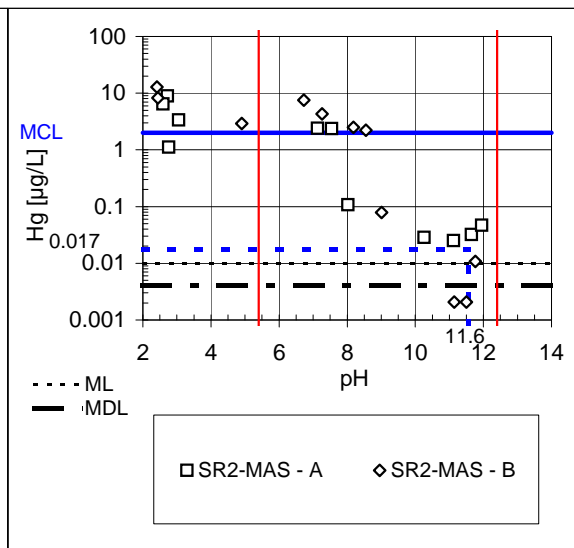
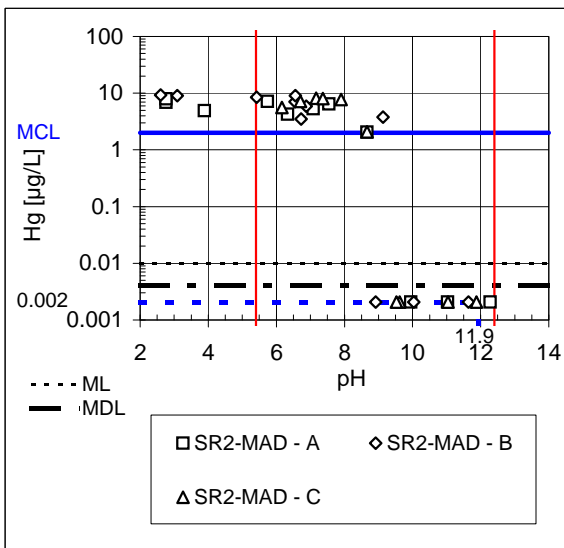
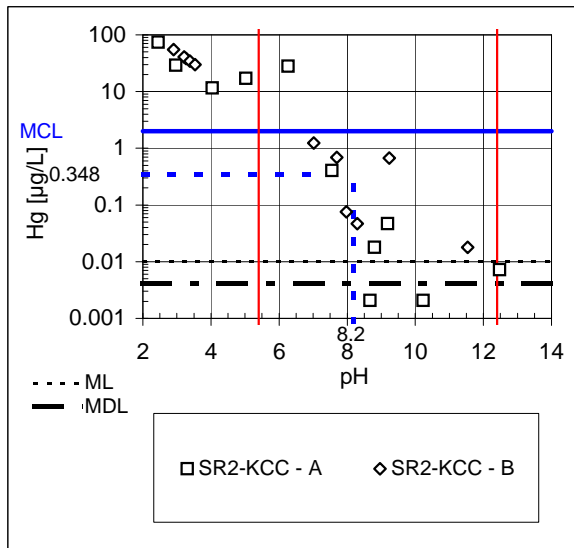
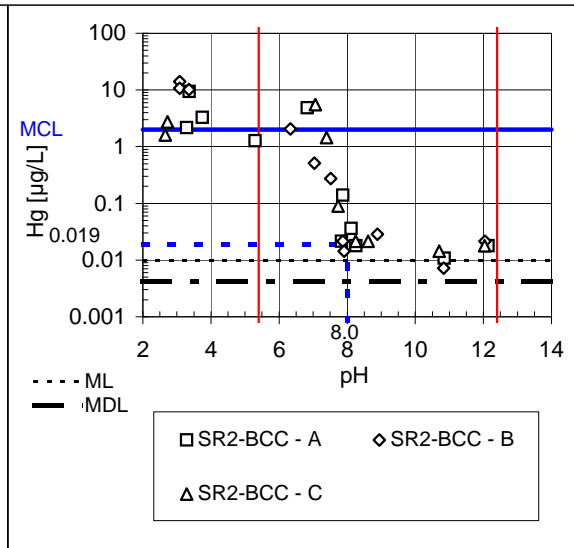

Off

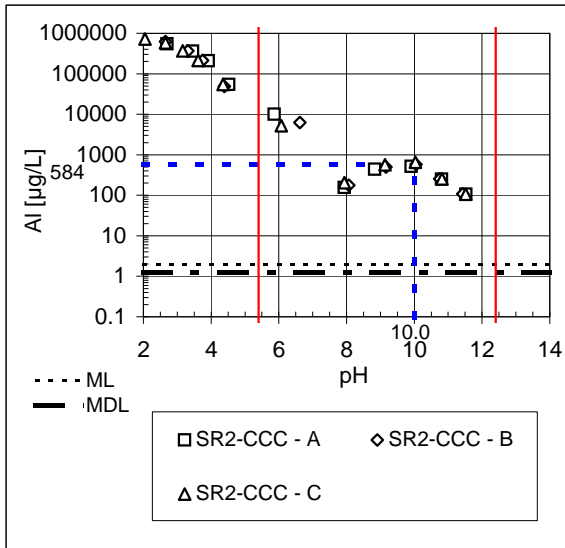

On

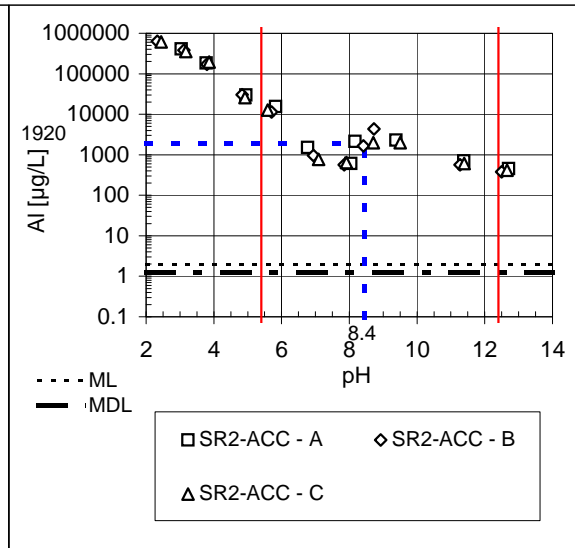

Off

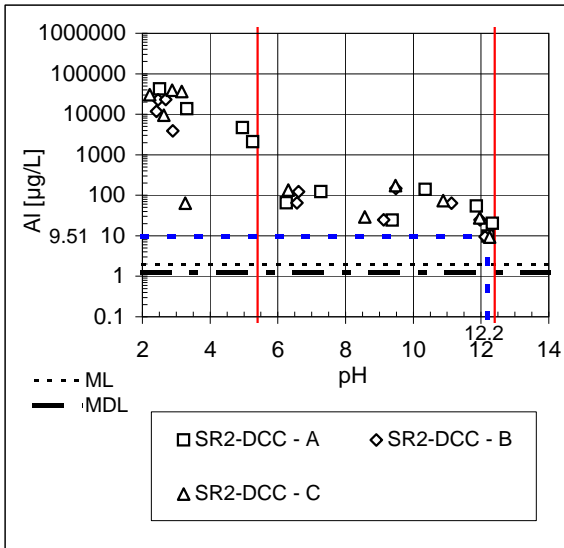

On

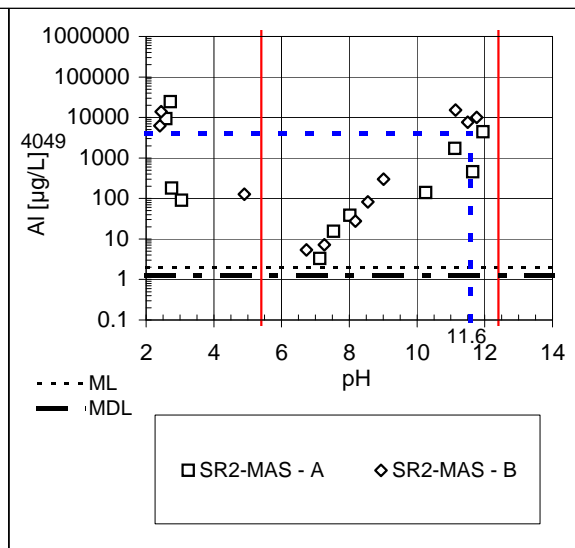
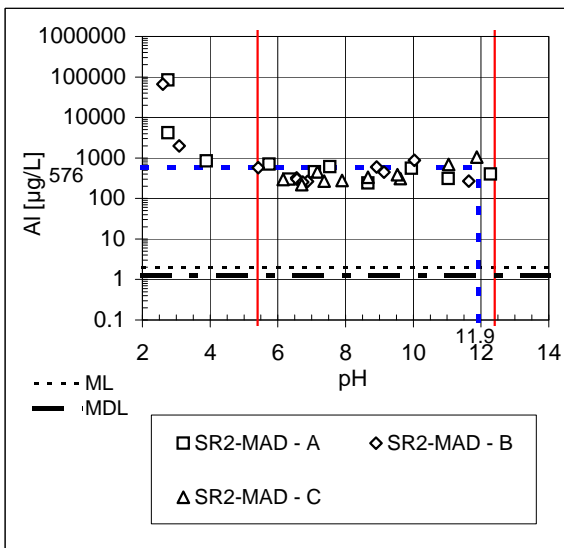
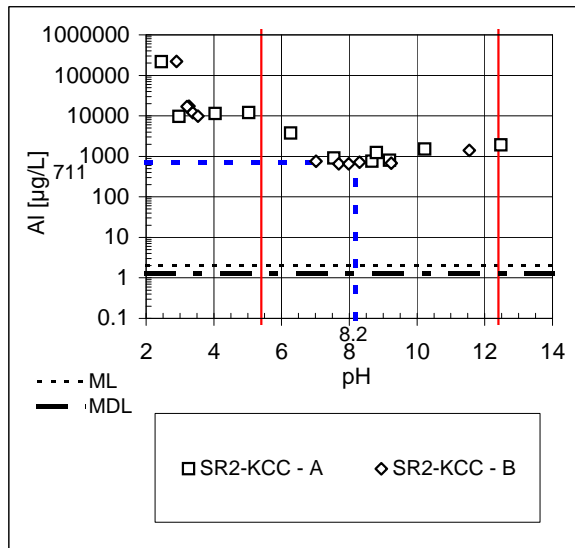
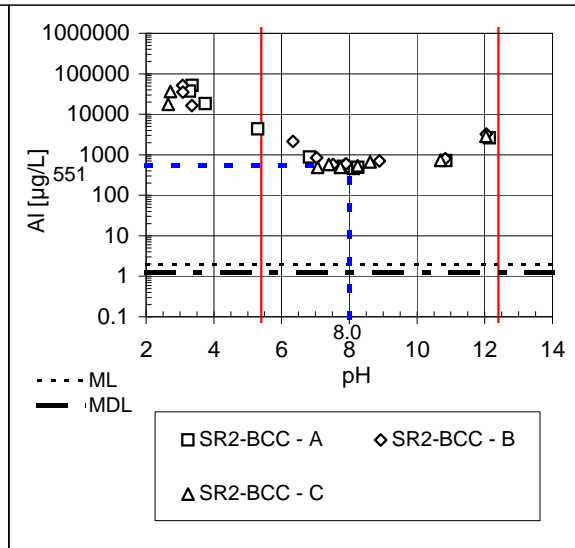

Off

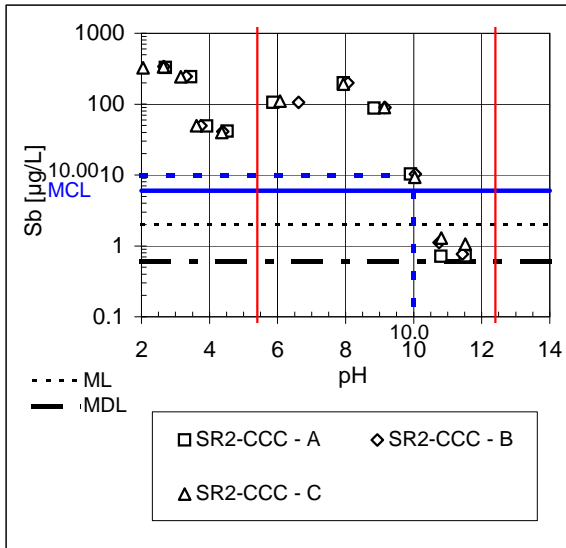

On

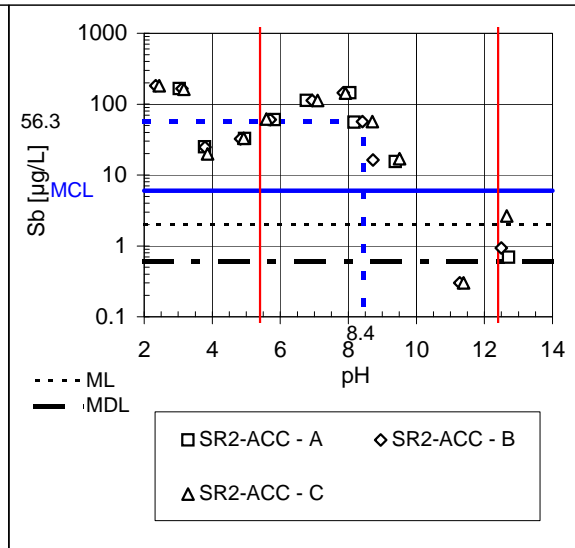

Off

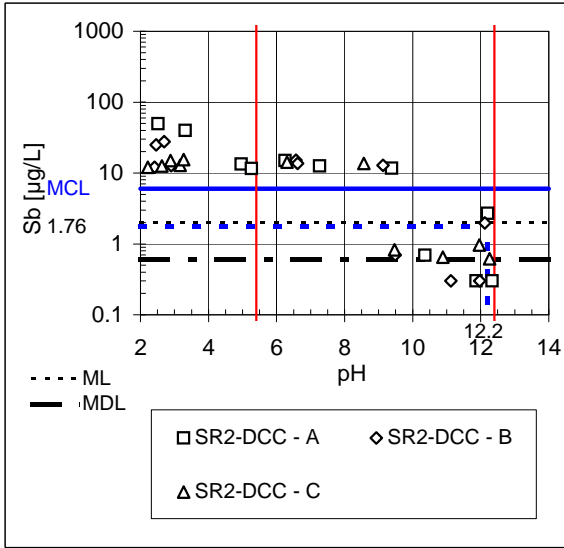

On

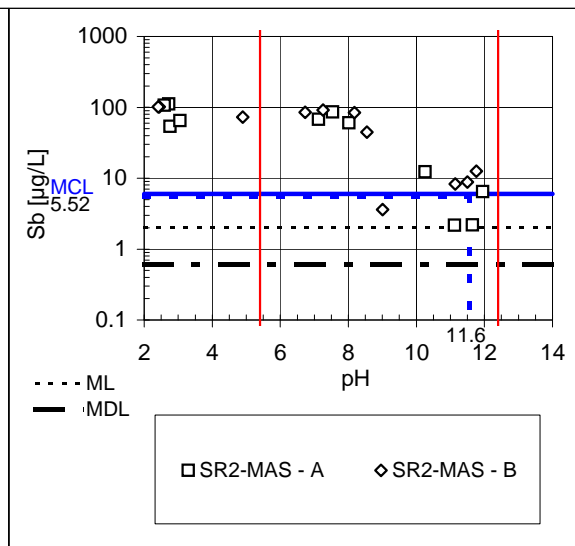
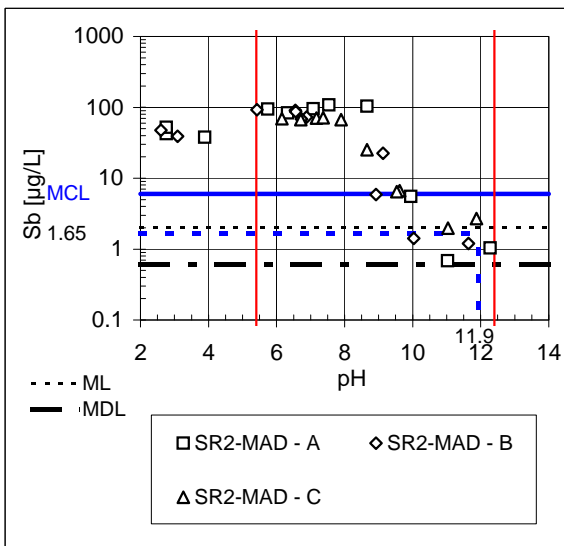
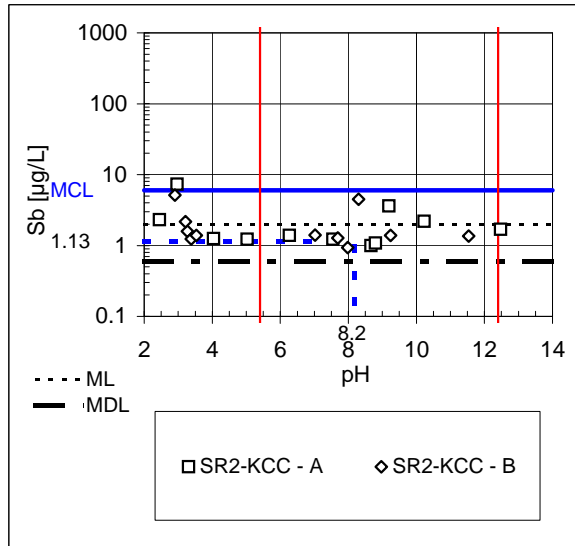
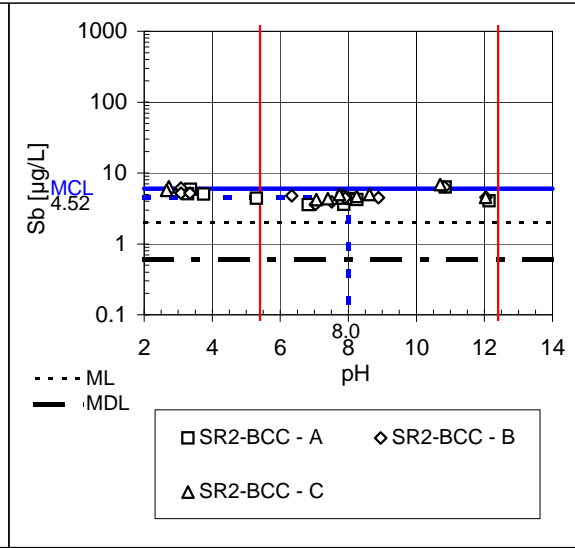

Off

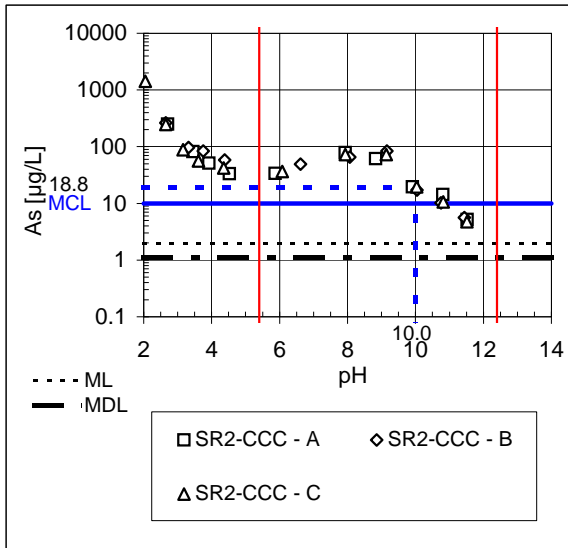

On

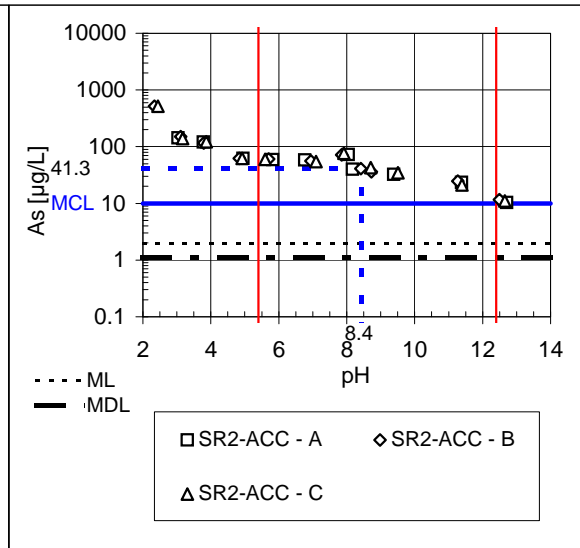

Off

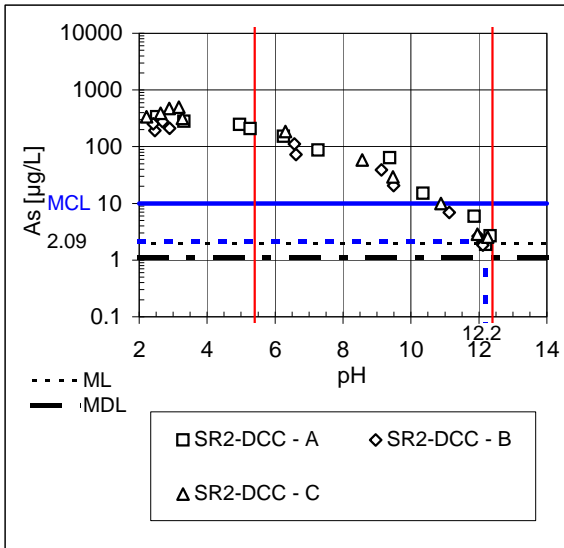

On

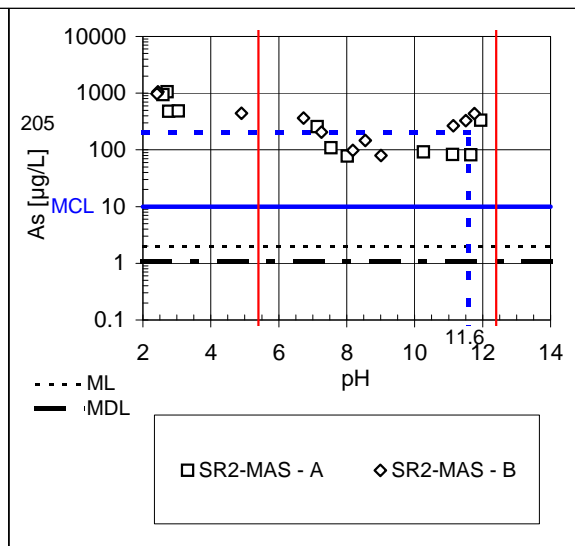
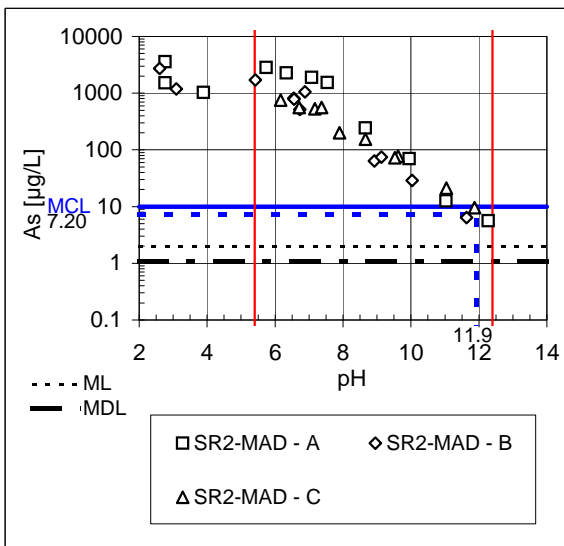
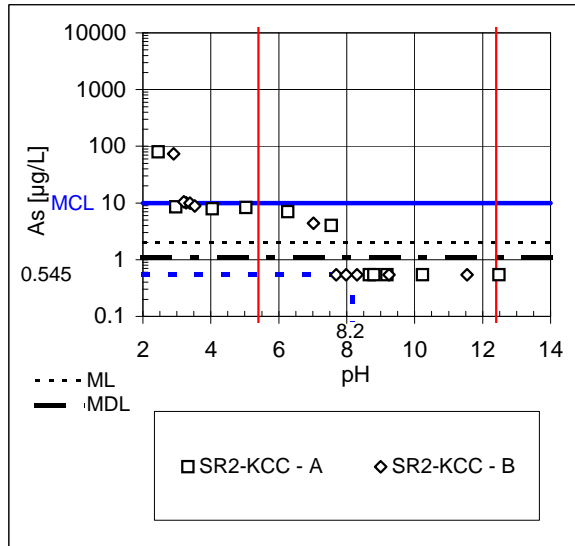
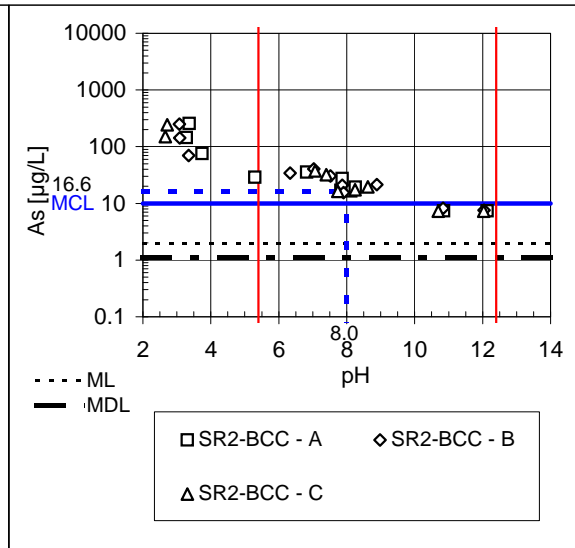

Off

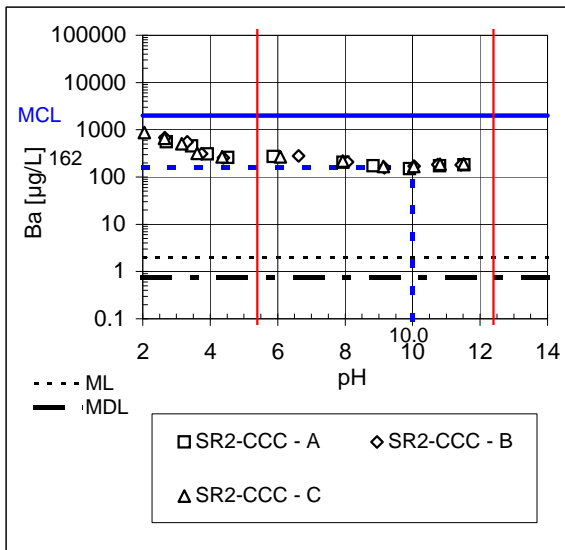

On

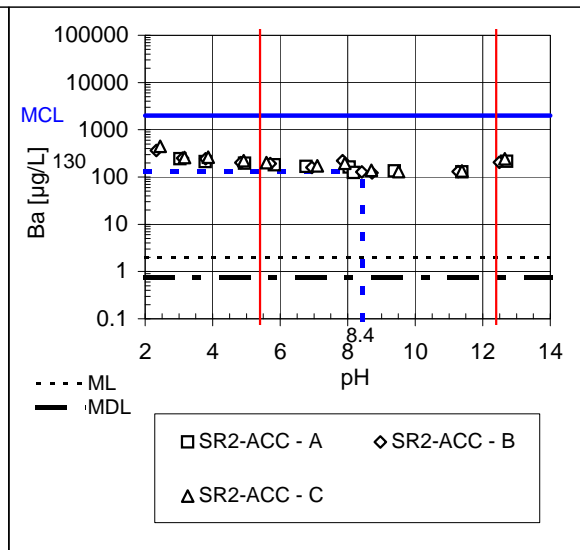

Off

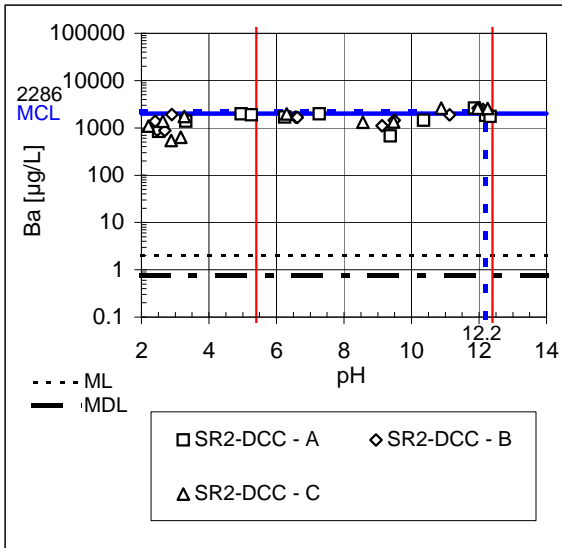

On

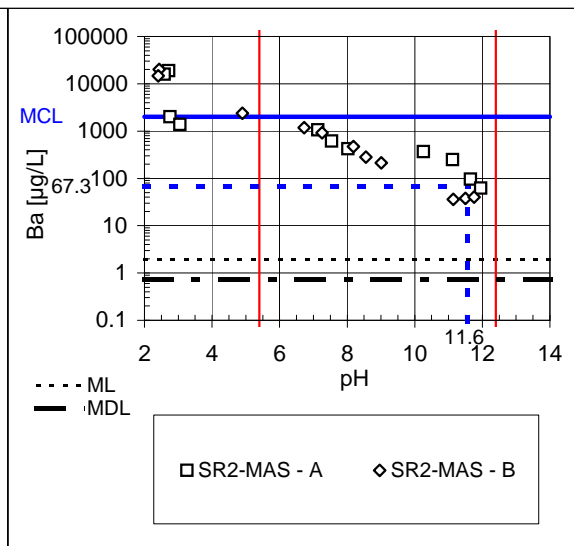
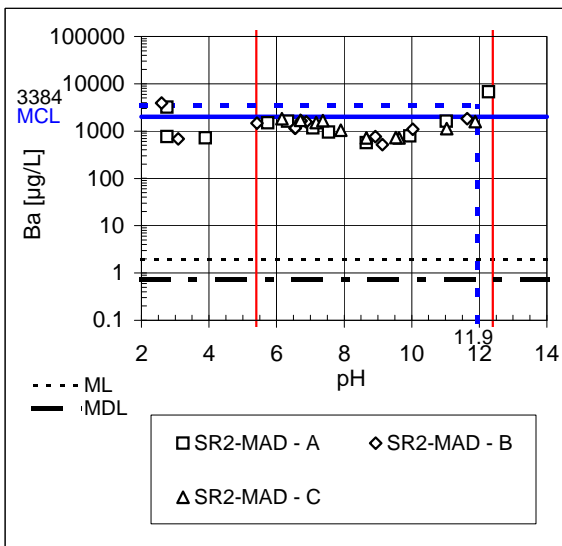
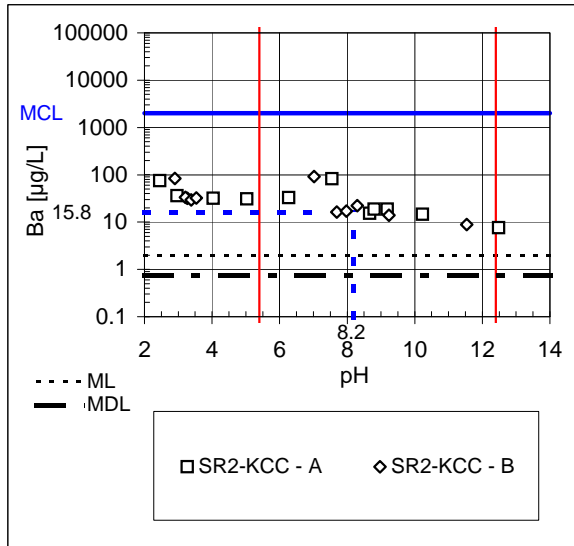
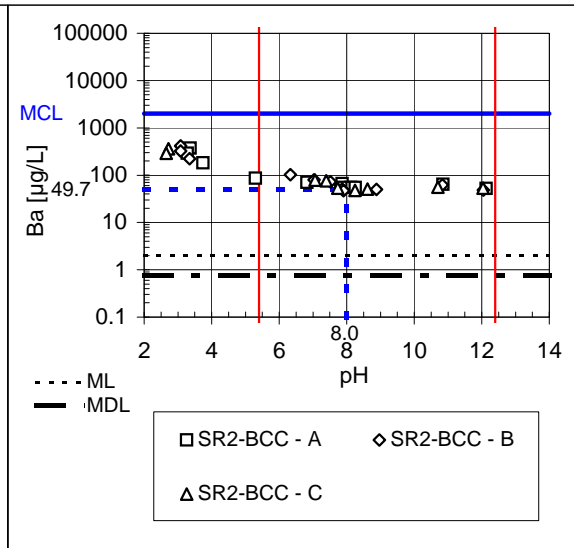

Off

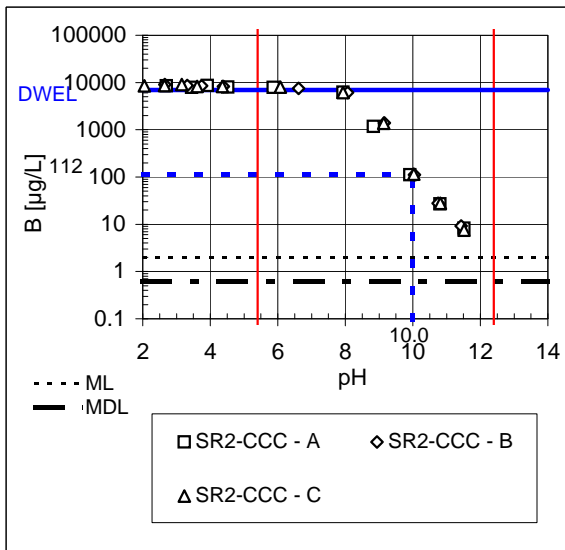

On

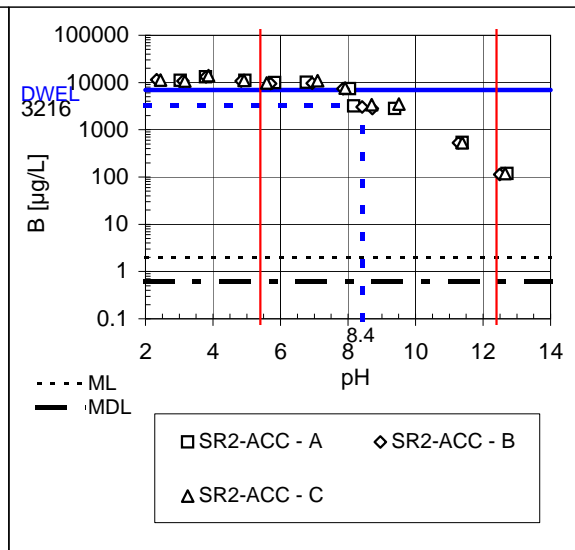

Off

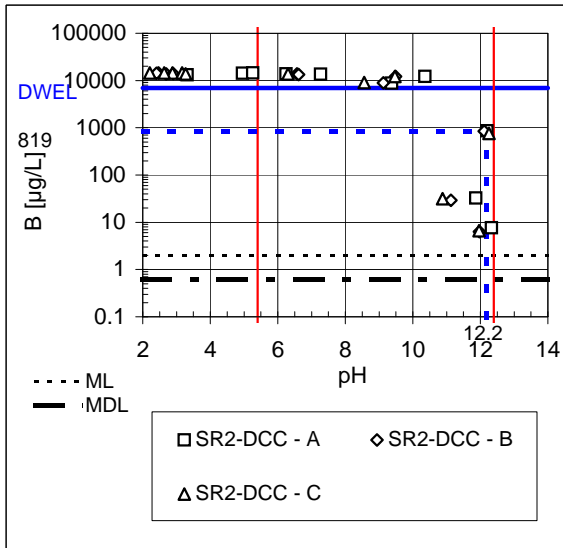

On

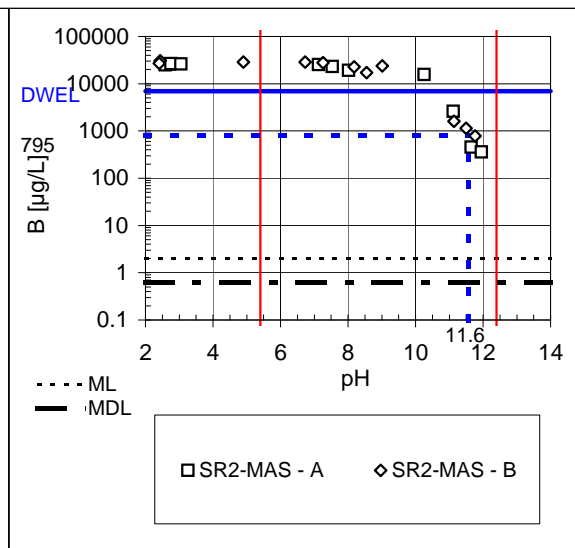
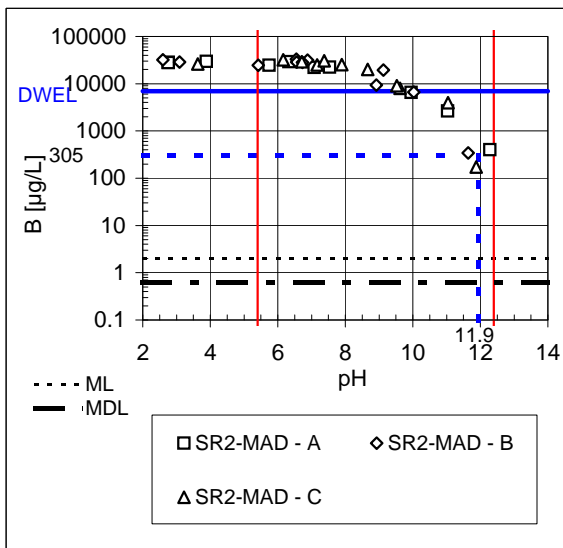
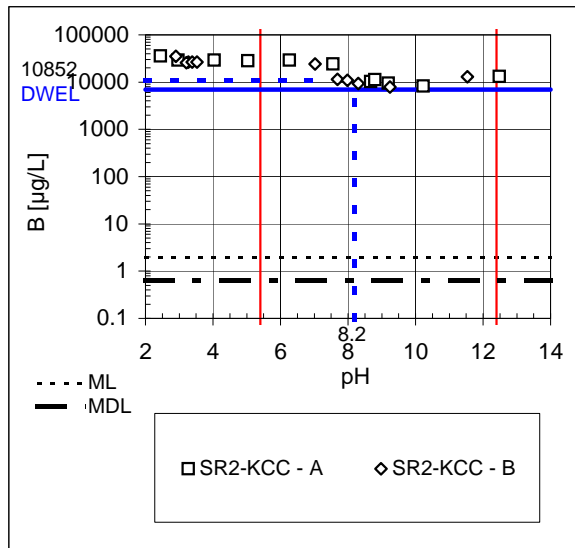
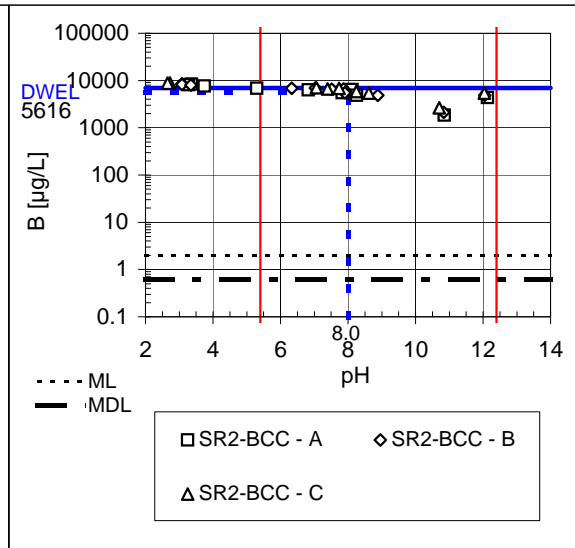

Off

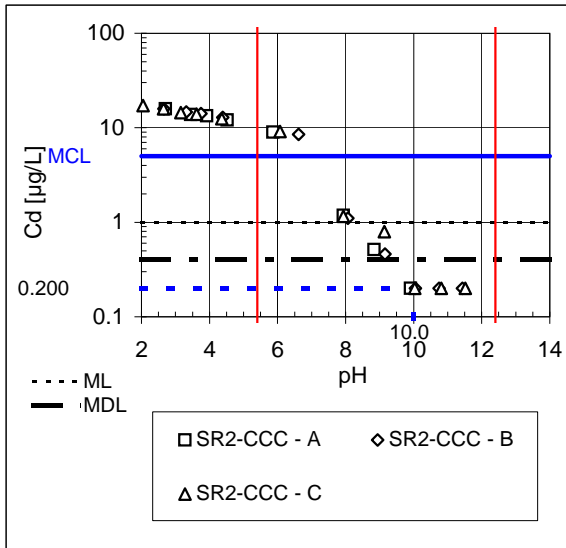

On

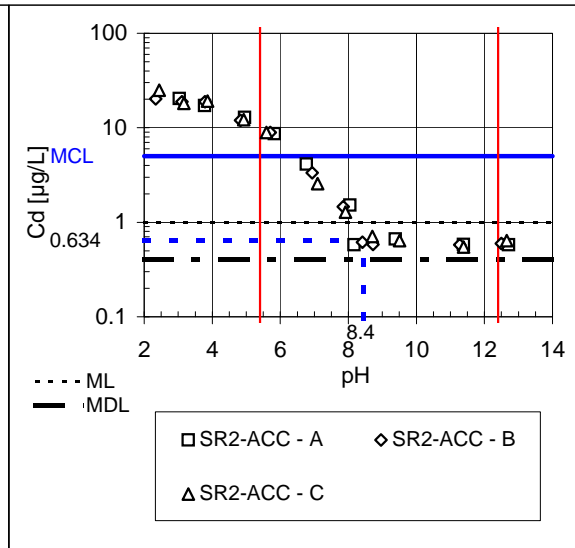

Off

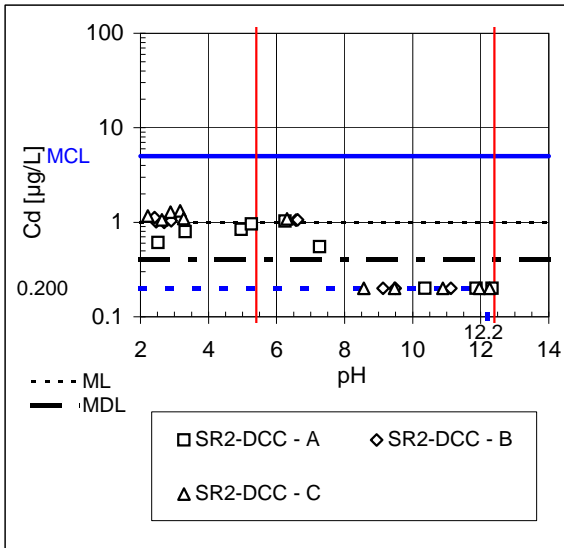

On

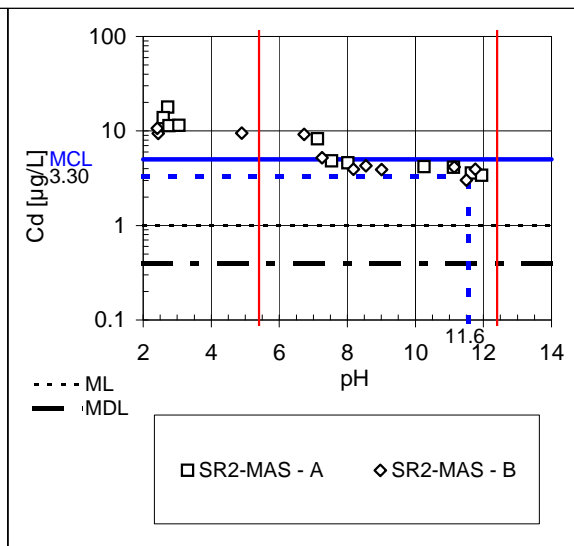
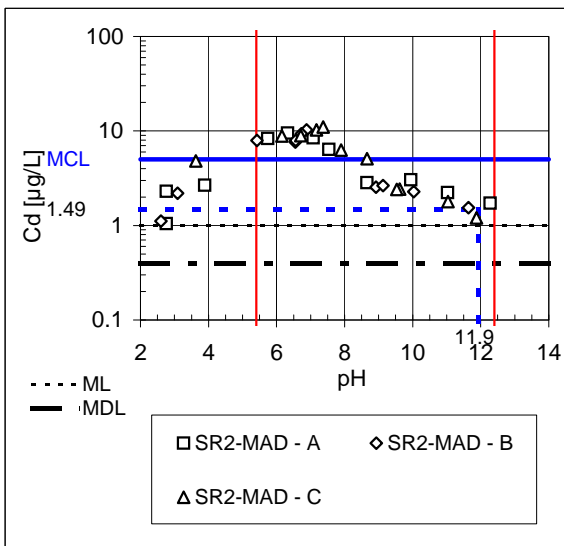
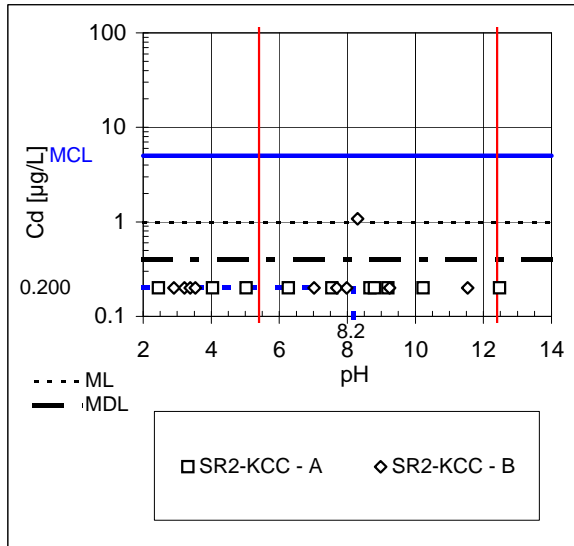
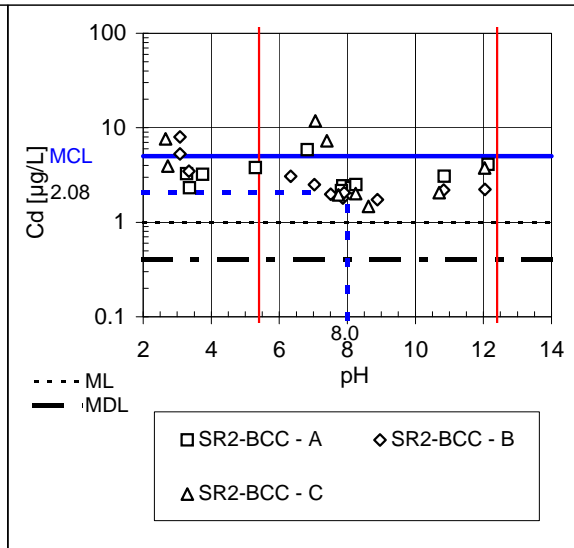

Off

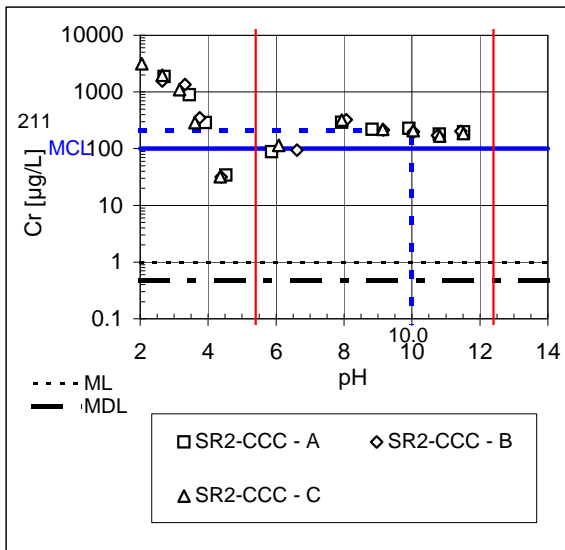

On

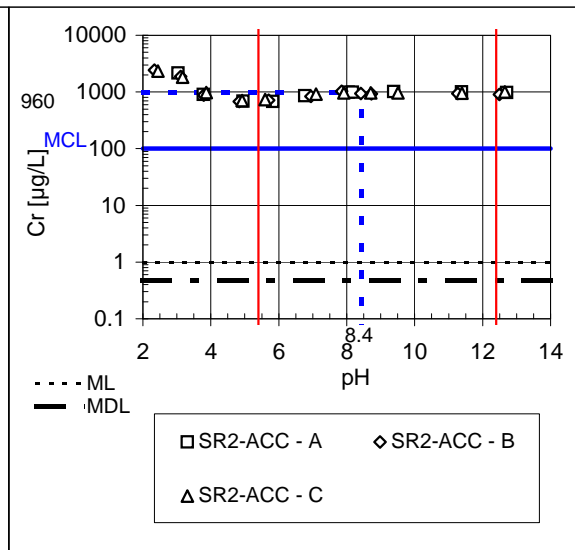

Off

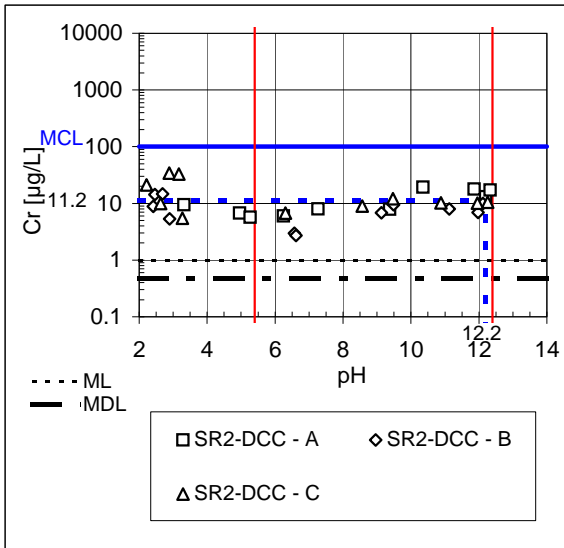

On

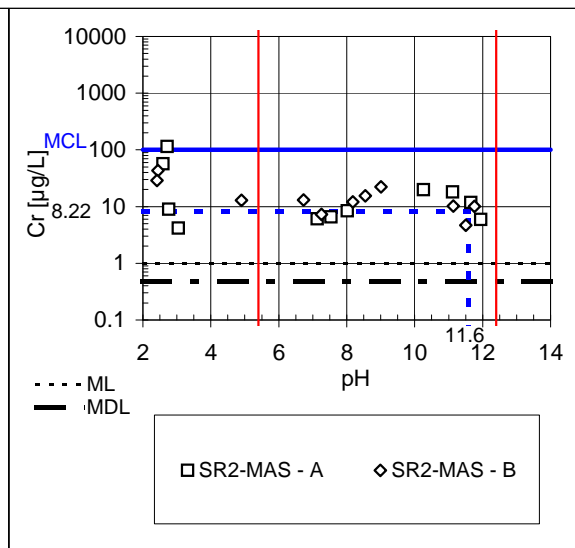
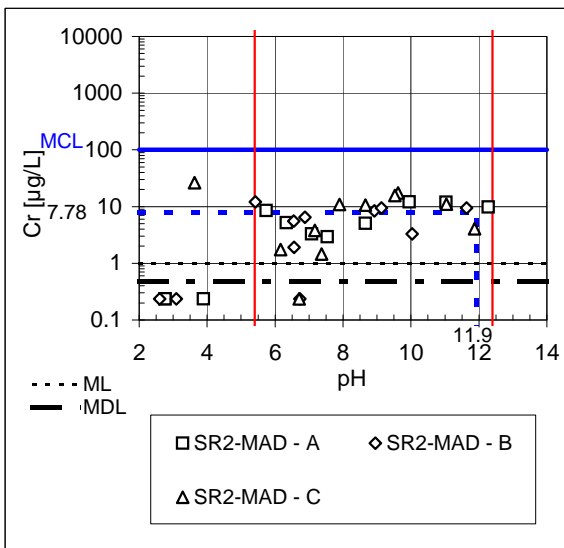
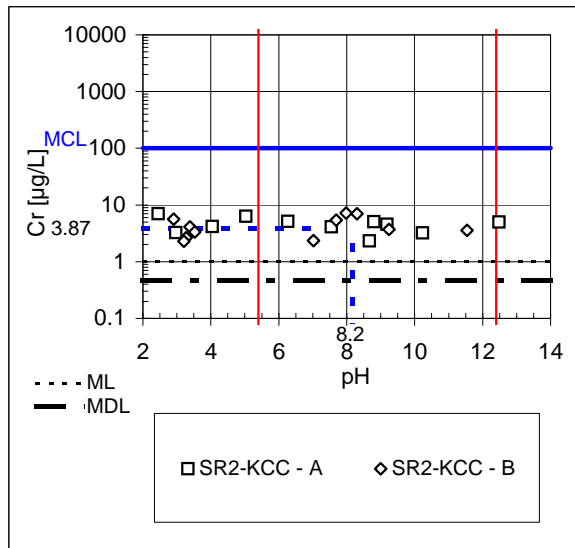
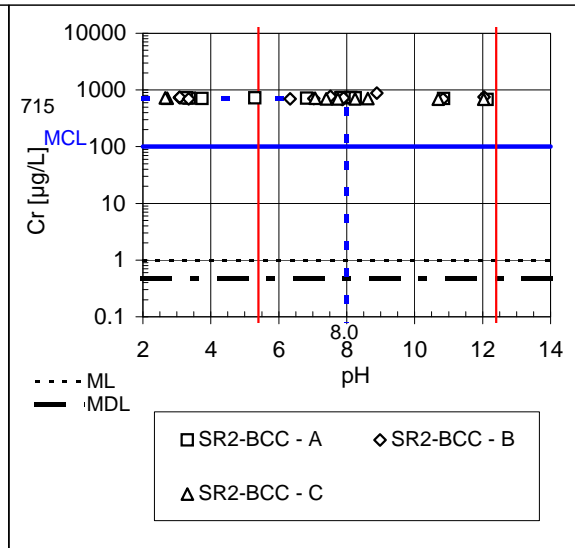

Off

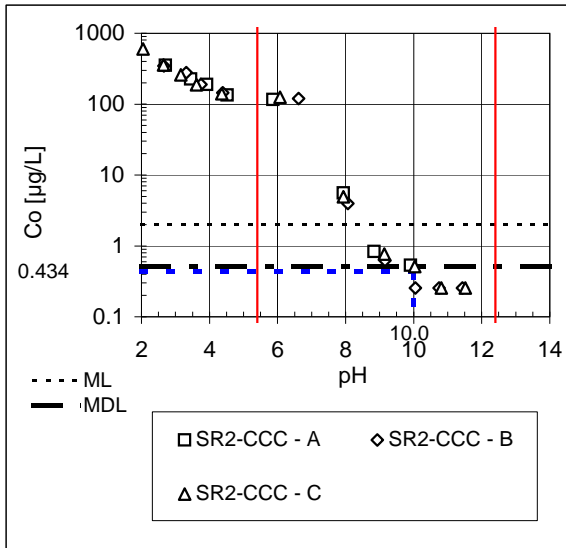

On

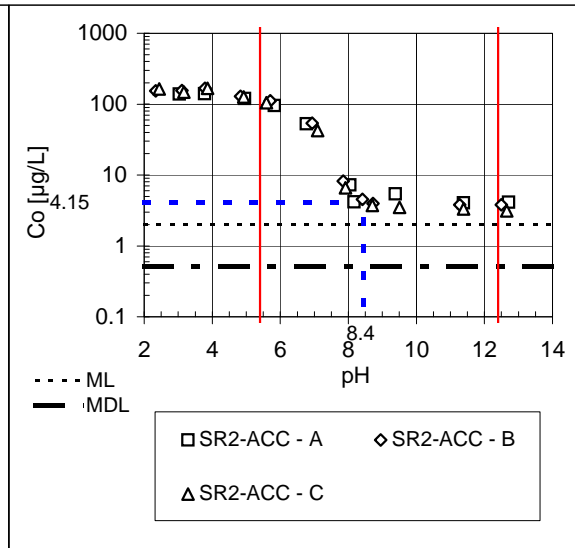

Off

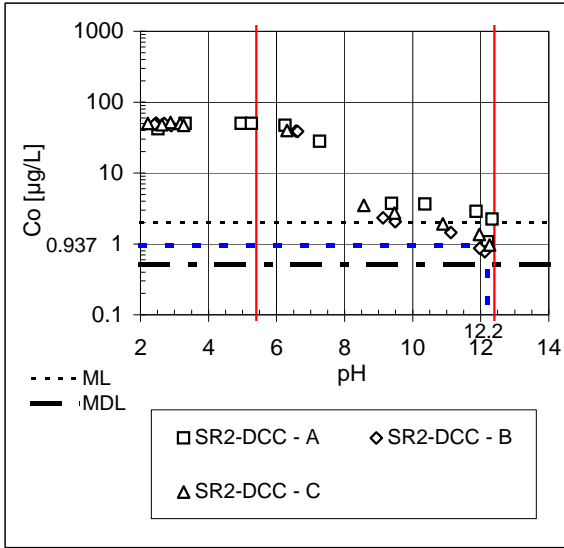

On

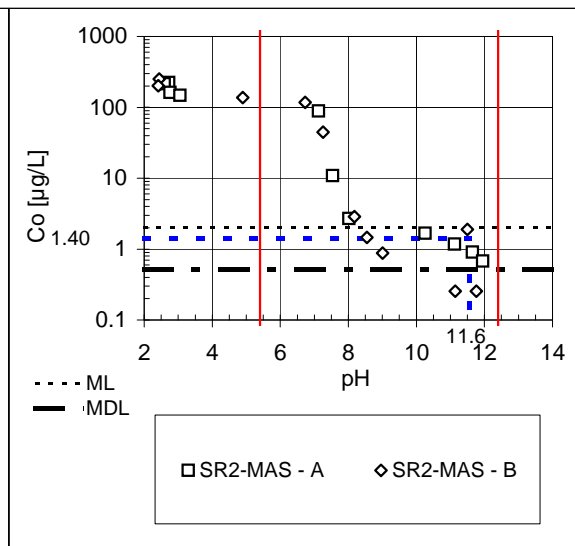
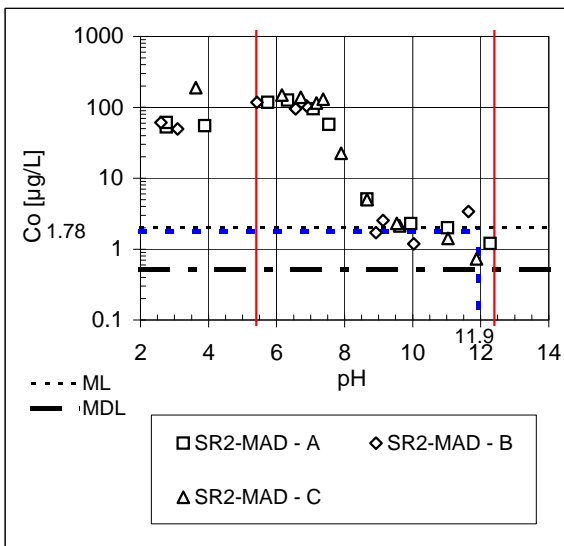
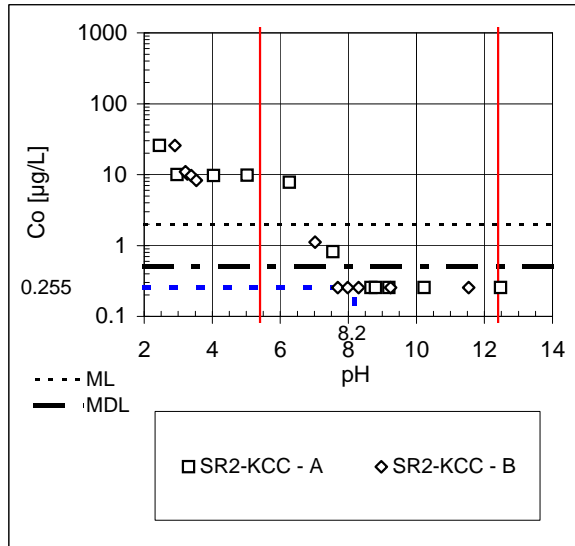
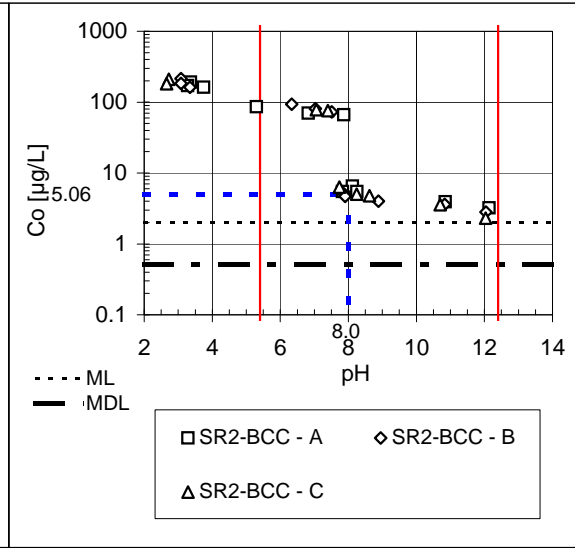

Off

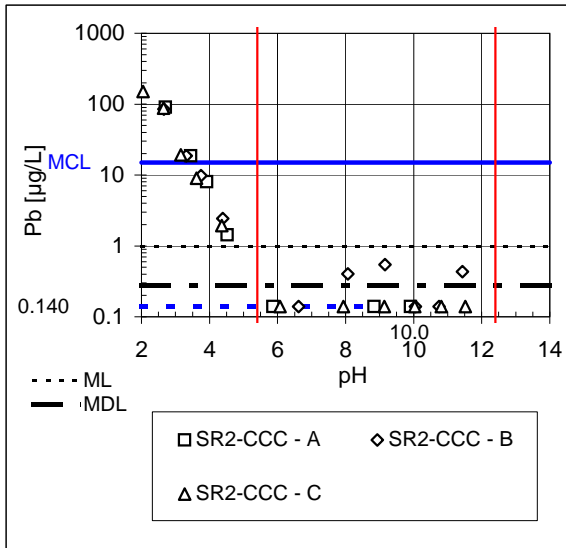

On

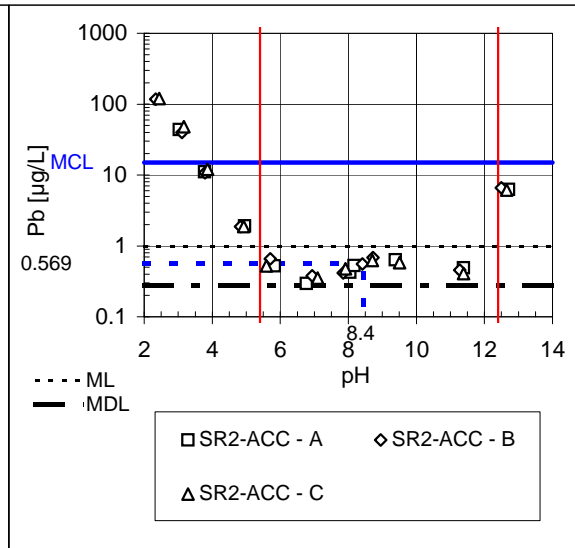

Off

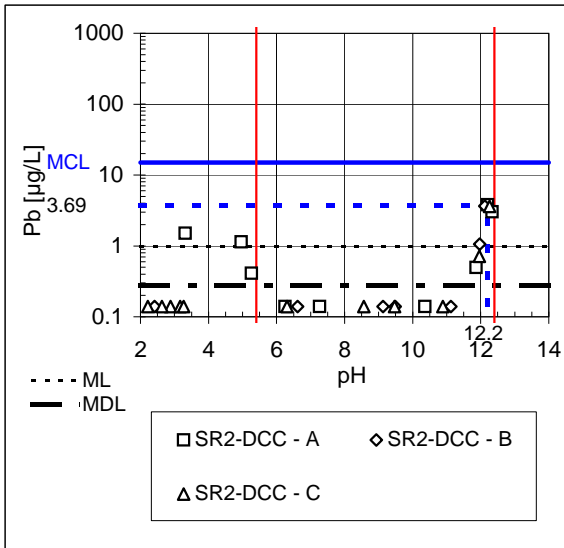

On

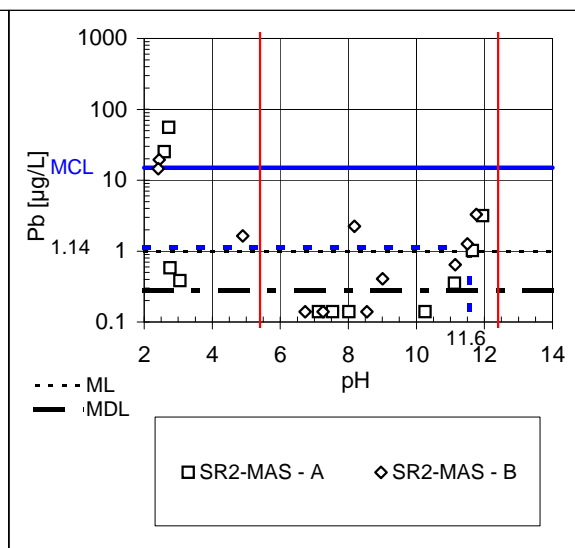
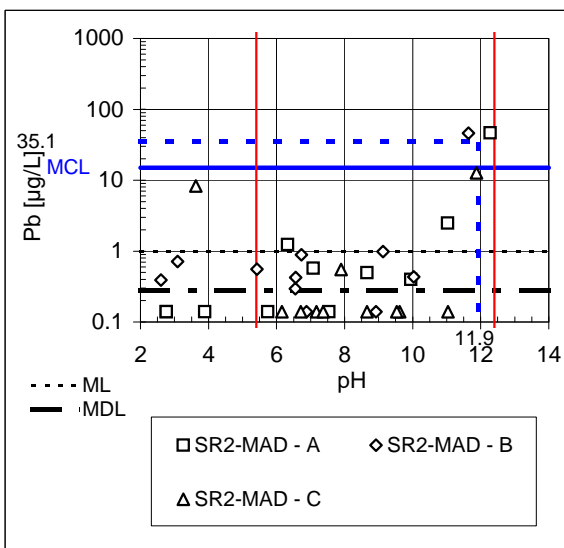
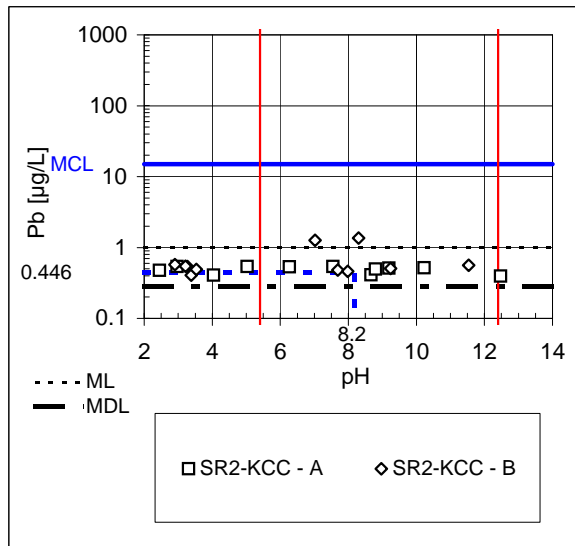
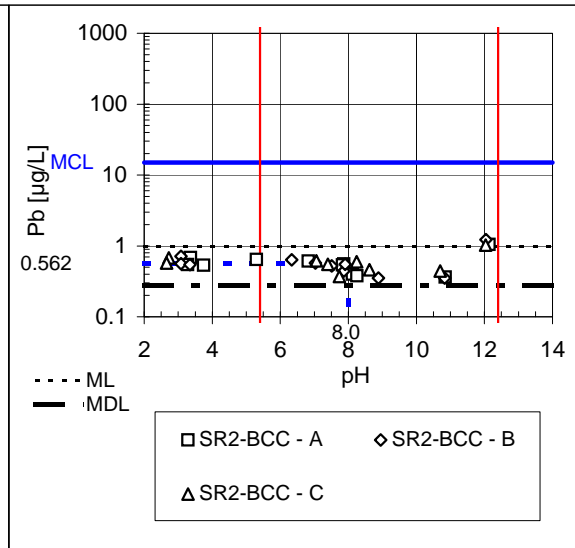

Off

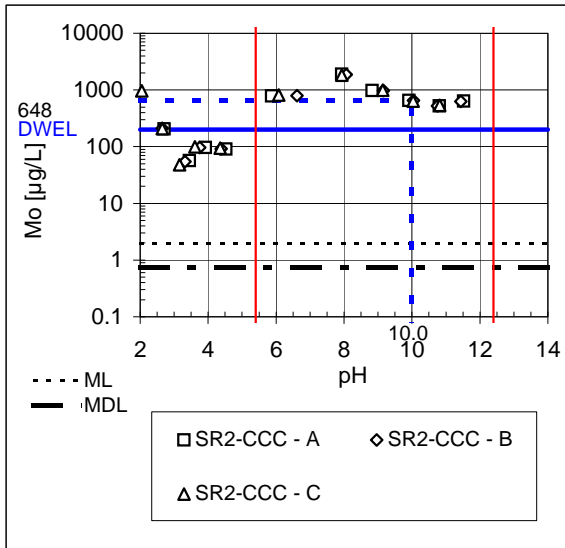

On

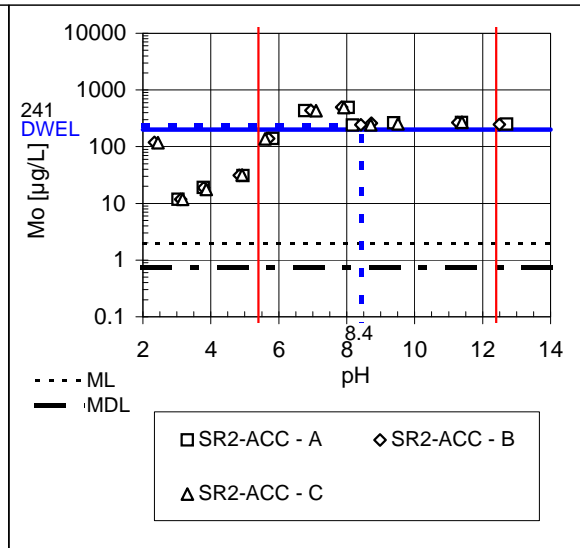

Off

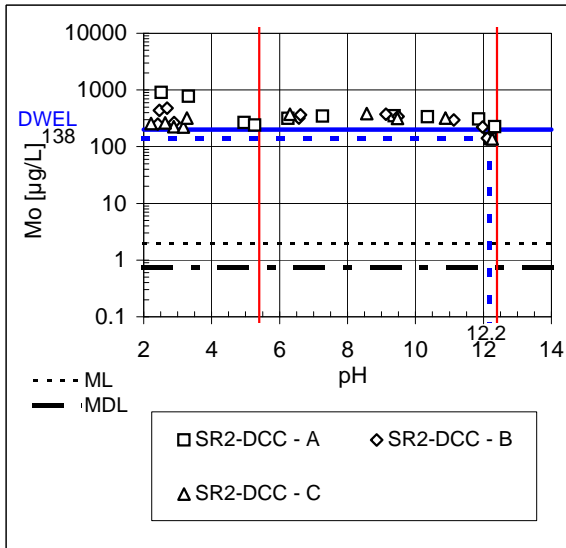

On

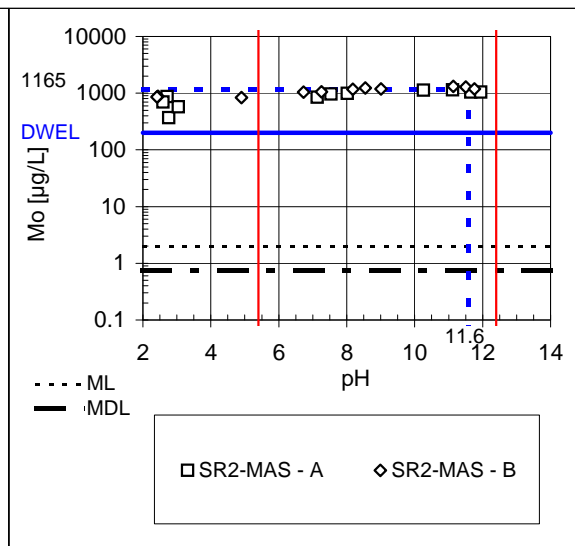
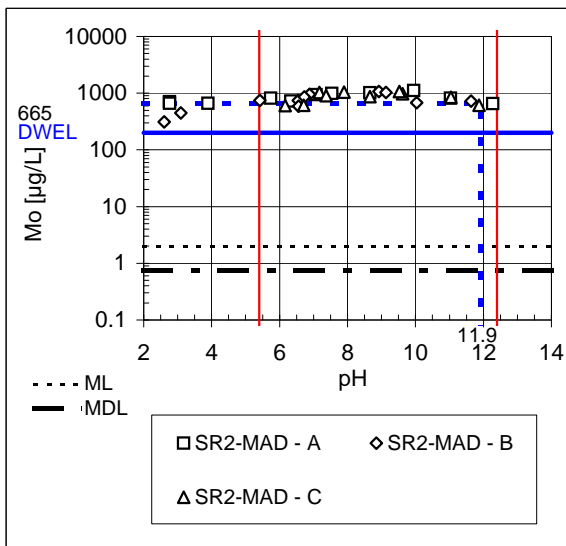
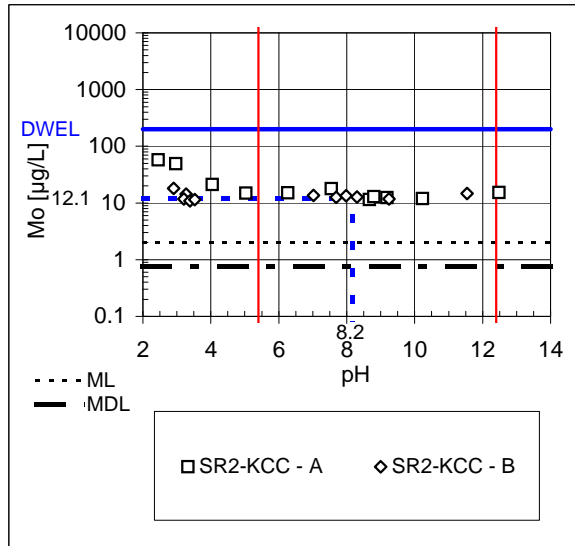
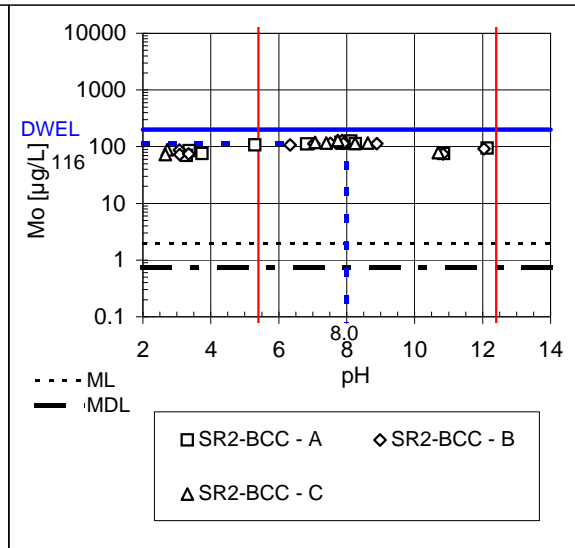

Off

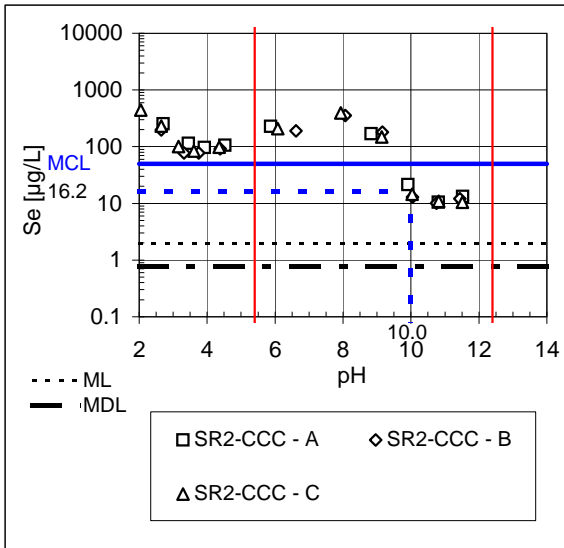

On

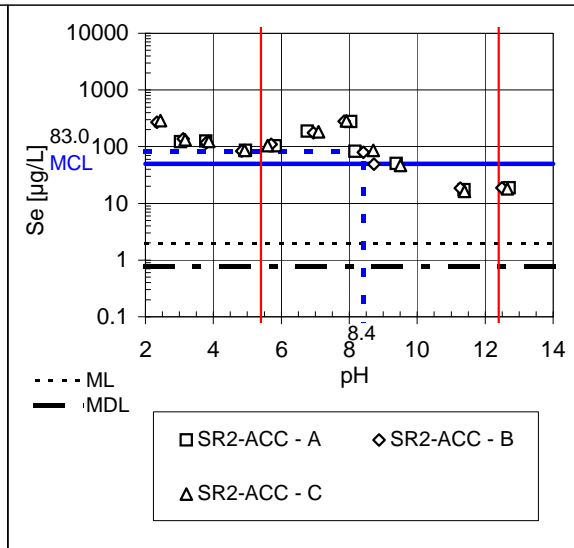

Off

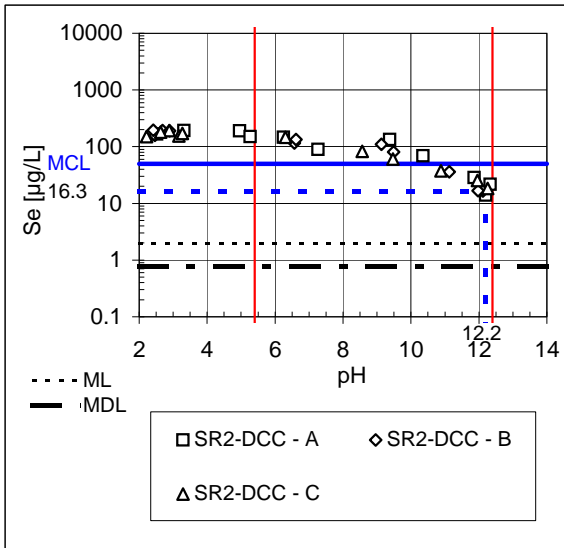

On

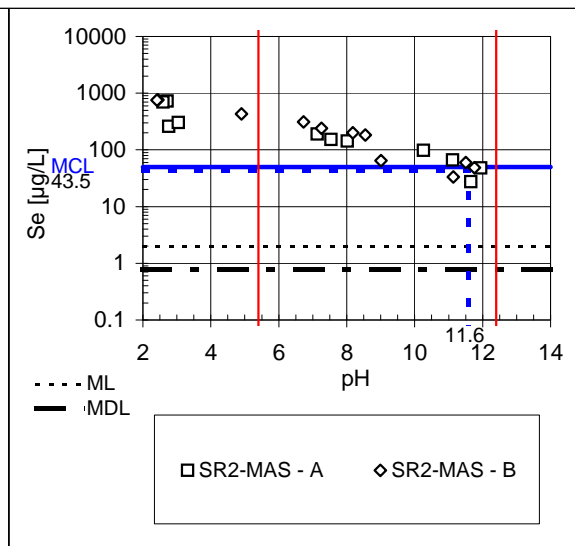
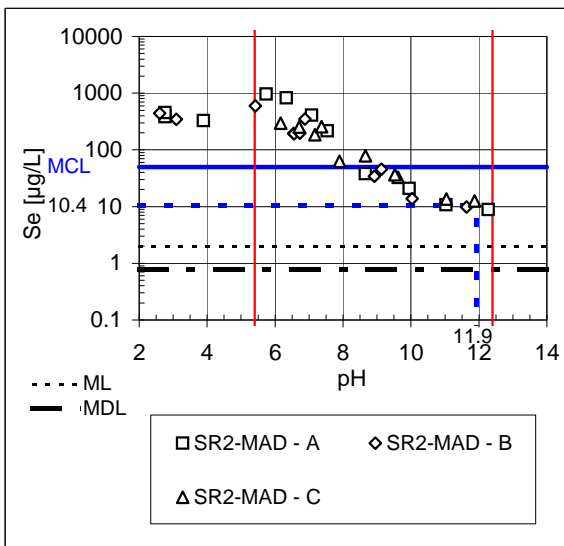
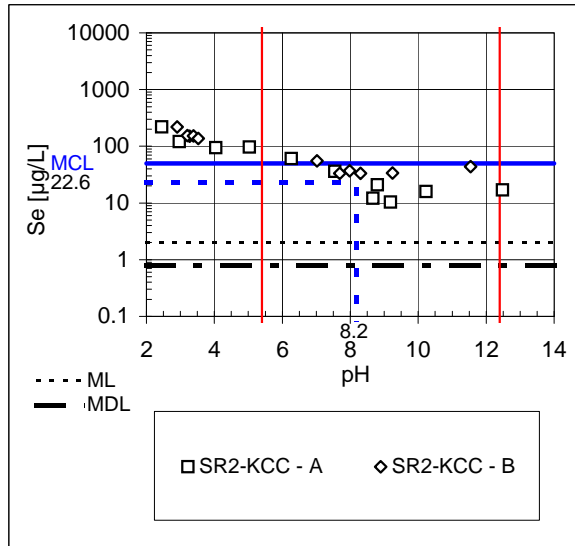
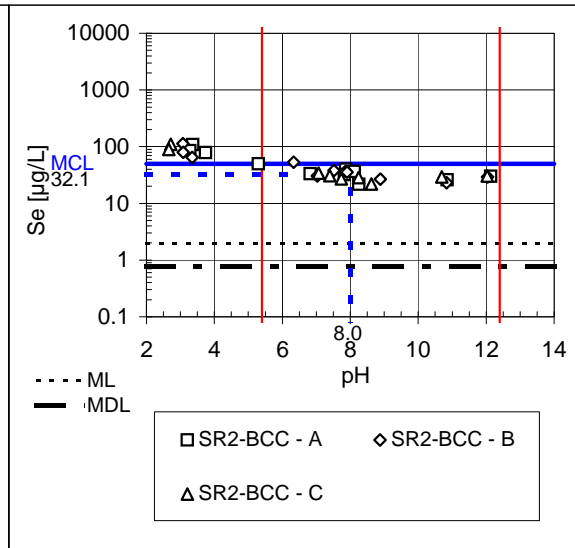

Off

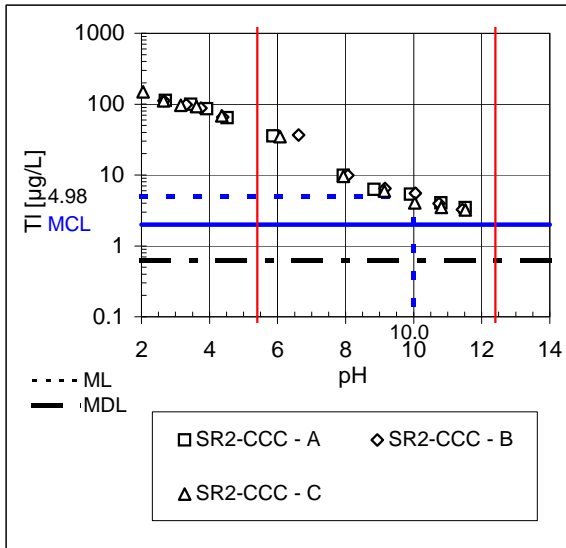

On

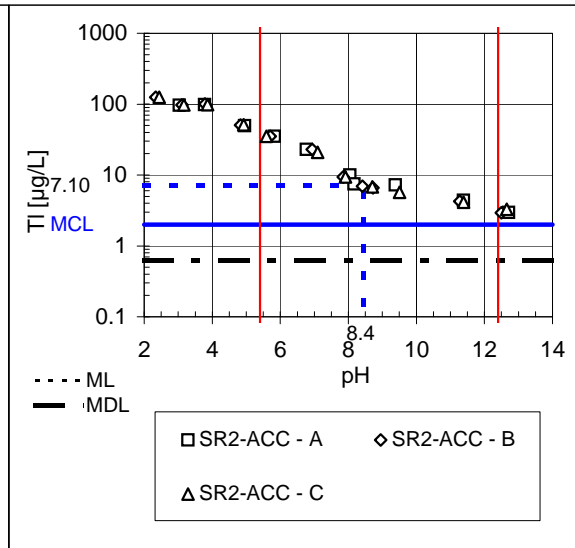

Off

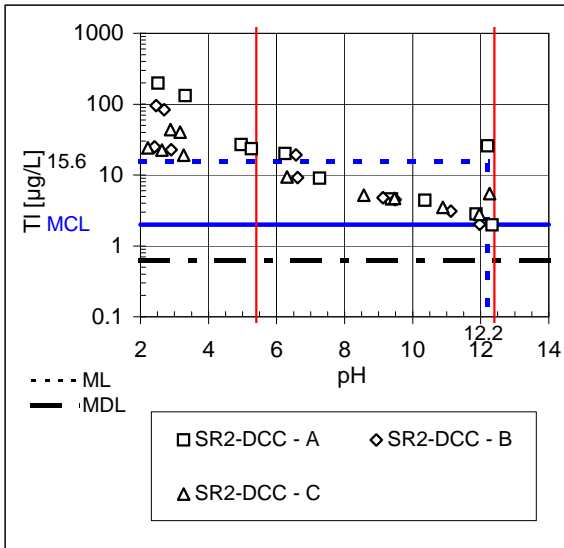

On

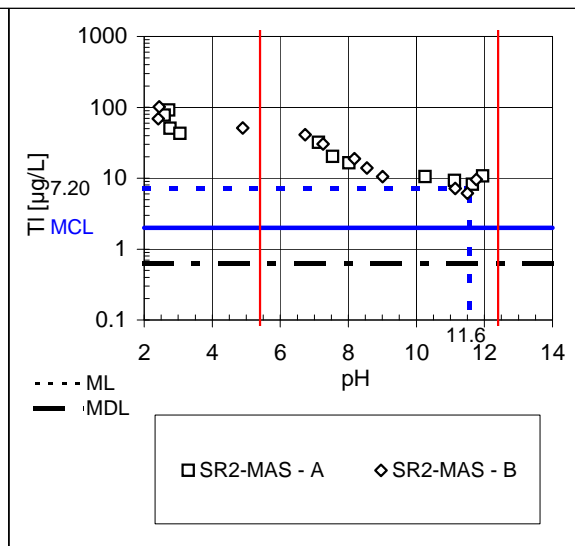
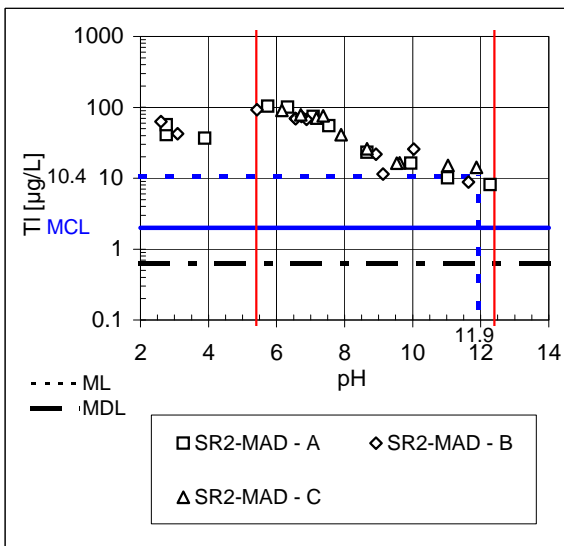
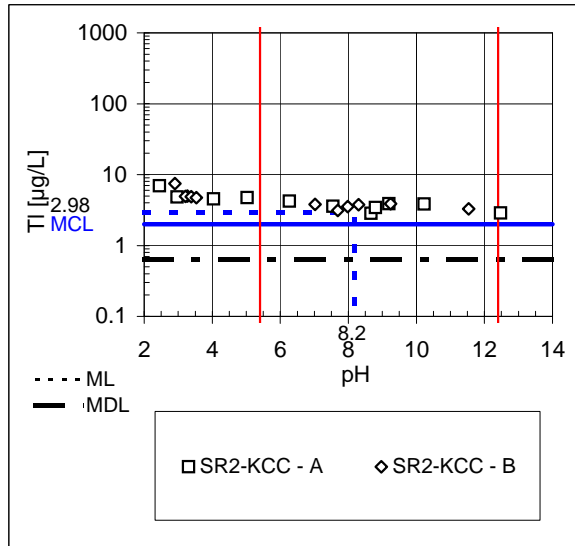
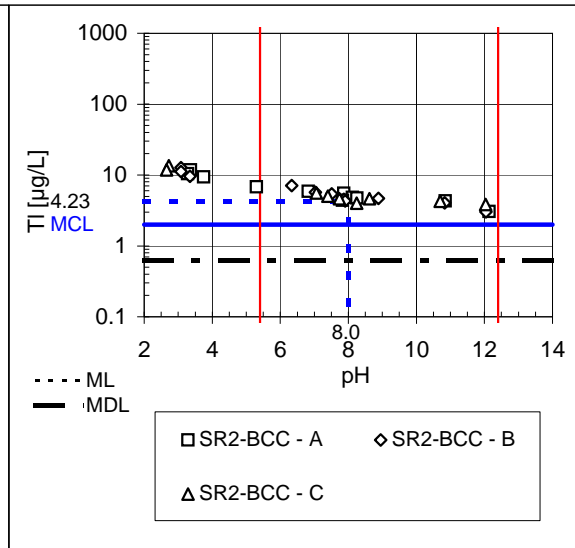

SR002.1 Outliers resulting from inconsistency in pH determination.

Material	Test Position	Replicate	Conc. [$\mu\text{g/L}$]													
			pH	Hg	Al	Sb	As	Ba	B	Cd	Cr	Co	Pb	Mo	Se	Tl
			S.I.	$\mu\text{g/L}$	$\mu\text{g/L}$	$\mu\text{g/L}$	$\mu\text{g/L}$	$\mu\text{g/L}$	$\mu\text{g/L}$	$\mu\text{g/L}$	$\mu\text{g/L}$	$\mu\text{g/L}$	$\mu\text{g/L}$	$\mu\text{g/L}$	$\mu\text{g/L}$	$\mu\text{g/L}$
AFA	T08	A	8.40	0.245	7570	31.4	57.9	312	557	0.608	1310	8.4	0	877	83	3.33
BFA	T08	C	8.36	0.01	1210	6.17	29.3	142	7532	1.190	873	7.0	0	1874	14	1.94
KFA	T05	B	5.05	0.02	721	34.9	114	226	37652	1.478	6	1.8	0	2071	40.9	87.9
AGD	T01	C	1.35	0.01	52800	61.3	243	80.0	7185	2.0	900	106	64	117	119	8.65
AGD	T02	C	1.65	0.01	43800	20.6	129	93.7	7859	2.0	882	90.3	35	61.9	68	7.96
AGD	T03	C	1.85	0.03	39700	16.1	13.3	83.8	8154	1.93	869	85.0	8	7.9	37	6.56
AGD	T04	C	2.03	0.03	34800	9.55	9.26	70.4	7103	1.77	848	79.0	3	0.4	20	7.38
AGD	T05	C	2.32	0.01	24700	5.01	7.16	69.7	7266	1.750	732	81.9	0	0.4	25	7.45
AGD	T06	C	2.58	0.01	22000	4.15	6.11	61.8	7647	1.700	787	77.0	0	4.1	21	6.50
AGD	T07	C	3.76	0.02	9580	3.65	6.12	37.2	6632	1.660	719	63.2	0	21.6	20	7.15
BGD	T09	B	7.61	0.025	2440	2.79	5.54	162	583	0.200	220	0.26	0	61.4	3	4.15
NAU	T06	B	4.12	0.002	341	0.971	0.55	65.9	2164	0.200	6	1.4	0	14.5	17.0	4.36
BCC	T03	C	2.71	1.49	3780	6.02	69.1	188	8435	7.360	703	168.0	1	77	61	9.91
BCC	T04	C	3.74	1.74	808	4.73	28.4	83.8	7121	9.410	712	83.8	1	103	47	7.07
MAD	T11	C	3.63	8.23	74546	75.6	4317	2725	26299	4.81	26	190	8	697	873	182

SR002.1 Outliers resulting from inconsistency in concentration measurements.

Material	Replicate	Element	pH [S.I.]	Conc. [$\mu\text{g/L}$]
CFA	A	Cd	3.32	72.9
CFA	A	Co	9.00	6.73
CFA	A	Co	7.92	0.730
AFA	B	Cd	11.6	4.22
CGD	B	Sb	5.23	11.1
CGD	B	Mo	5.23	9.42
CGD	C	Cd	8.98	1.17
DGD	C	Cr	9.03	24.3
NAW	A	As	7.25	10.2
NAW	B	Pb	5.39	9.32