

PRICE LIST

Freestanding Desk System

XXI Notes

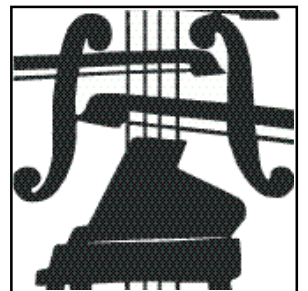

Prices Effective June 2006.

UNICOR

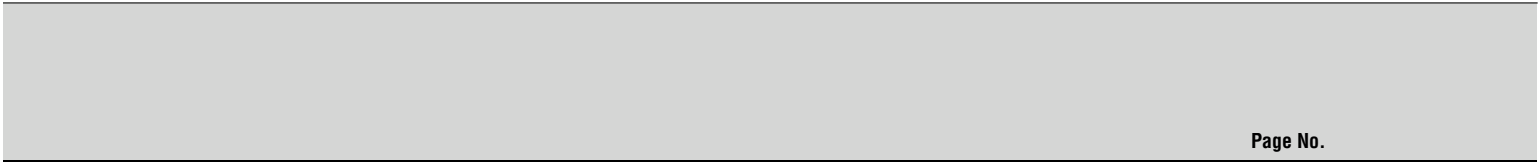

		Page No.
General Information	Terms and Conditions	4
XXI Notes	General Information	6
	Basic Worksurfaces	8
	Basic/Transitional Surfaces	18
	Mobile Surfaces	20
	Transitional Surfaces	22
	End-of-Run Surfaces	28
	Components General Information	30
	Printer Stands	32
	Overhead Storage	34
	Privacy Screens	40
	Accessories (Contemporary) General Information	42
	Accessories (Traditional) General Information	48
	Task Lights	52
	Adjustable/Securable CPU Holder	56
	Computer Accessories Computer	58
Adjustable XXI Notes	General Information	60
	Worksurfaces	62
	Overhead Storage	68
	Accessories	72
XXI Notes with PowerUp	General Information	74
	Level One Specifications	75
	Level Two Specifications	76
	Level Three Specifications	77
	Level Four Specifications	78
	Level Five Specifications	79
	Worksurfaces - Level One	80
	Worksurfaces - Level Two	96
	Worksurfaces - Level Three	112
	Worksurfaces - Level Four	128
	Worksurfaces - Level Five	144
	Electrical	160
XXI Notes EA	General Information	162
	Worksurfaces	164
XXI Notes Budget Typicals	Assistant Station	166
	Clerk Station	166
	Engineer Station	167
	Shared Station	167
	Manager Station	168
	Receptionist Station	168

Terms & Conditions

Terms of Sale

All prices listed are FOB Destination unless otherwise requested and noted.

Billing is Net 30 days on all products. All other services rendered are subject to payment at completion of each phase, when signed off by the customer. All prices are subject to annual review for adjustments. All custom and non-standard products are subject to a customer letter of intent to purchase in good faith, in lieu of a deposit.

Glossary of Terms used within this price list are as follows:

COM - Customer's own material, customer purchased and supplied to UNICOR/FPI.

COL - Customer's own leather, customer purchased and supplied to UNICOR/FPI.

Due Date - Date required for product to be at customer site, installation to begin.

Order Acknowledgment- Written confirmation of acceptance of order, containing the following information; work order number/purchase order number, project manager name and invoicing information.

Receipt of Order - Date UNICOR/FPI receives the order.

Ship Date - Date product ships from UNICOR/FPI factory.

Sales Policy

Products sold through this catalog are intended for federal government customers and their designee, and must be procured with federal funds.

Order Acknowledgment

UNICOR/FPI accepts orders, manufactures products, provides installation services and invoices based on the customer's request. The written order confirmation is verification and confirmation that requirements have been correctly translated to a sales order. An acknowledgment will be provided in writing, by fax or e-mail. If there is any information discrepancy in your order acknowledgment, please advise us immediately to avoid any miscommunication or problems. Communications should be directed to the assigned project manager listed on your order acknowledgment. Your order will be invoiced based on your request. Standard process is for product to be billed when it ships and the services are billed after confirmation of acceptance from the customer. Requests for billing, other than through the standard method, must be identified on the customer purchase order.

Your order acknowledgment indicates a date when your product is scheduled to arrive. In the event your order is manufactured earlier than scheduled, we will contact you with the option of providing an early shipment authorization. This will be coordinated through the project manager.

Order Modifications

Modification to your purchase order will be accepted up to two weeks prior to the due date indicated on your order acknowledgment. However, any modification made after production has begun, which changes the due date, product requested, or quantity requested will be subject to additional charges. For example, a delay in the delivery date could result in storage charges, a change in the quantity may result in a new ship date, or cancellation after the order is in production is subject to restocking fees. All purchase order modifications will be acknowledged in writing, including the annotation of any adjusted delivery dates and/or charges. UNICOR will assist the customer in obtaining storage for their product if delays in receipt are necessary. Product will not be stored at the UNICOR locations beyond 15 days, all storage will be arranged by our installation vendors or at the customer location.

Standard Lead Time

Typical lead time for products with this price list is 45 days ARO (after receipt of order). Orders which include custom items, e.g., COM, COL or special fabrics may require a longer manufacturing cycle. The extended date will be reflected on your order acknowledgment. The project manager, listed on your order acknowledgment, will gladly discuss your options with you.

Product Delivery and Pricing

All pricing listed in this publication is FOB Destination, CONUS (Continental United States) only, unless otherwise noted. Freight charges are included in the product price as listed in the FOB Destination column. FOB Origin pricing is available upon written request through, the UNICOR/FPI Customer Service Center.

On FOB Destination orders, the ownership responsibility passes to the customer at the time the product is accepted at the designated off-load point. Responsibility for inside delivery passes to the customer at final placement, or as specified in writing by the project manager.

On FOB Origin orders, UNICOR/FPI can arrange a coordinated delivery with the carrier of your choice. If no carrier is specified at time of order, it will be shipped common carrier, using our contract carrier at your expense. Freight charges will be added to your invoice.

Services, such as space planning, storage, inside delivery and installation are available at competitive prices. UNICOR/FPI offers both fee for service and negotiated pricing tailored to each project. Contact your sales representative or project manager to discuss these services.

Special Note: On shipments "Out of CONUS", FOB Destination orders, shipments are prepaid to the designated point of debarkation. Freight and handling charges beyond the point of debarkation are the responsibility of the local purchasing/governing agency, unless other arrangement are made with the project manager. The freight charges for deliveries out of CONUS, including Alaska and Hawaii, will be negotiated and quoted at competitive freight rates, at time of shipment.

Packaging of Product

UNICOR/FPI products are packaged to comply with carrier requirements to insure that products arrive in excellent condition. UNICOR/FPI can accommodate special packaging requests, special identification markings and special delivery instructions. Normally, this is a fee-for-service option. Contact your project manager to discuss options.

Direct Shipment Claims

UNICOR/FPI products are inspected and packaged to comply with shipping carrier requirements prior to leaving the manufacturing site. All shipments need to be inspected by the consignee, before acceptance. At the time of acceptance, any visible damage or shortage of items must be recorded with the freight carrier and reported to the UNICOR/FPI project manager immediately. Claims for visual shipping damage and/or shortage must be filed within 12 days of receipt of product. This applies to both FOB Destination and Origin shipments.

UNICOR/FPI reserves the right to use contracted carriers or commercial carriers for "best method" shipments. Any other shipping requirements must be negotiated with the project manager prior to shipping.

Concealed Damage Claims

By utilizing improved packaging and handling UNICOR/FPI takes great care to avoid concealed damages. UNICOR/FPI recommends inspection of all products within 12 days of delivery for both FOB Destination and Origin shipments, in order to insure prompt shipment of a replacement, and determination of liability.

Product Storage

UNICOR/FPI will provide free storage for up to 15 calendar days from original ship date. However, if additional time is needed, UNICOR/FPI can arrange for storage at current rates. Discuss the options with your project manager.

Customer Delayed Deliveries

UNICOR/FPI will accommodate requests to delay your order if we are notified two weeks before the product is scheduled to ship. The request for delay must be made as soon as possible. Contact your project manager to discuss date changes. If product is already in production at the time of delay notification, storage arrangements must be coordinated through your project manager. If product is en route, in most cases the product can be diverted to a storage location designated by the customer, or UNICOR/FPI can arrange storage at an additional cost. Costs usually include loading and unloading of product, plus any warehousing/storage cost. Order modifications are required when additional costs are incurred and are invoiced to you on your order.

Product Returns

Any product returns must be negotiated with the project manager. The terms and conditions will be evaluated on a case by case basis through negotiation with the project manager. UNICOR/FPI reserves the right to inspect the returned product and evaluate the resale value of the product when considering a credit or exchange.

Product Order Status

Order status can be verified by:

- (1) Contacting your project manager (name and phone number are listed on your order acknowledgment).
- (2) Making an inquiry at www.unicor.gov/customer/index.htm - Enter your work order / purchase order number, for a shipping status report for your order. Credit card order delivery status can be verified by logging the last name of the card holder in the purchase order number box.

Shipped orders will be identified by a tracking number in response to your inquiry. If a tracking number is not reported, contact the project manager for a current status report.

Invoice Payments

All general billing questions should be directed to UNICOR/FPI Customer Service Center, in writing to the following address:

FPI - LEX
Accounts Receivable
P.O. Box 11670
Lexington, KY 40583-3640

Send payments from government agencies to the following address:

FPI - FPI
P.O. Box 371736
Pittsburgh, PA 15252-7736



Send Payments from sources other than government agencies to the following address:

FPI - LEX
Accounts Receivable
P.O. Box 11670
Lexington, KY 40583-3640

Product Warranty

UNICOR/FPI guarantees all product to meet or exceed the standard commercial life expectancy of the product. UNICOR/FPI will repair or replace any defective product promptly, during the life expectancy of that product. UNICOR/FPI does warranty all product to be free of defects in material and workmanship. This does not apply to any COM or COL fabrics supplied by sources other than UNICOR/FPI.

COM Fabric Requirements

All fabric or upholsteries must be approved prior to acceptance of an order. Upon approval a memo sample swatch must accompany the order. UNICOR/FPI assumes no responsibility for wear or defects of performance of any COM or COL supplied by sources other than FPI.

Use of COM as panel fabrics require UL approval and must be tested for approval prior to acceptance of an order. UNICOR/FPI will require three yards of the actual panel fabric to be tested prior to quoting.

All COM fabric or upholstery must be received in continuous linear yards. UNICOR/FPI requires a 5 to 10% overage clause to insure appropriate amount of coverage.

COM Material Acceptance

UNICOR/FPI reserves the right to reject COM fabrics or upholstery that are not suitable for the intended application. Customer selecting any COM or COL takes responsibility of performance of the supplied product.

XXI Notes Worksurfaces

General Information



Basic Worksurfaces

WBW

p. 8



Adjustable Keyboard Pad Worksurfaces

WAK

p. 10



Transitional Worksurfaces

CT

p. 26

Features

Solid core top	•	•	•
Plastic laminate surface	•	•	•
Seam-welded tubular steel frame	•	•	•
Chrome plated glides	•	•	•
Enamel legs	•	•	•
3mm PVC edge	•	•	•
Flat vinyl T-edge	•	•	•

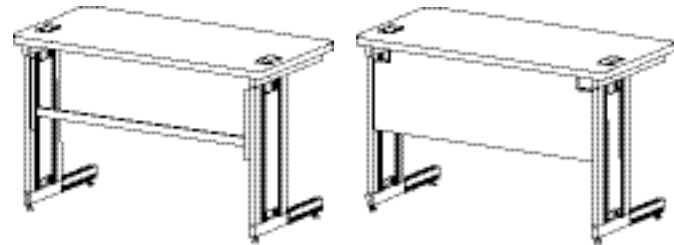
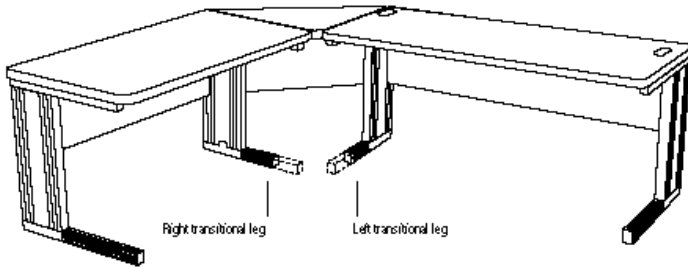

Beam Frame (WB)

Modesty Panel Frame (WM)

Transitional Leg

Transitional leg bases are 6 inches shorter than standard leg bases for greater leg room and chair clearance when two surfaces are joined. When seated at the worksurface, "right" or "left" refers to the individual worksurface, not the assembled workstation. Cannot be ordered for an individual, free-standing worksurface.

SPECIFICATIONS

Worksurface Frames

Heavy-gauge seam-welded powder-coat finished tubular steel. Horizontal table top support tube, 16-ga., 1" x 2" steel. Floor support member, 16-ga., 1" x 2" steel tube. Top floor support tubes are welded with (2) 16-ga., 1" x 2" vertical leg members. 19-ga. steel modesty panel. Leg interior provides concealed management of wire from floor to worksurface. Adjustable chrome-plated glides.

Worksurface Frame Options

There are two frame style options. The modesty panel (WM) is 19-ga. steel. It is located 1-1/2" from the backside of the worksurface. The modesty panel is 13.31" H on the 27" H worksurfaces and 15.31" on the 29" tables. The receptacle clearance beam option (WB) replaces the modesty panel with a 16-ga., 1/2" x 1-1/2" steel tube cross brace, welded to two 14-ga., L-brackets for support.

Worksurface Top

1/4" thick consisting of high-density particleboard, .050" high-pressure plastic laminate top surface with .045" phenolic backing sheet. Available with flat-vinyl T-edge and 3mm PVC edge.

Transitional Surface Splice Plates

Die-formed steel splice plates attach to underside of units with screws. Splice plates are provided with Transitional Surfaces only. Standard connector plate provided when surfaces are of common height. Step connector plate provided for connecting 29" to 27" surfaces. Basic and keyboard worksurfaces are not provided with splice plates.

Adjustable Keyboard Pad Worksurface

Die-formed L-brackets attach to table and keyboard pad with screws. Threaded hand knobs lock keyboard pad in position. Available with flat vinyl T-edge only.

Wire Management

3" x 2" openings with protected edges are provided for all worksurfaces. On basic adjustable keyboard worksurfaces and rectangular transitional surfaces, the grommets are located at the top of the modesty panels on both sides. On the end-of-run square, corner and peninsula transitionals, the grommet is located in the top center. The triangular transitional does not have a wire management grommet.

Weight Capacity

All XXI Notes tables exceed ANSI/BIFMA 5.5 Standards. All XXI Notes tables have been tested to withstand a weight of 10 pounds per linear inch of worksurface evenly distributed along the entire length of the worksurface. Please contact Customer Service for additional information.

Wireway Option

Wireway trough connects to existing openings at top of modesty panels and is constructed of 19 gauge steel with 1" deep by 1/2" high opening for cables. Wireway option is not available with Beam Frame (WB).

Scuff Guards

Extruded rigid PVC scuff guards cover the foot on all XXI Notes legs. The scuff guard's finish matches the finish for the corresponding leg insert style, either extruded ribbed texture or a sprayed clear acrylic texture.



ORDERING INFORMATION

Modesty panel codes:

- M** = With modesty panel
- B** = With beam frame

CODES FOR POWER UP:

Data location:

- L** = Left
- R** = Right
- C** = Center
- B** = Left and right. Only available on 60" x 72" worksurfaces.

Accessory level:

- L1** = Consists of one or two PowerUp modules with 108" cord.
- L3** = Consists of one or two PowerUp modules with 108" cord plus data door with steel divider, table-to-table steel wireway, splice plate and notched vertical wireways

L5*** = Consists of one or two power modules with 22" cord, data door with steel divider, table-to-table steel wireway, splice plate, notched vertical wireways, eight-wire four circuit pre-wired harness.

L2 = Consists of data door with steel divider, table-to-table steel wireway, splice plate and notched vertical wireway.

L4*** = Consists of data door with steel divider, table-to-table steel wireway, splice plate, notched vertical wireway, eight-wire four circuit pre-wired harness.***Duplex receptacles must be ordered separately. See page 112.

***Floor infeed (four-circuit pre-wired) must be ordered separately. See page 112.

***Eight-wire table-to-table connector must be ordered separately. See page 112.

Floor Infeed (Four-Circuit Pre-wired)

Two 90° connectors. Flexible steel conduit with eight 12-gauge conductors in the leg. Includes steel trim plate with dual holes for electrical and data entry.

Receptacle Requirements

Width	No. of Duplex Receptacles
30"	2
36"	2
42"	2
48"	2
54"	2
60"	4
72"	4

INFORMATION

Warranty

See "Terms" for general information.

XXI Notes Worksurfaces

Basic



MODEL

Basic Worksurface

- 1¼" solid core top with high-pressure laminate surface
- Flat vinyl T-edge or 3mm PVC edge
- Powder-coat finish on legs
- Each leg is a welded unit joined by a modesty panel. Leg cavity provides concealed management of wire from floor to worksurface. Legs are located 1½" from worksurface edge.
- Heavy-gauge seam-welded tubular steel frame
- 3" x 2" wire management port provided for all tables on both sides, at top of modesty panels
- Scuff plates
- Adjustable chrome-plated glides
- Wireway connects to existing openings at top of modesty panels with metal channel for wire management
- Optional transitional legs (6" shortened leg base)
- Modesty panel is 15" high on 27" and 17½" on 29" tables and is located 1½" from backside of worksurface.

MODEL NUMBER

D x W	MODEL NUMBER						
	Worksurface	Edge Style	Hgt	Tr Legs	Frame Style	Trim	Laminate
24x30"	WBW2430	<input type="checkbox"/>	<input type="checkbox"/>	<input type="checkbox"/>	<input type="checkbox"/>	<input type="checkbox"/>	<input type="checkbox"/>
24x36"	WBW2436	<input type="checkbox"/>	<input type="checkbox"/>	<input type="checkbox"/>	<input type="checkbox"/>	<input type="checkbox"/>	<input type="checkbox"/>
24x42"	WBW2442	<input type="checkbox"/>	<input type="checkbox"/>	<input type="checkbox"/>	<input type="checkbox"/>	<input type="checkbox"/>	<input type="checkbox"/>
24x48"	WBW2448	<input type="checkbox"/>	<input type="checkbox"/>	<input type="checkbox"/>	<input type="checkbox"/>	<input type="checkbox"/>	<input type="checkbox"/>
24x54"	WBW2454	<input type="checkbox"/>	<input type="checkbox"/>	<input type="checkbox"/>	<input type="checkbox"/>	<input type="checkbox"/>	<input type="checkbox"/>
24x60"	WBW2460	<input type="checkbox"/>	<input type="checkbox"/>	<input type="checkbox"/>	<input type="checkbox"/>	<input type="checkbox"/>	<input type="checkbox"/>
24x72"	WBW2472	<input type="checkbox"/>	<input type="checkbox"/>	<input type="checkbox"/>	<input type="checkbox"/>	<input type="checkbox"/>	<input type="checkbox"/>
30x30"	WBW3030	<input type="checkbox"/>	<input type="checkbox"/>	<input type="checkbox"/>	<input type="checkbox"/>	<input type="checkbox"/>	<input type="checkbox"/>
30x36"	WBW3036	<input type="checkbox"/>	<input type="checkbox"/>	<input type="checkbox"/>	<input type="checkbox"/>	<input type="checkbox"/>	<input type="checkbox"/>
30x42"	WBW3042	<input type="checkbox"/>	<input type="checkbox"/>	<input type="checkbox"/>	<input type="checkbox"/>	<input type="checkbox"/>	<input type="checkbox"/>
30x48"	WBW3048	<input type="checkbox"/>	<input type="checkbox"/>	<input type="checkbox"/>	<input type="checkbox"/>	<input type="checkbox"/>	<input type="checkbox"/>
30x54"	WBW3054	<input type="checkbox"/>	<input type="checkbox"/>	<input type="checkbox"/>	<input type="checkbox"/>	<input type="checkbox"/>	<input type="checkbox"/>
30x60"	WBW3060	<input type="checkbox"/>	<input type="checkbox"/>	<input type="checkbox"/>	<input type="checkbox"/>	<input type="checkbox"/>	<input type="checkbox"/>
30x72"	WBW3072	<input type="checkbox"/>	<input type="checkbox"/>	<input type="checkbox"/>	<input type="checkbox"/>	<input type="checkbox"/>	<input type="checkbox"/>

A B C D E F G

HOW TO ORDER

Indicate the following information on order form:

1. Quantity of each item.
2. Model number, including options. See "How to Build a Model Number."
3. Any special service required.

- Note:
- The indicates that a choice is required.
 - The absence of indicates that no choice is required.
 - Alpha-numeric characters in place of indicate that no other alternatives are available.

HOW TO BUILD A MODEL NUMBER

- A** Select size of worksurface.

- B** Select edge style.
T = Flat Vinyl T-edge
M = 3mm PVC edge

- C** Select height.
7 = 27"
9 = 29"

- D** Indicate location and type of leg.*
S = Standard (both standard legs)
R = Right (right transitional leg)
L = Left (left transitional leg)
B = Both (both transitional legs)

*Note: If ordering Basic Worksurface as a freestanding unit, or if only one side connects to a transitional worksurface, the "B" option for both transitional legs is not available.

- **Must order corresponding worksurface connector to attach to adjacent table when using transitional legs.**

- E** Select frame style.
B = With beam
M = With modesty panel

- F** Select trim color for painted surfaces.
B = Black
G = Gray
S = Sand
W = Warm Gray
L = Light Tone

- G** Select laminate surface.
AA = Cream
AB = Champagne
AC = Barcelona
AF = Aruba Tan
AG = Black

- AH** = Dark Gray
AI = Dawn Gray (Greige)
AJ = Fog
AK = Black Grandin
AL = Smoke Granite
AM = Sand Grandin
AN = Light Granite
AO = Tundra
AP = Earthen
AQ = Rose Grafix
AS = Sierra Grafix
AT = Beige Grafix
AU = Sand Stone
AV = Kentucky Walnut
AW = Tennessee Oak
AX = Light Oak
AY = Red Birch
AZ = Ash
BA = Philadelphia Cherry
BB = Pennsylvania Cherry
BC = Mahogany



Edge Styles



T-Edge
Price **(T)**

3mm PVC Edge
Price **(M)**

27"	Total Weight	29"	T-Edge Price (T)	3mm PVC Edge Price (M)
66#		69#	\$ 220	\$ 230
73#		76#	225	235
80#		83#	230	240
86#		89#	235	245
93#		96#	245	255
98#		102#	250	260
111#		116#	265	275
73#		76#	220	230
80#		83#	225	235
89#		92#	230	240
97#		100#	235	245
103#		106#	245	255
109#		113#	250	260
122#		126#	265	275

- BD** = Oak
- BE** = Maple
- BF** = Pearwood
- CA** = Pumice
- CB** = Rock Maple
- CC** = Medium Cherry
- CD** = Anigre
- ZZ** = COM

FINISH INFORMATION

Laminate Surface
See Keys for Progression swatch card.

ACCESSORIES

Casters
4 swivel casters (2½" diameter), 2 with locks.
Add 2" to top surface height. Add 2lbs. to weight.
Order separately, specify 87.2840
List price \$34.00/set

Worksurface Connectors
For attaching two freestanding tables together
of same height. Black finish.
Specify 87.4632.WZ.BL.
List price \$8.00

For attaching two freestanding tables together
of different heights. Black finish.
Specify 87.4624.WZ.BL.
List price \$12.00

Specifications and prices are subject to
change without prior notice.

XXI Notes Worksurfaces

Basic



MODEL

MODEL	D x W	MODEL NUMBER								
		Worksurface	Edge Style	Pad	Hgt	Tr Legs	Frame Style	Trim	Laminate	
Adjustable Keyboard Pad Worksurface <ul style="list-style-type: none"> • 1 1/4" solid core top with high-pressure laminate surface • Adjustable keyboard pad right, centered (shown) or left 10" x 24"; 3" height adjustments; 1" forward extension adjustment; 15° maximum downward tilt • Flat vinyl T-edge or 3mm PVC edge • Powder-coat finish on legs • Each leg is a welded unit joined by a modesty panel. Leg cavity provides concealed management of wire from floor to worksurface. Legs are located 1 1/2" from worksurface edge • Heavy-gauge seam-welded tubular steel frame • 3" x 2" wire management port provided for all tables on both sides, at top of modesty panels • Scuff plates • Adjustable chrome-plated glides • Wireway connects to existing openings at top of modesty panels with metal channel for wire management • Optional transitional legs (6" shortened leg base) • When adding a pedestal, pad must be RH or LH and worksurface must be at least 60" long • Modesty panel is 15" high on 27" and 17 1/2" on 29", and is located 1 1/2" from backside of worksurface • Keyboard is located 5 1/4" from edge of worksurface on left and right locations 	24x36"	WAK2436	<input type="checkbox"/>	C	<input type="checkbox"/>	<input type="checkbox"/>	<input type="checkbox"/>	<input type="checkbox"/>	<input type="checkbox"/>	<input type="checkbox"/>
	24x42"	WAK2442	<input type="checkbox"/>	C	<input type="checkbox"/>	<input type="checkbox"/>	<input type="checkbox"/>	<input type="checkbox"/>	<input type="checkbox"/>	<input type="checkbox"/>
	24x48"	WAK2448	<input type="checkbox"/>	<input type="checkbox"/>	<input type="checkbox"/>	<input type="checkbox"/>	<input type="checkbox"/>	<input type="checkbox"/>	<input type="checkbox"/>	<input type="checkbox"/>
	24x54"	WAK2454	<input type="checkbox"/>	<input type="checkbox"/>	<input type="checkbox"/>	<input type="checkbox"/>	<input type="checkbox"/>	<input type="checkbox"/>	<input type="checkbox"/>	<input type="checkbox"/>
	24x60"	WAK2460	<input type="checkbox"/>	<input type="checkbox"/>	<input type="checkbox"/>	<input type="checkbox"/>	<input type="checkbox"/>	<input type="checkbox"/>	<input type="checkbox"/>	<input type="checkbox"/>
	24x72"	WAK2472	<input type="checkbox"/>	<input type="checkbox"/>	<input type="checkbox"/>	<input type="checkbox"/>	<input type="checkbox"/>	<input type="checkbox"/>	<input type="checkbox"/>	<input type="checkbox"/>
	30x36"	WAK3036	<input type="checkbox"/>	C	<input type="checkbox"/>	<input type="checkbox"/>	<input type="checkbox"/>	<input type="checkbox"/>	<input type="checkbox"/>	<input type="checkbox"/>
	30x42"	WAK3042	<input type="checkbox"/>	C	<input type="checkbox"/>	<input type="checkbox"/>	<input type="checkbox"/>	<input type="checkbox"/>	<input type="checkbox"/>	<input type="checkbox"/>
	30x48"	WAK3048	<input type="checkbox"/>	<input type="checkbox"/>	<input type="checkbox"/>	<input type="checkbox"/>	<input type="checkbox"/>	<input type="checkbox"/>	<input type="checkbox"/>	<input type="checkbox"/>
	30x54"	WAK3054	<input type="checkbox"/>	<input type="checkbox"/>	<input type="checkbox"/>	<input type="checkbox"/>	<input type="checkbox"/>	<input type="checkbox"/>	<input type="checkbox"/>	<input type="checkbox"/>
	30x60"	WAK3060	<input type="checkbox"/>	<input type="checkbox"/>	<input type="checkbox"/>	<input type="checkbox"/>	<input type="checkbox"/>	<input type="checkbox"/>	<input type="checkbox"/>	<input type="checkbox"/>
	30x72"	WAK3072	<input type="checkbox"/>	<input type="checkbox"/>	<input type="checkbox"/>	<input type="checkbox"/>	<input type="checkbox"/>	<input type="checkbox"/>	<input type="checkbox"/>	<input type="checkbox"/>
	Left	Right								
	D x W x W x D									



- Stand Alone Corner Worksurface with Keyboard**
- Solid core top with high-pressure laminate surface
 - Flat vinyl T-edge or 3mm PVC edge
 - Powder-coat finish on legs. Legs are located 1 1/2" from worksurface edge
 - Adjustable glides
 - Keyboard pad: 10" x 24"; 3" height adjustments; 1" forward extension adjustment; 15° maximum downward tilt
 - Available in 27" or 29" heights
 - Corner support leg is 1/4" square tubular steel
 - **Not available with both (B) transitional legs**
 - Modesty panel is 15" high on 27" and 17 1/2" on 29" and is located 1 1/2" from backside of worksurface
 - Wireway connects to existing openings at top of modesty panels with metal channel for wire management

24x42x42x24"	WCSK2442	<input type="checkbox"/>		<input type="checkbox"/>	<input type="checkbox"/>	<input type="checkbox"/>	<input type="checkbox"/>	<input type="checkbox"/>	<input type="checkbox"/>
24x48x48x24"	WCSK2448	<input type="checkbox"/>		<input type="checkbox"/>	<input type="checkbox"/>	<input type="checkbox"/>	<input type="checkbox"/>	<input type="checkbox"/>	<input type="checkbox"/>
30x48x48x30"	WCSK3048	<input type="checkbox"/>		<input type="checkbox"/>	<input type="checkbox"/>	<input type="checkbox"/>	<input type="checkbox"/>	<input type="checkbox"/>	<input type="checkbox"/>

A **B** **C** **D** **E** **F** **G** **H**

HOW TO ORDER

Indicate the following information on order form:

- Quantity of each item.
- Model number, including options. See "How to Build a Model Number."
- Any special service required.

- Note:
- The indicates that a choice is required.
 - The absence of indicates that no choice is required.
 - Alpha-numeric characters in place of indicate that no other alternatives are available.

HOW TO BUILD A MODEL NUMBER

- A** Select size of worksurface.
B Select edge style.
T = Flat Vinyl T-edge
M = 3mm PVC edge
C Location of keypad.
C = Center
R = Right
L = Left
D Select height.
7 = 27"
9 = 29"
E Indicate location and type of leg.*
S = Standard (both standard legs)
R = Right (right transitional leg)
L = Left (left transitional leg)
B = Both (both transitional legs)

*Note: If ordering Basic Worksurface as a freestanding unit, or if only one side connects to a transitional worksurface, the "B" option for both transitional legs is not available.

• **Must order corresponding worksurface connector to attach to adjacent table when using transitional legs.**

- F** Select frame style.
B = With beam
M = With modesty panel
G Select trim color for painted surfaces.
B = Black
G = Gray
S = Sand
W = Warm Gray
L = Light Tone

- H** Select laminate surface.
AA = Cream
AB = Champagne
AC = Barcelona
AF = Aruba Tan
AG = Black
AH = Dark Gray
AI = Dawn Gray (Greige)
AJ = Fog
AK = Black Grandin
AL = Smoke Granite
AM = Sand Grandin
AN = Light Granite
AO = Tundra
AP = Earthen
AQ = Rose Grafix
AS = Sierra Grafix
AT = Beige Grafix
AU = Sand Stone
AV = Kentucky Walnut



Edge Styles



T-Edge
Price **(T)**

3mm PVC Edge
Price **(M)**

27" Total Weight 29"

27"	Total Weight	29"	T-Edge Price (T)	3mm PVC Edge Price (M)
74#		77#	\$235	\$245
81#		84#	240	250
87#		90#	245	260
93#		96#	255	270
99#		103#	260	275
112#		126#	275	290
81#		84#	235	245
90#		93#	240	250
98#		101#	245	260
106#		110#	255	270
110#		114#	260	275
126#		130#	275	290

97#	99#	225	235	Joins 24" deep worksurface to 24" deep worksurface
103#	106#	230	240	Joins 24" deep worksurface to 24" deep worksurface
116#	118#	235	245	Joins 30" deep worksurface to 30" deep worksurface

- AW** = Tennessee Oak
- AX** = Light Oak
- AY** = Red Birch
- AZ** = Ash
- BA** = Philadelphia Cherry
- BB** = Pennsylvania Cherry
- BC** = Mahogany
- BD** = Oak
- BE** = Maple
- BF** = Pearwood
- CA** = Pumice
- CB** = Rock Maple
- CC** = Medium Cherry
- CD** = Anigre
- ZZ** = COM

FINISH INFORMATION

Laminate Surface

See Keys for Progression swatch card.

ACCESSORIES

Casters

4 swivel casters (2 1/2" diameter), 2 with locks. Add 2" to top surface height. Add 2lbs. to weight. Order separately, specify 87.2840

List price \$34.00/set

Worksurface Connectors

For attaching two freestanding tables together of same height. Black finish. Specify 87.4632.WZ.BL.

List price \$8.00



For attaching two freestanding tables together of different heights. Black finish. Specify 87.4624.WZ.BL.

List price \$12.00

Specifications and prices are subject to change without prior notice.

XXI Notes Worksurfaces

Basic

MODEL	D x W	MODEL NUMBER							
		Worksurface	Edge Style	Hgt	Tr Legs	Frame Style	Trim	Laminate	
 <p>Stand-up Worksurface</p> <ul style="list-style-type: none"> • Solid core top with high-pressure laminate surface • Flat vinyl T-edge or 3mm PVC edge • Powder-coat finish on legs. Legs are located 1½" from worksurface edge • Available in 42" height only • Only connects to 30" wide work surface • Modesty panel is 17½" high and is located 1½" from backside of worksurface • Wireway connects to existing openings at top of modesty panels with metal channel for wire management • Stand-Up Worksurface available in 42" height only 	30x36"	WSU3036	<input type="checkbox"/>	2	S	<input type="checkbox"/>	<input type="checkbox"/>	<input type="checkbox"/>	
	Left	Right							
	D x W	x W x D							
	 <p>Stand Alone Corner Worksurface</p> <ul style="list-style-type: none"> • Solid core top with high-pressure laminate surface • Flat vinyl T-edge or 3mm PVC edge • Powder-coat finish on legs. Legs located 1½" from worksurface edge • Adjustable glides • Available in 27" or 29" heights • Modesty panel is 15" high on 27" and 17½" on 29" tables and is located 1½" from backside of worksurface • Corner support leg is ¼" sq. tubular steel • Front edge dimension is 17" on 24x36" and 30x42"; 25½" on 24x42" and 30x48"; 34" on 24x48" • Wireway connects to existing openings at top of modesty panels with metal channel for wire management 	24x36" x 36x24"	WCS2436	<input type="checkbox"/>	<input type="checkbox"/>	<input type="checkbox"/>	<input type="checkbox"/>	<input type="checkbox"/>	<input type="checkbox"/>
		24x42" x 42x24"	WCS2442	<input type="checkbox"/>	<input type="checkbox"/>	<input type="checkbox"/>	<input type="checkbox"/>	<input type="checkbox"/>	<input type="checkbox"/>
		24x48" x 48x24"	WCS2448	<input type="checkbox"/>	<input type="checkbox"/>	<input type="checkbox"/>	<input type="checkbox"/>	<input type="checkbox"/>	<input type="checkbox"/>
		30x42" x 42x30"	WCS3042	<input type="checkbox"/>	<input type="checkbox"/>	<input type="checkbox"/>	<input type="checkbox"/>	<input type="checkbox"/>	<input type="checkbox"/>
30x48" x 48x30"		WCS3048	<input type="checkbox"/>	<input type="checkbox"/>	<input type="checkbox"/>	<input type="checkbox"/>	<input type="checkbox"/>	<input type="checkbox"/>	
 <p>Stand Alone Corner Curvilinear Worksurface</p> <ul style="list-style-type: none"> • Solid core top with high-pressure laminate surface • Flat vinyl T-edge or 3mm PVC edge • Front edge is curved • Powder-coat finish on legs. Legs located 1½" from worksurface edge • Adjustable glides • Available in 27" or 29" heights • Modesty panel is 15" high on 27" and 17½" on 29" tables and is located 1½" from backside of worksurface • Corner support leg is ¼" sq. tubular steel • Front edge dimension is 17" on 24x36" and 30x42"; 25½" on 24x42" and 30x48"; 34" on 24x48" • Wireway connects to existing openings at top of modesty panels with metal channel for wire management 	24x36" x 36x24"	WCC2436	<input type="checkbox"/>	<input type="checkbox"/>	<input type="checkbox"/>	<input type="checkbox"/>	<input type="checkbox"/>	<input type="checkbox"/>	
	24x42" x 42x24"	WCC2442	<input type="checkbox"/>	<input type="checkbox"/>	<input type="checkbox"/>	<input type="checkbox"/>	<input type="checkbox"/>	<input type="checkbox"/>	
	24x48" x 48x24"	WCC2448	<input type="checkbox"/>	<input type="checkbox"/>	<input type="checkbox"/>	<input type="checkbox"/>	<input type="checkbox"/>	<input type="checkbox"/>	
	30x42" x 42x30"	WCC3042	<input type="checkbox"/>	<input type="checkbox"/>	<input type="checkbox"/>	<input type="checkbox"/>	<input type="checkbox"/>	<input type="checkbox"/>	
	30x48" x 48x30"	WCC3048	<input type="checkbox"/>	<input type="checkbox"/>	<input type="checkbox"/>	<input type="checkbox"/>	<input type="checkbox"/>	<input type="checkbox"/>	

A **B** **C** **D** **E** **F** **G**

HOW TO ORDER

Indicate the following information on order form:

1. Quantity of each item.
2. Model number, including options. See "How to Build a Model Number."
3. Any special service required.

- Note:
- The indicates that a choice is required.
 - The absence of indicates that no choice is required.
 - Alpha-numeric characters in place of indicate that no other alternatives are available.

HOW TO BUILD A MODEL NUMBER

- A** Select size of worksurface.
B Select edge style.
T = Flat Vinyl T-edge
M = 3mm PVC edge
C Select height.
2 = 42"
7 = 27"
9 = 29"
D Indicate location and type of leg.*
S = Standard (both standard legs)
R = Right (right transitional leg)
L = Left (left transitional leg)
E Select frame style.
B = With beam
M = With modesty panel
F Select trim color for painted surfaces.
B = Black
G = Gray
S = Sand
W = Warm Gray
L = Light Tone
G Select laminate surface.
AA = Cream
AB = Champagne
AC = Barcelona
AF = Aruba Tan
AG = Black
AH = Dark Gray
AI = Dawn Gray (Greige)
AJ = Fog
AK = Black Grandin

• **Must order corresponding worksurface connector to attach to adjacent table when using transitional legs.**

- AL** = Smoke Granite
AM = Sand Grandin
AN = Light Granite
AO = Tundra
AP = Earthen
AQ = Rose Grafix
AS = Sierra Grafix
AT = Beige Grafix
AU = Sand Stone
AV = Kentucky Walnut
AW = Tennessee Oak
AX = Light Oak
AY = Red Birch
AZ = Ash
BA = Philadelphia Cherry
BB = Pennsylvania Cherry
BC = Mahogany
BD = Oak
BE = Maple
BF = Pearwood
CA = Pumice
CB = Black Granite



Edge Styles



T-Edge
 Price **(T)**



3mm PVC Edge
 Price **(M)**

Total Weight
 27" 29" 42"

94#

\$255

\$270

73#	76#	260	270
93#	96#	280	295
103#	106#	300	315
105#	108#	280	295
115#	118#	300	315

73#	76#	260	270
93#	96#	280	295
103#	106#	300	315
105#	108#	280	295
115#	118#	300	315

- CC** = Medium Cherry
- CD** = Anigre
- ZZ** = COM

FINISH INFORMATION

Laminate Surface

See Keys for Progression swatch cards.

ACCESSORIES

Casters

4 swivel casters (2 1/2" diameter), 2 with locks. Add 2" to top surface height. Add 2lbs. to weight. Order separately, specify 87.2840

List price \$34.00/set

Worksurface Connectors

For attaching two freestanding tables together of same height. Black finish. Specify 87.4632.WZ.BL.

List price \$8.00



For attaching two freestanding tables together of different heights. Black finish. Specify 87.4624.WZ.BL.

List price \$12.00

Specifications and prices are subject to change without prior notice.

XXI Notes Worksurfaces

Basic

MODEL	Left D x W x D	Right D	MODEL NUMBER							
			Worksurface	Edge Style	Hgt	Tr Legs	Frame Style	Trim	Laminate	
 <p>Curvilinear Worksurface</p> <ul style="list-style-type: none"> • Solid core top with high-pressure laminate surface • Flat vinyl T-edge or 3mm PVC edge • Joins 24" width worksurface to 30" width worksurface • Powder-coat finish on legs. Legs are located 1½" from worksurface edge • Adjustable glides • Available in 27" or 29" heights • Modesty panel is 15" high on 27" and 17½" high on 29" tables and is located 1½" from backside of worksurface • Wireway connects to existing openings at top of modesty panels with metal channel for wire management 	24 x 42 x 30"									
	24 x 48 x 30"									
	24 x 54 x 30"									
	24 x 60 x 30"									
	24 x 72 x 30"									
	30 x 42 x 24"									
	30 x 48 x 24"									
	30 x 54 x 24"									
	30 x 60 x 24"									
	30 x 72 x 24"									
	Left	Right								
	D x W	x W x D								
 <p>Stand Alone Corner Reduction Worksurface</p> <ul style="list-style-type: none"> • Solid core top with high-pressure laminate surface • Flat vinyl T-edge or 3mm PVC edge • Joins 24" width worksurface to 30" width worksurface • Powder-coat finish on legs. Legs are located 1½" from worksurface edge • Adjustable glides • Available in 27" or 29" heights • Modesty panel is 15" high on 27" and 17½" on 29" tables and is located 1½" from backside of worksurface • Corner support leg is ¼" sq. tubular steel • Wireway connects to existing openings at top of modesty panels with metal channel for wire management 	24x42" x 42x30"									
	24x48" x 48x30"									
	30x42" x 42x24"									
	30x48" x 48x24"									
 <p>Stand Alone Corner Curvilinear Reduction Worksurface</p> <ul style="list-style-type: none"> • Solid core top with high-pressure laminate surface • Flat vinyl T-edge or 3mm PVC edge • Front edge is curved • Powder-coat finish on legs. Legs are located 1½" from worksurface edge • Adjustable glides • Available in 27" or 29" heights • Modesty panel is 15" high on 27" and 17½" on 29" tables and is located 1½" from backside of worksurface • Corner support leg is ¼" sq. tubular steel • Wireway connects to existing openings at top of modesty panels with metal channel for wire management 	24x42" x 42x30"									
	24x48" x 48x30"									
	30x42" x 42x24"									
	30x48" x 48x24"									
			A	B	C	D	E	F	G	

HOW TO ORDER

Indicate the following information on order form:

- Quantity of each item.
- Model number, including options. See "How to Build a Model Number."
- Any special service required.

- Note:
- The indicates that a choice is required.
 - The absence of indicates that no choice is required.
 - Alpha-numeric characters in place of indicate that no other alternatives are available.

HOW TO BUILD A MODEL NUMBER

- A** Select size of worksurface.
- B** Select edge style
T = Flat Vinyl T-edge
M = 3mm PVC edge
- C** Select height.
7 = 27"
9 = 29"
- D** Indicate location and type of leg.*
S = Standard (both standard legs)
R = Right (right transitional leg)
L = Left (left transitional leg)
B = Both (Both transitional legs)

* Note: If ordering Basic Worksurface as a freestanding unit, or if only one side connects to a transitional worksurface, the "B" option for both transitional legs is not available.

• **Must order corresponding worksurface connector to attach to adjacent table when using transitional legs.**

- E** Select frame style.
B = With beam
M = With modesty panel
- F** Select trim color for painted surfaces.
B = Black
G = Gray
S = Sand
W = Warm Gray
L = Light Tone
- G** Select laminate surface.
AA = Cream
AB = Champagne
AC = Barcelona
AF = Aruba Tan
AG = Black

- AH** = Dark Gray
- AI** = Dawn Gray (Greige)
- AJ** = Fog
- AK** = Black Grandin
- AL** = Smoke Granite
- AM** = Sand Grandin
- AN** = Light Granite
- AO** = Tundra
- AP** = Earthen
- AQ** = Rose Grafix
- AS** = Sierra Grafix
- AT** = Beige Grafix
- AU** = Sand Stone
- AV** = Kentucky Walnut
- AW** = Tennessee Oak
- AX** = Light Oak
- AY** = Red Birch
- AZ** = Ash
- BA** = Philadelphia Cherry
- BB** = Pennsylvania Cherry
- BC** = Mahogany



Edge Styles



T-Edge
 Price **(T)**

3mm PVC Edge
 Price **(M)**

Total Weight
 27" 29"

27"	29"	T-Edge Price (T)	3mm PVC Edge Price (M)
81#	84#	\$230	\$240
88#	91#	235	245
95#	98#	245	255
100#	103#	250	260
114#	117#	265	275

93#	96#	280	295
99#	102#	300	315
93#	96#	280	295
99#	102#	300	315

93#	96#	280	295
99#	102#	300	315
93#	96#	280	295
99#	102#	300	315

- BE** = Maple
- BF** = Pearwood
- CA** = Pumice
- CB** = Rock Maple
- CC** = Medium Cherry
- CD** = Anigre
- ZZ** = COM

FINISH INFORMATION

Laminate Surface
 See Keys for Progression swatch card.

ACCESSORIES

Casters
 4 swivel casters (2½" diameter), 2 with locks.
 Add 2" to top surface height. Add 2lbs. to weight.
 Order separately, specify 87.2840
 List price \$34.00/set

Worksurface Connectors
 For attaching two freestanding tables together
 of same height. Black finish.
 Specify 87.4632.WZ.BL.
 List price \$8.00

For attaching two freestanding tables together
 of different heights. Black finish.
 Specify 87.4624.WZ.BL.
 List price \$12.00

**Specifications and prices are subject to
 change without prior notice.**

XXI Notes Worksurfaces

Basic Surfaces



(Right shown)

- “P” Shaped Peninsula Worksurface**
- 1¼" solid particleboard with .050" laminate
 - Flat vinyl T-edge or 3mm PVC edge
 - Includes two worksurface grommets
 - Concealed vertical wire management
 - Includes modesty panel with 3" x 2" wire management port at top of modesty panel on 48" side
 - Modesty panel is 15" high on 27" and 17½" on 29" tables and is located 1½" from backside of worksurface
 - Heavy-gauge seam-welded tubular steel frame
 - Scuff plates
 - Wireway connects to existing openings at top of modesty panel with metal channel for wire management on 48" side
 - Long surface is supported by 3" diameter metal support leg with adjustable glide
 - Powder-coat finish on legs
 - Connects to either 24" or 30" worksurface
 - Adjustable chrome plated glides
 - Optional transitional legs (6" shortened leg base)
 - **Available with 29" height only**

MODEL	D x W x L	MODEL NUMBER								
		Worksurface	Edge Style	Direction	Hgt	Trans. Leg	Frame Style	Frame Option	Trim	Laminate
	24x48x60"	ZPT244860	<input type="checkbox"/>	<input type="checkbox"/>	9	<input type="checkbox"/>	<input type="checkbox"/>	<input type="checkbox"/>	<input type="checkbox"/>	<input type="checkbox"/>
	24x48x72"	ZPT244872	<input type="checkbox"/>	<input type="checkbox"/>	9	<input type="checkbox"/>	<input type="checkbox"/>	<input type="checkbox"/>	<input type="checkbox"/>	<input type="checkbox"/>
	30x48x72"	ZPT304872	<input type="checkbox"/>	<input type="checkbox"/>	9	<input type="checkbox"/>	<input type="checkbox"/>	<input type="checkbox"/>	<input type="checkbox"/>	<input type="checkbox"/>



(Right shown)

- Piano Peninsula Worksurface**
- 1¼" solid particleboard with .050" laminate
 - Flat vinyl T-edge or 3mm PVC edge
 - Includes two worksurface grommets
 - Concealed vertical wire management
 - Includes modesty panel with 3" x 2" wire management port at top of modesty panel on 48" side
 - Modesty panel is 15" high on 27" and 17½" on 29" tables and is located 1½" from backside of worksurface
 - Heavy-gauge seam-welded tubular steel frame
 - Scuff plates
 - Wireway connects to existing openings at top of modesty panel with metal channel for wire management on 48" side
 - Long surface is supported by 3" diameter metal support leg with adjustable glide
 - Powder-coat finish on legs
 - Connects to either 24" or 30" worksurface
 - Adjustable chrome plated glides
 - Optional transitional legs (6" shortened leg base)
 - **Available with 29" height only**

	24x48x60"	ZPP244860	<input type="checkbox"/>	<input type="checkbox"/>	9	<input type="checkbox"/>	<input type="checkbox"/>	<input type="checkbox"/>	<input type="checkbox"/>	<input type="checkbox"/>
	24x48x72"	ZPP244872	<input type="checkbox"/>	<input type="checkbox"/>	9	<input type="checkbox"/>	<input type="checkbox"/>	<input type="checkbox"/>	<input type="checkbox"/>	<input type="checkbox"/>
	30x48x72"	ZPP304872	<input type="checkbox"/>	<input type="checkbox"/>	9	<input type="checkbox"/>	<input type="checkbox"/>	<input type="checkbox"/>	<input type="checkbox"/>	<input type="checkbox"/>

A **B** **C** **D** **E** **F** **G** **H** **I**

HOW TO ORDER

Indicate the following information on order form:

1. Quantity of each item.
2. Model number, including options. See "How to Build a Model Number."
3. Any special service required.

- Note:
- The indicates that a choice is required.
 - The absence of indicates that no choice is required.
 - Alpha-numeric characters in place of indicate that no other alternatives are available.

HOW TO BUILD A MODEL NUMBER

- A** Select size of worksurface.
B Select edge style
T = Flat Vinyl T-edge
M = 3mm PVC edge
C Specify surface direction.
L = Left
R = Right
 *Direction is determined by the side of the worksurface that the 3" diameter leg is on.
D Select height.
9 = 29"
E Indicate location and type of leg.*
S = Standard (both standard legs)
R = Right (right transitional leg)
L = Left (left transitional leg)
B = Both (Both transitional legs)

* Note: If ordering Basic Worksurface as a freestanding unit, or if only one side connects to a transitional worksurface, the "B" option for both transitional legs is not available.

• **Must order corresponding worksurface connector to attach to adjacent table when using transitional legs.**

- F** Select frame style.
B = With beam
M = With modesty panel
G Select frame option.
M = Modesty
B = Beam

- H** Select trim color for painted surfaces.
B = Black
G = Gray
S = Sand
W = Warm Gray
L = Light Tone

- I** Select laminate surface.
AA = Cream
AB = Champagne
AC = Barcelona
AF = Aruba Tan
AG = Black
AH = Dark Gray
AI = Dawn Gray (Greige)
AJ = Fog
AK = Black Grandin
AL = Smoke Granite
AM = Sand Grandin
AN = Light Granite

XXI Notes Worksurfaces

Basic and Transitional Surfaces



(Right shown)

MODEL

D x W x L

MODEL NUMBER

Worksurface	Edge Style	Direction	Hgt	Trans. Leg	Frame Style	Trim	Laminate
-------------	------------	-----------	-----	------------	-------------	------	----------

Square Shoe Worksurface

- 1/4" solid particleboard with .050" laminate
- Flat vinyl T-edge or 3mm PVC edge
- Includes two worksurface grommets
- Concealed vertical wire management
- Includes modesty panel with 3" x 2" wire management port at top of modesty panel on 48" side
- Modesty panel is 15" high on 27" and 17 1/2" on 29" tables and is located 1 1/2" from backside of worksurface
- Heavy-gauge seam-welded tubular steel frame
- Scuff plates
- Wireway connects to existing openings at top of modesty panel with metal channel for wire management on 48" side
- Long surface is supported by 3" diameter metal support leg with adjustable glide
- Powder-coat finish on legs
- Connects to either 24" or 30" worksurface
- Adjustable chrome plated glides
- Optional transitional legs (6" shortened leg base)
- **Available with 29" height only**

24x48x60"	ZSS244860	<input type="checkbox"/>	<input type="checkbox"/>	9	<input type="checkbox"/>	<input type="checkbox"/>	<input type="checkbox"/>
24x48x66"	ZSS244866	<input type="checkbox"/>	<input type="checkbox"/>	9	<input type="checkbox"/>	<input type="checkbox"/>	<input type="checkbox"/>
24x48x72"	ZSS244872	<input type="checkbox"/>	<input type="checkbox"/>	9	<input type="checkbox"/>	<input type="checkbox"/>	<input type="checkbox"/>
24x48x84"	ZSS244884	<input type="checkbox"/>	<input type="checkbox"/>	9	<input type="checkbox"/>	<input type="checkbox"/>	<input type="checkbox"/>
30x48x66"	ZSS304866	<input type="checkbox"/>	<input type="checkbox"/>	9	<input type="checkbox"/>	<input type="checkbox"/>	<input type="checkbox"/>
30x48x72"	ZSS304872	<input type="checkbox"/>	<input type="checkbox"/>	9	<input type="checkbox"/>	<input type="checkbox"/>	<input type="checkbox"/>
30x48x84"	ZSS304884	<input type="checkbox"/>	<input type="checkbox"/>	9	<input type="checkbox"/>	<input type="checkbox"/>	<input type="checkbox"/>

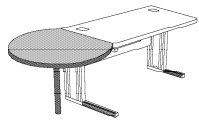

Conference End Worksurface

- Solid core top with high-pressure laminate surface
- Flat vinyl T-edge and 3mm PVC edge
- Powder-coat finish on legs
- 36" connects to 24" deep worksurface
- 42" connects to 30" deep worksurface
- 3" diameter metal support leg with adjustable chrome plated glide
- Includes splice plate
- Wireway not available
- **Available with 29" height only**

36"	WCE36	<input type="checkbox"/>		9		N/A	<input type="checkbox"/>	<input type="checkbox"/>
42"	WCE42	<input type="checkbox"/>		9		N/A	<input type="checkbox"/>	<input type="checkbox"/>

A **B** **C** **D** **E** **F** **G** **H**

HOW TO ORDER

Indicate the following information on order form:

1. Quantity of each item.
2. Model number, including options. See "How to Build a Model Number."
3. Any special service required.

- Note:
- The indicates that a choice is required.
 - The absence of indicates that no choice is required.
 - Alpha-numeric characters in place of indicate that no other alternatives are available.

HOW TO BUILD A MODEL NUMBER

- A** Select size of worksurface. _____
- B** Select edge style
T = Flat Vinyl T-edge
M = 3mm PVC edge
- C** Specify surface direction.
L = Left
R = Right
- *Direction is determined by the side of the worksurface that the 3" diameter leg is on.
- D** Select height. _____
9 = 29"
- E** Indicate location and type of leg.*
S = Standard (both standard legs)
R = Right (right transitional leg)
L = Left (left transitional leg)
B = Both (Both transitional legs)

* Note: If ordering Basic Worksurface as a freestanding unit, or if only one side connects to a transitional worksurface, the "B" option for both transitional legs is not available.

• **Must order corresponding worksurface connector to attach to adjacent table when using transitional legs.**

- F** Select frame style.
B = With beam
M = With modesty panel
- G** Select trim color for painted surfaces.
B = Black
G = Gray
S = Sand
W = Warm Gray
L = Light Tone

- H** Select laminate surface.
- AA** = Cream
AB = Champagne
AC = Barcelona
AF = Aruba Tan
AG = Black
AH = Dark Gray
AI = Dawn Gray (Greige)
AJ = Fog
AK = Black Grandin
AL = Smoke Granin
AM = Sand Grandin
AN = Light Granite
AO = Tundra
AP = Earthen
AQ = Rose Grafix
AS = Sierra Grafix
AT = Beige Grafix
AU = Sand Stone



Edge Styles



T-Edge
Price (T)



3mm PVC Edge
Price (M)

Total Weight

Total Weight	T-Edge Price (T)	3mm PVC Edge Price (M)
133#	\$280	\$295
139#	290	305
145#	295	310
157#	305	320
144#	290	305
150#	295	310
172#	305	320

75#	140	150
85#	150	160

- AV = Kentucky Walnut
- AW = Tennessee Oak
- AX = Light Oak
- AY = Red Birch
- AZ = Ash
- BA = Philadelphia Cherry
- BB = Pennsylvania Cherry
- BC = Mahogany
- BD = Oak
- BE = Maple
- BF = Pearwood
- CA = Pumice
- CB = Rock Maple
- CC = Medium Cherry
- CD = Anigre
- ZZ = COM

FINISH INFORMATION





Laminate Surface

See Keys for Progression swatch card.

Specifications and prices are subject to change without prior notice.

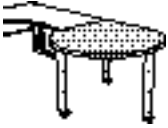
XXI Notes Worksurfaces

Mobile Surfaces

MODEL	D x Dia.	MODEL NUMBER					
		Worksurface	Edge Style	Hgt	Trim	Glides/Casters	Laminate
 WMT Mobile Teardrop Worksurface <ul style="list-style-type: none"> • 1¼" solid particleboard with .050" laminate • Flat vinyl T-edge or 3mm PVC edge • Base consists of three 3" diameter metal support leg with adjustable chrome-plated glide • Powder-coat finish on legs • 3" casters are optional; two are locking • Connects to end of 24" or 30" worksurface • Wireway not available • 29" height only with or without casters 	24x40" dia	WMT2440	<input type="checkbox"/>	9	<input type="checkbox"/>	<input type="checkbox"/>	<input type="checkbox"/>
	30x50" dia	WMT3050	<input type="checkbox"/>	9	<input type="checkbox"/>	<input type="checkbox"/>	<input type="checkbox"/>
 WMTP <ul style="list-style-type: none"> • Pointed end is removed to accommodate corner of two Classic XXI System panels 	24x45" dia for panel	WMTP2445	<input type="checkbox"/>	9	<input type="checkbox"/>	<input type="checkbox"/>	<input type="checkbox"/>
	30x55" dia for panel	WMTP3055	<input type="checkbox"/>	9	<input type="checkbox"/>	<input type="checkbox"/>	<input type="checkbox"/>
 WMSC Mobile Semi-Circle Worksurface <ul style="list-style-type: none"> • 1¼" solid particleboard with .050" laminate • Flat vinyl T-edge or 3mm PVC edge • Base consists of three 3" diameter metal support leg with adjustable chrome-plated glide • Powder-coat finish on legs • Connects to end of 24" or 30" worksurface • Notched in center for wire management • Wireway not available • 29" height only with or without casters • 3" casters are optional; two are locking 	24x48"	WMSC48	<input type="checkbox"/>	9	<input type="checkbox"/>	<input type="checkbox"/>	<input type="checkbox"/>
	30x60"	WMSC60	<input type="checkbox"/>	9	<input type="checkbox"/>	<input type="checkbox"/>	<input type="checkbox"/>
 WMSCP <ul style="list-style-type: none"> • Notch enables surface to wrap around end cap of Classic XXI System panel • 50½" diameter accommodates two 24" deep worksurfaces separated by a Classic XXI System panel • 62½" diameter accommodates two 30" deep worksurfaces separated by a Classic XXI System panel 	24x50½" for panel	WMSCP51	<input type="checkbox"/>	9	<input type="checkbox"/>	<input type="checkbox"/>	<input type="checkbox"/>
	30x62½" for panel	WMSCP63	<input type="checkbox"/>	9	<input type="checkbox"/>	<input type="checkbox"/>	<input type="checkbox"/>

A
B
C
D
E
F

HOW TO ORDER

Indicate the following information on order form:

- Quantity of each item.
- Model number, including options. See "How to Build a Model Number."
- Any special service required.

- Note:
- The indicates that a choice is required.
 - The absence of indicates that no choice is required.
 - Alpha-numeric characters in place of indicate that no other alternatives are available.

HOW TO BUILD A MODEL NUMBER

- A** Select size of worksurface.

- B** Specify edge style.
T = Flat vinyl T-edge
M = 3mm PVC edge

- C** Select height.
9 = 29"

- D** Select trim color for painted surfaces.
B = Black
G = Gray
S = Sand
W = Warm Gray
L = Light Tone

- E** Select glides or casters.
G = Glides
C = Casters. (Add \$26.)

- F** Select laminate surface.
AA = Cream
AB = Champagne
AC = Barcelona
AF = Aruba Tan
AG = Black
AH = Dark Gray
AI = Dawn Gray (Greige)
AJ = Fog
AK = Black Grandin
AL = Smoke Granite
AM = Sand Grandin
AN = Light Granite
AO = Tundra
AP = Earthen
AQ = Rose Grafix
AS = Sierra Grafix
AT = Beige Grafix
AU = Sand Stone

- AV** = Kentucky Walnut
AW = Tennessee Oak
AX = Light Oak
AY = Red Birch
AZ = Ash
BA = Philadelphia Cherry
BB = Pennsylvania Cherry
BC = Mahogany
BD = Oak
BE = Maple
BF = Pearwood
CA = Pumice
CB = Rock Maple
CC = Medium Cherry
CD = Anigre
ZZ = COM



Edge Styles



T-Edge
Price **(T)**



3mm PVC Edge
Price **(M)**

Total Weight

70#	\$185	\$195
104#	190	200

98#	185	195
132#	190	200

68#	190	200
86#	220	230

69#	220	230
88#	225	235

FINISH INFORMATION



Laminate Surface

See Keys for Progression swatch card.

Specifications and prices are subject to change without prior notice.

XXI Notes Worksurfaces

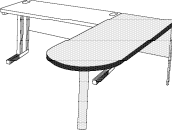
Transitional Surfaces

MODEL	D x W	MODEL NUMBER						
		Worksurface	Edge Style	Hgt	Trim	Laminate		
 <p>Peninsula End Worksurface</p> <ul style="list-style-type: none"> • Solid core top with high-pressure laminate surface • Flat vinyl T-edge or 3mm PVC edge • Powder-coat finish on 3" diameter metal support leg • Wireway not available • Available with 29" height only 	24x48"	WPW2448	<input type="checkbox"/>	9	<input type="checkbox"/>	<input type="checkbox"/>		
	24x60"	WPW2460	<input type="checkbox"/>	9	<input type="checkbox"/>	<input type="checkbox"/>		
	24x72"	WPW2472	<input type="checkbox"/>	9	<input type="checkbox"/>	<input type="checkbox"/>		
	30x48"	WPW3048	<input type="checkbox"/>	9	<input type="checkbox"/>	<input type="checkbox"/>		
	30x60"	WPW3060	<input type="checkbox"/>	9	<input type="checkbox"/>	<input type="checkbox"/>		
	30x72"	WPW3072	<input type="checkbox"/>	9	<input type="checkbox"/>	<input type="checkbox"/>		
 <p>Peninsula Side Mount Worksurface</p> <ul style="list-style-type: none"> • Solid core top with high-pressure laminate surface • Flat vinyl T-edge or 3mm PVC edge • Powder-coat finish on 3" diameter metal support leg • Includes modesty panel located 1½" from worksurface edge • When specifying a peninsula side mount worksurface, a transitional leg must be ordered on the basic surface to which it will connect • Wireway not available • Available with 29" height only 	24x48"	WPW2448S	<input type="checkbox"/>	9	<input type="checkbox"/>	<input type="checkbox"/>		
	24x60"	WPW2460S	<input type="checkbox"/>	9	<input type="checkbox"/>	<input type="checkbox"/>		
	24x72"	WPW2472S	<input type="checkbox"/>	9	<input type="checkbox"/>	<input type="checkbox"/>		
	30x48"	WPW3048S	<input type="checkbox"/>	9	<input type="checkbox"/>	<input type="checkbox"/>		
	30x60"	WPW3060S	<input type="checkbox"/>	9	<input type="checkbox"/>	<input type="checkbox"/>		
	30x72"	WPW3072S	<input type="checkbox"/>	9	<input type="checkbox"/>	<input type="checkbox"/>		
 <p>Peninsula Center Mount Worksurface</p> <ul style="list-style-type: none"> • Solid core top with high-pressure laminate surface • Flat vinyl T-edge or 3mm PVC edge • Powder-coat finish on 3" diameter metal support leg • Includes modesty panel located 1½" from worksurface edge • Wireway not available • Available with 29" height only 	24x48"	WPW2448C	<input type="checkbox"/>	9	<input type="checkbox"/>	<input type="checkbox"/>		
	24x60"	WPW2460C	<input type="checkbox"/>	9	<input type="checkbox"/>	<input type="checkbox"/>		
	24x72"	WPW2472C	<input type="checkbox"/>	9	<input type="checkbox"/>	<input type="checkbox"/>		
	30x48"	WPW3048C	<input type="checkbox"/>	9	<input type="checkbox"/>	<input type="checkbox"/>		
	30x60"	WPW3060C	<input type="checkbox"/>	9	<input type="checkbox"/>	<input type="checkbox"/>		
	30x72"	WPW3072C	<input type="checkbox"/>	9	<input type="checkbox"/>	<input type="checkbox"/>		
				A	B	C	D	E

HOW TO ORDER

Indicate the following information on order form:

1. Quantity of each item.
2. Model number, including options. See "How to Build a Model Number."
3. Any special service required.

- Note:
- The indicates that a choice is required.
 - The absence of indicates that no choice is required.
 - Alpha-numeric characters in place of indicate that no other alternatives are available.

HOW TO BUILD A MODEL NUMBER

- A** Select size of transitional worksurface. _____
- B** Specify edge style. _____
T = Flat Vinyl T-edge
M = 3mm PVC edge
- C** Select height. _____
9 = 29"
- D** Select trim color for painted surfaces. _____
B = Black
G = Gray
S = Sand
W = Warm Gray
L = Light Tone
- E** Select laminate surface. _____
AA = Cream
AB = Champagne
AC = Barcelona
AF = Aruba Tan
AG = Black
AH = Dark Gray
AI = Dawn Gray (Greige)
AJ = Fog
AK = Black Grandin
AL = Smoke Granite
AM = Sand Grandin
AN = Light Granite
AO = Tundra
AP = Earthen
AQ = Rose Grafix
AS = Sierra Grafix
AT = Beige Grafix
AU = Sand Stone

- AV** = Kentucky Walnut
AW = Tennessee Oak
AX = Light Oak
AY = Red Birch
AZ = Ash
BA = Philadelphia Cherry
BB = Pennsylvania Cherry
BC = Mahogany
BD = Oak
BE = Maple
BF = Pearwood
CA = Pumice
CB = Rock Maple
CC = Medium Cherry
CD = Anigre
ZZ = COM



Edge Styles



Total Weight
29"

T-Edge
Price **(T)**

3mm PVC Edge
Price **(M)**

44#	\$125	\$130
57#	135	140
68#	150	160
48#	125	130
63#	135	140
75#	150	160

51#	120	125
64#	130	135
77#	145	155
59#	120	125
71#	130	135
83#	145	155

49#	115	120
62#	125	130
75#	140	150
57#	115	120
69#	125	130
81#	140	150

FINISH INFORMATION

Laminate Surface

See Keys for Progression swatch card.

Specifications and prices are subject to change without prior notice.

XXI Notes Worksurfaces

Transitional Surfaces

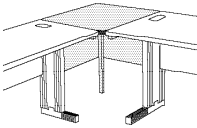
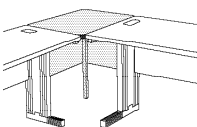
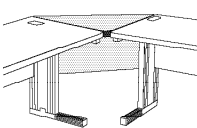
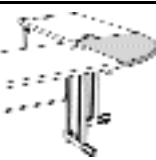
MODEL	Left D x D	Right D x D	MODEL NUMBER					
			Worksurface	Edge Style	Trans. Direction	Height	Trim	Laminate
 <p>Square Transitional Surface</p> <ul style="list-style-type: none"> • Two splice plates provided • Full wrap modesty panel included • For use with fixed height workstations only • Available with flat vinyl T-edge or 3mm PVC edge • Corner support leg is 1/2" square tubular steel • Wireway connects to existing openings at top of modesty panel with metal channel 	24x24"		WST2424	<input type="checkbox"/>	<input type="checkbox"/>	<input type="checkbox"/>	<input type="checkbox"/>	<input type="checkbox"/>
	30x30"		WST3030	<input type="checkbox"/>	<input type="checkbox"/>	<input type="checkbox"/>	<input type="checkbox"/>	<input type="checkbox"/>
 <p>Rectangle Transitional Surface</p> <ul style="list-style-type: none"> • Two splice plates provided • Full wrap modesty panel included • For use with fixed height workstations only • Available with flat vinyl T-edge or 3mm PVC edge • Corner support leg is 1/2" square tubular steel • Wireway connects to existing openings at top of modesty panel with metal channel 	30x24"		WRT3024	<input type="checkbox"/>	<input type="checkbox"/>	<input type="checkbox"/>	<input type="checkbox"/>	<input type="checkbox"/>
	24x30"		WRT2430	<input type="checkbox"/>	<input type="checkbox"/>	<input type="checkbox"/>	<input type="checkbox"/>	<input type="checkbox"/>
 <p>Triangle Transitional Surface</p> <ul style="list-style-type: none"> • Two splice plates provided • Full wrap modesty panel included • For use with fixed height workstations only • Available with flat vinyl T-edge or 3mm PVC edge • Wireway connects to existing openings at top of modesty panel with metal channel 	24x24x34"		WTT2424	<input type="checkbox"/>	<input type="checkbox"/>	<input type="checkbox"/>	<input type="checkbox"/>	<input type="checkbox"/>
	30x30x42"		WTT3030	<input type="checkbox"/>	<input type="checkbox"/>	<input type="checkbox"/>	<input type="checkbox"/>	<input type="checkbox"/>
 <p>Quarter Round Transitional Surface</p> <ul style="list-style-type: none"> • Two splice plates provided • For use with fixed height workstations only • Available with flat vinyl T-edge or 3mm PVC edge • For use as conferencing corner • Wireway not available • Modesty panel not required • 24" surface can be wrapped with a Classic XXI Systems curved panel on module • 24" surface has radius of 26 1/2" and 30" surface has a radius of 35" • WQRP version has pointed end removed to accommodate corner of two Classic XXI Systems panels <p>All square, rectangular, and triangular transitional surfaces connected at the same height do not require Right (R) or (L) transition direction. Use "X" for transition direction. Transitional direction required for "97" transitional height.</p>	24x24"		WQR24	<input type="checkbox"/>		<input type="checkbox"/>	<input type="checkbox"/>	<input type="checkbox"/>
	30x30"		WQR30	<input type="checkbox"/>		<input type="checkbox"/>	<input type="checkbox"/>	<input type="checkbox"/>
	24x24" for panel		WQRP24	<input type="checkbox"/>		<input type="checkbox"/>	<input type="checkbox"/>	<input type="checkbox"/>
	30x30" for panel		WQRP30	<input type="checkbox"/>		<input type="checkbox"/>	<input type="checkbox"/>	<input type="checkbox"/>
				A	B	C	D	E

HOW TO ORDER

Indicate the following information on order form:

1. Quantity of each item.
2. Model number, including options. See "How to Build a Model Number."
3. Any special service required.

- Note:
- The indicates that a choice is required.
 - The absence of indicates that no choice is required.
 - Alpha-numeric characters in place of indicate that no other alternatives are available.

HOW TO BUILD A MODEL NUMBER

- A** Select size of transitional worksurface.
- B** Select edge style.
T = Flat Vinyl T-edge
M = 3mm PVC edge
- C** Select transition direction.*
L = Left
R = Right
X = None
- *Transition direction is determined from the originating 24" or 30" basic or keyboard pad worksurface.
- D** Select transition height.
9 = 29" to 27"
- E** Select trim color for painted surfaces.
B = Black
G = Gray
S = Sand
W = Warm Gray
L = Light Tone
- F** Select laminate surface.
AA = Cream
AB = Champagne
AC = Barcelona
AF = Aruba Tan
AG = Black
AH = Dark Gray
AI = Dawn Gray (Greige)
AJ = Fog
AK = Black Grandin
AL = Smoke Granite
AM = Sand Grandin
AN = Light Granite

- AO** = Tundra
AP = Earthen
AQ = Rose Grafix
AS = Sierra Grafix
AT = Beige Grafix
AU = Sand Stone
AV = Kentucky Walnut
AW = Tennessee Oak
AX = Light Oak
AY = Red Birch
AZ = Ash
BA = Philadelphia Cherry
BB = Pennsylvania Cherry
BC = Mahogany
BD = Oak
BE = Maple
BF = Pearwood
CA = Pumice
CB = Rock Maple
CC = Medium Cherry
CD = Anigre



Edge Styles



T-Edge
Price **(T)**



3mm PVC Edge
Price **(M)**

Total Weight

Joins table

34#	\$115	\$120	24" deep worksurface to 24" deep worksurface
51#	120	125	30" deep worksurface to 30" deep worksurface
38#	120	125	30" deep worksurface to 24" deep worksurface
38#	120	125	24" deep worksurface to 30" deep worksurface
30#	90	95	24" deep worksurface to 24" deep worksurface
30#	100	105	30" deep worksurface to 30" deep worksurface
34#	100	105	24" deep worksurface to 24" deep worksurface
51#	105	110	30" deep worksurface to 30" deep worksurface
34#	100	105	24" deep worksurface to 24" deep worksurface
51#	105	110	30" deep worksurface to 30" deep worksurface

ZZ = COM

FINISH INFORMATION





Laminate Surface

See Keys for Progression swatch card.

Specifications and prices are subject to change without prior notice.

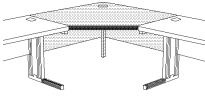
XXI Notes Worksurfaces

Transitional Surfaces

MODEL	Left D x W x	Right W x D	MODEL NUMBER				
			Worksurface	Edge Style	Trans. Direction	Transition Height	Trim
 <p>Corner Transitional Surface</p> <ul style="list-style-type: none"> Available with flat vinyl T-edge or 3mm PVC edge Full wrap modesty panel included For use with fixed height workstations only Front edge dimension is 17" on 24x36" and 30x42"; 25½" on 24x42" and 30x48"; 34" on 24x48" Wireway 	24x36" x 36x24"	CT2436	<input type="checkbox"/>	<input type="checkbox"/>	<input type="checkbox"/>	<input type="checkbox"/>	<input type="checkbox"/>
	24x42" x 42x24"	CT2442	<input type="checkbox"/>	<input type="checkbox"/>	<input type="checkbox"/>	<input type="checkbox"/>	<input type="checkbox"/>
	24x48" x 48x24"	CT2448	<input type="checkbox"/>	<input type="checkbox"/>	<input type="checkbox"/>	<input type="checkbox"/>	<input type="checkbox"/>
	30x42" x 42x30"	CT3042	<input type="checkbox"/>	<input type="checkbox"/>	<input type="checkbox"/>	<input type="checkbox"/>	<input type="checkbox"/>
	30x48" x 48x30"	CT3048	<input type="checkbox"/>	<input type="checkbox"/>	<input type="checkbox"/>	<input type="checkbox"/>	<input type="checkbox"/>
 <p>Corner Transitional Surface with Keyboard Pad</p> <ul style="list-style-type: none"> Available with flat vinyl T-edge or 3mm PVC vinyl edge Keyboard pad: 10 x 24"; 3" height adjustments; 1" forward extension adjustment; 15° maximum downward tilt Full wrap modesty panel included For use with fixed height workstations only Wireway 	24x42" x 42x24"	CTK2442	<input type="checkbox"/>	<input type="checkbox"/>	<input type="checkbox"/>	<input type="checkbox"/>	<input type="checkbox"/>
	24x48" x 48x24"	CTK2448	<input type="checkbox"/>	<input type="checkbox"/>	<input type="checkbox"/>	<input type="checkbox"/>	<input type="checkbox"/>
	30x48" x 48x30"	CTK3048	<input type="checkbox"/>	<input type="checkbox"/>	<input type="checkbox"/>	<input type="checkbox"/>	<input type="checkbox"/>
 <p>Corner Transitional Reduction Surface</p> <ul style="list-style-type: none"> Available with flat vinyl T-edge or 3mm PVC vinyl edge Full wrap modesty panel included For use with fixed height workstations only Used to join 24" and 30" worksurfaces in corner Wireway 	24x42" x 42x30"	CT244230	<input type="checkbox"/>	<input type="checkbox"/>	<input type="checkbox"/>	<input type="checkbox"/>	<input type="checkbox"/>
	24x48" x 48x30"	CT244830	<input type="checkbox"/>	<input type="checkbox"/>	<input type="checkbox"/>	<input type="checkbox"/>	<input type="checkbox"/>
	30x42" x 42x24"	CT304224	<input type="checkbox"/>	<input type="checkbox"/>	<input type="checkbox"/>	<input type="checkbox"/>	<input type="checkbox"/>
	30x48" x 48x24"	CT304824	<input type="checkbox"/>	<input type="checkbox"/>	<input type="checkbox"/>	<input type="checkbox"/>	<input type="checkbox"/>
 <p>Corner Curvilinear Transitional Surface</p> <ul style="list-style-type: none"> Available with flat vinyl T-edge or 3mm PVC vinyl edge Full wrap modesty panel included For use with fixed height workstations only Curved front surface Wireway 	24x36" x 36x24"	CCT2436	<input type="checkbox"/>	<input type="checkbox"/>	<input type="checkbox"/>	<input type="checkbox"/>	<input type="checkbox"/>
	24x42" x 42x24"	CCT2442	<input type="checkbox"/>	<input type="checkbox"/>	<input type="checkbox"/>	<input type="checkbox"/>	<input type="checkbox"/>
	24x48" x 48x24"	CCT2448	<input type="checkbox"/>	<input type="checkbox"/>	<input type="checkbox"/>	<input type="checkbox"/>	<input type="checkbox"/>
	30x42" x 42x30"	CCT3042	<input type="checkbox"/>	<input type="checkbox"/>	<input type="checkbox"/>	<input type="checkbox"/>	<input type="checkbox"/>
	30x48" x 48x30"	CCT3048	<input type="checkbox"/>	<input type="checkbox"/>	<input type="checkbox"/>	<input type="checkbox"/>	<input type="checkbox"/>
 <p>Corner Curvilinear Transitional Reduction Surface</p> <ul style="list-style-type: none"> Available with flat vinyl T-edge or 3mm PVC vinyl edge Full wrap modesty panel included For use with fixed height workstations only Used to join 24" and 30" worksurfaces in corner Curved front surface Wireway 	24x42" x 42x30"	CCT244230	<input type="checkbox"/>	<input type="checkbox"/>	<input type="checkbox"/>	<input type="checkbox"/>	<input type="checkbox"/>
	24x48" x 48x30"	CCT244830	<input type="checkbox"/>	<input type="checkbox"/>	<input type="checkbox"/>	<input type="checkbox"/>	<input type="checkbox"/>
	30x42" x 42x24"	CCT304224	<input type="checkbox"/>	<input type="checkbox"/>	<input type="checkbox"/>	<input type="checkbox"/>	<input type="checkbox"/>
	30x48" x 48x24"	CCT304824	<input type="checkbox"/>	<input type="checkbox"/>	<input type="checkbox"/>	<input type="checkbox"/>	<input type="checkbox"/>

A
B
C
D
E
F

All corner transitional surfaces connected at the same height do not require right (R) or left (L) transition direction. Use "X" for transition direction. Transition height required for "97" transitional.

HOW TO ORDER

Indicate the following information on order form:

- Quantity of each item.
- Model number, including options. See "How to Build a Model Number."
- Any special service required.

- Note:
- The indicates that a choice is required.
 - The absence of indicates that no choice is required.
 - Alpha-numeric characters in place of indicate that no other alternatives are available.

HOW TO BUILD A MODEL NUMBER

- A** Select size of transitional worksurface. _____
- B** Select edge style. _____
T = Flat Vinyl T-edge
M = 3mm PVC edge
- C** Select transition direction.* _____
L = Left
R = Right
X = None
- *Transition direction is determined from the originating 24" or 30" basic or keyboard pad worksurface.
- D** Select transition height. _____
99 = 29" to 29"
97 = 29" to 27"
77 = 27" to 27"
- E** Select trim color for painted surfaces. _____
B = Black
G = Gray
S = Sand
W = Warm Gray
L = Light Tone
- F** Select laminate surface. _____
AA = Cream
AB = Champagne
AC = Barcelona
AF = Aruba Tan
AG = Black
AH = Dark Gray
AI = Dawn Gray (Greige)
AJ = Fog
AK = Black Grandin
AL = Smoke Granite
AM = Sand Grandin
AN = Light Granite

- AO** = Tundra
AP = Earthen
AQ = Rose Grafix
AS = Sierra Grafix
AT = Beige Grafix
AU = Sand Stone
AV = Kentucky Walnut
AW = Tennessee Oak
AX = Light Oak
AY = Red Birch
AZ = Ash
BA = Philadelphia Cherry
BB = Pennsylvania Cherry
BC = Mahogany
BD = Oak
BE = Maple
BF = Pearwood
CA = Pumice
CB = Rock Maple
CC = Medium Cherry
CD = Anigre



Edge Styles



T-Edge
Price (**T**)



3mm Vinyl Edge
Price (**M**)

Total Weight

72#	\$200	\$210	24" deep worksurface to 24" deep worksurface
80#	205	215	24" deep worksurface to 24" deep worksurface
96#	220	230	24" deep worksurface to 24" deep worksurface
98#	230	240	30" deep worksurface to 30" deep worksurface
102#	240	250	30" deep worksurface to 30" deep worksurface

80#	150	160	24" deep worksurface to 24" deep worksurface
91#	155	165	24" deep worksurface to 24" deep worksurface
102#	160	170	30" deep worksurface to 30" deep worksurface

96#	225	235	24" deep worksurface to 30" deep worksurface
102#	245	260	24" deep worksurface to 30" deep worksurface
96#	225	235	30" deep worksurface to 24" deep worksurface
102#	245	260	30" deep worksurface to 24" deep worksurface

72#	165	175	24" deep worksurface to 24" deep worksurface
80#	175	185	24" deep worksurface to 24" deep worksurface
102#	190	200	24" deep worksurface to 24" deep worksurface
90#	200	210	30" deep worksurface to 30" deep worksurface
102#	215	225	30" deep worksurface to 30" deep worksurface

96#	225	235	24" deep worksurface to 30" deep worksurface
102#	245	260	24" deep worksurface to 30" deep worksurface
96#	225	235	30" deep worksurface to 24" deep worksurface
102#	245	260	30" deep worksurface to 24" deep worksurface

ZZ = COM

FINISH INFORMATION



Laminate Surface

See Keys for Progression swatch card.

Specifications and prices are subject to change without prior notice.

XXI Notes Worksurfaces

End-of-Run Surfaces

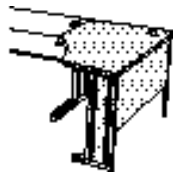
MODEL	Left W x D	Right D x W	MODEL NUMBER					
			Worksurface	Edge Style	Trans. Direction	Height	Trim	Laminate
 <p>End-of-Run Corner Surface</p> <ul style="list-style-type: none"> • Two splice plates provided • Full wrap modesty panel included • For use with fixed height workstations only • Available with flat vinyl T-edge or 3mm PVC vinyl edge • Corner support leg is 1/2" square tubular steel • Wireway 	24x36" x 36x24"	WER2436	<input type="checkbox"/>	<input type="checkbox"/>	<input type="checkbox"/>	<input type="checkbox"/>	<input type="checkbox"/>	<input type="checkbox"/>
	24x42" x 42x24"	WER2442	<input type="checkbox"/>	<input type="checkbox"/>	<input type="checkbox"/>	<input type="checkbox"/>	<input type="checkbox"/>	<input type="checkbox"/>
	24x48" x 48x24"	WER2448	<input type="checkbox"/>	<input type="checkbox"/>	<input type="checkbox"/>	<input type="checkbox"/>	<input type="checkbox"/>	<input type="checkbox"/>
	30x42" x 42x30"	WER3042	<input type="checkbox"/>	<input type="checkbox"/>	<input type="checkbox"/>	<input type="checkbox"/>	<input type="checkbox"/>	<input type="checkbox"/>
	30x48" x 48x30"	WER3048	<input type="checkbox"/>	<input type="checkbox"/>	<input type="checkbox"/>	<input type="checkbox"/>	<input type="checkbox"/>	<input type="checkbox"/>
 <p>End-of-Run Surface with Keyboard Pad</p> <ul style="list-style-type: none"> • Two splice plates provided • Full wrap modesty panel included • For use with fixed height workstations only • Available with flat vinyl T-edge or 3mm PVC vinyl edge • Corner support leg is 1/2" square tubular steel • Wireway 	24x42" x 42x24"	WERK2442	<input type="checkbox"/>	<input type="checkbox"/>	<input type="checkbox"/>	<input type="checkbox"/>	<input type="checkbox"/>	<input type="checkbox"/>
	24x48" x 48x24"	WERK2448	<input type="checkbox"/>	<input type="checkbox"/>	<input type="checkbox"/>	<input type="checkbox"/>	<input type="checkbox"/>	<input type="checkbox"/>
	30x48" x 48x30"	WERK3048	<input type="checkbox"/>	<input type="checkbox"/>	<input type="checkbox"/>	<input type="checkbox"/>	<input type="checkbox"/>	<input type="checkbox"/>
 <p>End-of-Run Curvilinear Surface</p> <ul style="list-style-type: none"> • Full wrap modesty panel included • For use with fixed height workstations only • Available with T-edge or 3mm PVC vinyl edge • Corner support leg is 1/2" square tubular steel • Wireway 	24x36" x 36x24"	WCCE2436	<input type="checkbox"/>	<input type="checkbox"/>	<input type="checkbox"/>	<input type="checkbox"/>	<input type="checkbox"/>	<input type="checkbox"/>
	24x42" x 42x24"	WCCE2442	<input type="checkbox"/>	<input type="checkbox"/>	<input type="checkbox"/>	<input type="checkbox"/>	<input type="checkbox"/>	<input type="checkbox"/>
	24x48" x 48x24"	WCCE2448	<input type="checkbox"/>	<input type="checkbox"/>	<input type="checkbox"/>	<input type="checkbox"/>	<input type="checkbox"/>	<input type="checkbox"/>
	30x42" x 42x30"	WCCE3042	<input type="checkbox"/>	<input type="checkbox"/>	<input type="checkbox"/>	<input type="checkbox"/>	<input type="checkbox"/>	<input type="checkbox"/>
	30x48" x 48x30"	WCCE3048	<input type="checkbox"/>	<input type="checkbox"/>	<input type="checkbox"/>	<input type="checkbox"/>	<input type="checkbox"/>	<input type="checkbox"/>

A
B
C
D
E
F

When ordering an end-of-run worksurface, the adjoining worksurface must have a transitional leg. Order a right transitional, left transitional or both transitional.

HOW TO ORDER

Indicate the following information on order form:

- Quantity of each item.
- Model number, including options. See "How to Build a Model Number."
- Any special service required.

- Note:
- The indicates that a choice is required.
 - The absence of indicates that no choice is required.
 - Alpha-numeric characters in place of indicate that no other alternatives are available.

HOW TO BUILD A MODEL NUMBER

- A** Select size of end-of-run worksurface.
- B** Select edge style.
T = Flat Vinyl T-edge
M = 3mm PVC edge
- C** Select transition direction.
L = Left
R = Right
- *Transition direction is determined from the originating 24" or 30" basic or keyboard pad worksurface.
- D** Select end-of-run height.
7 = 27"
9 = 29"
- E** Select trim color for painted surfaces.
B = Black
G = Gray
S = Sand
W = Warm Gray
L = Light Tone
- F** Select laminate surface.
AA = Cream
AB = Champagne
AC = Barcelona
AF = Aruba Tan
AG = Black
AH = Dark Gray
AI = Dawn Gray (Greige)
AJ = Fog
AK = Black Grandin
AL = Smoke Granite
AM = Sand Grandin
AN = Light Granite

- AO** = Tundra
AP = Earthen
AQ = Rose Grafix
AS = Sierra Grafix
AT = Beige Grafix
AU = Sand Stone
AV = Kentucky Walnut
AW = Tennessee Oak
AX = Light Oak
AY = Red Birch
AZ = Ash
BA = Philadelphia Cherry
BB = Pennsylvania Cherry
BC = Mahogany
BD = Oak
BE = Maple
BF = Pearwood
CA = Pumice
CB = Rock Maple
CC = Medium Cherry
CD = Anigre



Edge Styles



T-Edge
Price (T)



3mm Vinyl Edge
Price (M)

Total Weight

Joins table

74#	\$195	\$205	24" deep worksurface to 24" deep worksurface
78#	220	230	24" deep worksurface to 24" deep worksurface
82#	270	285	24" deep worksurface to 24" deep worksurface
96#	220	230	30" deep worksurface to 30" deep worksurface
100#	270	285	30" deep worksurface to 30" deep worksurface

78#	215	225	24" deep worksurface to 24" deep worksurface
80#	235	245	24" deep worksurface to 24" deep worksurface
102#	265	280	30" deep worksurface to 30" deep worksurface

76#	195	205	24" deep worksurface to 24" deep worksurface
96#	220	230	24" deep worksurface to 24" deep worksurface
106#	270	285	24" deep worksurface to 24" deep worksurface
108#	220	230	30" deep worksurface to 30" deep worksurface
118#	270	285	30" deep worksurface to 30" deep worksurface

ZZ = COM

FINISH INFORMATION

Laminate Surface

See Keys for Progression swatch card.

Specifications and prices are subject to change without prior notice.

XXI Notes Components

General Information



Universal Printer Stand

PU

p. 32



Basic Printer Stand

PS

p. 32

Features

Formed steel construction

•

•

Casters (optional)

•

•

Solid core top

•

Plastic laminate surface

•

Adjustable glides

•

•

SPECIFICATIONS

Universal Printer Stand

Seam-welded 40 sheen powder-coated tubular steel frame. Horizontal top member and foot are 16-ga. 1 x 2"; vertical leg member 16-ga., 1 x 3". Trays are 14-ga. formed steel. Slide-out forms loading tray and paper catch tray with three vertical adjustments. Adjustable platform in 2 sections, locked with thumb screws and faced with plastic anti-vibration pad. Platform sections of 16-ga. formed steel welded to 14-ga. brackets. Adjustable chrome-plated glides.

Optional Casters

2" hard plastic wheels. Swivel casters, 2 are lockable. Raises worksurface height 2".

Wire Management

3 x 2" openings with protected edges are provided for all worksurfaces on both sides at top of modesty panels.

Basic Printer Stand Receiver Basket

Solid 1/2" steel rod construction, zinc plated finish; 31 x 21 1/2". Fastens to printer stand underside at back.

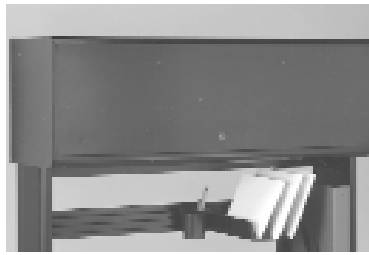

Steel Overhead Cabinet

WFDS

p. 34

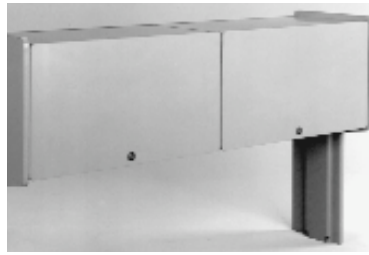

Laminated Overhead Storage

WOC

p. 38



Privacy Screens

WZP

p.40

Features

Steel construction	•		
Solid core construction		•	
Wire management	•	•	
Enamel finish on metal parts	•	•	
Fabric covered	•	Optional	•
Field installable	•	•	•
Plastic laminate surface	•	•	
Steel door	•	Optional	

WOC and WDS Models:

Overhead Width	Door Overhang In Open Position	No. Of Doors	Inside Width of Overhead	Dimension Between Side Sets at Worksurface
30"	3/4"	1	27"	25 1/4"
36"	3/4"	1	33"	31 1/4"
42"	3/4"	1	39"	37 1/4"
48"	3/4"	1	45"	43 1/4"
54"	3/4"	2	2 x 25 1/2"	49 1/4"
60"	3/4"	2	2 x 28 1/2"	55 1/4"
72"	3/4"	2	2 x 34 1/2"	67 1/4"

Overall height from worksurface to top of overhead is 34 1/4".
Overhead allows for 18 1/2" clearance from worksurface to underside of shelf.

WFDS, WFDF, WFDL Models:

Overhead Width	Door Overhang In Open Position	No. Of Doors	Inside Width of Overhead	Dimension Between Side Sets at Worksurface
30"	3 1/2"	1	29 1/2"	27"
36"	3 1/2"	1	35 1/2"	33"
42"	3 1/2"	1	41 1/2"	39"
48"	3 1/2"	1	47 1/2"	45"
54"	3 1/2"	1	53 1/2"	51"
60"	3 1/2"	1	59 1/2"	57"
72"	3 1/2"	2	2 x 35 1/2"	2 x 34"

Overall height from worksurface to top of overhead is 36".
Overhead allows for 19 1/2" clearance from worksurface to underside of shelf.

SPECIFICATIONS

Overheads (WFDS, WFDF, WFDL Models)

Constructed of 18 gauge steel back, side panels and door front. Supported by 16 gauge steel uprights with concealed vertical wire management to conceal task light cord. Uprights are secured to top of steel legs through grommet holes. The steel door front is of honeycomb core construction with an enamel finish. Steel door front is available with upholstery or covered with high pressure laminate over particleboard core. Door front operates on a rack and pinion gear system utilizing a center lock mechanism. Door front stores recessed inside the cabinet with the dual durometer handle exposed. 72" overhead consists of two cabinets supported by a 16 gauge steel bracket located in the middle. Middle bracket is attached to the underside of the worksurface.

Overheads (WOC, WDS Models)

3/8" Novaply with .050 laminate on the faces with vinyl edging. Slides are steel with steel ball bearings. Exceeds BIFMA requirements. Steel

construction lock has five tumblers. Overhead locks can be keyed alike to match pedestals. Overheads also available with fabric finish.

Privacy Screen

Two 1/2" Gypsum boards joined together with industrial adhesive. Attaches to the rear of the worksurface using two or three 1/8" cold rolled steel brackets. Brackets attach to privacy screen with fasteners. Steel splice plates run the full height of the screen to align adjoining privacy screens. Privacy screen is 19 1/2" high above worksurface.

Overhead Privacy Screen

Same construction as basic privacy screen except that it mounts flush to the back of the overhead and is attached to the back of the overhead as well as to the underside of worksurface. Overhead privacy screen is attached to the overhead and worksurface with fasteners. Middle support bracket on 72" overhead attaches to underside of worksurface. Cannot be used with laminated overhead storage (WOC and WDS models)

INFORMATION

Warranty

See "Terms" for general information.

XXI Notes Components

Printer Stands

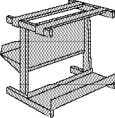
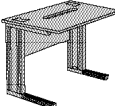
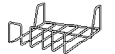
MODEL	D x W	MODEL NUMBER				
		Basic Model	Height	Trans Leg	Trim	Laminate
 <p>Universal Printer Stand</p> <ul style="list-style-type: none"> • Infinitely adjustable • Accommodates printers up to 24" wide x 27½" deep • Formed steel construction • Total depth with trays 35" • Adjustable glides • Available with casters 	24x27½"	PU272427	7		<input type="checkbox"/>	
 <p>Basic Printer Stand</p> <ul style="list-style-type: none"> • Solid core top with plastic laminate surface • Flat vinyl T-edge only • Enamel finish on legs • Each leg section is a welded unit joined by modesty panel which provides wire management • Adjustable glides • Available with casters • Slot is 4¼"d. x 18¼"w. and is located in center of worksurface 	24x30"	PS3024	<input type="checkbox"/>	<input type="checkbox"/>	<input type="checkbox"/>	<input type="checkbox"/>
	30x36"	PS3036	<input type="checkbox"/>	<input type="checkbox"/>	<input type="checkbox"/>	<input type="checkbox"/>
 <p>Receiver Basket</p> <ul style="list-style-type: none"> • Zinc-plated welded steel wire • Attaches to table top of printer stand • Increases overall table size to 41" x 36" 	31x21½"	WRB3121				

A
B
C
D
E

HOW TO ORDER

Indicate the following information on order form:

1. Quantity of each item.
2. Model number, including options. See "How to Build a Model Number."
3. Any special service required.

- Note:
- The indicates that a choice is required.
 - The absence of indicates that no choice is required.
 - Alpha-numeric characters in place of indicate that no other alternatives are available.

HOW TO BUILD A MODEL NUMBER

- A** Select basic model.
- B** Select height.
7 = 27"
9 = 29"
- C** Indicate location and type of leg.
S = Standard (both standard legs)
R = Right (right transitional leg)
L = Left (left transitional leg)
- D** Select trim color for painted surfaces.
B = Black
G = Gray
S = Sand
W = Warm Gray
L = Light Tone
- E** Select laminate surface.
AA = Cream
AB = Champagne
AC = Barcelona
AF = Aruba Tan
AG = Black
AH = Dark Gray
AI = Dawn Gray (Greige)
AJ = Fog
AK = Black Grandin
AL = Smoke Granite
AM = Sand Grandin
AN = Light Granite
AO = Tundra
AP = Earthen
AQ = Rose Grafix
AS = Sierra Grafix
AT = Beige Grafix
AU = Sand Stone

- AV** = Kentucky Walnut
AW = Tennessee Oak
AX = Light Oak
AY = Red Birch
AZ = Ash
BA = Philadelphia Cherry
BB = Pennsylvania Cherry
BC = Mahogany
BD = Oak
BE = Maple
BF = Pearwood
CA = Pumice
CB = Rock Maple
CC = Medium Cherry
CD = Anigre
ZZ = COM



Total Weight		Price
27"	29"	
50#		\$180
65#	68#	240
79#	82#	245
6#	6#	30

FINISH INFORMATION

Laminate Surface

See Keys for Progression swatch card.

OPTIONS

Casters



4 swivel casters (2½" diameter), 2 with locks.
 Add 2" to top surface height. Add 2lbs. to weight.
 Order separately, specify 87.2840

List price \$34.00/set

Specifications and prices are subject to change without prior notice.

XXI Notes Components

Overhead Storage

MODEL	W x H x D	MODEL NUMBER					
		Overhead	Trim	Fabric	Laminate	Key	
 <p>Steel Overhead Cabinet with Steel Door</p> <ul style="list-style-type: none"> • Steel end panels, bottom, top shelf, and door with enamel finish • Double bit lock is included with key alike option • Door stores recessed with handle exposed • Shelf depth is 13 1/4" • Meets all BIFMA standards: X5.6-1986, Section #'s 8.2, 8.3, 8.4, 8.5 and 13 • 72" overhead has two 36" doors • For use with fixed height worksurfaces • Concealed vertical wire management • Secured to steel legs by concealed mounting brackets • Accepts shelf divider • Cannot be mounted on tables with casters 	30 x 16 1/2 x 14 1/2"	WFDS30	<input type="checkbox"/>			<input type="checkbox"/> <input type="checkbox"/>	
	36 x 16 1/2 x 14 1/2"	WFDS36	<input type="checkbox"/>			<input type="checkbox"/> <input type="checkbox"/>	
	42 x 16 1/2 x 14 1/2"	WFDS42	<input type="checkbox"/>			<input type="checkbox"/> <input type="checkbox"/>	
	48 x 16 1/2 x 14 1/2"	WFDS48	<input type="checkbox"/>			<input type="checkbox"/> <input type="checkbox"/>	
	54 x 16 1/2 x 14 1/2"	WFDS54	<input type="checkbox"/>			<input type="checkbox"/> <input type="checkbox"/>	
	60 x 16 1/2 x 14 1/2"	WFDS60	<input type="checkbox"/>			<input type="checkbox"/> <input type="checkbox"/>	
	72 x 16 1/2 x 14 1/2"	WFDS72	<input type="checkbox"/>			<input type="checkbox"/> <input type="checkbox"/>	
 <p>Steel Overhead Cabinet with Fabric Door</p> <ul style="list-style-type: none"> • Steel end panels, bottom and top shelf with enamel finish • Fabric-covered door • Double bit lock is included with key alike option • End panel bracket design prevents accidental dislodging of components • Shelf depth is 13 1/4" • Door stores recessed with handle exposed • Meets all BIFMA standards: X5.6-1986, Section #'s 8.2, 8.3, 8.4, 8.5 and 13 • 72" overhead has two 36" doors • For use with fixed height worksurfaces • Concealed vertical wire management • Secured to steel legs by concealed mounting brackets • Accepts shelf divider • Cannot be mounted on tables with casters 	30 x 16 1/2 x 14 1/2"	WFDF30	<input type="checkbox"/>	<input type="checkbox"/> <input type="checkbox"/> <input type="checkbox"/> <input type="checkbox"/>		<input type="checkbox"/> <input type="checkbox"/>	
	36 x 16 1/2 x 14 1/2"	WFDF36	<input type="checkbox"/>	<input type="checkbox"/> <input type="checkbox"/> <input type="checkbox"/> <input type="checkbox"/>		<input type="checkbox"/> <input type="checkbox"/>	
	42 x 16 1/2 x 14 1/2"	WFDF42	<input type="checkbox"/>	<input type="checkbox"/> <input type="checkbox"/> <input type="checkbox"/> <input type="checkbox"/>		<input type="checkbox"/> <input type="checkbox"/>	
	48 x 16 1/2 x 14 1/2"	WFDF48	<input type="checkbox"/>	<input type="checkbox"/> <input type="checkbox"/> <input type="checkbox"/> <input type="checkbox"/>		<input type="checkbox"/> <input type="checkbox"/>	
	54 x 16 1/2 x 14 1/2"	WFDF54	<input type="checkbox"/>	<input type="checkbox"/> <input type="checkbox"/> <input type="checkbox"/> <input type="checkbox"/>		<input type="checkbox"/> <input type="checkbox"/>	
	60 x 16 1/2 x 14 1/2"	WFDF60	<input type="checkbox"/>	<input type="checkbox"/> <input type="checkbox"/> <input type="checkbox"/> <input type="checkbox"/>		<input type="checkbox"/> <input type="checkbox"/>	
	72 x 16 1/2 x 14 1/2"	WFDF72	<input type="checkbox"/>	<input type="checkbox"/> <input type="checkbox"/> <input type="checkbox"/> <input type="checkbox"/>		<input type="checkbox"/> <input type="checkbox"/>	
 <p>Steel Overhead Cabinet with Laminate Door</p> <ul style="list-style-type: none"> • Steel end panels, bottom and top shelf with enamel finish • High-pressure laminate on particleboard door • Double bit lock is included with key alike option • End panel bracket design prevents accidental dislodging of components • Shelf depth is 13 1/4" • Door stores recessed with handle exposed • Meets all BIFMA standards: X5.6-1986, Section #'s 8.2, 8.3, 8.4, 8.5 and 13 • 72" overhead has two 36" doors • For use with fixed height worksurfaces • Concealed vertical wire management • Secured to steel legs by concealed mounting brackets • Accepts shelf divider • Cannot be mounted on tables with casters 	30 x 16 1/2 x 14 1/2"	WFDL30	<input type="checkbox"/>		<input type="checkbox"/> <input type="checkbox"/>	<input type="checkbox"/> <input type="checkbox"/>	
	36 x 16 1/2 x 14 1/2"	WFDL36	<input type="checkbox"/>		<input type="checkbox"/> <input type="checkbox"/>	<input type="checkbox"/> <input type="checkbox"/>	
	42 x 16 1/2 x 14 1/2"	WFDL42	<input type="checkbox"/>		<input type="checkbox"/> <input type="checkbox"/>	<input type="checkbox"/> <input type="checkbox"/>	
	48 x 16 1/2 x 14 1/2"	WFDL48	<input type="checkbox"/>		<input type="checkbox"/> <input type="checkbox"/>	<input type="checkbox"/> <input type="checkbox"/>	
	54 x 16 1/2 x 14 1/2"	WFDL54	<input type="checkbox"/>		<input type="checkbox"/> <input type="checkbox"/>	<input type="checkbox"/> <input type="checkbox"/>	
	60 x 16 1/2 x 14 1/2"	WFDL60	<input type="checkbox"/>		<input type="checkbox"/> <input type="checkbox"/>	<input type="checkbox"/> <input type="checkbox"/>	
	72 x 16 1/2 x 14 1/2"	WFDL72	<input type="checkbox"/>		<input type="checkbox"/> <input type="checkbox"/>	<input type="checkbox"/> <input type="checkbox"/>	
			A	B	C	D	E

HOW TO ORDER

Indicate the following information on order form:

1. Quantity of each item.
2. Model number, including options. See "How to Build a Model Number."
3. Any special service required.

- Note:
- The indicates that a choice is required.
 - The absence of indicates that no choice is required.
 - Alpha-numeric characters in place of indicate that no other alternatives are available.

HOW TO BUILD A MODEL NUMBER

- A** Select basic model.
- B** Select trim color for painted surfaces.
- B** = Black
G = Gray
S = Sand
W = Warm Gray
L = Light Tone
- C** Select cabinet door fabric.
- Group A:
- FR701**
- 1511** = Blue Neutral
1506 = Green Neutral
1518 = Wedgewood
1510 = Silver Paper
1546 = Cherry Neutral
1515 = Quartz
1531 = Gray Mix

Eclipse

- 1197** = Meteor
1690 = Tourmaline
4604 = Chicory
4605 = Amber Grain
4593 = Serengeti
4594 = Cocoa Palm
1691 = Iron Ore

Carrara

- 9447** = Beeswax
9454 = Verdigris
9456 = Tinctoria
9455 = Green Earth
9448 = Teak Oil
9445 = Gesso
9444 = Casein

Galaxy

- 4526** = Desert Sand
4528 = ...

4544 = Blueberry

- 4542** = Sundew
4525 = Fog
4531 = Gobi
4541 = Wrought Iron

Group B:

Serendipity

- 9617** = Coincidence
9626 = Four Leaf Clover
9622 = Lady Luck
9619 = Guardian Angel
9620 = Lucky Duck
9618 = Fortuitous
9624 = Silver Spoon

D Select laminate surface.

- AA** = Cream
AB = Champagne
AC = Barcelona



Total Weight	Delivered Pricing	
	Unupholstered Price	Upholstered Price

72#	\$220	
81#	225	
88#	240	
99#	260	
106#	265	
115#	310	
156#	430	

73#		\$225
81#		230
89#		245
99#		265
107#		270
116#		315
157#		435

73#	230	
81#	240	
89#	290	
99#	300	
107#	315	
116#	330	
157#	450	

- AG** = Black
- AH** = Dark Gray
- AI** = Dawn Gray (Greige)
- AJ** = Fog
- AK** = Black Grandin
- AL** = Smoke Granite
- AM** = Sand Grandin
- AN** = Light Granite
- AO** = Tundra
- AP** = Earthen
- AQ** = Rose Grafix
- AS** = Sierra Grafix
- AT** = Beige Grafix
- AU** = Sand Stone
- AV** = Kentucky Walnut
- AW** = Tennessee Oak
- AX** = Light Oak
- AY** = Red Birch
- AZ** = Ash
- BA** = Philadelphia Cherry
- BB** = Pennsylvania Cherry

- BD** = Oak
- BE** = Maple
- BF** = Pearwood
- CA** = Pumice
- CB** = Rock Maple
- CC** = Medium Cherry
- CD** = Anigre
- ZZ** = COM

- ⓔ Select key option.
- KA** = Key alike
- KS** = Key standard

Note: Different lock options are available. Please call the Systems Department for details.

FINISH INFORMATION



Laminate Surface

See Keys for Progression swatch card.

Specifications and prices are subject to change without prior notice.

XXI Notes Components

Overhead Storage

MODEL	W x H x D	MODEL NUMBER	
		Overhead	Trim
 <p>Steel Shelf</p> <ul style="list-style-type: none"> • Enamel steel end panels and bottom shelf • Accepts shelf dividers • End bracket design prevents accidental dislodging of components • Shelf depth is 13 1/4" • Concealed vertical wire management • Secured to steel legs by concealed mounting brackets • Field installable to compatible WorkZone surfaces • For use with fixed height worksurfaces only • Meets all BIFMA standards: X5.6-1986, Section numbers 6 and 13 • 72" shelf consists of two 36" shelves supported by middle upright • Cannot be mounted on tables with casters 	30 x 16 1/2 x 13 1/4"	WSS30	<input type="checkbox"/>
	36 x 16 1/2 x 13 1/4"	WSS36	<input type="checkbox"/>
	42 x 16 1/2 x 13 1/4"	WSS42	<input type="checkbox"/>
	48 x 16 1/2 x 13 1/4"	WSS48	<input type="checkbox"/>
	54 x 16 1/2 x 13 1/4"	WSS54	<input type="checkbox"/>
	60 x 16 1/2 x 13 1/4"	WSS60	<input type="checkbox"/>
	72 x 16 1/2 x 13 1/4"	WSS72	<input type="checkbox"/>
 <p>Shelf Divider</p> <ul style="list-style-type: none"> • Steel shelf dividers with enamel finish • Fits shelves and cabinets on pages 34 and 36 	7 1/2" x 11 1/2"	NSD	<input type="checkbox"/>
		A	B

HOW TO ORDER

Indicate the following information on order form:

1. Quantity of each item.
2. Model number, including options. See "How to Build a Model Number."
3. Any special service required.

- Note:
- The indicates that a choice is required.
 - The absence of indicates that no choice is required.
 - Alpha-numeric characters in place of indicate that no other alternatives are available.

HOW TO BUILD A MODEL NUMBER

- A** Select basic model.
- B** Select trim color for painted surfaces.
 - B** = Black
 - G** = Gray
 - S** = Sand
 - W** = Warm Gray
 - L** = Light Tone

XXI Notes Components

Overhead Storage

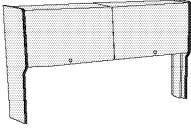
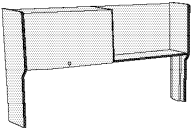
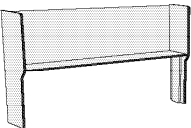
MODEL	MODEL NUMBER						
	Overhead	Door	Trim	Laminate	Upholstery	Key	
 <p>Overhead Cabinets and Shelves</p> <ul style="list-style-type: none"> • Solid core construction with plastic laminate • Enamel finish on metal parts • Cabinet doors have laminated or upholstered surface with flat vinyl T-edge only • Concealed vertical wire management • Secured to steel legs by concealed mounting brackets • Field installable to compatible XXI Notes worksurfaces • Key-different (standard) or key-alike (optional) to match other overheads and/or pedestals. (Specify which items need to be key-alike on order.) • For use with fixed height workstations only • Overhead allows for 18½" clearance above worksurface • Overall height is 34¼" • Cannot be mounted on tables with casters 	Laminated						
	30" single door	WOC30		<input type="checkbox"/>	<input type="checkbox"/>		<input type="checkbox"/>
	36" single door	WOC36		<input type="checkbox"/>	<input type="checkbox"/>		<input type="checkbox"/>
	42" single door	WOC42		<input type="checkbox"/>	<input type="checkbox"/>		<input type="checkbox"/>
	48" single door	WOC48		<input type="checkbox"/>	<input type="checkbox"/>		<input type="checkbox"/>
	Two 27" doors	WOC54		<input type="checkbox"/>	<input type="checkbox"/>		<input type="checkbox"/>
	Two 30" doors	WOC60		<input type="checkbox"/>	<input type="checkbox"/>		<input type="checkbox"/>
	Two 36" doors	WOC72		<input type="checkbox"/>	<input type="checkbox"/>		<input type="checkbox"/>
	Upholstered						
	30" single door	WOC30F		<input type="checkbox"/>	<input type="checkbox"/>	<input type="checkbox"/>	<input type="checkbox"/>
	36" single door	WOC36F		<input type="checkbox"/>	<input type="checkbox"/>	<input type="checkbox"/>	<input type="checkbox"/>
	42" single door	WOC42F		<input type="checkbox"/>	<input type="checkbox"/>	<input type="checkbox"/>	<input type="checkbox"/>
	48" single door	WOC48F		<input type="checkbox"/>	<input type="checkbox"/>	<input type="checkbox"/>	<input type="checkbox"/>
	Two 27" doors	WOC54F		<input type="checkbox"/>	<input type="checkbox"/>	<input type="checkbox"/>	<input type="checkbox"/>
Two 30" doors	WOC60F		<input type="checkbox"/>	<input type="checkbox"/>	<input type="checkbox"/>	<input type="checkbox"/>	
Two 36" doors	WOC72F		<input type="checkbox"/>	<input type="checkbox"/>	<input type="checkbox"/>	<input type="checkbox"/>	
 <p>Overhead with Door and Shelf Combo</p> <ul style="list-style-type: none"> • Solid core construction with plastic laminate • Enamel finish on metal parts • Cabinet doors have laminated or upholstered surface with flat vinyl T-edge only • Concealed vertical wire management • Secured to steel legs by concealed mounting brackets • Field installable to compatible XXI Notes worksurfaces • Key-different (standard) or key-alike (optional) to match other overheads and/or pedestals. (Specify which items need to be key-alike on order.) • For use with fixed height workstations only • Overhead allows for 18½" clearance above worksurface • Overall height is 34¼" • Cannot be mounted on tables with casters 	Laminated						
	30" shelf/30" door	WDS60	<input type="checkbox"/>	<input type="checkbox"/>	<input type="checkbox"/>		<input type="checkbox"/>
	36" shelf/36" door	WDS72	<input type="checkbox"/>	<input type="checkbox"/>	<input type="checkbox"/>		<input type="checkbox"/>
	Upholstered						
	30" shelf/30" door	DS60F	<input type="checkbox"/>	<input type="checkbox"/>	<input type="checkbox"/>	<input type="checkbox"/>	<input type="checkbox"/>
	36" shelf/36" door	DS72F	<input type="checkbox"/>	<input type="checkbox"/>	<input type="checkbox"/>	<input type="checkbox"/>	<input type="checkbox"/>
 <p>Open Shelf</p> <ul style="list-style-type: none"> • Solid core construction with plastic laminate • Flat vinyl T-edge only • Enamel finish on metal parts • Concealed vertical wire management • Secured to steel legs by concealed mounting brackets • Field installable to compatible XXI Notes worksurfaces • For use with fixed height workstations only • Overhead allows for 18½" clearance above worksurface • Overall height is 34¼" • Cannot be mounted on tables with casters 	30"	WOS30		<input type="checkbox"/>	<input type="checkbox"/>	<input type="checkbox"/>	
	36"	WOS36		<input type="checkbox"/>	<input type="checkbox"/>	<input type="checkbox"/>	
	42"	WOS42		<input type="checkbox"/>	<input type="checkbox"/>	<input type="checkbox"/>	
	48"	WOS48		<input type="checkbox"/>	<input type="checkbox"/>	<input type="checkbox"/>	
	54"	WOS54		<input type="checkbox"/>	<input type="checkbox"/>	<input type="checkbox"/>	
	60"	WOS60		<input type="checkbox"/>	<input type="checkbox"/>	<input type="checkbox"/>	
	72"	WOS72		<input type="checkbox"/>	<input type="checkbox"/>	<input type="checkbox"/>	

A **B** **C** **D** **E** **F**

HOW TO ORDER

Indicate the following information on order form:

1. Quantity of each item.
2. Model number, including options. See "How to Build a Model Number."
3. Any special service required.

- Note:
- The indicates that a choice is required.
 - The absence of indicates that no choice is required.
 - Alpha-numeric characters in place of indicate that no other alternatives are available.

HOW TO BUILD A MODEL NUMBER

- A** Select size of overhead. Length of overhead must be identical to length of worksurface.
- B** Select flipper door position.
L = Left
R = Right
- C** Select trim color for painted surfaces.
B = Black
G = Gray
S = Sand
W = Warm Gray
L = Light Tone
- D** Select laminate surface.
AA = Cream
AB = Champagne
AC = Barcelona
AF = Aruba Tan
AG = Black

- AH** = Dark Gray
AI = Dawn Gray (Greige)
AJ = Fog
AK = Black Grandin
AL = Smoke Granite
AM = Sand Grandin
AN = Light Granite
AO = Tundra
AP = Earthen
AQ = Rose Grafix
AS = Sierra Grafix
AT = Beige Grafix
AU = Sand Stone
AV = Kentucky Walnut
AW = Tennessee Oak
AX = Light Oak
AY = Red Birch
AZ = Ash
BA = Philadelphia Cherry
BB = Pennsylvania Cherry
BC = Mahogany

- BE** = Maple
BF = Pearwood
CA = Pumice
CB = Rock Maple
CC = Medium Cherry
CD = Anigre
ZZ = COM
- E** Select cabinet door fabric.
 Group A:
FR701
1511 = Blue Neutral
1506 = Green Neutral
1518 = Wedgewood
1510 = Silver Paper
1546 = Cherry Neutral
1515 = Quartz
1531 = Gray Mix
- Eclipse**
1107 = Mahogany



Total Weight	Delivered Pricing	
	Unupholstered Price	Upholstered Price

70#	\$180	
75#	185	
76#	190	
90#	200	
100#	205	
115#	260	
125#	285	

70#		\$180
75#		185
76#		190
90#		200
100#		205
115#		260
125#		285

92#	245	
100#	255	

92#		245
100#		255

49#	125	
52#	130	
54#	135	
58#	140	
62#	150	
65#	155	
71#	160	

- 1690** = Tourmaline
- 4604** = Chicory
- 4605** = Amber Grain
- 4593** = Serengeti
- 4594** = Cocoa Palm
- 1691** = Iron Ore

Carrara

- 9447** = Beeswax
- 9454** = Verdigris
- 9456** = Tincoria
- 9455** = Green Earth
- 9448** = Teak Oil
- 9445** = Gesso
- 9444** = Casein

Galaxy

- 4526** = Desert Sand
- 4538** = Bermuda
- 4544** = Blueberry

- 4525** = Fog
- 4531** = Gobi
- 4541** = Wrought Iron

Group B:

Serendipity

- 9617** = Coincidence
- 9626** = Four Leaf Clover
- 9622** = Lady Luck
- 9619** = Guardian Angel
- 9620** = Lucky Duck
- 9618** = Fortuitous
- 9624** = Silver Spoon

- F** Select key option.
- KA** = Key alike
- KS** = Key standard

FINISH INFORMATION

Laminate Surface

See Keys for Progression swatch card.

Specifications and prices are subject to change without prior notice.

XXI Notes Components

Privacy Screens

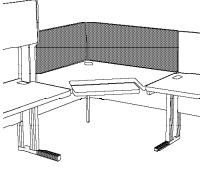
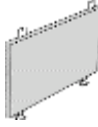
MODEL	FEATURES	W x H	MODEL NUMBER		
			Privacy Screen	Trim	Upholstery
 <p>Privacy Screen</p> <ul style="list-style-type: none"> • 1" thick screen upholstered with tackable fabric • Painted steel mounting brackets • Screens available for all worksurfaces and transitional surfaces • Field installable • Provides seated privacy • WZP60 has two 30" privacy screens with connector • WZP72 has two 36" privacy screens with connector • Corner (square and rectangular) screens come as a set with splice plate • Available with manual height adjustable surfaces • Provides 3/4" space between screen and worksurface for cables 	Basic workstations	24x19"	WZP24	<input type="checkbox"/>	<input type="checkbox"/> <input type="checkbox"/> <input type="checkbox"/> <input type="checkbox"/>
		30x19"	WZP30	<input type="checkbox"/>	<input type="checkbox"/> <input type="checkbox"/> <input type="checkbox"/> <input type="checkbox"/>
		36x19"	WZP36	<input type="checkbox"/>	<input type="checkbox"/> <input type="checkbox"/> <input type="checkbox"/> <input type="checkbox"/>
		42x19"	WZP42	<input type="checkbox"/>	<input type="checkbox"/> <input type="checkbox"/> <input type="checkbox"/> <input type="checkbox"/>
		48x19"	WZP48	<input type="checkbox"/>	<input type="checkbox"/> <input type="checkbox"/> <input type="checkbox"/> <input type="checkbox"/>
		54x19"	WZP54	<input type="checkbox"/>	<input type="checkbox"/> <input type="checkbox"/> <input type="checkbox"/> <input type="checkbox"/>
		60x19"	WZP60	<input type="checkbox"/>	<input type="checkbox"/> <input type="checkbox"/> <input type="checkbox"/> <input type="checkbox"/>
		72x19"	WZP72	<input type="checkbox"/>	<input type="checkbox"/> <input type="checkbox"/> <input type="checkbox"/> <input type="checkbox"/>
		Stand alone corner worksurfaces			
		42x19"	WZP2442	<input type="checkbox"/>	<input type="checkbox"/> <input type="checkbox"/> <input type="checkbox"/> <input type="checkbox"/>
		48x19"	WZP3048	<input type="checkbox"/>	<input type="checkbox"/> <input type="checkbox"/> <input type="checkbox"/> <input type="checkbox"/>
		Transitional surfaces			
		corner	36x19"	WZPC2436	<input type="checkbox"/>
	corner	42x19"	WZPC2442	<input type="checkbox"/>	<input type="checkbox"/> <input type="checkbox"/> <input type="checkbox"/> <input type="checkbox"/>
	corner	48x19"	WZPC3048	<input type="checkbox"/>	<input type="checkbox"/> <input type="checkbox"/> <input type="checkbox"/> <input type="checkbox"/>
	square (2 screens)	24x19"	WZPS2424	<input type="checkbox"/>	<input type="checkbox"/> <input type="checkbox"/> <input type="checkbox"/> <input type="checkbox"/>
	square (2 screens)	30x19"	WZPS3030	<input type="checkbox"/>	<input type="checkbox"/> <input type="checkbox"/> <input type="checkbox"/> <input type="checkbox"/>
	triangle (1 screen)	30x19"	WZPT3030	<input type="checkbox"/>	<input type="checkbox"/> <input type="checkbox"/> <input type="checkbox"/> <input type="checkbox"/>
	rectangle (2 screens)	30x24x19"	WZPR3024	<input type="checkbox"/>	<input type="checkbox"/> <input type="checkbox"/> <input type="checkbox"/> <input type="checkbox"/>
 <p>Overhead Privacy Screen</p> <ul style="list-style-type: none"> • For use on WFDS, WFDL and WFDF overheads and WSS shelves only • 1" thick screen upholstered with tackable fabric • Painted steel mounting brackets • Available on rectangular worksurfaces only • 60" screen consists of two 30" screens with middle support and 72" screen consists of two 36" screens with middle support • Overhead privacy screen attaches to worksurface and overhead and mounts flush with overhead • Overhead privacy screen available only on fixed height units 	Overhead cabinets	24x19"	WZOP24	<input type="checkbox"/>	<input type="checkbox"/> <input type="checkbox"/> <input type="checkbox"/> <input type="checkbox"/>
		30x19"	WZOP30	<input type="checkbox"/>	<input type="checkbox"/> <input type="checkbox"/> <input type="checkbox"/> <input type="checkbox"/>
		36x19"	WZOP36	<input type="checkbox"/>	<input type="checkbox"/> <input type="checkbox"/> <input type="checkbox"/> <input type="checkbox"/>
		42x19"	WZOP42	<input type="checkbox"/>	<input type="checkbox"/> <input type="checkbox"/> <input type="checkbox"/> <input type="checkbox"/>
		48x19"	WZOP48	<input type="checkbox"/>	<input type="checkbox"/> <input type="checkbox"/> <input type="checkbox"/> <input type="checkbox"/>
		54x19"	WZOP54	<input type="checkbox"/>	<input type="checkbox"/> <input type="checkbox"/> <input type="checkbox"/> <input type="checkbox"/>
		60x19"	WZOP60	<input type="checkbox"/>	<input type="checkbox"/> <input type="checkbox"/> <input type="checkbox"/> <input type="checkbox"/>
		72x19"	WZOP72	<input type="checkbox"/>	<input type="checkbox"/> <input type="checkbox"/> <input type="checkbox"/> <input type="checkbox"/>

A B C

HOW TO ORDER

Indicate the following information on order form:

1. Quantity of each item.
2. Model number, including options. See "How to Build a Model Number."
3. Any special service required.

- Note:
- The indicates that a choice is required.
 - The absence of indicates that no choice is required.
 - Alpha-numeric characters in place of indicate that no other alternatives are available.

HOW TO BUILD A MODEL NUMBER

- A** Select privacy screen size.
- B** Select trim color for painted surfaces.
- B** = Black
- G** = Gray
- S** = Sand
- W** = Warm Gray
- L** = Light Tone
- C** Select cabinet door fabric.
- Group A:
- FR701**
- 1511** = Blue Neutral
- 1506** = Green Neutral
- 1518** = Wedgewood
- 1510** = Silver Paper
- 1546** = Cherry Neutral
- 1515** = Quartz
- 1531** = Gray Mix

Eclipse

- 1197** = Meteor
- 1690** = Tourmaline
- 4604** = Chicory
- 4605** = Amber Grain
- 4593** = Serengeti
- 4594** = Cocoa Palm
- 1691** = Iron Ore

Carrara

- 9447** = Beeswax
- 9454** = Verdigris
- 9456** = Tincoria
- 9455** = Green Earth
- 9448** = Teak Oil
- 9445** = Gesso
- 9444** = Casein

Galaxy

- 4526** = Desert Sand
- 4538** = Bermuda
- 4544** = Blueberry
- 4542** = Sundew
- 4525** = Fog
- 4531** = Gobi
- 4541** = Wrought Iron

Group B:

Serendipity

- 9617** = Coincidence
- 9626** = Four Leaf Clover
- 9622** = Lady Luck
- 9619** = Guardian Angel
- 9620** = Lucky Duck
- 9618** = Fortuitous
- 9624** = Silver Spoon



Total Weight	Delivered Pricing	
	Group A Price	Group B Price
13#	\$68	\$70
15#	70	72
17#	73	75
19#	76	78
21#	81	83
24#	85	87
30#	89	91
34#	94	96
34#	89	91
40#	94	96
45#	84	86
34#	89	91
40#	94	96
20#	68	70
29#	75	77
19#	74	76
26#	75	77
13#	68	70
15#	70	72
17#	73	75
19#	76	78
21#	78	80
24#	81	83
30#	89	91
34#	94	96

Specifications and prices are subject to change without prior notice.

XXI Notes Accessories (Contemporary)

General Information

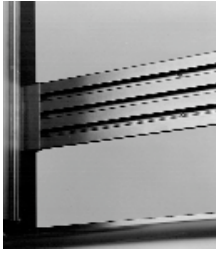

Tool Rail

PMTR

p. 44

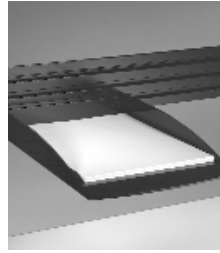

Paper Tray

PLL

p. 44

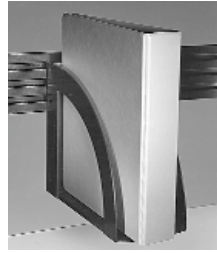

Vertical Storage

PVS

p. 44

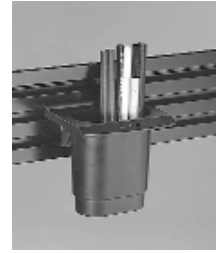

Pencil Cup

PPC

p. 46

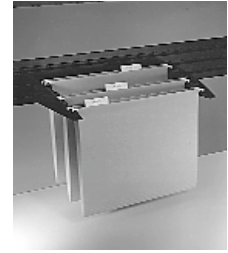

Hanging Folder Holder

PFH

p. 44

Features

Painted aluminum	•					
Plastic construction		•	•	•	•	•
Suspends from tool rail		•	•	•	•	•
Field installable	•	•	•	•	•	•

SPECIFICATIONS

Tool Rail

Aluminum extrusion tool rail, powder-coated finish. Attaches between overhead uprights. Consists of four slots to accept paper management components. To be used on WFDS, WFDF, WFDL, and WSS models only.

Paper Tray

Constructed of injection molded plastic. Tray measures 9½" wide by 2" high by 14" deep and accommodates both letter and legal size documents. Includes three hooks to mount on tool rail.

Vertical Storage

Constructed of injection molded plastic. Holder measures 5" wide by 9" high and 10½" deep. Includes two hooks to mount on tool rail.

Pencil Cup

Constructed of injection molded plastic. Cup measures 4" wide by 3" high by 3½" deep for storage of pens, pencils, and highlighters. Includes one hook to mount on tool rail.

Hanging Folder Holder

Constructed of injection molded plastic. Holder consists of a pair of stepped brackets providing orderly file access above the desk. Each bracket is 1" wide by 2" high by 8½" deep and includes two hooks to mount on tool rail.

Diagonal Storage

Constructed of injection molded plastic. Storage tray consists of three diagonal slats with black dividers to sort files or papers. Tray measures 7" wide by 2½" high by 12½" deep and includes three hooks to mount on tool rail.

Telephone Caddy

Constructed of injection molded plastic. Caddy measures 8½" wide by 2" high by 9½" deep. Includes adjustable rail to accommodate a phone up to 10¾" deep. Includes three hooks to mount on tool rail.

CD Holder

Constructed of injection molded plastic. Holder measures 5½" wide by 2" high by 7" deep and includes two hooks to mount to tool rail. Holder accommodates up to 10 CDs.

Accessory Tray

Constructed of injection molded plastic. Holder measures 9½" wide by 2" high by 10" deep and includes three hooks to mount to tool rail. Tray includes six compartments for storage of supplies.

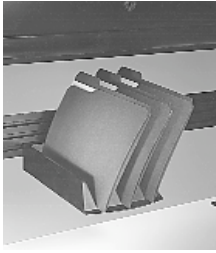

Diagonal Storage

PDS p. 44

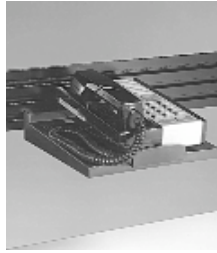

Telephone Caddy

PTC p. 46

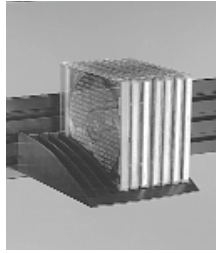

CD Holder

PDH p. 46

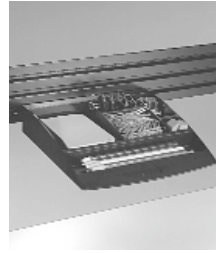

Accessory Tray

PAT p. 46





- | | | | |
|---|---|---|---|
| • | • | • | • |
| • | • | • | • |
| • | • | • | • |

INFORMATION

Warranty
 See "Terms" for general information.

XXI Notes Accessories

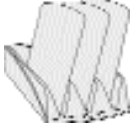
Contemporary

MODEL	H x W x D	MODEL NUMBER	
		Basic Model	Trim
 <p>Tool Rail</p> <ul style="list-style-type: none"> Accommodates paper management components Attaches between overhead uprights Field installable Painted aluminum construction 72" rail consists of two 36" rails with middle support Consists of four slots to accept components 	4½" 30"	PMTR30	<input type="checkbox"/>
	4½" 36"	PMTR36	<input type="checkbox"/>
	4½" 42"	PMTR42	<input type="checkbox"/>
	4½" 48"	PMTR48	<input type="checkbox"/>
	4½" 54"	PMTR54	<input type="checkbox"/>
	4½" 60"	PMTR60	<input type="checkbox"/>
	4½" 72"	PMTR72	<input type="checkbox"/>
 <p>Hanging Folder Holder</p> <ul style="list-style-type: none"> Plastic construction One pair in each set Allows letter and legal hanging file folders to be suspended from tool rail Folders cascade down 	2" 1" 8½"	PFH	<input type="checkbox"/>
 <p>Paper Tray</p> <ul style="list-style-type: none"> Plastic construction Stores letter or legal size documents Suspends from tool rail Suitable for free-standing worksurface or overhead location 	2" 9½" 14"	PLL	<input type="checkbox"/>
 <p>Diagonal Storage</p> <ul style="list-style-type: none"> Plastic construction Suspends only from tool rail Suitable for free-standing worksurface or overhead location Three slanted partitions per unit Dividers in black only 	2½" 7" 12½"	PDS	<input type="checkbox"/>
 <p>Vertical Storage</p> <ul style="list-style-type: none"> Injection molded plastic construction Suspends only from tool rail Suitable for free-standing worksurface or overhead location Stores binders, phone books or periodicals 	9" 5" 10½"	PVS	<input type="checkbox"/>
		A	B

HOW TO ORDER

Indicate the following information on order form:

- Quantity of each item.
- Model number, including options. See "How to Build a Model Number."
- Any special service required.

- Note:
- The indicates that a choice is required.
 - The absence of indicates that no choice is required.
 - Alpha-numeric characters in place of indicate that no other alternatives are available.

HOW TO BUILD A MODEL NUMBER

- A** Select basic model.
- B** Select trim color for painted surfaces.
- B** = Black
- G** = Gray
- S** = Sand
- W** = Warm Gray
- L** = Light Tone



Total Weight	Price
4#	\$ 33
5#	34
6#	36
6#	38
7#	43
7#	48
8#	53
.2#	10



1#	16
----	----

4#	30
----	----





1#	20
----	----



Specifications and prices are subject to change without prior notice.

XXI Notes Accessories

Contemporary

MODEL	H x W x D	MODEL NUMBER	
		Basic Model	Trim
 <p>Telephone Caddy</p> <ul style="list-style-type: none"> • Plastic construction • Holds telephone up to 8½" wide and 9½" deep • Suspends from tool rail 	2" 8½" 9½"	PTC	<input type="checkbox"/>
 <p>CD Holder</p> <ul style="list-style-type: none"> • Plastic construction • Stores up to 10 CDs • Suspends from tool rail 	2" 5½" 7"	PDH	<input type="checkbox"/>
 <p>Accessory Tray</p> <ul style="list-style-type: none"> • Injection molded plastic • Stores stamps, tape dispenser, post-it pads and paper clips • Suspends from tool rail 	2" 9½" 10"	PAT	<input type="checkbox"/>
 <p>Pencil Cup</p> <ul style="list-style-type: none"> • Injection molded plastic • Suspends from tool rail 	4" 4" 3½"	PPC	<input type="checkbox"/>

A

B

HOW TO ORDER

Indicate the following information on order form:

1. Quantity of each item.
2. Model number, including options. See "How to Build a Model Number."
3. Any special service required.

- Note:
- The indicates that a choice is required.
 - The absence of indicates that no choice is required.
 - Alpha-numeric characters in place of indicate that no other alternatives are available.

HOW TO BUILD A MODEL NUMBER

- A** Select basic model.
- B** Select trim color for painted surfaces.
 - B** = Black
 - G** = Gray
 - S** = Sand
 - W** = Warm Gray
 - L** = Light Tone



Total Weight

Price

.75#

\$11



.25#

8



6#

8



.25#

8



Specifications and prices are subject to change without prior notice.

XXI Notes Accessories (Traditional)

General Information



Work Bar

WWB

p. 50

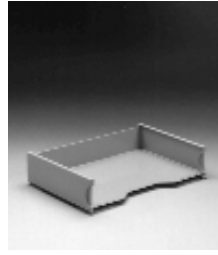

Paper Tray

PMHLT

p. 50

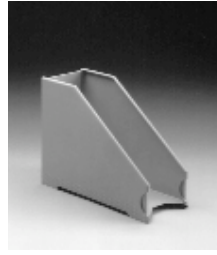

Binder Bin

PMV

p. 50



Task Light

TLN

p. 54



Hanging Rails

WHR

p. 50

Features

Painted aluminum	•					
Enamel finish					•	•
Laminate finish						
Plastic/metal construction		•	•			
Steel construction					•	
Suspends from work bar		•	•			
Field installable	•	•	•		•	•
Adjustable height						
UL listed					•	
Suspends from overhead					•	

SPECIFICATIONS

Work Bar

Aluminum extrusion load bar, epoxy powder coated. To be used on WOC, WDS, DS, and WOS models only.

Letter Tray

20-ga. epoxy powder coated steel, and plastic molded in color, then painted to assure color match. Steel and plastic joined permanently by sonic welding. Roll formed steel clip for component attachment to work bar. ID clips included with tray.

Binder Bin

20-ga. epoxy powder coated steel, and plastic molded in color, then painted to assure color match. Steel and plastic joined permanently by sonic welding. Roll formed steel clip for component attachment to work bar. ID clips included with tray.

Slanted Storage

24-ga. epoxy powder coated steel, and plastic molded in color, then painted to assure color match. Steel and plastic joined permanently by sonic welding. Roll formed steel clip for component attachment to work bar.

Task Lights

Task lights are available in three levels of efficiency and cost. The standard light has a magnetic high-power factor ballast with rapid start, cool-white T-8 fluorescent lamp. The energy efficient model has an electrical ballast with rapid start and cool-white T-8 fluorescent lamp. The third model has a 2-step (hi/low) high-power factor ballast with rapid start and cool-white T-8 fluorescent lamp which helps reduce glare on computer screens and helps reduce eye strain.

Task Lights attach to the underside of the shelf on overhead cabinets. Lights are UL listed and available in the four trim colors. They are available 20" wide for use with 30" and 36" wide overhead cabinets, 32" wide for 42" and

48" wide units, and 44" wide for 60" and 72" wide units.

CPU Sling

The CPU Sling straps have positive locking strap clamps that keep the CPU firmly in place. The CPU Sling is mounted below the worksurface and provides 5 1/2" of travel and 359° swivel for ease of accessibility. Front and rear bumpers prevent over travel. The mounting bracket is 18" deep by 5 3/8" wide. The CPU Sling is available in black finish only. The maximum weight capacity is 75 pounds and accommodates CPUs with maximum circumference of 65". The mounting bracket serves as a template showing hole locations. Assembly instructions are included with each unit. Sling is available on 30" deep worksurfaces only.

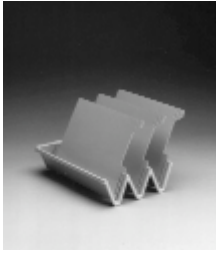

Slanted Storage

Center Drawer

PMD

p. 48

3CD

p. 58



INFORMATION

Warranty

See "Terms" for general information.

XXI Notes Accessories

Traditional

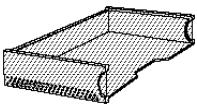
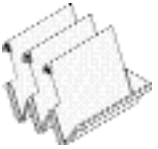
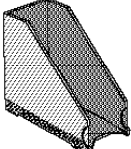
MODEL	H x W x D	MODEL NUMBER	
		Basic Model	Trim
 <p>Work Bar</p> <ul style="list-style-type: none"> Accommodates paper management components Attaches between overhead uprights Field installable Painted aluminum construction 	30"	WWB30	<input type="checkbox"/>
	36"	WWB36	<input type="checkbox"/>
	42"	WWB42	<input type="checkbox"/>
	48"	WWB48	<input type="checkbox"/>
	54"	WWB54	<input type="checkbox"/>
	60"	WWB60	<input type="checkbox"/>
	72"	WWB72	<input type="checkbox"/>
 <p>Hanging Rails</p> <ul style="list-style-type: none"> One pair in each set Allows letter or legal tray to be suspended from underside of overhead shelf on WOC and WDS overheads Cannot be used with task light on overhead unit 		WHR	<input type="checkbox"/>
 <p>Paper Tray</p> <ul style="list-style-type: none"> Plastic and metal construction Letter or legal size Stackable Suspends from work bar or hanging rails Suitable for free-standing worksurface or overhead location 	3" 13 1/4" 9" Letter	PMHLT	<input type="checkbox"/>
	3" 16 1/4" 9" Legal	PMHLG	<input type="checkbox"/>
 <p>Slanted Storage</p> <ul style="list-style-type: none"> Plastic and metal construction Suspends only from work bar Suitable for free-standing worksurface or overhead location Three slanted partitions per unit, with ID clips 	7" 10 1/2" 12 1/2"	PMD	<input type="checkbox"/>
 <p>Binder Bin</p> <ul style="list-style-type: none"> Plastic and metal construction Includes identification clip Suspends only from work bar Suitable for free-standing worksurface or overhead location 	9 1/2" 5" 12 1/2"	PMV	<input type="checkbox"/>

A

B

HOW TO ORDER

Indicate the following information on order form:

- Quantity of each item.
- Model number, including options. See "How to Build a Model Number."
- Any special service required.

- Note:
- The indicates that a choice is required.
 - The absence of indicates that no choice is required.
 - Alpha-numeric characters in place of indicate that no other alternatives are available.

HOW TO BUILD A MODEL NUMBER

- A** Select basic model.
- B** Select trim color for painted surfaces.
- B** = Black
- G** = Gray
- S** = Sand
- W** = Warm Gray
- L** = Light Tone



Total Weight	Price
4#	\$22
5#	23
6#	26
6#	27
7#	30
7#	31
8#	32
6#	32
2#	14
3#	19
4#	32
3#	20

Specifications and prices are subject to change without prior notice.

XXI Notes Accessories

Lighting

MODEL	Actual Light Width	Cabinet Width	MODEL NUMBER	
			Basic Model	Trim
 <p>Magnetic Ballast, Normal Power Factor Task Light</p> <ul style="list-style-type: none"> • For use with WFDS, WFDL, WFDF, AWFDS, AWFDL and AWFDF cabinets and WSS shelves • Task light mounts flush with shelves and overhead cabinets • Magnetic high-power factor ballast with rapid start cool white lamp • UL listed • Includes 9' cord • Cords can be routed down overhead uprights 	30"	30"	CINTLN30	<input type="checkbox"/>
	36"	36"	CINTLN36	<input type="checkbox"/>
	42"	42"	CINTLN42	<input type="checkbox"/>
	48"	48"	CINTLN48	<input type="checkbox"/>
	54"	54"	CINTLN54	<input type="checkbox"/>
	60"	60"	CINTLN60	<input type="checkbox"/>
<p>Normal Power Factor/2-Step Dimming Task Light</p> <ul style="list-style-type: none"> • For use with WFDS, WFDL, WFDF, AWFDS, AWFDL and AWFDF cabinets and WSS shelves • Task light mounts flush with shelves and overhead cabinets • Magnetic high-power factor/2-step dimming (Hi/Low) with rapid start cool white lamp • UL listed • Includes 9' cord • Cords can be routed down overhead uprights 	30"	30"	CINTLV30	<input type="checkbox"/>
	36"	36"	CINTLV36	<input type="checkbox"/>
	42"	42"	CINTLV42	<input type="checkbox"/>
	48"	48"	CINTLV48	<input type="checkbox"/>
	54"	54"	CINTLV54	<input type="checkbox"/>
	60"	60"	CINTLV60	<input type="checkbox"/>
<p>Electronic Ballast, Normal Power Factor Task Light</p> <ul style="list-style-type: none"> • For use with WFDS, WFDL, WFDF, AWFDS, AWFDL and AWFDF cabinets and WSS shelves • Task light mounts flush with shelves and overhead cabinets • Electronic ballast with rapid start cool white lamp • UL listed • Includes 9' cord • Cords can be routed down overhead uprights 	30"	30"	CINTLE30	<input type="checkbox"/>
	36"	36"	CINTLE36	<input type="checkbox"/>
	42"	42"	CINTLE42	<input type="checkbox"/>
	48"	48"	CINTLE48	<input type="checkbox"/>
	54"	54"	CINTLE54	<input type="checkbox"/>
	60"	60"	CINTLE60	<input type="checkbox"/>

A

B

HOW TO ORDER

Indicate the following information on order form:

1. Quantity of each item.
2. Model number, including options. See "How to Build a Model Number."
3. Any special service required.

- Note:
- The indicates that a choice is required.
 - The absence of indicates that no choice is required.
 - Alpha-numeric characters in place of indicate that no other alternatives are available.

HOW TO BUILD A MODEL NUMBER

- A** Select basic model.
- B** Select trim color for painted surfaces.
 - B** = Black
 - G** = Gray
 - S** = Sand
 - W** = Warm Gray
 - L** = Light Tone

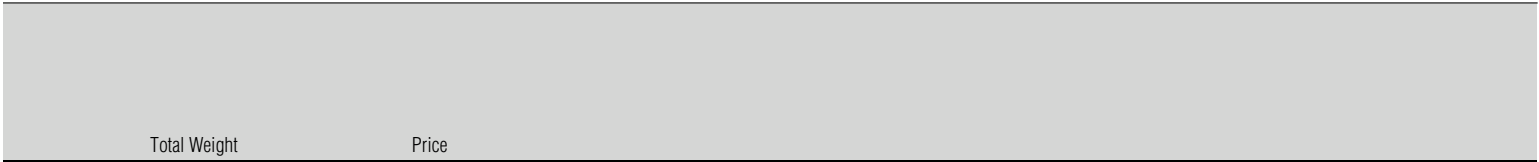

Total Weight Price

10#	\$35
12#	35
13#	37
14#	38
15#	40
16#	41

10#	40
12#	41
13#	42
14#	43
15#	44
16#	45

10#	59
12#	60
13#	61
14#	63
15#	64
16#	65

INFORMATION

For additional lighting, see Compliments.

Specifications and prices are subject to change without prior notice.

XXI Notes Accessories

Lighting

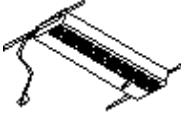
MODEL	Actual Light Width	Fits Overhead Width	MODEL NUMBER	
			Basic Model	Trim
 <p>Magnetic Ballast Task Light</p> <ul style="list-style-type: none"> • For use with WOC overheads, WDS door and shelf combo, and WOS open shelf units • Task light attaches to the underside of overhead shelf • Magnetic high-power factor ballast with rapid start cool white lamp • UL listed 	20"	30" & 36"	TLN24	<input type="checkbox"/>
	32"	42" & 48"	TLN36	<input type="checkbox"/>
	44"	60" & 72"	TLN48	<input type="checkbox"/>
<p>Electronic Ballast Task Light</p> <ul style="list-style-type: none"> • For use with WOC overheads, WDS door and shelf combo, and WOS open shelf units • Task light attaches to the underside of overhead shelf • Electronic ballast with rapid start cool white lamp • UL listed 	20"	30" & 36"	TLE24	<input type="checkbox"/>
	32"	42" & 48"	TLE36	<input type="checkbox"/>
	44"	60" & 72"	TLE48	<input type="checkbox"/>
<p>2-Step Dimming Task Light</p> <ul style="list-style-type: none"> • For use with WOC overheads, WDS door and shelf combo, and WOS open shelf units • Task light attaches to the underside of overhead shelf • Magnetic high-power factor/2-step dimming (Hi/Low) with rapid start cool white lamp • UL listed 	20"	30" & 36"	TLV24	<input type="checkbox"/>
	32"	42" & 48"	TLV36	<input type="checkbox"/>
	44"	60" & 72"	TLV48	<input type="checkbox"/>
			A	B

HOW TO ORDER

Indicate the following information on order form:

1. Quantity of each item.
2. Model number, including options. See "How to Build a Model Number."
3. Any special service required.

- Note:
- The indicates that a choice is required.
 - The absence of indicates that no choice is required.
 - Alpha-numeric characters in place of indicate that no other alternatives are available.

HOW TO BUILD A MODEL NUMBER

- A** Select basic model.
- B** Select trim color for painted surfaces.
 - B** = Black
 - G** = Gray
 - S** = Sand
 - W** = Warm Gray
 - L** = Light Tone

XXI Notes Accessories

Adjustable/Securable CPU Holder

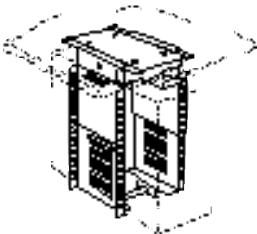
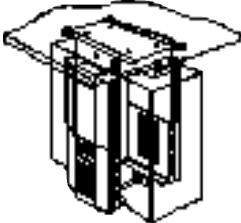
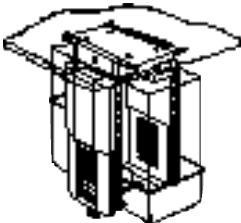
MODEL	MODEL NUMBER			Weight	Price
	Basic Model	Covers	Lock		
 <p>Basic</p> <ul style="list-style-type: none"> Slide mechanism of 14 ga. steel with 5" forward slide Adjustable side panels of 16 ga. steel to accommodate CPU's with the following dimensions: <ul style="list-style-type: none"> Vertical 11" to 21" Horizontal (side-to-side) 2" to 10 1/2" Three lengths of 1/4"-20 clamping bolts (4", 7" and 10") Torx head mounting screws (to aid in tamper resistance) (includes torx drivers) Black Only 	ACPU	NC	NO LOCK	6#	\$ 63
 <p>Basic with Covers</p> <ul style="list-style-type: none"> Slide mechanism of 14 ga. steel with 5" forward slide Adjustable side panels of 16 ga. steel to accommodate CPU's with the following dimensions: <ul style="list-style-type: none"> Vertical 11" to 21" Horizontal (side-to-side) 2" to 10 1/2" Three lengths of 1/4"-20 clamping bolts (4", 7" and 10") Torx head mounting screws (to aid in tamper resistance) (includes torx drivers) Adjustable covers of 16 ga. steel (to enhance aesthetics) Black Only 	ACPU	WC	NO LOCK	9#	92
 <p>Basic with Covers and Security Kit</p> <ul style="list-style-type: none"> Slide mechanism of 14 ga. steel with 5" forward slide Adjustable side panels of 16 ga. steel to accommodate CPU's with the following dimensions: <ul style="list-style-type: none"> Vertical 11" to 21" Horizontal (side-to-side) 2" to 10 1/2" Depth (front-to-back) 16" maximum Three lengths of 1/4"-20 clamping bolts (4", 7" and 10") Torx head mounting screws (to aid in tamper resistance) (includes torx drivers) Adjustable covers of 16 ga. steel Three lengths of 1/16" dia. bolts with holes for padlock 4", 7" and 10" Two each 1/4" dia. plastic coated steel aircraft cables with lock collars 3/32" allen wrench (for lock collars) Black Only 	ACPU	WC	LOCK	11#	137

A
B
C

HOW TO ORDER

Indicate the following information on order form:

- Quantity of each item.
- Model number, including options. See "How to Build a Model Number."
- Any special service required.

- Note:
- The indicates that a choice is required.
 - The absence of indicates that no choice is required.
 - Alpha-numeric characters in place of indicate that no other alternatives are available.

HOW TO BUILD A MODEL NUMBER

- A** Select basic model.
- B** Select covers.
NC = No Covers
WC = With Covers
- C** Select lock.
NO LOCK
LOCK



INFORMATION

Adjustable/Securable CPU Holder is available on 24" and 30" deep worksurfaces for the following products:
 Basic XXI Notes
 Classic XXI
 Crescendo

Security Kit Keyed Alike Option

To specify keyed alike option, add /KA to end of model number. No additional charge.

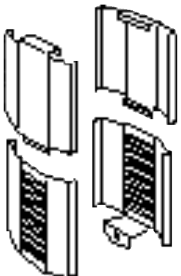

MODEL	MODEL NUMBER		
	Basic Model	Weight	Price
 <p>Covers</p> <ul style="list-style-type: none"> • Can be retrofitted in field to Basic Adjustable (to enhance aesthetics) • Adjustable covers of 16 ga. steel • Black Only 	ACPUC	3#	\$29
 <p>Security Kit</p> <ul style="list-style-type: none"> • Accommodates CPU 16" max. depth (at 10 1/2" wide) • Security device requires 16 ga. steel covers to also be installed • Three lengths of 7/16" dia. bolts with holes for padlock (4", 7" and 10") • Two each 1/4" dia. plastic coated steel aircraft cables with lock collars • 3/32" allen wrench (for lock collars) • Rear access guard with tamper resistant screws • Black Only 	ACPUSK	2#	44
 <p>Extra Cable</p> <ul style="list-style-type: none"> • 1/4" dia. plastic coated steel aircraft cable with lock collar • 3/32" allen wrench (for lock collar) • Black Only 	ACPUCABLE	.5#	5



HOW TO ORDER

Indicate the following information on order form:

1. Quantity of each item.
2. Model number, including options. See "How to Build a Model Number."
3. Any special service required.

Note:

- The indicates that a choice is required.
- The absence of indicates that no choice is required.
- Alpha-numeric characters in place of indicate that no other alternatives are available.

HOW TO BUILD A MODEL NUMBER

- A** Select basic model.

Specifications and prices are subject to change without prior notice.

XXI Notes Accessories

Computer

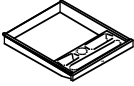
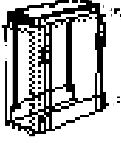
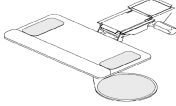
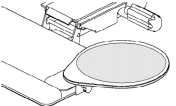
MODEL	W x D	MODEL NUMBER		
		Basic Model	Trim	Laminate
 <p>Center Drawer • Molded plastic compartment tray</p>	18" x 18" x 2 3/4"H	3CD	<input type="checkbox"/>	
 <p>CPU-Sling • Vertically supports and stores CPU below the worksurface • Straps have positive locking clamps • Provides 5 1/2" of travel and 359° swivel • Maximum weight capacity is 75 lbs. • Available in black only • Accommodates CPU with maximum circumference of 65" • Cannot be used on adjustable worksurfaces</p>	5 1/2" x 18"	CPUSLING	BL	
 <p>Composer Articulating Keyboard • Full articulation • Adjustable wristrest • Mouse arm • ADA height</p>		HWS3305		
 <p>Optional Tilting Mousepad with Bracket Assembly • Converts stationary mousepad to tilting • Independent movement</p>		KIT5772		

A
B
C

HOW TO ORDER

Indicate the following information on order form:

- Quantity of each item.
- Model number, including options. See "How to Build a Model Number."
- Any special service required.

- Note:
- The indicates that a choice is required.
 - The absence of indicates that no choice is required.
 - Alpha-numeric characters in place of indicate that no other alternatives are available.

HOW TO BUILD A MODEL NUMBER

- A** Select basic model.

- B** Select trim color for painted surfaces.
B = Black _____
G = Gray _____
S = Sand _____
W = Warm Gray _____
L = Light Tone _____
- C** Select laminate surface.
AA = Cream _____
AB = Champagne _____
AE = Porcelain _____
AF = Aruba Tan _____
AG = Black _____
AH = Dark Gray _____
AI = Dawn Gray (Greige) _____
AJ = Fog _____
AK = Black Grandin _____
AL = Smoke Granite _____

- AM** = Sand Grandin _____
AN = Light Granite _____
AO = Tundra _____
AP = Earthen _____
AQ = Rose Grafix _____
AS = Sierra Grafix _____
AT = Beige Grafix _____
AU = Sand Stone _____
AV = Kentucky Walnut _____
AW = Tennessee Oak _____
AX = Light Oak _____
AY = Red Birch _____
AZ = Ash _____
BA = Philadelphia Cherry _____
BB = Pennsylvania Cherry _____
BC = Mahogany _____
BD = Oak _____
BE = Maple _____
BF = Pearwood _____
CA = Pumice _____
CB = Rock Maple _____

- CC** = Medium Cherry _____
CD = Anigre _____
ZZ = COM _____



Total Weight	Price
10#	\$ 40
11#	46
12#	135
2#	15

FINISH INFORMATION

Laminate Surface

See Keys for Progression swatch card.

Specifications and prices are subject to change without prior notice.

Adjustable XXI Notes

Worksurfaces



Adjustable XXI Notes Single Surface

AWS

p. 62



Adjustable XXI Notes Dual Surface

AWD

p. 62



Adjustable XXI Notes Corner Dual Surface

AWDC

p. 64

Features

Solid core top	•	•	•
Plastic laminate surface	•	•	•
Flat vinyl T-edge	•	•	•
3mm PVC edge	•	•	•
Seam-welded tubular steel frame	•	•	•
Chrome plated adjustable glides	•	•	•
Enamel legs	•	•	•
Height adjustable from either side	•	•	•
Wire management	•	•	•
Laminate finish	•	•	•

NOTE:

When specifying storage and accessories for manual adjustable workstations, only products within the Manual Adjustable section may be integrated.

ADJUSTABLE XXI NOTES SPECIFICATIONS

Adjustable Worksurface Frames

The frame consists of two-piece welded 16-ga. formed steel outer legs and 14-ga. 1½" x 2½" rectangular steel tubing inner legs. Legs are 1" x 2" 14-ga. rectangular tubing attached to 11-ga. formed steel cross channels. Worksurfaces are supported by ¼" thick steel support arms. All frames are 40 sheen powder-coated.

Adjustable Worksurface Top

1¼" thick consisting of Novaply particle board with a .045" phenolic backing sheet.

Available with .050" high-pressure laminate and flat vinyl T-edge and 3mm PVC edge.

Wire Management

1" x 4" x 12" leg cavity with removable cover for easy access. Worksurfaces are designed with 2" x 4" grommets for optional worksurface access. Formed powder-coated steel wire trough 1" x 2" available at an upcharge. Integral 1" x 2" wire management mounted between lower leg assembly.

Height Adjustment

Tables are adjustable from 23" to 34". Adjustments are accomplished by a chain driven sprocket mechanism. Adjustment rate of 10 turns per inch. Height adjustment is located on left and right sides of worksurface.

Standards

Meets or exceeds all ANSI/HFS100—1988, BIFMA, and ADA requirements.

Modesty Panels

Formed 18-ga. steel powder-coated modesty panel. Attaches to worksurface and conceals

Optional Casters

Four swivel casters. Two with locks. Raises worksurface height 3".

Glides

Standard with chrome-plated adjustable glides.

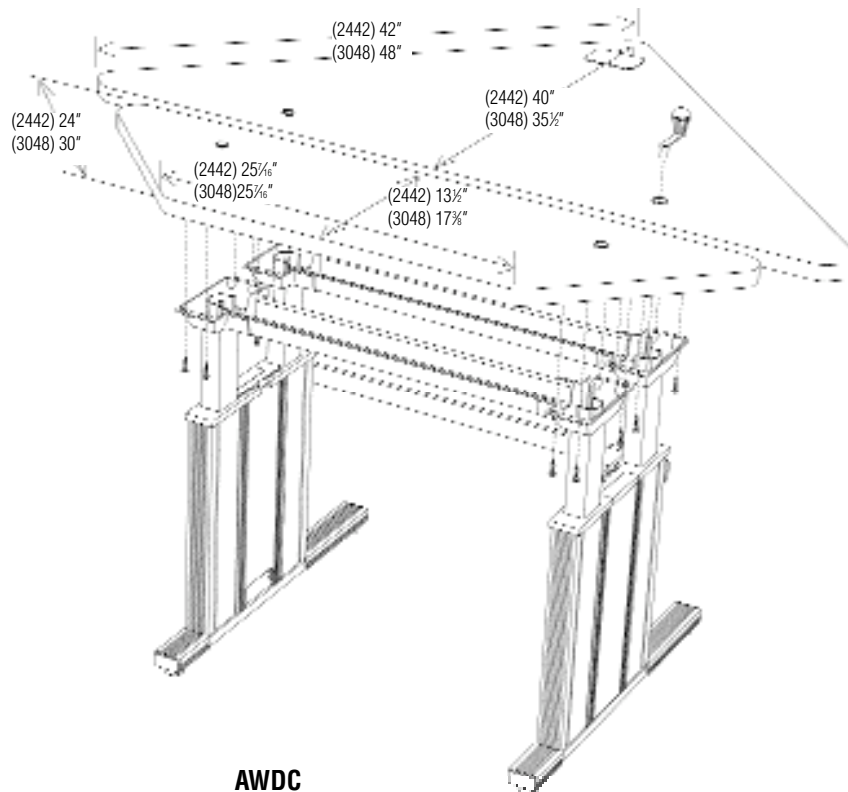

AWDC



INFORMATION

Warranty

See "Terms" for general information.

Adjustable XXI Notes

Worksurfaces

MODEL	D x W	MODEL NUMBER					
		Worksurface	Edge Style	Modesty Panel	Trim	Laminate	
 <p>Single Surfaces</p> <ul style="list-style-type: none"> • 1 1/4" solid core top with high pressure laminate surface • Flat T-edge or 3mm PVC edge • Left and right adjustment control location • Powder-coated finish on legs • Scuff plates cover legs • Adjustable glides • 23-34" height adjustment • Two grommets per surface on tops 48" and larger • One grommet per surface on 42" and smaller 	24x30"	AWS2430	<input type="checkbox"/>	<input type="checkbox"/>	<input type="checkbox"/>	<input type="checkbox"/>	
	24x36"	AWS2436	<input type="checkbox"/>	<input type="checkbox"/>	<input type="checkbox"/>	<input type="checkbox"/>	
	24x42"	AWS2442	<input type="checkbox"/>	<input type="checkbox"/>	<input type="checkbox"/>	<input type="checkbox"/>	
	24x48"	AWS2448	<input type="checkbox"/>	<input type="checkbox"/>	<input type="checkbox"/>	<input type="checkbox"/>	
	24x54"	AWS2454	<input type="checkbox"/>	<input type="checkbox"/>	<input type="checkbox"/>	<input type="checkbox"/>	
	24x60"	AWS2460	<input type="checkbox"/>	<input type="checkbox"/>	<input type="checkbox"/>	<input type="checkbox"/>	
	24x72"	AWS2472	<input type="checkbox"/>	<input type="checkbox"/>	<input type="checkbox"/>	<input type="checkbox"/>	
	30x30"	AWS3030	<input type="checkbox"/>	<input type="checkbox"/>	<input type="checkbox"/>	<input type="checkbox"/>	
	30x36"	AWS3036	<input type="checkbox"/>	<input type="checkbox"/>	<input type="checkbox"/>	<input type="checkbox"/>	
	30x42"	AWS3042	<input type="checkbox"/>	<input type="checkbox"/>	<input type="checkbox"/>	<input type="checkbox"/>	
	30x48"	AWS3048	<input type="checkbox"/>	<input type="checkbox"/>	<input type="checkbox"/>	<input type="checkbox"/>	
	30x54"	AWS3054	<input type="checkbox"/>	<input type="checkbox"/>	<input type="checkbox"/>	<input type="checkbox"/>	
	30x60"	AWS3060	<input type="checkbox"/>	<input type="checkbox"/>	<input type="checkbox"/>	<input type="checkbox"/>	
	30x72"	AWS3072	<input type="checkbox"/>	<input type="checkbox"/>	<input type="checkbox"/>	<input type="checkbox"/>	
	 <p>Single Corner Surfaces</p> <ul style="list-style-type: none"> • Flat T-edge or 3mm PVC edge • Postformed on front edge only • Powder-coated finish on legs • Single grommet located in rear corner • Left and right adjustment control location 	24x36"	AWSC2436	<input type="checkbox"/>	<input type="checkbox"/>	<input type="checkbox"/>	<input type="checkbox"/>
24x42"		AWSC2442	<input type="checkbox"/>	<input type="checkbox"/>	<input type="checkbox"/>	<input type="checkbox"/>	
24x48"		AWSC2448	<input type="checkbox"/>	<input type="checkbox"/>	<input type="checkbox"/>	<input type="checkbox"/>	
30x42"		AWSC3042	<input type="checkbox"/>	<input type="checkbox"/>	<input type="checkbox"/>	<input type="checkbox"/>	
30x48"		AWSC3048	<input type="checkbox"/>	<input type="checkbox"/>	<input type="checkbox"/>	<input type="checkbox"/>	
 <p>Dual Surfaces</p> <ul style="list-style-type: none"> • 1 1/4" solid core top with high pressure laminate surface • Flat T-edge or 3mm PVC edge • Powder-coated finish on legs • Front and rear surfaces split 11 1/2" and 17 1/2" respectively with 1" space between surfaces. • Left and right adjustment control location • Scuff plates cover legs • Adjustable glides • 23-34" height adjustment • Two grommets per surface on tops 48" and larger • One grommet per surface on 42" and smaller 	30x30"	AWD3030	<input type="checkbox"/>	<input type="checkbox"/>	<input type="checkbox"/>	<input type="checkbox"/>	
	30x36"	AWD3036	<input type="checkbox"/>	<input type="checkbox"/>	<input type="checkbox"/>	<input type="checkbox"/>	
	30x42"	AWD3042	<input type="checkbox"/>	<input type="checkbox"/>	<input type="checkbox"/>	<input type="checkbox"/>	
	30x48"	AWD3048	<input type="checkbox"/>	<input type="checkbox"/>	<input type="checkbox"/>	<input type="checkbox"/>	
	30x54"	AWD3054	<input type="checkbox"/>	<input type="checkbox"/>	<input type="checkbox"/>	<input type="checkbox"/>	
	30x60"	AWD3060	<input type="checkbox"/>	<input type="checkbox"/>	<input type="checkbox"/>	<input type="checkbox"/>	
	30x72"	AWD3072	<input type="checkbox"/>	<input type="checkbox"/>	<input type="checkbox"/>	<input type="checkbox"/>	
			A	B	C	D	E

HOW TO ORDER

Indicate the following information on order form:
 1. Quantity of each item.
 2. Model number, including options. See "How to Build a Model Number."
 3. Any special service required.

Note: • The indicates that a choice is required.
 • The absence of indicates that no choice is required.
 • Alpha-numeric characters in place of indicate that no other alternatives are available.

HOW TO BUILD A MODEL NUMBER

- A** Select size of worksurface.

B Select edge style.
 T = Flat vinyl T-edge
 M = 3mm PVC edge

C Indicate modesty panel option. Add upcharge to unit price.
 WM = With modesty panel
 NM = No modesty panel



D Select trim color for painted surfaces.
 B = Black
 G = Gray
 S = Sand
 W = Warm Gray
 L = Light Tone

- E** Select laminate surface.
 AA = Cream
 AB = Champagne
 AC = Barcelona
 AF = Aruba Tan
 AG = Black
 AH = Dark Gray
 AI = Dawn Gray (Greige)
 AJ = Fog
 AK = Black Grandin
 AL = Smoke Granite
 AM = Sand Grandin
 AN = Light Granite
 AO = Tundra
 AP = Earthen
 AQ = Rose Grafix
 AS = Sierra Grafix
 AT = Beige Grafix
 AU = Sand Stone

- AV = Kentucky Walnut
 AW = Tennessee Oak
 AX = Light Oak
 AY = Red Birch
 AZ = Ash
 BA = Philadelphia Cherry
 BB = Pennsylvania Cherry
 BC = Mahogany
 BD = Oak
 BE = Maple
 BF = Pearwood
 CA = Pumice
 CB = Rock Maple
 CC = Medium Cherry
 CD = Anigre
 ZZ = COM

Adjustable XXI Notes

Worksurfaces

MODEL	D x W	MODEL NUMBER					
		Worksurface	Edge Style	Modesty Panel	Trim/Edge	Laminate	
 <p>Dual Corner Surfaces</p> <ul style="list-style-type: none"> • Flat T-edge or 3mm PVC edge • Single grommet located in rear corner • 42" units front and rear surfaces split 13½" and 31½" respectively • 48" units front and rear surfaces split 17½" and 35¾" respectively with 1" space between surfaces • Left and right adjustment control location • Power-coated finish on legs 	24x42"	AWDC2442	<input type="checkbox"/>	<input type="checkbox"/>	<input type="checkbox"/>	<input type="checkbox"/>	
	30x48"	AWDC3048	<input type="checkbox"/>	<input type="checkbox"/>	<input type="checkbox"/>	<input type="checkbox"/>	
 <p>Single Surface for Overhead</p> <ul style="list-style-type: none"> • Designed for use with overhead unit • 1¼" solid core top with high-pressure laminate surface • 23-34" height adjustment • Flat T-edge or 3mm PVC edge • Power-coated finish on legs • Single rear center grommet on 30"-42" wide surfaces • Two grommets on each rear corner on 48" wide to 72" wide worksurfaces • Left and right adjustment control location 	24x30"	AWOH2430	<input type="checkbox"/>	<input type="checkbox"/>	<input type="checkbox"/>	<input type="checkbox"/>	
	24x36"	AWOH2436	<input type="checkbox"/>	<input type="checkbox"/>	<input type="checkbox"/>	<input type="checkbox"/>	
	24x42"	AWOH2442	<input type="checkbox"/>	<input type="checkbox"/>	<input type="checkbox"/>	<input type="checkbox"/>	
	24x48"	AWOH2448	<input type="checkbox"/>	<input type="checkbox"/>	<input type="checkbox"/>	<input type="checkbox"/>	
	24x54"	AWOH2454	<input type="checkbox"/>	<input type="checkbox"/>	<input type="checkbox"/>	<input type="checkbox"/>	
	24x60"	AWOH2460	<input type="checkbox"/>	<input type="checkbox"/>	<input type="checkbox"/>	<input type="checkbox"/>	
	24x72"	AWOH2472	<input type="checkbox"/>	<input type="checkbox"/>	<input type="checkbox"/>	<input type="checkbox"/>	
	30x30"	AWOH3030	<input type="checkbox"/>	<input type="checkbox"/>	<input type="checkbox"/>	<input type="checkbox"/>	
	30x36"	AWOH3036	<input type="checkbox"/>	<input type="checkbox"/>	<input type="checkbox"/>	<input type="checkbox"/>	
	30x42"	AWOH3042	<input type="checkbox"/>	<input type="checkbox"/>	<input type="checkbox"/>	<input type="checkbox"/>	
	30x48"	AWOH3048	<input type="checkbox"/>	<input type="checkbox"/>	<input type="checkbox"/>	<input type="checkbox"/>	
	30x54"	AWOH3054	<input type="checkbox"/>	<input type="checkbox"/>	<input type="checkbox"/>	<input type="checkbox"/>	
	30x60"	AWOH3060	<input type="checkbox"/>	<input type="checkbox"/>	<input type="checkbox"/>	<input type="checkbox"/>	
30x72"	AWOH3072	<input type="checkbox"/>	<input type="checkbox"/>	<input type="checkbox"/>	<input type="checkbox"/>		
			A	B	C	D	E

HOW TO ORDER

Indicate the following information on order form:

- Quantity of each item.
- Model number, including options. See "How to Build a Model Number."
- Any special service required.

- Note:
- The indicates that a choice is required.
 - The absence of indicates that no choice is required.
 - Alpha-numeric characters in place of indicate that no other alternatives are available.



HOW TO BUILD A MODEL NUMBER

- A** Select size of worksurface.
- B** Select edge style.
T = Flat vinyl T-edge
M = 3mm PVC edge
- C** Indicate modesty panel option. Add upcharge to unit price.
WM = With modesty panel
NM = No modesty panel
- D** Select trim color for painted surfaces.
B = Black
G = Gray
S = Sand
W = Warm Gray
L = Light Tone
- E** Select laminate surface.
AA = Cream
AB = Champagne
AC = Barcelona
AF = Aruba Tan
AG = Black
AH = Dark Gray
AI = Dawn Gray (Greige)
AJ = Fog
AK = Black Grandin
AL = Smoke Granite
AM = Sand Grandin
AN = Light Granite
AO = Tundra
AP = Earthen
AQ = Rose Grafix
AS = Sierra Grafix
AT = Beige Grafix
AU = Sand Stone
AV = Kentucky Walnut

- AW** = Tennessee Oak
AX = Light Oak
AY = Red Birch
AZ = Ash
BA = Philadelphia Cherry
BB = Pennsylvania Cherry
BC = Mahogany
BD = Oak
BE = Maple
BF = Pearwood
CA = Pumice
CB = Rock Maple
CC = Medium Cherry
CD = Anigre
ZZ = COM

Adjustable XXI Notes

Overhead Storage

MODEL	W x H x D	MODEL NUMBER					
		Overhead	Trim	Fabric	Laminate	Key	
 <p>Steel Overhead Cabinet with Steel Door</p> <ul style="list-style-type: none"> • Steel bottom, top shelf, and front with enamel finish • Double bit lock is included with key alike option • Door stores recessed with handle exposed • Shelf depth is 13 3/4" • 72" overhead not available • Attaches to leg • Only attaches to single surface for overhead worksurface • Meets all BIFMA standards: X5.6-1986, Section #s 8.2, 8.3, 8.4, 8.5 and 13 • Cannot be mounted on tables with casters. 	30 x 16 1/2 x 14 1/2"	AWFDS30	<input type="checkbox"/>			<input type="checkbox"/>	<input type="checkbox"/>
	36 x 16 1/2 x 14 1/2"	AWFDS36	<input type="checkbox"/>			<input type="checkbox"/>	<input type="checkbox"/>
	42 x 16 1/2 x 14 1/2"	AWFDS42	<input type="checkbox"/>			<input type="checkbox"/>	<input type="checkbox"/>
	48 x 16 1/2 x 14 1/2"	AWFDS48	<input type="checkbox"/>			<input type="checkbox"/>	<input type="checkbox"/>
	54 x 16 1/2 x 14 1/2"	AWFDS54	<input type="checkbox"/>			<input type="checkbox"/>	<input type="checkbox"/>
	60 x 16 1/2 x 14 1/2"	AWFDS60	<input type="checkbox"/>			<input type="checkbox"/>	<input type="checkbox"/>
 <p>Steel Overhead Cabinet with Fabric Door</p> <ul style="list-style-type: none"> • Steel end panels, bottom and top shelf with enamel finish • Fabric-covered front • Double bit lock is included with key alike option • End panel bracket design prevents accidental dislodging of components • Shelf depth is 13 3/4" • Door stores recessed with handle exposed • 72" overhead not available • Attaches to leg • Only attaches to single surface for overhead worksurface • Meets all BIFMA standards: X5.6-1986, Section #s 8.2, 8.3, 8.4, 8.5 and 13 • Cannot be mounted on tables with casters. 	30 x 16 1/2 x 14 1/2"	AWFDF30	<input type="checkbox"/>	<input type="checkbox"/>	<input type="checkbox"/>	<input type="checkbox"/>	<input type="checkbox"/>
	36 x 16 1/2 x 14 1/2"	AWFDF36	<input type="checkbox"/>	<input type="checkbox"/>	<input type="checkbox"/>	<input type="checkbox"/>	<input type="checkbox"/>
	42 x 16 1/2 x 14 1/2"	AWFDF42	<input type="checkbox"/>	<input type="checkbox"/>	<input type="checkbox"/>	<input type="checkbox"/>	<input type="checkbox"/>
	48 x 16 1/2 x 14 1/2"	AWFDF48	<input type="checkbox"/>	<input type="checkbox"/>	<input type="checkbox"/>	<input type="checkbox"/>	<input type="checkbox"/>
	54 x 16 1/2 x 14 1/2"	AWFDF54	<input type="checkbox"/>	<input type="checkbox"/>	<input type="checkbox"/>	<input type="checkbox"/>	<input type="checkbox"/>
	60 x 16 1/2 x 14 1/2"	AWFDF60	<input type="checkbox"/>	<input type="checkbox"/>	<input type="checkbox"/>	<input type="checkbox"/>	<input type="checkbox"/>
 <p>Steel Overhead Cabinet with Laminate Door</p> <ul style="list-style-type: none"> • Steel end panels, bottom and top shelf with enamel finish • High-pressure laminate front • Double bit lock is included with key alike option • End panel bracket design prevents accidental dislodging of components • Shelf depth is 13 3/4" • Door stores recessed with handle exposed • 72" overhead not available • Attaches to leg • Only attaches to single surface for overhead worksurface • Meets all BIFMA standards: X5.6-1986, Section #s 8.2, 8.3, 8.4, 8.5 and 13 • Cannot be mounted on tables with casters. 	30 x 16 1/2 x 14 1/2"	AWFDL30	<input type="checkbox"/>		<input type="checkbox"/>	<input type="checkbox"/>	<input type="checkbox"/>
	36 x 16 1/2 x 14 1/2"	AWFDL36	<input type="checkbox"/>		<input type="checkbox"/>	<input type="checkbox"/>	<input type="checkbox"/>
	42 x 16 1/2 x 14 1/2"	AWFDL42	<input type="checkbox"/>		<input type="checkbox"/>	<input type="checkbox"/>	<input type="checkbox"/>
	48 x 16 1/2 x 14 1/2"	AWFDL48	<input type="checkbox"/>		<input type="checkbox"/>	<input type="checkbox"/>	<input type="checkbox"/>
	54 x 16 1/2 x 14 1/2"	AWFDL54	<input type="checkbox"/>		<input type="checkbox"/>	<input type="checkbox"/>	<input type="checkbox"/>
	60 x 16 1/2 x 14 1/2"	AWFDL60	<input type="checkbox"/>		<input type="checkbox"/>	<input type="checkbox"/>	<input type="checkbox"/>
			A	B	C	D	E

HOW TO ORDER

Indicate the following information on order form:

1. Quantity of each item.
2. Model number, including options. See "How to Build a Model Number."
3. Any special service required.

- Note:
- The indicates that a choice is required.
 - The absence of indicates that no choice is required.
 - Alpha-numeric characters in place of indicate that no other alternatives are available.

HOW TO BUILD A MODEL NUMBER

- A** Select basic model.
- B** Select trim color for painted surfaces.
- B** = Black
- G** = Gray
- S** = Sand
- W** = Warm Gray
- L** = Light Tone
- C** Select cabinet door fabric.
- Group A:
- FR701**
- 1511** = Blue Neutral
- 1506** = Green Neutral
- 1518** = Wedgewood
- 1510** = Silver Paper
- 1546** = Cherry Neutral
- 1515** = Quartz
- 1531** = Gray Mix

Eclipse

- 1197** = Meteor
- 1690** = Tourmaline
- 4604** = Chicory
- 4605** = Amber Grain
- 4593** = Serengeti
- 4594** = Cocoa Palm
- 1691** = Iron Ore

Carrara

- 9447** = Beeswax
- 9454** = Verdigris
- 9456** = Tincoria
- 9455** = Green Earth
- 9448** = Teak Oil
- 9445** = Gesso
- 9444** = Casein

Galaxy

- 4526** = Desert Sand
- 4528** = ...

4544 = Blueberry

4542 = Sundew

4525 = Fog

4531 = Gobi

4541 = Wrought Iron

Group B:

Serendipity

9617 = Coincidence

9626 = Four Leaf Clover

9622 = Lady Luck

9619 = Guardian Angel

9620 = Lucky Duck

9618 = Fortuitous

9624 = Silver Spoon

D Select laminate surface.

AA = Cream

AB = Champagne

AC = Barcelona



Total Weight	Delivered Pricing		
	Unupholstered Price	Group A Price	Group B Price

72#	\$280		
81#	286		
88#	295		
99#	316		
106#	323		
115#	348		

73#		\$307	\$313
81#		315	321
89#		324	330
99#		347	354
107#		353	360
116#		381	389

73#	330		
81#	343		
89#	412		
99#	432		
107#	450		
116#	474		

- AG** = Black
- AH** = Dark Gray
- AI** = Dawn Gray (Greige)
- AJ** = Fog
- AK** = Black Grandin
- AL** = Smoke Granite
- AM** = Sand Grandin
- AN** = Light Granite
- AO** = Tundra
- AP** = Earthen
- AQ** = Rose Grafix
- AS** = Sierra Grafix
- AT** = Beige Grafix
- AU** = Sand Stone
- AV** = Kentucky Walnut
- AW** = Tennessee Oak
- AX** = Light Oak
- AY** = Red Birch
- AZ** = Ash
- BA** = Philadelphia Cherry
- BB** = Pennsylvania Cherry

- BD** = Oak
- BE** = Maple
- BF** = Pearwood
- CA** = Pumice
- CB** = Rock Maple
- CC** = Medium Cherry
- CD** = Anigre
- ZZ** = COM

- ⓔ Select key option.
- KA** = Key alike
- KS** = Key standard

Note: Different lock options are available. Please call the Systems Department for details.

FINISH INFORMATION

Laminate Surface

See Keys for Progression switch card.

Specifications and prices are subject to change without prior notice.

Adjustable XXI Notes

Overhead Storage

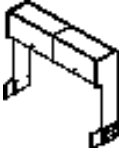
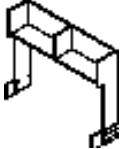
MODEL		MODEL NUMBER						
		Overhead	Trim	Laminate	Upholstery			
 <p>Overhead Cabinet with Flipper Doors</p> <ul style="list-style-type: none"> For use on single rectangular adjustable XXI Notes stations. When surface is at 29", the clearance between overhead and top is 18½". Edges finished with flat vinyl T-molding. Optional random or key alike locks 	Laminated	30" single door	AWOC30	<input type="checkbox"/>	<input type="checkbox"/>	<input type="checkbox"/>		
		36" single door	AWOC36	<input type="checkbox"/>	<input type="checkbox"/>	<input type="checkbox"/>		
		42" single door	AWOC42	<input type="checkbox"/>	<input type="checkbox"/>	<input type="checkbox"/>		
		48" single door	AWOC48	<input type="checkbox"/>	<input type="checkbox"/>	<input type="checkbox"/>		
		Two 27" doors	AWOC54	<input type="checkbox"/>	<input type="checkbox"/>	<input type="checkbox"/>		
		Two 30" doors	AWOC60	<input type="checkbox"/>	<input type="checkbox"/>	<input type="checkbox"/>		
		Two 36" doors	AWOC72	<input type="checkbox"/>	<input type="checkbox"/>	<input type="checkbox"/>		
		Upholstered	30" single door	AWOC30F	<input type="checkbox"/>	<input type="checkbox"/>	<input type="checkbox"/>	<input type="checkbox"/>
			36" single door	AWOC36F	<input type="checkbox"/>	<input type="checkbox"/>	<input type="checkbox"/>	<input type="checkbox"/>
			42" single door	AWOC42F	<input type="checkbox"/>	<input type="checkbox"/>	<input type="checkbox"/>	<input type="checkbox"/>
			48" single door	AWOC48F	<input type="checkbox"/>	<input type="checkbox"/>	<input type="checkbox"/>	<input type="checkbox"/>
			Two 27" doors	AWOC54F	<input type="checkbox"/>	<input type="checkbox"/>	<input type="checkbox"/>	<input type="checkbox"/>
			Two 30" doors	AWOC60F	<input type="checkbox"/>	<input type="checkbox"/>	<input type="checkbox"/>	<input type="checkbox"/>
			Two 36" doors	AWOC72F	<input type="checkbox"/>	<input type="checkbox"/>	<input type="checkbox"/>	<input type="checkbox"/>
 <p>Open Shelf</p> <ul style="list-style-type: none"> For use on single rectangular adjustable XXI Notes stations. When surface is at 29", the clearance between overhead and top is 18½". 		30"	AWOS30	<input type="checkbox"/>	<input type="checkbox"/>			
		36"	AWOS36	<input type="checkbox"/>	<input type="checkbox"/>			
		42"	AWOS42	<input type="checkbox"/>	<input type="checkbox"/>			
		48"	AWOS48	<input type="checkbox"/>	<input type="checkbox"/>			
		54"	AWOS54	<input type="checkbox"/>	<input type="checkbox"/>			
		60"	AWOS60	<input type="checkbox"/>	<input type="checkbox"/>			
		72"	AWOS72	<input type="checkbox"/>	<input type="checkbox"/>			
				A	B	C	D	

HOW TO ORDER

Indicate the following information on order form:

- Quantity of each item.
- Model number, including options. See "How to Build a Model Number."
- Any special service required.

- Note:
- The indicates that a choice is required.
 - The absence of indicates that no choice is required.
 - Alpha-numeric characters in place of indicate that no other alternatives are available.

HOW TO BUILD A MODEL NUMBER

- A** Select size of overhead. Length of overhead must be identical to length of work surface.
- B** Select trim color for painted surfaces.
- B** = Black
G = Gray
S = Sand
W = Warm Gray
L = Light Tone
- C** Select laminate surface.
- AA** = Cream
AB = Champagne
AC = Barcelona
AF = Aruba Tan
AG = Black
AH = Dark Gray
AI = Dawn Gray (Greige)
AJ = Fog
AK = Black Grandin

- AL** = Smoke Granite
AM = Sand Grandin
AN = Light Granite
AO = Tundra
AP = Earthen
AQ = Rose Grafix
AS = Sierra Grafix
AT = Beige Grafix
AU = Sand Stone
AV = Kentucky Walnut
AW = Tennessee Oak
AX = Light Oak
AY = Red Birch
AZ = Ash
BA = Philadelphia Cherry
BB = Pennsylvania Cherry
BC = Mahogany
BD = Oak
BE = Maple
BF = Pearwood
CA = Pumice
CB = ...

- CC** = Medium Cherry
CD = Anigre
ZZ = COM

- D** Select cabinet door fabric.
- Group A:
- FR701**
- 1511** = Blue Neutral
1506 = Green Neutral
1518 = Wedgewood
1510 = Silver Paper
1546 = Cherry Neutral
1515 = Quartz
1531 = Gray Mix

- Eclipse**
- 1197** = Meteor
1690 = Tourmaline
4604 = Chicory
4605 = Amber Grain
4593 = Serengeti



Total Weight	Delivered Pricing		
	Unupholstered Price	Group A Price	Group B Price
82#	\$298		
87#	306		
88#	313		
102#	319		
114#	351		
127#	383		
137#	397		
82#		\$344	\$350
87#		355	361
88#		363	369
102#		371	377
114#		411	417
127#		451	457
137#		469	475
62#	264		
64#	268		
66#	276		
70#	284		
73#	286		
77#	294		
83#	300		

4594 = Cocoa Palm

1691 = Iron Ore

Carrara

9447 = Beeswax

9454 = Verdigris

9456 = Tincoria

9455 = Green Earth

9448 = Teak Oil

9445 = Gesso

9444 = Casein

Galaxy

4526 = Desert Sand

4538 = Bermuda

4544 = Blueberry

4542 = Sundew

4525 = Fog

4531 = Gobi

4541 = Wrought Iron

Group B:

Serendipity

9617 = Coincidence

9626 = Four Leaf Clover

9622 = Lady Luck

9619 = Guardian Angel

9620 = Lucky Duck

9618 = Fortuitous

9624 = Silver Spoon

FINISH INFORMATION



Laminate Surface

See Keys for Progression swatch card.

Specifications and prices are subject to change without prior notice.

Adjustable XXI Notes

Accessories

	MODEL		MODEL NUMBER		Total Weight
			Basic Model	Trim	
 <p>CPU Holder</p> <ul style="list-style-type: none"> • Designed for use with manual adjustable WorkZone tables only. • Accommodates CPUs 4" x 8½" wide. • Consult your hardware supplier to determine if unit can be placed horizontally. 	4" D x 8½" W	AWCPU	<input type="checkbox"/>	4#	
 <p>Mouse</p> <ul style="list-style-type: none"> • Mouse swivels under surface and has travel range of 5¾" • Neoprene pad included for positive contact. • Slides in and out for positioning. 	8" x 8"	AWMOUSE	B	10#	
			A	B	

HOW TO ORDER

Indicate the following information on order form:

1. Quantity of each item.
2. Model number, including options. See "How to Build a Model Number."
3. Any special service required.

- Note:
- The indicates that a choice is required.
 - The absence of indicates that no choice is required.
 - Alpha-numeric characters in place of indicate that no other alternatives are available.

HOW TO BUILD A MODEL NUMBER

- A** Select basic model.
- B** Select trim color for painted surfaces.
 - B** = Black
 - G** = Gray
 - S** = Sand
 - W** = Warm Gray
 - L** = Light Tone



Price

\$ 38

--

--

--

XXI Notes with PowerUp

General Information

SPECIFICATIONS

Worksurface Frames

Heavy-gauge seam-welded powder-coat finished tubular steel. Horizontal tabletop support tube, 16-ga., 1" x 2" steel. Floor support member, 16-ga., 1" x 2" steel tube. Top floor support tubes are welded with (2) 16-ga. 1" x 2" vertical leg members. Leg interior provides concealed management of wire from floor to worksurface. Adjustable chrome-plated glides.

There is one frame style for XXI Notes with PowerUp. The modesty panel is 19-ga. steel. It is located 1-1/2" from the backside of the worksurface. The modesty panel is 13.31"H on the 27"H worksurfaces and 15.31" on the 29" tables.

PowerUp Power/Data Module

The power/data module is inserted into a rectangular hole in the worksurface. The module has a flip-up cover and is 6 1/4" long x 3" wide x 2 1/2" high. The cover locks in the upright position to allow cords to be unplugged without the cover closing. The cover is unlocked and returned to the down position by pushing two tabs. It has one duplex receptacle (110 volts), dual data ports and a power cord with a 3-prong plug. The cord is 22" long when used with Level Five tables and 108" long when used with Level One and Level Three tables. Level One tables have a 16-gauge U-shaped steel guard that is attached to the underside of the worksurface to protect the module. Modules are not used on Level Two and Level Four tables. The PowerUp module provides for two AT & T brand connectors. Connections for phones, modems, printers and networks can be incorporated into the system, but must be ordered separately by the customer through a third party source. Communications wiring is completed in the field by the customer. Other brand name connectors, for example: AMP and Panduit, may be accommodated. Contact Customer Service for more information

The module is available on 24" and 30" deep rectangular worksurfaces. The module is not available on the printer worksurfaces, square corner worksurfaces or D-shaped peninsula worksurfaces. One module is standard on surfaces for Levels One, Three and Five. The single module is located at the rear right, rear left or center position of the worksurface. Two modules are available on 60" and 72" wide surfaces and are located at the rear left and rear right position of the worksurface.

The PowerUp module is available in five standard colors: B (Black), G (Gray), W (Warm Gray), L (Light Tone) and S (Sand).

Data Door

The data door is constructed of rigid PVC .06 wall thickness with a radius of 2 1/2". The door is 8" deep and is 4 1/4" high. It attaches to the underside of the table top and to the inside of the modesty panel. Power and data cables are separated from each other by a 24-gauge steel divider that is 2" high by 2 3/4" deep. There is also space allowed for cord management.

Table-To-Table Wireway

The table-to-table wireway is a 16-gauge steel trough that attaches to the underside of the adjoining table tops. The wireway is 3 3/4" deep by 4 1/4" wide. The wireway routes the eight-wire table-to-table connector and data wires between tables. The table-to-table wireway also includes a splice plate that attaches the front of the adjoining tops together to prevent separation.

Eight-Wire Four-Circuit Pre-Wired Harness

Single sided, rigid eight-wire harness that holds two duplex receptacles (60" and 72" wide tables provide four duplex receptacles. Duplex receptacles are located under the worksurface). The harness has mounting brackets to attach to the underside of the table top with screws. The harness is 2 1/2" wide and the length of the harness varies with the size of the top. Power is obtained by use of the Eight-Wire Power Infeed Kit.

Eight-Wire Table-To-Table Connector

Eight-wire table-to-table connector consists of plastic coated flexible conduit which provides power connections from adjoining tables. The jumper is 18 1/2" long and is routed through the table-to-table wireway.

Eight-Wire Power Infeed Kit

The eight-wire infeed kit provides power from fixed, floor, or wall sources to the eight-wire harness. It includes six feet of plastic covered flexible conduit, and 1/2" waterproof 90° connector. Also included are two steel covers which replace the existing plastic vertical wireway.

Horizontal Wire Management Trough

Horizontal wire management trough (WW) connects to existing openings below the worksurface top and is constructed of rigid PVC with 1" deep by 1-1/2" high openings for cables.

Notched Leg Insert Wire Management

The notched leg insert (CW) allows wires to be routed to adjoining tables on both sides of the centrally located table. There is a notch located at the top of the leg insert.

PowerUp On XXI Notes Applications

Level One

Level One consists of one or two PowerUp modules with 108° cord for instances where laptops are used but under the worksurface wire management is not crucial. An optional Wire Management Trough (WW) is offered. Example: when a user is interested in only the power aspect of the module and will not run data wires.

Level Two

Level Two consists of data door with steel divider, table-to-table steel wireway, splice plate, and notched leg insert wire management. For instances where laptops are not used; therefore, the surface module is not required; however, it is necessary to conceal the cords and wires. Example: a computer lab where extension cords are used to plug in desktop computers. Note: Power supply cords are not to be routed across or through more than one complete unit/worksurface.

Level Three

Level Three consists of one or two power modules with 22" cord, data door with steel divider, table-to-table steel wireway, splice plate, notched leg insert wire management, eight-wire four circuit pre-wired harness. For instances where laptops are used and it is necessary to conceal cords and wire. Example: a computer lab where extension cords are used to plug in a desktop computer (under the worksurface) plus there needs to be a provision for laptops.

Level Four

Level Four consists of data door with steel divider, table-to-table steel wireway, splice plate, notched leg insert, eight-wire four circuit pre-wired harness. For instances where a prewired four-circuit harness is required. Example: several desktop computers per row but laptops are not required. Duplex receptacles, floor infeeds, and eight-wire able-to-table connectors must be ordered separately.

Level Five

Level Five consists of one or two power modules with 22" cord, data door with steel divider, table-to-table steel wireway, splice plate, notched leg inserts, eight-wire four circuit pre-wired harness. For instances where a prewired four-circuit harness is required. Example: several desktop computers per row plus the need to provide for laptops. Duplex receptacles, floor infeeds, and eight-wire able-to-table connectors must be ordered separately.

UL Listed

The XXI Notes with PowerUp System is listed to applicable UL standards and requirements by Underwriters Laboratories Inc.

Two of the standards used to evaluate XXI Notes are UL/286 Office Furnishings and UL/723 Standard for Test for Surface Burning Characteristics of Building Materials.

The standard used to evaluate PowerUp is UL 1363 Relocatable Power Taps.

Surface Splice Plates

Die-formed steel splice plates attach to underside of units with screws. Two splice plates are provided with all surfaces. Standard connector plate provided when surfaces are of common height. Worksurface height change connector provided for connecting 29" to 27" surfaces on transitional height worksurfaces. Specify worksurface height change connector for connecting non-transitional worksurfaces of two different heights.

Scuff Guards

Extruded rigid PVC scuff guards cover the foot on all XXI Notes legs.

Grommets for Wire Management

3" x 2" openings with protected edges are provided for all worksurfaces. On basic adjustable keyboard worksurfaces and rectangular transitional surfaces, the grommets are located on both sides. On the end-of-run squire, corner and peninsula transitionals, the grommet is located in the top center. The triangular transitional does not have a wire management grommet.

Warranty

See "Terms" for general information.

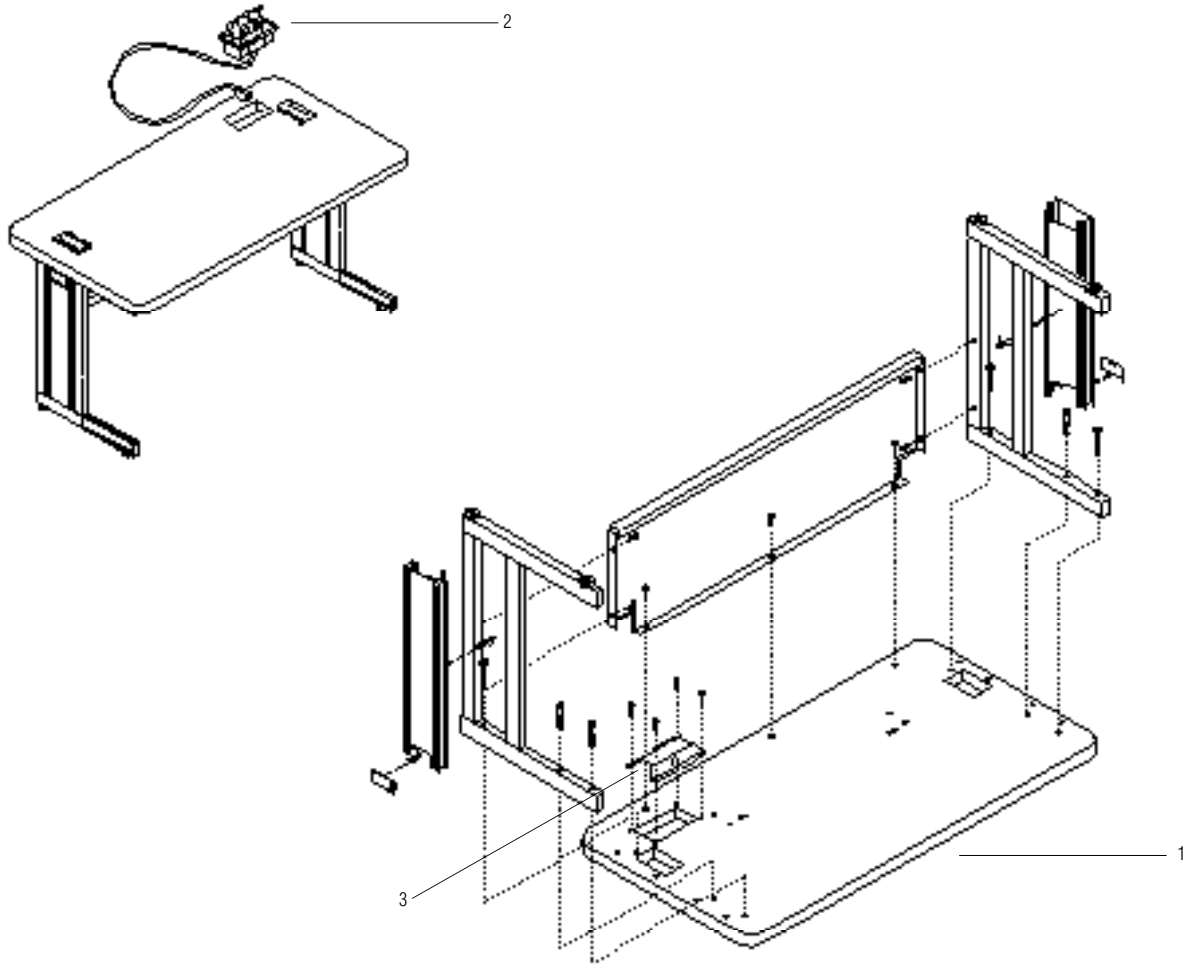

PowerUp Parts Listing

Item No.	Item Description
1	XXI Notes Top with cutout for PowerUp module Bullnose Edge Post-Formed Edge
2	Power Data Module with 108" cord
3	Steel Guard

XXI Notes with PowerUp

Level Two

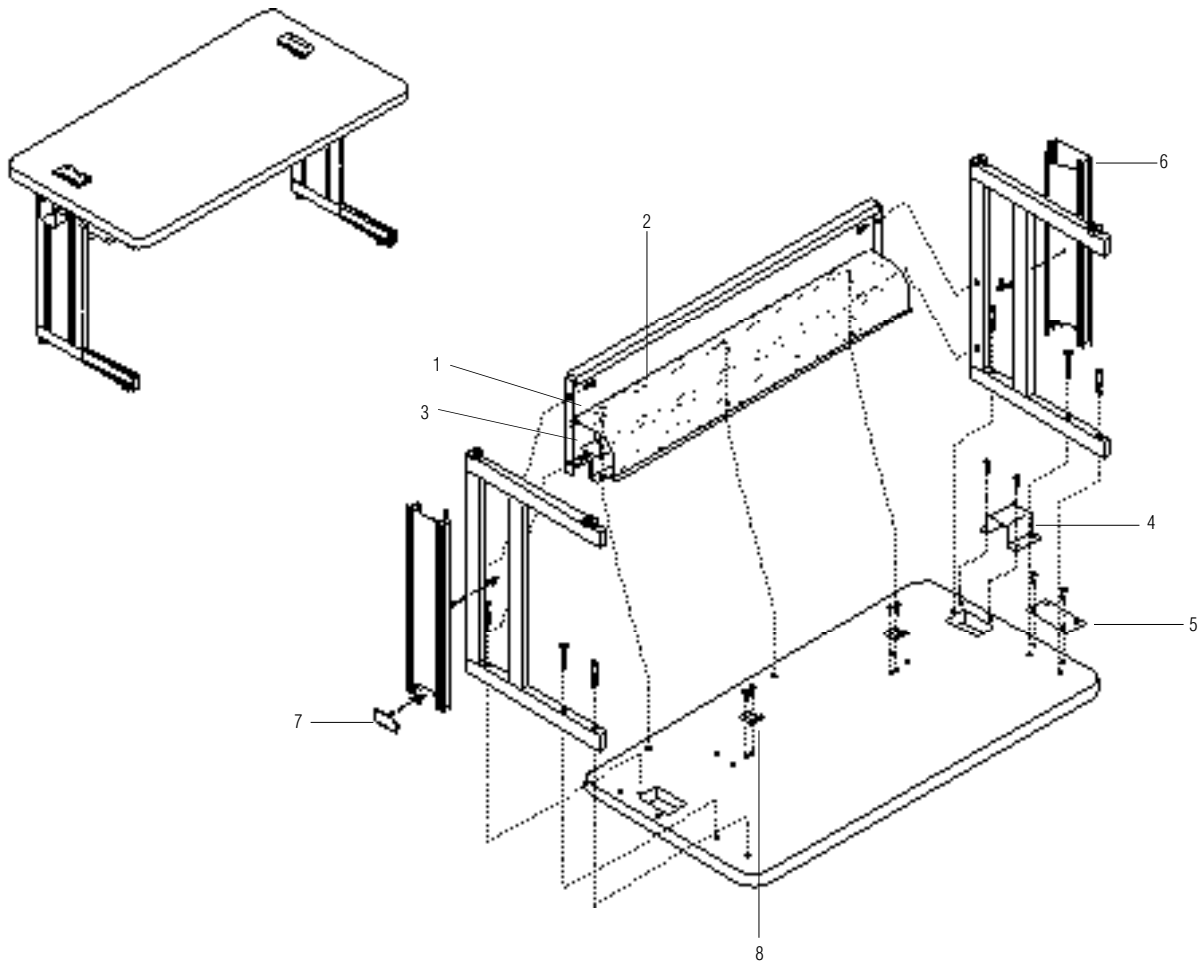

PowerUp Parts Listing

Item No.	Item Description
1	Data Door Extrusion 30"
	Data Door Extrusion 36"
	Data Door Extrusion 42"
	Data Door Extrusion 48"
	Data Door Extrusion 54"
	Data Door Extrusion 60"
	Data Door Extrusion 72"
2	Door Mounting Bracket 30"
	Door Mounting Bracket 36"
	Door Mounting Bracket 42"
	Door Mounting Bracket 48"
	Door Mounting Bracket 54"
	Door Mounting Bracket 60"
	Door Mounting Bracket 72"
3	Steel Power/Data Divider 30"
	Steel Power/Data Divider 36"
	Steel Power/Data Divider 42"
	Steel Power/Data Divider 48"
	Steel Power/Data Divider 54"
	Steel Power/Data Divider 60"
	Steel Power/Data Divider 72"

Item No.	Item Description
4	Table-To-Table Wireway
5	Splice Plate
6	Notched Vertical Wireway
	(used in conjunction with table-to-table cover)
7	Cap for vertical wireway
8	Clips for Door

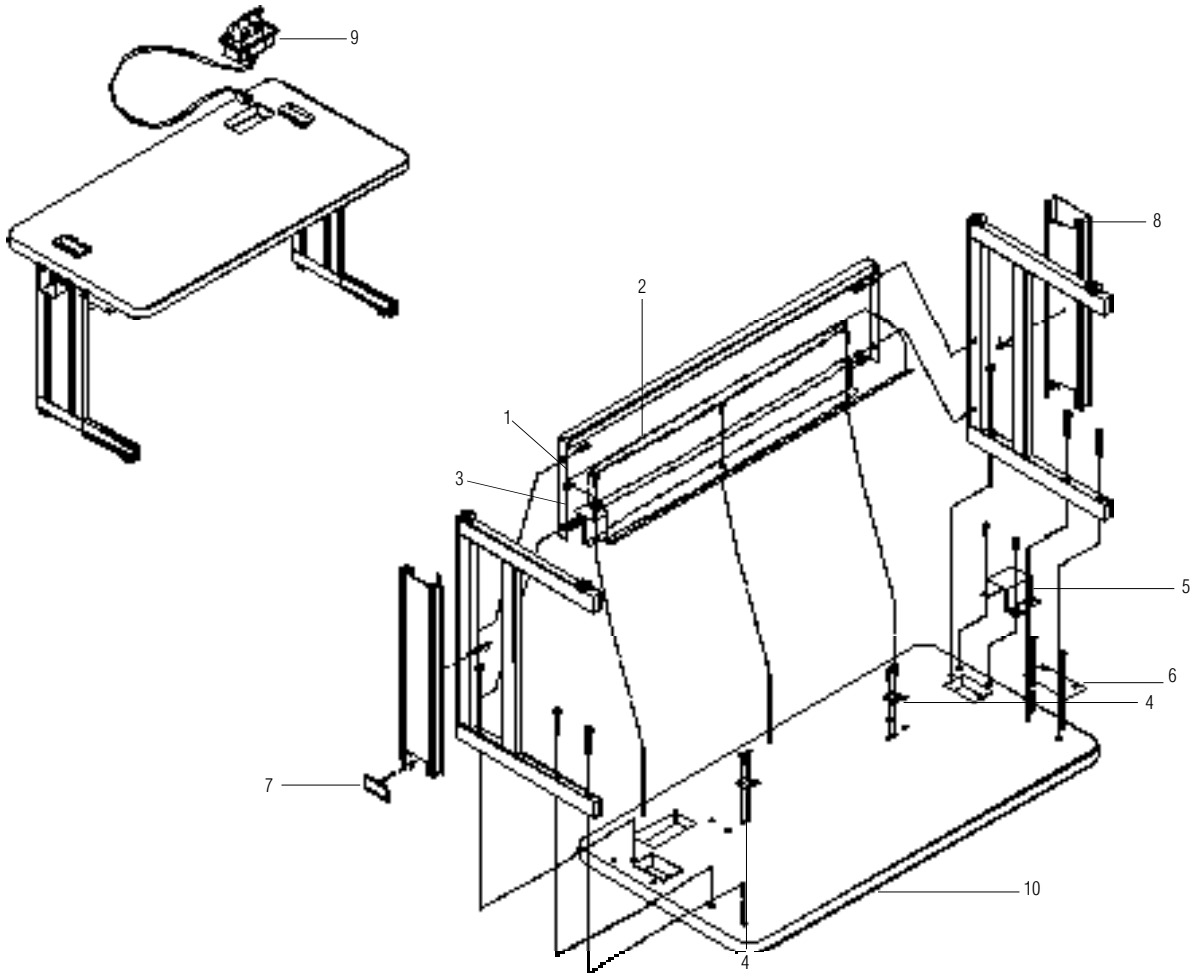

PowerUp Parts Listing

Item No.	Item Description
1	Data Door Extrusion 30"
	Data Door Extrusion 36"
	Data Door Extrusion 42"
	Data Door Extrusion 48"
	Data Door Extrusion 54"
	Data Door Extrusion 60"
	Data Door Extrusion 72"
2	Door Mounting Bracket 30"
	Door Mounting Bracket 36"
	Door Mounting Bracket 42"
	Door Mounting Bracket 48"
	Door Mounting Bracket 54"
	Door Mounting Bracket 60"
	Door Mounting Bracket 72"
3	Steel Power/Data Divider 30"
	Steel Power/Data Divider 36"
	Steel Power/Data Divider 42"
	Steel Power/Data Divider 48"
	Steel Power/Data Divider 54"
	Steel Power/Data Divider 60"
	Steel Power/Data Divider 72"

Item No.	Item Description
4	Clips for Door
5	Table-To-Table Wireway
6	Splice Plate
7	Cap for Wireway
8	Notched Vertical Wireway (used in conjunction with table-to-table cover)
9	Power Data Module with 108" cord
10	XXI Notes Top only with cutout (Bullnose)

XXI Notes with PowerUp

Level Four

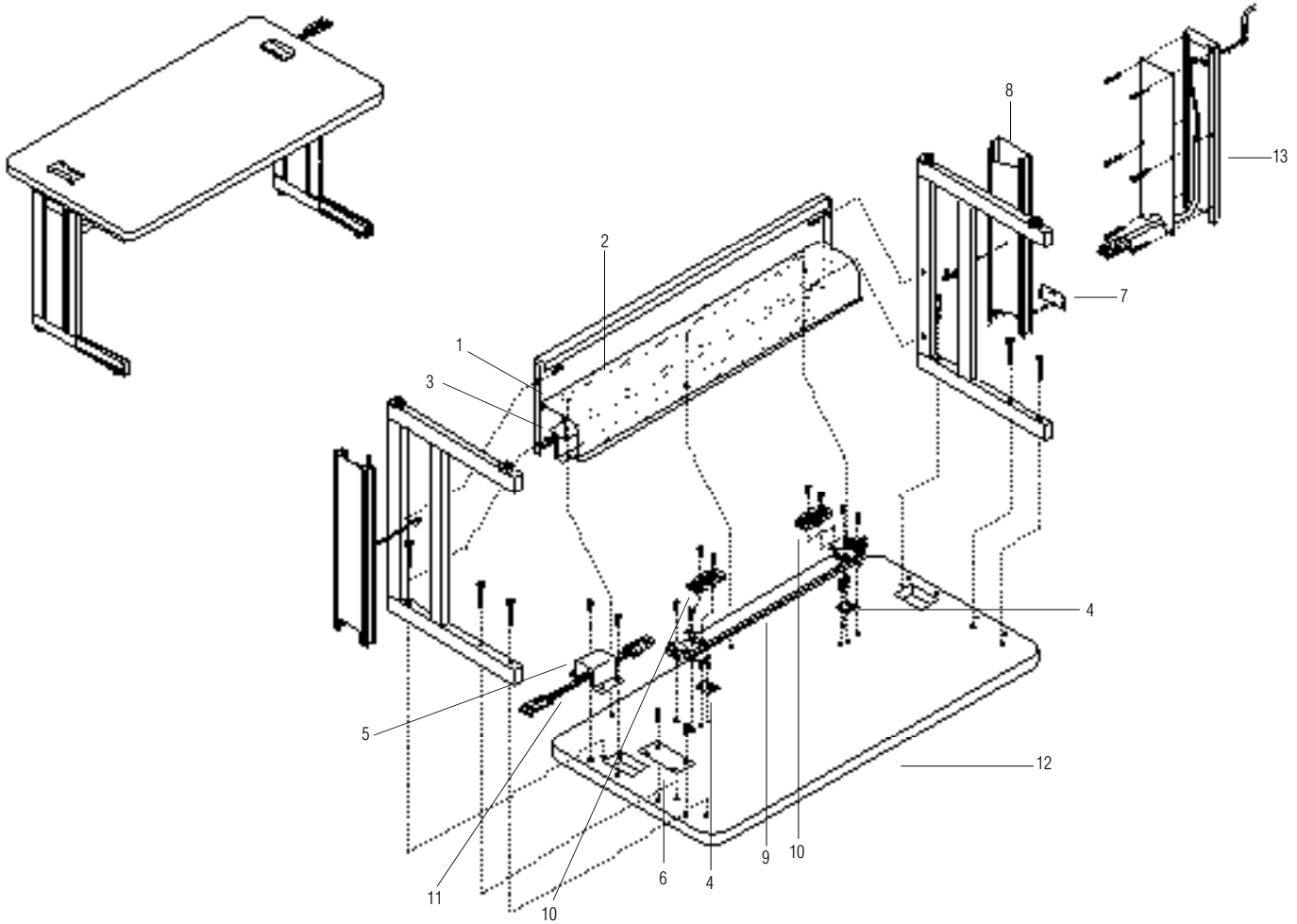

PowerUp Parts Listing

Item No.	Item Description
1	Data Door Extrusion 30"
	Data Door Extrusion 36"
	Data Door Extrusion 42"
	Data Door Extrusion 48"
	Data Door Extrusion 54"
	Data Door Extrusion 60"
	Data Door Extrusion 72"
2	Door Mounting Bracket 30"
	Door Mounting Bracket 36"
	Door Mounting Bracket 42"
	Door Mounting Bracket 48"
	Door Mounting Bracket 54"
	Door Mounting Bracket 60"
	Door Mounting Bracket 72"
3	Steel Power/Data Divider 30"
	Steel Power/Data Divider 36"
	Steel Power/Data Divider 42"
	Steel Power/Data Divider 48"
	Steel Power/Data Divider 54"
	Steel Power/Data Divider 60"
	Steel Power/Data Divider 72"
4	Clips for Door
5	Table-To-Table Wireway

Item No.	Item Description
7	Cap for Wireway
8	Notched Vertical Wireway (used in conjunction with table-to-table cover)
9	Eight-Wire Harness 30"
	Eight-Wire Harness 36"
	Eight-Wire Harness 42"
	Eight-Wire Harness 48"
	Eight-Wire Harness 54"
	Eight-Wire Harness 60"
	Eight-Wire Harness 72"
10	Duplex Receptacles (optional - must be ordered separately)
11	Eight-Wire Table-To-Table Connector (optional - must be ordered separately)
12	XXI Notes Top only (Bullnose)
	Steel Infeed 27" Cover Plate Assembly
13	Steel Infeed 29" Cover Plate Assembly
	Steel Infeed 42" Cover Plate Assembly (optional - must be ordered separately)

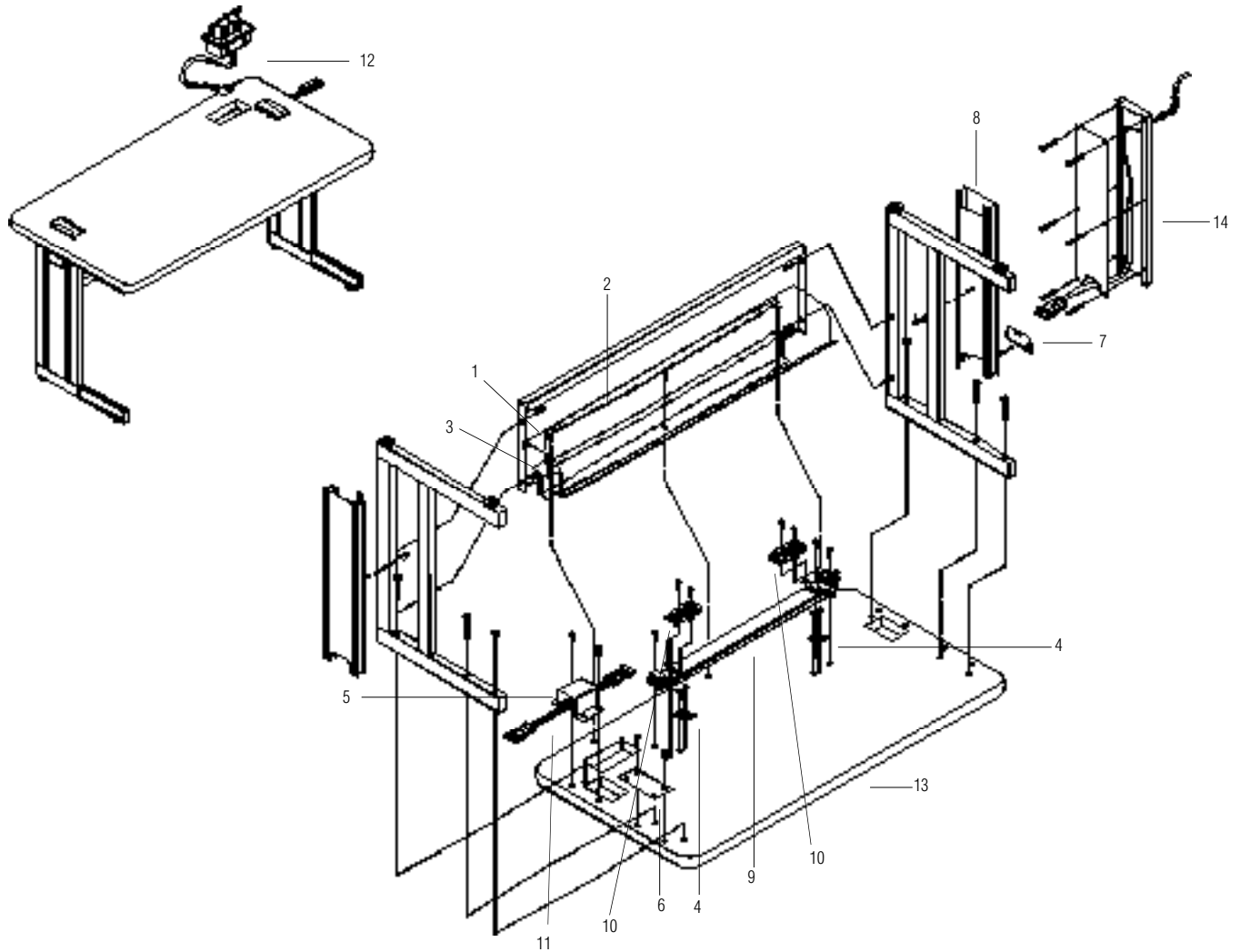

PowerUp Parts Listing

Item No.	Item Description
1	Data Door Extrusion 30" Data Door Extrusion 36" Data Door Extrusion 42" Data Door Extrusion 48" Data Door Extrusion 54" Data Door Extrusion 60" Data Door Extrusion 72"
2	Door Mounting Bracket 30" Door Mounting Bracket 36" Door Mounting Bracket 42" Door Mounting Bracket 48" Door Mounting Bracket 54" Door Mounting Bracket 60" Door Mounting Bracket 72"
3	Steel Power/Data Divider 30" Steel Power/Data Divider 36" Steel Power/Data Divider 42" Steel Power/Data Divider 48" Steel Power/Data Divider 54" Steel Power/Data Divider 60" Steel Power/Data Divider 72"
4	Clips for Door
5	Table-To-Table Wireway

Item No.	Item Description
7	Cap for Vertical Wireway
8	Notched Vertical Wireway
9	Eight-Wire Harness 30" Eight-Wire Harness 36" Eight-Wire Harness 42" Eight-Wire Harness 48" Eight-Wire Harness 54" Eight-Wire Harness 60" Eight-Wire Harness 72"
10	Duplex Receptacles (optional - must be ordered separately)
11	Eight-Wire Table-To-Table Connector (optional - must be ordered separately)
12	Power Data Module with 22" cord
13	XXI Notes Top only with cutout - (Bullnose)
14	Steel Infed 27" Cover Plate Assembly Steel Infed 29" Cover Plate Assembly Steel Infed 42" Cover Plate Assembly (optional - must be ordered separately)

XXI Notes Worksurfaces with PowerUp

Level One

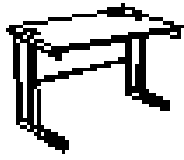

Basic Worksurface

- One PowerUp module
- Wireway standard
- Notched vertical wireway and modesty panel frame style is standard



- One or two PowerUp modules available on 60" and 72" wide surfaces.
- Left and right data location only available on 60" and 72" worksurface.
- Wireway standard
- Notched vertical wireway and modesty panel frame style is standard

MODEL	D x W	MODEL NUMBER						
		Worksurface	Edge Style	P/Up Location	Hgt	Tr Legs	Trim Color	Laminate
	24x30"	WBW24301	<input type="checkbox"/>	<input type="checkbox"/>	<input type="checkbox"/>	<input type="checkbox"/>	<input type="checkbox"/>	<input type="checkbox"/>
	24x36"	WBW24361	<input type="checkbox"/>	<input type="checkbox"/>	<input type="checkbox"/>	<input type="checkbox"/>	<input type="checkbox"/>	<input type="checkbox"/>
	24x42"	WBW24421	<input type="checkbox"/>	<input type="checkbox"/>	<input type="checkbox"/>	<input type="checkbox"/>	<input type="checkbox"/>	<input type="checkbox"/>
	24x48"	WBW24481	<input type="checkbox"/>	<input type="checkbox"/>	<input type="checkbox"/>	<input type="checkbox"/>	<input type="checkbox"/>	<input type="checkbox"/>
	24x54"	WBW24541	<input type="checkbox"/>	<input type="checkbox"/>	<input type="checkbox"/>	<input type="checkbox"/>	<input type="checkbox"/>	<input type="checkbox"/>
	30x30"	WBW30301	<input type="checkbox"/>	<input type="checkbox"/>	<input type="checkbox"/>	<input type="checkbox"/>	<input type="checkbox"/>	<input type="checkbox"/>
	30x36"	WBW30361	<input type="checkbox"/>	<input type="checkbox"/>	<input type="checkbox"/>	<input type="checkbox"/>	<input type="checkbox"/>	<input type="checkbox"/>
	30x42"	WBW30421	<input type="checkbox"/>	<input type="checkbox"/>	<input type="checkbox"/>	<input type="checkbox"/>	<input type="checkbox"/>	<input type="checkbox"/>
	30x48"	WBW30481	<input type="checkbox"/>	<input type="checkbox"/>	<input type="checkbox"/>	<input type="checkbox"/>	<input type="checkbox"/>	<input type="checkbox"/>
	30x54"	WBW30541	<input type="checkbox"/>	<input type="checkbox"/>	<input type="checkbox"/>	<input type="checkbox"/>	<input type="checkbox"/>	<input type="checkbox"/>
	24x60"	WBW24601	<input type="checkbox"/>	<input type="checkbox"/>	<input type="checkbox"/>	<input type="checkbox"/>	<input type="checkbox"/>	<input type="checkbox"/>
	24x72"	WBW24721	<input type="checkbox"/>	<input type="checkbox"/>	<input type="checkbox"/>	<input type="checkbox"/>	<input type="checkbox"/>	<input type="checkbox"/>
	30x60"	WBW30601	<input type="checkbox"/>	<input type="checkbox"/>	<input type="checkbox"/>	<input type="checkbox"/>	<input type="checkbox"/>	<input type="checkbox"/>
	30x72"	WBW30721	<input type="checkbox"/>	<input type="checkbox"/>	<input type="checkbox"/>	<input type="checkbox"/>	<input type="checkbox"/>	<input type="checkbox"/>

A **B** **C** **D** **E** **F** **G**

HOW TO ORDER

Indicate the following information on order form:

1. Quantity of each item.
2. Model number, including options. See "How to Build a Model Number."
3. Any special service required.

- Note:
- The indicates that a choice is required.
 - The absence of indicates that no choice is required.
 - Alpha-numeric characters in place of indicate that no other alternatives are available.

HOW TO BUILD A MODEL NUMBER

- A** Select size of worksurface.
B Select edge style.
T = Flat Vinyl T-edge
M = 3mm PVC edge
C Select PowerUp location.
L = Left
R = Right
C = Center
B = Left and right (60" and 72" only)
D Select height.
7 = 27"
9 = 29"
E Indicate location and type of leg.*
S = Standard (both standard legs)
R = Right (right transitional leg)
L = Left (left transitional leg)
B = Both (both transitional legs)

*Note: If ordering Basic Worksurface as a freestanding unit, or if only one side connects to a transitional worksurface, the "B" option for both transitional legs is not available.

• **Must order corresponding worksurface connector to attach to adjacent table when using transitional legs.**

- F** Select trim color for painted surfaces.
B = Black
G = Gray
S = Sand
W = Warm Gray
L = Light Tone
G Select laminate surface.
AA = Cream
AB = Champagne
AC = Barcelona
AF = Aruba Tan
AG = Black

- AH** = Dark Gray
AI = Dawn Gray (Greige)
AJ = Fog
AK = Black Grandin
AL = Smoke Granite
AM = Sand Grandin
AN = Light Granite
AO = Tundra
AP = Earthen
AQ = Rose Grafix
AS = Sierra Grafix
AT = Beige Grafix
AU = Sand Stone
AV = Kentucky Walnut
AW = Tennessee Oak
AX = Light Oak
AY = Red Birch
AZ = Ash
BA = Philadelphia Cherry
BB = Pennsylvania Cherry
BC = Mahogany



Edge Styles



T-Edge
Price **(T)**

3mm PVC Edge
Price **(M)**

27"	Total Weight	29"	T-Edge Price (T)	3mm PVC Edge Price (M)
66#	69#		\$ 220	\$ 230
73#	76#		225	235
80#	83#		230	240
86#	89#		235	245
93#	96#		245	255
73#	76#		220	230
80#	83#		225	235
89#	92#		230	240
97#	100#		235	245
103#	106#		245	255
98#	102#		250	260
111#	116#		265	275
109#	113#		250	260
122#	126#		265	275

- BE** = Maple
- BF** = Pearwood
- CA** = Pumice
- CB** = Rock Maple
- CC** = Medium Cherry
- CD** = Anigre
- ZZ** = COM

FINISH INFORMATION

Laminate Surface
See Keys for Progression swatch card.

ACCESSORIES

Casters
4 swivel casters (2½" diameter), 2 with locks. Add 2" to top surface height. Add 2lbs. to weight. Order separately, specify 87.2840
List price \$34.00/set

Worksurface Connectors
For attaching two freestanding tables together of same height. Black finish. Specify 87.4632.WZ.BL.
List price \$8.00

For attaching two freestanding tables together of different heights. Black finish. Specify 87.4624.WZ.BL.
List price \$12.00

Specifications and prices are subject to change without prior notice.

XXI Notes Worksurfaces with PowerUp

Level One

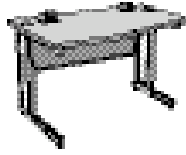

Curvilinear Worksurface

- One PowerUp module only on 42" to 54" wide surfaces.
- One or two PowerUp modules available on 60" and 72" wide surfaces.
- Wireway standard.
- Notched vertical wireway and modesty panel frame style is standard.

MODEL	D x W	MODEL NUMBER						
		Worksurface	Edge Style	P/Up Location	Hgt	Tr Legs	Trim Color	Laminate
	24x42x30"	WRC2442301	<input type="checkbox"/>	<input type="checkbox"/>	<input type="checkbox"/>	<input type="checkbox"/>	<input type="checkbox"/>	<input type="checkbox"/>
	24x48x30"	WRC2448301	<input type="checkbox"/>	<input type="checkbox"/>	<input type="checkbox"/>	<input type="checkbox"/>	<input type="checkbox"/>	<input type="checkbox"/>
	24x54x30"	WRC2454301	<input type="checkbox"/>	<input type="checkbox"/>	<input type="checkbox"/>	<input type="checkbox"/>	<input type="checkbox"/>	<input type="checkbox"/>
	24x60x30"	WRC2460301	<input type="checkbox"/>	<input type="checkbox"/>	<input type="checkbox"/>	<input type="checkbox"/>	<input type="checkbox"/>	<input type="checkbox"/>
	24x72x30"	WRC2472301	<input type="checkbox"/>	<input type="checkbox"/>	<input type="checkbox"/>	<input type="checkbox"/>	<input type="checkbox"/>	<input type="checkbox"/>
	30x42x24"	WRC3042241	<input type="checkbox"/>	<input type="checkbox"/>	<input type="checkbox"/>	<input type="checkbox"/>	<input type="checkbox"/>	<input type="checkbox"/>
	30x48x24"	WRC3048241	<input type="checkbox"/>	<input type="checkbox"/>	<input type="checkbox"/>	<input type="checkbox"/>	<input type="checkbox"/>	<input type="checkbox"/>
	30x54x24"	WRC3054241	<input type="checkbox"/>	<input type="checkbox"/>	<input type="checkbox"/>	<input type="checkbox"/>	<input type="checkbox"/>	<input type="checkbox"/>
	30x60x24"	WRC3060241	<input type="checkbox"/>	<input type="checkbox"/>	<input type="checkbox"/>	<input type="checkbox"/>	<input type="checkbox"/>	<input type="checkbox"/>
	30x72x24"	WRC3072241	<input type="checkbox"/>	<input type="checkbox"/>	<input type="checkbox"/>	<input type="checkbox"/>	<input type="checkbox"/>	<input type="checkbox"/>
	30x36"	WSU30361	<input type="checkbox"/>	<input type="checkbox"/>	2	S	<input type="checkbox"/>	<input type="checkbox"/>



Stand Alone Stand-Up Worksurface

- Available in 42" height only
- Not available with transitional legs.
- One PowerUp module.
- Wireway standard.
- Notched vertical wireway and modesty panel frame style is standard.

A **B** **C** **D** **E** **F** **G**

HOW TO ORDER

Indicate the following information on order form:

1. Quantity of each item.
2. Model number, including options. See "How to Build a Model Number."
3. Any special service required.

- Note:
- The indicates that a choice is required.
 - The absence of indicates that no choice is required.
 - Alpha-numeric characters in place of indicate that no other alternatives are available.

HOW TO BUILD A MODEL NUMBER

- A** Select size of worksurface.
B Select edge style.
T = Flat Vinyl T-edge
M = 3mm PVC edge
C Select PowerUp location.
L = Left
R = Right
C = Center
B = Left and right (60" and 72" only)
D Select height.
2 = 42"
7 = 27"
9 = 29"
E Indicate location and type of leg.*
S = Standard (both standard legs)
R = Right (right transitional leg)
L = Left (left transitional leg)

*Note: If ordering Basic Worksurface as a freestanding unit, or if only one side connects to a transitional worksurface, the "B" option for both transitional legs is not available.

• **Must order corresponding worksurface connector to attach to adjacent table when using transitional legs.**

- F** Select trim color for painted surfaces.
B = Black
G = Gray
S = Sand
W = Warm Gray
L = Light Tone
G Select laminate surface.
AA = Cream
AB = Champagne
AC = Barcelona
AF = Aruba Tan
AG = Black

- AH** = Dark Gray
AI = Dawn Gray (Greige)
AJ = Fog
AK = Black Grandin
AL = Smoke Granite
AM = Sand Grandin
AN = Light Granite
AO = Tundra
AP = Earthen
AQ = Rose Grafix
AS = Sierra Grafix
AT = Beige Grafix
AU = Sand Stone
AV = Kentucky Walnut
AW = Tennessee Oak
AX = Light Oak
AY = Red Birch
AZ = Ash
BA = Philadelphia Cherry
BB = Pennsylvania Cherry
BC = Mahogany



Edge Styles



T-Edge
Price (T)

3mm PVC Edge
Price (M)

Total Weight
27" 29" 42"

27"	29"	42"	T-Edge Price (T)	3mm PVC Edge Price (M)
81#	84#		\$230	\$240
88#	91#		235	245
95#	98#		245	255
100#	103#		250	260
114#	117#		265	275
81#	84#		230	240
88#	91#		235	245
95#	98#		245	255
100#	103#		250	260
114#	117#		265	275
94#			\$255	\$270

- BE** = Maple

- BF** = Pearwood

- CA** = Pumice

- CB** = Rock Maple

- CC** = Medium Cherry

- CD** = Anigre

- ZZ** = COM

FINISH INFORMATION

Laminate Surface
See Keys for Progression swatch card.

ACCESSORIES

Casters
4 swivel casters (2½" diameter), 2 with locks.
Add 2" to top surface height. Add 2lbs. to weight.
Order separately, specify 87.2840
List price \$34.00/set



Worksurface Connectors
For attaching two freestanding tables together
of same height. Black finish.
Specify 87.4632.WZ.BL.
List price \$8.00

For attaching two freestanding tables together
of different heights. Black finish.
Specify 87.4624.WZ.BL.
List price \$12.00

Specifications and prices are subject to change without prior notice.

XXI Notes Worksurfaces with PowerUp

Level One

MODEL	D x W	MODEL NUMBER							
		Worksurface	Edge Style	P/Up Location	Hgt	Tr Legs	Trim Color	Laminate	
 <p>Adjustable Keyboard Pad Worksurface</p> <ul style="list-style-type: none"> • One PowerUp module • Only center keypad available on 36" and 42" worksurfaces • Wireway standard • Notched vertical wireway and modesty panel frame style is standard 	24x36"	WAK24361	<input type="checkbox"/>	<input type="checkbox"/>	<input type="checkbox"/>	<input type="checkbox"/>	<input type="checkbox"/>	<input type="checkbox"/>	
	24x42"	WAK24421	<input type="checkbox"/>	<input type="checkbox"/>	<input type="checkbox"/>	<input type="checkbox"/>	<input type="checkbox"/>	<input type="checkbox"/>	
	24x48"	WAK24481	<input type="checkbox"/>	<input type="checkbox"/>	<input type="checkbox"/>	<input type="checkbox"/>	<input type="checkbox"/>	<input type="checkbox"/>	
	24x54"	WAK24541	<input type="checkbox"/>	<input type="checkbox"/>	<input type="checkbox"/>	<input type="checkbox"/>	<input type="checkbox"/>	<input type="checkbox"/>	
	30x36"	WAK30361	<input type="checkbox"/>	<input type="checkbox"/>	<input type="checkbox"/>	<input type="checkbox"/>	<input type="checkbox"/>	<input type="checkbox"/>	
	30x42"	WAK30421	<input type="checkbox"/>	<input type="checkbox"/>	<input type="checkbox"/>	<input type="checkbox"/>	<input type="checkbox"/>	<input type="checkbox"/>	
	30x48"	WAK30481	<input type="checkbox"/>	<input type="checkbox"/>	<input type="checkbox"/>	<input type="checkbox"/>	<input type="checkbox"/>	<input type="checkbox"/>	
	30x54"	WAK30541	<input type="checkbox"/>	<input type="checkbox"/>	<input type="checkbox"/>	<input type="checkbox"/>	<input type="checkbox"/>	<input type="checkbox"/>	
 <ul style="list-style-type: none"> • One or two PowerUp modules available on 60" and 72" wide surfaces. • Left and right data location only available on 60" and 72" worksurface. • Wireway standard • Notched vertical wireway and modesty panel frame style is standard 	24x60"	WAK24601	<input type="checkbox"/>	<input type="checkbox"/>	<input type="checkbox"/>	<input type="checkbox"/>	<input type="checkbox"/>	<input type="checkbox"/>	
	24x72"	WAK24721	<input type="checkbox"/>	<input type="checkbox"/>	<input type="checkbox"/>	<input type="checkbox"/>	<input type="checkbox"/>	<input type="checkbox"/>	
	30x60"	WAK30601	<input type="checkbox"/>	<input type="checkbox"/>	<input type="checkbox"/>	<input type="checkbox"/>	<input type="checkbox"/>	<input type="checkbox"/>	
	30x72"	WAK30721	<input type="checkbox"/>	<input type="checkbox"/>	<input type="checkbox"/>	<input type="checkbox"/>	<input type="checkbox"/>	<input type="checkbox"/>	
			A	B	C	D	E	F	G

HOW TO ORDER

Indicate the following information on order form:

- Quantity of each item.
- Model number, including options. See "How to Build a Model Number."
- Any special service required.

- Note:
- The indicates that a choice is required.
 - The absence of indicates that no choice is required.
 - Alpha-numeric characters in place of indicate that no other alternatives are available.

HOW TO BUILD A MODEL NUMBER

- A** Select size of worksurface.

- B** Select edge style.
 - T** = Flat Vinyl T-edge
 - M** = 3mm PVC edge
- C** Select PowerUp location.
 - L** = Left
 - R** = Right
 - C** = Center
 - B** = Left and right (60" and 72" only)
- D** Select height.
 - 7** = 27"
 - 9** = 29"
- E** Indicate location and type of leg.*
 - S** = Standard (both standard legs)
 - R** = Right (right transitional leg)
 - L** = Left (left transitional leg)
 - B** = Both (both transitional legs)

*Note: If ordering Basic Worksurface as a freestanding unit, or if only one side connects to a transitional worksurface, the "B" option for both transitional legs is not available.

• **Must order corresponding worksurface connector to attach to adjacent table when using transitional legs.**

- F** Select trim color for painted surfaces.
 - B** = Black
 - G** = Gray
 - S** = Sand
 - W** = Warm Gray
 - L** = Light Tone
- G** Select laminate surface.
 - AA** = Cream
 - AB** = Champagne
 - AC** = Barcelona
 - AF** = Aruba Tan
 - AG** = Black

- AH** = Dark Gray
- AI** = Dawn Gray (Greige)
- AJ** = Fog
- AK** = Black Grandin
- AL** = Smoke Granite
- AM** = Sand Grandin
- AN** = Light Granite
- AO** = Tundra
- AP** = Earthen
- AQ** = Rose Grafix
- AS** = Sierra Grafix
- AT** = Beige Grafix
- AU** = Sand Stone
- AV** = Kentucky Walnut
- AW** = Tennessee Oak
- AX** = Light Oak
- AY** = Red Birch
- AZ** = Ash
- BA** = Philadelphia Cherry
- BB** = Pennsylvania Cherry
- BC** = Mahogany



Edge Styles



T-Edge
Price **(T)**

3mm PVC Edge
Price **(M)**

Total Weight
27" 29"

27"	Total Weight	29"	T-Edge Price (T)	3mm PVC Edge Price (M)
74#		77#	\$235	\$245
81#		84#	240	250
87#		90#	245	260
93#		96#	255	270
81#		84#	235	245
90#		93#	240	250
98#		101#	245	260
106#		110#	255	270
99#		103#	260	275
112#		126#	275	290
110#		114#	260	275
126#		130#	275	290

- BE** = Maple
- BF** = Pearwood
- CA** = Pumice
- CB** = Rock Maple
- CC** = Medium Cherry
- CD** = Anigre
- ZZ** = COM

FINISH INFORMATION

Laminate Surface
See Keys for Progression swatch card.

ACCESSORIES

Casters
4 swivel casters (2½" diameter), 2 with locks.
Add 2" to top surface height. Add 2lbs. to weight.
Order separately, specify 87.2840
List price \$34.00/set

Worksurface Connectors
For attaching two freestanding tables together
of same height. Black finish.
Specify 87.4632.WZ.BL.
List price \$8.00

For attaching two freestanding tables together
of different heights. Black finish.
Specify 87.4624.WZ.BL.
List price \$12.00

Specifications and prices are subject to change without prior notice.

XXI Notes Worksurfaces with PowerUp

Level One

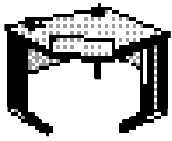

Stand Alone Corner Worksurface with Keyboard

- Not available with transitional legs
- Wireway standard
- Only center keypad available
- Notched vertical wireway and modesty panel frame style is standard



Stand Alone Corner Worksurface

- Not available with transitional legs
- Wireway standard
- Notched vertical wireway and modesty panel frame style is standard

MODEL	D x W	MODEL NUMBER							
		Worksurface	Edge Style	Keypad Location	P/Up Location	Hgt	Tr Legs	Trim Color	Laminate
Stand Alone Corner Worksurface with Keyboard	24x42"	WCS24421	<input type="checkbox"/>	<input type="checkbox"/>	<input type="checkbox"/>	<input type="checkbox"/>	<input type="checkbox"/>	<input type="checkbox"/>	<input type="checkbox"/>
	30x48"	WCS30481	<input type="checkbox"/>	<input type="checkbox"/>	<input type="checkbox"/>	<input type="checkbox"/>	<input type="checkbox"/>	<input type="checkbox"/>	<input type="checkbox"/>
Stand Alone Corner Worksurface	24x36"	WCSK24361	<input type="checkbox"/>	NA	<input type="checkbox"/>	<input type="checkbox"/>	<input type="checkbox"/>	<input type="checkbox"/>	<input type="checkbox"/>
	24x72"	WCSK24721	<input type="checkbox"/>	NA	<input type="checkbox"/>	<input type="checkbox"/>	<input type="checkbox"/>	<input type="checkbox"/>	<input type="checkbox"/>
	30x48"	WCSK30481	<input type="checkbox"/>	NA	<input type="checkbox"/>	<input type="checkbox"/>	<input type="checkbox"/>	<input type="checkbox"/>	<input type="checkbox"/>

A B C D E F G H

HOW TO ORDER

Indicate the following information on order form:

- Quantity of each item.
- Model number, including options. See "How to Build a Model Number."
- Any special service required.

- Note:
- The indicates that a choice is required.
 - The absence of indicates that no choice is required.
 - Alpha-numeric characters in place of indicate that no other alternatives are available.

HOW TO BUILD A MODEL NUMBER

- A** Select size of worksurface.
B Select edge style.
T = Flat Vinyl T-edge
M = 3mm PVC edge
C Select keypad location.
C = Center
R = Right
L = Left
D Select PowerUp location.
L = Left
R = Right
C = Center
B = Left and right (60" and 72" only)
E Select height.
7 = 27"
9 = 29"
- F** Indicate location and type of leg.*
S = Standard (both standard legs)
R = Right (right transitional leg)
L = Left (left transitional leg)
B = Both (both transitional legs)
 *Note: If ordering Basic Worksurface as a freestanding unit, or if only one side connects to a transitional worksurface, the "B" option for both transitional legs is not available.
G Select trim color for painted surfaces.
B = Black
G = Gray
S = Sand
W = Warm Gray
L = Light Tone
H Select laminate surface.
AA = Cream
AB = Champagne
AC = Barcelona
AF = Aruba Tan
AG = Black
AH = Dark Gray
AI = Dawn Gray (Greige)
AJ = Fog
AK = Black Grandin
AL = Smoke Granite
AM = Sand Grandin
AN = Light Granite
AO = Tundra
AP = Earthen
AQ = Rose Grafix
AS = Sierra Grafix
AT = Beige Grafix
AU = Sand Stone
AV = Kentucky Walnut
- **Must order corresponding worksurface connector to attach to adjacent table when using transitional legs.**



Edge Styles



T-Edge
Price **(T)**

3mm PVC Edge
Price **(M)**

Total Weight
27" 29"

Joins Table

97#	99#	225	235	24" deep worksurface to 24" deep worksurface
116#	118#	235	245	30" deep worksurface to 30" deep worksurface

73#	76#	260	270
93#	96#	280	295
115#	118#	300	315

- AW** = Tennessee Oak
- AX** = Light Oak
- AY** = Red Birch
- AZ** = Ash
- BA** = Philadelphia Cherry
- BB** = Pennsylvania Cherry
- BC** = Mahogany
- BD** = Oak
- BE** = Maple
- BF** = Pearwood
- CA** = Pumice
- CB** = Rock Maple
- CC** = Medium Cherry
- CD** = Anigre
- ZZ** = COM

FINISH INFORMATION

Laminate Surface
See Keys for Progression swatch card.

ACCESSORIES

Casters
4 swivel casters (2½" diameter), 2 with locks.
Add 2" to top surface height. Add 2lbs. to weight.
Order separately, specify 87.2840
List price \$34.00/set



Worksurface Connectors
For attaching two freestanding tables together
of same height. Black finish.
Specify 87.4632.WZ.BL.
List price \$8.00

For attaching two freestanding tables together
of different heights. Black finish.
Specify 87.4624.WZ.BL.
List price \$12.00

Specifications and prices are subject to change without prior notice.

XXI Notes Worksurfaces with PowerUp

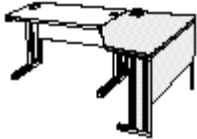
Level One

MODEL	Left D x W x D	Right D x W x D	MODEL NUMBER								
			Worksurface	Edge Style	P/Up Location	Trans Direct	Hgt	Trim Color	Laminate		
 End-of-Run Worksurface with Keyboard <ul style="list-style-type: none"> • 36" width not available with key pad • 42" and 48" widths available with center keypad and bullnose edge • Transition direction is figured from the originating 24" or 30" basic or keyboard pad worksurface • Wireway standard • Notched vertical wireway and modesty panel frame style is standard 	24x42x42x24"	24x48x48x24"	30x48x48x30"	WERK24421	<input type="checkbox"/>	<input type="checkbox"/>	<input type="checkbox"/>	<input type="checkbox"/>	<input type="checkbox"/>	<input type="checkbox"/>	<input type="checkbox"/>
				WERK24481	<input type="checkbox"/>	<input type="checkbox"/>	<input type="checkbox"/>	<input type="checkbox"/>	<input type="checkbox"/>	<input type="checkbox"/>	<input type="checkbox"/>
				WERK30481	<input type="checkbox"/>	<input type="checkbox"/>	<input type="checkbox"/>	<input type="checkbox"/>	<input type="checkbox"/>	<input type="checkbox"/>	<input type="checkbox"/>
 End-of-Run Worksurface <ul style="list-style-type: none"> • Wireway standard • Notched vertical wireway and modesty panel frame style is standard 	24x42x42x24"	24x48x48x24"	30x48x48x30"	WER24421	<input type="checkbox"/>	<input type="checkbox"/>	<input type="checkbox"/>	<input type="checkbox"/>	<input type="checkbox"/>	<input type="checkbox"/>	
				WER24481	<input type="checkbox"/>	<input type="checkbox"/>	<input type="checkbox"/>	<input type="checkbox"/>	<input type="checkbox"/>	<input type="checkbox"/>	
				WER30481	<input type="checkbox"/>	<input type="checkbox"/>	<input type="checkbox"/>	<input type="checkbox"/>	<input type="checkbox"/>	<input type="checkbox"/>	
 End-of-Run Curvilinear Worksurface <ul style="list-style-type: none"> • Wireway standard • Notched vertical wireway and modesty panel frame style is standard 	24x36x36x24"	24x42x42x24"	24x48x48x24"	30x42x42x30"	30x48x48x30"	WCCE24361	<input type="checkbox"/>	<input type="checkbox"/>	<input type="checkbox"/>	<input type="checkbox"/>	<input type="checkbox"/>
						WCCE24421	<input type="checkbox"/>	<input type="checkbox"/>	<input type="checkbox"/>	<input type="checkbox"/>	<input type="checkbox"/>
						WCCE24481	<input type="checkbox"/>	<input type="checkbox"/>	<input type="checkbox"/>	<input type="checkbox"/>	<input type="checkbox"/>
						WCCE30421	<input type="checkbox"/>	<input type="checkbox"/>	<input type="checkbox"/>	<input type="checkbox"/>	<input type="checkbox"/>
						WCCE30481	<input type="checkbox"/>	<input type="checkbox"/>	<input type="checkbox"/>	<input type="checkbox"/>	<input type="checkbox"/>
				A	B	C	D	E	F	G	

HOW TO ORDER

Indicate the following information on order form:

- Quantity of each item.
- Model number, including options. See "How to Build a Model Number."
- Any special service required.

Note:

- The indicates that a choice is required.
- The absence of indicates that no choice is required.
- Alpha-numeric characters in place of indicate that no other alternatives are available.

HOW TO BUILD A MODEL NUMBER

- A** Select size of worksurface.
B Select edge style.
T = Flat Vinyl T-edge
M = 3mm PVC edge
- C** Select PowerUp location.
L = Left
R = Right
C = Center
B = Left and right (60" and 72" only)
- D** Select transitional direction.
L = Left
R = Right
- E** Select height.
2 = 42"
7 = 27"
9 = 29"
- F** Select trim color for painted surfaces.
B = Black
G = Gray
S = Sand
W = Warm Gray
L = Light Tone
- G** Select laminate surface.
AA = Cream
AB = Champagne
AC = Barcelona
AF = Aruba Tan
AG = Black
AH = Dark Gray
AI = Dawn Gray (Greige)
AJ = Fog
AK = Black Grandin
AL = Smoke Granite
AM = Sand Grandin
AN = Light Granite

- AO** = Tundra
AP = Earthen
AQ = Rose Grafix
AS = Sierra Grafix
AT = Beige Grafix
AU = Sand Stone
AV = Kentucky Walnut
AW = Tennessee Oak
AX = Light Oak
AY = Red Birch
AZ = Ash
BA = Philadelphia Cherry
BB = Pennsylvania Cherry
BC = Mahogany
BD = Oak
BE = Maple
BF = Pearwood
CA = Pumice
CB = Rock Maple
CC = Medium Cherry
CD = Anigre



Edge Styles



Total Weight
27" 29"

T-Edge
Price **(T)**

3mm PVC Edge
Price **(M)**

Joins Table

78# 215 225 24" deep worksurface to 24" deep worksurface

102# 265 280 30" deep worksurface to 30" deep worksurface

78# 220 230 24" deep worksurface to 24" deep worksurface

82# 270 285 24" deep worksurface to 24" deep worksurface

100# 270 285 30" deep worksurface to 30" deep worksurface

76# 195 205 24" deep worksurface to 24" deep worksurface

96# 220 230 24" deep worksurface to 24" deep worksurface

106# 270 285 24" deep worksurface to 24" deep worksurface

108# 220 230 30" deep worksurface to 30" deep worksurface

118# 270 285 30" deep worksurface to 30" deep worksurface

FINISH INFORMATION

Laminate Surface

See Keys for Progression swatch card.

ACCESSORIES

Casters

4 swivel casters (2½" diameter), 2 with locks. Add 2" to top surface height. Add 2lbs. to weight. Order separately, specify 87.2840

List price \$34.00/set

Worksurface Connectors

For attaching two freestanding tables together of same height. Black finish. Specify 87.4632.WZ.BL.

List price \$8.00





For attaching two freestanding tables together of different heights. Black finish. Specify 87.4624.WZ.BL.

List price \$12.00

Specifications and prices are subject to change without prior notice.

XXI Notes Worksurfaces with PowerUp

Level One

MODEL	Left D x W x D	Right D x W x D	MODEL NUMBER						
			Worksurface	Edge Style	P/Up Location	Hgt	Tr Legs	Trim Color	Laminate
 Corner Transitional Worksurface • One PowerUp module • Wireway standard • Notched vertical wireway and modesty panel frame style is standard	24x36"		CT24361	<input type="checkbox"/>	<input type="checkbox"/>	<input type="checkbox"/>	<input type="checkbox"/>	<input type="checkbox"/>	<input type="checkbox"/>
	24x42"		CT24421	<input type="checkbox"/>	<input type="checkbox"/>	<input type="checkbox"/>	<input type="checkbox"/>	<input type="checkbox"/>	<input type="checkbox"/>
	30x48"		CT30481	<input type="checkbox"/>	<input type="checkbox"/>	<input type="checkbox"/>	<input type="checkbox"/>	<input type="checkbox"/>	<input type="checkbox"/>
 Corner Transitional Worksurface with Keyboard Pad • One PowerUp module • Wireway standard • Available with center keypad and bullnose edge • Notched vertical wireway and modesty panel frame style is standard	24x42"		CTK24421	<input type="checkbox"/>	<input type="checkbox"/>	<input type="checkbox"/>	<input type="checkbox"/>	<input type="checkbox"/>	<input type="checkbox"/>
	30x48"		CTK30481	<input type="checkbox"/>	<input type="checkbox"/>	<input type="checkbox"/>	<input type="checkbox"/>	<input type="checkbox"/>	<input type="checkbox"/>
 Corner Transitional Reduction Worksurface • One PowerUp module • Wireway standard • Notched vertical wireway and modesty panel frame style is standard	24x42x42x30"		CT2442301	<input type="checkbox"/>	<input type="checkbox"/>	<input type="checkbox"/>	<input type="checkbox"/>	<input type="checkbox"/>	<input type="checkbox"/>
	24x48x48x30"		CT2448301	<input type="checkbox"/>	<input type="checkbox"/>	<input type="checkbox"/>	<input type="checkbox"/>	<input type="checkbox"/>	<input type="checkbox"/>
	30x42x42x24"		CT3042241	<input type="checkbox"/>	<input type="checkbox"/>	<input type="checkbox"/>	<input type="checkbox"/>	<input type="checkbox"/>	<input type="checkbox"/>
	30x48x48x24"		CT3048241	<input type="checkbox"/>	<input type="checkbox"/>	<input type="checkbox"/>	<input type="checkbox"/>	<input type="checkbox"/>	<input type="checkbox"/>
 Corner Curvilinear Transitional Worksurface • One PowerUp module • Wireway standard • Notched vertical wireway and modesty panel frame style is standard	24x36x36x24"		CCT24361	<input type="checkbox"/>	<input type="checkbox"/>	<input type="checkbox"/>	<input type="checkbox"/>	<input type="checkbox"/>	<input type="checkbox"/>
	24x42x42x24"		CCT24421	<input type="checkbox"/>	<input type="checkbox"/>	<input type="checkbox"/>	<input type="checkbox"/>	<input type="checkbox"/>	<input type="checkbox"/>
	24x48x48x24"		CCT24481	<input type="checkbox"/>	<input type="checkbox"/>	<input type="checkbox"/>	<input type="checkbox"/>	<input type="checkbox"/>	<input type="checkbox"/>
	30x42x42x30"		CCT30421	<input type="checkbox"/>	<input type="checkbox"/>	<input type="checkbox"/>	<input type="checkbox"/>	<input type="checkbox"/>	<input type="checkbox"/>
	30x48x48x30"		CCT30481	<input type="checkbox"/>	<input type="checkbox"/>	<input type="checkbox"/>	<input type="checkbox"/>	<input type="checkbox"/>	<input type="checkbox"/>
 Corner Curvilinear Transitional Reduction Worksurface • One PowerUp module • Wireway standard • Notched vertical wireway and modesty panel frame style is standard	24x42x42x30"		CCT2442301	<input type="checkbox"/>	<input type="checkbox"/>	<input type="checkbox"/>	<input type="checkbox"/>	<input type="checkbox"/>	<input type="checkbox"/>
	24x48x48x30"		CCT2448301	<input type="checkbox"/>	<input type="checkbox"/>	<input type="checkbox"/>	<input type="checkbox"/>	<input type="checkbox"/>	<input type="checkbox"/>
	30x42x42x24"		CCT3042241	<input type="checkbox"/>	<input type="checkbox"/>	<input type="checkbox"/>	<input type="checkbox"/>	<input type="checkbox"/>	<input type="checkbox"/>
	30x48x48x24"		CCT3048241	<input type="checkbox"/>	<input type="checkbox"/>	<input type="checkbox"/>	<input type="checkbox"/>	<input type="checkbox"/>	<input type="checkbox"/>

A B C D E F G

HOW TO ORDER

Indicate the following information on order form:

- Quantity of each item.
- Model number, including options. See "How to Build a Model Number."
- Any special service required.

- Note:
- The indicates that a choice is required.
 - The absence of indicates that no choice is required.
 - Alpha-numeric characters in place of indicate that no other alternatives are available.

HOW TO BUILD A MODEL NUMBER

- A** Select size of worksurface.

- B** Select edge style.

T = Flat Vinyl T-edge
M = 3mm PVC edge
- C** Select PowerUp location.

L = Left
R = Right
C = Center
B = Left and right (60" and 72" only)
- D** Select height.

2 = 42"
7 = 27"
9 = 29"

- E** Indicate location and type of leg.*

S = Standard (both standard legs)
R = Right (right transitional leg)
L = Left (left transitional leg)
B = Both (both transitional legs)

*Note: If ordering Basic Worksurface as a freestanding unit, or if only one side connects to a transitional worksurface, the "B" option for both transitional legs is not available.

- **Must order corresponding worksurface connector to attach to adjacent table when using transitional legs.**

- F** Select trim color for painted surfaces.

B = Black
G = Gray
S = Sand
W = Warm Gray
L = Light Tone

- G** Select laminate surface.

AA = Cream
AB = Champagne
AC = Barcelona
AF = Aruba Tan
AG = Black
AH = Dark Gray
AI = Dawn Gray (Greige)
AJ = Fog
AK = Black Grandin
AL = Smoke Granite
AM = Sand Grandin
AN = Light Granite
AO = Tundra
AP = Earthen
AQ = Rose Grafix
AS = Sierra Grafix
AT = Beige Grafix
AU = Sand Stone
AV = Kentucky Walnut



Edge Styles



Total Weight
27" 29"

T-Edge
Price (T)

3mm PVC Edge
Price (M)

Joins Table

72#	\$200	\$210	24" deep worksurface to 24" deep worksurface
80#	205	215	24" deep worksurface to 24" deep worksurface
102#	240	250	30" deep worksurface to 30" deep worksurface
80#	150	160	24" deep worksurface to 24" deep worksurface
102#	160	170	30" deep worksurface to 30" deep worksurface
96#	225	235	24" deep worksurface to 30" deep worksurface
102#	245	260	24" deep worksurface to 30" deep worksurface
96#	225	235	30" deep worksurface to 24" deep worksurface
102#	245	260	30" deep worksurface to 24" deep worksurface
72#	165	175	24" deep worksurface to 24" deep worksurface
80#	175	185	24" deep worksurface to 24" deep worksurface
102#	190	200	24" deep worksurface to 24" deep worksurface
90#	200	210	30" deep worksurface to 30" deep worksurface
102#	215	225	30" deep worksurface to 30" deep worksurface
96#	225	235	24" deep worksurface to 30" deep worksurface
102#	245	260	24" deep worksurface to 30" deep worksurface
96#	225	235	30" deep worksurface to 24" deep worksurface
102#	245	260	30" deep worksurface to 24" deep worksurface

- AW** = Tennessee Oak
- AX** = Light Oak
- AY** = Red Birch
- AZ** = Ash
- BA** = Philadelphia Cherry
- BB** = Pennsylvania Cherry
- BC** = Mahogany
- BD** = Oak
- BE** = Maple
- BF** = Pearwood
- CA** = Pumice
- CB** = Rock Maple
- CC** = Medium Cherry
- CD** = Anigre
- ZZ** = COM

FINISH INFORMATION

Laminate Surface
See Keys for Progression swatch card.

ACCESSORIES

Casters
4 swivel casters (2½" diameter), 2 with locks.
Add 2" to top surface height. Add 2lbs. to weight.
Order separately, specify 87.2840
List price \$34.00/set



Worksurface Connectors
For attaching two freestanding tables together
of same height. Black finish.
Specify 87.4632.WZ.BL.
List price \$8.00

For attaching two freestanding tables together
of different heights. Black finish.
Specify 87.4624.WZ.BL.
List price \$12.00

Specifications and prices are subject to change without prior notice.

XXI Notes Worksurfaces with PowerUp

Level One

MODEL	Left D x W x D	Right W x D	MODEL NUMBER					
			Worksurface	Edge Style	P/Up Location	Hgt	Trim Color	Laminate
 <p>Stand Alone Corner Reduction Worksurface</p> <ul style="list-style-type: none"> • Not available with transitional legs • One PowerUp module • Wireway standard • Notched vertical wireway and modesty panel frame style is standard 	24x42x42x30"		WCS2442301	<input type="checkbox"/>	<input type="checkbox"/>	<input type="checkbox"/>	<input type="checkbox"/>	<input type="checkbox"/>
	24x48x48x30"		WCS2448301	<input type="checkbox"/>	<input type="checkbox"/>	<input type="checkbox"/>	<input type="checkbox"/>	<input type="checkbox"/>
	30x42x42x24"		WCS3042241	<input type="checkbox"/>	<input type="checkbox"/>	<input type="checkbox"/>	<input type="checkbox"/>	<input type="checkbox"/>
	30x48x48x24"		WCS3048241	<input type="checkbox"/>	<input type="checkbox"/>	<input type="checkbox"/>	<input type="checkbox"/>	<input type="checkbox"/>
 <p>Stand Alone Corner Curvilinear Worksurface</p> <ul style="list-style-type: none"> • Not available with transitional legs • One PowerUp module • Wireway standard • Notched vertical wireway and modesty panel frame style is standard 	24x36x36x24"		WCC24361	<input type="checkbox"/>	<input type="checkbox"/>	<input type="checkbox"/>	<input type="checkbox"/>	<input type="checkbox"/>
	24x42x42x24"		WCC24421	<input type="checkbox"/>	<input type="checkbox"/>	<input type="checkbox"/>	<input type="checkbox"/>	<input type="checkbox"/>
	24x48x48x24"		WCC24481	<input type="checkbox"/>	<input type="checkbox"/>	<input type="checkbox"/>	<input type="checkbox"/>	<input type="checkbox"/>
	30x42x42x30"		WCC30421	<input type="checkbox"/>	<input type="checkbox"/>	<input type="checkbox"/>	<input type="checkbox"/>	<input type="checkbox"/>
	30x48x48x30"		WCC30481	<input type="checkbox"/>	<input type="checkbox"/>	<input type="checkbox"/>	<input type="checkbox"/>	<input type="checkbox"/>
 <p>Stand Alone Corner Curvilinear Reduction Worksurface</p> <ul style="list-style-type: none"> • Not available with transitional legs • One PowerUp module • Wireway standard • Notched vertical wireway and modesty panel frame style is standard 	24x42x42x30"		CCS2442301	<input type="checkbox"/>	<input type="checkbox"/>	<input type="checkbox"/>	<input type="checkbox"/>	<input type="checkbox"/>
	24x48x48x30"		CCS2448301	<input type="checkbox"/>	<input type="checkbox"/>	<input type="checkbox"/>	<input type="checkbox"/>	<input type="checkbox"/>
	30x42x42x24"		CCS3042241	<input type="checkbox"/>	<input type="checkbox"/>	<input type="checkbox"/>	<input type="checkbox"/>	<input type="checkbox"/>
	30x48x48x24"		CCS3048241	<input type="checkbox"/>	<input type="checkbox"/>	<input type="checkbox"/>	<input type="checkbox"/>	<input type="checkbox"/>

A B C D E F

HOW TO ORDER

Indicate the following information on order form:

- Quantity of each item.
- Model number, including options. See "How to Build a Model Number."
- Any special service required.

- Note:
- The indicates that a choice is required.
 - The absence of indicates that no choice is required.
 - Alpha-numeric characters in place of indicate that no other alternatives are available.

HOW TO BUILD A MODEL NUMBER

- A** Select size of worksurface.
B Select edge style.
C Select PowerUp location.
D Select height.
- E** Select trim color for painted surfaces.
- F** Select laminate surface.
- T** = Flat Vinyl T-edge
M = 3mm PVC edge
- L** = Left
R = Right
C = Center
B = Left and right (60" and 72" only)
- 2** = 42"
7 = 27"
9 = 29"
- B** = Black
G = Gray
S = Sand
W = Warm Gray
L = Light Tone
- AA** = Cream
AB = Champagne
AC = Barcelona
AF = Aruba Tan
AG = Black
AH = Dark Gray
AI = Dawn Gray (Greige)
AJ = Fog
AK = Black Grandin
AL = Smoke Granite
AM = Sand Grandin
AN = Light Granite

- AO** = Tundra
AP = Earthen
AQ = Rose Grafix
AS = Sierra Grafix
AT = Beige Grafix
AU = Sand Stone
AV = Kentucky Walnut
AW = Tennessee Oak
AX = Light Oak
AY = Red Birch
AZ = Ash
BA = Philadelphia Cherry
BB = Pennsylvania Cherry
BC = Mahogany
BD = Oak
BE = Maple
BF = Pearwood
CA = Pumice
CB = Rock Maple
CC = Medium Cherry
CD = Anigre



Edge Styles



Total Weight
27" 29"

T-Edge
Price **(T)**

3mm PVC Edge
Price **(M)**

93#	96#	280	295
99#	102#	300	315
93#	96#	280	295
99#	102#	300	315
73#	76#	260	270
93#	96#	280	295
103#	106#	300	315
105#	108#	280	295
115#	118#	300	315
93#	96#	280	295
99#	102#	300	315
93#	96#	280	295
99#	102#	300	315

FINISH INFORMATION

Laminate Surface

See Keys for Progression swatch card.

ACCESSORIES

Casters

4 swivel casters (2½" diameter), 2 with locks.
Add 2" to top surface height. Add 2lbs. to weight.
Order separately, specify 87.2840

List price \$34.00/set

Worksurface Connectors

For attaching two freestanding tables together
of same height. Black finish.
Specify 87.4632.WZ.BL.

List price \$8.00



For attaching two freestanding tables together
of different heights. Black finish.
Specify 87.4624.WZ.BL.

List price \$12.00

**Specifications and prices are subject to
change without prior notice.**

XXI Notes Worksurfaces with PowerUp

Level One

MODEL	D x W x L	MODEL NUMBER							
		Worksurface	Edge Style	Surface Direct	P/Up Location	Hgt	Tr Legs	Trim Color	Laminate
 "P" Shaped Peninsula Worksurface • One PowerUp module • Wireway standard • Notched vertical wireway and modesty panel frame style is standard	24x48x60"	ZPT2448601	<input type="checkbox"/>	<input type="checkbox"/>	<input type="checkbox"/>	<input type="checkbox"/>	<input type="checkbox"/>	<input type="checkbox"/>	<input type="checkbox"/>
	24x48x72"	ZPT2448721	<input type="checkbox"/>	<input type="checkbox"/>	<input type="checkbox"/>	<input type="checkbox"/>	<input type="checkbox"/>	<input type="checkbox"/>	<input type="checkbox"/>
	30x48x72"	ZPT3048721	<input type="checkbox"/>	<input type="checkbox"/>	<input type="checkbox"/>	<input type="checkbox"/>	<input type="checkbox"/>	<input type="checkbox"/>	<input type="checkbox"/>
 Piano Peninsula Worksurface • One PowerUp module • Wireway standard • Notched vertical wireway and modesty panel frame style is standard	24x48x60"	ZPP2448601	<input type="checkbox"/>	<input type="checkbox"/>	<input type="checkbox"/>	<input type="checkbox"/>	<input type="checkbox"/>	<input type="checkbox"/>	<input type="checkbox"/>
	24x48x72"	ZPP2448721	<input type="checkbox"/>	<input type="checkbox"/>	<input type="checkbox"/>	<input type="checkbox"/>	<input type="checkbox"/>	<input type="checkbox"/>	<input type="checkbox"/>
	30x48x72"	ZPP3048721	<input type="checkbox"/>	<input type="checkbox"/>	<input type="checkbox"/>	<input type="checkbox"/>	<input type="checkbox"/>	<input type="checkbox"/>	<input type="checkbox"/>
 Square Shoe Worksurface • One PowerUp module • Wireway standard • Notched vertical wireway and modesty panel frame style is standard	24x48x60"	ZSS2448601	<input type="checkbox"/>	<input type="checkbox"/>	<input type="checkbox"/>	<input type="checkbox"/>	<input type="checkbox"/>	<input type="checkbox"/>	<input type="checkbox"/>
	24x48x66"	ZSS2448661	<input type="checkbox"/>	<input type="checkbox"/>	<input type="checkbox"/>	<input type="checkbox"/>	<input type="checkbox"/>	<input type="checkbox"/>	<input type="checkbox"/>
	24x48x72"	ZSS2448721	<input type="checkbox"/>	<input type="checkbox"/>	<input type="checkbox"/>	<input type="checkbox"/>	<input type="checkbox"/>	<input type="checkbox"/>	<input type="checkbox"/>
	24x48x84"	ZSS2448841	<input type="checkbox"/>	<input type="checkbox"/>	<input type="checkbox"/>	<input type="checkbox"/>	<input type="checkbox"/>	<input type="checkbox"/>	<input type="checkbox"/>
	30x48x66"	ZSS3048661	<input type="checkbox"/>	<input type="checkbox"/>	<input type="checkbox"/>	<input type="checkbox"/>	<input type="checkbox"/>	<input type="checkbox"/>	<input type="checkbox"/>
	30x48x72"	ZSS3048721	<input type="checkbox"/>	<input type="checkbox"/>	<input type="checkbox"/>	<input type="checkbox"/>	<input type="checkbox"/>	<input type="checkbox"/>	<input type="checkbox"/>
	30x48x84"	ZSS3048841	<input type="checkbox"/>	<input type="checkbox"/>	<input type="checkbox"/>	<input type="checkbox"/>	<input type="checkbox"/>	<input type="checkbox"/>	<input type="checkbox"/>

A B C D E F G H

HOW TO ORDER

Indicate the following information on order form:

- Quantity of each item.
- Model number, including options. See "How to Build a Model Number."
- Any special service required.

- Note:
- The indicates that a choice is required.
 - The absence of indicates that no choice is required.
 - Alpha-numeric characters in place of indicate that no other alternatives are available.

HOW TO BUILD A MODEL NUMBER

- A** Select size of worksurface.

- B** Select edge style.

T = Flat Vinyl T-edge
M = 3mm PVC edge
- C** Select surface direction.

L = Left
R = Right
- D** Select PowerUp location.

L = Left
R = Right
C = Center
B = Left and right (60" and 72" only)
- E** Select height.

9 = 29"

- F** Indicate location and type of leg.*

S = Standard (both standard legs)
R = Right (right transitional leg)
L = Left (left transitional leg)
B = Both (both transitional legs)

*Note: If ordering Basic Worksurface as a freestanding unit, or if only one side connects to a transitional worksurface, the "B" option for both transitional legs is not available.

- **Must order corresponding worksurface connector to attach to adjacent table when using transitional legs.**

- G** Select trim color for painted surfaces.

B = Black
G = Gray
S = Sand
W = Warm Gray
L = Light Tone

- H** Select laminate surface.

AA = Cream
AB = Champagne
AC = Barcelona
AF = Aruba Tan
AG = Black
AH = Dark Gray
AI = Dawn Gray (Greige)
AJ = Fog
AK = Black Grandin
AL = Smoke Granite
AM = Sand Grandin
AN = Light Granite
AO = Tundra
AP = Earthen
AQ = Rose Grafix
AS = Sierra Grafix
AT = Beige Grafix
AU = Sand Stone
AV = Kentucky Walnut



Edge Styles



T-Edge
Price **(T)**

3mm PVC Edge
Price **(M)**

Total Weight

134#	\$315	\$330
146#	325	340
150#	335	350

132#	290	305
144#	300	315
148#	310	325

133#	\$280	\$295
139#	290	305
145#	295	310
157#	305	320
144#	290	305
150#	295	310
172#	305	320

- AW** = Tennessee Oak
- AX** = Light Oak
- AY** = Red Birch
- AZ** = Ash
- BA** = Philadelphia Cherry
- BB** = Pennsylvania Cherry
- BC** = Mahogany
- BD** = Oak
- BE** = Maple
- BF** = Pearwood
- CA** = Pumice
- CB** = Rock Maple
- CC** = Medium Cherry
- CD** = Anigre
- ZZ** = COM

FINISH INFORMATION

Laminate Surface
See Keys for Progression swatch card.

ACCESSORIES

Casters
4 swivel casters (2½" diameter), 2 with locks.
Add 2" to top surface height. Add 2lbs. to weight.
Order separately, specify 87.2840
List price \$34.00/set

Worksurface Connectors
For attaching two freestanding tables together
of same height. Black finish.
Specify 87.4632.WZ.BL.
List price \$8.00

For attaching two freestanding tables together
of different heights. Black finish.
Specify 87.4624.WZ.BL.
List price \$12.00

Specifications and prices are subject to change without prior notice.

XXI Notes Worksurfaces with PowerUp

Level Two



Basic Worksurface

- Wireway not available on Level 2
- Notched vertical wireway and modesty panel frame style is standard

- Wireway not available on Level 2
- Notched vertical wireway and modesty panel frame style is standard

MODEL	D x W	MODEL NUMBER					
		Worksurface	Edge Style	Hgt	Tr Legs	Trim Color	Laminate
	24x30'	WBW24302	<input type="checkbox"/>	<input type="checkbox"/>	<input type="checkbox"/>	<input type="checkbox"/>	<input type="checkbox"/>
	24x36"	WBW24362	<input type="checkbox"/>	<input type="checkbox"/>	<input type="checkbox"/>	<input type="checkbox"/>	<input type="checkbox"/>
	24x42"	WBW24422	<input type="checkbox"/>	<input type="checkbox"/>	<input type="checkbox"/>	<input type="checkbox"/>	<input type="checkbox"/>
	24x48"	WBW24482	<input type="checkbox"/>	<input type="checkbox"/>	<input type="checkbox"/>	<input type="checkbox"/>	<input type="checkbox"/>
	24x54"	WBW24542	<input type="checkbox"/>	<input type="checkbox"/>	<input type="checkbox"/>	<input type="checkbox"/>	<input type="checkbox"/>
	30x30"	WBW30302	<input type="checkbox"/>	<input type="checkbox"/>	<input type="checkbox"/>	<input type="checkbox"/>	<input type="checkbox"/>
	30x36"	WBW30362	<input type="checkbox"/>	<input type="checkbox"/>	<input type="checkbox"/>	<input type="checkbox"/>	<input type="checkbox"/>
	30x42"	WBW30422	<input type="checkbox"/>	<input type="checkbox"/>	<input type="checkbox"/>	<input type="checkbox"/>	<input type="checkbox"/>
	30x48"	WBW30482	<input type="checkbox"/>	<input type="checkbox"/>	<input type="checkbox"/>	<input type="checkbox"/>	<input type="checkbox"/>
	30x54"	WBW30542	<input type="checkbox"/>	<input type="checkbox"/>	<input type="checkbox"/>	<input type="checkbox"/>	<input type="checkbox"/>
	24x60"	WBW24602	<input type="checkbox"/>	<input type="checkbox"/>	<input type="checkbox"/>	<input type="checkbox"/>	<input type="checkbox"/>
	24x72"	WBW24722	<input type="checkbox"/>	<input type="checkbox"/>	<input type="checkbox"/>	<input type="checkbox"/>	<input type="checkbox"/>
	30x60"	WBW30602	<input type="checkbox"/>	<input type="checkbox"/>	<input type="checkbox"/>	<input type="checkbox"/>	<input type="checkbox"/>
	30x72"	WBW30722	<input type="checkbox"/>	<input type="checkbox"/>	<input type="checkbox"/>	<input type="checkbox"/>	<input type="checkbox"/>

A **B** **C** **D** **E** **F**

HOW TO ORDER

Indicate the following information on order form:

- Quantity of each item.
- Model number, including options. See "How to Build a Model Number."
- Any special service required.

- Note:
- The indicates that a choice is required.
 - The absence of indicates that no choice is required.
 - Alpha-numeric characters in place of indicate that no other alternatives are available.

HOW TO BUILD A MODEL NUMBER

- A** Select size of worksurface.
B Select edge style.
T = Flat Vinyl T-edge
M = 3mm PVC edge
C Select height.
7 = 27"
9 = 29"
D Indicate location and type of leg.*
S = Standard (both standard legs)
R = Right (right transitional leg)
L = Left (left transitional leg)
B = Both (both transitional legs)

*Note: If ordering Basic Worksurface as a freestanding unit, or if only one side connects to a transitional worksurface, the "B" option for both transitional legs is not available.

- **Must order corresponding worksurface connector to attach to adjacent table when using transitional legs.**

- E** Select trim color for painted surfaces.
B = Black
G = Gray
S = Sand
W = Warm Gray
L = Light Tone

- F** Select laminate surface.
AA = Cream
AB = Champagne
AC = Barcelona
AF = Aruba Tan
AG = Black
AH = Dark Gray
AI = Dawn Gray (Greige)
AJ = Fog
AK = Black Grandin

- AL** = Smoke Granite
AM = Sand Grandin
AN = Light Granite
AO = Tundra
AP = Earthen
AQ = Rose Grafix
AS = Sierra Grafix
AT = Beige Grafix
AU = Sand Stone
AV = Kentucky Walnut
AW = Tennessee Oak
AX = Light Oak
AY = Red Birch
AZ = Ash
BA = Philadelphia Cherry
BB = Pennsylvania Cherry
BC = Mahogany
BD = Oak
BE = Maple
BF = Pearwood
CA = Pumice
CC = ...



Edge Styles



T-Edge
Price **(T)**

3mm PVC Edge
Price **(M)**

27"	Total Weight	29"	T-Edge Price (T)	3mm PVC Edge Price (M)
66#		69#	\$ 220	\$ 230
73#		76#	225	235
80#		83#	230	240
86#		89#	235	245
93#		96#	245	255
73#		76#	220	230
80#		83#	225	235
89#		92#	230	240
97#		100#	235	245
103#		106#	245	255
98#		102#	250	260
111#		116#	265	275
109#		113#	250	260
122#		126#	265	275

- CC** = Medium Cherry
- CD** = Anigre
- ZZ** = COM

FINISH INFORMATION

Laminate Surface

See Keys for Progression swatch card.

ACCESSORIES

Casters

4 swivel casters (2½" diameter), 2 with locks. Add 2" to top surface height. Add 2lbs. to weight. Order separately, specify 87.2840

List price \$34.00/set

Worksurface Connectors

For attaching two freestanding tables together of same height. Black finish. Specify 87.4632.WZ.BL.

List price \$8.00



For attaching two freestanding tables together of different heights. Black finish. Specify 87.4624.WZ.BL.

List price \$12.00

Specifications and prices are subject to change without prior notice.

XXI Notes Worksurfaces with PowerUp

Level Two

MODEL	DxWxD	MODEL NUMBER					
		Worksurface	Edge Style	Hgt	Tr Legs	Trim Color	Laminate
 Curvilinear Worksurface • Wireway not available on Level 2. • Notched vertical wireway and modesty panel frame style is standard.	24x42x30"	WRC2442302	<input type="checkbox"/>	<input type="checkbox"/>	<input type="checkbox"/>	<input type="checkbox"/>	<input type="checkbox"/>
	24x48x30"	WRC2448302	<input type="checkbox"/>	<input type="checkbox"/>	<input type="checkbox"/>	<input type="checkbox"/>	<input type="checkbox"/>
	24x54x30"	WRC2454302	<input type="checkbox"/>	<input type="checkbox"/>	<input type="checkbox"/>	<input type="checkbox"/>	<input type="checkbox"/>
	24x60x30"	WRC2460302	<input type="checkbox"/>	<input type="checkbox"/>	<input type="checkbox"/>	<input type="checkbox"/>	<input type="checkbox"/>
	24x72x30"	WRC2472302	<input type="checkbox"/>	<input type="checkbox"/>	<input type="checkbox"/>	<input type="checkbox"/>	<input type="checkbox"/>
	30x42x24"	WRC3042242	<input type="checkbox"/>	<input type="checkbox"/>	<input type="checkbox"/>	<input type="checkbox"/>	<input type="checkbox"/>
	30x48x24"	WRC3048242	<input type="checkbox"/>	<input type="checkbox"/>	<input type="checkbox"/>	<input type="checkbox"/>	<input type="checkbox"/>
	30x54x24"	WRC3054242	<input type="checkbox"/>	<input type="checkbox"/>	<input type="checkbox"/>	<input type="checkbox"/>	<input type="checkbox"/>
	30x60x24"	WRC3060242	<input type="checkbox"/>	<input type="checkbox"/>	<input type="checkbox"/>	<input type="checkbox"/>	<input type="checkbox"/>
	30x72x24"	WRC3072242	<input type="checkbox"/>	<input type="checkbox"/>	<input type="checkbox"/>	<input type="checkbox"/>	<input type="checkbox"/>
 Stand Alone Stand-Up Worksurface • Available in 42" height only • Not available with transitional legs. • Wireway not available on Level 2. • Notched vertical wireway and modesty panel frame style is standard.	30x36"	WSU30362	<input type="checkbox"/>	2	S	<input type="checkbox"/>	<input type="checkbox"/>

A B C D E F

HOW TO ORDER

Indicate the following information on order form:

- Quantity of each item.
- Model number, including options. See "How to Build a Model Number."
- Any special service required.

- Note:
- The indicates that a choice is required.
 - The absence of indicates that no choice is required.
 - Alpha-numeric characters in place of indicate that no other alternatives are available.

HOW TO BUILD A MODEL NUMBER

- A** Select size of worksurface.
B Select edge style.
 T = Flat Vinyl T-edge
 M = 3mm PVC edge
C Select height.
 2 = 42"
 7 = 27"
 9 = 29"
D Indicate location and type of leg.*
 S = Standard (both standard legs)
 R = Right (right transitional leg)
 L = Left (left transitional leg)
 B = Both (both transitional legs)

*Note: If ordering Basic Worksurface as a freestanding unit, or if only one side connects to a transitional worksurface, the "B" option for both transitional legs is not available.

- **Must order corresponding worksurface connector to attach to adjacent table when using transitional legs.**

- E** Select trim color for painted surfaces.
 B = Black
 G = Gray
 S = Sand
 W = Warm Gray
 L = Light Tone
F Select laminate surface.
 AA = Cream
 AB = Champagne
 AC = Barcelona
 AF = Aruba Tan
 AG = Black
 AH = Dark Gray
 AI = Dawn Gray (Greige)
 AJ = Fog
 AK = Black Grandin

- AL = Smoke Granite
 AM = Sand Grandin
 AN = Light Granite
 AO = Tundra
 AP = Earthen
 AQ = Rose Grafix
 AS = Sierra Grafix
 AT = Beige Grafix
 AU = Sand Stone
 AV = Kentucky Walnut
 AW = Tennessee Oak
 AX = Light Oak
 AY = Red Birch
 AZ = Ash
 BA = Philadelphia Cherry
 BB = Pennsylvania Cherry
 BC = Mahogany
 BD = Oak
 BE = Maple
 BF = Pearwood
 CA = Pumice
 CB = ...



Edge Styles



T-Edge
Price **(T)**

3mm PVC Edge
Price **(M)**

Total Weight
27" 29" 42"

81#	84#	\$230	\$240
88#	91#	235	245
95#	98#	245	255
100#	103#	250	260
114#	117#	265	275
81#	84#	230	240
88#	91#	235	245
95#	98#	245	255
100#	103#	250	260
114#	117#	265	275

94# \$255 \$270

- CC** = Medium Cherry
- CD** = Anigre
- ZZ** = COM

FINISH INFORMATION

Laminate Surface
See Keys for Progression swatch card.

ACCESSORIES

Casters
4 swivel casters (2½" diameter), 2 with locks.
Add 2" to top surface height. Add 2lbs. to weight.
Order separately, specify 87.2840
List price \$34.00/set

Worksurface Connectors
For attaching two freestanding tables together
of same height. Black finish.
Specify 87.4632.WZ.BL.
List price \$8.00

For attaching two freestanding tables together
of different heights. Black finish.
Specify 87.4624.WZ.BL.
List price \$12.00

Specifications and prices are subject to change without prior notice.

XXI Notes Worksurfaces with PowerUp

Level Two



MODEL	D x W	MODEL NUMBER							
		Worksurface	Edge Style	Keypad Location	Hgt	Tr Legs	Trim Color	Laminate	
Adjustable Keyboard Pad Worksurface <ul style="list-style-type: none"> • Only center keypad available on 36" and 42" worksurfaces • Wireway not available on Level 2 • Notched vertical wireway and modesty panel frame style is standard 	24x36"	WAK24362	<input type="checkbox"/>	<input type="checkbox"/>	<input type="checkbox"/>	<input type="checkbox"/>	<input type="checkbox"/>	<input type="checkbox"/>	
	24x42"	WAK24422	<input type="checkbox"/>	<input type="checkbox"/>	<input type="checkbox"/>	<input type="checkbox"/>	<input type="checkbox"/>	<input type="checkbox"/>	
	24x48"	WAK24482	<input type="checkbox"/>	<input type="checkbox"/>	<input type="checkbox"/>	<input type="checkbox"/>	<input type="checkbox"/>	<input type="checkbox"/>	
	24x54"	WAK24542	<input type="checkbox"/>	<input type="checkbox"/>	<input type="checkbox"/>	<input type="checkbox"/>	<input type="checkbox"/>	<input type="checkbox"/>	
	30x36"	WAK30362	<input type="checkbox"/>	<input type="checkbox"/>	<input type="checkbox"/>	<input type="checkbox"/>	<input type="checkbox"/>	<input type="checkbox"/>	
	30x42"	WAK30422	<input type="checkbox"/>	<input type="checkbox"/>	<input type="checkbox"/>	<input type="checkbox"/>	<input type="checkbox"/>	<input type="checkbox"/>	
	30x48"	WAK30482	<input type="checkbox"/>	<input type="checkbox"/>	<input type="checkbox"/>	<input type="checkbox"/>	<input type="checkbox"/>	<input type="checkbox"/>	
	30x54"	WAK30542	<input type="checkbox"/>	<input type="checkbox"/>	<input type="checkbox"/>	<input type="checkbox"/>	<input type="checkbox"/>	<input type="checkbox"/>	
<ul style="list-style-type: none"> • Wireway not available on Level 2 • Notched vertical wireway and modesty panel frame style is standard 	24x60"	WAK24602	<input type="checkbox"/>	<input type="checkbox"/>	<input type="checkbox"/>	<input type="checkbox"/>	<input type="checkbox"/>	<input type="checkbox"/>	
	24x72"	WAK24722	<input type="checkbox"/>	<input type="checkbox"/>	<input type="checkbox"/>	<input type="checkbox"/>	<input type="checkbox"/>	<input type="checkbox"/>	
	30x60"	WAK30602	<input type="checkbox"/>	<input type="checkbox"/>	<input type="checkbox"/>	<input type="checkbox"/>	<input type="checkbox"/>	<input type="checkbox"/>	
	30x72"	WAK30722	<input type="checkbox"/>	<input type="checkbox"/>	<input type="checkbox"/>	<input type="checkbox"/>	<input type="checkbox"/>	<input type="checkbox"/>	
			A	B	C	D	E	F	G

HOW TO ORDER

Indicate the following information on order form:

- Quantity of each item.
- Model number, including options. See "How to Build a Model Number."
- Any special service required.

- Note:
- The indicates that a choice is required.
 - The absence of indicates that no choice is required.
 - Alpha-numeric characters in place of indicate that no other alternatives are available.

HOW TO BUILD A MODEL NUMBER

- A** Select size of worksurface.

- B** Select edge style.
 - T** = Flat Vinyl T-edge
 - M** = 3mm PVC edge
- C** Select keypad location.
 - C** = Center
 - R** = Right
 - L** = Left
- D** Select height.
 - 7** = 27"
 - 9** = 29"
- E** Indicate location and type of leg.*
 - S** = Standard (both standard legs)
 - R** = Right (right transitional leg)
 - L** = Left (left transitional leg)
 - B** = Both (both transitional legs)

*Note: If ordering Basic Worksurface as a freestanding unit, or if only one side connects to a transitional worksurface, the "B" option for both transitional legs is not available.

- **Must order corresponding worksurface connector to attach to adjacent table when using transitional legs.**

- F** Select trim color for painted surfaces.
 - B** = Black
 - G** = Gray
 - S** = Sand
 - W** = Warm Gray
 - L** = Light Tone
- G** Select laminate surface.
 - AA** = Cream
 - AB** = Champagne
 - AC** = Barcelona
 - AF** = Aruba Tan

- AG** = Black
- AH** = Dark Gray
- AI** = Dawn Gray (Greige)
- AJ** = Fog
- AK** = Black Grandin
- AL** = Smoke Granite
- AM** = Sand Grandin
- AN** = Light Granite
- AO** = Tundra
- AP** = Earthen
- AQ** = Rose Grafix
- AS** = Sierra Grafix
- AT** = Beige Grafix
- AU** = Sand Stone
- AV** = Kentucky Walnut
- AW** = Tennessee Oak
- AX** = Light Oak
- AY** = Red Birch
- AZ** = Ash
- BA** = Philadelphia Cherry
- BB** = Pennsylvania Cherry



Edge Styles



T-Edge
Price **(T)**

3mm PVC Edge
Price **(M)**

27"	Total Weight	29"	T-Edge Price (T)	3mm PVC Edge Price (M)
74#		77#	\$235	\$245
81#		84#	240	250
87#		90#	245	260
93#		96#	255	270
81#		84#	235	245
90#		93#	240	250
98#		101#	245	260
106#		110#	255	270
99#		103#	260	275
112#		126#	275	290
110#		114#	260	275
126#		130#	275	290

- BD** = Oak
- BE** = Maple
- BF** = Pearwood
- CA** = Pumice
- CB** = Rock Maple
- CC** = Medium Cherry
- CD** = Anigre
- ZZ** = COM

FINISH INFORMATION

Laminate Surface
See Keys for Progression swatch card.

ACCESSORIES

Casters
4 swivel casters (2½" diameter), 2 with locks.
Add 2" to top surface height. Add 2lbs. to weight.
Order separately, specify 87.2840
List price \$34.00/set



Worksurface Connectors
For attaching two freestanding tables together
of same height. Black finish.
Specify 87.4632.WZ.BL.
List price \$8.00

For attaching two freestanding tables together
of different heights. Black finish.
Specify 87.4624.WZ.BL.
List price \$12.00

Specifications and prices are subject to change without prior notice.

XXI Notes Worksurfaces with PowerUp

Level Two

MODEL	D x W	MODEL NUMBER							
		Worksurface	Edge Style	Keypad Location	Hgt	Tr Legs	Trim Color	Laminate	
 <p>Stand Alone Corner Worksurface with Keyboard</p> <ul style="list-style-type: none"> • Not available with transitional legs • Wireway not available on Level 2 • Only center keypad available • Notched vertical wireway and modesty panel frame style is standard 	24x42"	WCS24422	<input type="checkbox"/>	<input type="checkbox"/>	<input type="checkbox"/>	<input type="checkbox"/>	<input type="checkbox"/>	<input type="checkbox"/>	
	30x48"	WCS30482	<input type="checkbox"/>	<input type="checkbox"/>	<input type="checkbox"/>	<input type="checkbox"/>	<input type="checkbox"/>	<input type="checkbox"/>	
 <p>Stand Alone Corner Worksurface</p> <ul style="list-style-type: none"> • Not available with transitional legs • Wireway not available on Level 2 • Notched vertical wireway and modesty panel frame style is standard 	24x36"	WCSK24362	<input type="checkbox"/>	NA	<input type="checkbox"/>	<input type="checkbox"/>	<input type="checkbox"/>	<input type="checkbox"/>	
	24x72"	WCSK24722	<input type="checkbox"/>	NA	<input type="checkbox"/>	<input type="checkbox"/>	<input type="checkbox"/>	<input type="checkbox"/>	
	30x48"	WCSK30482	<input type="checkbox"/>	NA	<input type="checkbox"/>	<input type="checkbox"/>	<input type="checkbox"/>	<input type="checkbox"/>	
			A	B	C	D	E	F	G

HOW TO ORDER

Indicate the following information on order form:

- Quantity of each item.
- Model number, including options. See "How to Build a Model Number."
- Any special service required.

- Note:
- The indicates that a choice is required.
 - The absence of indicates that no choice is required.
 - Alpha-numeric characters in place of indicate that no other alternatives are available.

HOW TO BUILD A MODEL NUMBER

- A** Select size of worksurface.
B Select edge style.
T = Flat Vinyl T-edge
M = 3mm PVC edge
C Select keypad location.
C = Center
R = Right
L = Left
D Select height.
7 = 27"
9 = 29"
E Indicate location and type of leg.*
S = Standard (both standard legs)
R = Right (right transitional leg)
L = Left (left transitional leg)
B = Both (both transitional legs)

*Note: If ordering Basic Worksurface as a freestanding unit, or if only one side connects to a transitional worksurface, the "B" option for both transitional legs is not available.

- **Must order corresponding worksurface connector to attach to adjacent table when using transitional legs.**

- F** Select trim color for painted surfaces.
B = Black
G = Gray
S = Sand
W = Warm Gray
L = Light Tone
G Select laminate surface.
AA = Cream
AB = Champagne
AC = Barcelona
AF = Aruba Tan

- AG** = Black
AH = Dark Gray
AI = Dawn Gray (Greige)
AJ = Fog
AK = Black Grandin
AL = Smoke Granite
AM = Sand Grandin
AN = Light Granite
AO = Tundra
AP = Earthen
AQ = Rose Grafix
AS = Sierra Grafix
AT = Beige Grafix
AU = Sand Stone
AV = Kentucky Walnut
AW = Tennessee Oak
AX = Light Oak
AY = Red Birch
AZ = Ash
BA = Philadelphia Cherry
BB = Pennsylvania Cherry



Edge Styles



T-Edge
Price **(T)**

3mm PVC Edge
Price **(M)**

Total Weight
27" 29"

Joins Tables

97#	99#	\$ 225	\$ 235	24" deep worksurface to 24" deep worksurface
116#	118#	235	245	30" deep worksurface to 30" deep worksurface

73#	76#	260	270
93#	96#	280	295
115#	118#	300	315

- BD** = Oak
- BE** = Maple
- BF** = Pearwood
- CA** = Pumice
- CB** = Rock Maple
- CC** = Medium Cherry
- CD** = Anigre
- ZZ** = COM

FINISH INFORMATION

Laminate Surface
See Keys for Progression swatch card.

ACCESSORIES

Casters
4 swivel casters (2½" diameter), 2 with locks.
Add 2" to top surface height. Add 2lbs. to weight.
Order separately, specify 87.2840
List price \$34.00/set



Worksurface Connectors
For attaching two freestanding tables together
of same height. Black finish.
Specify 87.4632.WZ.BL.
List price \$8.00

For attaching two freestanding tables together
of different heights. Black finish.
Specify 87.4624.WZ.BL.
List price \$12.00

Specifications and prices are subject to change without prior notice.

XXI Notes Worksurfaces with PowerUp

Level Two

MODEL	Left D x W x D	Right W x D	MODEL NUMBER					
			Worksurface	Edge Style	Trans Direct	Hgt	Trim Color	Laminate
 <p>End-of-Run Worksurface with Keyboard</p> <ul style="list-style-type: none"> • 36" width not available with key pad • 42" and 48" widths available with center keypad and bullnose edge • Transition direction is figured from the originating 24" or 30" basic or keyboard pad worksurface • Wireway not available on Level 2 • Notched vertical wireway and modesty panel frame style is standard 	24x42x42x24"	WERK24422	<input type="checkbox"/>	<input type="checkbox"/>	<input type="checkbox"/>	<input type="checkbox"/>	<input type="checkbox"/>	<input type="checkbox"/>
	24x48x48x24"	WERK24482	<input type="checkbox"/>	<input type="checkbox"/>	<input type="checkbox"/>	<input type="checkbox"/>	<input type="checkbox"/>	<input type="checkbox"/>
	30x48x48x30"	WERK30482	<input type="checkbox"/>	<input type="checkbox"/>	<input type="checkbox"/>	<input type="checkbox"/>	<input type="checkbox"/>	<input type="checkbox"/>
 <p>End-of-Run Worksurface</p> <ul style="list-style-type: none"> • Wireway not available on Level 2 • Notched vertical wireway and modesty panel frame style is standard 	24x42x42x24"	WER24422	<input type="checkbox"/>	<input type="checkbox"/>	<input type="checkbox"/>	<input type="checkbox"/>	<input type="checkbox"/>	<input type="checkbox"/>
	24x48x48x24"	WER24482	<input type="checkbox"/>	<input type="checkbox"/>	<input type="checkbox"/>	<input type="checkbox"/>	<input type="checkbox"/>	<input type="checkbox"/>
	30x48x48x30"	WER30482	<input type="checkbox"/>	<input type="checkbox"/>	<input type="checkbox"/>	<input type="checkbox"/>	<input type="checkbox"/>	<input type="checkbox"/>
 <p>End-of-Run Curvilinear Worksurface</p> <ul style="list-style-type: none"> • Wireway not available on Level 2 • Notched vertical wireway and modesty panel frame style is standard 	24x36x36x24"	WCCE24362	<input type="checkbox"/>	<input type="checkbox"/>	<input type="checkbox"/>	<input type="checkbox"/>	<input type="checkbox"/>	<input type="checkbox"/>
	24x42x42x24"	WCCE24422	<input type="checkbox"/>	<input type="checkbox"/>	<input type="checkbox"/>	<input type="checkbox"/>	<input type="checkbox"/>	<input type="checkbox"/>
	24x48x48x24"	WCCE24482	<input type="checkbox"/>	<input type="checkbox"/>	<input type="checkbox"/>	<input type="checkbox"/>	<input type="checkbox"/>	<input type="checkbox"/>
	30x42x42x30"	WCCE30422	<input type="checkbox"/>	<input type="checkbox"/>	<input type="checkbox"/>	<input type="checkbox"/>	<input type="checkbox"/>	<input type="checkbox"/>
	30x48x48x30"	WCCE30482	<input type="checkbox"/>	<input type="checkbox"/>	<input type="checkbox"/>	<input type="checkbox"/>	<input type="checkbox"/>	<input type="checkbox"/>
			A	B	C	D	E	F

HOW TO ORDER

Indicate the following information on order form:

- Quantity of each item.
- Model number, including options. See "How to Build a Model Number."
- Any special service required.

- Note:
- The indicates that a choice is required.
 - The absence of indicates that no choice is required.
 - Alpha-numeric characters in place of indicate that no other alternatives are available.

HOW TO BUILD A MODEL NUMBER

- A** Select size of worksurface.
- B** Select edge style.
T = Flat Vinyl T-edge
M = 3mm PVC edge
- C** Select transitional direction.
L = Left
R = Right
- D** Select height.
2 = 42"
7 = 27"
9 = 29"
- E** Select trim color for painted surfaces.
B = Black
G = Gray
S = Sand
W = Warm Gray
L = Light Tone
- F** Select laminate surface.
AA = Cream
AB = Champagne
AC = Barcelona
AF = Aruba Tan
AG = Black
AH = Dark Gray
AI = Dawn Gray (Greige)
AJ = Fog
AK = Black Grandin
AL = Smoke Granite
AM = Sand Grandin
AN = Light Granite
AO = Tundra
AP = Earthen
AQ = Rose Grafix
AS = Sierra Grafix
AT = Beige Grafix
AU = Sand Stone
AV = Kentucky Walnut

- AW** = Tennessee Oak
AX = Light Oak
AY = Red Birch
AZ = Ash
BA = Philadelphia Cherry
BB = Pennsylvania Cherry
BC = Mahogany
BD = Oak
BE = Maple
BF = Pearwood
CA = Pumice
CB = Rock Maple
CC = Medium Cherry
CD = Anigre
ZZ = COM



Edge Styles



Total Weight
27" 29"

T-Edge
Price **(T)**

3mm PVC Edge
Price **(M)**

Joins Table

78#	215	225	24" deep worksurface to 24" deep worksurface
102#	265	280	30" deep worksurface to 30" deep worksurface
78#	220	230	24" deep worksurface to 24" deep worksurface
82#	270	285	24" deep worksurface to 24" deep worksurface
100#	270	285	30" deep worksurface to 30" deep worksurface
76#	195	205	24" deep worksurface to 24" deep worksurface
96#	220	230	24" deep worksurface to 24" deep worksurface
106#	270	285	24" deep worksurface to 24" deep worksurface
108#	220	230	30" deep worksurface to 30" deep worksurface
118#	270	285	30" deep worksurface to 30" deep worksurface

FINISH INFORMATION

Laminate Surface

See Keys for Progression swatch card.

ACCESSORIES

Casters

4 swivel casters (2½" diameter), 2 with locks.
Add 2" to top surface height. Add 2lbs. to weight.
Order separately, specify 87.2840

List price \$34.00/set

Worksurface Connectors

For attaching two freestanding tables together
of same height. Black finish.
Specify 87.4632.WZ.BL.

List price \$8.00





For attaching two freestanding tables together
of different heights. Black finish.
Specify 87.4624.WZ.BL.

List price \$12.00

**Specifications and prices are subject to
change without prior notice.**

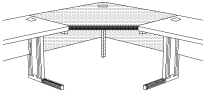
XXI Notes Worksurfaces with PowerUp

Level Two

MODEL	Left D x W x D	Right W x D	MODEL NUMBER					
			Worksurface	Edge Style	Hgt	Tr Legs	Trim Color	Laminate
 Corner Transitional Worksurface <ul style="list-style-type: none"> • Wireway not available on Level 2 • Notched vertical wireway and modesty panel frame style is standard 	24x36"		CT24362	<input type="checkbox"/>	<input type="checkbox"/>	<input type="checkbox"/>	<input type="checkbox"/>	<input type="checkbox"/>
	24x42"		CT24422	<input type="checkbox"/>	<input type="checkbox"/>	<input type="checkbox"/>	<input type="checkbox"/>	<input type="checkbox"/>
	30x48"		CT30482	<input type="checkbox"/>	<input type="checkbox"/>	<input type="checkbox"/>	<input type="checkbox"/>	<input type="checkbox"/>
 Corner Transitional Worksurface with Keyboard Pad <ul style="list-style-type: none"> • Wireway not available on Level 2 • Available with center keypad and bullnose edge • Notched vertical wireway and modesty panel frame style is standard 	24x42"		CTK24422	<input type="checkbox"/>	<input type="checkbox"/>	<input type="checkbox"/>	<input type="checkbox"/>	<input type="checkbox"/>
	30x48"		CTK30482	<input type="checkbox"/>	<input type="checkbox"/>	<input type="checkbox"/>	<input type="checkbox"/>	<input type="checkbox"/>
 Corner Transitional Reduction Worksurface <ul style="list-style-type: none"> • Wireway not available on Level 2 • Notched vertical wireway and modesty panel frame style is standard 	24x42x42x30"		CT2442302	<input type="checkbox"/>	<input type="checkbox"/>	<input type="checkbox"/>	<input type="checkbox"/>	<input type="checkbox"/>
	24x48x48x30"		CT2448302	<input type="checkbox"/>	<input type="checkbox"/>	<input type="checkbox"/>	<input type="checkbox"/>	<input type="checkbox"/>
	30x42x42x24"		CT3042242	<input type="checkbox"/>	<input type="checkbox"/>	<input type="checkbox"/>	<input type="checkbox"/>	<input type="checkbox"/>
	30x48x48x24"		CT3048242	<input type="checkbox"/>	<input type="checkbox"/>	<input type="checkbox"/>	<input type="checkbox"/>	<input type="checkbox"/>
 Corner Curvilinear Transitional Worksurface <ul style="list-style-type: none"> • Wireway not available on Level 2 • Notched vertical wireway and modesty panel frame style is standard 	24x36x36x24"		CCT24362	<input type="checkbox"/>	<input type="checkbox"/>	<input type="checkbox"/>	<input type="checkbox"/>	<input type="checkbox"/>
	24x42x42x24"		CCT24422	<input type="checkbox"/>	<input type="checkbox"/>	<input type="checkbox"/>	<input type="checkbox"/>	<input type="checkbox"/>
	24x48x48x24"		CCT24482	<input type="checkbox"/>	<input type="checkbox"/>	<input type="checkbox"/>	<input type="checkbox"/>	<input type="checkbox"/>
	30x42x42x30"		CCT30422	<input type="checkbox"/>	<input type="checkbox"/>	<input type="checkbox"/>	<input type="checkbox"/>	<input type="checkbox"/>
	30x48x48x30"		CCT30482	<input type="checkbox"/>	<input type="checkbox"/>	<input type="checkbox"/>	<input type="checkbox"/>	<input type="checkbox"/>
 Corner Curvilinear Transitional Reduction Worksurface <ul style="list-style-type: none"> • Wireway not available on Level 2 • Notched vertical wireway and modesty panel frame style is standard 	24x42x42x30"		CCT2442302	<input type="checkbox"/>	<input type="checkbox"/>	<input type="checkbox"/>	<input type="checkbox"/>	<input type="checkbox"/>
	24x48x48x30"		CCT2448302	<input type="checkbox"/>	<input type="checkbox"/>	<input type="checkbox"/>	<input type="checkbox"/>	<input type="checkbox"/>
	30x42x42x24"		CCT3042242	<input type="checkbox"/>	<input type="checkbox"/>	<input type="checkbox"/>	<input type="checkbox"/>	<input type="checkbox"/>
	30x48x48x24"		CCT3048242	<input type="checkbox"/>	<input type="checkbox"/>	<input type="checkbox"/>	<input type="checkbox"/>	<input type="checkbox"/>

A B C D E F

HOW TO ORDER

Indicate the following information on order form:

- Quantity of each item.
- Model number, including options. See "How to Build a Model Number."
- Any special service required.

- Note:
- The indicates that a choice is required.
 - The absence of indicates that no choice is required.
 - Alpha-numeric characters in place of indicate that no other alternatives are available.

HOW TO BUILD A MODEL NUMBER

- A** Select size of worksurface.
B Select edge style.
T = Flat Vinyl T-edge
M = 3mm PVC edge
C Select height.
2 = 42"
7 = 27"
9 = 29"
D Indicate location and type of leg.*
S = Standard (both standard legs)
R = Right (right transitional leg)
L = Left (left transitional leg)
B = Both (both transitional legs)

*Note: If ordering Basic Worksurface as a freestanding unit, or if only one side connects to a transitional worksurface, the "B" option for both transitional legs is not available.

- **Must order corresponding worksurface connector to attach to adjacent table when using transitional legs.**

- E** Select trim color for painted surfaces.
B = Black
G = Gray
S = Sand
W = Warm Gray
L = Light Tone

- F** Select laminate surface.
AA = Cream
AB = Champagne
AC = Barcelona
AF = Aruba Tan
AG = Black
AH = Dark Gray
AI = Dawn Gray (Greige)
AJ = Fog
AK = Black Grandin

- AL** = Smoke Granite
AM = Sand Grandin
AN = Light Granite
AO = Tundra
AP = Earthen
AQ = Rose Grafix
AS = Sierra Grafix
AT = Beige Grafix
AU = Sand Stone
AV = Kentucky Walnut
AW = Tennessee Oak
AX = Light Oak
AY = Red Birch
AZ = Ash
BA = Philadelphia Cherry
BB = Pennsylvania Cherry
BC = Mahogany
BD = Oak
BE = Maple
BF = Pearwood
CA = Pumice
CC = ...



Edge Styles



Total Weight
 27" 29"

T-Edge
 Price (T)

3mm PVC Edge
 Price (M)

Joins Table

72#	\$200	\$210	24" deep worksurface to 24" deep worksurface
80#	205	215	24" deep worksurface to 24" deep worksurface
102#	240	250	30" deep worksurface to 30" deep worksurface
<hr/>			
80#	150	160	24" deep worksurface to 24" deep worksurface
102#	160	170	30" deep worksurface to 30" deep worksurface
<hr/>			
96#	225	235	24" deep worksurface to 30" deep worksurface
102#	245	260	24" deep worksurface to 30" deep worksurface
96#	225	235	30" deep worksurface to 24" deep worksurface
102#	245	260	30" deep worksurface to 24" deep worksurface
<hr/>			
72#	165	175	24" deep worksurface to 24" deep worksurface
80#	175	185	24" deep worksurface to 24" deep worksurface
102#	190	200	24" deep worksurface to 24" deep worksurface
90#	200	210	30" deep worksurface to 30" deep worksurface
102#	215	225	30" deep worksurface to 30" deep worksurface
<hr/>			
96#	225	235	24" deep worksurface to 30" deep worksurface
102#	245	260	24" deep worksurface to 30" deep worksurface
96#	225	235	30" deep worksurface to 24" deep worksurface
102#	245	260	30" deep worksurface to 24" deep worksurface

CC = Medium Cherry
CD = Anigre
ZZ = COM

FINISH INFORMATION

Laminate Surface

See Keys for Progression swatch card.

ACCESSORIES

Casters

4 swivel casters (2 1/2" diameter), 2 with locks.
 Add 2" to top surface height. Add 2lbs. to weight.
 Order separately, specify 87.2840

List price \$34.00/set

Worksurface Connectors

For attaching two freestanding tables together
 of same height. Black finish.
 Specify 87.4632.WZ.BL.

List price \$8.00



For attaching two freestanding tables together
 of different heights. Black finish.
 Specify 87.4624.WZ.BL.

List price \$12.00

**Specifications and prices are subject to
 change without prior notice.**

XXI Notes Worksurfaces with PowerUp

Level Two

MODEL	Left D x W x W x D	Right D x W x W x D	MODEL NUMBER				
			Worksurface	Edge Style	Hgt	Trim Color	Laminate
 <p>Stand Alone Corner Reduction Worksurface</p> <ul style="list-style-type: none"> • Not available with transitional legs • Wireway not available on Level 2 • Notched vertical wireway and modesty panel frame style is standard 	24x42x42x30"	24x42x42x30"	WCS2442302	<input type="checkbox"/>	<input type="checkbox"/>	<input type="checkbox"/>	<input type="checkbox"/>
	24x48x48x30"	24x48x48x30"	WCS2448302	<input type="checkbox"/>	<input type="checkbox"/>	<input type="checkbox"/>	<input type="checkbox"/>
	30x42x42x24"	30x42x42x24"	WCS3042242	<input type="checkbox"/>	<input type="checkbox"/>	<input type="checkbox"/>	<input type="checkbox"/>
	30x48x48x24"	30x48x48x24"	WCS3048242	<input type="checkbox"/>	<input type="checkbox"/>	<input type="checkbox"/>	<input type="checkbox"/>
 <p>Stand Alone Corner Curvilinear Worksurface</p> <ul style="list-style-type: none"> • Not available with transitional legs • Wireway not available on Level 2 • Notched vertical wireway and modesty panel frame style is standard 	24x36x36x24"	24x36x36x24"	WCC24362	<input type="checkbox"/>	<input type="checkbox"/>	<input type="checkbox"/>	<input type="checkbox"/>
	24x42x42x24"	24x42x42x24"	WCC24422	<input type="checkbox"/>	<input type="checkbox"/>	<input type="checkbox"/>	<input type="checkbox"/>
	24x48x48x24"	24x48x48x24"	WCC24482	<input type="checkbox"/>	<input type="checkbox"/>	<input type="checkbox"/>	<input type="checkbox"/>
	30x42x42x30"	30x42x42x30"	WCC30422	<input type="checkbox"/>	<input type="checkbox"/>	<input type="checkbox"/>	<input type="checkbox"/>
	30x48x48x30"	30x48x48x30"	WCC30482	<input type="checkbox"/>	<input type="checkbox"/>	<input type="checkbox"/>	<input type="checkbox"/>
 <p>Stand Alone Corner Curvilinear Reduction Worksurface</p> <ul style="list-style-type: none"> • Not available with transitional legs • Wireway not available on Level 2 • Notched vertical wireway and modesty panel frame style is standard 	24x42x42x30"	24x42x42x30"	CCS2442302	<input type="checkbox"/>	<input type="checkbox"/>	<input type="checkbox"/>	<input type="checkbox"/>
	24x48x48x30"	24x48x48x30"	CCS2448302	<input type="checkbox"/>	<input type="checkbox"/>	<input type="checkbox"/>	<input type="checkbox"/>
	30x42x42x24"	30x42x42x24"	CCS3042242	<input type="checkbox"/>	<input type="checkbox"/>	<input type="checkbox"/>	<input type="checkbox"/>
	30x48x48x24"	30x48x48x24"	CCS3048242	<input type="checkbox"/>	<input type="checkbox"/>	<input type="checkbox"/>	<input type="checkbox"/>

A
B
C
D
E

HOW TO ORDER

Indicate the following information on order form:

- Quantity of each item.
- Model number, including options. See "How to Build a Model Number."
- Any special service required.

- Note:
- The indicates that a choice is required.
 - The absence of indicates that no choice is required.
 - Alpha-numeric characters in place of indicate that no other alternatives are available.

HOW TO BUILD A MODEL NUMBER

- A** Select size of worksurface.
B Select edge style.
T = Flat Vinyl T-edge
M = 3mm PVC edge
C Select height.
2 = 42"
7 = 27"
9 = 29"
D Select trim color for painted surfaces.
B = Black
G = Gray
S = Sand
W = Warm Gray
L = Light Tone
E Select laminate surface.
AA = Cream
AB = Champagne

- AC** = Barcelona
AF = Aruba Tan
AG = Black
AH = Dark Gray
AI = Dawn Gray (Greige)
AJ = Fog
AK = Black Grandin
AL = Smoke Granite
AM = Sand Grandin
AN = Light Granite
AO = Tundra
AP = Earthen
AQ = Rose Grafix
AS = Sierra Grafix
AT = Beige Grafix
AU = Sand Stone
AV = Kentucky Walnut
AW = Tennessee Oak
AX = Light Oak
AY = Red Birch

- AZ** = Ash
BA = Philadelphia Cherry
BB = Pennsylvania Cherry
BC = Mahogany
BD = Oak
BE = Maple
BF = Pearwood
CA = Pumice
CB = Rock Maple
CC = Medium Cherry
CD = Anigre
ZZ = COM



Edge Styles



Total Weight
27" 29"

T-Edge
Price **(T)**

3mm PVC Edge
Price **(M)**

93#	96#	280	295
99#	102#	300	315
93#	96#	280	295
99#	102#	300	315
73#	76#	260	270
93#	96#	280	295
103#	106#	300	315
105#	108#	280	295
115#	118#	300	315
93#	96#	280	295
99#	102#	300	315
93#	96#	280	295
99#	102#	300	315

FINISH INFORMATION

Laminate Surface

See Keys for Progression swatch card.

ACCESSORIES

Casters

4 swivel casters (2½" diameter), 2 with locks.
Add 2" to top surface height. Add 2lbs. to weight.
Order separately, specify 87.2840

List price \$34.00/set

Worksurface Connectors

For attaching two freestanding tables together
of same height. Black finish.
Specify 87.4632.WZ.BL.

List price \$8.00



For attaching two freestanding tables together
of different heights. Black finish.
Specify 87.4624.WZ.BL.

List price \$12.00

**Specifications and prices are subject to
change without prior notice.**

XXI Notes Worksurfaces with PowerUp

Level Two

MODEL	D x W x L	MODEL NUMBER						
		Worksurface	Edge Style	Surface Direct	Hgt	Tr Legs	Trim Color	Laminate
 <p>"P" Shaped Peninsula Worksurface</p> <ul style="list-style-type: none"> • Wireway not available on Level 2 • Notched vertical wireway and modesty panel frame style is standard 	24x48x60"	ZPT2448602	<input type="checkbox"/>	<input type="checkbox"/>	<input type="checkbox"/>	<input type="checkbox"/>	<input type="checkbox"/>	<input type="checkbox"/>
	24x48x72"	ZPT2448722	<input type="checkbox"/>	<input type="checkbox"/>	<input type="checkbox"/>	<input type="checkbox"/>	<input type="checkbox"/>	<input type="checkbox"/>
	30x48x72"	ZPT3048722	<input type="checkbox"/>	<input type="checkbox"/>	<input type="checkbox"/>	<input type="checkbox"/>	<input type="checkbox"/>	<input type="checkbox"/>
 <p>Piano Peninsula Worksurface</p> <ul style="list-style-type: none"> • Wireway not available on Level 2 • Notched vertical wireway and modesty panel frame style is standard 	24x48x60"	ZPP2448602	<input type="checkbox"/>	<input type="checkbox"/>	<input type="checkbox"/>	<input type="checkbox"/>	<input type="checkbox"/>	<input type="checkbox"/>
	24x48x72"	ZPP2448722	<input type="checkbox"/>	<input type="checkbox"/>	<input type="checkbox"/>	<input type="checkbox"/>	<input type="checkbox"/>	<input type="checkbox"/>
	30x48x72"	ZPP3048722	<input type="checkbox"/>	<input type="checkbox"/>	<input type="checkbox"/>	<input type="checkbox"/>	<input type="checkbox"/>	<input type="checkbox"/>
 <p>Square Shoe Worksurface</p> <ul style="list-style-type: none"> • Wireway not available on Level 2 • Notched vertical wireway and modesty panel frame style is standard 	24x48x60"	ZSS2448602	<input type="checkbox"/>	<input type="checkbox"/>	<input type="checkbox"/>	<input type="checkbox"/>	<input type="checkbox"/>	<input type="checkbox"/>
	24x48x66"	ZSS2448662	<input type="checkbox"/>	<input type="checkbox"/>	<input type="checkbox"/>	<input type="checkbox"/>	<input type="checkbox"/>	<input type="checkbox"/>
	24x48x72"	ZSS2448722	<input type="checkbox"/>	<input type="checkbox"/>	<input type="checkbox"/>	<input type="checkbox"/>	<input type="checkbox"/>	<input type="checkbox"/>
	24x48x84"	ZSS2448842	<input type="checkbox"/>	<input type="checkbox"/>	<input type="checkbox"/>	<input type="checkbox"/>	<input type="checkbox"/>	<input type="checkbox"/>
	30x48x66"	ZSS3048662	<input type="checkbox"/>	<input type="checkbox"/>	<input type="checkbox"/>	<input type="checkbox"/>	<input type="checkbox"/>	<input type="checkbox"/>
	30x48x72"	ZSS3048722	<input type="checkbox"/>	<input type="checkbox"/>	<input type="checkbox"/>	<input type="checkbox"/>	<input type="checkbox"/>	<input type="checkbox"/>
	30x48x84"	ZSS3048842	<input type="checkbox"/>	<input type="checkbox"/>	<input type="checkbox"/>	<input type="checkbox"/>	<input type="checkbox"/>	<input type="checkbox"/>

A **B** **C** **D** **E** **F** **G**

HOW TO ORDER

Indicate the following information on order form:

1. Quantity of each item.
2. Model number, including options. See "How to Build a Model Number."
3. Any special service required.

- Note:
- The indicates that a choice is required.
 - The absence of indicates that no choice is required.
 - Alpha-numeric characters in place of indicate that no other alternatives are available.

HOW TO BUILD A MODEL NUMBER

- A** Select size of worksurface.
B Select edge style.
T = Flat Vinyl T-edge
M = 3mm PVC edge
C Select surface direction.
L = Left
R = Right
D Select height.
9 = 29"
E Indicate location and type of leg.*
S = Standard (both standard legs)
R = Right (right transitional leg)
L = Left (left transitional leg)
B = Both (both transitional legs)

*Note: If ordering Basic Worksurface as a freestanding unit, or if only one side connects to a transitional worksurface, the "B" option for both transitional legs is not available.

- **Must order corresponding worksurface connector to attach to adjacent table when using transitional legs.**

- F** Select trim color for painted surfaces.
B = Black
G = Gray
S = Sand
W = Warm Gray
L = Light Tone
G Select laminate surface.
AA = Cream
AB = Champagne
AC = Barcelona
AF = Aruba Tan

- AG** = Black
AH = Dark Gray
AI = Dawn Gray (Greige)
AJ = Fog
AK = Black Grandin
AL = Smoke Granite
AM = Sand Grandin
AN = Light Granite
AO = Tundra
AP = Earthen
AQ = Rose Grafix
AS = Sierra Grafix
AT = Beige Grafix
AU = Sand Stone
AV = Kentucky Walnut
AW = Tennessee Oak
AX = Light Oak
AY = Red Birch
AZ = Ash
BA = Philadelphia Cherry
BB = Pennsylvania Cherry



Edge Styles



T-Edge
Price **(T)**



3mm PVC Edge
Price **(M)**

Total Weight

134#	\$315	\$330
146#	325	340
150#	335	350

132#	290	305
144#	300	315
148#	310	325

133#	\$280	\$295
139#	290	305
145#	295	310
157#	305	320
144#	290	305
150#	295	310
172#	305	320

- BD** = Oak
- BE** = Maple
- BF** = Pearwood
- CA** = Pumice
- CB** = Rock Maple
- CC** = Medium Cherry
- CD** = Anigre
- ZZ** = COM

FINISH INFORMATION

Laminate Surface

See Keys for Progression swatch card.

ACCESSORIES

Casters

4 swivel casters (2 1/2" diameter), 2 with locks. Add 2" to top surface height. Add 2lbs. to weight. Order separately, specify 87.2840

List price \$34.00/set

Worksurface Connectors

For attaching two freestanding tables together of same height. Black finish. Specify 87.4632.WZ.BL.

List price \$8.00

For attaching two freestanding tables together of different heights. Black finish. Specify 87.4624.WZ.BL.

List price \$12.00

Specifications and prices are subject to change without prior notice.

XXI Notes Worksurfaces with PowerUp

Level Three

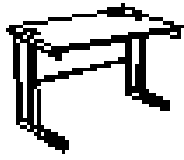

Basic Worksurface

- One PowerUp module
- Wireway not available on Level 3
- Notched vertical wireway and modesty panel frame style is standard



- One or two PowerUp modules available on 60" and 72" wide surfaces.
- Left and right data location only available on 60" and 72" worksurface.
- Wireway not available on Level 3
- Notched vertical wireway and modesty panel frame style is standard

MODEL	D x W	MODEL NUMBER						
		Worksurface	Edge Style	P/Up Location	Hgt	Tr Legs	Trim Color	Laminate
	24x30"	WBW24303	<input type="checkbox"/>	<input type="checkbox"/>	<input type="checkbox"/>	<input type="checkbox"/>	<input type="checkbox"/>	<input type="checkbox"/>
	24x36"	WBW24363	<input type="checkbox"/>	<input type="checkbox"/>	<input type="checkbox"/>	<input type="checkbox"/>	<input type="checkbox"/>	<input type="checkbox"/>
	24x42"	WBW24423	<input type="checkbox"/>	<input type="checkbox"/>	<input type="checkbox"/>	<input type="checkbox"/>	<input type="checkbox"/>	<input type="checkbox"/>
	24x48"	WBW24483	<input type="checkbox"/>	<input type="checkbox"/>	<input type="checkbox"/>	<input type="checkbox"/>	<input type="checkbox"/>	<input type="checkbox"/>
	24x54"	WBW24543	<input type="checkbox"/>	<input type="checkbox"/>	<input type="checkbox"/>	<input type="checkbox"/>	<input type="checkbox"/>	<input type="checkbox"/>
	30x30"	WBW30303	<input type="checkbox"/>	<input type="checkbox"/>	<input type="checkbox"/>	<input type="checkbox"/>	<input type="checkbox"/>	<input type="checkbox"/>
	30x36"	WBW30363	<input type="checkbox"/>	<input type="checkbox"/>	<input type="checkbox"/>	<input type="checkbox"/>	<input type="checkbox"/>	<input type="checkbox"/>
	30x42"	WBW30423	<input type="checkbox"/>	<input type="checkbox"/>	<input type="checkbox"/>	<input type="checkbox"/>	<input type="checkbox"/>	<input type="checkbox"/>
	30x48"	WBW30483	<input type="checkbox"/>	<input type="checkbox"/>	<input type="checkbox"/>	<input type="checkbox"/>	<input type="checkbox"/>	<input type="checkbox"/>
	30x54"	WBW30543	<input type="checkbox"/>	<input type="checkbox"/>	<input type="checkbox"/>	<input type="checkbox"/>	<input type="checkbox"/>	<input type="checkbox"/>
	24x60"	WBW24603	<input type="checkbox"/>	<input type="checkbox"/>	<input type="checkbox"/>	<input type="checkbox"/>	<input type="checkbox"/>	<input type="checkbox"/>
	24x72"	WBW24723	<input type="checkbox"/>	<input type="checkbox"/>	<input type="checkbox"/>	<input type="checkbox"/>	<input type="checkbox"/>	<input type="checkbox"/>
	30x60"	WBW30603	<input type="checkbox"/>	<input type="checkbox"/>	<input type="checkbox"/>	<input type="checkbox"/>	<input type="checkbox"/>	<input type="checkbox"/>
	30x72"	WBW30723	<input type="checkbox"/>	<input type="checkbox"/>	<input type="checkbox"/>	<input type="checkbox"/>	<input type="checkbox"/>	<input type="checkbox"/>

A **B** **C** **D** **E** **F** **G**

HOW TO ORDER

Indicate the following information on order form:

1. Quantity of each item.
2. Model number, including options. See "How to Build a Model Number."
3. Any special service required.

- Note:
- The indicates that a choice is required.
 - The absence of indicates that no choice is required.
 - Alpha-numeric characters in place of indicate that no other alternatives are available.

HOW TO BUILD A MODEL NUMBER

- A** Select size of worksurface.
B Select edge style.
T = Flat Vinyl T-edge
M = 3mm PVC edge
C Select PowerUp location.
L = Left
R = Right
C = Center
B = Left and right (60" and 72" only)
D Select height.
7 = 27"
9 = 29"
E Indicate location and type of leg.*
S = Standard (both standard legs)
R = Right (right transitional leg)
L = Left (left transitional leg)
B = Both (both transitional legs)

*Note: If ordering Basic Worksurface as a freestanding unit, or if only one side connects to a transitional worksurface, the "B" option for both transitional legs is not available.

• **Must order corresponding worksurface connector to attach to adjacent table when using transitional legs.**

- F** Select trim color for painted surfaces.
B = Black
G = Gray
S = Sand
W = Warm Gray
L = Light Tone
G Select laminate surface.
AA = Cream
AB = Champagne
AC = Barcelona
AF = Aruba Tan
AG = Black

- AH** = Dark Gray
AI = Dawn Gray (Greige)
AJ = Fog
AK = Black Grandin
AL = Smoke Granite
AM = Sand Grandin
AN = Light Granite
AO = Tundra
AP = Earthen
AQ = Rose Grafix
AS = Sierra Grafix
AT = Beige Grafix
AU = Sand Stone
AV = Kentucky Walnut
AW = Tennessee Oak
AX = Light Oak
AY = Red Birch
AZ = Ash
BA = Philadelphia Cherry
BB = Pennsylvania Cherry
BC = Mahogany



Edge Styles



T-Edge
Price **(T)**

3mm PVC Edge
Price **(M)**

27"	Total Weight	29"	T-Edge Price (T)	3mm PVC Edge Price (M)
66#		69#	\$ 220	\$ 230
73#		76#	225	235
80#		83#	230	240
86#		89#	235	245
93#		96#	245	255
73#		76#	220	230
80#		83#	225	235
89#		92#	230	240
97#		100#	235	245
103#		106#	245	255
98#		102#	250	260
111#		116#	265	275
109#		113#	250	260
122#		126#	265	275

- BE** = Maple
- BF** = Pearwood
- CA** = Pumice
- CB** = Rock Maple
- CC** = Medium Cherry
- CD** = Anigre
- ZZ** = COM

FINISH INFORMATION

Laminate Surface
See Keys for Progression swatch card.

ACCESSORIES

Casters
4 swivel casters (2½" diameter), 2 with locks.
Add 2" to top surface height. Add 2lbs. to weight.
Order separately, specify 87.2840
List price \$34.00/set

Worksurface Connectors
For attaching two freestanding tables together
of same height. Black finish.
Specify 87.4632.WZ.BL.
List price \$8.00

For attaching two freestanding tables together
of different heights. Black finish.
Specify 87.4624.WZ.BL.
List price \$12.00

Specifications and prices are subject to change without prior notice.

XXI Notes Worksurfaces with PowerUp

Level Three

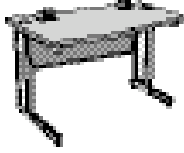

Curvilinear Worksurface

- One PowerUp module only on 42" to 54" wide surfaces.
- One or two PowerUp modules available on 60" and 72" wide surfaces.
- Wireway not available on Level 3
- Notched vertical wireway and modesty panel frame style is standard.

MODEL	D x W	MODEL NUMBER						
		Worksurface	Edge Style	P/Up Location	Hgt	Tr Legs	Trim Color	Laminate
	24x42x30"	WRC2442303	<input type="checkbox"/>	<input type="checkbox"/>	<input type="checkbox"/>	<input type="checkbox"/>	<input type="checkbox"/>	<input type="checkbox"/>
	24x48x30"	WRC2448303	<input type="checkbox"/>	<input type="checkbox"/>	<input type="checkbox"/>	<input type="checkbox"/>	<input type="checkbox"/>	<input type="checkbox"/>
	24x54x30"	WRC2454303	<input type="checkbox"/>	<input type="checkbox"/>	<input type="checkbox"/>	<input type="checkbox"/>	<input type="checkbox"/>	<input type="checkbox"/>
	24x60x30"	WRC2460303	<input type="checkbox"/>	<input type="checkbox"/>	<input type="checkbox"/>	<input type="checkbox"/>	<input type="checkbox"/>	<input type="checkbox"/>
	24x72x30"	WRC2472303	<input type="checkbox"/>	<input type="checkbox"/>	<input type="checkbox"/>	<input type="checkbox"/>	<input type="checkbox"/>	<input type="checkbox"/>
	30x42x24"	WRC3042243	<input type="checkbox"/>	<input type="checkbox"/>	<input type="checkbox"/>	<input type="checkbox"/>	<input type="checkbox"/>	<input type="checkbox"/>
	30x48x24"	WRC3048243	<input type="checkbox"/>	<input type="checkbox"/>	<input type="checkbox"/>	<input type="checkbox"/>	<input type="checkbox"/>	<input type="checkbox"/>
	30x54x24"	WRC3054243	<input type="checkbox"/>	<input type="checkbox"/>	<input type="checkbox"/>	<input type="checkbox"/>	<input type="checkbox"/>	<input type="checkbox"/>
	30x60x24"	WRC3060243	<input type="checkbox"/>	<input type="checkbox"/>	<input type="checkbox"/>	<input type="checkbox"/>	<input type="checkbox"/>	<input type="checkbox"/>
	30x72x24"	WRC3072243	<input type="checkbox"/>	<input type="checkbox"/>	<input type="checkbox"/>	<input type="checkbox"/>	<input type="checkbox"/>	<input type="checkbox"/>
	30x36"	WSU30363	<input type="checkbox"/>	<input type="checkbox"/>	2	S	<input type="checkbox"/>	<input type="checkbox"/>

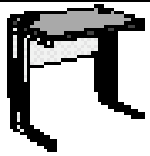

Stand Alone Stand-Up Worksurface

- Available in 42" height only
- Not available with transitional legs.
- One PowerUp module.
- Wireway not available on Level 3
- Notched vertical wireway and modesty panel frame style is standard.

A B C D E F G

HOW TO ORDER

Indicate the following information on order form:

1. Quantity of each item.
2. Model number, including options. See "How to Build a Model Number."
3. Any special service required.

- Note:
- The indicates that a choice is required.
 - The absence of indicates that no choice is required.
 - Alpha-numeric characters in place of indicate that no other alternatives are available.

HOW TO BUILD A MODEL NUMBER

- A** Select size of worksurface.
B Select edge style.
T = Flat Vinyl T-edge
M = 3mm PVC edge
C Select PowerUp location.
L = Left
R = Right
C = Center
B = Left and right (60" and 72" only)
D Select height.
2 = 42"
7 = 27"
9 = 29"
E Indicate location and type of leg.*
S = Standard (both standard legs)
R = Right (right transitional leg)
L = Left (left transitional leg)

*Note: If ordering Basic Worksurface as a freestanding unit, or if only one side connects to a transitional worksurface, the "B" option for both transitional legs is not available.

• **Must order corresponding worksurface connector to attach to adjacent table when using transitional legs.**

- F** Select trim color for painted surfaces.
B = Black
G = Gray
S = Sand
W = Warm Gray
L = Light Tone
G Select laminate surface.
AA = Cream
AB = Champagne
AC = Barcelona
AF = Aruba Tan
AG = Black

- AH** = Dark Gray
AI = Dawn Gray (Greige)
AJ = Fog
AK = Black Grandin
AL = Smoke Granite
AM = Sand Grandin
AN = Light Granite
AO = Tundra
AP = Earthen
AQ = Rose Grafix
AS = Sierra Grafix
AT = Beige Grafix
AU = Sand Stone
AV = Kentucky Walnut
AW = Tennessee Oak
AX = Light Oak
AY = Red Birch
AZ = Ash
BA = Philadelphia Cherry
BB = Pennsylvania Cherry
BC = Mahogany



Edge Styles



T-Edge
Price (**T**)

3mm PVC Edge
Price (**M**)

Total Weight
27" 29" 42"

27"	29"	42"	T-Edge Price (T)	3mm PVC Edge Price (M)
81#	84#		\$230	\$240
88#	91#		235	245
95#	98#		245	255
100#	103#		250	260
114#	117#		265	275
81#	84#		230	240
88#	91#		235	245
95#	98#		245	255
100#	103#		250	260
114#	117#		265	275

94# \$255 \$270

- BE** = Maple
- BF** = Pearwood
- CA** = Pumice
- CB** = Rock Maple
- CC** = Medium Cherry
- CD** = Anigre
- ZZ** = COM

FINISH INFORMATION

Laminate Surface
See Keys for Progression swatch card.

ACCESSORIES

Casters
4 swivel casters (2½" diameter), 2 with locks.
Add 2" to top surface height. Add 2lbs. to weight.
Order separately, specify 87.2840
List price \$34.00/set



Worksurface Connectors
For attaching two freestanding tables together
of same height. Black finish.
Specify 87.4632.WZ.BL.
List price \$8.00

For attaching two freestanding tables together
of different heights. Black finish.
Specify 87.4624.WZ.BL.
List price \$12.00

**Specifications and prices are subject to
change without prior notice.**

XXI Notes Worksurfaces with PowerUp

Level Three

MODEL	D x W	MODEL NUMBER						
		Worksurface	Edge Style	P/Up Location	Hgt	Tr Legs	Trim Color	Laminate
 <p>Adjustable Keyboard Pad Worksurface</p> <ul style="list-style-type: none"> • One PowerUp module • Only center keypad available on 36" and 42" worksurfaces • Wireway not available on Level 3 • Notched vertical wireway and modesty panel frame style is standard 	24x36"	WAK24363	<input type="checkbox"/>	<input type="checkbox"/>	<input type="checkbox"/>	<input type="checkbox"/>	<input type="checkbox"/>	<input type="checkbox"/>
	24x42"	WAK24423	<input type="checkbox"/>	<input type="checkbox"/>	<input type="checkbox"/>	<input type="checkbox"/>	<input type="checkbox"/>	<input type="checkbox"/>
	24x48"	WAK24483	<input type="checkbox"/>	<input type="checkbox"/>	<input type="checkbox"/>	<input type="checkbox"/>	<input type="checkbox"/>	<input type="checkbox"/>
	24x54"	WAK24543	<input type="checkbox"/>	<input type="checkbox"/>	<input type="checkbox"/>	<input type="checkbox"/>	<input type="checkbox"/>	<input type="checkbox"/>
	30x36"	WAK30363	<input type="checkbox"/>	<input type="checkbox"/>	<input type="checkbox"/>	<input type="checkbox"/>	<input type="checkbox"/>	<input type="checkbox"/>
	30x42"	WAK30423	<input type="checkbox"/>	<input type="checkbox"/>	<input type="checkbox"/>	<input type="checkbox"/>	<input type="checkbox"/>	<input type="checkbox"/>
	30x48"	WAK30483	<input type="checkbox"/>	<input type="checkbox"/>	<input type="checkbox"/>	<input type="checkbox"/>	<input type="checkbox"/>	<input type="checkbox"/>
	30x54"	WAK30543	<input type="checkbox"/>	<input type="checkbox"/>	<input type="checkbox"/>	<input type="checkbox"/>	<input type="checkbox"/>	<input type="checkbox"/>
 <ul style="list-style-type: none"> • One or two PowerUp modules available on 60" and 72" wide surfaces. • Left and right data location only available on 60" and 72" worksurface. • Wireway not available on Level 3 • Notched vertical wireway and modesty panel frame style is standard 	24x60"	WAK24603	<input type="checkbox"/>	<input type="checkbox"/>	<input type="checkbox"/>	<input type="checkbox"/>	<input type="checkbox"/>	<input type="checkbox"/>
	24x72"	WAK24723	<input type="checkbox"/>	<input type="checkbox"/>	<input type="checkbox"/>	<input type="checkbox"/>	<input type="checkbox"/>	<input type="checkbox"/>
	30x60"	WAK30603	<input type="checkbox"/>	<input type="checkbox"/>	<input type="checkbox"/>	<input type="checkbox"/>	<input type="checkbox"/>	<input type="checkbox"/>
	30x72"	WAK30723	<input type="checkbox"/>	<input type="checkbox"/>	<input type="checkbox"/>	<input type="checkbox"/>	<input type="checkbox"/>	<input type="checkbox"/>

A B C D E F G

HOW TO ORDER

Indicate the following information on order form:

- Quantity of each item.
- Model number, including options. See "How to Build a Model Number."
- Any special service required.

- Note:
- The indicates that a choice is required.
 - The absence of indicates that no choice is required.
 - Alpha-numeric characters in place of indicate that no other alternatives are available.

HOW TO BUILD A MODEL NUMBER

- A** Select size of worksurface.

- B** Select edge style.
 - T** = Flat Vinyl T-edge
 - M** = 3mm PVC edge
- C** Select PowerUp location.
 - L** = Left
 - R** = Right
 - C** = Center
 - B** = Left and right (60" and 72" only)
- D** Select height.
 - 7** = 27"
 - 9** = 29"
- E** Indicate location and type of leg.*
 - S** = Standard (both standard legs)
 - R** = Right (right transitional leg)
 - L** = Left (left transitional leg)
 - B** = Both (both transitional legs)

*Note: If ordering Basic Worksurface as a freestanding unit, or if only one side connects to a transitional worksurface, the "B" option for both transitional legs is not available.

• **Must order corresponding worksurface connector to attach to adjacent table when using transitional legs.**

- F** Select trim color for painted surfaces.
 - B** = Black
 - G** = Gray
 - S** = Sand
 - W** = Warm Gray
 - L** = Light Tone
- G** Select laminate surface.
 - AA** = Cream
 - AB** = Champagne
 - AC** = Barcelona
 - AF** = Aruba Tan
 - AG** = Black

- AH** = Dark Gray
- AI** = Dawn Gray (Greige)
- AJ** = Fog
- AK** = Black Grandin
- AL** = Smoke Granite
- AM** = Sand Grandin
- AN** = Light Granite
- AO** = Tundra
- AP** = Earthen
- AQ** = Rose Grafix
- AS** = Sierra Grafix
- AT** = Beige Grafix
- AU** = Sand Stone
- AV** = Kentucky Walnut
- AW** = Tennessee Oak
- AX** = Light Oak
- AY** = Red Birch
- AZ** = Ash
- BA** = Philadelphia Cherry
- BB** = Pennsylvania Cherry
- BC** = Mahogany



Edge Styles



T-Edge
Price **(T)**

3mm PVC Edge
Price **(M)**

27" Total Weight

29"

27"	Total Weight	29"	T-Edge Price (T)	3mm PVC Edge Price (M)
74#		77#	\$235	\$245
81#		84#	240	250
87#		90#	245	260
93#		96#	255	270
81#		84#	235	245
90#		93#	240	250
98#		101#	245	260
106#		110#	255	270
99#		103#	260	275
112#		126#	275	290
110#		114#	260	275
126#		130#	275	290

- BE** = Maple
- BF** = Pearwood
- CA** = Pumice
- CB** = Rock Maple
- CC** = Medium Cherry
- CD** = Anigre
- ZZ** = COM

FINISH INFORMATION

Laminate Surface
See Keys for Progression swatch card.

ACCESSORIES

Casters
4 swivel casters (2½" diameter), 2 with locks. Add 2" to top surface height. Add 2lbs. to weight. Order separately, specify 87.2840
List price \$34.00/set

Worksurface Connectors
For attaching two freestanding tables together of same height. Black finish. Specify 87.4632.WZ.BL.
List price \$8.00

For attaching two freestanding tables together of different heights. Black finish. Specify 87.4624.WZ.BL.
List price \$12.00

Specifications and prices are subject to change without prior notice.

XXI Notes Worksurfaces with PowerUp

Level Three

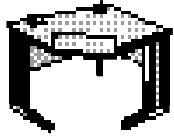

Stand Alone Corner Worksurface with Keyboard

- Not available with transitional legs
- Wireway not available on Level 3
- Only center keypad available
- Notched vertical wireway and modesty panel frame style is standard

MODEL	D x W	MODEL NUMBER							
		Worksurface	Edge Style	Keypad Location	P/Up Location	Hgt	Tr Legs	Trim Color	Laminate
	24x42"	WCS24423	<input type="checkbox"/>	<input type="checkbox"/>	<input type="checkbox"/>	<input type="checkbox"/>	<input type="checkbox"/>	<input type="checkbox"/>	<input type="checkbox"/>
	30x48"	WCS30483	<input type="checkbox"/>	<input type="checkbox"/>	<input type="checkbox"/>	<input type="checkbox"/>	<input type="checkbox"/>	<input type="checkbox"/>	<input type="checkbox"/>
	24x36"	WCSK24363	<input type="checkbox"/>	NA	<input type="checkbox"/>	<input type="checkbox"/>	<input type="checkbox"/>	<input type="checkbox"/>	<input type="checkbox"/>
	24x72"	WCSK24723	<input type="checkbox"/>	NA	<input type="checkbox"/>	<input type="checkbox"/>	<input type="checkbox"/>	<input type="checkbox"/>	<input type="checkbox"/>
	30x48"	WCSK30483	<input type="checkbox"/>	NA	<input type="checkbox"/>	<input type="checkbox"/>	<input type="checkbox"/>	<input type="checkbox"/>	<input type="checkbox"/>



Stand Alone Corner Worksurface

- Not available with transitional legs
- Wireway not available on Level 3
- Notched vertical wireway and modesty panel frame style is standard

A B C D E F G H

HOW TO ORDER

Indicate the following information on order form:

- Quantity of each item.
- Model number, including options. See "How to Build a Model Number."
- Any special service required.

- Note:
- The indicates that a choice is required.
 - The absence of indicates that no choice is required.
 - Alpha-numeric characters in place of indicate that no other alternatives are available.

HOW TO BUILD A MODEL NUMBER

- A** Select size of worksurface.
B Select edge style.
T = Flat Vinyl T-edge
M = 3mm PVC edge
C Select keypad location.
C = Center
R = Right
L = Left
D Select PowerUp location.
L = Left
R = Right
C = Center
B = Left and right (60" and 72" only)
E Select height.
7 = 27"
9 = 29"

- F** Indicate location and type of leg.*
S = Standard (both standard legs)
R = Right (right transitional leg)
L = Left (left transitional leg)
B = Both (both transitional legs)

*Note: If ordering Basic Worksurface as a freestanding unit, or if only one side connects to a transitional worksurface, the "B" option for both transitional legs is not available.

- **Must order corresponding worksurface connector to attach to adjacent table when using transitional legs.**

- G** Select trim color for painted surfaces.
B = Black
G = Gray
S = Sand
W = Warm Gray
L = Light Tone

- H** Select laminate surface.
AA = Cream
AB = Champagne
AC = Barcelona
AF = Aruba Tan
AG = Black
AH = Dark Gray
AI = Dawn Gray (Greige)
AJ = Fog
AK = Black Grandin
AL = Smoke Granite
AM = Sand Grandin
AN = Light Granite
AO = Tundra
AP = Earthen
AQ = Rose Grafix
AS = Sierra Grafix
AT = Beige Grafix
AU = Sand Stone
AV = Kentucky Walnut



Edge Styles



T-Edge
Price **(T)**

3mm PVC Edge
Price **(M)**

27" Total Weight

29"

Joins Table

97#

99#

225

235

24" deep worksurface to 24" deep worksurface

116#

118#

235

245

30" deep worksurface to 30" deep worksurface

73#

76#

260

270

93#

96#

280

295

115#

118#

300

315

- AW** = Tennessee Oak
- AX** = Light Oak
- AY** = Red Birch
- AZ** = Ash
- BA** = Philadelphia Cherry
- BB** = Pennsylvania Cherry
- BC** = Mahogany
- BD** = Oak
- BE** = Maple
- BF** = Pearwood
- CA** = Pumice
- CB** = Rock Maple
- CC** = Medium Cherry
- CD** = Anigre
- ZZ** = COM

FINISH INFORMATION

Laminate Surface

See Keys for Progression swatch card.

ACCESSORIES

Casters

4 swivel casters (2½" diameter), 2 with locks. Add 2" to top surface height. Add 2lbs. to weight. Order separately, specify 87.2840

List price \$34.00/set

Worksurface Connectors

For attaching two freestanding tables together of same height. Black finish. Specify 87.4632.WZ.BL.

List price \$8.00



For attaching two freestanding tables together of different heights. Black finish. Specify 87.4624.WZ.BL.

List price \$12.00

Specifications and prices are subject to change without prior notice.

XXI Notes Worksurfaces with PowerUp

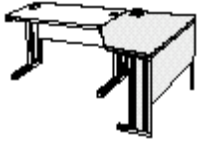
Level Three

MODEL	Left D x W x D	Right D x W x D	MODEL NUMBER									
			Worksurface	Edge Style	P/Up Location	Trans Direct	Hgt	Trim Color	Laminate			
 End-of-Run Worksurface with Keyboard <ul style="list-style-type: none"> • 36" width not available with key pad • 42" and 48" widths available with center keypad and bullnose edge • Transition direction is figured from the originating 24" or 30" basic or keyboard pad worksurface • Wireway not available on Level 3 • Notched vertical wireway and modesty panel frame style is standard 	24x36x36x24"	24x42x42x24"	30x48x48x30"	WERK24363	<input type="checkbox"/>	<input type="checkbox"/>	<input type="checkbox"/>	<input type="checkbox"/>	<input type="checkbox"/>	<input type="checkbox"/>	<input type="checkbox"/>	
				WERK24423	<input type="checkbox"/>	<input type="checkbox"/>	<input type="checkbox"/>	<input type="checkbox"/>	<input type="checkbox"/>	<input type="checkbox"/>	<input type="checkbox"/>	
				WERK30483	<input type="checkbox"/>	<input type="checkbox"/>	<input type="checkbox"/>	<input type="checkbox"/>	<input type="checkbox"/>	<input type="checkbox"/>	<input type="checkbox"/>	
 End-of-Run Worksurface <ul style="list-style-type: none"> • Wireway standard • Notched vertical wireway and modesty panel frame style is standard 	24x42x42x24"	24x48x48x24"	30x48x48x30"	WER24423	<input type="checkbox"/>	<input type="checkbox"/>	<input type="checkbox"/>	<input type="checkbox"/>	<input type="checkbox"/>	<input type="checkbox"/>		
				WER24483	<input type="checkbox"/>	<input type="checkbox"/>	<input type="checkbox"/>	<input type="checkbox"/>	<input type="checkbox"/>	<input type="checkbox"/>		
				WER30483	<input type="checkbox"/>	<input type="checkbox"/>	<input type="checkbox"/>	<input type="checkbox"/>	<input type="checkbox"/>	<input type="checkbox"/>		
 End-of-Run Curvilinear Worksurface <ul style="list-style-type: none"> • Wireway standard • Notched vertical wireway and modesty panel frame style is standard 	24x36x36x24"	24x42x42x24"	24x48x48x24"	30x42x42x30"	30x48x48x30"	WCCE24363	<input type="checkbox"/>	<input type="checkbox"/>	<input type="checkbox"/>	<input type="checkbox"/>	<input type="checkbox"/>	
						WCCE24423	<input type="checkbox"/>	<input type="checkbox"/>	<input type="checkbox"/>	<input type="checkbox"/>	<input type="checkbox"/>	
						WCCE24483	<input type="checkbox"/>	<input type="checkbox"/>	<input type="checkbox"/>	<input type="checkbox"/>	<input type="checkbox"/>	
						WCCE30423	<input type="checkbox"/>	<input type="checkbox"/>	<input type="checkbox"/>	<input type="checkbox"/>	<input type="checkbox"/>	
						WCCE30483	<input type="checkbox"/>	<input type="checkbox"/>	<input type="checkbox"/>	<input type="checkbox"/>	<input type="checkbox"/>	
						A	B	C	D	E	F	G

HOW TO ORDER

Indicate the following information on order form:

- Quantity of each item.
- Model number, including options. See "How to Build a Model Number."
- Any special service required.

- Note:
- The indicates that a choice is required.
 - The absence of indicates that no choice is required.
 - Alpha-numeric characters in place of indicate that no other alternatives are available.

HOW TO BUILD A MODEL NUMBER

- A** Select size of worksurface.
B Select edge style.
T = Flat Vinyl T-edge
M = 3mm PVC edge
C Select PowerUp location.
L = Left
R = Right
C = Center
B = Left and right (60" and 72" only)
D Select transitional direction.
L = Left
R = Right
E Select height.
2 = 42"
7 = 27"
9 = 29"
- F** Select trim color for painted surfaces.
B = Black
G = Gray
S = Sand
W = Warm Gray
L = Light Tone
G Select laminate surface.
AA = Cream
AB = Champagne
AC = Barcelona
AF = Aruba Tan
AG = Black
AH = Dark Gray
AI = Dawn Gray (Greige)
AJ = Fog
AK = Black Grandin
AL = Smoke Granite
AM = Sand Grandin
AN = Light Granite

- AO** = Tundra
AP = Earthen
AQ = Rose Grafix
AS = Sierra Grafix
AT = Beige Grafix
AU = Sand Stone
AV = Kentucky Walnut
AW = Tennessee Oak
AX = Light Oak
AY = Red Birch
AZ = Ash
BA = Philadelphia Cherry
BB = Pennsylvania Cherry
BC = Mahogany
BD = Oak
BE = Maple
BF = Pearwood
CA = Pumice
CB = Rock Maple
CC = Medium Cherry
CD = Anigre



Edge Styles



T-Edge
Price **(T)**



3mm PVC Edge
Price **(M)**

Total Weight
27" 29"

Joins Table

78#	215	225	24" deep worksurface to 24" deep worksurface
102#	265	280	30" deep worksurface to 30" deep worksurface
78#	220	230	24" deep worksurface to 24" deep worksurface
82#	270	285	24" deep worksurface to 24" deep worksurface
100#	270	285	30" deep worksurface to 30" deep worksurface
76#	195	205	24" deep worksurface to 24" deep worksurface
96#	220	230	24" deep worksurface to 24" deep worksurface
106#	270	285	24" deep worksurface to 24" deep worksurface
108#	220	230	30" deep worksurface to 30" deep worksurface
118#	270	285	30" deep worksurface to 30" deep worksurface

FINISH INFORMATION

Laminate Surface

See Keys for Progression swatch card.

ACCESSORIES

Casters

4 swivel casters (2½" diameter), 2 with locks. Add 2" to top surface height. Add 2lbs. to weight. Order separately, specify 87.2840

List price \$34.00/set

Worksurface Connectors

For attaching two freestanding tables together of same height. Black finish. Specify 87.4632.WZ.BL.

List price \$8.00





For attaching two freestanding tables together of different heights. Black finish. Specify 87.4624.WZ.BL.

List price \$12.00

Specifications and prices are subject to change without prior notice.

XXI Notes Worksurfaces with PowerUp

Level Three

MODEL	Left D x W x D	Right D x W x D	MODEL NUMBER						
			Worksurface	Edge Style	P/Up Location	Hgt	Tr Legs	Trim Color	Laminate
 Corner Transitional Worksurface • One PowerUp module • Wireway not available on Level 3 • Notched vertical wireway and modesty panel frame style is standard	24x36"		CT24363	<input type="checkbox"/>	<input type="checkbox"/>	<input type="checkbox"/>	<input type="checkbox"/>	<input type="checkbox"/>	<input type="checkbox"/>
	24x42"		CT24423	<input type="checkbox"/>	<input type="checkbox"/>	<input type="checkbox"/>	<input type="checkbox"/>	<input type="checkbox"/>	<input type="checkbox"/>
	30x48"		CT30483	<input type="checkbox"/>	<input type="checkbox"/>	<input type="checkbox"/>	<input type="checkbox"/>	<input type="checkbox"/>	<input type="checkbox"/>
 Corner Transitional Worksurface with Keyboard Pad • One PowerUp module • Wireway not available on Level 3 • Available with center keypad and bullnose edge • Notched vertical wireway and modesty panel frame style is standard	24x42"		CTK24423	<input type="checkbox"/>	<input type="checkbox"/>	<input type="checkbox"/>	<input type="checkbox"/>	<input type="checkbox"/>	<input type="checkbox"/>
	30x48"		CTK30483	<input type="checkbox"/>	<input type="checkbox"/>	<input type="checkbox"/>	<input type="checkbox"/>	<input type="checkbox"/>	<input type="checkbox"/>
 Corner Transitional Reduction Worksurface • One PowerUp module • Wireway not available on Level 3 • Notched vertical wireway and modesty panel frame style is standard	24x42x42x30"		CT2442303	<input type="checkbox"/>	<input type="checkbox"/>	<input type="checkbox"/>	<input type="checkbox"/>	<input type="checkbox"/>	<input type="checkbox"/>
	24x48x48x30"		CT2448303	<input type="checkbox"/>	<input type="checkbox"/>	<input type="checkbox"/>	<input type="checkbox"/>	<input type="checkbox"/>	<input type="checkbox"/>
	30x42x42x24"		CT3042243	<input type="checkbox"/>	<input type="checkbox"/>	<input type="checkbox"/>	<input type="checkbox"/>	<input type="checkbox"/>	<input type="checkbox"/>
	30x48x48x24"		CT3048243	<input type="checkbox"/>	<input type="checkbox"/>	<input type="checkbox"/>	<input type="checkbox"/>	<input type="checkbox"/>	<input type="checkbox"/>
 Corner Curvilinear Transitional Worksurface • One PowerUp module • Wireway not available on Level 3 • Notched vertical wireway and modesty panel frame style is standard	24x36x36x24"		CCT24363	<input type="checkbox"/>	<input type="checkbox"/>	<input type="checkbox"/>	<input type="checkbox"/>	<input type="checkbox"/>	<input type="checkbox"/>
	24x42x42x24"		CCT24423	<input type="checkbox"/>	<input type="checkbox"/>	<input type="checkbox"/>	<input type="checkbox"/>	<input type="checkbox"/>	<input type="checkbox"/>
	24x48x48x24"		CCT24483	<input type="checkbox"/>	<input type="checkbox"/>	<input type="checkbox"/>	<input type="checkbox"/>	<input type="checkbox"/>	<input type="checkbox"/>
	30x42x42x30"		CCT30423	<input type="checkbox"/>	<input type="checkbox"/>	<input type="checkbox"/>	<input type="checkbox"/>	<input type="checkbox"/>	<input type="checkbox"/>
	30x48x48x30"		CCT30483	<input type="checkbox"/>	<input type="checkbox"/>	<input type="checkbox"/>	<input type="checkbox"/>	<input type="checkbox"/>	<input type="checkbox"/>
 Corner Curvilinear Transitional Reduction Worksurface • One PowerUp module • Wireway not available on Level 3 • Notched vertical wireway and modesty panel frame style is standard	24x42x42x30"		CCT2442303	<input type="checkbox"/>	<input type="checkbox"/>	<input type="checkbox"/>	<input type="checkbox"/>	<input type="checkbox"/>	<input type="checkbox"/>
	24x48x48x30"		CCT2448303	<input type="checkbox"/>	<input type="checkbox"/>	<input type="checkbox"/>	<input type="checkbox"/>	<input type="checkbox"/>	<input type="checkbox"/>
	30x42x42x24"		CCT3042243	<input type="checkbox"/>	<input type="checkbox"/>	<input type="checkbox"/>	<input type="checkbox"/>	<input type="checkbox"/>	<input type="checkbox"/>
	30x48x48x24"		CCT3048243	<input type="checkbox"/>	<input type="checkbox"/>	<input type="checkbox"/>	<input type="checkbox"/>	<input type="checkbox"/>	<input type="checkbox"/>

A B C D E F G

HOW TO ORDER

Indicate the following information on order form:

- Quantity of each item.
- Model number, including options. See "How to Build a Model Number."
- Any special service required.

- Note:
- The indicates that a choice is required.
 - The absence of indicates that no choice is required.
 - Alpha-numeric characters in place of indicate that no other alternatives are available.

HOW TO BUILD A MODEL NUMBER

- A** Select size of worksurface.

- B** Select edge style.

T = Flat Vinyl T-edge
M = 3mm PVC edge
- C** Select PowerUp location.

L = Left
R = Right
C = Center
B = Left and right (60" and 72" only)
- D** Select height.

2 = 42"
7 = 27"
9 = 29"

- E** Indicate location and type of leg.*

S = Standard (both standard legs)
R = Right (right transitional leg)
L = Left (left transitional leg)
B = Both (both transitional legs)

*Note: If ordering Basic Worksurface as a freestanding unit, or if only one side connects to a transitional worksurface, the "B" option for both transitional legs is not available.

- **Must order corresponding worksurface connector to attach to adjacent table when using transitional legs.**

- F** Select trim color for painted surfaces.

B = Black
G = Gray
S = Sand
W = Warm Gray
L = Light Tone

- G** Select laminate surface.

AA = Cream
AB = Champagne
AC = Barcelona
AF = Aruba Tan
AG = Black
AH = Dark Gray
AI = Dawn Gray (Greige)
AJ = Fog
AK = Black Grandin
AL = Smoke Granite
AM = Sand Grandin
AN = Light Granite
AO = Tundra
AP = Earthen
AQ = Rose Grafix
AS = Sierra Grafix
AT = Beige Grafix
AU = Sand Stone
AV = Kentucky Walnut



Edge Styles



Total Weight
27" 29"

T-Edge
Price (**T**)

3mm PVC Edge
Price (**M**)

Joins Table

72#	\$200	\$210	24" deep worksurface to 24" deep worksurface
80#	205	215	24" deep worksurface to 24" deep worksurface
102#	240	250	30" deep worksurface to 30" deep worksurface

80#	150	160	24" deep worksurface to 24" deep worksurface
102#	160	170	30" deep worksurface to 30" deep worksurface

96#	225	235	24" deep worksurface to 30" deep worksurface
102#	245	260	24" deep worksurface to 30" deep worksurface
96#	225	235	30" deep worksurface to 24" deep worksurface
102#	245	260	30" deep worksurface to 24" deep worksurface

72#	165	175	24" deep worksurface to 24" deep worksurface
80#	175	185	24" deep worksurface to 24" deep worksurface
102#	190	200	24" deep worksurface to 24" deep worksurface
90#	200	210	30" deep worksurface to 30" deep worksurface
102#	215	225	30" deep worksurface to 30" deep worksurface

96#	225	235	24" deep worksurface to 30" deep worksurface
102#	245	260	24" deep worksurface to 30" deep worksurface
96#	225	235	30" deep worksurface to 24" deep worksurface
102#	245	260	30" deep worksurface to 24" deep worksurface

- AW** = Tennessee Oak
- AX** = Light Oak
- AY** = Red Birch
- AZ** = Ash
- BA** = Philadelphia Cherry
- BB** = Pennsylvania Cherry
- BC** = Mahogany
- BD** = Oak
- BE** = Maple
- BF** = Pearwood
- CA** = Pumice
- CB** = Rock Maple
- CC** = Medium Cherry
- CD** = Anigre
- ZZ** = COM

FINISH INFORMATION

Laminate Surface

See Keys for Progression swatch card.

ACCESSORIES

Casters

4 swivel casters (2½" diameter), 2 with locks. Add 2" to top surface height. Add 2lbs. to weight. Order separately, specify 87.2840

List price \$34.00/set

Worksurface Connectors

For attaching two freestanding tables together of same height. Black finish. Specify 87.4632.WZ.BL.

List price \$8.00



For attaching two freestanding tables together of different heights. Black finish. Specify 87.4624.WZ.BL.

List price \$12.00

Specifications and prices are subject to change without prior notice.

XXI Notes Worksurfaces with PowerUp

Level Three

MODEL	Left D x W x D	Right W x D	MODEL NUMBER					
			Worksurface	Edge Style	P/Up Location	Hgt	Trim Color	Laminate
 <p>Stand Alone Corner Reduction Worksurface</p> <ul style="list-style-type: none"> • Not available with transitional legs • One PowerUp module • Wireway not available on Level 3 • Notched vertical wireway and modesty panel frame style is standard 	24x42x42x30"		WCS2442303	<input type="checkbox"/>	<input type="checkbox"/>	<input type="checkbox"/>	<input type="checkbox"/>	<input type="checkbox"/>
	24x48x48x30"		WCS2448303	<input type="checkbox"/>	<input type="checkbox"/>	<input type="checkbox"/>	<input type="checkbox"/>	<input type="checkbox"/>
	30x42x42x24"		WCS3042243	<input type="checkbox"/>	<input type="checkbox"/>	<input type="checkbox"/>	<input type="checkbox"/>	<input type="checkbox"/>
	30x48x48x24"		WCS3048243	<input type="checkbox"/>	<input type="checkbox"/>	<input type="checkbox"/>	<input type="checkbox"/>	<input type="checkbox"/>
 <p>Stand Alone Corner Curvilinear Worksurface</p> <ul style="list-style-type: none"> • Not available with transitional legs • One PowerUp module • Wireway not available on Level 3 • Notched vertical wireway and modesty panel frame style is standard 	24x36x36x24"		WCC24363	<input type="checkbox"/>	<input type="checkbox"/>	<input type="checkbox"/>	<input type="checkbox"/>	<input type="checkbox"/>
	24x42x42x24"		WCC24423	<input type="checkbox"/>	<input type="checkbox"/>	<input type="checkbox"/>	<input type="checkbox"/>	<input type="checkbox"/>
	24x48x48x24"		WCC24483	<input type="checkbox"/>	<input type="checkbox"/>	<input type="checkbox"/>	<input type="checkbox"/>	<input type="checkbox"/>
	30x42x42x30"		WCC30423	<input type="checkbox"/>	<input type="checkbox"/>	<input type="checkbox"/>	<input type="checkbox"/>	<input type="checkbox"/>
	30x48x48x30"		WCC30483	<input type="checkbox"/>	<input type="checkbox"/>	<input type="checkbox"/>	<input type="checkbox"/>	<input type="checkbox"/>
 <p>Stand Alone Corner Curvilinear Reduction Worksurface</p> <ul style="list-style-type: none"> • Not available with transitional legs • One PowerUp module • Wireway not available on Level 3 • Notched vertical wireway and modesty panel frame style is standard 	24x42x42x30"		CCS2442303	<input type="checkbox"/>	<input type="checkbox"/>	<input type="checkbox"/>	<input type="checkbox"/>	<input type="checkbox"/>
	24x48x48x30"		CCS2448303	<input type="checkbox"/>	<input type="checkbox"/>	<input type="checkbox"/>	<input type="checkbox"/>	<input type="checkbox"/>
	30x42x42x24"		CCS3042243	<input type="checkbox"/>	<input type="checkbox"/>	<input type="checkbox"/>	<input type="checkbox"/>	<input type="checkbox"/>
	30x48x48x24"		CCS3048243	<input type="checkbox"/>	<input type="checkbox"/>	<input type="checkbox"/>	<input type="checkbox"/>	<input type="checkbox"/>

A B C D E F

HOW TO ORDER

Indicate the following information on order form:

1. Quantity of each item.
2. Model number, including options. See "How to Build a Model Number."
3. Any special service required.

- Note:
- The indicates that a choice is required.
 - The absence of indicates that no choice is required.
 - Alpha-numeric characters in place of indicate that no other alternatives are available.

HOW TO BUILD A MODEL NUMBER

- A** Select size of worksurface.
B Select edge style.
T = Flat Vinyl T-edge
M = 3mm PVC edge
C Select PowerUp location.
L = Left
R = Right
C = Center
B = Left and right (60" and 72" only)
D Select height.
2 = 42"
7 = 27"
9 = 29"
E Select trim color for painted surfaces.
B = Black
G = Gray
S = Sand
W = Warm Gray
L = Light Tone
F Select laminate surface.
AA = Cream
AB = Champagne
AC = Barcelona
AF = Aruba Tan
AG = Black
AH = Dark Gray
AI = Dawn Gray (Greige)
AJ = Fog
AK = Black Grandin
AL = Smoke Granite
AM = Sand Grandin
AN = Light Granite

- AO** = Tundra
AP = Earthen
AQ = Rose Grafix
AR = Shale Grafix
AS = Sierra Grafix
AT = Beige Grafix
AU = Sand Stone
AV = Kentucky Walnut
AW = Tennessee Oak
AX = Light Oak
AY = Red Birch
AZ = Ash
BA = Philadelphia Cherry
BB = Pennsylvania Cherry
BC = Mahogany
BD = Oak
BE = Maple
BF = Pearwood
CA = Pumice
CB = Rock Maple
CC = Medium Cherry
CD = Light Cherry



Edge Styles



Total Weight
27" 29"

T-Edge
Price **(T)**

3mm PVC Edge
Price **(M)**

93#	96#	280	295
99#	102#	300	315
93#	96#	280	295
99#	102#	300	315
73#	76#	260	270
93#	96#	280	295
103#	106#	300	315
105#	108#	280	295
115#	118#	300	315
93#	96#	280	295
99#	102#	300	315
93#	96#	280	295
99#	102#	300	315

ZZ = COM

FINISH INFORMATION

Laminate Surface
See Keys for Progression swatch card.

ACCESSORIES

Casters
4 swivel casters (2½" diameter), 2 with locks.
Add 2" to top surface height. Add 2lbs. to weight.
Order separately, specify 87.2840
List price \$34.00/set



Worksurface Connectors
For attaching two freestanding tables together
of same height. Black finish.
Specify 87.4632.WZ.BL.
List price \$8.00

For attaching two freestanding tables together
of different heights. Black finish.
Specify 87.4624.WZ.BL.
List price \$12.00

Specifications and prices are subject to change without prior notice.

XXI Notes Worksurfaces with PowerUp

Level Three

MODEL	D x W x L	MODEL NUMBER							
		Worksurface	Edge Style	Surface Direct	P/Up Location	Hgt	Tr Legs	Trim Color	Laminate
 "P" Shaped Peninsula Worksurface <ul style="list-style-type: none"> • One PowerUp module • Wireway not available on Level 3 • Notched vertical wireway and modesty panel frame style is standard 	24x48x60"	ZPT2448603	<input type="checkbox"/>	<input type="checkbox"/>	<input type="checkbox"/>	<input type="checkbox"/>	<input type="checkbox"/>	<input type="checkbox"/>	<input type="checkbox"/>
	24x48x72"	ZPT2448723	<input type="checkbox"/>	<input type="checkbox"/>	<input type="checkbox"/>	<input type="checkbox"/>	<input type="checkbox"/>	<input type="checkbox"/>	<input type="checkbox"/>
	30x48x72"	ZPT3048723	<input type="checkbox"/>	<input type="checkbox"/>	<input type="checkbox"/>	<input type="checkbox"/>	<input type="checkbox"/>	<input type="checkbox"/>	<input type="checkbox"/>
 Piano Peninsula Worksurface <ul style="list-style-type: none"> • One PowerUp module • Wireway not available on Level 3 • Notched vertical wireway and modesty panel frame style is standard 	24x48x60"	ZPP2448603	<input type="checkbox"/>	<input type="checkbox"/>	<input type="checkbox"/>	<input type="checkbox"/>	<input type="checkbox"/>	<input type="checkbox"/>	
	24x48x72"	ZPP2448723	<input type="checkbox"/>	<input type="checkbox"/>	<input type="checkbox"/>	<input type="checkbox"/>	<input type="checkbox"/>	<input type="checkbox"/>	
	30x48x72"	ZPP3048723	<input type="checkbox"/>	<input type="checkbox"/>	<input type="checkbox"/>	<input type="checkbox"/>	<input type="checkbox"/>	<input type="checkbox"/>	
 Square Shoe Worksurface <ul style="list-style-type: none"> • One PowerUp module • Wireway not available on Level 3 • Notched vertical wireway and modesty panel frame style is standard 	24x48x60"	ZSS2448603	<input type="checkbox"/>	<input type="checkbox"/>	<input type="checkbox"/>	<input type="checkbox"/>	<input type="checkbox"/>	<input type="checkbox"/>	
	24x48x66"	ZSS2448663	<input type="checkbox"/>	<input type="checkbox"/>	<input type="checkbox"/>	<input type="checkbox"/>	<input type="checkbox"/>	<input type="checkbox"/>	
	24x48x72"	ZSS2448723	<input type="checkbox"/>	<input type="checkbox"/>	<input type="checkbox"/>	<input type="checkbox"/>	<input type="checkbox"/>	<input type="checkbox"/>	
	24x48x84"	ZSS2448843	<input type="checkbox"/>	<input type="checkbox"/>	<input type="checkbox"/>	<input type="checkbox"/>	<input type="checkbox"/>	<input type="checkbox"/>	
	30x48x66"	ZSS304866L3	<input type="checkbox"/>	<input type="checkbox"/>	<input type="checkbox"/>	<input type="checkbox"/>	<input type="checkbox"/>	<input type="checkbox"/>	
	30x48x72"	ZSS3048723	<input type="checkbox"/>	<input type="checkbox"/>	<input type="checkbox"/>	<input type="checkbox"/>	<input type="checkbox"/>	<input type="checkbox"/>	
	30x48x84"	ZSS3048843	<input type="checkbox"/>	<input type="checkbox"/>	<input type="checkbox"/>	<input type="checkbox"/>	<input type="checkbox"/>	<input type="checkbox"/>	

A B C D E F G H

HOW TO ORDER

Indicate the following information on order form:

- Quantity of each item.
- Model number, including options. See "How to Build a Model Number."
- Any special service required.

- Note:
- The indicates that a choice is required.
 - The absence of indicates that no choice is required.
 - Alpha-numeric characters in place of indicate that no other alternatives are available.

HOW TO BUILD A MODEL NUMBER

- A** Select size of worksurface.
B Select edge style.
T = Flat Vinyl T-edge
M = 3mm PVC edge
C Select surface direction.
L = Left
R = Right
D Select PowerUp location.
L = Left
R = Right
C = Center
B = Left and right (60" and 72" only)
E Select height.
9 = 29"

- F** Indicate location and type of leg.*
S = Standard (both standard legs)
R = Right (right transitional leg)
L = Left (left transitional leg)
B = Both (both transitional legs)

*Note: If ordering Basic Worksurface as a freestanding unit, or if only one side connects to a transitional worksurface, the "B" option for both transitional legs is not available.

- **Must order corresponding worksurface connector to attach to adjacent table when using transitional legs.**

- G** Select trim color for painted surfaces.
B = Black
G = Gray
S = Sand
W = Warm Gray
L = Light Tone

- H** Select laminate surface.
AA = Cream
AB = Champagne
AC = Barcelona
AF = Aruba Tan
AG = Black
AH = Dark Gray
AI = Dawn Gray (Greige)
AJ = Fog
AK = Black Grandin
AL = Smoke Granite
AM = Sand Grandin
AN = Light Granite
AO = Tundra
AP = Earthen
AQ = Rose Grafix
AS = Sierra Grafix
AT = Beige Grafix
AU = Sand Stone
AV = Kentucky Walnut



Edge Styles



T-Edge
Price **(T)**

3mm PVC Edge
Price **(M)**

Total Weight

134#	\$315	\$330
146#	325	340
150#	335	350

132#	290	305
144#	300	315
148#	310	325

133#	\$280	\$295
139#	290	305
145#	295	310
157#	305	320
144#	290	305
150#	295	310
172#	305	320

- AW** = Tennessee Oak
- AX** = Light Oak
- AY** = Red Birch
- AZ** = Ash
- BA** = Philadelphia Cherry
- BB** = Pennsylvania Cherry
- BC** = Mahogany
- BD** = Oak
- BE** = Maple
- BF** = Pearwood
- CA** = Pumice
- CB** = Rock Maple
- CC** = Medium Cherry
- CD** = Anigre
- ZZ** = COM

FINISH INFORMATION

Laminate Surface
See Keys for Progression swatch card.

ACCESSORIES

Casters
4 swivel casters (2½" diameter), 2 with locks.
Add 2" to top surface height. Add 2lbs. to weight.
Order separately, specify 87.2840
List price \$34.00/set

Worksurface Connectors
For attaching two freestanding tables together
of same height. Black finish.
Specify 87.4632.WZ.BL.
List price \$8.00

For attaching two freestanding tables together
of different heights. Black finish.
Specify 87.4624.WZ.BL.
List price \$12.00

Specifications and prices are subject to change without prior notice.

XXI Notes Worksurfaces with PowerUp

Level Four



Basic Worksurface

- Wireway not available on Level 4
- Notched vertical wireway and modesty panel frame style is standard

- Wireway not available on Level 4
- Notched vertical wireway and modesty panel frame style is standard

MODEL	D x W	MODEL NUMBER					
		Worksurface	Edge Style	Hgt	Tr Legs	Trim Color	Laminate
	24x30'	WBW24304	<input type="checkbox"/>	<input type="checkbox"/>	<input type="checkbox"/>	<input type="checkbox"/>	<input type="checkbox"/>
	24x36"	WBW24364	<input type="checkbox"/>	<input type="checkbox"/>	<input type="checkbox"/>	<input type="checkbox"/>	<input type="checkbox"/>
	24x42"	WBW24424	<input type="checkbox"/>	<input type="checkbox"/>	<input type="checkbox"/>	<input type="checkbox"/>	<input type="checkbox"/>
	24x48"	WBW24484	<input type="checkbox"/>	<input type="checkbox"/>	<input type="checkbox"/>	<input type="checkbox"/>	<input type="checkbox"/>
	24x54"	WBW24544	<input type="checkbox"/>	<input type="checkbox"/>	<input type="checkbox"/>	<input type="checkbox"/>	<input type="checkbox"/>
	30x30"	WBW30304	<input type="checkbox"/>	<input type="checkbox"/>	<input type="checkbox"/>	<input type="checkbox"/>	<input type="checkbox"/>
	30x36"	WBW30364	<input type="checkbox"/>	<input type="checkbox"/>	<input type="checkbox"/>	<input type="checkbox"/>	<input type="checkbox"/>
	30x42"	WBW30424	<input type="checkbox"/>	<input type="checkbox"/>	<input type="checkbox"/>	<input type="checkbox"/>	<input type="checkbox"/>
	30x48"	WBW30484	<input type="checkbox"/>	<input type="checkbox"/>	<input type="checkbox"/>	<input type="checkbox"/>	<input type="checkbox"/>
	30x54"	WBW30544	<input type="checkbox"/>	<input type="checkbox"/>	<input type="checkbox"/>	<input type="checkbox"/>	<input type="checkbox"/>
	24x60"	WBW24604	<input type="checkbox"/>	<input type="checkbox"/>	<input type="checkbox"/>	<input type="checkbox"/>	<input type="checkbox"/>
	24x72"	WBW24724	<input type="checkbox"/>	<input type="checkbox"/>	<input type="checkbox"/>	<input type="checkbox"/>	<input type="checkbox"/>
	30x60"	WBW30604	<input type="checkbox"/>	<input type="checkbox"/>	<input type="checkbox"/>	<input type="checkbox"/>	<input type="checkbox"/>
	30x72"	WBW30724	<input type="checkbox"/>	<input type="checkbox"/>	<input type="checkbox"/>	<input type="checkbox"/>	<input type="checkbox"/>

A **B** **C** **D** **E** **F**

HOW TO ORDER

Indicate the following information on order form:

- Quantity of each item.
- Model number, including options. See "How to Build a Model Number."
- Any special service required.

- Note:
- The indicates that a choice is required.
 - The absence of indicates that no choice is required.
 - Alpha-numeric characters in place of indicate that no other alternatives are available.

HOW TO BUILD A MODEL NUMBER

- A** Select size of worksurface.
B Select edge style.
T = Flat Vinyl T-edge
M = 3mm PVC edge
C Select height.
7 = 27"
9 = 29"
D Indicate location and type of leg.*
S = Standard (both standard legs)
R = Right (right transitional leg)
L = Left (left transitional leg)
B = Both (both transitional legs)

*Note: If ordering Basic Worksurface as a freestanding unit, or if only one side connects to a transitional worksurface, the "B" option for both transitional legs is not available.

- **Must order corresponding worksurface connector to attach to adjacent table when using transitional legs.**

- E** Select trim color for painted surfaces.
B = Black
G = Gray
S = Sand
W = Warm Gray
L = Light Tone

- F** Select laminate surface.
AA = Cream
AB = Champagne
AC = Barcelona
AF = Aruba Tan
AG = Black
AH = Dark Gray
AI = Dawn Gray (Greige)
AJ = Fog
AK = Black Grandin

- AL** = Smoke Granite
AM = Sand Grandin
AN = Light Granite
AO = Tundra
AP = Earthen
AQ = Rose Grafix
AS = Sierra Grafix
AT = Beige Grafix
AU = Sand Stone
AV = Kentucky Walnut
AW = Tennessee Oak
AX = Light Oak
AY = Red Birch
AZ = Ash
BA = Philadelphia Cherry
BB = Pennsylvania Cherry
BC = Mahogany
BD = Oak
BE = Maple
BF = Pearwood
CA = Pumice
CB = ...



Edge Styles



T-Edge
Price **(T)**

3mm PVC Edge
Price **(M)**

27"	Total Weight	29"	T-Edge Price (T)	3mm PVC Edge Price (M)
66#		69#	\$ 220	\$ 230
73#		76#	225	235
80#		83#	230	240
86#		89#	235	245
93#		96#	245	255
73#		76#	220	230
80#		83#	225	235
89#		92#	230	240
97#		100#	235	245
103#		106#	245	255
98#		102#	250	260
111#		116#	265	275
109#		113#	250	260
122#		126#	265	275

- CC** = Medium Cherry
- CD** = Anigre
- ZZ** = COM

FINISH INFORMATION

Laminate Surface

See Keys for Progression swatch card.

ACCESSORIES

Casters

4 swivel casters (2½" diameter), 2 with locks. Add 2" to top surface height. Add 2lbs. to weight. Order separately, specify 87.2840

List price \$34.00/set

Worksurface Connectors

For attaching two freestanding tables together of same height. Black finish. Specify 87.4632.WZ.BL.

List price \$8.00

For attaching two freestanding tables together of different heights. Black finish. Specify 87.4624.WZ.BL.

List price \$12.00

Specifications and prices are subject to change without prior notice.

XXI Notes Worksurfaces with PowerUp

Level Four



MODEL	D x W	MODEL NUMBER							
		Worksurface	Edge Style	Keypad Location	Hgt	Tr Legs	Trim Color	Laminate	
Adjustable Keyboard Pad Worksurface • Only center keypad available on 36" and 42" worksurfaces • Wireway not available on Level 4 • Notched vertical wireway and modesty panel frame style is standard	24x36"	WAK24364	<input type="checkbox"/>	<input type="checkbox"/>	<input type="checkbox"/>	<input type="checkbox"/>	<input type="checkbox"/>	<input type="checkbox"/>	
	24x42"	WAK24424	<input type="checkbox"/>	<input type="checkbox"/>	<input type="checkbox"/>	<input type="checkbox"/>	<input type="checkbox"/>		
	24x48"	WAK24484	<input type="checkbox"/>	<input type="checkbox"/>	<input type="checkbox"/>	<input type="checkbox"/>	<input type="checkbox"/>		
	24x54"	WAK24544	<input type="checkbox"/>	<input type="checkbox"/>	<input type="checkbox"/>	<input type="checkbox"/>	<input type="checkbox"/>		
	30x36"	WAK30364	<input type="checkbox"/>	<input type="checkbox"/>	<input type="checkbox"/>	<input type="checkbox"/>	<input type="checkbox"/>		
	30x42"	WAK30424	<input type="checkbox"/>	<input type="checkbox"/>	<input type="checkbox"/>	<input type="checkbox"/>	<input type="checkbox"/>		
	30x48"	WAK30484	<input type="checkbox"/>	<input type="checkbox"/>	<input type="checkbox"/>	<input type="checkbox"/>	<input type="checkbox"/>		
	30x54"	WAK30544	<input type="checkbox"/>	<input type="checkbox"/>	<input type="checkbox"/>	<input type="checkbox"/>	<input type="checkbox"/>		
	• Wireway not available on Level 4 • Notched vertical wireway and modesty panel frame style is standard	24x60"	WAK24604	<input type="checkbox"/>	<input type="checkbox"/>	<input type="checkbox"/>	<input type="checkbox"/>	<input type="checkbox"/>	
		24x72"	WAK24724	<input type="checkbox"/>	<input type="checkbox"/>	<input type="checkbox"/>	<input type="checkbox"/>	<input type="checkbox"/>	
30x60"		WAK30604	<input type="checkbox"/>	<input type="checkbox"/>	<input type="checkbox"/>	<input type="checkbox"/>	<input type="checkbox"/>		
30x72"		WAK30724	<input type="checkbox"/>	<input type="checkbox"/>	<input type="checkbox"/>	<input type="checkbox"/>	<input type="checkbox"/>		
			A	B	C	D	E	F	G

HOW TO ORDER

Indicate the following information on order form:

- Quantity of each item.
- Model number, including options. See "How to Build a Model Number."
- Any special service required.

- Note:
- The indicates that a choice is required.
 - The absence of indicates that no choice is required.
 - Alpha-numeric characters in place of indicate that no other alternatives are available.

HOW TO BUILD A MODEL NUMBER

- A** Select size of worksurface.
B Select edge style.
T = Flat Vinyl T-edge
M = 3mm PVC edge
C Select keypad location.
C = Center
R = Right
L = Left
D Select height.
7 = 27"
9 = 29"
E Indicate location and type of leg.*
S = Standard (both standard legs)
R = Right (right transitional leg)
L = Left (left transitional leg)
B = Both (both transitional legs)

*Note: If ordering Basic Worksurface as a freestanding unit, or if only one side connects to a transitional worksurface, the "B" option for both transitional legs is not available.

- **Must order corresponding worksurface connector to attach to adjacent table when using transitional legs.**

- F** Select trim color for painted surfaces.
B = Black
G = Gray
S = Sand
W = Warm Gray
L = Light Tone
G Select laminate surface.
AA = Cream
AB = Champagne
AC = Barcelona
AF = Aruba Tan

- AG** = Black
AH = Dark Gray
AI = Dawn Gray (Greige)
AJ = Fog
AK = Black Grandin
AL = Smoke Granite
AM = Sand Grandin
AN = Light Granite
AO = Tundra
AP = Earthen
AQ = Rose Grafix
AS = Sierra Grafix
AT = Beige Grafix
AU = Sand Stone
AV = Kentucky Walnut
AW = Tennessee Oak
AX = Light Oak
AY = Red Birch
AZ = Ash
BA = Philadelphia Cherry
BB = Pennsylvania Cherry



Edge Styles



T-Edge
Price **(T)**

3mm PVC Edge
Price **(M)**

27" Total Weight

29"

27"	Total Weight	29"	T-Edge Price (T)	3mm PVC Edge Price (M)
74#		77#	\$235	\$245
81#		84#	240	250
87#		90#	245	260
93#		96#	255	270
81#		84#	235	245
90#		93#	240	250
98#		101#	245	260
106#		110#	255	270
99#		103#	260	275
112#		126#	275	290
110#		114#	260	275
126#		130#	275	290

- BD** = Oak
- BE** = Maple
- BF** = Pearwood
- CA** = Pumice
- CB** = Rock Maple
- CC** = Medium Cherry
- CD** = Anigre
- ZZ** = COM

FINISH INFORMATION

Laminate Surface
See Keys for Progression swatch card.

ACCESSORIES

Casters
4 swivel casters (2½" diameter), 2 with locks.
Add 2" to top surface height. Add 2lbs. to weight.
Order separately, specify 87.2840
List price \$34.00/set

Worksurface Connectors
For attaching two freestanding tables together
of same height. Black finish.
Specify 87.4632.WZ.BL.
List price \$8.00

For attaching two freestanding tables together
of different heights. Black finish.
Specify 87.4624.WZ.BL.
List price \$12.00

Specifications and prices are subject to change without prior notice.

XXI Notes Worksurfaces with PowerUp

Level Four

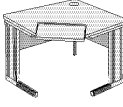
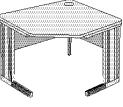
MODEL	D x W	MODEL NUMBER						
		Worksurface	Edge Style	Keypad Location	Hgt	Tr Legs	Trim Color	Laminate
 <p>Stand Alone Corner Worksurface with Keyboard</p> <ul style="list-style-type: none"> • Not available with transitional legs • Wireway not available on Level 4 • Only center keypad available • Notched vertical wireway and modesty panel frame style is standard 	24x42"	WCS24424	<input type="checkbox"/>	<input type="checkbox"/>	<input type="checkbox"/>	<input type="checkbox"/>	<input type="checkbox"/>	<input type="checkbox"/>
	30x48"	WCS30484	<input type="checkbox"/>	<input type="checkbox"/>	<input type="checkbox"/>	<input type="checkbox"/>	<input type="checkbox"/>	<input type="checkbox"/>
 <p>Stand Alone Corner Worksurface</p> <ul style="list-style-type: none"> • Not available with transitional legs • Wireway not available on Level 4 • Notched vertical wireway and modesty panel frame style is standard 	24x36"	WCSK24364	<input type="checkbox"/>	NA	<input type="checkbox"/>	<input type="checkbox"/>	<input type="checkbox"/>	<input type="checkbox"/>
	24x72"	WCSK24724	<input type="checkbox"/>	NA	<input type="checkbox"/>	<input type="checkbox"/>	<input type="checkbox"/>	<input type="checkbox"/>
	30x48"	WCSK30484	<input type="checkbox"/>	NA	<input type="checkbox"/>	<input type="checkbox"/>	<input type="checkbox"/>	<input type="checkbox"/>

A
B
C
D
E
F
G

HOW TO ORDER

Indicate the following information on order form:

- Quantity of each item.
- Model number, including options. See "How to Build a Model Number."
- Any special service required.

- Note:
- The indicates that a choice is required.
 - The absence of indicates that no choice is required.
 - Alpha-numeric characters in place of indicate that no other alternatives are available.

HOW TO BUILD A MODEL NUMBER

- A** Select size of worksurface.
 24x42" 30x48"
- B** Select edge style.
 T = Flat Vinyl T-edge
 M = 3mm PVC edge
- C** Select keypad location.
 C = Center
 R = Right
 L = Left
- D** Select height.
 7 = 27"
 9 = 29"
- E** Indicate location and type of leg.*
 S = Standard (both standard legs)
 R = Right (right transitional leg)
 L = Left (left transitional leg)
 B = Both (both transitional legs)

*Note: If ordering Basic Worksurface as a freestanding unit, or if only one side connects to a transitional worksurface, the "B" option for both transitional legs is not available.

- **Must order corresponding worksurface connector to attach to adjacent table when using transitional legs.**

- F** Select trim color for painted surfaces.
 B = Black
 G = Gray
 S = Sand
 W = Warm Gray
 L = Light Tone
- G** Select laminate surface.
 AA = Cream
 AB = Champagne
 AC = Barcelona
 AF = Aruba Tan

- AG = Black
 AH = Dark Gray
 AI = Dawn Gray (Greige)
 AJ = Fog
 AK = Black Grandin
 AL = Smoke Granite
 AM = Sand Grandin
 AN = Light Granite
 AO = Tundra
 AP = Earthen
 AQ = Rose Grafix
 AS = Sierra Grafix
 AT = Beige Grafix
 AU = Sand Stone
 AV = Kentucky Walnut
 AW = Tennessee Oak
 AY = Red Birch
 AZ = Ash
 BA = Philadelphia Cherry
 BB = Pennsylvania Cherry
 BC = Mahogany
 BD = ...



Edge Styles



T-Edge
Price **(T)**

3mm PVC Edge
Price **(M)**

Total Weight
27"

29"

Joins Tables

97#

99#

\$ 225

\$ 235

24" deep worksurface to 24" deep worksurface

116#

118#

235

245

30" deep worksurface to 30" deep worksurface

73#

76#

260

270

93#

96#

280

295

115#

118#

300

315

BE = Maple

BF = Pearwood

CA = Pumice

CB = Rock Maple

CC = Medium Cherry

CD = Anigre

ZZ = COM

FINISH INFORMATION

Laminate Surface

See Keys for Progression swatch card.

ACCESSORIES

Casters

4 swivel casters (2½" diameter), 2 with locks. Add 2" to top surface height. Add 2lbs. to weight. Order separately, specify 87.2840

List price \$34.00/set

Worksurface Connectors

For attaching two freestanding tables together of same height. Black finish. Specify 87.4632.WZ.BL.

List price \$8.00



For attaching two freestanding tables together of different heights. Black finish. Specify 87.4624.WZ.BL.

List price \$12.00

Specifications and prices are subject to change without prior notice.

XXI Notes Worksurfaces with PowerUp

Level Four

MODEL	Left D x W x D	Right W x D	MODEL NUMBER						
			Worksurface	Edge Style	Trans Direct	Hgt	Trim Color	Laminate	
 <p>End-of-Run Worksurface with Keyboard</p> <ul style="list-style-type: none"> • 36" width not available with key pad • 42" and 48" widths available with center keypad and bullnose edge • Transition direction is figured from the originating 24" or 30" basic or keyboard pad worksurface • Wireway not available on Level 4 • Notched vertical wireway and modesty panel frame style is standard 	24x36x36x24"		WERK24364	<input type="checkbox"/>	<input type="checkbox"/>	<input type="checkbox"/>	<input type="checkbox"/>	<input type="checkbox"/>	<input type="checkbox"/>
	24x42x42x24"		WERK24424	<input type="checkbox"/>	<input type="checkbox"/>	<input type="checkbox"/>	<input type="checkbox"/>	<input type="checkbox"/>	<input type="checkbox"/>
	30x48x48x30"		WERK30484	<input type="checkbox"/>	<input type="checkbox"/>	<input type="checkbox"/>	<input type="checkbox"/>	<input type="checkbox"/>	<input type="checkbox"/>
 <p>End-of-Run Worksurface</p> <ul style="list-style-type: none"> • Wireway not available on Level 4 • Notched vertical wireway and modesty panel frame style is standard 	24x42x42x24"		WER24424	<input type="checkbox"/>	<input type="checkbox"/>	<input type="checkbox"/>	<input type="checkbox"/>	<input type="checkbox"/>	<input type="checkbox"/>
	24x48x48x24"		WER24484	<input type="checkbox"/>	<input type="checkbox"/>	<input type="checkbox"/>	<input type="checkbox"/>	<input type="checkbox"/>	<input type="checkbox"/>
	30x48x48x30"		WER30484	<input type="checkbox"/>	<input type="checkbox"/>	<input type="checkbox"/>	<input type="checkbox"/>	<input type="checkbox"/>	<input type="checkbox"/>
 <p>End-of-Run Curvilinear Worksurface</p> <ul style="list-style-type: none"> • Wireway not available on Level 4 • Notched vertical wireway and modesty panel frame style is standard 	24x36x36x24"		WCCE24364	<input type="checkbox"/>	<input type="checkbox"/>	<input type="checkbox"/>	<input type="checkbox"/>	<input type="checkbox"/>	<input type="checkbox"/>
	24x42x42x24"		WCCE24424	<input type="checkbox"/>	<input type="checkbox"/>	<input type="checkbox"/>	<input type="checkbox"/>	<input type="checkbox"/>	<input type="checkbox"/>
	24x48x48x24"		WCCE24484	<input type="checkbox"/>	<input type="checkbox"/>	<input type="checkbox"/>	<input type="checkbox"/>	<input type="checkbox"/>	<input type="checkbox"/>
	30x42x42x30"		WCCE30424	<input type="checkbox"/>	<input type="checkbox"/>	<input type="checkbox"/>	<input type="checkbox"/>	<input type="checkbox"/>	<input type="checkbox"/>
	30x48x48x30"		WCCE30484	<input type="checkbox"/>	<input type="checkbox"/>	<input type="checkbox"/>	<input type="checkbox"/>	<input type="checkbox"/>	<input type="checkbox"/>

A B C D E F

HOW TO ORDER

Indicate the following information on order form:

- Quantity of each item.
- Model number, including options. See "How to Build a Model Number."
- Any special service required.

- Note:
- The indicates that a choice is required.
 - The absence of indicates that no choice is required.
 - Alpha-numeric characters in place of indicate that no other alternatives are available.

HOW TO BUILD A MODEL NUMBER

- A** Select size of worksurface.
 24" 30"
- B** Select edge style.
 T = Flat Vinyl T-edge
 M = 3mm PVC edge
- C** Select transitional direction.
 L = Left
 R = Right
- D** Select height.
 2 = 42"
 7 = 27"
 9 = 29"
- E** Select trim color for painted surfaces.
 B = Black
 G = Gray
 S = Sand
 W = Warm Gray
 L = Light Tone
- F** Select laminate surface.
 AA = Cream
 AB = Champagne
 AC = Barcelona
 AF = Aruba Tan
 AG = Black
 AH = Dark Gray
 AI = Dawn Gray (Greige)
 AJ = Fog
 AK = Black Grandin
 AL = Smoke Granite
 AM = Sand Grandin
 AN = Light Granite
 AO = Tundra
 AP = Earthen
 AQ = Rose Grafix
 AS = Sierra Grafix
 AT = Beige Grafix
 AU = Sand Stone
 AV = Kentucky Walnut

- AW** = Tennessee Oak
AX = Light Oak
AY = Red Birch
AZ = Ash
BA = Philadelphia Cherry
BB = Pennsylvania Cherry
BC = Mahogany
BD = Oak
BE = Maple
BF = Pearwood
CA = Pumice
CB = Rock Maple
CC = Medium Cherry
CD = Anigre
ZZ = COM



Edge Styles



T-Edge
Price **(T)**



3mm PVC Edge
Price **(M)**

Total Weight
27" 29"

Joins Table

	T-Edge Price (T)	3mm PVC Edge Price (M)	
78#	215	225	24" deep worksurface to 24" deep worksurface
102#	265	280	30" deep worksurface to 30" deep worksurface
78#	220	230	24" deep worksurface to 24" deep worksurface
82#	270	285	24" deep worksurface to 24" deep worksurface
100#	270	285	30" deep worksurface to 30" deep worksurface
76#	195	205	24" deep worksurface to 24" deep worksurface
96#	220	230	24" deep worksurface to 24" deep worksurface
106#	270	285	24" deep worksurface to 24" deep worksurface
108#	220	230	30" deep worksurface to 30" deep worksurface
118#	270	285	30" deep worksurface to 30" deep worksurface

FINISH INFORMATION

Laminate Surface

See Keys for Progression swatch card.

ACCESSORIES

Casters

4 swivel casters (2½" diameter), 2 with locks. Add 2" to top surface height. Add 2lbs. to weight. Order separately, specify 87.2840

List price \$34.00/set

Worksurface Connectors

For attaching two freestanding tables together of same height. Black finish. Specify 87.4632.WZ.BL.

List price \$8.00





For attaching two freestanding tables together of different heights. Black finish. Specify 87.4624.WZ.BL.

List price \$12.00

Specifications and prices are subject to change without prior notice.

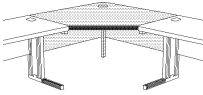
XXI Notes Worksurfaces with PowerUp

Level Four

MODEL	Left D x W x D	Right W x D	MODEL NUMBER					
			Worksurface	Edge Style	Hgt	Tr Legs	Trim Color	Laminate
 Corner Transitional Worksurface • Wireway not available on Level 4 • Notched vertical wireway and modesty panel frame style is standard	24x36"		CT24364	<input type="checkbox"/>	<input type="checkbox"/>	<input type="checkbox"/>	<input type="checkbox"/>	<input type="checkbox"/>
	24x42"		CT24424	<input type="checkbox"/>	<input type="checkbox"/>	<input type="checkbox"/>	<input type="checkbox"/>	<input type="checkbox"/>
	30x48"		CT30484	<input type="checkbox"/>	<input type="checkbox"/>	<input type="checkbox"/>	<input type="checkbox"/>	<input type="checkbox"/>
 Corner Transitional Worksurface with Keyboard Pad • Wireway not available on Level 4 • Available with center keypad and bullnose edge • Notched vertical wireway and modesty panel frame style is standard	24x42"		CTK24424	<input type="checkbox"/>	<input type="checkbox"/>	<input type="checkbox"/>	<input type="checkbox"/>	<input type="checkbox"/>
	30x48"		CTK30484	<input type="checkbox"/>	<input type="checkbox"/>	<input type="checkbox"/>	<input type="checkbox"/>	<input type="checkbox"/>
 Corner Transitional Reduction Worksurface • Wireway not available on Level 4 • Notched vertical wireway and modesty panel frame style is standard	24x42x42x30"		CT2442304	<input type="checkbox"/>	<input type="checkbox"/>	<input type="checkbox"/>	<input type="checkbox"/>	<input type="checkbox"/>
	24x48x48x30"		CT2448304	<input type="checkbox"/>	<input type="checkbox"/>	<input type="checkbox"/>	<input type="checkbox"/>	<input type="checkbox"/>
	30x42x42x24"		CT3042244	<input type="checkbox"/>	<input type="checkbox"/>	<input type="checkbox"/>	<input type="checkbox"/>	<input type="checkbox"/>
	30x48x48x24"		CT3048244	<input type="checkbox"/>	<input type="checkbox"/>	<input type="checkbox"/>	<input type="checkbox"/>	<input type="checkbox"/>
 Corner Curvilinear Transitional Worksurface • Wireway not available on Level 4 • Notched vertical wireway and modesty panel frame style is standard	24x36x36x24"		CCT24364	<input type="checkbox"/>	<input type="checkbox"/>	<input type="checkbox"/>	<input type="checkbox"/>	<input type="checkbox"/>
	24x42x42x24"		CCT24424	<input type="checkbox"/>	<input type="checkbox"/>	<input type="checkbox"/>	<input type="checkbox"/>	<input type="checkbox"/>
	24x48x48x24"		CCT24484	<input type="checkbox"/>	<input type="checkbox"/>	<input type="checkbox"/>	<input type="checkbox"/>	<input type="checkbox"/>
	30x42x42x30"		CCT30424	<input type="checkbox"/>	<input type="checkbox"/>	<input type="checkbox"/>	<input type="checkbox"/>	<input type="checkbox"/>
	30x48x48x30"		CCT30484	<input type="checkbox"/>	<input type="checkbox"/>	<input type="checkbox"/>	<input type="checkbox"/>	<input type="checkbox"/>
 Corner Curvilinear Transitional Reduction Worksurface • Wireway not available on Level 4 • Notched vertical wireway and modesty panel frame style is standard	24x42x42x30"		CCT2442304	<input type="checkbox"/>	<input type="checkbox"/>	<input type="checkbox"/>	<input type="checkbox"/>	<input type="checkbox"/>
	24x48x48x30"		CCT2448304	<input type="checkbox"/>	<input type="checkbox"/>	<input type="checkbox"/>	<input type="checkbox"/>	<input type="checkbox"/>
	30x42x42x24"		CCT3042244	<input type="checkbox"/>	<input type="checkbox"/>	<input type="checkbox"/>	<input type="checkbox"/>	<input type="checkbox"/>
	30x48x48x24"		CCT3048244	<input type="checkbox"/>	<input type="checkbox"/>	<input type="checkbox"/>	<input type="checkbox"/>	<input type="checkbox"/>

A B C D E F

HOW TO ORDER

Indicate the following information on order form:

- Quantity of each item.
- Model number, including options. See "How to Build a Model Number."
- Any special service required.

- Note:
- The indicates that a choice is required.
 - The absence of indicates that no choice is required.
 - Alpha-numeric characters in place of indicate that no other alternatives are available.

HOW TO BUILD A MODEL NUMBER

- A** Select size of worksurface.
B Select edge style.
 T = Flat Vinyl T-edge
 M = 3mm PVC edge
C Select height.
 2 = 42"
 7 = 27"
 9 = 29"
D Indicate location and type of leg.*
 S = Standard (both standard legs)
 R = Right (right transitional leg)
 L = Left (left transitional leg)
 B = Both (both transitional legs)

*Note: If ordering Basic Worksurface as a freestanding unit, or if only one side connects to a transitional worksurface, the "B" option for both transitional legs is not available.

- **Must order corresponding worksurface connector to attach to adjacent table when using transitional legs.**

- E** Select trim color for painted surfaces.
 B = Black
 G = Gray
 S = Sand
 W = Warm Gray
 L = Light Tone

- F** Select laminate surface.
 AA = Cream
 AB = Champagne
 AC = Barcelona
 AF = Aruba Tan
 AG = Black
 AH = Dark Gray
 AI = Dawn Gray (Greige)
 AJ = Fog
 AK = Black Grandin

- AL = Smoke Granite
 AM = Sand Grandin
 AN = Light Granite
 AO = Tundra
 AP = Earthen
 AQ = Rose Grafix
 AS = Sierra Grafix
 AT = Beige Grafix
 AU = Sand Stone
 AV = Kentucky Walnut
 AW = Tennessee Oak
 AX = Light Oak
 AY = Red Birch
 AZ = Ash
 BA = Philadelphia Cherry
 BB = Pennsylvania Cherry
 BC = Mahogany
 BD = Oak
 BE = Maple
 BF = Pearwood
 CA = Pumice
 CB = ...



Edge Styles



Total Weight
 27" 29"

T-Edge
 Price (T)

3mm PVC Edge
 Price (M)

Joins Table

72#	\$200	\$210	24" deep worksurface to 24" deep worksurface
80#	205	215	24" deep worksurface to 24" deep worksurface
102#	240	250	30" deep worksurface to 30" deep worksurface

80#	150	160	24" deep worksurface to 24" deep worksurface
102#	160	170	30" deep worksurface to 30" deep worksurface

96#	225	235	24" deep worksurface to 30" deep worksurface
102#	245	260	24" deep worksurface to 30" deep worksurface
96#	225	235	30" deep worksurface to 24" deep worksurface
102#	245	260	30" deep worksurface to 24" deep worksurface

72#	165	175	24" deep worksurface to 24" deep worksurface
80#	175	185	24" deep worksurface to 24" deep worksurface
102#	190	200	24" deep worksurface to 24" deep worksurface
90#	200	210	30" deep worksurface to 30" deep worksurface
102#	215	225	30" deep worksurface to 30" deep worksurface

96#	225	235	24" deep worksurface to 30" deep worksurface
102#	245	260	24" deep worksurface to 30" deep worksurface
96#	225	235	30" deep worksurface to 24" deep worksurface
102#	245	260	30" deep worksurface to 24" deep worksurface

- CC** = Medium Cherry
- CD** = Anigre
- ZZ** = COM

FINISH INFORMATION

Laminate Surface
 See Keys for Progression swatch card.

ACCESSORIES

Casters
 4 swivel casters (2½" diameter), 2 with locks.
 Add 2" to top surface height. Add 2lbs. to weight.
 Order separately, specify 87.2840
 List price \$34.00/set



Worksurface Connectors
 For attaching two freestanding tables together
 of same height. Black finish.
 Specify 87.4632.WZ.BL.
 List price \$8.00

For attaching two freestanding tables together
 of different heights. Black finish.
 Specify 87.4624.WZ.BL.
 List price \$12.00

**Specifications and prices are subject to
 change without prior notice.**

XXI Notes Worksurfaces with PowerUp

Level Four

MODEL	Left D x W x D	Right W x D	MODEL NUMBER				
			Worksurface	Edge Style	Hgt	Trim Color	Laminate
 <p>Stand Alone Corner Reduction Worksurface</p> <ul style="list-style-type: none"> • Not available with transitional legs • Wireway not available on Level 4 • Notched vertical wireway and modesty panel frame style is standard 	24x42x42x30"		WCS244234	<input type="checkbox"/>	<input type="checkbox"/>	<input type="checkbox"/>	<input type="checkbox"/>
	24x48x48x30"		WCS2448304	<input type="checkbox"/>	<input type="checkbox"/>	<input type="checkbox"/>	<input type="checkbox"/>
	30x42x42x24"		WCS3042244	<input type="checkbox"/>	<input type="checkbox"/>	<input type="checkbox"/>	<input type="checkbox"/>
	30x48x48x24"		WCS3048244	<input type="checkbox"/>	<input type="checkbox"/>	<input type="checkbox"/>	<input type="checkbox"/>
 <p>Stand Alone Corner Curvilinear Worksurface</p> <ul style="list-style-type: none"> • Not available with transitional legs • Wireway not available on Level 4 • Notched vertical wireway and modesty panel frame style is standard 	24x36x36x24"		WCC24364	<input type="checkbox"/>	<input type="checkbox"/>	<input type="checkbox"/>	<input type="checkbox"/>
	24x42x42x24"		WCC24424	<input type="checkbox"/>	<input type="checkbox"/>	<input type="checkbox"/>	<input type="checkbox"/>
	24x48x48x24"		WCC24484	<input type="checkbox"/>	<input type="checkbox"/>	<input type="checkbox"/>	<input type="checkbox"/>
	30x42x42x30"		WCC30424	<input type="checkbox"/>	<input type="checkbox"/>	<input type="checkbox"/>	<input type="checkbox"/>
	30x48x48x30"		WCC30484	<input type="checkbox"/>	<input type="checkbox"/>	<input type="checkbox"/>	<input type="checkbox"/>
 <p>Stand Alone Corner Curvilinear Reduction Worksurface</p> <ul style="list-style-type: none"> • Not available with transitional legs • Wireway not available on Level 4 • Notched vertical wireway and modesty panel frame style is standard 	24x42x42x30"		CCS2442304	<input type="checkbox"/>	<input type="checkbox"/>	<input type="checkbox"/>	<input type="checkbox"/>
	24x48x48x30"		CCS2448304	<input type="checkbox"/>	<input type="checkbox"/>	<input type="checkbox"/>	<input type="checkbox"/>
	30x42x42x24"		CCS3042244	<input type="checkbox"/>	<input type="checkbox"/>	<input type="checkbox"/>	<input type="checkbox"/>
	30x48x48x24"		CCS3048244	<input type="checkbox"/>	<input type="checkbox"/>	<input type="checkbox"/>	<input type="checkbox"/>

A
B
C
D
E

HOW TO ORDER

Indicate the following information on order form:

- Quantity of each item.
- Model number, including options. See "How to Build a Model Number."
- Any special service required.

- Note:
- The indicates that a choice is required.
 - The absence of indicates that no choice is required.
 - Alpha-numeric characters in place of indicate that no other alternatives are available.

HOW TO BUILD A MODEL NUMBER

- A** Select size of worksurface.
B Select edge style.
T = Flat Vinyl T-edge
M = 3mm PVC edge
C Select height.
2 = 42"
7 = 27"
9 = 29"
D Select trim color for painted surfaces.
B = Black
G = Gray
S = Sand
W = Warm Gray
L = Light Tone
E Select laminate surface.
AA = Cream
AB = Champagne

- AC** = Barcelona
AF = Aruba Tan
AG = Black
AH = Dark Gray
AI = Dawn Gray (Greige)
AJ = Fog
AK = Black Grandin
AL = Smoke Granite
AM = Sand Grandin
AN = Light Granite
AO = Tundra
AP = Earthen
AQ = Rose Grafix
AS = Sierra Grafix
AT = Beige Grafix
AU = Sand Stone
AV = Kentucky Walnut
AW = Tennessee Oak
AX = Light Oak
AY = Red Birch

- AZ** = Ash
BA = Philadelphia Cherry
BB = Pennsylvania Cherry
BC = Mahogany
BD = Oak
BE = Maple
BF = Pearwood
CA = Pumice
CB = Rock Maple
CC = Medium Cherry
CD = Anigre
ZZ = COM



Edge Styles



Total Weight
27" 29"

T-Edge
Price **(T)**

3mm PVC Edge
Price **(M)**

93#	96#	280	295
99#	102#	300	315
93#	96#	280	295
99#	102#	300	315

73#	76#	260	270
93#	96#	280	295
103#	106#	300	315
105#	108#	280	295
115#	118#	300	315

93#	96#	280	295
99#	102#	300	315
93#	96#	280	295
99#	102#	300	315

FINISH INFORMATION

Laminate Surface

See Keys for Progression swatch card.

ACCESSORIES

Casters

4 swivel casters (2½" diameter), 2 with locks.
Add 2" to top surface height. Add 2lbs. to weight.
Order separately, specify 87.2840

List price \$34.00/set

Worksurface Connectors

For attaching two freestanding tables together
of same height. Black finish.
Specify 87.4632.WZ.BL.

List price \$8.00



For attaching two freestanding tables together
of different heights. Black finish.
Specify 87.4624.WZ.BL.

List price \$12.00

**Specifications and prices are subject to
change without prior notice.**

XXI Notes Worksurfaces with PowerUp

Level Four

MODEL	D x W x L	MODEL NUMBER						
		Worksurface	Edge Style	Surface Direct	Hgt	Tr Legs	Trim Color	Laminate
 <p>"P" Shaped Peninsula Worksurface</p> <ul style="list-style-type: none"> • Wireway not available on Level 4 • Notched vertical wireway and modesty panel frame style is standard 	24x48x60"	ZPT2448604	<input type="checkbox"/>	<input type="checkbox"/>	<input type="checkbox"/>	<input type="checkbox"/>	<input type="checkbox"/>	<input type="checkbox"/>
	24x48x72"	ZPT2448724	<input type="checkbox"/>	<input type="checkbox"/>	<input type="checkbox"/>	<input type="checkbox"/>	<input type="checkbox"/>	<input type="checkbox"/>
	30x48x72"	ZPT3048724	<input type="checkbox"/>	<input type="checkbox"/>	<input type="checkbox"/>	<input type="checkbox"/>	<input type="checkbox"/>	<input type="checkbox"/>
 <p>Piano Peninsula Worksurface</p> <ul style="list-style-type: none"> • Wireway not available on Level 4 • Notched vertical wireway and modesty panel frame style is standard 	24x48x60"	ZPP2448604	<input type="checkbox"/>	<input type="checkbox"/>	<input type="checkbox"/>	<input type="checkbox"/>	<input type="checkbox"/>	
	24x48x72"	ZPP2448724	<input type="checkbox"/>	<input type="checkbox"/>	<input type="checkbox"/>	<input type="checkbox"/>	<input type="checkbox"/>	
	30x48x72"	ZPP3048724	<input type="checkbox"/>	<input type="checkbox"/>	<input type="checkbox"/>	<input type="checkbox"/>	<input type="checkbox"/>	
 <p>Square Shoe Worksurface</p> <ul style="list-style-type: none"> • Wireway not available on Level 4 • Notched vertical wireway and modesty panel frame style is standard 	24x48x60"	ZSS2448604	<input type="checkbox"/>	<input type="checkbox"/>	<input type="checkbox"/>	<input type="checkbox"/>	<input type="checkbox"/>	
	24x48x66"	ZSS2448664	<input type="checkbox"/>	<input type="checkbox"/>	<input type="checkbox"/>	<input type="checkbox"/>	<input type="checkbox"/>	
	24x48x72"	ZSS2448724	<input type="checkbox"/>	<input type="checkbox"/>	<input type="checkbox"/>	<input type="checkbox"/>	<input type="checkbox"/>	
	24x48x84"	ZSS2448844	<input type="checkbox"/>	<input type="checkbox"/>	<input type="checkbox"/>	<input type="checkbox"/>	<input type="checkbox"/>	
	30x48x66"	ZSS3048664	<input type="checkbox"/>	<input type="checkbox"/>	<input type="checkbox"/>	<input type="checkbox"/>	<input type="checkbox"/>	
	30x48x72"	ZSS3048724	<input type="checkbox"/>	<input type="checkbox"/>	<input type="checkbox"/>	<input type="checkbox"/>	<input type="checkbox"/>	
	30x48x84"	ZSS3048844	<input type="checkbox"/>	<input type="checkbox"/>	<input type="checkbox"/>	<input type="checkbox"/>	<input type="checkbox"/>	

A
B
C
D
E
F
G

HOW TO ORDER

Indicate the following information on order form:

- Quantity of each item.
- Model number, including options. See "How to Build a Model Number."
- Any special service required.

- Note:
- The indicates that a choice is required.
 - The absence of indicates that no choice is required.
 - Alpha-numeric characters in place of indicate that no other alternatives are available.

HOW TO BUILD A MODEL NUMBER

- A** Select size of worksurface.

- B** Select edge style.
 - T** = Flat Vinyl T-edge _____
 - M** = 3mm PVC edge _____
- C** Select surface direction.
 - L** = Left _____
 - R** = Right _____
- D** Select height.
 - 9** = 29" _____
- E** Indicate location and type of leg.*
 - S** = Standard (both standard legs) _____
 - R** = Right (right transitional leg) _____
 - L** = Left (left transitional leg) _____
 - B** = Both (both transitional legs) _____

*Note: If ordering Basic Worksurface as a freestanding unit, or if only one side connects to a transitional worksurface, the "B" option for both transitional legs is not available.

- **Must order corresponding worksurface connector to attach to adjacent table when using transitional legs.**

- F** Select trim color for painted surfaces.
 - B** = Black _____
 - G** = Gray _____
 - S** = Sand _____
 - W** = Warm Gray _____
 - L** = Light Tone _____
- G** Select laminate surface.
 - AA** = Cream _____
 - AB** = Champagne _____
 - AC** = Barcelona _____
 - AF** = Aruba Tan _____

- AG** = Black _____
- AH** = Dark Gray _____
- AI** = Dawn Gray (Greige) _____
- AJ** = Fog _____
- AK** = Black Grandin _____
- AL** = Smoke Granite _____
- AM** = Sand Grandin _____
- AN** = Light Granite _____
- AO** = Tundra _____
- AP** = Earthen _____
- AQ** = Rose Grafix _____
- AS** = Sierra Grafix _____
- AT** = Beige Grafix _____
- AU** = Sand Stone _____
- AV** = Kentucky Walnut _____
- AW** = Tennessee Oak _____
- AX** = Light Oak _____
- AY** = Red Birch _____
- AZ** = Ash _____
- BA** = Philadelphia Cherry _____
- BB** = Pennsylvania Cherry _____



Edge Styles



T-Edge
Price **(T)**

3mm PVC Edge
Price **(M)**

Total Weight

134#	\$315	\$330
146#	325	340
150#	335	350

132#	290	305
144#	300	315
148#	310	325

133#	\$280	\$295
139#	290	305
145#	295	310
157#	305	320
144#	290	305
150#	295	310
172#	305	320

- BD** = Oak
- BE** = Maple
- BF** = Pearwood
- CA** = Pumice
- CB** = Rock Maple
- CC** = Medium Cherry
- CD** = Anigre
- ZZ** = COM

FINISH INFORMATION

Laminate Surface
See Keys for Progression swatch card.

ACCESSORIES

Casters
4 swivel casters (2 1/2" diameter), 2 with locks.
Add 2" to top surface height. Add 2lbs. to weight.
Order separately, specify 87.2840
List price \$34.00/set

Worksurface Connectors
For attaching two freestanding tables together
of same height. Black finish.
Specify 87.4632.WZ.BL.
List price \$8.00

For attaching two freestanding tables together
of different heights. Black finish.
Specify 87.4624.WZ.BL.
List price \$12.00

Specifications and prices are subject to change without prior notice.

XXI Notes Worksurfaces with PowerUp

Level Five

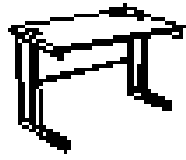

Basic Worksurface

- One PowerUp module
- Wireway not available on Level 5
- Notched vertical wireway and modesty panel frame style is standard

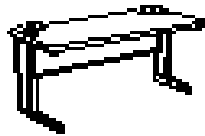

- One or two PowerUp modules available on 60" and 72" wide surfaces.
- Left and right data location only available on 60" and 72" worksurface.
- Wireway not available on Level 5
- Notched vertical wireway and modesty panel frame style is standard

MODEL	D x W	MODEL NUMBER						
		Worksurface	Edge Style	P/Up Location	Hgt	Tr Legs	Trim Color	Laminate
	24x30"	WBW24305	<input type="checkbox"/>	<input type="checkbox"/>	<input type="checkbox"/>	<input type="checkbox"/>	<input type="checkbox"/>	<input type="checkbox"/>
	24x36"	WBW24365	<input type="checkbox"/>	<input type="checkbox"/>	<input type="checkbox"/>	<input type="checkbox"/>	<input type="checkbox"/>	<input type="checkbox"/>
	24x42"	WBW24425	<input type="checkbox"/>	<input type="checkbox"/>	<input type="checkbox"/>	<input type="checkbox"/>	<input type="checkbox"/>	<input type="checkbox"/>
	24x48"	WBW24485	<input type="checkbox"/>	<input type="checkbox"/>	<input type="checkbox"/>	<input type="checkbox"/>	<input type="checkbox"/>	<input type="checkbox"/>
	24x54"	WBW24545	<input type="checkbox"/>	<input type="checkbox"/>	<input type="checkbox"/>	<input type="checkbox"/>	<input type="checkbox"/>	<input type="checkbox"/>
	30x30"	WBW30305	<input type="checkbox"/>	<input type="checkbox"/>	<input type="checkbox"/>	<input type="checkbox"/>	<input type="checkbox"/>	<input type="checkbox"/>
	30x36"	WBW30365	<input type="checkbox"/>	<input type="checkbox"/>	<input type="checkbox"/>	<input type="checkbox"/>	<input type="checkbox"/>	<input type="checkbox"/>
	30x42"	WBW30425	<input type="checkbox"/>	<input type="checkbox"/>	<input type="checkbox"/>	<input type="checkbox"/>	<input type="checkbox"/>	<input type="checkbox"/>
	30x48"	WBW30485	<input type="checkbox"/>	<input type="checkbox"/>	<input type="checkbox"/>	<input type="checkbox"/>	<input type="checkbox"/>	<input type="checkbox"/>
	30x54"	WBW30545	<input type="checkbox"/>	<input type="checkbox"/>	<input type="checkbox"/>	<input type="checkbox"/>	<input type="checkbox"/>	<input type="checkbox"/>
	24x60"	WBW24605	<input type="checkbox"/>	<input type="checkbox"/>	<input type="checkbox"/>	<input type="checkbox"/>	<input type="checkbox"/>	<input type="checkbox"/>
	24x72"	WBW24725	<input type="checkbox"/>	<input type="checkbox"/>	<input type="checkbox"/>	<input type="checkbox"/>	<input type="checkbox"/>	<input type="checkbox"/>
	30x60"	WBW30605	<input type="checkbox"/>	<input type="checkbox"/>	<input type="checkbox"/>	<input type="checkbox"/>	<input type="checkbox"/>	<input type="checkbox"/>
	30x72"	WBW30725	<input type="checkbox"/>	<input type="checkbox"/>	<input type="checkbox"/>	<input type="checkbox"/>	<input type="checkbox"/>	<input type="checkbox"/>

A **B** **C** **D** **E** **F** **G**

HOW TO ORDER

Indicate the following information on order form:

1. Quantity of each item.
2. Model number, including options. See "How to Build a Model Number."
3. Any special service required.

- Note:
- The indicates that a choice is required.
 - The absence of indicates that no choice is required.
 - Alpha-numeric characters in place of indicate that no other alternatives are available.

HOW TO BUILD A MODEL NUMBER

- A** Select size of worksurface.

- B** Select edge style.
T = Flat Vinyl T-edge
M = 3mm PVC edge

- C** Select PowerUp location.
L = Left
R = Right
C = Center
B = Left and right (60" and 72" only)

- D** Select height.
7 = 27"
9 = 29"

- E** Indicate location and type of leg.*
S = Standard (both standard legs)
R = Right (right transitional leg)
L = Left (left transitional leg)
B = Both (both transitional legs)

*Note: If ordering Basic Worksurface as a freestanding unit, or if only one side connects to a transitional worksurface, the "B" option for both transitional legs is not available.

• Must order corresponding worksurface connector to attach to adjacent table when using transitional legs.

- F** Select trim color for painted surfaces.
B = Black
G = Gray
S = Sand
W = Warm Gray
L = Light Tone

- G** Select laminate surface.
AA = Cream
AB = Champagne
AC = Barcelona
AF = Aruba Tan
AG = Black

- AH** = Dark Gray
AI = Dawn Gray (Greige)
AJ = Fog
AK = Black Grandin
AL = Smoke Granite
AM = Sand Grandin
AN = Light Granite
AO = Tundra
AP = Earthen
AQ = Rose Grafix
AS = Sierra Grafix
AT = Beige Grafix
AU = Sand Stone
AV = Kentucky Walnut
AW = Tennessee Oak
AX = Light Oak
AY = Red Birch
AZ = Ash
BA = Philadelphia Cherry
BB = Pennsylvania Cherry
BC = Mahogany
BD = _____



Edge Styles



T-Edge
Price **(T)**

3mm PVC Edge
Price **(M)**

27"	Total Weight	29"	T-Edge Price (T)	3mm PVC Edge Price (M)
66#		69#	\$ 220	\$ 230
73#		76#	225	235
80#		83#	230	240
86#		89#	235	245
93#		96#	245	255
73#		76#	220	230
80#		83#	225	235
89#		92#	230	240
97#		100#	235	245
103#		106#	245	255
98#		102#	250	260
111#		116#	265	275
109#		113#	250	260
122#		126#	265	275

- BE** = Maple
- BF** = Pearwood
- CA** = Pumice
- CB** = Rock Maple
- CC** = Medium Cherry
- CD** = Anigre
- ZZ** = COM

FINISH INFORMATION

Laminate Surface
See Keys for Progression swatch card.

ACCESSORIES

Casters
4 swivel casters (2½" diameter), 2 with locks.
Add 2" to top surface height. Add 2lbs. to weight.
Order separately, specify 87.2840
List price \$34.00/set

Worksurface Connectors
For attaching two freestanding tables together
of same height. Black finish.
Specify 87.4632.WZ.BL.
List price \$8.00

For attaching two freestanding tables together
of different heights. Black finish.
Specify 87.4624.WZ.BL.
List price \$12.00

Specifications and prices are subject to change without prior notice.

XXI Notes Worksurfaces with PowerUp

Level Five

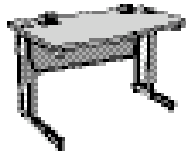

Curvilinear Worksurface

- One PowerUp module only on 42" to 54" wide surfaces.
- One or two PowerUp modules available on 60" and 72" wide surfaces.
- Wireway not available on Level 5
- Notched vertical wireway and modesty panel frame style is standard.

MODEL	D x W	MODEL NUMBER						
		Worksurface	Edge Style	P/Up Location	Hgt	Tr Legs	Trim Color	Laminate
	24x42x30"	WRC2442305	<input type="checkbox"/>	<input type="checkbox"/>	<input type="checkbox"/>	<input type="checkbox"/>	<input type="checkbox"/>	<input type="checkbox"/>
	24x48x30"	WRC2448305	<input type="checkbox"/>	<input type="checkbox"/>	<input type="checkbox"/>	<input type="checkbox"/>	<input type="checkbox"/>	<input type="checkbox"/>
	24x54x30"	WRC2454305	<input type="checkbox"/>	<input type="checkbox"/>	<input type="checkbox"/>	<input type="checkbox"/>	<input type="checkbox"/>	<input type="checkbox"/>
	24x60x30"	WRC2460305	<input type="checkbox"/>	<input type="checkbox"/>	<input type="checkbox"/>	<input type="checkbox"/>	<input type="checkbox"/>	<input type="checkbox"/>
	24x72x30"	WRC2472305	<input type="checkbox"/>	<input type="checkbox"/>	<input type="checkbox"/>	<input type="checkbox"/>	<input type="checkbox"/>	<input type="checkbox"/>
	30x42x24"	WRC3042245	<input type="checkbox"/>	<input type="checkbox"/>	<input type="checkbox"/>	<input type="checkbox"/>	<input type="checkbox"/>	<input type="checkbox"/>
	30x48x24"	WRC3048245	<input type="checkbox"/>	<input type="checkbox"/>	<input type="checkbox"/>	<input type="checkbox"/>	<input type="checkbox"/>	<input type="checkbox"/>
	30x54x24"	WRC3054245	<input type="checkbox"/>	<input type="checkbox"/>	<input type="checkbox"/>	<input type="checkbox"/>	<input type="checkbox"/>	<input type="checkbox"/>
	30x60x24"	WRC3060245	<input type="checkbox"/>	<input type="checkbox"/>	<input type="checkbox"/>	<input type="checkbox"/>	<input type="checkbox"/>	<input type="checkbox"/>
	30x72x24"	WRC3072245	<input type="checkbox"/>	<input type="checkbox"/>	<input type="checkbox"/>	<input type="checkbox"/>	<input type="checkbox"/>	<input type="checkbox"/>
	30x36"	WSU30365	<input type="checkbox"/>	<input type="checkbox"/>	2	S	<input type="checkbox"/>	<input type="checkbox"/>



Stand Alone Stand-Up Worksurface

- Available in 42" height only
- Not available with transitional legs.
- One PowerUp module.
- Wireway not available on Level 5
- Notched vertical wireway and modesty panel frame style is standard.

A **B** **C** **D** **E** **F** **G**

HOW TO ORDER

Indicate the following information on order form:

1. Quantity of each item.
2. Model number, including options. See "How to Build a Model Number."
3. Any special service required.

- Note:
- The indicates that a choice is required.
 - The absence of indicates that no choice is required.
 - Alpha-numeric characters in place of indicate that no other alternatives are available.

HOW TO BUILD A MODEL NUMBER

- A** Select size of worksurface.
B Select edge style.
T = Flat Vinyl T-edge
M = 3mm PVC edge
C Select PowerUp location.
L = Left
R = Right
C = Center
B = Left and right (60" and 72" only)
D Select height.
2 = 42"
7 = 27"
9 = 29"
E Indicate location and type of leg.*
S = Standard (both standard legs)
R = Right (right transitional leg)
L = Left (left transitional leg)

*Note: If ordering Basic Worksurface as a freestanding unit, or if only one side connects to a transitional worksurface, the "B" option for both transitional legs is not available.

• **Must order corresponding worksurface connector to attach to adjacent table when using transitional legs.**

- F** Select trim color for painted surfaces.
B = Black
G = Gray
S = Sand
W = Warm Gray
L = Light Tone
G Select laminate surface.
AA = Cream
AB = Champagne
AC = Barcelona
AF = Aruba Tan
AG = Black

- AH** = Dark Gray
AI = Dawn Gray (Greige)
AJ = Fog
AK = Black Grandin
AL = Smoke Granite
AM = Sand Grandin
AN = Light Granite
AO = Tundra
AP = Earthen
AQ = Rose Grafix
AS = Sierra Grafix
AT = Beige Grafix
AU = Sand Stone
AV = Kentucky Walnut
AW = Tennessee Oak
AX = Light Oak
AY = Red Birch
AZ = Ash
BA = Philadelphia Cherry
BB = Pennsylvania Cherry
BC = Mahogany



Edge Styles



T-Edge
Price **(T)**

3mm PVC Edge
Price **(M)**

Total Weight
27" 29" 42"

27"	29"	42"	T-Edge Price (T)	3mm PVC Edge Price (M)
81#	84#		\$230	\$240
88#	91#		235	245
95#	98#		245	255
100#	103#		250	260
114#	117#		265	275
81#	84#		230	240
88#	91#		235	245
95#	98#		245	255
100#	103#		250	260
114#	117#		265	275

	94#		\$255	\$270
--	-----	--	-------	-------

- BE** = Maple
- BF** = Pearwood
- CA** = Pumice
- CB** = Rock Maple
- CC** = Medium Cherry
- CD** = Anigre
- ZZ** = COM

FINISH INFORMATION

Laminate Surface
See Keys for Progression swatch card.

ACCESSORIES

Casters
4 swivel casters (2½" diameter), 2 with locks.
Add 2" to top surface height. Add 2lbs. to weight.
Order separately, specify 87.2840
List price \$34.00/set



Worksurface Connectors
For attaching two freestanding tables together
of same height. Black finish.
Specify 87.4632.WZ.BL.
List price \$8.00

For attaching two freestanding tables together
of different heights. Black finish.
Specify 87.4624.WZ.BL.
List price \$12.00

Specifications and prices are subject to change without prior notice.

XXI Notes Worksurfaces with PowerUp

Level Five

MODEL	D x W	MODEL NUMBER						
		Worksurface	Edge Style	P/Up Location	Hgt	Tr Legs	Trim Color	Laminate
 <p>Adjustable Keyboard Pad Worksurface</p> <ul style="list-style-type: none"> • One PowerUp module • Only center keypad available on 36" and 42" worksurfaces • Wireway not available on Level 5 • Notched vertical wireway and modesty panel frame style is standard 	24x36"	WAK24365	<input type="checkbox"/>	<input type="checkbox"/>	<input type="checkbox"/>	<input type="checkbox"/>	<input type="checkbox"/>	<input type="checkbox"/>
	24x42"	WAK24425	<input type="checkbox"/>	<input type="checkbox"/>	<input type="checkbox"/>	<input type="checkbox"/>	<input type="checkbox"/>	<input type="checkbox"/>
	24x48"	WAK24485	<input type="checkbox"/>	<input type="checkbox"/>	<input type="checkbox"/>	<input type="checkbox"/>	<input type="checkbox"/>	<input type="checkbox"/>
	24x54"	WAK24545	<input type="checkbox"/>	<input type="checkbox"/>	<input type="checkbox"/>	<input type="checkbox"/>	<input type="checkbox"/>	<input type="checkbox"/>
	30x36"	WAK30365	<input type="checkbox"/>	<input type="checkbox"/>	<input type="checkbox"/>	<input type="checkbox"/>	<input type="checkbox"/>	<input type="checkbox"/>
	30x42"	WAK30425	<input type="checkbox"/>	<input type="checkbox"/>	<input type="checkbox"/>	<input type="checkbox"/>	<input type="checkbox"/>	<input type="checkbox"/>
	30x48"	WAK30485	<input type="checkbox"/>	<input type="checkbox"/>	<input type="checkbox"/>	<input type="checkbox"/>	<input type="checkbox"/>	<input type="checkbox"/>
	30x54"	WAK30545	<input type="checkbox"/>	<input type="checkbox"/>	<input type="checkbox"/>	<input type="checkbox"/>	<input type="checkbox"/>	<input type="checkbox"/>
 <ul style="list-style-type: none"> • One or two PowerUp modules available on 60" and 72" wide surfaces. • Left and right data location only available on 60" and 72" worksurface. • Wireway not available on Level 5 • Notched vertical wireway and modesty panel frame style is standard 	24x60"	WAK24605	<input type="checkbox"/>	<input type="checkbox"/>	<input type="checkbox"/>	<input type="checkbox"/>	<input type="checkbox"/>	<input type="checkbox"/>
	24x72"	WAK24725	<input type="checkbox"/>	<input type="checkbox"/>	<input type="checkbox"/>	<input type="checkbox"/>	<input type="checkbox"/>	<input type="checkbox"/>
	30x60"	WAK30605	<input type="checkbox"/>	<input type="checkbox"/>	<input type="checkbox"/>	<input type="checkbox"/>	<input type="checkbox"/>	<input type="checkbox"/>
	30x72"	WAK30725	<input type="checkbox"/>	<input type="checkbox"/>	<input type="checkbox"/>	<input type="checkbox"/>	<input type="checkbox"/>	<input type="checkbox"/>

A
B
C
D
E
F
G

HOW TO ORDER

Indicate the following information on order form:

- Quantity of each item.
- Model number, including options. See "How to Build a Model Number."
- Any special service required.

- Note:
- The indicates that a choice is required.
 - The absence of indicates that no choice is required.
 - Alpha-numeric characters in place of indicate that no other alternatives are available.

HOW TO BUILD A MODEL NUMBER

- A** Select size of worksurface.

- B** Select edge style.
 - T** = Flat Vinyl T-edge
 - M** = 3mm PVC edge
- C** Select PowerUp location.
 - L** = Left
 - R** = Right
 - C** = Center
 - B** = Left and right (60" and 72" only)
- D** Select height.
 - 7** = 27"
 - 9** = 29"
- E** Indicate location and type of leg.*
 - S** = Standard (both standard legs)
 - R** = Right (right transitional leg)
 - L** = Left (left transitional leg)
 - B** = Both (both transitional legs)

*Note: If ordering Basic Worksurface as a freestanding unit, or if only one side connects to a transitional worksurface, the "B" option for both transitional legs is not available.

• **Must order corresponding worksurface connector to attach to adjacent table when using transitional legs.**

- F** Select trim color for painted surfaces.
 - B** = Black
 - G** = Gray
 - S** = Sand
 - W** = Warm Gray
 - L** = Light Tone
- G** Select laminate surface.
 - AA** = Cream
 - AB** = Champagne
 - AC** = Barcelona
 - AF** = Aruba Tan
 - AG** = Black

- AH** = Dark Gray
- AI** = Dawn Gray (Greige)
- AJ** = Fog
- AK** = Black Grandin
- AL** = Smoke Granite
- AM** = Sand Grandin
- AN** = Light Granite
- AO** = Tundra
- AP** = Earthen
- AQ** = Rose Grafix
- AS** = Sierra Grafix
- AT** = Beige Grafix
- AU** = Sand Stone
- AV** = Kentucky Walnut
- AW** = Tennessee Oak
- AX** = Light Oak
- AY** = Red Birch
- AZ** = Ash
- BA** = Philadelphia Cherry
- BB** = Pennsylvania Cherry
- BC** = Mahogany



Edge Styles



T-Edge
Price **(T)**

3mm PVC Edge
Price **(M)**

27"	Total Weight	29"	T-Edge Price (T)	3mm PVC Edge Price (M)
74#		77#	\$235	\$245
81#		84#	240	250
87#		90#	245	260
93#		96#	255	270
81#		84#	235	245
90#		93#	240	250
98#		101#	245	260
106#		110#	255	270
99#		103#	260	275
112#		126#	275	290
110#		114#	260	275
126#		130#	275	290

- BE** = Maple

- BF** = Pearwood

- CA** = Pumice

- CB** = Rock Maple

- CC** = Medium Cherry

- CD** = Anigre

- ZZ** = COM

FINISH INFORMATION

Laminate Surface
See Keys for Progression swatch card.

ACCESSORIES

Casters
4 swivel casters (2½" diameter), 2 with locks.
Add 2" to top surface height. Add 2lbs. to weight.
Order separately, specify 87.2840
List price \$34.00/set

Worksurface Connectors
For attaching two freestanding tables together
of same height. Black finish.
Specify 87.4632.WZ.BL.
List price \$8.00

For attaching two freestanding tables together
of different heights. Black finish.
Specify 87.4624.WZ.BL.
List price \$12.00

Specifications and prices are subject to change without prior notice.



Edge Styles



T-Edge
Price **(T)**

3mm PVC Edge
Price **(M)**

Total Weight
27" 29"

Joins Table

97#	99#	225	235	24" deep worksurface to 24" deep worksurface
116#	118#	235	245	30" deep worksurface to 30" deep worksurface

73#	76#	260	270
93#	96#	280	295
115#	118#	300	315

- AW** = Tennessee Oak
- AX** = Light Oak
- AY** = Red Birch
- AZ** = Ash
- BA** = Philadelphia Cherry
- BB** = Pennsylvania Cherry
- BC** = Mahogany
- BD** = Oak
- BE** = Maple
- BF** = Pearwood
- CA** = Pumice
- CB** = Rock Maple
- CC** = Medium Cherry
- CD** = Anigre
- ZZ** = COM

FINISH INFORMATION

Laminate Surface
See Keys for Progression swatch card.

ACCESSORIES

Casters
4 swivel casters (2½" diameter), 2 with locks.
Add 2" to top surface height. Add 2lbs. to weight.
Order separately, specify 87.2840
List price \$34.00/set



Worksurface Connectors
For attaching two freestanding tables together
of same height. Black finish.
Specify 87.4632.WZ.BL.
List price \$8.00

For attaching two freestanding tables together
of different heights. Black finish.
Specify 87.4624.WZ.BL.
List price \$12.00

Specifications and prices are subject to change without prior notice.

XXI Notes Worksurfaces with PowerUp

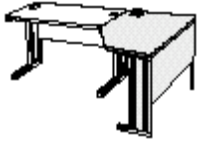
Level Five

MODEL	Left D x W x D	Right D x W x D	MODEL NUMBER									
			Worksurface	Edge Style	P/Up Location	Trans Direct	Hgt	Trim Color	Laminate			
 End-of-Run Worksurface with Keyboard <ul style="list-style-type: none"> • 36" width not available with key pad • 42" and 48" widths available with center keypad and bullnose edge • Transition direction is figured from the originating 24" or 30" basic or keyboard pad worksurface • Wireway not available on Level 5 • Notched vertical wireway and modesty panel frame style is standard 	24x36x36x24"	24x42x42x24"	30x48x48x30"	WERK24365	<input type="checkbox"/>	<input type="checkbox"/>	<input type="checkbox"/>	<input type="checkbox"/>	<input type="checkbox"/>	<input type="checkbox"/>	<input type="checkbox"/>	
				WERK24425	<input type="checkbox"/>	<input type="checkbox"/>	<input type="checkbox"/>	<input type="checkbox"/>	<input type="checkbox"/>	<input type="checkbox"/>	<input type="checkbox"/>	
				WERK30485	<input type="checkbox"/>	<input type="checkbox"/>	<input type="checkbox"/>	<input type="checkbox"/>	<input type="checkbox"/>	<input type="checkbox"/>	<input type="checkbox"/>	
 End-of-Run Worksurface <ul style="list-style-type: none"> • Wireway standard • Notched vertical wireway and modesty panel frame style is standard 	24x42x42x24"	24x48x48x24"	30x48x48x30"	WER24425	<input type="checkbox"/>	<input type="checkbox"/>	<input type="checkbox"/>	<input type="checkbox"/>	<input type="checkbox"/>	<input type="checkbox"/>	<input type="checkbox"/>	
				WER24485	<input type="checkbox"/>	<input type="checkbox"/>	<input type="checkbox"/>	<input type="checkbox"/>	<input type="checkbox"/>	<input type="checkbox"/>	<input type="checkbox"/>	
				WER30485	<input type="checkbox"/>	<input type="checkbox"/>	<input type="checkbox"/>	<input type="checkbox"/>	<input type="checkbox"/>	<input type="checkbox"/>	<input type="checkbox"/>	
 End-of-Run Curvilinear Worksurface <ul style="list-style-type: none"> • Wireway standard • Notched vertical wireway and modesty panel frame style is standard 	24x36x36x24"	24x42x42x24"	24x48x48x24"	30x42x42x30"	30x48x48x30"	WCCE24365	<input type="checkbox"/>	<input type="checkbox"/>	<input type="checkbox"/>	<input type="checkbox"/>	<input type="checkbox"/>	<input type="checkbox"/>
						WCCE24425	<input type="checkbox"/>	<input type="checkbox"/>	<input type="checkbox"/>	<input type="checkbox"/>	<input type="checkbox"/>	<input type="checkbox"/>
						WCCE24485	<input type="checkbox"/>	<input type="checkbox"/>	<input type="checkbox"/>	<input type="checkbox"/>	<input type="checkbox"/>	<input type="checkbox"/>
						WCCE30425	<input type="checkbox"/>	<input type="checkbox"/>	<input type="checkbox"/>	<input type="checkbox"/>	<input type="checkbox"/>	<input type="checkbox"/>
						WCCE30485	<input type="checkbox"/>	<input type="checkbox"/>	<input type="checkbox"/>	<input type="checkbox"/>	<input type="checkbox"/>	<input type="checkbox"/>
						A	B	C	D	E	F	G

HOW TO ORDER

Indicate the following information on order form:

- Quantity of each item.
- Model number, including options. See "How to Build a Model Number."
- Any special service required.

- Note:
- The indicates that a choice is required.
 - The absence of indicates that no choice is required.
 - Alpha-numeric characters in place of indicate that no other alternatives are available.

HOW TO BUILD A MODEL NUMBER

- A** Select size of worksurface.
B Select edge style.
T = Flat Vinyl T-edge
M = 3mm PVC edge
C Select PowerUp location.
L = Left
R = Right
C = Center
B = Left and right (60" and 72" only)
D Select transitional direction.
L = Left
R = Right
E Select height.
2 = 42"
7 = 27"
9 = 29"
- F** Select trim color for painted surfaces.
B = Black
G = Gray
S = Sand
W = Warm Gray
L = Light Tone
G Select laminate surface.
AA = Cream
AB = Champagne
AC = Barcelona
AF = Aruba Tan
AG = Black
AH = Dark Gray
AI = Dawn Gray (Greige)
AJ = Fog
AK = Black Grandin
AL = Smoke Granite
AM = Sand Grandin
AN = Light Granite

- AO** = Tundra
AP = Earthen
AQ = Rose Grafix
AS = Sierra Grafix
AT = Beige Grafix
AU = Sand Stone
AV = Kentucky Walnut
AW = Tennessee Oak
AX = Light Oak
AY = Red Birch
AZ = Ash
BA = Philadelphia Cherry
BB = Pennsylvania Cherry
BC = Mahogany
BD = Oak
BE = Maple
BF = Pearwood
CA = Pumice
CB = Rock Maple
CC = Medium Cherry
CD = Anigre



Edge Styles



T-Edge
Price **(T)**



3mm PVC Edge
Price **(M)**

Total Weight
27" 29"

Joins Table

78#	215	225	24" deep worksurface to 24" deep worksurface
102#	265	280	30" deep worksurface to 30" deep worksurface
78#	220	230	24" deep worksurface to 24" deep worksurface
82#	270	285	24" deep worksurface to 24" deep worksurface
100#	270	285	30" deep worksurface to 30" deep worksurface
76#	195	205	24" deep worksurface to 24" deep worksurface
96#	220	230	24" deep worksurface to 24" deep worksurface
106#	270	285	24" deep worksurface to 24" deep worksurface
108#	220	230	30" deep worksurface to 30" deep worksurface
118#	270	285	30" deep worksurface to 30" deep worksurface

FINISH INFORMATION

Laminate Surface

See Keys for Progression swatch card.

ACCESSORIES

Casters

4 swivel casters (2½" diameter), 2 with locks. Add 2" to top surface height. Add 2lbs. to weight. Order separately, specify 87.2840

List price \$34.00/set

Worksurface Connectors

For attaching two freestanding tables together of same height. Black finish. Specify 87.4632.WZ.BL.

List price \$8.00





For attaching two freestanding tables together of different heights. Black finish. Specify 87.4624.WZ.BL.

List price \$12.00

Specifications and prices are subject to change without prior notice.

XXI Notes Worksurfaces with PowerUp

Level Five

MODEL	Left D x W x D	Right D x W x D	MODEL NUMBER						
			Worksurface	Edge Style	P/Up Location	Hgt	Tr Legs	Trim Color	Laminate
 Corner Transitional Worksurface <ul style="list-style-type: none"> • One PowerUp module • Wireway not available on Level 5 • Notched vertical wireway and modesty panel frame style is standard 	24x36"		CT24365	<input type="checkbox"/>	<input type="checkbox"/>	<input type="checkbox"/>	<input type="checkbox"/>	<input type="checkbox"/>	<input type="checkbox"/>
	24x42"		CT24425	<input type="checkbox"/>	<input type="checkbox"/>	<input type="checkbox"/>	<input type="checkbox"/>	<input type="checkbox"/>	<input type="checkbox"/>
	30x48"		CT30485	<input type="checkbox"/>	<input type="checkbox"/>	<input type="checkbox"/>	<input type="checkbox"/>	<input type="checkbox"/>	<input type="checkbox"/>
 Corner Transitional Worksurface with Keyboard Pad <ul style="list-style-type: none"> • One PowerUp module • Wireway not available on Level 5 • Available with center keypad and bullnose edge • Notched vertical wireway and modesty panel frame style is standard 	24x42"		CTK24425	<input type="checkbox"/>	<input type="checkbox"/>	<input type="checkbox"/>	<input type="checkbox"/>	<input type="checkbox"/>	<input type="checkbox"/>
	30x48"		CTK30485	<input type="checkbox"/>	<input type="checkbox"/>	<input type="checkbox"/>	<input type="checkbox"/>	<input type="checkbox"/>	<input type="checkbox"/>
 Corner Transitional Reduction Worksurface <ul style="list-style-type: none"> • One PowerUp module • Wireway not available on Level 5 • Notched vertical wireway and modesty panel frame style is standard 	24x42x42x30"		CT2442305	<input type="checkbox"/>	<input type="checkbox"/>	<input type="checkbox"/>	<input type="checkbox"/>	<input type="checkbox"/>	<input type="checkbox"/>
	24x48x48x30"		CT2448305	<input type="checkbox"/>	<input type="checkbox"/>	<input type="checkbox"/>	<input type="checkbox"/>	<input type="checkbox"/>	<input type="checkbox"/>
	30x42x42x24"		CT3042245	<input type="checkbox"/>	<input type="checkbox"/>	<input type="checkbox"/>	<input type="checkbox"/>	<input type="checkbox"/>	<input type="checkbox"/>
	30x48x48x24"		CT3048245	<input type="checkbox"/>	<input type="checkbox"/>	<input type="checkbox"/>	<input type="checkbox"/>	<input type="checkbox"/>	<input type="checkbox"/>
 Corner Curvilinear Transitional Worksurface <ul style="list-style-type: none"> • One PowerUp module • Wireway not available on Level 5 • Notched vertical wireway and modesty panel frame style is standard 	24x36x36x24"		CCT24365	<input type="checkbox"/>	<input type="checkbox"/>	<input type="checkbox"/>	<input type="checkbox"/>	<input type="checkbox"/>	<input type="checkbox"/>
	24x42x42x24"		CCT24425	<input type="checkbox"/>	<input type="checkbox"/>	<input type="checkbox"/>	<input type="checkbox"/>	<input type="checkbox"/>	<input type="checkbox"/>
	24x48x48x24"		CCT24485	<input type="checkbox"/>	<input type="checkbox"/>	<input type="checkbox"/>	<input type="checkbox"/>	<input type="checkbox"/>	<input type="checkbox"/>
	30x42x42x30"		CCT30425	<input type="checkbox"/>	<input type="checkbox"/>	<input type="checkbox"/>	<input type="checkbox"/>	<input type="checkbox"/>	<input type="checkbox"/>
	30x48x48x30"		CCT30485	<input type="checkbox"/>	<input type="checkbox"/>	<input type="checkbox"/>	<input type="checkbox"/>	<input type="checkbox"/>	<input type="checkbox"/>
 Corner Curvilinear Transitional Reduction Worksurface <ul style="list-style-type: none"> • One PowerUp module • Wireway not available on Level 5 • Notched vertical wireway and modesty panel frame style is standard 	24x42x42x30"		CCT2442305	<input type="checkbox"/>	<input type="checkbox"/>	<input type="checkbox"/>	<input type="checkbox"/>	<input type="checkbox"/>	<input type="checkbox"/>
	24x48x48x30"		CCT2448305	<input type="checkbox"/>	<input type="checkbox"/>	<input type="checkbox"/>	<input type="checkbox"/>	<input type="checkbox"/>	<input type="checkbox"/>
	30x42x42x24"		CCT3042245	<input type="checkbox"/>	<input type="checkbox"/>	<input type="checkbox"/>	<input type="checkbox"/>	<input type="checkbox"/>	<input type="checkbox"/>
	30x48x48x24"		CCT3048245	<input type="checkbox"/>	<input type="checkbox"/>	<input type="checkbox"/>	<input type="checkbox"/>	<input type="checkbox"/>	<input type="checkbox"/>

A B C D E F G

HOW TO ORDER

Indicate the following information on order form:

- Quantity of each item.
- Model number, including options. See "How to Build a Model Number."
- Any special service required.

- Note:
- The indicates that a choice is required.
 - The absence of indicates that no choice is required.
 - Alpha-numeric characters in place of indicate that no other alternatives are available.

HOW TO BUILD A MODEL NUMBER

- A** Select size of worksurface.
B Select edge style.
T = Flat Vinyl T-edge
M = 3mm PVC edge
C Select PowerUp location.
L = Left
R = Right
C = Center
B = Left and right (60" and 72" only)
D Select height.
2 = 42"
7 = 27"
9 = 29"

- E** Indicate location and type of leg.*
S = Standard (both standard legs)
R = Right (right transitional leg)
L = Left (left transitional leg)
B = Both (both transitional legs)

*Note: If ordering Basic Worksurface as a freestanding unit, or if only one side connects to a transitional worksurface, the "B" option for both transitional legs is not available.

- **Must order corresponding worksurface connector to attach to adjacent table when using transitional legs.**

- F** Select trim color for painted surfaces.
B = Black
G = Gray
S = Sand
W = Warm Gray
L = Light Tone

- G** Select laminate surface.
AA = Cream
AB = Champagne
AC = Barcelona
AF = Aruba Tan
AG = Black
AH = Dark Gray
AI = Dawn Gray (Greige)
AJ = Fog
AK = Black Grandin
AL = Smoke Granite
AM = Sand Grandin
AN = Light Granite
AO = Tundra
AP = Earthen
AQ = Rose Grafix
AS = Sierra Grafix
AT = Beige Grafix
AU = Sand Stone
AV = Kentucky Walnut



Edge Styles



Total Weight
27" 29"

T-Edge
Price (**T**)

3mm PVC Edge
Price (**M**)

Joins Table

72#	\$200	\$210	24" deep worksurface to 24" deep worksurface
80#	205	215	24" deep worksurface to 24" deep worksurface
102#	240	250	30" deep worksurface to 30" deep worksurface

80#	150	160	24" deep worksurface to 24" deep worksurface
102#	160	170	30" deep worksurface to 30" deep worksurface

96#	225	235	24" deep worksurface to 30" deep worksurface
102#	245	260	24" deep worksurface to 30" deep worksurface
96#	225	235	30" deep worksurface to 24" deep worksurface
102#	245	260	30" deep worksurface to 24" deep worksurface

72#	165	175	24" deep worksurface to 24" deep worksurface
80#	175	185	24" deep worksurface to 24" deep worksurface
102#	190	200	24" deep worksurface to 24" deep worksurface
90#	200	210	30" deep worksurface to 30" deep worksurface
102#	215	225	30" deep worksurface to 30" deep worksurface

96#	225	235	24" deep worksurface to 30" deep worksurface
102#	245	260	24" deep worksurface to 30" deep worksurface
96#	225	235	30" deep worksurface to 24" deep worksurface
102#	245	260	30" deep worksurface to 24" deep worksurface

- AW** = Tennessee Oak
- AX** = Light Oak
- AY** = Red Birch
- AZ** = Ash
- BA** = Philadelphia Cherry
- BB** = Pennsylvania Cherry
- BC** = Mahogany
- BD** = Oak
- BE** = Maple
- BF** = Pearwood
- CA** = Pumice
- CB** = Rock Maple
- CC** = Medium Cherry
- CD** = Anigre
- ZZ** = COM

FINISH INFORMATION

Laminate Surface

See Keys for Progression swatch card.

ACCESSORIES

Casters

4 swivel casters (2 1/2" diameter), 2 with locks. Add 2" to top surface height. Add 2lbs. to weight. Order separately, specify 87.2840

List price \$34.00/set

Worksurface Connectors

For attaching two freestanding tables together of same height. Black finish. Specify 87.4632.WZ.BL.

List price \$8.00



For attaching two freestanding tables together of different heights. Black finish. Specify 87.4624.WZ.BL.

List price \$12.00

Specifications and prices are subject to change without prior notice.

XXI Notes Worksurfaces with PowerUp

Level Five

MODEL	Left D x W x D	Right W x D	MODEL NUMBER					
			Worksurface	Edge Style	P/Up Location	Hgt	Trim Color	Laminate
 <p>Stand Alone Corner Reduction Worksurface</p> <ul style="list-style-type: none"> • Not available with transitional legs • One PowerUp module • Wireway not available on Level 5 • Notched vertical wireway and modesty panel frame style is standard 	24x42x42x30"		WCS2442305	<input type="checkbox"/>	<input type="checkbox"/>	<input type="checkbox"/>	<input type="checkbox"/>	<input type="checkbox"/>
	24x48x48x30"		WCS2448305	<input type="checkbox"/>	<input type="checkbox"/>	<input type="checkbox"/>	<input type="checkbox"/>	<input type="checkbox"/>
	30x42x42x24"		WCS3042245	<input type="checkbox"/>	<input type="checkbox"/>	<input type="checkbox"/>	<input type="checkbox"/>	<input type="checkbox"/>
	30x48x48x24"		WCS3048245	<input type="checkbox"/>	<input type="checkbox"/>	<input type="checkbox"/>	<input type="checkbox"/>	<input type="checkbox"/>
 <p>Stand Alone Corner Curvilinear Worksurface</p> <ul style="list-style-type: none"> • Not available with transitional legs • One PowerUp module • Wireway not available on Level 5 • Notched vertical wireway and modesty panel frame style is standard 	24x36x36x24"		WCC24365	<input type="checkbox"/>	<input type="checkbox"/>	<input type="checkbox"/>	<input type="checkbox"/>	<input type="checkbox"/>
	24x42x42x24"		WCC24425	<input type="checkbox"/>	<input type="checkbox"/>	<input type="checkbox"/>	<input type="checkbox"/>	<input type="checkbox"/>
	24x48x48x24"		WCC24485	<input type="checkbox"/>	<input type="checkbox"/>	<input type="checkbox"/>	<input type="checkbox"/>	<input type="checkbox"/>
	30x42x42x30"		WCC30425	<input type="checkbox"/>	<input type="checkbox"/>	<input type="checkbox"/>	<input type="checkbox"/>	<input type="checkbox"/>
	30x48x48x30"		WCC30485	<input type="checkbox"/>	<input type="checkbox"/>	<input type="checkbox"/>	<input type="checkbox"/>	<input type="checkbox"/>
 <p>Stand Alone Corner Curvilinear Reduction Worksurface</p> <ul style="list-style-type: none"> • Not available with transitional legs • One PowerUp module • Wireway not available on Level 5 • Notched vertical wireway and modesty panel frame style is standard 	24x42x42x30"		CCS2442305	<input type="checkbox"/>	<input type="checkbox"/>	<input type="checkbox"/>	<input type="checkbox"/>	<input type="checkbox"/>
	24x48x48x30"		CCS2448305	<input type="checkbox"/>	<input type="checkbox"/>	<input type="checkbox"/>	<input type="checkbox"/>	<input type="checkbox"/>
	30x42x42x24"		CCS3042245	<input type="checkbox"/>	<input type="checkbox"/>	<input type="checkbox"/>	<input type="checkbox"/>	<input type="checkbox"/>
	30x48x48x24"		CCS3048245	<input type="checkbox"/>	<input type="checkbox"/>	<input type="checkbox"/>	<input type="checkbox"/>	<input type="checkbox"/>

A B C D E F

HOW TO ORDER

Indicate the following information on order form:

- Quantity of each item.
- Model number, including options. See "How to Build a Model Number."
- Any special service required.

- Note:
- The indicates that a choice is required.
 - The absence of indicates that no choice is required.
 - Alpha-numeric characters in place of indicate that no other alternatives are available.

HOW TO BUILD A MODEL NUMBER

- A** Select size of worksurface.
B Select edge style.
T = Flat Vinyl T-edge
M = 3mm PVC edge
C Select PowerUp location.
L = Left
R = Right
C = Center
B = Left and right (60" and 72" only)
D Select height.
2 = 42"
7 = 27"
9 = 29"
E Select trim color for painted surfaces.
B = Black
G = Gray
S = Sand
W = Warm Gray
L = Light Tone
F Select laminate surface.
AA = Cream
AB = Champagne
AC = Barcelona
AF = Aruba Tan
AG = Black
AH = Dark Gray
AI = Dawn Gray (Greige)
AJ = Fog
AK = Black Grandin
AL = Smoke Granite
AM = Sand Grandin
AN = Light Granite

- AO** = Tundra
AP = Earthen
AQ = Rose Grafix
AS = Sierra Grafix
AT = Beige Grafix
AU = Sand Stone
AV = Kentucky Walnut
AW = Tennessee Oak
AX = Light Oak
AY = Red Birch
AZ = Ash
BA = Philadelphia Cherry
BB = Pennsylvania Cherry
BC = Mahogany
BD = Oak
BE = Maple
BF = Pearwood
CA = Pumice
CB = Rock Maple
CC = Medium Cherry
CD = Anigre



Edge Styles



Total Weight
27" 29"

T-Edge
Price **(T)**

3mm PVC Edge
Price **(M)**

93#	96#	280	295
99#	102#	300	315
93#	96#	280	295
99#	102#	300	315
73#	76#	260	270
93#	96#	280	295
103#	106#	300	315
105#	108#	280	295
115#	118#	300	315
93#	96#	280	295
99#	102#	300	315
93#	96#	280	295
99#	102#	300	315

FINISH INFORMATION

Laminate Surface

See Keys for Progression swatch card.

ACCESSORIES

Casters

4 swivel casters (2½" diameter), 2 with locks. Add 2" to top surface height. Add 2lbs. to weight. Order separately, specify 87.2840

List price \$34.00/set

Worksurface Connectors

For attaching two freestanding tables together of same height. Black finish. Specify 87.4632.WZ.BL.

List price \$8.00



For attaching two freestanding tables together of different heights. Black finish. Specify 87.4624.WZ.BL.

List price \$12.00

Specifications and prices are subject to change without prior notice.

XXI Notes Worksurfaces with PowerUp

Level Five

MODEL	D x W x L	MODEL NUMBER							
		Worksurface	Edge Style	Surface Direct	P/Up Location	Hgt	Tr Legs	Trim Color	Laminate
 "P" Shaped Peninsula Worksurface <ul style="list-style-type: none"> • One PowerUp module • Wireway not available on Level 5 • Notched vertical wireway and modesty panel frame style is standard 	24x48x60"	ZPT2448605	<input type="checkbox"/>	<input type="checkbox"/>	<input type="checkbox"/>	<input type="checkbox"/>	<input type="checkbox"/>	<input type="checkbox"/>	<input type="checkbox"/>
	24x48x72"	ZPT2448725	<input type="checkbox"/>	<input type="checkbox"/>	<input type="checkbox"/>	<input type="checkbox"/>	<input type="checkbox"/>	<input type="checkbox"/>	<input type="checkbox"/>
	30x48x72"	ZPT3048725	<input type="checkbox"/>	<input type="checkbox"/>	<input type="checkbox"/>	<input type="checkbox"/>	<input type="checkbox"/>	<input type="checkbox"/>	<input type="checkbox"/>
 Piano Peninsula Worksurface <ul style="list-style-type: none"> • One PowerUp module • Wireway not available on Level 5 • Notched vertical wireway and modesty panel frame style is standard 	24x48x60"	ZPP2448605	<input type="checkbox"/>	<input type="checkbox"/>	<input type="checkbox"/>	<input type="checkbox"/>	<input type="checkbox"/>	<input type="checkbox"/>	
	24x48x72"	ZPP2448725	<input type="checkbox"/>	<input type="checkbox"/>	<input type="checkbox"/>	<input type="checkbox"/>	<input type="checkbox"/>	<input type="checkbox"/>	
	30x48x72"	ZPP3048725	<input type="checkbox"/>	<input type="checkbox"/>	<input type="checkbox"/>	<input type="checkbox"/>	<input type="checkbox"/>	<input type="checkbox"/>	
 Square Shoe Worksurface <ul style="list-style-type: none"> • One PowerUp module • Wireway not available on Level 5 • Notched vertical wireway and modesty panel frame style is standard 	24x48x60"	ZSS2448605	<input type="checkbox"/>	<input type="checkbox"/>	<input type="checkbox"/>	<input type="checkbox"/>	<input type="checkbox"/>	<input type="checkbox"/>	
	24x48x66"	ZSS2448665	<input type="checkbox"/>	<input type="checkbox"/>	<input type="checkbox"/>	<input type="checkbox"/>	<input type="checkbox"/>	<input type="checkbox"/>	
	24x48x72"	ZSS2448725	<input type="checkbox"/>	<input type="checkbox"/>	<input type="checkbox"/>	<input type="checkbox"/>	<input type="checkbox"/>	<input type="checkbox"/>	
	24x48x84"	ZSS2448845	<input type="checkbox"/>	<input type="checkbox"/>	<input type="checkbox"/>	<input type="checkbox"/>	<input type="checkbox"/>	<input type="checkbox"/>	
	30x48x66"	ZSS3048665	<input type="checkbox"/>	<input type="checkbox"/>	<input type="checkbox"/>	<input type="checkbox"/>	<input type="checkbox"/>	<input type="checkbox"/>	
	30x48x72"	ZSS3048725	<input type="checkbox"/>	<input type="checkbox"/>	<input type="checkbox"/>	<input type="checkbox"/>	<input type="checkbox"/>	<input type="checkbox"/>	
	30x48x84"	ZSS3048845	<input type="checkbox"/>	<input type="checkbox"/>	<input type="checkbox"/>	<input type="checkbox"/>	<input type="checkbox"/>	<input type="checkbox"/>	

A B C D E F G H

HOW TO ORDER

Indicate the following information on order form:

1. Quantity of each item.
2. Model number, including options. See "How to Build a Model Number."
3. Any special service required.

- Note:
- The indicates that a choice is required.
 - The absence of indicates that no choice is required.
 - Alpha-numeric characters in place of indicate that no other alternatives are available.

HOW TO BUILD A MODEL NUMBER

- A** Select size of worksurface.
B Select edge style.
T = Flat Vinyl T-edge
M = 3mm PVC edge
C Select surface direction.
L = Left
R = Right
D Select PowerUp location.
L = Left
R = Right
C = Center
B = Left and right (60" and 72" only)
E Select height.
9 = 29"

- F** Indicate location and type of leg.*
S = Standard (both standard legs)
R = Right (right transitional leg)
L = Left (left transitional leg)
B = Both (both transitional legs)

*Note: If ordering Basic Worksurface as a freestanding unit, or if only one side connects to a transitional worksurface, the "B" option for both transitional legs is not available.

- **Must order corresponding worksurface connector to attach to adjacent table when using transitional legs.**

- G** Select trim color for painted surfaces.
B = Black
G = Gray
S = Sand
W = Warm Gray
L = Light Tone

- H** Select laminate surface.
AA = Cream
AB = Champagne
AC = Barcelona
AF = Aruba Tan
AG = Black
AH = Dark Gray
AI = Dawn Gray (Greige)
AJ = Fog
AK = Black Grandin
AL = Smoke Granite
AM = Sand Grandin
AN = Light Granite
AO = Tundra
AP = Earthen
AQ = Rose Grafix
AS = Sierra Grafix
AT = Beige Grafix
AU = Sand Stone
AV = Kentucky Walnut



Edge Styles



T-Edge
Price **(T)**

3mm PVC Edge
Price **(M)**

Total Weight

134#	\$315	\$330
146#	325	340
150#	335	350

132#	290	305
144#	300	315
148#	310	325

133#	\$280	\$295
139#	290	305
145#	295	310
157#	305	320
144#	290	305
150#	295	310
172#	305	320

- AW** = Tennessee Oak
- AX** = Light Oak
- AY** = Red Birch
- AZ** = Ash
- BA** = Philadelphia Cherry
- BB** = Pennsylvania Cherry
- BC** = Mahogany
- BD** = Oak
- BE** = Maple
- BF** = Pearwood
- CA** = Pumice
- CB** = Rock Maple
- CC** = Medium Cherry
- CD** = Anigre
- ZZ** = COM

FINISH INFORMATION

Laminate Surface
See Keys for Progression swatch card.

ACCESSORIES

Casters
4 swivel casters (2½" diameter), 2 with locks.
Add 2" to top surface height. Add 2lbs. to weight.
Order separately, specify 87.2840
List price \$34.00/set





Worksurface Connectors
For attaching two freestanding tables together
of same height. Black finish.
Specify 87.4632.WZ.BL.
List price \$8.00

For attaching two freestanding tables together
of different heights. Black finish.
Specify 87.4624.WZ.BL.
List price \$12.00

Specifications and prices are subject to change without prior notice.

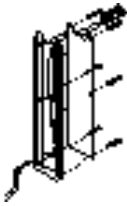
XXI Notes Worksurfaces with PowerUp

Electrical

MODEL	MODEL NUMBER	
	Worksurface	Trim Color
 <p>Floor Infeed (Four-Circuit Pre-wired)</p> <ul style="list-style-type: none"> Provides power from fixed floor or wall sources to table distribution system on level four and five only. Select height to match leg height. Example: 27", 29" or 42" Must be ordered separately for Levels 4 and 5 Specify trim color Infeed whip is 6 feet long 	WZPI27	<input type="checkbox"/>
	WZPI29	<input type="checkbox"/>
	WZPI42	<input type="checkbox"/>
 <p>Duplex Receptacle - Eight-Wire System</p> <ul style="list-style-type: none"> Convenience circuits share a neutral and ground wire Must be ordered separately for Levels 4 and 5 Same receptacle is used in Classic XXI Black only 	WZRECP1	B
	WZRECP2	B
	WZRECP3	B
 <p>Dedicated Receptacle - Eight-Wire System</p> <ul style="list-style-type: none"> Dedicated circuit has its own neutral and ground Must be ordered separately for Levels 4 and 5 Same receptacle is used in Classic XXI Orange only 	WZRECP41	0
 <p>Eight-Wire Table-to-Table Connector</p> <ul style="list-style-type: none"> Connects the eight-wire power system of two adjoining tables 18" long Includes steel wireway and splice plate Must be ordered separately for Levels 4 and 5 Specify trim color Only one connector is needed for a Level 4 or 5 corner table 	WZSC18	<input type="checkbox"/>

A **B**

HOW TO ORDER

Indicate the following information on order form:

- Quantity of each item.
- Model number, including options. See "How to Build a Model Number."
- Any special service required.

- Note:
- The indicates that a choice is required.
 - The absence of indicates that no choice is required.
 - Alpha-numeric characters in place of indicate that no other alternatives are available.

HOW TO BUILD A MODEL NUMBER

- A** Select size of worksurface.
- B** Select trim color.
 - B** = Black
 - G** = Gray
 - S** = Sand
 - W** = Warm Gray
 - L** = Light Tone



Total Weight

Price

FINISH INFORMATION

Laminate Surface

See Keys for Progression swatch card.

ACCESSORIES

Casters

4 swivel casters (2½" diameter), 2 with locks.
Add 2" to top surface height. Add 2lbs. to weight.
Order separately, specify 87.2840

List price \$34.00/set

Worksurface Connectors

For attaching two freestanding tables together
of same height. Black finish.
Specify 87.4632.WZ.BL.

List price \$8.00

For attaching two freestanding tables together
of different heights. Black finish.
Specify 87.4624.WZ.BL.

List price \$12.00

**Specifications and prices are subject to
change without prior notice.**



Single Surface Tables

p. 164

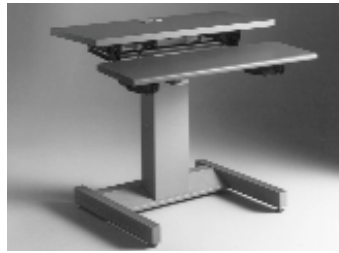

Dual Surface Tables

p. 164

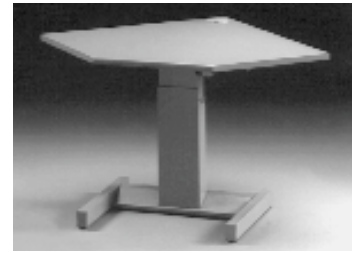

Corner Tables

p. 164

Features

Single pedestal	•	•	•
Dual pedestal		•	•
Single worksurface	•		•
Dual worksurface		•	•
Sliding rear surface		•	•
Available with keyboard		•	•
Powder-coated finish	•	•	•

Dimensions

height range	26"–40"	26"–40"	26"–40"
table width	34"–58"	34"–58"	40–47"
table depth	29"	29"–41"	—
front surface depth	29"	11½"–24"	—
rear surface depth	—	16½"–18"	—

PECIFICATIONS

Worksurface Top

¼" thick consisting of Novaply particle board with a .020" phenolic backing sheet.

available with .053" high-pressure laminate and flat vinyl T-edge or 180° post-formed front edge with .042" high-pressure laminate and flat .V.C. side and rear edge.

dual surface tops provide a 1" clearance between surfaces for cables. Worksurfaces are oversized 1" on both sides and rear for proper clearance during operation. Grommets are standard on rear surface.

Height Adjustment

ranges from 26" to 40". PositionMate keyboard surface 21" to 47".

Drive System

60 Hz, 110 V, AC motor. 250 lbs. lift capacity; higher weight capacities are available. No belts, pulleys or hydraulics. The motor is 1.2 amps–no load; 1.6 amps–full load for single pedestal, 2.4–3.2 for dual pedestal.

Leg Assembly

Designed with integral foot support and non-marring foot cover.

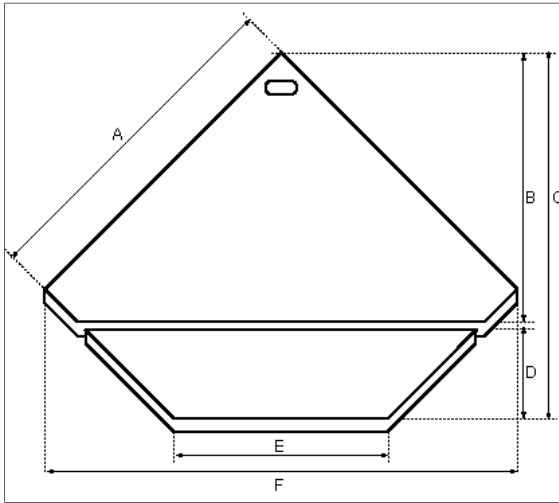

EWDC-3048

- A = 39⁵/₁₆"
- B = 32²/₃"
- C = 45"
- D = 11¹/₅"
- E = 22¹/₂"
- F = 56¹/₃"

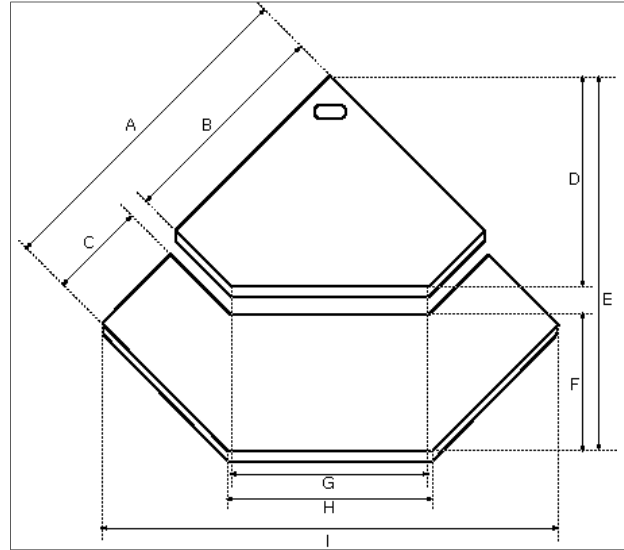

A







EW2C-3048

- A = 39⁵/₁₆"
- B = 27"
- C = 11¹/₄"
- D = 26²/₃"
- E = 45"
- F = 17¹/₃"
- G = 23¹/₃"
- H = 22¹/₂"
- I = 56¹/₃"

INFORMATION

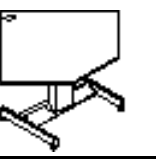
Warranty

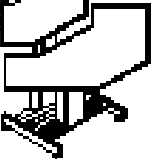
See "Terms" for more information.

		TOP DIMENSIONS	MODEL NUMBER			
			Worksurface	Edge Style	Trim	Laminate
	Rectangular Single Surface • Single pedestal unit with single rectangular worksurface	29" x 34"	EWS3036	<input type="checkbox"/>	<input type="checkbox"/>	<input type="checkbox"/>
		29" x 40"	EWS3042	<input type="checkbox"/>	<input type="checkbox"/>	<input type="checkbox"/>
		29" x 46"	EWS3048	<input type="checkbox"/>	<input type="checkbox"/>	<input type="checkbox"/>
		29" x 52"	EWS3054	<input type="checkbox"/>	<input type="checkbox"/>	<input type="checkbox"/>
		29" x 58"	EWS3060	<input type="checkbox"/>	<input type="checkbox"/>	<input type="checkbox"/>
	Rectangular Dual Surface • Single pedestal unit with dual rectangular worksurfaces; 11½" front/16½" rear • PositionMate™ keyboard	29" x 34"	EWD3036	<input type="checkbox"/>	<input type="checkbox"/>	<input type="checkbox"/>
		29" x 40"	EWD3042	<input type="checkbox"/>	<input type="checkbox"/>	<input type="checkbox"/>
		29" x 46"	EWD3048	<input type="checkbox"/>	<input type="checkbox"/>	<input type="checkbox"/>
		29" x 52"	EWD3054	<input type="checkbox"/>	<input type="checkbox"/>	<input type="checkbox"/>
		29" x 58"	EWD3060	<input type="checkbox"/>	<input type="checkbox"/>	<input type="checkbox"/>
	Corner Single Surface • Single pedestal unit with single corner worksurface	23" x 40" x 40"	EWSC2442	<input type="checkbox"/>	<input type="checkbox"/>	<input type="checkbox"/>
		29" x 47" x 47"	EWSC3048	<input type="checkbox"/>	<input type="checkbox"/>	<input type="checkbox"/>
	Corner Surface with Keyboard • Single pedestal unit with dual corner worksurface; 11½" front • PositionMate™ keyboard	23" x 40" x 40"	EWDC2442	<input type="checkbox"/>	<input type="checkbox"/>	<input type="checkbox"/>
		29" x 46" x 46"	EWDC3048	<input type="checkbox"/>	<input type="checkbox"/>	<input type="checkbox"/>
	Corner Dual Pedestal/Dual Surface • Dual pedestal unit with dual corner worksurface	23" x 40" x 40"	EW2C2442	<input type="checkbox"/>	<input type="checkbox"/>	<input type="checkbox"/>
		29" x 46" x 46"	EW2C3048	<input type="checkbox"/>	<input type="checkbox"/>	<input type="checkbox"/>
	Corner Dual Pedestal/Dual Surface with Sliding Surface • Dual pedestal unit with dual corner surfaces • Sliding rear surface	23" x 40" x 40"	EW2CS2442	<input type="checkbox"/>	<input type="checkbox"/>	<input type="checkbox"/>
		29" x 46" x 46"	EW2CS3048	<input type="checkbox"/>	<input type="checkbox"/>	<input type="checkbox"/>

A
 B
 C
 D

HOW TO ORDER

Indicate the following information on order form:

- Quantity of each item.
- Model number, including options. See "How to Build a Model Number."
- Any special service required.

- Note:
- The indicates that a choice is required.
 - The absence of indicates that no choice is required.
 - Alpha-numeric characters in place of indicate that no other alternatives are available.

HOW TO BUILD A MODEL NUMBER

- A** Select size of worksurface.

T = Flat Vinyl T-edge
M = 3mm PVC edge
- C** Select trim color for painted surfaces.

B = Black
G = Gray
S = Sand
W = Warm Gray
L = Light Tone
- D** Select laminate surface.

AA = Cream
AB = Champagne
AC = Barcelona
AF = Aruba Tan
AG = Black
AH = Dark Gray
AI = Dawn Gray (Greige)

- AJ** = Fog
- AK** = Black Grandin
- AL** = Smoke Granite
- AM** = Sand Grandin
- AN** = Light Granite
- AO** = Tundra
- AP** = Earthen
- AQ** = Rose Grafix
- AS** = Sierra Grafix
- AT** = Beige Grafix
- AU** = Sand Stone
- AV** = Kentucky Walnut
- AW** = Tennessee Oak
- AX** = Light Oak
- AY** = Red Birch
- AZ** = Ash
- BA** = Philadelphia Cherry
- BB** = Pennsylvania Cherry
- BC** = Mahogany
- BD** = Oak
- BE** = Maple

- BF** = Pearwood
- CA** = Pumice
- CB** = Rock Maple
- CC** = Medium Cherry
- CD** = Anigre
- ZZ** = COM
- CA** = Pumice
- CB** = Rock Maple
- CC** = Medium Cherry
- CD** = Anigre
- ZZ** = COM



Edge Styles



T-Edge
List Price **(T)**



3mm PVC Edge
List Price **(M)**

Total Weight

168#	\$1065	\$1075
177#	1094	2004
186#	1122	1132
192#	1153	1163
198#	1187	1197

190#	1249	1259
198#	1296	1306
211#	1344	1354
217#	1392	1402
223#	1440	1450

189#	1282	1292
214#	1344	1354

211#	1448	1458
236#	1510	1520

207#	2024	2034
237#	2100	2110

231#	2156	2166
256#	2232	2242

FINISH INFORMATION

Laminate Surface

See Keys for Progression swatch card.

Specifications and prices are subject to change without prior notice.

Assistant Station

Workspace 48 sq. ft.
Budget Price \$1,927

Note: Budget price is based on single typical workstation. Price will decrease when workstations are clustered.

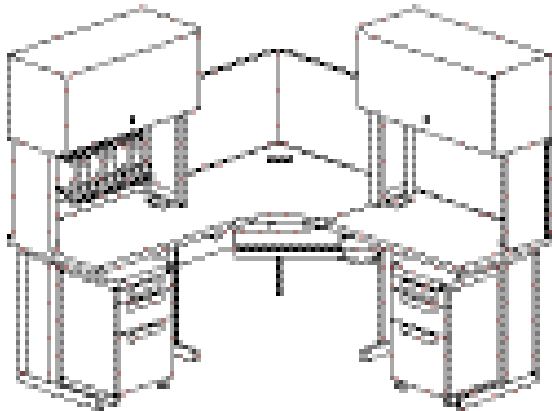
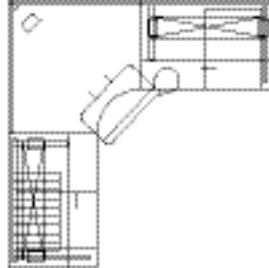

Workstation Features:

- Laminate surfaces with flat vinyl T-edge
- Fabric overhead units with task lights
- Two mobile pedestals pencil/box/file
- Paper management tool rail and accessories
- Articulating keyboard with mouse pad
- Privacy screens

Clerk Station

Workspace 36 sq. ft.
Budget Price \$1,458

Note: Budget price is based on single typical workstation. Price will decrease when workstations are clustered.

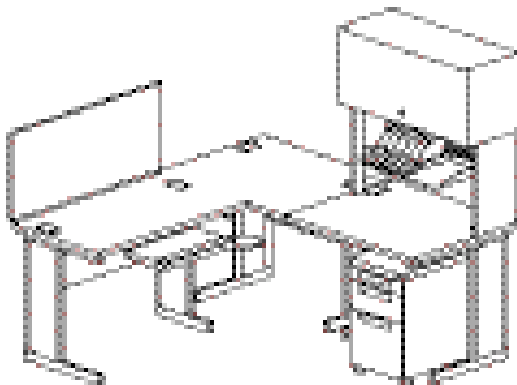
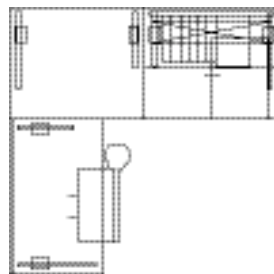

Workstation Features:

- Laminate surfaces with flat vinyl T-edge
- Fabric overhead unit with task light
- Mobile pedestals pencil/box/file
- Paper management tool rail and accessories
- Articulating keyboard with mouse pad
- Privacy screen

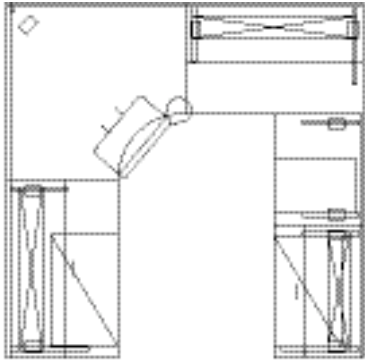
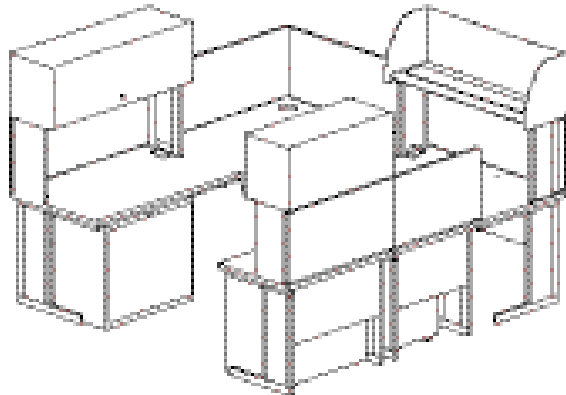

Engineer Station

Workspace 36 sq. ft.
Budget Price \$3,149

Note: Budget price is based on single typical workstation. Price will decrease when workstations are clustered.

Workstation Features:

- Laminate surfaces with flat vinyl T-edge
- Fabric overheads, open shelf with task lights
- Mobile pedestal pencil/box/file
- Two 30" wide 2-high lateral files
- Articulating keyboard with mouse pad
- Privacy screens

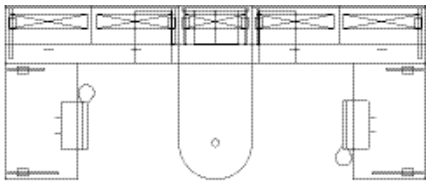
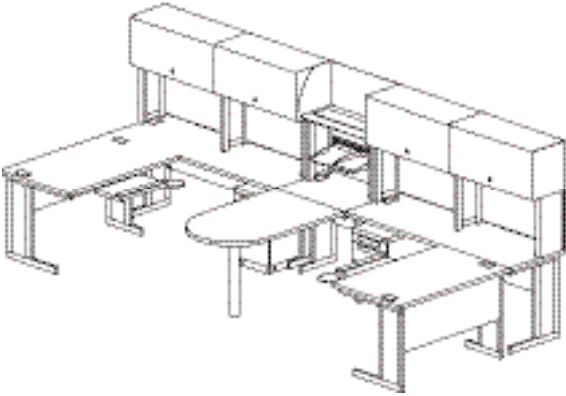

Shared Station

Workspace 87 sq. ft.
Budget Price \$3,430

Note: Budget price is based on single typical workstation. Price will decrease when workstations are clustered.

Workstation Features:

- Laminate surfaces with flat vinyl T-edge
- Fabric overheads, open shelf with task lights
- Two mobile pedestals pencil/box/file
- Paper management tool rail and accessories
- Articulating keyboard with mouse pad
- Privacy screens

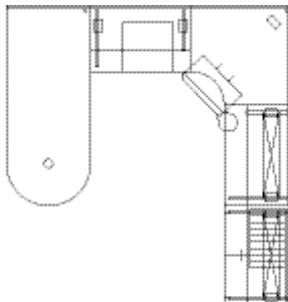
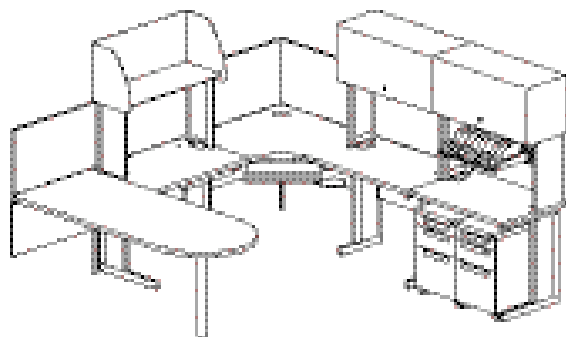

Manager Station

Workspace 64 sq. ft.
Budget Price \$2,648

Note: Budget price is based on single typical workstation. Price will decrease when workstations are clustered.

Workstation Features:

- Laminate surfaces with flat vinyl T-edge
- Fabric overheads, open shelf with task lights
- Two mobile pedestals pencil/box/file
- Paper management tool rail and accessories
- Articulating keyboard with mouse pad
- Center drawer
- Privacy screens

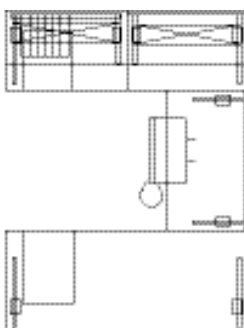
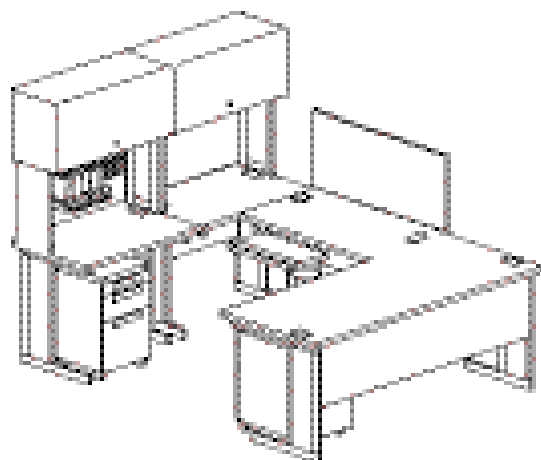

Receptionist Station

Workspace 92 sq. ft.
Budget Price \$2,225

Note: Budget price is based on single typical workstation. Price will decrease when workstations are clustered.

Workstation Features:

- Laminate surfaces with flat vinyl T-edge
- Fabric overheads with task lights
- Two mobile pedestals pencil/box/file
- Paper management tool rail and accessories
- Articulating keyboard with mouse pad



U.S. Department of Justice

UNICOR

Federal Prison Industries, Inc.

CATPP502

