



Movable-Wall System
Basic Installation Manual

General Information	Introduction	2
	Required Tools	4
	Unloading	5
Step by Step Instruction	1:00 Shop Prints	6
	1:01 Ceiling Track	8
	1:02 Panel Preparation	9
	1:03 Positioning	10
	1:04 Adjustment	11
	1:05 Connection	12
	1:06 Posts	14
	1:07 Door Frames and Clear Openings	15
	1:08 Door Pivot	16
	1:09 Securing Panels	18
	1:10 Trim	19
	1:11 Panel Shells	20

INTRODUCTION

This manual outlines the installation procedures for Counter Point Wall floor-to-ceiling movable wall partitions and various accessory components. It is a guide to how to prepare, position, adjust, connect and trim panels for a typical installation.

The installation instructions assume an appropriate floor plan has been established. Use the floor plan in combination with this manual as a reference for the location and orientation of the various Counter Point Wall components and finishes. Also special installation instructions and detail drawings will be provided on the floor plan.

This manual should be completely reviewed before any installation begins.

Counter Point Wall is a custom product and additional technical information may be required. For additional information please contact the factory at:

U.S. Department of Justice
UNICOR Customer Service Center
Federal Prison Industries, Inc.
1-800-827-3168

Ceiling Track

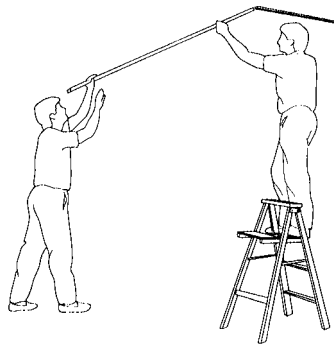

Positioning

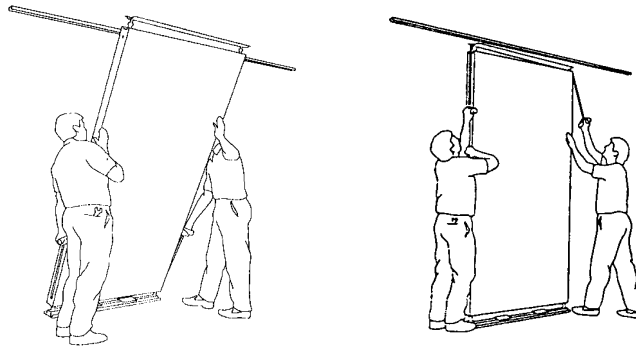

Connection

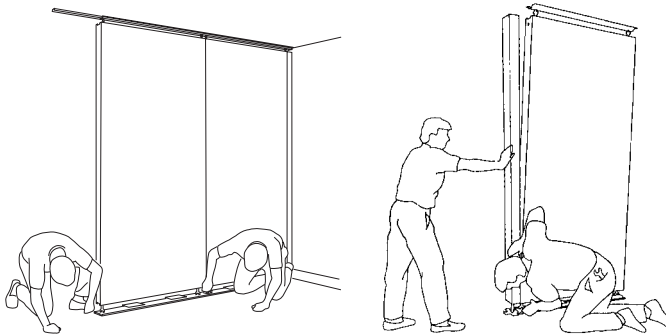

Doors

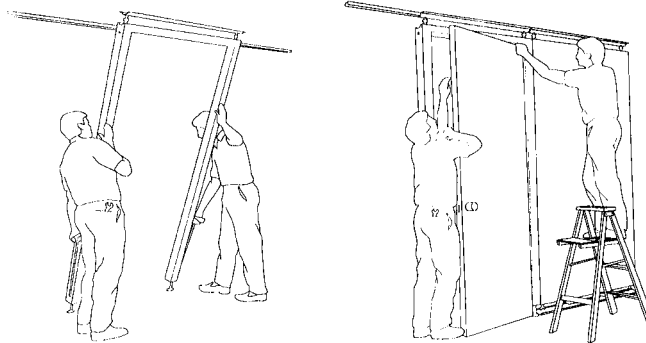

Trim Installation

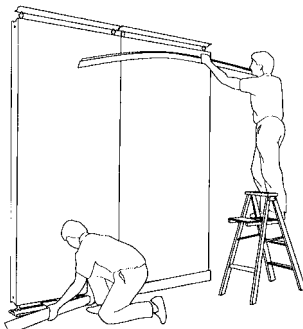

REQUIRED TOOLS

TOOLS THAT MAY BE FURNISHED BY UNICOR:

- Grapple hooks
- Door Tool
- Panel alignment tools
- Door Pivot Gauge
- Trim Removal Tools

TOOLS REQUIRED ON A TYPICAL JOB:

- Tape Measure
- Four-foot Levels
- $\frac{3}{8}$ ", $\frac{1}{2}$ ", $\frac{3}{4}$ " Combination Wrenches
- Squares
- $\frac{1}{4}$ " and $\frac{7}{16}$ " Nut Drivers
- Screwdrivers
- $\frac{3}{8}$ " Ratcheting Box Wrenches
- Channel Locks
- Plastic Mallets
- Hacksaw
- Aviation Snips
- $\frac{5}{32}$ " Hex Driver (ball end)
- Drill/Drivers with Drill & Screwdriver bits
- $\frac{7}{8}$ " Holesaws
- Drywall-Type Carts padded to safely transport panels
- Ladders: Recommended at least one ladder per two workers (minimum of two ladders) to safely reach ceiling

Note: Specific types of tools may be required in cases where special components are used, or non-standard hardware and custom modifications are required.

We recommend panels be staged vertically leaning against a wall at a slight angle. However, if panels must be stacked on edge or flat, no more than 12 panels of like size should be in one stack. They must be stacked with padding against wall or on floor to prevent damage.

As each Counter Point Wall panel or component is unloaded it should be checked against packing list and/or drawing to ensure completeness of order. All items are identified by both a part number sticker and a carton number sticker. Use panel grapple hooks enclosed in one of the component boxes to lift panels from skid or truck. Inspect each panel for shipping damage as it is removed from the truck. If damage exists, notify UNICOR of carton number, type of damage, and probable cause of damage within 24 hours of unloading. Damage must be indicated on bill of lading in order to file freight claim. Report all other on-site damage as soon as possible to ensure prompt replacements. To transport panels on site, use a well-padded drywall cart to minimize damage.

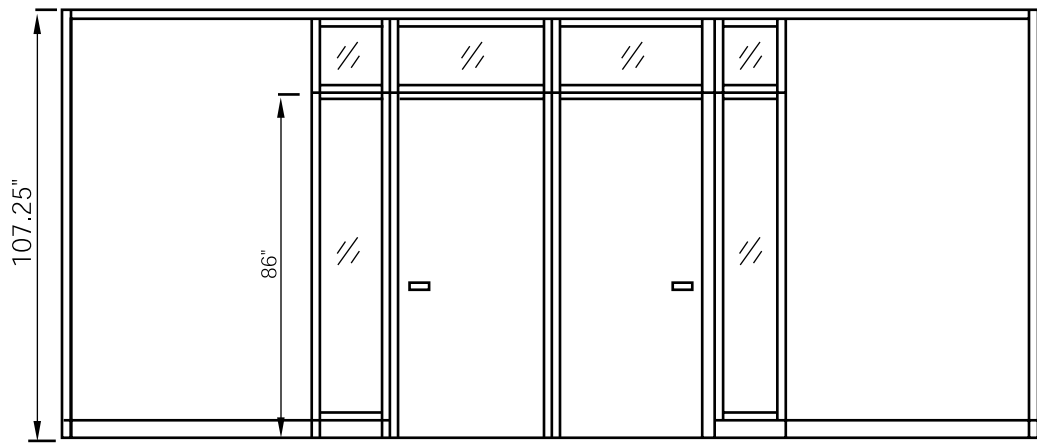
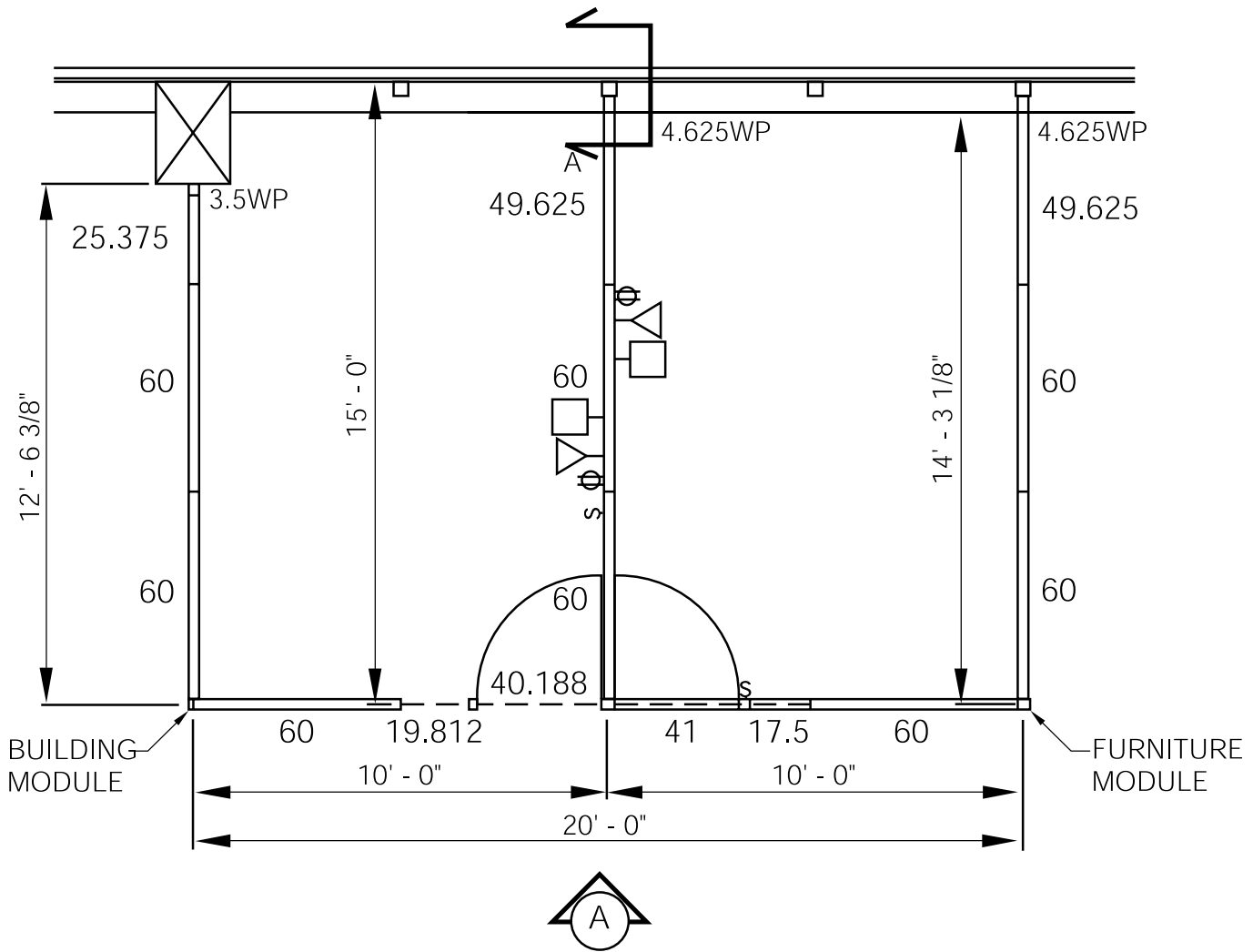

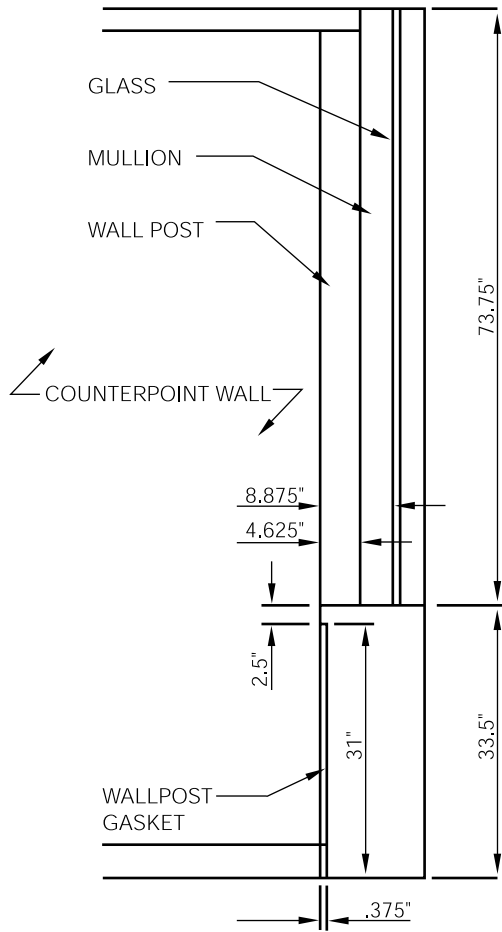

DETAIL AA

LEGEND

	SOLID PANEL
	FULL HEIGHT GLASS
	SOLID / GLASS
	CLEAR OPENING
	FILLER PANEL
	FABRIC
	VINYL
	ENAMEL
	WOOD
	LAMINATE
	FULL HEIGHT DOOR PANEL
	DOOR PANEL W/TRANSOM
(X)	PANEL SIZE TO BE DETERMINED UPON FIELD VERIFICATION
WP	WALL POST
UC	U-CHANNEL
PCM	PANEL CENTER MOUNT

FINISHES:

PANELS - SOLID: CANDIAN GENERAL ROWER LODESTER MM 11991 AJB
 GLASS/GLASS: 1/4" CLEAR TEMPERED GLASS TO 86" A.F.F.,
 1/4" CLEAR TEMPERED GLASS TO CEILING

DOOR - 1 3/4" SOLID CORE BULLNOSE PIVOT HUNG
 RED OAK VENEER WITH CLEAR FINISH TO 86" A.F.F.,
 1/4" CLEAR TEMPERED GLASS TO CEILING
 LIGHT SWITCH IN DOOR FRAME PROVIDED BY UNICOR
 L9010 SCHLAGE 626 FINISH 07A
 LEVER LATCHSET PROVIDED BY UNICOR
 PIVOT HARDWARE AND STRIKE BOX SUPPLIED BY UNICOR

BASE AND CEILING COVER TRIM - BLACK PEARL METALLIC
 DOOR AND GLAZING TRIM - BLACK PEARL METALLIC
 PANEL TO PANEL GASKET - UNICOR STANDARD BLACK
 ELECTRICAL - (2) RECEPTACLES, (2) TELEPHONE, (2) COMPUTER BOXES
 (1) LIGHT SWITCH SUPPLIED BY UNICOR

CEILING GRID TYPE : 15/16" RECESSED

HANG-ON COMPONENTS: NONE

CEILING HEIGHT = 107.25"

P = POWER PANEL

= COMPUTER BOX

= TELEPHONE BOX

= RECEPTACLE

BILL OF MATERIALS

ITEM	QTY		DESCRIPTION
1	1	17.5	GLASS / GLASS
2	1	19.812	GLASS / GLASS
3	1	25.375	SOLID
4	1	40.188 PIVOT	36" RH - TRANSOM DOOR
5	1	41 PIVOT	36" RH - TRANSOM DOOR W/SWITCH
6	2	49.625	SOLID
7	7	60	SOLID
8	1	60	SOLID: P
9	2	BUILDING MOD. CONN.	BUILDING MODULE
10	1	CORNER POST RIGHT	VINYL
11	2	SPECIAL WALL POST	VINYL
12	1	COUNTER POINT WALL CORNER	VINYL
13	1	COUNTER POINT WALL POST	VINYL

Counter Point Wall shop prints include information about the dimensions and other details of each installation. The "Legends", "Bill of Materials", "Elevations", "Details" and job information should be completely reviewed before any installation begins. It is most important that you understand whether dimensions are centerline to centerline, inside to inside or other special reference point. If any questions arise please contact UNICOR for additional information.

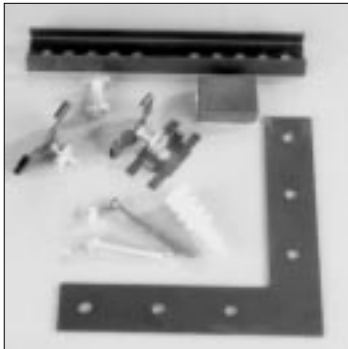
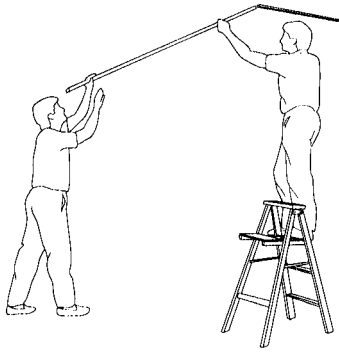

Many ceiling grids accept standard caddy clips such as 3/8" and 1/2". When grid is recessed, spring spacers and closed cell foam pads must be used. In some cases, washers must be added to space track properly to ceiling. Donn 3/8" fine line uses a 1/2"-20 T-bolt. Drywall and hidden grid ceiling require direct attachment of the track with screws or anchors.

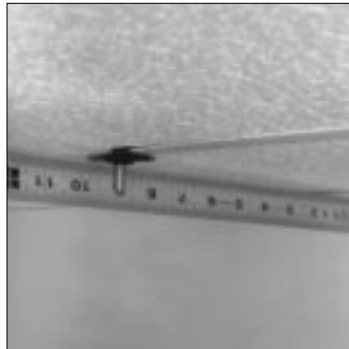

Fig. 3

After positioning and securing tracks on caddy clips with 1/2" x 20 hex nuts, ensure that it cannot slide, does not push up ceiling tiles and that there are not light gaps between ceiling and rail. (Fig. 5 & 6)

Note: Some local codes may require physical attachment of ceiling grid and Counter Point Wall ceiling track to the ceiling superstructure.

On all corners insert the 90° splice plate. (Fig. 6) Between all track sections insert the 180° splice plate. On 3-ways and 4-ways cut out one leg of the track to accept a 90° splice plate.



Fig. 1

A ceiling track layout must be completed to verify fit of components. Ceiling track **must** be set in place before positioning the various components. Installation of ceiling track accurately per shop drawings is critical to a satisfactory installation. If any discrepancies exist, please contact UNICOR.



Fig. 4

Check fit and strength. Verify accuracy of all measurements. Plumb-bob down for panel centerline and snap chalk lines or you may plumb panels later using a level as they are connected.

Note: If ceiling is not stable, reinforcement may be necessary by using suitable materials above the tiles. This work is not included in the installation bid.

Using the floor plan for reference and working in teams of two, fasten the ceiling track clips to the ceiling grid securely. **Caution:** do not overtighten. On drywall and hidden grid ceilings, mark location of track centerline or edge, then attach track. (Fig. 1 & 2)



Fig. 2

Measure from wall, column or other starting point to the first attachment point. Cut track accordingly so that all subsequent attachment points fall on track slotting module. (Fig. 3 & 4)



Fig. 5

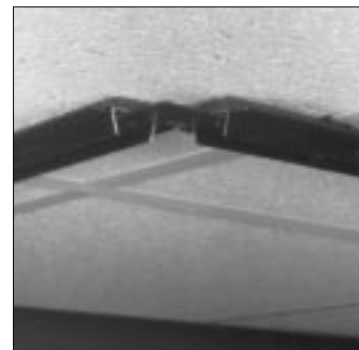

Fig. 6

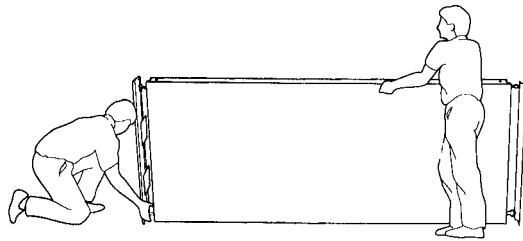

Fig. 1 Secured for Transport

Select appropriate panel according to your floor plan. Laying the panel on its side edge, unpack it by slitting one side of shrink-wrap, taking care not to damage the finish.



Fig. 3

Note: Two panel connectors are required for any given connection, one for the top and one for the bottom. A set of panel connectors is included from the factory and located on one side of the panel. A second set may be added on the other side of the panel for connection to a post, opening or filler panel. **These are shipped separately.** (Fig. 3)



Fig. 2 Released

Release the spring-loaded glides by unscrewing the locking mechanism. Ensure the panel connectors are in place on the appropriate side. (Fig. 1 & 2)

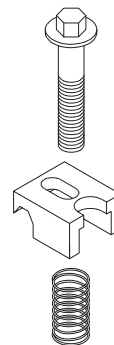

The base glides are preset from the factory at 2 $\frac{3}{4}$ " for 4" base cover and 3 $\frac{3}{4}$ " for 5" base cover. In extreme situations, the base glides may need to be adjusted before panel positioning to ensure proper ceiling clearance. This can be done while the panel is still on its side. Set the glide height so the retracted and depressed upper glides clear the ceiling rail.

Note: Please refer to the sections on positioning and adjustments for more details.

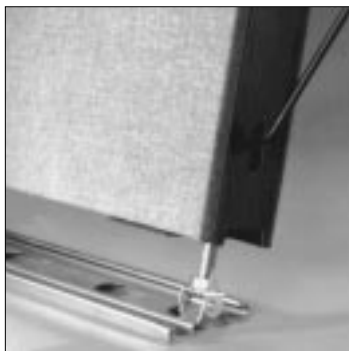
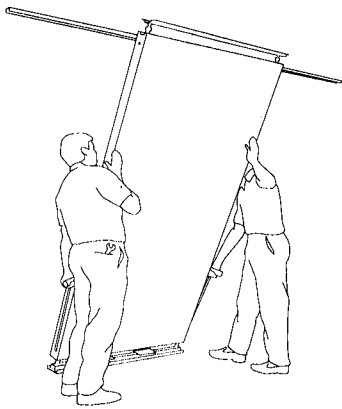

Fig. 1

Working in teams of two, stand panel on its base, slightly inclined.

Using the installation grapple hooks provided, hook into the holes located in the bottom of both sides of the panel. (Fig. 1)

Holding the panel securely, lift or slide the panel into position underneath the ceiling track.



Fig. 2

Using the grapple hook, pull down the spring-loaded upper glides. (Fig. 2)



Fig. 3

Pivot the panel up and release the top glides into the ceiling track, securing it in an upright position. (Fig. 3)

Note: To save time and space, move all panels in sequence to this point before connecting them to one another. If possible, this should be done as the panels are unloaded from the truck, eliminating double handling and potential damage.

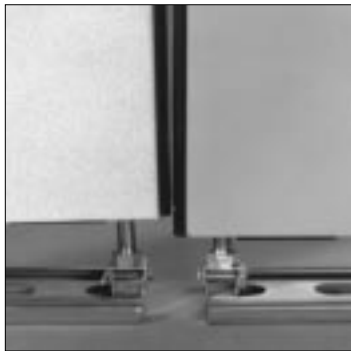
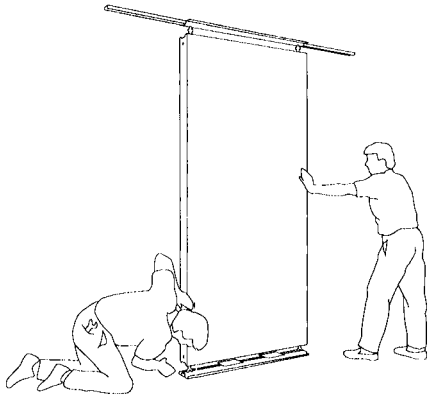

Fig. 1

Using a $\frac{3}{4}$ " wrench, channel locks or pliers, readjust the level and height of the panel by turning the bolts of the bottom glides. (Fig. 1)

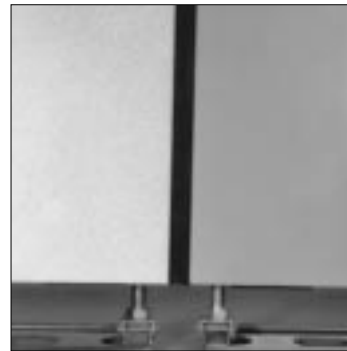

Fig. 3

Once the previous panel sections are aligned and leveled, subsequent adjustment can be made visually by placing the panels side by side and setting height and adjusting level unit achieving a tight seal between the panel-to-panel gaskets. (Fig. 3)

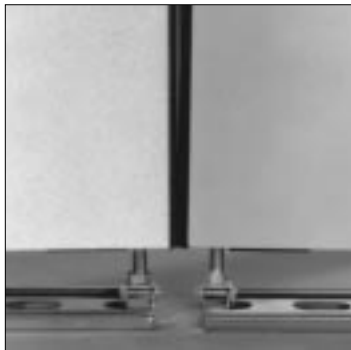
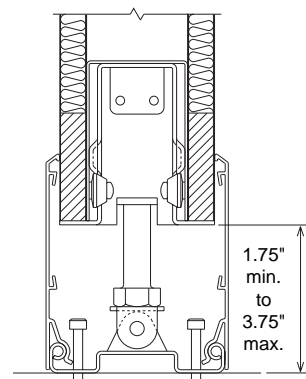

Fig. 2

Panels must be at equal height for the connectors to engage at the top and bottom of the panel.

Verify plumb of first panel using a level in both directions. (Fig. 2)



Nominal Base Clearance

Base adjustment for standard door heights fall between $2\frac{7}{8}$ " minimum and $3\frac{7}{8}$ " maximum for 4" base cover- $3\frac{7}{8}$ " minimum and $4\frac{3}{8}$ " maximum for 5" base. If base is set less than minimum, door will have to be cut off on the bottom and remortised for proper fit. Minimum base adjustment for field wired base electrical is $2\frac{7}{8}$ ".

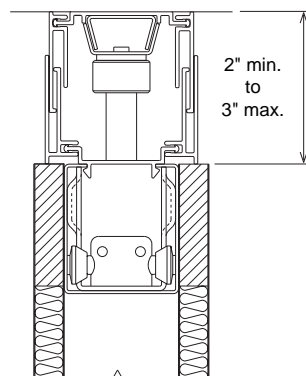

Nominal Ceiling Clearance

If base is set greater than maximum, shims will have to be placed above bottom pivot plate assembly in door. This will make the door undercut larger.

If minimum or maximum top glide height cannot be maintained, ceiling grid will have to be raised or lowered.

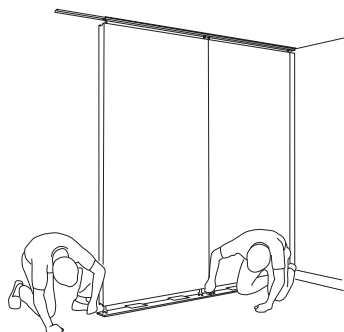

Connector Retracted



Connector Exposed



Fig. 1

To connect, join two properly aligned and adjusted panels side by side, in perfect contact with one another.

Slide the panel connector block to the side, toward the other panel or post. (Fig. 1)



Fig. 2

Visually or by touch, check that the connector engages with the flange of the adjoining panel or post.

Using a $\frac{3}{8}$ " wrench, securely fasten one panel to another by tightening the panel connector bolt. Repeat this process for the bottom panel connector. (Fig. 2)



Fig. 3

Building module clip

This clip is shipped loose from the factory and is located as per photos. If additional information is needed, contact UNICOR. (Fig. 3, 4, 5 & 8)



Fig. 6

Panel Center Mount

The panel center mount clip is used when panels are connected off modules. This clip is shipped loose from the factory. (Fig. 6)



Fig. 4

To connect building module post, or panel connections, use the building module clip with longer bolt and washer. (Fig. 4 & 5)



Fig. 7

The panel center mount clip is used on the top (Fig. 7) and a building module clip is used on the bottom. (Fig. 8) Installation requires removal of the bottom ceiling cover holder at the top of the panel and cutting a 2" section out of it at the clip location. (Fig. 7)



Fig. 5



Fig. 8

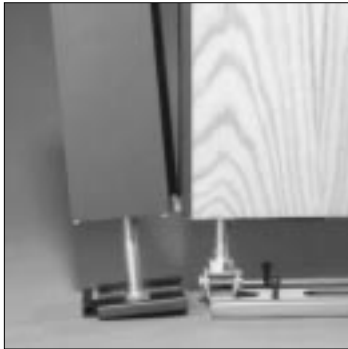
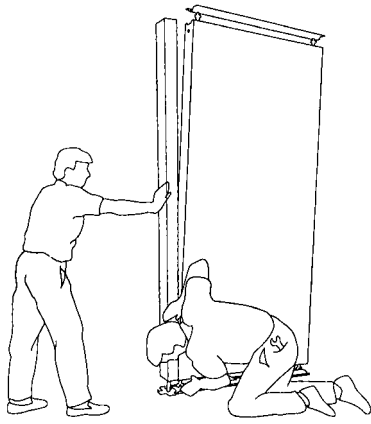

Fig. 1

Posts do not have connectors on them. For any given connection, two connectors on the adjoining panel are required. If necessary, add one to the top and one to the bottom of the adjacent panel. Because posts do not have spring-loaded top glides, they must be held in position manually until connected to a secured component.

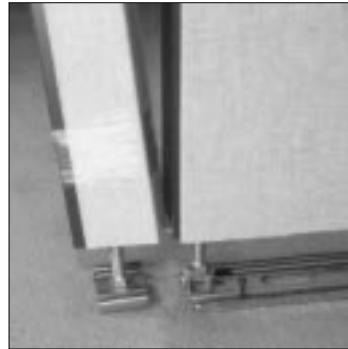

Fig. 3

Wallposts also use standard connectors for attachment as described previously. Adjust base glide so the two halves of the post align at the top. (Fig. 3)

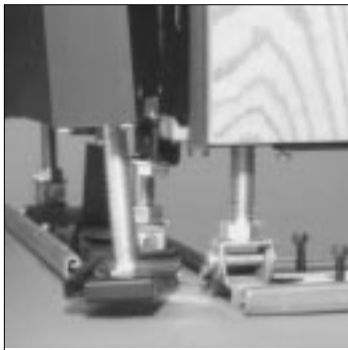

Fig. 2

To connect a post, place it against a properly leveled and adjusted component making sure it is flush. Tighten top and bottom connectors as described in section 1:05. Then adjust base glide as necessary. (Fig. 1)

Note: Bottom connector may be extended and tightened. Set post on top of connector, align post and tighten top connector. (Fig. 2)

Building module posts are attached on the 3" dimension the same as all other posts. On the 1½" side they require a special clip attached to the adjoining panel. Refer to section 1:05 Building Module Clip for additional information.

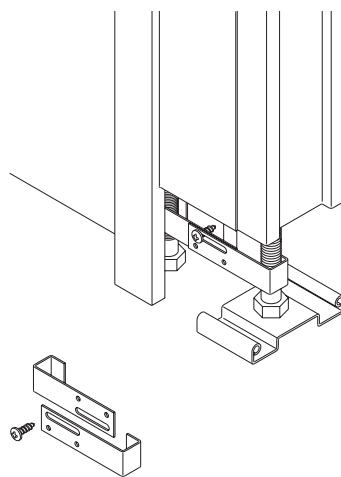

Fig. 4

If wall post is located next to a small panel return, door frame or clear opening, a wall post locking strap is required to prevent the spring pressure from pushing the adjoining component out of position. (Fig. 4)

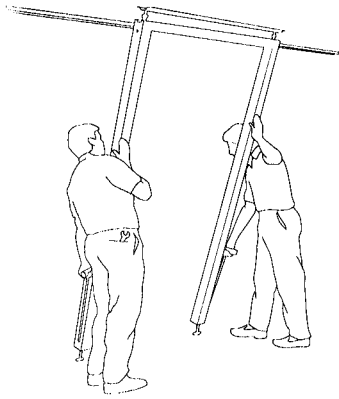

Fig. 1

Door frames and clear opening frames are shipped with vertical moldings longer than required in order to account for floor irregularities.

Prepare for installing the frame by leveling the panels on each side of the opening to each other using a long level. (Fig. 1)



Fig. 3

Cut door frame vertical moldings to length by measuring down from the door frame vertical post using dimension obtained in Figure 2. (Fig. 3)



Fig. 2

Measure distance from bottom of vertical posts to floor. (Fig. 2)



Fig. 4

On door frames, notch vertical moldings to clear bottom door pivot as necessary. (Fig. 4)

Connect frame to adjoining panels as described in section 1:05. After connection, recheck header and verticals for plumb and level. These are critical for door to function properly. Adjust adjoining panel heights if necessary.

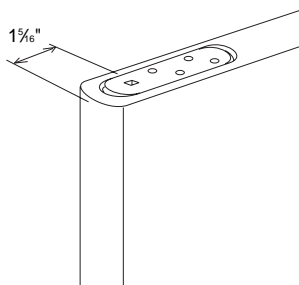
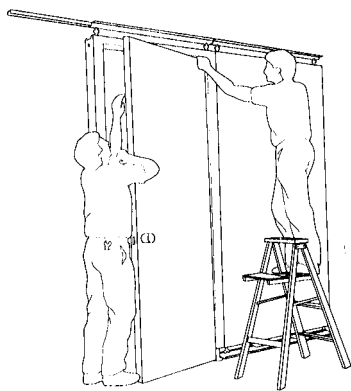

Fig. 1

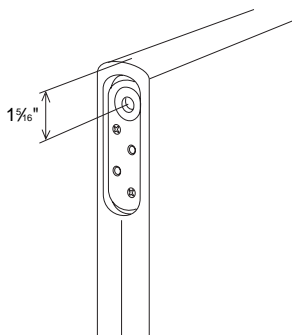
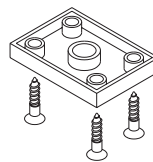

Fig. 2

Prepare the door by installing the top and bottom door pivot assemblies so the pivot center is 1 5/16" from the bullnose and centered in the mortise. (Fig. 1, 2 & 5)



Insert door top pivot pin after inserting the spring. Orient the top pivot so the release slot is facing the bullnose edge of the door and door removal tool can only be inserted when door is open. (Fig. 3)

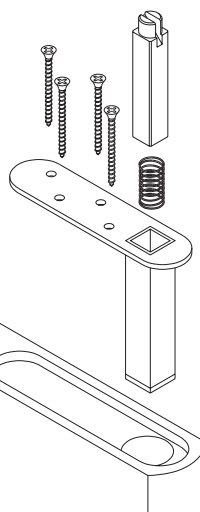

Fig. 3

Install door by first placing the door bottom pivot thrust bearing over the door frame bottom pivot acorn nut. Depress the spring-loaded top pivot, move door into position, then release the spring-loaded pivot into the top pivot plate. (Fig. 4)

At this point, the door should remain in a neutral position, not swinging outward or inward under its own weight. If door moves, plumb is not correct.

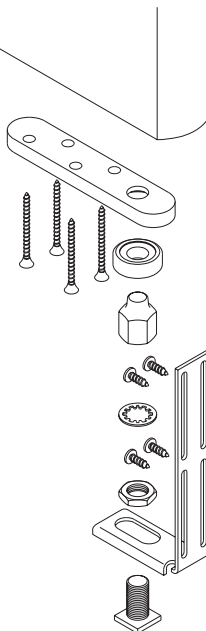
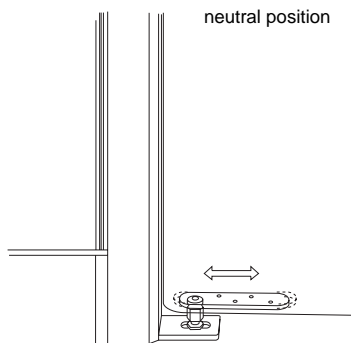

Fig. 4

Adjust the height of the door to provide a 1/8" clearance between the underside of the top molding and the top edge of the door.

Note: The door should brush the pile weatherstrip lightly on both the pivot side and top header. Fine tune adjacent panel after door installation to achieve an even reveal at header. Move pivot assemblies to achieve an even reveal along pivot side. This is critical for door to function properly and to have the reveal look correct.



neutral position

Generally, most offices have doors set to swing open and storage room doors are set to swing shut. This can be achieved by following these additional instructions.

Fig. 5

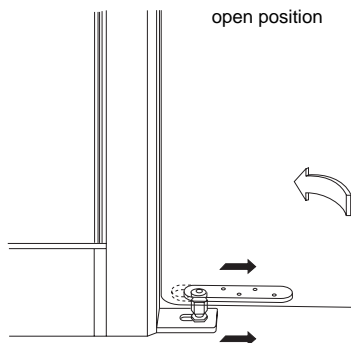

open position

Moving the bottom door plate and the pivot $\frac{1}{4}$ " toward the center of the door will make the door swing open under its own weight. (Fig. 6)

Fig. 6

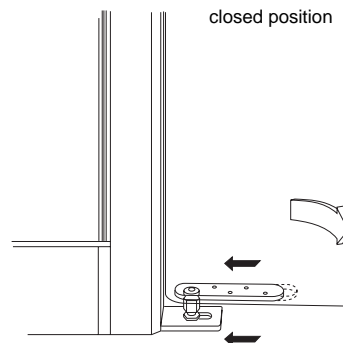

closed position

Moving the bottom door plate and the pivot $\frac{1}{4}$ " away from the center of the door will make the door swing shut under its own weight. (Fig. 7)

Note: If door does not swing properly, plumb is not correct.

Fig. 7

Butt Hinge Door

This door requires hinges be installed on the door first. Then with a block underneath the door, align hinges with mounting holes on the hinge-style door frame. Start all screws and assure alignment, then tighten. If necessary, adjust height of adjacent panels to achieve an even reveal at top. Vertical reveal may be adjusted by using prepunched fiber shims between frame and hinge, if necessary.

Note: All additional door hardware should be installed per manufacturer instructions. Contact UNICOR if additional information is needed.

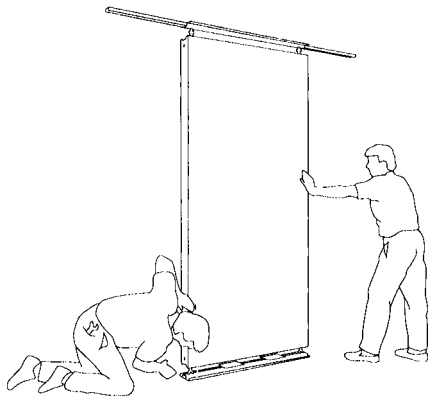

Fig. 1 Released

After positioning and connecting all the components, secure the panels in place by locking the upper glide mechanisms into the ceiling track by turning them counter-clockwise until engaged. (Fig. 1 & 2)

Note: It may be necessary to place screws through upper glide saddle into track to meet local codes.



Fig. 2 Engaged

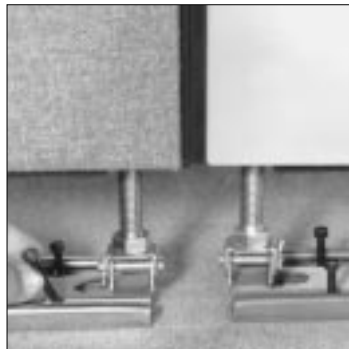

Fig. 3

Finally, secure the panel floor channel by inserting and tightening the carpet grippers and screws, approximately one turn past finger tight. (Fig. 3 & 4)

Note: If Counter Point Wall is installed on hard floors, it is customary to have the neoprene gasket applied to the bottom of the floor channel to prevent slipping. It may be necessary to attach the unit to the floor to meet local codes.

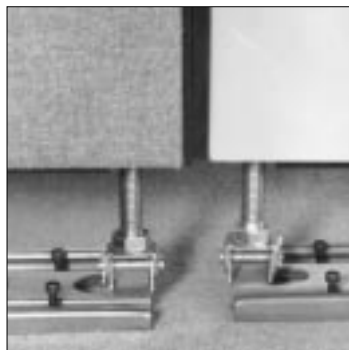

Fig. 4

Note: In most cases, it is preferable that all panels and components be positioned, leveled and connected before securing.

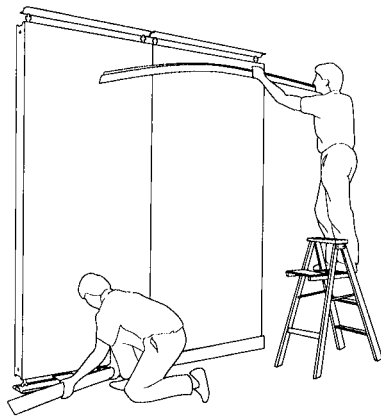

Fig. 1

Base Covers

As a standard, base covers are factory precut to panel module width, less 1/2". To install the base covers, firmly press the proper size base cover on to the floor channel. (Fig. 1)

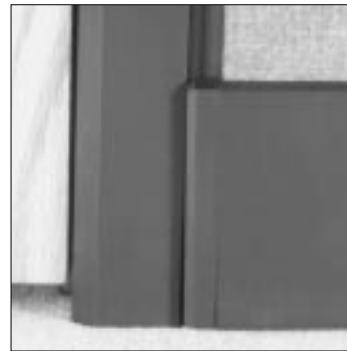

Fig. 4

Covers ending at doors may require a 1/2" base cover end. (Fig. 4)

Note: It will be necessary to field cut base covers at the inside of all building module connections and on adjustable wall posts.

Note: After one side of base cover is installed, insert fiberglass soundproofing strips into base assembly void.



Fig. 2

All base covers on panels in a straight run will use left and right 1/4" base cover ends (Fig. 2) except those next to posts and door frames.



Fig. 5

Ceiling Covers

Ceiling covers are composed of two sections which fit into one another for adjustability. Usually, length is 10 feet and they are field-cut as necessary. Make sure ceiling cover assembly is oriented with longer leg on bottom. (Fig. 5)

Start outside cover placement at the pre-molded corner. (Fig. 6)

Inside ceiling covers may be started at any point; however, make sure one inside corner extends, beyond the panel to form a gap-free butt joint.

Note: After one side is installed, insert fiberglass soundproofing strips into upper glide assembly voids.

We recommend not using pieces of ceiling cover smaller than one foot and not splicing within two inches of a panel seam to ensure flush, tight joints.



Fig. 3

Post base covers will be attached to the adjacent base cover with a 180°, 1/4" base cover connector base. (Fig. 3)



Fig. 6

Note: In most cases, it is preferable that all trim be installed after all components have been positioned, leveled, connected and secured.

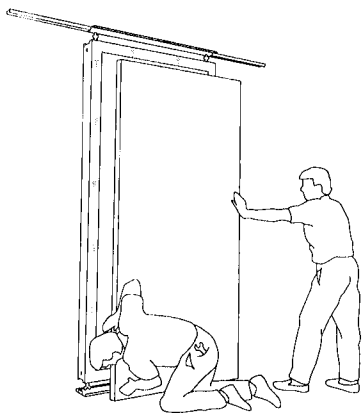

Fig. 1

Panel shells that are fastened to the frame of each panel are demountable. These removable shells permit access for electrical and communication wiring, and allow for changing or repairing of surface finishes. (Fig. 1)



Fig. 4

Panel hooks are fastened to the perimeter of the inside of the shell. These hooks are positioned into pre-punched key slots in the vertical posts and the horizontal distance channels of the frame. (Fig. 4)

Remove the shell locks from the bottom of the shell. Move the shell up and then outward to remove it.

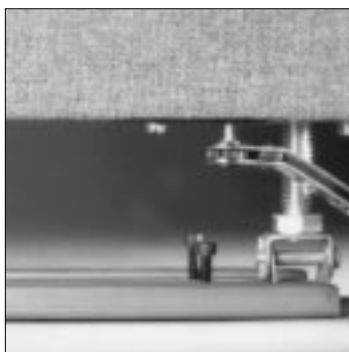

Fig. 2

The ceiling and base covers must be removed before the shell can be removed from the panel. This will allow access to the anchoring screws or the shell lock on the bottom of the shell. (Fig. 2 & 3)



Fig. 3

To re-install the shell, align the panel hooks with the pre-punched key slots and move the shell toward the panel frame and then down. Secure the panel shell in place by installing the screws or the shell lock in the bottom of the shell.

Note: The panel shell should not have to be forced on to the frame if panel hooks are installed correctly. Apply pressure towards panel frame to ensure all hooks engage. Then shell should slide downward easily. If force is required, not all hooks are engaged properly into key slots.

Note: Transom shells have shell lock in top distance channel. The bottom ceiling cover holder must be removed to access the transom shell lock.



U.S. Department of Justice

UNICOR

Federal Prison Industries, Inc.

PIEP300/OEI/1099

www.unicor.gov

