

# PRICE LIST

Freestanding Desk Based System

# Bravo

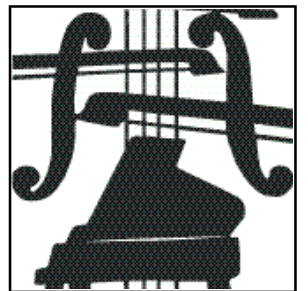

Prices Effective June 2006.

UNICOR



Section/Product	Page No.
<b>Terms and Conditions</b>	4
<b>Standard Product Overview</b>	5
<b>Technical Specifications</b>	6
<b>Worksurfaces</b>	
Rectangular Worksurfaces	8
Corner Worksurfaces	12
Reduction Rectangular Worksurfaces	20
Piano Worksurfaces	24
P-Shaped Worksurfaces	26
D-Shaped Worksurfaces	28
Add-On Worksurfaces	30
Transaction Worksurfaces	32
<b>Executive Desks</b>	36
<b>Privacy Screens</b>	
Between Stanchion Mounted Screen	38
Behind Worksurface Mounted Screen	38
Behind Worksurface Mounted Corner Screen	40
Stanchion and On-Worksurface Mounted Screen	42
On-Worksurface Mounted Screen	42
On-Surface Mounted Corner Screen	44
Stackable Mounted Screen	44
<b>Privacy Screen Accessories</b>	
Stacked BSBWC Bracket	46
Stacked BSOWC Bracket	46
<b>Overhead Storage</b>	
Universal Overhead	48
Shelf Divider	48, 50, 52
Venus Overhead	50
Venus Overhead Conversion Kit	50
Universal Shelves	52
Universal Overhead Conversion Kit	52
<b>Under Shelf/Cabinet Lighting</b>	
Universal Task Lights	54
<b>Communication Accessories</b>	
Communications Pole	56
Face Plate Bracket	56
Cable Support	56
<b>Electrical</b>	
Rigid Wireway	57
Desk Jumper	57
Base Feed	57
Top Feed	57
Panel Feed	58
Receptacles	58
Power Pass Through	58
Stanchion Power Tap	58
<b>Components</b>	
Tool Rail Kits	59
Backpacks	60
<b>Storage Solutions</b>	
Mobile and Freestanding Pedestals	61
Kiosks	62
<b>Worksurface Accessories</b>	63
<b>Paper Management</b>	67
<b>Budget Typicals</b>	
Receptionist Station	68
Assistant Station	68
Clerk Station	69
Shared Station	69
Engineer Station	70
Manager Station	70

# Terms & Conditions

## Terms of Sale

All prices listed are FOB Destination unless otherwise requested and noted.

Billing is Net 30 days on all products. All other services rendered are subject to payment at completion of each phase, when signed off by the customer. All prices are subject to annual review for adjustments. All custom and non-standard products are subject to a customer letter of intent too purchase in good faith, in lieu of a deposit.

Glossary of Terms used within this price list are as follows:

**COM** - Customer's own material, customer purchased and supplied to UNICOR/FPI.

**COL** - Customer's own leather, customer purchased and supplied to UNICOR/FPI.

**Due Date** - Date required for product to be at customer site, installation to begin.

**Order Acknowledgment** - Written confirmation of acceptance of order, containing the following information: work order number/purchase order number, project manager name and invoicing information.

**Receipt of Order** - Date UNICOR/FPI receives the order.

**Ship Date** - Date product ships from UNICOR/FPI factory.

## Sales Policy

Products sold through this catalog are intended for federal government customers and their designer, and must be procured with federal funds.

## Order Acknowledgment

UNICOR/FPI accepts orders, manufactures products, provides installation services and invoices based on the customer's request. The written order confirmation is verification and confirmation that requirements have been correctly translated to a sales order. An acknowledgment will be provided in writing, by fax or e-mail. If there is any information discrepancy in your order acknowledgment, please advise us immediately to avoid any mis-communication or problems. Communications should be directed to the assigned project manager listed on your order acknowledgment. Your order will be invoiced based on your request. Standard process is for product to be billed when it ships and the services are billed after confirmation of acceptance from the customer. Requests for billing, other than through the standard method, must be identified on the customer purchase order.

Your order acknowledgment indicates a date when your product is scheduled to arrive. In the event your order is manufactured earlier than scheduled, we will contact you with the option of providing an early shipment authorization. This will be coordinated through the project manager.

## Order Modifications

Modification to your purchase order will be accepted up to two weeks prior to the due date indicated on your order acknowledgment.

However, any modification made after production has begun, which changes the due date, product requested, or quantity requested will be subject to additional charges. For example, a delay in the delivery date could result in storage charges, a change in the quantity may result in a new ship date, or cancellation after the order is in production is subject to restocking fees. All purchase order modifications will be acknowledged in writing, including the annotation of any adjusted delivery dates and/or charges. UNICOR will assist the customer in obtaining storage for their product if delays in receipt are necessary. Product will not be stored at the UNICOR locations beyond 15 days, all storage will be arranged by our installation vendors or at the customer location.

## Standard Lead Time

Typical lead time for products with this price list is 45 days ARO (after receipt of order). Orders which include custom items, e.g., COM, COL or special fabrics may require a longer manufacturing cycle. The extended date will be reflected on your order acknowledgment. The project manager, listed on your order acknowledgment, will gladly discuss your options with you.

## Product Delivery and Pricing

All pricing listed in this publication is FOB Destination, CONUS (Continental United States) only, unless otherwise noted. Freight charges are included in the product price as listed in the FOB Destination column. FOB Origin pricing is available upon written request through, the UNICOR/FPI Customer Service Center.

On FOB Destination orders, the ownership responsibility passes to the customer at the time the product is accepted at the designated off-load point. Responsibility for inside delivery passes to the customer at final placement, or as specified in writing by the project manager.

On FOB Origin orders, UNICOR/FPI can arrange a coordinated delivery with the carrier of your choice. If no carrier is specified at time of order, it will be shipped common carrier, using our contract carrier at your expense. Freight charges will be added to your invoice.

Services, such as space planning, storage, inside delivery and installation are available at competitive prices. UNICOR/FPI offers both fee for service and negotiated pricing tailored to each project. Contact your sales representative or project manager to discuss these services.

**Special Note:** On shipments "Out of CONUS", FOB Destination orders, shipments are prepaid to the designated point of debarkation. Freight and handling charges beyond the point of debarkation are the responsibility of the local purchasing/ governing agency, unless other arrangements are made with the project manager. The freight charges for deliveries out of CONUS, including Alaska and Hawaii, will be negotiated and quoted at competitive freight rates, at time of shipment.

## Packaging of Product

UNICOR/FPI products are packaged to comply with carrier requirements to insure that products arrive in excellent condition. UNICOR/FPI can accommodate special packaging requests, special identification markings and special delivery instructions. Normally, this a fee-for-service option. Contact your project manager to discuss options.

## Direct Shipment Claims

UNICOR/FPI products are inspected and packaged to comply with shipping carrier requirements prior to leaving the manufacturing site. All shipments need to be inspected by the consignee, before acceptance. At the time of acceptance, any visible damage or shortage of items must be recorded with the freight carrier and reported to the UNICOR/FPI project manager immediately. Claims for visual shipping damage and/or shortage must be filed within 12 days of receipt of product. This applies to both FOB Destination and Origin shipments.

UNICOR/FPI reserves the right to use contracted carriers or commercial carriers for "best method" shipments. Any other shipping requirements must be negotiated with the project manager prior to shipping.

## Concealed Damage Claims

By utilizing improved packaging and handling, UNICOR/FPI takes great care to avoid concealed damages. UNICOR/FPI recommends inspection of all products within 12 days of delivery for both FOB Destination and Origin shipments, in order to insure prompt shipment of a replacement, and determination of liability.

## Product Storage

UNICOR/FPI will provide free storage for up to 15 calendar days from original ship date. However, if additional time is needed, UNICOR/FPI can arrange for storage at current rates. Discuss the options with your project manager.

## Customer Delayed Deliveries

UNICOR/FPI will accommodate requests to delay your order if we are notified two weeks before the product is scheduled to ship. The request for delay must be made as soon as possible. Contact your project manager to discuss date changes. If product is already in production at the time of delay notification, storage arrangements must be coordinated through your project manager. If product is en route, in most cases the product can be diverted to a storage location designated by the customer, or UNICOR/FPI can arrange storage at an additional cost. Costs usually include loading and unloading of product, plus any warehousing/storage cost. Order modifications are required when additional costs are incurred and are invoiced to you on your order.

## Product Returns

Any product returns must be negotiated with the project manager. The terms and conditions will be evaluated on a case by case basis through negotiation with the project manager. UNICOR/FPI reserves the right to inspect the returned product and evaluate the resale value of the product when considering a credit or exchange.

## Product Order Status

Order status can be verified by:

- (1) Contacting your project manager (name and phone number are listed on your order acknowledgment).
- (2) Making an inquiry at [www.unicor.gov/customer/index.htm](http://www.unicor.gov/customer/index.htm) - Enter your work order/purchase order number, for a shipping status report for your order. Credit card order delivery status can be verified by logging the last name of the card holder in the purchase order number box.

Shipped orders will be identified by a tracking number in response to your inquiry. If a tracking number is not reported, contact the project manager for a current status report.



**Invoice Payments**

All general billing questions should be directed to UNICOR/FPI Customer Service Center, in writing to the following address:

FPI - LEX  
Accounts Receivable  
P.O. Box 11670  
Lexington, KY 40583-3640 or  
email: \_\_\_\_\_  
Phone: \_\_\_\_\_

Send Payments from government agencies to the following address:

FPI - FPI  
P.O. Box 371736  
Pittsburgh, PA 15252-7736

Send Payments from sources other than government agencies to the following address:

FPI - LEX  
Accounts Receivable  
P.O. Box 11670  
Lexington, KY 40583-3640

**Product Warranty**

UNICOR/FPI guarantees all product to meet or exceed the standard commercial life expectancy of the product. UNICOR/FPI will repair or replace any defective product promptly, during the life expectancy of that product. UNICOR/FPI does warranty all product to be free of defects in material and workmanship. This does not apply to any C.O.M. or C.O.L. fabrics supplied by sources other than UNICOR/FPI.

**C.O.M. Fabric Requirements**

All fabric or upholsteries must be approved prior to acceptance of an order. Upon approval, a memo sample swatch must accompany the order. UNICOR/FPI assumes no responsibility for wear or defects of performance of any C.O.M. or C.O.L. supplied by sources other than FPI.

Use of C.O.M. as panel fabrics require UL approval and must be tested for approval prior to acceptance of an order. UNICOR/FPI will require three yards of the actual panel fabric to be tested prior to quoting.

All C.O.M. fabric or upholstery must be received in continuous linear yards. UNICOR/FPI requires a 5 to 10% overage clause to insure appropriate amount of coverage.

**C.O.M. Material Acceptance**

UNICOR/FPI reserves the right to reject C.O.M. fabrics or upholstery that are not suitable for the intended application. Customer selecting any C.O.M. or C.O.L. takes responsibility of performance of the supplied product.

**Standard Product Overview**

Bravo is a freestanding desk system. Several combinations of shapes and sizes are offered to allow for an almost infinite amount of layouts. Shapes range from rectangles to piano shapes to various conference ends. Since the system is freestanding it allows for easy changes to meet the users needs.

Bravo was designed with power and data needs in mind. Power and data can be hidden above or below the desk to maintain the clean look of the end user's office. All desks have grommets. Wire troughs and cord dumps keep cables organized and out of the way. Stanchions that can support overhead units also house electrical and data receptacles. An optional wire trough system can be installed on the back face of the desks when situations warrant it.

Bravo easily integrates with other UNICOR/FPI systems. Classic XXI or Crescendo brackets can be added to the desks to allow them to support those panel systems. Power from either of these panel systems and Bravo can be easily connected when the systems are integrated. This makes future changes and additions easier to manage.

Bravo offers several options on almost every desk. All desks offer a standard modesty panel but an optional panel can be added that gives the desk a full modesty configuration. Privacy screens are available for sit-down privacy or stand-up privacy. A stackable privacy panel is also offered for environments that change occasionally. Screens can be ordered in a variety of materials to include fabrics and translucent plastic. Tool rails provide for paper and accessory management. Workstation end panels can be ordered in shorter lengths to allow for increased leg clearance.

Bravo is offered in numerous painted colors, with a wide array of laminate selections available.

# Technical Specifications

## ANSI/BIFMA

Bravo meets or exceeds the required ANSI/BIFMA X5.5-1998 desk systems test.

## Quality

All Bravo desking components shall originate from ISO 9000, ISO 9001, or ISO 9002 registered facilities.

## UL Listed

Bravo desks are listed to applicable UL standards and requirements by Underwriters Laboratories Inc. Two of the standards used to evaluate Bravo desks are UL 1286 Office Furnishing and UL 723 Standard Test for Surface Burning Characteristics of Building Materials.

## Basic Worksurfaces

Worksurfaces shall define the shape of the workstation and provide support for overhead storage, hanging pedestals, electrical componentry, and privacy screens. Worksurfaces shall be designed to integrate function and ergonomics to provide solutions that meet ANSI/HFS-100-1998 and ADA user requirements.

## Rectangular Worksurfaces

Worksurface tops shall be 1 1/8" high density particleboard with .03 or .04 high pressure laminate surface and .02 to .04 phenolic backing sheet, available in a choice of over 30 colors. Top shall be available with a flat PVC edge in a choice of 5 edge colors. Worksurfaces shall be available in 24", 30", 36", 42", 48", 54", 60" and 72" widths and 24" and 30" depths. They shall be available in a 29" height.

Basic Rectangular worksurfaces shall include 2 triangular worksurface grommets, located in the back corners of each worksurface. 60" and 72" worksurfaces shall have 3 triangular wireway grommets, two in the corners and one located near the back center of the desk. Grommets shall be color matched to the worksurface edge color. The legs shall have (4) 3.27" x 2.27" wire management ports located in the top and bottom outside edge of each back corner. Worksurface and leg grommets will be molded from polycarbonate.

Leg Assembly - Each leg assembly consists of welded and assembled components which come together to form the full leg assembly. The leg assembly is attached to the underside of the worksurfaces from above. A metal leg cover can be removed from the front of the leg to gain entry to the interior of the leg. Within the leg, there is a metal structural support that can be used to separate power and data running within the leg. A glide is attached to the bottom of the leg for up to 1 1/8" of adjustability. The desk leg - Formed of 18-gage steel, overall dimensions are 6.00 x 6.00 x 27.25.

Modesty Panel Beam - Formed of 18-gage steel, overall dimensions are 3.00 x 9.00 x length determined by size of worksurface. The modesty panel beam is attached to the underside of the worksurface and the leg assembly. The modesty panel beam allows basic cabling to be run along the width of the desk. Plastic worksurface spacers that provide a slight stand off distance between the worksurface and modesty panel beam shall snap into place to aid installation.

Data Modesty Panel Bracket - A steel bracket shall be available that will attach to the underside of the modesty panel beam near the worksurface. It will have a 1.38" x 2.70" opening to accept several different manufacturers' power and data faceplates.

Lower Modesty Panel - Optional. Formed of 18-gage steel, overall dimensions are 1.00 x 18.00 x length determined by size of worksurface. The lower modesty panel is attached to the leg assembly and will complete the full enclosure of the back of the desk.

Finish for all metal parts shall be made available in over 12 standard enamel colors unless specified.

End Panel Assembly - Each end panel consists of welded and assembled components which come together to form the full end panel assembly. The end panel is formed of 18-gage steel and has a honeycomb core for strength and noise reduction. Overall dimensions are 1.25 x 27.00 x depth determined by worksurface size or configuration. The depth is available in three sizes based on the depth of the worksurface (24" or 30") and whether or not a transitional or full end panel configuration is desired. The end panel assembly is attached to the underside of the worksurface and the leg assembly. A glide is attached to the bottom of the end panel for up to 1 1/8" adjustability.

## Rectangular Reduction Worksurface

Rectangular reduction worksurfaces shall have the same basic construction as the rectangular worksurfaces. These worksurfaces shall have a depth of 24" on one end and 30" on the opposite end. The reduction shall be accomplished with two gently curving (12" radius) arcs that change direction halfway into the width of the worksurface. Widths of 24" to 72" in 6" increments will be available.

## Executive Worksurface

Executive worksurfaces shall have the same basic construction as the rectangular worksurfaces. These worksurfaces shall have a depth of 24" or 30" with a radius edge on the back of the worksurface. The radius edge shall extend a maximum of 6" beyond the normal depth. A right and left back corner grommet will be standard. Widths available will be 60", 66", and 72".

## Corner Worksurface

Corner worksurfaces shall have the same basic construction as the rectangular worksurfaces with an additional leg assembly, modesty panel beam, and optional lower modesty panel. In freestanding applications, standard end panels must be used. If attached to another worksurface, transitional end panels may be ordered to replace standard end panels for the sides of the attachment on both worksurfaces. Transitional legs shall be available that allow additional clearance. The front working edge will have a 16" or 22" radius depending on the size of the worksurface. Depths of 24" and 30" and widths of 48" to 72" will be standard (54" width is not available). Two different widths may be used to create what is known as a square shoe desk. One side is always 48". Fifteen different combinations of sizes will be available. Three grommets, one per corner, are standard. Whenever a width is 60" or 72", a grommet will be added approximately midway of that width.

## P-Shaped and Piano Shaped Worksurfaces

P-shaped and piano shaped worksurfaces shall have the same basic construction as the rectangular worksurfaces with an additional 4" support leg and standard modesty panel. The support leg shall be attached towards the rounded front end of the worksurface. The tubular support leg will have a diameter of 4", be constructed of 14-gage steel, and have a 1 1/8" adjustable steel glide. In freestanding applications, standard end panels must be used. If attached to another worksurface, transitional end panels may be ordered to replace standard end panels for the sides of the attachment on both worksurfaces. The front working edge will have a 16" or 22" radius depending on the size of the worksurface. Depths of 60" and 72" and widths of 48" will be standard. Fifteen different combinations of sizes will be available. Two grommets, one per corner, are standard.

## D-Shaped Worksurface

D-shaped worksurfaces shall have the same basic construction as the rectangular worksurfaces with an additional 4" support leg and standard modesty panel. The support leg shall be attached towards the rounded front end of the worksurface. The tubular support leg will have a diameter of 4", be constructed of 14-gage steel, and have a 1 1/8" adjustable steel glide. The width of the top shall be 24", 30", or 36". The depth shall be available in a range from 48" to 72".

## Round Add-On Worksurface

Round add-on worksurfaces shall be available with the same edge treatments as the rectangular

worksurfaces. They shall be available in a diameter of 36" and 42". The 36" diameter round add-on will have a flat edge of 24" and the 42" round add-on will have a flat edge of 30". The single tubular support leg will have a diameter of 4", be constructed of 14-gage steel, and have a 1 1/8" adjustable steel glide. A pair of steel splice plates will be included to attach the round add-on to a pair of worksurfaces.

## 1/2 Round Add-On Worksurface

1/2 round add-on worksurfaces shall be available with the same edge treatments as the rectangular worksurfaces. They shall be available in a diameter of 48" and 60". The 48" diameter 1/2 round add-on will have one flat edge of 48" and the 60" round add-on will have one flat edge of 60". A single tubular support leg will have a diameter of 4", be constructed of 14-gage steel, and have a 1 1/8" adjustable steel glide. The 1/2 round add-on will be able to attach to a pair of 24" or 30" worksurface ends. A pair of steel splice plates will be included to attach the 1/2 round add-on to a pair of worksurfaces.

## 1/4 Round Add-On Worksurface

1/4 round add-on worksurfaces shall be available with the same edge treatments as the rectangular worksurfaces. They shall be available in a diameter of 36" and 42". The 36" diameter 1/4 round add-on will have two flat perpendicular edges of 24" and the 42" round add-on will have two flat perpendicular edges of 30". A single tubular support leg will have a diameter of 4", be constructed of 14-gage steel, and have a 1 1/8" adjustable steel glide. The 1/4 round add-on will be able to bridge a pair of identical depth (24" or 30") 90° worksurface ends. It will also be able to be attached to an appropriate matching (24" or 30") edge of a single worksurface edge. A pair of steel splice plates will be included to attach the 1/4 round add-on to a pair of worksurfaces.

## Relocatable Power Tap (RPT)

The RPT shall have a pair of outlets and be mountable in the overhead stanchions or transaction countertop stanchion. Two RPTs may be mountable per stanchion. Cord lengths available for RPTs shall be available with a cord length of 36" or 96". RPTs will provide above worksurface height power via an installed 10-wire electrical system or through the use of building wall outlets.

## Backpack Wire Trough Kit

The backpack kit shall consist of 3 steel wire troughs, a pair of trough mounting brackets, a backpack cover, and any applicable end trim. The backpack cover shall be made of 18-gage steel and be removable without the use of any tools. The wire troughs shall be made of 20-gage steel and provide 1.25" by .92" of room for lay in cabling per trough. Various trim pieces shall be made available to conceal any gaps in corner, straight, or end of run conditions.

## 10-Wire Electrical Distribution System

The 10-wire system is available in two configurations (6-2-2 and 4-4-2). The UL label is green for 6-2-2 and blue for 4-4-2 applications. These numbers refer to the quantity of hot - neutral - ground wires configured in each system. Both the 6-2-2 and 4-4-2 systems may be brought into the system from the ceiling, the wall or floor, through the use of top feeds and base feeds. Bravo 10-wire electrical will be able to integrate with existing UNICOR panel systems (Classic XXI, Crescendo) with the addition of the appropriate connectors.

The 10-wire electrical distribution system will consist of a 10-wire harness, table to table connectors, and a 10-wire infeed kit. The 2.16" wide double sided, rigid 10-wire harness shall mount to the underside of the modesty panel beam and shall be available in widths to span the worksurface. The 30" to 66" wide worksurface harness kit shall accommodate (2) 15 amp duplex receptacles and the 72" wide worksurface harness kit shall accommodate up to (4) 15 amp duplex receptacles.

Receptacles shall be available to access the up to 6 circuits within the harness and must be ordered separately.

Both 10-wire systems are rated at 120 vAC @ 20 amps. All receptacles are rated at 15 amps. The specifics of each wiring configuration are detailed below.

**Note: The two ten wire systems (4-4-2 and 6-2-2) cannot be mixed together. The wiring systems must be separate.**

There are different receptacles for each system, and different connectors specific to each system. Mixed connectors will not allow the 2 systems to be keyed.

## 6-2-2 Configuration

The 6-2-2 configuration of the 10-wire system will have three "convenience" circuits (1, 2, & 3) which will each have their own hot wire, will share an oversized neutral wire, and will share the building ground wire. Circuits 4, 5, & 6 are "isolated ground" circuits that will each have their own hot wire, will share an oversized neutral wire, and will share an isolated ground wire.

The advantage of this system is that it will be able to have 6 circuits coming in via one top feed or base feed. This will cut down on the number of feed points on an installation. The number 4, 5, & 6 receptacles will be colored orange to designate that they are on the isolated ground, while the number 1, 2, & 3 receptacles come in the standard trim colors.

## 4-4-2 Configuration

The 4-4-2 configuration of the 10-wire system will have two "convenience" circuits (1 & 2) which will each have their own hot wire, their own neutral wire, and will share the building ground wire. Circuits 3 & 4 are "isolated ground" which will each have their own hot wire, their own neutral wire, and will share an isolated ground wire.

The advantage of this system is that all of the circuits will have their own neutral wires, and has two circuits (3 & 4) that use an isolated ground. The number 3 & 4 receptacles will be colored orange to designate that they are on the isolated ground, while the number 1 & 2 receptacles come in the standard trim colors.

## 10-Wire Power Infeed Kit

The 10-wire power infeed kit shall provide power from fixed, floor, or wall sources to the 10-wire harness. It shall include 6' of plastic covered flexible conduit. To connect the "hard wire" end of a 10-wire topfeed or basefeed to your building, use a 3/4" Romex connector on the conduit.

## 10-Wire Power Table to Table Connector

10-wire table to table connector shall consist of a fiberglass sleeved flexible harness, which provides power connections from adjoining desks. The jumper shall have a length of 27".

## Power Pole

The power pole body shall be made of extruded aluminum, 16-gage, overall dimensions are 1.73 x 3.43. It will have two cavities for physical power and data separation. Length of top feed harness is 12". The power pole cover will be made of extruded aluminum, 16-gage; overall dimensions are 1.73 x 3.43 x height determined by ceiling. A plastic trim piece will cover the area where the pole intersects the ceiling.

## Pedestal Storage

Pedestal storage for Bravo shall be provided by Opus Pedestals. 3 styles shall be available to meet personal storage requirements. Freestanding, mobile, and hanging pedestals.

Pedestals shall be available in 3 depths, 17 5/8" that may be used with any depth worksurface, 21 1/8" for maximum storage under a 30" worksurface, and 27 1/8". Multiple drawer combinations shall be available.

The 12" file and 15" EDP drawer sizes shall have a full extensions slide arm suspensions for full access to storage space. The 3" pencil drawers and 6" box drawers shall have 3/4" extension, steel ball-bearing suspension.

Locks shall be included in each pedestal and shall be randomly keyed. Specific keying combinations shall be available.

**Freestanding Pedestals**

Freestanding pedestals shall have a finished top and 4 adjustable glides. They shall be placed under a worksurface or anywhere else in the office. A counterbalance weight shall be included with each unit.

**Mobile Pedestals**

Mobile pedestals shall have a finished top and 4 twin wheel hooded casters. Front casters shall be locking and back casters shall be non-locking. A counterbalance weight shall be included with each unit.

**Hanging Pedestals**

Hanging pedestals shall have keyhole slots for attachment under basic worksurfaces. No more than one hanging pedestal should be specified on any one worksurface.

**Center Drawer**

Center drawers shall be of a formed plastic construction with a front compartment tray integral to the molding. Locks shall be included and shall be randomly keyed. Specific keying combinations shall be available. They shall attach under Bravo worksurfaces and shall be available in the 4 trim colors.

**CPU Sling**

The CPU sling shall attach to the underside of worksurfaces and accommodate a range of CPUs up to 65" in circumference and a maximum of 75 lbs. It shall provide 5 1/2" of front to back travel and 359° swivel for ease of accessibility. The CPU sling shall be available in black only.

**CPU Holder**

The CPU holder shall accommodate a range of CPUs from 2" to 10 1/2" thick and 11" to 21" tall. An optional security kit will be available that prevents tampering or removal of the CPU. The CPU holder shall be available in black only.

**Privacy Screens**

Privacy screens shall be available to provide sit down or stand up privacy within the Bravo workstation. Screens shall be 3/4" thick, 18 1/4" or 38" high, and available in widths to fit all worksurfaces. They shall be mountable to either the overhead support (BVSBS), to the underside of the worksurface (BVSBW), to the top of the worksurface (BVSOW), or with a combination of attaching to an overhead support and a worksurface top (BVSSO). A stackable 18 1/4" high section (BVSSS) shall also be available.

Stackable privacy screens will be able to be mounted to the BVSBW or BVSOW privacy screens. The BVSSS privacy screen mounting will not require any tools.

Privacy screens shall be designed for straight-line applications. They shall include mounting brackets for attachment to the worksurface. Screens shall be available for straight applications in 24", 30", 36", 42", 48", 54", 60", 66", and 72" widths. The 66" and 72" widths shall consist of a pair of screens (1) 30" plus (1) 36" screen for 66" applications and (2) 36" screens with splice extrusions for 72" applications.

Screens may be used to serve 2 worksurfaces placed back to back. Privacy screens shall be useable on worksurfaces with overhead storage units to close the opening between the worksurface and the bottom of the shelf. Corner screens shall include a corner light block channel. The light block channel will also serve to align and hold the back corner together. Screens shall be available in configurations to match the worksurface application, basic worksurface, or corner worksurface.

Privacy screens will consist of two different aluminum extrusion profiles, each assembled with die-cast corner connectors to create a rectangular frame. The frames will be either upholstered or painted, depending on option. Between the two assembled frames, different core materials can be inserted. The screen material shall be made of 1/8" or 3/4" thick tackable iron core light or a 10mm thick non-tackable translucent plastic. The frame shall be made of extruded aluminum that is .060 in. thick. Overall dimensions of the frame shall be 1.40" x length and height dependent on desk size and screen height. The bracket extrusion shall be made of extruded aluminum. Overall dimensions of the bracket extrusions shall be .75" x 3.12" x length determined by screen height. Overall dimensions are dependent on screen option and height and desk size. The mounting brackets shall be formed of 7-gage steel with overall dimensions of 2.00" x 2.25" x 10.00".

**Overstorage Mounted Privacy Screen**

Same construction as above with the exception of mounting bracket and elimination of bracket extrusion and bracket insert. The mounting brackets shall be formed of 16-gage steel with overall dimensions of 54" x .92" x 12.38".

**Transaction Worksurface**

Transaction worksurfaces shall be available in rectangular and corner configurations. The construction of the worksurface will be similar to a standard worksurface except for shape and overall dimensions.

The transaction panel shall be formed of 18-gage steel and attach to the underside of the transaction worksurface. Depths for rectangular and corner shapes shall be 16". Overall rectangular widths available shall be from 24" to 72" in 6" increments. Overall corner transaction sizes available shall be 42" x 42", 48" x 60", 48" x 66", 48" x 72", 48" x 48", 60" x 48", 66" x 48", and 72" x 48".

Transaction Worksurface Support - Formed of 16-gage steel. Overall dimensions are 6.00" x 6.00" x height determined by height of transaction worksurface. Support Cover - R/C (QMFZ2), rated 94HB minimum or formed of 20-gage steel. Overall dimensions are 6.62" x 11.38".

**Overhead Support Stanchion**

The overhead support stanchions shall be formed of 16-gage steel, overall dimensions will be 6.00" x 6.00" x 19.50". A reinforcement plate (16-gage steel) inside the support shall have 4 cutouts that can accommodate either commercially available data plates or Removable Power Taps (RPT).

Overhead support stanchion covers shall be standard. The covers shall be made of extruded plastic and available in 5 standard trim colors. They will be hinged to allow access to the inside of the overhead support stanchions. A flexible rubber trim piece shall allow power or data cables to be run from the worksurface into the overhead support stanchions.

**Overhead Storage**

Bravo shall offer 2 styles of overhead storage units for use with any worksurface. The two styles are the Universal overhead and the Venus overhead. Overheads for basic rectangular worksurfaces shall attach through the grommets in the top of the worksurface. They shall have vertical wire channels that conceal the attachment and wires from the top of the shelf to the worksurface.

Shelf dividers made of powder coated steel shall be offered in 5 standard trim colors. The installation or removal of them shall be accomplished without the use of tools or fasteners.

All overheads (Universal or Venus) shall be able to be used on Classic XXI, Panel Mounted or Off Module, or Bravo. All 72" overheads will consist of a pair of 36" overheads. All 66" overheads will consist of a 30" and 36" overhead combination.

**Universal Overhead**

Overhead cabinets shall be 34" high and shall have 18 1/2" clearance between the worksurface and the bottom of shelf. The universal overhead shall be offered in widths of 30", 36", 42", 48", 54", 60", 66", and 72". The flipper door opening shall be 13" high. They shall be available with doors of painted steel, fabric, laminate, or veneer. Locks shall be randomly assigned or keyed per customer requests.

**Universal Overhead Regular Shelf**

Product Offering - The product shall be offered in widths of 30", 36", 42", 48", 54", 60", 66", and 72". The overall dimensions of the end panels shall be 16 1/2" x 15". The shelf depth shall be 15".

Construction - The end panels shall be constructed of 14-gage steel, with a powder coat finish. The end panels shall have self-locking mounting tabs formed into the back edge. The shelf shall be an 18-gage steel weldment with a powder coat finish. The front edge of the shelf shall be a PVC extrusion that also provides space for a concealed flush mount task light.

**Universal Overhead Low Shelf**

Product Offering - The product shall be offered in widths of 30", 36", 42", 48", 54", 60", 66", and 72". The overall dimensions of the end panels shall be 9 1/4" x 15". The shelf depth shall be 15".

Construction - Same as a Universal overhead regular shelf unit.

**Venus Overhead**

The cabinet sides shall be constructed of 14-gage sheet steel, while the top, back, and shelf will be constructed out of 18-gage sheet steel. Venus overheads will be offered in widths of 30", 36", 42", 48", 54", 60", 66", and 72". The top, sides, back, and shelf will be resistance welded so there are no visible weld marks on the class A surfaces (outside visible surfaces). The cabinet shall be painted one of the 5 standard trim colors. Other colors shall be available if requested. The upper door shall be comprised of extruded rigid PVC. The extruded rigid PVC will be available in the 5 standard trim colors along with translucent. The lower door shall be comprised of extruded aluminum, which shall be available in the 5 standard trim colors and many optional colors. A 10-gage hot rolled steel link arm connects the upper door and lower door.

Spring tension shall be used to assist in the opening and closing of the door. Applying pressure to the lower door opens both doors. Less than 5 pounds of force shall be needed to open both doors. The overhead door shall be able to be opened with a closed fist as well. The force and ease of opening shall make this overhead ADA compliant.

The shelf and back shall be slotted every two inches to allow for the use of shelf dividers. The underside of the shelf is also slotted with 1.5" by 1.5" slots to allow for electrical cords to run through the back.

**Various Ballast Task Lights**

Task lights shall be offered in one standard level of efficiency and cost. The standard light shall have a magnetic high power ballast with rapid start, cool white T-8 fluorescent lamp. Task lights shall attach to the underside of the shelf on overhead cabinets. Power cord length will be 9' long. Lights shall be UL listed and available in the 4 trim colors. They shall be available for all widths of Universal or Venus overheads.

**Paper Management System**

The paper management system shall address the storage and movement of files, binders, and documents. Components shall be available with integrated hooks for attachment to the work bar. The system shall be available in the 5 trim colors.

The paper management system shall include the following components: Tool Rail, Paper Tray, Diagonal Storage Unit, Vertical Storage Unit, Hanging File Folder Holder, Telephone Caddy, CD Holder, Accessory Tray, and a Pencil Cup.

The tool rail shall be fabricated from a powder coated aluminum extrusion with injection molded plastic end caps. The tool rail shall be attached to the workstation in one of two options. Option one is to attach the tool rail to the overhead storage supports through the use of self-locking steel brackets. Option two is to attach the tool rail to desk mounted brackets. Desk mounted brackets shall be 15.75" high, non handed, and constructed of 16-gage steel. The tool rail shall be 4 1/2" high and 1/2" deep, with the length corresponding to the worksurface width minus the width of the overhead supports. Multiple combinations of paper management units shall hang on the bar in any of 4 vertical locations. All components shall be of injection molded ABS plastic.

The paper tray shall be 2" x 9 1/2" x 14". It shall be used freestanding or suspended from the tool rail.

The diagonal storage unit shall be 2 1/2" x 7" x 12 1/2". ABS dividers shall be able to be used in either left or right positions. It shall be used freestanding or suspended from the tool rail.

The vertical storage unit shall measure 5" x 10 1/2". It shall be used freestanding or suspended from the tool rail.

Hanging folder holders shall measure 2" x 1" x 8 1/2". They will be shipped one pair per set.

The telephone caddy shall measure 2" x 8 1/2" x 9 1/2". It will have a retractable tab to adjust to various size phones.

The CD holder shall measure 2" x 5 1/2" x 7". It shall store 10 CDs vertically.

The accessory tray shall measure 2" x 9 1/2" x 10". It will have compartments for the storage of common items such as: stamps, small note pads, tape, pencils, and paper clips.

The pencil cup shall measure 4" x 4" x 3 1/2".

# Bravo Desks

## Rectangular Worksurfaces

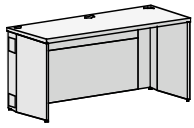

\*Standard Transition End Panels shown.

### MODEL

#### Rectangular Freestanding Worksurface with Full Modesty Panels

- Consists of top, two legs, modesty panel, optional filler panel (full modesty panel), two end panels (optional transitional size), ganging plates, and all required assembly hardware
- Each leg has four cable access grommet locations
- Top has two cable access grommets above the legs (66" and 72" have a third middle grommet)
- Top grommets allow for attachment of overhead storage units (see pages 48-53)
- Modesty panel allows for optional 10-wire electrical system (see pages 59 & 60)
- Edging for all tops is a 3mm PVC edge banding

D x W	MODEL NUMBER				
	Worksurface	Transition End Panel	Trim Color	Paint Color	Laminate
24 x 24"	BVR2424F	<input type="checkbox"/>	<input type="checkbox"/>	<input type="checkbox"/>	<input type="checkbox"/>
24 x 30"	BVR2430F	<input type="checkbox"/>	<input type="checkbox"/>	<input type="checkbox"/>	<input type="checkbox"/>
24 x 36"	BVR2436F	<input type="checkbox"/>	<input type="checkbox"/>	<input type="checkbox"/>	<input type="checkbox"/>
24 x 42"	BVR2442F	<input type="checkbox"/>	<input type="checkbox"/>	<input type="checkbox"/>	<input type="checkbox"/>
24 x 48"	BVR2448F	<input type="checkbox"/>	<input type="checkbox"/>	<input type="checkbox"/>	<input type="checkbox"/>
24 x 54"	BVR2454F	<input type="checkbox"/>	<input type="checkbox"/>	<input type="checkbox"/>	<input type="checkbox"/>
24 x 60"	BVR2460F	<input type="checkbox"/>	<input type="checkbox"/>	<input type="checkbox"/>	<input type="checkbox"/>
24 x 66"	BVR2466F	<input type="checkbox"/>	<input type="checkbox"/>	<input type="checkbox"/>	<input type="checkbox"/>
24 x 72"	BVR2472F	<input type="checkbox"/>	<input type="checkbox"/>	<input type="checkbox"/>	<input type="checkbox"/>
30 x 24"	BVR3024F	<input type="checkbox"/>	<input type="checkbox"/>	<input type="checkbox"/>	<input type="checkbox"/>
30 x 30"	BVR3030F	<input type="checkbox"/>	<input type="checkbox"/>	<input type="checkbox"/>	<input type="checkbox"/>
30 x 36"	BVR3036F	<input type="checkbox"/>	<input type="checkbox"/>	<input type="checkbox"/>	<input type="checkbox"/>
30 x 42"	BVR3042F	<input type="checkbox"/>	<input type="checkbox"/>	<input type="checkbox"/>	<input type="checkbox"/>
30 x 48"	BVR3048F	<input type="checkbox"/>	<input type="checkbox"/>	<input type="checkbox"/>	<input type="checkbox"/>
30 x 54"	BVR3054F	<input type="checkbox"/>	<input type="checkbox"/>	<input type="checkbox"/>	<input type="checkbox"/>
30 x 60"	BVR3060F	<input type="checkbox"/>	<input type="checkbox"/>	<input type="checkbox"/>	<input type="checkbox"/>
30 x 66"	BVR3066F	<input type="checkbox"/>	<input type="checkbox"/>	<input type="checkbox"/>	<input type="checkbox"/>
30 x 72"	BVR3072F	<input type="checkbox"/>	<input type="checkbox"/>	<input type="checkbox"/>	<input type="checkbox"/>

A B C D E

### HOW TO ORDER

Indicate the following information on order form:

1. Quantity of each item.
2. Model Number, including options. See "How to Build a Model Number".
3. Any special service required.

Note: • The  indicates that a choice is required.

- The absence of the  indicates that no choice is required.
- Alpha-numeric characters in place of  indicate that no other options are available.

### HOW TO BUILD A MODEL NUMBER

**A** Select size of worksurface.

**B** Select transition end panel.

- S** = Standard
- L** = Left transition only
- R** = Right transition only
- B** = Both end panels transition

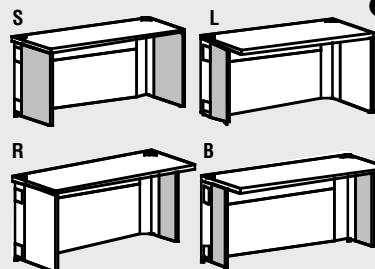

**C** Select trim color (edge and grommets).\*

- B** = Black = 27
- G** = Grey = 29
- L** = Light Tone = 32
- S** = Sand = 28
- W** = Warm Grey = 33

\*Trim color matches paint color.

**D** Select paint color.

- 27** = Black
- 29** = Grey
- 33** = Warm Grey
- 28** = Sand
- 32** = Light Tone
- 59** = Juniper
- 25** = Medium Bronze
- 26** = Hunter Green
- 31** = Eggshell White
- 50** = Beige
- 51** = Baltic
- 52** = Bordeaux
- SP** = COM

**E** Select laminate surface.

- AA** = Cream
- AB** = Champagne
- AC** = Barcelona
- AF** = Aruba Tan
- AG** = Black
- AH** = Dark Gray
- AI** = Dawn Gray (Greige)
- AJ** = Fog
- AK** = Black Grandin
- AL** = Smoke Granite
- AM** = Sand Grandin
- AN** = Light Granite
- AO** = Tundra
- AP** = Earthen
- AQ** = Rose Graphix
- AS** = Sierra Graphix
- AT** = Beige Grafix
- AU** = Sand Stone
- AV** = Kentucky Walnut
- AW** = Tennessee Oak



TRANSITION END PANEL STYLE				
	B=Both Transition Price	L=Left Transition Price	R=Right Transition Price	S=Standard Price
	\$272	\$287	\$287	\$302
	283	298	298	313
	293	308	308	323
	304	319	319	334
	314	329	329	344
	332	347	347	362
	353	368	368	383
	374	389	389	404
	381	396	396	411
	282	297	297	312
	292	307	307	322
	302	317	317	332
	313	328	328	343
	323	338	338	353
	341	356	356	371
	362	377	377	392
	383	398	398	413
	391	406	406	421

- AX** = Light Oak
- AY** = Red Birch
- AZ** = Ash
- BA** = Philadelphia Cherry
- BB** = Pennsylvania Cherry
- BC** = Mahogany
- BD** = Oak
- BE** = Maple
- BF** = Pearwood
- ZZ** = COM

Specifications and prices are subject to change without prior notice.



# Bravo Desks

Rectangular Worksurfaces

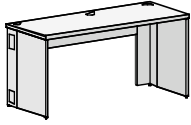

\*Standard Transition End Panels shown.

## MODEL

### Rectangular Freestanding Worksurface with Partial Modesty Panels

- Consists of top, two legs, modesty panel, optional filler panel (partial modesty panel), two end panels (optional transitional size), ganging plates, and all required assembly hardware
- Each leg has four cable access grommet locations
- Top has two cable access grommets above the legs (66" and 72" have a third middle grommet)
- Top grommets allow for attachment of overhead storage units (see pages 48-53)
- Modesty panel allows for optional 10-wire electrical system (see pages 59 & 60)
- Edging for all tops is a 3mm PVC edge banding

D x W	MODEL NUMBER				
	Worksurface	Transition End Panel	Trim Color	Paint Color	Laminate
24 x 24"	BVR2424P	<input type="checkbox"/>	<input type="checkbox"/>	<input type="checkbox"/>	<input type="checkbox"/>
24 x 30"	BVR2430P	<input type="checkbox"/>	<input type="checkbox"/>	<input type="checkbox"/>	<input type="checkbox"/>
24 x 36"	BVR2436P	<input type="checkbox"/>	<input type="checkbox"/>	<input type="checkbox"/>	<input type="checkbox"/>
24 x 42"	BVR2442P	<input type="checkbox"/>	<input type="checkbox"/>	<input type="checkbox"/>	<input type="checkbox"/>
24 x 48"	BVR2448P	<input type="checkbox"/>	<input type="checkbox"/>	<input type="checkbox"/>	<input type="checkbox"/>
24 x 54"	BVR2454P	<input type="checkbox"/>	<input type="checkbox"/>	<input type="checkbox"/>	<input type="checkbox"/>
24 x 60"	BVR2460P	<input type="checkbox"/>	<input type="checkbox"/>	<input type="checkbox"/>	<input type="checkbox"/>
24 x 66"	BVR2466P	<input type="checkbox"/>	<input type="checkbox"/>	<input type="checkbox"/>	<input type="checkbox"/>
24 x 72"	BVR2472P	<input type="checkbox"/>	<input type="checkbox"/>	<input type="checkbox"/>	<input type="checkbox"/>
30 x 24"	BVR3024P	<input type="checkbox"/>	<input type="checkbox"/>	<input type="checkbox"/>	<input type="checkbox"/>
30 x 30"	BVR3030P	<input type="checkbox"/>	<input type="checkbox"/>	<input type="checkbox"/>	<input type="checkbox"/>
30 x 36"	BVR3036P	<input type="checkbox"/>	<input type="checkbox"/>	<input type="checkbox"/>	<input type="checkbox"/>
30 x 42"	BVR3042P	<input type="checkbox"/>	<input type="checkbox"/>	<input type="checkbox"/>	<input type="checkbox"/>
30 x 48"	BVR3048P	<input type="checkbox"/>	<input type="checkbox"/>	<input type="checkbox"/>	<input type="checkbox"/>
30 x 54"	BVR3054P	<input type="checkbox"/>	<input type="checkbox"/>	<input type="checkbox"/>	<input type="checkbox"/>
30 x 60"	BVR3060P	<input type="checkbox"/>	<input type="checkbox"/>	<input type="checkbox"/>	<input type="checkbox"/>
30 x 66"	BVR3066P	<input type="checkbox"/>	<input type="checkbox"/>	<input type="checkbox"/>	<input type="checkbox"/>
30 x 72"	BVR3072P	<input type="checkbox"/>	<input type="checkbox"/>	<input type="checkbox"/>	<input type="checkbox"/>

**A**      **B**      **C**      **D**      **E**

## HOW TO ORDER

Indicate the following information on order form:

1. Quantity of each item.
2. Model Number, including options. See "How to Build a Model Number".
3. Any special service required.

Note: • The  indicates that a choice is required.

- The absence of the  indicates that no choice is required.
- Alpha-numeric characters in place of  indicate that no other options are available.

## HOW TO BUILD A MODEL NUMBER

**A** Select size of worksurface.

**B** Select transition end panel.

- S** = Standard
- L** = Left transition only
- R** = Right transition only
- B** = Both end panels transition

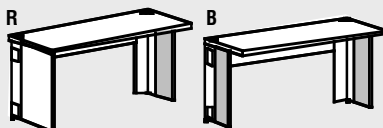
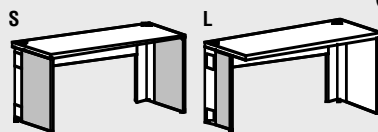

**C** Select trim color (edge and grommets).\*

- B** = Black = 27
- G** = Grey = 29
- L** = Light Tone = 32
- S** = Sand = 28
- W** = Warm Grey = 33

\*Trim color matches paint color.

**D** Select paint color.

- 27** = Black
- 29** = Grey
- 33** = Warm Grey
- 28** = Sand
- 32** = Light Tone
- 59** = Juniper
- 25** = Medium Bronze
- 26** = Hunter Green
- 31** = Eggshell White
- 50** = Beige
- 51** = Baltic
- 52** = Bordeaux
- SP** = COM

**E** Select laminate surface.

- AA** = Cream
- AB** = Champagne
- AC** = Barcelona
- AF** = Aruba Tan
- AG** = Black
- AH** = Dark Gray
- AI** = Dawn Gray (Greige)
- AJ** = Fog
- AK** = Black Grandin
- AL** = Smoke Granite
- AM** = Sand Grandin
- AN** = Light Granite
- AO** = Tundra
- AP** = Earthen
- AQ** = Rose Graphix
- AS** = Sierra Graphix
- AT** = Beige Grafix
- AU** = Sand Stone
- AV** = Kentucky Walnut
- AW** = Tennessee Oak



<b>TRANSITION END PANEL STYLE</b>				
	B=Both Transition Price	L=Left Transition Price	R=Right Transition Price	S=Standard Price
	\$249	\$264	\$264	\$279
	258	273	273	288
	267	282	282	297
	276	291	291	306
	285	300	300	315
	302	317	317	332
	317	332	332	347
	336	351	351	366
	342	357	357	372
	258	273	273	288
	267	282	282	297
	276	291	291	306
	285	300	300	315
	295	310	310	325
	311	326	326	341
	326	341	341	356
	345	360	360	375
	352	367	367	382

- AX** = Light Oak
- AY** = Red Birch
- AZ** = Ash
- BA** = Philadelphia Cherry
- BB** = Pennsylvania Cherry
- BC** = Mahogany
- BD** = Oak
- BE** = Maple
- BF** = Pearwood
- ZZ** = COM

**Specifications and prices are subject to change without prior notice.**

# Bravo Desks

## Corner Worksurfaces

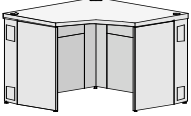
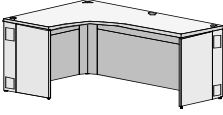
MODEL	Left D x W x W x D	Right W x D	MODEL NUMBER				
			Worksurface	Transition End Panel	Trim Color	Paint Color	Laminate
  <p>*Standard Transition End Panels shown.</p> <p><b>Freestanding Corner Worksurface with Full, Full Modesty Panels</b></p> <ul style="list-style-type: none"> <li>Consists of top, three legs, two modesty panels, two optional filler panels (full modesty panel), two end panels (optional transitional size), ganging plates, and all required assembly hardware</li> <li>Each leg has four cable access grommet locations</li> <li>Top has three cable access grommets above the legs (66" and 72" have a fourth middle grommet)</li> <li>Top grommets allow for attachment of overhead storage units (see pages 48-53)</li> <li>Modesty panel allows for optional 10-wire electrical system (see pages 59 &amp; 60)</li> <li>Edging for all tops is a 3mm PVC edge banding</li> </ul>	<b>24 x 42" x 42 x 24"</b>		BC24424224FF	<input type="checkbox"/>	<input type="checkbox"/>	<input type="checkbox"/>	<input type="checkbox"/>
	<b>24 x 48" x 48 x 24"</b>		BC24484824FF	<input type="checkbox"/>	<input type="checkbox"/>	<input type="checkbox"/>	<input type="checkbox"/>
	<b>24 x 48" x 60 x 24"</b>		BC24486024FF	<input type="checkbox"/>	<input type="checkbox"/>	<input type="checkbox"/>	<input type="checkbox"/>
	<b>24 x 48" x 66 x 24"</b>		BC24486624FF	<input type="checkbox"/>	<input type="checkbox"/>	<input type="checkbox"/>	<input type="checkbox"/>
	<b>24 x 48" x 72 x 24"</b>		BC24487224FF	<input type="checkbox"/>	<input type="checkbox"/>	<input type="checkbox"/>	<input type="checkbox"/>
	<b>24 x 60" x 48 x 24"</b>		BC24604824FF	<input type="checkbox"/>	<input type="checkbox"/>	<input type="checkbox"/>	<input type="checkbox"/>
	<b>24 x 66" x 48 x 24"</b>		BC24664824FF	<input type="checkbox"/>	<input type="checkbox"/>	<input type="checkbox"/>	<input type="checkbox"/>
	<b>24 x 72" x 48 x 24"</b>		BC24724824FF	<input type="checkbox"/>	<input type="checkbox"/>	<input type="checkbox"/>	<input type="checkbox"/>
	<b>30 x 48" x 48 x 30"</b>		BC30484830FF	<input type="checkbox"/>	<input type="checkbox"/>	<input type="checkbox"/>	<input type="checkbox"/>
	<b>30 x 48" x 60 x 30"</b>		BC30486030FF	<input type="checkbox"/>	<input type="checkbox"/>	<input type="checkbox"/>	<input type="checkbox"/>
	<b>30 x 48" x 66 x 30"</b>		BC30486630FF	<input type="checkbox"/>	<input type="checkbox"/>	<input type="checkbox"/>	<input type="checkbox"/>
	<b>30 x 48" x 72 x 30"</b>		BC30487230FF	<input type="checkbox"/>	<input type="checkbox"/>	<input type="checkbox"/>	<input type="checkbox"/>
	<b>30 x 60" x 48 x 30"</b>		BC30604830FF	<input type="checkbox"/>	<input type="checkbox"/>	<input type="checkbox"/>	<input type="checkbox"/>
	<b>30 x 66" x 48 x 30"</b>		BC30664830FF	<input type="checkbox"/>	<input type="checkbox"/>	<input type="checkbox"/>	<input type="checkbox"/>
	<b>30 x 72" x 48 x 30"</b>		BC30724830FF	<input type="checkbox"/>	<input type="checkbox"/>	<input type="checkbox"/>	<input type="checkbox"/>
			<b>A</b>	<b>B</b>	<b>C</b>	<b>D</b>	<b>E</b>

### HOW TO ORDER

Indicate the following information on order form:

- Quantity of each item.
- Model Number, including options. See "How to Build a Model Number".
- Any special service required.

Note: • The  indicates that a choice is required.

- The absence of the  indicates that no choice is required.
- Alpha-numeric characters in place of  indicate that no other options are available.

### HOW TO BUILD A MODEL NUMBER

**A** Select size of worksurface (left to right).

**B** Select transition end panel.

- S** = Standard  
**L** = Left transition only  
**R** = Right transition only  
**B** = Both end panels transition

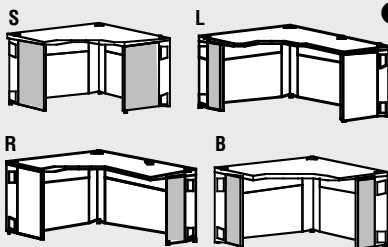

**C** Select trim color (edge and grommets).\*

- B** = Black = 27  
**G** = Grey = 29  
**L** = Light Tone = 32  
**S** = Sand = 28  
**W** = Warm Grey = 33

\*Trim color matches paint color.

**D** Select paint color.

- 27** = Black  
**29** = Grey  
**33** = Warm Grey  
**28** = Sand  
**32** = Light Tone  
**59** = Juniper  
**25** = Medium Bronze  
**26** = Hunter Green  
**31** = Eggshell White  
**50** = Beige  
**51** = Baltic  
**52** = Bordeaux  
**SP** = COM

**E** Select laminate surface.

- AA** = Cream  
**AB** = Champagne  
**AC** = Barcelona  
**AF** = Aruba Tan  
**AG** = Black  
**AH** = Dark Gray  
**AI** = Dawn Gray (Greige)  
**AJ** = Fog  
**AK** = Black Grandin  
**AL** = Smoke Granite  
**AM** = Sand Grandin  
**AN** = Light Granite  
**AO** = Tundra  
**AP** = Earthen  
**AQ** = Rose Graphix  
**AS** = Sierra Graphix  
**AT** = Beige Grafix



**TRANSITION END PANEL STYLE**

B=Both Transition Price	L=Left Transition Price	R=Right Transition Price	S=Standard Price
\$479	\$494	\$494	\$509
503	518	518	533
578	593	593	608
610	625	625	640
625	640	640	655
578	593	593	608
610	625	625	640
625	640	640	655
516	531	531	546
591	606	606	621
623	638	638	653
638	653	653	668
591	606	606	621
623	638	638	653
638	653	653	668

- AU** = Sand Stone
- AV** = Kentucky Walnut
- AW** = Tennessee Oak
- AX** = Light Oak
- AY** = Red Birch
- AZ** = Ash
- BA** = Philadelphia Cherry
- BB** = Pennsylvania Cherry
- BC** = Mahogany
- BD** = Oak
- BE** = Maple
- BF** = Pearwood
- ZZ** = COM

**INFORMATION**

Options are always specified left to right from the seated position.

Example:

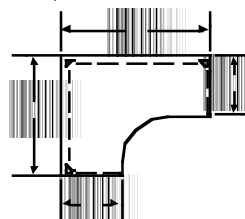

BC24486024FF

**Specifications and prices are subject to change without prior notice.**

# Bravo Desks

## Corner Worksurfaces

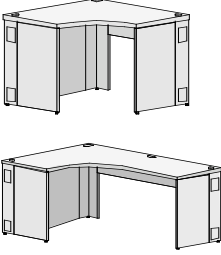
MODEL	Left D x W x	Right W x D	MODEL NUMBER				
			Worksurface	Transition End Panel	Trim Color	Paint Color	Laminate
 <p><b>Freestanding Corner Worksurface with Full, Partial Modesty Panels</b></p> <ul style="list-style-type: none"> <li>Consists of top, three legs, two modesty panels, one optional filler panel (full modesty panel), two end panels (optional transitional size), ganging plates, and all required assembly hardware</li> <li>Each leg has four cable access grommet locations</li> <li>Top has three cable access grommets above the legs (66" and 72" have a fourth middle grommet)</li> <li>Top grommets allow for attachment of overhead storage units (see pages 48-53)</li> <li>Modesty panel allows for optional 10-wire electrical system (see pages 59 &amp; 60)</li> <li>Edging for all tops is a 3mm PVC edge banding</li> </ul> <p>*Standard Transition End Panels shown.</p>	<b>24 x 42" x 42 x 24"</b>	BC24424224FP	<input type="checkbox"/>	<input type="checkbox"/>	<input type="checkbox"/>	<input type="checkbox"/>	
	<b>24 x 48" x 48 x 24"</b>	BC24484824FP	<input type="checkbox"/>	<input type="checkbox"/>	<input type="checkbox"/>	<input type="checkbox"/>	
	<b>24 x 48" x 60 x 24"</b>	BC24486024FP	<input type="checkbox"/>	<input type="checkbox"/>	<input type="checkbox"/>	<input type="checkbox"/>	
	<b>24 x 48" x 66 x 24"</b>	BC24486624FP	<input type="checkbox"/>	<input type="checkbox"/>	<input type="checkbox"/>	<input type="checkbox"/>	
	<b>24 x 48" x 72 x 24"</b>	BC24487224FP	<input type="checkbox"/>	<input type="checkbox"/>	<input type="checkbox"/>	<input type="checkbox"/>	
	<b>24 x 60" x 48 x 24"</b>	BC24604824FP	<input type="checkbox"/>	<input type="checkbox"/>	<input type="checkbox"/>	<input type="checkbox"/>	
	<b>24 x 66" x 48 x 24"</b>	BC24664824FP	<input type="checkbox"/>	<input type="checkbox"/>	<input type="checkbox"/>	<input type="checkbox"/>	
	<b>24 x 72" x 48 x 24"</b>	BC24724824FP	<input type="checkbox"/>	<input type="checkbox"/>	<input type="checkbox"/>	<input type="checkbox"/>	
	<b>30 x 48" x 48 x 30"</b>	BC30484830FP	<input type="checkbox"/>	<input type="checkbox"/>	<input type="checkbox"/>	<input type="checkbox"/>	
	<b>30 x 48" x 60 x 30"</b>	BC30486030FP	<input type="checkbox"/>	<input type="checkbox"/>	<input type="checkbox"/>	<input type="checkbox"/>	
	<b>30 x 48" x 66 x 30"</b>	BC30486630FP	<input type="checkbox"/>	<input type="checkbox"/>	<input type="checkbox"/>	<input type="checkbox"/>	
	<b>30 x 48" x 72 x 30"</b>	BC30487230FP	<input type="checkbox"/>	<input type="checkbox"/>	<input type="checkbox"/>	<input type="checkbox"/>	
	<b>30 x 60" x 48 x 30"</b>	BC30604830FP	<input type="checkbox"/>	<input type="checkbox"/>	<input type="checkbox"/>	<input type="checkbox"/>	
	<b>30 x 66" x 48 x 30"</b>	BC30664830FP	<input type="checkbox"/>	<input type="checkbox"/>	<input type="checkbox"/>	<input type="checkbox"/>	
	<b>30 x 72" x 48 x 30"</b>	BC30724830FP	<input type="checkbox"/>	<input type="checkbox"/>	<input type="checkbox"/>	<input type="checkbox"/>	
			<b>A</b>	<b>B</b>	<b>C</b>	<b>D</b>	<b>E</b>

### HOW TO ORDER

Indicate the following information on order form:

- Quantity of each item.
- Model Number, including options. See "How to Build a Model Number".
- Any special service required.

Note:  indicates that a choice is required.  
 indicates that no choice is required.  
 Alpha-numeric characters in place of  indicate that no other options are available.

### HOW TO BUILD A MODEL NUMBER

- A** Select size of worksurface (left to right).  
**B** Select transition end panel.  
**S** = Standard  
**L** = Left transition only  
**R** = Right transition only  
**B** = Both end panels transition

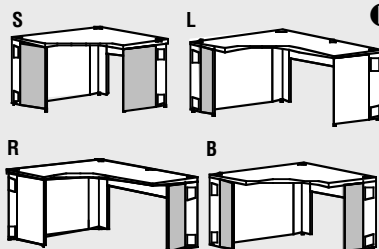

- C** Select trim color (edge and grommets).\*
- B** = Black = 27  
**G** = Grey = 29  
**L** = Light Tone = 32  
**S** = Sand = 28  
**W** = Warm Grey = 33
- \*Trim color matches paint color.

- D** Select paint color.
- 27** = Black  
**29** = Grey  
**33** = Warm Grey  
**28** = Sand  
**32** = Light Tone  
**59** = Juniper  
**25** = Medium Bronze  
**26** = Hunter Green  
**31** = Eggshell White  
**50** = Beige  
**51** = Baltic  
**52** = Bordeaux  
**SP** = COM

- E** Select laminate surface.
- AA** = Cream  
**AB** = Champagne  
**AC** = Barcelona  
**AF** = Aruba Tan  
**AG** = Black  
**AH** = Dark Gray  
**AI** = Dawn Gray (Greige)  
**AJ** = Fog  
**AK** = Black Grandin  
**AL** = Smoke Granite  
**AM** = Sand Grandin  
**AN** = Light Granite  
**AO** = Tundra  
**AP** = Earthen  
**AQ** = Rose Graphix  
**AS** = Sierra Graphix  
**AT** = Beige Grafix  
**AU** = Sand Stone  
**AV** = Kentucky Walnut  
**AW** = Tennessee Oak



**TRANSITION END PANEL STYLE**

B=Both Transition Price	L=Left Transition Price	R=Right Transition Price	S=Standard Price
\$417	\$432	\$432	\$447
438	453	453	468
507	522	522	537
537	552	552	567
551	566	566	581
507	522	522	537
537	552	552	567
551	566	566	581
450	465	465	480
519	534	534	549
549	564	564	579
563	578	578	593
519	534	534	549
549	564	564	579
563	578	578	593

- AX** = Light Oak
- AY** = Red Birch
- AZ** = Ash
- BA** = Philadelphia Cherry
- BB** = Pennsylvania Cherry
- BC** = Mahogany
- BD** = Oak
- BE** = Maple
- BF** = Pearwood
- ZZ** = COM

**INFORMATION**

Options are always specified left to right from the seated position.

Example:

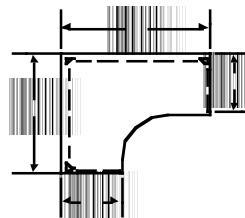

BC24486024FP

**Specifications and prices are subject to change without prior notice.**

# Bravo Desks

## Corner Worksurfaces

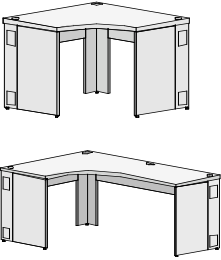
MODEL	Left D x W x	Right W x D	MODEL NUMBER				
			Worksurface	Transition End Panel	Trim Color	Paint Color	Laminate
 <p><b>Freestanding Corner Worksurface with Partial, Partial Modesty Panels</b></p> <ul style="list-style-type: none"> <li>Consists of top, three legs, two modesty panels, one optional filler panel (partial modesty panel), two end panels (optional transitional size), ganging plates, and all required assembly hardware</li> <li>Each leg has four cable access grommet locations</li> <li>Top has three cable access grommets above the legs (66" and 72" have a fourth middle grommet)</li> <li>Top grommets allow for attachment of overhead storage units (see pages 48-53)</li> <li>Modesty panel allows for optional 10-wire electrical system (see pages 59 &amp; 60)</li> <li>Edging for all tops is a 3mm PVC edge banding</li> </ul> <p>*Standard Transition End Panels shown.</p>	<b>24 x 42" x 42 x 24"</b>	BC24424224PP	<input type="checkbox"/>	<input type="checkbox"/>	<input type="checkbox"/>	<input type="checkbox"/>	
	<b>24 x 48" x 48 x 24"</b>	BC24484824PP	<input type="checkbox"/>	<input type="checkbox"/>	<input type="checkbox"/>	<input type="checkbox"/>	
	<b>24 x 48" x 60 x 24"</b>	BC24486024PP	<input type="checkbox"/>	<input type="checkbox"/>	<input type="checkbox"/>	<input type="checkbox"/>	
	<b>24 x 48" x 66 x 24"</b>	BC24486624PP	<input type="checkbox"/>	<input type="checkbox"/>	<input type="checkbox"/>	<input type="checkbox"/>	
	<b>24 x 48" x 72 x 24"</b>	BC24487224PP	<input type="checkbox"/>	<input type="checkbox"/>	<input type="checkbox"/>	<input type="checkbox"/>	
	<b>24 x 60" x 48 x 24"</b>	BC24604824PP	<input type="checkbox"/>	<input type="checkbox"/>	<input type="checkbox"/>	<input type="checkbox"/>	
	<b>24 x 66" x 48 x 24"</b>	BC24664824PP	<input type="checkbox"/>	<input type="checkbox"/>	<input type="checkbox"/>	<input type="checkbox"/>	
	<b>24 x 72" x 48 x 24"</b>	BC24724824PP	<input type="checkbox"/>	<input type="checkbox"/>	<input type="checkbox"/>	<input type="checkbox"/>	
	<b>30 x 48" x 48 x 30"</b>	BC30484830PP	<input type="checkbox"/>	<input type="checkbox"/>	<input type="checkbox"/>	<input type="checkbox"/>	
	<b>30 x 48" x 60 x 30"</b>	BC30486030PP	<input type="checkbox"/>	<input type="checkbox"/>	<input type="checkbox"/>	<input type="checkbox"/>	
	<b>30 x 48" x 66 x 30"</b>	BC30486630PP	<input type="checkbox"/>	<input type="checkbox"/>	<input type="checkbox"/>	<input type="checkbox"/>	
	<b>30 x 48" x 72 x 30"</b>	BC30487230PP	<input type="checkbox"/>	<input type="checkbox"/>	<input type="checkbox"/>	<input type="checkbox"/>	
	<b>30 x 60" x 48 x 30"</b>	BC30604830PP	<input type="checkbox"/>	<input type="checkbox"/>	<input type="checkbox"/>	<input type="checkbox"/>	
	<b>30 x 66" x 48 x 30"</b>	BC30664830PP	<input type="checkbox"/>	<input type="checkbox"/>	<input type="checkbox"/>	<input type="checkbox"/>	
	<b>30 x 72" x 48 x 30"</b>	BC30724830PP	<input type="checkbox"/>	<input type="checkbox"/>	<input type="checkbox"/>	<input type="checkbox"/>	

**A**      **B**      **C**      **D**      **E**

### HOW TO ORDER

Indicate the following information on order form:

- Quantity of each item.
- Model Number, including options. See "How to Build a Model Number".
- Any special service required.

Note: • The  indicates that a choice is required.

- The absence of the  indicates that no choice is required.
- Alpha-numeric characters in place of  indicate that no other options are available.

### HOW TO BUILD A MODEL NUMBER

**A** Select size of worksurface (left to right).

**B** Select transition end panel.

- S** = Standard
- L** = Left transition only
- R** = Right transition only
- B** = Both end panels transition

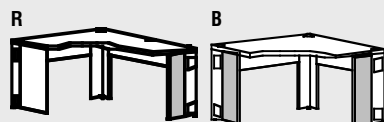
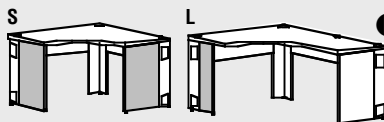

**C** Select trim color (edge and grommets).\*

- B** = Black = 27
- G** = Grey = 29
- L** = Light Tone = 32
- S** = Sand = 28
- W** = Warm Grey = 33

\*Trim color matches paint color.

**D** Select paint color.

- 27** = Black
- 29** = Grey
- 33** = Warm Grey
- 28** = Sand
- 32** = Light Tone
- 59** = Juniper
- 25** = Medium Bronze
- 26** = Hunter Green
- 31** = Eggshell White
- 50** = Beige
- 51** = Baltic
- 52** = Bordeaux
- SP** = COM

**E** Select laminate surface.

- AA** = Cream
- AB** = Champagne
- AC** = Barcelona
- AF** = Aruba Tan
- AG** = Black
- AH** = Dark Gray
- AI** = Dawn Gray (Greige)
- AJ** = Fog
- AK** = Black Grandin
- AL** = Smoke Granite
- AM** = Sand Grandin
- AN** = Light Granite
- AO** = Tundra
- AP** = Earthen
- AQ** = Rose Graphix
- AS** = Sierra Graphix
- AT** = Beige Grafix
- AU** = Sand Stone
- AV** = Kentucky Walnut
- AW** = Tennessee Oak



**TRANSITION END PANEL STYLE**

B=Both Transition Price	L=Left Transition Price	R=Right Transition Price	S=Standard Price
\$392	\$407	\$407	\$422
412	427	427	442
473	488	488	503
502	517	517	532
515	530	530	545
473	488	488	503
502	517	517	532
515	530	530	545
424	439	439	454
485	500	500	515
514	529	529	544
527	542	542	557
485	500	500	515
514	529	529	544
527	542	542	557

- AX** = Light Oak
- AY** = Red Birch
- AZ** = Ash
- BA** = Philadelphia Cherry
- BB** = Pennsylvania Cherry
- BC** = Mahogany
- BD** = Oak
- BE** = Maple
- BF** = Pearwood
- ZZ** = COM

**INFORMATION**

Options are always specified left to right from the seated position.

Example:

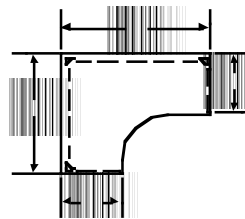

BC24486024PP

**Specifications and prices are subject to change without prior notice.**



# Bravo Desks

## Corner Worksurfaces

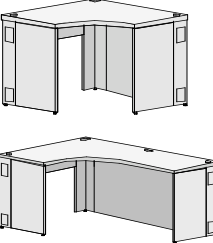
MODEL	Left D x W x	Right W x D	MODEL NUMBER				
			Worksurface	Transition End Panel	Trim Color	Paint Color	Laminate
 <p><b>Freestanding Corner Worksurface with Partial, Full Modesty Panels</b></p> <ul style="list-style-type: none"> <li>• Consists of top, three legs, two modesty panels, two optional filler panels (partial modesty panel), two end panels (optional transitional size), ganging plates, and all required assembly hardware</li> <li>• Each leg has four cable access grommet locations</li> <li>• Top has three cable access grommets above the legs (66" and 72" have a fourth middle grommet)</li> <li>• Top grommets allow for attachment of overhead storage units (see pages 48-53)</li> <li>• Modesty panel allows for optional 10-wire electrical system (see pages 59 &amp; 60)</li> <li>• Edging for all tops is a 3mm PVC edge banding</li> </ul> <p>*Standard Transition End Panels shown.</p>	<b>24 x 42" x 42 x 24"</b>	BC24424224PF	<input type="checkbox"/>	<input type="checkbox"/>	<input type="checkbox"/>	<input type="checkbox"/>	
	<b>24 x 48" x 48 x 24"</b>	BC24484824PF	<input type="checkbox"/>	<input type="checkbox"/>	<input type="checkbox"/>	<input type="checkbox"/>	
	<b>24 x 48" x 60 x 24"</b>	BC24486024PF	<input type="checkbox"/>	<input type="checkbox"/>	<input type="checkbox"/>	<input type="checkbox"/>	
	<b>24 x 48" x 66 x 24"</b>	BC24486624PF	<input type="checkbox"/>	<input type="checkbox"/>	<input type="checkbox"/>	<input type="checkbox"/>	
	<b>24 x 48" x 72 x 24"</b>	BC24487224PF	<input type="checkbox"/>	<input type="checkbox"/>	<input type="checkbox"/>	<input type="checkbox"/>	
	<b>24 x 60" x 48 x 24"</b>	BC24604824PF	<input type="checkbox"/>	<input type="checkbox"/>	<input type="checkbox"/>	<input type="checkbox"/>	
	<b>24 x 66" x 48 x 24"</b>	BC24664824PF	<input type="checkbox"/>	<input type="checkbox"/>	<input type="checkbox"/>	<input type="checkbox"/>	
	<b>24 x 72" x 48 x 24"</b>	BC24724824PF	<input type="checkbox"/>	<input type="checkbox"/>	<input type="checkbox"/>	<input type="checkbox"/>	
	<b>30 x 48" x 48 x 30"</b>	BC30484830PF	<input type="checkbox"/>	<input type="checkbox"/>	<input type="checkbox"/>	<input type="checkbox"/>	
	<b>30 x 48" x 60 x 30"</b>	BC30486030PF	<input type="checkbox"/>	<input type="checkbox"/>	<input type="checkbox"/>	<input type="checkbox"/>	
	<b>30 x 48" x 66 x 30"</b>	BC30486630PF	<input type="checkbox"/>	<input type="checkbox"/>	<input type="checkbox"/>	<input type="checkbox"/>	
	<b>30 x 48" x 72 x 30"</b>	BC30487230PF	<input type="checkbox"/>	<input type="checkbox"/>	<input type="checkbox"/>	<input type="checkbox"/>	
	<b>30 x 60" x 48 x 30"</b>	BC30604830PF	<input type="checkbox"/>	<input type="checkbox"/>	<input type="checkbox"/>	<input type="checkbox"/>	
	<b>30 x 66" x 48 x 30"</b>	BC30664830PF	<input type="checkbox"/>	<input type="checkbox"/>	<input type="checkbox"/>	<input type="checkbox"/>	
	<b>30 x 72" x 48 x 30"</b>	BC30724830PF	<input type="checkbox"/>	<input type="checkbox"/>	<input type="checkbox"/>	<input type="checkbox"/>	
				<b>A</b>	<b>B</b>	<b>C</b>	<b>D</b>

### HOW TO ORDER

Indicate the following information on order form:

- Quantity of each item.
- Model Number, including options. See "How to Build a Model Number".
- Any special service required.

Note: • The  indicates that a choice is required.

- The absence of the  indicates that no choice is required.
- Alpha-numeric characters in place of  indicate that no other options are available.

### HOW TO BUILD A MODEL NUMBER

**A** Select size of worksurface (left to right).

**B** Select transition end panel.

- S** = Standard
- L** = Left transition only
- R** = Right transition only
- B** = Both end panels transition

**S**



**L**

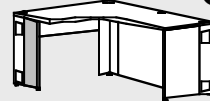

**R**

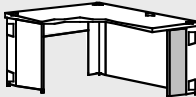

**B**

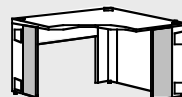

**C** Select trim color (edge and grommets).\*

- B** = Black = 27
- G** = Grey = 29
- L** = Light Tone = 32
- S** = Sand = 28
- W** = Warm Grey = 33

\*Trim color matches paint color.

**D** Select paint color.

- 27** = Black
- 29** = Grey
- 33** = Warm Grey
- 28** = Sand
- 32** = Light Tone
- 59** = Juniper
- 25** = Medium Bronze
- 26** = Hunter Green
- 31** = Eggshell White
- 50** = Beige
- 51** = Baltic
- 52** = Bordeaux
- SP** = COM

**E** Select laminate surface.

- AA** = Cream
- AB** = Champagne
- AC** = Barcelona
- AF** = Aruba Tan
- AG** = Black
- AH** = Dark Gray
- AI** = Dawn Gray (Greige)
- AJ** = Fog
- AK** = Black Grandin
- AL** = Smoke Granite
- AM** = Sand Grandin
- AN** = Light Granite
- AO** = Tundra
- AP** = Earthen
- AQ** = Rose Graphix
- AS** = Sierra Graphix
- AT** = Beige Grafix
- AU** = Sand Stone
- AV** = Kentucky Walnut
- AW** = Tennessee Oak



**TRANSITION END PANEL STYLE**

B=Both Transition Price	L=Left Transition Price	R=Right Transition Price	S=Standard Price
\$417	\$432	\$432	\$447
438	453	453	468
507	522	522	537
537	552	552	567
551	566	566	581
507	522	522	537
537	552	552	567
551	566	566	581
450	465	465	480
519	534	534	549
549	564	564	579
563	578	578	593
519	534	534	549
549	564	564	579
563	578	578	593

- AX** = Light Oak
- AY** = Red Birch
- AZ** = Ash
- BA** = Philadelphia Cherry
- BB** = Pennsylvania Cherry
- BC** = Mahogany
- BD** = Oak
- BE** = Maple
- BF** = Pearwood
- ZZ** = COM

**INFORMATION**

Options are always specified left to right from the seated position.

Example:

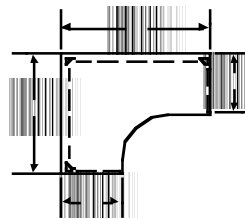

BC24486024PF

**Specifications and prices are subject to change without prior notice.**

# Bravo Desks

## Reduction Rectangular Worksurfaces

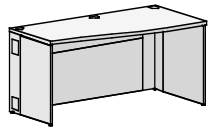

\*Standard Transition End Panels shown.

### MODEL

#### Freestanding Reduction Rectangular Worksurface with Full Modesty Panel

- Desk reduces size from 24" on one end to 30" on opposite end
- Consists of top, two legs, modesty panel, optional filler panel (full modesty panel), two end panels (optional transitional size), ganging plates, and all required assembly hardware
- Each leg has four cable access grommet locations
- Top has two cable access grommets above the legs (66" and 72" have a third middle grommet)
- Top grommets allow for attachment of overhead storage units (see pages 48-53)
- Modesty panel allows for optional 10-wire electrical system (see pages 59 & 60)
- Edging for all tops is a 3mm PVC edge banding

Left D x W x D	Right D x W x D	MODEL NUMBER				
		Worksurface	Transition End Panel	Trim Color	Paint Color	Laminate
24 x 42 x 30"	30 x 42 x 24"	BVRR244230F	<input type="checkbox"/>	<input type="checkbox"/>	<input type="checkbox"/>	<input type="checkbox"/>
24 x 48 x 30"	30 x 48 x 24"	BVRR244830F	<input type="checkbox"/>	<input type="checkbox"/>	<input type="checkbox"/>	<input type="checkbox"/>
24 x 54 x 30"	30 x 54 x 24"	BVRR245430F	<input type="checkbox"/>	<input type="checkbox"/>	<input type="checkbox"/>	<input type="checkbox"/>
24 x 60 x 30"	30 x 60 x 24"	BVRR246030F	<input type="checkbox"/>	<input type="checkbox"/>	<input type="checkbox"/>	<input type="checkbox"/>
24 x 66 x 30"	30 x 66 x 24"	BVRR246630F	<input type="checkbox"/>	<input type="checkbox"/>	<input type="checkbox"/>	<input type="checkbox"/>
24 x 72 x 30"	30 x 72 x 24"	BVRR247230F	<input type="checkbox"/>	<input type="checkbox"/>	<input type="checkbox"/>	<input type="checkbox"/>
30 x 42 x 24"	30 x 42 x 24"	BVRR304224F	<input type="checkbox"/>	<input type="checkbox"/>	<input type="checkbox"/>	<input type="checkbox"/>
30 x 48 x 24"	30 x 48 x 24"	BVRR304824F	<input type="checkbox"/>	<input type="checkbox"/>	<input type="checkbox"/>	<input type="checkbox"/>
30 x 54 x 24"	30 x 54 x 24"	BVRR305424F	<input type="checkbox"/>	<input type="checkbox"/>	<input type="checkbox"/>	<input type="checkbox"/>
30 x 60 x 24"	30 x 60 x 24"	BVRR306024F	<input type="checkbox"/>	<input type="checkbox"/>	<input type="checkbox"/>	<input type="checkbox"/>
30 x 66 x 24"	30 x 66 x 24"	BVRR306624F	<input type="checkbox"/>	<input type="checkbox"/>	<input type="checkbox"/>	<input type="checkbox"/>
30 x 72 x 24"	30 x 72 x 24"	BVRR307224F	<input type="checkbox"/>	<input type="checkbox"/>	<input type="checkbox"/>	<input type="checkbox"/>

**A**      **B**      **C**      **D**      **E**

## HOW TO ORDER

Indicate the following information on order form:

- Quantity of each item.
- Model Number, including options. See "How to Build a Model Number".
- Any special service required.

Note: • The  indicates that a choice is required.

- The absence of the  indicates that no choice is required.
- Alpha-numeric characters in place of  indicate that no other options are available.

## HOW TO BUILD A MODEL NUMBER

**A** Select size of worksurface (left to right).

**B** Select transition end panel.

- S** = Standard
- L** = Left transition only
- R** = Right transition only
- B** = Both end panels transition

**S**

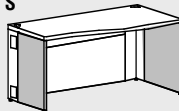

**L**

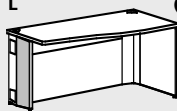

**R**

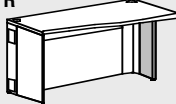

**B**

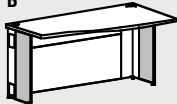

**C** Select trim color (edge and grommets).\*

- B** = Black = 27
- G** = Grey = 29
- L** = Light Tone = 32
- S** = Sand = 28
- W** = Warm Grey = 33

\*Trim color matches paint color.

**D** Select paint color.

- 27** = Black
- 29** = Grey
- 33** = Warm Grey
- 28** = Sand
- 32** = Light Tone
- 59** = Juniper
- 25** = Medium Bronze
- 26** = Hunter Green
- 31** = Eggshell White
- 50** = Beige
- 51** = Baltic
- 52** = Bordeaux
- SP** = COM

**E** Select laminate surface.

- AA** = Cream
- AB** = Champagne
- AC** = Barcelona
- AF** = Aruba Tan
- AG** = Black
- AH** = Dark Gray
- AI** = Dawn Gray (Greige)
- AJ** = Fog
- AK** = Black Grandin
- AL** = Smoke Granite
- AM** = Sand Grandin
- AN** = Light Granite
- AO** = Tundra
- AP** = Earthen
- AQ** = Rose Graphix
- AS** = Sierra Graphix
- AT** = Beige Grafix
- AU** = Sand Stone
- AV** = Kentucky Walnut
- AW** = Tennessee Oak



TRANSITION END PANEL STYLE				
	B=Both Transition Price	L=Left Transition Price	R=Right Transition Price	S=Standard Price
	\$353	\$368	\$368	\$383
	369	384	384	399
	384	399	399	414
	410	425	425	440
	429	444	444	459
	445	460	460	475
	353	368	368	383
	369	384	384	399
	384	399	399	414
	410	425	425	440
	429	444	444	459
	445	460	460	475

- AX** = Light Oak
- AY** = Red Birch
- AZ** = Ash
- BA** = Philadelphia Cherry
- BB** = Pennsylvania Cherry
- BC** = Mahogany
- BD** = Oak
- BE** = Maple
- BF** = Pearwood
- ZZ** = COM

**INFORMATION**

Size is specified left to right from the seated position.

Example:

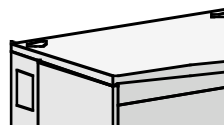

BVRR245430F

**Specifications and prices are subject to change without prior notice.**

# Bravo Desks

## Reduction Rectangular Worksurfaces

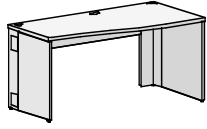

\*Standard Transition End Panels shown.

### MODEL

#### Freestanding Reduction Rectangular Worksurface with Partial Modesty Panel

- Desk reduces size from 24" on one end to 30" on opposite end
- Consists of top, two legs, modesty panel, optional filler panel (partial modesty panel), two end panels (optional transitional size), ganging plates, and all required assembly hardware
- Each leg has four cable access grommet locations
- Top has two cable access grommets above the legs (66" and 72" have a third middle grommet)
- Top grommets allow for attachment of overhead storage units (see pages 48-53)
- Modesty panel allows for optional 10-wire electrical system (see pages 59 & 60)
- Edging for all tops is a 3mm PVC edge banding

Left  
D x W x D

24 x 42 x 30"	24 x 48 x 30"	24 x 54 x 30"	24 x 60 x 30"	24 x 66 x 30"	24 x 72 x 30"	30 x 42 x 24"	30 x 48 x 24"	30 x 54 x 24"	30 x 60 x 24"	30 x 66 x 24"	30 x 72 x 24"
---------------	---------------	---------------	---------------	---------------	---------------	---------------	---------------	---------------	---------------	---------------	---------------

### MODEL NUMBER

Worksurface	Transition End Panel	Trim Color	Paint Color	Laminate
BVRR244230P	<input type="checkbox"/>	<input type="checkbox"/>	<input type="checkbox"/>	<input type="checkbox"/>
BVRR244830P	<input type="checkbox"/>	<input type="checkbox"/>	<input type="checkbox"/>	<input type="checkbox"/>
BVRR245430P	<input type="checkbox"/>	<input type="checkbox"/>	<input type="checkbox"/>	<input type="checkbox"/>
BVRR246030P	<input type="checkbox"/>	<input type="checkbox"/>	<input type="checkbox"/>	<input type="checkbox"/>
BVRR246630P	<input type="checkbox"/>	<input type="checkbox"/>	<input type="checkbox"/>	<input type="checkbox"/>
BVRR247230P	<input type="checkbox"/>	<input type="checkbox"/>	<input type="checkbox"/>	<input type="checkbox"/>
BVRR304224P	<input type="checkbox"/>	<input type="checkbox"/>	<input type="checkbox"/>	<input type="checkbox"/>
BVRR304824P	<input type="checkbox"/>	<input type="checkbox"/>	<input type="checkbox"/>	<input type="checkbox"/>
BVRR305424P	<input type="checkbox"/>	<input type="checkbox"/>	<input type="checkbox"/>	<input type="checkbox"/>
BVRR306024P	<input type="checkbox"/>	<input type="checkbox"/>	<input type="checkbox"/>	<input type="checkbox"/>
BVRR306624P	<input type="checkbox"/>	<input type="checkbox"/>	<input type="checkbox"/>	<input type="checkbox"/>
BVRR307224P	<input type="checkbox"/>	<input type="checkbox"/>	<input type="checkbox"/>	<input type="checkbox"/>

**A**

**B**

**C**

**D**

**E**

## HOW TO ORDER

Indicate the following information on order form:

- Quantity of each item.
- Model Number, including options. See "How to Build a Model Number".
- Any special service required.

Note: • The  indicates that a choice is required.

- The absence of the  indicates that no choice is required.
- Alpha-numeric characters in place of  indicate that no other options are available.

## HOW TO BUILD A MODEL NUMBER

**A** Select size of worksurface (left to right).

**B** Select transition end panel.

- S** = Standard
- L** = Left transition only
- R** = Right transition only
- B** = Both end panels transition

**C** Select trim color (edge and grommets).\*

- B** = Black = 27
- G** = Grey = 29
- L** = Light Tone = 32
- S** = Sand = 28
- W** = Warm Grey = 33

\*Trim color matches paint color.

**D** Select paint color.

- 27** = Black
- 29** = Grey
- 33** = Warm Grey
- 28** = Sand
- 32** = Light Tone
- 59** = Juniper
- 25** = Medium Bronze
- 26** = Hunter Green
- 31** = Eggshell White
- 50** = Beige
- 51** = Baltic
- 52** = Bordeaux
- SP** = COM

**E** Select laminate surface.

- AA** = Cream
- AB** = Champagne
- AC** = Barcelona
- AF** = Aruba Tan
- AG** = Black
- AH** = Dark Gray
- AI** = Dawn Gray (Greige)
- AJ** = Fog
- AK** = Black Grandin
- AL** = Smoke Granite
- AM** = Sand Grandin
- AN** = Light Granite
- AO** = Tundra
- AP** = Earthen
- AQ** = Rose Graphix
- AS** = Sierra Graphix
- AT** = Beige Grafix
- AU** = Sand Stone
- AV** = Kentucky Walnut
- AW** = Tennessee Oak

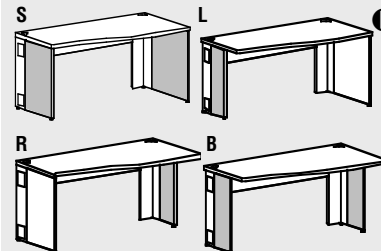



TRANSITION END PANEL STYLE				
	B=Both Transition Price	L=Left Transition Price	R=Right Transition Price	S=Standard Price
	\$326	\$341	\$341	\$356
	340	355	355	370
	354	369	369	384
	374	389	389	404
	391	406	406	421
	406	421	421	436
	326	341	341	356
	340	355	355	370
	354	369	369	384
	374	389	389	404
	391	406	406	421
	406	421	421	436

- AX** = Light Oak
- AY** = Red Birch
- AZ** = Ash
- BA** = Philadelphia Cherry
- BB** = Pennsylvania Cherry
- BC** = Mahogany
- BD** = Oak
- BE** = Maple
- BF** = Pearwood
- ZZ** = COM

**INFORMATION**

Size is specified left to right from the seated position.

Example:

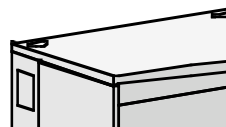

BVRR245430P

**Specifications and prices are subject to change without prior notice.**

# Bravo Desks

## Piano Worksurfaces

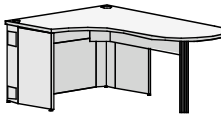
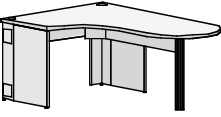
MODEL	Left D x W x D	Right D x W x D	MODEL NUMBER					
			Worksurface	Transition End Panel	Trim Color	Paint Color	Laminate	
 <p><b>Freestanding Piano Worksurface with Full Modesty Panel</b></p> <ul style="list-style-type: none"> <li>Consists of top, two legs, modesty panel, optional filler panel (full modesty panel), two end panels (optional transitional size), ganging plates, one round leg, one 9" tall steel partial modesty panel along the 60" or 72" side, and all required assembly hardware</li> <li>Each leg has four cable access grommet locations</li> <li>Top has two cable access grommets above the legs</li> <li>Top grommets allow for attachment of overhead storage units (see pages 48-53)</li> <li>Modesty panel allows for optional 10-wire electrical system (see pages 59 &amp; 60)</li> <li>Piano end is 30" wide (15" radius)</li> <li>Edging for all tops is a 3mm PVC edge banding</li> </ul>	<b>24 x 48 x 60"</b>	<b>24 x 48 x 72"</b>	BVP244860F	<input type="checkbox"/>	<input type="checkbox"/>	<input type="checkbox"/>	<input type="checkbox"/>	
				BVP244872F	<input type="checkbox"/>	<input type="checkbox"/>	<input type="checkbox"/>	<input type="checkbox"/>
				BVP304872F	<input type="checkbox"/>	<input type="checkbox"/>	<input type="checkbox"/>	<input type="checkbox"/>
				BVP604824F	<input type="checkbox"/>	<input type="checkbox"/>	<input type="checkbox"/>	<input type="checkbox"/>
				BVP724824F	<input type="checkbox"/>	<input type="checkbox"/>	<input type="checkbox"/>	<input type="checkbox"/>
				BVP724830F	<input type="checkbox"/>	<input type="checkbox"/>	<input type="checkbox"/>	<input type="checkbox"/>
 <p><b>Freestanding Piano Worksurface with Partial Modesty Panel</b></p> <ul style="list-style-type: none"> <li>Consists of top, two legs, modesty panel, optional filler panel (partial modesty panel), two end panels (optional transitional size), ganging plates, one round leg, one 9" tall steel partial modesty panel along the 60" or 72" side, and all required assembly hardware</li> <li>Each leg has four cable access grommet locations</li> <li>Top has two cable access grommets above the legs</li> <li>Top grommets allow for attachment of overhead storage units (see pages 48-53)</li> <li>Modesty panel allows for optional 10-wire electrical system (see pages 59 &amp; 60)</li> <li>Piano end is 30" wide (15" radius)</li> <li>Edging for all tops is a 3mm PVC edge banding</li> </ul>	<b>24 x 48 x 60"</b>	<b>24 x 48 x 72"</b>	BVP244860P	<input type="checkbox"/>	<input type="checkbox"/>	<input type="checkbox"/>	<input type="checkbox"/>	
				BVP244872P	<input type="checkbox"/>	<input type="checkbox"/>	<input type="checkbox"/>	<input type="checkbox"/>
				BVP304872P	<input type="checkbox"/>	<input type="checkbox"/>	<input type="checkbox"/>	<input type="checkbox"/>
				BVP604824P	<input type="checkbox"/>	<input type="checkbox"/>	<input type="checkbox"/>	<input type="checkbox"/>
				BVP724824P	<input type="checkbox"/>	<input type="checkbox"/>	<input type="checkbox"/>	<input type="checkbox"/>
				BVP724830P	<input type="checkbox"/>	<input type="checkbox"/>	<input type="checkbox"/>	<input type="checkbox"/>

\*Standard Transition End Panels shown.

\*Standard Transition End Panels shown.

**A**      **B**      **C**      **D**      **E**

### HOW TO ORDER

Indicate the following information on order form:

- Quantity of each item.
- Model Number, including options. See "How to Build a Model Number".
- Any special service required.

Note: • The  indicates that a choice is required.

- The absence of the  indicates that no choice is required.
- Alpha-numeric characters in place of  indicate that no other options are available.

### HOW TO BUILD A MODEL NUMBER

**A** Select size of worksurface (left to right).

**B** Select transition end panel.

- S** = Standard
- L** = Left transition only
- R** = Right transition only
- B** = Both end panels transition

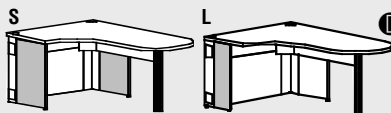

**C** Select trim color (edge and grommets).\*

- B** = Black = 27
- G** = Grey = 29
- L** = Light Tone = 32
- S** = Sand = 28
- W** = Warm Grey = 33

\*Trim color matches paint color.

**D** Select paint color.

- 27** = Black
- 29** = Grey
- 33** = Warm Grey
- 28** = Sand
- 32** = Light Tone
- 59** = Juniper
- 25** = Medium Bronze
- 26** = Hunter Green
- 31** = Eggshell White
- 50** = Beige
- 51** = Baltic
- 52** = Bordeaux
- SP** = COM

**E** Select laminate surface.

- AA** = Cream
- AB** = Champagne
- AC** = Barcelona
- AF** = Aruba Tan
- AG** = Black
- AH** = Dark Gray
- AI** = Dawn Gray (Greige)
- AJ** = Fog
- AK** = Black Granite
- AL** = Smoke Granite
- AM** = Sand Granite
- AN** = Light Granite
- AO** = Tundra
- AP** = Earthen
- AQ** = Rose Graphix
- AS** = Sierra Graphix
- AT** = Beige Grafix
- AU** = Sand Stone
- AV** = Kentucky Walnut
- AW** = Tennessee Oak





# Bravo Desks

## P-Shaped Worksurfaces

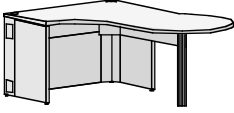
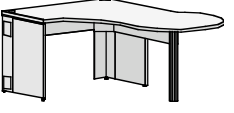
MODEL	Left D x W x D	Right D x W x D	MODEL NUMBER				
			Worksurface	Transition End Panel	Trim Color	Paint Color	Laminate
 <p><b>Freestanding P-Shaped Worksurface with Full Modesty Panel</b></p> <ul style="list-style-type: none"> <li>Consists of top, two legs, modesty panel, optional filler panel (full modesty panel), two end panels (optional transitional size), ganging plates, one round leg, one 9" tall steel partial modesty panel along the 60" or 72" side, and all required assembly hardware</li> <li>Each leg has four cable access grommet locations</li> <li>Top has two cable access grommets above the legs</li> <li>Top grommets allow for attachment of overhead storage units (see pages 48-53)</li> <li>Modesty panel allows for optional 10-wire electrical system (see pages 59 &amp; 60)</li> <li>P-end is 18" radius</li> <li>Edging for all tops is a 3mm PVC edge banding</li> </ul>	<b>24 x 48 x 60"</b>	<b>60"</b>	BVPD244860F	<input type="checkbox"/>	<input type="checkbox"/>	<input type="checkbox"/>	<input type="checkbox"/>
	<b>24 x 48 x 72"</b>	<b>72"</b>	BVPD244872F	<input type="checkbox"/>	<input type="checkbox"/>	<input type="checkbox"/>	<input type="checkbox"/>
	<b>30 x 48 x 72"</b>	<b>72"</b>	BVPD304872F	<input type="checkbox"/>	<input type="checkbox"/>	<input type="checkbox"/>	<input type="checkbox"/>
	<b>60 x 48 x 24"</b>	<b>24"</b>	BVPD604824F	<input type="checkbox"/>	<input type="checkbox"/>	<input type="checkbox"/>	<input type="checkbox"/>
	<b>72 x 48 x 24"</b>	<b>24"</b>	BVPD724824F	<input type="checkbox"/>	<input type="checkbox"/>	<input type="checkbox"/>	<input type="checkbox"/>
	<b>72 x 48 x 30"</b>	<b>30"</b>	BVPD724830F	<input type="checkbox"/>	<input type="checkbox"/>	<input type="checkbox"/>	<input type="checkbox"/>
 <p><b>Freestanding P-Shaped Worksurface with Partial Modesty Panel</b></p> <ul style="list-style-type: none"> <li>Consists of top, two legs, modesty panel, optional filler panel (partial modesty panel), two end panels (optional transitional size), ganging plates, one round leg, one 9" tall steel partial modesty panel along the 60" or 72" side, and all required assembly hardware</li> <li>Each leg has four cable access grommet locations</li> <li>Top has two cable access grommets above the legs</li> <li>Top grommets allow for attachment of overhead storage units (see pages 48-53)</li> <li>Modesty panel allows for optional 10-wire electrical system (see pages 59 &amp; 60)</li> <li>P-end is 18" radius</li> <li>Edging for all tops is a 3mm PVC edge banding</li> </ul>	<b>24 x 48 x 60"</b>	<b>60"</b>	BVPD244860P	<input type="checkbox"/>	<input type="checkbox"/>	<input type="checkbox"/>	<input type="checkbox"/>
	<b>24 x 48 x 72"</b>	<b>72"</b>	BVPD244872P	<input type="checkbox"/>	<input type="checkbox"/>	<input type="checkbox"/>	<input type="checkbox"/>
	<b>30 x 48 x 72"</b>	<b>72"</b>	BVPD304872P	<input type="checkbox"/>	<input type="checkbox"/>	<input type="checkbox"/>	<input type="checkbox"/>
	<b>60 x 48 x 24"</b>	<b>24"</b>	BVPD604824P	<input type="checkbox"/>	<input type="checkbox"/>	<input type="checkbox"/>	<input type="checkbox"/>
	<b>72 x 48 x 24"</b>	<b>24"</b>	BVPD724824P	<input type="checkbox"/>	<input type="checkbox"/>	<input type="checkbox"/>	<input type="checkbox"/>
	<b>72 x 48 x 30"</b>	<b>30"</b>	BVPD724830P	<input type="checkbox"/>	<input type="checkbox"/>	<input type="checkbox"/>	<input type="checkbox"/>

\*Standard Transition End Panels shown.

\*Standard Transition End Panels shown.

**A**      **B**      **C**      **D**      **E**

### HOW TO ORDER

Indicate the following information on order form:

- Quantity of each item.
- Model Number, including options. See "How to Build a Model Number".
- Any special service required.

Note: • The  indicates that a choice is required.

- The absence of the  indicates that no choice is required.
- Alpha-numeric characters in place of  indicate that no other options are available.

### HOW TO BUILD A MODEL NUMBER

**A** Select size of worksurface (left to right).

**B** Select transition end panel.

- S** = Standard
- L** = Left transition only
- R** = Right transition only
- B** = Both end panels transition

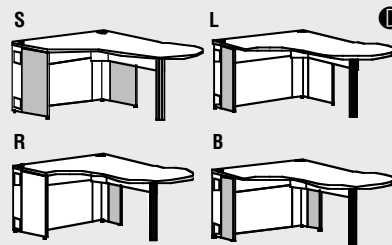

**C** Select trim color (edge and grommets).\*

- B** = Black = 27
- G** = Grey = 29
- L** = Light Tone = 32
- S** = Sand = 28
- W** = Warm Grey = 33

\*Trim color matches paint color.

**D** Select paint color.

- 27** = Black
- 29** = Grey
- 33** = Warm Grey
- 28** = Sand
- 32** = Light Tone
- 59** = Juniper
- 25** = Medium Bronze
- 26** = Hunter Green
- 31** = Eggshell White
- 50** = Beige
- 51** = Baltic
- 52** = Bordeaux
- SP** = COM

**E** Select laminate surface.

- AA** = Cream
- AB** = Champagne
- AC** = Barcelona
- AF** = Aruba Tan
- AG** = Black
- AH** = Dark Gray
- AI** = Dawn Gray (Greige)
- AJ** = Fog
- AK** = Black Granite
- AL** = Smoke Granite
- AM** = Sand Granite
- AN** = Light Granite
- AO** = Tundra
- AP** = Earthen
- AQ** = Rose Graphix
- AS** = Sierra Graphix
- AT** = Beige Grafix
- AU** = Sand Stone
- AV** = Kentucky Walnut
- AW** = Tennessee Oak



# Bravo Desks

## D-Shaped Worksurfaces

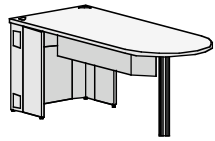

\*Both End Panels Transition shown.

### MODEL

#### Freestanding D-Shaped Worksurface with Full Modesty Panel

- Consists of top, two legs, modesty panel, optional filler panel (full modesty panel), two transitional size end panels, ganging plates, one round leg, one 9" tall steel partial modesty panel along the 60" or 72" side, and all required assembly hardware
- Each leg has four cable access grommet locations
- Top has two cable access grommets above the legs
- Top grommets allow for attachment of overhead storage units (see pages 48-53)
- Modesty panel allows for optional 10-wire electrical system (see pages 59 & 60)
- Edging for all tops is a 3mm PVC edge banding

L x D	MODEL NUMBER				
	Worksurface	Transition End Panel	Trim Color	Paint Color	Laminate
24 x 48"	BVD2448F	B	<input type="checkbox"/>	<input type="checkbox"/>	<input type="checkbox"/>
24 x 54"	BVD2454F	B	<input type="checkbox"/>	<input type="checkbox"/>	<input type="checkbox"/>
24 x 60"	BVD2460F	B	<input type="checkbox"/>	<input type="checkbox"/>	<input type="checkbox"/>
24 x 66"	BVD2466F	B	<input type="checkbox"/>	<input type="checkbox"/>	<input type="checkbox"/>
24 x 72"	BVD2472F	B	<input type="checkbox"/>	<input type="checkbox"/>	<input type="checkbox"/>
30 x 48"	BVD3048F	B	<input type="checkbox"/>	<input type="checkbox"/>	<input type="checkbox"/>
30 x 54"	BVD3054F	B	<input type="checkbox"/>	<input type="checkbox"/>	<input type="checkbox"/>
30 x 60"	BVD3060F	B	<input type="checkbox"/>	<input type="checkbox"/>	<input type="checkbox"/>
30 x 66"	BVD3066F	B	<input type="checkbox"/>	<input type="checkbox"/>	<input type="checkbox"/>
30 x 72"	BVD3072F	B	<input type="checkbox"/>	<input type="checkbox"/>	<input type="checkbox"/>
36 x 48"	BVD3648F	B	<input type="checkbox"/>	<input type="checkbox"/>	<input type="checkbox"/>
36 x 54"	BVD3654F	B	<input type="checkbox"/>	<input type="checkbox"/>	<input type="checkbox"/>
36 x 60"	BVD3660F	B	<input type="checkbox"/>	<input type="checkbox"/>	<input type="checkbox"/>
36 x 66"	BVD3666F	B	<input type="checkbox"/>	<input type="checkbox"/>	<input type="checkbox"/>
36 x 72"	BVD3672F	B	<input type="checkbox"/>	<input type="checkbox"/>	<input type="checkbox"/>

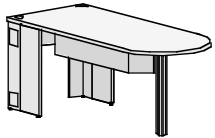

\*Both End Panels Transition shown.

#### Freestanding D-Shaped Worksurface with Partial Modesty Panel

- Consists of top, two legs, modesty panel, optional filler panel (partial modesty panel), two transitional size end panels, ganging plates, one round leg, one 9" tall steel partial modesty panel along the 60" or 72" side, and all required assembly hardware
- Each leg has four cable access grommet locations
- Top has two cable access grommets above the legs
- Top grommets allow for attachment of overhead storage units (see pages 48-53)
- Modesty panel allows for optional 10-wire electrical system (see pages 59 & 60)
- Edging for all tops is a 3mm PVC edge banding

24 x 48"	BVD2448P	B	<input type="checkbox"/>	<input type="checkbox"/>	<input type="checkbox"/>
24 x 54"	BVD2454P	B	<input type="checkbox"/>	<input type="checkbox"/>	<input type="checkbox"/>
24 x 60"	BVD2460P	B	<input type="checkbox"/>	<input type="checkbox"/>	<input type="checkbox"/>
24 x 66"	BVD2466P	B	<input type="checkbox"/>	<input type="checkbox"/>	<input type="checkbox"/>
24 x 72"	BVD2472P	B	<input type="checkbox"/>	<input type="checkbox"/>	<input type="checkbox"/>
30 x 48"	BVD3048P	B	<input type="checkbox"/>	<input type="checkbox"/>	<input type="checkbox"/>
30 x 54"	BVD3054P	B	<input type="checkbox"/>	<input type="checkbox"/>	<input type="checkbox"/>
30 x 60"	BVD3060P	B	<input type="checkbox"/>	<input type="checkbox"/>	<input type="checkbox"/>
30 x 66"	BVD3066P	B	<input type="checkbox"/>	<input type="checkbox"/>	<input type="checkbox"/>
30 x 72"	BVD3072P	B	<input type="checkbox"/>	<input type="checkbox"/>	<input type="checkbox"/>
36 x 48"	BVD3648P	B	<input type="checkbox"/>	<input type="checkbox"/>	<input type="checkbox"/>
36 x 54"	BVD3654P	B	<input type="checkbox"/>	<input type="checkbox"/>	<input type="checkbox"/>
36 x 60"	BVD3660P	B	<input type="checkbox"/>	<input type="checkbox"/>	<input type="checkbox"/>
36 x 66"	BVD3666P	B	<input type="checkbox"/>	<input type="checkbox"/>	<input type="checkbox"/>
36 x 72"	BVD3672P	B	<input type="checkbox"/>	<input type="checkbox"/>	<input type="checkbox"/>

**A** **B** **C** **D** **E**

### HOW TO ORDER

Indicate the following information on order form:

1. Quantity of each item.
2. Model Number, including options. See "How to Build a Model Number".
3. Any special service required.

Note: • The  indicates that a choice is required.  
 • The absence of the  indicates that no choice is required.  
 • Alpha-numeric characters in place of  indicate that no other options are available.

### HOW TO BUILD A MODEL NUMBER

**A** Select size of worksurface (left to right).

**B** Select transition end panel.  
**B** = Both end panels transition

**C** Select trim color (edge and grommets).\*

**B** = Black = 27  
**G** = Grey = 29  
**L** = Light Tone = 32  
**S** = Sand = 28  
**W** = Warm Grey = 33  
 \*Trim color matches paint color.

**D** Select paint color.

**27** = Black  
**29** = Grey  
**33** = Warm Grey  
**28** = Sand  
**32** = Light Tone  
**59** = Juniper  
**25** = Medium Bronze  
**26** = Hunter Green  
**31** = Eggshell White

**50** = Beige  
**51** = Baltic  
**52** = Bordeaux  
**SP** = COM

**E** Select laminate surface.

**AA** = Cream  
**AB** = Champagne  
**AC** = Barcelona  
**AF** = Aruba Tan  
**AG** = Black  
**AH** = Dark Gray  
**AI** = Dawn Gray (Greige)  
**AJ** = Fog  
**AK** = Black Grandin  
**AL** = Smoke Granite  
**AM** = Sand Grandin  
**AN** = Light Granite  
**AO** = Tundra  
**AP** = Earthen  
**AQ** = Rose Graphix  
**AS** = Sierra Graphix  
**AT** = Beige Grafix

**AU** = Sand Stone  
**AV** = Kentucky Walnut  
**AW** = Tennessee Oak  
**AX** = Light Oak  
**AY** = Red Birch  
**AZ** = Ash  
**BA** = Philadelphia Cherry  
**BB** = Pennsylvania Cherry  
**BC** = Mahogany  
**BD** = Oak  
**BE** = Maple  
**BF** = Pearwood  
**ZZ** = COM



U.S. Department of Justice

**UNICOR**

Federal Prison Industries, Inc.

**Bravo Desks**

D-Shaped Worksurfaces

Edge Style



PVC Edge  
Price

\$380

396

411

427

442

390

406

422

437

453

409

424

440

455

471

357

372

388

403

419

366

381

397

412

428

383

398

414



429

445

Specifications and prices are subject to  
change without prior notice.

# Bravo Desks

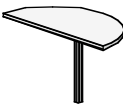
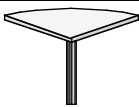
## Add-On Worksurfaces

MODEL	D x Dia.	MODEL NUMBER				
		Worksurface	Trim Color	Glides/Casters	Paint Color	Laminate
 <p><b>Round Add-On Worksurface</b></p> <ul style="list-style-type: none"> <li>Consists of top, 36" or 42" diameter, ganging plates for attaching to existing desks, and all required assembly hardware</li> <li>Edging for all tops is a 3mm PVC edge banding</li> <li>Glide only</li> </ul>	<b>24 x 36" dia</b>	BVRA2436	<input type="checkbox"/>		<input type="checkbox"/>	<input type="checkbox"/>
	<b>30 x 42" dia</b>	BVRA3042	<input type="checkbox"/>		<input type="checkbox"/>	<input type="checkbox"/>
<b>D x Rad.</b>						
 <p><b>Half Round Add-On Worksurface</b></p> <ul style="list-style-type: none"> <li>Consists of top, 24" or 30" radius, ganging plates for attaching to existing desks, and all required assembly hardware</li> <li>Edging for all tops is a 3mm PVC edge banding</li> <li>Glide only</li> </ul>	<b>48 x 24" rad</b>	BVHA2448	<input type="checkbox"/>		<input type="checkbox"/>	<input type="checkbox"/>
	<b>60 x 30" rad</b>	BVHA3060	<input type="checkbox"/>		<input type="checkbox"/>	<input type="checkbox"/>
<b>D x Rad.</b>						
 <p><b>Quarter Round Add-On Worksurface</b></p> <ul style="list-style-type: none"> <li>Consists of top, 24" or 30" radius, ganging plates for attaching to existing desks, and all required assembly hardware</li> <li>Edging for all tops is a 3mm PVC edge banding</li> <li>Glide only</li> </ul>	<b>24 x 24" rad</b>	BVQA2424	<input type="checkbox"/>		<input type="checkbox"/>	<input type="checkbox"/>
	<b>30 x 30" rad</b>	BVQA3030	<input type="checkbox"/>		<input type="checkbox"/>	<input type="checkbox"/>
<b>D x Rad.</b>						
 <p><b>Mobile Half Round Add-On Worksurface</b></p> <ul style="list-style-type: none"> <li>Edging for all tops is a 3mm PVC edge banding</li> <li>Base consists of three 3" diameter metal support legs with adjustable chrome-plated glide</li> <li>Powder-coat finish on legs</li> <li>Connects to end of 24" or 30" worksurface</li> <li>Notched in center for wire management</li> <li>Wi reway not available</li> <li>29" height only with or without casters</li> <li>3" casters are optional; two are locking</li> </ul>	<b>24 x 48"</b>	WMSC48	<input type="checkbox"/>	<input type="checkbox"/>	<input type="checkbox"/>	<input type="checkbox"/>
	<b>30 x 60"</b>	WMSC60	<input type="checkbox"/>	<input type="checkbox"/>	<input type="checkbox"/>	<input type="checkbox"/>
			<b>A</b>	<b>B</b>	<b>C</b>	<b>D</b>
			<b>E</b>			

### HOW TO ORDER

Indicate the following information on order form:

- Quantity of each item.
- Model Number, including options. See "How to Build a Model Number".
- Any special service required.

Note:  indicates that a choice is required.  
 indicates that no choice is required.  
 Alpha-numeric characters in place of  indicate that no other options are available.

### HOW TO BUILD A MODEL NUMBER

**A** Select size of worksurface (left to right).

**B** Select trim color (edge).\*

**B** = Black = 27

**G** = Grey = 29

**L** = Light Tone = 32

**S** = Sand = 28

**W** = Warm Grey = 33

\*Trim color matches paint color.

**C** Select glides or casters.

**G** = Glides

**C** = Casters (**Add \$26**)

**D** Select paint color (column leg).

**27** = Black

**29** = Grey

**33** = Warm Grey

**28** = Sand

**32** = Light Tone

**59** = Juniper

**25** = Medium Bronze

**26** = Hunter Green

**31** = Eggshell White

**50** = Beige

**51** = Baltic

**52** = Bordeaux

**SP** = COM

**E** Select laminate surface.

**AA** = Cream

**AB** = Champagne

**AC** = Barcelona

**AF** = Aruba Tan

**AG** = Black

**AH** = Dark Gray

**AI** = Dawn Gray (Greige)

**AJ** = Fog

**AK** = Black Grandin

**AL** = Smoke Granite

**AM** = Sand Grandin

**AN** = Light Granite

**AO** = Tundra

**AP** = Earthen

**AQ** = Rose Graphix

**AS** = Sierra Graphix

**AT** = Beige Grafix

**AU** = Sand Stone

**AV** = Kentucky Walnut

**AW** = Tennessee Oak

**AX** = Light Oak

**AY** = Red Birch

**AZ** = Ash

**BA** = Philadelphia Cherry

**BB** = Pennsylvania Cherry

**BC** = Mahogany

**BD** = Oak

**BE** = Maple

**BF** = Pearwood

**ZZ** = COM



U.S. Department of Justice

**UNICOR**

Federal Prison Industries, Inc.

**Bravo Desks**

Add-On Worksurfaces

Edge Style



PVC Edge  
Price

\$152

184

145

171

119

145

200

230

**INFORMATION**

The first dimension in the model number refers to the length of the straight edge.

**Specifications and prices are subject to change without prior notice.**

# Bravo Desks

Transaction Worksurfaces

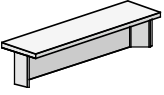
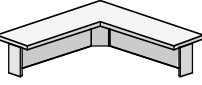
MODEL	Length	MODEL NUMBER			
		Worksurface	Trim Color	Paint Color	Laminate
 <p><b>Transaction Counter Standard Height Straight</b></p> <ul style="list-style-type: none"> <li>Consists of a top, two stanchions, steel privacy panel, and all required assembly hardware</li> <li>Top of transaction surface is approximately 42" from floor</li> <li>Space below transaction surface = 11½"</li> <li>Edging for all tops is a 3mm PVC edge banding</li> </ul>	24"	BVTSS24	<input type="checkbox"/>	<input type="checkbox"/>	<input type="checkbox"/>
	30"	BVTSS30	<input type="checkbox"/>	<input type="checkbox"/>	<input type="checkbox"/>
	36"	BVTSS36	<input type="checkbox"/>	<input type="checkbox"/>	<input type="checkbox"/>
	42"	BVTSS42	<input type="checkbox"/>	<input type="checkbox"/>	<input type="checkbox"/>
	48"	BVTSS48	<input type="checkbox"/>	<input type="checkbox"/>	<input type="checkbox"/>
	54"	BVTSS54	<input type="checkbox"/>	<input type="checkbox"/>	<input type="checkbox"/>
	60"	BVTSS60	<input type="checkbox"/>	<input type="checkbox"/>	<input type="checkbox"/>
	66"	BVTSS66	<input type="checkbox"/>	<input type="checkbox"/>	<input type="checkbox"/>
	72"	BVTSS72	<input type="checkbox"/>	<input type="checkbox"/>	<input type="checkbox"/>
	Left Length x Right Length				
 <p><b>Transaction Counter Standard Height Corner</b></p> <ul style="list-style-type: none"> <li>Consists of a top, three stanchions, steel privacy panels, and all required assembly hardware</li> <li>Top of transaction surface is approximately 42" from floor</li> <li>Space below transaction surface = 11½"</li> <li>Edging for all tops is a 3mm PVC edge banding</li> </ul>	42 x 42"	BVTSC4242	<input type="checkbox"/>	<input type="checkbox"/>	<input type="checkbox"/>
	48 x 48"	BVTSC4848	<input type="checkbox"/>	<input type="checkbox"/>	<input type="checkbox"/>
	48 x 60"	BVTSC4860	<input type="checkbox"/>	<input type="checkbox"/>	<input type="checkbox"/>
	48 x 66"	BVTSC4866	<input type="checkbox"/>	<input type="checkbox"/>	<input type="checkbox"/>
	48 x 72"	BVTSC4872	<input type="checkbox"/>	<input type="checkbox"/>	<input type="checkbox"/>
	60 x 48"	BVTSC6048	<input type="checkbox"/>	<input type="checkbox"/>	<input type="checkbox"/>
	66 x 48"	BVTSC6648	<input type="checkbox"/>	<input type="checkbox"/>	<input type="checkbox"/>
	72 x 48"	BVTSC7248	<input type="checkbox"/>	<input type="checkbox"/>	<input type="checkbox"/>

**A**   **B**   **C**   **D**

## HOW TO ORDER

Indicate the following information on order form:

- Quantity of each item.
- Model Number, including options. See "How to Build a Model Number".
- Any special service required.

Note: • The  indicates that a choice is required.  
 • The absence of the  indicates that no choice is required.  
 • Alpha-numeric characters in place of  indicate that no other options are available.

## HOW TO BUILD A MODEL NUMBER

- A** Select size of worksurface (left to right).  
**B** Select trim color (edge and stanchion cover).\*
- B** = Black = 27  
**G** = Grey = 29  
**L** = Light Tone = 32  
**S** = Sand = 28  
**W** = Warm Grey = 33  
 \*Trim color matches paint color.
- C** Select paint color (stanchions and below surface panel).  
**27** = Black  
**29** = Grey  
**33** = Warm Grey  
**28** = Sand  
**32** = Light Tone  
**59** = Juniper  
**25** = Medium Bronze  
**26** = Hunter Green  
**31** = Eggshell White  
**50** = Beige

- 51** = Baltic  
**52** = Bordeaux  
**SP** = COM
- E** Select laminate surface.  
**AA** = Cream  
**AB** = Champagne  
**AC** = Barcelona  
**AF** = Aruba Tan  
**AG** = Black  
**AH** = Dark Gray  
**AI** = Dawn Gray (Greige)  
**AJ** = Fog  
**AK** = Black Grandin  
**AL** = Smoke Granite  
**AM** = Sand Grandin  
**AN** = Light Granite  
**AO** = Tundra  
**AP** = Earthen  
**AQ** = Rose Graphix  
**AS** = Sierra Graphix  
**AT** = Beige Grafix

- AU** = Sand Stone  
**AV** = Kentucky Walnut  
**AW** = Tennessee Oak  
**AX** = Light Oak  
**AY** = Red Birch  
**AZ** = Ash  
**BA** = Philadelphia Cherry  
**BB** = Pennsylvania Cherry  
**BC** = Mahogany  
**BD** = Oak  
**BE** = Maple  
**BF** = Pearwood  
**ZZ** = COM



U.S. Department of Justice

**UNICOR**

Federal Prison Industries, Inc.

**Bravo Desks**

Transaction Worksurfaces

**Edge Style**



PVC Edge  
Price

\$173

182

191

200

209

218

227

236

245

341

372

409

438

467

409

438

467

**INFORMATION**

**Note:**



Transaction surfaces must be specified with worksurface desks of the same size.

**Specifications and prices are subject to change without prior notice.**



# Bravo Desks

## Transaction Low Height Worksurfaces

MODEL	Length	MODEL NUMBER			
		Worksurface	Trim Color	Paint Color	Laminate
 <p><b>Transaction Counter Low Height Straight</b></p> <ul style="list-style-type: none"> <li>Consists of a top, two stanchions, steel privacy panel, and all required assembly hardware</li> <li>Top of transaction surface is approximately 34" from floor</li> <li>Space below transaction surface = 3 3/4"</li> <li>Edging for all tops is a 3mm PVC edge banding</li> </ul>	24"	BVTLS24	<input type="checkbox"/>	<input type="checkbox"/>	<input type="checkbox"/>
	30"	BVTLS30	<input type="checkbox"/>	<input type="checkbox"/>	<input type="checkbox"/>
	36"	BVTLS36	<input type="checkbox"/>	<input type="checkbox"/>	<input type="checkbox"/>
	42"	BVTLS42	<input type="checkbox"/>	<input type="checkbox"/>	<input type="checkbox"/>
	48"	BVTLS48	<input type="checkbox"/>	<input type="checkbox"/>	<input type="checkbox"/>
	54"	BVTLS54	<input type="checkbox"/>	<input type="checkbox"/>	<input type="checkbox"/>
	60"	BVTLS60	<input type="checkbox"/>	<input type="checkbox"/>	<input type="checkbox"/>
	66"	BVTLS66	<input type="checkbox"/>	<input type="checkbox"/>	<input type="checkbox"/>
	72"	BVTLS72	<input type="checkbox"/>	<input type="checkbox"/>	<input type="checkbox"/>
	Left Length x Right Length				
 <p><b>Transaction Counter Low Height Corner</b></p> <ul style="list-style-type: none"> <li>Consists of a top, three stanchions, steel privacy panels, and all required assembly hardware</li> <li>Top of transaction surface is approximately 34" from floor</li> <li>Space below transaction surface = 3 3/4"</li> <li>Edging for all tops is a 3mm PVC edge banding</li> </ul>	42 x 42"	BVTLC4242	<input type="checkbox"/>	<input type="checkbox"/>	<input type="checkbox"/>
	48 x 48"	BVTLC4848	<input type="checkbox"/>	<input type="checkbox"/>	<input type="checkbox"/>
	48 x 60"	BVTLC4860	<input type="checkbox"/>	<input type="checkbox"/>	<input type="checkbox"/>
	48 x 66"	BVTLC4866	<input type="checkbox"/>	<input type="checkbox"/>	<input type="checkbox"/>
	48 x 72"	BVTLC4872	<input type="checkbox"/>	<input type="checkbox"/>	<input type="checkbox"/>
	60 x 48"	BVTLC6048	<input type="checkbox"/>	<input type="checkbox"/>	<input type="checkbox"/>
	66 x 48"	BVTLC6648	<input type="checkbox"/>	<input type="checkbox"/>	<input type="checkbox"/>
	72 x 48"	BVTLC7248	<input type="checkbox"/>	<input type="checkbox"/>	<input type="checkbox"/>

A B C D

### HOW TO ORDER

Indicate the following information on order form:

- Quantity of each item.
- Model Number, including options. See "How to Build a Model Number".
- Any special service required.

Note: • The  indicates that a choice is required.  
 • The absence of the  indicates that no choice is required.  
 • Alpha-numeric characters in place of  indicate that no other options are available.

### HOW TO BUILD A MODEL NUMBER

- A** Select size of worksurface (left to right).
- B** Select trim color (edge and stanchion cover).\*
- B** = Black = 27  
**G** = Grey = 29  
**L** = Light Tone = 32  
**S** = Sand = 28  
**W** = Warm Grey = 33  
 \*Trim color matches paint color.
- C** Select paint color (stanchions and below surface panel).
- 27** = Black  
**29** = Grey  
**33** = Warm Grey  
**28** = Sand  
**32** = Light Tone  
**59** = Juniper  
**25** = Medium Bronze  
**26** = Hunter Green  
**31** = Eggshell White  
**50** = Beige

- 51** = Baltic  
**52** = Bordeaux  
**SP** = COM
- E** Select laminate surface.
- AA** = Cream  
**AB** = Champagne  
**AC** = Barcelona  
**AF** = Aruba Tan  
**AG** = Black  
**AH** = Dark Gray  
**AI** = Dawn Gray (Greige)  
**AJ** = Fog  
**AK** = Black Grandin  
**AL** = Smoke Granite  
**AM** = Sand Grandin  
**AN** = Light Granite  
**AO** = Tundra  
**AP** = Earthen  
**AQ** = Rose Graphix  
**AS** = Sierra Graphix  
**AT** = Beige Grafix

- AU** = Sand Stone  
**AV** = Kentucky Walnut  
**AW** = Tennessee Oak  
**AX** = Light Oak  
**AY** = Red Birch  
**AZ** = Ash  
**BA** = Philadelphia Cherry  
**BB** = Pennsylvania Cherry  
**BC** = Mahogany  
**BD** = Oak  
**BE** = Maple  
**BF** = Pearwood  
**ZZ** = COM



U.S. Department of Justice

**UNICOR**

Federal Prison Industries, Inc.

**Bravo Desks**

Transaction Low Height Worksurfaces

Edge Style



PVC Edge  
Price

\$188

196

204

211

219

227

235

243

250

356

385

420

447

475

420

447

475

**INFORMATION**

Transaction surfaces must be specified with worksurface desks of the same size.

**Specifications and prices are subject to change without prior notice.**

# Bravo Desks

## Executive Desks

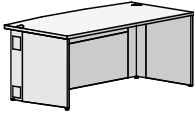

### MODEL

#### Executive Desk

- Consists of a top, two legs, full modesty panel, and standard depth end panels
- Each leg has four cable access grommet locations
- Top has two cable access grommets above the legs
- Modesty panel allows for optional 10-wire electrical system (see pages 59 & 60)
- "Guest" side of desk has a 6" deep bowed overhang worksurface edge
- Edging for all tops is a 3mm PVC edge banding

D x L	MODEL NUMBER				
	Worksurface	End Panel	Trim Color	Paint Color	Laminate
24 x 60"	BVED2460F	S	<input type="checkbox"/>	<input type="checkbox"/>	<input type="checkbox"/>
24 x 66"	BVED2466F	S	<input type="checkbox"/>	<input type="checkbox"/>	<input type="checkbox"/>
24 x 72"	BVED2472F	S	<input type="checkbox"/>	<input type="checkbox"/>	<input type="checkbox"/>
30 x 60"	BVED3060F	S	<input type="checkbox"/>	<input type="checkbox"/>	<input type="checkbox"/>
30 x 66"	BVED3066F	S	<input type="checkbox"/>	<input type="checkbox"/>	<input type="checkbox"/>
30 x 72"	BVED3072F	S	<input type="checkbox"/>	<input type="checkbox"/>	<input type="checkbox"/>

**A**      **B**      **C**      **D**      **E**

### HOW TO ORDER

Indicate the following information on order form:

- Quantity of each item.
- Model Number, including options. See "How to Build a Model Number".
- Any special service required.

- Note:
- The  indicates that a choice is required.
  - The absence of the  indicates that no choice is required.
  - Alpha-numeric characters in place of  indicate that no other options are available.

### HOW TO BUILD A MODEL NUMBER

**A** Select size of worksurface.

**B** End panel.

**S** = Standard

**C** Select trim color (edge and grommets).\*

**B** = Black = 27

**G** = Grey = 29

**L** = Light Tone = 32

**S** = Sand = 28

**W** = Warm Grey = 33

\*Trim color matches paint color.

**D** Select paint color.

**27** = Black

**29** = Grey

**33** = Warm Grey

**28** = Sand

**32** = Light Tone

**59** = Juniper

**25** = Medium Bronze

**26** = Hunter Green

**31** = Eggshell White

**50** = Beige

**51** = Baltic

**52** = Bordeaux

**SP** = COM

**E** Select laminate surface.

**AA** = Cream

**AB** = Champagne

**AC** = Barcelona

**AF** = Aruba Tan

**AG** = Black

**AH** = Dark Gray

**AI** = Dawn Gray (Greige)

**AJ** = Fog

**AK** = Black Grandin

**AL** = Smoke Granite

**AM** = Sand Grandin

**AN** = Light Granite

**AO** = Tundra

**AP** = Earthen

**AQ** = Rose Graphix

**AS** = Sierra Graphix

**AT** = Beige Grafix

**AU** = Sand Stone

**AV** = Kentucky Walnut

**AW** = Tennessee Oak

**AX** = Light Oak

**AY** = Red Birch

**AZ** = Ash

**BA** = Philadelphia Cherry

**BB** = Pennsylvania Cherry

**BC** = Mahogany

**BD** = Oak

**BE** = Maple

**BF** = Pearwood

**ZZ** = COM



U.S. Department of Justice

**UNICOR**

Federal Prison Industries, Inc.

**Bravo Desks**

Executive Desks

Edge Style



PVC Edge  
Price

\$429

438

448

441

450

459

Specifications and prices are subject to  
change without prior notice.

# Bravo Components

## Privacy Screens

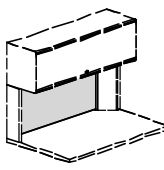
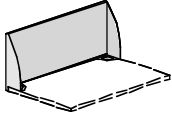
MODEL	H x W	MODEL NUMBER				
		Privacy Screen	Frame Options	Paint Color	Screen Fabric	
 <p><b>Between Stanchion Mounted Screen</b></p> <ul style="list-style-type: none"> <li>Mounts above the worksurface mounted from the stanchions used to support any overhead storage unit</li> <li>Available in:                             <ul style="list-style-type: none"> <li>completely upholstered (upholstered frame)</li> <li>exposed frame (core upholstered, frame painted)</li> <li>translucent (core is translucent, frame painted)</li> </ul> </li> <li>Includes screen and all required mounting hardware</li> <li>"W" size refers to the desk size screen is mounted on (not the distance between stanchions)</li> </ul>	<b>19 x 24"</b>	BVSBS1924	<input type="checkbox"/>	<input type="checkbox"/>	<input type="checkbox"/>	<input type="checkbox"/>
	<b>19 x 30"</b>	BVSBS1930	<input type="checkbox"/>	<input type="checkbox"/>	<input type="checkbox"/>	<input type="checkbox"/>
	<b>19 x 36"</b>	BVSBS1936	<input type="checkbox"/>	<input type="checkbox"/>	<input type="checkbox"/>	<input type="checkbox"/>
	<b>19 x 42"</b>	BVSBS1942	<input type="checkbox"/>	<input type="checkbox"/>	<input type="checkbox"/>	<input type="checkbox"/>
	<b>19 x 48"</b>	BVSBS1948	<input type="checkbox"/>	<input type="checkbox"/>	<input type="checkbox"/>	<input type="checkbox"/>
	<b>19 x 54"</b>	BVSBS1954	<input type="checkbox"/>	<input type="checkbox"/>	<input type="checkbox"/>	<input type="checkbox"/>
	<b>19 x 60"</b>	BVSBS1960	<input type="checkbox"/>	<input type="checkbox"/>	<input type="checkbox"/>	<input type="checkbox"/>
	<b>19 x 66"</b>	BVSBS1966	<input type="checkbox"/>	<input type="checkbox"/>	<input type="checkbox"/>	<input type="checkbox"/>
	<b>19 x 72"</b>	BVSBS1972	<input type="checkbox"/>	<input type="checkbox"/>	<input type="checkbox"/>	<input type="checkbox"/>
	 <p><b>Behind Worksurface Mounted Screen</b></p> <ul style="list-style-type: none"> <li>Mounts behind the back edge of the worksurface on brackets that attach through grommets of worksurface</li> <li>Available in:                             <ul style="list-style-type: none"> <li>completely upholstered (upholstered frame)</li> <li>exposed frame (core upholstered, frame painted)</li> <li>translucent (core is translucent, frame painted)</li> </ul> </li> <li>Includes screen and all required mounting hardware</li> <li>"W" size refers to the desk size screen is mounted on</li> <li>Available in two heights:                             <ul style="list-style-type: none"> <li>20" matches the height of a stanchion mounted screen</li> <li>38" matches the height of an overhead storage unit</li> </ul> </li> <li>66" and 72" BVSBW screens are made up of two smaller screens</li> </ul>	<b>20 x 24"</b>	BVSBW2024	<input type="checkbox"/>	<input type="checkbox"/>	<input type="checkbox"/>
<b>20 x 30"</b>		BVSBW2030	<input type="checkbox"/>	<input type="checkbox"/>	<input type="checkbox"/>	<input type="checkbox"/>
<b>20 x 36"</b>		BVSBW2036	<input type="checkbox"/>	<input type="checkbox"/>	<input type="checkbox"/>	<input type="checkbox"/>
<b>20 x 42"</b>		BVSBW2042	<input type="checkbox"/>	<input type="checkbox"/>	<input type="checkbox"/>	<input type="checkbox"/>
<b>20 x 48"</b>		BVSBW2048	<input type="checkbox"/>	<input type="checkbox"/>	<input type="checkbox"/>	<input type="checkbox"/>
<b>20 x 54"</b>		BVSBW2054	<input type="checkbox"/>	<input type="checkbox"/>	<input type="checkbox"/>	<input type="checkbox"/>
<b>20 x 60"</b>		BVSBW2060	<input type="checkbox"/>	<input type="checkbox"/>	<input type="checkbox"/>	<input type="checkbox"/>
<b>20 x 66"</b>		BVSBW2066	<input type="checkbox"/>	<input type="checkbox"/>	<input type="checkbox"/>	<input type="checkbox"/>
<b>20 x 72"</b>		BVSBW2072	<input type="checkbox"/>	<input type="checkbox"/>	<input type="checkbox"/>	<input type="checkbox"/>
<b>38 x 24"</b>		BVSBW3824	<input type="checkbox"/>	<input type="checkbox"/>	<input type="checkbox"/>	<input type="checkbox"/>
<b>38 x 30"</b>		BVSBW3830	<input type="checkbox"/>	<input type="checkbox"/>	<input type="checkbox"/>	<input type="checkbox"/>
<b>38 x 36"</b>		BVSBW3836	<input type="checkbox"/>	<input type="checkbox"/>	<input type="checkbox"/>	<input type="checkbox"/>
<b>38 x 42"</b>		BVSBW3842	<input type="checkbox"/>	<input type="checkbox"/>	<input type="checkbox"/>	<input type="checkbox"/>
<b>38 x 48"</b>		BVSBW3848	<input type="checkbox"/>	<input type="checkbox"/>	<input type="checkbox"/>	<input type="checkbox"/>
<b>38 x 54"</b>		BVSBW3854	<input type="checkbox"/>	<input type="checkbox"/>	<input type="checkbox"/>	<input type="checkbox"/>
<b>38 x 60"</b>		BVSBW3860	<input type="checkbox"/>	<input type="checkbox"/>	<input type="checkbox"/>	<input type="checkbox"/>
<b>38 x 66"</b>		BVSBW3866	<input type="checkbox"/>	<input type="checkbox"/>	<input type="checkbox"/>	<input type="checkbox"/>
<b>38 x 72"</b>		BVSBW3872	<input type="checkbox"/>	<input type="checkbox"/>	<input type="checkbox"/>	<input type="checkbox"/>

**A**      **B**      **C**      **D**

### HOW TO ORDER

Indicate the following information on order form:

- Quantity of each item.
- Model Number, including options. See "How to Build a Model Number".
- Any special service required.

Note:

- The  indicates that a choice is required.
- The absence of the  indicates that no choice is required.
- Alpha-numeric characters in place of  indicate that no other options are available.

### HOW TO BUILD A MODEL NUMBER

- A** Select privacy screen size.
- B** Select frame options.
- UF = Upholstered frame  
EF = Exposed frame  
TF = Translucent
- C** Select paint color.
- 27 = Black  
29 = Grey  
33 = Warm Grey  
28 = Sand  
32 = Light Tone  
59 = Juniper  
25 = Medium Bronze  
26 = Hunter Green  
31 = Eggshell White  
50 = Beige  
51 = Baltic  
52 = Bordeaux  
SP = COM

- D** Select screen fabric.
- Group A:
- Pattern Name FR701**
- 1511 = Blue Neutral  
1506 = Green Neutral  
1518 = Wedgewood  
1510 = Silver Papier  
1546 = Cherry Neutral  
1515 = Quartz  
1531 = Gray Mix
- Pattern Name Eclipse**
- 4595 = Meteor  
1690 = Tourmaline  
4604 = Chicory  
4605 = Amber Grain  
4593 = Serengeti  
4594 = Coco Palm  
1691 = Iron Ore

### Pattern Name Carrara

- 9447 = Beeswax  
9454 = Verdigris  
9456 = Tinctoria  
9455 = Green Earth  
9448 = Teak Oil  
9445 = Gesso  
9444 = Casein

### Pattern Name Galaxy

- 4526 = Desert Sand Gravel  
4538 = Bermuda Seamist  
4544 = Blueberry Sky  
4542 = Sundew Sandrift  
4525 = Fog Stardust  
4531 = Gobi Moonbeam  
4541 = Wrought Silver



FRAME STYLE				
"UF" Upholstered Frame		"EF" Exposed Frame		"TF" Translucent Frame
Fabric A Price	Fabric B Price	Fabric A Price	Fabric B Price	Price
\$100	\$102	\$ 90	\$ 92	\$ 85
105	107	95	97	90
110	112	100	102	95
117	119	107	109	102
124	126	114	116	109
132	135	122	124	117
140	143	130	133	125
150	153	140	143	135
160	163	150	153	145
130	133	120	122	115
135	138	125	128	120
140	143	130	133	125
147	150	137	140	132
154	157	144	147	139
162	165	152	155	147
170	173	160	163	155
225	230	215	219	210
235	240	225	230	220
140	143	130	133	125
148	151	138	141	133
158	161	148	151	143
170	173	160	163	155
182	186	172	175	167
197	201	187	191	182
212	216	202	206	197
267	272	257	262	252
277	283	267	272	262

Group B:

**Pattern Name Serendipity**

**9617** = Coincidence

**9626** = Four Leaf Clover

**9622** = Lady Luck

**9619** = Guardian Angel

**9620** = Lucky Duck

**9618** = Fortuitous

**9624** = Silver Spoon

Specifications and prices are subject to change without prior notice.

# Bravo Components

## Privacy Screens

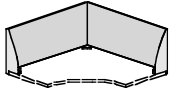

MODEL	Left H x Length x Length	Right H x Length	MODEL NUMBER				
			Privacy Screen	Frame Options	Paint Color	Screen Fabric	
<b>Behind Worksurface Mounted Corner Screen</b> <ul style="list-style-type: none"> <li>Mounts behind the back edge of the work surface on brackets that attach to the underside of the work surface</li> <li>Available in:                             <ul style="list-style-type: none"> <li>completely upholstered (upholstered frame)</li> <li>exposed frame (core upholstered, frame painted)</li> <li>translucent (core is translucent, frame painted)</li> </ul> </li> <li>Includes screen and all required mounting hardware</li> <li>"W" size refers to the desk size screen is mounted on</li> <li>Available in two heights:                             <ul style="list-style-type: none"> <li>20" matches the height of a stanchion mounted screen</li> <li>38" matches the height of an overhead storage unit</li> </ul> </li> <li>66" and 72" BSBWC screens are made up of two smaller screens</li> </ul>	20 x 42 x 42"	42"	BSBWC204242	<input type="checkbox"/>	<input type="checkbox"/>	<input type="checkbox"/>	<input type="checkbox"/>
	20 x 48 x 48"	48"	BSBWC204848	<input type="checkbox"/>	<input type="checkbox"/>	<input type="checkbox"/>	<input type="checkbox"/>
	20 x 48 x 60"	60"	BSBWC204860	<input type="checkbox"/>	<input type="checkbox"/>	<input type="checkbox"/>	<input type="checkbox"/>
	* 20 x 48 x 66"	66"	BSBWC204866	<input type="checkbox"/>	<input type="checkbox"/>	<input type="checkbox"/>	<input type="checkbox"/>
	** 20 x 48 x 72"	72"	BSBWC204872	<input type="checkbox"/>	<input type="checkbox"/>	<input type="checkbox"/>	<input type="checkbox"/>
	20 x 60 x 48"	60"	BSBWC206048	<input type="checkbox"/>	<input type="checkbox"/>	<input type="checkbox"/>	<input type="checkbox"/>
	* 20 x 66 x 48"	66"	BSBWC206648	<input type="checkbox"/>	<input type="checkbox"/>	<input type="checkbox"/>	<input type="checkbox"/>
	** 20 x 72 x 48"	72"	BSBWC207248	<input type="checkbox"/>	<input type="checkbox"/>	<input type="checkbox"/>	<input type="checkbox"/>
	38 x 42 x 42"	42"	BSBWC384242	<input type="checkbox"/>	<input type="checkbox"/>	<input type="checkbox"/>	<input type="checkbox"/>
	38 x 48 x 48"	48"	BSBWC384848	<input type="checkbox"/>	<input type="checkbox"/>	<input type="checkbox"/>	<input type="checkbox"/>
	38 x 48 x 60"	60"	BSBWC384860	<input type="checkbox"/>	<input type="checkbox"/>	<input type="checkbox"/>	<input type="checkbox"/>
	* 38 x 48 x 66"	66"	BSBWC384866	<input type="checkbox"/>	<input type="checkbox"/>	<input type="checkbox"/>	<input type="checkbox"/>
	** 38 x 48 x 72"	72"	BSBWC384872	<input type="checkbox"/>	<input type="checkbox"/>	<input type="checkbox"/>	<input type="checkbox"/>
	38 x 60 x 48"	60"	BSBWC386048	<input type="checkbox"/>	<input type="checkbox"/>	<input type="checkbox"/>	<input type="checkbox"/>
	* 38 x 66 x 48"	66"	BSBWC386648	<input type="checkbox"/>	<input type="checkbox"/>	<input type="checkbox"/>	<input type="checkbox"/>
	** 38 x 72 x 48"	72"	BSBWC387248	<input type="checkbox"/>	<input type="checkbox"/>	<input type="checkbox"/>	<input type="checkbox"/>

Ⓐ
Ⓑ
Ⓒ
Ⓓ

### HOW TO ORDER

Indicate the following information on order form:

- Quantity of each item.
- Model Number, including options. See "How to Build a Model Number".
- Any special service required.

Note:

- The  indicates that a choice is required.
- The absence of the  indicates that no choice is required.
- Alpha-numeric characters in place of  indicate that no other options are available.

### HOW TO BUILD A MODEL NUMBER

**A** Select privacy screen size.

**B** Select frame options.

- UF** = Upholstered frame
- EF** = Exposed frame
- TF** = Translucent

**C** Select paint color.

- 27** = Black
- 29** = Grey
- 33** = Warm Grey
- 28** = Sand
- 32** = Light Tone
- 59** = Juniper
- 25** = Medium Bronze
- 26** = Hunter Green
- 31** = Eggshell White
- 50** = Beige
- 51** = Baltic
- 52** = Bordeaux
- SP** = COM

**D** Select screen fabric.

Group A:

**Pattern Name FR701**

- 1511** = Blue Neutral
- 1506** = Green Neutral
- 1518** = Wedgewood
- 1510** = Silver Papier
- 1546** = Cherry Neutral
- 1515** = Quartz
- 1531** = Gray Mix

**Pattern Name Eclipse**

- 4595** = Meteor
- 1690** = Tourmaline
- 4604** = Chicory
- 4605** = Amber Grain
- 4593** = Serengeti
- 4594** = Coco Palm
- 1691** = Iron Ore

**Pattern Name Carrara**

- 9447** = Beeswax
- 9454** = Verdigris
- 9456** = Tinctoria
- 9455** = Green Earth
- 9448** = Teak Oil
- 9445** = Gesso
- 9444** = Casein

**Pattern Name Galaxy**

- 4526** = Desert Sand Gravel
- 4538** = Bermuda Seamist
- 4544** = Blueberry Sky
- 4542** = Sundew Sandrift
- 4525** = Fog Stardust
- 4531** = Gobi Moonbeam
- 4541** = Wrought Silver



FRAME STYLE				
"UF" Upholstered Frame		"EF" Exposed Frame		"TF" Translucent Frame
Fabric A Price	Fabric B Price	Fabric A Price	Fabric B Price	Price
\$285	\$291	\$270	\$275	\$255
305	311	290	296	275
325	332	310	316	295
355	362	340	347	325
385	393	370	377	355
325	332	310	316	295
355	362	340	347	325
385	393	370	377	355
335	342	320	326	305
355	362	340	347	325
375	383	360	367	345
405	413	390	398	375
435	444	420	428	405
375	383	360	367	345
405	413	390	398	375
435	444	420	428	405

Group B:

**Pattern Name Serendipity**

**9617** = Coincidence

**9626** = Four Leaf Clover

**9622** = Lady Luck

**9619** = Guardian Angel

**9620** = Lucky Duck

**9618** = Fortuitous

**9624** = Silver Spoon

**INFORMATION**

**Notes:**

42" Back Left is only used with the 42" Back Right.

\*66" screens are made up of a separate 30" and 36" screen, a dovetail splice mechanism and mounting hardware.

\*\*72" screens are made up of two separate 36" screens, a dovetail splice mechanism and mounting hardware.

**Specifications and prices are subject to change without prior notice.**



# Bravo Components

## Privacy Screens

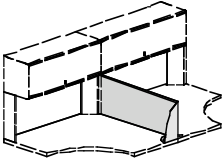
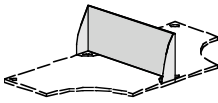
MODEL	H x W	MODEL NUMBER						
		Privacy Screen	Direction	Frame Options	Paint Color	Screen Fabric		
 <p><b>Stanchion and On-Worksurface Mounted Screen (between a stanchion and an end mount bracket)</b></p> <ul style="list-style-type: none"> <li>Mounts on the worksurface between a stanchion used to support any overhead storage unit and an end mount bracket</li> <li>Available in:                             <ul style="list-style-type: none"> <li>completely upholstered (upholstered frame)</li> <li>exposed frame (core upholstered, frame painted)</li> <li>translucent (core is translucent, frame painted)</li> </ul> </li> <li>Includes screen and all required mounting hardware</li> <li>"W" size refers to the desk size screen is mounted on (not the distance between the stanchion and the bracket)</li> <li>Available in a 19" height to match a between stanchion mounted screen</li> <li>72" BVSSO screen is made up of two smaller screens</li> </ul>	19 x 24"	BVSSO1924	<input type="checkbox"/>	<input type="checkbox"/>	<input type="checkbox"/>	<input type="checkbox"/>	<input type="checkbox"/>	<input type="checkbox"/>
	19 x 30"	BVSSO1930	<input type="checkbox"/>	<input type="checkbox"/>	<input type="checkbox"/>	<input type="checkbox"/>	<input type="checkbox"/>	<input type="checkbox"/>
	19 x 36"	BVSSO1936	<input type="checkbox"/>	<input type="checkbox"/>	<input type="checkbox"/>	<input type="checkbox"/>	<input type="checkbox"/>	<input type="checkbox"/>
	19 x 42"	BVSSO1942	<input type="checkbox"/>	<input type="checkbox"/>	<input type="checkbox"/>	<input type="checkbox"/>	<input type="checkbox"/>	<input type="checkbox"/>
	19 x 48"	BVSSO1948	<input type="checkbox"/>	<input type="checkbox"/>	<input type="checkbox"/>	<input type="checkbox"/>	<input type="checkbox"/>	<input type="checkbox"/>
	19 x 54"	BVSSO1954	<input type="checkbox"/>	<input type="checkbox"/>	<input type="checkbox"/>	<input type="checkbox"/>	<input type="checkbox"/>	<input type="checkbox"/>
	19 x 60"	BVSSO1960	<input type="checkbox"/>	<input type="checkbox"/>	<input type="checkbox"/>	<input type="checkbox"/>	<input type="checkbox"/>	<input type="checkbox"/>
	19 x 66"	BVSSO1966	<input type="checkbox"/>	<input type="checkbox"/>	<input type="checkbox"/>	<input type="checkbox"/>	<input type="checkbox"/>	<input type="checkbox"/>
	19 x 72"	BVSSO1972	<input type="checkbox"/>	<input type="checkbox"/>	<input type="checkbox"/>	<input type="checkbox"/>	<input type="checkbox"/>	<input type="checkbox"/>
 <p><b>On-Worksurface Mounted Screen (between two end mount brackets)</b></p> <ul style="list-style-type: none"> <li>Mounts on the worksurface between two end mount brackets</li> <li>Available in:                             <ul style="list-style-type: none"> <li>completely upholstered (upholstered frame)</li> <li>exposed frame (core upholstered, frame painted)</li> <li>translucent (core is translucent, frame painted)</li> </ul> </li> <li>Includes screen and all required mounting hardware</li> <li>"W" size refers to the desk size screen is mounted on</li> <li>Available in two heights:                             <ul style="list-style-type: none"> <li>19" matches the height of a stanchion mounted screen</li> <li>37" matches the height of an overhead storage unit</li> </ul> </li> <li>66" and 72" BVSOW screens are made up of two smaller screens</li> <li>19" height can accept (BSTK) stackable screens</li> <li>37" height is not stackable</li> </ul>	19 x 24"	BVSOW1924		<input type="checkbox"/>	<input type="checkbox"/>	<input type="checkbox"/>	<input type="checkbox"/>	<input type="checkbox"/>
	19 x 30"	BVSOW1930		<input type="checkbox"/>	<input type="checkbox"/>	<input type="checkbox"/>	<input type="checkbox"/>	<input type="checkbox"/>
	19 x 36"	BVSOW1936		<input type="checkbox"/>	<input type="checkbox"/>	<input type="checkbox"/>	<input type="checkbox"/>	<input type="checkbox"/>
	19 x 42"	BVSOW1942		<input type="checkbox"/>	<input type="checkbox"/>	<input type="checkbox"/>	<input type="checkbox"/>	<input type="checkbox"/>
	19 x 48"	BVSOW1948		<input type="checkbox"/>	<input type="checkbox"/>	<input type="checkbox"/>	<input type="checkbox"/>	<input type="checkbox"/>
	19 x 54"	BVSOW1954		<input type="checkbox"/>	<input type="checkbox"/>	<input type="checkbox"/>	<input type="checkbox"/>	<input type="checkbox"/>
	19 x 60"	BVSOW1960		<input type="checkbox"/>	<input type="checkbox"/>	<input type="checkbox"/>	<input type="checkbox"/>	<input type="checkbox"/>
	19 x 66"	BVSOW1966		<input type="checkbox"/>	<input type="checkbox"/>	<input type="checkbox"/>	<input type="checkbox"/>	<input type="checkbox"/>
	19 x 72"	BVSOW1972		<input type="checkbox"/>	<input type="checkbox"/>	<input type="checkbox"/>	<input type="checkbox"/>	<input type="checkbox"/>
	37 x 24"	BVSOW3724		<input type="checkbox"/>	<input type="checkbox"/>	<input type="checkbox"/>	<input type="checkbox"/>	<input type="checkbox"/>
	37 x 30"	BVSOW3730		<input type="checkbox"/>	<input type="checkbox"/>	<input type="checkbox"/>	<input type="checkbox"/>	<input type="checkbox"/>
	37 x 36"	BVSOW3736		<input type="checkbox"/>	<input type="checkbox"/>	<input type="checkbox"/>	<input type="checkbox"/>	<input type="checkbox"/>
	37 x 42"	BVSOW3742		<input type="checkbox"/>	<input type="checkbox"/>	<input type="checkbox"/>	<input type="checkbox"/>	<input type="checkbox"/>
	37 x 48"	BVSOW3748		<input type="checkbox"/>	<input type="checkbox"/>	<input type="checkbox"/>	<input type="checkbox"/>	<input type="checkbox"/>
	37 x 54"	BVSOW3754		<input type="checkbox"/>	<input type="checkbox"/>	<input type="checkbox"/>	<input type="checkbox"/>	<input type="checkbox"/>
	37 x 60"	BVSOW3760		<input type="checkbox"/>	<input type="checkbox"/>	<input type="checkbox"/>	<input type="checkbox"/>	<input type="checkbox"/>
	37 x 66"	BVSOW3766		<input type="checkbox"/>	<input type="checkbox"/>	<input type="checkbox"/>	<input type="checkbox"/>	<input type="checkbox"/>
	37 x 72"	BVSOW3772		<input type="checkbox"/>	<input type="checkbox"/>	<input type="checkbox"/>	<input type="checkbox"/>	<input type="checkbox"/>

A
B
C
D
E

### HOW TO ORDER

Indicate the following information on order form:

- Quantity of each item.
- Model Number, including options. See "How to Build a Model Number".
- Any special service required.

Note:

- The  indicates that a choice is required.
- The absence of the  indicates that no choice is required.
- Alpha-numeric characters in place of  indicate that no other options are available.

### HOW TO BUILD A MODEL NUMBER

**A** Select privacy screen size.

**B** Select bracket direction.

L = Left  
R = Right

**C** Select frame options.

UF = Upholstered frame  
EF = Exposed frame  
TF = Translucent

**D** Select paint color.

27 = Black  
29 = Grey  
33 = Warm Grey  
28 = Sand  
32 = Light Tone  
59 = Juniper  
25 = Medium Bronze  
26 = Hunter Green  
31 = Eggshell White  
50 = Beige

51 = Baltic  
52 = Bordeaux  
SP = COM

**E** Select screen fabric.

Group A:

**Pattern Name FR701**

1511 = Blue Neutral

1506 = Green Neutral

1518 = Wedgewood

1510 = Silver Papier

1546 = Cherry Neutral

1515 = Quartz

1531 = Gray Mix

**Pattern Name Eclipse**

4595 = Meteor

1690 = Tourmaline

4604 = Chicory

4605 = Amber Grain

4593 = Serengeti

4594 = Coco Palm

1691 = Iron Ore

**Pattern Name Carrara**

9447 = Beeswax

9454 = Verdigris

9456 = Tinctoria

9455 = Green Earth

9448 = Teak Oil

9445 = Gesso

9444 = Casein

**Pattern Name Galaxy**

4526 = Desert Sand Gravel

4538 = Bermuda Seamist

4544 = Blueberry Sky

4542 = Sundew Sandrift

4525 = Fog Stardust

4531 = Gobi Moonbeam

4541 = Wrought Silver



# Bravo Components

## Privacy Screens

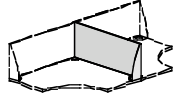

\*Right shown.

### MODEL

### H x W

### MODEL NUMBER

Privacy Screen	Direction	Frame Options	Paint Color	Screen Fabric
BSOWC1942	<input type="checkbox"/>	<input type="checkbox"/>	<input type="checkbox"/>	<input type="checkbox"/>
BSOWC1948	<input type="checkbox"/>	<input type="checkbox"/>	<input type="checkbox"/>	<input type="checkbox"/>
BSOWC1960	<input type="checkbox"/>	<input type="checkbox"/>	<input type="checkbox"/>	<input type="checkbox"/>
*19 x 66"	<input type="checkbox"/>	<input type="checkbox"/>	<input type="checkbox"/>	<input type="checkbox"/>
**19 x 72"	<input type="checkbox"/>	<input type="checkbox"/>	<input type="checkbox"/>	<input type="checkbox"/>
BSOWC3742	<input type="checkbox"/>	<input type="checkbox"/>	<input type="checkbox"/>	<input type="checkbox"/>
BSOWC3748	<input type="checkbox"/>	<input type="checkbox"/>	<input type="checkbox"/>	<input type="checkbox"/>
BSOWC3760	<input type="checkbox"/>	<input type="checkbox"/>	<input type="checkbox"/>	<input type="checkbox"/>
*37 x 66"	<input type="checkbox"/>	<input type="checkbox"/>	<input type="checkbox"/>	<input type="checkbox"/>
**37 x 72"	<input type="checkbox"/>	<input type="checkbox"/>	<input type="checkbox"/>	<input type="checkbox"/>
BSTK1924		<input type="checkbox"/>	<input type="checkbox"/>	<input type="checkbox"/>
BSTK1930		<input type="checkbox"/>	<input type="checkbox"/>	<input type="checkbox"/>
BSTK1936		<input type="checkbox"/>	<input type="checkbox"/>	<input type="checkbox"/>
BSTK1942		<input type="checkbox"/>	<input type="checkbox"/>	<input type="checkbox"/>
BSTK1948		<input type="checkbox"/>	<input type="checkbox"/>	<input type="checkbox"/>
BSTK1954		<input type="checkbox"/>	<input type="checkbox"/>	<input type="checkbox"/>
BSTK1960		<input type="checkbox"/>	<input type="checkbox"/>	<input type="checkbox"/>
*19 x 66"		<input type="checkbox"/>	<input type="checkbox"/>	<input type="checkbox"/>
**19 x 72"		<input type="checkbox"/>	<input type="checkbox"/>	<input type="checkbox"/>

### On-Worksurface Mounted Corner Screen

- Mounts along the back edge of a corner work surface and is supported by an end mount bracket, and a bracket that attaches it to a BVSBW screen
- Available in:
  - completely upholstered (upholstered frame)
  - exposed frame (core upholstered, frame painted)
  - translucent (core is translucent, frame painted)
- Includes screen and all required mounting hardware
- "W" size refers to the desk size screen is mounted on
- Available in two heights:
  - 19" matches the height of a stanchion mounted screen
  - 37" matches the height of an overhead storage unit
- 66" and 72" BSOWC screens are made up of two smaller screens
- 19" height is capable of having a stackable screen (BSTK) attached to it.
- Direction determined by the end mount bracket used

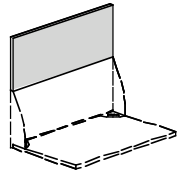

### Stackable Mounted Screen

- Mounts on top of 20" BVSBW or BSBWC screens and 19" BVSOW or BSOWC screens
- Available in:
  - completely upholstered (upholstered frame)
  - exposed frame (core upholstered, frame painted)
  - translucent (core is translucent, frame painted)
- Includes screen and all required mounting hardware
- "W" size refers to the desk size screen is mounted on
- 66" and 72" BSTK screens are made up of two smaller screens

**A**      **B**      **C**      **D**      **E**

## HOW TO ORDER

Indicate the following information on order form:

- Quantity of each item.
- Model Number, including options. See "How to Build a Model Number".
- Any special service required.

Note: • The  indicates that a choice is required.  
 • The absence of the  indicates that no choice is required.  
 • Alpha-numeric characters in place of  indicate that no other options are available.

## HOW TO BUILD A MODEL NUMBER

**A** Select privacy screen size.

**B** Select bracket direction.

**L** = Left  
**R** = Right

**C** Select frame options.

**UF** = Upholstered frame  
**EF** = Exposed frame  
**TF** = Translucent

**D** Select paint color.

**27** = Black  
**29** = Grey  
**33** = Warm Grey  
**28** = Sand  
**32** = Light Tone  
**59** = Juniper  
**25** = Medium Bronze  
**26** = Hunter Green  
**31** = Eggshell White  
**50** = Beige  
**51** = Baltic

**52** = Bordeaux

**SP** = COM

**E** Select screen fabric.

Group A:

**Pattern Name FR701**

**1511** = Blue Neutral

**1506** = Green Neutral

**1518** = Wedgewood

**1510** = Silver Papier

**1546** = Cherry Neutral

**1515** = Quartz

**1531** = Gray Mix

**Pattern Name Eclipse**

**4595** = Meteor

**1690** = Tourmaline

**4604** = Chicory

**4605** = Amber Grain

**4593** = Serengeti

**4594** = Coco Palm

**1691** = Iron Ore

**Pattern Name Carrara**

**9447** = Beeswax

**9454** = Verdigris

**9456** = Tinctoria

**9455** = Green Earth

**9448** = Teak Oil

**9445** = Gesso

**9444** = Casein

**Pattern Name Galaxy**

**4526** = Desert Sand Gravel

**4538** = Bermuda Seamist

**4544** = Blueberry Sky



**4542** = Sundew Sandrift

**4525** = Fog Stardust



# Bravo Components

Privacy Screen Accessories

MODEL	MODEL NUMBER	
	Basic Model	Paint Color
 <p><b>Stacked BSBWC Bracket</b></p> <ul style="list-style-type: none"> <li>Mounts to the ends of two BSTK screens at the 90° corner</li> <li>Connects the two BSTK screens that are on top of BSBWC 20" screens</li> </ul>	BVSSBWC	<input type="checkbox"/> <input type="checkbox"/>
 <p><b>Stacked BSOWC Bracket</b></p> <ul style="list-style-type: none"> <li>Mounts to the ends of two BSTK screens at the 90° corner</li> <li>Connects the two BSTK screens that are on top of BVSBW and BSOWC screens</li> </ul>	BVSSOWC	<input type="checkbox"/> <input type="checkbox"/>
	<b>A</b> <b>B</b>	

## HOW TO ORDER

Indicate the following information on order form:

- Quantity of each item.
- Model Number, including options. See "How to Build a Model Number".
- Any special service required.

Note:

- The  indicates that a choice is required.
- The absence of the  indicates that no choice is required.
- Alpha-numeric characters in place of  indicate that no other options are available.

## HOW TO BUILD A MODEL NUMBER

- A** Select basic model.
- B** Select paint color.
- |           |                  |
|-----------|------------------|
| <b>27</b> | = Black          |
| <b>29</b> | = Grey           |
| <b>33</b> | = Warm Grey      |
| <b>28</b> | = Sand           |
| <b>32</b> | = Light Tone     |
| <b>59</b> | = Juniper        |
| <b>25</b> | = Medium Bronze  |
| <b>26</b> | = Hunter Green   |
| <b>31</b> | = Eggshell White |
| <b>50</b> | = Beige          |
| <b>51</b> | = Baltic         |
| <b>52</b> | = Bordeaux       |
| <b>SP</b> | = COM            |



U.S. Department of Justice

**UNICOR**

Federal Prison Industries, Inc.

**Bravo Components**

Privacy Screen Accessories

Destination  
Price

\$6

6

Specifications and prices are subject to  
change without prior notice.

# Bravo Components

## Universal Overhead Storage

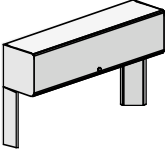
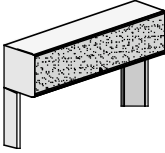
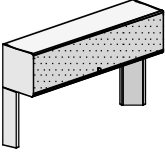
MODEL	Size	MODEL NUMBER				
		Overhead	Trim Color	Cabinet & Door Color	Door Fabric	Door Laminate
 <p><b>Universal Overhead with Painted Steel Door</b></p> <ul style="list-style-type: none"> <li>• Steel bottom and top shelf, end panels, full back and door front with powder coat finish</li> <li>• Door recedes inside the cabinet with exposed handle</li> <li>• Includes the overhead cabinet, two (or three on 66" and 72") stanchions, and all required assembly hardware</li> <li>• 66" includes one 36" unit and one 30" unit</li> <li>• 72" includes two 36" units</li> <li>• Shelf dividers (NSD) available separately (see below)</li> <li>• Overhead must attach to a desk of the same size</li> </ul>	24"	BVUS24	<input type="checkbox"/>	<input type="checkbox"/>		
	30"	BVUS30	<input type="checkbox"/>	<input type="checkbox"/>		
	36"	BVUS36	<input type="checkbox"/>	<input type="checkbox"/>		
	42"	BVUS42	<input type="checkbox"/>	<input type="checkbox"/>		
	48"	BVUS48	<input type="checkbox"/>	<input type="checkbox"/>		
	54"	BVUS54	<input type="checkbox"/>	<input type="checkbox"/>		
	60"	BVUS60	<input type="checkbox"/>	<input type="checkbox"/>		
	66"	BVUS66	<input type="checkbox"/>	<input type="checkbox"/>		
	72"	BVUS72	<input type="checkbox"/>	<input type="checkbox"/>		
	 <p><b>Universal Overhead with Fabric Covered Door</b></p> <ul style="list-style-type: none"> <li>• Steel bottom and top shelf, end panels, full back and fabric covered steel door with powder coat finish</li> <li>• Door recedes inside the cabinet with exposed handle</li> <li>• Includes the overhead cabinet, two (or three on 66" and 72") stanchions, and all required assembly hardware</li> <li>• 66" includes one 36" unit and one 30" unit</li> <li>• 72" includes two 36" units</li> <li>• Shelf dividers (NSD) available separately (see below)</li> <li>• Overhead must attach to a desk of the same size</li> </ul>	24"	BVUF24	<input type="checkbox"/>	<input type="checkbox"/>	<input type="checkbox"/>
30"		BVUF30	<input type="checkbox"/>	<input type="checkbox"/>	<input type="checkbox"/>	<input type="checkbox"/>
36"		BVUF36	<input type="checkbox"/>	<input type="checkbox"/>	<input type="checkbox"/>	<input type="checkbox"/>
42"		BVUF42	<input type="checkbox"/>	<input type="checkbox"/>	<input type="checkbox"/>	<input type="checkbox"/>
48"		BVUF48	<input type="checkbox"/>	<input type="checkbox"/>	<input type="checkbox"/>	<input type="checkbox"/>
54"		BVUF54	<input type="checkbox"/>	<input type="checkbox"/>	<input type="checkbox"/>	<input type="checkbox"/>
60"		BVUF60	<input type="checkbox"/>	<input type="checkbox"/>	<input type="checkbox"/>	<input type="checkbox"/>
66"		BVUF66	<input type="checkbox"/>	<input type="checkbox"/>	<input type="checkbox"/>	<input type="checkbox"/>
72"		BVUF72	<input type="checkbox"/>	<input type="checkbox"/>	<input type="checkbox"/>	<input type="checkbox"/>
 <p><b>Universal Overhead with Laminate Covered Door</b></p> <ul style="list-style-type: none"> <li>• Steel bottom and top shelf, end panels, full back with powder coat finish, and laminate covered particle board door</li> <li>• Door recedes inside the cabinet with exposed handle</li> <li>• Includes the overhead cabinet, two (or three on 66" and 72") stanchions, and all required assembly hardware</li> <li>• 66" includes one 36" unit and one 30" unit</li> <li>• 72" includes two 36" units</li> <li>• Shelf dividers (NSD) available separately (see below)</li> <li>• Overhead must attach to a desk of the same size</li> </ul>		24"	BVUL24	<input type="checkbox"/>	<input type="checkbox"/>	
	30"	BVUL30	<input type="checkbox"/>	<input type="checkbox"/>		<input type="checkbox"/>
	36"	BVUL36	<input type="checkbox"/>	<input type="checkbox"/>		<input type="checkbox"/>
	42"	BVUL42	<input type="checkbox"/>	<input type="checkbox"/>		<input type="checkbox"/>
	48"	BVUL48	<input type="checkbox"/>	<input type="checkbox"/>		<input type="checkbox"/>
	54"	BVUL54	<input type="checkbox"/>	<input type="checkbox"/>		<input type="checkbox"/>
	60"	BVUL60	<input type="checkbox"/>	<input type="checkbox"/>		<input type="checkbox"/>
	66"	BVUL66	<input type="checkbox"/>	<input type="checkbox"/>		<input type="checkbox"/>
	72"	BVUL72	<input type="checkbox"/>	<input type="checkbox"/>		<input type="checkbox"/>
	<b>Shelf Divider</b>		NSD	<input type="checkbox"/>		

A B C D E

### HOW TO ORDER

Indicate the following information on order form:

1. Quantity of each item.
2. Model Number, including options. See "How to Build a Model Number".
3. Any special service required.

Note: • The  indicates that a choice is required.  
 • The absence of the  indicates that no choice is required.  
 • Alpha-numeric characters in place of  indicate that no other options are available.

### HOW TO BUILD A MODEL NUMBER

**A** Select overhead door size.

**B** Select trim color (stanchion cover and door handle).\*

**B** = Black = 27  
**G** = Grey = 29  
**L** = Light Tone = 32  
**S** = Sand = 28  
**W** = Warm Grey = 33

\*Trim color matches paint color.

**C** Select cabinet and door color.

**27** = Black  
**29** = Grey  
**33** = Warm Grey  
**28** = Sand  
**32** = Light Tone  
**59** = Juniper  
**25** = Medium Bronze  
**26** = Hunter Green  
**31** = Eggshell White  
**50** = Beige  
**51** = Baltic

**52** = Bordeaux

**SP** = COM

**D** Select upper door fabric (if required).

Group A:

**Pattern Name FR701**

**1511** = Blue Neutral  
**1506** = Green Neutral  
**1518** = Wedgewood  
**1510** = Silver Papier  
**1546** = Cherry Neutral  
**1515** = Quartz  
**1531** = Gray Mix

**Pattern Name Eclipse**

**4595** = Meteor  
**1690** = Tourmaline  
**4604** = Chicory  
**4605** = Amber Grain  
**4593** = Serengeti

**4594** = Coco Palm

**1691** = Iron Ore

**Pattern Name Carrara**

**9447** = Beeswax  
**9454** = Verdigris  
**9456** = Tinctoria  
**9455** = Green Earth  
**9448** = Teak Oil  
**9445** = Gesso  
**9444** = Casein

**Pattern Name Galaxy**

**4526** = Desert Sand Gravel  
**4538** = Bermuda Seamist  
**4544** = Blueberry Sky  
**4542** = Sundew Sandrift  
**4525** = Fog Stardust  
**4531** = Gobi Moonbeam  
**4541** = Wrought Silver



Painted	Fabric Group A Price	Fabric Group B Price	Laminate
\$280			
291			
307			
319			
335			
365			
396			
530			
550			
	\$290	\$293	
	303	307	
	319	323	
	332	336	
	349	353	
	380	384	
	412	416	
	560	565	
	580	585	
			\$305
			315
			333
			347
			366
			400
			436
			600
			630
5			

Group B:

**Pattern Name Serendipity**

**9617** = Coincidence

**9626** = Four Leaf Clover

**9622** = Lady Luck

**9619** = Guardian Angel

**9620** = Lucky Duck

**9618** = Fortuitous

**9624** = Silver Spoon

**Ⓛ** Select door laminate (if required).

**AA** = Cream

**AB** = Champagne

**AC** = Barcelona

**AF** = Aruba Tan

**AG** = Black

**AH** = Dark Gray

**AI** = Dawn Gray (Greige)

**AJ** = Fog

**AK** = Black Grandin

**AL** = Smoke Granite

**AM** = Sand Grandin

**AN** = Light Granite

**AO** = Tundra

**AP** = Earthen

**AQ** = Rose Graphix

**AS** = Sierra Graphix

**AT** = Beige Grafix

**AU** = Sand Stone

**AV** = Kentucky Walnut

**AW** = Tennessee Oak

**AX** = Light Oak

**AY** = Red Birch

**AZ** = Ash

**BA** = Philadelphia Cherry

**BB** = Pennsylvania Cherry

**BC** = Mahogany

**BD** = Oak

**BE** = Maple

**BF** = Pearwood

**ZZ** = COM

Specifications and prices are subject to change without prior notice.



# Bravo Components

## Venus Overhead Storage

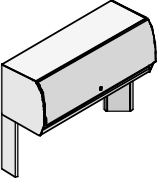
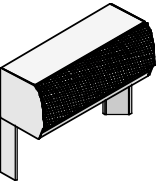
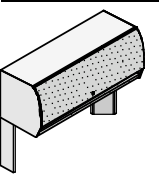
MODEL	Size	MODEL NUMBER					
		Basic Model	Trim Color	Cabinet & Stanchion Paint Color	Upper Door Solid Color	Upper Door Fabric	Upper Door Laminate
 <p><b>Venus Overhead Solid Door</b></p> <ul style="list-style-type: none"> <li>• Color or translucent extruded PVC upper door</li> <li>• Painted lower door</li> <li>• Includes the overhead cabinet, two (or three on 66" and 72") stanchions, all required assembly hardware</li> <li>• 66" includes one 36" unit and one 30" unit</li> <li>• 72" includes two 36" units</li> <li>• Shelf dividers (NSD) available separately (see below)</li> <li>• Overhead must attach to a desk of the same size</li> </ul>	30"	BVS30	<input type="checkbox"/>	<input type="checkbox"/>	<input type="checkbox"/>		
	36"	BVS36	<input type="checkbox"/>	<input type="checkbox"/>	<input type="checkbox"/>		
	42"	BVS42	<input type="checkbox"/>	<input type="checkbox"/>	<input type="checkbox"/>		
	48"	BVS48	<input type="checkbox"/>	<input type="checkbox"/>	<input type="checkbox"/>		
	54"	BVS54	<input type="checkbox"/>	<input type="checkbox"/>	<input type="checkbox"/>		
	60"	BVS60	<input type="checkbox"/>	<input type="checkbox"/>	<input type="checkbox"/>		
	66"	BVS66	<input type="checkbox"/>	<input type="checkbox"/>	<input type="checkbox"/>		
	72"	BVS72	<input type="checkbox"/>	<input type="checkbox"/>	<input type="checkbox"/>		
 <p><b>Venus Overhead Fabric Covered Door</b></p> <ul style="list-style-type: none"> <li>• Fabric covered PVC upper door</li> <li>• Painted lower door</li> <li>• Includes the overhead cabinet, two (or three on 66" and 72") stanchions, all required assembly hardware</li> <li>• 66" includes one 36" unit and one 30" unit</li> <li>• 72" includes two 36" units</li> <li>• Shelf dividers (NSD) available separately (see below)</li> <li>• Overhead must attach to a desk of the same size</li> </ul>	30"	BVF30	<input type="checkbox"/>	<input type="checkbox"/>		<input type="checkbox"/>	<input type="checkbox"/>
	36"	BVF36	<input type="checkbox"/>	<input type="checkbox"/>		<input type="checkbox"/>	<input type="checkbox"/>
	42"	BVF42	<input type="checkbox"/>	<input type="checkbox"/>		<input type="checkbox"/>	<input type="checkbox"/>
	48"	BVF48	<input type="checkbox"/>	<input type="checkbox"/>		<input type="checkbox"/>	<input type="checkbox"/>
	54"	BVF54	<input type="checkbox"/>	<input type="checkbox"/>		<input type="checkbox"/>	<input type="checkbox"/>
	60"	BVF60	<input type="checkbox"/>	<input type="checkbox"/>		<input type="checkbox"/>	<input type="checkbox"/>
	66"	BVF66	<input type="checkbox"/>	<input type="checkbox"/>		<input type="checkbox"/>	<input type="checkbox"/>
	72"	BVF72	<input type="checkbox"/>	<input type="checkbox"/>		<input type="checkbox"/>	<input type="checkbox"/>
 <p><b>Venus Overhead Laminate Covered Door</b></p> <ul style="list-style-type: none"> <li>• Laminate covered PVC upper door</li> <li>• Painted lower door</li> <li>• Includes the overhead cabinet, two (or three on 66" and 72") stanchions, all required assembly hardware</li> <li>• 66" includes one 36" unit and one 30" unit</li> <li>• 72" includes two 36" units</li> <li>• Shelf dividers (NSD) available separately (see below)</li> <li>• Overhead must attach to a desk of the same size</li> </ul>	30"	BVL30	<input type="checkbox"/>	<input type="checkbox"/>			<input type="checkbox"/>
	36"	BVL36	<input type="checkbox"/>	<input type="checkbox"/>			<input type="checkbox"/>
	42"	BVL42	<input type="checkbox"/>	<input type="checkbox"/>			<input type="checkbox"/>
	48"	BVL48	<input type="checkbox"/>	<input type="checkbox"/>			<input type="checkbox"/>
	54"	BVL54	<input type="checkbox"/>	<input type="checkbox"/>			<input type="checkbox"/>
	60"	BVL60	<input type="checkbox"/>	<input type="checkbox"/>			<input type="checkbox"/>
	66"	BVL66	<input type="checkbox"/>	<input type="checkbox"/>			<input type="checkbox"/>
	72"	BVL72	<input type="checkbox"/>	<input type="checkbox"/>			<input type="checkbox"/>
<b>Shelf Divider</b>		NSD	<input type="checkbox"/>				
<p><b>Venus Overhead Conversion Kit</b></p> <ul style="list-style-type: none"> <li>• Kit includes all the parts and hardware required to convert a Classic XXI or Crescendo Venus Overhead into a Bravo Venus Overhead</li> <li>• Overhead must attach to a desk of the same size</li> </ul>	30"-66"	BVVDCK	<input type="checkbox"/>	<input type="checkbox"/>			
	72"	BVVDCK72	<input type="checkbox"/>	<input type="checkbox"/>			

**A**   **B**   **C**   **D**   **E**   **F**

### HOW TO ORDER

Indicate the following information on order form:

- Quantity of each item.
- Model Number, including options. See "How to Build a Model Number".
- Any special service required.

Note: • The  indicates that a choice is required.  
 • The absence of the  indicates that no choice is required.  
 • Alpha-numeric characters in place of  indicate that no other options are available.

### HOW TO BUILD A MODEL NUMBER

**A** Select overhead door size.

**B** Select trim color (stanchion door covers).\*

**B** = Black = 27

**G** = Grey = 29

**L** = Light Tone = 32

**S** = Sand = 28

**W** = Warm Grey = 33

\*Trim color matches paint color.

**C** Select cabinet lower door and stanchion color.

**27** = Black

**29** = Grey

**33** = Warm Grey

**28** = Sand

**32** = Light Tone

**59** = Juniper

**25** = Medium Bronze

**26** = Hunter Green

**31** = Eggshell White

**50** = Beige

**52** = Bordeaux

**SP** = COM

**D** Select upper door solid color (if required).

**B** = Black

**G** = Grey

**L** = Light Tone

**S** = Sand

**W** = Warm Grey

**T** = Translucent

**E** Select upper door fabric (if required).

Group A:

**Pattern Name FR701**

**1511** = Blue Neutral

**1506** = Green Neutral

**1518** = Wedgewood

**1510** = Silver Papier

**1546** = Cherry Neutral

**1515** = Quartz

**1531** = Gray Mix

**Pattern Name Eclipse**

**4595** = Meteor

**1690** = Tourmaline

**4604** = Chicory

**4605** = Amber Grain

**4593** = Serengeti

**4594** = Coco Palm

**1691** = Iron Ore

**Pattern Name Carrara**

**9447** = Beeswax

**9454** = Verdigris

**9456** = Tinctoria

**9455** = Green Earth

**9448** = Teak Oil

**9445** = Gesso

**9444** = Casein

**Pattern Name Galaxy**

**4526** = Desert Sand Gravel



Solid	Fabric Group A Price	Fabric Group B Price	Laminate
\$306			
322			
335			
352			
383			
416			
537			
557			
	\$318	\$323	
	335	340	
	349	354	
	366	371	
	399	405	
	433	439	
	559	565	
	581	587	
			\$331
			350
			364
			384
			420
			458
			589
			612
10			
120			
180			

- 4544 = Blueberry Sky
- 4542 = Sundew Sandrift
- 4525 = Fog Stardust
- 4531 = Gobi Moonbeam
- 4541 = Wrought Silver

Group B:

**Pattern Name Serendipity**

- 9617 = Coincidence
- 9626 = Four Leaf Clover
- 9622 = Lady Luck
- 9619 = Guardian Angel
- 9620 = Lucky Duck
- 9618 = Fortuitous
- 9624 = Silver Spoon

**F** Select upper door laminate (if required).



- AA = Cream
- AB = Champagne
- AC = Barcelona
- AF = Aruba Tan
- AG = Black
- AH = Dark Gray
- AI = Dawn Gray (Greige)
- AJ = Fog
- AK = Black Grandin
- AL = Smoke Granite
- AM = Sand Grandin
- AN = Light Granite
- AO = Tundra
- AP = Earthen
- AQ = Rose Graphix
- AS = Sierra Graphix
- AT = Beige Grafix
- AU = Sand Stone
- AV = Kentucky Walnut
- AW = Tennessee Oak

- AX = Light Oak
- AY = Red Birch
- AZ = Ash
- BA = Philadelphia Cherry
- BB = Pennsylvania Cherry
- BC = Mahogany
- BD = Oak
- BE = Maple
- BF = Pearwood
- ZZ = COM

Specifications and prices are subject to change without prior notice.

# Bravo Components

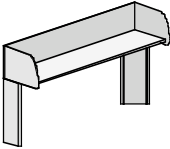
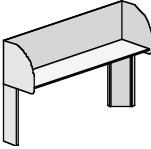
Overhead Storage (Universal Shelves)

MODEL	Size	MODEL NUMBER		
		Overhead	Trim Color	Cabinet & Stanchion Paint Color
 <p><b>Universal Low Shelf</b></p> <ul style="list-style-type: none"> <li>• Steel bottom shelf, end panels, and full back with powder coat finish</li> <li>• Includes the overhead cabinet, two (or three on 66" and 72") stanchions, and all required assembly hardware</li> <li>• 66" includes one 36" unit and one 30" unit</li> <li>• 72" includes two 36" units</li> <li>• Shelf dividers (NSD) available separately</li> <li>• Overhead must attach to a desk of the same size</li> </ul>	24"	BVULSR24	<input type="checkbox"/>	<input type="checkbox"/>
	30"	BVULSR30	<input type="checkbox"/>	<input type="checkbox"/>
	36"	BVULSR36	<input type="checkbox"/>	<input type="checkbox"/>
	42"	BVULSR42	<input type="checkbox"/>	<input type="checkbox"/>
	48"	BVULSR48	<input type="checkbox"/>	<input type="checkbox"/>
	54"	BVULSR54	<input type="checkbox"/>	<input type="checkbox"/>
	60"	BVULSR60	<input type="checkbox"/>	<input type="checkbox"/>
	66"	BVULSR66	<input type="checkbox"/>	<input type="checkbox"/>
72"	BVULSR72	<input type="checkbox"/>	<input type="checkbox"/>	
 <p><b>Universal Regular Shelf</b></p> <ul style="list-style-type: none"> <li>• Steel bottom shelf, end panels, and full back with powder coat finish</li> <li>• Includes the overhead cabinet, two (or three on 66" and 72") stanchions, and all required assembly hardware</li> <li>• 66" includes one 36" unit and one 30" unit</li> <li>• 72" includes two 36" units</li> <li>• Shelf dividers (NSD) available separately</li> <li>• Overhead must attach to a desk of the same size</li> </ul>	24"	BVURSR24	<input type="checkbox"/>	<input type="checkbox"/>
	30"	BVURSR30	<input type="checkbox"/>	<input type="checkbox"/>
	36"	BVURSR36	<input type="checkbox"/>	<input type="checkbox"/>
	42"	BVURSR42	<input type="checkbox"/>	<input type="checkbox"/>
	48"	BVURSR48	<input type="checkbox"/>	<input type="checkbox"/>
	54"	BVURSR54	<input type="checkbox"/>	<input type="checkbox"/>
	60"	BVURSR60	<input type="checkbox"/>	<input type="checkbox"/>
	66"	BVURSR66	<input type="checkbox"/>	<input type="checkbox"/>
72"	BVURSR72	<input type="checkbox"/>	<input type="checkbox"/>	
<p><b>Universal Overhead Conversion Kit</b></p> <ul style="list-style-type: none"> <li>• Kit includes all the parts and hardware required to convert a Classic XXI or Crescendo Universal Overhead into a Bravo Universal Overhead</li> <li>• Overhead must attach to a desk of the same size</li> </ul>	24"	BVPRDCK24	<input type="checkbox"/>	<input type="checkbox"/>
	30"	BVPRDCK30	<input type="checkbox"/>	<input type="checkbox"/>
	36"	BVPRDCK36	<input type="checkbox"/>	<input type="checkbox"/>
	42"	BVPRDCK42	<input type="checkbox"/>	<input type="checkbox"/>
	48"	BVPRDCK48	<input type="checkbox"/>	<input type="checkbox"/>
	54"	BVPRDCK54	<input type="checkbox"/>	<input type="checkbox"/>
	60"	BVPRDCK60	<input type="checkbox"/>	<input type="checkbox"/>
	66"	BVPRDCK66	<input type="checkbox"/>	<input type="checkbox"/>
72"	BVPRDCK72	<input type="checkbox"/>	<input type="checkbox"/>	
 <p><b>Shelf Divider</b></p>		NSD	<input type="checkbox"/>	<input type="checkbox"/>
				<input type="checkbox"/>

**A**   **B**   **C**

## HOW TO ORDER

Indicate the following information on order form:

- Quantity of each item.
- Model Number, including options. See "How to Build a Model Number".
- Any special service required.

Note: • The  indicates that a choice is required.  
 • The absence of the  indicates that no choice is required.  
 • Alpha-numeric characters in place of  indicate that no other options are available.

## HOW TO BUILD A MODEL NUMBER

- A** Select overhead size.
- B** Select trim color (stanchion cover).\*
- B** = Black = 27  
**G** = Grey = 29  
**L** = Light Tone = 32  
**S** = Sand = 28  
**W** = Warm Grey = 33  
 \*Trim color matches paint color.
- C** Select cabinet and stanchion paint color.
- 27** = Black  
**29** = Grey  
**33** = Warm Grey  
**28** = Sand  
**32** = Light Tone  
**59** = Juniper  
**25** = Medium Bronze  
**26** = Hunter Green  
**31** = Eggshell White  
**50** = Beige  
**51** = Baltic  
**52** = Bordeaux  
**SP** = COM



U.S. Department of Justice

**UNICOR**

Federal Prison Industries, Inc.

**Bravo Components**

Overhead Storage (Universal Shelves)

Destination  
Price

\$195

200

205

214

223

238

249

340

350

198

204

210

216

227

242

250

350

360

118

120

122

125

127

130

133

198

204

10

Specifications and prices are subject to  
change without prior notice.

# Bravo Components

## Universal Overhead Task Lights

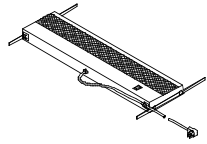

### MODEL

#### Universal Electronic Ballast Task Lights

- Task light attaches to the underside of low shelf, regular shelf, countertops, or flipper door unit
- UL listed
- Includes T-8 cool white bulb
- Uses rapid start magnetic ballast
- Light has 8' cord that can be routed either right hand or left hand

Overhead Size	Actual Light Case	Bulb Length	MODEL NUMBER	
			Basic Model	Trim Color
24"	7" x 17"	15"	CITLE18	<input type="checkbox"/>
30"	7" x 20"	18"	CITLE24	<input type="checkbox"/>
36"	7" x 26"	24"	CITLE30	<input type="checkbox"/>
42"	7" x 32"	24"	CITLE36	<input type="checkbox"/>
48"	7" x 38"	36"	CITLE42	<input type="checkbox"/>
54"	7" x 44"	36"	CITLE48	<input type="checkbox"/>
60"	7" x 44"	36"	CITLE48	<input type="checkbox"/>

**A**

**B**

### HOW TO ORDER

Indicate the following information on order form:

1. Quantity of each item.
2. Model Number, including options. See "How to Build a Model Number".
3. Any special service required.

Note: • The  indicates that a choice is required.

- The absence of the  indicates that no choice is required.
- Alpha-numeric characters in place of  indicate that no other options are available.

### HOW TO BUILD A MODEL NUMBER

**A** Select width of basic model.

**B** Select trim color.\*

**B** = Black = 27

**G** = Grey = 29

**L** = Light Tone = 32

**S** = Sand = 28

**W** = Warm Grey = 33

\*Trim color matches paint color.



U.S. Department of Justice

**UNICOR**

Federal Prison Industries, Inc.

**Bravo Components**

Universal Overhead Task Lights

Destination  
Price

\$ 58

60

60

64

71



71

71

Specifications and prices are subject to  
change without prior notice.

# Bravo Components

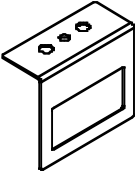
Data/Communication Accessories

MODEL	Size	MODEL NUMBER			Destination Price
		Basic Model/Part	Trim Color	Paint Color	
 <p><b>Communications Pole</b></p> <ul style="list-style-type: none"> <li>Includes a 7' or 10' aluminum 2-channel power pole and ceiling trim</li> <li>Used to route data/communication cables from a ceiling feed point to the below the worksurface cable channel</li> <li>Attaches to the desk at a corner grommet location</li> </ul>	7 ft.	BVCOMCP7	<input type="checkbox"/>	<input type="checkbox"/>	\$65
	10 ft.	BVCOMCP10	<input type="checkbox"/>	<input type="checkbox"/>	71
 <p><b>Face Plate Bracket</b></p> <ul style="list-style-type: none"> <li>Includes a bracket and attachment hardware that allows a TIA/EIA standard faceplate (approximately 1.38" x 2.7" opening) to mount below the desk</li> <li>Face plate and data/communication jacks must be ordered separately</li> </ul>		BVCOMFB		<input type="checkbox"/>	8
 <p><b>Cable Support</b></p> <ul style="list-style-type: none"> <li>A plastic hook that attaches to the inside of the modesty panel to assist in the routing of data/communication cables</li> <li>Pack of 25</li> </ul>		460099PCK	B		10
		460099	B		1

A   
  B   
  C

## HOW TO ORDER

Indicate the following information on order form:



- Quantity of each item.
- Model Number, including options.  
See "How to Build a Model Number".
- Any special service required.

- Note:
- The  indicates that a choice is required.
  - The absence of the  indicates that no choice is required.
  - Alpha-numeric characters in place of  indicate that no other options are available.

## HOW TO BUILD A MODEL NUMBER

- A** Select basic model.
- B** Select trim color (if required).\*
  - B** = Black = 27
  - G** = Grey = 29
  - L** = Light Tone = 32
  - S** = Sand = 28
  - W** = Warm Grey = 33
- \*Trim color matches paint color.
- C** Select paint color (if required).
  - 27** = Black
  - 29** = Grey
  - 33** = Warm Grey
  - 28** = Sand
  - 32** = Light Tone
  - 59** = Juniper
  - 25** = Medium Bronze
  - 26** = Hunter Green
  - 31** = Eggshell White
  - 50** = Beige
  - 51** = Baltic
  - 52** = Bordeaux

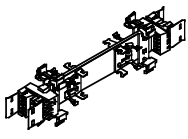
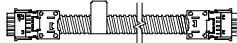
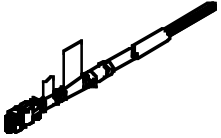

MODEL	Size	MODEL NUMBER				6-2-2 Destination Price	4-4-2 Destination Price
		6-2-2 Basic Model	4-4-2 Basic Model	Trim Color	Paint Color		
 <p><b>Rigid Wireway</b></p> <ul style="list-style-type: none"> <li>Includes rigid wireway electrical harness, steel wireway cover, and all required attachment hardware</li> <li>Available in two 10-wire styles: 6-2-2 (6 circuits) and 4-4-2 (4 circuits). Note: 10-wire styles must match on all electrical parts.</li> <li>Allows two duplex receptacles (ordered separately) to be mounted below the desk worksurface</li> <li>Size must match the desk length. Note: the 72D (dual) provides four possible receptacle locations.</li> </ul>	30"	BVET6RW30	BVET4RW30	<input type="checkbox"/>	<input type="checkbox"/>	\$60	\$58
	36"	BVET6RW36	BVET4RW36	<input type="checkbox"/>	<input type="checkbox"/>	62	61
	42"	BVET6RW42	BVET4RW42	<input type="checkbox"/>	<input type="checkbox"/>	65	64
	48"	BVET6RW48	BVET4RW48	<input type="checkbox"/>	<input type="checkbox"/>	68	67
	54"	BVET6RW54	BVET4RW54	<input type="checkbox"/>	<input type="checkbox"/>	71	70
	60"	BVET6RW60	BVET4RW60	<input type="checkbox"/>	<input type="checkbox"/>	74	73
	66"	BVET6RW66	BVET4RW66	<input type="checkbox"/>	<input type="checkbox"/>	86	84
	72"	BVET6RW72	BVET4RW72	<input type="checkbox"/>	<input type="checkbox"/>	89	88
	72"	BVET6RW72D	BVET4RW72D	<input type="checkbox"/>	<input type="checkbox"/>	153	151
	 <p><b>Desk Jumper</b></p> <ul style="list-style-type: none"> <li>Includes jumper harness to make the electrical connection between adjacent desks</li> <li>See specifications for length that must be specified</li> <li>Available in two 10-wire styles: 6-2-2 (6 circuits) and 4-4-2 (4 circuits). Note: 10-wire styles must match on all electrical parts.</li> </ul>	Std	BVET6DJST	BVET4DJST			41
24"		BVET6DJ24	BVET4DJ24			49	49
30"		BVET6DJ30	BVET4DJ30			52	52
 <p><b>Base Feed</b></p> <ul style="list-style-type: none"> <li>Includes base feed harness with 6' of colored liquid tite conduit covering. Used to feed power from a hard wired J-box or floor monument to the rigid wireway on a desk.</li> <li>Available in two 10-wire styles: 6-2-2 (6 circuits) and 4-4-2 (4 circuits). Note: 10-wire styles must match on all electrical parts.</li> <li>Building connection hardware must be supplied by customer</li> </ul>		BVET6BF6	BVET4BF6	<input type="checkbox"/>		100	100
 <p><b>Top Feed</b></p> <ul style="list-style-type: none"> <li>Includes electrical harness (144" or 216"), aluminum 2-channel power pole (7' or 10' respectively) and ceiling trim</li> <li>Used to feed power from a hard wired J-box above a false ceiling to the rigid wireway or a desk</li> <li>Attaches to the desk at a corner grommet location</li> <li>Available in two 10-wire styles: 6-2-2 (6 circuits) and 4-4-2 (4 circuits). Note: 10-wire styles must match on all electrical parts.</li> <li>Building connection hardware must be supplied by customer</li> </ul>		BVET6TF144	BVET4TF144		<input type="checkbox"/>	137	135
		BVET6TF216	BVET4TF216		<input type="checkbox"/>	162	159

A
A
B
C

**HOW TO ORDER**

Indicate the following information on order form:

- Quantity of each item.
- Model Number, including options. See "How to Build a Model Number".
- Any special service required.

Note: • The  indicates that a choice is required.  
 • The absence of the  indicates that no choice is required.  
 • Alpha-numeric characters in place of  indicate that no other options are available.

**HOW TO BUILD A MODEL NUMBER**



- A** Select basic model.
- B** Select trim color (if required):\*
  - B** = Black = 27
  - G** = Grey = 29
  - L** = Light Tone = 32
  - S** = Sand = 28
  - W** = Warm Grey = 33
 \*Trim color matches paint color.
- C** Select paint color (if required).
  - 27** = Black
  - 29** = Grey
  - 33** = Warm Grey
  - 28** = Sand
  - 32** = Light Tone
  - 59** = Juniper
  - 25** = Medium Bronze
  - 26** = Hunter Green
  - 31** = Eggshell White
  - 50** = Beige
  - 51** = Baltic
  - 52** = Bordeaux

Specifications and prices are subject to change without prior notice.

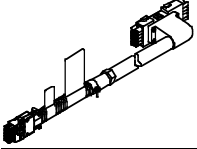
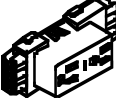

# Bravo Components

Electrical

MODEL	MODEL NUMBER			6-2-2 Destination Price	4-4-2 Destination Price
	6-2-2 Basic Model	4-4-2 Basic Model	Trim Color		
 <p><b>Panel Feed</b></p> <ul style="list-style-type: none"> <li>Includes base feed harness that connects to the electrical system in an adjacent Crescendo Panel system. All required connection hardware included.</li> <li>Available in two 10-wire styles: 6-2-2 (6 circuits) and 4-4-2 (4 circuits). Note: 10-wire styles must match on all electrical parts.</li> </ul>	BVET6PF6L	BVET4PF6L	<input type="checkbox"/>	\$98	\$98
	BVET6PF6R	BVET4PF6R	<input type="checkbox"/>	98	98
 <p><b>Receptacles*</b></p> <ul style="list-style-type: none"> <li>Includes the modular duplex 15 amp receptacle that snaps onto a rigid wireway</li> <li>Available in two 10-wire styles: 6-2-2 (6 circuits) and 4-4-2 (4 circuits). Note: 10-wire styles must match on all electrical parts.</li> </ul>	BVET6RC1	BVET4RC1	<input type="checkbox"/>	14	14
	BVET6RC2	BVET4RC2	<input type="checkbox"/>	14	14
	BVET6RC3		<input type="checkbox"/>	14	
	BVET6RC4I	BVET4RC3I		14	14
	BVET6RC5I	BVET4RC4I		14	14
	BVET6RC6I			14	
 <p><b>Power Pass Through</b></p> <ul style="list-style-type: none"> <li>Includes the power pass through harness that allows power to continue through one side of a desk between two rigid wireway equipped desks</li> <li>Available in two 10-wire styles: 6-2-2 (6 circuits) and 4-4-2 (4 circuits). Note: 10-wire styles must match on all electrical parts.</li> <li>Length must match the desk length it is passing through</li> </ul>	BVET6PP24	BVET4PP24		52	52
	BVET6PP30	BVET4PP30		55	55
	BVET6PP36	BVET4PP36		57	57
	BVET6PP42	BVET4PP42		60	60
	BVET6PP48	BVET4PP48		62	62
	BVET6PP54	BVET4PP54		65	65
	BVET6PP60	BVET4PP60		68	68
	BVET6PP66	BVET4PP66		70	70
BVET6PP72	BVET4PP72		73	73	
 <p><b>Stanchion Power Tap</b></p> <ul style="list-style-type: none"> <li>Provides a duplex 15 amp receptacle that is located behind a desk stanchion door</li> <li>Circuit number will be determined by the receptacle it is plugged into</li> <li>Two lengths available: 36" used when it is plugged into a rigid wireway receptacle 96" used when it is plugged into an adjacent building wall receptacle</li> </ul>	BVESR36	BVESR36		43	43
	BVESR96	BVESR96		47	47

A
A
B

## HOW TO ORDER

Indicate the following information on order form:

- Quantity of each item.
- Model Number, including options.  
See "How to Build a Model Number".
- Any special service required.

Note:



- The  indicates that a choice is required.
- The absence of the  indicates that no choice is required.
- Alpha-numeric characters in place of  indicate that no other options are available.

## HOW TO BUILD A MODEL NUMBER

- A** Select basic model.
- B** Select trim color (if required).\*
- |          |                   |
|----------|-------------------|
| <b>B</b> | = Black = 27      |
| <b>G</b> | = Grey = 29       |
| <b>L</b> | = Light Tone = 32 |
| <b>S</b> | = Sand = 28       |
| <b>W</b> | = Warm Grey = 33  |
- \*Trim color matches paint color.

\*Receptacles on circuits 31, 41, 51, and 61 are always orange.

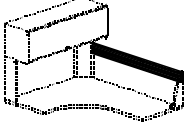

MODEL	Width	MODEL NUMBER		Destination Price
		Basic Model	Paint Color	
 <p><b>Between Stanchion Mounted Tool Rail Kit</b></p> <ul style="list-style-type: none"> <li>Mounts above the worksurface off the stanchions used to support any overhead storage unit</li> <li>Allows paper management accessories to be hung off the tool rail</li> <li>Includes the aluminum tool rail and all required mounting hardware</li> <li>"Width" refers to the desk size the tool rail is mounted above (tool rail size must match desk size)</li> </ul>	24"	BVTSM24	<input type="checkbox"/>	\$48
	30"	BVTSM30	<input type="checkbox"/>	54
	36"	BVTSM36	<input type="checkbox"/>	59
	42"	BVTSM42	<input type="checkbox"/>	64
	48"	BVTSM48	<input type="checkbox"/>	69
	54"	BVTSM54	<input type="checkbox"/>	74
	60"	BVTSM60	<input type="checkbox"/>	80
	66"	BVTSM66	<input type="checkbox"/>	85
	72"	BVTSM72	<input type="checkbox"/>	90
	 <p><b>Worksurface Mounted Tool Rail Kit</b></p> <ul style="list-style-type: none"> <li>Mounts above the worksurface on brackets that attach to the grommets at each back corner</li> <li>Allows paper management accessories to be hung off the tool rail</li> <li>Includes the aluminum tool rail and all required mounting hardware</li> <li>"Width" refers to the desk size the tool rail is mounted above (tool rail size must match desk size)</li> </ul>	24"	BVTWM24	<input type="checkbox"/>
30"		BVTWM30	<input type="checkbox"/>	93
36"		BVTWM36	<input type="checkbox"/>	98
42"		BVTWM42	<input type="checkbox"/>	103
48"		BVTWM48	<input type="checkbox"/>	108
54"		BVTWM54	<input type="checkbox"/>	113
60"		BVTWM60	<input type="checkbox"/>	119
66"		BVTWM66	<input type="checkbox"/>	124
72"		BVTWM72	<input type="checkbox"/>	129
 <p><b>Stanchion &amp; On-Worksurface Mounted Tool Rail Kit</b></p> <ul style="list-style-type: none"> <li>Mounts above the worksurface between a stanchion used to support any overhead storage unit and an end mount bracket</li> <li>Allows paper management accessories to be hung off the tool rail</li> <li>Includes the aluminum tool rail and all required mounting hardware</li> <li>"Width" refers to the desk size the tool rail is mounted above (tool rail size must match desk size)</li> </ul>		24"	BVTS024	<input type="checkbox"/>
	30"	BVTS030	<input type="checkbox"/>	73
	36"	BVTS036	<input type="checkbox"/>	78
	42"	BVTS042	<input type="checkbox"/>	83
	48"	BVTS048	<input type="checkbox"/>	89
	54"	BVTS054	<input type="checkbox"/>	94
	60"	BVTS060	<input type="checkbox"/>	99
	66"	BVTS066	<input type="checkbox"/>	104
	72"	BVTS072	<input type="checkbox"/>	109

**A**

**B**

**HOW TO ORDER**

Indicate the following information on order form:

- Quantity of each item.
- Model Number, including options. See "How to Build a Model Number".
- Any special service required.

Note:

- The  indicates that a choice is required.
- The absence of the  indicates that no choice is required.
- Alpha-numeric characters in place of  indicate that no other options are available.

**HOW TO BUILD A MODEL NUMBER**

**A** Select size of basic model.

**B** Select paint color.

- 27** = Black
- 29** = Grey
- 33** = Warm Grey
- 28** = Sand
- 32** = Light Tone
- 59** = Juniper
- 25** = Medium Bronze
- 26** = Hunter Green
- 31** = Eggshell White
- 50** = Beige
- 51** = Baltic
- 52** = Bordeaux
- SP** = COM

# Bravo Components

## Backpacks

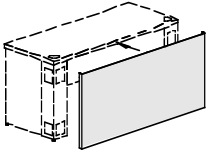
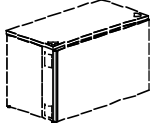
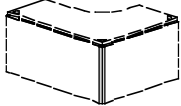
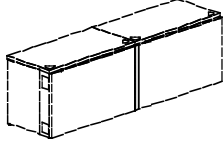
MODEL	Length	MODEL NUMBER		Destination Price
		Basic Model	Paint Color	
 <p><b>Backpack</b></p> <ul style="list-style-type: none"> <li>A steel panel that provides a solid look to the back surface of the desk, and provides a space to route data cables</li> <li>Available with three optional data channels to support cable wires behind the removable panel (for BVBDP model numbers)</li> <li>BVBDP models do not include data channels</li> <li>"Length" matches the length of the desk edge</li> <li>Includes backpack panel, and all required attachment hardware and data channels on BVBDP models</li> </ul>	24"	BVBDP24	<input type="checkbox"/>	\$108
	30"	BVBDP30	<input type="checkbox"/>	112
	36"	BVBDP36	<input type="checkbox"/>	116
	42"	BVBDP42	<input type="checkbox"/>	120
	48"	BVBDP48	<input type="checkbox"/>	124
	54"	BVBDP54	<input type="checkbox"/>	138
	60"	BVBDP60	<input type="checkbox"/>	141
	66"	BVBDP66	<input type="checkbox"/>	149
	72"	BVBDP72	<input type="checkbox"/>	157
	24"	BVBDP24	<input type="checkbox"/>	65
	30"	BVBDP30	<input type="checkbox"/>	67
	36"	BVBDP36	<input type="checkbox"/>	69
	42"	BVBDP42	<input type="checkbox"/>	71
	48"	BVBDP48	<input type="checkbox"/>	73
	54"	BVBDP54	<input type="checkbox"/>	77
	60"	BVBDP60	<input type="checkbox"/>	80
	66"	BVBDP66	<input type="checkbox"/>	84
72"	BVBDP72	<input type="checkbox"/>	88	
 <p><b>Backpack End Cap</b></p> <ul style="list-style-type: none"> <li>Steel filler that fits in the end of the backpack panel at the end of a desk run</li> <li>Includes all required attachment hardware</li> </ul>		BVBPEC	<input type="checkbox"/>	12
 <p><b>Backpack 90° Cap</b></p> <ul style="list-style-type: none"> <li>Steel trim that covers the ends of two backpacks at a 90° intersection</li> </ul>		BVBP90	<input type="checkbox"/>	12
 <p><b>Backpack 180° Cap</b></p> <ul style="list-style-type: none"> <li>Steel trim that covers the ends of two backpacks on adjacent desks</li> </ul>		BVBP180	<input type="checkbox"/>	12

A

B

### HOW TO ORDER

Indicate the following information on order form:

- Quantity of each item.
- Model Number, including options. See "How to Build a Model Number".
- Any special service required.

Note: • The  indicates that a choice is required.

- The absence of the  indicates that no choice is required.
- Alpha-numeric characters in place of  indicate that no other options are available.

### HOW TO BUILD A MODEL NUMBER

A Select length of basic model.

B Select paint color.

27	= Black
29	= Grey
33	= Warm Grey
28	= Sand
32	= Light Tone
59	= Juniper
25	= Medium Bronze
26	= Hunter Green
31	= Eggshell White
50	= Beige
51	= Baltic
52	= Bordeaux
SP	= COM

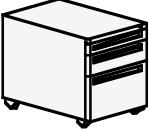
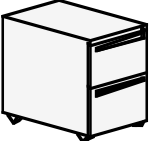
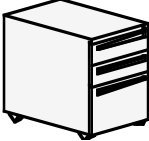

	MODEL	FEATURE	W x D x H	MODEL NUMBER		Destination Price
				Basic Model	Paint Color	
 *Mobile shown	<b>Three Drawer File Pedestal</b> • One 3" pencil drawer with tray • One 6" box drawer • One 12" file drawer • Counterbalance weight is included in mobile and freestanding units	<b>Mobile</b>	15 x 17 $\frac{1}{2}$ x 24 $\frac{1}{2}$ "	PEDMPPBF20	<input type="checkbox"/>	\$222
		<b>Freestanding</b>	15 x 17 $\frac{1}{2}$ x 22 $\frac{1}{4}$ "	PEDFPPBF20	<input type="checkbox"/>	218
		<b>Mobile</b>	15 x 21 $\frac{1}{2}$ x 24 $\frac{1}{2}$ "	PEDMPPBF24	<input type="checkbox"/>	222
		<b>Freestanding</b>	15 x 21 $\frac{1}{2}$ x 22 $\frac{1}{4}$ "	PEDFPPBF24	<input type="checkbox"/>	218
 *Mobile shown	<b>Two Drawer File Pedestal</b> • Two 12" file drawers • Counterbalance weight is included in mobile and freestanding units	<b>Mobile</b>	15 x 17 $\frac{1}{2}$ x 27 $\frac{1}{16}$ "	PEDMPFF20	<input type="checkbox"/>	212
		<b>Freestanding</b>	15 x 17 $\frac{1}{2}$ x 25 $\frac{3}{16}$ "	PEDFPPFF20	<input type="checkbox"/>	209
		<b>Mobile</b>	15 x 21 $\frac{1}{2}$ x 27 $\frac{1}{16}$ "	PEDMPFF24	<input type="checkbox"/>	212
		<b>Freestanding</b>	15 x 21 $\frac{1}{2}$ x 25 $\frac{3}{16}$ "	PEDFPPFF24	<input type="checkbox"/>	209
 *Mobile shown	<b>Three Drawer File Pedestal</b> • Two 6" box drawers • One 12" file drawer • Counterbalance weight is included in mobile and freestanding units	<b>Mobile</b>	15 x 17 $\frac{1}{2}$ x 27 $\frac{1}{16}$ "	PEDMPBBF20	<input type="checkbox"/>	216
		<b>Freestanding</b>	15 x 17 $\frac{1}{2}$ x 25 $\frac{3}{16}$ "	PEDFPBBF20	<input type="checkbox"/>	217
		<b>Mobile</b>	15 x 21 $\frac{1}{2}$ x 27 $\frac{1}{16}$ "	PEDMPBBF24	<input type="checkbox"/>	216
		<b>Freestanding</b>	15 x 21 $\frac{1}{2}$ x 25 $\frac{3}{16}$ "	PEDFPBBF24	<input type="checkbox"/>	217

**A**

**B**

**HOW TO ORDER**

Indicate the following information on order form:

- Quantity of each item.
- Model Number, including options. See "How to Build a Model Number".
- Any special service required.

Note: • The  indicates that a choice is required.  
• The absence of the  indicates that no choice is required.  
• Alpha-numeric characters in place of  indicate that no other options are available.

**HOW TO BUILD A MODEL NUMBER**

- A** Select size of basic model.
- B** Select paint color.
- 27** = Black
  - 29** = Grey
  - 33** = Warm Grey
  - 28** = Sand
  - 32** = Light Tone
  - 59** = Juniper
  - 25** = Medium Bronze
  - 26** = Hunter Green
  - 31** = Eggshell White
  - 50** = Beige
  - 51** = Baltic
  - 52** = Bordeaux
  - SP** = COM

**INFORMATION**

**Note:**  
20" deep pedestals must be used with 24" deep desks. 20" and 24" deep pedestals may be used with 30" deep desks.

**Lock**  
All units include a lock. Keying is random unless otherwise specified at time of order entry.

**Height**  
All freestanding pedestals include  $\frac{1}{8}$ " allowance for glides in recessed position. Mobile pedestals include 2 $\frac{3}{16}$ " allowance for casters.

**Specifications and prices are subject to change without prior notice.**

# Bravo Components

## Kiosks

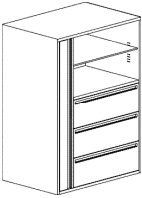
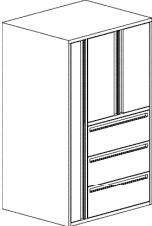
MODEL	Dimensions W x D Door End	MODEL NUMBER		Destination Price
		Basic Model	Paint Color	
 <p>*Left shown</p> <p><b>Kiosk with Open Bookshelf</b></p> <ul style="list-style-type: none"> <li>• Steel kiosk available in 30" and 36" width, 65½" height and 24" depth</li> <li>• Kiosk includes three 12" high x 24" or 30" wide lateral filing drawers with folder bars. One lock secures all three drawers.</li> <li>• Kiosk includes a 6" wide full height wardrobe area with a separate lock and coat hanger rod</li> <li>• Wardrobe door must be specified on right or left side of kiosk</li> <li>• Open bookcase area has one adjustable blank shelf and a blank bottom shelf</li> </ul>	30 x <b>24</b> Right	KIOSK3024RHOP	<input type="checkbox"/> <input type="checkbox"/>	\$821
	36 x <b>24</b> Right	KIOSK3624RHOP	<input type="checkbox"/> <input type="checkbox"/>	854
	30 x <b>24</b> Left	KIOSK3024LHOP	<input type="checkbox"/> <input type="checkbox"/>	821
	36 x <b>24</b> Left	KIOSK3624LHOP	<input type="checkbox"/> <input type="checkbox"/>	854
 <p>*Left shown</p> <p><b>Kiosk with Hinged Doors</b></p> <ul style="list-style-type: none"> <li>• Steel kiosk available in 30" and 36" width, 65½" height and 24" depth</li> <li>• Kiosk includes three 12" high x 24" or 30" wide lateral filing drawers with folder bars. One lock secures all three drawers.</li> <li>• Kiosk includes a 6" wide full height wardrobe area with a separate lock and coat hanger rod</li> <li>• Wardrobe door must be specified on right or left side of kiosk</li> <li>• Hinged doors hide bookshelf area with one adjustable blank shelf and a slotted bottom shelf</li> </ul>	30 x <b>24</b> Right	KIOSK3024RHCL	<input type="checkbox"/> <input type="checkbox"/>	838
	36 x <b>24</b> Right	KIOSK3624RHCL	<input type="checkbox"/> <input type="checkbox"/>	881
	30 x <b>24</b> Left	KIOSK3024LHCL	<input type="checkbox"/> <input type="checkbox"/>	838
	36 x <b>24</b> Left	KIOSK3624LHCL	<input type="checkbox"/> <input type="checkbox"/>	881

**A**

**B**

### HOW TO ORDER

Indicate the following information on order form:

1. Quantity of each item.
2. Model Number, including options. See "How to Build a Model Number".
3. Any special service required.

Note: • The  indicates that a choice is required.  
 • The absence of the  indicates that no choice is required.  
 • Alpha-numeric characters in place of  indicate that no other options are available.

### HOW TO BUILD A MODEL NUMBER

- A** Select basic model.
- B** Select paint color.
- 27** = Black
  - 29** = Grey
  - 33** = Warm Grey
  - 28** = Sand
  - 32** = Light Tone
  - 59** = Juniper
  - 25** = Medium Bronze
  - 26** = Hunter Green
  - 31** = Eggshell White
  - 50** = Beige
  - 51** = Baltic
  - 52** = Bordeaux
  - SP** = COM

### INFORMATION

**Lock**  
 All units include a lock. Keying is random unless otherwise specified at time of order entry.

**Specifications and prices are subject to change without prior notice.**



**MODEL**

**MODEL NUMBER**

Basic Model	Trim Color	Paint Color	Laminate Color	Destination Price
-------------	------------	-------------	----------------	-------------------

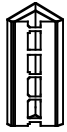

**Freestanding Stanchion Large**  
• 19½" tall (4 openings)  
• Stanchion door and top cap included

BVFSL	<input type="checkbox"/>	<input type="checkbox"/>		\$45
-------	--------------------------	--------------------------	--	------



**Freestanding Stanchion Short**  
• 11½" tall (2 openings)  
• Stanchion door and top cap included

BVFSS	<input type="checkbox"/>	<input type="checkbox"/>		41
-------	--------------------------	--------------------------	--	----

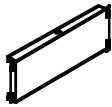

**End Panel Trough**  
• For 24" desk and attachment bolt  
• For 30" desk and attachment bolt

BVEPT24		<input type="checkbox"/>		17
---------	--	--------------------------	--	----

BVEPT30		<input type="checkbox"/>		18
---------	--	--------------------------	--	----



**Carousel**  
• 18" wide x 16½" deep

CICAR	<input type="checkbox"/>		<input type="checkbox"/>	38
-------	--------------------------	--	--------------------------	----



**CPU Sling**  
• 5½" wide x 18" deep

CPUSLING	B	<input type="checkbox"/>		48
----------	---	--------------------------	--	----

**Grommets**



Leg Grommet Cover



Worksurface Grommet



Worksurface Grommet Cover

Regular Grommet	55020	<input type="checkbox"/>			1
Leg Grommet Cover	55022	<input type="checkbox"/>			1
Worksurface Grommet	55023	<input type="checkbox"/>			2
Worksurface Grommet Cover	55024	<input type="checkbox"/>			1

**A**   **B**   **C**   **D**

**HOW TO ORDER**

Indicate the following information on order form:

- Quantity of each item.
- Model Number, including options. See "How to Build a Model Number".
- Any special service required.

Note: • The  indicates that a choice is required.  
• The absence of the  indicates that no choice is required.  
• Alpha-numeric characters in place of  indicate that no other options are available.

**HOW TO BUILD A MODEL NUMBER**

**A** Select basic model.

**B** Select trim color.\*

**B** = Black = 27

**G** = Grey = 29

**L** = Light Tone = 32

**S** = Sand = 28

**W** = Warm Grey = 33

\*Trim color matches paint color.

**C** Select paint color (if required).

**27** = Black

**29** = Grey

**33** = Warm Grey

**28** = Sand

**32** = Light Tone

**59** = Juniper

**25** = Medium Bronze

**26** = Hunter Green

**31** = Eggshell White

**50** = Beige

**51** = Baltic

**52** = Bordeaux

**SP** = COM

**D** Select laminate surface (if required).

**AA** = Cream

**AB** = Champagne

**AC** = Barcelona

**AF** = Aruba Tan

**AG** = Black

**AH** = Dark Gray

**AI** = Dawn Gray (Greige)

**AJ** = Fog

**AK** = Black Grandin

**AL** = Smoke Granite

**AM** = Sand Grandin

**AN** = Light Granite

**AO** = Tundra

**AP** = Earthen

**AQ** = Rose Graphix

**AS** = Sierra Graphix

**AT** = Beige Grafix

**AU** = Sand Stone

**AV** = Kentucky Walnut

**AW** = Tennessee Oak

**AX** = Light Oak

**AY** = Red Birch

**AZ** = Ash

**BA** = Philadelphia Cherry

**BB** = Pennsylvania Cherry

**BC** = Mahogany

**BD** = Oak

**BE** = Maple







**BF** = Pearwood

**ZZ** = COM

**Specifications and prices are subject to change without prior notice.**

# Bravo Components

Worksurface Accessories/Adjustable Securable CPU Holder

MODEL	MODEL NUMBER		Destination Price
	Basic Model	Key Alike	
 <p><b>Basic</b></p> <ul style="list-style-type: none"> <li>• Black only</li> <li>• No covers</li> <li>• No lock</li> </ul>	ACPUNCNOLOCK		\$60
 <p><b>Basic with Covers</b></p> <ul style="list-style-type: none"> <li>• Black only</li> <li>• With covers</li> <li>• No lock</li> </ul>	ACPUWCNOLOCK		87
 <p><b>Basic with Covers and Security Kit</b></p> <ul style="list-style-type: none"> <li>• Black only</li> <li>• With covers</li> <li>• With lock</li> </ul>	ACPUWCLOCK	<input type="checkbox"/> <input type="checkbox"/>	130
 <p><b>Covers</b></p> <ul style="list-style-type: none"> <li>• Black only</li> </ul>	ACPUCK		28
 <p><b>Security Kit</b></p> <ul style="list-style-type: none"> <li>• Black only</li> </ul>	ACPUSK		42
 <p><b>Extra Cable</b></p> <ul style="list-style-type: none"> <li>• Black only</li> </ul>	ACPUCABLE		5

**A**

**B**

## HOW TO ORDER

Indicate the following information on order form:

1. Quantity of each item.
2. Model Number, including options. See "How to Build a Model Number".
3. Any special service required.

Note:

- The  indicates that a choice is required.
- The absence of the  indicates that no choice is required.
- Alpha-numeric characters in place of  indicate that no other options are available.

## HOW TO BUILD A MODEL NUMBER

- A** Select basic model.
- B** Select key option (if required).  
**KA** = Keyed alike

## INFORMATION

### Locks and Keying

All units include a lock. Keying is random unless otherwise specified at time of order entry. For this option use "KS".

The keyed alike option is specified by entering the two-letter designation "KA". This option specifies that the core is removed from the product. Lock and keys must be ordered as separate line items and shipped in bulk. Contact Customer Service.

Master keys are available.

**Specifications and prices are subject to change without prior notice.**

**Specifications and prices are subject to change without prior notice.**



**MODEL**

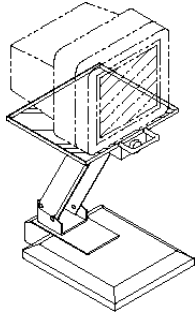

**Monitor Lift**

- Spring loaded steel platform supports monitors weighing 15-35 pounds on a 13½" x 12½" surface
- Height adjustment is 4" - 11" above the worksurface
- Non-skid mat keeps the monitor in place on the pad surface

**Height Adj. Range**  
 4" - 11"

**Platform Size**  
 13½" W x 12½" D

**MODEL NUMBER**

Basic Model	Trim Color	Paint Color	Destination Price
CICRTL	<input type="checkbox"/>		\$190
BVPMBL		27	9
BVPMBR		27	9

**Panel Mount Bracket**

- Allows a desk unit to be attached to a Crescendo panel
- Available in black only



**A**      **B**      **C**

**HOW TO ORDER**

Indicate the following information on order form:

1. Quantity of each item.
2. Model Number, including options. See "How to Build a Model Number".
3. Any special service required.

Note: • The  indicates that a choice is required.  
 • The absence of the  indicates that no choice is required.  
 • Alpha-numeric characters in place of  indicate that no other options are available.

**HOW TO BUILD A MODEL NUMBER**





- A** Select basic model.
- B** Select trim color (if required). \*  
**B** = Black = 27  
**S** = Sand = 28  
 \*Trim color matches paint color.
- C** Select paint color (if required).  
**27** = Black

Specifications and prices are subject to change without prior notice.

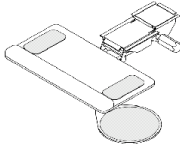
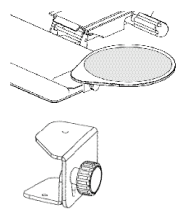

# Bravo Components

Worksurface Accessories/Keyboard Supports

MODEL	W x H x D	MODEL NUMBER		Destination Price
		Basic Model	Trim Color	
 <p><b>Composer Articulating Keyboard</b></p> <ul style="list-style-type: none"> <li>• Full articulation</li> <li>• Adjustable wristrest</li> <li>• Mouse arm</li> <li>• ADA height</li> </ul>		HWS0002	<input type="checkbox"/>	\$135
 <p><b>Optional Tilting Mousepad with Bracket Assembly</b></p> <ul style="list-style-type: none"> <li>• Converts stationary mousepad to tilting</li> <li>• Independent movement</li> </ul>		KIT5772	<input type="checkbox"/>	14
 <p><b>Center Drawer</b></p> <ul style="list-style-type: none"> <li>• Molded plastic compartment tray</li> </ul>	18" x 2¾" x 18"	3CD	<input type="checkbox"/>	33
 <p><b>Plastic Hanging Folder Holder</b></p> <ul style="list-style-type: none"> <li>• Plastic construction</li> <li>• One pair in each set</li> </ul>	2" x 1" x 8½"	PFH	<input type="checkbox"/>	10
 <p><b>Plastic Paper Tray Unit</b></p> <ul style="list-style-type: none"> <li>• Plastic construction</li> </ul>	2" x 9½" x 14"	PLL	<input type="checkbox"/>	15

**A**

**B**

## HOW TO ORDER

Indicate the following information on order form:

1. Quantity of each item.
2. Model Number, including options. See "How to Build a Model Number".
3. Any special service required.

Note:

- The  indicates that a choice is required.
- The absence of the  indicates that no choice is required.
- Alpha-numeric characters in place of  indicate that no other options are available.

## HOW TO BUILD A MODEL NUMBER







**A** Select basic model.

**B** Select trim color.

- B** = Black
- G** = Grey
- L** = Light Tone
- S** = Sand
- W** = Warm Grey

Specifications and prices are subject to change without prior notice.



	MODEL	W	H	D	MODEL NUMBER		Destination Price
					Basic Model	Trim Color	
	<b>Plastic Diagonal Storage Unit</b> • Plastic construction • Three slanted partitions per unit	2½"	7"	12½"	PDS	<input type="checkbox"/>	\$29
	<b>Plastic Vertical Storage Unit</b> • Injection-molded plastic construction	9"	5"	10½"	PVS	<input type="checkbox"/>	14
	<b>Telephone Caddy</b> • Plastic construction	2"	8½"	9½"	PTC	<input type="checkbox"/>	10
	<b>CD Holder</b> • Plastic construction • Stores up to 10 CDs	2"	5½"	7"	PDH	<input type="checkbox"/>	8
	<b>Accessory Tray</b> • Injection-molded plastic • Stores stamps, tape dispenser, post-it pads, and paper clips	2"	9½"	10"	PAT	<input type="checkbox"/>	8
	<b>Pencil Cup</b> • Injection-molded plastic	4"	4"	3½"	PPC	<input type="checkbox"/>	8

**A**

**B**

**HOW TO ORDER**

Indicate the following information on order form:

- Quantity of each item.
- Model Number, including options. See "How to Build a Model Number".
- Any special service required.

Note: • The  indicates that a choice is required.  
 • The absence of the  indicates that no choice is required.  
 • Alpha-numeric characters in place of  indicate that no other options are available.

**HOW TO BUILD A MODEL NUMBER**

**A** Select basic model.

**B** Select trim color.

- B** = Black
- G** = Grey
- L** = Light Tone
- S** = Sand
- W** = Warm Grey

Specifications and prices are subject to change without prior notice.

# Bravo Budget Typical

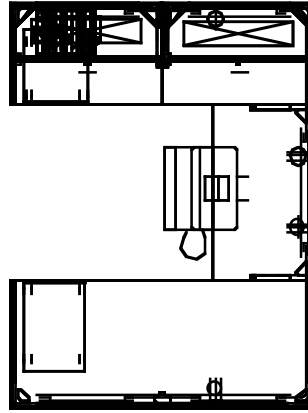
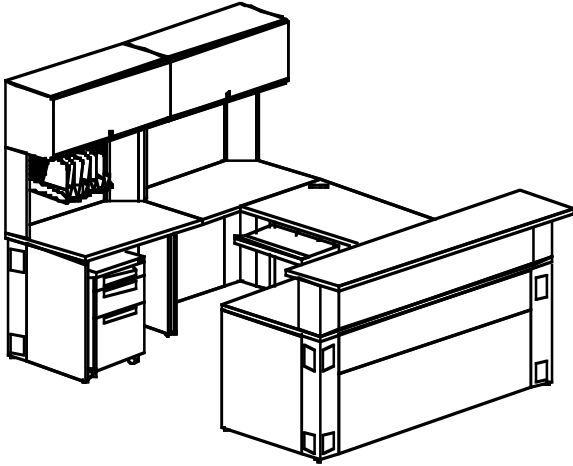

## Receptionist Station

Workspace 48 sq. ft.  
Budget Price \$3,558

Note: Budget price is based on single typical workstation. Price will decrease when workstations are clustered.

### Workstation Features:

- Laminate surfaces with flat vinyl T-edge
- Fabric overhead units with task lights
- Two mobile pedestals pencil, box, file
- Transaction countertop
- Paper management tool rail and accessories
- Articulating keyboard with mouse pad
- Powered and non-powered options available
- Wire management capabilities in stanchions
- Privacy screen

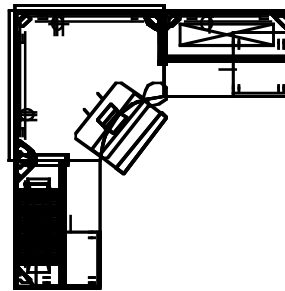
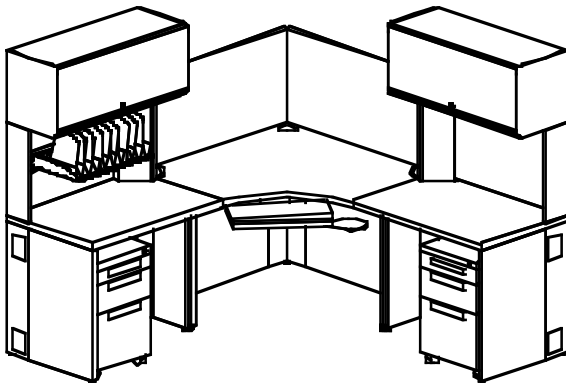

## Assistant Station

Workspace 36 sq. ft.  
Budget Price \$3,166

Note: Budget price is based on single typical workstation. Price will decrease when workstations are clustered.

### Workstation Features:

- Laminate surfaces with flat vinyl T-edge
- Fabric overhead units with task lights
- Two mobile pedestals pencil, box, file
- Paper management tool rail and accessories
- Articulating keyboard with mouse pad
- Powered and non-powered options available
- Wire management capabilities in stanchions
- Privacy screen

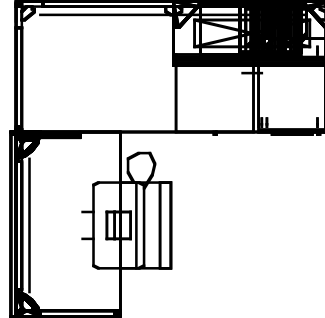
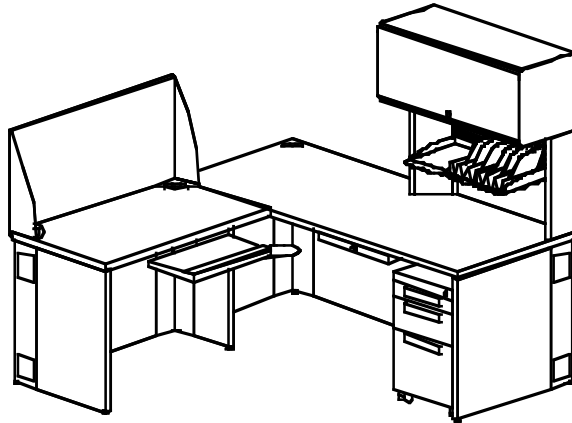

## Clerk Station

Workspace 36 sq. ft.

Budget Price \$1,733

Note: Budget price is based on single typical workstation. Price will decrease when workstations are clustered.

### Workstation Features:

- Laminate surfaces with flat vinyl T-edge
- Fabric overhead units with task lights
- Mobile pedestal pencil, box, file
- Paper management tool rail and accessories
- Articulating keyboard with mouse pad
- Center pencil drawer
- Powered and non-powered options available
- Wire management capabilities in stanchions
- Privacy screen

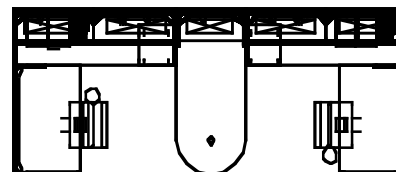
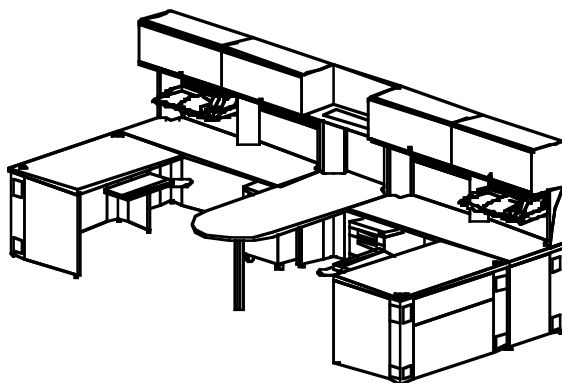

## Shared Station

Workspace 87 sq. ft.

Budget Price \$5,566

Note: Budget price is based on single typical workstation. Price will decrease when workstations are clustered.

### Workstation Features:

- Laminate surfaces with flat vinyl T-edge
- Fabric overhead units and open shelf with task lights
- Two mobile pedestals pencil, box, file
- Paper management accessories and privacy screens
- Articulating keyboard with mouse pad
- Powered and non-powered options available
- Wire management capabilities in stanchions

# Bravo Budget Typical

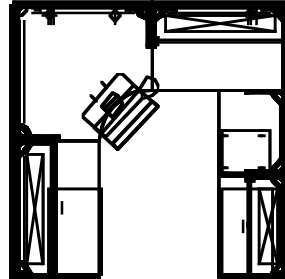
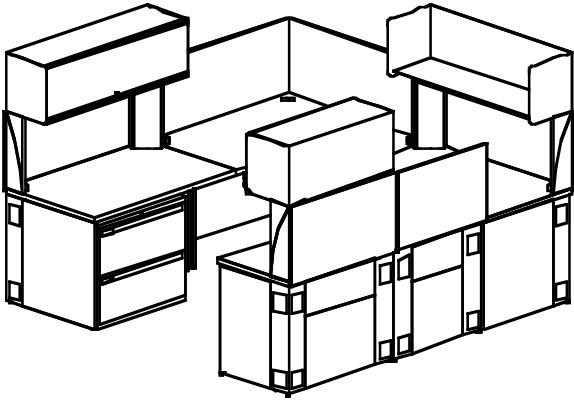

## Engineer's Station

Workspace 64 sq. ft.  
Budget Price \$4,780

Note: Budget price is based on single typical workstation. Price will decrease when workstations are clustered.

### Workstation Features:

- Laminate surfaces with flat vinyl T-edge
- Fabric overhead units and open shelf with task lights
- Mobile pedestal pencil, box, file
- Privacy screens
- Articulating keyboard with mouse pad
- Powered and non-powered options available
- Wire management capabilities in stanchions
- Two 30" wide 2-high lateral files

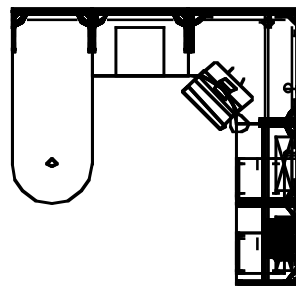
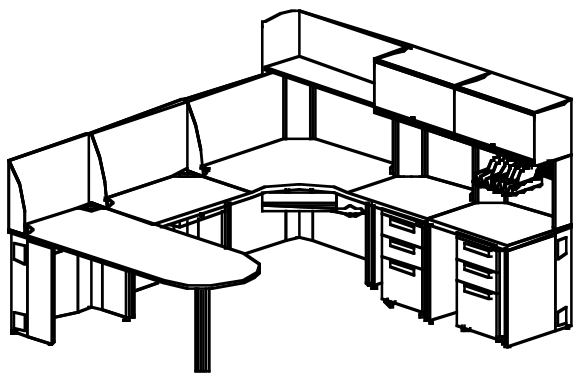

## Manager's Station

Workspace 92 sq. ft.  
Budget Price \$4,486

Note: Budget price is based on single typical workstation. Price will decrease when workstations are clustered.

### Workstation Features:

- Laminate surfaces with flat vinyl T-edge including peninsula top
- Fabric overhead units and open shelf with task lights
- Two mobile pedestals pencil, box, file
- Paper management tool rail and accessories
- Articulating keyboard with mouse pad
- Powered and non-powered options available
- Wire management capabilities in stanchions
- Privacy screens
- Center pencil drawer





U.S. Department of Justice

**UNICOR**

Federal Prison Industries, Inc.

CATPP701

