



Modular Signage Products

Elevadores



7

7
4
0

Pedro Cortés
Expresa Asociados

Corporativo BOA
Torre de Profesionistas

Corporativo BOA
Torre de Profesionistas

ISE Gerardo Guzmán

BOA Corp. Latinoamérica

Guzman Asesores

Expresa & Asociados

Reyo Maldonado & Ruiz

Servicios Administrativos del Norte

Table of Contents

System 2/90 is the flexible response to the demand for modular interior and exterior facility signage.

| | |
|-------------------------------------|-------------------|
| The System..... | 2 |
| Combo Signs..... | 3 |
| Three Systems in One..... | 4-5 |
| Component Design Options..... | 6-7 |
| Graphic Design Options..... | 8-9 |
| People and Department Signs..... | 10-11 |
| Direction/Directory Signs..... | 12-13 |
| Window Signs..... | 14-15 |
| Window Insert Signs..... | 14-15 |
| Sliding Insert Signs..... | 16-17 |
| In/Out Signs..... | 16-17 |
| Quick Change Number Signs..... | 18-19 |
| Quick Change LNS Signs..... | 18-19 |
| Freestanding Signs..... | 20-21 |
| Frame Signs..... | 22-23 |
| Quad Signs..... | 24-25 |
| Display Signs..... | 24-25 |
| Heavy Duty Interior Signs..... | 26-27 |
| Exterior Signs (Standard Duty)..... | 28-29 |
| Exterior Signs (Heavy Duty)..... | 30-31 |
| System 2/90 SPECS..... | 32 |
| Mounting Options..... | Inside Back Cover |
| Product Chart..... | Back Pocket |
| Color Chart..... | Back Pocket |
| Typestyle Chart..... | Back Pocket |

The System

The System is composed of three primary elements: a structural rail, removable copy inserts and interlocking end caps or frame.

Rails

Rails are made of extruded aluminum and can be specified as Thin, Standard or Box Rail. Rails are 2", 3", 4" or 6" in height, and up to 90" in width.

Inserts

Inserts range in height from 1" to 24". Maximum width is 90". Standard insert material is Korad® clad ABS, with aluminum and woodgrain laminate along with numerous special materials available.

End Caps

End caps interlock with the ends of the rail to enclose and secure the inserts. End caps can be ordered with locking features.

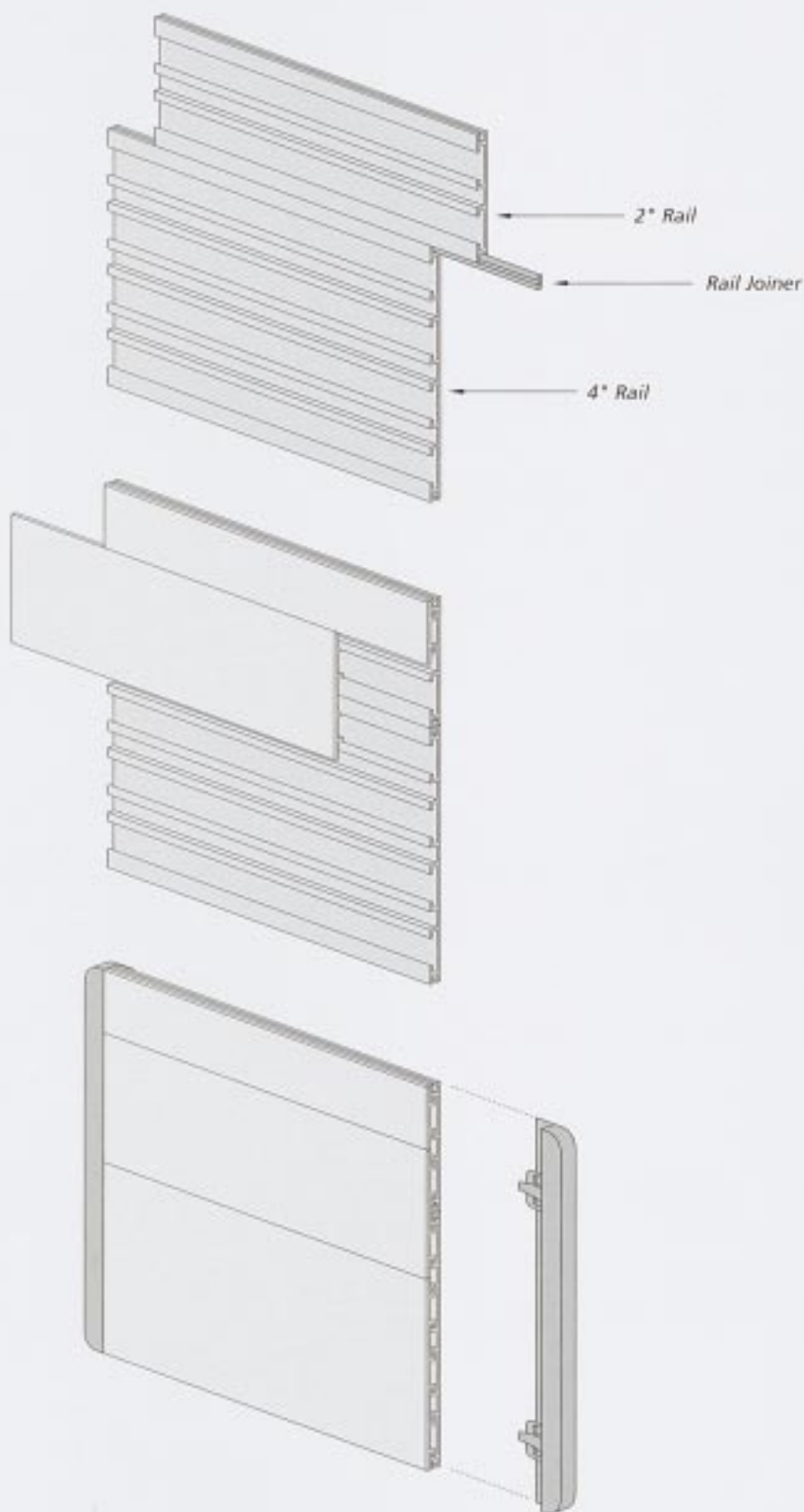

COMBO Signs

Larger signs can be made by combining smaller individual signs from the System 2/90 Product Chart to form COMBO Signs.

COMBO Signs

All standard System 2/90 signs are illustrated in the Product Chart (back pocket of brochure). To specify larger signs, a combination of standard signs can be specified.

System 2/90 COMBO signs accommodate large volumes of information as well as irregular formats such as very high or very wide layouts. COMBO signs can be expanded by adding any sign of the same height or width. The example illustrated here shows one of many ways in which a COMBO sign can be created, using standard System 2/90 signs.

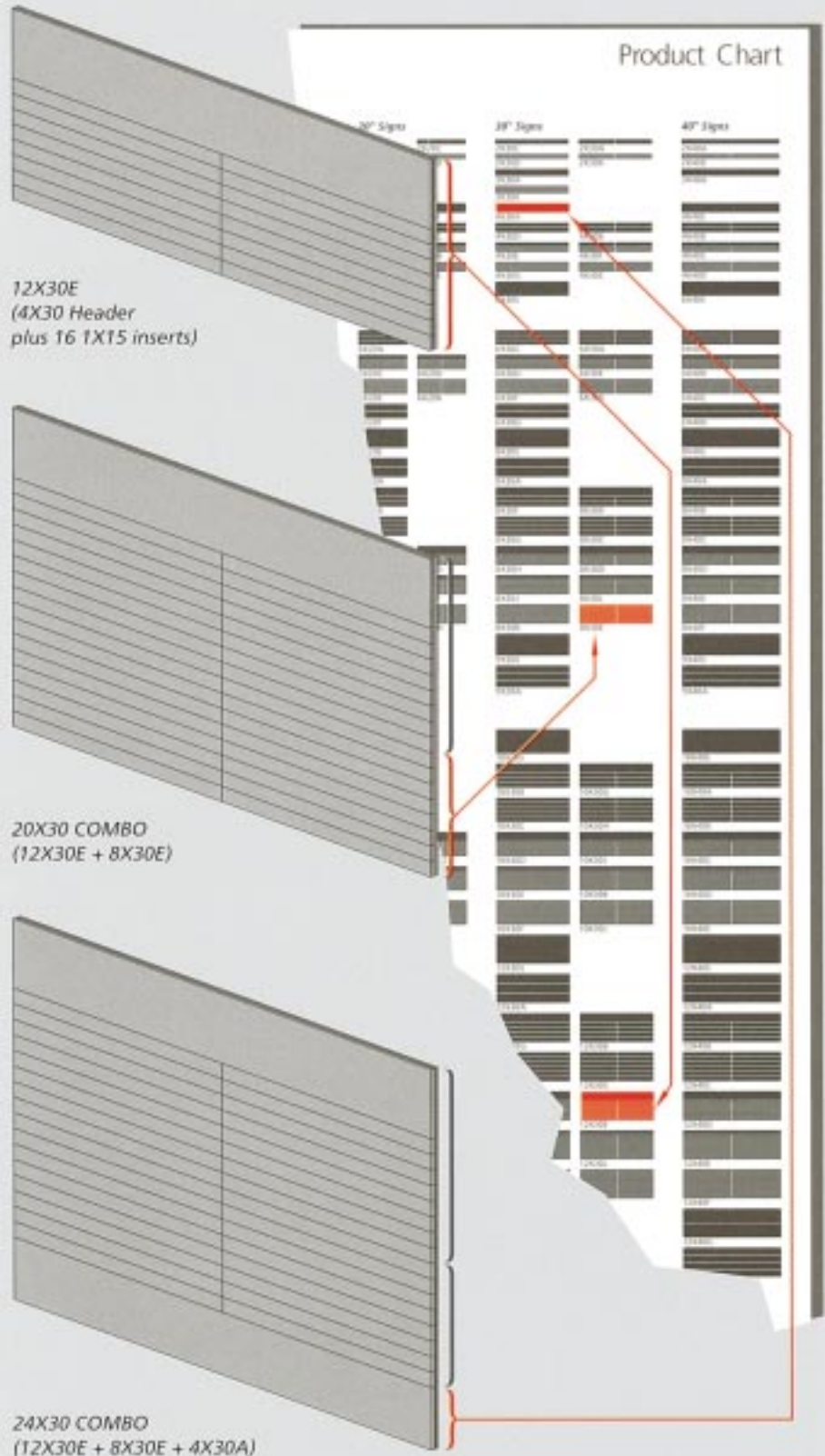

Three Systems In One

System 2/90 signs are available in three basic structural styles: the one-sided 2/90 Thin, the two-sided System 2/90 Standard, and the two-sided Box Rail design used for Heavy Duty Interior options.

From these three structural styles virtually any System 2/90 sign can be created. All rail faces are identical, allowing any System 2/90 insert to be used on any sign style, including Series 1 exterior signs. * End cap, accent strip, frame, top and bottom trim and insert options allow for infinite creative flexibility, within a system that is elegantly simple.

System 2/90 THIN

- 9/32" thickness
- Recommended maximum of 400 square inches
- Accepts inserts on face side only

System 2/90 Standard

- 9/16" thickness
- Recommended maximum of 2000 square inches
- Accepts inserts on both sides

System 2/90 Box Rail

- 2" or 3 1/4" thickness
- Used for Heavy Duty Interior Signs
- Recommended maximum of 5400 square inches
- Accepts inserts on both sides

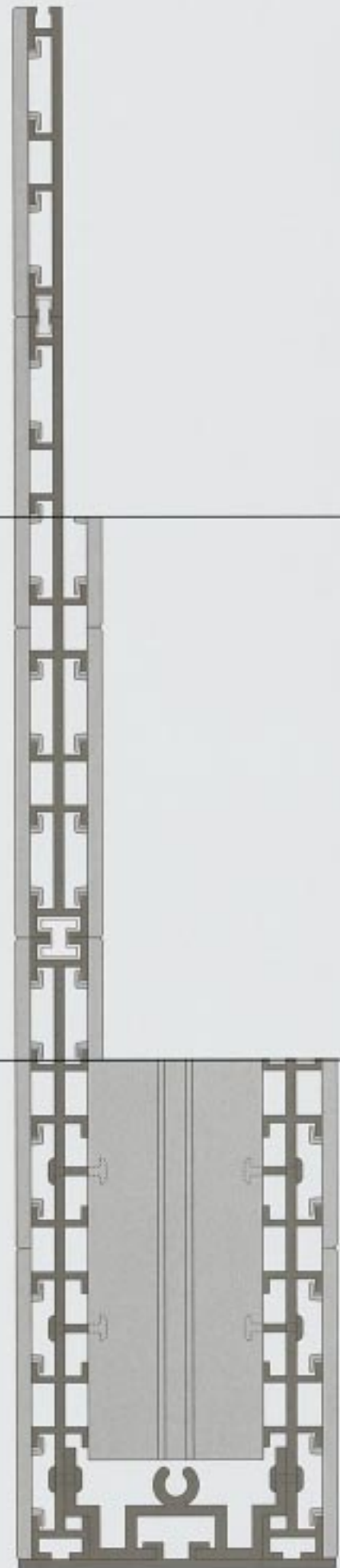

* System 2/90 Heavy Duty Exterior signs (pages 30 & 31) utilize aluminum panels instead of rails and inserts.



126

Jason Hendricks

Humanities Director

WELCOME

please sign r

erwache 23

WEST

H

Erste Hilfe
Toiletten

ACIÓN



Casa Omega

Cristina Gonzalez
Director de Residentes

Ana Valero
Director de Asistentes

Javier Garcia
Director de Asistentes

Alfonso Villalba
Coordinador de Actividades

Belen Lopez
Asociado

Antonio Santillana
Personal

Francisco Linare
Gerente de Mantenimiento

José Gomez
Gerente de Asistentes

Silvia Casado
Representativo

Carmen Losada
Representativo

8

126

Dr. Henri DuVall

Circuit Courts

Presiding Judge

Courtroom A

The Hon. Judge Andrew MacRae

Courtroom B

The Hon. Judge Phyllis Kinnel

Courtroom C

The Hon. Judge Edward Smith

Courtroom D

The Hon. Judge William Adelman

Courtroom E

The Hon. Judge Kristin Humbert

Courtroom F

The Hon. Judge Richard Myers

H

Erste Hilfe
Toiletten

Hombres

Component Design Options

Each component of the system is available in a variety of styles, providing a virtually unlimited range of possible configurations.

End Caps and Trim Options

Six end cap styles are offered in eight standard colors plus natural anodized aluminum. An unlimited range of optional Color Match selections is available. Wood and chrome end caps are also offered. Top and Bottom Trim and Accent Strip options are available to customize System 2/90 signage.

Other Sign Styles

Other Sign Styles—including Small and Large Frame, Heavy Duty Interior, Exterior, Freestanding, Quad Signs and Display Signs—are covered in later sections of this catalog.

End Caps

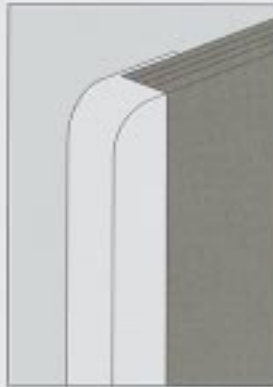

RC
Round Corner

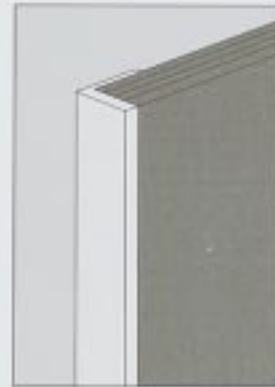

SL
Slimline

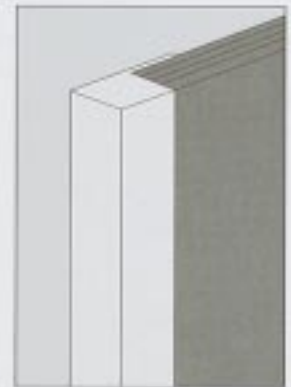

SC
Square Corner

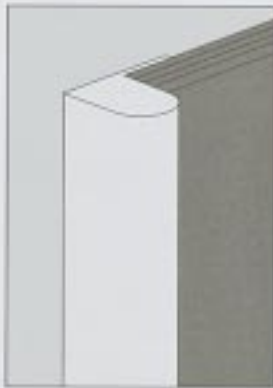

BN
Bullnose



AB
Angleback



SB
Stepback

Trim Options

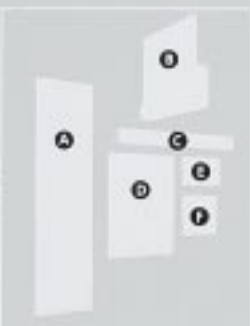
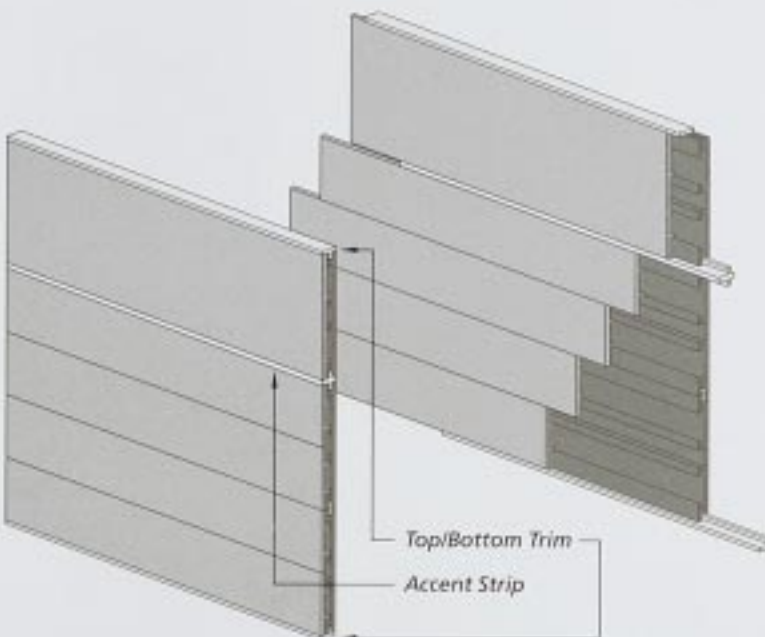

- A 8 1/2 x 8 Standard Slimline End Cap w/ Top & Bottom Trim & Accent Strip
- B 10 x 12 Standard Exterior Series 1 Perpendicular Mount Mod-Fit Square Post Trim
- C 2 x 20 Thin Bullnose End Cap Top and Bottom Trim
- D 15 x 18 Thin Square End Caps
- E 4 x 8 Standard Bullnose End Cap Top and Bottom Trim Yellow Accent Strip
- F 6 x 6 Thin Slimline End Caps

Graphic Design Options

System 2/90 projects your company's commitment to quality. A comprehensive selection of standard features plus custom options is available to provide flexibility in color, texture and style.

Colors, Copy and Textures

Korad® clad ABS copy inserts are available in eight standard colors. More than 30 standard Color Match colors plus unlimited custom colors are also offered. Brushed aluminum and woodgrain laminate inserts are also available.

System 2/90's durable premium grade PVC copy material is available in 18 standard colors as well as hundreds of additional colors through special order. Standard finish is gloss. Matte finish is used for ADA* and under glass applications.

In addition to standard surface application of vinyl copy, System 2/90 offers Silkscreened, Engraved, Sub-Surface, Tactile and Braille.*

System 2/90 offers a large selection of popular type styles. Additional styles or custom font development are available through special order. Copy ranges from 3/8" to 24" in height. (See Typestyle Chart in back pocket of brochure.)

A comprehensive selection of international symbols are available as well as logos or custom graphics in any size or color desired.

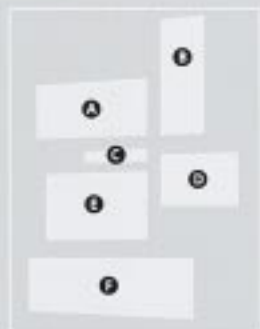

- A 18 x 28 Standard Bulbous End Caps and Standard End Caps Window Sign 1/2" inserts
- B 28 x 6 Standard Angled End Caps
- C 2 x 10 Thin Stepback End Caps Sliding Knob
- D 9 x 12 Standard Bulbous End Caps 3/4" recessed front
- E 12 x 18 Standard Bulbous End Caps Photopolymer Insert
- F 18 x 28 Standard Standard End Caps "Edge" graphic insert

Standard Copy Application

Surface-applied vinyl copy is standard and is available in a wide range of colors and type styles. (See System 2/90 Color Chart and Typestyle Chart)



Copy Application Options

Optional copy application methods can be ordered for part or all of any System 2/90 sign.

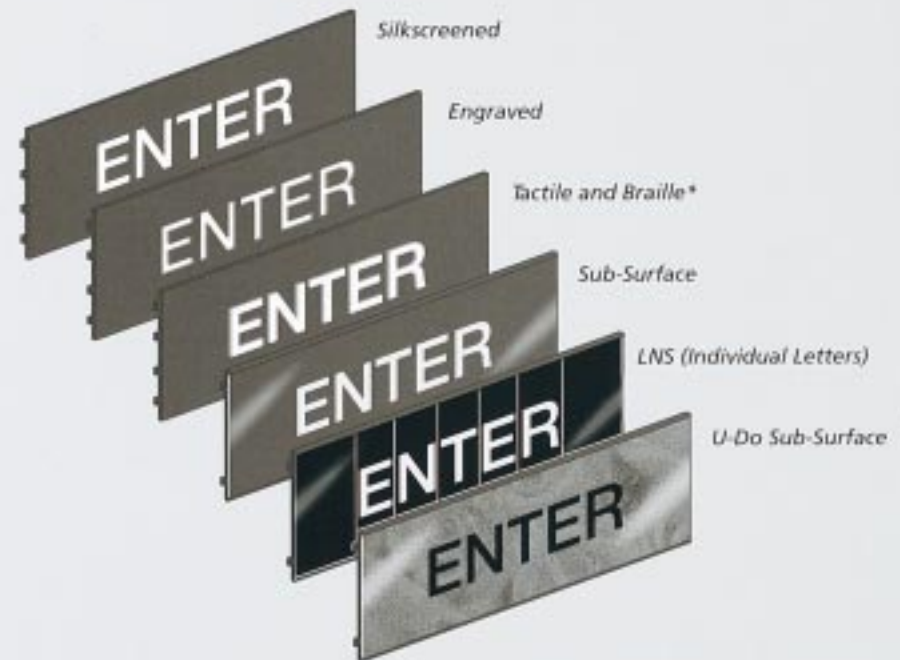

LNS signs—offer individual changeable letters that slide into LNS inserts behind a clear lens. Letters are printed white on black PVC, creating a near perfect match with black face of the window insert.

U-Do Sub-Surface signs—allow you to create your own custom graphics as a background behind lens-applied letters. Or you can create your own copy on supplied laser-print paper, to be inserted behind a clear Lexan® lens.

* Specifying signage for accessibility, including compliance with government regulations such as the Americans with Disabilities Act (ADA), does not compromise the original simplicity of the system. For more information, refer to the System 2/90 ADA Facts and Specifications brochure.

Panthers Roster

- Allen Sorenson
- Clayton Douglas
- Jack Peterson
- John Tyler
- Adam Jones
- Frank Mitchell
- Henry Dixon
- Clayton Patten
- Edward Devere
- Michael Potts
- John Smith
- Kevin Clark
- David Hill
- Dwight King
- Frank Cook
- Stephen Lee
- James Hill
- Frank Williams



Immobiliaria Peterson

- 2110
- 2112
- 2114
- 2116
- 2118
- 2120
- 2122
- 2124
- 2126
- 2128
- 2130
- 2132
- 2134
- 2136
- 2138
- 2140
- 2142

Marcel [unclear]
Available

4TH STREET STATION



GOTA -
GREATER OAKLAND TRANSIT AUTHORITY

Italian Frescos



Boxen für Anfänger

Stunden – Erhält nur für Mitglieder der "Newcomer-Sporthalle"

| | |
|---------------------|----------------------|
| Montag – Donnerstag | 6.00 Uhr – 23.00 Uhr |
| Freitag & Samstag | 8.30 Uhr – 24.00 Uhr |
| Sonntags | geschlossen |



pharmacy
Orlando Eyebank



recovery/patient rooms
Orlando Eyebank

8 lounge

Orlando Eyebank admissions

Dr. Harriet Marx
Staff Physician
Rm. 102

consultation
Orlando Eyebank

Oliver Bente



Helmut Fischer
Stations Pfarrer

Feuerwache 23
Phillip Warn
Brandmeister

WELCOME
please sign register

INFORMACIÓN

Jason Hendricks
Humanities Director

Next Window Please

3

People and Department Signs

System 2/90, in its most basic application, offers facilities a consistent program of identification signage for people and departments that can be updated quickly, easily and inexpensively.

People Signs

Layouts for people signs accommodate name only, name and title, name and room number, and even name and photo. Choice of sign sizes range from our smallest 2" x 6" signs to any size needed.

System 2/90 Photo Signs can be used in roster style applications as well as in people signs.

Department Signs

The ability to create a variety of sizes is critical to creating effective department signs. Some facilities standardize the height of their department signs and determine width by the length of copy to be included. Others prefer a single size sign which accommodates various copy.

People Signs = 2"

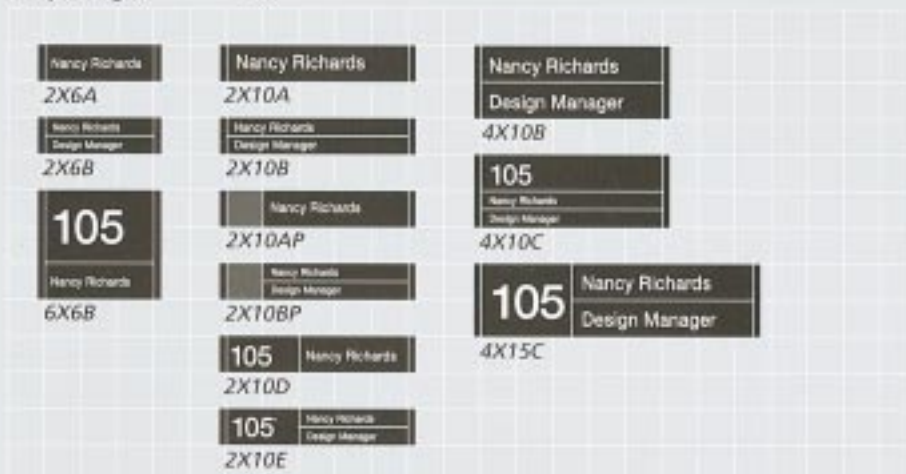

Department Signs = 2"

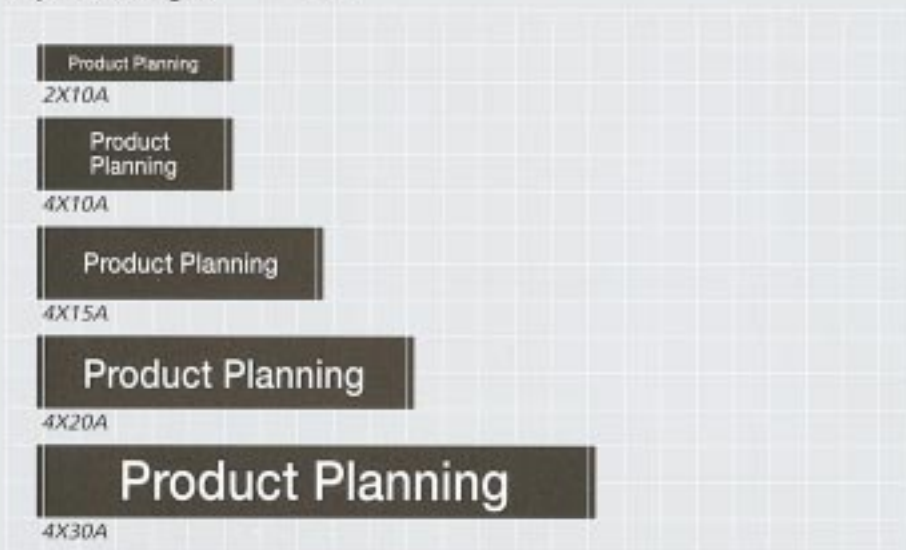

Department Signs = 2"



- A. 4 x 10 Standard Square End Caps
- B. 5 1/2 x 9 Standard Square End Caps
- C. 6 x 10 Standard Square End Caps
- D. 4 x 20 Standard Square End Caps
- E. 3 x 36 Standard Square End Caps
- F. 6 x 12 Standard Square End Caps
- G. 6 x 36 Standard Square End Caps
- H. 2 x 18 Standard Square End Caps
- I. 6 x 6 Thin Angled End Caps
- J. 4 x 8 Thin Angled End Caps Slide Knob
- K. 4 x 18 Thin Angled End Caps
- L. 4 x 15 Thin Angled End Caps
- M. 2 x 6 Thin Square End Caps
- N. 2 x 10 Standard Beveled Corner End Caps
- O. 2 x 10 Standard Bulbous End Caps
- P. 2 x 10 Triangle Sign
- Q. 2 x 4 Triangle Sign



Direction/Directory Signs

Ease of insert changes, range of insert sizes and variety of insert layouts make System 2/90 Direction Signs and Directory Signs the most complete in the industry.

Direction Signs

In larger direction signage the flexibility of System 2/90 provides an economical solution when changes have to be made.

Any System 2/90 sign can be used for direction sign applications.

Colors and contrasting copy add emphasis and clarity to direction signs. Price is not affected by either copy color or insert color combinations.

Directory Signs

Replacement inserts are the key to a good directory sign. Combo Signs are generally used for directory signs. Insert capacity can be increased after installation by adding sign sections to the original sign.



- A. 12 x 54 HD Interior Square Corner Trim Hanging Mount
- B. 54 x 6 Standard Slimline End Caps Bulletin Top/Bottom Trim
- C. 16 x 28 Thin Slimline End Caps Custom Bulletin Accent Trim
- D. 16 x 32 Standard Bulletin End Caps
- E. 16 x 16 Standard Angled End Caps Hand Placed Textile Copy
- F. 8 x 15 Thin Round Corner End Caps
- G. 4 x 15 Thin Square End Caps

Direction Signs = 2"

| | |
|--------------------|-------------------|
| ↑ Purchasing | ↑ Marketing |
| ↑ Accounting | ↑ Facilities |
| ← Personnel | → Interior Design |
| ← Medical | → Product Design |
| ← Customer Service | → Human Factors |

12X30C (MODIFIED)

| | |
|--------------------|-------------------|
| ↑ Purchasing | ↑ Marketing |
| ↑ Accounting | ↑ Facilities |
| ← Personnel | Interior Design → |
| ← Medical | Product Design → |
| ← Customer Service | Human Factors → |

12X40C

| | | |
|------------------|------------|-----------------|
| ← | ↑ | → |
| Personnel | Purchasing | Interior Design |
| Medical | Accounting | Product Design |
| Customer Service | Marketing | Human Factors |
| | Facilities | |

12X60 COMBO (3ea. 12X20B)

Directory Signs = 2"

| | |
|---|----------------|
| 1 | Alpha Building |
| | |
| | |
| | |
| | |
| | |
| | |
| | |
| | |
| | |
| | |
| | |
| | |
| | |

12X30E

| | |
|---|--------------|
| 2 | Plaza Suites |
| | 300-306 |
| | 308-312 |
| | 314-320 |
| | 322-324 |
| | 326-330 |
| | 332-336 |
| | 332-336 |
| | 332-336 |
| | |
| | |
| | |
| | |
| | |
| | |
| | |
| | |
| | |

54X15 COMBO
(3ea. 6X15S
& 3ea. 12X15C)

36X30 COMBO
(8X30S, 2ea. 12X30A & 4X30A)

INTERNATIONALE ABFLÜGE
 INTERNATIONAL DEPARTURES
 DEPARTS INTERNATIONAUX
 SALIDAS INTERNACIONALES

CONCOURSE

B



- 1**
- ALLEN B
- AMALONE I
- BALDWIN B
- BELMONT K
- BENNETT J
- BENNETT V
- BYRNE M
- CHAMBERLAIN J
- COOPER B
- FRANK A
- FRANK B
- FRANK C
- FRANK D
- FRANK E
- FRANK F
- FRANK G
- FRANK H
- FRANK I
- FRANK J
- FRANK K
- FRANK L
- FRANK M
- FRANK N
- FRANK O
- FRANK P
- FRANK Q
- FRANK R
- FRANK S
- FRANK T
- FRANK U
- FRANK V
- FRANK W
- FRANK X
- FRANK Y
- FRANK Z
- 2**
- FRANK A
- FRANK B
- FRANK C
- FRANK D
- FRANK E
- FRANK F
- FRANK G
- FRANK H
- FRANK I
- FRANK J
- FRANK K
- FRANK L
- FRANK M
- FRANK N
- FRANK O
- FRANK P
- FRANK Q
- FRANK R
- FRANK S
- FRANK T
- FRANK U
- FRANK V
- FRANK W
- FRANK X
- FRANK Y
- FRANK Z
- 3**
- FRANK A
- FRANK B
- FRANK C
- FRANK D
- FRANK E
- FRANK F
- FRANK G
- FRANK H
- FRANK I
- FRANK J
- FRANK K
- FRANK L
- FRANK M
- FRANK N
- FRANK O
- FRANK P
- FRANK Q
- FRANK R
- FRANK S
- FRANK T
- FRANK U
- FRANK V
- FRANK W
- FRANK X
- FRANK Y
- FRANK Z



East Wing Madison Medical Center

- ↑ Sleep Disorders
- ↑ Trauma Center
- ↑ Maternity
- ← Family Care
- ← Radiology
- ← Physical Therapy
- ↑ Infant Care
- ↑ Eldercare
- Cafeteria
- Registration
- Administration
- Pharmacy & Gifts

Executive Plaza

2000

- 201 Krause & Assoc
- 202 Rafael J Diaz
- 203 Newman & Winter, PC
- 204 Conner Consulting Inc
- 205 Frontier Developers
- 206 Janet P. Bogard
- 207 Stanley Kleinman
- 208 Summit Financial Inc
- 209 Lynch & Company
- 210 Samuel E. Merrill
- 211 The Ames Group
- 212 James T. Galliano
- 213 Modern Engineering
- 214 Robertson, Inc.
- 215 Philip Thompson
- 216 Sally Gibbs & Assoc
- 217 TRC Productions
- 218 Aaron J. Kilbane

DIRETORIA

- ↑ Financeiro
- ← Administrativo
- Recursos Humanos

SORTIE →

Courts

Magistrate's Court

Justice of the peace John Tide

Crown Court

Phylis Himel presiding chairperson

Assize Court

Edward Smith presiding barrister

Court of Appeals

Lord Chief Justice William Adelman

Lords Justice of Appeals K. Hume

Puisne Judge Richard Myers

Chief Officer

Ronald
Montegue
III

Departments of officials



Mary Combs

Rm 905



Evacuation Route



EDGERTON

Civic Calendar

| DATE | EVENT |
|-------------|----------------------------------|
| December 7 | Edgerton Coloured Light Festival |
| December 9 | Founder's Day |
| December 14 | Council Meeting |
| December 15 | City Planning Commission Meeting |
| December 25 | Christmas Day |
| December 26 | Boxing Day |
| December 31 | End of Fiscal Year |

EDGERTON
THE PLACE TO BE

Rate Pounding
Assessment has
moved to third floor



Window and Window Insert Signs

System 2/90 provides specialty-insert solutions for temporary or customized displaying of documents, photographs, messages and names.

Window Sign

The System 2/90 Window Sign displays any letter-size printed matter, including photographs, under glass. The clear, low glare, acrylic face insert can be attached to the sign by standard sliding hook or by front-loading magnetic strip.

An 8 1/2" x 11" viewing size is standard, but any size up to 400 square inches is acceptable.

Window Insert

Primarily used as people signs—any standard System 2/90 sign, using 1", 2", 3" or 4" high inserts can be specified with Window Insert. Window Inserts can be combined with other standard insert materials within a particular sign.

Standard insert color is black anodized channels and white paper. Color Match sign colors are available, and special paper colors and/or patterns can be specified. Window Inserts can be used for computer-generated signs (printing on die-cut paper inserts) and for U-Do Subsurface, where reverse-cut vinyl copy is applied to back surface of Lexan® lens.

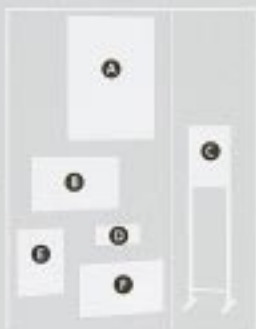
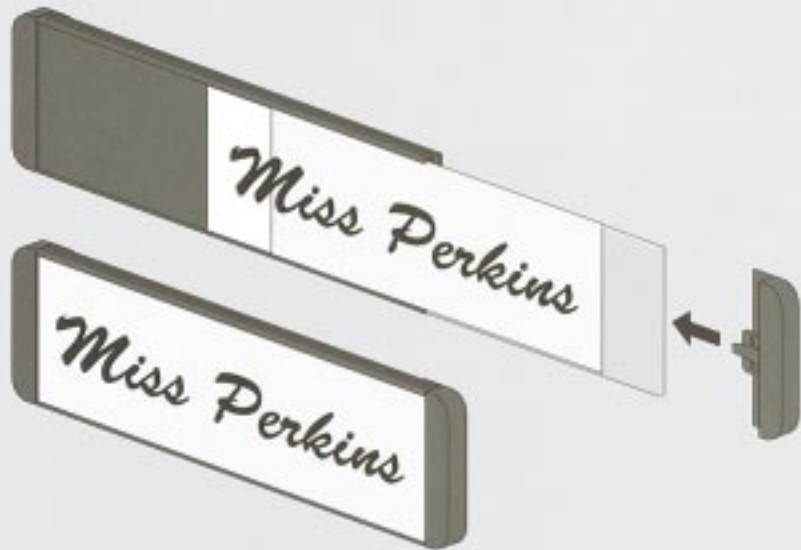
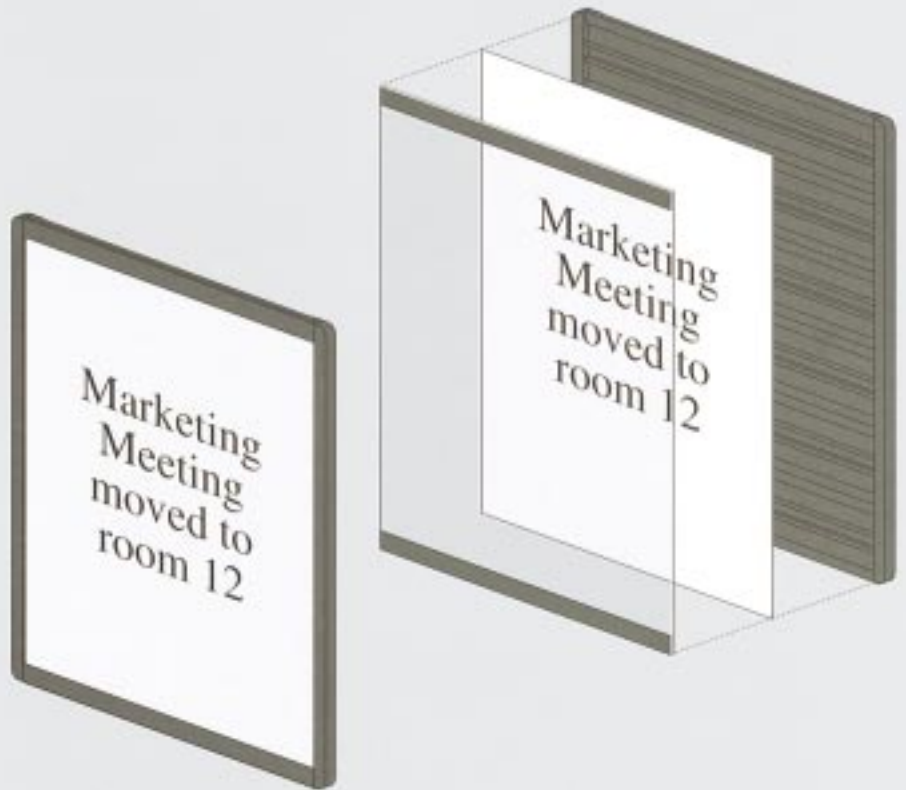

- A. 28 x 20 Window Insert
Standard
Rounded Corner End Caps
- B. 12 x 20 Window Sign
Standard
Rounded Corner End Caps
- C. 12 x 10 Window Sign
w/ 4 x 10 Header
Standard
Freestanding
- D. 4 x 18 Photo Sign
Standard
Rounded Corner End Caps
- E. 18 x 10 Window Sign
w/ 6 x 10 Header
Standard
Rounded Corner End Caps
- F. 12 x 20 Window Insert
Standard
Rounded Corner End Caps

Sliding Insert Signs

Clear and convenient display of the availability of key personnel and facilities is provided by System 2/90 Sliding Insert Signs and In/Out Signs.

Basic Sliding Insert Signs

Sliding Insert Signs are typically used for conference or meeting rooms to indicate availability. Any sign with a 1", 2", 3" or 4" high insert can be used as a Sliding Insert Sign. All Sliding Insert Signs have Locking End Caps with the exception of Angleback and Stepback End Caps.

In/Out Sign

In/Out Signs have the same flexibility as any System 2/90 sign. The basic sign measures 12" in height by 20" in width and will accept up to 10 names. Name capacity can be increased by adding 4" x 20" modules, which accommodate four additional names each.

The sign can also be expanded by adding modules to the right. The standard addition is a 5" wide white dry marker material. Corkboard sections can also be specified.

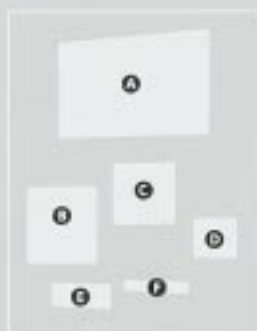

- A 18 x 25 Standard In/Out Sign
w/ Pen Shelf
Bulbless End Cap
- B 13 x 12 Thin In/Out Sign
Bulbless End Cap
- C 18 x 18 Sliding Insert
Standard
w/ Slide Holder
Bulbless End Cap
- D 4 x 4 Sliding Knob
Thin
Bulbless End Cap
- E 4 x 30 Sliding Insert
Thin
Bulbless End Cap
- F 2 x 30 Sliding Insert
Thin
Bulbless End Cap

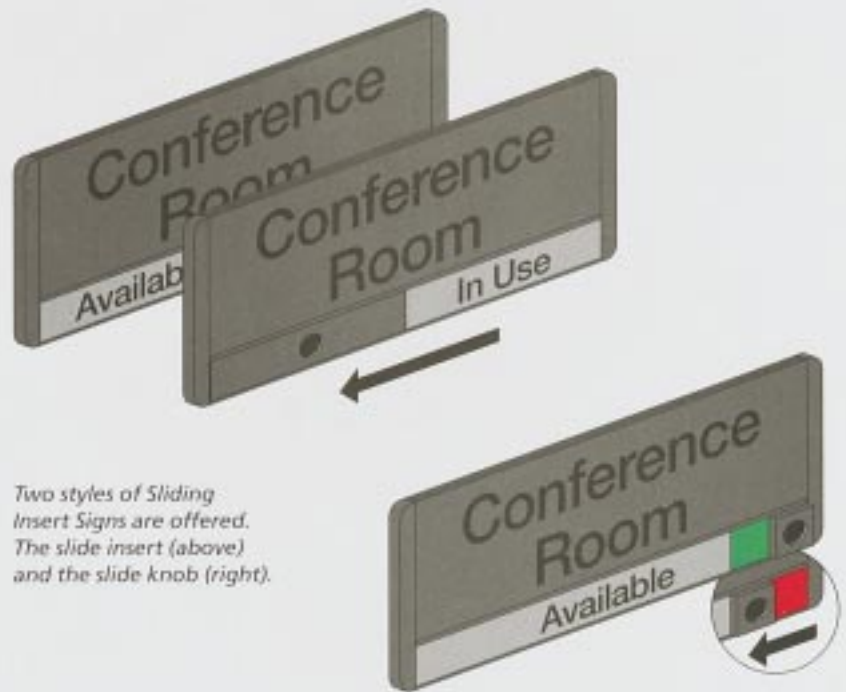

Two styles of Sliding Insert Signs are offered. The slide insert (above) and the slide knob (right).

The basic In/Out Sign is 12" high by 20" wide and will accept up to ten names.



Additional 4" x 20" modules, which accommodate four names each, can be attached to the bottom.



Message center modules in white dry marker material or corkboard expand sign width in 5" sections.

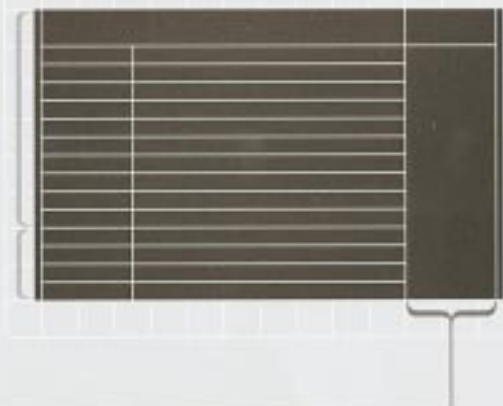

PINE STATE UNIVERSITY

ADMISSIONS

NOTES

WILL RETURN AT:

| NAME | IN | 9 | 10 | 11 | 12 | 1 | 2 | 3 | 4 | 5 | OUT |
|-------------|----|---|----|----|----|---|---|---|---|---|-----|
| TRATTIO, R. | | | | | | | ● | | | | |
| O'NEIL, J. | ● | | | | | | | | | | |
| CASSIDY, S. | ● | | | | | | | | | | |
| TENRICK, F. | | | ● | | | | | | | | |
| BROWN, D. | | | | | | | | | ● | | |
| CHUNG, C. | ● | | | | | | | | | | |
| HINKLE, T. | ● | | | | | | | | | | |
| FUENTES, A. | | | | | | | | | | | ● |
| ALBOM, G. | ● | | | | | | | | | | |

STAFF MEETING
3/14
8:00 AM
SHARP!

FINE STATE UNIVERSITY

BOOKSTORE

| | IN | OUT |
|-----------------|----|-----|
| RON PHILLIPS | ■ | ■ |
| CYNTHIA ROGERS | ■ | ■ |
| OSCAR OLIVAREZ | ■ | ■ |
| HANS GUTENBERG | ■ | ■ |
| LARRY MCNICHOLS | ■ | ■ |
| MIKE WAYBRIGHT | ■ | ■ |
| SHARON TRENT | ■ | ■ |
| MITCHELL HABER | ■ | ■ |

PLEASE COME IN



CAPER WILLIAMS
JOB PLACEMENT COUNSELOR

MESSAGES

Mr. Williams
I would like to set up an appointment with you before the break. Please call me at 546-7785
Thank you
Matt Conway

RODRIGO LOPEZ-CARRERA

OFFICE HOURS
M, W, F 9:00 AM - 10:30 AM
T, TH 2:00 PM - 4:30 PM
OTHER BY APPOINTMENT

LATIN AMERICAN AFFAIRS
COLLEGE OF POLITICAL SCIENCE

AVAILABILITY

C. W. CUMMINGS FINE ARTS AUDITORIUM

BOX OFFICE

SOLD OUT

WEST CONFERENCE ROOM

Occupied

International Currency Exchange Rates

Taux de Change Internationaux — Divisas
Taxas de Câmbio de Divisas Internacionais

| Country | Currency | Buy | Sell |
|----------------|--------------|---------|---------|
| Australia | Dollar | 0.7800 | 0.8100 |
| Belgium | Franc | 0.7500 | 0.7800 |
| Canada | Dollar | 0.7300 | 0.7600 |
| France | Franc | 0.1800 | 0.1900 |
| Germany | Franc | 0.2600 | 0.2700 |
| Ireland | Draught mark | 0.7200 | 0.7500 |
| Italy | Lira | 0.1700 | 0.1800 |
| Japan | Yen | 0.00650 | 0.00660 |
| Mexico | Peso | 0.04000 | 0.04100 |
| Netherlands | Guilder | 0.5400 | 0.5600 |
| Portugal | Escudo | 0.66000 | 0.68000 |
| Spain | Peseta | 0.01600 | 0.01650 |
| Switzerland | Franc | 0.82000 | 0.84000 |
| United Kingdom | Pound | 1.58000 | 1.60000 |

All exchange rates are in United States Dollars

Blue Moon Video

NEW RELEASES

- Cat Women on the Moon
- The Wasp
- Bride of the Gorilla
- The Indestructible Man

Vía **16** Madrid/Cordoba
Salida 16:40

Douglas Brothers Development

| Project/Building | Status | Comments |
|---------------------------|------------|---------------|
| Forsyth Medical | TR1, Comp. | 3rd Available |
| Green Acres Business Park | 20% | Exp. 4/12 |
| McKay Tower | 95% | |
| Malco Mall | 3rd Stage | Sched. Comp. |
| Waterfront Plaza | 1 | 4/12-Critical |

325 Unfallfreie Tage!

Industrie Service Hannover
West Küsten Händler
Konferenz-Raum **A**

LC Imobiliária

Plano de Venda

| | |
|-----------|--------|
| Anderson | 705.50 |
| Carolina | 640.00 |
| Lucas | 625.00 |
| Elizabeth | 475.50 |
| Marcelo | 300.00 |

CREDIT REGIONAL EUROPEEN

| | |
|------------------|-------|
| PLAN D'EPARGNE | 5.50% |
| COMPTE EPARGNE | 1.25% |
| COMPTE RETRAITE | 2.75% |
| CREDIT LOGEMENT | 8.50% |
| C.D. - 6 MOIS | 5.00% |
| C.D. - 1 AN | 5.00% |
| PRET ENTREPRISES | 9.50% |
| PRET PERSONNEL | 8.25% |



Quick Change Signs

System 2/90 offers the ultimate in changeable-on-demand signage.

Quick Change Number Sign

System 2/90's is the simplest and most easily maintained changeable numbers sign available. The reusable printed fluorescent paper insert slips into System 2/90's Window Insert, protected by a clear Lexan® lens. The result is a simulated electronic LCD sign that is unbelievably realistic.

Numbers are changed by wiping clean the paper insert and creating a new number with the water soluble black marker pen (supplied). Both magnetic (front-loading) and standard hook-mounted inserts are offered.



Quick Change LNS Sign

LNS—Letter, Number and Symbol inserts slide into System 2/90's standard Window Insert to create messages that can be changed on site. A non-glare Lexan® lens protects the changeable inserts from vandalism. Both magnetic (front loading) and standard hook mounted Window Inserts are available. For further information, refer to the *System 2/90 LNS Brochure*.

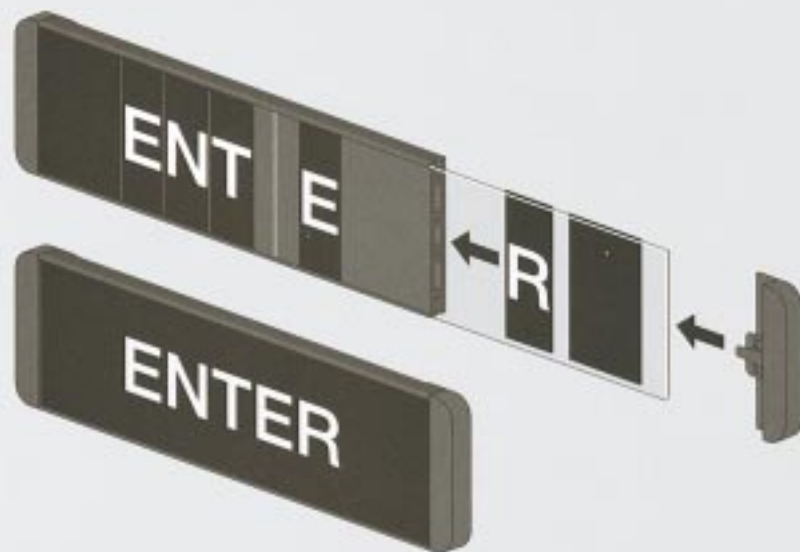

- A 24 x 26 Quick Change - 1" LCD Standard Round Corner End Caps Window Insert (not flap)
- B 24 x 30 Quick Change - 2" LNS Standard Round Corner End Caps Accent Strip
- C 6 x 28 Quick Change - 2" LNS Thin Bulbrite End Caps
- D 12 x 30 Quick Change - 1" LNS Standard Square End Caps
- E 15 x 12 Quick Change - 1" LCD Standard Freestanding
- F 4 x 15 Modified Quick Change - 2" LNS Thin Bulbrite End Caps
- G 15 x 30 Quick Change - 4" LNS Thin Silicone End Caps
- H 18 x 27 Quick Change - 2" LCD Thin Square Corner End Caps

Freestanding Signs

Freestanding signs include light duty, medium duty and heavy duty stands for System 2/90 signs.

Light Duty

Light Duty stands are constructed of a fabricated aluminum frame with a welded steel base. Stand height is 48" and maximum sign size is 400 square inches.

The Brochure Holder Sign is similar to the Light Duty Freestanding Sign with the addition of a lower filler panel and a clear acrylic pocket. A sign above the pocket is 9" wide and may be any standard height. Brochure holder holds 8 1/2" x 11" materials and can be specified for one or two sides of sign.

The brochure holder is also available on custom applications for all freestanding signs. Other holder sizes can also be specified.

Medium Duty

Medium Duty stands are constructed of welded steel square tubing. Standard height is 60", and maximum sign size is 1200 square inches.

Heavy Duty

Heavy Duty stands are constructed of the same 2 1/4" round extruded aluminum as is used in System 2/90 standard duty exterior signs (see page 28 for assembly details). Recommended maximum sign size is 2400 square inches, in total height up to 72".

Copy inserts on Medium and Heavy Duty signs are under glass (clear acrylic). Leveler feet are standard, with casters offered as an option on Medium Duty only.

Standard finish on all freestanding signs is black.

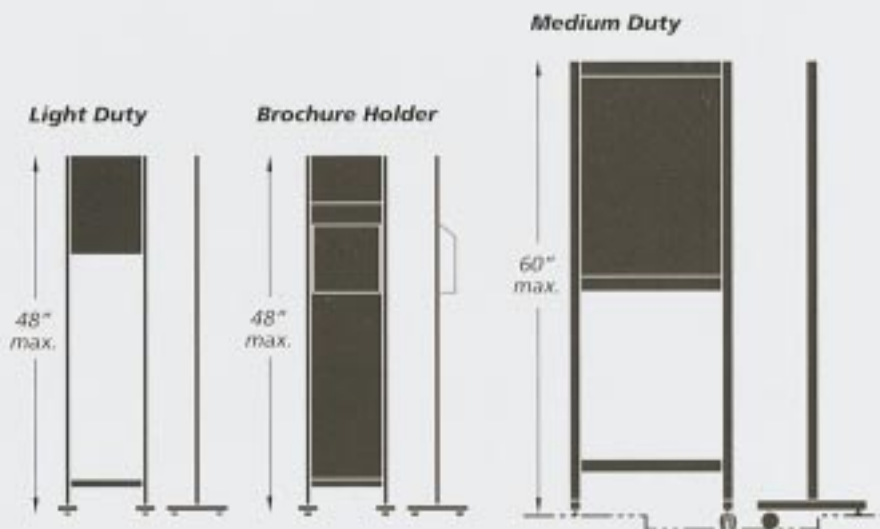

Heavy Duty

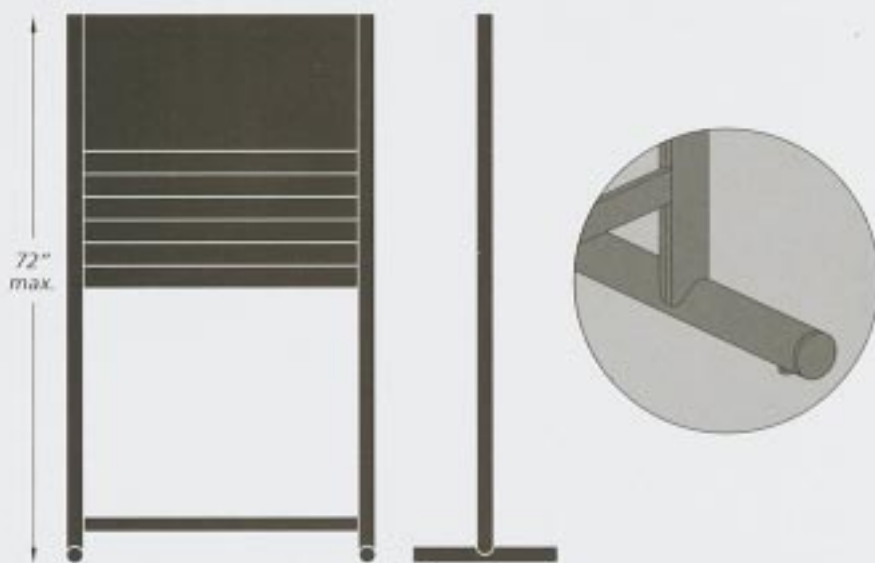

- A. 10 x 12 Light Duty Freestanding Sign
- B. 10 x 12 Light Duty Freestanding Sign
- C. 30 x 30 Medium Duty Freestanding w/ LPS Inserts, Window Sign and Casters
- D. 10 x 18 Light Duty Freestanding Sign with Brochure Holder
- E. 8 x 18 Light Duty Freestanding Sign
- F. 20 x 20 Heavy Duty Freestanding Sign

Horário de Funcionamento

9:00 - 4:00 Seg.-Sáb.
10:00 - 2:00 Dom.

*Balcony
Closed*

Thank you

Las Palmas

Hotel and Convention Center

Association of
International Travel Agents

Welcome!
Bienvenidos!
Wilkommen!

ACHTUNG

RUTSCHGEFAHR

Evenements

Aôut

Metroplex



4
ROOM

coat and
hat room

Girls
Restrooms

Boys
Restrooms

SUNSHINE
DAYCARE



AUDITORIO SÃO PAULO

FUNDADORES

| | |
|-------------------------|----------------------------|
| ROSA MORELLO | OTAVIO COSTA MACHADO |
| MARIA DEL MAR CARRELO | PERISSACA CARVALHO |
| OSWALDO CALMON | LEON OZAM |
| JULIANA LIMA | PAULO OTAVIO SILVA |
| FRANCISCO ALVES | TERESA P. |
| CAROLINE GAVELLI | ALICE |
| MARCOLO THOMAS JERONIMO | BRUNO CARVALHO |
| JACIRO PASSETO | ATA CARVALHO |
| ERICA SANTOS | MARCO VIG BRUNO |
| MARINA MOREL | ELIANE TRAM |
| FLORA MARQUES DE NEVEZ | ELIZABETH CRISTINA MACHADO |
| ELIZE OLIVEIRA | MAURICIO LOPES |
| MARCELA FERREIRA | JANE CARLOS PEREIRA |
| JOSIE VIEIRA | PAULA DE OLIVEIRA |
| MARCO SILVA | OSVALDO PEREIRA |
| PRISCILA FERREIRO | OSVALDO LOPES |

CAMAROTES

K-S

Frame Signs

System 2/90 Frame Signs add both vandal resistance and structural strength.

Small Frames

The Small Frame is ideal for signs up to 400 square inches. Side frames are removable to allow for insert change. A protective lens, made of clear, low-glare acrylic, protects the sign copy from vandalism.

Sign thickness is $3/4"$. Width of side frame is $3/8"$ and top/bottom frame is $3/16"$. Frame material is extruded aluminum with natural anodized finish. Color match finishes are optional. Locking side frame available.

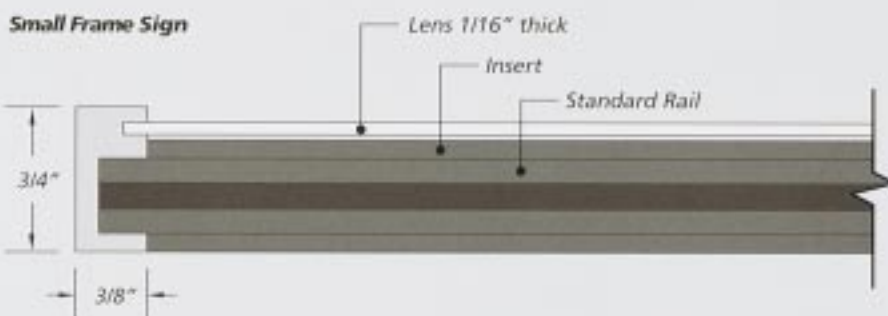

Large Frames

The Large Frame, offered with and without clear, low-glare acrylic* lens, is used for larger signs up to 5400 square inches.

Large Frame section measures $3/4"$ wide by $1\ 3/4"$ deep. Side frame standard finish is brushed natural anodized aluminum. Top/bottom frame is finished to match insert color unless otherwise specified. Side frame also has four optional wood finishes: Light or Medium Oak, Walnut or Mahogany. Color match finishes are also available. Side frames are attached with special screws and are removable for insert change. Mitered corner detail is optional.

Low glare tempered glass is available for both frame designs as a special order item.

* Low-glare acrylic is not offered for signs larger than 900 square inches; larger signs must use glossy clear acrylic.

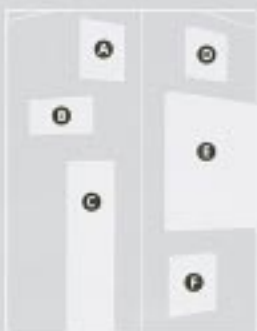
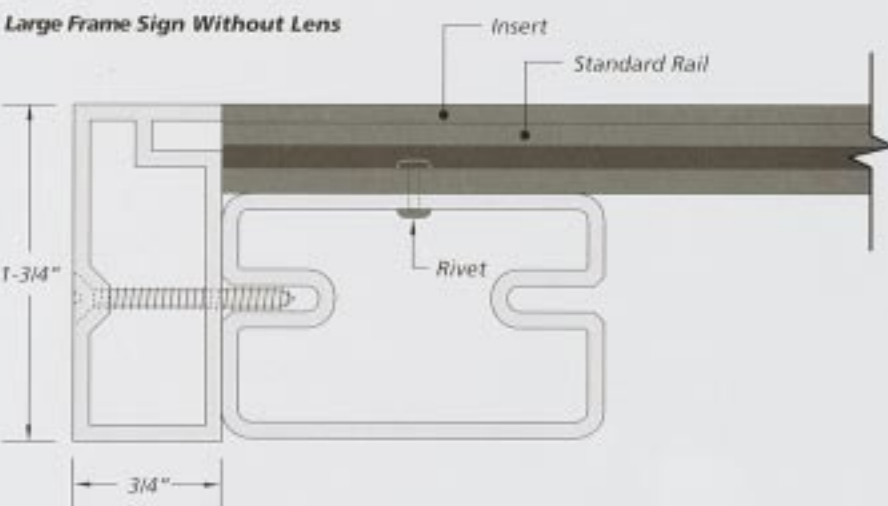
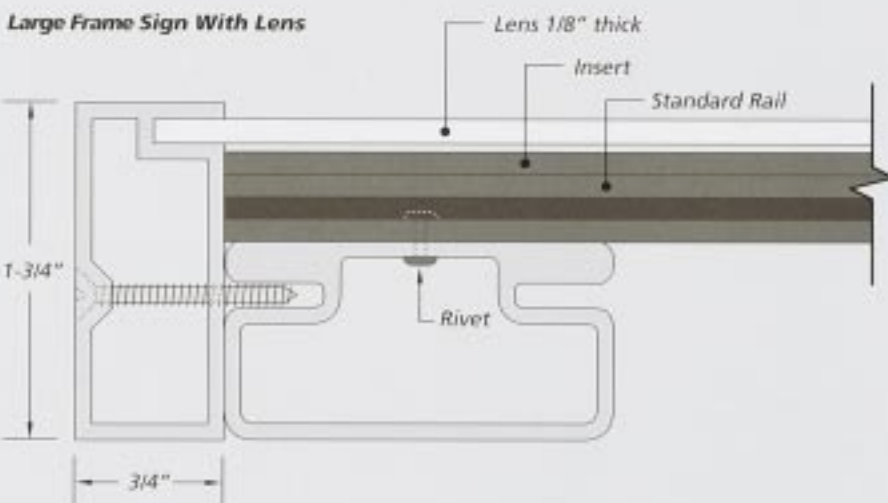

- A. 12 x 12 Modified Small Frame Perpendicular Mount
- B. 8 x 28 Small Frame Acrylic Cover
- C. 12 x 40 Large Frame Acrylic Cover
- D. 70 x 12 Large Frame
- E. 30 x 40 Large Frame
- F. 12 x 15 Large Frame

Quad Signs/ Display Signs

System 2/90 Quad Signs and Display Signs with changeable inserts are ideal for intersection applications or high-impact visuals.

Quad Signs

The System 2/90 Quad Sign is a four-sided, changeable insert sign ideal for intersection applications. They can be mounted directly to a ceiling grid system or various overhead details and can also be used in a freestanding configuration.

Standard Quad Sign dimensions are 2' x 2' (20" wide inserts), 3' x 3' (30" wide inserts), and 4' x 4' (44" wide inserts). Inserts range in height from 1" to full sign height.

Quad Signs are shipped assembled, ready for installation.

Display Signs

Display Signs use the three-sided sign rail as a post to support various signs or display panels. Based on an equilateral triangle, an endless variety of freestanding configurations can be formed. Standard System 2/90 sign rails and inserts attach to rail posts at any height to create full-post-height sign walls or partial-height spanner signs.

Quad Signs

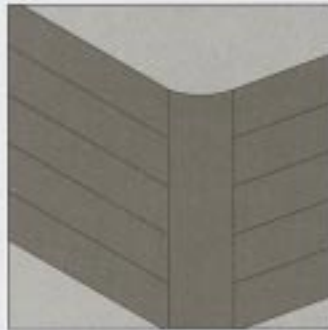

Rigid Mount – N



Ceiling Grid Mount – I



Direct Mount – D



Hanging Mount – J

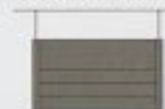

Display Signs

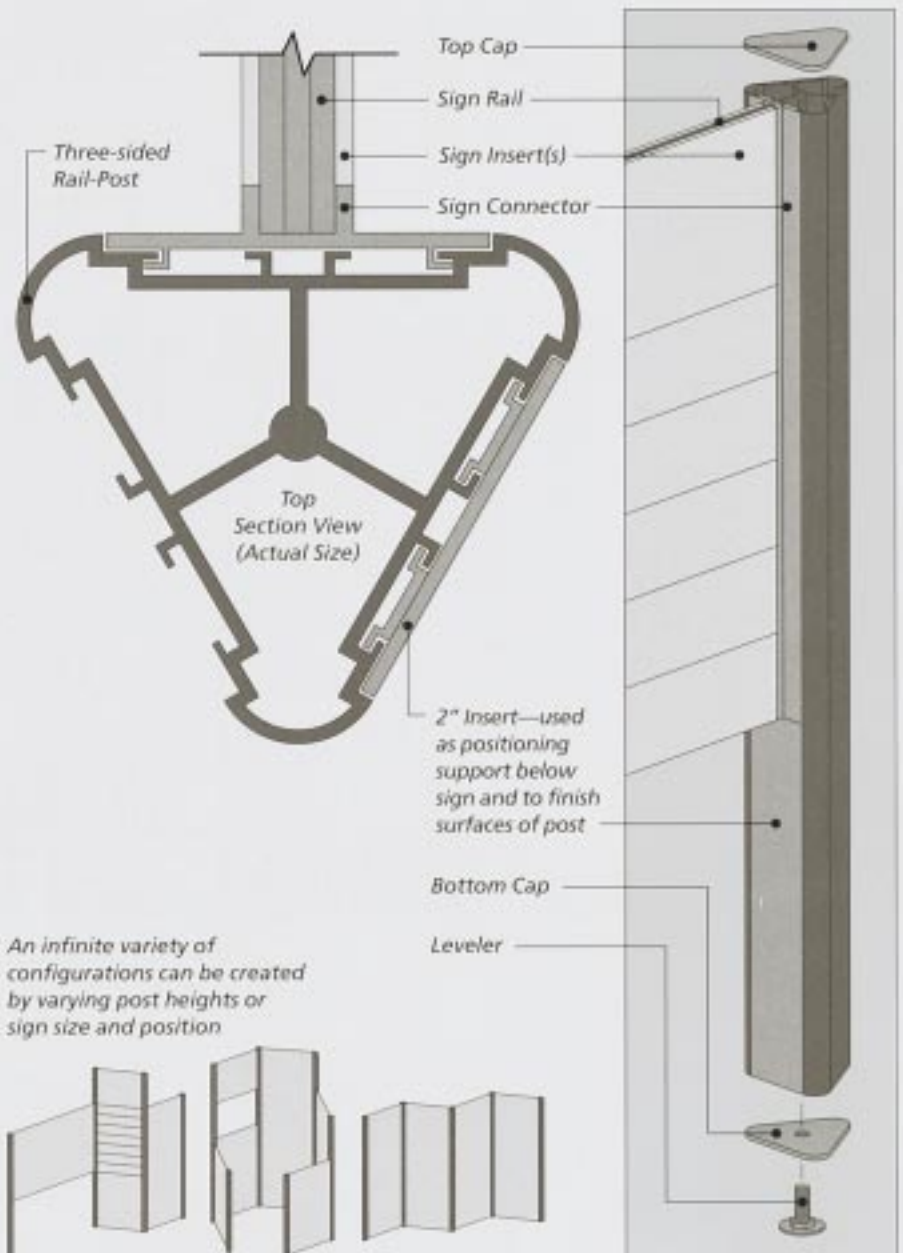

An infinite variety of configurations can be created by varying post heights or sign size and position



- A 12 x 20 Quad Sign Ceiling Grid Mount
- B 12 x 20 Freestanding Quad Sign
- C 48 x 20 Triangular Display Sign w/ 120 Inserts and End Post Holders



Musée d'Orsay

Science et Technologie

Musée d'Orsay

- Hall de la Découverte** >
 - Exposition libre
 - Le monde est petit
 - Voir, entendre et sentir
- Salle Centrale** >
 - L'aéronautique
 - Voyage interstellaire
 - Pour tous
- Allée de l'Innovation** <
 - Autour de la maison
 - Petits miracles
 - Machines intelligentes



Musée d'Orsay

Planetarium Mercury

Projection en Cours

Mystères de la Voie Lactée



Heures de Projection

| | |
|------------------------------|-------------------------|
| Lundi - Jeudi | 10:30 13:30 15:30 |
| Vendredi - Samedi - Dimanche | 10:30 13:30 15:30 17:30 |



East Wing Nursing Station

Patient Information
Restrooms



FOURTH

4

Burn Unit
Cardiovascular Services
Children's Hospital
CT Scanner
EEG
EKG
Endoscopy
Hyperbaric Oxygen Therapy
Critical Care Unit
Intermediate Care Unit
MRI
Nuclear Medicine
OB-Special Care Unit
Pediatrics
Pediatrics Intensive Care
Radiation Oncology
Surgical Critical Care
Ultrasound
Visitors Lounge
Restrooms
Telephones

BIOHAZARD AREA

AUTHORIZED PERSONNEL ONLY
OPER PROTECTION MUST BE WORN AT ALL TIMES



Resident Hall

- ↑ Library
- ↑ Recreation Center / Music Room
- ↑ Resident Hall Director's Office
- ← Resident Rooms - A-J
- Resident Rooms - K-Z



METROPOLITAN HOSPITAL
ADMITTING DESK

PLEASE HAVE INSURANCE PAPERS
READY FOR PRESENTATION

PLEASE FILL OUT ADMITTING
FORMS UPON ARRIVAL

Heavy Duty Interior Signs

Large interior environments, such as airports and shopping malls, may require the added thickness of System 2/90 Heavy Duty Interior Signs.

Sign Structure

System 2/90 Heavy Duty Interior uses the same structural rails and inserts as standard System 2/90, in a "box-rail" design which is offered in thicknesses of 2" (Series 2) and 3 1/4" (Series 3). The thicker sections provide added structure and "architectural" thickness proportional to larger sign sizes.

Three top/bottom trim packages are offered: Square Corner, Round Corner and Bullnose. Removable end caps are 1/8" thick aluminum, shaped to match the top/bottom trim shape.

Mounting Options

Three mounting options are offered: Wall Mount, Perpendicular Mount and Hanging Mount. Sign height equal to, or greater than, width of sign is recommended for perpendicular mount.



- A 60 x 15 Heavy Duty Interior Bullnose Trim Wall Mount
- B 12 x 12 Heavy Duty Interior Square Corner Trim Perpendicular Mount
- C 15 x 60 Heavy Duty Interior Square Corner Trim
- D 12 x 18 Heavy Duty Interior Square Corner Trim Rigid Post/Hanging Mount
- E 28 x 48 Heavy Duty Interior Square Corner Trim
- F 38 x 38 Heavy Duty Interior Round Corner Trim Sub-Surface Insert

Heavy Duty Interior Signs

2"



12X20A Square Corner Trim



12X20A Round Corner Trim

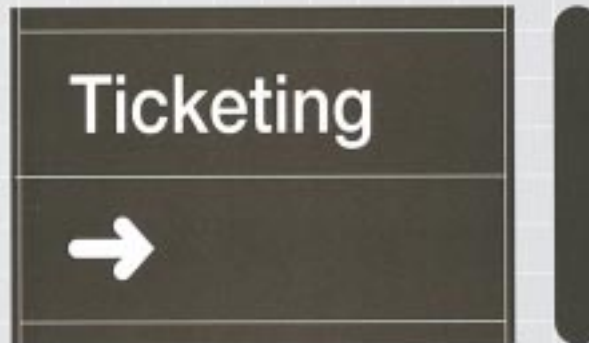

12X20A Bullnose Trim

Series 1 Standard Duty Exterior Signs

Versatile post options used with Standard System 2/90 rails and inserts, for exterior signs up to 1800 square inches.

Sign Structure

Series 1 accepts standard System 2/90 signs. Two design options are offered: Post Only and Post and Spanner. The sign is captured at each end by the slotted post. All standard System 2/90 insert sizes, colors and materials are offered. Maximum sign size is 1800 square inches.

Series 1 Exterior signs can also be used to create quad signs, freestanding kiosks and a variety of other interior applications.

Posts and Mounting Options

Four post shapes are offered (see right). All System 2/90 standard colors plus unlimited color match finishes are available.

In addition to mounting signs into various post configurations, three other mounts are standard: Wall Mount, Perpendicular Mount and Hanging Mount.

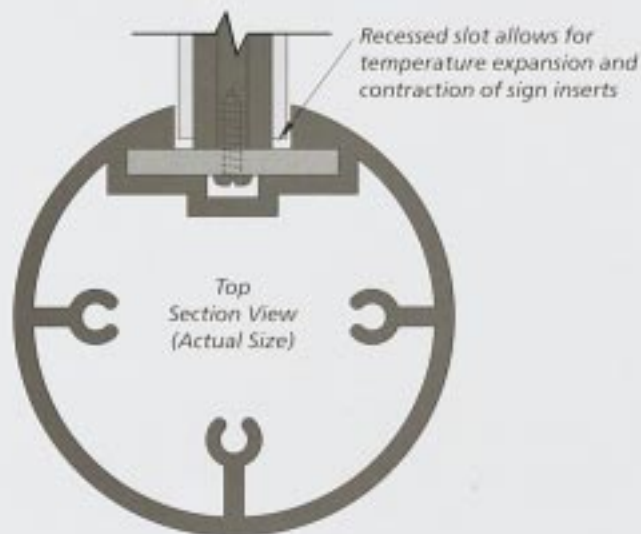
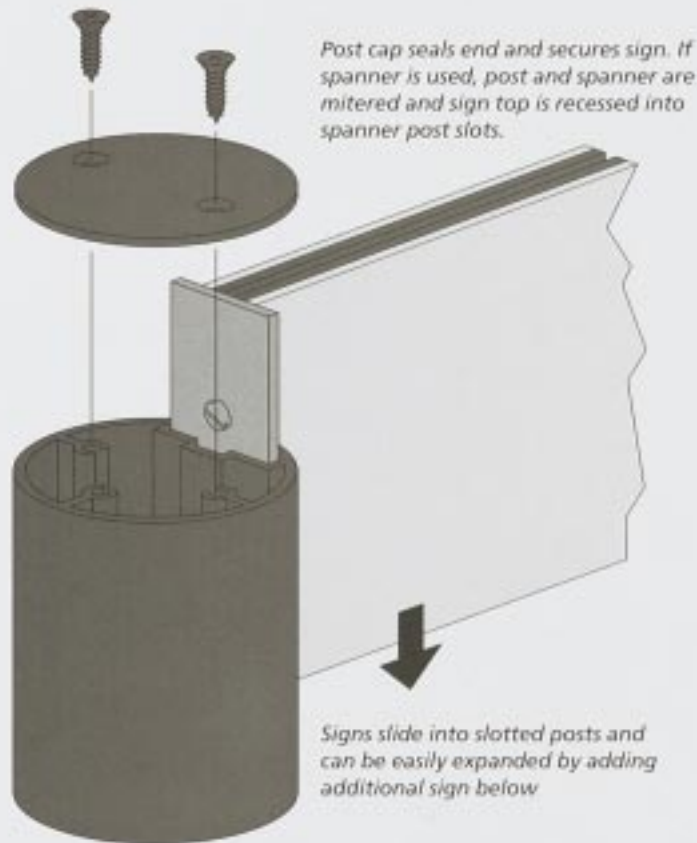
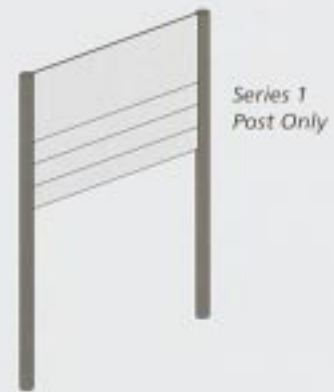
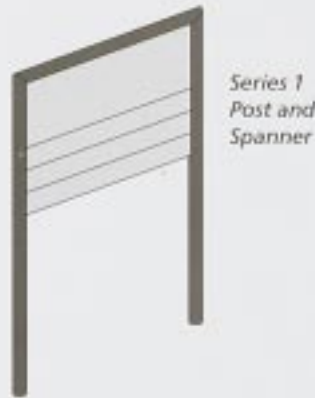

Post Shapes

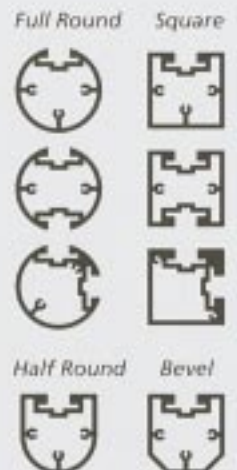

- A 24 x 48 Exterior Ballhook Post w/ Spanner
- B 22 x 24 x 24 4-Sided Stackhook Exterior Square Post
- C 4 x 12 x 4" Standard Exterior "I" Post Mount Square Post
- D 12 x 12 Standard Exterior 6" Round Post Flag Mount
- E 24 x 36 Standard Exterior 90° Intersection 4" Round Post
- F 12 x 12 Standard Exterior 6" Round Post 90° Flag Intersection



EMERGENCY ↑
 MAIN ENTRANCE ←
 VISITOR PARKING ←
 FAMILY HEALTH CLINIC ←
 COMMUNITY SERVICES ←
 DAYCARE FACILITY →
 ADMINISTRATIVE OFFICES →
 DELRAY CANCER CENTER →

er Center

→
 →
 ←

AMBULANCE/
 PARAMEDIC ONLY

DISABLED
 ENTRANCE



STAFF
 PARKING



VISITOR
 PARKING



Emergency →
 Main Entrance →
 Visitor Parking ←

Emergency →
 Main Entrance →
 Visitor Parking ←



METROPOLITAN
HOSPITAL

MAIN ENTRANCE



METROPOLITAN
HOSPITAL

PHARMACY

East Wing

- ◀ Burn Center
- ◀ Women's Center
- ◀ Mammography
- ◀ Maternity

West Wing

- Orthotics/Prosthetics ▶
- Regional Poison Center ▶
- Radiation/Oncology ▶
- Cardiac Rehabilitation ▶

Series 3 Heavy Duty Exterior Signs

An all aluminum system, in 3 1/4" thickness for heavy duty applications.

Series 3 is an aluminum system which features box-shaped extrusions clad with 1/8"-thick aluminum sheet. Finished panel thickness of 3 1/4" with heights up to 96" are available. Maximum sign size is 5600 square inches for Series 3.

When larger or illuminated signs are needed, we also offer Series 7 (7" thick), and Series 12 (12" thick).

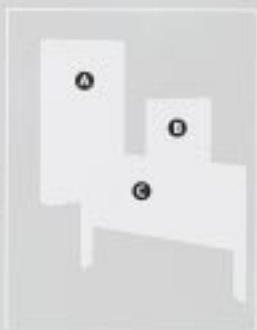
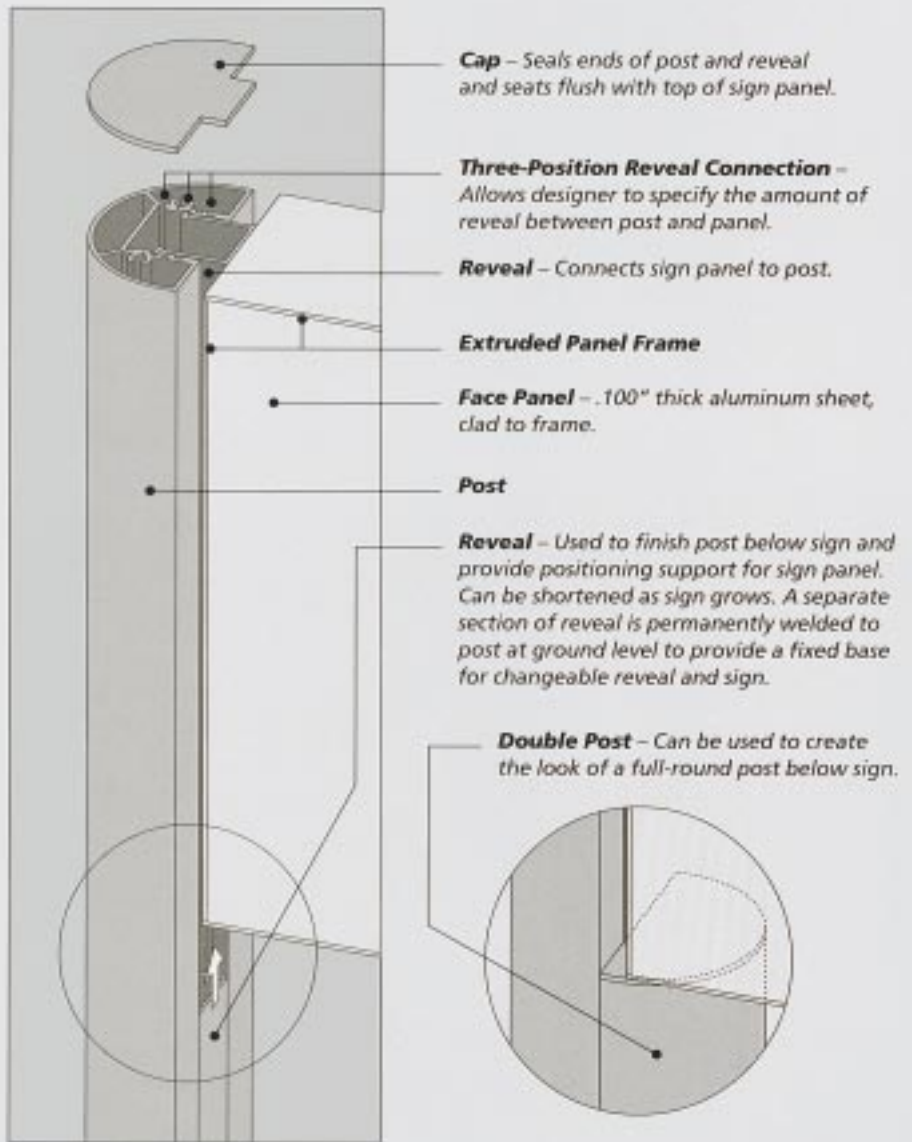

- A. 36 x 36 x 7 Heavy Duty Exterior Rectangular Post Three-Way Gap
- B. 36 x 36 Heavy Duty Exterior 4" Triangular Post
- C. 24 x 36 Heavy Duty Exterior 4" Radius Post Full Round below sign

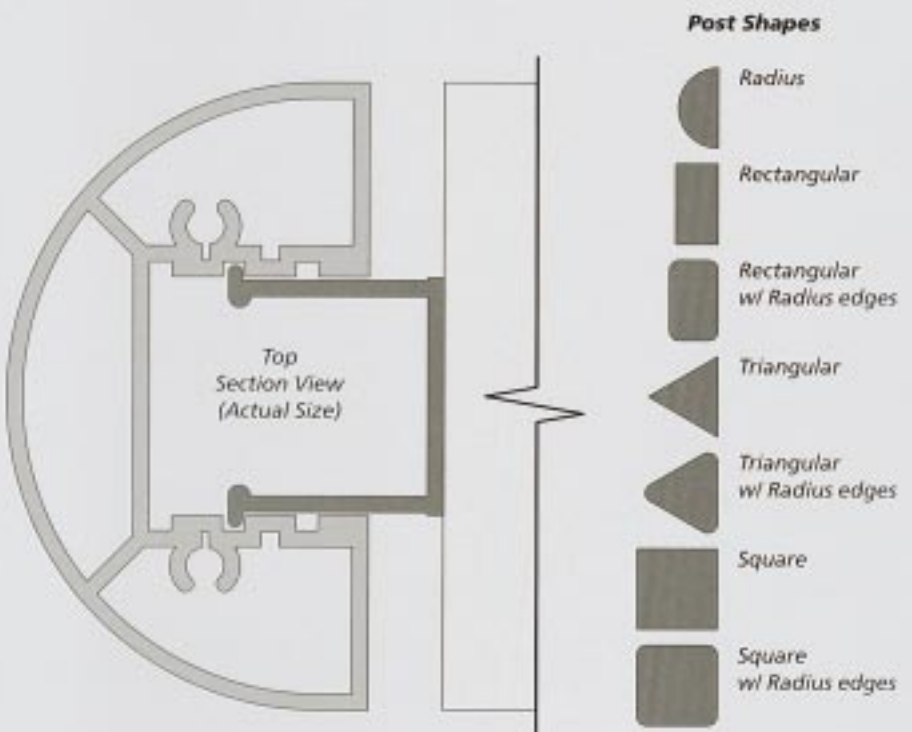

System 2/90 SPECS

Design and specify System 2/90 signage on your PC.

System 2/90 SPECS (Sign Programming Electronic Catalog System) was developed to aid in the specification and design of your System 2/90 modular facility signage.

System 2/90 SPECS provides easy, point-and-click access to all of the variables and options that have made System 2/90 the best signage system for change. Using System 2/90 SPECS enhances the ordering process while creating a personalized, up-to-date and readily available record of your facility's signage.

Features include the System 2/90 Order Form, a complete Product Chart, and onscreen design of all sign elements. Each window has a help menu or button to explain all the features of that particular window as well as general information about the program. Printing capabilities include completed Order Forms and individual sign illustrations.

System Requirements

The minimum recommended system configuration is a 486 33 megahertz computer running Windows version 3.1 with a VGA card, 256 colors. Memory requirements are 4MB RAM, 12MB free hard drive space, and at least 512K VRAM (1MB VRAM recommended).

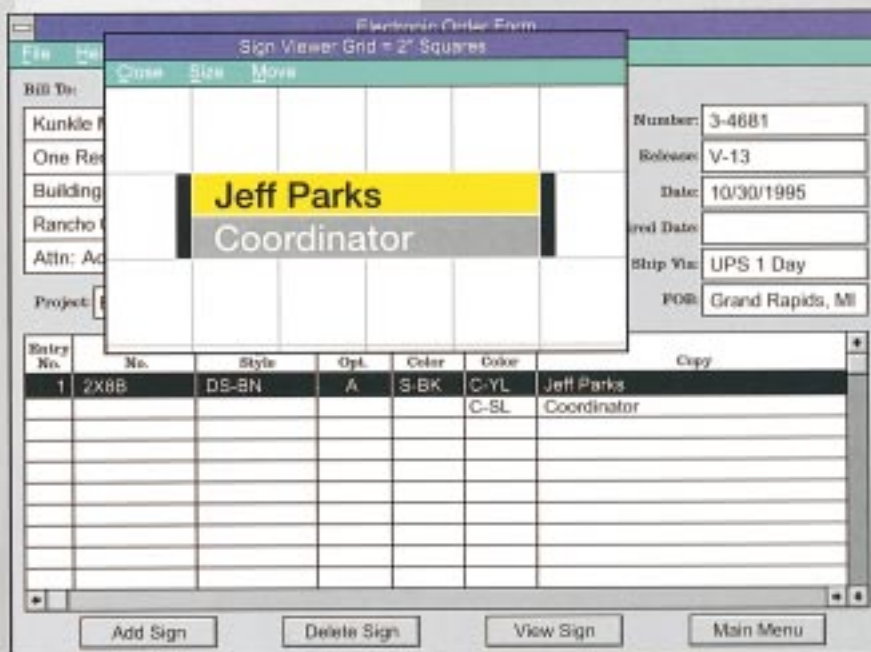

System 2/90 SPECS software enables onscreen design of all sign elements, with Electronic Order Form for efficient, accurate completion of your signage order.

Mounting Options Prices for all Mounting Options, except "N", are included in blank sign price.

A Pressure Sensitive – Pressure sensitive mounting intended for smooth, hard surfaces. Not recommended for selected vinyl wall coverings. Can be used with silastic bonding.

B Magnetic – Same as "A" but uses magnetic mounting for steel surfaces.

C Velcro – Same as "A" but uses Velcro mounting for fabric surfaces.

D Screw-on – Screw-on mounting for rough surfaces such as brick and drywall, where "A" mount is not recommended. Recommended on all wall mounted signs larger than 12" x 20".

E Pin – A specially designed pin device for fabric surfaces. Unique one piece pin design enables mounting to any fabric surface including fabrics mounted over hard base materials.

F Hook – Hook device in clear plastic which "hooks over" top of panel. Automatically locates sign two inches from top of panel. ORDER MUST SPECIFY PANEL MAKE AND THICKNESS.

G Freestanding – For freestanding applications such as receptionist. Clear extruded Lexan® bracket. MAXIMUM SIGN HEIGHT OF 8" IS RECOMMENDED.

*Not available for 2/90 THIN

H Panel Top – For mounting on top surface of panel. Pressure sensitive. Clear extruded Lexan® bracket. MAXIMUM SIGN HEIGHT OF 8" IS RECOMMENDED.*

I Ceiling Mount (Suspended Ceiling) – Connects to ceiling grid system using clear 2" plastic brackets. Signs appear to be "floating" below ceiling line. SPECIFY 1/2" OR 1" GRID SYSTEM.*

J Ceiling Mount (Hanging) – General purpose hanging applications for high or irregular ceilings. Hang lines tie to various points (rafters, beams, duct work, piping etc.). Customer must supply hang line material.*

K Perpendicular Wall Mount – Mounts sign at 90° angle to wall surface. Screw on device. NOT RECOMMENDED ON SIGNS WIDER THAN 15".*

L Inside of Glass Mount – Clear acrylic bracket attached to glass with clear pressure sensitive tape.

M Ceiling Mount (Hanging) – Clear plastic, screw mount. No mounting screws provided with this mount.*

N Ceiling Mount (Rigid Post) – Sign mounts 6, 12 or 24 inches from ceiling using 1/2" aluminum rod. Refer to Price List for added cost*



U.S. Department of Justice
UNICOR
 Federal Prison Industries, Inc.
 115-99

