

Stevenson, Todd A.

159

From: Information Center
Sent: Tuesday, June 10, 2003 8:10 AM
To: 'mxquad294@cox-internet.com'
Subject: ATV BAN

Hello,

We have forwarded your comments to the appropriate agency personnel. If additional information is needed, someone from the agency will be in contact with you.

Please be advised that you may obtain CPSC publications, recalls and general safety related information via our web site at www.cpsc.gov. Click on the "Search" icon and type in your topic. You may also file an incident report via the web site mentioned above. If you have additional inquiries, you may call our toll-free hotline at 1-800-638-2772, Monday - Friday, 8:30am to 5:00pm, Eastern Standard Time. Press 1 to begin and then press 300 to speak with a representative.

tm

-----Original Message-----

From: Tim K. [mailto:mxquad294@cox-internet.com]
Sent: Monday, June 09, 2003 8:39 PM
To: Information Center
Subject: ATV BAN

To whom it may concern:

I am truly saddened to learn that the CPSC is in favor of banning and/or restricting the use of ATV's. As your fellow American, I beg you to use common sense when making decisions that may have an effect on my rights. US Soldiers have died on foreign soil to protect my freedoms- even those as simple as riding an ATV. People will get hurt on ATVs, this is an undeniable fact. However, it is my right to get hurt if I so choose. The majority of the people that are injured while using ATVs are not operating them properly and/or are not wearing suitable safety equipment. This you probably already know from the data in which you are basing the proposed bans. But like most other common activities (i.e.. baseball, football, mountain biking, etc.), injuries and even death are, at times, unavoidable. So based off of common sense, if you ban one, logically, you should ban them all.

Let common sense lead the way.

Respectfully yours,

Tim Koenigseder
Barling, AR

Stevenson, Todd A.

160

From: Information Center
Sent: Tuesday, June 10, 2003 8:09 AM
To: 'daveo2006@hotmail.com'
Subject: Banning the legal use of ATV's

Hello,

We have forwarded your comments to the appropriate agency personnel. If additional information is needed, someone from the agency will be in contact with you.

Please be advised that you may obtain CPSC publications, recalls and general safety related information via our web site at www.cpsc.gov. Click on the "Search" icon and type in your topic. You may also file an incident report via the web site mentioned above. If you have additional inquiries, you may call our toll-free hotline at 1-800-638-2772, Monday - Friday, 8:30am to 5:00pm, Eastern Standard Time. Press 1 to begin and then press 300 to speak with a representative.

tm

-----Original Message-----

From: Dave Overman [mailto:daveo2006@hotmail.com]
Sent: Monday, June 09, 2003 10:14 PM
To: Information Center
Subject:

Hi, my name is David Overman . I have learned that the CPSC is currently considered banning the legal use and or production of atvs, aka four wheelers. It troubles me deeply as a free American citizen that the CPSC would even consider taking away RIGHTS from free Americans. These groups that are pushing the ban have the RIGHT not to participate. THEY NOR YOU have the right to take our rights away. Atving is a wonderful sport, and like all sports, people do get hurt. If you dont like it, dont participate. Please make the only common sense decision. I would just like to add that there is millions of riders out there that will fight this ban if you keep trying! And i am Proud to say i am one of them!!

MSN 8 with e-mail virus protection service: 2 months FREE*
<http://join.msn.com/?page=features/virus>

Stevenson, Todd A.

161

From: Information Center
Sent: Tuesday, June 10, 2003 8:12 AM
To: 'pierre_remi@hotmail.com'
Subject: Banning ATVs

Hello,

We have forwarded your comments to the appropriate agency personnel. If additional information is needed, someone from the agency will be in contact with you.

Please be advised that you may obtain CPSC publications, recalls and general safety related information via our web site at www.cpsc.gov. Click on the "Search" icon and type in your topic. You may also file an incident report via the web site mentioned above. If you have additional inquiries, you may call our toll-free hotline at 1-800-638-2772, Monday - Friday, 8:30am to 5:00pm, Eastern Standard Time. Press 1 to begin and then press 300 to speak with a representative.

tm

-----Original Message-----

From: Pierre Gagnon [mailto:pierre_remi@hotmail.com]
Sent: Monday, June 09, 2003 7:06 PM
To: Information Center
Subject: Banning ATVs

Hi, my name is Pierre Gagnon. I have learned that the CPSC is currently considered banning the legal use and or production of atvs, aka four wheelers. It troubles me deeply that the CPSC would even consider taking away RIGHTS from free Americans. These groups that are pushing the ban have the RIGHT not to participate. THEY NOR YOU have the right to take our rights away. Atving is a wonderful sport, and like all sports, people do get hurt.

Attack the tobacco industry instead, it kills allot more people!

Add photos to your messages with MSN 8. Get 2 months FREE*.
<http://join.msn.com/?page=features/featuredemail>

Stevenson, Todd A.

162

From: Information Center
Sent: Tuesday, June 10, 2003 4:01 PM
To: 'Jim@mcallenconstruction.com'
Subject: ATV ban

Hello,

We have forwarded your comments to the appropriate agency personnel. If additional information is needed, someone from the agency will be in contact with you.

Please be advised that you may obtain CPSC publications, recalls and general safety related information via our web site at www.cpsc.gov. Click on the "Search" icon and type in your topic. You may also file an incident report via the web site mentioned above. If you have additional inquiries, you may call our toll-free hotline at 1-800-638-2772, Monday - Friday, 8:30am to 5:00pm, Eastern Standard Time. Press 1 to begin and then press 300 to speak with a representative.

man/tm

-----Original Message-----

From: Jim Eckroat [mailto:Jim@mcallenconstruction.com]
Sent: Tuesday, June 10, 2003 3:01 PM
To: Information Center
Subject: ATV Ban

It is not the ATV's that are dangerous, it is some of the people riding them. What must be banned is ignorant irresponsible behavior, when you are able to successfully ban that 90% of the world's problems will be solved.

Please quit waste our tax dollars on these silly "witch hunts" and focus on products which are defective or poorly made.

Sincerely,
James Eckroat
P.O. Box 8080
Mission, Texas 78572

Spam Protected

163

Stevenson, Todd A.

From: Information Center
Sent: Tuesday, June 10, 2003 3:12 PM
To: 'sobeahonda@hotmail.com'
Subject: The ban...

Hello,

We have forwarded your comments to the appropriate agency personnel. If additional information is needed, someone from the agency will be in contact with you.

Please be advised that you may obtain CPSC publications, recalls and general safety related information via our web site at www.cpsc.gov. Click on the "Search" icon and type in your topic. You may also file an incident report via the web site mentioned above. If you have additional inquiries, you may call our toll-free hotline at 1-800-638-2772, Monday - Friday, 8:30am to 5:00pm, Eastern Standard Time. Press 1 to begin and then press 300 to speak with a representative.

myg

-----Original Message-----

From: Jason Jensen [mailto:sobeahonda@hotmail.com]
Sent: Tuesday, June 10, 2003 12:57 PM
To: Information Center
Subject: The ban...

Hi, my name is Jason Jensen. I have learned that the CPSC is currently considered banning the legal use and or production of atvs, aka four wheelers. It troubles me deeply as a free American citizen that the CPSC would even consider taking away RIGHTS from free Americans. These groups that are pushing the ban have the RIGHT not to participate. THEY NOR YOU have the right to take our rights away. Atving is a wonderful sport, and like all sports, people do get hurt. If you dont like it, dont participate. Please make the only common sense decision.

-Jason Jensen

--)-(@ Faire de beau rêves.

J'ai vu la vue de la sale salle avec une accienne prof accienne qui a une bete bete comme bete.

The new MSN 8: smart spam protection and 2 months FREE*

6/10/03

Stevenson, Todd A.

164

From: Information Center
Sent: Tuesday, June 10, 2003 12:27 PM
To: 'Smpmotocross2488@aol.com'
Subject: CPSC is currently considered banning the legal use and or production of atvs

Hello,

We have forwarded your comments to the appropriate agency personnel. If additional information is needed, someone from the agency will be in contact with you.

Please be advised that you may obtain CPSC publications, recalls and general safety related information via our web site at www.cpsc.gov. Click on the "Search" icon and type in your topic. You may also file an incident report via the web site mentioned above. If you have additional inquiries, you may call our toll-free hotline at 1-800-638-2772, Monday - Friday, 8:30am to 5:00pm, Eastern Standard Time. Press 1 to begin and then press 300 to speak with a representative.

man/tm

-----Original Message-----

From: Smpmotocross2488@aol.com [mailto:Smpmotocross2488@aol.com]
Sent: Tuesday, June 10, 2003 11:59 AM
To: Information Center
Subject: (no subject)

Hi, my name is Ben Boles. I have learned that the CPSC is currently considered banning the legal use and or production of atvs, aka four wheelers. It troubles me deeply as a free American citizen that the CPSC would even consider taking away RIGHTS from free Americans. These groups that are pushing the ban have the RIGHT not to participate. THEY NOR YOU have the right to take our rights away. Atving is a wonderful sport, and like all sports, people do get hurt. If you dont like it, dont participate. Please make the only common sense decision.

165

Stevenson, Todd A.

From: Gray Steward [gshilltop@yahoo.com]
Sent: Tuesday, June 10, 2003 12:53 PM
To: Stevenson, Todd A.
Subject: Atv ban

The perposed ATV regulations are ridiculous. You can't control stupidity. Most all the ATV accidents I have ever heard of are cause by personal irresponsibility.

NO BAN IS NEEDED!!!!!!!!!!!!

Gray Steward
Forest,LA.

Do you Yahoo!?
Free online calendar with sync to Outlook(TM).

Stevenson, Todd A.

166

From: Information Center
Sent: Tuesday, June 10, 2003 11:53 AM
To: 'TMadrid@pcjcc.co.pima.az.us'
Subject: CPSC is currently considered banning the legal use and or production of atvs

Hello,

We have forwarded your comments to the appropriate agency personnel. If additional information is needed, someone from the agency will be in contact with you.

Please be advised that you may obtain CPSC publications, recalls and general safety related information via our web site at www.cpsc.gov. Click on the "Search" icon and type in your topic. You may also file an incident report via the web site mentioned above. If you have additional inquiries, you may call our toll-free hotline at 1-800-638-2772, Monday - Friday, 8:30am to 5:00pm, Eastern Standard Time. Press 1 to begin and then press 300 to speak with a representative.

myg/tm

-----Original Message-----

From: Madrid, Tony [mailto:TMadrid@pcjcc.co.pima.az.us]
Sent: Tuesday, June 10, 2003 10:19 AM
To: Information Center
Subject:

Hi, my name is Tony Madrid . I have learned that the CPSC is currently considered banning the legal use and or production of atvs, aka four wheelers. It troubles me deeply as a free American citizen that the CPSC would even consider taking away RIGHTS from free Americans. These groups that are pushing the ban have the RIGHT not to participate. THEY NOR YOU have the right to take our rights away. Atving is a wonderful sport, and like all sports, people do get hurt. If you dont like it, dont participate. Please make the only common sense decision.
Tony Madrid

Stevenson, Todd A.

167

From: Information Center
Sent: Tuesday, June 10, 2003 10:35 AM
To: 'tasmith68@earthlink.net'
Subject: banning the legal use and or production of atvs

Hello,

We have forwarded your comments to the appropriate agency personnel. If additional information is needed, someone from the agency will be in contact with you.

Please be advised that you may obtain CPSC publications, recalls and general safety related information via our web site at www.cpsc.gov. Click on the "Search" icon and type in your topic. You may also file an incident report via the web site mentioned above. If you have additional inquiries, you may call our toll-free hotline at 1-800-638-2772, Monday - Friday, 8:30am to 5:00pm, Eastern Standard Time. Press 1 to begin and then press 300 to speak with a representative.

myg/tm

-----Original Message-----

From: Teresa Smith [mailto:tasmith68@earthlink.net]
Sent: Monday, June 09, 2003 5:33 PM
To: Information Center
Subject:

Hi, my name is Garrett Graves. I have learned that the CPSC is currently considered banning the legal use and or production of atvs, aka four wheelers. It troubles me deeply as a free American citizen that the CPSC would even consider taking away RIGHTS from free Americans. These groups that are pushing the ban have the RIGHT not to participate. THEY NOR YOU have the right to take our rights away. Atving is a wonderful sport, and like all sports, people do get hurt. If you dont like it, dont participate. Please make the only common sense decision. thank you for your time.

Garrett Graves

--- Garrett Graves
--- tasmith68@earthlink.net
--- EarthLink: The #1 provider of the Real Internet.

6/10/03

Stevenson, Todd A.

168

From: Information Center
Sent: Tuesday, June 10, 2003 4:14 PM
To: 'Durber515@aol.com'
Subject: ATV Ban

Hello,

We have forwarded your comments to the appropriate agency personnel. If additional information is needed, someone from the agency will be in contact with you.

Please be advised that you may obtain CPSC publications, recalls and general safety related information via our web site at www.cpsc.gov. Click on the "Search" icon and type in your topic. You may also file an incident report via the web site mentioned above. If you have additional inquiries, you may call our toll-free hotline at 1-800-638-2772, Monday - Friday, 8:30am to 5:00pm, Eastern Standard Time. Press 1 to begin and then press 300 to speak with a representative.

tm

-----Original Message-----

From: Durber515@aol.com [mailto:Durber515@aol.com]
Sent: Monday, June 09, 2003 11:12 PM
To: Information Center
Subject: ATV Ban

Hello my name is Joseph Raffiee and I am a registered voter. I want to write you to let you know that I strongly oppose the proposed ban of ATVs. ATVs are a great sport and is safe granted there is supervision, but what is really safe without supervision of children? A child could burn their hands on the exhaust pipe of a car in a parking lot or spill boiling water on themselves in the kitchen. All I am saying is the proposed ATV ban is no solution at all. Banning ATVs would not benifit anyone but only take away a great thing, the joy of riding ATVs.

Thank You
Joseph Raffiee

Stevenson, Todd A.

169

From: Information Center
Sent: Tuesday, June 10, 2003 4:14 PM
To: 'Duncan400ex@att.net'
Subject: ATV ban

Hello,

We have forwarded your comments to the appropriate agency personnel. If additional information is needed, someone from the agency will be in contact with you.

Please be advised that you may obtain CPSC publications, recalls and general safety related information via our web site at www.cpsc.gov. Click on the "Search" icon and type in your topic. You may also file an incident report via the web site mentioned above. If you have additional inquiries, you may call our toll-free hotline at 1-800-638-2772, Monday - Friday, 8:30am to 5:00pm, Eastern Standard Time. Press 1 to begin and then press 300 to speak with a representative.

tm

-----Original Message-----

From: Jason [mailto:Duncan400ex@att.net]
Sent: Monday, June 09, 2003 11:13 PM
To: Information Center
Subject: ATV ban

Hi, my name is Jason McCune I have learned that the CPSC is currently considered banning the legal use and or production of atvs, aka four wheelers. It troubles me deeply as a free American citizen that the CPSC would even consider taking away RIGHTS from free Americans. These groups that are pushing the ban have the RIGHT not to participate. THEY NOR YOU have the right to take our rights away. Atving is a wonderful sport, and like all sports, people do get hurt. If you dont like it, dont participate. Please make the only common sense decision.

6/10/03



Ohio Department of Natural Resources

BOB TAFT, GOVERNOR

SAMUEL W. SPECK, DIRECTOR

Office of the Director
1930 Belcher Drive – Bldg. D-3
Columbus, OH 43224-1387

Phone: (614) 265-6879 Fax: (614) 261-9601

May 22, 2003

Hal Stratton
US Consumer Product Safety Commission
Washington, DC 20207

Dear Mr. Stratton:

This letter is in response to your letter dated April 23, 2003, regarding All Terrain Vehicle (ATV) usage in Ohio. We are responding as an agency who administers ATV use on State Forest Lands. We do not maintain records for or regulate use of ATVs on private lands.

ATV riding can be hazardous. Minor injuries and an occasional fatal accident occur. Helmets and eye protection are required on state forest ATV areas by Ohio Administrative Code (OAC) 1501:3-4-14.

ATVs can have relatively large engines and considerable power. This increases the potential for personal injury and environmental damage. OAC 1501:3-4-15 provides for seasonal closure in an effort to minimize erosion.

Ohio Revised Code (ORC) 4519 is the section of the state law regulating ATV use. It can be accessed via the Internet at the State of Ohio homepage. I have provided a table of contents for immediate referral. I am also sending copies of the Division of Forestry OAC State Forest Rules that pertain to ATVs.

Sincerely,

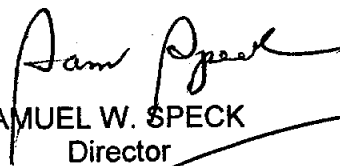
SAMUEL W. SPECK
Director

SWS:JD: ejm
cc: Scott Zody
John Dorka



171

Rachel Carson State Office Building
P.O. Box 8552
Harrisburg, PA 17105-8552
May 29, 2003

Bureau of Forestry

717-783-7941
Fax: 717-783-5109

Mr. Hal Stratton
Chairman
U. S. Consumer Product Safety Commission
Washington, DC 20207-0001

Dear Mr. Stratton:

Your letter sent to Colonel Jeffrey B. Miller, Commissioner of Pennsylvania State Police, concerning the Consumer Product Safety Commission's public hearing on ATVs was forwarded to the Bureau of Forestry in the Department of Conservation and Natural Resources (DCNR) for a direct reply.

In Pennsylvania the laws governing the use of ATVs is contained in Chapter 77 of the State Vehicle Laws. An attachment to this letter is a copy of a pamphlet that summarizes most of the sections of Chapter 77 that pertains to riding an ATV. The entire ATV Law is available in a good reference library in the Pennsylvania Vehicle Law.

DCNR was designated in 1985 as the state agency responsible for administering the ATV registration program. DCNR is also responsible for the implementation of a safety education and training program and for issuing ATV safety-training certificates to those who complete the training program. State law requires an ATV operator to be at least 10 years old and have successfully completed an approved safety-training course in order to legally operate on any land except what is owned or leased by a parent or legal guardian. Persons age 16 or above are not required by law to complete the safety training, but they are encouraged to take the course. The Department has approved the safety-training program being conducted by the ATV Safety Institute (ASI). Most of the training given in Pennsylvania during the past 10 years has been the ASI course.

The DCNR will be updating and reactivating their ATV safety-training program in June 2003. This will provide more opportunities for people to obtain the safety training at a reasonable cost. The emphasis is on training ATV riders ages 10 through 15 years.

May 29, 2003

The Department does attempt to compile data on the ATV accidents that occur in Pennsylvania. Although there is a requirement in the vehicle law to report ATV accidents to DCNR some accidents go unreported. With the aid of a newspaper clipping service and the cooperation from the State Police and our department field staff we do feel that our tally of the number of fatalities is very accurate. Attached to this letter is a basic data sheet concerning ATV accidents, number of registered machines and current trail mileage. This information has been provided to a few people from Pennsylvania who are planning to attend the hearing on June 5, 2003, in Morgantown, West Virginia.

We really do not have any scientific data concerning contributing factors that influence the increased number of injuries and deaths involving ATVs. We are aware that speed and carrying a passenger on a machine designed for one person are indicated as major factors associated with ATV accidents.

Thank you for the opportunity to provide you with comments and information concerning ATV use in Pennsylvania. Our department does not plan to make an oral presentation at the hearing, but we will be very interested in reading the reports.

Sincerely yours,

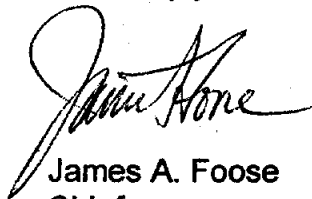

James A. Foose
Chief
Division of Operations and Recreation
Department of Conservation and
Natural Resources

cc: Lynn Hess

Enclosures

ATV Accidents Reported to DCNR

| <u>Year</u> | <u>Total No. of Accidents Reported</u> | <u>Total No. of Persons Injured</u> | <u>Total No. of Fatalities</u> |
|-------------|--|---|------------------------------------|
| 1997 | 254 | 269 | 15 |
| 1998 | 268 | 294 | 14 |
| 1999 | 146 | 141 | 4 |
| 2000 | 403 | 413 | 21 |
| 2001 | 404 | 400 | 30 |
| 2002 | 353 | 316 | 17 |

Note: There is no way of knowing how many accidents occur that are not reported. Because we receive accident investigation reports from the State Police and employ the services of a newspaper clipping service we feel rather confident that the number of fatalities has a very small chance of error.

ATV REGISTRATIONS

| <u>Month / Year</u> | <u>No. of Active Registrations</u> |
|---------------------|------------------------------------|
| April 1996 | 27,636 |
| April 1998 | 36,860 |
| April 2000 | 63,873 |
| April 2002 | 90,198 |
| April 2003 | 106,567 * |

* In addition to the active registrations there are over 61,000 limited registration in the system. Limited registrations are issued to persons who indicate the machine will be used exclusively on their own property. They receive a plate, but no expiration sticker.

Miles of ATV Trails on State Forest Land

Currently there are 209 miles of summer trails on state forest lands designated for ATV use. In the winter the mileage is reduced to 131 miles. These trails are in seven forest districts at a total of eleven locations.

Allegheny National Forest in northwest PA has a little over 100 miles of ATV trails.

There are also ATV trails on private lands in PA, but we do not have an accurate tabulation of their mileage.

ACCIDENT REPORTS

The operator of any ATV involved in an accident that results in the injury or death of any person, or property damages to the estimated amount of \$100 or more, must report the matter in writing within seven days to the DCNR.

The operator of an ATV involved in an accident must stop and give his or her name and address, the name and address of the owner of the ATV and its registration number to the other person(s) involved in the accident or to a police officer.

It is a violation of the ATV Law not to report an ATV accident to the DCNR, Bureau of Forestry, P.O. Box 8552, Harrisburg, PA 17105.

Accident forms are available upon request from the Snowmobile/ATV Section, Bureau of Forestry and State Park offices and state police stations.

LIABILITY INSURANCE

Liability insurance coverage is required for all ATVs that are required to have general registration. Proof of this coverage should be carried by the operator. The law does not specify a minimum dollar amount for this coverage. If you have questions about insurance coverage for ATVs contact the PA Dept. of Insurance consumer hotline at 1-877-981-6388.

ATV FUND

All registration fees are deposited in a special ATV Fund. DCNR uses monies from this fund to carry out the ATV registration, safety education and law enforcement requirements of the ATV Law, to develop and maintain trails on public land and to encourage trail development on private land through grants.

ENFORCEMENT

All law enforcement officers in the state, including local and state police, are authorized to enforce the ATV Law.

EQUIPMENT

All ATVs operating in Pennsylvania must be equipped with a brake system capable of producing deceleration of 14 feet per second at a speed of 20 miles per hour; and a muffler in good working order. The sound intensity produced by an ATV may not exceed 99dba, or decibels, when measured at 20 inches from the tailpipe.

All ATVs operated during hours of darkness or when visibility is less than 500 feet must be equipped with an operating headlight and taillight. The headlight must produce a white light sufficient to reveal persons and vehicles at a distance of 100 feet. The taillight must produce a red light plainly visible during darkness from a distance of 500 feet.

ATV TRAILS

Certain trails on state forest land and the Allegheny National Forest have been designated for ATV use. Class 2 ATVs are not permitted on these trails unless the trail is specifically marked for their use. Additional ATV trail information is available from the Bureau of Forestry website: www.dcnr.state.pa.us/forestry or from the Snowmobile/ATV Section.

HELMETS

It is illegal to operate an ATV without a securely fastened helmet on the head of the operator.

TITLES

All ATVs in Pennsylvania must have a title issued by DCNR. The only exceptions to this requirement are those ATVs registered with the Department prior to February 12, 1987. These ATVs do not require a title until they are sold by the owner.

FINES

Failure to register your ATV or obtain liability insurance may result in a fine of \$300.

A violation of other provisions of the ATV Law is punishable by a fine of no less than \$50 or more than \$200 plus the cost of prosecution for a first offense, and a fine of no less than \$100 or more than \$300 plus the cost of prosecution for a second offense.

FOR MORE INFORMATION CONTACT:

By Mail:

Snowmobile/ATV Registration Section
P.O. Box 8553
Harrisburg, PA 17105-8553

Location:

Riverfront Office Center
1101 S. Front Street
Harrisburg, PA 17104

Telephone (717) 783-9227
Tollfree 1-866-545-2476

Or visit the PA PowerPort at www.state.pa.us
or visit DCNR directly at www.dcnr.state.pa.us.

**THINK SAFETY
ACT SAFELY**

8170-PA-DCNR1517 Rev. 5/2003

Summary of

PENNSYLVANIA'S ALL-TERRAIN VEHICLE LAW

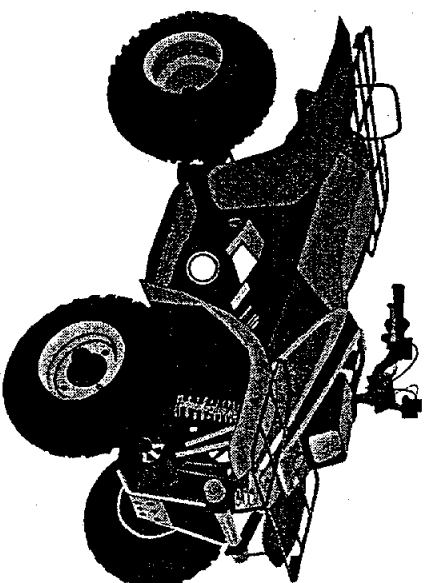

COMMONWEALTH OF PENNSYLVANIA

Edward G. Rendell, Governor

DEPARTMENT OF CONSERVATION AND

NATURAL RESOURCES

Michael Diberardinis, Secretary

BUREAU OF FORESTRY

SUMMARY OF PENNSYLVANIA'S ALL-TERRAIN VEHICLE LAW

INTRODUCTION

Pennsylvania has beautiful and challenging opportunities for all-terrain vehicle (ATV) riding. Many trails have been developed on public and private lands to accommodate this recreational pursuit. To ensure safe and enjoyable riding on Pennsylvania's lands an ATV law was established in 1985 and modified in 2001.

This pamphlet summarizes the ATV requirements of the Snowmobile and All-Terrain Vehicle Law (Chapter 77 of the PA Vehicle Law) including the changes made by Act 68 of 2001. It is not the complete law and is only meant to familiarize you with your legal responsibilities as an ATV owner or operator.

REGISTRATION

Pennsylvania residents owning and intending to use their ATV in Pennsylvania (except those used exclusively as a farm or business vehicle) must be titled and registered with the Department of Conservation and Natural Resources (DCNR), Snowmobile/ATV Registration Section.

General Registration

This registration permits the machine to be operated off the owner or operator's private property. The registration fee is \$20 for two years. The owner is provided with a registration plate, an expiration sticker and a Certificate of Registration wallet card.

Limited Registration

This registration is for machines used exclusively on the property of the owner. There is no fee and the registration does not expire. The owner is provided with a registration plate and a card, but no expiration sticker.

All-Terrain Vehicles are defined as follows:

1. Class 1 ATV - A motorized off-highway vehicle, which travels on three or more inflatable tires and has a maximum width of 50 inches and a maximum dry weight of 800 pounds.
2. Class 2 ATV - A motorized off-highway vehicle, which travels on three or more inflatable tires and has a width which exceeds 50 inches or a dry weight which exceeds 800 pounds.

Applications for registration of ATVs are available from the DCNR's Snowmobile/ATV Registration Section. The ATV registration application form must be completed and sent to the DCNR, Snowmobile/ATV Section, P.O. Box 8553, Harrisburg, PA 17105-8553, along with the required fee and sales tax statement. Registration applications are also available from: ATV dealers, Forest Districts and State Park Offices or download and print from the web at www.dcnr.state.pa.us/snowmobile.

Exempt from the registration requirements are ATVs owned by non-residents covered by a valid registration in their state, province or country that honors a Pennsylvania registration. Temporary registrations are available from registered ATV dealers.

SALE - THEFT - DESTRUCTION - CHANGE OF ADDRESS

The ATV owner shall notify the DCNR's Snowmobile/ATV Section in writing of any change of address within 15 days.

Upon the transfer, destruction or theft of an ATV, the reverse side of the Certification of Registration must be properly filled out in the spaces provided, signed by the owner, and returned to the DCNR's Snowmobile/ATV Section.

OPERATION

ATVs may be operated:

1. On private property with the consent of the owner or lessor;
 2. On state-owned property on clearly marked and previously designated ATV trails;
 3. On highways and streets for a short distance when necessary to cross a bridge or culvert;
 4. On highways and streets during periods of emergency when so declared by a governmental agency having jurisdiction;
 5. On highways and streets for special ATV events of limited duration that are conducted according to a prearranged schedule under permit from the governmental unit having jurisdiction
 6. On streets and highways that have been designated as "ATV Roads" by the governmental agency having jurisdiction.
- * Only by persons 16 years or older.
- An ATV may make a direct crossing of a street or two-lane highway provided:
- The crossing is made at an angle of approximately 90 degrees to the direction of the highway, and at a place where no obstruction prevents a quick and safe crossing;
 - The ATV is brought to a complete stop before crossing the highway;
 - The driver yields the right-of-way to all oncoming traffic that constitutes an immediate hazard.
- It is illegal to operate an ATV:
- On State Forest Roads open for use by licensed motor vehicles.
 - At the rate of speed that is unreasonable or improper under existing conditions or in excess of the maximum limits posted for vehicular traffic;
 - In a careless way so as to endanger the person or property of another;
 - While under the influence of alcohol, narcotics or drugs.

REGISTRATION NUMBERS

The five-digit registration number containing a combination of numbers and letters is embossed on an aluminum plate, which measures four inches in height and seven inches in width. This permanent registration plate is to be attached to the back of the machine near the center and as high as possible. The plate must be vertical and clearly visible from behind the ATV. This plate remains with the ATV if it is sold or transferred to a different owner.

General Registration requires a valid expiration sticker to be attached to the plate.

REGISTRATION PLATE

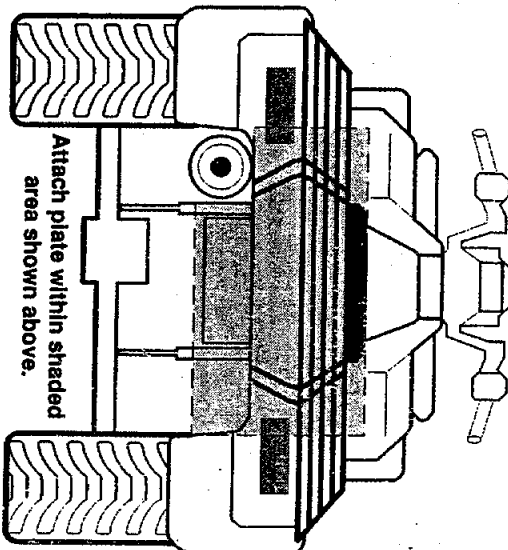
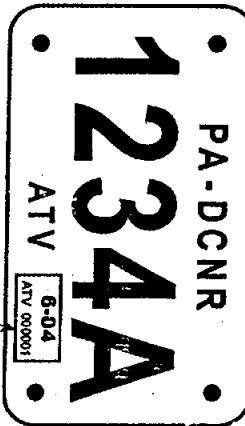

OPERATION OF ATVS BY YOUTH

No one under 10 years of age shall operate an ATV on any state-owned property.

No person under the age of 16 shall drive an ATV across any highway unless he has a valid safety certificate and is under the supervision of a person 18 years of age.

No person from age 10 to their 16th birthday shall operate an ATV except on lands of his parent or guardian, unless he or she has completed a prescribed safety training course and received an ATV safety training certificate.

Stevenson, Todd A.

172

From: Information Center
Sent: Wednesday, June 11, 2003 3:25 PM
To: 'mattp@smhco.com'
Subject: ATV

Hello,

We have forwarded your comments to the appropriate agency personnel. If additional information is needed, someone from the agency will be in contact with you.

Please be advised that you may obtain CPSC publications, recalls and general safety related information via our web site at www.cpsc.gov. Click on the "Search" icon and type in your topic. You may also file an incident report via the web site mentioned above. If you have additional inquiries, you may call our toll-free hotline at 1-800-638-2772, Monday - Friday, 8:30am to 5:00pm, Eastern Standard Time. Press 1 to begin and then press 300 to speak with a representative.

man/tm

-----Original Message-----

From: Matt Peltzer [mailto:mattp@smhco.com]
Sent: Wednesday, June 11, 2003 10:19 AM
To: Information Center
Subject: ATV

Hello, my name is Matt Peltzer. I have been riding and racing ATV's for 20 years. I have seen that the CPSC is considered banning the legal use and or production of atvs. It troubles me deeply as a free American citizen that the CPSC would even consider taking away RIGHTS from free Americans. These groups that are pushing the ban have the RIGHT not to participate. THEY NOR YOU have the right to take our rights away. Atving is a wonderful sport, a family sport and like all sports, people do get hurt. If you don't like it, don't participate. Please make the only common sense decision.

Injury rates have increased I'll agree with that. But look at how many atv's are being sold now compared to five years ago. The market is booming. There are a lot of inexperienced people getting involved with the sport. Rider education and more awareness on the parents part (making sure the kids are riding safely and wearing safety gear) is key to getting the injury rates down. Plane and simple there are a lot of atv's out there now and some people are going to get hurt. Your always going to have a number of irresponsible people involved in an activity no matter what it is. Sales will eventually level out and so will the accident rate.

Sincerely
Matt Peltzer
11101 SW Hwy 59
Rushville, MO 64484

mpeltzer@journey.com

Hammond, Rocky

173

From: Mike Lewis [MLewis@interpower.com]
Sent: Wednesday, June 11, 2003 10:10 PM
To: 'rdfleege'; 'Steve & Gale'; affordableplumb@aol.com; andy_christensen@quakeroats.com; 'Angela Mickelson'; 'ANTHONY TOIGO'; arrowspeed@prodigy.net; brandon-bos@quakeroats.com; cdrumm@netins.net; cswarts@trxinc.com; 'Dan Kleen'; darrellsparks@quakeroats.com; David.Downing@dnr.state.ia.us; Dbraden@amfan.com; djghost@pcii.net; djunge@msn.com; duffes@netins.net; f4dfan@msn.com; harthome@ncn.net; hnda450s@aol.com; iowahuntr@aol.com; kenjk@juno.com; kevco@netconx.net; KLEINSCHMIDT2291@aol.com; kztrike@iowatelecom.net; lsiouxohv@hotmail.com; 'MIKE KRAUSE'; Mrsweet88@aol.com; 'Rod Slings'; rolo1962@aol.com; s.belz@mchsi.com; sajburdick@aol.com; schutt@avalon.net; shira@heartland.net; snapp3@msn.com; swedegerm_2000@yahoo.com; swimmrfish@southslope.net; tbird3290@hotmail.com; thormotorsports@aol.com; 'Tony Toigo'; vonracing@aol.com; witzd@kdsi.net; 'Rick,Hope Wald,Weinmeister'; 'Mitch Williams'; Mike Lewis; 'Mike Lewis'; 'Michael Grant'; 'Matt Hoss'; 'Jonathan Hildenbrand'; 'Jim,Dana Shafer'; 'Jim Stephens'; 'Jim Schafer'; 'Jay Stephens'; 'Gary Storck'; 'Dan Beougher'; 'Curtis Arnold'; 'mike silverio'; 'susan fahey'
Subject: RE: Banning ATV's

Its like the old saying "guns don't kill people, people kill people" so why blame ATV's???. You get some underage underskilled yahoo on a quad not wearing any protective equipment making the news and this degenerate represents the rest of us... Bull. Banning ATV's is not the answer.. Get individuals undercontrol and off the ATV's till they are mature enough and or capable of handling it RESPONSIBLY, that i pose to be the task at hand .(I ask----where is the parental supervision in most cases ????) granted you cant lay all the blame on parents but come on folks these kids are somebody's responsibility... parents step up...

Mike Lewis
BCRA Coordinator

-----Original Message-----

From: rdfleege [mailto:rdflleege@atvscene.com]
Sent: Wednesday, June 11, 2003 20:41
To: 'Steve & Gale'; affordableplumb@aol.com; andy_christensen@quakeroats.com; 'Angela Mickelson'; 'ANTHONY TOIGO'; arrowspeed@prodigy.net; brandon-bos@quakeroats.com; cdrumm@netins.net; cswarts@trxinc.com; 'Dan Kleen'; darrellsparks@quakeroats.com; David.Downing@dnr.state.ia.us; Dbraden@amfan.com; djghost@pcii.net; djunge@msn.com; duffes@netins.net; f4dfan@msn.com; harthome@ncn.net; hnda450s@aol.com; iowahuntr@aol.com; kenjk@juno.com; kevco@netconx.net; KLEINSCHMIDT2291@aol.com; kztrike@iowatelecom.net; lsiouxohv@hotmail.com; 'MIKE KRAUSE'; Mrsweet88@aol.com; 'Rod Slings'; rolo1962@aol.com; s.belz@mchsi.com; sajburdick@aol.com; schutt@avalon.net; shira@heartland.net; snapp3@msn.com; swedegerm_2000@yahoo.com; swimmrfish@southslope.net; tbird3290@hotmail.com; thormotorsports@aol.com; 'Tony Toigo'; vonracing@aol.com; witzd@kdsi.net; 'Rick,Hope Wald,Weinmeister'; 'Mitch Williams'; 'Mike Lewis 2'; 'Mike Lewis'; 'Michael Grant'; 'Matt Hoss'; 'Jonathan Hildenbrand'; 'Jim,Dana Shafer'; 'Jim Stephens'; 'Jim Schafer'; 'Jay Stephens'; 'Gary Storck'; 'Dan Beougher'; 'Curtis Arnold'; 'mike silverio'; 'susan fahey'
Subject: RE: Banning ATVs

Then they had better ban football, soccer motorcycles and numerous other sports which results in many more injuries than ATV's.

Bob Fleege

Iowa OHVA Regional Director
E-Mail OldmanWheeler
Cell Phone 515-571-3000

-----Original Message-----

From: Steve & Gale [mailto:jakncoke@kdsi.net]
Sent: Wednesday, June 11, 2003 5:15 PM
To: affordableplumb@aol.com; andy_christensen@quakeroats.com; Angela Mickelson; ANTHONY TOIGO; arrowspeed@prodigy.net; brandon-bos@quakeroats.com; cdrumm@netins.net; cswarts@trxinc.com; Dan Kleen; darrellsparks@quakeroats.com; David.Downing@dnr.state.ia.us; Dbraden@amfan.com; djghost@pcii.net; djunge@msn.com; duffes@netins.net; f4dfan@msn.com; harthome@ncn.net; hnda450s@aol.com; iowahuntr@aol.com; kenjk@juno.com; kevco@netconx.net; KLEINSCHMIDT2291@aol.com; kztrike@iowatelecom.net; lsiouxohv@hotmail.com; MIKE KRAUSE; Mrsweet88@aol.com; rdfleege@atvscene.com; Rod Slings; rolo1962@aol.com; s.belz@mchsi.com; sajburdick@aol.com; schutt@avalon.net; shira@heartland.net; snapp3@msn.com; swedegerm_2000@yahoo.com; swimmrfish@southslope.net; tbird3290@hotmail.com; thormotorsports@aol.com; Tony Toigo; vonracing@aol.com; witzd@kdsi.net; Rick, Hope Wald, Weinmeister; Mitch Williams; Mike Lewis 2; Mike Lewis; Michael Grant; Matt Hoss; Jonathan Hildenbrand; Jim, Dana Shafer; Jim Stephens; Jim Schafer; Jay Stephens; Gary Storck; Dan Beougher; Curtis Arnold; mike silverio; susan fahey
Subject: Re: Banning ATVs

CFA Lawyers are only petitioning the CPSC, which they do all the time anyway, read below

Lets take a look at the groups involved and the facts before we go spreading rumors or 1/2 truths!

Yes we always need to be on the watch and not let something slip under us, but we don't need to gain ground be spreading lies or mis-truths

Joint CPSC - Industry Study on ATVs Due in January

A petition filed by the Consumer Federation of America (CFA) and several other groups on Aug. 21, asked CPSC to ban the sale of adult-size four-wheel all-terrain vehicles (ATVs) for the use of children under sixteen years of age.[3] CPSC docketed that portion of the petition, but did not docket another CFA demand, that the government should order consumer refunds for all three-wheeled ATVs sold for use by children. The Commission has asked for comments on the ATV petition.

Meanwhile, even before the petition was filed, CPSC was working with the ATV industry to develop a new risk analysis report.

The industry (Honda, Yamaha, Kawasaki, Polaris, and Suzuki) sponsored an exposure survey in the fall of 2001 to determine the numbers of ATVs in use, the numbers of drivers and riders, their age, gender and experience with ATVs, and the number of hours they use ATVs. These are basically the same questions CPSC used in its 1997 risk analysis.

CPSC staff, during the same time period, collected data on injuries, gathering information from its NEISS[4] files, and doing follow-up reports on injuries by using a telephone questionnaire.

Sue Ahmed, the CPSC study's coordinator, says that the industry-government joint study is working well thus far, and that the finished report should be available for the Commissioners and the public by early January.

ATV industry lawyers visited CPSC recently, asking for an opportunity to study the results of the risk analysis before the Commission makes a decision on the CFA petition.

----- Original Message -----

From: "Dale Witzenburg" <witzd@kdsi.net>
To: "steve hensyel" <jakncoke@kdsi.net>; "mike lewis"
<coyote4mx@hotmail.com>; "mike lewis" <mlewis@interpower.com>;
<Jrsahfer@aol.com>; "randy vanmaaren" <rvanmaaren@lisco.net>
Sent: Wednesday, June 11, 2003 8:09 PM
Subject: Fw: Banning ATVs

>
> ----- Original Message -----
> From: "rdfleege" <rdfleege@atvscene.com>
> To: <"AC Racing (Business Fax)"@frontrunner.kdsi.net>; "Adam Campbell -
ACP
> Photography" <proquad34@aol.com>; "Andrew Smith - ATV Illustrated"
> <Andrew@ATVIllustrated.com>; "Angela Mickelson" <amick@opencominc.com>;
"Ben
> Champ" <fdplanben@netscape.net>; "Bennett O'Connor"
> <b_omconnor@omconnorinsurance.com>; "Bruce Breerer" <bnc@mchsi.com>; "Bruce
> Egeness" <begeness@cyclecountry.com>; "Double M Signs "
> <sales@doublesigns.com>; "Chris Walterman "
> <cwalterman@OnMediaAdSales.com>; "Craig Erickson"
> <cerickson@shive-hattery.com>; "Curt Bacon" <cbbs@frontiernet.net>;
> <"Cynthia Kaneshiro (Business Fax)"@frontrunner.kdsi.net>; "Dan Beougher"
> <offroadnews@aol.com>; "Dan Kleen" <dkleen@ncn.net>; "Dave Brown"
> <insurance@dodgenet.com>; "David Downing" <david.downing@dnr.state.ia.us>;
> "Denny Plautz" <fdplanning@dodgenet.com>; "Des Moines River Ridge Runners"
> <dmrr@webtv.net>; "Dick Maier" <maier.dsbt@dodgenet.com>; "Dirt Surffers"
> <starks1230@msn.com>; "Doug Morris " <dmorris@ama-cycle.org>; "Eric Eddie"
> <Eric.Eide@JohnsonLawIA.com>; "Ernie Kersten" <kersten@mchsi.com>; "Gary
> Dutchfield" <newbrook@telusplanet.net>; "Geoff Engels"
> <sales@doublesigns.net>; "Iowa River OHV" <arrowspeed@prodigy.net>;
"Jarrod
> Ulery" <ulery@marshallnet.com>; "Jason Mickelson" <jmick@opencominc.com>;
> "Jeff McChesney" <jsmcchesney@nationalgypsum.com>; <"Jeff Schultz
(Business
> Fax)"@frontrunner.kdsi.net>; "Jennifer Asa - Webster City ABI"
> <jennifer@wmtel.net>; "Jennifer Smith" <jsmith@omconnorinsurance.com>;
> "Jeremy Adams" <jsadams@wccta.net>; "Jim Dahl "
> <jnjcyclerepair@hotmail.com>; "Jim Kersten" <jbk@mchsi.com>; "Jim White"
> <jcwhite31@aol.com>; "Joe Utley " <bodyshop.fdford@dodgenet.com>; "John
> Pellan " <jpellan@atvscene.com>; "John Williams " <j314@frontiernet.net>;
> "Kam Schmeher" <redryder@wccta.net>; "Kathi Black" <kathiblack3@aol.com>;
> "Ken Horner - Cycle Country" <khorner@cyclecountry.com>; "Ken Owens,
ABATE"
> <keno@pcpartner.net>; "Kent Ricke" <iabud1@frontiernet.net>; "Kory Ellis "
> <atvkoryellis@msn.com>; "Kurtis Johnson" <station502@yahoo.com>; "Larry
> Leiting" <cwflooringamerica@dodgenet.com>; <"Leif Glesne (Business
> Fax)"@frontrunner.kdsi.net>; "Leo Reigelsberger" <leor81@hotmail.com>;
> "Linda Von Bank" <linda_von_bank@hotmail.com>; "Little Sioux Explores"
> <lsiouxohv@hotmail.com>; "Mark Campbell" <soup@dodgenet.com>; " Mark
> Mitchell - Speed Channel" <Publisher@SpeedTV.com>; "Mary Ann Newman"
> <iowaohv@hotmail.com>; "Matt Bender (mbender@pivot-works.com)"
> <mbender@pivotworks.com>; "Matt Cooper" <mwts02@frontiernet.net>; "Midwest
> Off-Road News" <offroadnews@aol.com>; "Mike Price"
> <fortdodgesales@automotivefinishes.com>; "Mitra" <ridemitra@juno.com>;
"Nate
> Gibson" <accessaudio@frontiernet.net>; "NEAT" <djghost@pcii.net>; "North
> Iowa Dirt Riders" <kevco@netconx.net>; "Off-Road Unlimited"
> <shira@heartland.net>; "Oskaloosa Off Road" <witzd@kdsi.net>; "Paul
Dayton"
> <cpdayton@dodgenet.com>; "Rick Williams" <willstef@dodgenet.com>; "River
> Valley Trail Riders" <rivervalley@cox.net>; "Rob Johnson"
> <hidstore@aol.com>; "Roni McColley " <roni.mcolley@uscellular.com>; "Sandy
> Belz" <s.belz@mchsi.com>; "Scott Kilby" <skilby@primeline.com>; "Shawn
> Hoaglan" <trailblazer@indytel.com>; "South Central Dirt Riders"
> <cdrumm@netins.net>; "Sportsman Corner " <Honda-racer33@hotmail.com>;

"Stacy

> Anderson" <stacyanderson@spherion.com>; "Steve Casper- NOHVCC"
> <stevecasper@msn.com>; "Tom Prendergast" <tprender@hotmail.com>; "Pivot
> Works" <ttice@pivotworks.com>; "Top of Iowa Mud Dogs" <rjemtp@netins.net>;
> "Tyler Pritchard" <nitro_psycho@hotmail.com>; "Upper Iowa OHV"
> <kztrike@iowatelecom.net>; "Wes Miller - H-Bomb Films"
<wes@hbombfilms.com>

> Sent: Sunday, June 08, 2003 10:40 PM

> Subject: FW: Banning ATVs

>

>

> >

> > The FEDERAL CONSUMER PRODUCT SAFETY COMMISSION held a meeting JUNE 5th
they

> > are looking at banning ATV's. There were only 1300 letters sent in
against

> > this. The deadline has now been extended. Get off your duff spend a few

> > minutes filling out this forum, send it in. We need to counter act the

> > YA-HOOS, that would have them taken away from us. Just on our site alone

> > we

> > are almost 4000 members we can make a difference. You will need ADOBE to

> > download this, it is a free down load. No excuses!

> >

> >

> > <http://www.atvaonline.com/rights/petition.pdf>

> >

> >

> > This very important notice has been forwarded to you from the ATVA by:

> >

> > Bob Fleege

> > Iowa OHV Association

> > Regional Director

> >

> > Please do as I have and forward it to everyone you know so we do not
have

> > a

> > repeat of the past. The bottom line is that ones we need to protect

> > ourselves from is the Product Safety Commission so please take a minute
to

> > stand up and be heard on the behave of our great family sport. Thank

you,

> > Bob Fleege.

> >

>

>

> ---

> Outgoing mail is certified Virus Free.

> Checked by AVG anti-virus system (<http://www.grisoft.com>).

> Version: 6.0.487 / Virus Database: 286 - Release Date: 6/1/03

Outgoing mail is certified Virus Free.

Checked by AVG anti-virus system (<http://www.grisoft.com>).

Version: 6.0.488 / Virus Database: 287 - Release Date: 6/5/2003

174

Hammond, Rocky

From: Thomas R Waldron
Sent: Wednesday, June 11, 2003 5:09 PM
To: Hammond, Rocky
Cc: Main Identity; CAROL WALDRON
Subject: ATV Ban

If nearly 50,000 people die our nations highways yearly, why not a move to ban vehicles period? The answer is easy - legislators who want votes like to drive their vehicles and listen only to those who line there pockets, not to common sense. Just because you folks do not operate ATV's, you think that because some abuse their safety features and end up injured or worse, noone should own or operate one! Understanding bureaucratic government as I do, I know you do not listen to the entire story, but just to those who make the most noise. And, you will do what you will, when the people with the most influence yell the most...

Tom Waldron

6/13/03

Hammond, Rocky

175

From: Randy Martin [rmartin@net66.com]
Sent: Thursday, June 12, 2003 8:27 AM
To: Hammond, Rocky
Subject: Against ATV Ban

ATV Hearing
Office of the Secretary, Consumer
Product Safety Commission
Washington DC 20207

We, the undersigned, believe that ATVs aren't inherently dangerous and that Consumer Product Safety Commission concerns about safety can be addressed through an increase in designated, as well as specially designed, ATV riding areas, and through the promotion of rider safety training.

- We especially believe that it is important for the youth of America to be able to ride properly sized ATVs and to get safety training before they ride. Family participation in ATV riding is an important contributor to cultivating family closeness and respect in hundreds of thousands of American families. Also, ATV riding by minors with adult supervision provides important learning opportunities for minors.

- In addition, family ATV recreation provides essential income for recreational destinations and communities, and ATV sales provide jobs, business income and tax revenue for thousands of communities in the United States.

- Finally, we don't support any performance restrictions on ATVs. And we don't support restrictions on the sale of adult sized ATVs for use by children under 16 if the adult sized machine is the appropriate size for the child. Make your voice heard. Return this signed petition by June 2nd and we will personally hand it to the Commissioners at the June 5th public hearing in Morgantown, WV. Any petitions received after that date will be delivered to the CPSC office in Washington, D. C. You do not have to be an ATVA member to sign and return the petition.

Randy Martin
14647 E. 4000 N Rd
Hoopeston, IL 60942

I really enjoy my ATV. I ride it almost everyday. I use it for recreation, yard work, running back and forth between a shed and where I am working. I have picked up over 6250 rocks with my ATV on the neighbors farm for letting me ride is place. I have over 6,000 miles on it.

I have travel and ridden in these states on licensed trails: Illinois, Indiana, Michigan, Wisconsin, Minnesota, Iowa, Missouri, and Kentucky .

I think training is the key here not banning. I have taken an ATV riding class as well as my wife.

Thanks for you consideration,
Randy Martin

Stevenson, Todd A.

176

From: Information Center
Sent: Thursday, June 12, 2003 11:41 AM
To: 'S220431@mail.nwmissouri.edu'
Subject: All Terrain Vehicles

Hello,

We have forwarded your comments to the appropriate agency personnel. If additional information is needed, someone from the agency will be in contact with you.

Please be advised that you may obtain CPSC publications, recalls and general safety related information via our web site at www.cpsc.gov. Click on the "Search" icon and type in your topic. You may also file an incident report via the web site mentioned above. If you have additional inquiries, you may call our toll-free hotline at 1-800-638-2772, Monday - Friday, 8:30am to 5:00pm, Eastern Standard Time. Press 1 to begin and then press 300 to speak with a representative.

tm

-----Original Message-----

From: Phelps, Andrew [mailto:S220431@mail.nwmissouri.edu]
Sent: Thursday, June 12, 2003 9:50 AM
To: Information Center
Subject: All Terrain Vehicles

Hi, my name is Andrew Phelps. I have learned that the CPSC is currently considered banning the legal use and or production of atvs, aka four wheelers. It troubles me deeply as a free American citizen that the CPSC would even consider taking away RIGHTS from free Americans. These groups that are pushing the ban have the RIGHT not to participate. THEY NOR YOU have the right to take our rights away. Atving is a wonderful sport, and like all sports, people do get hurt. If you dont like it, dont participate. Please make the only common sense decision.

Stevenson, Todd A.

177

From: CarlBlech@aol.com
Sent: Thursday, June 12, 2003 10:58 AM
To: Stevenson, Todd A.
Subject: Radiator Speciality Co.

Todd,

I am doing some work for an attorney on the labeling of Liquid Wrench. You had previously received an FOIA request from Kim Chapman, a paralegal for this attorney (November 2002? or later). Your FOIA Request number was:S2110060. The records you found for their somewhat broad request were sent to Kim on February 3, 2003. It was not what they were looking for. I would like to develop a more specific request for them. I remember, from the early days when I visited the Atlanta Office that they had files on every manufacturer in their region which would have included Radiator Speciality Co. Those files contained all information including establishment inspection reports that likely contain results of a review with the manufacturer of the labels on the Liquid Wrench. These files predated the Commission because this Regional Office did enforcement activities for the FDA which at the time enforced the Federal Hazardous Substances Labeling Act. Do these files still exist in some form? Are there any other establishment inspection reports at the Commission?

Let me know if and what I could advise Kim to request?

CARL BLECHSCHMIDT
703-532-5273 x 226

Stevenson, Todd A.

178

From: Information Center
Sent: Thursday, June 12, 2003 9:34 AM
To: 'extracer416@hotmail.com'
Subject: Legality of ATVs

Hello,

We have forwarded your comments to the appropriate agency personnel. If additional information is needed, someone from the agency will be in contact with you.

Please be advised that you may obtain CPSC publications, recalls and general safety related information via our web site at www.cpsc.gov. Click on the "Search" icon and type in your topic. You may also file an incident report via the web site mentioned above. If you have additional inquiries, you may call our toll-free hotline at 1-800-638-2772, Monday - Friday, 8:30am to 5:00pm, Eastern Standard Time. Press 1 to begin and then press 300 to speak with a representative.

man/tm

-----Original Message-----

From: Jason LaBelle [mailto:extracer416@hotmail.com]
Sent: Wednesday, June 11, 2003 10:24 PM
To: Information Center
Subject: Legality of ATVs

Hi, my name is Jason LaBelle. I have learned that the CPSC is currently considered banning the legal use and or production of atvs, aka four wheelers. It troubles me deeply as a free American citizen that the CPSC would even consider taking away RIGHTS from free Americans. These groups that are pushing the ban have the RIGHT not to participate. THEY NOR YOU have the right to take our rights away. Atving is a wonderful sport, and like all sports, people do get hurt. If you dont like it, dont participate. Please make the only common sense decision.

Sincerely,
Jason

STOP MORE SPAM with the new MSN 8 and get 2 months FREE*
<http://join.msn.com/?page=features/junkmail>

Stevenson, Todd A.

179

From: Information Center
Sent: Thursday, June 12, 2003 9:25 AM
To: 'Skaterp2333@aol.com'
Subject: Banning of Atv's

Hello,

We have forwarded your comments to the appropriate agency personnel. If additional information is needed, someone from the agency will be in contact with you.

Please be advised that you may obtain CPSC publications, recalls and general safety related information via our web site at www.cpsc.gov. Click on the "Search" icon and type in your topic. You may also file an incident report via the web site mentioned above. If you have additional inquiries, you may call our toll-free hotline at 1-800-638-2772, Monday - Friday, 8:30am to 5:00pm, Eastern Standard Time. Press 1 to begin and then press 300 to speak with a representative.

man/tm

-----Original Message-----

From: Skaterp2333@aol.com [mailto:Skaterp2333@aol.com]
Sent: Wednesday, June 11, 2003 10:20 PM
To: Information Center
Subject: Banning of Atv's

Hi i ride atvs and it has helped me get muscle tone and it has also made my mom feel better from her disease(it is a muscle disease that attacks the muscles and weakens you) by riding my mom and thousands of other people have felt better about them selves. Yes u are right people have been getting hurt and killed, but thats only because there doing there job(like professional) or just being careless, there are millions of people that ride, and you are going to try and pass a law that says we cant ride anymore? Why? Theres no point in it. Atvs are the biggest and going sport in the U.S. How do you know that one of your people dont ride there self? The United States is a free country and we should be able to do whatever we would like to. Like all sports people get hurt. But also most sports include exercise like the Atving sport. Thank you and please dont take away our right to ride and live as free Americans, and dont disappoint EVERYONE that RIDES. Thank you Scott

Stevenson, Todd A.

180

From: Information Center
Sent: Thursday, June 12, 2003 9:18 AM
To: 'live2ride300@yahoo.com'
Subject: CPSC is currently considered banning the legal use and or production of atvs

Hello,

Thank you for contacting the U.S. Consumer Product Safety Commission (CPSC). We have forwarded your comments to the appropriate personnel within the agency. If further information is needed, a representative will contact you directly.

Please be advised that you may obtain CPSC publications, recalls and general safety-related information via our web site at www.cpsc.gov. Click on the "Search" icon and type in your topic. You may also file an incident report via the web site mentioned above. If you have additional inquiries, you may call our hotline toll-free at 1-800-638-2772. Press 1 to begin and then press 300 to speak with a representative. A representative is available to assist you Monday - Friday, 8:30am to 5:00pm, Eastern time.

myg/tm

-----Original Message-----

From: Chuck B [mailto:live2ride300@yahoo.com]
Sent: Wednesday, June 11, 2003 9:55 PM
To: Information Center
Subject: Hi

Hi, my name is Charlie. I have learned that the CPSC is currently considered banning the legal use and or production of atvs, aka four wheelers. It troubles me deeply as a free American citizen that the CPSC would even consider taking away RIGHTS from free Americans. These groups that are pushing the ban have the RIGHT not to participate. THEY NOR YOU have the right to take our rights away. Atving is a wonderful sport, and like all sports, people do get hurt. If you dont like it, dont participate. Please make the only common sense decision.

Do you Yahoo!?
Yahoo! News - Today's headlines

181

June 9, 2003

ATV Hearing, Office of the Secretary, Consumer Product Safety Commission
4330 East West Highway, Room 502
Bethesda, Maryland 20814

CPSC OFFICE OF THE SECRETARY

2003 JUN 12 P 3:01

Dear CPS Commission:

It has been brought to my attention that a movement is currently underway to limit or do away with All Terrain Vehicles altogether. If done, this could possibly be the greatest fleecing of America to date. Hundreds of thousands of people depend on ATVs not only for enjoyment, but as a means of living. Any such limiting on a tool such as ATVs would be an injustice to those people as well as generations to come.

Some may say that ATVs are dangerous and I will not dispute that an ATV can be dangerous. However, that is only if the person riding is not educated in the correct way to ride safely. Just as a person driving a car can be a danger, so can a person on an ATV. It should be the objective of the CPSC to educate new riders on how to ride safely and responsibly rather than take the privilege away from everyone for the mistakes of the minority. Car accidents occur daily, but taking cars away from drivers is not the solution, just as taking ATVs away is not a solution. The CPSC should be interested in bettering a resource rather than eliminating it.

Besides the safety issue, one fact that cannot be afforded to overlook is the economic damage a ban or limitation on ATV size would have on our country. Farmers and ranchers everywhere depend on ATVs as a means for transportation in harsh terrain that only a well equipped ATV can navigate through. An ATV is just that, an All Terrain Vehicle. No other vehicle on the planet can do the things that an ATV in capable hands can do. The preceding issue now brings me to the notion of banning ATVs larger than 400cc. As anyone who has ridden an ATV in challenging conditions (that which farmers and ranchers face on an almost daily basis) will attest to, is that an engine over 400cc in size is a necessity. As our rural lands become limited by urban sprawl, farm lands are forced into locations that only capable machines can navigate. It is clear that with larger engine sizes, the need for more education on how to handle such machines should be provided to the public. It is in the general interest of our country and all involved citizens to concentrate our efforts on educating young and advanced riders alike to the correct ways to machines we use to provide for day to day life.

I will now add my personal experiences with ATVs to this plea. I have grown up on ATVs. The first ATV I sat on was a three wheeled Honda when I was 7 years old. Such vehicles have since been banned from production for potential dangers. I now find myself at 20 years of age and 4 ATVs later. I am proud to say that I have not had a single serious accident in those 13 years of riding. In addition to the 13 years of recreation ATVs have provided, they have also given me countless opportunities to go places and meet people that I would have never been able to explore or meet if not given the privilege to own an ATV. I attended my first ATV safety course one month ago. I attended for several reasons, but one major factor was the promotion that Honda provided me when I purchased my latest ATV. Honda not only encouraged me to attend a safety class, but they paid me \$100 plus driving costs to attend the class. I would only hope all manufacturers (some already do) would follow in such a manner. The question of safety is not one about mechanical engineering, rather one about personal control. Every rider, regardless of age should be allowed to be taught the proper way to ride in a safe environment. An idea such as this was taught to me from my older brother as well as my father and then further enforced when I attended the ATV safety course provided by the ATV Safety Institute.

In closing, I would like to challenge any opponent of ATVs to come out for a weekend of safe and run riding with myself and a few friends. I truly believe that after an experience such as that, even the most opposed persons to ATVs will understand their value in today's society (my contact information is below). Please do not limit the chances of future generations to enjoy the experiences that ATVs have given to me and thousands of people like me.

Sincerely,

David Schéffler
Phone: (830) 391-1023
ATV Outdoors Administrator
www.atvoutdoors.net

AW
Comment

802 WEAVER ROAD
FESTUS, MO 63028

In reply to: ATV Hearing

Office of the Secretary, ATV Hearing
Consumer Products Safety Commission
Washington, DC 20207

Dear Office of the Secretary, ATV Hearing,

Hear we go again. I am 62 year of age. My wife, Linda and I have 10 children and 23 grandchildren. We have had ATV's at our home for our children and grandchildren since 1980. We also have a swimming pool. A small lake. A trampoline. A place for our grandchildren to Roller Blade and ride their dirt bikes and bicycle's. We have a canoe for them to play in the lake. We play in the snow with sleds and ski's. From time to time somebody hurts himself or herself a bit.

Our children don't use drugs or abuse alcohol. I know why. We have provided them with enough excitement and because of that they love life and themselves.

I believe that the people pushing this issue have a different axe to grind. They are either extreme environmental whacos who wish to completely eliminate the use of ATV's and safety has nothing to do with it or plaintiff's lawyers after the deep pockets of the OEM's

GARY M SURDYKE

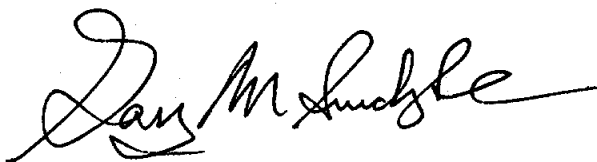

Stevenson, Todd A.

From: Information Center
Sent: Friday, June 13, 2003 1:01 PM
To: 'tprender@hotmail.com'
Subject: ATV restrictions

Hello,

We have forwarded your comments to the appropriate agency personnel. If additional information is needed, someone from the agency will be in contact with you.

Please be advised that you may obtain CPSC publications, recalls and general safety related information via our web site at www.cpsc.gov. Click on the "Search" icon and type in your topic. You may also file an incident report via the web site mentioned above. If you have additional inquiries, you may call our toll-free hotline at 1-800-638-2772, Monday - Friday, 8:30am to 5:00pm, Eastern Standard Time. Press 1 to begin and then press 300 to speak with a representative.

myg

-----Original Message-----

From: Tom Prendergast [mailto:tprender@hotmail.com]
Sent: Friday, June 13, 2003 12:32 PM
To: Information Center
Subject: ATV restrictions

To whom it may concern:

I am writing this letter in concern about the restrictions that some groups would like placed on the use of ATV's. I have been an instructor with ASI for ATV's for over 13 years and a middle school math teacher for 30 years, I have worked with ATV riders and youth's between the ages of 12 and 15 during this time period. Some of the restrictions that were placed on ATV's in the 1988 did more harm than good for the safety of ATV riding. A youth rider under the age of 16 was supposed to ride an ATV of 90cc or less. The ATV's that were being made at that time were too small for them to ride, so if they wanted to ride they had to ride a larger ATV. Now the manufactories are making ATV's between 91-300cc than a youth rider can ride safely. This is just like teaching a student can not fit into a student desk because of their size and this happens very often. The school would go to the high school and get a larger desk, but until that happened I would place that student at a table with a regular chair.

The sport of ATV riding is very much a family sport, more so than baseball and soccer. With ATV riding everyone can enjoy riding, not just the person that is playing like in other sports. Many families will go on weekend outings as well as just going riding for the day. My family has taken many trips only for the purpose of

6/13/03

riding ATV's and seeing the great outdoors. Some of the groups that want the banding of ATV's is just a back door effort by them of closing the great outdoors for motorize use. If you look at there backgrounds they are for the closing of the National Forest to much public use by people with motor vehicle's. And the banning or restricting of ATV's would help in there cause. So, when you look at the numbers that they are giving for safety look at both sides and think about what there hidden purpose for wanting the restrictions placed on the use of ATV's.

Tom Prendergast

ASI ATV instructor

7th and 8th grade Math teacher

MSN 8 helps ELIMINATE E-MAIL VIRUSES. Get 2 months FREE*.

Hammond, Rocky

184

From: john goodson

Sent: Saturday, June 14, 2003 12:55 PM

To: Hammond, Rocky

Subject: cspc atv ban please read

i am 100%against a ban of any kind on four wheelers let me do my own parenting, you parent your kids ill parent mine thank you john goodson 1108 naes dr. imperial mo. 63052

ATV

185

Stevenson, Todd A.

From: SHANNON [bansheegurl@yahoo.com]
Sent: Monday, June 16, 2003 11:36 AM
To: Stevenson, Todd A.
Subject: "ATV Hearing"

Unfortunately I do not have a scanner so I converted file to a j-peg and added in signatures. I wish good luck on the hearing as this will effect many.

Do you Yahoo!?
SBC Yahoo! DSL - Now only \$29.95 per month!

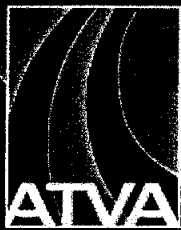

ATVA "Protect Your Right to Ride" PETITION

To: Commissioners of the Consumer Product Safety Commission
RE: All-Terrain Vehicle Safety

- We, the undersigned, believe that ATVs aren't inherently dangerous and that Consumer Product Safety Commission concerns about safety can be addressed through an increase in designated, as well as specially designed, ATV riding areas, and through the promotion of rider safety training.
- We especially believe that it is important for the youth of America to be able to ride properly sized ATVs and to get safety training before they ride. Family participation in ATV riding is an important contributor to cultivating family closeness and respect in hundreds of thousands of American families. Also, ATV riding by minors with adult supervision provides important learning opportunities for minors.
- In addition, family ATV recreation provides essential income for recreational destinations and communities, and ATV sales provide jobs, business income and tax revenue for thousands of communities in the United States.
- Finally, we don't support any performance restrictions on ATVs. And we don't support restrictions on the sale of adult-sized ATVs for use by children under 16 if the adult-sized machine is the appropriate size for the child.

Shannon Friesen Box 290 Anola, Man ROE 0AO

| Name | Address | City | State | Zip |
|---------------|---------|------------|-------|-----|
| Jason Friesen | Box 290 | Anola, Man | ROE | 0AO |
| Susan Brown | Box 232 | Anola, Man | ROE | 0AO |
| John Brown | Box 232 | Anola, Man | ROE | 0AO |



Make your voice heard. Return this signed petition by June 2nd and we will personally hand it to the Commissioners at the June 5th public hearing in Morgantown, WV. Any petitions received after that date will be delivered to the CPSC office in Washington, D.C. You do not have to be an ATVA member to sign and return the petition.

Stevenson, Todd A.

From: Information Center
Sent: Monday, June 16, 2003 10:06 AM
To: 'bkp2@attbi.com'
Subject: atv ban

Hello,

We have forwarded your comments to the appropriate agency personnel. If additional information is needed, someone from the agency will be in contact with you.

Please be advised that you may obtain CPSC publications, recalls and general safety related information via our web site at www.cpsc.gov. Click on the "Search" icon and type in your topic. You may also file an incident report via the web site mentioned above. If you have additional inquiries, you may call our toll-free hotline at 1-800-638-2772, Monday - Friday, 8:30am to 5:00pm, Eastern Standard Time. Press 1 to begin and then press 300 to speak with a representative.

myg

-----Original Message-----

From: Brian Potter [mailto:bkp2@attbi.com]
Sent: Monday, June 16, 2003 12:45 AM
To: Information Center
Subject: atv ban

I'm writing in response to you looking into limiting the use of atv's by kids or banning them. I think that what you should do is go after the idiots who let there kids ride a quad without showing them how to ride. The 99% of us responsible parents should not have to worry about whether our kids can ride their quads anymore because a few idiots let their kids ride with no gear and no experience. My daughter is 14 and going into highschool. There is no way she could ride a 90cc quad. Her knees would be above the handle bars. It would be more dangerous for to ride that tiny bike than one to big for her. I used to ride a three wheeler in the 80s. There was nothing wrong with those if you knew how to ride one properly. The problem with those was some people don't use any common sense.
Please forward my opinion to the appropriate people.

Thanks,
Brian Potter

6/16/03

Mr. Todd A. Stevenson
Secretary, Consumer Product Safety Commission
Room 502
4330 East-West Highway
Bethesda, Maryland 20814

CPSC/OFFICE OF
THE SECRETARY

2003 JUN 25 P 2: 35

ATV
187

Regarding ATV Hearing held on June 5, 2003.

Dear Mr. Stevenson,

The concern for public safety regarding ATV use is valid. Any activity growing as fast as the use of recreational vehicles should be monitored and reasonable limitations put in place. Our sport is growing rapidly, and with the numbers provided in your letter, seems the injuries are not out of line when the hours of use and the number of new inexperienced riders are considered. That does not mean a study should not be done to consider reasonable effective ways to reduce deaths and injuries.

My name is Bill Stinson, I am the president of the Arizona ATV Riders, Inc. Our club was formed from a group of active ATV riders in December of 2001. In just 16 months we have grown to over 130 paid members. We have supported our local land managers assisting with the management of trails and trash pickup in our state.

The Arizona ATV Riders, Inc have guide lines, reasonable safety built into our group rides. The majority of our group rides are not of any great speed, usually about 20 MPH. We are typically putting along the back country roads and trails in our state, and adjacent states. Due to this low key casual ride, many of us do not wear helmets. In Arizona riding a motorcycle on public roads does not require a helmet if you are over 18. I ride a Honda Goldwing every day, but NEVER without my helmet (and I saw 18 many many years ago). However, I do not wear a helmet on my ATV as a general rule. I have ridden many motorcycles over many years and for this type of riding and I don't feel it is needed. If I choose to join in on an advanced ride, I do wear a helmet. My point here is responsible use of the ATV's is required. Not forcing helmet laws, or any restrictions regarding size of ATV, or even children riding ATV's. I take 3 boys riding, they were 8, 10 and 12 when I meet them and taught them how to ride. They are now 3 years older, they have never been allowed to ride without their helmet, and to date they have never wrecked. Simply proper training and parental guidance is all that is needed.

The ATV Safety Institute limits children under 16 to 90cc or less. This is extremely unreasonable. That means my 15 year old that weighs 170 lbs can only ride a 90 cc ATV. It would only go down hill with him on it, and I wonder if the brakes are equipped for that much weight. The smallest ATV I have is 250cc, and the children have no problem riding them safely.

They outlawed the new sales of ATC's, and now I hear ATC's and ATV's are considered the same thing and just as dangerous. This cannot be further from the truth. 3 wheels to 4 wheels makes a world of difference in stability. I don't own a 3 wheeler any more, and

would not allow the children to ride one if I did, mostly just because 4 wheels are available, and much more stable.

As I am out riding in many areas I see lots of ATV's being ridden. Those that bother me are the late teens and early twenty year olds that ride in shorts, flip-flops, no shirt and no helmet while riding a Raptor (600cc sport quad). This is an accident waiting to happen. I avoid these riding areas because they not only hurt themselves, they run into other riders as well.

The reports of deaths and injuries due to ATV use needs to be analyzed. What is the age break down?, where under 18 is involved was there adult supervision? How were they dressed? What safety equipment did they use? What type of ATV was used (Sport or Utility, what size to weight of rider)? What training or experience level was the rider? Where any of them passengers? Were they riding in a group? Did they wreck on their own, or were they a victim of another rider?

SUMMARY:

1. I agree a study needs to take place and consider ways to implement safety in ATV riding.
2. I don't support mandatory helmet laws, those breaking laws will still break them, but then I would be required to wear a helmet on my backcountry putt-putt rides.
3. Users of ATV's need to be responsible, have adult supervision if under age. Laws should not negatively affect the responsible users of ATV's.
4. Do not allow ATV's to be considered the same as ATC's.
5. Research where the problem is and focus on it. Not a general "ATV's are not safe" type of approach. With 90,000 new ATV's sold in 2002 in Arizona alone, attempting unreasonable, unenforceable laws will only make criminals out of the responsible user.

Sincerely,



Bill Stinson
Arizona ATV Riders, Inc.
<http://www.azatvriders.org>

Stevenson, Todd A.

ATV 188

From: Information Center
Sent: Wednesday, June 18, 2003 8:11 AM
To: 'trx300exnj@hotmail.com'
Subject: atv banning?!

Hello,

We have forwarded your comments to the appropriate agency personnel. If additional information is needed, someone from the agency will be in contact with you.

Please be advised that you may obtain CPSC publications, recalls and general safety related information via our web site at www.cpsc.gov. Click on the "Search" icon and type in your topic. You may also file an incident report via the web site mentioned above. If you have additional inquiries, you may call our toll-free hotline at 1-800-638-2772, Monday - Friday, 8:30am to 5:00pm, Eastern Standard Time. Press 1 to begin and then press 300 to speak with a representative.

tm

-----Original Message-----

From: Brian McLaughlin [mailto:trx300exnj@hotmail.com]
Sent: Tuesday, June 17, 2003 10:55 PM
To: Information Center
Subject: atv banning?!

I am concerned about the decision you are making about the ban of atvs (quads, four wheelers ect.) This decision is not only abserd do to the fact that it is one of the country's most favorite recreational activity but also one of the activities that are most neglected. It is bad enough that people try to take away our riding areas and our rights to live as free americans enjoying life. Have you ever heard the phrase "you only live once"? well why do you have to bother with people out in the middle of the woods? are we bothering anyone? Are animals calling your office complaining?

Can u please think about this very highly before you make any kind of decision. America's people want to enjoy they're life except all the tree huggers worrying about the animals.... You should look into tread lightly it is a program all about saftey in the trails and animal awareness, personally everyone i ride with and have ever talked to is very aware of the life of wildlife and takes it seriously enough not to hurt animal or cut down trees. maybe u should make building houses illegal too since you are cutting down trees... we should all live in tree houses.

I hope you have seen my point in this email have a nice day.

Brian McLaughlin

Help STOP SPAM with the new MSN 8 and get 2 months FREE*
<http://join.msn.com/?page=features/junkmail>

Stevenson, Todd A.

ATV

189

From: Information Center
Sent: Wednesday, June 18, 2003 4:30 PM
To: 'jim@nacs racing.com'
Subject: ATV Safety

Hello,

We have forwarded your comments to the appropriate agency personnel. If additional information is needed, someone from the agency will be in contact with you.

Please be advised that you may obtain CPSC publications, recalls and general safety related information via our web site at www.cpsc.gov. Click on the "Search" icon and type in your topic. You may also file an incident report via the web site mentioned above. If you have additional inquiries, you may call our toll-free hotline at 1-800-638-2772, Monday - Friday, 8:30am to 5:00pm, Eastern Standard Time. Press 1 to begin and then press 300 to speak with a representative.

man/tm

-----Original Message-----

From: Jim at Nacs [mailto:jim@nacs racing.com]
Sent: Wednesday, June 18, 2003 12:19 PM
To: Information Center
Subject: ATV Safety

I have read the news item on your website pertaining to ATV safety. In looking at the statistics I am somewhat confused. These stats are stated in a way to be a little misleading.

From 1997 to 2001 the increase in injuries (104%) went up proportionately with the actual increase in sales of ATVs (359,000 to 730,000 or 103.3%).

I'm not sure how the determination was made that "the estimated number of ATV drivers increased 36%" I would say that number is understated especially as more and more family members of ATV owners come of age to ride their parents or siblings machines.

I suspect the majority of ATV accidents are the result of carelessness, stupidity, or lack of proper supervision, as would be the same for automobiles, farm tractors, riding lawn mowers, bicycles, firearms, etc.

ATVs are a crucial part of our nation's economy (an estimated 10 billion dollars per year) and they have become instrumental in our nation's workforce (farmers and ranchers), safety institutions (police, fire departments, emergency/rescue operations), conservation (Departments of conservation and Forest Rangers) and our national defense (the military). The ATV is much more economical in fuel consumption and environmentally safer than the pickup trucks, tractors, and jeeps that they have replaced.

Common sense should prevail, we should not let a small percentage of careless individuals ruin an Industry that caters to millions of responsible ATV owners.

Sincerely,
James R. Naccarato
645 Rt. 212
Saugerties, NY 12477

Stevenson, Todd A.

ATV 190

From: Information Center
Sent: Thursday, June 19, 2003 4:43 PM
To: 'stonyledgefarm@ricconnect.com'
Subject: BAN

Hello,

We have forwarded your comments to the appropriate agency personnel. If additional information is needed, someone from the agency will be in contact with you.

Please be advised that you may obtain CPSC publications, recalls and general safety related information via our web site at www.cpsc.gov. Click on the "Search" icon and type in your topic. You may also file an incident report via the web site mentioned above. If you have additional inquiries, you may call our toll-free hotline at 1-800-638-2772, Monday - Friday, 8:30am to 5:00pm, Eastern Standard Time. Press 1 to begin and then press 300 to speak with a representative.

man

-----Original Message-----

From: The Learneds [mailto:stonyledgefarm@ricconnect.com]
Sent: Sunday, May 18, 2003 5:29 PM
To: Information Center
Subject: BAN

Hi, my name is Ben Learned. I have learned that the CPSC is currently considered banning the legal use and or production of atvs, aka four wheelers. It troubles me deeply as a free American citizen that the CPSC would even consider taking away RIGHTS from free Americans. These groups that are pushing the ban have the RIGHT not to participate. THEY NOR YOU have the right to take our rights away. Atving is a wonderful sport, and like all sports, people do get hurt. If you dont like it, dont participate. Please make the only common sense decision. Give up your push for the banning of atv's.

ATV

DEPARTMENT OF THE SECRETARY

2003 JUN 19 P 2: 06/15/2003

To Whom It May Concern:

I am a 36 year old responsible and safe ATV rider and owner who loves taking rides with my friends and family. I find it hard to believe that there is talk of an ATV ban. Do people really think that ATV's are any more dangerous than Motorcycles (both street and dirt), speedboats, snowmobiles or the car or truck that you drive ever day to work?

I am against any proposed ban on ATV's, I not only use them for fun, I use them for work. I use them to work cattle, haul feed to my deer feeders, carry tools for working fences & for transportation to and from my deer stand. I put almost 1500 miles a year on my ATV. Banning ATV would be a crime against our freedoms and our way of life.

This proposed ban needs to be reconsidered. Maybe there could be some mandatory safety training and a sticker be applied to the ATV to prove that the owner has successfully completed this training.

Signed Matthew T. Grant

Matthew T. Grant
2108 Skylark dr.
Waco, Texas
76712



ALL-TERRAIN VEHICLE ASSOCIATION OF MINNESOTA

Post Office Box 557

Osseo, MN 55369

763-503-1975

1-800-HI-ATVAM

www.atvam.org

June 12, 2003

Office of the Secretary
Consumer Product Safety Commission
Washington, DC 20207

ATTN: ATV Hearing

In response to your request for comments to obtain information and views from the public concerning all-terrain vehicles and safety outlined in Federal Register DOCOD: fr23ap03-23, the position and comments of the All Terrain Vehicle Association of Minnesota (ATVAM) are discussed below.

In a state with over 180,000 registered ATV's and 61% of fatalities involving riders over 17 years old, ATVAM supports the Commission's concern about the current level of deaths and injuries associated with ATV's and support enhanced safety training to achieve a further reduction in such deaths and injuries. This training should include proper riding gear, safe riding techniques and improve the users riding skills. ATVAM does not support further regulation.

As for youthful operators 16 years old and younger, Minnesota law does not allow operation of ATV's for youth under 12 years old. Youth 12 to 16 years old requires safety certification using a computer based home study program along with a hands on ATV safety training course. This is a new program for Minnesota and will be implemented effective July 1, 2003.

In closing, the Consumer Product Safety Commission should support increased training opportunities for all ATV riders to educate them on proper riding gear and techniques. Thank you for the opportunity to comment on ATV safety.

On behalf of the All Terrain Vehicle Association of Minnesota Board of Directors,

Dustin Young
President
ATVAM
P.O. Box 557
Osseo, MN 55369

JUN 19 11:01
FBI MINN
②

ATV Hearing
Office of the Secretary
Consumer Product Safety Commission
Washington D.C. 20207

6/20/2003

I am sending this letter to relay my comments and concerns regarding the upcoming July 5th hearing on ATV Product Safety.

As a long time motor sport enthusiast, I must say that the proposals I am seeing related to restrictions for ATV manufactures and ATV riders are simply unreasonable. People go through life facing many hazards – common sense on the part of the public and training where appropriate is the real answer here. The government can't possibly protect the public from all the potential hazards in the world – I expect them to protect me from an ATV that would have a defect in design potentially causing me unexpected risk, such as a wheel that may fall off. I don't expect the Consumer Product Safety Commission to mandate a change to a product in an attempt to prevent me from choosing to legally use it in a fashion that some individual or group deems inappropriate.

Does the Consumer Product Safety Commission mandate that all Bath Tubs be sold with Bath Mats? No, they expect the public to have some common sense and purchase a mat so one won't slip, fall and get injured.

Please continue to work toward protecting us – but not when it means protecting us from ourselves.

Sincerely,
Jack Kress
869 South Hewitt Ave.
Washington, PA 15301

ATV
19.4**Stevenson, Todd A.**

From: Pam Falcioni [mailto:powroll.com]
Sent: Tuesday, June 24, 2003 6:32 PM
To: Stevenson, Todd A.
Subject: ATV Hearing

Hello,

Thank you for allowing me to voice my opinion regarding ATV regulation.

I am a 40 year old lady who has been riding 3 and 4 wheeled ATV's since I was 24. I also ride two wheeled dirt bikes and street bikes.

My trail riding experience started on a two wheeler, and moved quickly to a small three wheeler. I then purchased a four wheeler in 1992. I have been riding ever since.

I am part of a local OHV club, Central Oregon Motorcycle & ATV Club. This club is comprised of about 100 families and over 350 individual members. The members ride a variety of off-highway OHV's -- dirt bikes, sport quads, utility quads, 3 wheelers. Riding members range in age from 3 to 85.

In the 10 years I have been active in our club, there has been only one serious accident involving a club member riding an OHV. During that same period of time, three members were seriously injured in auto accidents, and one killed.

This is my own personal proof of the national statistics showing that you are much more likely to be injured or killed in a car accident than in a mishap with an ATV.

Most of the people who tell you that 'ATV's are dangerous!' are reactionaries. They are the same people who wanted to pass a law after Regan was shot, pass another law when arsenic was found in a Tylenol bottle, pass another law after a local child was kidnapped, pass a few more laws during the Mad Cow disease scare, pass a few more laws after 9-11, and are probably in the process of drawing up a few laws after the SARS scare.

Sometimes good legislation comes from these knee-jerk reactions. Most of the time though, regulations were already in place that should have averted tragedy, if only we cared enough to have them implemented and regulated correctly.

The current regulations covering ATV usage are doing their job.

Accidents are not caused by larger displacement machines.

Accidents are caused by many factors, but it basically boils down to one main problem. Lack of personal responsibility. People riding without proper training, not taking responsibility for their children, riding under the influence of drugs and alcohol, riding without proper gear.

Most accidents can be traced back to a choice (or series of choices) the rider made that resulted in a dangerous situation -- not to a dangerous vehicle!

A drunk driver who jumps behind the wheel of a Corvette is not more dangerous than a drunk behind the wheel of a Pinto.

If you want to make ATV'ing safer for the public, make sure that ATV safety training is more readily available to all new owners. Education will reduce accidents. Legislation will simply be ignored.

Keep the regulations as they currently stand.

Thank you.

6/25/03

Pamela Falcioni
Central Oregon Motorcycle & ATV Club
Past President
Rider & Owner of: Honda 88 TRX 250R, Honda 89 TRX 250R, KTM 250 EXCR, Ducati 620 Monster

ATV 195

June 13, 2003

Johnny Thompson
218 Jackson
Mangum, Oklahoma

Office of the Secretary,
Consumer Product Safety Commission

Atten: ATV Hearing

I question the motivation of the groups involved in this concern .How many injuries happen in our supervised sports program. We are always trying to Ban something. I myself have a ATV Honda 4/4 it helps me in hunting and fishing for I am 65 years of age and my walking ability is limited. WE will never be able to control what people will do and how they conduct them-selves. If we could our incarceration rate in the United States would not be such a tax demand both state and federal. Let us just enjoy our ATV and let the other people enjoy what they do.

Thank You
Johnny Thompson

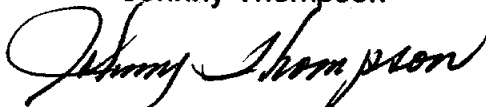



L.A. Amundson

6-16-03

AN

Gentlemen/Ladies

I AM NOT FOR MORE
REGULATION BUT WHEN AN
INDUSTRY DOESN'T REGULATE
THEMSELVES - I FEEL THE
GOVT. MUST!

I FEEL THE SAME WAY
ABOUT THE HELMET LAW
FOR MOTOR CYCLES!

J. Amundson



ADW 197

ATV HEARING – SAFETY ISSUES & REGULATIONS

Rider safety is always of the utmost concern regardless of mode of vehicle we choose to ride; and the knowledge, skill and maturity level of the participant plays an important role in ATV safety. Nobody wants to see anyone get hurt while riding an ATV, but accidents will and are going to happen. Agreeable, safety measures need to be in place and preventive measures can be taken to establish a safer riding experience, it is the form and manner of implementation of these measures take which needs to be scrutinized carefully when “reforms” or “bans” are being discussed.

The age/engine size restrictions currently in place was established by ATV manufacturers to prevent their company from being held legally liable for an accident involving a child. (Our society seems to subscribe to the ideology people are not held responsible for their own actions so laws are made to enable them to sue somebody else in any situation.) Since all children grow and mature at a different rate, it is unrealistic to not take that fact into consideration when placing restrictions on the size of machine they are allowed to ride.

Youth need to be certified on engine size comparable to their physical size, ability, and skill level. To knowingly place a youth on an undersized machine creating a dangerous riding environment for the youth is irresponsible behavior on the part of intelligent adult.

Our 14-year-old grandson is a skilled experienced rider. He has been riding ATVs for a number of years and he now rides a Blaster. In an attempt for him to become certified this Spring, first we had to find and borrow an ATV to become certified on. Since his age group required a 70 to 90 cc machine he was placed in a situation that could have been injurious to him. His physical size, riding skill, and maturity level which exceeded the machine size and engine size actually created a dangerous situation for him. Visually, he looked like a monkey balancing on a small rubber ball. The safety course was a walk in the park for him, in part due to his parents involvement in all aspects of his riding experience. Older riders taking the same safety course riding 500 cc and above had more difficulty in maneuvering their machines safely than he would have had on the same machine. We paid a fee for the certification course. Both children started out at an early age on a 125cc. Machine in a wide open field. They were taught how and when to shift gears, how to maintain their own machines, and respect for other riders. Our 7 year old grandson, wearing protective gear, rides a 125cc ATV with supervision. He cannot become certified until he is older due to the machine/age restriction, and we don't have access to a smaller 50cc ATV. Nobody rides alone is a steadfast rule in our family. They were taught these are machines and not TOYS. Kids that are riding the 50s and 70s have a different attitude toward their machine.

Youth need to be certified on the machines with the engine size that they are accustomed to riding.

Safety gear: Since the teenager is “into” the nationally known “name brand” gear, it has been easy to keep him outfitted head to toe in safety gear without a power struggle. Younger brother falls in line because he mimics the oldest. The entire family rides with protective safety gear. Forgot the helmet! Too bad, you don't ride. Both take care of maintaining their own equipment and machine

Double riding is a mute issue as far as safety is concerned and should not even be considered as a safety hazard on stable safe machines as long as every body wears protective gear. I support the wearing of safety gear while riding double.

How can riding an ATV on public county roads be considered a hazard when it is legal to ride a non-motorized bicycle on those same roads and on state highways!! I prefer to ride on forest trails but

sometimes it could be necessary to ride on a county road to get from trail to trail. I support legalizing riding on county roads.

We are a generational family of riders: grandparents, children, and grandchildren. We ride with helmets and protective gear, "tread lightly" upon the forest trail in the course of family recreation. In a time when "family values" have gone astray, ATV riding has provided our family with an opportunity to come together in a cohesive manner to experience the great outdoors, being responsible for nature and the environment, and respecting the living wild animals habitat. We carry a trash bag in our carrier on the machines and pick up trash in the forest while riding. Our family participates in restoration efforts as a result of the Hayman Colorado forest fire. We ride on established trails established by the Bureau of Land Management and our National forest service and do little or no damage to the environment.

Interestingly enough, the groups that seem to be so concerned about "riders' safety and increase in youth accidents" are the ones that are trying to close down trails all over the United States. I question the ulterior motive of these environmental groups as being self-serving in aligning with the Consumer Product Safety department to establish "safety requirements". If they are successful in securing an outright ban or curbing of ATV usage, the result will be an economic hardship on families across the nation through loss of jobs. The ATV industry a booming business, extending out from the raw materials required for the manufacturing of ATVs to sales people, repair mechanics, fuel, clothing industry, and accessories. A loss of revenue in these areas would be catastrophic.

Any person taking a college statistic class will tell you that statistics can be skewed to support whatever position you want to take. If there is an "increase in serious youth injury accidents", that claim needs to be supported by a study performed by an independent, unbiased group of clinicians. Compare apples to apples, oranges to oranges. A survey outlining these essential components would be helpful in making well informed decisions and reform of safety requirements: how the accident happened, age, experience, skill level/maturity of rider, type and size of machine, environment/type of terrain where incident occurred, circumstances of the crash, was protective gear being worn, was the rider certified, equipment failure, improper maintenance of the machine, was the rider alone or supervised at the time of the incident, severity of injury, did the incident result in death or serious bodily injury? Compare the number of accidents versus the number of riders and the total amount of miles traveled yearly. All of these factors need to be clearly understood prior to a "witch hunt" being conducted on the ATV rider.

People can and do make their own riding/living safety rules within the family. In comparison, children have died playing football, riding bikes, swimming, walking across the street, and participating in any type of activity in life. While riding on public land is a privilege, those same public lands were set aside for the enjoyment of the entire population, not to be controlled and eliminated by any one particular interest group.

ATV RIDERS ARE ELECTION VOTERS.

Shelby & Judy Moore
8410 Chipita Park Road
Cascade CO 80809

ATV 198

June 20, 2003

To: Federal Consumer Product Safety Commission
Office of the Secretary, Consumer Product Safety Commission
Washington, D.C. 20207

Subject : ATV Hearing

I am writing in regards to ATV safety. My family (kids' ages 4, 9 and 12) have had ATVs for the past four years. My 4 year old is still satisfied with her battery powered 4-wheeler. But, not my 9 year old son and 12 year old daughter. Both started out on two Yamaha 50ccs. 4 years ago. They learned how to ride on those bikes and now are riding Alpha Sports, 70cc and 90cc, respectively.

My oldest two children are very well-trained (more than you can understand unless you ride ATVs yourself) and extremely good riders. They get constant instruction from their father and other racing/riding enthusiasts regarding how to ride safely. They are NEVER left unattended to ride, race or practice on their quads. They have full riding gear which includes: helmet, goggles, chest protector, kidney belt, boots, and gloves. They are never on their quads without this gear NO MATTER WHERE THEY ARE RIDING.

The sport of ATV'ing has played a large part in bringing us together as a family. At the end of each week, the oldest kids have the responsibility to pack up their riding gear and extra clothes for the weekend of riding. They pack a cooler of drinks for everyone. On weekends we travel to other cities to race or ride ATVs. We travel together, setup (for the day or days) together, eat together, ride together, laugh together and clean up together. At the end of each weekend, the whole family participates in unloading the trailer full of ATVs, riding gear, food, drinks, gym bags, etc, and the gear and bikes are cleaned up. During the week the kids and their dad check over the bikes to make sure the weekend riding didn't damage any part of the bike. Soon my oldest will be a teenager and I am sure she will continue to "want" to spend weekends with the family because we have such a blast together. She will not be one of the kids, hanging around with too much time on her hands.

The kids work with their dad and are able to remove parts from their bike, in order to replace it with new parts. Both kids can take on and off the air filter, the tires, the bumper, the shocks, the chain, the A-arm, and the pipe.

The kids have learned camaraderie, good sportsmanship, helping out a fellow rider (which may also be a competitor if you are racing). They have learned about team work and riding safety . And most of all about family and having fun together.

How many families do you know that hang out together on the weekends? ATV families do!!! And I am proud to be one of them. Please consider my letter /story before making any harsh decision to ban ATV for kids under 16. I love my kids and make every effort to keep them safe, as do most other parents.

The sport of ATV'ing is growing . There are many more people owning ATVs than in the past. Naturally, with more people in the sport of ATV'ing, there will be a natural progression of accidents. This is true with any sport.

Recently a young child died on the baseball field when he was hit by the ball. Are we considering banning baseball? No, we are looking for better ways to keep the kids safe and allow them to continue the sport they love.

Let's look for ways to keep our ATV kids safe and allow them to continue in the sport they love. There are alot of families like mine.

Thank You.
Angela Rovnak
ATV Mom

AAW 199

June 22, 2003

ATV Hearing
Office of the Secretary
Consumer Product Safety Commission
Washington, DC 20207

Dear Sir or Madam:

My family and I are avid ATV users. We have been involved with this sport for almost 2 years now and have many happy, safe and fun memories and look forward to more rides in the future.

I question the motives of the Natural Trails and Waters Coalition and the Bluewater Network. It seems to me they have been unsuccessful to block off-road vehicle use by citing exaggerated environmental concerns so now they are concentrating on safety issues. They have never been concerned about our safety. Before and I feel they are simply "grasping at straws" to do anything to support their radical agenda.

I agree that ATV safety is an important issue. I believe safety training should be readily available and maybe the ATV manufacturers could offer discounts of some kind to those who complete the courses either before purchasing or within a reasonable period following purchase.

Consumer education is also important. Consumers should know and sellers should be trained to ask what the ATV will be used for (trail riding, cross country use, racing etc.) and how much experience the rider has. The inexperienced rider should buy a smaller, less powerful ATV until they develop the experience needed for a larger size. Many inexperienced people buy their ATVs based on "looks" and as a result buy the more powerful sport quads. These are powerful and fast machines and should only be used by experienced riders.

The increase in injuries is due to the fast growth of the sport and increased sales of ATVs. Where there is more of something (ATVs, automobiles, horses etc.) there will always be an increase in injuries and unfortunately deaths. The increase of injuries in the 400cc and higher size ATVs is due to their increased power and heavier size.

The majority of ATV users are responsible reasonable people who know the risk of their sport. I believe education in safety and proper use is the key to decreasing injuries and deaths. ATVs are like anything else, they must be used properly and treated with respect. The proper use of safety equipment (helmets, pads, chest protectors etc) needs also to be promoted. The majority of accidents are caused by not using protective equipment, going too fast for the particular terrain, or using an ATV that is too powerful for one's experience level. All of these factors can be dealt with by proper education.

Press coverage by the Consumer Federation of America on national news broadcasts showed extreme misuse of ATVs and poor parental judgement. Also, ATV users were not allowed to tell their side of the story. Apparently, during one of these broadcasts someone from an ATV club or part of the industry was interviewed as well as someone from Consumer Federation of America. However, the interview with the ATV person was cut short and his few comments that were publicized were used out of context. The majority of air time was unfairly given to the Consumer Federation of America and their co-horts.

I applaud the Consumer Products Safety Commission for not following the advice of the Consumer Federation of America, the Natural Trails and Waters Coalition, and the Bluewater Network to ban all ATV use by those under age 16. This would have been unfair to those families who enjoy this sport and have properly trained their children in ATV use and supervise their children when using their ATVs.

Sincerely,
Adrienne Schiele
Adrienne Schiele

ATV 200

ATV Hearing

Office of the Secretary
Consumer Product Safety Commission
Washington D.C. 20207

Comments...

I have been a member of ATVAM (ATV Association of Minnesota) for just over a year and I am appalled at all of the regulations that are being set up in the government because of handful of idiots. I am a 25-year-old responsible rider and I have to be punished for the crimes of a couple an irresponsible citizens.

Here in Minnesota our ATV organizations help benefit the community. They clean up ditches, repair fences, talk with landowners, groom trails, help preserve our beautiful state, and teach safety to anyone willing to learn. I get so tired of us being lumped with a VERY small group of reckless riders.

I go camping almost every weekend with friends, family and acquaintances and we all bring our ATV's. Not only do we bond with the children (who love riding on the trails) but also we teach them all that we can about respecting the land. We aren't thoughtless or inattentive of the surroundings if fact, we stop to appreciate all that we are blessed to use in our State Forests.

It is a shame that most the people on this Consumer Product Safety Commission have never had the trill of riding an ATV. Going though gorgeous forest at a leisurely pace, stopping to look at deer or picking berries is something that they will never be able to experience. The delight at climbing your first hill and sitting atop that hill and watching the fireworks from 8 different towns is something that they want to take away.

I guess that all I feel is pity for you and a sense of loss for me because there is not more that I can do to make you understand the wonderful occurrence that you are trying to ban and restrict.

Please take into consideration that most of us love our sport. We are die-hard enthusiasts that would work with the DNR or any government board to keep our sport. There are other sports the are environmentally damaging (fishing contests) or causing noise and air pollution (NASCAR), but they just don't seem to get picked on as mush as we do. Do you think that there are not rogues in all sports that cause some type misfortune for the whole club?

Thank you,

Jennifer Lindberg
862 - 85th Lane NW
Coon Rapids, MN 55433
763-785-1506

201

Hammond, Rocky

From: adgadg10@aaahawk.com
Sent: Friday, June 27, 2003 12:49 PM
To: Hammond, Rocky
Subject: Attn: ATV Hearing

Rockelle Hammond,

Please do not take anymore rights away from the American public as you have done in the past. There are more people killed in swimming pools than on ATV's and you don't ban swimming pools. You can't control fools as they will always find a way to get hurt or die.

I don't ride ATV's just yet, but since I'm disabled I will need too. I even cuss some of the people who ride, more than not, but I still think it's up to us to decide just how stupid to be this day and NOT you!

Thank You,
Ken Davis



June 25, 2003

Todd A. Stevenson, Secretary
Office of the Secretary
Consumer Product Safety Commission
Washington, DC 20207

DIRK KEMPTHORNE
governor

Richard J. Collignon
director

Rick Cummins, Administrator
division of management services

Dean Sangrey, Administrator
division of operations

IDAHO PARK AND
RECREATION BOARD

Robert M. Haakenson
region one

Randal F. Rice
region two

Ernest J. Lombard
region three

Latham Williams
region four

Jean S. McDevitt
region five

Douglas A. Hancey
region six

IDAHO DEPARTMENT OF
PARKS AND RECREATION

p.o. box 83720
boise, idaho 83720-0065

(208) 334-4199

fax (208) 334-3741

tdd 1-800-377-3529

street address
5657 warm springs avenue

www.idahoparks.org

RE: ATV Hearing

Dear Mr. Stevenson:

The 2003-2007 Idaho Statewide Comprehensive Outdoor Recreation and Tourism Plan stated that, "In 2002, ATV fatalities in Idaho were more than eight times higher than boating fatalities per 100,000." The major reason for this higher fatality rate is the lack of ATV Safety Education.

While manufacturers offer ATV Safety Training courses to purchasers of new ATVs free of charge, few purchasers take the course. In contrast, boaters have a well-funded boating safety program. Idaho also provides skilled law enforcement on the waters through Coast Guard Boating Safety Program through our department. Law enforcement presence doubtless contributes much to safe boating. There is little law enforcement presence on public lands specific to the activities of those who ride snowmobiles, ATVs and motorbikes.

Most ATV accidents in Idaho involve one of the following factors: alcohol, lack of safety equipment, riding with a passenger, youth operating machines larger than recommended by the manufacturers, or risky riding behavior.

In order to reduce the risk of ATV operator injuries, especially those associated with youth, our department is initiating an Off-Highway Vehicle (OHV) Safety Education Program. We hope to model this program after the successful Idaho Boater Safety Education Program and OHV safety education programs in other states. We are utilizing federal Recreational Trails Program (RTP) funds and state ATV Registration Funds to start up this program. However, there is a limited amount of RTP funding (5%) that can be used for safety and education purposes.

One reason why the Boating Safety Program is such a success in Idaho is that boaters have had a dedicated federal funding source since 1972, from a portion of the federal motorboat fuel tax. This program funding can be used for safety education and law enforcement.

While it is tempting to restrict size or age requirements at the federal level, local enforcement of such requirements would be spotty at best. We believe it would make more sense to create a dedicated ATV Safety Program from federal ATV fuel taxes. This funding could be used for both safety education and law enforcement.

Until adequate education and law enforcement funding is available on the ground, no amount of federal or state laws, rules and regulations can be adequately enforced. In Idaho, public agencies are hard pressed to place an emphasis on ATV safety issues without an adequate funding source to sustain a long term educational effort. Idaho has created funding for ATV safety education through its registration program. It is time for the federal government to also step up to the plate and provide a funding source that can be used for safety education programs and law enforcement.

Sincerely,

A handwritten signature in black ink, appearing to read 'Rick Collignon', with a long horizontal line extending to the right.

Rick Collignon, Director
Idaho Department of Parks and Recreation

Stevenson, Todd A.

ATV 203

From: Information Center
Sent: Wednesday, July 02, 2003 4:28 PM
To: 'michaelq88@hotmail.com'
Subject: ATV Hearings

Hello,

We have forwarded your information to the appropriate agency personnel. If additional information is needed, someone from the agency will contact you directly. A representative from that office will respond to your request directly.

Please be advised that you may obtain CPSC publications, recalls and general safety related information via our web site at www.cpsc.gov. Click on the "Search" icon and type in your topic. You may also file an incident report via the web site mentioned above. If you have additional inquiries, you may call our toll-free hotline at 1-800-638-2772, Monday - Friday, 8:30am to 5:00pm, Eastern Standard Time. Press 1 to begin and then press 300 to speak with a representative.

man

-----Original Message-----

From: Collin . [mailto:michaelq88@hotmail.com]
Sent: Wednesday, July 02, 2003 4:17 PM
To: Information Center
Subject: ATV Hearings

Hello, my name is Collin. I recently found out that the CPSC is once again trying to ban and/or restrict the use of ATV's, otherwise known as "four wheelers" or "quads". I am deeply saddened by this. Because this is America, we have been granted a few things -- one of them is the right to choose self responsibility, another is the right to pick and choose our own pursuit of Happiness - however unpleasant it may seem to others -- we have been guaranteed that right by the constitution of this country, which was written by men who were trying to extricate themselves from tyranny. Tyranny that was oppressive and overbearing. By giving into socialistically minded special interest groups whose outward agenda is to protect me from me and under agenda is to further their own delusional special interests, you would in fact be denying me my right to the pursuit of happiness and self responsibility and would continue down the path of this governments seaming destiny to become just the thing it was created to avoid. Please do not march from a healthy, capitalistic free society, into a communistic, governmentally controlled entity that has to have some part in determining how I live my life by granting the misguided wishes of a few misinformed and informational manipulative to their own private agenda people, whose own narrow mindedness will determine the fate of a great many of this still great countries ATVing public. Placing any more limits on an already over-governed industry may cause grave consequences -- primarily the potential loss of thousands of jobs because of a stranglehold of unrealistic limitations that would be placed upon the ATV industry. That is something this country does not need right now, job lay-offs. This would lead to stagnation and not a competitive, healthy, industry. This would also ultimately lead to the denial of new, improved, evolved and safer product to the ATVing public. If you don't think its happened before, just look at what the CPSC and the last Consent Decree did to ATVing - it oppressed and bullied the manufacturers so badly that it stagnated the industry for nearly 13 years and curtailed the introduction of any real "new," improved, or even "safer" models for that time. It contained "unrealistic" and even dangerous limitations for ATV's including the frighteningly dangerous stipulation that no youth oriented ATV's may be built with lighting. What sense does it make to not equip children's ATV's with something that could only make them MORE visible and therefore safer? I, and a great many other people believe the CPSC to be down right negligent with that one. Because of these and other limitations

contained in the Decree, one manufacturer, Suzuki, nearly quit the industry completely and didn't even have a sport minded ATV in their line up from 1993 until late last year. The industry was already really governing itself and heading away from the supposedly "dangerous" three wheeled ATV's and towards four wheeled models when the last misguided decree was implemented. I beg you, let the "people" decide what is right for themselves and not what the "government" sees fit. I would also like to add, that the CPSC has seen a substantial increase in injuries on ATV's of 400 cc or greater of 567% from 1997 to 2001. But in 1997, only 9 ATV's were of 400cc's or greater, and in 2001, that number rose to 31. Now, in 2003, that number is probably quadrupled from 1997. So when figuring statistics, you should take into account the number of 400cc plus Atv's from 1997 to 2001.

Help STOP SPAM with the new MSN 8 <<http://g.msn.com/8HMMENUS/2731??PS=>>>and get 2 months FREE*

DTN 204

Stevenson, Todd A.

From: Information Center
Sent: Wednesday, July 02, 2003 9:46 AM
To: 'ascotta@pdi.net'
Subject: ban on kids riding

Hello,

Thank you for contacting the U.S. Consumer Product Safety Commission (CPSC). We have forwarded your comments to appropriate agency personnel.

Please be advised that you may obtain CPSC publications, recalls and general safety-related information via our web site at www.cpsc.gov. Click on the "Search" icon and type in your topic. You may also file an incident report via the web site mentioned above. If you have additional inquiries, you may call our toll-free hotline at 1-800-638-2772, Monday - Friday, 8:30am to 5:00pm, Eastern Standard Time. Press 1 to begin and then press 300 to speak with a representative.

myg

-----Original Message-----

From: Scott & Amy Anderson [mailto:ascotta@pdi.net]
Sent: Tuesday, July 01, 2003 8:02 PM
To: Information Center
Subject: ban on kids riding

Are family enjoys riding together. That is one of the main things that we enjoy doing : family. We make are children wear there safety gear at all times. It really upsets us the any-one wants to take that away from us. Scott & Amy Anderson (Oklahoma)



Incredimail - Email has finally evolved - [Click Here](#)

Stevenson, Todd A.

205

From: Information Center
Sent: Wednesday, July 02, 2003 9:01 AM
To: 'jrkrips@clear.lakes.com'
Subject: RE:

Hello,

Thank you for contacting the U.S. Consumer Product Safety Commission (CPSC). We have forwarded your comments to the appropriate agency personnel.

Please be advised that you may obtain CPSC publications, recalls and general safety-related information via our web site at www.cpsc.gov. Click on the "Search" icon and type in your topic. You may also file an incident report via the web site mentioned above. If you have additional inquiries, you may call our toll-free hotline at 1-800-638-2772, Monday - Friday, 8:30am to 5:00pm, Eastern Standard Time. Press 1 to begin and then press 300 to speak with a representative.

myg

-----Original Message-----

From: James Krips [mailto:jrkrips@clear.lakes.com]
Sent: Wednesday, July 02, 2003 12:39 AM
To: Information Center
Subject:

Why is it that the CSPC thinks ATV's are so dangerous?

In 1999 357 people were killed on ATV's. Does the CSPC know that in New Mexico over 1,000 people are killed each year from scorpions? Does the CSPC know that more kids under the age of 16 die playing high school football than on ATV's? Does the CSPC know that more people are killed from bees or dogs than ATV's? What the CSPC has to realize that there are many dangers out in the world!! Yes ATV's can be dangerous, but almost all of the deaths have been caused by not wearing the proper safety equipment ie. Helmet, goggles, boots, and gloves. Some of the deaths have been caused by people drinking and operating an ATV, not smart if you ask me.

I believe there should be no age restrictions on ATV's, but rather SIZE restrictions for children under the age of 16. Riding with your knees hitting you in the face isn't fun believe me. I also believe that restricting ATV's to 399cc's is completely ridiculous!!! This is America a FREE country! We as Americans have the right to take risks and ride ATV's! Why can't the CSPC just leave us alone, and stop trying to run people's lives!!!! Thanks for listening.

Christopher Krips
P.S Please don't ban our sport, it's just not right!

ATV
206

Stevenson, Todd A.

From: Joshua Scheeringa [scheeringa1@yahoo.com]
Sent: Wednesday, July 02, 2003 8:20 PM
To: Stevenson, Todd A.
Subject: ATV Hearing

To whom it may concern,

My name is Josh and I am I young ATV rider (19 years old) who would like to protest the idea of a ban on Sport ATVs. I have ridden since a young age, and I believe it to be one of the freedoms that we may enjoy here in the United States. I am very patriotic, and I ask, why ban my hobby because some say its dangerous, when the more athletic types are allowed to injure themselves in high school football? Riding is something I truly enjoy, and I know the potential risks every time I put my helmet on and start the motor. If the satisfaction of riding wasn't worth the known risks involved, then I would just stay inside and watch Television.

Thanks for your time,
Joshua S. Scheeringa

Do you Yahoo!?
SBC Yahoo! DSL - Now only \$29.95 per month!

207

Stevenson, Todd A.

From: Rick Just [rjust@IDPR.state.id.us]
Sent: Thursday, July 03, 2003 3:04 PM
To: Stevenson, Todd A.
Subject: ATV Safety Hearing Comments

Attached are comments from the Idaho Department of Parks and Recreation. Thanks for your consideration.

Rick Just
Coordinator
Idaho Outdoor Recreation Data Center
Idaho Department of Parks and Recreation
PO Box 83720
Boise ID 83720-0065
(208)-334-4180, ext. 306
FAX (208)-334-5232
rjust@idpr.state.id.us
Visit our website at www.idahoparks.org

Stevenson, Todd A.

208

From: GLAMISPOKERRUN@aol.com
Sent: Friday, July 04, 2003 3:44 AM
To: Stevenson, Todd A.
Subject: OHV safety

Hi, our family club sponsors an Educational Poker Run at the Imperial Sand Dunes recreational area in California. We require all participants to read each of the 5 checkpoint "themes" before they can draw their next playing card. We then ask them a bonus question regarding what they just read.

The topics are: Safety in the dunes, Environment issues, Rules and Regulations, Checkered Flag program and Trash issues. We also provide an incentive for trash removal along their journey from checkpoint to checkpoint. We reward those with an extra draw of the cards for turning in a bag of trash. We have had a + 90% participation in this effort to date.

We feel that this is a family sport and the opportunity for an accident is KNOWN before you do OFF highway vehicle recreation. Education is the KEY...

Thanks,
Jim Colln
President
R&R Duners Club

GLAMIS POKER RUN

Hammond, Rocky

209

From: Cary Richardson [cary@jacobyhomes.com]
Sent: Friday, June 27, 2003 7:12 PM
To: xpax-0s@cpsc.gov; Hammond, Rocky
Subject: ATV Hearing

Office of the Secretary,

I am very concerned about ATV issues. I have owned ATV's since 1993, I was 16 years of age at the time. I first owned a 3 wheeler (Honda 350X) from 1993 until 2001 and now own a four wheeler (Honda 400EX) and a dirt bike (Honda CR 250).

The thought of placing further restrictions on ATV's and their use frightens me. I still do not agree with the ban on 3 wheelers. No vehicle, no matter what type, places humans in dangerous situations. It is humans that put themselves and the vehicles in dangerous situations. Motorcycles have been around for decades and no one (to my knowledge) has tried to ban or restrict their use. I do not understand how ATV's have gotten such a bad reputation, other than from the slanted media coverage. I myself have never been seriously injured on an ATV or motorcycle. I consider myself an aggressive rider that rides at a fast pace, both in the woods and sand dunes. I am simply careful, ride within my limits, wear a helmet, boots, gloves, and kidney belt, at the least, and I never drink and ride.

My argument can be further supported to use any inanimate object: guns don't kill and injure people, it is the person pulling the trigger. Cigarettes don't kill people, without someone smoking them.

Not to be cynical, but maybe the focus should be on humans. We could look at banning the use of ourselves, or restrict the amount of strength one person could develop so that we wouldn't have the possibility of injuring others. It sounds ridiculous, but unfortunately it is no more ridiculous than banning or restricting ATV's.

My cynicism is not meant to offend or be critical of anyone, I am simply trying to express my strong feelings about this issue. Thank you for your time and consideration of my point of view. Also please remember that sometimes with issues like these, people with my point of view may not be as organized and have as strong of a public voice as the other side, but that doesn't make our argument any less important.

Thank you,

Cary Richardson
Central Point, Oregon

210

Hammond, Rocky

From: mary nutting [marynutn@localnet.com]**Sent:** Tuesday, July 01, 2003 8:08 PM**To:** Hammond, Rocky**Subject:** banning atv's

I would like for the record to state that the sales of ATV's should speak for those who have not signed a petition or e-mailed info in. Many people are not comfortable putting any personal info on a computer, online, or have computers or internet, so why doesn't the number of ATV's being sold count towards the amount of people for ATV'S. Cars are involved in accidents every day, are they being banned??? When are we going to accept responsibility for ourselves and our children in this country instead of worrying over who we are going to sue. Cigarettes and liquor are still being sold, so are chain saws, motorcycles, dirt bikes, bicycles, toy guns , guns etc..... the list could go on.....we live in a free country, with enough taxes and regulations to choke an ordinary person, put the responsibility and choice back in our hands. And for the record put it on a sales liability release that ATV's are not a babysitter for your children, use sound judgement and if they don't have that they don't deserve to purchase an ATV.

Hammond, Rocky

211

From: Rich Duncan [richjduncan@hotmail.com]
Sent: Tuesday, July 01, 2003 8:43 PM
To: Hammond, Rocky
Subject: ATV safety

Dear Mr. Hammond,
I read an article in Dealer News magazine about ATV safety and upcoming hearings that gave contact information for you. My company has been working on bringing a much safer ATV to market for some time with the goal of providing a safe alternative to consumers. We're in preproduction stage right now and are looking to expand both by finding more funding and marketing the vehicle to ATV dealers and consumers.

Our web site (www.castleduncaninc.com) has a basic description of the vehicle which you can see is a mini-dune buggy. Its much safer than an ATV as it has a roll cage, lower center of gravity, wider wheelbase, and seat belts. Do you know of or can point me in the direction of any government agency who might be willing to help us out in any way? We look forward to hearing from you.

Best Regards,
Rich Duncan
President, Castle Duncan Inc.
6655 - M Amberton Dr.
Elkridge, MD 21075
301-788-4376
fax 410-796-1413
rduncan@castleduncaninc.com

STOP MORE SPAM with the new MSN 8 and get 2 months FREE*
<http://join.msn.com/?page=features/junkmail>

Hammond, Rocky

212

From: Dale Slagley [dslagley@charter.net]
Sent: Tuesday, July 01, 2003 9:16 PM
To: Hammond, Rocky
Subject: Atv

Please do not regulate atvs.

Hammond, Rocky

213

From: Cheri Casey [cheri@iwgraphics.com]
Sent: Thursday, July 03, 2003 5:01 PM
To: Hammond, Rocky
Cc: Joyce Casey; Michele Casey
Subject: ATV Hearing Testimony

Rockelle,

Enclosed is my letter regarding the ATV Hearings. I sent it via mail and it returned to me as unknown address. I hope these are still useable notes.

Sincerely,

Cheri Casey

"I have ridden ATV's since age 11. My parents made sure that I was properly trained and had riding gear to protect me. It must be amazing to the CPSC that I have lived to be 36 years old. Especially since my parents trained me, not the manufacturers or the government.

Ultimately it is up to parents to be responsible and teach children responsibility. With 23 years of riding experience, and first hand knowledge of my child's mental retention skills and physical capabilities, I am the one most qualified to train and supervise my child.

Most recently when purchasing an ATV I was offered a manufacturers rebate to attend safety training. I paid additional to have my daughter take it as well as myself. Her experience at 12 years old already exceeded that of the instructor and she demonstrated the skills to pass the tests. Her skills were acquired through hours and hours of hands on training and riding with me as her supervisor/instructor.

I think we have all seen the skewed statistics on ATV's. I know more people who have been injured or killed riding bicycles than ATV's. So when is the CPSC going to try and ban these?

I wasn't offered drivers education when I was licensed, my parents taught me. But now you wouldn't think of giving a 16 year old a drivers license without it. CPSC Didn't ban cars or driving they mandated training.

So instead of a ban how about the sensible choice, offer training to all members of the family that will be riding the ATV/OHV.

ATVing is a family sport. I was riding 3 wheelers with my family in the early 1980's. I know this activity with my parents kept me from getting involved with drugs and other things. I now ride with my daughter. We camp, ride and enjoy the outdoors with other families. Who are responsible and respected.

A ban on ATV's would take families out of the sport and put children out there to get involved with who knows what.

Let's put PARENTAL RESPONSIBILITY back where it belongs...with the parents. Not on the CPSC or Government. "



July 3, 2003

U.S. Consumer Product Safety Commission
Office of the Secretary
4330 East-West Highway, Suite 610
Bethesda, MD 20814

RE: Petition Number: CP-02-4/HP-02-1

Please accept the following supplemental comments to the testimony provided before the U.S. Consumer Product Safety Commission in Morgantown, West Virginia on June 5, 2003.

The Specialty Vehicle Institute of America ("SVIA") would like everyone that operates an ATV to take advantage of training. This is especially true of the first-time rider and those with little experience. To help reach these riders, ASI works cooperatively with states that have a legislated requirement for ATV operator training. As more and more families are enjoying ATV riding for recreation, and as typical state training requirements apply to operators under 18 years of age, the training demand for younger riders has increased.

The nationwide hands-on ATV RiderCourse training program sponsored by the ATV Safety Institute ("ASI"), an affiliate of SVIA, incorporates the age/engine size criteria that were originally established in the Final Consent Decree. The SVIA-member companies each agreed to continue enforcing these criteria in voluntary undertakings executed with CPSC in 1998. Under these criteria, a child younger than 16 cannot participate in the ASI training course using a vehicle with an engine larger than 90cc.

In many states the law is silent with respect to ATV operator age and ATV size. We have experienced a number of parents who want their child to receive ASI training using an ATV which is acceptable under state law but which does not meet the age/size guidelines enforced by SVIA-member companies and incorporated in the ASI training program. Parents and children who are trying in good faith to comply with their state law training requirement have expressed frustration when participation in ASI training is denied due to age/ATV size criteria they feel is unrealistic.

SVIA and ASI very much regret having to decline to provide training for a child in any circumstances. While we remain committed to the age/engine size criteria enforced by our member companies, we hope that some more workable approach can be found to provide ASI training to all children whose parents wish them to take it. SVIA encourages the CPSC to consider more flexible approaches to the age/size guidelines that would accommodate the growing demands for more family-oriented training, and could be recommended to the SVIA-member companies.

Sincerely,

Thomas S. Yager
Vice President, Safety Programs

2 Jenner St., Suite 150, Irvine, California USA

(949) 727-3727, Fax (949) 727 4216