

# Geography

## Highlights

### The Nation's Report Card 2001

**INSIDE THIS ISSUE**

	Page
Average Scale Scores . . . . .	1
Students Reaching NAEP Achievement Levels . .	2
Percentile Scores . . . . .	3
2001 Assessment . . . . .	3
Student Subgroup Findings	4
School Factors . . . . .	9
Sample Test Questions . . .	12
NAEP on the Web . . . . .	20



National Assessment of Educational Progress

### An Important Indicator of Educational Progress

Since 1969, NAEP has been the sole, ongoing national indicator of what American students know and can do in major academic subjects.

Over the years, NAEP has measured students' achievement in many subjects, including reading, mathematics, science, writing, geography, civics, and the arts. In 2001, NAEP conducted a national assessment in geography at grades 4, 8, and 12.

NAEP is a project of the National Center for Education Statistics (NCES) in the U.S. Department of Education and is overseen by the National Assessment Governing Board (NAGB).

## Improvements Seen in NAEP 2001 Geography Results at Grades 4 and 8

Results for the National Assessment of Educational Progress (NAEP) 2001 geography assessment show that the average scores of fourth- and eighth-grade students have improved since 1994. The average score of twelfth-grade students, however, has not changed significantly.



\* Significantly different from 1994.

SOURCE: U.S. Department of Education, Office of Educational Research and Improvement, National Center for Education Statistics, National Assessment of Educational Progress (NAEP), 1994 and 2001 Geography Assessments.

This geography assessment was first administered to nationally representative samples of fourth-, eighth-, and twelfth-grade students in 1994. The figure above shows national average scores in 1994 and 2001 based on a 0–500 NAEP geography scale at each grade.

In 2001, the average scores of fourth- and eighth-graders improved in comparison to 1994. The 2001 score for twelfth-graders was not statistically different from the 1994 score.

It should be noted that every test score has a

standard error—a range of a few points plus or minus the score—which accounts for potential score fluctuation due to sampling error and measurement error. Statistical tests that factor in these standard errors are used to determine whether the differences between average scores are significant. Estimates based on smaller subgroups are likely to have relatively large standard errors. As a consequence, some seemingly large differences may not be statistically significant. Only statistically significant differences are cited in this report.

## Achievement Levels Provide Yardstick for Student Performance

Achievement levels provide a context for interpreting student performance on NAEP. These performance standards, set by NAGB and based on recommendations from broadly representative panels of educators and members of the public, determine what students should know and be able to do for the *Basic*, *Proficient*, and *Advanced* levels of performance in each subject area and at each grade assessed.

As provided by law, the Deputy Commissioner of Education Statistics, upon review of a congressionally mandated evaluation of NAEP, has determined that the achievement levels are to be used on a trial basis and should be interpreted and used with caution.

However, both the Deputy Commissioner and NAGB believe that these performance standards are useful for understanding trends in student achievement. NAEP achievement levels have been widely used by national and state officials.

Detailed descriptions of the NAEP geography achievement levels can be found on the NAEP Web Site at <http://nces.ed.gov/nationsreportcard>.

## Gains Seen in Fourth- and Eighth-Graders' 2001 Achievement-Level Performance

The 2001 geography assessment results show some changes since 1994 in the percentages of students at or above the NAEP achievement levels. At grades 4 and 8, the percentage of students performing at or above *Basic* increased between 1994 and 2001, although there were no statistically significant changes in the percentages of students performing at or above *Proficient* and at *Advanced*. At grade 12, however, the percentages of students performing at or above the *Basic* and *Proficient* levels and at *Advanced* in 2001 were not statistically different from 1994.

### Percentage of students within and at or above achievement levels, grades 4, 8, and 12: 1994 and 2001

#### How to Read These Figures:

- The *italicized* percentages to the right of the shaded bars represent the percentages of students at or above *Basic* and *Proficient*.
- The percentages in the shaded bars represent the percentages of students within each achievement level.

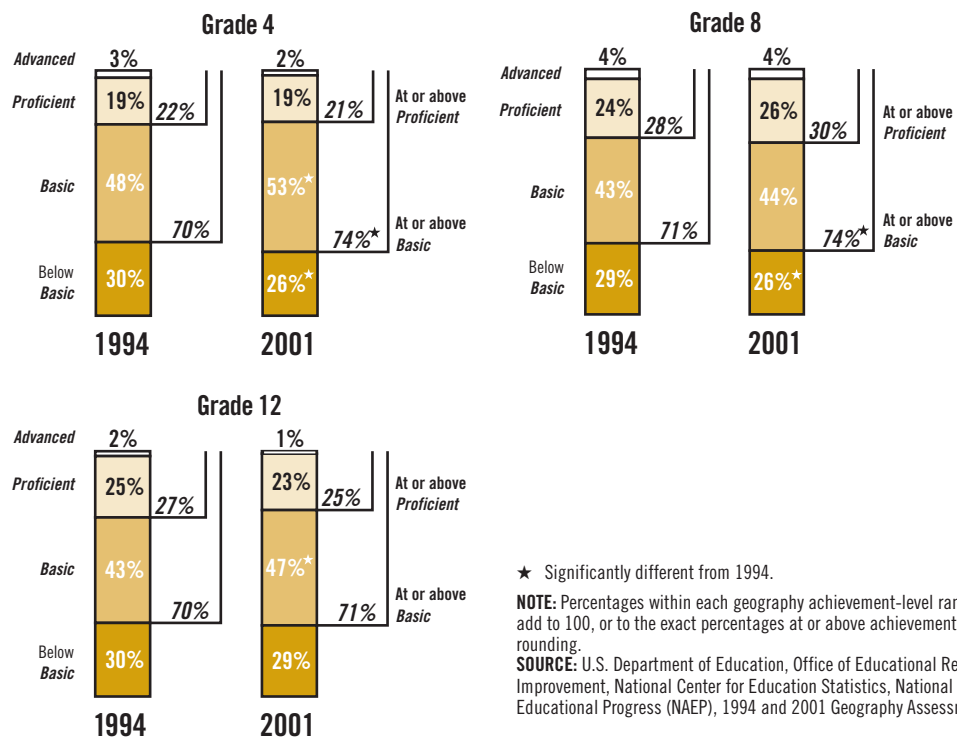

★ Significantly different from 1994.

NOTE: Percentages within each geography achievement-level range may not add to 100, or to the exact percentages at or above achievement levels, due to rounding.

SOURCE: U.S. Department of Education, Office of Educational Research and Improvement, National Center for Education Statistics, National Assessment of Educational Progress (NAEP), 1994 and 2001 Geography Assessments.

## Achievement Levels

**Basic:** This level denotes partial mastery of prerequisite knowledge and skills that are fundamental for proficient work at each grade.

**Proficient:** This level represents solid academic performance for each grade assessed. Students reaching this level have demonstrated competency over challenging subject matter, including subject-matter knowledge, application of such knowledge to real-world situations, and analytical skills appropriate to the subject matter.

**Advanced:** This level signifies superior performance.

## Gains Made by Lower-Performing Fourth- and Eighth-Graders

Looking at how scores changed across the performance distribution clarifies the source of the improvement in the average national score at grades 4 and 8. An examination of scores at

different percentiles on the 0–500 geography scale at each grade indicates whether or not the changes seen in the national average score results are reflected in the perfor-

mance of lower-, middle-, and higher-performing students. The percentile indicates the percentage of students whose scores fell below a particular average score.

As shown in the figures below, there were some changes between 1994 and 2001 at various points in the score distribution for fourth- and eighth-graders, but no statistically significant changes for twelfth-graders.

### Scale score percentiles, grades 4, 8, and 12: 1994 and 2001

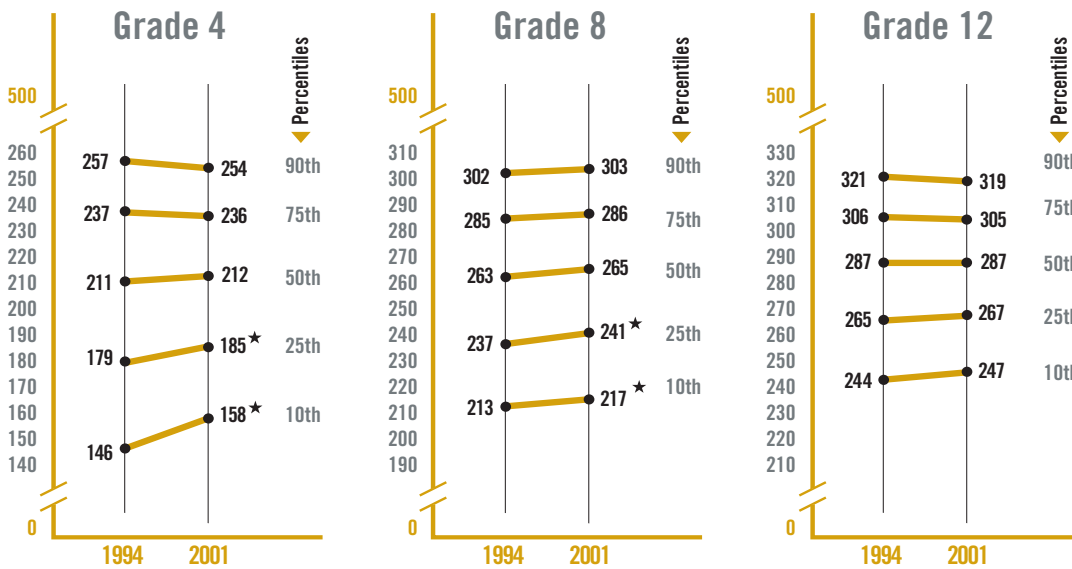

★ Significantly different from 1994.

SOURCE: U.S. Department of Education, Office of Educational Research and Improvement, National Center for Education Statistics, National Assessment of Educational Progress (NAEP), 1994 and 2001 Geography Assessments.

At grades 4 and 8, score increases between 1994 and 2001 at the 10th and 25th percentiles indicate an improvement for lower-performing students.

At grade 12, performance across the score distribution in 2001 was not statistically different from 1994—a finding that reflects the results seen in the overall national average score at this grade.

## NAEP 2001 Geography Assessment Design: Framework, Accommodations, and Samples

The NAEP geography framework that describes the content for both the 1994 and 2001 assessments was developed through a national consensus process and adopted by NAGB.

The geography framework is organized along two dimensions, a content dimension and a cognitive dimension. The content dimension is divided into three areas: Space and Place, Environment and

Society, and Spatial Dynamics and Connections. The three cognitive areas are labeled as Knowing, Understanding, and Applying.

The complete framework is available at the NAGB Web Site at <http://www.nagb.org>.

The results presented here are based on a national sample that included special-needs students; however, no testing accommodations were offered to these

students. As a consequence, a small percentage of sampled students were excluded from the assessment because they could not be tested meaningfully without accommodations. No testing accommodations were offered in 1994 or 2001 so that results from the two assessment years could be compared. However, a second set of 2001 results is available that is based on a sample for which accommodations were

provided. This second set of results is presented in the full report, *The Nation's Report Card: Geography 2001*, and on the NAEP Web Site at <http://nces.ed.gov/nationsreportcard>. In addition, the percentage of students excluded from both samples is provided.



# Subgroup Data Reveal How Various Groups of Students Performed on NAEP

In addition to reporting information on all students' performance on its assessments, NAEP also studies the performance of various subgroups of students. The geography achievement of

subgroups of students in 2001 reveals whether they have progressed since 1994, as well as how they performed in comparison to other subgroups in 2001.

When reading these subgroup results, it is important to keep in mind that there is no simple, cause-and-effect relationship between membership in a subgroup and

achievement on NAEP. A complex mix of educational and socioeconomic factors may interact to affect student performance.

## Average Geography Scores by Gender

The figures below present average geography scores for males and females in 1994 and 2001. There were no statistically significant changes from 1994 to 2001 in the average scores of either male or female

students at any of the three grades.

Although the score point differences across years for both male and female students at grades 4 and 8 appear similar to those for the

population as a whole, the smaller sample size and slightly larger standard error for each of the two subgroups prevented the statistical tests from reaching the significant level.

In 2001, male students at all three grades had higher average scores than female students. The gap between male and female students' average scores did not change significantly between 1994 and 2001.

Average geography scale scores by gender, grades 4, 8, and 12: 1994 and 2001

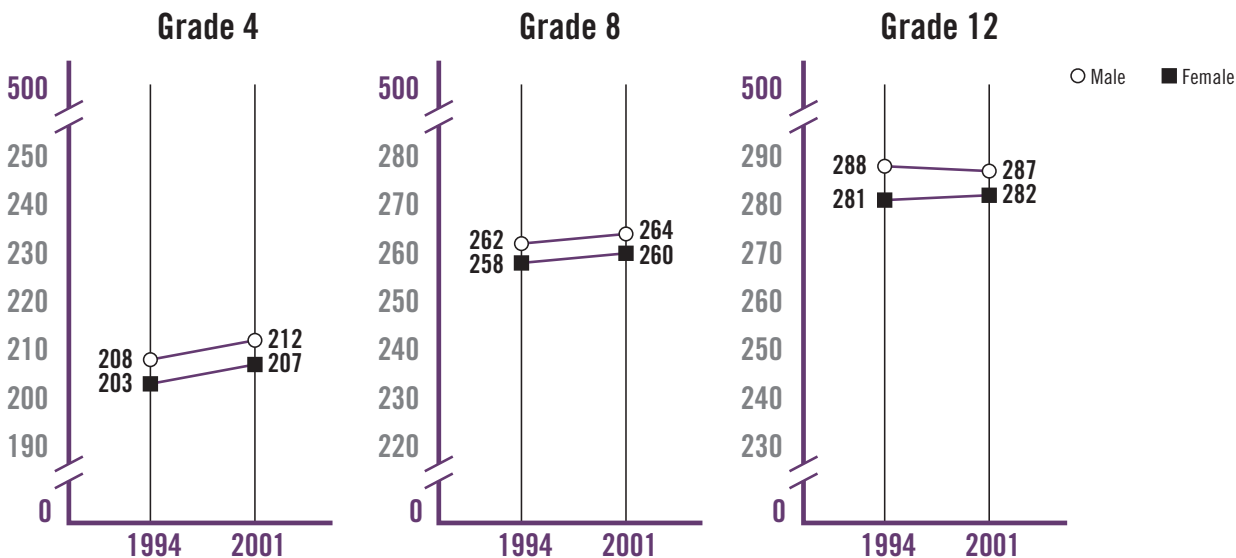

SOURCE: U.S. Department of Education, Office of Educational Research and Improvement, National Center for Education Statistics, National Assessment of Educational Progress (NAEP), 1994 and 2001 Geography Assessments.



### Achievement-Level Results by Gender

The percentages of male and female students at or above the *Basic* and *Proficient* geography achievement levels are presented below. Comparing the 1994 and 2001

achievement-level results for males and females shows no statistically significant increases or decreases since 1994 at all three grades.

A comparison of the differences in the percentages of male and female students at or above the *Basic* and *Proficient* levels in 2001 shows higher percentages of male than of female stu-

dents at or above *Proficient* at grades 4 and 8. At grade 12, a higher percentage of males than females were at or above *Basic* and at or above *Proficient*.

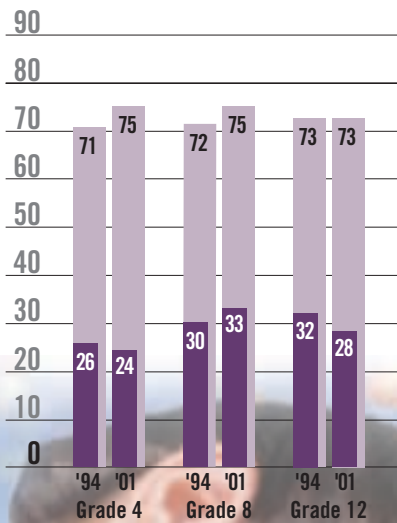

Achievement-level results by gender, grades 4, 8, and 12: 1994 and 2001

#### Male

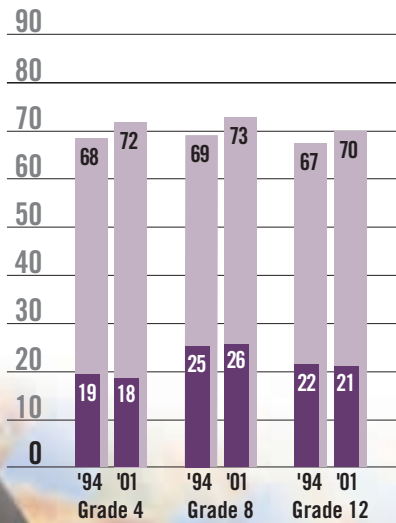

#### Female



 % at or above *Basic*  
 % at or above *Proficient*

**SOURCE:** U.S. Department of Education, Office of Educational Research and Improvement, National Center for Education Statistics, National Assessment of Educational Progress (NAEP), 1994 and 2001 Geography Assessments.

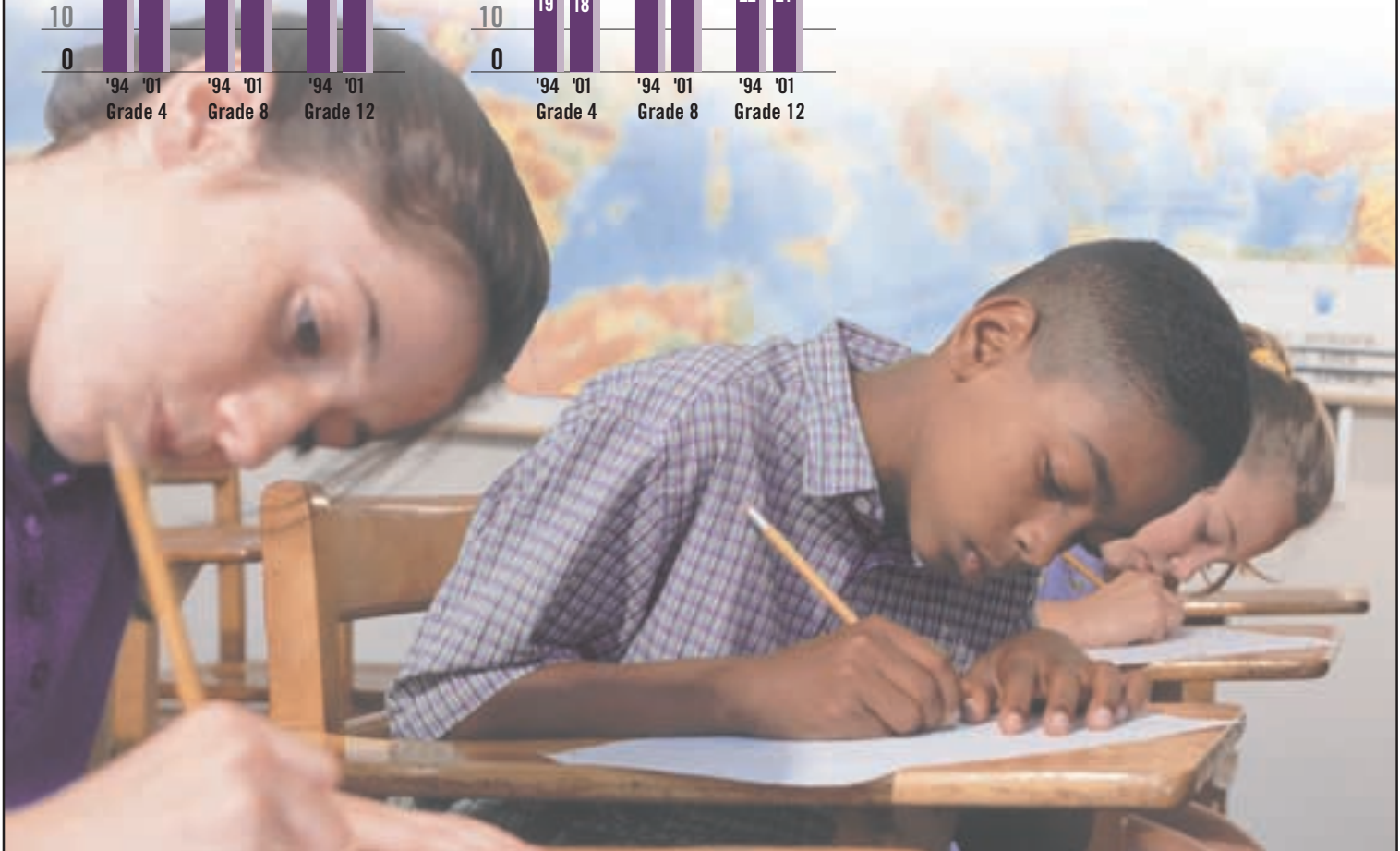



### Average Geography Scores by Race/Ethnicity

Students who took the NAEP geography assessment were asked to indicate which of the following racial/ethnic subgroups best described them: White, Black, Hispanic, Asian/Pacific Islander, or American Indian (including Alaska Native).

The figures below show the average geography scores for students in these subgroups at grades 4, 8, and 12 in 1994 and 2001.

At grade 4, the average score of Black students was higher in 2001 than in 1994. Appar-

ent changes for other groups of students were not statistically significant.

The 2001 results show a continuing pattern of average score differences between the racial/ethnic subgroups.

At all three grades, White students, Asian/Pacific Islander students, and American Indian students had higher average scores than their Black and Hispanic peers. Hispanic students had higher average scores than Black students at grades 8 and 12.

Average geography scale scores by race/ethnicity, grades 4, 8, and 12: 1994 and 2001

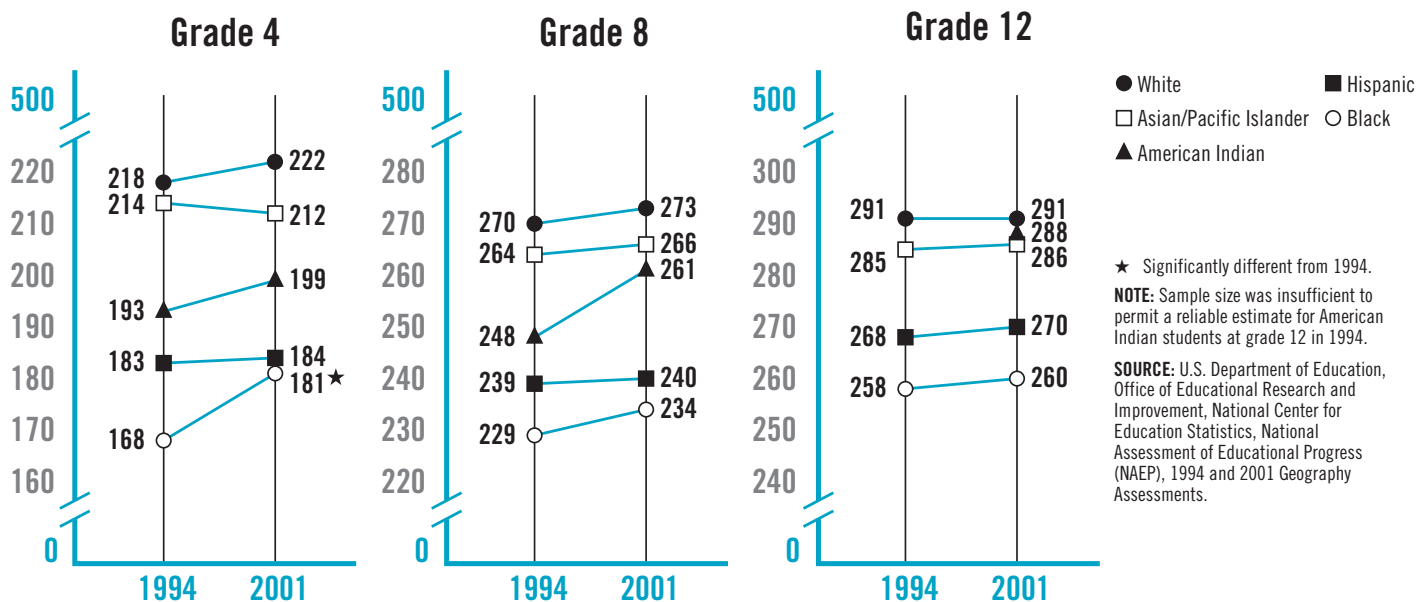

★ Significantly different from 1994.  
 NOTE: Sample size was insufficient to permit a reliable estimate for American Indian students at grade 12 in 1994.  
 SOURCE: U.S. Department of Education, Office of Educational Research and Improvement, National Center for Education Statistics, National Assessment of Educational Progress (NAEP), 1994 and 2001 Geography Assessments.

### Average Geography Score Gaps Between Selected Racial/Ethnic Subgroups

Average score differences in 1994 and 2001 between White students and Black students and between White students and Hispanic students are presented in the figures shown to the right. Results from the 2001 geography assessment reflect a narrowing of the score gap between White students and Black students at grade 4.

Score differences by race/ethnicity, grades 4, 8, and 12: 1994 and 2001

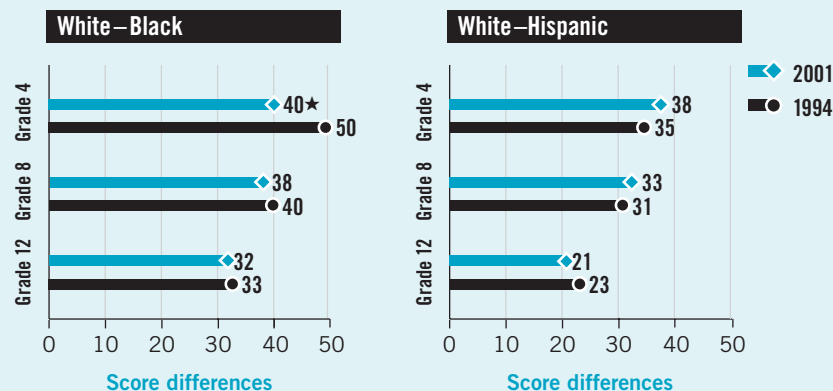

★ Significantly different from 1994.  
 NOTE: Score differences are calculated based on differences between unrounded average scale scores.  
 SOURCE: U.S. Department of Education, Office of Educational Research and Improvement, National Center for Education Statistics, National Assessment of Educational Progress (NAEP), 1994 and 2001 Geography Assessments.

### Achievement-Level Results by Race/Ethnicity

Achievement-level results for the racial/ethnic subgroups are presented in the figures below. While there have been some gains since 1994 at grades 4 and 8, not all subgroups of students have improved.

At grade 4, both White students and Black students

had higher percentages at or above *Basic* in 2001 compared to 1994. At grade 8, White students were the only group to show any improvement, with an increase in the percentage at or above *Basic*. At grade 12, none of the apparent changes in the percentages of students at or

above the *Basic* and *Proficient* geography achievement levels from 1994 to 2001 were statistically significant.

Comparing the subgroups' performance in 2001 shows higher percentages of White and Asian/Pacific Islander students than of Black and Hispanic students at or above

the *Basic* and *Proficient* levels at all three grades. There were also higher percentages of American Indian students than Black or Hispanic students at or above *Basic* at all three grades and higher percentages at or above *Proficient* at grade 12.

Achievement-level results by race/ethnicity, grades 4, 8, and 12: 1994 and 2001

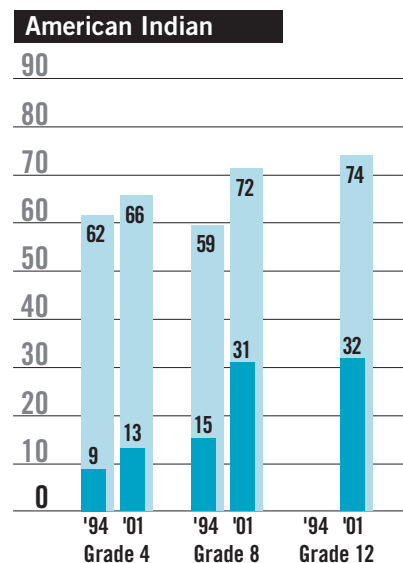
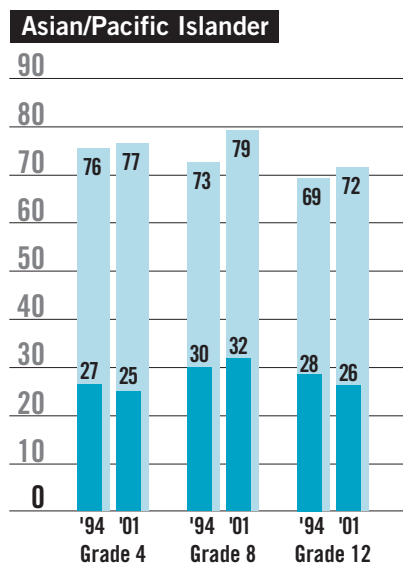
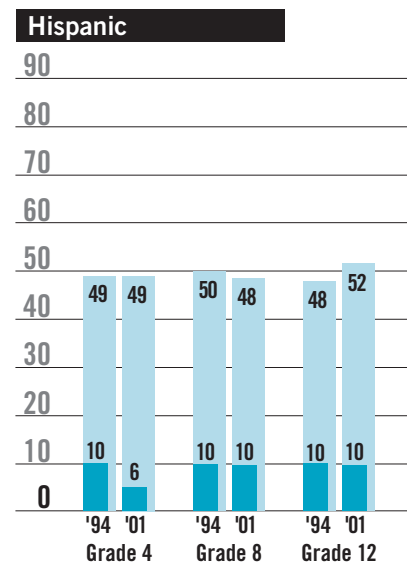
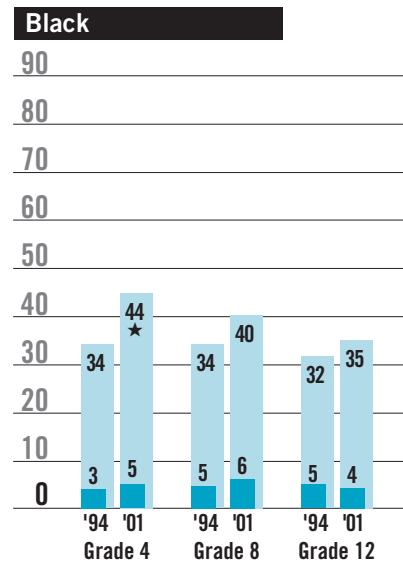
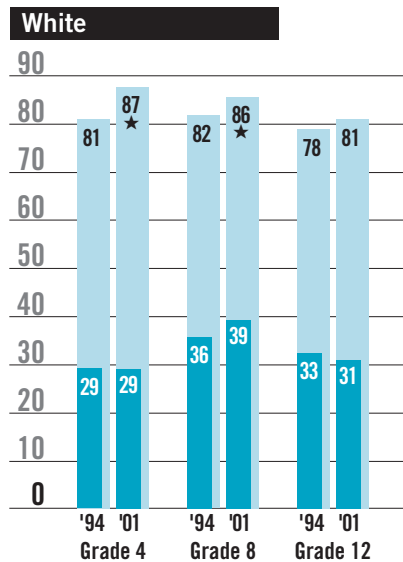

■ % at or above *Basic*  
■ % at or above *Proficient*

★ Significantly different from 1994.

**NOTE:** Sample size was insufficient to permit a reliable estimate for American Indian students at grade 12 in 1994.

**SOURCE:** U.S. Department of Education, Office of Educational Research and Improvement, National Center for Education Statistics, National Assessment of Educational Progress (NAEP), 1994 and 2001 Geography Assessments.



### Average Geography Scores by Type of School

Schools that participate in NAEP assessments are classified as either public or nonpublic. Looking at students' performance within school type indicates that eighth-grade public school students' average score was higher in 2001 than in 1994.

None of the other apparent changes by school type were statistically significant. In 2001, as in 1994, fourth-, eighth-, and twelfth-graders attending nonpublic schools had higher scores, on average, than their peers attending public schools. Readers

should, however, avoid making assumptions about the comparative quality of instruction in public and nonpublic schools when reading this information. Socioeconomic and sociological factors that may affect student performance should

be considered before interpreting these results. Additional information about the performance of students by type of school can be found in the full report, *The Nation's Report Card: Geography 2001*, as well as on the NAEP Web Site at <http://nces.ed.gov/nationsreportcard>.

Average geography scale scores by type of school, grades 4, 8, and 12: 1994 and 2001

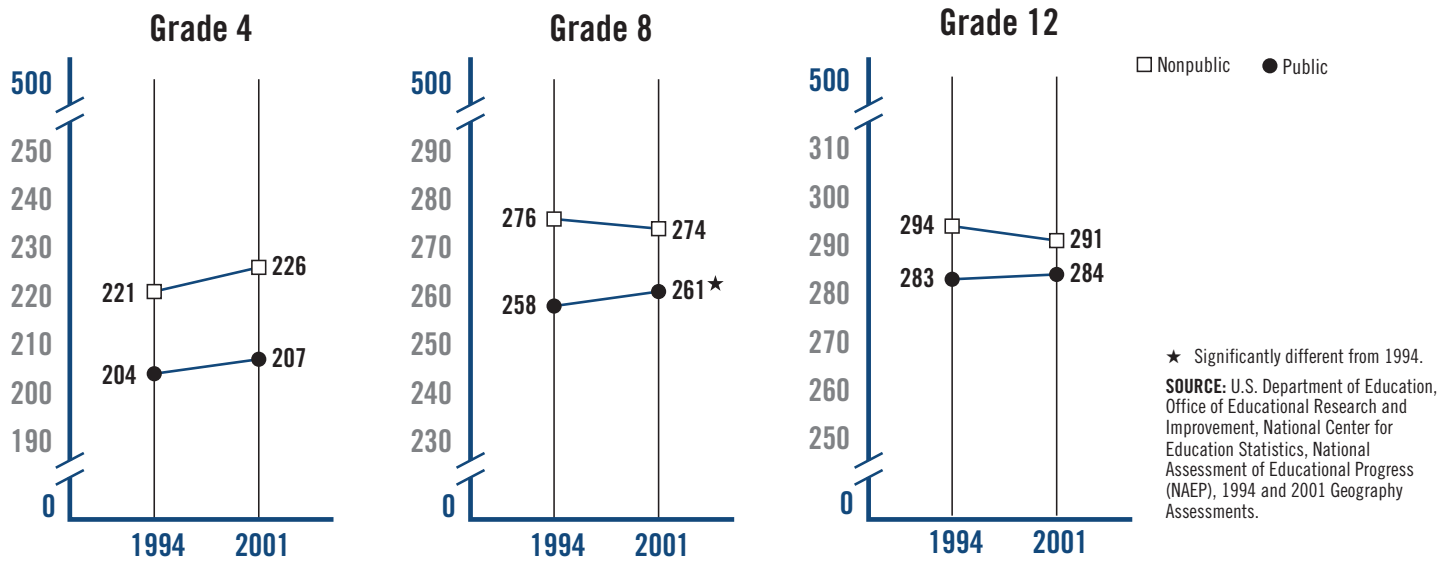

### Achievement-Level Results by Type of School

Achievement-level results for students attending public and nonpublic schools are presented in the figures to the right. They indicate that a higher percentage of eighth-grade public school students were at or above the *Basic* achievement level in 2001 than in 1994. Comparing student performance by type of school in 2001 shows that higher percentages of nonpublic school students than of public school students were at or above the *Basic* and the *Proficient* achievement levels at all three grades.

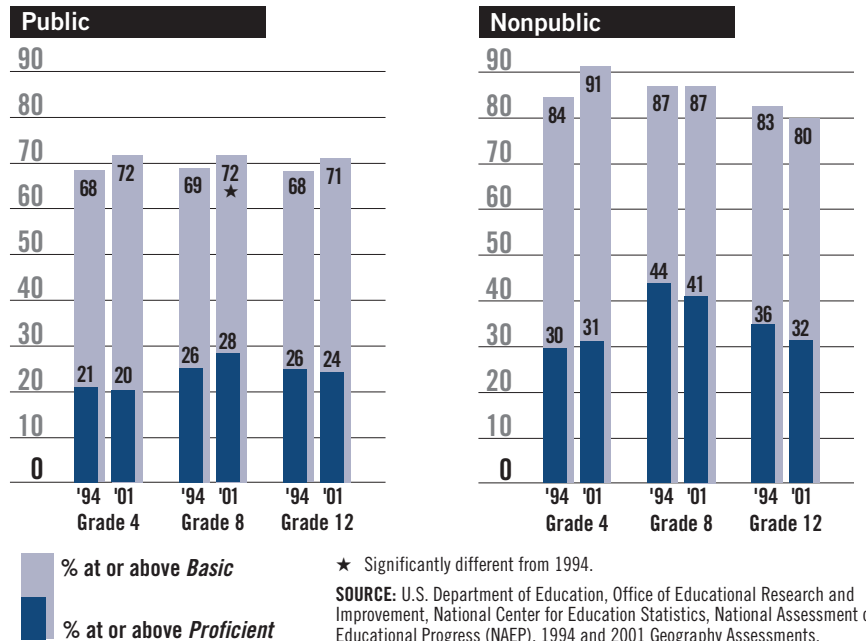



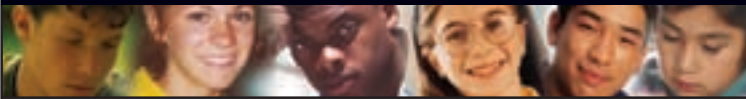

# Teacher and Student Factors Play a Role in Geography Performance

Students who participated in the NAEP 2001 geography assessment and their teachers answered questions related to their background and their experiences at school. The

responses were used to investigate whether relationships exist between these factors and students' performance on the geography assessment. Some of these

findings are presented here and on the next two pages. While these findings may suggest positive or negative relationships between performance and particular factors,

it is important to note that these relationships are not necessarily causal: there are many factors that may play a role in students' geography performance.

## Computer Use

Using computers to enhance learning has been an important challenge for educators in all content areas. The teachers of fourth- and eighth-grade students who participated in the NAEP 2001 geography

assessment were asked about the extent to which they use CD-ROMs or the Internet for social studies instruction. As shown in the bar chart below, fourth- and eighth-graders in

2001 whose teachers reported having their students use CD-ROMs to a small or moderate extent had higher average geography scores than those whose teachers reported not

using CD-ROMs at all. As shown in the pie charts below, about two-thirds of fourth- and eighth-graders had teachers who reported using CD-ROMs to look up reference works.

**Fourth- and eighth-grade average scores by extent of use of CD-ROMs for reference: 2001**

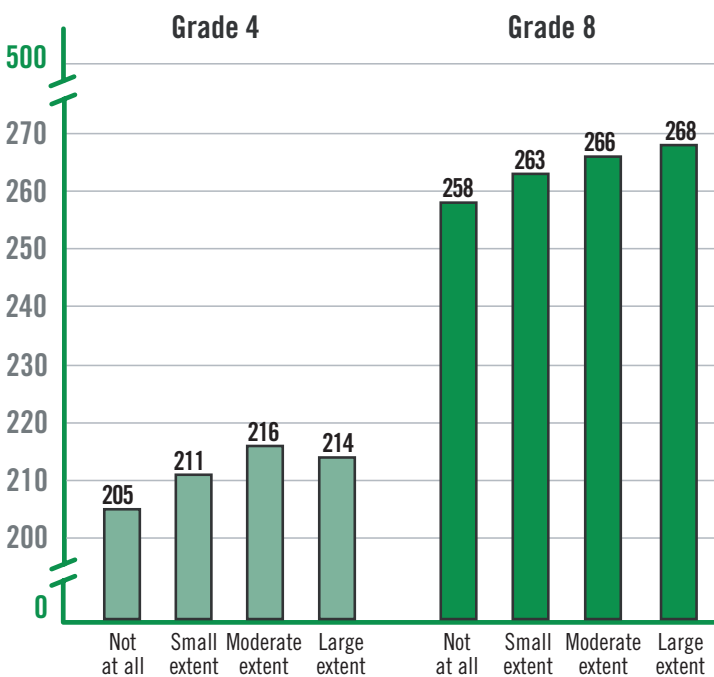

**Percentage of fourth- and eighth-graders by extent of use of CD-ROMs for reference: 2001**

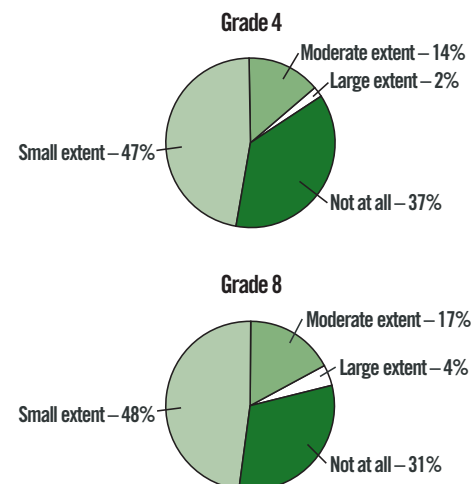

SOURCE: U.S. Department of Education, Office of Educational Research and Improvement, National Center for Education Statistics, National Assessment of Educational Progress (NAEP), 2001 Geography Assessment.

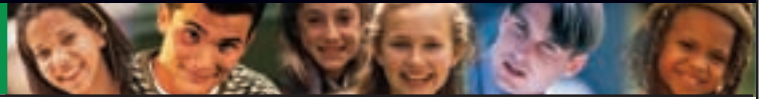

As shown in the bar chart below, fourth-graders in 2001 whose teachers had their students use the Internet to a small or moderate extent had higher average

geography scores than those whose teachers did not have them use the Internet at all. Eighth-graders whose teachers had them use the Internet to a large extent had higher average

scores than those whose teachers had them use the Internet to a small extent or not at all. The pie charts below indicate that about two-thirds of fourth-graders

and four-fifths of eighth-graders in 2001 had teachers who reported having their students use the Internet to retrieve information.

**Fourth- and eighth-grade average scores by extent of Internet use: 2001**

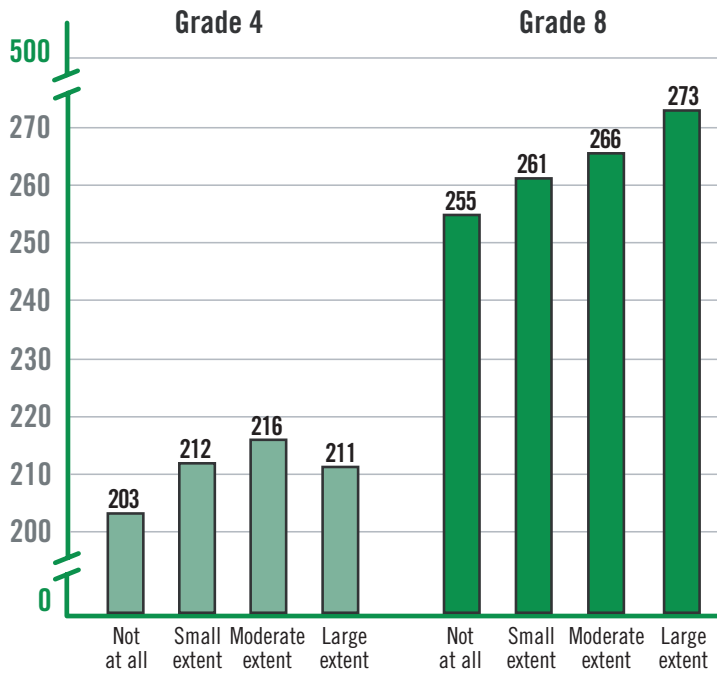

**Percentage of fourth- and eighth-graders by extent of Internet use: 2001**

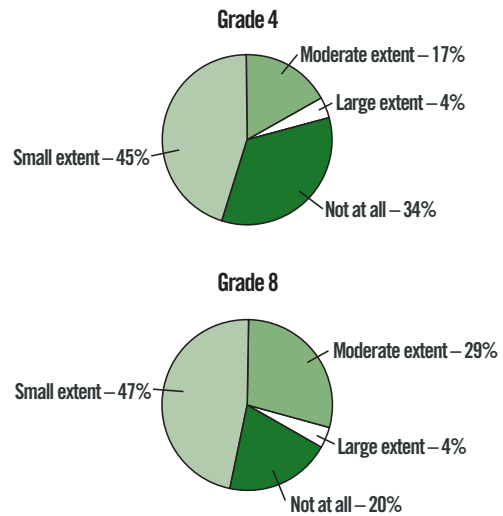

The bar chart below indicates that twelfth-graders who reported using the Internet

and CD-ROMs to a moderate or large extent had a higher average score than those who

said they did so to a small extent or not at all. The pie chart below indicates that

about three-quarters of twelfth-graders used the Internet and CD-ROMs.

**Twelfth-grade average scores by extent of Internet and CD-ROM use: 2001**

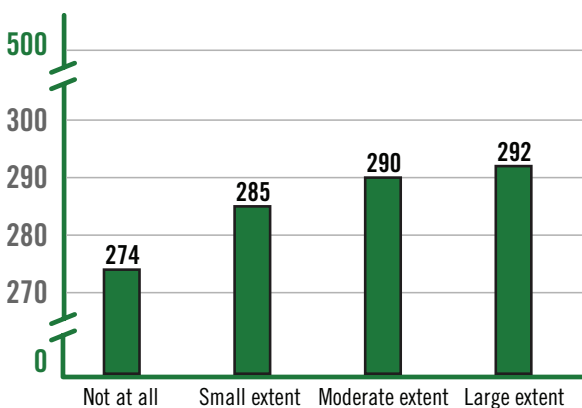

**Percentage of twelfth-graders by extent of Internet and CD-ROM use: 2001**

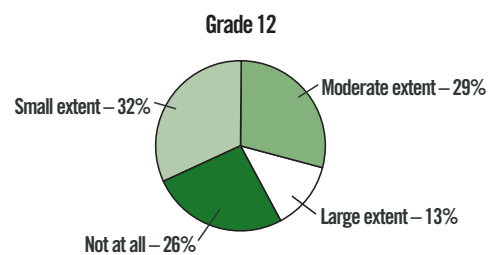

SOURCE: U.S. Department of Education, Office of Educational Research and Improvement, National Center for Education Statistics, National Assessment of Educational Progress (NAEP), 2001 Geography Assessment.

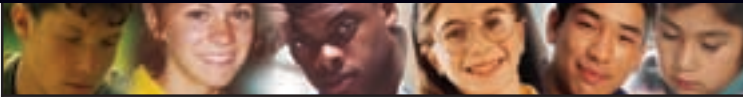

## Geography Topics Studied: Countries and Cultures

At grades 8 and 12, students were asked how frequently they studied countries and cultures. In 2001, 63 percent of eighth-graders said they studied countries and cultures almost

every day or once or twice a week. Eighth-graders who never studied countries and cultures had lower scores, on average, than students who did so at least once or twice a month.

At grade 12, 52 percent of students reported studying this topic almost every day or weekly. Furthermore, twelfth-graders who never studied

countries and cultures had lower average scores than students who did so at least once or twice a month.

**Eighth- and twelfth-grade average scores by frequency of studying countries and cultures: 2001**

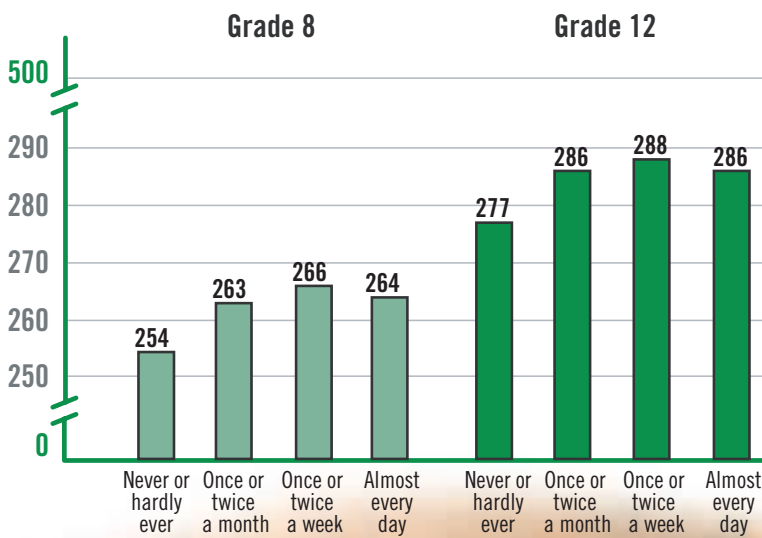

**Percentage of eighth- and twelfth-graders by frequency of studying countries and cultures: 2001**

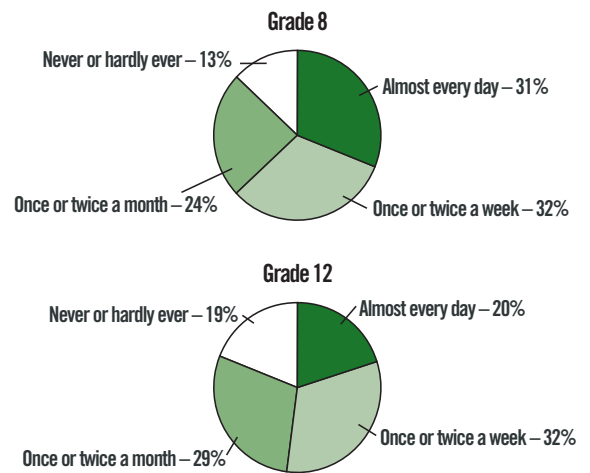

SOURCE: U.S. Department of Education, Office of Educational Research and Improvement, National Center for Education Statistics, National Assessment of Educational Progress (NAEP), 2001 Geography Assessment.



# Sample Geography Questions

A better understanding of students' performance on the NAEP 2001 geography assessment can be gained by examining sample test questions and students' responses to them. The questions shown here—one multiple-choice and one or two constructed-response questions for each grade—were used in the 2001 geography

assessment. The tables that accompany these sample questions show two types of percentages: the overall percentage of students answering the question successfully and the percentage of students at each achievement level answering successfully. For the multiple-choice questions shown, the

oval corresponding to the correct multiple-choice response is filled in. For the constructed-response questions, sample student responses are presented along with brief descriptions of how the responses were scored. Because it was a timed test of geography knowledge and skills, scoring was based solely

on content—students may have made minor spelling and grammatical errors that would not have affected their score. In addition, the content area is identified for each sample question. Additional sample questions can be viewed on the NAEP Web Site at <http://nces.ed.gov/nationsreportcard>.

## Grade 4 Sample Questions and Responses

### Fourth-Grade Multiple-Choice Question

This question assessed students' understanding of how geography plays a role in conflict among nations.

Overall percentage correct	Percentage correct within achievement-level intervals			
	Below <i>Basic</i> 186 and below*	<i>Basic</i> 187–239*	<i>Proficient</i> 240–275*	<i>Advanced</i> 276 and above*
33	22	28	56	—

\*NAEP geography scale range.

— Sample size is insufficient to permit a reliable estimate.

SOURCE: U.S. Department of Education, Office of Educational Research and Improvement, National Center for Education Statistics, National Assessment of Educational Progress (NAEP), 2001 Geography Assessment.

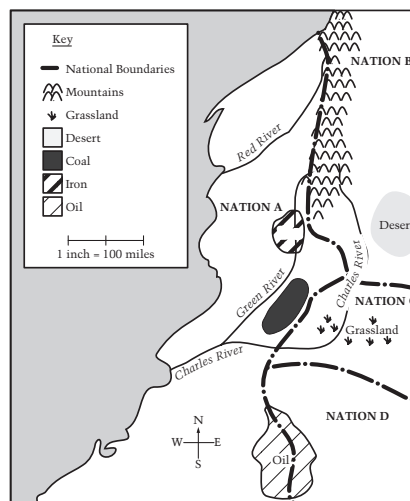

Which two nations are most likely to have a conflict over mineral resources?

- (A) Nation A and Nation B
- (B) Nation A and Nation C
- (C) Nation A and Nation D
- (D) Nation C and Nation D

Geography Content Area:

Spatial Dynamics and Connections



### Fourth-Grade Extended Constructed-Response Question

Responses to this question were scored according to a four-level guide as:

- “Complete”;
- “Essential”;
- “Partial”;
- “Inappropriate.”

This question required students to draw a map on a grid using written descriptions of features of a town.

Responses scored “Complete” correctly located all four features and drew the length and width to scale in the correct direction.

### Percentage “Complete” within achievement-level intervals

Overall percentage “Complete”	Below <i>Basic</i> 186 and below*	<i>Basic</i> 187–239*	<i>Proficient</i> 240–275*	<i>Advanced</i> 276 and above*
11	0	6	32	—

\*NAEP geography scale range.

—Sample size is insufficient to permit a reliable estimate.

SOURCE: U.S. Department of Education, Office of Educational Research and Improvement, National Center for Education Statistics, National Assessment of Educational Progress (NAEP), 2001 Geography Assessment.

### Sample “Complete” Response

#### LITTLE TOWN

- *Width: 4.0 miles east to west*
- *Length: 3.0 miles north to south*
- *Main Street runs east to west through the town.*
- *The school is on the northeast side of town.*
- *Phelps Park is on the southwest side of town.*
- *Runt River runs north to south through the town.*

On the grid below, each square is one mile wide and one mile long. Draw a map of Little Town on the grid. Draw the town’s borders. Then, use the symbols in the key below to draw the features listed above.

Key	
(S)	School
—	Street
(P)	Park
≈	River

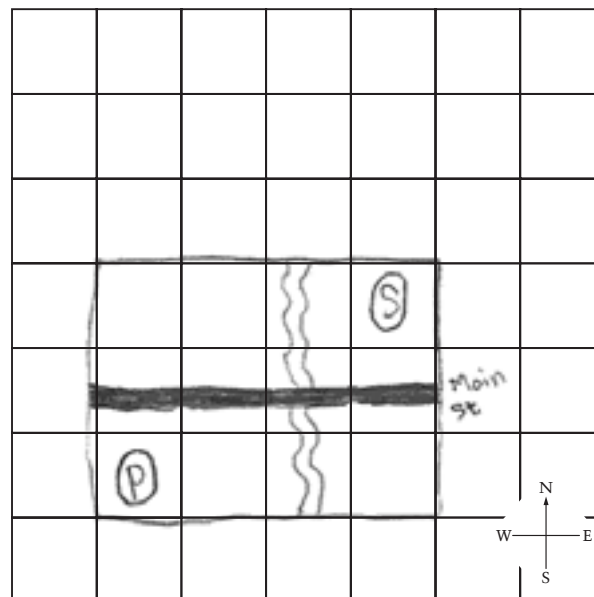

Scale  
 = 1 mile

Geography Content Area:

Space and Place

## sample questions



### Fourth-Grade Extended Constructed-Response Question

This "Essential" response correctly located four features but did not correctly draw the length and width to scale.

### Percentage "Essential" or better within achievement-level intervals

Overall percentage "Essential" or better	Below <i>Basic</i> 186 and below*	<i>Basic</i> 187–239*	<i>Proficient</i> 240–275*	<i>Advanced</i> 276 and above*
28	1	25	65	—

\*NAEP geography scale range.

—Sample size is insufficient to permit a reliable estimate.

SOURCE: U.S. Department of Education, Office of Educational Research and Improvement, National Center for Education Statistics, National Assessment of Educational Progress (NAEP), 2001 Geography Assessment.

### Sample "Essential" Response

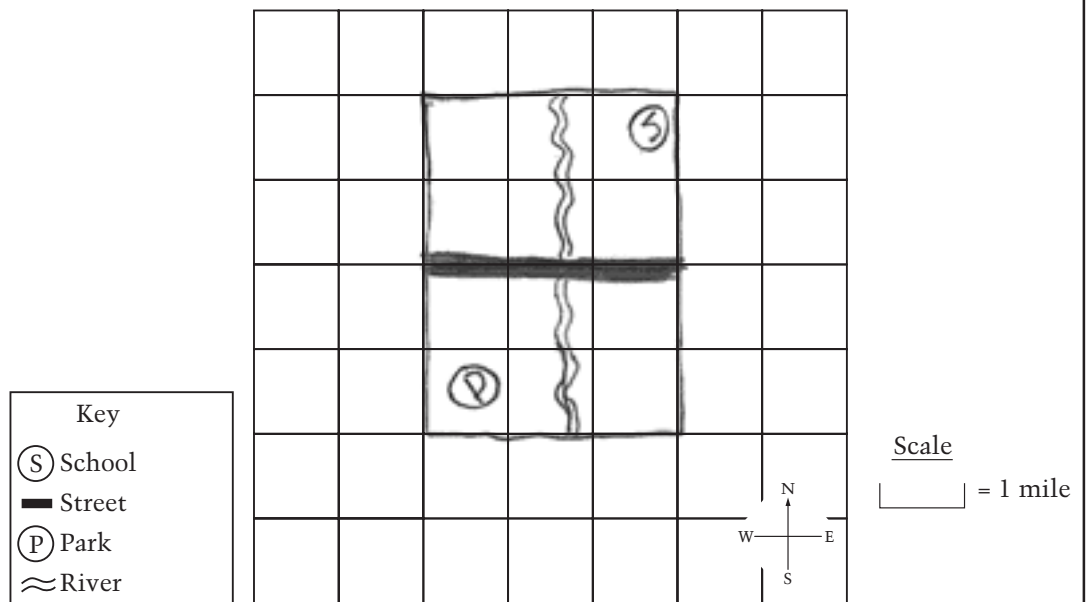

### Geography Content Area:

Space and Place

### Grade 8 Sample Questions and Responses

#### Eighth-Grade Multiple-Choice Question

This question asked students to interpret a kind of map they may never have seen to determine exactly what kind of information it provides and doesn't provide.

#### Percentage correct within achievement-level intervals

Overall percentage correct	Below <i>Basic</i> 241 and below*	<i>Basic</i> 242–281*	<i>Proficient</i> 282–314*	<i>Advanced</i> 315 and above*
70	37	74	91	97

\*NAEP geography scale range.

SOURCE: U.S. Department of Education, Office of Educational Research and Improvement, National Center for Education Statistics, National Assessment of Educational Progress (NAEP), 2001 Geography Assessment.

MASSACHUSETTS BAY TRANSIT AUTHORITY RAPID TRANSIT LINES

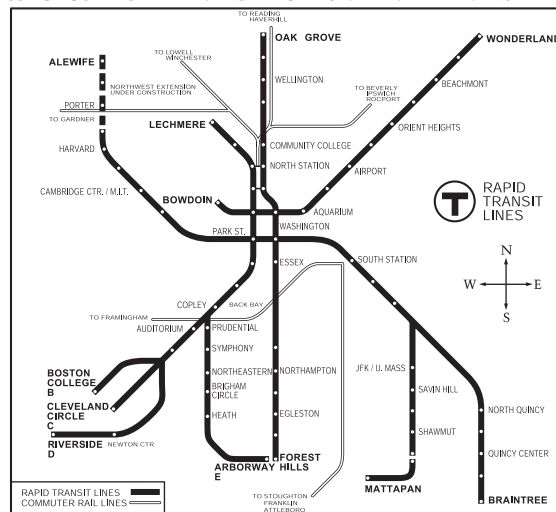

Which question could you answer based only on the information in the map?

- Ⓐ At what times do the public trains arrive?
- Ⓑ How much time does it take to go from Forest Hills to Oak Grove?
- Ⓒ How many miles is it from one station to another?
- Ⓓ How can one travel from Alewife to the Aquarium by public train?

#### Geography Content Area:

Spatial Dynamics and Connections

## sample questions



### Eighth-Grade Short Constructed-Response Question

### Percentage "Complete" within achievement-level intervals

Responses to this question were scored according to a three-level guide as:

- "Complete";
- "Partial"; or
- "Inappropriate."

This question measured students' understanding of the interaction between human beings and the environment.

Responses scored "Complete" provided two reasons for the high rate of tropical deforestation.

Overall percentage "Complete"	Below <i>Basic</i> 241 and below*	<i>Basic</i> 242–281*	<i>Proficient</i> 282–314*	<i>Advanced</i> 315 and above*
22	6	18	38	—

\*NAEP geography scale range.

—Sample size is insufficient to permit a reliable estimate.

SOURCE: U.S. Department of Education, Office of Educational Research and Improvement, National Center for Education Statistics, National Assessment of Educational Progress (NAEP), 2001 Geography Assessment.

### Sample "Complete" Response

*Tropical forests are being destroyed at the rate of at least eleven million hectares each year, an area the size of Pennsylvania. About half of all tropical forests are already gone.*

*Discuss two major reasons for this high rate of tropical deforestation.*

*One reason is the building of cities. The people use the rainforests as land. Another reason is for agriculture. The people find the farms more useful than rainforests.*

### Geography Content Area:

Environment and Society



### Grade 12 Sample Questions and Responses

#### Twelfth-Grade Multiple-Choice Question

This question asked students to demonstrate an understanding of the conventions used in what is known as a “flow map.”

#### Percentage correct within achievement-level intervals

Overall percentage correct	Below <i>Basic</i> 269 and below*	<i>Basic</i> 270–304*	<i>Proficient</i> 305–338*	<i>Advanced</i> 339 and above*
78	46	86	99	—

\*NAEP geography scale range.

—Sample size is insufficient to permit a reliable estimate.

SOURCE: U.S. Department of Education, Office of Educational Research and Improvement, National Center for Education Statistics, National Assessment of Educational Progress (NAEP), 2001 Geography Assessment.

MOVEMENT OF AN IMPORTANT INTERNATIONAL PRODUCT

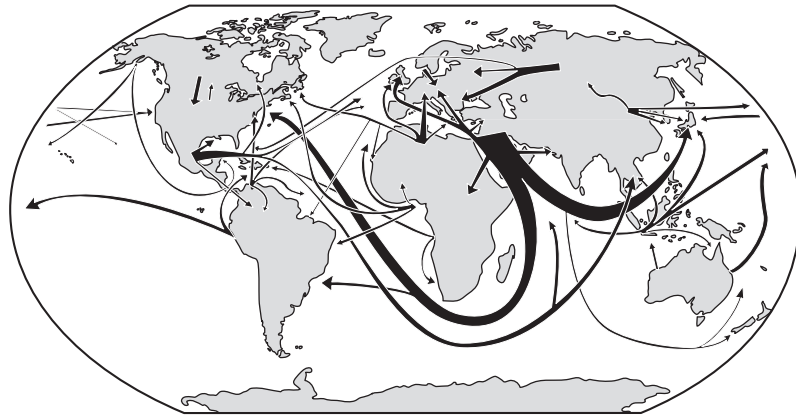

The varying widths of the lines on the map most probably indicate the

- (A) strength of ocean currents
- (B) type of trade
- (C) volume of trade
- (D) type of transportation used

#### Geography Content Area:

Space and Place

## sample questions

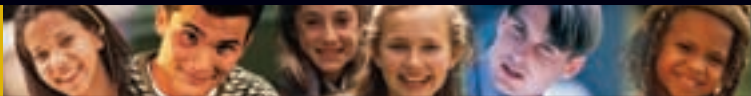

### Twelfth-Grade Short Constructed-Response Question

### Percentage "Complete" within achievement-level intervals

Responses to this question were scored according to a three-level guide as:

- "Complete";
- "Partial"; or
- "Inappropriate."

This question deals with the interaction between humans and the natural environment. Although some students may have been able to answer without referring to the map, others could use it to gain valuable information about the region.

Responses scored "Complete" provided two valid reasons why river valleys were important to the early civilization of Iraq.

Overall percentage  
"Complete"  
47

Below *Basic*  
269 and below\*  
17

*Basic*  
270–304\*  
52

*Proficient*  
305–338\*  
70

*Advanced*  
339 and above\*  
—

\*NAEP geography scale range.

—Sample size is insufficient to permit a reliable estimate.

SOURCE: U.S. Department of Education, Office of Educational Research and Improvement, National Center for Education Statistics, National Assessment of Educational Progress (NAEP), 2001 Geography Assessment.

### Sample "Complete" Response

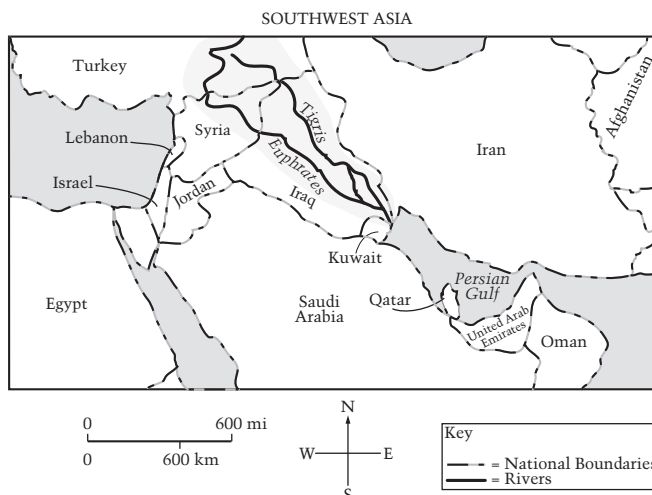

Give two reasons why early civilizations flourished in the valley of the Tigris and Euphrates rivers.

*The Tigris and Euphrates Rivers made these early civilizations flourish because of farming, trading, and a way of transportation. These rivers were their main source of everything like watering animals and rich, fertile farmland.*

### Geography Content Area:

Environment and Society

### Twelfth-Grade Short Constructed-Response Question

### Percentage "Complete" within achievement-level intervals

Responses to this question were scored according to a three-level guide as:

- "Complete";
- "Partial"; or
- "Inappropriate."

This question measured students' ability to read and understand population pyramids.

Responses scored "Complete" accurately described the difference between the population patterns for people age 60 and over in the two countries and gave a plausible explanation for the difference.

Overall percentage "Complete"	Below <i>Basic</i> 269 and below*	<i>Basic</i> 270–304*	<i>Proficient</i> 305–338*	<i>Advanced</i> 339 and above*
16	2	15	33	—

\*NAEP geography scale range.

—Sample size is insufficient to permit a reliable estimate.

SOURCE: U.S. Department of Education, Office of Educational Research and Improvement, National Center for Education Statistics, National Assessment of Educational Progress (NAEP), 2001 Geography Assessment.

### Sample "Complete" Response

COUNTRY 1  
Age Distribution

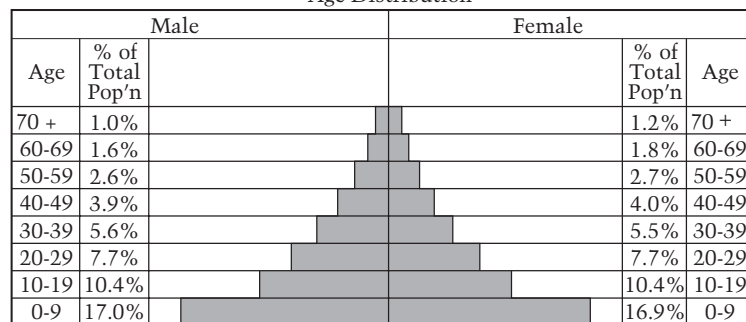

COUNTRY 2  
Age Distribution



Describe the difference in population patterns for people age 60 and over in countries 1 and 2. Give one possible explanation for the difference you have identified.

Country two has a larger portion of the population aged 60 or over. This could be due to a more advanced medical system leading to a higher life expectancy.

### Geography Content Area:

Spatial Dynamics and Connections

The Nation's  
Report Card

# Geography Highlights 2001

National Center for  
Education Statistics

## More Information

Additional results and detailed information about the NAEP 2001 geography assessment can be found on the NAEP Web Site. Additional NAEP publications can be ordered from

U.S. Department of Education  
ED Pubs  
P.O. Box 1398  
Jessup, MD 20794-1398  
1-877-4ED-PUBS  
(1-877-433-7827)

Additional information about the NAEP geography framework can be found on the National Assessment Governing Board Web Site at <http://www.nagb.org>.

# NAEP

## on the Web

<http://nces.ed.gov/nationsreportcard>

The NAEP Web Site offers a wealth of assessment information, publications, and analysis tools, including

- fast “one-stop” access to free NAEP publications and assessment data
- national and state “report cards” on student achievement in core subject areas such as reading, math, and science
- sample test questions, student responses, and scoring guides
- interactive data analysis tool and student performance results from past NAEP assessments
- calendars of current NAEP events, training, and professional development activities
- technical assistance and online discussions with leading assessment and subject-matter experts

United States  
Department of Education  
ED Pubs  
8242-B Sandy Court  
Jessup, MD 20794-1398

Postage and Fees Paid  
U.S. Department of  
Education  
Permit No. G-17

**Standard**

---

Official Business Only  
Penalty for Private Use, \$300

