

An Overview of Water Disinfection in Developing Countries and the Potential for Solar Thermal Water Pasteurization

Jay Burch
Karen E. Thomas



MASTER

National Renewable Energy Laboratory
1617 Cole Boulevard
Golden, Colorado 80401-3393
A national laboratory of the U.S. Department of Energy
Managed by the Midwest Research Institute
for the U.S. Department of Energy
Under Contract No. DE-AC36-83CH10093

Prepared under Task No. SH71.3001/SH71.1001

January 1998

DISTRIBUTION OF THIS DOCUMENT IS UNLIMITED

A handwritten signature in the bottom right corner of the page, appearing to be the initials "df".

NOTICE

This report was prepared as an account of work sponsored by an agency of the United States government. Neither the United States government nor any agency thereof, nor any of their employees, makes any warranty, express or implied, or assumes any legal liability or responsibility for the accuracy, completeness, or usefulness of any information, apparatus, product, or process disclosed, or represents that its use would not infringe privately owned rights. Reference herein to any specific commercial product, process, or service by trade name, trademark, manufacturer, or otherwise does not necessarily constitute or imply its endorsement, recommendation, or favoring by the United States government or any agency thereof. The views and opinions of authors expressed herein do not necessarily state or reflect those of the United States government or any agency thereof.

Available to DOE and DOE contractors from:
Office of Scientific and Technical Information (OSTI)
P.O. Box 62
Oak Ridge, TN 37831
Prices available by calling (423) 576-8401

Available to the public from:
National Technical Information Service (NTIS)
U.S. Department of Commerce
5285 Port Royal Road
Springfield, VA 22161
(703) 487-4650



DISCLAIMER

Portions of this document may be illegible electronic image products. Images are produced from the best available original document.

Executive Summary

This study originated within the Solar Buildings Program at the U.S. Department of Energy. Its goal is to assess the potential for solar thermal water disinfection in developing countries. In order to assess solar thermal potential, the alternatives must be clearly understood and compared. The objectives of the study are to: a) characterize the developing world disinfection needs and market; b) identify competing technologies, both traditional and emerging; c) analyze and characterize solar thermal pasteurization; d) compare technologies on cost-effectiveness and appropriateness; and e) identify research opportunities. Natural consequences of the study beyond these objectives include a broad knowledge of water disinfection problems and technologies, introduction of solar thermal pasteurization technologies to a broad audience, and general identification of disinfection opportunities for renewable technologies.

Waterborne disease is a staggering problem. Several billion people drink water potentially contaminated with pathogens that cause a variety of diseases. There are approximately 2.5 billion cases of waterborne sickness per year, causing about 5 million deaths per year (mostly children). Variables that are relevant to water disinfection problems and potential solutions include:

- Local population density: urban, village, and dispersed single family
- Existing water supply: deep-sealed well, shallow unsealed or sealed well, surface waters
- Water treatment: acceptable, questionable, or none
- Water pathogens: bacteria and viruses are ubiquitous, but protozoa and worms are localized
- Water turbidity: clean well water to “dirty” river water
- Water use: from several to several hundred liters per day per person
- Hygiene and washing practices: dependent on water supply and culture
- Availability of electricity: reliable, questionable, or none
- Local labor cost
- Income
- Infrastructure issues: varying access to supplies; training for operation, maintenance, and repair; and organizational support
- Education: implications for operation and maintenance of complex technologies
- Awareness of disease (the fecal-oral cycle): affects motivation to invest in and maintain water treatment.

Desired data are not readily available. The market segments of interest here are those with smaller volume/day demand (less than 25 m³/day), including villages, and both dispersed and urban single family. Many authors believe that, for this market segment, the infrastructure issues are foremost in choosing the appropriate technology.

Water pathogens include bacteria, viruses, protozoa, and worms. Bacteria and viruses are readily treated with chemicals and ultraviolet (UV) light, but smaller bacteria and viruses are too small to be mechanically filtered. Protozoa and worms are larger and more easily filtered mechanically; however, they are resistant to chemicals and radiation. Turbidity in water allows viruses and bacteria to escape chemical and ultraviolet treatments. Water turbidity must be reduced by filtering to acceptable limits before chemical and ultraviolet techniques can be effective. Thus, chemical and UV treatments are almost always combined with filtering designed to reduce water turbidity to ~5 nephelometric turbidity units.

Disinfection methods appropriate for smaller-scale markets in the developing world include chlorination (dosing plant and batch processes), oxidant generation from electrolysis, slow sand filtration, household filtration, UV irradiation (from both sunlight and UV bulbs), boiling, and solar thermal pasteurization. These technologies are described, with emphasis on characterizing lesser-known solar thermal techniques. Solar

thermal pasteurization includes batch and continuous-flow devices. Commercial devices using domestic hot-water technology have recently become available. To determine if there is a potential role for solar thermal techniques, technologies are compared on the basis of economics and appropriateness.

Principal economic comparison indices are the life-cycle water treatment cost per unit volume and the capacity cost (first cost per unit volume capacity). Technology costs reported in the literature vary widely (factors of two or more). Cost estimates provided here are considered approximate averages that could vary more than a factor of two in particular cases. Appropriateness comparison is based on assessment of effectiveness and maintenance needs. Maintenance needs are broken down into need for supplies; need for skilled labor to operate, maintain, and repair the system; and need for unskilled labor for operation and maintenance.

Economic comparison of selected technologies is summarized in Figure 1. Recently emerging solar thermal pasteurization systems have a high cost compared to the village-scale technologies. On the home scale, boiling has no capacity cost, but has a very high treatment cost because of high fuel costs. Existing solar devices have a water treatment cost of an order of magnitude less than boiling.

Appropriateness comparison is difficult but critical in choosing a technology. Chlorination requires a continuing supply of fresh chemicals. Batch chlorination is very easy but only moderately effective. (Cysts, eggs, and high turbidity present problems that require filtering.) Chlorine-dosing devices in treatment plants require trained operators and increase in complexity with the size of the system. Water pretreatment with roughing filters is usually done in dosing plants. Slow sand filters are effective and low cost but require lots of maintenance and construction labor. Pretreatment with roughing filters is usually required. Household filtration units are moderately effective; however, they require consistent maintenance and are prone to failure from cracking and problems with bacteria and viruses. Batch UV sunlight methods are emerging that are very low cost and easy to use but are very small scale, moderately effective, and need further study. UV lamp techniques are moderately simple; however, high turbidity or cysts/eggs require filtering. The devices require access to infrastructure for bulb and power supply maintenance. Water boiling is common and effective but is extremely costly and laborious. Solar thermal water treatment costs are relatively high with current technology. For solar thermal pasteurization systems with metallic passageways, maintenance considerations might include scaling and freeze damage. These issues should be taken as restrictions on suitable sites, rather than as maintenance problems. Solar thermal is inherently very low in maintenance if these restrictions are followed. Solar thermal pasteurization is extremely effective against all pathogens, and does not require substantive filtering before treatment.

Solar thermal pasteurization tends to cost more than the alternatives, but is the most effective and (in some markets) requires the least maintenance. It is unclear whether appropriateness advantages will overcome cost disadvantages. Economic assessment is uncertain because solar thermal pasteurization is an emerging technology that has not yet been cost optimized to the extent that other technologies have. If costs of \$380/m² could be attained, home-scale use would be competitive with the best home filter and UV/photovoltaic (PV) system. If costs of \$90/m² could be achieved, village-scale application would become cost competitive with PV-driven ultraviolet techniques.

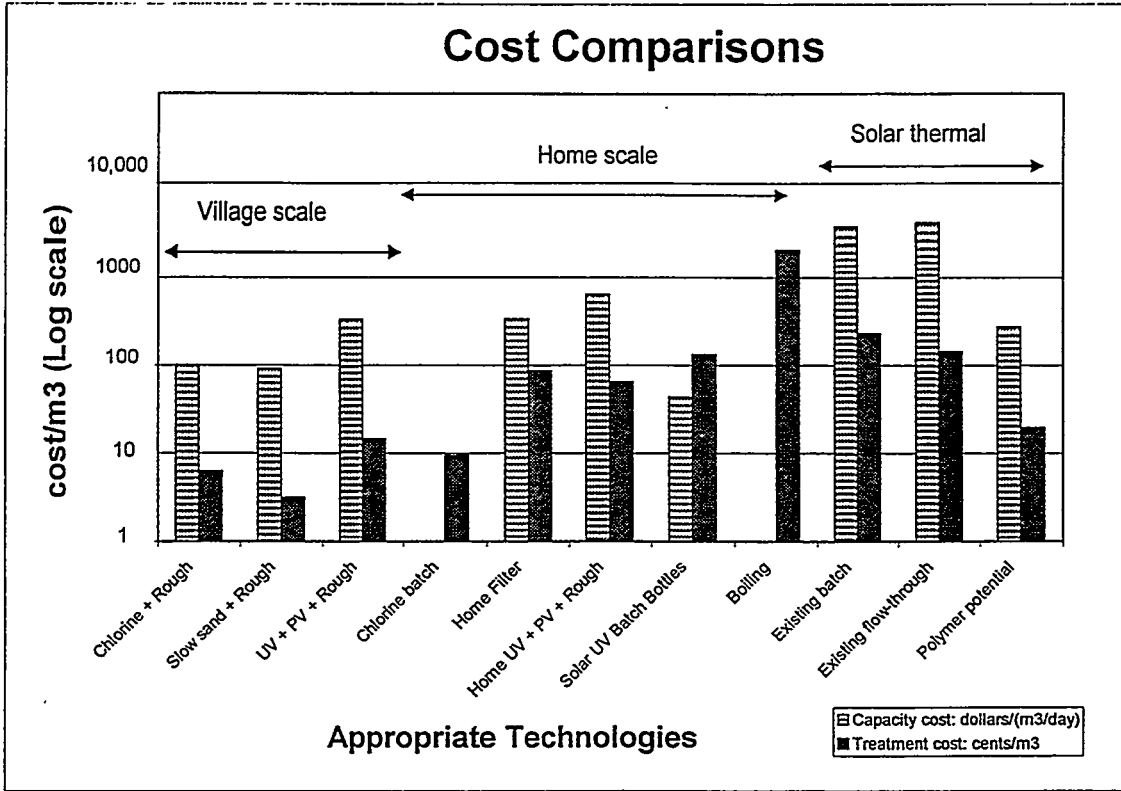

Figure 1. Cost comparison between selected small-scale water disinfection technologies. The y axis is the normalized costs on a logarithmic scale. The hatched bar is the capacity cost, which is first cost divided by the daily output of the system in $\$/m^3$. The solid bar is the normalized life-cycle cost of water disinfection in cents/ m^3 .

Contents

	<u>Page</u>
Executive Summary	iii
List of Figures	ix
List of Tables	xii
1.0 Problem Characterization	1
1.1 The Need	1
1.2 Description of Pathogens	1
1.3 Benefits of Water Disinfection and Improved Sanitation	5
1.4 Relevant Water Characteristics	6
1.4.1 Source	7
1.4.2 Turbidity and Color	7
1.4.3 Pathogen Content	8
1.4.4 Water Hardness	8
2.0 Market Analysis	10
2.1 Total Market Size in Developing Countries	10
2.2 Market Characterization	11
2.2.1 Basic Market Parameters	11
2.2.2 World Bank Study	14
2.2.3 Promising Market Segments	15
2.2.3.1 Small, Single-Family-Scale Systems	16
2.2.3.2 Larger, Village-Scale Systems	17
2.3 Market Information Needs	18
3.0 Disinfection Technologies: General	19
3.1 Technology Classification and Selection	19
3.2 Technology Characterization: General	19
3.3 Cost Analysis Methodology	20
4.0 Appropriate Technology Assessment	21
4.1 Chemical Approaches	21
4.1.1 Chlorine Bleach	21
4.1.2 Mixed-Oxidant Gases Generated On Demand (MOGGOD) Technology	25
4.2 Filtration	27
4.2.1 Slow Sand Filters	27
4.2.2 Household Filters	28
4.2.3 Roughing Filters	29

Contents (Continued)

	<u>Page</u>
4.3 Ultraviolet Disinfection	30
4.3.1 General Features of UV Radiation	30
4.3.1.1 UV Radiation Sources	30
4.3.1.2 Cautions in Use of UV Disinfection	31
4.3.2 Practical UV Systems	32
4.3.2.1 Solar-Driven UV Disinfection	32
4.3.2.2 Lamp-Driven UV Disinfection	33
4.3.3 Photocatalytic Disinfection	40
4.4 Pasteurization (Thermal Disinfection)	40
4.4.1 Fossil Fuel Heating/Batch Processes: Water Boiling	41
4.4.2 Fossil Fuel Heating, Flow-Through Pasteurization Device	42
4.4.3 Solar Thermal Pasteurization	43
4.4.3.1 Batch Solar Thermal Devices	43
4.4.3.2 Flow-Through Solar Thermal Pasteurization Systems	46
4.5 Solar Thermal Multi-Use Systems	53
4.5.1 SUN Hybrid Systems	53
4.5.2 Copper Sunsatation Plus	54
5.0 Technology Intercomparison	56
5.1 Technology Summaries	56
5.1.1 Traditional Technologies	56
5.1.2 Emerging Technologies	57
5.2 Solar Thermal Market Estimates	59
5.2.1 Small-Volume System: Single Families	59
5.2.1.1 Urban Market	59
5.2.1.2 Remote Single Family	60
5.2.2 Medium-Volume System: Health Clinic	60
5.2.3 Large-Volume System: Public Taps	61
6.0 Research Recommendations	62
6.1 U.S. DOE Programs	62
6.1.1 The Solar Building Program	62
6.1.1.1 Incremental Cost-Reduction Strategy	62
6.1.1.2 Polymer Systems	62
6.1.1.3 Small-Scale Flow-Through Units	62
6.1.1.4 Multi-Use Solar Thermal Products	63
6.1.2 The Solar Thermal Electric Program	63
6.1.3 Other Programs	63
6.2 NREL International Programs	63
Bibliography	64

Contents (Concluded)

	<u>Page</u>
Appendix A. Characteristics of Waterborne Pathogens	A-1
Appendix B. Access to Safe Water in Selected Countries	B-1
Appendix C. List of Organizations Involved in Water Treatment Activities	C-1
Appendix D. Brief Description of the Full Range of Treatment Options	D-1
Appendix E. Detailed Assumptions and Calculations in Life-Cycle Cost Analysis	E-1
Appendix F. PV Sizing Algorithms for UV/PV Systems	F-1
Appendix G. Polymer Solar Pasteurization System	G-1
Appendix H. Cost of Fuel	H-1
Appendix I. Modeling of Flow-Through Solar Pasteurization Process	I-1
Appendix J. Comparison of Disinfection Technologies	J-1

List of Figures

		<u>Page</u>
1	Cost comparison between selected small-scale water disinfection technologies . . .	v
1.2-1	Map of the distribution of Trachoma	4
1.2-2	Map of the distribution of Schistosomiasis	4
1.2-3	Map of the distribution of Dracunculiasis (guinea worm)	5
2.1-1	World Health Organization estimates of population in developing countries provided with/without adequate drinking water	11
2.1-2	Estimated distribution of water services for 1970	12
2.1-3	World Health Organization estimates of population of developing countries in tropical areas with adequate water	12
2.2-1	Range of daily consumption per person in liters for major classes of water use . . .	13
4-1	Cost comparisons between selected small-scale water disinfection technologies . .	21
4.1.2-1	Oxi-2 mixed-oxidant generator developed by Oxi Generators, Inc.	25
4.2.1-1	A schematic of a slow sand filter	27
4.2.2-1	A multimedia household sand filter designed for an upward flow by local craftspeople	29
4.2.3-1	A horizontal-flow roughing filter	30
4.3.1-1	Germicidal, solar, and transmission curves	31
4.3.1.2-1	Bacterial regrowth following UV treatment	32
4.3.2.1-1	Batch solar UV disinfection using plastic bottles	35
4.3.2.1-2	Water temperature increase and inactivation of fecal coliforms and <i>Vibrio cholerae</i> in plastic bags	35
4.3.2.1-3	Two flow-through solar disinfection systems	35
4.3.2.2-1	A small UV water disinfectant tailored for applications in developing countries developed by U.S. Department of Energy's Lawrence Berkeley National Laboratory	35

List of Figures (Continued)

	<u>Page</u>
4.3.2.2-2 A small UV water disinfection unit manufactured by Global Water Technologies	36
4.3.2.2-3 Sun-Pure unit mounted under a sink	37
4.3.2.2-4 Cutaway details of the Sun-Pure filtration cartridges and UV lamp	38
4.3.2.2-5 Sun-Pure lamp and reactor chamber	39
4.4-1 Temperature-time chart for safe water pasteurization	41
4.4.1-1 Water pasteurization indicator	42
4.4.2-1 Schematic of a flow-through pasteurizer	42
4.4.2-2 The Wood-Saver device	43
4.4.3.1-1 Family Sol-Saver	44
4.4.3.1-2 Stagnation temperature and critical irradiation (for flow-through devices) as a function of the ratio of collector parameters	44
4.4.3.1-3 A batch solar disinfector manufactured by SUN, Inc.	45
4.4.3.1-4 A basic solar puddle shown with horizontal dimensions compressed for clarity ..	45
4.4.3.2-1 Schematic of a flow-through solar thermal water pasteurization system	46
4.4.3.2-2 Flow rate versus sterilization temperature	47
4.4.3.2-3 Flow rate as a function of heat exchanger effectiveness for three solar collector types	48
4.4.3.2-4 Flow rate and heater exchanger effectiveness versus heat exchanger area	48
4.4.3.2-5 Graph of flow and heat exchanger effectiveness versus irradiance shows a decreasing flow rate with reduced incidence	49
4.4.3.2-6 The Family Sol-Saver pasteurizer from Safe Water Systems, Inc.	50
4.4.3.2-7 A parabolic-trough solar pasteurization system consisting of a tracking parabolic trough, control valve, patented counterflow tube and shell heat exchanger, and a PV-pumping system	51

List of Figures (Concluded)

	<u>Page</u>
4.4.3-2-8 Parabolic-trough system heat exchanger configuration includes wire windings to increase the film coefficient between hot and cold fluids	52
4.5.1-1 SUN autoclave applications schematic	53
4.5.1-2 SUN multi-use system for single-family application	54
4.5.2-1 A combined hot-water/pasteurization system	54
4.5.2-2 A schematic of a combined hot-water/pasteurization system developed by Safe Water Systems, Inc.	55

List of Tables

		<u>Page</u>
1.1-1	Number of Episodes and Deaths per Year from the Major Waterborne Diseases . .	1
1.2-1	Pathogen Characterization	2
1.2-2	Pathogens Categorized by Transmittal	2
1.3-1	Expected Reduction in Morbidity and Mortality from Improved Water and Sanitation for Selected Diseases	5
1.3-2	Potential Improvement in Morbidity Rates from Water and Sanitation Interventions for Selected Diseases	6
1.3-3	Expected Reduction in Diarrheal Disease Morbidity from Improvements in One or More Components of Water and Sanitation	6
1.4.2-1	Water Turbidity Levels	7
2.1-1	World Bank Development Report Summary for Selected Areas	10
4-1	Appropriate Disinfection Technologies: Cost and Appropriateness Summary (Labor costs included)	22
4-2	Appropriate Disinfection Technologies: Cost and Appropriateness Summary (No labor costs)	23
4.3.2.2-1	PV System Cost for Various Operating Scenarios	34
5.1.2-1	Cost Goals for Solar System Cost/Area	58
5.1.2-2	Break-Even Cost/Area of Flow-Through Solar Systems	58
5.2-1	System Capacity/Water Volume and Markets for Solar Thermal Disinfection	59

1.0 Problem Characterization

1.1 The Need

The need to disinfect water in the developing world is indisputable. Nearly half of all deaths of children in the developing world are caused by diarrheal and respiratory diseases (approximately 3 million per year each), many of which are caused by waterborne pathogens (UNICEF 1995). Approximately 4.6 million children and adults die from diarrhea each year. The average child experiences 2.2 episodes of diarrhea each year (Snyder and Merson 1982). Frequent episodes of diarrhea leave the victims weakened and malnourished, resulting in greater susceptibility to other diseases and loss of productivity. In addition to diarrhea, other waterborne diseases lead to blindness, lesions of internal organs, weakness, and other debilitations. Approximately 80% of all illnesses in the developing world result from waterborne diseases (Anderson and Collier 1996). At any one time, about 1 billion people are suffering from waterborne disease and 50% of hospitalizations are from waterborne disease (Alward, Ayoub, and Brunet 1994). Table 1.1-1 summarizes the prevalence of the major waterborne diseases.

Table 1.1-1. Number of Episodes and Deaths per Year from the Major Waterborne Diseases

Disease	Cases per Year	Deaths per Year
Ascariasis (roundworm)	900 million	20,000
Cholera	5.5 million	120,000
Diarrhea (including shigellosis, amoebic dysentery, giardiasis, and enteric viruses)	875 million	4.6 million
Dracunculiasis (guinea worm)	500,000	a
Hepatitis	7 million	a
Schistosomiasis	200 million	a
Trachoma	500 million	b

Sources: Esrey et al. 1991; Feachem et al. 1983; Jones 1994

^aeffect is usually debilitation rather than death

^beffect is blindness (8 million blinded per year)

1.2 Description of Pathogens

The major pathogens of concern are bacteria, viruses, protozoa, and helminths (worms). Most of these pathogens are transmitted by the fecal-oral cycle. The sizes of the pathogen is important in the selection of mechanical filtering devices. Ranges of pathogen sizes are given in Table 1.2-1. Appendix A provides a summary of the various waterborne microbes, the diseases they cause, and their susceptibility to various types of disinfection.

Table 1.2-1. Pathogen Characterization

Pathogen Class	Size
Bacteria	0.5-2 μm
Viruses	20-80 nm
Protozoa	4-20 μm (cysts)
Helminths	0.03-2 mm (eggs)

Source: Feachem et al. 1983

Feachem et al. (1983) categorized the pathogens based on how they are transmitted. This classification indicates disease type and appropriate treatments, which include disinfecting drinking and bathing water, improving water supply, and waste sanitation, and is presented in modified form in this section. Categories 1 and 2 pathogens are transmitted in drinking water, and Categories 3 and 4 involve washing water; improvement is expected through water disinfection. Category 5 will be unaffected by disinfection; instead, it requires waste treatment. This categorization is summarized in Table 1.2-2 and described in the remainder of this section.

Table 1.2-2. Pathogens Categorized by Transmittal

Category	Pathogens	Diseases Caused
Category 1: Primarily waterborne, cannot multiply outside of host, very few needed to infect		
Protozoa	Giardia, entamoeba, cryptosporidium	Giardiasis, amoebic dysentery, diarrhea
Viruses	Rotavirus, adenovirus, enterovirus, reovirus	Hepatitis, polio, diarrhea, meningitis, respiratory disease
Category 2: Primarily waterborne, can multiply outside of host, large number needed to infect		
Bacteria	Campylobacter, escherichia, yersinia, vibrio, salmonella, shigella	Diarrhea, cholera, enteric fever, typhoid fever, dysentery
Category 3: Primarily soil-transmitted, maturation period needed before it can infect new host, very few needed to infect		
Worms	Ascaris	Roundworm infection
Category 4: Primarily transmitted through lack of washing and contaminated wash water		
Bacteria	Trachoma	Blindness
Mites	Scabies	Skin rash
Category 5: Primarily controllable through sanitation, require intermediate host to complete life cycle		
Worms	Dracunculiasis, schistosomes	Guinea worm, schistosomiasis

Category 1 pathogens include the waterborne viruses and protozoa. The viruses cause diseases such as hepatitis, respiratory infections, polio, meningitis, and diarrhea. The protozoa cause diseases such as amoebic dysentery and giardiasis, whose symptoms include diarrhea. Very few (1 to 100) viruses or protozoa need be

ingested to cause an infection, and they are infective as soon as they enter the environment (i.e., they need no intermediate host or maturation period). However, they cannot multiply outside of a human host. The major routes of transmission are through person-to-person contact and drinking water. Although the pathogens rarely cause death, they do cause a very high number of cases each year, infecting more than 10% of the world's population at any given time (Feachem et al. 1983).

Category 2 pathogens include the waterborne bacteria, which cause a large percentage of diarrhea cases in addition to typhoid fever and cholera. A large number of bacteria (more than a million) must be ingested for infection to occur. Bacteria are capable of multiplying outside of human hosts, particularly in nutrient-rich waters and on food, and require no intermediate host or maturation period. Ingestion of contaminated drinking water or uncooked food is the primary route of transmission, although person-to-person contact may be of more importance in the transmission of shigella (Feachem et al. 1983). Rates of death can be high depending on the health of the victims, which may depend on malnutrition caused by previous infections.

Category 3 pathogens include ascaris (roundworm), which causes various symptoms including respiratory and digestive disorders and, in serious cases, death caused by infection of the vital organs. Eggs excreted from one victim must mature in soil before they can infect another host, and infection can result from the ingestion of very few worm larva. Transmission occurs primarily by walking barefoot on contaminated soil, although it can also occur through the ingestion of contaminated, uncooked vegetables. Although this disease is not primarily a waterborne disease, many sources believe that it can be reduced by water disinfection (Esrey et al. 1990).

Category 4 pathogens include bacteria and mites that cause diseases such as trachoma and scabies. Unlike the other diseases mentioned here, these pathogens are not ingested but rather infect external organs such as the eyes and skin, resulting in blindness and rashes. Transmission occurs when adequate hygiene with clean water, such as hand washing, is not practiced.

Finally, Category 5 pathogens consist of worms, such as schistosomiasis and guinea worm, which require an intermediate host to complete their life cycle. The eggs excreted from human hosts must find an intermediate host to mature to the larvae stage, such as a snail in the case of schistosomiasis, which then can infect another human host. Therefore, these pathogens cannot multiply in water unless the intermediate host is present. These diseases result in damage to internal organs and muscle tissues. Very few pathogens need penetrate the victim for infection to occur. Although guinea worm must be ingested, the larva of the schistosomes penetrate the skin, usually while the victim is bathing in contaminated water. Guinea worm is large enough that it can be removed by simply filtering water through a cloth strainer. As a result of an intense United Nations campaign to educate communities on how to prevent reinfection of water supplies and how to strain water, the incidence of guinea worm has declined from 4 million in 1990 to 500,000 in 1995 (UNICEF 1995). Removing these worms from drinking water is most easily accomplished through simple filtration, and the worms are best controlled through improving sanitation to prevent recontamination of water supplies. Therefore, these diseases will not be greatly reduced through disinfection of drinking water alone (Feachem et al. 1983).

Category 1, 2, and 3 pathogens (viruses, giardia, entamoeba, waterborne bacteria, and roundworm) are endemic to all regions of the world; typically, a sizable percentage of a community is a carrier of these pathogens. The exact location of communities with high rates of infection attributed to any one of these pathogens (e.g., giardia) is difficult to determine because the symptoms are similar for a number of enteric diseases, and reported health statistics are usually lumped together under the category of "diarrhea." Figures 1.2-1 through 1.2-3 show maps of the distribution of trachoma, schistosomiasis, and guinea worm, respectively.

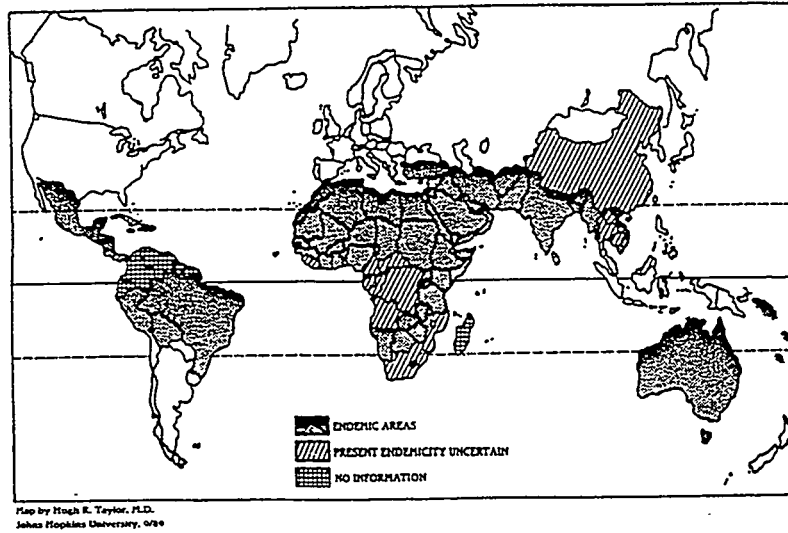

Figure 1.2-1. Map of the distribution of Trachoma (Esrey et al. 1990).

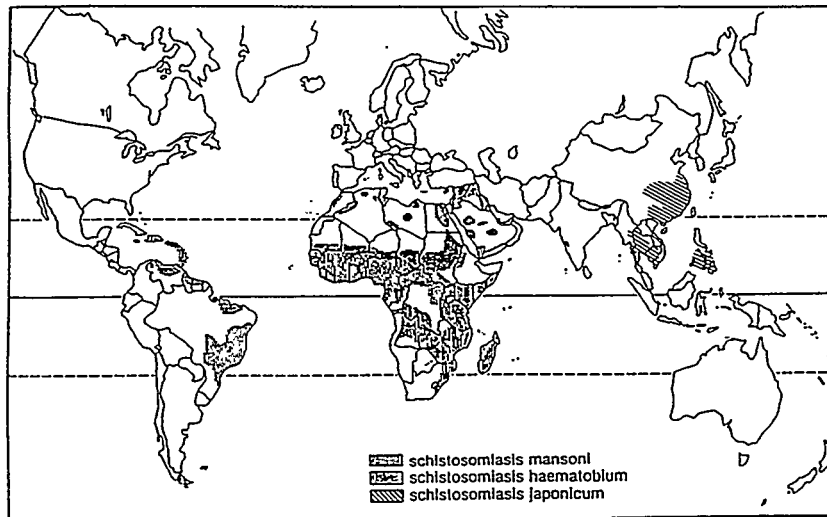

Figure 1.2-2. Map of the distribution of Shistosomiasis (Markell 1986).

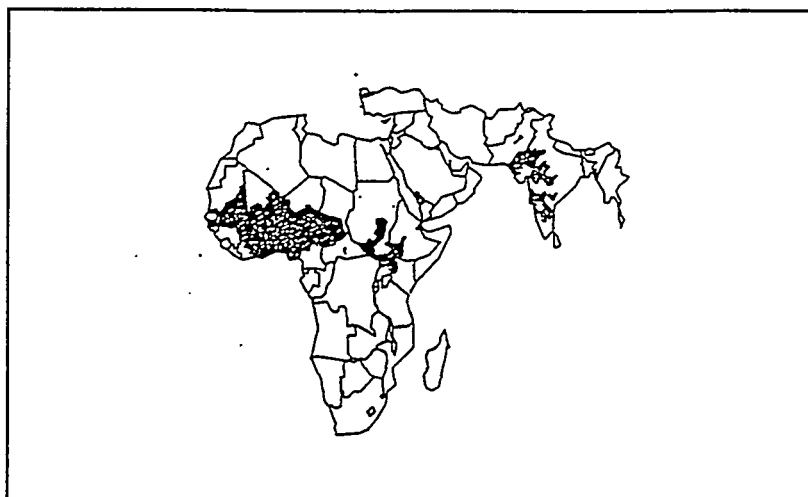

Figure 1.2-3. Map of the distribution of Dracunculiasis (guinea worm) (Esrey et al. 1990).

1.3 Benefits of Water Disinfection and Improved Sanitation

Although water disinfection significantly improves health, it is not a panacea for waterborne diseases, most of which are transmitted through the fecal-oral cycle. Any contact between the feces of a contaminated person and what another person ingests (e.g., water, food, or dirt) may result in spreading the disease. Widespread, effective waste sanitation breaks the fecal-oral cycle at the source and would greatly reduce pathogen intake. Generally, the balance between intervention measures (supply disinfection, hygiene education, additional water supply for hygiene, and sanitation) should be carefully weighed and optimized (Feachem, McGarry, and Mara 1977). Thus, it is important to be realistic about the benefits that will actually be obtained from water disinfection alone.

Esrey et al. (1991) compared the results of 144 studies of the impact of improved drinking water quality, water quantity, and sanitation on the occurrence of six categories of disease. Table 1.3-1 indicates that success is highly variable, although high reductions in diarrheal mortality and worm infections were reported in all studies. Table 1.3-2 indicates qualitatively the potential for improvement by disease and by specific intervention combinations. Water disinfection alone can be expected to reduce the incidence of diarrhea by about 15%, as shown in Table 1.3-3.

Table 1.3-1. Expected Reduction in Morbidity and Mortality from Improved Water and Sanitation for Selected Diseases

Disease	Median Reduction (%)	Range of Reductions (%)
Ascariasis	28	0 to 83
Diarrheal diseases		
Morbidity	22	0 to 100
Mortality	65	43 to 79
Dracunculiasis	76	37 to 98
Schistosomiasis	73	59 to 87
Trachoma	50	0 to 91

Source: Esrey et al. 1991

Table 1.3-2. Potential Improvement in Morbidity Rates from Water and Sanitation Interventions for Selected Diseases

Disease	Intervention			
	Improved Drinking Water Quality	More Water for Domestic Hygiene	More Water for Personal Hygiene	Human Excreta Disposal
Ascariasis	+	++	-	++
Diarrheal diseases	+	++	++	++
Dracunculiasis	++	-	-	-
Schistosomiasis	-	++	++	++
Trachoma	-	+	+	-

Source: Esrey et al. 1991

Notes: ++ denotes a strong impact; + denotes a moderate impact; - denotes little or no impact. For a particular disease, a package of interventions with pluses is expected to produce a larger impact than any one intervention. Improved drinking water quality means appropriate filtration or disinfection. Domestic hygiene includes washing cooking utensils, floors, and food; personal hygiene includes hand and face washing. Human excreta disposal means isolating feces from drinking water and dirt around the home.

Table 1.3-3. Expected Reduction in Diarrheal Disease Morbidity from Improvements in One or More Components of Water and Sanitation

Improvement	Mean Reduction in Morbidity (%)
Water and sanitation	20
Sanitation	22
Water quality and quantity	16
Water quality	17
Water quantity	27
Hygiene	33

Source: Esrey et al. 1991

1.4 Relevant Water Characteristics

Characteristics of the water to be treated influence the design of appropriate water treatment systems. Characteristics for disinfection include the water source, turbidity, color, pathogen content, and hardness. The general effects of these characteristics on different types of treatment systems are discussed in this section.

1.4.1 Source

The source of the water determines the characteristics of the water. Water sources, in order of decreasing quality, include springs, boreholes, sealed wells, hand-dug wells, streams, rivers, and lakes. Boreholes are wells drilled with a drilling rig, and, like springs, tap groundwater sources that have been filtered through layers of soil and rock and are isolated from the surface. These sources may contain unpleasant color, odor, or minerals but are generally free from pathogen contamination and, therefore, will not require disinfection. Sealed wells are shallow wells that have been sealed with cement around a pump to prevent contamination. However, contamination is possible, and sealed wells are often treated with chlorine. Hand-dug wells are typically contaminated. Wells become contaminated from contaminated water entering the well from above, particularly during flooding. Improper drainage (sloping in toward the well) also promotes well contamination. Finally, depending upon upstream conditions, streams, rivers, and lakes usually contain pathogens and require treatment.

1.4.2 Turbidity and Color

Turbidity, or the amount of solid particles in water, is commonly measured in nephelometric turbidity units: (NTU), an index of the scattering of light passing through the water. Turbidity levels for common water sources are given in Table 1.4.2-1. The turbidity of well water is quite low, while the turbidity of dirty river and lake water may be several orders of magnitude greater. As a result of population pressures, increased development, and decreasing costs of pumping water from wells, the aquifer resources are declining in many parts of the world. It can be expected that future use of the more turbid surface water will increase relative to well water usage (Feachem, McGarry, and Mara 1977).

Table 1.4.2-1. Water Turbidity Levels

Source	*Turbidity (NTU)
Well water	1–10
Small streams	5–100
Rivers	10–2000
Lakes	10–1000

Sources: Feachem, McGarry, and Mara 1977; EPA 1991

*Maximum NTU allowed in the United States—1; maximum NTU allowed by the World Health Organization—5.

Turbidity decreases the effectiveness of most disinfection systems. A notable exception is pasteurization. The effectiveness of pasteurization is *not* influenced by turbidity. Turbidity comes from scattering centers in the water, including dissolved ions and suspended material such as small particles (e.g., bits of organic matter), fecal matter, or colloids (micron-sized clay particles). These particles can reflect or absorb ultraviolet (UV) radiation, decreasing the effectiveness of UV disinfection. In addition, these particles, particularly colloids, serve as shelters for microorganisms, shielding them from UV and chemical disinfectants. Finally, high turbidity levels cause filters to become clogged rapidly, thereby increasing the filter maintenance needs. In addition to particulate turbidity, certain organic acids found in soils and ions found in anaerobic aquifers can add color to the water and can absorb UV radiation.

Turbidity and color can be removed by several pretreatment methods. Sedimentation basins allow most larger particles to settle out of the water. Coagulation chemicals are added to the water (often followed by

flocculation, or mechanical mixing), which causes the small particles and larger molecules to stick together and form larger particles that settle or filter out more easily. Filtration is the most common pretreatment method (see Section 4.2.3). Filters can be designed to remove particles of any size. Particles smaller than the pore size are removed by complex adsorption processes. The most common filters remove particles down to 25 micrometers (μm), eliminating most of the turbidity, and also remove organic and ionic color. When treating surface waters, pretreatment to remove turbidity must be included in the cost of chemical, UV, and filtration systems (Feachem, McGarry, and Mara 1977; Schulz and Okun 1984; Cheremisinoff 1995).

1.4.3 Pathogen Content

The effectiveness of treatment systems also depends on the types of pathogens present. Section 4 discusses some of the specific pathogen spectrum issues that arise with specific technologies. Protozoa form cysts when under stress. Cysts have a tough, protective encapsulation that is resistant to UV and chemical disinfection. Worms and worm eggs are also resistant to UV and chemical disinfection. Viruses are difficult to remove by filtration because of their small size. Bacteria present a unique challenge to UV disinfection because bacteria contain enzymes that allow them to repair their DNA after it has been damaged by UV radiation via photorepair (in the presence of light) or dark repair (in the absence of light). These mechanisms allow bacteria to gradually "regenerate" themselves after exposure to radiation (Ellis 1991; Carlson et al. 1985). Therefore, water treated by UV disinfection must be used within 36 hours (Weintraub 1997). Village-scale data on pathogenic contamination by pathogen types is rarely available. Ideally, such data would be gathered to properly design a water treatment facility (Wegelin 1996).

One issue of concern with any water treatment that does not leave residual disinfectant in the water is the potential for recontamination of the water after treatment and before ingestion. Recontamination often occurs when people dip contaminated hands or utensils into a storage container; leaky distribution pipes are contaminated during periods of heavy rains; storage containers containing snail hosts allow multiplication of worm pathogens such as schistosomiasis. Several options are available to prevent recontamination. A commonly recommended option is chlorination, which leaves a residual in water that can disinfect subsequent contamination. The most important option is education of the users so that they do not dip unwashed hands or utensils into storage vessels. Finally, disinfection of water just before it is used removes the potential for recontamination.

Bacterial multiplication (a separate phenomenon from bacterial regeneration) after treatment could be an issue. Most disinfection systems do not completely eliminate bacteria, and some bacteria will remain in the treated water (because millions of bacteria may be present in every milliliter of untreated water). Under ideal conditions, bacteria can double as quickly as once every 20 minutes (Sanchez 1997). However, conditions are rarely ideal for bacteria growth, and most observations have reported die-off of bacteria in treated water over time rather than regrowth (Sanchez 1997). Storage is a simple method for reducing the microbial load; one day of storage of otherwise untreated water can result in die-off of more than 50% of most bacteria (Feachem, McGarry, and Mara 1983).

1.4.4 Water Hardness

Water hardness affects the maintenance of some treatment systems. Hardness is a measure of the scale-forming potential for calcium and magnesium ions. The ions can precipitate and form a hard crystalline scale, which can foul pipes and heat exchangers. Scale is of particular concern with high-temperature systems such as pasteurization. Also, hardness increases the amount of salt consumed by mixed-oxidant generators (MIOX Corporation 1996).

Disinfection effectiveness for first-order rate processes (i.e., chemical and radiation methods) is usually denoted by "x-log" or "x-nines." For example, a 3-log (or 3-nines) effectiveness, which is generally recommended as the minimum effectiveness by the U.S. Environmental Protection Agency (EPA), removes 99.9% of a particular pathogen type (bacteria, virus, or protozoa) (EPA 1991). Many water supplies have pathogen concentrations on the order of millions per mL, so that 3-log disinfection can still leave behind thousands of pathogens per liter.

2.0 Market Analysis

This section analyzes the market for small-scale systems appropriate for single families to larger villages. Renewable energy marketing opportunities are more likely to be found within this range than in larger urban areas. Larger urban areas usually have access to central treatment plants, where there will likely be an extensive technical infrastructure to support the cost-effective and well-developed treatment techniques familiar in the developed countries. Data stratifying developing country population in these size scales has not been found. Therefore, we introduced a market stratification that allows some quantitative (and very uncertain) estimates and implies specific marketing approaches. Information needs are given in Section 2.3.

Although the focus here is on markets in developing countries, other markets for disinfection exist in the developed world, including: (a) small rural communities, (b) national and state parks, (c) Native American reservations, and (d) backpackers and campers. MIOX (1996) provides some estimates of the size of these U.S. markets; however, these markets are not included in our analyses.

2.1 Total Market Size in Developing Countries

Appendix B provides a compilation of World Development Indicators as reported in the World Bank's 1994 *World Development Report*. Population in about 120 countries is classified as urban and rural with and without access to "safe" water supplies.¹ Table 2.1-1 shows regional summaries. As expected, high percentages of the population without access to safe water exist in sub-Saharan Africa, Asia, the Middle East, and Latin America. The total percentage is highest in sub-Saharan Africa, where approximately 70% of the rural population has no access to safe drinking water.

Table 2.1-1. World Bank Development Report Summary for Selected Areas

Region/Country	Total Population (Millions)	Urban/No Access (Millions)	Rural/No Access (Millions)	Total Percent/ No Access
East Asia	1339	41	279	24
Latin America	432	34	58	21
Middle East	328	7.7	70	24
North Africa	116	1.2	18	17
Pacific Islands/ Australia	25	0.02	3	12
Southeast Asia	1411	94	343	31
Sub-Saharan Africa	488	26	225	45
Total	4319	203	996	28

¹"Safe" is defined by the World Bank as treated surface waters or untreated waters from springs or protected wells or boreholes within a reasonable distance. In urban areas, a reasonable distance is defined as 200 meters. In rural areas, a reasonable distance does not require household members to spend a disproportionate part of the day fetching water. Supply systems may include private taps, public wells, or public standposts (World Bank 1994).

Market data from various sources are not always consistent. Figures 2.1-1 through 2.1-3 show 1970 statistics on percentages of urban and rural population without adequate water. Figure 2.1-1 implies that in developing world rural and urban areas about 90% and 30%, respectively, are without access to adequate water, whereas the 1994 World Bank Study indicates "no safe access" for about 40% and 10% for rural and urban areas, respectively. Similarly, it appears the percentages in Figure 2.1-3 are much higher in selected countries than in the World Bank data. Using these sources, we can estimate the total population at risk as one to three billion.

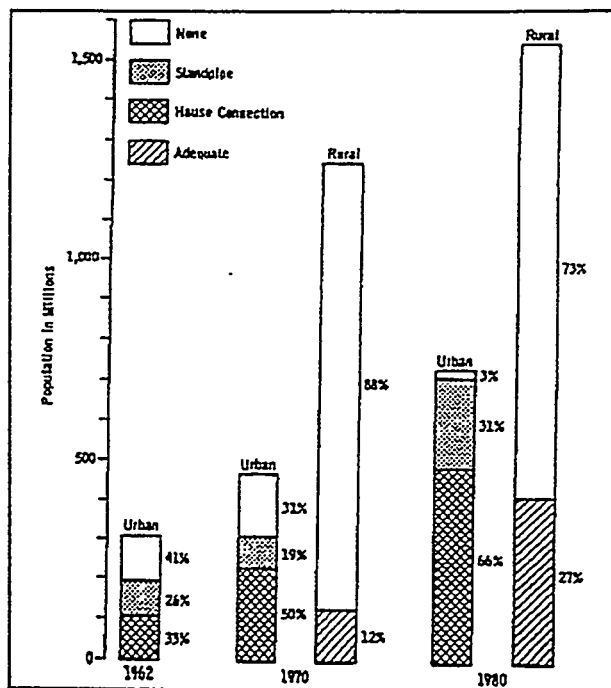

Figure 2.1-1. World Health Organization estimates of populations in developing countries provided with/without adequate drinking water (Feachem et al. 1983).

2.2 Market Characterization

The water disinfection market in developing countries is extremely diverse compared to the developed countries. For example, three interrelated key issues are: (1) financial resources to acquire and maintain treatment, (2) technical infrastructure for operation and maintenance, and (3) willingness to pay for treatment. Because developing countries vary in development status, the resolution of these issues will vary widely, affecting choice of system.

2.2.1 Basic Market Parameters

We discuss the following data parameters in this section: population density, volume of water consumed per capita, water characteristics, income, access to supplies and services, technical skill, local labor costs, understanding of the relationship between disease and water quality, and electricity supply. The National Renewable Energy Laboratory (NREL) is conducting a study funded by the U.S. Department of Energy (DOE) Solar Thermal Electric Program to clarify small-scale market size and characteristics (Lilienthal 1997).

Average daily water demand on the treatment system is obviously a key parameter for estimating the market potential of systems with varying design capacities. Ideally, we would like to produce a histogram giving the

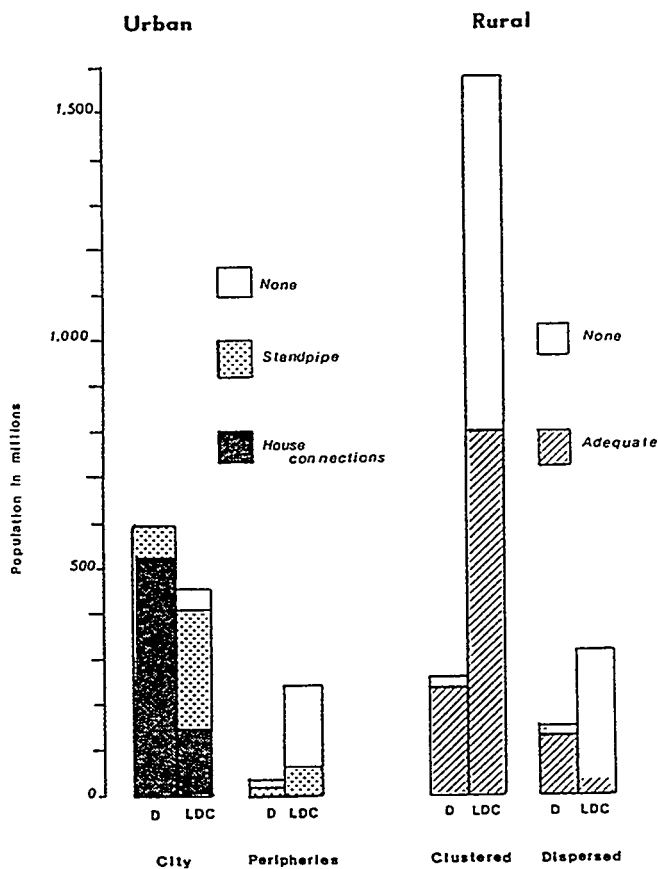

Figure 2.1-2. Estimated distribution of water services for 1970, D=developed, LDC=less-developed countries.

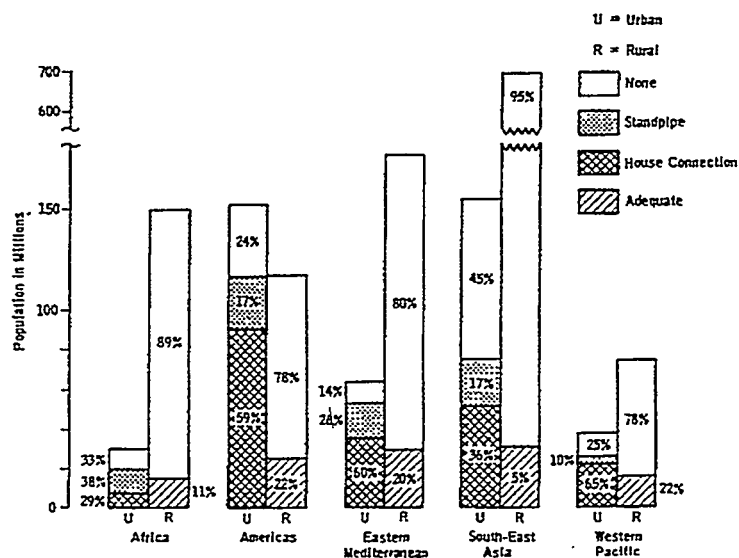

Figure 2.1-3. World Health Organization estimates of population of developing countries in tropical areas with adequate water.

potential number of systems versus the system capacity. The number of people served by a treatment facility times expected per capita water use determines the demand on the system and its capacity. The number of people served by a single treatment system ranges from a single family to an entire village (with either a few public or many private taps off the central water system). Village sizes will vary continuously up to a maximum size of interest. The maximum size of interest here is roughly 10,000. However, data regarding village size and distribution have not been found. Another consideration in estimating market by demand is that in cities with existing larger distribution networks, the market might include individual families who want to treat their private tap water or peri-urban slums without public supply (see Section 2.2.3). In this case, population density does not relate to the capacity of a potential disinfection system.

Per capita water consumption variations are shown in Figure 2.2-1. Consumption ranges from drinking water only (4 liters per day [lpd]) to include dishwashing, domestic hygiene, personal hygiene, showering, watering livestock, and irrigating (hundreds of lpd). Consumption is a highly elastic function of cost and convenience of water supply. Supplying private taps will greatly increase consumption versus when water is ported from public taps (World Bank 1993). UNICEF recommends the use of 45 liters per capita per day (lpcpd) of treated water as a rough guideline for system capacity (Jordan 1980). For comparison, per capita water consumption in Canada is currently about 450 lpcpd (McFadyen 1997).

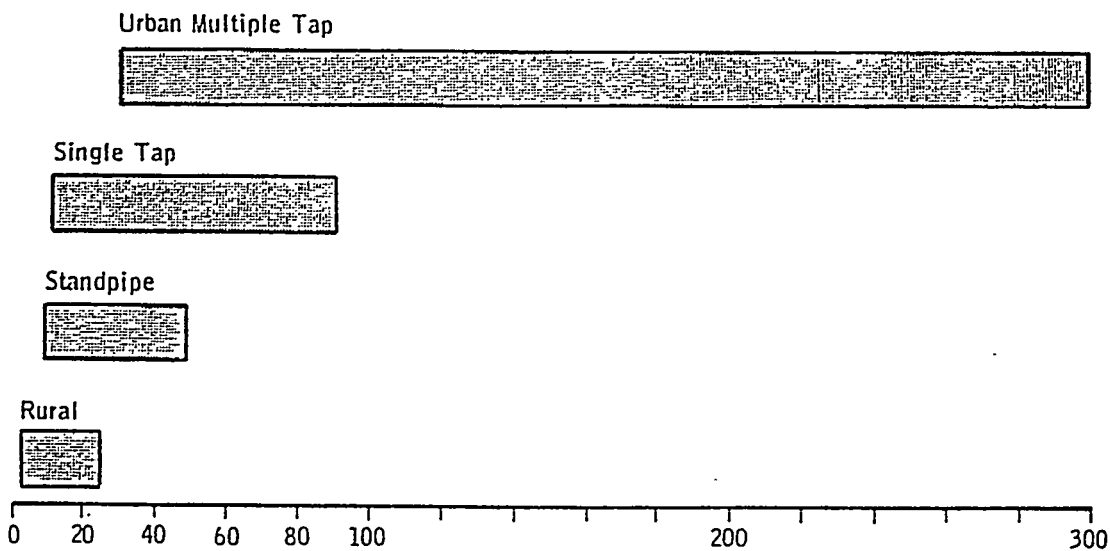

Figure 2.2-1. Range of daily consumption per person in liters for major classes of water use (Feachem 1983)

Water characteristics, such as turbidity and presence of pathogens (see Section 1.4), affect the choice of system and the market potential. The water used may be untreated or it may be treated but of questionable quality. Data of this kind are mostly nonexistent (Feachem 1973). Data on the water source (e.g., percentages by location; springs, boreholes, sealed wells, hand-dug wells, streams, rivers, or lakes) may be available in some areas. Because water characteristics are roughly correlated with water sources, such data would be of great interest for market assessment.

In many countries income is well under \$1,000 per year. Therefore, one can quickly conclude that disinfection cost is a key issue and must be as low as possible, and that willingness to pay for water treatment must be relatively high because water treatment acquisition and maintenance will be relatively costly compared to developed country norms. We would like to know how income is correlated with population size (related to capacity), though we would expect income to decrease as population size decreases. Water treatment needs likely increase with decreasing population size and with decreasing income level. Per capita gross national product is given in the World Bank Data in Appendix B.

Any installed technology that cannot be properly operated and maintained is useless. The literature is replete with failures that resulted from an inability to maintain water treatment and supply systems. A good lesson is the case of the widespread promotion of sealing wells. In principle, sealing wells are a good idea for preventing well contamination. Sealed wells require pumps, such as hand pumps. In some areas, the hand pumps could not be maintained, so that the sealed wells became useless: back to square one. Foremost, the users must value the system or it will not be maintained (World Bank 1993; WASH 1993). Thus, to understand appropriateness of technologies and their possible market share, the maintenance needs must be carefully defined. Access to a technical infrastructure for parts, training, and supplies will vary widely. For example, urban markets may have good access to a continuing, high-quality supply of depletable chemicals, whereas remote areas may not.

Education level influences maintenance practices. Complex operations (e.g., monitoring the residual chlorination and adjusting dose rate to reach suitable targets) demand significant training and might not be compatible with the local situation. An interesting anecdote was given by Feachem (1971). When the local personnel for plant operation had been trained, they became employable at higher wages elsewhere and tended to leave their positions for greener pastures soon after training was completed. It was very difficult to maintain a pool of trained operators. On the other hand, it might be presumed that unskilled labor would always be available.

Market assessment is clearly affected by electricity supply. Off-grid locations cannot use electrically driven systems (e.g., ultraviolet radiation and mixed-oxidant gas generation on demand [MOGGOD]) unless electricity is supplied (e.g., from wind, photovoltaics [PV], diesel with the system or from a minigrad), which increases the costs significantly. We would expect that as village size decreases, the off-grid percentage rises.

An understanding of the relationship between disease and water quality is essential to motivating purchases and maintenance of water treatment systems (see Section 2.2.2). As education level and income decrease, we expect the understanding of disease causes to decrease, along with motivation to spend scarce resources on water treatment.

2.2.2 World Bank Study

An excellent introduction to the issue of markets for water systems in developing countries was recently produced by the World Bank's Water Demand Research Team (World Bank Water Demand Research Team 1993). The team found that people must both want and be willing to pay for water services. There are two important implications. First, if people are not willing to pay the full cost of water treatment, the private-sector

resources cannot be used effectively and water services will not be sustainable, maintained, or widely installed. Second, the limited subsidy resources for water/health should be applied only when the services are self-motivated (requested) and the people are willing to pay at least part of the true cost. It is hard to say whether this philosophy preceded or emerged from the study.

People's water supply choices were surveyed and directly observed in Brazil, Nigeria, Zimbabwe, Pakistan, India, Haiti, Tanzania, and Kenya. The team determined how much people are willing to pay for water as a function of demographic variables. Variables included education, occupation, size of family, gender, income, existing water supply options (cost, quality, and reliability), potential water supply improvements, and people's attitudes towards government (whether or not they felt entitled to government services or whether they distrusted the government). The researchers found that people's willingness to pay for a new water source is primarily affected by whether the new source provides a significant increase in quality, convenience, and reliability over the existing source; whether the people recognize the value of improved water quality (which correlates to level of education); cost of the new source; and whether or not the people are willing to wait for government subsidies. The researchers found that many households are willing to pay high costs—as much as 2% of their income for private connections—for water services in some parts of Africa, people are already paying 9% of their income for water from vendors that is of questionable quality. Therefore, a successful disinfection technology is best marketed where awareness of quality issues is high and where it is significantly more reliable and convenient to use than the alternatives. Also, a successful marketing strategy would likely include education regarding the benefits of disinfected water.

The World Bank study identified four types of villages:

Type 1. Those able and willing to pay for private but not public connections (large villages in Southeast Asia, South Asia, Central and Latin America, and North Africa).

Type 2. Those able and willing to pay for public connections but not able to afford private connections (better-off villages in Africa, poorer communities in Asia and Latin America).

Type 3. Those willing to pay for public connections but not able to afford the full cost (places where water cost is very high relative to income (e.g., very arid areas with low population density).

Type 4. Those not willing to pay for water (communities which think water is the responsibility of the government and still believe that the government will follow through with its promises (e.g., Zimbabwe).

In Types 1–3, people are willing to pay a significant percentage of their income to obtain an improved supply of water. If quality is perceived as an issue, they would probably also be willing to pay an incremental amount to ensure that their improved supply is also safe to drink. The ongoing NREL market study mentioned above may be a source of future insights or data on the fraction of the populations by country that fall into similar categories as regards water quality. The questions include what fraction of the population (by country, and as a function of village size) perceives water quality as an issue and would be willing to pay for improved quality.

2.2.3 Promising Market Segments

According to the World Bank study, market potential is most influenced by user "motivation": perception of water quality needs and willingness to pay for treatment. Based on being able to roughly gauge motivation, we can order market segments from high to low motivation (and thus, level of market potential). This stratification also provides some rationale for estimating system installation potential, factoring in both size and motivation. According to the study, the estimated market potential of water disinfection systems for single

families is 7.8 million and for villages 8.6 million. The urban markets are somewhat accessible. Remote markets are inherently difficult to reach and any penetration would be difficult.

2.2.3.1 Small Single-Family-Scale Systems

SF-1 Urban Dwellers Who Currently Boil Their Water

Anecdotal evidence from a variety of sources (World Bank 1992; Allderice 1997; Ayarza 1997) indicates that a significant percentage of the residents (particularly well-educated, upper-class residents) of cities in South and Southeast Asia and Latin America do not trust the quality of the municipal water supply and therefore boil all of their water before drinking it. These anecdotes are somewhat inconsistent with *1994 World Development Report* data, which equate treated water with safe water. Generally speaking, community systems may be of unreliable quality (common in medium to large villages in the developing world which use full-scale water treatment but do not have the expertise to properly operate and maintain the water treatment [Schulz and Okun 1984]). These people represent a good market because they already realize the benefits of disinfection through pasteurization and are already paying very high costs (see Section 4.4.1) to pasteurize their water. These people should be willing to purchase a disinfection system if it were more convenient and significantly cheaper than boiling water over a stove and if they were convinced that it was just as effective. According to the *1992 World Development Report*, more than \$50 million per year is spent in Jakarta alone for fuel to boil water in households. The size of the market segment, however, cannot be estimated with any certainty. To provide an order-of-magnitude estimate, we took 3% of all urban dwellers not in cities over a population of 1 million people. Using Appendix B data, this algorithm yields an estimate of 28 million people, or about 4.7 million systems assuming a family of six.

SF-2 Peri-Urban Dwellers

Rapidly growing communities on the fringes of large cities (often called "peri-urban" populations and categorized by the World Bank as urban) lack access to municipal infrastructure such as treated water supplies. These people often live in squalid conditions. The "entrepreneurial scenario," where one individual would operate a business selling treated water (thus easing the financing burdens), may be a good match. Although the needs can be met by extending a tap from the main water supply system, there may be many cases in which people would be willing to pay for treatment of the local, usually polluted, water sources (Singha 1996). The market is also "concentrated" and easier to reach than people in remote locations. Some awareness of disinfection needs can be expected.

We cannot estimate the size of the market segment with any certainty. City-periphery population in developing countries without water services was about 200 million in 1970 (see Figure 2.1-2). It is probably four times that large today (about 800 million). To provide an order-of-magnitude estimate, we take 1% of this value (people who are willing and able to pay for public water supply and treatment), yielding about 8 million people, or about 1.3 million systems assuming a family of six.

SF-3 Urban Dwellers Distrustful of Water Quality but Currently Not Boiling Water

Some urban dwellers currently not boiling their water realize the importance of water and are willing to pay for it, as is shown by the fact that they have a private tap. However, they do not currently boil their water, and would presumably have relatively low awareness of water quality problems. Generally speaking, community water supply systems may be of unreliable quality. A home-treatment system might also prove desirable to eliminate recontamination from the drinking water, and/or to treat giardia and amoebic dysentery, which are not easily disinfected by chlorination (Ellis 1991; Hoff 1986). To provide an order-of-magnitude estimate, we take 3% of all urban dwellers not in cities over a population of 1 million people. Using the same algorithm

used for SF-1, this algorithm yields a raw market estimate of 28 million people, or about 4.7 million systems assuming a family of six. However, the motivation level will be much lower than for SF-1. Arbitrarily, we reduced the above raw market estimate by a factor of 5, yielding about 1 million systems.

SF-4 Purchasers of Vendor Water of Questionable Quality

Those who buy water from vendors are spending a large percentage of their income for water of questionable quality in an area where water is scarce during several months of the year. Hundreds of thousands of such people live in the arid and semiarid regions of Africa (World Bank Water Demand Research Team 1993). Because they are already spending such a large amount of money on water (as much as 9% of their spendable income in some places), they might be willing to spend an additional incremental amount to ensure the safety of their drinking water. The motivation for water treatment is not as high as that for SF-1, but is probably higher than that for SF-5.

SF-5 Remote Single Family

This market would encompass remote, isolated families that do not have access to safe groundwater, are from a community too small to justify village-scale technology, and that are too remote for chlorine importation. This situation characterizes rural dwellers in Latin America more so than in Africa (Flowers 1997). Taking 10% of the rural population without safe access, the raw market is estimated at 100 million, or about 16 million systems for families of six. We arbitrarily reduced the market estimate by a factor of 20, yielding about 0.8 million systems.

2.2.3.2 Larger, Village-Scale Systems

V-1 Remote Health Clinics

In many areas of the rural developing world, health care is provided by small health posts. Providing health posts with necessary equipment, such as clean water and lighting, is often the first priority for remote villages. Other needs include sterilization of surgical equipment and distilled water for vaccines. Because health posts realize the need for disinfected water (in many cases they are already boiling their water) and are a high priority in the community and for state governments (i.e., have resources), they could be a significant market for disinfection systems. The health post market is hundreds of thousands of units (Jimenez 1997); we estimated the market at 0.3 million.

V-2 Remote Schools/Other Institutions

Other central village institutions such as schools and post offices may be a market for on-site disinfection systems in villages lacking a central water treatment facility. These institutions, often the only institutions in the village, may have villager and government resources to provide water quality. The directors of these institutions will likely be aware—as a result of higher education and broader interactions—that they need water disinfection. The institutional market is estimated at 10% of the number of villages having unsafe water, or about 0.2 million systems.

V-3 Villages

The total number of villages without safe water² and not included in Category V-2 is about 1.6 million. The realistic market would consist primarily of Type 2 and Type 3 communities, which are willing and able to afford a central village water tap (but not private taps). This includes the poorer villages of Asia and Latin America and the better-off villages of Africa. There could be some Type 1 communities without water treatment that would desire water treatment. The village market is taken as 5% of the number of villages in this category, or about 0.1 million systems.

2.3 Market Information Needs

Most water treatment systems in developing country villages are installed with the aid of governmental agencies and nongovernmental organizations (NGOs). The NGOs active in a country may be the best source of market data for that country. A list of NGOs involved with water treatment is given in Appendix C. A useful Web site is <http://www.oneworld.org/ircwater/index.htm>, which lists some NGOs active by country (Hartzell 1997). Data from the knowledge and experience of the NGOs should be coordinated and compiled.

Population density data have not been located on the small scales of interest. Histograms by country providing the number of villages by size of village would be the desired form. Dispersed single families might be considered as "very small villages" or as a separate category of data. Cross-correlation of these data with any other parameters of interest (see Section 2.2) would be desirable, though likely not available. For example, within the various size bins, how many have unsafe water sources (surface water or shallow wells), lack electricity, or are willing/able to have a community water supply and treatment system, and so on.

Water boiling is a key indicator of a good disinfection market; it indicates that motivation for water treatment is very high. Useful market data pertaining to water boiling could be provided by questions such as: How many people currently boil their drinking water? How many of these people are in concentrated urban environments, in peri-urban settings, in villages, and in dispersed homes? How much do they pay for fuel? How much would they be willing to pay in up-front capital cost to avoid long-term fuel cost? In urban populations that boil water, how many have access to electricity and what fraction have water containing chemical/UV-resistant cyst and worm pathogens?

Other questions include: Of those in the World Bank category of "lacking access to safe water," how many lack access to quality water (as opposed to an adequate quantity of water)? What percentage of water sources that are of poor quality have turbidity of such high levels that filtration would be required as pretreatment for slow sand filters, chlorination, and UV disinfection systems? How many village health posts lack electricity and currently boil water to sterilize medical instruments and drinking water? How many people currently buy water from vendors during at least one season of the year that they consider unsafe?

²The number of villages is computed from Appendix B data as 90% of the total rural population divided by an average population size of 500. This algorithm yields a total number of villages (both with and without access to safe water) of about 4.6 million. The number of villages without access to safe water is about 1.8 million, using population ratios from Appendix B data.

3.0 Disinfection Technologies: General

3.1 Technology Classification and Selection

General classes of appropriate water treatment are sedimentation, coagulation/ flocculation, filtration, chemical addition, UV radiation, and pasteurization. Radiation, heat, and chemical methods are the only types of water treatment that can technically be called disinfection, because they actually kill the pathogenic microbes (as opposed to simply removing them). As a number of water treatment techniques are used to make water safe to drink, the terms disinfection and water treatment are interchanged in this report, although technically, disinfection is a subset of water treatment.

The number of treatment techniques used in the developing countries is staggering. Sedimentation ranges from simple holding ponds to engineered ponds with weirs designed to attain specific holding times based on calculated settling rates. Coagulation/flocculation may be used with both natural substances and manufactured chemicals. Filtration methods include diatomaceous earth, porous ceramic, rapid sand, slow sand, cartridge, activated charcoal, local media (including the use of coconut shells and rice hulls), silver-coated porous ceramic, artificial recharge, and river bank infiltration. Chemicals are the most widely used treatment method worldwide. Very simple batch processes (such as chlorine compounds) are widely promoted in many smaller-scale markets. There are automated dosing plants suitable only for cities with good access to technical infrastructure and training. Many forms of pasteurization have been implemented. Thus, disinfection is highly complex, with success and user satisfaction varying with combined market and technology characteristics. Appendix D provides a brief summary of some of the many options and their limitations for use in developing countries. This appendix explains why certain treatment options (e.g., iodine treatment and ozonation) were not selected for more detailed analysis.

Technologies were selected for analysis in this report based on: (a) appropriate water production scale (<30 m³/day), (b) adequate or potentially adequate cost-effectiveness, (c) reasonable maintenance requirements, and (d) historical NGO choices. The latter condition is most important. Most water treatment systems in developing country villages were installed with the aid of governmental agencies and NGOs. Any water treatment technology must compete for the confidence of the NGOs that install water treatment systems. Worldwide, most NGOs have concentrated on a few water treatment technologies for use in developing country villages: chlorine bleach, slow sand filtration, and household sand or ceramic filtration. Roughing filtration is commonly used as pretreatment where prefiltration is necessary (i.e., with highly turbid waters). In addition, two new technologies have recently gained the attention of the NGO community: UV light and MOGGOD technologies. Emerging solar technologies are also examined.

3.2 Technology Characterization: General

Technology intercomparison involves cost, performance, cost-effectiveness, operations and maintenance (O&M) requirements, and appropriateness. Cost, performance, cost-effectiveness, and O&M costs are relatively straightforward, and the methods used are discussed below. Appropriateness is a complex topic, depending on the actual market being considered (see Section 2.2). The appropriateness indicators are need for skilled labor, need for unskilled labor, and need for supplies (repair parts and any continuing supplies such as chemicals). These needs are categorized as none, low, medium, or high, and are considered key to a good technology choice.

Because the particulars of the water distribution system will be site specific, water distribution costs were left out of the analysis. However, central disinfection facilities will require some sort of distribution network, whereas systems for a village tap or an individual home may be incorporated into the villagers' current system

of obtaining water (though a storage tank may be required for some options). In addition, pumping costs were not included: most of the treatment systems described in this report do not require pumping. UV, MOGGOD, and drip chlorination systems require no pumping for the water treatment system itself, although pumping would be needed for the central distribution system. Because of the pressure drop across filters, filter systems require some method to pressurize water. In some cases, the pressure can simply be supplied by gravity. Because the particulars of gravity feed will vary from site to site, head drops across filters are mentioned in the text, but pumping needs are not included in the energy demand or capital costs. Head drops also occur across heat exchangers. For the solar thermal systems considered in this report, head drops are not expected to be greater than 1 centimeter (cm) of water.

3.3 Cost Analysis Methodology

Costs are intended to be user costs in 1997 U.S. dollars. First cost (hardware and installation labor) and O&M costs must be considered. A conventional life-cycle cost (LCC) analysis is used, assuming a discount rate of 20% and an inflation rate of 10% for all future costs. Two normalized indicators of water disinfection cost are the life-cycle cost per unit volume of water produced, and the capacity cost (first cost per unit of daily capacity). The following algorithms were used:

$$LCC = (\text{First Cost}) + (\text{Annual O\&M cost}) * PWF(N_{\text{years}}, d, i)$$

where:

First cost = U.S. hardware cost * 1.3 + installation cost

Installation cost = (Skilled hours)*(Skilled hourly rate) + (Unskilled hours)*(Unskilled hourly rate)

Annual O&M cost = Fuel operating costs + replacement hardware cost + (Skilled hours)*
(Skilled hourly rate) + (Unskilled hours)*(Unskilled hourly rate)

$PWF(N_{\text{years}}, d, i)$ = present worth factor, Equation 11.5.1 in Duffie and Beckman (1991)

where:

N_{years} = equipment lifetime

d = discount rate (0.2 is assumed)

i = inflation rate for all future fuel, hardware and labor costs (0.1 is assumed)

$$\begin{aligned} \text{Normalized water cost} &= (LCC)/(\text{discounted total volume of disinfected water}) \\ &= LCC / [PWF*365*(\text{daily water production})] \end{aligned}$$

$$\text{Capacity cost} = \text{First cost}/(\text{daily water production})$$

For imported products, the hardware costs (first cost and necessary replacement hardware) are generally intended to include shipping and other international market costs that the user must pay. Thus, all U.S. freight on board (FOB) costs are multiplied by 1.3 to account for these incremental international business costs.

Labor costs for installation and maintenance are difficult to quantify. Rather arbitrarily, two labor rates were used, depending on the type of labor needed. A high labor cost of \$0.5/hour (\$1,000/year income) is assumed for "skilled labor" hours, and a cost of \$0.05/hour is assumed for "unskilled labor" hours. In remote village applications, some have recommended zero labor costs (Flowers 1997). Calculations without labor costs are also reported for comparison purposes.

4.0 Appropriate Technology Assessment

Technology costs and appropriateness are summarized in Tables 4-1 (with cost of labor) and 4-2 (without cost of labor) on pages 22 and 23. A graphical comparison of a subset of these technologies is shown in Figure 4-1. Labor hours were somewhat arbitrary, but the values assumed are generally documented in the text. Appendix E contains the detailed spreadsheet we used for cost calculations, with notes (by cell number) on the assumptions made. A number of low-cost/high-cost variations are included in Appendix E. Appendix J provides details on effectiveness by pathogen and maintenance requirements of the technologies. Effectiveness is somewhat of a qualitative indicator, as it depends on correct operation and maintenance and on what pathogens are present in the input water. For example, chlorine (when properly dosed) is effective against viruses and bacteria, but not very effective against cysts and eggs.

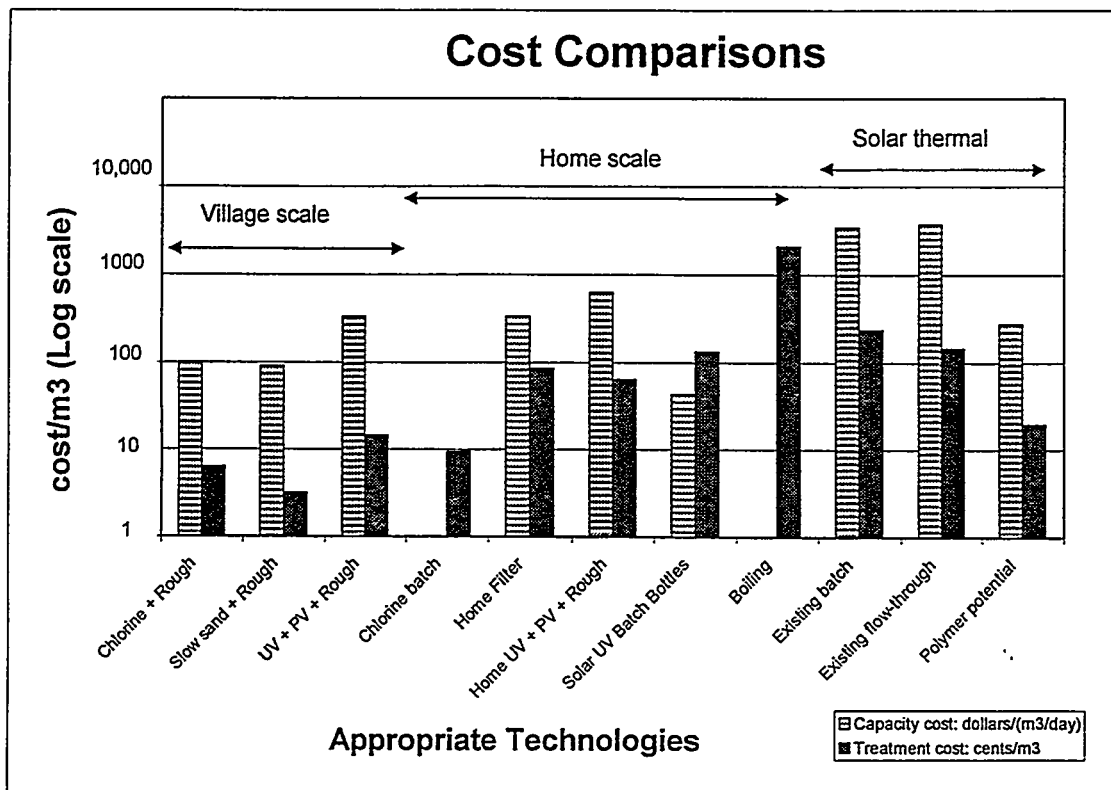

Figure 4-1. Cost comparison between selected small-scale water disinfection technologies. The y axis is the normalized costs on a logarithmic scale. The hatched bar is the capacity cost, which is first cost divided by the daily output of the system in $\$/m^3$. The solid bar is the normalized life-cycle cost of water disinfection in cents/ m^3 .

4.1 Chemical Approaches

4.1.1 Chlorine Bleach

Chlorine is the most common form of water treatment used worldwide. Chlorine is relatively low cost, widely available, and can be applied in many forms and ways. Automated dosing plants using chlorine gas, chlorine dioxide, and chloramines are suitable only for larger towns with trained operators and accessible repair infrastructures. Bleaching powder is generally used in developing countries because it is easier to transport and handle safely. It may be applied as a liquid solution in a central drip-chlorination system, or a 1% liquid solution made from bleaching powder at a central health post and distributed to individual households, who then add a given amount of the solution to every bucket of water. Generally, chlorine is distributed as a dilute

Table 4-1. Appropriate Disinfection Technologies: Cost and Appropriateness Summary
(Labor costs included)

Technologies/Variables	Production	First Cost	Capac. Cost	LC Cost	Effectiveness ¹			Appropriateness ²		
					res ³	b/v ⁴	p/w ⁵	sup ⁶	hi ⁷	lo ⁸
Units or Subcategory:	L/day	\$	\$/m ³ /day	cents/m ³						
Chlorine-dosing plant	24,000	2,400	100	6	***	***	**		*	*
Chlorine (batch, average dose)	200	0	0	9	**	***	*		***	**
MOGGOD	24,000	34,472	1,436	57	***	***	***	*		**
MOGGOD/PV, 24 hr/day	24,000	48,222	2,009	73	***	***	***	*		**
Slow sand filter (low cost)	24,000	1,200	50	2		**	***	***	***	*
Roughing filter (low cost)	24,000	960	40	1			***	***	***	*
Slow sand + roughing filter	24,000	2,160	90	3		***	***	***	***	*
Household filter (low cost)	60	20	333	85		*	**	***	***	**
Sol-UV/batch: bottles	14	1	43	133		**		***	***	**
Sol-UV/flow-through	684	2,574	3,764	144		***	*	***	***	***
UV-WHI/SO.1/kWh ⁹	21,600	687	32	2		***		**	**	***
UV-WHI/PV:8 hr+ roughing filter	7,200	2,366	329	14		***	***	**	**	***
UV/PV/pump (GWT) ¹⁰	10,800	10,004	926	35		***	***	*	**	**
UV-UST200 + filter + PV (4.4 hr)	500	313	625	63		***	**	**	***	**
Water boiling, purchased fuel	20	0	0	2,083		***	***		***	*
Wood-saver (12-hour oper.)	1,361	1,236	908	190		***	***		***	*
Batch solar/Family Sol-Saver	23	78	3,425	235		***	***	***	***	***
Batch solar/SUN tube	19	143	7,537	338		***	***	***	***	***
Batch solar/solar puddle	480	34	70	70		**	**	*	***	**
Flow-through solar/Family Sol-Saver	570	2,145	3,764	144		***	***	***	***	***
Flow-through solar/trough	1,436	5,872	4,088	174		***	***	**	**	***
Flow-through solar/pot. polymer	304	84	276	19		***	***	***	***	***

Notes:

¹Effectiveness scales: High = ***, Med = **, Low = *, None = blank.

²Appropriateness scales: No need = ***, Low need = **, Medium need = *, High need = blank.

³res = residual disinfection ability.

⁴b/v = effectiveness against bacteria and viruses.

⁵p/w = effectiveness against protozoa and worms.

⁶sup = supplies; high need = blank, no need = ***.

⁷hi = highly skilled labor; high need = blank, no need = ***.

⁸lo = low-skilled labor; high need = blank, no need = ***.

⁹WHI = Water Health International product, Section 4.3.2.2.

¹⁰GWT = Global Water Technologies product, Section 4.3.2.2.

Table 4-2. Appropriate Disinfection Technologies: Cost and Appropriateness Summary (No labor costs)

Technologies/Variables	Production	First Cost	Capac. Cost	LC Cost
Units or Subcategory:	L/day	\$	\$m ³ /day	Cents/m ³
Chlorine-dosing plant	24,000	2,400	100	4
Chlorine (batch, average dose)	200	0	0	1
MOGGOD	24,000	34,450	1,435	56
MOGGOD/PV, 24 hr/day	24,000	48,178	2,007	72
Slow sand filter (low cost)	24,000	1,200	50	2
Roughing filter (low cost)	24,000	960	40	1
Slow sand + roughing filter	24,000	2,160	90	3
Household filter (low cost)	60	20	333	57
Sol-UV/batch: bottles	14	0	14	5
Sol-UV/flow-through	684	2,574	3,763	141
UV-WHL/\$0.1/kWh	21,600	683	32	2
UV-WHL/PV:8 hr+ roughing filter	7,200	2,358	327	13
UV/PV/Pump (GWT)	10,800	10,000	926	34
UV-UST200 + filter + PV (4.4 hr)	500	311	622	61
Water boiling, purchased fuel	20	0	0	2,000
Wood-saver (12-hour oper.)	1,361	1,235	908	167
Batch solar/Family Sol-Saver	23	78	3,421	161
Batch solar/SUN tube	19	143	7,526	250
Batch solar/solar puddle	480	33	68	47
Flow-through solar/Family Sol-Saver	570	2,145	3,763	141
Flow-through solar/trough	1,436	5,872	4,088	167
Flow-through solar/pot. polymer	304	83	274	14

solution to remove the hazards associated with concentrated bleaching powder, which can burn skin and is harmful if ingested. Chlorine disinfection can be designed for any size system.

Appendix A lists the chlorine dose needed for disinfection of various pathogens. The chemical dosage equals the concentration of applied disinfectant multiplied by the contact time. Contact time is defined as the time between application of the chemical and consumption by the first user. The dose is the chlorine residual contact, not the total amount of chlorine that must be applied. The total amount of chlorine is the sum of the necessary residual plus the chlorine "demand" of the water, i.e., how much chlorine will be taken up for oxidation of organic and nitrogen compounds in the water. This sum must be determined for each particular water source. Doses for bacteria and viruses are roughly the same. Protozoa, however, require much higher doses because they form cysts when in a hostile environment (see Section 1.4). Some studies have shown that because of the resistance of cysts to chlorine, complete cyst inactivation may not be reached even after eight hours of exposure to typical disinfectant concentrations (Ongerth et al. 1989).

The needed chlorine dose also depends on other factors. The chlorine dose increases roughly eightfold for an increase in turbidity from 1 to 10 NTU, increases roughly tenfold for an increase in pH from 6 to 10, and decreases roughly tenfold for a 20°C increase in temperature (Ellis 1991). With especially poor-quality water,

it may be impossible for chlorine to completely disinfect the water. EPA reports that a chlorine residual of 2 mg/L gives 99.9% disinfection of giardia cysts after 30 minutes contact time in water at 20°C, pH 7, and 1 NTU (EPA 1991). Given that surface water of turbidity greater than 20 NTU is not uncommon (Water for People 1997), the required dose may be as high as 3840 mg-min/L. This would either require contact time of more than a full day or a chlorine dose so high as to make taste objectionable. In addition, because it takes very few giardia cysts to cause an infection, 99.9% disinfection may not be sufficient to completely protect against infection (Sanchez 1997).

Careful measurement is needed to ensure that the proper amount of chlorine is added to disinfect all pathogens in the water. In drip-chlorination systems, adequate operation includes performing appropriate tests and adjusting the equipment for proper dosage. This requires skilled labor. In home bleaching, such measurement is never made, which can result in inadequate disinfection or overchlorination and an unpleasant taste.

A key advantage of chlorine is its ability to leave a "disinfection residual" that can disinfect any pathogens introduced to the water after treatment. A disadvantage of chlorine is that it leaves an unpleasant taste. In many countries, people find the chlorine taste unacceptable and revert to their traditional water sources (Feachem, McGarry, and Mara 1977). Moreover, chlorine can react with organic compounds in the water to form carcinogens such as trihalomethanes (Ellis 1991). These "disinfection by-products" have been the subject of extensive research in the developed world and have led to attempts to minimize the amount of chlorine applied by using such pretreatments as filtration (Ellis 1991). The chlorine-induced carcinogen problem may become more serious in the future, leading to deployment of alternative technologies (Collier 1997). However, in the developing world, the threat of death from waterborne pathogens is so much greater than the small risk of increased incidence of cancer that the use of chlorine for disinfection is still widely advocated.

The primary disadvantage of chlorine is that a constant supply is needed, because liquid bleach degrades over time. (Liquid bleach has a half-life of approximately two months if the container is sealed when not in use. Bleaching powder has a half-life of approximately one year if it is kept dry.) (New Klix Corp. 1997; Harris 1992). Insufficient chlorination may occur when a villager unwittingly uses an old bleaching solution that has lost its disinfecting ability (Ellis 1991). Cholera outbreaks have been reported in India when impassable roads blocked the chlorine supply during heavy storms (Gadgil and Shown 1997). However, when comparing chlorine to more high-tech systems that do not require constant supply, such as MOGGOD and UV, the question arises as to whether it would be more difficult to transport a drum of bleaching powder even over blocked roads or to locate a maintenance technician in the event of a mechanical failure (Niewoehner 1997).

For small-scale treatment plants appropriate for village application, a number of dosing apparatus designs have been developed that are easily constructed and maintained locally (Schulz and Okun 1984). Sedimentation and filtration always accompany the chemical dosing.

Cost

For a home disinfection system (i.e., batch application), the capital cost is assumed to be zero. Labor costs are low, assumed to be 20 minutes of unskilled labor/day. The main cost is the chlorine itself, assumed to be about \$0.01/g (Water for People 1997). The actual amount of chlorine needed will depend on the turbidity, pathogen types, pH, and temperature of the water, and will range from 0.1 mg/L to 5 mg/L (EPA 1991). Therefore, the life-cycle cost of chlorine supply will range from \$0.1 to \$0.5/m³ of water.

For a small-scale chlorine disinfection water treatment plant, the capacity cost was estimated at \$100/m³/day and water treatment costs at \$0.6/m³/day using treatment plant total costs from Schulz and Okun (1984) adjusted to 1997 dollars. Chlorine cost was estimated at \$0.5/g, 1/2 of the batch chlorination cost.

Appropriateness

Summary—batch system: Low cost, residual disinfection capability, easy to use, favored by NGOs as a "good enough" form of treatment. Requires constant supply of chlorine, and it is not effective against cysts or worms at reasonable dosages.

Summary—chlorination plant: Moderate cost, residual disinfection capability, requires skilled labor for operation and maintenance. Requires constant supply of chlorine, and it is not effective against cysts or worms at reasonable dosages. Pretreatment with a roughing filter is generally needed.

4.1.2 Mixed-Oxidant Gases Generated on Demand (MOGGOD) Technology

MOGGOD is the most complex of all of the technologies described in this report. Although several MOGGOD systems, including a few powered by photovoltaics, have been installed in villages, the technology is still new to the NGO and water disinfection communities. A dedicated PV-powered MOGGOD pilot plant was installed in El Volcan, Honduras, with the help of Sandia National Laboratories (Chapman 1996).

MOGGOD consists of an electrochemical cell that electrolyzes salt brine to produce a mixture of oxidants, which include ozone, chlorine dioxide, and hypochlorite. The oxidant is injected directly into the water stream to be disinfected, with the resulting dosage inversely proportional to the treated water flow rate. Some of the oxidant solution can be taken off and distributed for batch disinfection of untreated water.

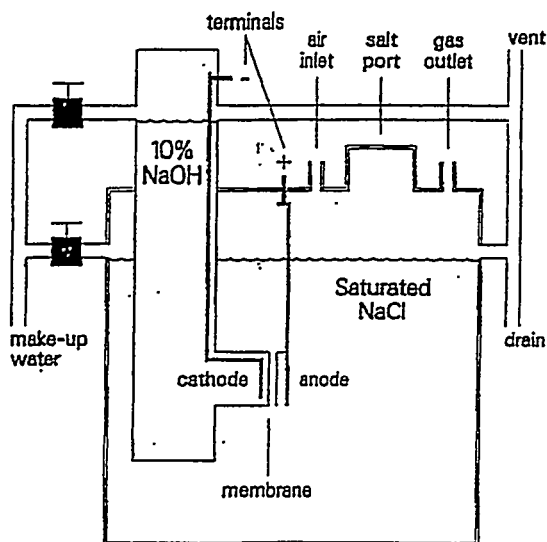

Figure 4.1.2-1. Oxi-2 mixed-oxidant generator developed by Oxi Generators, Inc.

disinfection of bacteria and viruses. A higher dose of 19 mg/L for 240 minutes is required to provide 99.99% disinfection of *Cryptosporidium* (MIOX 1996). These doses are roughly comparable to doses required for chlorine disinfection. No data were available for the influence of pH, temperature, or turbidity on the needed dose. Because mixed-oxidant disinfecting solutions contain less chlorine per mg of disinfectant than chlorine bleach, 60% fewer carcinogenic disinfectant by-products are produced and less of a chlorine taste is produced.

There are several different designs and manufacturers of MOGGOD systems. The primary design difference is between systems that use a membrane to separate the two parts of the electrochemical cell and systems that use density differences between salt and fresh water to separate the two parts of the electrochemical cell. The latter method is preferred for use in developing countries, because membranes are costly and require periodic replacement and delicate handling. U.S. manufacturers include MIOX and Oxi Generators, Inc. A diagram of the Oxi Generators, Inc. Oxi-2 system is shown in Figure 4.1.2-1. MIOX systems are not produced in sizes smaller than 4 cubic meters per day capacity at highest dosages, and therefore might be suitable only for villages greater than about 100 people, or typically 1000 people at moderate consumption.

The mixture of oxidants forms a more effective disinfecting solution than chlorine alone, yet also leaves a chlorine residual. MIOX claims that a mixed-oxidant dose of 4 mg/L for 60 minutes provides greater than 99.99% disinfection of giardia cysts, and 99.9999%

Filters are generally used as pretreatment to remove cysts. Filters are included in the packaged system cost analyzed here (the MIOX P3 unit). A 100- μm and 1- μm filter are included to remove grit and giardia cysts.

Operation requirements consist of electricity supply, a low-skilled operator, and high-skilled maintenance personnel. Power input for the MIOX P3 unit is about 132 watts (W). With PV systems, varying voltage will lead to varying power. Power is taken as constant at 132 W for these analyses. Energy consumption per m^3 will depend on the dosage desired, which is adjusted by changing the water flow rate. For a 1 ppm dosage, the energy consumption is roughly 0.03 kilowatt-hour (kWh) per cubic meter of treated water (MIOX 1996; Chapman 1996). Different systems are designed for different power supplies. Oxi Generation Inc.'s system uses 4 volts from a battery source, while MIOX's uses 12 volts and has a built-in rectifier for use with standard AC power. The P3 unit power input is 132 W, including pumping power.

Maintenance requirements are relatively high. The salt supply can be delivered a few times per year and then stored. For membrane systems, the salt must be high quality, because poor-quality salt can foul the membrane. Salt quality is not as crucial for density gradient systems. In addition to the low-skilled operator overseeing operation and adding salt, skilled labor is required for maintenance. MIOX (1996) claims 25 hours/year is required, though 80 hours/year was assumed here. Requirements include maintenance of the electrochemical system, which includes the handling of caustic chemicals, and maintenance of the dosing valves, flow meters, and venturi ducts. Membrane systems would require the additional maintenance of cleaning and replacing membranes every few months to a year (depending on salt quality) and are considered inappropriate for the developing countries in general.

Cost

The smallest available MIOX system is said to produce 3.8 to 95 cubic meters/day (1000-25,000 gallons/day), depending on the dosage needed. If we assume a dosage of 4 ppm, then the capacity is about 24 m^3 /day. The unit costs roughly \$26,500 without data acquisition equipment. This translates to about \$1,000/ m^3 /day capacity cost and \$0.56/ m^3 /day water treatment costs. Installation labor was taken as 40 and 80 hours of both low- and high-cost labor for the MOGGOD and MOGGOD/PV, respectively. It is quite possible that lower cost units will appear, given the current technology age and low volume. The MOGGOD/PV subsystem was sized assuming 24-hour operation of a 132-W load, which requires about a 1-kW peak-power system and increases system cost by about \$14,000. PV sizing and cost algorithms are provided in Appendix F.

Operations and maintenance costs consist of four parts: salt supply, energy, labor, and replacement parts. Roughly 0.08 pounds of salt are required to produce enough disinfectant for 1 m^3 of water (assuming a dose of 4 mg/L) (MIOX 1996). Information on the cost of salt in developing countries was not available, and was estimated to be \$1/pound. An energy cost of \$0.30/kWh was assumed in this analysis. Maintenance assumed was two hours/day unskilled labor and two weeks/year skilled labor. Repair supplies were assumed to be 1% of the system first cost/year. The overall life-cycle cost is approximately \$0.56/ m^3 without PV.

Appropriateness

Summary—High first cost, relatively easy installation, probably high effectiveness, residual disinfection, high skills needed for maintenance, parts supply needed, electrical power needed; not produced in sizes suitable for villages of less than 100 people.

MOGGOD systems are probably most appropriate for use in large yet remote villages that have an electricity minigrid. The primary advantage of MOGGOD systems is that they produce disinfectants, rather than relying on a constant supply. Although salt is needed, it can be stored for an indefinite period of time while chlorine

decays. Such considerations are important in areas where roads are often impassable during monsoon seasons or where transportation is otherwise unreliable.

4.2 Filtration

4.2.1 Slow Sand Filters

Slow sand filtration is a very popular method of water treatment among NGOs as well as among small towns in the developed world (EPA 1991). Figure 4.2.1-1 shows a schematic of a slow sand filter. It involves filtering water through about 100 cm of fine sand at a rate slow enough that a biological film (the *schmutzdecke*) develops on top of the sand. The top film serves as a biological filter that effectively removes more than 99% of all pathogens (Pirnie et al. 1991; Schulz 1984). Unlike chemical treatment methods, slow sand filters do not leave an unpleasant taste in the water. They improve water taste by removing dissolved solids. Slow sand filters are not generally constructed for villages smaller than 100 people. In these cases, individual home filters are generally used (see Section 4.2.2) (Wegelin, Schertenleib, and Boller 1991).

Operation of slow sand filters is fairly straightforward; it requires untrained laborers for most tasks. Supplies of chemicals or spare parts are not required, which is the primary advantage of slow sand filters. The only energy requirement would be pumping to compensate for 6 to 120 cm of head loss, which increases gradually after each scraping as the biological layer builds; the majority of slow sand filters are designed for gravity-feed operation (Schulz et al. 1984). Maintenance involves raking the biological film every few weeks, depending on water quality; scraping off the top layer of sand every few rakings; and replacement of a few inches of sand every few scrapings. One disadvantage of slow sand filters is that the biological filter is removed after scraping; therefore, the filter is not functional for several days every two to five months while the biological film regrows ("ripens"). Although this problem can be solved by having two independently operable filters, a second filter increases the capital cost. The time between scrapings, and therefore the amount of maintenance and downtime, is determined by the turbidity of the feedwater; a roughing filter should be used for pretreatment of waters of turbidity greater than 20 to 50 NTU (Water for People 1997). The roughing filter further adds to the capital cost of the system.

Cost

The capital cost of slow sand filters can be relatively high, depending on cost of local labor and the availability of appropriate sand. The flow rate is slow (about 0.1 to 0.4 m³ of water/m² of filter/hour [Schulz and Okun 1984]), and a relatively large area is required. Costs of construction and maintenance labor are both high. In addition, the cost of slow sand filters depends greatly on the cost of sand. In some areas, sand of appropriate quality may not be available and must be imported. Slow sand filter costs depend somewhat on economies of scale, the total cost increasing as the 0.8 power of the throughput (Feachem, McGarry, and Mara 1977). The fact that slow sand filters are so popular despite their high labor and maintenance costs shows that people are willing to pay for a reliable, easy-to-use technology that doesn't need a technical infrastructure.

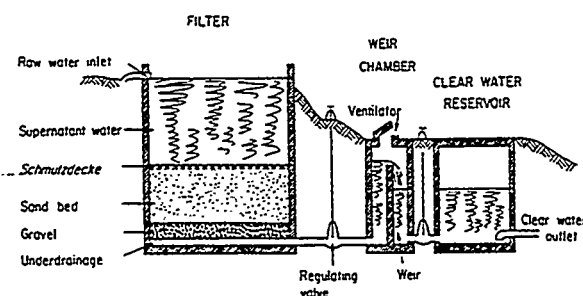

Figure 4.2.1-1. A schematic of a slow sand filter.

Slow sand filter costs are uncertain, as different sources are not in good agreement. Two costs are generated, corresponding to low and high cost estimates. Water for People (1997) estimated that the total capacity cost of slow sand filters is about \$50/m³/day (in smaller capacities), and it is the least expensive treatment method in use. Low-cost water treatment was estimated at \$0.02/m³/day using this assumption. Costs are as much as 30 times higher for U.S. applications with higher labor rates and more valving. The developing country high-capacity cost was \$200/m³/day, corresponding to the upper ranges of costs in Wegelin (1996); high water treatment costs were estimated at \$0.07/m³/day. A 1-m² area (2.4 m³/day capacity at lower-limit flow rate) was assumed, though normalized costs are independent of size. We assumed that two days per week, on average, would be needed for all O&M tasks.

Appropriateness

Summary—Ease of maintenance and operation, moderately high effectiveness, no supplies required, technology favored by NGOs for medium-sized villages, relatively low cost if sand is available, low labor rates, prefiltration required for turbid waters, and not appropriate for villages smaller than 100 people. The slow sand filter cannot be used for several days every few months during "ripening" after scraping, probably requiring double capacity. The slow sand filter almost always requires prefiltration for turbid waters.

4.2.2 Household Filters

In developing countries, household filters have been constructed and used in many ways. They include:

- Simple pots filled with sand through which water is poured
- "Candle" filters in which water in one vessel flows through a "candle" filter of diatomaceous earth into another vessel below
- Ceramic filters in which water is poured into a porous ceramic vessel and flows through the ceramic into a nonporous container below
- More complex designs incorporating upward flow, multiple sand and/or ceramic layers, and use of charcoal in addition to sand
- Finer ceramics that require pumping or elevated water sources to overcome the head loss
- Household-sized versions of slow sand filters.

Charcoal, which is similar in structure to activated carbon, is often used as a filter medium because it has a very high surface area for adsorption of pollutants. One particular design for an upward flow, multimedia household sand filter promoted by UNICEF is shown in Figure 4.2.2-1. Filters can be sized to treat from one to hundreds of liters per day. A primary advantage of home filters is that they are produced by local craftspeople. They form part of the traditional way of life in many parts of the world, such as Sudan, where ceramic filters are common (Azrag 1996). Local craftspeople are often skilled at making the porous ceramics. According to *Household Water Disinfection in Cholera Prevention, WASH Technical Note*, household-sized versions of slow sand filters have been built. However, most households have been unable to operate these filters.

Testing of some indigenous filters has shown that most can remove 90% to 99.99% of bacteria, and that the finer filters can also remove 90% of viruses (Gupta and Chadhuri 1992). Filter effectiveness is determined by the size of the filter pores, absorptive forces within the filter media, and the presence of cracks in the filter. Poorer quality filters remove only 90% of bacteria, which can mean that millions of bacteria (enough to cause infection) may be left behind in very-poor-quality water. Ceramic filters produced by hand may vary widely in quality (e.g., they may contain cracks). Finally, filter quality can deteriorate over time unbeknownst to the user. Although filters improve water taste by removing turbidity, they provide no residual disinfection. Filters must be regularly cleaned, either by boiling or backwashing, and periodically replaced.

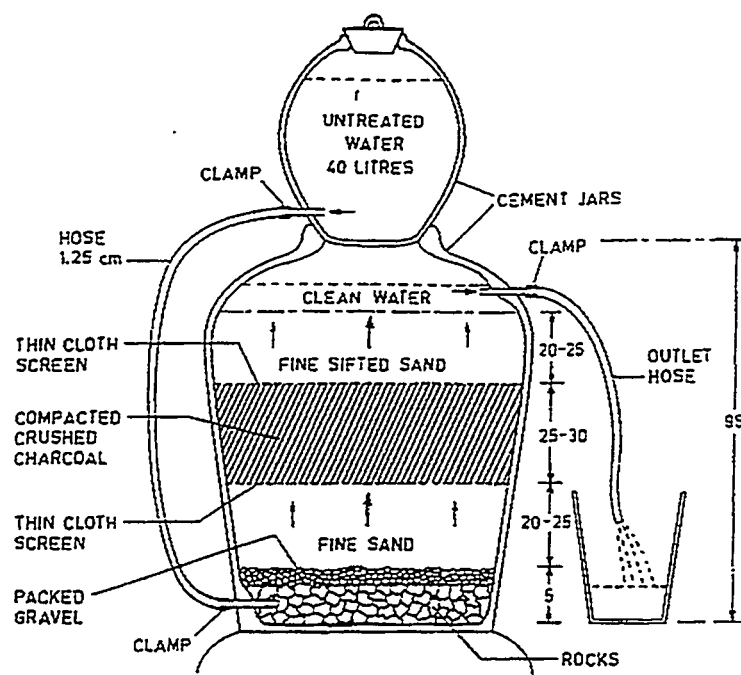

Figure 4.2.2-1. A multimedia household sand filter designed for an upward flow by local craftspeople. Filters can treat 1 to 100 liters of water per day, depending on size.

Cost

Clearly, the cost and effectiveness of a household filter will vary widely, depending upon the particular design, materials used, and cost of the skilled or unskilled production labor. Information on the cost of various filters in developing countries was not available. Low and high cost estimates were done. A capital cost of \$20 and replacement interval of two years was assumed for the low-cost estimate, with a capacity cost of \$330/m³/day and water treatment cost of \$0.85/m³/day. A capital cost of \$50 and replacement interval of every one year was assumed for the high cost estimate, with a capacity cost of \$830/m³/day and a water treatment cost of \$2.56/m³. The filter was assumed to treat 20 L/day (5 gal/day). Unskilled labor required was estimated at 20 min/day.

Appropriateness

Summary—Low cost, low maintenance, locally produced, traditional product, poor to unreliable effectiveness, and no residual disinfection.

4.2.3 Roughing Filters

Chlorine, slow sand filtration, and UV disinfection systems all require pretreatment of water with high turbidity levels. This pretreatment must be factored into the cost and complexity of the system. The simplest and cheapest (and often most favored by NGOs) pretreatment system is the roughing filter, shown in Figure 4.2.3-1. There are several possible configurations of roughing filters, including downward flow, upward flow, and horizontal flow. Figure 4.2.3-1 shows a horizontal-flow roughing filter. The filter consists of a 5- to 9-m total thickness of gravel in three layers: coarse gravel, fine gravel, and coarse sand. The grain size is much larger—and the flow rates are much higher—than those used in slow sand filters. A roughing filter can

treat 0.30 to 1.5 m³ of water/m² of filter area/hour, about three times as much as a slow sand filter. Because of the higher flow rate, no biological film forms. Roughing filters are usually not used in water systems supplying villages smaller than about 200 people; for such small systems, a sand filter similar to that described in the household sand filter section would be used. The filter can remove as much as 900 NTU of turbidity, and about 90% of bacteria, protozoa, and worms (Wegelin, Schertenleib, and Boller 1991).

Operation is fairly straightforward, requiring unskilled labor for most tasks. Supplies of chemicals or spare parts are not required. Head loss is normally less than 30 cm. Maintenance consists of monthly cleaning by rapidly flowing water through the filter. Occasionally, manual removal, washing, and replacement of filters may be required (Wegelin 1991).

Cost

Water for People (1997) estimates that the cost of a roughing filter is \$40/m³/day of capacity. Maintenance requirements are assumed to be 16 hours of unskilled labor per month. Pumping costs to provide 30 cm of head were not included in the cost estimates. Based on these assumptions, the estimated life-cycle cost ranges from \$0.013 to \$0.10/m³. Therefore, these costs must be added to those of chlorine, UV, and slow sand filtration in locations where the water has turbidity greater than about 20 NTU.

Appropriateness

Summary—Provides sufficient removal of turbidity to meet the pretreatment needs of most disinfection systems, moderate cost, low maintenance. Roughing filters are not effective enough to be used without another form of disinfection.

4.3 Ultraviolet Disinfection

4.3.1 General Features of UV Radiation

It is well known that UV light disables DNA involved in reproduction of bacteria and viruses, rendering these pathogens harmless upon ingestion. UV is broken into three bands: UV-A (320–400 nanometers [nm]), UV-B (280–320 nm), and UV-C (200–280 nm). UV-C radiation is sometimes called the germicidal band, because it is most effective in killing pathogens per unit energy. Acra et al. (1991) discuss the relative biocidal effectiveness of UV at various wavelengths, indicating a relatively broad range that peaks at around 250 nm, corresponding to a known absorption peak of RNA. Schenck (1987) shows an order-of-magnitude reduction in the relative "action spectrum" for killing *E. coli* and *Staphylococcus aureus*, going from 250 to 300 nm. An action spectrum is shown in Figure 4.3.1-1. UV radiation need not be at specific wavelengths corresponding to peak DNA absorption.

4.3.1.1 UV Radiation Sources

UV radiation can come from natural sunlight or from discharge tubes. UV from the sun has been studied by several groups (Acra et al. 1991; Wegelin et al. 1994). A clear-sky solar UV spectrum is shown in

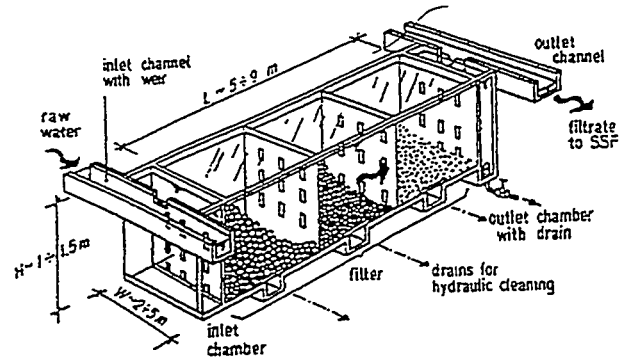

Figure 4.2.3-1. A horizontal-flow roughing filter with a 5- to 9-meter total thickness of gravel in three layers: coarse gravel, fine gravel, and coarse sand.

Figure 4.3.1-1. Sunlight UV (< 400 nm) incidence may approach several percent of the total solar power spectrum (20 W/m²) in clear conditions. The germicidal-band UV content in sunlight is essentially zero, as a result of basic black-body effects and ozone-layer absorption. Sunlight UV is mostly in the UV-A band. Thus, significant exposure time (on the order of hours) is required for disinfection (Acra et al. 1991; Wegelin et al. 1996). This fundamental barrier has led DOE's Solar Industrial Program to abandon solar-driven detoxification in favor of lamp-driven processes (Hale 1997).

UV lamps have been widely used in Europe to disinfect water (Ellis 1991), sterilize surgical equipment, and reduce airborne viruses in heating, ventilating, and air-conditioning systems (Scheir 1996). Ultraviolet radiation in the germicidal band is the dominant radiation produced by electric discharge in mercury vapor. Recent advances in discharge-tube technology (electrical excitation and gas/vapor combinations) have increased the UV-C production by about 500% over older tube technologies (Scheir 1996), making this technology more effective. In the familiar fluorescent tube, the radiation is transformed to visible light by use

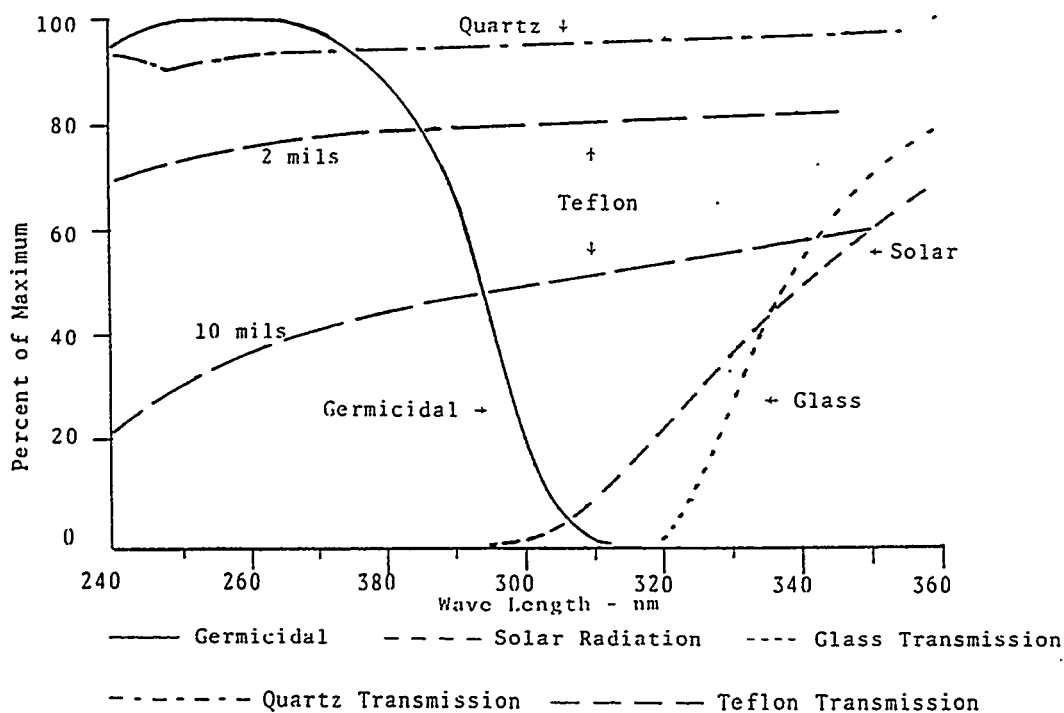

Figure 4.3.1-1. Germicidal, solar, and transmission curves.

of a phosphorescent coating on the glass tube. For a UV tube, the standard soda-lime-silica glass tube is replaced with an uncoated tube made from borosilicate glass or other material having high UV transmission. These tubes and associated ballasts are inexpensive primarily because of mass production techniques. (The Phillips tube replacement cost is \$26.)

4.3.1.2 Cautions in Use of UV Disinfection

Pathogen Limitations

The UV dosage necessary to disinfect pathogens is listed in Appendix A, measured in irradiation rate times exposure time. Virus and bacteria dosages range from 40 to 80 W-sec/m², whereas listed protozoan cysts require 1200–2000 W-sec/m². Although theoretically possible, UV disinfection of cysts and worms is not done

because: (a) required lamp power becomes excessive; (b) as a probabilistic process, photon deactivation may still allow passage of some cysts, which have very small infective dosages (~1); and (c) simple alternatives such as filtering (Ellis 1991) are available for eliminating these pathogens.

Limitations in Turbid Water

For a given geometry and flow, there will be a maximum turbidity beyond which the UV radiation is below dosage requirements. In addition, particles such as fecal matter and colloids can "hide" pathogens from the radiation. (See Section 1.4 for discussion of turbidity.) In these cases, water pretreatment to decrease turbidity (typically filtering) must be used.

Regrowth of Bacteria

As noted in Section 1.4, bacteria can repair themselves after UV disinfection. Figure 4.3.1.2-1 shows the gradual regeneration of bacteria following UV treatments. The solid and open circles show data from a prepared *E. coli* sample treated under lamp and sunlight, respectively. The sunlight-treated laboratory bacteria did not regenerate. The squares indicate sunlight-treated river bacteria that did regenerate. Therefore, there is still some uncertainty about the conditions under which regeneration can occur (Wegelin et al. 1994). These data show a doubling time on the order of four hours, with return to original levels of contamination in roughly five days. We recommend that UV-disinfected water be used within 36 hours (Weintraub 1997).

Electrical Power

For villages with existing reliable electrical supply, the cost of electricity will likely be relatively minor (Gadgil 1997), even at higher electricity costs. For villages with off-grid or unreliable power, the UV system must be powered by some "reasonable" supply of electricity. It will generally cost less to use electricity from a "village-scale" power system serving other loads. The cost of electricity from a generator is typically ~\$0.30–\$0.60/kWh, and is highly dependent on transport costs. Village-scale wind, PV, and wind/PV/generator hybrids are an emerging market that would provide lower-cost power, typically \$0.10–\$0.60/kWh. PV is assumed when the cost for renewable electricity is included. Life-cycle cost of electricity for household-scale systems is typically ~\$0.70–\$1.00/kWh. Small wind systems cost somewhat less (~\$0.70/kWh) than PV (\$1.00/kWh) (Flowers 1997).

4.3.2 Practical UV Systems

4.3.2.1 Solar-Driven UV Disinfection

Solar UV faces two fundamental barriers: low irradiation and lower effectiveness. As a result, treatment at ambient temperatures requires long exposures, particularly for viruses. However, combining UV-A radiation and heat may be practical because of the synergistic heat/UV-A effects reported by Wegelin et al. (1994). For example, the irradiation needed for a 3-log *E. coli* reduction decreases by a factor of 4 at 50°C relative to 20°C water. The 50°C value corresponds to about 90 minutes of clear-day noon radiation. Data produced by these experiments have led to development of two UV-A approaches, as outlined by Wegelin (1996a), using

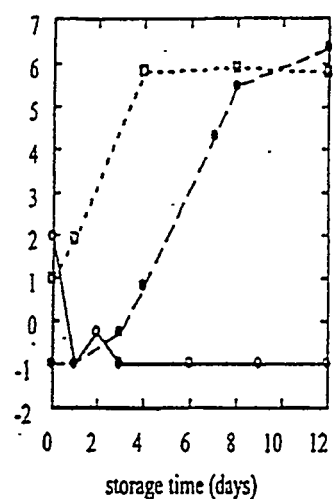

Figure 4.3.1.2-1. Bacterial regrowth following UV treatment. Both lamp and solar UV treatments are shown (Wegelin et al. 1994).

batch processes and flow-through devices. A simple batch process using half-blackened plastic bottles is shown in Figure 4.3.2.1-1. UV transmission of these bottles is an issue (Lawand 1994). Some polymer materials will have added UV inhibitors, which reduce transmission. Also, tinting can become a problem. Some UV transmission curves are shown in Figure 4.3.1-1. Another proposed batch process using a transparent outer film and blackened back film is shown in Figure 4.3.2.1-2. Approximately 700 households are participating in a 1996–1997 field test of these processes. In both of these devices, it is not clear whether temperatures of 50°C will be reached under a wide range of ambient temperature and wind conditions. Lawand (1994) reports maximum temperatures of 30° to 35°C during cooler, partly sunny, and windy conditions.

Two flow-through systems are shown in Figure 4.3.2.1-3 (Wegelin 1996b). The system on the left is heat + UV-A (SODIS). The system on the right is heat alone (SOPAS). The SODIS system includes a flat-plate solar collector to heat the water, an open channel to admit UV-A radiation, a heat exchanger to recover some of the sensible heat, and a 50°C control valve. Daily capacity is around 100 L/m² per clear day.

Cost

Costs are shown in Table 4-1. The two batch processes have extremely low first cost and low daily throughput. Water treatment life-cycle costs are on the order of \$1.00/m³. The flow-through device has higher daily throughput and higher first cost. Water treatment costs roughly about \$1.40/m³ assuming system costs comparable to those of the Family Sol-Saver device. The estimated capacity cost is \$3,800/m³.

Appropriateness

The batch process, if it proves effective and not subject to misuse, has the right elements of appropriateness: low first cost, low maintenance, and zero fuel cost. However, daily volume is small. In addition, the technology must also combine filtering when turbidity and cysts/worms are present, as explained in Section 4.3.1.2. The flow-through process will cost more than flow-through pasteurization, but may have more throughput because of the lower operating temperature. Additional study is needed before these issues can be resolved.

4.3.2.2 Lamp-Driven UV Disinfection Products

LBNL Water Disinfectors

Lawrence Berkeley National Laboratory (LBNL) recently developed a small UV water disinfectors tailored for developing countries. It received a *Discovery* award in 1996 as the year's most significant environmental product. A Web site posting some LBNL materials is at <http://eande.lbl.gov/CBS/archive/uv/>. LBNL licensed the technology to a firm in India for distribution there as well as to Water Health International (WHI) for the remaining world market. WHI stated that the product would be available in June 1997. The production price of the WHI unit is estimated at \$525 (WHI 1997). A Web site describing the WHI system is located at www.waterhealth.com. The unit, which is shown in Figure 4.3.2.1-4, consists of a single 36-W UV emitting lamp powered by a solid-state ballast. The total electrical input required is 40 W, including all electronics. Options are also available for direct DC input. The unit has an optional safety disconnect that disables the lamp when the lid is opened. It also has an optional photo-diode sensor that closes the flow passageway when the light output falls below a level sufficient to safely disinfect the water. The unit is portable, measuring 0.7 × 0.4 × 0.3 meters (27 × 16 × 11 inches) and weighing only 7 kg (15 lb). Maximum flow rate is 15 L/min. Operated continuously at this flow, the system would produce about 23,000 L (6000 gallons) of disinfected water per day.

PV System Sizing and Cost: NREL Analysis

A source of electricity is needed in the stand-alone market, and costs must be included for proper intercomparison with competing technologies. Sizing and cost algorithms are detailed in Appendix F. In a PV system, the cost of the PV panels is the dominant cost item, whereas the storage batteries are the dominant maintenance item. Results for the UV-WaterWorks system are shown in Table 4.3.2.2-1.

Table 4.3.2.2-1. PV System Cost for Various Operating Scenarios¹

Hours of Operation	Volume (L/day)	PV Panel Size (watts)	PV System Cost (\$)	PV O&M Cost ² (\$/yr)	Roughing Filter Cost ³ (\$)
4	3,600	53	693	14	144
8	7,200	107	1,387	27	288
12	10,800	160	2,080	41	432
24	21,600	320	4,160	82	864

Notes:

¹Assumptions are: five hours of effective full sun, 60% overall system efficiency (including off-peak and battery inefficiencies), and system cost (for international market) at \$13/watt.

²PV maintenance assumes car battery replacement at two-year intervals. Battery is assumed to cost \$0.50/amp-hour storage capacity. Miscellaneous maintenance is 1% of system cost/year.

³Roughing filter cost is \$40/m³/day.

Renewable Energy Attachments: Energy Unlimited/WHI

WHI recently contracted with Energy Unlimited, Inc., to supply renewable energy options for powering the UV water disinfectors. PV, wind, and micro-hydro units are available. The PV unit specified in WHI literature (WHI 1997) is an 80-W panel. According to sales literature, the unit provides 12 hours of operation with 5.5 hours full-sun equivalence. Monthly and annual average irradiation data, provided in Appendix F for various developing-country locations, indicates that 5.5 hours is a good average value. An 80-W panel would provide 0.44 kWh with 5.5 hours peak sun, assuming 100% efficiency. This would power the 40-W unit for 11 hours. Table 4.3.2.2-1 interpolates to about six hours for 80-W panels. WHI also offers a 400-W nominal-power wind unit quoted at \$699/\$999 for standard/marine units and a micro-hydro unit quoted at \$1,295. (The marine unit uses aluminum blades resistant to salt corrosion.)

Water Pretreatment: UV WaterWorks

The UV WaterWorks system (UV-WW) must be used with a roughing filter when the input water is sufficiently turbid. Initial tests conducted by LBNL indicated that the unit should perform adequately at water turbidity of as much as 80 NTU if the turbidity is the result of impenetrable clay particles (Weintraub 1997). However, for safety, prefiltering should be used at water turbidity of more than 20 NTU. The cost of roughing filters is discussed in Section 4.2.3. The size of the roughing filter must be matched to the throughput of the UV system. Roughing-filter cost estimates are shown in Table 4-1. WHI is developing a sand filter unit, which consists essentially of a small sealed box, with appropriate sand to be added at the site. The anticipated sale price was not available.

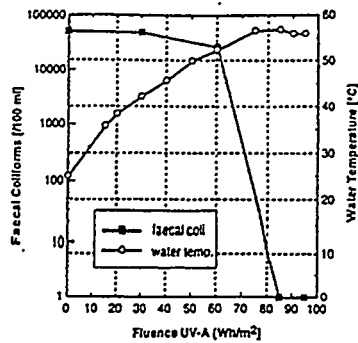
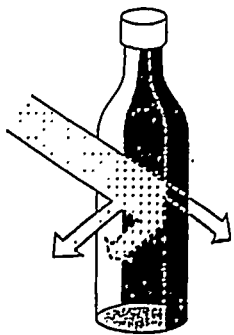

Figure 4.3.2.1-1. Batch solar UV disinfection using plastic bottles (Wegelin 1996).

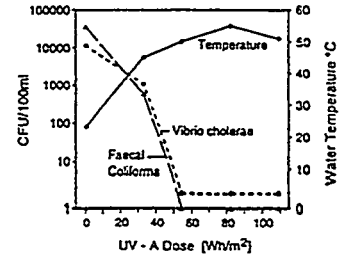
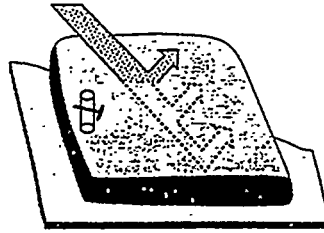

Figure 4.3.2.1-2. Water temperature increase and inactivation of fecal coliforms and *Vibrio cholerae* in plastic bags.

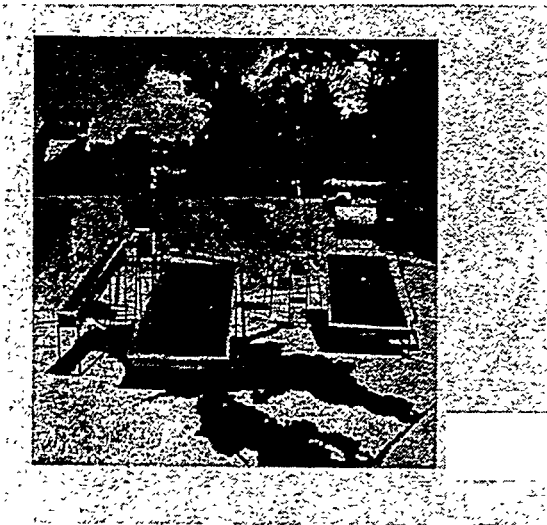

Figure 4.3.2.1-3. Two flow-through solar disinfection systems. The system on the left is heat and UV-A (SODIS). The system on the right is heat alone (SOPAS).

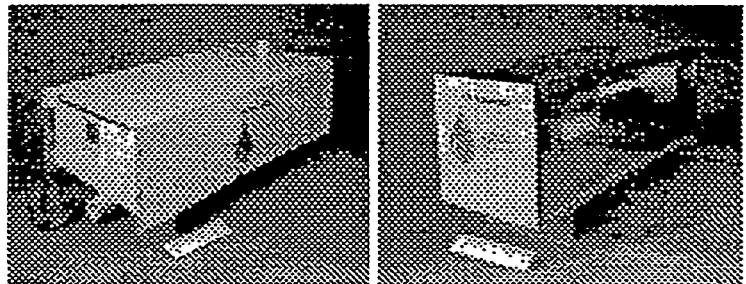

Figure 4.3.2.2-1. A small UV water disinfectant tailored for applications in developing countries, developed by U.S. Department of Energy's Lawrence Berkeley National Laboratory.

Cost

The cost of the bare unit is low, \$525 FOB or \$687 overseas. WHI recommends that the UV bulb be replaced after about 8000 hours of operation, or annually when operated 24 hours/day; the ballast lifetime is about 24,000 hours. Cost/volume of the UV WaterWorks system under various scenarios is shown in Table 4.3.2.2-1. For remote applications, the bulbs must be sold with the unit at time of purchase, or the unit will probably not be correctly maintained. The capacity cost is \$32/m³/day, and water treatment cost is \$0.02/m³. With a low-cost roughing filter, capacity cost is \$72/m³/day and water treatment cost is \$0.04/m³. With PV, the capacity cost is \$330/m³/day, and treatment cost is \$0.14/m³/day.

Appropriateness

Both first cost and maintenance costs are low, yielding low capacity and treatment cost. Access to technical infrastructure is required to replace lamps, ballasts, and other electronic components. Installation appears very simple, although a roughing filter is needed.

Global Water Technologies LS3 Model 100

The addition of a PV/pump/filter combination to a UV/PV system would solve the problems with cysts and water turbidity and provide convenient water pumping. One such system is the Global Water Technologies (GWT) LS3 Model 100, shown in Figure 4.3.2.2-2. This system uses a 5-micron and a 1-micron mechanical filter in series, a "proprietary" filter to remove metals and odors, and finishes with UV light. It has a maximum flow of about 2 gpm. The lamp and associated electronics draw about 40 W for a UV dose of 300 W-sec/m². The pump power, at a nominal 2 gpm flow rate (actual rate of 1.7 gpm [6.4 L/m]), was about 70 W, implying roughly 110 W for total operation.

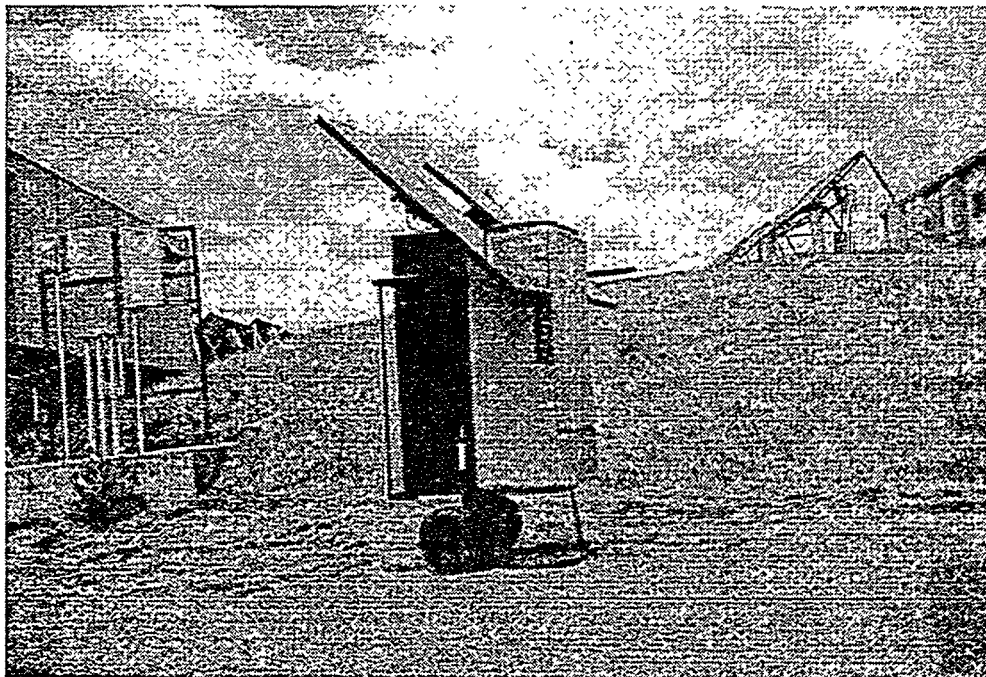

Figure 4.3.2.2-2. A small UV water disinfection unit, complete with PV, water pump, and filtering. This unit is manufactured by Global Water Technologies.

Cost

The GWT system, with 140 W of PV panels, costs \$9,000 in the United States (Stafford 1997). Sustained run time at maximum flow was only a few hours with 140 W of PV. This increases costs for additional PV panels to \$10,000 for an eight-hour operation. The system requires about three times the kWh of the UV WaterWorks system; therefore, a PV system for an eight-hour operation would require a 320-W panel and cost about \$4,000. Maintenance requirements include filter cleaning; four hours once a week was assumed (more frequently with more turbid water). The filters must be replaced at regular intervals, at a replacement cost of \$200 a year. Capacity costs for the GWT system were estimated at \$930/m³/day and water treatment costs were estimated at \$0.35/m³.

Appropriateness

The cost is relatively high, but convenience (especially with a pump) and effectiveness (because of the fine filters) are high. The filtering system requires access to a technology infrastructure for filter replacements.

Small-Scale UV System: Ultra-Sun Technologies

A small-scale UV system with a filter unit called Sun-Pure is manufactured by Ultra-Sun Technologies, Inc. Information about the system can be found on the firm's Web site at www.ultrasun.com and was the source of data presented in this section (Ultra-Sun 1997). Figure 4.3.2.2-3 shows the unit mounted under a sink. The unit incorporates two multistage filter cartridges, as shown in Figure 4.3.2.2-4. Filtering includes: (a) a one-micron filter to remove turbidity and cysts, (b) a carbon block to remove chlorine and organic hydrocarbons, (c) a lead sorbent matrix to reduce lead, (d) an activated bone carbon filter filter (calcium hydroxyapatite) to remove fluoride and heavy metals, and (e) granular, activated carbon to absorb radon and any chlorine compounds that might pass through the initial carbon-block filter. A lamp cutaway is shown in Figure 4.3.2.2-5. The unit incorporates a 6-W UV bulb with quartz envelope that remains on continuously. The unit has a maximum flow rate of 1.9 L/min (0.5 gpm). The power input requirement was assumed to be 10 W. Water is forced through the filters by line pressure, and there are no additional pumps. Pressure-drop data are not available. The unit is designed for the U.S. domestic market.

The manufacturer claims the unit is very simple to install, with only minimal skills required. For this analysis, we assume the unit would produce 500 L/day (100 L/person for a five-person family) at a flow rate of 1.9 L/min (0.5 gpm); the unit probably operated about 4.4 hours per day. The filters must be replaced about every 5300 L (1400 gallons), according to the manufacturer's literature (Ultra-Sun 1997). The UV lamp lifetime was independently quoted as 10,000 hours and probably need not be replaced as indicated. The filter and lamp replacements lead to a relatively high operating cost.

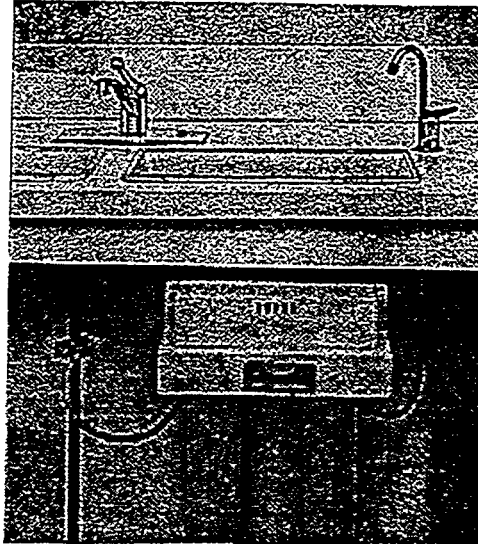

Figure 4.3.2.2-3. Sun-Pure unit mounted under a sink.

Cost

The unit costs \$385 FOB. The filter replacement cost is about \$30, and the lamp unit cost is about \$50. The assumed capacity cost is \$1,000/m³/day, and the water treatment cost is \$8.1/m³. The manufacturer claims a cost of \$13/m³ (\$0.05/gallon) (Ultra Sun 1997).

Appropriateness

The unit appears to be very effective against all pathogens, although data substantiating this were not available. The first cost of the unit is relatively low, and it is very suitable for urban markets with pressurized private taps that have good access to a technical infrastructure for parts (routine replacement of filters and lamps) and other maintenance needs. The high cost of specified filter replacements makes this particular unit high in water treatment cost. The high degree of filtration makes the unit appealing to higher-end markets.

Potential Ultra-Sun and Home Filter System

The Sun-Pure system incorporates filtering beyond that needed for removal of enteric pathogens. The manufacturer provides the UV lamp, power supply, and casing separately for use by other manufacturers, targeting the reverse-osmosis market (Ultra-Sun 1997). The Ultra-Sun UST-200 unit incorporates the 6-W bulb and has a maximum flow rate of 3.8 L/min (1 gpm), presumably limited by a UV dosage requirement. This UV unit could be combined with a home filtering unit (see Section 4.2.2) to provide a unit more suitable for developing countries. The filter must be designed to remove cysts and eggs and to reduce turbidity sufficiently. The homeowner would maintain the filter using indigenous gravel and sand. This potential unit is included in cost analyses, because it represents a "dream system" for urban markets with pressurized taps.

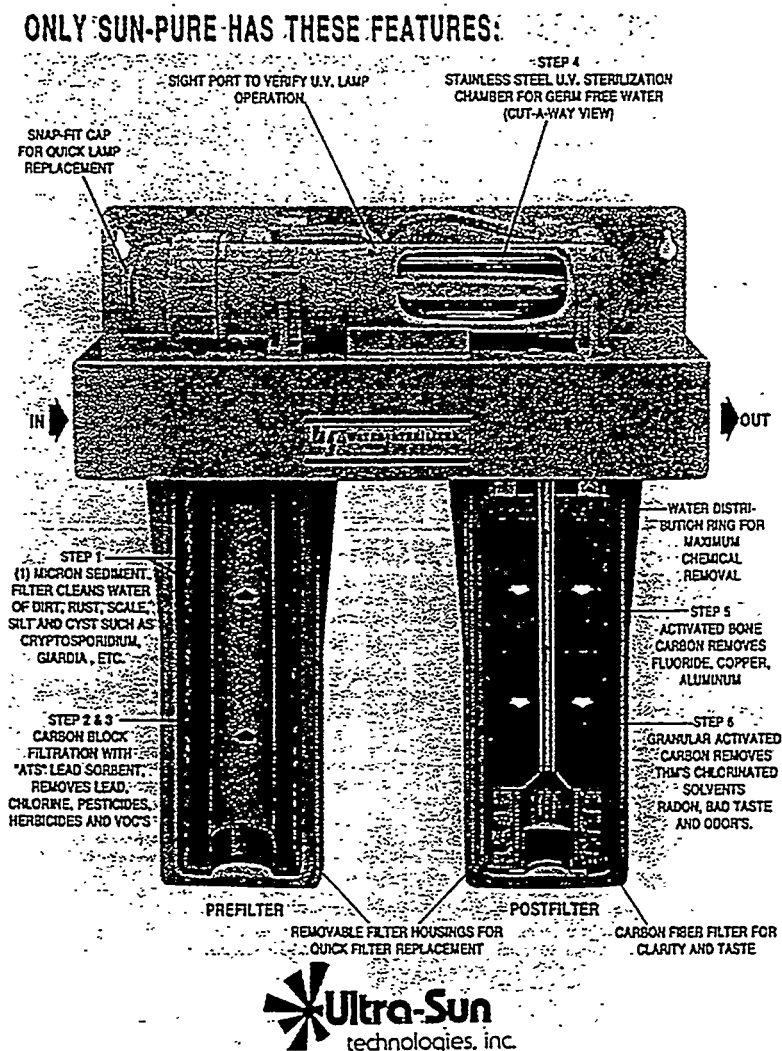

Figure 4.3.2.2-4. Cutaway details of the Sun-Pure filtration cartridges and UV lamp.



Figure 4.3.2.2-5. Sun-Pure lamp and reactor chamber.

Cost

The UV unit is assumed to cost \$58.50 (Ultra-Sun 1997). The home filter was twice the cost of the roughing filter analyzed for village scale: $2 \times 40 = \$80/\text{m}^3/\text{day}$. The lamp unit should be replaced every 8000 hours of operation and was assumed to cost \$50 FOB. For use with PV, a 10-W load for 24 hours requires an 80-W PV system, at a cost of \$1,040. Assuming an "ideal" unit could be designed to require lamp operation only on draw, a 15-W PV unit costing \$195 is needed. We assumed the unit would supply 500 L/day. For the unit without PV, the capacity cost is \$230/ m^3/day , and the water treatment cost is \$0.46/ m^3 . With PV, the capacity cost increased to \$630/ m^3/day , and water treatment cost increased to \$0.63/ m^3 .

Appropriateness

The unit's weakest point would be the operation and maintenance of the home filtering unit. If designed and operated correctly, the unit would be highly effective. The first cost of the unit is low, although significant labor is needed for filter maintenance. The unit is suitable for markets with pressurized private taps having good access to a technical infrastructure for parts (routine replacement of lamps) and other maintenance needs. Under-the-sink operation is very convenient, obviating the need for storage tanks.

4.3.3 Photocatalytic Disinfection

Photocatalytic disinfection is mentioned because it may likely be a useful approach in the near future. The photocatalytic process is still at the laboratory stage of development for disinfection but has been demonstrated to be effective on the pilot scale for removal of hazardous organic compounds from water and air (Blake 1994) and for disinfection of certain bacteria (Cooper 1997).

The basis of photocatalytic oxidation (PCO) differs from the action of the direct-acting UV systems discussed above. In photocatalysis, a photon incident on a catalyst initiates a chemical reaction producing a useful oxidant. Microorganisms are susceptible to damage from the action of reactive oxygen species, which include hydrogen peroxide (H_2O_2), superoxide ion (HO_2^-), hydroxyl radical (OH), and singlet oxygen (a form of electronically excited O_2). The first three are formed when a semiconductor, such as titanium dioxide in contact with water and air, is irradiated with light having a wavelength shorter than 385 nm. Singlet oxygen is formed when dyes such as methylene blue in water absorb visible light in the solar spectrum and transfer the energy to dissolved oxygen (Blake 1994). These processes were shown to kill a variety of bacteria and some viruses in water. The singlet oxygen process was demonstrated on the pilot scale to be effective in killing fecal coliform bacteria in secondary waste treatment effluent using sunlight.

With semiconductor catalysts such as titanium dioxide, the photon energy must be above the semiconductor band gap for the reaction to proceed. PCO can be driven by either UV lamps or sunlight. With UV lamps, PCO appears to be a natural and useful enhancement of the existing UV hardware. In addition to enhancement of direct UV, PCO would also lead to destructive decomposition of organic contaminants (Cooper 1997). With sunlight, these techniques may allow a larger portion of the sunlight spectrum to be effective compared to direct UV. Current catalyst research may enable use of higher wavelengths than those of the well-studied titanium dioxide catalyst (Goswami 1997). Techniques for stably coating titanium dioxide on thin plastic films were demonstrated at costs under \$0.20/m² (Taylor 1997), which may lead to inexpensive and practical reactor designs.

4.4 Pasteurization (Thermal Disinfection)

Thermal sterilization of liquids (e.g., water and milk) is termed "pasteurization" after Louis Pasteur, who first articulated the fundamental germ basis of infectious diseases in the 19th century. Pasteurization by boiling of water has long been recognized as a safe way of treating water contaminated with enteric pathogens. Although some bacteria can survive even boiling temperatures (leading to autoclave temperature requirements of 120°C for sterilization of surgical instruments, for example), none of the disease-causing enteric pathogens survive boiling. In fact, pasteurization can take place at much lower temperatures, depending on the time the water is held at the pasteurization temperature T_p . Time decreases exponentially with increasing temperature. A semi-log plot of required time versus temperature is shown in Figure 4.4-1 (Feachem et al. 1983). Viruses are generally the hardest to kill and essentially set the line of acceptable minimum time-temperature pasteurization domain. It is not considered common knowledge that boiling is not necessary; this may be a significant market impediment for solar thermal systems (Hamasaki 1997; Hartzell 1997).

There are two classes of pasteurization systems: batch and flow-through. In a batch process, the water in a container is brought to an appropriate temperature for appropriate time and then "removed" from the process. In a flow-through process, a continuous flow of water (usually via temperature-control valving) proceeds through a heating process, usually followed by a heat exchanger. The heat exchanger recovers heat of pasteurization, which is important for reducing the effective cost of treatment. The valving and heat exchanger increase product cost, but also greatly increase throughput; this tends to significantly lower the cost/volume compared to batch processes.

Section 4.4.1 describes batch pasteurization powered by fossil fuel, whereas Section 4.4.2 describes flow-through, fossil fuel-powered pasteurization. Section 4.4.3 describes solar-powered pasteurization systems, including three designs of batch systems and three designs of flow-through systems. Section 4.5 describes solar systems that perform multiple heating functions.

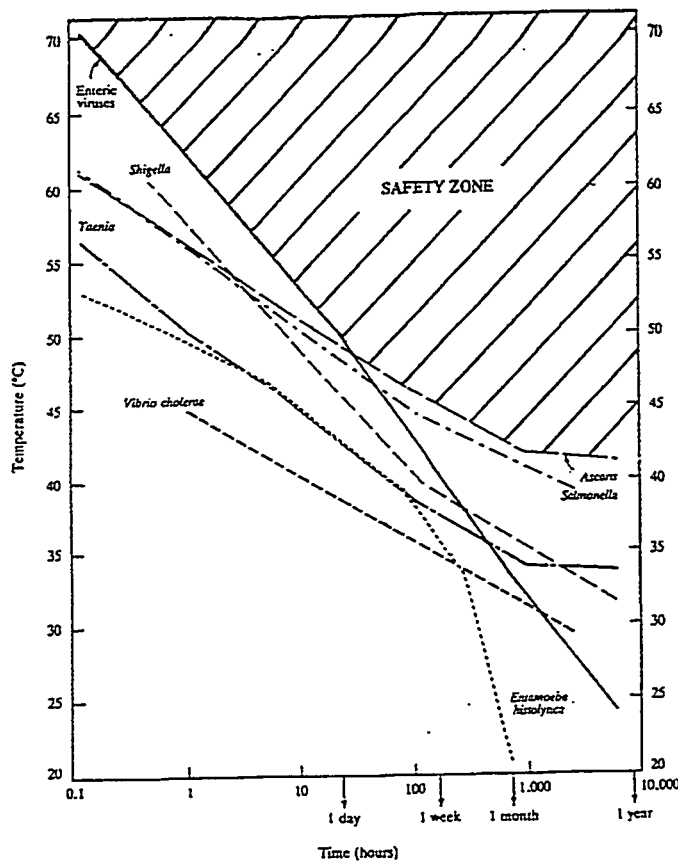

Figure 4.4-1. Temperature-time chart for safe water pasteurization (Feachem et al. 1983).

4.4.1 Fossil Fuel Heating/Batch Processes: Water Boiling

Cost

For simple small-scale boiling over an open flame, there is no incremental first cost, and dominant costs are for fuel (if fuel is purchased) and labor (both for attending and for fuel gathering when not purchased). We disregard such costs as vessel maintenance and replacement, health costs from polluted indoor air, deforestation, and other indirect costs. Fuel costs are generally high, although dedicated biomass processes could have moderate costs. The cost of fuel purchased has been estimated at \$0.02/L (Andreatta 1994) and at \$0.005/L (see Appendix H). When "free" fuel is gathered, the cost is in time and is difficult to quantify with any precision. It is not uncommon for women to spend several hours per day gathering fuel to cook with and boiling small batches of water (Feachem et al. 1977). This is partly because of the long distances one must travel to reach fuel. The estimate in Table 4-1 is based on the assumption of one hour of low-skill time (\$0.05/hour) to gather fuel to disinfect 20 L (5 gal). Gathered fuel is cheaper, if labor is not valued highly. If labor is \$0.50/hr, the cost of fuel becomes higher than that of purchased fuel. The second issue is the labor cost of attending the batch process. We assumed 20 minutes for a single batch of 20 L.

Pasteurization Indicator

Water-boiling costs can be reduced, because boiling is not required for water pasteurization. If we take the pasteurization temperature T_p as roughly 68°C (154°F), about half the energy required for boiling could be saved by heating water to T_p rather than boiling temperature. This requires having a simple indicator of when T_p is reached. One device available for use with any batch process is shown in Figure 4.4.1-1 (Andreatta 1994). The device consists of a closed tube containing a small plug of vegetable fat that melts at 68°C (154°F). The tube is placed in the cold water with the fat plug at the upper end of the tube. When the fat melts, the plug flows into the lower part of the tube, indicating that safe temperatures were reached during the batch cycle. First cost of a pasteurization indicator is very low, but operating cost is still about half that of boiling, making this a costly technique.

Appropriateness

Summary: Labor is unskilled but high and fuel supply can be a problem. Effectiveness is high if boiling is faithfully performed for all drinking water.

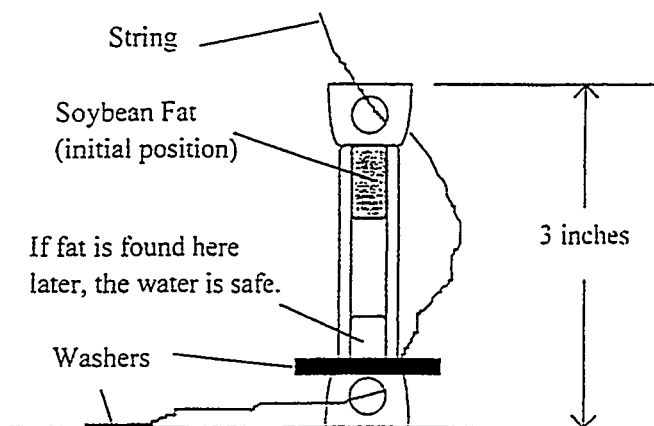

Figure 4.4.1-1. Water pasteurization indicator. The indicator would sit at the bottom of a water container.

4.4.2 Fossil Fuel Heating: Flow-Through Pasteurization Device

A schematic of a flow-through pasteurization device incorporating a heat exchanger and a control valve is shown in Figure 4.4.2-1. The heat exchanger uses the heat contained in the pasteurized outlet stream to preheat the contaminated inlet water. The control valve modulates flow with the outlet temperature control set above safe pasteurization temperature T_p .

The Wood-Saver

The Wood-Saver, shown in Figure 4.4.2-2, is a flow-through system manufactured by Safe Water Systems (a division of Grand Solar, Inc., Hawaii). Data on this and other Safe Water Systems products (discussed below) are available on the Internet at www.safewatersystems.com. The system incorporates a small stove with a simple copper tube heating coil at the top of the stove chamber near the outlet flue. The Wood-Saver incorporates the same control valve and heat exchanger described in Section 4.4.4.1 for the solar flow-through device. It is also an accessory to be used in parallel process with the solar thermal device described in Section 4.4.3 (for use in cloudy periods or at night to increase product volume).

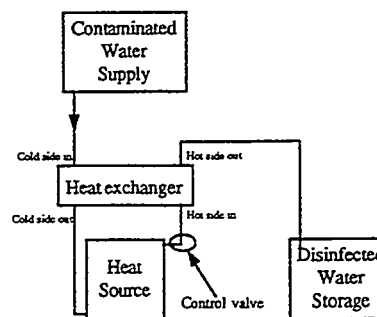

Figure 4.4.2-1. Schematic of a flow-through pasteurizer.

Cost

Wood-Saver claims that its unit saves 90% of the energy required to boil water (Hartzell 1997). The unit sells for \$950 FOB, and is expected to last 15 years. The maximum flow rate is about 1.6 L/min, (0.42 gpm), implying production of 1140 L (300 gal) during a 12-hour duty cycle. Maintenance requirements include having the valve rebuilt every 10 years, and cleaning the stove chamber and coil (every two months). Capacity cost was estimated at \$910/m³/day and water treatment costs at \$1.90/m³, including fuel costs.

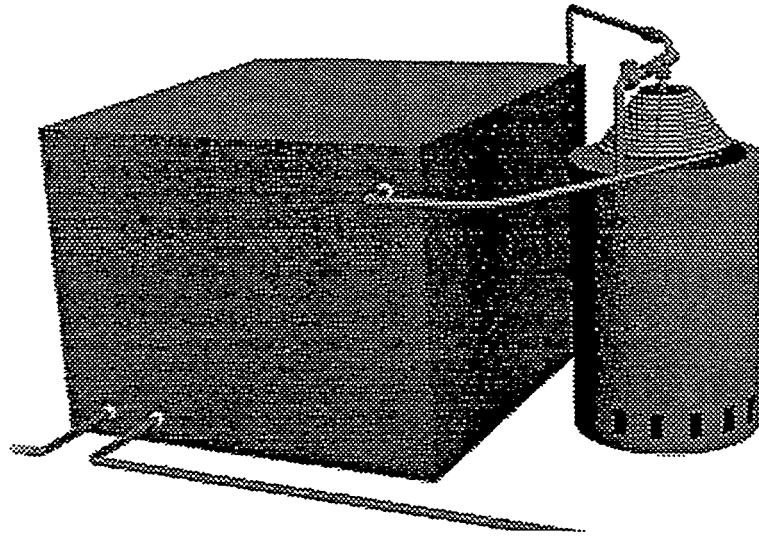

Figure 4.4.2-2. The Wood-Saver device (Hartzell 1997).

4.4.3 Solar Thermal Pasteurization

Solar thermal pasteurization has not been widely applied. Although little information is available, de Leon (1989) reports on successful field trials with a combined filtering and solar pasteurization system. The technologies discussed below are being field-tested at publication of this report.

Solar thermal devices have the advantage of low maintenance. Filtering is not required except for prevention of clogging of fluid passageways. There is only one moving part, a control valve used for flow-through devices. However, there are two caveats on maintenance; scaling and freeze damage. Scaling is a natural consequence of heating hard water, especially with metallic collector passageways (Burch 1989; Vliet 1996). The problem will be more severe for pasteurization than for solar domestic hot-water systems because of the relatively higher temperatures. Periodic flushing with acidic solutions may be needed to remove scale. There is limited evidence that polymer-based collector passageways will not scale as badly because of crystalline mismatch (Burch 1989). Magnetic anti-scaling devices may be useful in preventing scale (Burch 1989), but this has not been demonstrated at the relatively low velocities used on solar thermal pasteurization devices. Metallic collectors should not be used in climates where freezing might occur, even as infrequently as only once a decade. Freezing may be less of a problem for more flexible materials such as polybutylene piping. Freezing should not be a problem for flexible polymer thin films.

4.4.3.1 Batch Solar Thermal Devices

A characteristic of any batch pasteurization system is the inability to effectively reclaim pasteurization energy. Per unit area, these devices are lower in first cost and higher in cost/volume than similar flow-through systems.

Family Sol-Saver

The Family Sol-Saver, shown in Figure 4.4.3.1-1, is a batch solar thermal system manufactured by Safe Water Systems/Grand Solar, Inc. It has an integral-collector storage (ICS) design that holds about 15 L (4 gal) of water. The system consists of a double-wall, blow-moulded polypropylene pan with a twin-wall polycarbonate glazing. There is no control valve. A thermo-chromic indicator indicates when the water has been safely pasteurized, which requires observation. The water is drained from the system. Several midday hours

of sunshine may be sufficient; this implies that the process might be done twice per day in some climates.

Cost

First cost is low, and cost/volume is moderately low. The unit is projected to cost about \$60 FOB. No maintenance costs were assumed. Cost of water treatment is about \$2.30/m³ and capacity cost is about \$3,400/m³/day.

Appropriateness

The unit has appropriately low levels of maintenance. Aside from possible scale removal in hard-water areas, there is essentially no maintenance on the system and no supplies are needed.

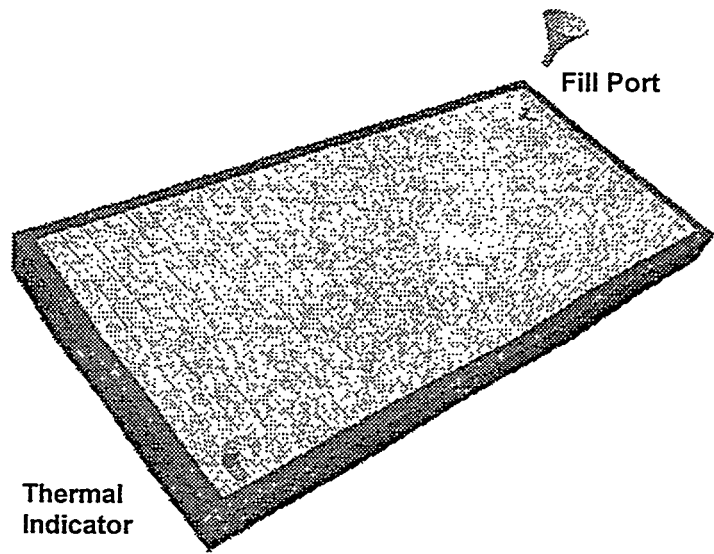

Figure 4.4.3.1-1. Family Sol-Saver (Hartzell 1997).

Stagnation temperatures of a single-glazed solar collector system are shown in Figure 4.4.3.1-2, as a function of the ratio of the effective loss coefficient and the product of transmission and absorptivity. The operating temperature of the Family Sol-Saver should be toward the lower end of the nonselective scale (about 140°C [280°F]). The continuous high temperature limit of polypropylene is 90°C (194°F), and that of polybutylene is about 93°C (199°F) (Kutscher 1984). Thus, to avoid materials breakdown, the system should not be subjected to dry stagnation. The unit may be used in climates with occasional freezing, as polybutylene piping can withstand limited freeze-thaw cycling when filled with water (Farrington 1987). The unit should probably not be used in climates with frequent hard freezing, because the polybutylene piping might freeze repeatedly (Burch 1995).

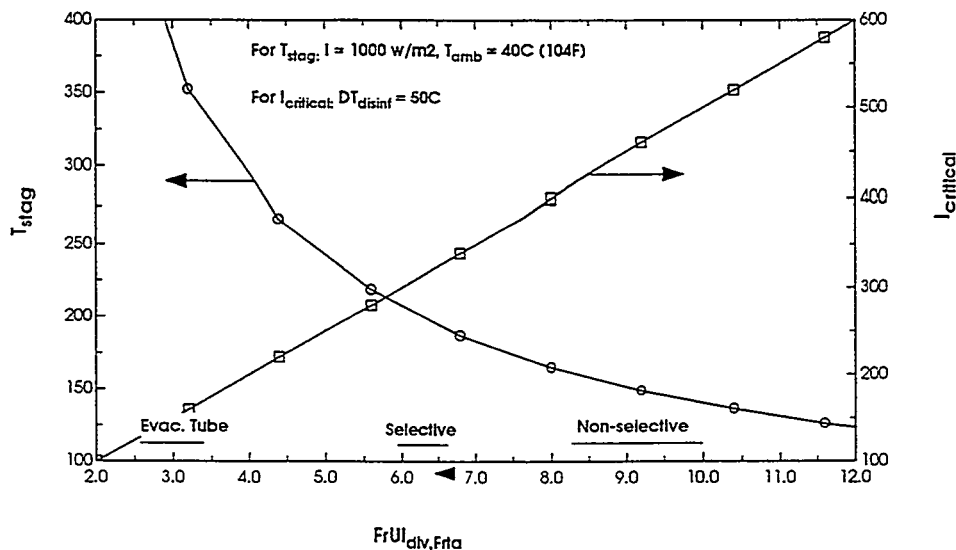

Figure 4.4.3.1-2. Stagnation temperature and critical irradiation (for flow-through devices) as a function of the ratio of collector parameters. The x axis is the ratio of the collector loss coefficient to the collector optical-gain coefficient.

SUN Evacuated-Tube Disinfector

A batch solar disinfector manufactured by SUN, Inc., is shown in Figure 4.4.3.1-3. The evacuated-tube technology of Nippon Electric Gas (NEG) incorporates a 19-liter (5-gal) storage tank within the evacuated tube. This is the same tube used in the SUN family integral-collector storage system certified by the Solar Rating and Certification Corporation (SRCC) for U.S. Solar Domestic Hot Water (SRCC 1996). A back reflector (specular or diffuse) will increase throughput, depending on tube spacing and reflector optics. A stainless-steel back reflector is available for about \$240, more than twice the tube cost of \$110 (Hamasaki 1997). The unit produces 19–39 L (5–10 gal) per day, with one to two batches/day. The throughput could be dramatically increased by use of a heat exchanger, which converts to a flow-through device.

Cost

The cost of the unit is relatively low, about \$110 FOB although the normalized capacity cost is \$7,500/m³/day. Life-cycle cost of water treatment is about \$3.40/m³.

Appropriateness

Maintenance should be minimal, except for scale problems in hard-water areas.

Site-Built Solar Collector

Andreatta (1996) provides a sketch of a site-built collector shown in Figure 4.4.3.1-4 that uses thin-film plastics for glazings, absorber, and water containment. A horizontal trench is built with a small slope toward a depression in the trench on one side. A siphon is used to remove water from the depression after it has reached T_p . The thin films holding the water (double thickness) are secured by burying the edges in the built-up dirt curb. The glazings should be supported to allow rain to run off. We recommend that the small pasteurization indicator in Figure 4.4.1-1 be used with the system.

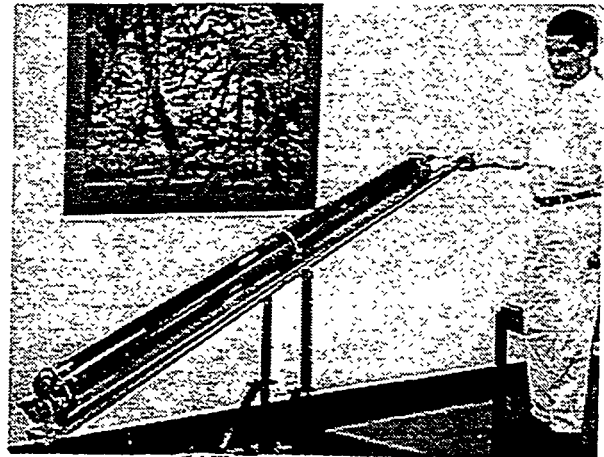

Figure 4.4.3.1-3. A batch solar disinfector manufactured by SUN, Inc.

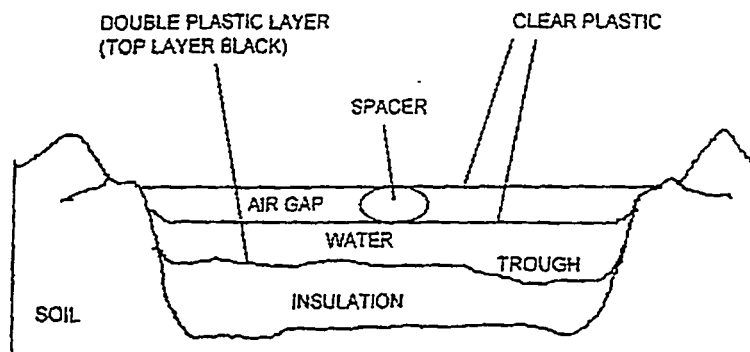

Figure 4.4.3.1-4. A basic solar puddle shown with horizontal dimensions compressed for clarity.

Cost

The capacity cost of a solar puddle system is estimated at \$70/m³/day and water treatment costs at \$0.70/m³.

Appropriateness

Although the cost of this system and of the polyethylene material is extremely low, there are maintenance problems. The system as described by Andreatta (1994) is developmental. It has two potential weaknesses: materials durability and dry-stagnation protection. The thin-film plastic used in the solar puddle demonstration was polyethylene, which typically has poor UV and fatigue resistance. Andreatta (1994) estimated the lifetime for polyethylene film to be around six months. UV-protected greenhouse polyethylene is more expensive but would have a lifetime of at least four years, assuming no wind damage. Polyethylene, without a carefully designed support (usually under air pressure), will fail in wind from fatigue. A more appropriate selection of polymer material is quite possible. A proposed flow-through solar system based on longer-lived polymer materials is discussed in Section 4.4.3.2. As shown in Figure 4.4.3.1-2, the dry-stagnation temperature of this system is about 140°C (280°F) This is above the continuous high-temperature limit of polyethylene film, which is about 104°C (220°F) (Kutscher 1984). Therefore, the system would be destroyed if not kept wet continuously. This problem can be overcome by using plastic films that have higher temperature tolerance.

4.4.3.2 Flow-Through Solar Thermal Pasteurization Systems

A schematic of a flow-through solar thermal water pasteurization system is shown in Figure 4.4.3.2-1. Cold water entering the system passes through the heat exchanger first, where it is preheated by the hot pasteurized water leaving the collector. The preheated water then enters the solar collector, where it is heated to T_p by the net solar gain. The control valve regulates the flow of water through the system. There could be an issue with dynamic response of the control valve and deadbands. Tests on one unit have shown 100% effectiveness against a variety of pathogens under typical operation (Fujioka and Geeta 1995). We do not deal with deadbands in the following analyses. Furthermore, the control valve might be eliminated using the expansion of heated water. Experimental designs were tested by Bansal (1988) and Cobb (1996). These designs are not analyzed here.

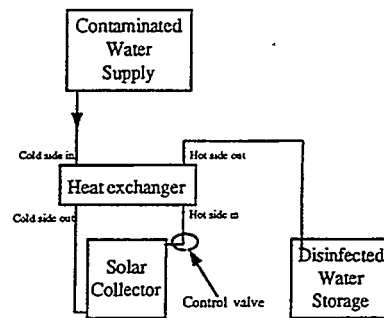

Figure 4.4.3.2-1. Schematic of a flow-through solar thermal water pasteurization system.

The throughput of the solar thermal devices of this type depends on the effectiveness of the heat exchanger. After an initial transient, the solar collector serves to provide the heat needed because of the "ineffectiveness" of the heat exchanger ($1-\epsilon_{hx}$) and piping/heat exchange losses (generally much smaller than the ineffectiveness term). We can model the steady-state behavior of this type of system straightforwardly by performing simple energy balance calculations on the components. Appendix I explains the solar thermal model in more detail. The basic system energy balance equation (disregarding piping and casing losses for the moment and making water supply temperature equal to ambient temperature) at steady-state operation can be written as:

$$mc_p [T_{past} - (T_{amb} + \epsilon_{hx} \Delta T_{past})] = A_{col} F_r [\tau \alpha \kappa I - U_l (\epsilon_{hx} \Delta T_{past})] \quad (\text{Eq. 4.4.3-1})$$

where: $\epsilon_{hx} = UA_{hx}/(UA_{hx} + mcp) =$ heat exchanger effectiveness (Eq. 4.4.4.3-2)
 $m =$ mass flow rate
 $c_p =$ specific heat
 $A_{col} =$ collector area
 $F_r =$ heat removal factor
 $\tau \alpha \kappa =$ optical parameters
 $I =$ instantaneous irradiance
 $U_l =$ collector loss coefficient
 $T =$ temperature (past = pasteurization, amb = ambient)
 $\Delta T_{past} = T_{past} - T_{amb}$

Flow rate decreases as the pasteurization temperature increases, independent of the required residence time. A graph of flow rate versus pasteurization temperature under peak sun is shown in Figure 4.4.3.2-2. The better the heat exchanger, the greater the flow. Figure 4.4.3.2-3 shows the flow rate increasing steadily as a function of heat exchanger effectiveness for three solar collector types. Above 0.9 the increase is dramatic, increasing a factor of five as effectiveness increases from 0.9 to 0.95. However, it is difficult to achieve high effectiveness at high flow rates. A graph of mass flow rate per unit collector area and heat exchanger effectiveness as a function of heat exchanger area is shown in Figure 4.4.3.2-4. Flow is a steadily increasing function of heat exchanger area, but increases less rapidly beyond about 3.5 m². This is caused by decreasing effectiveness with increasing flow rates, as in Equation 4.4.3-2. Flow rate decreases with reduced incidence as shown in Figure 4.4.3-5. For the given conditions, the cutoff radiation (below which no flow can occur) is also indicated. This can be derived from Equation 4.4.3-1 with ϵ_{hx} set equal to 1 and solving for I . The cutoff radiation is that I for which the stagnation temperature is equal to the pasteurization temperature.

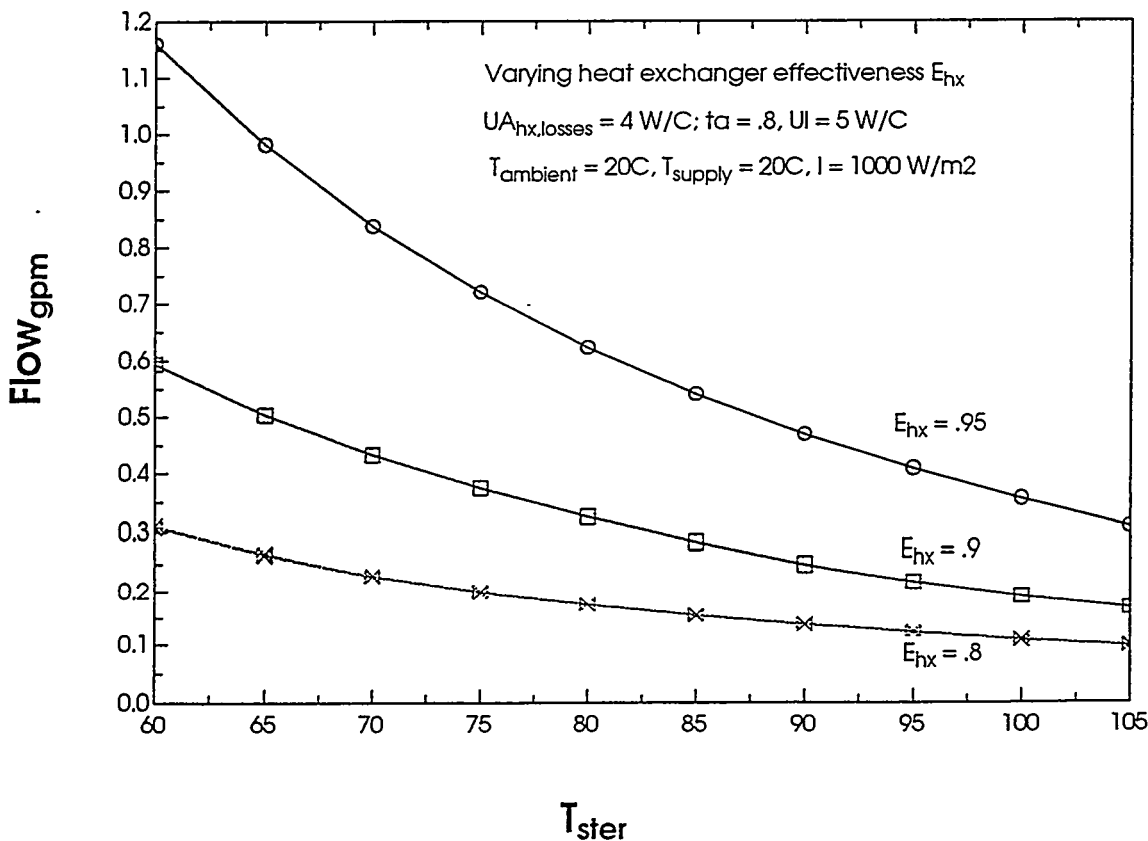
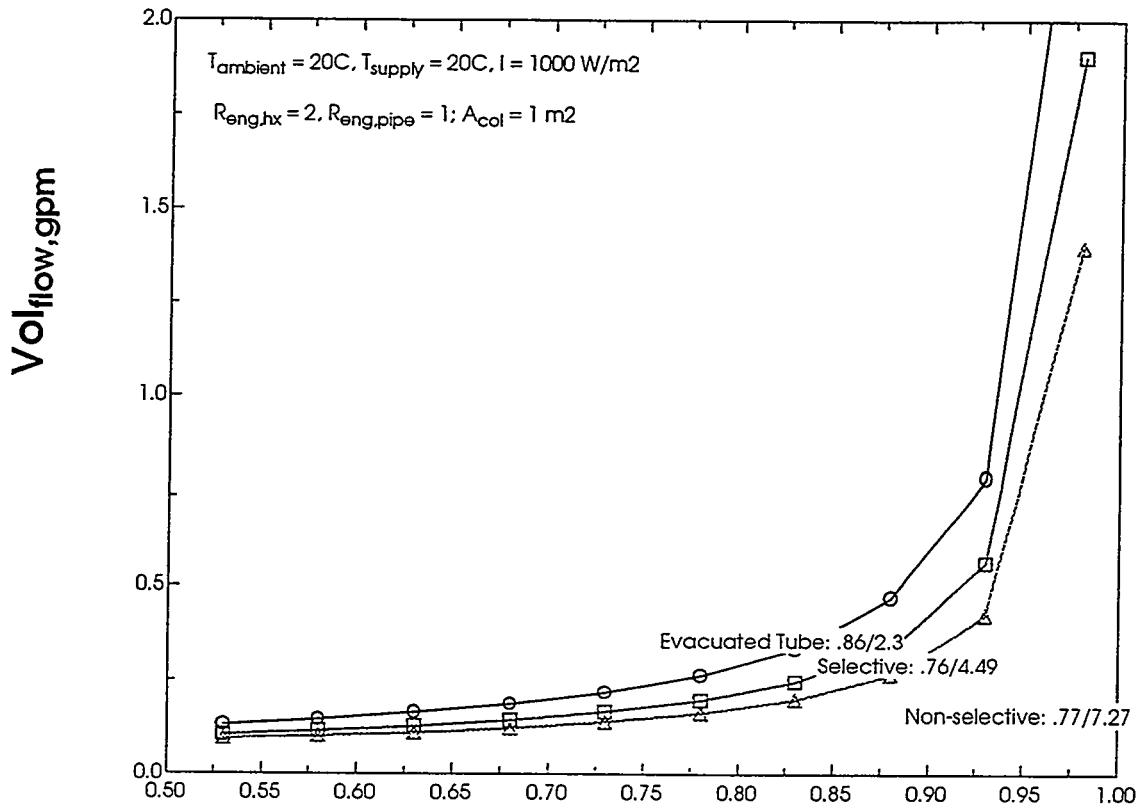

Figure 4.4.3.2-2. Flow rate versus sterilization temperature.



e_{hx}

Figure 4.4.3-2-3. Flow rate as a function of heat exchanger effectiveness for three solar collector types.

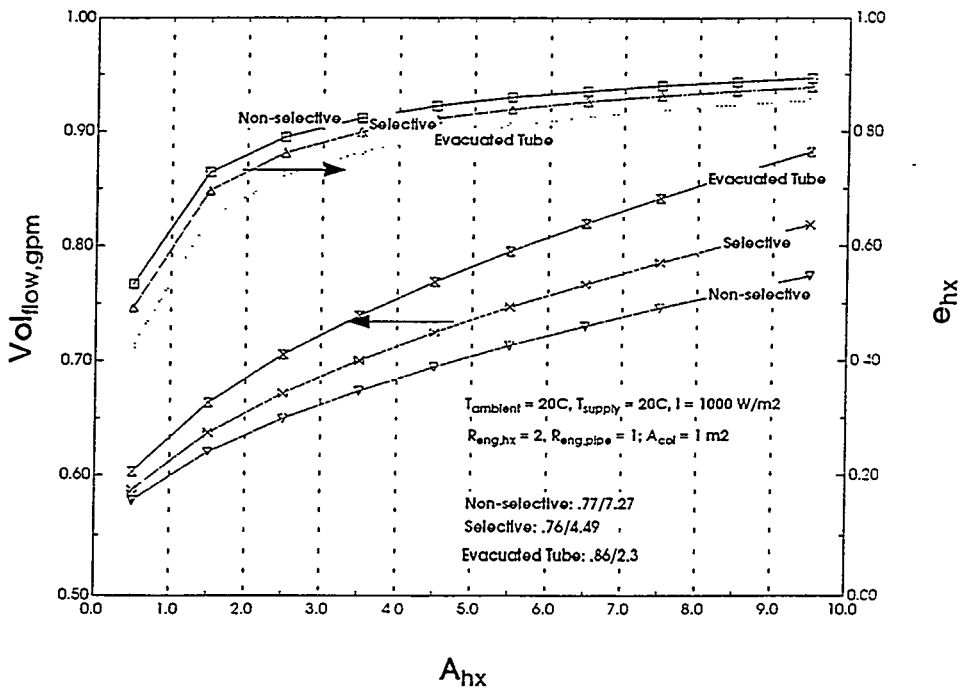

Figure 4.4.3-2-4. Flow rate and heat exchanger effectiveness versus heat exchanger area. Flow is a steadily increasing function of heat exchanger area.

There are significant differences between collector types. At peak sun, an evacuated-tube collector (per unit area) has an approximately 50% higher flow rate than a nonselective flat-plate collector. The effect is even more dramatic as a function of irradiance, as shown in Figure 4.4.3.2-5. Assuming the same areas of collector and heat exchanger, the evacuated tube's lower loss coefficient permits operation down to much lower irradiance levels. Taking a "day" as three hours at each of three irradiance levels (900, 600, and 300 W/m²), total flows through the evacuated-tube/selective surface/nonselective surface are, respectively: 663 (175), 431 (113), and 315 (83) L/day (gal/day). The higher performance of evacuated tubes is balanced by its higher cost. However, an evacuated-tube with cylindrical absorber (see Section 4.4.3.1-2) does not suffer any cosine effect (Incidence-angle modifiers are generally > 1 and go to infinity at 90 incidence.) When this collector is used in flow-through mode, the daily throughput per unobstructed m² would be about 940 L/day (250 gal/day).

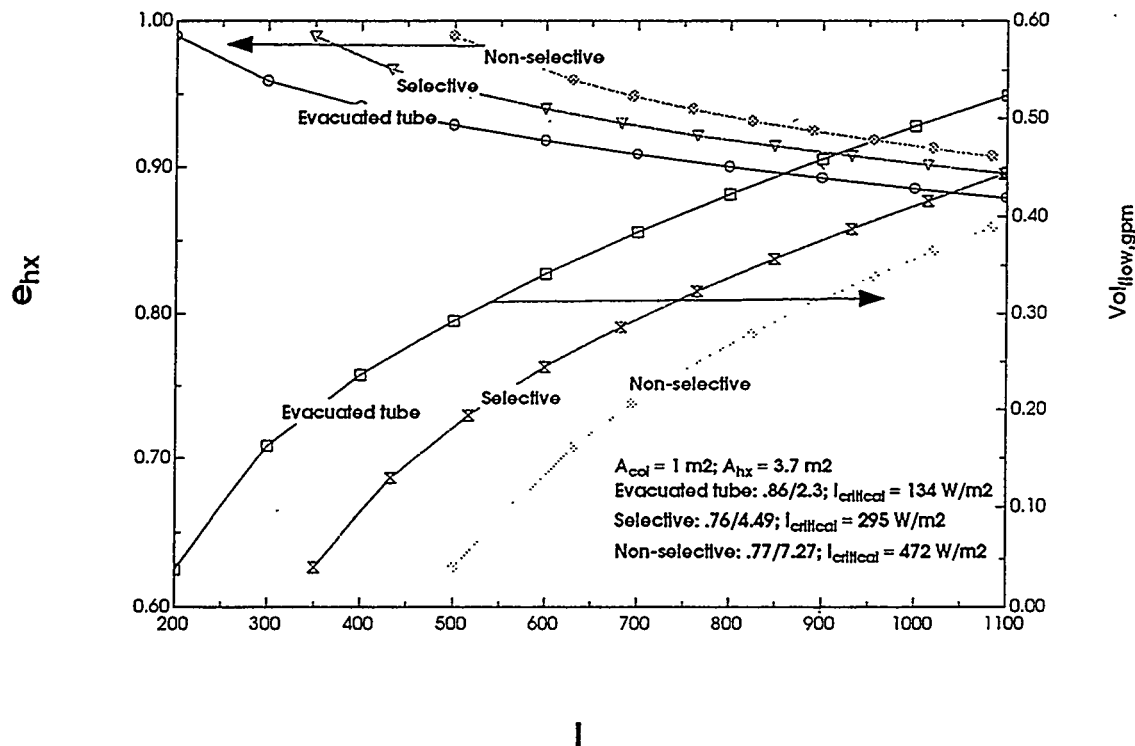

Figure 4.4.3.2-5. Graph of flow and heat exchanger effectiveness versus irradiance shows a decreasing flow rate with reduced incidence.

In this section, we describe three flow-through solar pasteurization systems: one from a U.S. solar manufacturer and two research products. A recently tested solar thermal pasteurization system is described by Wegelin (1996) and shown in Figure 4.2.3-3. A solar thermal pasteurization system was field-tested by de Leon (1989). However, the latter two systems are not described further here.

Family Sol-Saver

The Sol-Saver is a flat-plate, flow-through solar thermal system. It is manufactured by Safe Water Systems/Grand Solar, Inc. The unit is shown in Figure 4.4.3.2-6. The flat plate is a standard fin-tube design, with a selectively coated copper absorber. The heat exchanger is a copper-tube-in-shell device, approximately 15 m (50 ft) long, with a claimed effectiveness of about 0.8 (Oriens 1997). The control valve is a new product

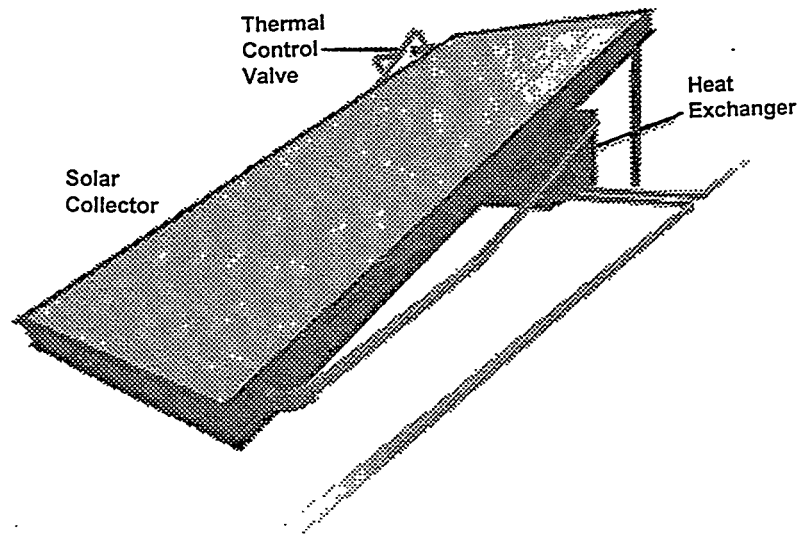

Figure 4.4.3.2-6. The Family Sol-Saver pasteurizer from Safe Water Systems (Hartzell 1997).

just released by Watts Regulator Company. The valve is driven by expansion/contraction of a wax phase-change material; at about 80°C the phase change drives the valve open. The valve has been tested without failure to 10⁶ cycles. It is recommended that the seals in the valve be replaced every 10 years. A valve refurbishment kit (Viton O-ring and return spring) is supplied with the unit. A unique, ingenious, and attractive feature of the Family Sol-Saver is that it can be combined with the Wood-Saver unit (see Section 4.4.2.1) to provide a means of producing pasteurized water during cloudy/night periods. Such a device might be considered for any small-scale solar thermal device so that water supply during extended cloudy periods does not become a problem. Cost-effectiveness of the combined unit was not considered. An anti-scale magnetic conditioning device is provided with the unit. As far as we know, the effectiveness of the magnetic device has not yet been proven.

Cost

The Family Sol-Saver costs \$1,650 FOB with user cost estimated at about \$2,150. The combined cost of the Family Sol-Saver and Wood-Saver unit is \$1,800 FOB. The cost of the heat exchanger is about \$400, and the valve cost is about \$100 (Hartzell 1997). It should produce about 570 L (150 gal) per day, based on five hours equivalent peak sun. Capacity cost for the Family Sol-Saver is estimated at \$3,800/m³/day and water treatment costs at \$1.40/m³.

Appropriateness

The first cost of the Family Sol-Saver is relatively high, as is the life-cycle cost of \$1.40/m³. However, the unit requires only valve maintenance, if scale and freeze damage are not concerns.

Parabolic-Trough Solar Pasteurization System

Compared to flat-plate collectors, concentrating collectors have the advantage of higher efficiency at higher operating temperatures. Sayigh (1992) studied a Fresnel reflector. A parabolic-trough system was proposed as the heat source for disinfection. A demonstration system was described by Anderson (1996) and is shown in Figure 4.4.3.2-7. It consists of a tracking parabolic trough, an inexpensive automotive radiator control valve, a patented counterflow tube and shell heat exchanger compactly located beneath the absorber, and a PV-pumping system. (The pump power, pressure drops, and PV panel size were not given.) The heat exchanger configuration is shown in Figure 4.4.3.2-8, and includes wire windings to increase the film coefficient between hot and cold fluids. The inner pipe is dead space. Pumping is probably not optional because of the narrow absorber and return annuli. The effectiveness of the heat exchanger is about 67% for a single-trough configuration.

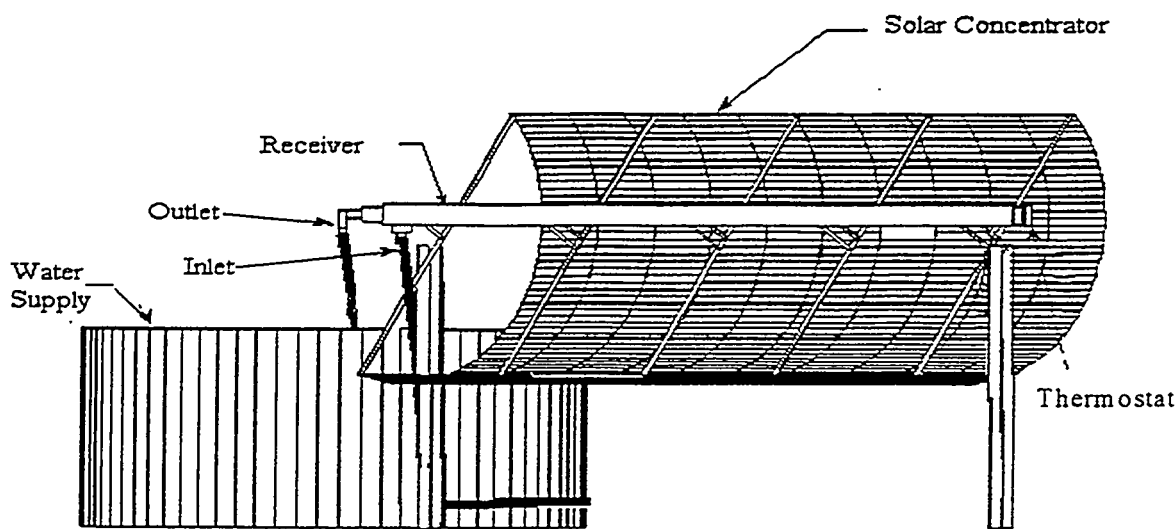

Figure 4.4.3.2-7. A parabolic-trough solar pasteurization system consisting of a tracking parabolic trough, control valve, patented counterflow tube and shell heat exchanger, and a PV-pumping system.

Cost

The trough first cost is \$250/m². (One trough is 6 by 2.3 m.) This is 15% below the current unit area cost for small-scale applications, because the automated controller will be omitted. The PV system was assumed to power a 40-W pump, and the sizing and costing methods in Appendix F were used for PV system costs. The heat exchanger construction is intended to be included in the estimated cost but may drive the cost higher. Maintenance is a significant issue. The reflector surface should be replaced every five years (Hale 1997) at a cost of \$50/m², including installation. PV system maintenance (battery replacement) was assumed to be \$25/year. There can also be maintenance issues with the flexible-piping connections on trough systems (Hale 1997). The capacity cost for a trough system is estimated at \$4,100/m³/day and water treatment cost at \$1.74/m³.

Appropriateness

Table 4-1 shows that the cost of disinfection is comparable to that of other flow-through solar pasteurization devices. However, there are maintenance issues. Trough systems may form the basis of useful multi-use systems because of their ability to attain high temperatures and pressures. (See multi-use discussion below in Section 4.5.)

Potential Polymer Solar Thermal Disinfection System

The life-cycle cost of solar thermal pasteurization techniques from industry is dominated by the rather high first cost. (Compare the normalized capacity cost of these systems with that of UV/PV systems.) We previously speculated that use of polymer thin-film materials could significantly reduce the first cost of medium-temperature solar systems. A study in 1982 (Wilhem and Andrews 1982) showed that a polymer flat-plate collector FOB cost could approach \$10/m², a cost reduction of about a factor of 10 over available metal/glass fin-tube flat-plate collectors. It is therefore appropriate to consider such a system and to detail the potential cost.

The polymer collector is described in Appendix G, with device sketches to aid visualization. Thin-film polymer materials are used for the collector and heat exchanger. The collector is two films seamed together to provide fully wetted flow passageways and structural integrity against the hydraulic head. The heat exchanger is a plate-frame design constructed with rigid-plastic spacers and thin-film channel separators. Flexible plastic tubing and a proprietary selective surface absorber are used. The flow control valve is an automotive radiator valve with modified seal. The gravity head is suitable for these flow rates.

Cost

The system materials cost is about \$36, excluding tanks for inlet and outlet water. Maintenance cost would include rebuilding or replacing the control valve about every five years. The system could be used in hard-freeze climates because of the elasticity of the flow passageways. It may be, as with all polymer devices, that scaling is minimized; further research is needed to verify this. The estimated capacity cost is \$280/m³/day and water treatment cost is \$0.19/m³.

Appropriateness

The first cost, capacity cost, and water treatment costs are low. The maintenance cost would be appropriately low, requiring no supplies, skilled maintenance, or operating expenses. The key issues with polymer systems include material durability under weathering and high-temperature tolerance of the materials. Fatigue resistance of the polymer glazing is also an issue. UV resistance of glazing film is probably adequate. Solar domestic hot-water systems using a Tedlar® glazing have been operating without significant glazing failure for more than 10 years (Burch 1997).

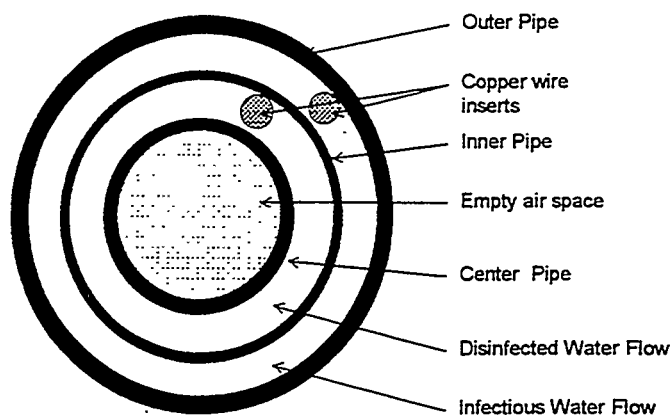

Cross-sectional view of receiver

Figure 4.4.3.2-8. Parabolic-trough system heat exchanger configuration includes wire windings to increase the film coefficient between hot and cold fluids.

4.5 Solar Thermal Multi-Use Systems

Multi-use systems use some of the hardware for all the uses, decreasing overall costs compared to separate systems. Evacuated-tube and trough technologies allow significantly higher temperatures than the flat-plate technology and may be used more efficiently in higher-temperature applications such as water distillation and sterilization. For the systems described below, no cost or appropriateness analyses were done because of the multiple uses.

4.5.1 SUN Multi-Use Systems

A family of multi-use systems based on evacuated tubes is being developed by Solar Utility Network (SUN), Inc. The product line is still being developed. The applications under consideration include autoclave (sterilizer, $>122^{\circ}\text{C}$), water distillation (from the steam produced), steam cooking ($\sim 150^{\circ}\text{--}250^{\circ}\text{C}$), water pasteurization ($\sim 84^{\circ}\text{C}$), and water heating ($\sim 50^{\circ}\text{C}$). At these temperatures the evacuated tube offers performance advantages (reduced losses) compared to flat-plate technologies. The higher-temperature performance is

needed for the cooker and, to a lesser extent, the autoclave applications, and much less so for disinfection and hot water.

A schematic of the unit designed for village health clinic application is shown in Figure 4.5.1-1. All possible applications would probably be useful: autoclaving, distillation, cooking, disinfecting, hot water. The high-temperature steam feeding the autoclave also provides distilled water for mixing of serums and other uses. A schematic of a system projected for single-family application is shown in Figure 4.5.1-2. To accommodate mixing higher-temperature cooking with lower-temperature pasteurization, low collector mass is best (i.e., use the tube with the flat-plate absorber, rather than the 5-gal cylindrical absorber). An automotive radiator valve is proposed for use as the control valve, opening at $\sim 82^{\circ}\text{C}$ (180°F). The heat exchanger proposed for use is a copper shell and tube, which has an effectiveness of around 0.6 from preliminary data reported by the manufacturer (Hamasaki 1997).

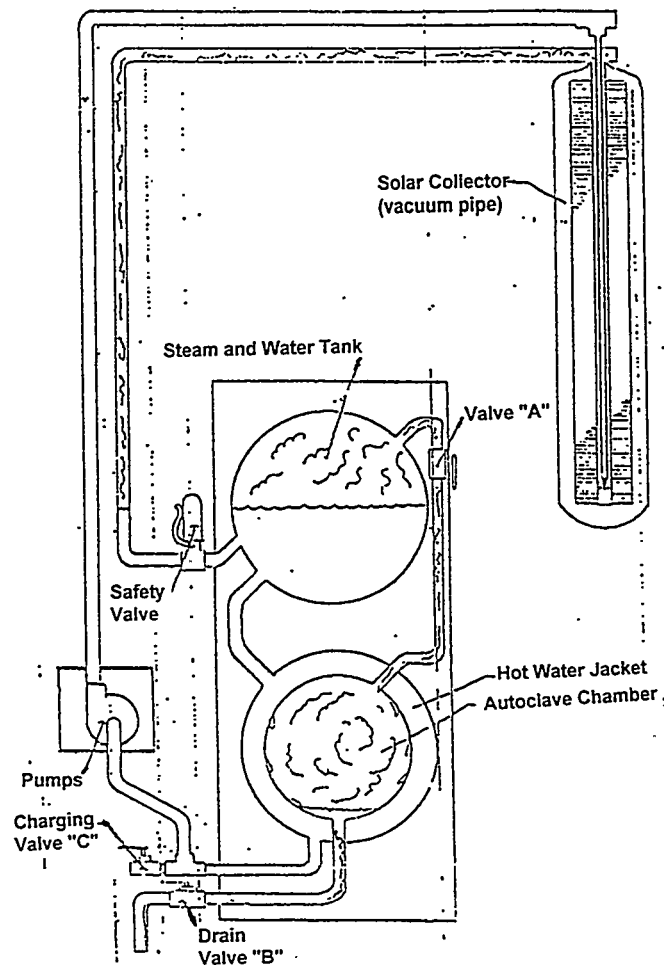

Figure 4.5.1-1. SUN autoclave applications schematic (Hamasaki 1997).

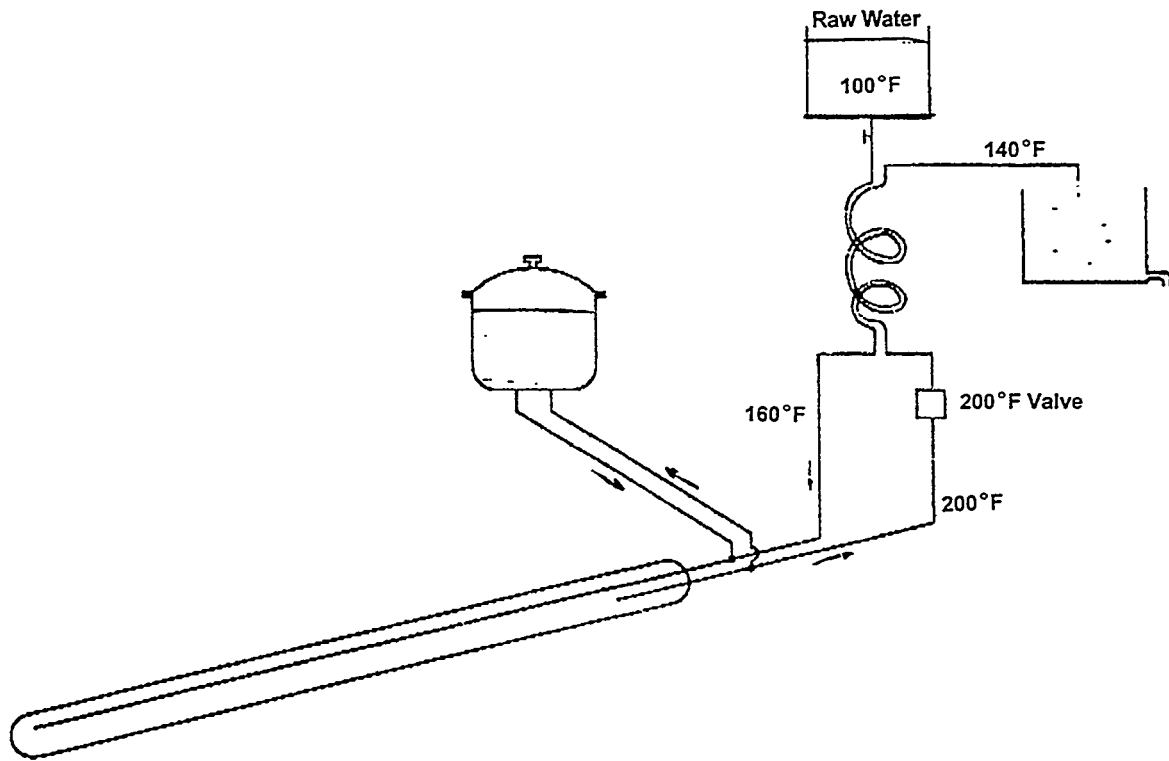

Figure 4.5.1-2. SUN multi-use system for single-family application.

4.5.2 Copper Sunsation Plus

A combined hot-water/pasteurization system is shown in Figure 4.5.2-1, with a schematic in Figure 4.5.2-2. It is in the final stages of development at Safe Water Systems, Inc. In this system, the water to be disinfected is heated until the wax-driven control valve (as described in Section 4.4.3.2.1) opens. The pasteurized water exits to a heat exchanger (a copper coil) located in the hot-water storage tank. The pasteurized water gives up a fraction of its energy before exiting. The hot water in the storage tank would presumably be used for bathing, according to the manufacturer. This would be satisfactory if cysts and worms that can penetrate the skin were not present in the water.

The Copper Sunsation is projected to be available in mid-1997 and to cost about \$1,350 FOB. The system should not be used in climates with chance of freezing. Like all systems having collectors with metallic passageways, scaling maintenance is required in hard-water areas.

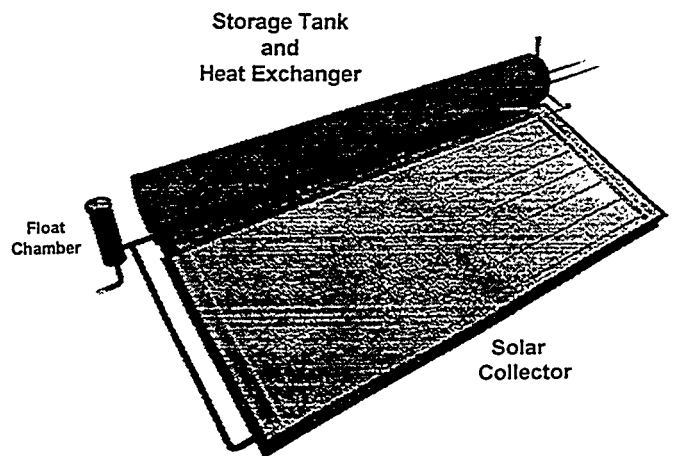

Figure 4.5.2-1. A combined hot-water/pasteurization system. The system is in the final stages of development by Safe Water Systems, Inc.

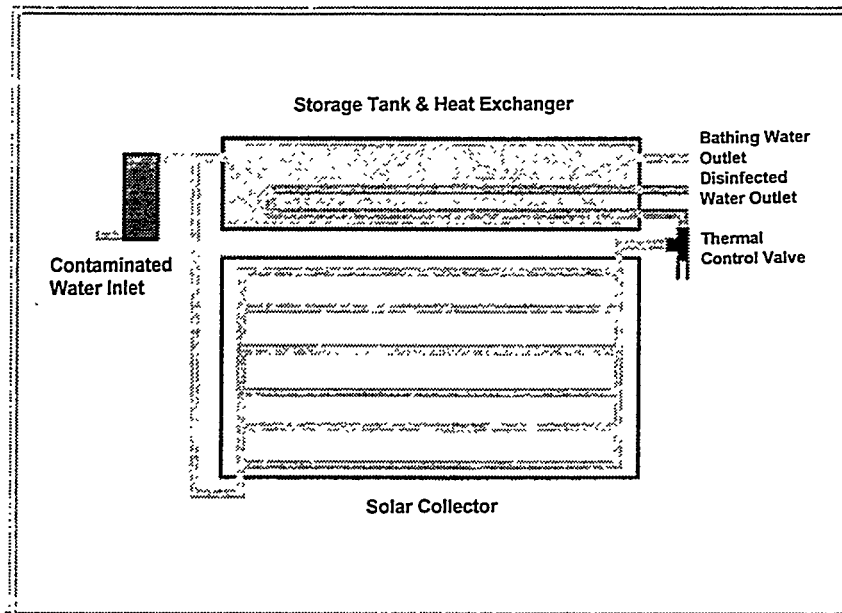

Figure 4.5.2-2. A schematic of a combined hot-water/pasteurization system developed by Safe Water Systems, Inc.

5.0 Technology Intercomparison

Comparing technologies is complex because there are many technologies (each with strengths and weaknesses in costs and appropriateness) and the market is very diverse (e.g., varying water load, water quality, operation and maintenance capability, and access to technical infrastructure). A complete market study would stratify the market (by variables such as those described in Section 2.2), and then rank and determine market share in each strata of the higher-ranked technologies. This is a large undertaking, and one that is beyond our needs. In Section 5.1, we make general comparisons between the technologies. We conclude that today's solar thermal disinfection devices are too costly on larger scales in which maintenance is not as crucial an item, and traditional treatment plants or UV methods would work well. We also conclude that solar thermal is a good option for small water demands in remote areas without access to trained personnel or technical infrastructure, in which maintenance requirements are absolutely crucial in technology selection. In Section 5.2, we provide market projections based on levels of water load and appropriateness.

5.1 Technology Summaries

We separate technologies into traditional and emerging categories.

5.1.1 Traditional Technologies

Chlorination is generally low in cost and leaves a disinfecting residual. Batch chlorination is easy to apply, whereas dosing plants require some skill for operation. Filtering is needed in turbid water and against cysts and worms. It is hard to judge proper dosage. Taste objections can lead to nonuse. Most importantly, supplies are needed, leading to "lapses." Boiling is very effective, but the real costs are high, and it is extremely labor-intensive. Slow sand filters are effective and use indigenous materials, but the construction and maintenance labor are high. A slow sand filter is limited to larger loads, because of the high level of effort in constructing and maintaining the facility. Wegelin (1996) recommends a lower limit of about 10 m², or a capacity of about 2.4 m³/day. Household ceramic filters are low in cost but are only moderately effective.

Traditional technologies do not rely on costly imported hardware, complex international supply chains, international financing, overly complex operation and required training, and so on. It is not clear why these traditional techniques have not "succeeded" already. Some of the barriers that have been identified include:

- *Basic education:* understanding disease processes and need for water treatment, which affect the motivation to install and maintain a system
- *Institutional infrastructure:* organizational support for the finance, construction, use, maintenance, and collection of user fees
- *Training:* in the case of village-scale treatment plants, training is needed for operation of the plant, especially for chlorination (chemical testing and dose adjustment)
- *Technical knowledge:* how to construct and maintain the systems
- *Supplies:* chlorination demands an ongoing supply of chemicals
- *Effectiveness:* batch chlorination and home filtering may not be sufficiently reliable in some circumstances
- *High labor needs:* the labor involved may appear overwhelming to smaller communities

- *Convenience:* boiling and keeping home filtering systems running demand considerable effort
- *Time delays:* treatment plants take some time to plan and build.

5.1.2 Emerging Technologies

At the low-volume scale, solar UV products may have some use. The solar-UV batch techniques (bottles and bags) appear especially promising in remote markets and in emergency situations. They are low cost and comparatively easy to use. The techniques have moderate effectiveness; filtering is needed in higher turbidities and when cyst and worm pathogens are present. There are questions remaining on operational problems: principally, whether the temperatures reached in various devices under various scenarios are sufficient to achieve adequate effectiveness. Solar-UV flow-through devices also have promise in that lower operating temperatures are used for the solar collector, allowing higher throughput. It remains to be seen, however, whether these techniques will prove sufficiently cost effective to be useful. Similarly, photocatalytic plus direct UV systems have promise, and may be useful in the future after workable reactor designs and catalysts are available.

At the larger-volume scales, two technologies appear potentially useful. MOGGOD water cost is relatively high (\$0.56–\$0.75/m³), though it will probably trend downward. As a chemical treatment, the residual disinfection is a real advantage. MOGGOD requires filtering in turbid waters and when cyst/worm problems exist. The unit described in Section 4.1.2 incorporates filtering. Hardware is very compact, and installation is simple. MOGGOD is presently limited to larger markets (high first cost, large volume) with very good access to a technical infrastructure for maintenance. The UV system first cost and water treatment costs are low (\$525 FOB and about \$0.02/m³ for UV/PV WaterWorks). First costs increase if reliable electricity is not already available. Filtering is needed in higher turbidities and when cyst or worm pathogens are present. It is easy to use and has only moderate maintenance needs (bulb/ballast replacements, batteries with PV). There is some need for access to technical infrastructure for maintenance and supplies.

Solar Thermal Products

The major advantages of solar thermal products are:

- *Simple installation:* inlet/outlet piping is needed, no electrical supply, minimal site preparation and filtering needs
- *High effectiveness:* all pathogens are addressed in all waters, independent of factors such as turbidity and pH
- *Low maintenance:* except for freezing and hard-water regions with metallic systems, maintenance is very low; batch systems require no maintenance, and flow-through systems have only one maintained part (control valve)
- *Modularity:* system is easy to scale up
- *Low first cost in small scales:* existing batch products are around \$100 or less, and have the potential to be significantly lower in cost with site-built products. Flow-through devices also have the potential to become very inexpensive.

The major barrier is cost. The solar thermal products have a wide range in water treatment cost (\$0.20–\$4.00/m³) that is higher than many alternatives. Although the water treatment cost is only one of many

considerations, it is nonetheless useful to derive the cost per unit area for solar thermal systems needed to break even with alternative technologies. These costs are obtained by equating solar water cost with a desired target:

$$(C_{\text{sol}}/A) / (\text{PWF}(N; I, d) * 365 * V_{\text{d, sol}}/A) = (\text{water treatment cost})_{\text{goal}} \quad (\text{Eq. 5-1})$$

Table 5.1.2-1 shows the break-even costs for a wide range of water treatment cost goals. Table 5.1.2-2 gives cost goals relative to estimated costs for specific alternative technologies.

Table 5.1.2-1. Cost Goals for Solar System Cost/Area¹

Water Treatment LCC Goal (cents/m ³)	Flow-Through Solar ² Cost/Area Goal (\$/m ²)	Batch Solar ³ Cost/Area Goal (\$/m ²)
0.1	0.6	0.06
1	6.0	0.6
10	60.0	6.0
100	600	60.0
1000	6,000	600.0

¹Assumed 20-year lifetime, discount rate of 20%, inflation rate of 10%.

²Flow-through solar unit production/area assumed to be 0.2 m³ water per m² of collector area per day.

³Batch solar unit production/area assumed to be 0.02 m³ water per m² of collector area per day.

Table 5.1.2-2. Break-Even Cost/Area of Flow-Through Solar Systems¹

Technology	Volume Scale	Technology Cost: (cents/m ²)	Flow-Through ² Solar Cost (\$/m ²)	Batch ³ Solar Cost (\$/m ²)
Chlorination	Small to very large	0.1–1	0.6–6	0.06–.6
MOGGOD	Large to very large	25–75	150–450	15–45
Slow sand	Medium to large	2–20	12–120	1.2–12
UV lamp/home	Small	40–120	240–720	24–72
Home filter	Small	90–260	540–1560	54–160
UV lamp/village	Medium to large	2–20	12–120	1.2–12
Boiling	Small	330–2100	1,600–13,000	160–1,300

¹Assumed 20-year lifetime, discount rate of 20%, inflation rate of 10%.

²Flow-through solar unit production/area assumed to be 0.2 m³ water per m² of collector area per day.

³Batch solar unit production/area assumed to be 0.02 m³ water per m² of collector area per day.

Present flow-through solar systems cost approximately \$600/m², indicating good cost competitiveness with home filtering and far superior performance to boiling. However, solar water costs are high versus the larger-scale treatments and chemicals. Polymer systems may cost about \$100/m². These systems could compete with MOGGOD and the upper end of UV-lamp technologies, opening up the village-scale market to solar thermal technologies. The potential solar systems will not compete on cost alone with chlorination or with slow sand filters. Batch solar systems currently cost approximately \$60/m², competitive with home filtering and much more cost effective than boiling.

5.2 Solar Thermal Market Estimates

The potential market for solar thermal products justifies continuing research and development (R&D) in this area. Table 5.2-1 divides the market into three load strata. Within these three strata, we list potential market estimates for solar thermal systems. Although the raw potential market is huge (see Section 2.1), the practical market is considered much smaller (see Section 2.2), as summarized in the table. The maximum potential is approximately 1 million systems, mostly of the small single-family type. These estimates are highly uncertain but do provide order-of-magnitude values. Some of the considerations and numerical assumptions are discussed below.

Table 5.2-1. System Capacity/Water Volume and Markets for Solar Thermal Disinfection

Capacity Category	No. People Served	Volume (L/day)	Markets	Maximum No. of Solar Systems ⁴
Small	5–50	20–200 ¹	sf-1 to sf-5	1.6
Medium	10–100	100–1000 ²	v-1	0.08
Village	50–500	200–2000 ³	v-2,3	0.01

¹Low-level single family is for drinking water/nonboiled cooking, at 4 L/person per day; high level is for drinking, hygiene, and bathing at 40 L/person per day.

²Health clinic water use is 10 L/person per day, drinking and hygiene.

³Public-tap usage at low volume is drinking only, at 4 L/person per day, and high volume at 40 L/person per day, for drinking and hygiene

⁴This column is the market size (see Section 2.2) times the estimated maximum solar penetration fraction.

5.2.1 Small-Volume System: Single Families

5.2.1.1 Urban Market (sf-1 + sf-3 Size is 5.8 Million)

The relevant market characteristics include pressurized private tap, electricity, good access to technical infrastructure, having access to resources, and willingness to pay (sf-1 especially). The competing technology options include chlorination, home filtering units, and "under-the-sink" UV-lamp units, in addition to boiling.

Batch solar pasteurizing is a good choice on the low-volume end. These units cost less today than potential small-scale UV systems or effective home filtering units. Low maintenance is important, but not as important as it is for the remaining single-family market. Storage vessels are required and solar access is an issue.

The *flow-through solar pasteurizer* might be a good choice on the higher end of volume needs. The high cost of present products relative to single-family resources seems to be an issue but may not be an impediment for

the wealthier segments. The potential exists for a very compact system (0.1 m²). Potential polymer products may help the cost issue. Storage for hundreds of liters seems cumbersome for crowded urban areas, and again, solar access is an issue.

We conclude that solar thermal products may have some share of this market segment; however, uncertainty is increased by potential "on-demand" products that are more convenient. Projection is difficult, in part because future alternatives are unclear. Maximum market potential is about 20% of this segment, or about 1.2 million small systems.

5.2.1.2 Remote Single Family (sf-5 Size is 0.8 Million) and Peri-Urban (sf-2 Size is 1.3 Million)

Relevant market characteristics: no electricity, no pressurized water, access to technical infrastructure varies from poor (sf-5) to moderate (sf-2). Low ability to pay, low to no recognition of need for water treatment, especially sf-5. The competing technology options include chlorination and home filtering units.

Batch solar UV-A. The exposed plastic bags may be a good, low-cost option, suitable for the low-volume end, if thin-film issues can be resolved satisfactorily. The plastic bottles also appear to have the advantage of very low cost in both markets. Issues remain with performance in cloudy, windy, cold periods.

Batch solar pasteurizers appear to be a good choice, combining moderate first cost and low maintenance. Solar access and cloudy periods are issues.

Flow-through solar pasteurization. High first cost will remain a barrier because of low income, unless low-cost polymer systems are successfully developed. Low maintenance is a big advantage. Solar access and cloudy periods are issues. The potential exists for a very compact (0.1 m²) system.

We conclude that batch solar thermal products might have a large share of this market segment. It will be very difficult to penetrate sf-5, but the peri-urban market, sf-2, can be more easily reached. For both segments, market potential is about 20%, or 0.4 million.

5.2.2 Medium-Volume System: Health Clinics (v-1 Size is 0.3 Million)

Relevant market characteristics: unpressurized water, no electricity, high motivation.

The competing technologies include chlorination, possibly an intermediate-size filtering device, and UV/PV/filtering. UV/PV/filtering appears to be a good option because no storage tanks would be needed. System maintenance in more remote areas is a crucial issue. Batch solar systems are too low in volume to be useful here.

Flow-through solar thermal. This is a good match in volume (e.g., Family Sol-Saver at 570 L/day) and effectiveness. Storage tanks would be needed. High current cost is a problem, with potential for low-cost polymer systems.

We conclude that flow-through solar thermal products may acquire modest market share, mainly because market access to technical infrastructure decreases. Assuming 25% market share, the solar thermal market is roughly 0.08 million systems. Because health clinic needs include sterilization, distilled water, cooking, and hot water, the most appealing products are solar thermal hybrid systems. Potentially, large market share might exist. However, these products are not well developed and are not considered further.

5.2.3 Large-Volume System: Public Taps (v-2 + v-3 Size is 0.28 Million)

Relevant market characteristics: no electricity, unpressurized water, varying motivation, low income, and poor access to technical infrastructure. Chlorination plant, slow sand filter, UV/PV/filter and MOGGOD/PV are competing technologies. Slow sand filtering is probably the most attractive option, because of the following factors: no imported goods, no supplies, use of local labor, and good effectiveness. Batch solar and solar-UV are not a good match because they are too low in volume.

Flow-through solar pasteurization. Low maintenance and no supplies are the key advantages whenever there is poor technology access. High current cost is a problem, with potential for low-cost polymer systems.

We conclude that solar thermal products may at best have a small market share (about 5%), because slow sand filters appear more suited to this market. This implies about 0.01 million large systems.

6.0 Research Recommendations

We examined water disinfection markets and technologies, with a focus on solar thermal opportunities. More R&D in solar thermal is needed to increase the attractiveness of this technology. Opportunities for other technologies are also identified. NREL teams focused on international markets for renewables should become knowledgeable on related water needs.

6.1 U.S. DOE Programs

6.1.1 Solar Buildings Program

Solar system costs should be reduced at all scales. On a small scale, existing solar batch products are already superior in cost-effectiveness to boiling and approach the high end of home filtering costs. Potential polymer systems could be more cost effective than competing home filter and home UV systems, and they are more effective. At moderate scales and above, flow-through solar costs begin competing with UV/PV/filters at around \$120/m³, and with MOGGOD at about \$450/m². The latter cost goal can likely be reached with incremental cost-reduction activity on existing metallic products, and the former cost can possibly be achieved with polymer-based systems (see Section 4.4.3.2).

6.1.1.1 Incremental Cost-Reduction Strategy

The current industry solar-disinfection products would be aided by use of a low-cost heat exchanger designed specifically for a low Reynolds number and low pressures. For the Family Sol-Saver, for example, the tube and shell heat exchanger adds approximately \$400 to the retail cost. Metal tube and shell designs are industry standards when water is pressurized. For low pressures (gravity feed), we might anticipate use of a plate-frame, thin-film heat exchanger (as in Appendix G), with a retail cost of around \$50. This would decrease the Family Sol-Saver first cost by around 25%. The evacuated-tube systems offer a low collector loss coefficient and operation at lower irradiance. A flow-through system using evacuated-tube technology should be developed.

6.1.1.2 Polymer Systems

Polymer solar pasteurizers have many development issues in common with other possible polymer-based solar thermal applications (Burch 1997). A reasonable strategy views polymer water disinfection systems as being one of many similar systems that could follow from a unified research effort focused on polymer systems. It would be unwise to push a polymer-based disinfection system until polymer durability issues are satisfactorily resolved. If and when this is done, it may be reasonable to develop market applications. Also, the potential for collaborating on the development of disinfection technologies is high. Two U.S. solar thermal industry members and the EAWAG/SANDEC Center (a Swiss group) for water treatment in developing countries are investing in solar pasteurization.

6.1.1.3 Small-Scale Flow-Through Units

There are many market segments in the developing world and elsewhere that have very small-scale disinfection needs (approximately 10–20 L/day). Although very attractive batch units exist, there is potential for developing a very compact flow-through solar pasteurizer. With proper design, an approximately 0.1-m² system would provide about 20 L/day. A very compact, lightweight polymer product appears possible.

6.1.1.4 Multi-Use Solar Thermal Products

Systems combining sterilization, disinfection, distillation, cooking, and hot water are discussed in Section 4.5. Useful combinations of applications, hybrid technologies, and their costs for the potential spectrum of needs served should be examined further to determine if program investment could spur a reasonably sized niche market.

6.1.2 Solar Electric Program

The DOE Solar Thermal Program is developing small dish-Stirling systems (~10–20 kilowatts [kW]) that may be suitable for use in developing countries. The cost of electricity is projected to be around \$0.15/kilowatt-hour. Using the waste heat of dish-Stirling machines for water pasteurization may present an important opportunity, given heat rejection at temperatures around 80°C. Rejection of heat to water may also lessen the expense of the heat exchanger.

6.1.3 Other Programs

There is need for further work on appropriate home filtering units. If inexpensive, effective, and easy to use, these units could become the technology of choice for remote single-family application. The units developed for the United States (both backpacking and home filters) are far too expensive for developing countries. Costs for these indigenous home filtering units are appropriate; however, they are not very effective and are difficult to use.

An appropriate "under-the-sink" UV+ filter unit should be developed. Such a unit could be the technology of choice for an urban market using pressurized water taps.

6.2 NREL International Programs

Several groups at NREL (and elsewhere) are examining the potential of renewable electricity systems in developing countries. Where renewable electricity is being installed, there is an opportunity to upgrade the water infrastructure, including water supply, treatment, and sanitation. For village-scale water treatment, slow sand filters remain a good option. However, given that renewable electricity is coming on-line, there are hardware options that may be more attractive. For instance, UV and MOGGOD offer reduced installation time and labor and reduced maintenance labor. MOGGOD also offers residual disinfection. With UV, the increase in electrical load is very small and the incremental hardware cost is low. (UV first costs range from \$600 to several thousand, depending on filter costs.) The incremental electric load of these devices is about 100 W or less.

Selecting any disinfection process requires an analysis of the complete water cycle and the power sources for each potential application. As with electrification, these are complex issues that require a global perspective of economic, social, and other factors. NREL should develop in-house expertise in water supply, treatment, and sanitation. This can best be accomplished through training and collaboration with other groups working in the field of water needs for developing countries.

Bibliography

- Acra, A.; Jurdi, M.; Muallem, H.; Karahagopian, Y.; Raffoul, Z. (1991). "Water Disinfection by Solar Radiation: Assessment and Application." International Development Research Center, P.O. Box 8500, Ottawa, Ontario, Canada.
- Allderdice, A. (1997). Personal communication. Grameen Bank, Bangladesh.
- Alward, R.; Ayoub, J.; Brunet, E. (1994). "Solar Water Disinfection." *Renewables 1994, Proceedings of the Solar Energy Society of Canada; Ottawa, Ontario, Canada.*
- Anderson, R.; Collier, K. (1996). "Solar Water Disinfection." *Proceedings of the 1996 ASES Conference; Asheville, North Carolina*; p. 184.
- Andreatta, D.; Yegian, D.; Connelly, L.; Metcalf, R. (1994). "Recent Advances in Devices for the Heat Pasteurization of Drinking Water in the Developing World." *Proceedings of the 29th Intersociety Energy Conversion Engineering Conference, 1994*; p. 1741.
- Ayarza, J. (1997). Personal communication. American Wind Energy Association, Washington, D.C.
- Azrag, E. (1996). Personal communication. Water for People, National Renewable Energy Laboratory, Golden, Colorado.
- Bansal, N.K.; Sawhney, R.L.; Misra, A. (1988). "Solar Sterilization of Water." *Solar Energy*, Vol. 40, No. 1, p. 35.
- Blake, D.M. (1994). "Solar Processes for the Destruction of Hazardous Chemicals." *Alternative Fuels and the Environment*. Edited by Frances Sterrett. CRC Press, Boca Raton, FL: Lewis Publishers; pp. 175-186.
- Burch, J.D. (1997). "Low-cost Solar Water Heating." Technical report available from author, National Renewable Energy Laboratory, Golden, CO.
- Burch, J.D.; Thomas, K.E. (1997). "Solar Thermal Water Pasteurization." Submitted for publication at 1998 ASES Conference. Boulder, CO: American Solar Energy Society.
- Carlson, D.A.; Seabloom, R.W.; DeWalle, F.B.; Wetzler, T.F.; Engeset, J.; Butler, R.; Wangsuphachart, S.; Wang, S. (September 1985). *Ultraviolet Disinfection of Water for Small Water Supplies*. EPA/600/S2-85/092. Cincinnati, OH: U.S. Environmental Protection Agency.
- Chapman, R. (1996). *Water Disinfection Using Photovoltaics*. Unpublished. Albuquerque, NM: Sandia National Laboratories.
- Cheremisinoff, P. (1995). *Handbook of Water and Wastewater Treatment Technology*. New York: Marcel Dekker.
- Cobb, J.C. (April 1996). "Solar Sanitary System (Sol-San)." *Proceedings of the 1996 ASES Conference, Asheville, North Carolina*. Boulder, CO: American Solar Energy Society.
- Collier, K. (1997). Private communication. NRG Technologies, Reno, Nevada.

- Cooper, A.T.; Goswami, D.Y.; Block, S.S. (1977). "Simultaneous Detoxification and Disinfection of Water by Solar Photocatalytic Treatment." *Solar Engineering*. New York: American Society of Mechanical Engineers.
- de Leon, E.D.; Gallegos, Y.; Rodriguez, R. (1989). "Potable Water In Rural Areas in Mexico." *9th Miami International Congress on Energy and Environment; December 1989, Miami Beach, Florida; Vol. 7*.
- Duffie, J.A.; Beckman, W.A. (1991). *Solar Engineering of Thermal Processes*. New York: John Wiley and Sons.
- Ellis, K.V. (1991). "Water Disinfection: A Review with Some Consideration of the Requirements of the Third World." *Critical Reviews in Environmental Control; Vol. 20, Nos. 5,6, pp. 341-407*.
- Engelbrecht, R.S.; Weber, M.J.; Schmidt, C.A.; Salter, B.L. (1978). *Virus Sensitivity to Chlorine Disinfection of Water Supplies*. EPA-600/2-78-123. Cincinnati, OH: U.S. Environmental Protection Agency.
- EPA (1991). *Guidance Manual for Compliance with the Filtration and Disinfection Requirements for Public Water Systems Using Surface Water Sources*. Washington, D.C.: U.S. Environmental Protection Agency.
- ESMAP (Energy Sector Management Assistance Programme). (1994). *Vietnam: Rural and Household Energy Issues and Options*. Report No. 161/94. Washington, D.C.: World Bank.
- Esrey, S.A.; Potash, J.B.; Roberts, L.; Shiff, C. (1991). "Effects of Improved Water Supply and Sanitation on Ascariasis, Diarrhea, Dracunculiasis, Hookworm Infection, Schistosomiasis, and Trachoma." *Bulletin of the World Health Organization; Vol. 69, No. 5, pp. 609-621*.
- Esrey, S.A.; Potash, J.B.; Roberts, L.; Shiff, C. (1990). "Health Benefits from Improvements in Water Supply and Sanitation: Survey and Analysis of the Literature on Selected Diseases." *Water and Sanitation for Health (WASH) Technical Report No. 66*. Washington, D.C.: U.S. Agency for International Development.
- Farrington, R. (1987). "Polybutylene Pipe Freeze/Thaw Reliability Testing." SERI/TP-254-3157. Solar Energy Research Institute. Available from the National Renewable Energy Laboratory, 1617 Cole Boulevard, Golden, Colorado 80401.
- Feachem, R.E.; Bradley, D.J.; Garelick, H.; Mara, D.D. (1983). *Sanitation and Disease: Health Aspects of Excreta and Wastewater Management*. New York: John Wiley and Sons.
- Feachem, R.; McGarry, M.; Mara, D. (1977). *Water, Wastes, and Health in Hot Climates*. Chichester, UK: John Wiley and Sons.
- Flowers, L. (1997). Personal communication. National Renewable Energy Laboratory, Golden, Colorado.
- Fujioka, R.; Geeta, R. (February 1995). *Evaluation of the Grand Solar Pasteurizing System to Disinfect Water*. Water Resources Research Center, University of Hawaii. Available from Safe Water Systems, Will Hartzel, 2800 Woodlawn Drive, Suite 131, Honolulu, Hawaii 96822-3935.
- Gadgil, A.J.; Shown, L.J. (1997). *To Drink Without Risk: The Use of Ultraviolet Light to Disinfect Drinking Water in Developing Countries*. <http://eande.lbl.gov/CBS/archive/uv/drink.html>.

- Gadgil, A.J.; Shown, L.J. (1997). *To Drink Without Risk: The Use of Ultraviolet Light to Disinfect Drinking Water in Developing Countries*. <http://eande.lbl.gov/CBS/archive/uv/drink.html>.
- Goswami, Y. (1997). Private communication. University of Central Florida, Gainesville, Florida.
- Gupta, A.; Chaudhuri, M. (1992). "Domestic Water Purification for Developing Countries." *Journal of Water Supply Research and Technology—Aqua*; Vol. 41, No. 5, pp. 290-298.
- Hale, M.J. (1977). Private communication. National Renewable Energy Laboratory, Golden, Colorado.
- Hamasaki, L. (1997). Private communication. Sun Utility Network, Los Angeles, California.
- Harris, D. (March 1992). *Disinfection for Rural Community Water Supply Systems in Developing Countries*. WASH Technical Note. Arlington, VA: U.S. Agency for International Development.
- Hartzell, W. (1997). Private communication. Safe Water Systems, Inc., Honolulu, Hawaii.
- Hoff, J.C. (September 1986). *Inactivation of Microbial Agents by Chemical Disinfectants*. EPA/600/S2-86/067. Cincinnati, Ohio: U.S. Environmental Protection Agency.
- Jimenez, T. (1997). Personal communication. National Renewable Energy Laboratory, Golden, Colorado.
- Jones, K. (1994). "Waterborne Diseases." *Inside Science*; Vol. No. 73, July 9, 1994, pp. 1-4.
- Jordan. (1980). UNICEF.
- Khan, K.A.; Khan, A.J. (September 1992). "Solar Water Heater for Domestic Use by Applying Fresnel Reflecting Concentrator." *Proceedings of the 2nd World Renewable Energy Congress*; Sept. 1992, Reading, UK: Pergamon Press, N.Y., N.Y.
- Lawand, T.A.; Papp, R.; Ayoub, J. (1994). "Recent Experiments in Solar Water Disinfection." *Renewables 1994, Proceedings of the Solar Energy Society of Canada*, Ottawa, Ontario, Canada.
- Lilienthal, Peter. (1997). Private communication. National Renewable Energy Laboratory, Golden, Colorado.
- Logsdon, G.S.; Lippy, E.C. (December 1982). "The Role of Filtration in Preventing Waterborne Disease." *Journal of the American Water Works Association*; Vol. 74 (12), pp. 649-655.
- Malcolm Pirnie, Inc. (April 1987). *Technologies and Costs for Treatment of Microbial Contaminants in Potable Water Supplies*. Paramus, NJ: U.S. Environmental Protection Agency.
- Malcolm Pirnie, Inc.; HDR Engineering, Inc. (1991). *Guidance Manual for Compliance with the Filtration and Disinfection Requirements for Public Water Systems Using Surface Water Sources*. Denver, CO: American Water Works Association.
- McFadyen, S. (1997). Research Assistant, Canadian Water and Wastewater Association. E-mail communication, Agua list-group.
- MIOX Corporation. (1996). Product literature. Albuquerque, New Mexico.

- Niewoehner, J. (Water for People) (1997). Personal communication. National Renewable Energy Laboratory, Golden, Colorado.
- Ongerth, J.E.; Johnson, R.L.; MacDonald, S.C.; Frost, F.; Frost, H.H. (1989). "Back-country Water Treatment to Prevent Giardiasis." *American Journal of Public Health*, Vol. 79, p. 1633.
- Oriens, M. (1997). Private communication. RADCO, Santa Maria, California.
- Sanchez, A. (February 1997). Personal communication. International Development Research Center, Canada.
- Scheir, R.; Fencl, F. (February 1996). "UVC and Indoor Air Quality." *Heating, Piping, Air Conditioning*; Vol. 68, No. 2, p. 109.
- Schenck, G. (1990). "Ultraviolet Sterilization." Chapter 16 in *Handbook of Water Purification*. 2nd Edition. Edited by Walter Lorch. New York: John Wiley and Sons.
- Schuler, P.F.; Ghogh, M.M.; Gopalan, P. (1991). "Slow Sand and Diatomaceous Earth Filtration of Cysts and Other Particulates." *Water Resources*; Vol. 25, No. 8, pp. 995-1005.
- Schulz, C.R.; Okun, D.A. (1984). *Surface Water Treatment for Communities in Developing Countries*. New York: John Wiley and Sons.
- Schulz, C.R.; Okun, D.A. (May 1983). "Treating Surface Waters for Communities in Developing Countries." *Journal of the American Water Works Association*; Vol. 75, No. 5, pp. 212-219.
- Singha, D. (October 1996). "Can Pay, Will Pay—Securing a Slum Water Supply for Squatters." *Waterlines*; Vol. 15, No. 2, pp. 4-6.
- Snyder, J.D.; Merson, M.H. (1982). "The Magnitude of the Global Problem of Acute Diarrheal Disease: A Review of Active Surveillance Data." *Bulletin of the WHO*; Vol. 60, No. 4, pp. 605-613.
- Stafford, B. (1997). Private communication. National Renewable Energy Laboratory, Golden, Colorado.
- Taylor, A. (1997). Private communication. Innovative Sputtering Technology, 1000 Park Forty Plaza, Suite 300, Durham, North Carolina 27713.
- Tchobanoglous, G.; Schroeder, E. (1987). *Water Quality*. Reading, MA: Addison-Wesley Publishing Company.
- Ultrasun. (1997). Data found at the Web site "www.ultrasun.com", June 9, 1997. Appendix A: Characteristics of Waterborne Pathogens.
- UNICEF (1995). *The State of the World's Children*. Oxford, UK: Oxford University Press.
- WASH. (1993). *Lessons Learned in Water Sanitation and Health: Thirteen Years of Experience in Developing Countries*. Alexandria, VA: U.S. Agency for International Development.
- Water for People. (1997). *Opportunities for Renewable Energy Technologies in Water Supply in Developing Country Villages*. NREL/SR-430-22359. Golden, CO: National Renewable Energy Laboratory.

- Water Health International. (1997). Private communication. WHI holds the international rights to UV WaterWorks manufacture and distribution.
- Wegelin, M. (1996). "Water Treatment with Solar Energy." Internal EAWAG/SANDEC report. Available from the author at wegelin@eawag.ch.
- Wegelin, M.; Canonica, S.; Mechsner, K.; Fleischmann, T.; Pasaro, F.; Metzler, A. (1994). "Solar Water Disinfection: Scope of the Process and Analysis of Radiation Experiments." *Journal of Water Supply Research Technology—Aqua*; Vol. 43, pp. 154-169.
- Wegelin, M.; Schertenleib, R.; Boller, M. (1991). "The Decade of Roughing Filters—Development of a Rural Water-Treatment Process for Developing Countries." *Journal of Water Supply Research and Technology—Aqua*; Vol. 40, No. 5, pp. 304-316.
- Wegelin, M.; Sommer, B. (October 1996). "Demonstration Project on Solar Water Disinfection." *SANDEC News*; No. 2. Available from EAWAG (Swiss Federal Institute for Environmental Science and Technology), Deubendorf, Switzerland.
- Weintraub, S. (1997). Personal communication. Lawrence Berkeley National Laboratory, Berkeley, California.
- Wilhelm, W.G.; Andrews, J.W. (1982). "The Development of Polymer Film Solar Collectors: A Status Report." BNL-51582. Upton, NY: Brookhaven National Laboratory.
- World Bank. (1994). *World Development Report*. Washington, D.C.: World Bank.
- World Bank. (1992). *World Development Report 1992*. Washington, D.C.: World Bank.
- World Bank Water Demand Research Team. (1993). "The Demand for Water in Rural Areas: Determinants and Policy Implications." *The World Bank Research Observer*; Vol. 8, No. 1, pp. 47-70.
- World Health Organization. (1996). *Guidelines for Drinking Water Quality*. 2nd Edition. Geneva, Switzerland: World Health Organization; Vol. 2.

Appendix A

Characteristics of Waterborne Pathogens

	Bacteria				
	Campylobacter, ¹ Escherichia, Yersinia	Vibrio ²	Salmonella ³	Shigella ⁴	Trachoma ⁵
How transmitted	Ingestion of contaminated water, food, or milk	Ingestion of contaminated water or food, person-to-person contact	Ingestion of contaminated water or food	Person-to-person contact, ingestion of contaminated water or food	Washing with contaminated water
Diseases it causes	Diarrhea, "travelers' diarrhea"	Cholera	Enteric fever, diarrhea, typhoid fever	Dysentery (Shigellosis)	Partial or complete blindness
How to prevent transmission	Sanitation, disinfect water, cook meat, pasteurize milk	Sanitation, disinfect water	Sanitation, cook meat, disinfect water	Sanitation, avoid person-to-person contact, hygiene, disinfect water	Increase quantity of water for washing, disinfect wash water
Cases/year	No data	5.5 million	About 1% of diarrhea cases	About 4% of diarrhea cases	500 million
Deaths/year	No data	120,000	No data	No data	0 (effect is blindness)
Size of pathogen	0.5 to 2 µm	0.6 to 6 µm	1 to 3 µm	0.5 to 10 µm	0.6 to 6 µm
Min. # for infection	> 10 ⁶	> 10 ⁶	> 10 ⁶	10 to 100	No data
Chlorine dose needed for >99.9% disinfection	0.034 to 0.05 mg-min/L at pH 6 to 7, 5°C	0.034 to 0.05 mg-min/L at pH 6 to 7, 5°C	0.034 to 0.05 mg-min/L at pH 6 to 7, 5°C	0.034 to 0.05 mg-min/L at pH 6 to 7, 5°C	No data
UV dose needed for >99.9% disinfection	60 W-sec/m ²	No data	80 W-sec/m ²	44 W-sec/m ²	No data

Notes:

¹ Feachem et al. 1983; Ellis 1991; Tschoba-noglous et al. 1987; WHO 1996; Hoff 1986

² Feachem et al. 1983; Jones 1994; Tschoba-noglous et al. 1987; WHO 1996; Hoff 1986

³ Feachem et al. 1983; Ellis 1991; Tschoba-noglous et al. 1987; WHO 1996; Hoff 1986

⁴ Feachem et al. 1983; Ellis 1991; Tschoba-noglous et al. 1987; WHO 1996; Hoff 1986

⁵ WHO 1996; Water for People 1997

Appendix A

Characteristics of Waterborne Pathogens (Continued)

	Protozoa			Viruses
	Cryptosporidium ¹	Entamoeba ²	Giardia ³	Hepatitis, Rotavirus ⁴ (Norwalk), Adenovirus, Enterovirus (polio, coxsackie, echo), Reovirus
How transmitted	Ingestion of cysts in contaminated water and food	Ingestion of cysts in contaminated water and food, person-to-person contact	Person-to-person contact, ingestion of cysts in contaminated water	Ingestion of contaminated water, person-to-person contact
Diseases it causes	Diarrhea	Amoebic dysentery	Diarrhea, various symptoms	Hepatitis, polio, diarrhea, meningitis, respiratory disease
How to prevent transmission	Disinfect water	Avoid person-to-person contact, disinfect water, cook food	Avoid person-to-person contact, disinfect water	Disinfect water, avoid person-to-person contact
Cases/year	No data	Approx. 50 million	Approx. 25 million	Enteroviruses: approx. 5 million. Hepatitis A: approx. 1 million. Rotavirus: 100,000
Deaths/year	No data	No data	Rarely fatal	No data
Size of pathogen	Cysts 4 to 6 µm	Cysts 10 to 20 µm	Cysts 8 to 12 µm	20 to 80 nm
Min. # for infection	1 to 30	<10 ²	1 to 10	1 to 100
Chlorine dose needed for >99.9% disinfection	No data	2 mg/L for 30 minutes	30 to 100 mg-min/L at 20°C, pH 6 to 8	3 mg-min/L for 20°C, pH 6 to 9
UV dose needed for >99.9% disinfection	1280 to 2000 W-sec/m ²	1280 to 2000 W-sec/m ²	1280 to 2000 W-sec/m ²	40 to 80 W-sec/m ²

Notes:

¹ Sanchez 1997; WHO 1996; Ellis 1991.

² WHO 1996; Feachem et al. 1983; Ellis 1991; Feachem et al. 1977

³ Sanchez 1997; WHO 1996; Feachem et al. 1983; Pirnie et al. 1991; Ellis 1991.

⁴ Sanchez 1997; WHO 1996; Feachem et al. 1983; Pirnie et al. 1991; Ellis 1991.

Appendix A

Characteristics of Waterborne Pathogens (Concluded)

	Worms		
	Guinea worm ¹	Schistosomiasis ²	Ascaris ³
How transmitted	Ingestion of contaminated water	Bathing/washing with contaminated water	Ingestion from contaminated fingers, food, soil, etc.
Diseases it causes	Blisters, damage to tendons	Lesions of internal organs	Roundworm infection
How to prevent transmission	Prevent contamination of water wells, sanitation, filter water	Use disinfected water for washing, sanitation, control of snail populations	Sanitation, hygiene, disinfect wash water
Cases/year	0.5 million	200 million	900 million
Deaths/year	0 (effect is debilitation)	0 (effect is usually debilitation)	20,000
Size of pathogen	0.5 to 2 mm	Eggs 0.14 mm	Eggs 35 to 70 µm
Min. # for infection	No data	< 10 ²	< 10 ²
Chlorine dose needed for >99.9% disinfection	No data	0.5 mg/l for 1 hour	No data
UVdose needed for >99.9% disinfection	No data	No data	No data

Notes:

¹ WHO 1996; UNICEF 1995

² WHO 1996; Feachem et al. 1983; Water for People 1997

³ WHO 1996; Feachem et al. 1983; Water for People 1997

Appendix B
Access to Safe Water in Selected Countries
(Source: World Bank 1994)

Region and Country	GNP per Capita (\$)	Total Population (thousands)	Urban Population (thousands) with Access to Safe Water	Urban Population (thousands) without Access to Safe Water	Rural Population (thousands) with Access to Safe Water	Rural Population (thousands) without Access to Safe Water	Population (thousands) in Cities Larger Than 1 Million People
East Asia	—	1,338,500.0	408,012.8	40,793.2	610,772.0	278,922.0	179,334.0
China	470	1,162,200.0	273,000.8	40,793.2	576,916.1	271,489.9	104,598.0
Mongolia	No data	2,300.0	1,357.0	0.0	546.9	396.1	0.0
Korea	6,790	43,700.0	32,338.0	0.0	8,635.1	2,726.9	23,161.0
Hong Kong	15,360	5,800.0	5,452.0	0.0	334.1	13.9	5,510.0
Japan	28,190	124,500.0	95,865.0	0.0	24,339.8	4,295.3	46,065.0
Europe	—	480,400.0	345,172.6	1,584.4	111,052.4	4,990.6	108,557.0
Romania	1,130	22,700.0	12,485.0	0.0	9,193.5	1,021.5	2,270.0
Bulgaria	1,330	8,500.0	5,865.0	0.0	2,529.6	105.4	1,360.0
Poland	1,910	38,400.0	22,740.5	1,451.5	11,650.6	2,557.4	6,912.0
Albania	No data	3,400.0	1,224.0	0.0	2,067.2	108.8	0.0
Hungary	2,970	10,300.0	6,798.0	0.0	3,326.9	175.1	2,163.0
Greece	7,290	10,300.0	6,592.0	0.0	3,522.6	185.4	3,502.0
Portugal	7,450	9,800.0	3,327.1	102.9	5,733.0	637.0	1,666.0
Ireland	12,210	3,500.0	2,030.0	0.0	1,470.0	0.0	0.0
Spain	13,970	39,100.0	30,889.0	0.0	8,211.0	0.0	8,993.0
United Kingdom	17,790	57,800.0	51,442.0	0.0	6,358.0	0.0	13,294.0
Italy	20,460	57,800.0	40,460.0	0.0	17,340.0	0.0	14,450.0
Netherlands	20,480	15,200.0	13,528.0	0.0	1,672.0	0.0	2,128.0
Belgium	20,880	10,000.0	9,600.0	0.0	400.0	0.0	1,300.0
Finland	21,970	5,000.0	2,970.0	30.0	1,800.0	200.0	1,000.0
France	22,260	57,400.0	41,902.0	0.0	15,498.0	0.0	1,2054.0
Austria	22,380	7,900.0	4,661.0	0.0	3,239.0	0.0	2,133.0
Germany	23,030	80,600.0	69,316.0	0.0	11,284.0	0.0	32,240.0
Norway	25,820	4,300.0	3,268.0	0.0	1,032.0	0.0	0.0
Denmark	26,000	5,200.0	4,420.0	0.0	780.0	0.0	1,352.0
Sweden	27,010	8,700.0	7,308.0	0.0	1,392.0	0.0	1,740.0

Appendix B

Access to Safe Water in Selected Countries (Continued)

Region and Country	GNP per Capita (\$)	Total Population (thousands)	Urban Population (thousands) with Access to Safe Water	Urban Population (thousands) without Access to Safe Water	Rural Population (thousands) with Access to Safe Water	Rural Population (thousands) without Access to Safe Water	Population (thousands) in Cities Larger Than 1 Million People
Switzerland	36,080	6,900.0	4,347.0	0.0	2,553.0	0.0	0.0
Latin America	—	432,400.0	281,790.4	33,898.6	54,755.2	58,355.8	135,153.0
Nicaragua	340	3,900.0	1,808.0	571.0	319.4	1,201.6	0.0
Honduras	580	5,400.0	2,065.5	364.5	1,425.6	1,544.4	0.0
Bolivia	680	7,500.0	2,964.0	936.0	1,080.0	2,520.0	1,125.0
Peru	950	22,400.0	10,814.7	5,089.3	1,559.0	4,937.0	6,944.0
Guatemala	980	9,700.0	3,569.6	310.4	2,502.6	3,317.4	0.0
Dominican Republic	1,050	7,300.0	3,711.3	814.7	1,248.3	1,525.7	2,409.0
Ecuador	1,070	11,000.0	4,019.4	2,360.6	2,032.8	2,587.2	3,410.0
El Salvador	1,170	5,400.0	2,114.1	315.9	445.5	2,524.5	0.0
Colombia	1,330	33,400.0	20,631.2	3,082.8	7,942.5	1,743.5	9,686.0
Jamaica	1,340	2,400.0	1,231.2	64.8	507.8	596.2	0.0
Paraguay	1,380	4,500.0	1,345.1	860.0	229.5	2,065.5	0.0
Costa Rica	1,960	3,200.0	1,536.0	0.0	1,397.8	266.2	0.0
Panama	2,420	2,500.0	1,350.0	0.0	759.0	391.0	0.0
Chile	2,730	13,600.0	11,560.0	0.0	428.4	1,611.6	5,168.0
Brazil	2,770	153,900.0	112,577.9	5,925.2	21,592.2	13,804.8	58,482.0
Venezuela	2,910	20,200.0	16,727.6	1,654.4	654.5	1,163.5	5,454.0
Uruguay	3,340	3,100.0	2,759.0	0.0	6.8	334.2	1,302.0
Mexico	3,470	85,000.0	59,126.0	3,774.0	9,503.0	12,597.0	25,500.0
Trinidad and Tobago	3,940	1,300.0	858.0	0.0	389.0	53.0	0.0
Argentina	6,050	33,100.0	21,021.8	7,775.2	731.5	3,571.5	14,233.0
Puerto Rico	6,590	3,600.0	No data	No data	No data	No data	1,440.0
Middle East	—	327,600.0	160,620.9	7,708.1	89,564.8	69,706.2	55,116.0
Pakistan	420	119,300.0	32,282.6	7,086.4	33,571.0	46,360.0	20,281.0
Yemen	No data	13,000.0	4,030.0	0.0	1,614.6	7,355.4	0.0
Jordan	1,120	39,000.0	26,910.0	0.0	11,727.3	362.7	0.0
Turkey	1,980	58,500.0	37,440.0	0.0	14,742.0	6,318.0	11,700.0
Iran	2,200	59,600.0	34,568.0	0.0	18,774.0	6,258.0	13,708.0
Syria	No data	13,000.0	6,033.3	596.7	4,331.6	2,038.4	3,640.0
Oman	6,480	1,600.0	167.0	25.0	591.4	816.6	0.0

Appendix B

Access to Safe Water in Selected Countries (Continued)

Region and Country	GNP per Capita (\$)	Total Population (thousands)	Urban Population (thousands) with Access to Safe Water	Urban Population (thousands) without Access to Safe Water	Rural Population (thousands) with Access to Safe Water	Rural Population (thousands) without Access to Safe Water	Population (thousands) in Cities Larger Than 1 Million People
Saudi Arabia	7,510	16,800.0	13,104.0	0.0	3,511.2	184.8	3,696.0
Israel	13,220	5,100.0	4,692.0	0.0	395.8	12.2	2,091.0
United Arab Emirates	22,020	1,700.0	1,394.0	0.0	306.0	0.0	0.0
North Africa	—	115,600.0	39,966.6	1,203.4	29,962.7	18,167.3	22,386.0
Egypt	640	54,700.0	22,864.6	1,203.4	26,343.5	4,288.5	12,581.0
Morocco	1,030	26,200.0	1,2314.0	0.0	2,499.5	11,386.5	4,454.0
Tunisia	1,720	8,400.0	4,788.0	0.0	1,119.7	2,492.3	1,932.0
Algeria	1,840	26,300.0	No data	No data	No data	No data	3,419.0
Pacific Islands and Australia		25,000.0	18,116.4	24.6	3,809.1	3,049.9	10,675.0
Papua New Guinea	950	4,100.0	385.4	24.6	738.0	2,952.0	0.0
New Zealand	12,300,000	3,400.0	2,856.0	0.0	446.1	97.9	0.0
Australia	17,260	17,500.0	14,875.0	0.0	2,625.0	0.0	10,675.0
Southeast Asia	—	1,411,400.0	285,746.0	94,381.0	688,148.2	343,124.8	135,434.0
Bangladesh	220	114,400.0	8,030.9	12,561.1	83,489.1	10,318.9	10,296.0
Laos	250	4,400.0	413.6	466.4	880.0	2,640.0	0.0
Indonesia	670	184,300.0	20,641.6	38,334.4	41,356.9	83,967.1	20,273.0
Myanmar	No data	43,700.0	8,630.8	2,294.3	23,598.0	9,177.0	3,496.0
Philippines	770	64,300.0	26,311.6	1,980.4	29,526.6	6,481.4	9,645.0
Thailand	1,840	58,000.0	8,671.0	4,669.0	37,961.0	6,699.0	7,540.0
Malaysia	2,790	18,600.0	8,035.2	334.8	6,751.8	3,478.2	1,860.0
Singapore	15,730	2,800.0	2,800.0	0.0	0.0	0.0	2,800.0
Nepal	1,70	19,900.0	1,576.1	811.9	5,954.1	11,557.9	0.0
Sri Lanka	5,40	1,7400.0	3,062.4	765.6	7,464.6	6,107.4	0.0
India	3,10	883,600.0	197,573.0	32,163.0	451,166.2	202697.8	79,524.0
Sub-Saharan Africa	—	488,300.0	95,002.6	26,003.4	96,252.2	225,241.8	34,988.0
Mozambique	60	16,500.0	2,178.0	2,772.0	1,963.5	9,586.5	1,980.0
Ethiopia	110	54,800.0	4,986.8	2,137.2	5,244.4	42,431.6	2,192.0
Tanzania	110	25,900.0	4,273.5	1,424.5	9,292.9	10,909.1	1,554.0
Sierra Leone	160	4,400.0	1,196.8	299.2	580.8	2,323.2	0.0
Uganda	170	17,500.0	1,260.0	840.0	4,620.0	10,780.0	0.0

Appendix B
Access to Safe Water in Selected Countries (Continued)

Region and Country	GNP per Capita (\$)	Total Population (thousands)	Urban Population (thousands) with Access to Safe Water	Urban Population (thousands) without Access to Safe Water	Rural Population (thousands) with Access to Safe Water	Rural Population (thousands) without Access to Safe Water	Population (thousands) in Cities Larger Than 1 Million People
Burundi	210	5,800.0	320.2	27.8	2,344.4	3,107.6	0.0
Malawi	210	9,100.0	720.7	371.3	3,923.9	4,084.1	0.0
Bhutan	180	1,500.0	54.0	36.0	423.0	987.0	0.0
Chad	220	6,000.0	No data	No data	No data	No data	0.0
Guinea-Bissau	220	1,000.0	37.8	172.2	213.3	576.7	0.0
Madagascar	230	12,400.0	1,922.0	1,178.0	930.0	8,370.0	0.0
Rwanda	250	7,300.0	367.9	70.1	4,597.5	2,264.5	0.0
Niger	280	8,200.0	1,687.6	34.4	2,915.1	3,562.9	0.0
Burkina Faso	300	9,500.0	710.6	904.4	5,519.5	2,365.5	0.0
Kenya	310	25,700.0	5,461.3	963.8	2,891.3	16,383.8	1,799.0
Mali	310	9,000.0	922.5	1,327.5	270.0	6,480.0	0.0
Nigeria	320	101,900.0	37,703.0	0.0	14,123.3	50,073.7	10,190.0
Togo	390	3,900.0	1,131.0	0.0	1,689.1	1,079.9	0.0
Benin	410	5,000.0	1,460.0	540.0	1,290.0	1,710.0	0.0
Central African Rep.	410	3,200.0	291.8	1,244.2	432.6	1,231.4	0.0
Ghana	450	15,800.0	3,483.9	2,046.1	3,389.1	6,880.9	1,580.0
Guinea	510	6,100.0	1,647.0	0.0	1,647.6	2,805.4	1,342.0
Mauritania	530	2,100.0	840.0	210.0	892.5	157.5	0.0
Zimbabwe	570	10,400.0	2,964.0	156.0	5,824.0	1,456.0	0.0
Lesotho	590	1,900.0	235.4	163.6	675.5	825.6	0.0
Somalia	No data	8,300.0	1,037.5	1,037.5	1,805.3	4,419.8	0.0
Sudan	No data	26,500.0	5,485.5	609.5	4,081.0	16,324.0	2,120.0
Zambia	753	8,300.0	2,649.4	836.6	2,070.0	2,744.0	0.0
Cote d'Ivoire	670	12,900.0	3,088.3	2,329.7	5,985.6	1,496.4	2,451.0
Senegal	780	7,800.0	2,078.7	1,119.3	1,196.5	3,405.5	1,794.0
Cameroon	820	12,200.0	2,152.1	2,971.9	3,184.2	3,891.8	1,220.0
Congo	1,030	2,400.0	927.4	80.6	27.8	1,364.2	0.0
Namibia	1,610	1,500.0	391.5	43.5	394.1	671.0	0.0
South Africa	2,670	39,800.0	No data	No data	No data	No data	6,766.0
Mauritius	2,700	1,100.0	451.0	0.0	597.1	51.9	0.0
Botswana	2,790	1,400.0	378.0	0.0	899.4	122.6	0.0
Gabon	4,450	1,200.0	507.6	56.4	318.0	318.0	0.0

Appendix C

List of Organizations Involved in Water Treatment Activities

USAID (United States Agency for International Development) EHP (Environmental Health Project)
PAHO (Pan-American Health Organization)
UNICEF
WHO (World Health Organization)
ODA (British Office of Development Assistance)
CARE
Water for People
Brace Research Institute
EAWAG/SANDEC
IRC (International Water and Sanitation Centre)
APACE (Appropriate Technology for Community and Environment)
BCA (Boliviacentrum Antwerpen)
VREILA (Vredeseilanden)
CHF (Canadian Hunger Foundation)
Plenty Canada
SIM Canada
Caritas
CCS (Centrale Sanitaire Suisse)
Enfants du Monde
HELVETAS (Schweizer Gesellschaft für Entwicklung und Zusammenarbeit)
KODIS (Center for Technical Education and Vocational Training in Developing Countries)
Stiftung Vivamos Mejor
ATELIER (Asociacion para la Cooperacion Internacional al Desarrollo)
Fe y Alegria
Fundacion INTERMON
Manos Unidas—Campana contra el Hombre
Medicus Mundi—Espana
Paz y Cooperacion
Personas
KUA (Kirkon Ulkomaanapu)
Economie et Humanisme
ACTIONAID
ACWW (Associated Country Women of the World)
CD (Cooperation for Development)
FARM-Africa (Food and Agricultural Research Management Africa)
IPPF (International Planned Parenthood Federation)
Skillshare Africa
TALC (Teaching Aids at Low Cost)
Self-Help Development International
ACT (Asian Community Trust)
IDRC (International Development Research Center)
KZA (Komitee Zuidelijk Afrika)
SEI (Stockholm Environmental Institute)
ADRA (Adventist Development and Relief Agency International)
Childreach
Freres des Hommes
FODEP (Foundation for Development)
Suomen World Vision
FINNIDA (Finnish International Development Agency)
Villages sans Frontieres

Appendix D

Brief Description of General Water Treatment Options

Description of Water Purification Technology	Suitability for Use in Developing Countries
Activated Charcoal Filtration - also called granular carbon; activated charcoal is pure carbon in a porous form that has extraordinarily large surface area; effectively removes bacteria, protozoa, and most organic compounds.	Not suitable for use in remote areas because the filter must be replaced periodically; cost and maintenance (must be backwashed under high pressure) make this technology unsuitable for use in developing country villages. Primarily used by campers.
Bleaching Powder - chloride of lime; transported in powder form and then either added directly to water, placed in gradual-release dosing containers, or dissolved in water and then decanted into the water supply to remove the powder sediment; lowest cost form of chlorine; decays rapidly.	Preferred disinfectant by many NGOs for its cost, ease of transport, and residual disinfection capability. Disadvantages: decays rapidly, constant supply needed, low effectiveness in turbid water (Ellis 1991).
Boiling - boiling of water using typical cooking fuels (charcoal, kerosene).	Widely used; expensive; wasteful of fuel.
Bromine - like iodine and chlorine, a chemical oxidant, effective on bacteria and viruses and leaves a residual.	High cost.
Cartridge Filtration - filtration through various types of media; filters particles larger than 5 microns; widely used as pretreatment for industrial water treatment; filter must be periodically cleaned and annually replaced; does not remove all bacteria and viruses.	Replacement requirements may make the cost and maintenance of this system prohibitive for remote areas.
Ceramic Filtration - many types of household ceramic and sand filters; produced locally; often traditional; effectiveness varies widely.	Suitable for household use; quality varies widely.
Ceramic Filtration (manufactured) - there are many types of filters designed for U.S. use, both domestic and backpacking.	Replacement requirements make the cost and maintenance of this system problematic for developing-country use. Treatment costs typically run between \$20 and \$80 per m ³ .
Chlorine Bleach - sodium hypochlorite (liquid) or calcium hypochlorite (powder or tablets) (also called HTH); corrosive; more effective than bleaching powder; leaves residual disinfection.	Not as appropriate for village use because of danger in handling and storing; widely used because of low cost, high chlorine concentration, and residual disinfection. (Harris 1992).
Chlorine Gas, Chlorine Dioxide, and Chloramines - various forms of chlorine used in the developed world and in large conventional treatment plants in the developing world; provide residual disinfection; can be injected into the feedwater with an automatic system.	Transportation of chemicals and operation of automated systems require technical capacity beyond that of most villages (Schulz et al. 1984).
Coagulation - certain natural and synthetic cationic chemicals cause the negatively charged clay and organic components of water to stick together, forming "flocs" that more easily settle out of the water; alum is the most common coagulant but coagulants from native plant species have also been used; cost and dose depend on type of coagulant used and turbidity of water; capable of reducing turbidity from 10,000 NTU to 20 NTU; removes 40% to 98% of pathogens.	Effectiveness at removing pathogens is not high enough for coagulation to be sufficient by itself. Coagulation forms a satisfactory pretreatment for chlorination or other disinfection method. (Gupta et al. 1992; Water for People 1997).

Appendix D

Brief Description of General Water Treatment Options (Concluded)

Description of Water Purification Technology	Suitability for Use in Developing Countries
Conventional Treatment - also known as full-scale water treatment, the term refers to what is generally practiced in large cities in developed countries; consists of coagulation, flocculation, sedimentation, and chlorination; generally a high-tech, fully automated procedure that meets EPA guidelines of 99.99% removal of all pathogens; usually used for communities greater than 10,000 people; life-cycle cost ranges from 0.08 to 2.5 cents per cubic meter; economy of scale is the major factor in cost.	The best choice in terms of cost, effectiveness, and quality of water produced where technical skill is available. Not considered appropriate for developing communities smaller than 10,000 people (Schulz et al. 1984; Pirnie 1987).
Diatomaceous Earth Filtration - consists of mixing feedwater with a slurry of "precoat" pulverized diatomaceous earth and cationic polymers, then filtering through a 3-mm-thick layer of diatomaceous earth; continuous supply of precoat material necessary; maintenance involves removal of precoat from the filter and periodic replacement of filter; greater than 99% effectiveness for bacteria, viruses, and protozoa.	Unsuitable for areas lacking technical skill because of its high maintenance requirements.
Iodine - like chlorine, a chemical oxidant; usually transported in liquid form; better able to disinfect protozoa than chlorine.	Its much higher cost compared to chlorine precludes its consideration (Ellis 1991; Harris 1992). More adverse health issues compared to chlorine.
Local Media Filtration - various media, including crushed coconut shells and rice husks, have been used; effectiveness and cost depends on the medium used.	May be suitable form of prefiltration for some locations, not sufficiently effective by itself (Schulz et al. 1984).
Mixed-Oxidant Gas Generation On Demand (MOGGOD) - use of direct current electricity to electrolyze brine to produce chlorine compounds and ozone; highly effective disinfectant; fewer disinfectant by-products than chlorine; easier to operate than a chlorine generator; requires skilled maintenance and salt supply; produces residual disinfectant.	Still developing technology; may be suitable for use in medium to large, remote villages with high technical skill.
Natural Ultraviolet (UV) Light - use of UV naturally occurring in sunlight for disinfection; requires large collector area and residence time; not effective on cysts.	Not very suitable due to large collector area.
Ozonation - ozone can be generated by running an electrical current through air; ozone is a more effective oxidant than chlorine; leaves no residual disinfectant.	Operation of an ozone generator requires more technical skill than is available in small villages; for large villages, it is just as complex as chlorine generators but leaves no residual disinfectant.
Pasteurization - heating of water until all pathogens are killed; can be batch mode or continuous flow with heat exchanger.	Still developing technology; may be suitable for individual home use.
Photocatalytic Oxidation - addition of photocatalytic materials such as titanium dioxide to produce ozone for disinfection; no residual disinfectant.	Still developing technology (Blake 1994).
Rapid Sand Filtration - filtration through coarse sand; requires skilled operator; periodic backwashing; generally used in conjunction with coagulation; removes 35% to 85% of bacteria and protozoa.	Not suitable because of high operation and maintenance requirements (Cheremisinoff 1995).

Appendix D

Brief Description of General Water Treatment Options (Continued)

Description of Water Purification Technology	Suitability for Use in Developing Countries
Riverbank Infiltration - consists of diverting a stream through a bank of sand so that the natural head of the water drives the filtration; high potential for recontamination in the catchment basin on the other side of the bank; little information on cost of construction available.	May be suitable when it can be designed to prevent recontamination (Ellis 1991).
Roughing Filtration - for pretreatment only; filtration through three grades of gravel/s and; monthly cleaning required.	Suitable for use in villages larger than 200 people (Wegelin 1991).
Silver-coated Ceramic Filtration - silver is toxic to pathogens; coating a ceramic filter with silver increases the effectiveness of the ceramic filter; relatively new technology; little information available.	May be suitable where local potters can manufacture the silver coating; insufficient information.
Slow Sand Filtration - filtration at a slow rate through fine sand; biological film serves as biological filter; high capital cost; water cannot be used for several days after scraping (every few months); effective removal of bacteria, protozoa, and most viruses; low-skill maintenance.	Suitable for use in villages larger than 200 people (Schulz et al. 1984).
Storage - simply storing drinking water before using it, either in large storage ponds or in household-sized containers, allows larger particles to settle out and results in die-off of most bacteria; about 55 hours required to remove most bacteria, 24 hours to remove 50% of bacteria.	Where cost of storage containers is low, may be cheap, easy way to obtain some water purification (Schulz 1984).
UV Light - use of a mercury-vapor lightbulb to produce UV light; requires electricity; prefiltration needed in turbid waters; effective on bacteria and viruses but not on protozoa; low cost.	Still developing technology; may be suitable for use in villages larger than 100 people (Gadgil et al. 1996).

Appendix E
Detailed Assumptions and Calculations in
Technology Assessments

Technology	First cost:				Operation and maintenance costs:					Descriptors:			Normalized costs:		
	1/9/98 Materials \$	Low labor hours	Hi labor hours	1st cost \$	Materials Ann. \$	Low labor Ann. hours	High labor Ann. hours	Operating costs Ann.	Tot. O&M Annual \$	Daily production (liters)	Lifetime (years)	PVE	Water consumption	Capacity \$/m ³ /day	
Chlorine-dosing plant	2,400	0	0	2,400			190	400	44	253	24,000	20	8	6	100
Chlorine (batch, low dose)	0	0	0	0	0		122	0	0	6	200	1	1	8	0
Chlorine (batch, high dose)	0	0	0	0	0		122	0	4	10	200	1	1	13	0
Chlorine (batch, average dose)	0	0	0	0	0		122	0	1	7	200	1	1	9	0
MOGGOD	34,450	40	40	34,472	346		730	80	347	770	24,000	20	8	57	1,436
MOGGOD/PV, 24 hr/day	48,178	80	80	48,222	484		730	80	0	560	24,000	20	8	73	2,009
Slow sand filter (low cost)	1,200	0	0	1,200	0		176	0	0	9	24,000	20	8	2	50
Slow sand filter (high cost)	4,800	0	0	4,800	0		176	0	0	9	24,000	20	8	7	200
Roughing Filter (low cost)	960	0	0	960	0		90	0	0	5	24,000	20	8	1	40
Roughing Filter (high cost)	7,200	0	0	7,200	0		90	0	0	5	24,000	20	8	10	300
Slow sand + roughing filter (low cost)	2,160	0	0	2,160	0		266	0	0	13	24,000	20	8	3	90
Slow sand + roughing filter (high cost)	12,000	0	0	12,000	0		266	0	0	13	24,000	20	8	17	500
Household filter (low cost)	20	0	0	20	0		122	0	0	6	60	2	2	85	333
Household filter (high cost)	50	0	0	50	0		122	0	0	6	60	1	1	256	833
Sol-UV/batch: bottles	0	8	0	1	0		122	0	0	6	14	1	1	133	43
Sol-UV/batch: bags	2	8	0	3	1		243	0	0	13	42	2	2	97	61
Sol-UV/flow-through	2,574	8	0	2,574	0		122	0	0	6	684	15	7	144	3,764
UV-WW/\$.1/kWh	683	8	8	687	33		365	16	35	94	21,600	20	8	2	32
UV-WW/\$1/kWh	683	8	8	687	33		365	16	350	409	21,600	20	8	6	32
UV-WW/PV:8 hr.	2,070	8	16	2,078	60		456	32	0	99	7,200	20	8	13	289
UV-WW/\$.1/kWh + low-cost roughing filter	1,547	8	8	1,551	41		455	16	35	107	21,600	20	8	4	72
UV-WW/\$1/kWh + high-cost roughing filter	7,163	8	8	7,167	33		455	16	350	414	21,600	20	8	16	332
UV-WW/PV:8 hr+low-cost roughing filter	2,358	8	16	2,366	46		546	32	0	89	7,200	20	8	14	329
UV/PV/Pump (GWT)	10,000	8	8	10,004	126		456	16	0	157	10,800	20	8	35	926
UV-Sun-Pure (as spec'd)	501	8	0	501	1,398		16	0	9	1,408	500	20	8	805	1,002
UV-UST200 + home filter	116	24	0	117	57		96	0	9	71	500	20	8	46	235
UV-UST200 +home filter + PV for 24 hr.	1,156	32	0	1,158	65		96	0	0	70	500	20	8	115	2,315
UV-UST200 +home filter + PV for 4.4 hr.	311	32	0	313	73		96	0	0	78	500	20	8	63	625
Water Boiling, purchased fuel	0	0	0	0	0		122	0	146	152	20	1	1	2,083	0
Water Boiling, gathered fuel	0	0	0	0	0		487	0	0	24	20	1	1	333	0
Water Boiling, gathered fuel with indicator	5	0	0	5	0		243	0	0	12	20	1	1	235	250
Wood-saver (12-hour operation)	1,235	10	0	1,236	0		2,214	0	662	773	1,361	15	7	190	908
Batch solar/Family Sol-Saver	78	2	0	78	0		122	0	0	6	23	10	6	235	3,425
Batch solar/SUN tube	143	4	0	143	0		122	0	0	6	19	20	8	338	7,537
Batch solar/Solar puddle	33	24	0	34	50		778	0	0	89	480	1	1	70	70
Flow-through solar/Sol-Saver	2,145	8	0	2,145	0		122	0	0	6	570	15	7	144	3,764
Flow-through solar/trough	5,872	0	0	5,872	165		365	32	0	199	1,436	20	8	174	4,088
Flow-through solar/pot. polymer	83	16	0	84	1		122	0	0	7	304	10	6	19	276

Cell: B8

Comment: Schultz and Okun give about \$100/m³ for developing-country chemical treatment plants.

Cell: I8

Comment: Cost of chlorine for dosing plant is estimated at \$0.005 per gram.

Cell: I9

Comment: Cost of chlorine is assumed to be \$0.01/gram.

Cell: B12

Comment: first cost multiplied by 1.3 to account for cost of international business.

Cell: F12

Comment: Cost of salt is assumed to be \$1/lb, and 0.072 lbs of salt needed per m³ produced. Cost of repair parts is 1% first cost per year.

Cell: G12

Comment: Two hours per day low labor.

Cell: I12

Comment: \$0.3/kWh. Load is estimated at 132 W.

Cell: B13

Comment: PV system is about 1 kW, to provide for 24 hour operation of a 132-watt load, 60% eff. Cost is 13.3K.

Cell: F13

Comment: Cost of salt is assumed to be \$1/lb, and 0.072 lbs of salt needed per m³ produced. Cost of repair parts is 1% first cost (less PV cost) + 13.33/year battery. replacement...

Cell: B14

Comment: Cost of construction is assumed in first cost from the Water for People rule of thumb, \$50/m³-day. A 1 m² area was used, assuming the lower-limit flow rate of 0.1 m³ per m² per hour, or 2.4 m³/m²-day; system capacity is thus 2.4 m³-day.

Cell: G14

Comment: From Wegelin 1996, total time of 88 hours; this time was doubled to account for other activities.

Cell: B16

Comment: Cost assumed is \$40/m³/day, from Water for People 1997. Other references report varying costs (e.g., \$100/m³/day, from Wegelin 1996).

Cell: G16

Comment: Wegelin 1996 provides 30 man-hours/year; tripled to account for other activities.

Cell: B17

Comment: Cost of 300/m³/day, from Wegelin 1996.

Cell: B20

Comment: Porous container within container, somewhat costly ceramic on inside.

Cell: F20

Comment: Replace inner ceramic every five years.

Cell: K20

Comment: 20-liter container, fill/sift three times per day?

Cell: B22

Comment: Twenty-one-liter plastic bottles at .01/bottle; bottles last one year.

Cell: K22

Comment: 20-liter bottles, once per day, working on 70% of the days...

Cell: B23

Comment: 1 m² bag, with top layer glazing at 0.1/m², and bottom layer at 0.05/m², plus a \$2 valve...

Cell: G23

Comment: 20 mins to fill/empty, done twice per day...

Cell: K23

Comment: Assumed depth of 3 cm in 1-m² area; cycle twice per day.

Cell: L23

Comment: Polyethylene bag lifetime: unsure; take 2 years. UV protected = bad UV transmission?

Cell: B24

Comment: No cost data really available; so, let us say that set cost equal to 20% more than the Sol-Saver, somewhat arbitrarily; they both could obviously be less expensive....See perf. note also..

Cell: G24

Comment: 20 min/day to attend operation.

Cell: K24

Comment: The data given: 1/2 l/min/m² (as in Wegelin 1996) with 2 m² area, and runs for four hours (said "several"...) on 70% of days...gives much less flow-through than the Sol-Saver; with a good hx, should be more, look like same area. Arbitrarily said 20% more than the Sol-Saver; but should also cost more due to extra exposure.

Cell: F25

Comment: Lamp replacement @ \$26 + 1% system cost.

Cell: G25

Comment: 1 hour per day.

Cell: H25

Comment: 1 day twice per year.

Cell: I25

Comment: Electricity at 0.1/kWh.

Cell: F27

Comment: Added on 13.33 battery replacement cost...

Cell: G27

Comment: Added on 15 mins/day for batteries, in addition to 1 hour per day for UV-WW unit.

Cell: B28

Comment: pv + slow sand at the capacity assumed for system oper. 8 hrs, scaled off rough sand cost.

Cell: F30

Comment: Added on 13.33 battery replacement cost...

Cell: G30

Comment: Added on 15 mins/day for batteries.

Cell: G31

Comment: 1 hour + 0.25/day for the filters.

Cell: B32

Comment: First cost is \$385 FOB, single-unit cost.

Cell: F32

Comment: Filters replaced every 1400 gallons, at FOB cost of \$30. Lamp replaced every 10,000 hours, at cost of \$50 FOB.

Cell: I32

Comment: 10-W load for 24 hours/day; electricity is at \$0.1/kWh.

Cell: K32

Comment: Assume 500 L/day, for family of five @ 100 L/day/person...

Cell: B33

Comment: Cost of the UST-200 unit (6W) with the PV only is assumed at \$58.5, quoted as the cost for 4-24 units. The home filter unit here cost two times as much as the low rough sand filtering unit, or \$80/m³/day capacity...

Cell: F33

Comment: Lamp replacement at 10,000 hours, lamp cost of \$30FOB.

Cell: G33

Comment: Clean, replace medium in home filter unit, once per month...

Cell: I33

Comment: 10-W load for 24 hours/day; electricity is at \$0.1/kWh.

Cell: B34

Comment: Add on the PV cost for a system capable of meeting a 10-W load with run time 24 hours/day minutes; this is calculated to be a 80-W PV system, costing \$263. It is not clear why the unit specifies 24 hour/day light on....

Cell: F34

Comment: Add on 3% of PV system maintenance cost.

Cell: B35

Comment: Add on the PV cost for a system capable of meeting a 10-W load with run time only during water draw, or $500L/(1.9 \cdot 60) = 4.4$ hours of operation. This is calculated to be a 15 W PV system, costing \$190.

Cell: F35

Comment: Add on 3% of PV system maintenance cost.

Cell: G36

Comment: 20 mins per day attending process.

Cell: I36

Comment: Andreatta 1996 gives the cost of fuel for boiling as \$0.02/liter.

Cell: G37

Comment: 20-min/day process + 1 hour/day gathering fuel.

Cell: B39

Comment: First cost of \$950 FOB, times 1.3.

Cell: G39

Comment: 2 hours once a month for cleaning, and 6 hours per day for attending (50% attention).

Cell: I39

Comment: Assumed 15 times more efficient than pure boiling: doubled efficiency, and about 75% heat recovery...

Cell: K39

Comment: Unit produces 30 gal/hour (Hartzel 1997), assumed to run 12 hours per day.

Cell: G40

Comment: 20 mins/day for filling, watching for indication of completion of pasteurization.

Cell: G41

Comment: 20 mins/day for filling, watching.

Cell: B42

Comment: \$25 film cost, no other costs.

Cell: G42

Comment: Replace films twice per year, + 2 hours per day attending.

Cell: G43

Comment: 20 min/day to attend operation.

Cell: K43

Comment: From Safe Water Systems sales literature.

Cell: B44

Comment: \$250/m² (including all labor), + PV costs, assuming elec. load of 8-hr day @ 40 W.

Cell: F44

Comment: \$50/m² to replace reflector every five years, including labor. \$27/year battery repl.

Cell: K44

Comment: Taken as 75% of the peak spring day production of 630 gallons (Anderson and Collier 1996).

Cell: F45

Comment: \$5 valve replacement every 5 years.

Cell: G45

Comment: 20 min/day to attend operation.

Appendix F

PV Sizing Algorithms for UV/PV System

The average daily water production volume W_{day} , the flow rate through the system m_{sys} , and the system power input requirement P_{sys} are given as system design parameters. The run time Δt_{sys} and the electrical energy required E_{sys} are related as

$$\Delta t_{sys} = W_{day}/m_{sys} \quad \text{Eq. 6-1}$$

$$E_{sys} = \Delta t_{sys} * P_{sys} \quad \text{Eq. 6-2}$$

To roughly estimate the PV panel peak power $P_{PV,peak}$ required to provide this energy, we used a simplified analysis. Assume that the panel will be irradiated at full-sun normal incidence I_{max} (1 kW/m²) for a time Δt_{sun} adjusted to give the average daily incidence H_{day} :

$$\Delta t_{sun} = H_{day}/I_{max} \quad \text{Eq. 6-3}$$

First, H_{day} must be known or estimated. Table A6-1 lists the monthly and annual total irradiation for a number of locations in developing countries (Duffie 1991). Generally, irradiation is higher near the equator, and in dry areas (Sudan). In the table, Sudan has the largest irradiance and New Delhi the smallest. The value of the average kWh/m²-day provides the input value H_{day} for Δt_{sun} calculation, via Equation 6-3.

Table A6-1. Irradiation at Various Third World Locations

Location	Angola	Ethiopia	Kenya	Sudan	Uganda	Malaysia	Sri Lanka	Thailand	India/ Madras	India/ New Delhi	Pakistan/ Lahore
Latitude	-8.8	9	-1.3	13.6	0.1	3.1	6.9	13.7	13	28.6	31.5
Months:											
1	20.2	19.1	23.2	20.5	18	17.7	16.6	16.6	18.2	11.3	10.1
2	20.9	21	23.6	23.3	18.1	19.1	17.4	17.4	22.1	13.8	13.7
3	19.5	21.3	22.3	25.4	18.2	19.4	19.6	19.6	24.2	16.2	17.9
4	18.6	20.4	18.9	26.1	17.4	18.8	19.6	19.6	24.6	19.9	20.4
5	17.3	19.3	16.7	25.7	16.4	17.7	18.1	18.1	22.7	21.1	22.7
6	14.7	16.6	15.1	24.5	16	16.8	16.9	17	20.2	18.7	22.2
7	12.7	13.6	12.9	23	15.5	17.1	16	16.1	19.6	18	20
8	12.6	14.1	14.2	23.1	16.5	17.4	16	16	20	16.9	19
9	15.8	17.1	19	23.5	18.1	17.2	15.5	15.5	19.7	18	18.4
10	18.1	21.7	20.2	22.8	17.9	18.3	16.3	16.3	16.6	15.6	15.6
11	20.2	22.3	19.1	21.7	17.6	15.5	17.1	17.2	15.5	12.4	12.2
12	19.5	20.1	22.1	20.5	17.4	16.7	16.8	16.4	14.3	10.5	10
Daily Avg ²	4.9	5.2	5.3	6.5	4.8	4.9	4.8	4.8	5.5	4.5	4.7

Notes:

¹ Units of the monthly data are MJ/m²/day.

² Units of the annual daily average data are kWh/m².

Two inefficiencies that are always accounted for in sizing the panels are: (a) battery roundtrip efficiency, η_{bat} ; and (b) operation off-peak power point, η_{ppp} . Battery roundtrip efficiency is typically estimated at 70%. PV panel peak power is always rated at the maximum power point. The battery forces the PV panel to operate off the maximum power point for most of the charging cycle. A typical value of 80% is assumed for η_{ppp} .

Stating these considerations quantitatively, we write:

$$E_{PV} = \eta_{bat} * \eta_{ppp} * P_{PV,peak} * \Delta t_{sun}$$

Equating E_{PV} with the required E_{sys} and solving for $P_{PV,peak}$, we have:

$$P_{PV,peak} = P_{sys} * \Delta t_{sys} / (\eta_{sys} * \Delta t_{sun})$$

where $\eta_{sys} = \eta_{bat} * \eta_{ppp}$.

Table A6-2 relates the required panel power as a function of the desired operation time and the system power input requirement. A Δt_{sun} value of five hours and a η_{eff} value of 0.6 were used. This simplified calculation does not include effects of operating temperature, module orientation or mounting, and other losses. The overall system efficiency of about 0.6 is useful as a rough first approximation.

Table A6-2. PV Panel Peak Watts versus Operating Time and System Power Requirement

$P_{sys} / \Delta t_{sys}$ (hr)	40	80	160	320
4	53	107	213	427
8	107	213	427	853
12	160	320	640	1,280
24	320	640	1,280	2,560

The cost of PV panels might be as low as \$5/W in this size range. However, the PV system (PV panels, charge controller, batteries, and other system components) approximately doubles this cost (balance of system scales with panel power). A multiplier of 1.3 is used to account for shipping, import duties, common delays, and other "hassles" of international business. Thus, system costs to the user are about \$13/W. Table A6-3 gives estimated PV subsystem cost, as a function of system operation time and system overall efficiency.

Table A6-3. PV System Costs versus Operating Time and System Power Requirement

$P_{sys} / \Delta t_{sys}$	40	80	160	320
4	693	1,387	2,773	5,547
8	1,387	2,773	5,547	11,093
12	2,080	4,160	8,320	16,640
24	4,160	8,320	16,640	33,280

There are three battery types commonly used with small-scale PV systems: (a) sealed deep-discharge gel cells, costing roughly \$2/amp-hour; (b) deep-discharge flooded lead-acid batteries, costing roughly \$1/amp-hour; and (c) flooded car batteries (not designed for deep discharge), costing roughly \$0.75/amp-hour. Car batteries are lower in first cost and have wide availability for replacement. However, they also require the most maintenance and have the shortest lifetime. Car batteries are often chosen for these applications because of replacement availability and lower first cost, though life-cycle cost may be higher. Battery lifetime ranges are shown in Table A6-4.

Table A6-4. Battery Lifetime Ranges

Battery type	Lifetime (years)
Sealed gel-cell	4-6
Flooded deep discharge	2-5
Car batteries (flooded, low discharge)	1-3

Appendix G

Polymer Solar Pasteurization System

A possible system is sketched in Figures G-1 through G-4. A Tedlar cover glazing is assumed, to provide low maintenance and a 10–15-year expected lifetime. The absorber/collector material is taken as a fluorocarbon with a proprietary selective surface. The collector seams are designed to create a serpentine passageway through the collector and provide structure to withstand hydraulic head. The depth/length of a seam is designed to provide the desired residence time for a given sterilization temperature. The heat exchanger is plate-frame, with mylar thin-film plates and polypropylene frames. An automotive radiator valve (modified for better leak protection) is used for the control valve. Material cost is about \$36. U.S. mark-up factor assumed is 400% total, for export scenario. With local manufacture, the mark-up factor could probably be reduced.

Polymer Disinfector Cost Estimation 1-m² System, Single Glazing

Cost Component	Cost (\$)	Notes
Glazing	3.36	Tedlar @ \$0.30/ft ² ; single layer, UV protected
Thin-film collector	11.00	22 ft ² fluorocarbon @ \$0.5/ft ²
Selective absorber surface	1.10	Proprietary, similar to BNL 1984; @ \$0.1/ft ²
Heat exchanger surfaces	5.00	100 ft ² mylar @ \$0.05/ft ² (110°C high temp. limit)
Heat exchanger spacers	5.27	Polyprop. @ \$0.3/lb
Tubing	2.20	CPVC @ \$0.22/ft
Insulation	1.40	4" fiberglass @ \$0.13/ft ²
Container/box	3.36	Galvanized steel @ \$0.2/ft ²
Control valve	3.00	Radiator valve, plug weep hole
Total materials	35.69	Sum previous items
Labor, G&A overhead, & profit	28.55	= 80% of material costs
Factory cost (FOB)	64.24	= Sum previous two items
User cost	128.48	= 2 times factory cost

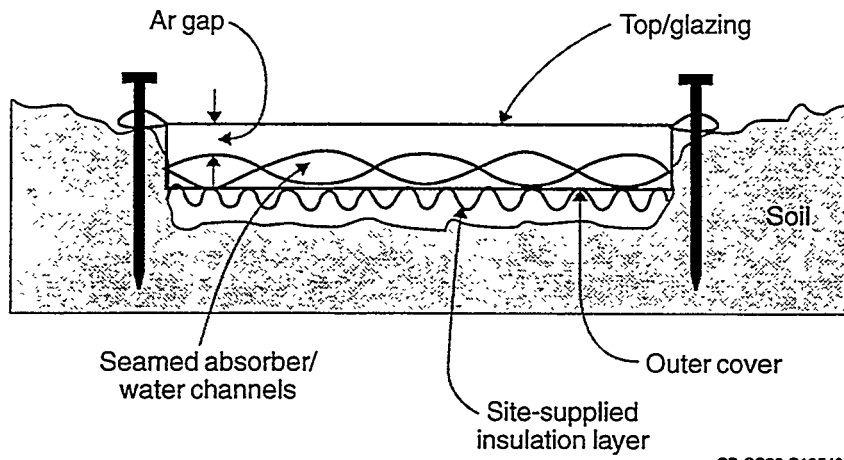

Figure G-1. Roll-out collector.

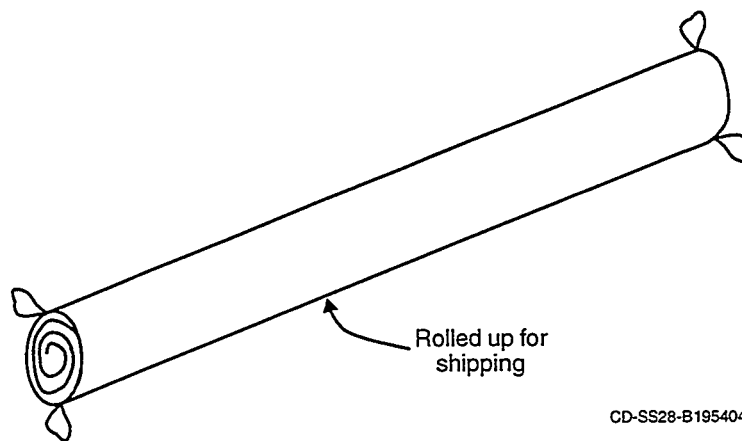

Figure G-2. Roll-out collector.

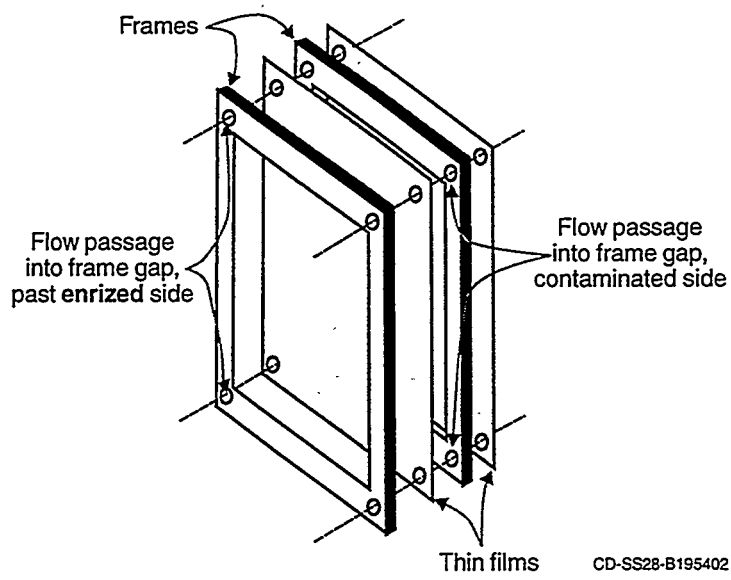

Figure G-3. Plate-frame heat exchanger.

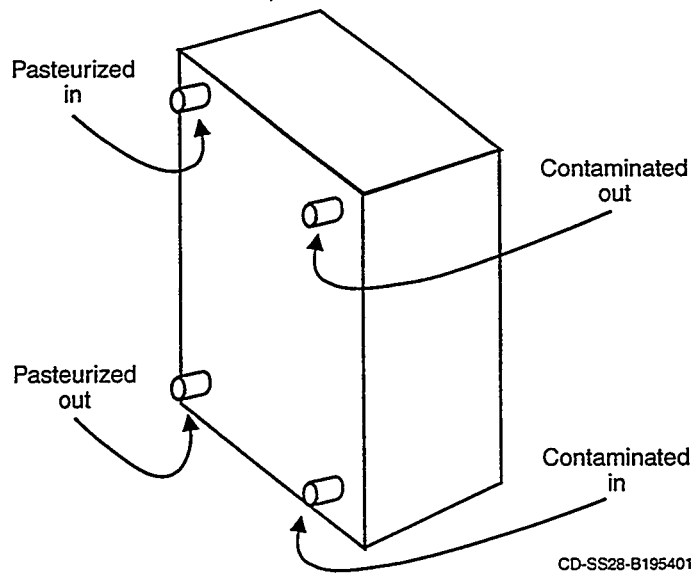

Figure G-4. Heat exchanger box.

Appendix H Cost of Fuel

According to ESMAP (1994), using data from Vietnam, the cost of wood fuel is \$0.0096 per delivered MJ, and the cost of kerosene and charcoal is \$0.0131 per delivered MJ. Delivered energy is based on the conversion efficiency of typical stoves, using 17% wood stove efficiency, 25% charcoal stove efficiency, and 45% kerosene efficiency.

The increase in enthalpy of water from 20°C to 100°C is 335.08 kJ/kg. Adding a 20% increase in the energy needed because boiling is generally continued for several minutes, we have

$$\$/\text{liter} = \$/\text{MJ}_{\text{eff}} * (80^\circ\text{C}) * 4.184 \text{ kJ/kg-C} * 1 \text{ kG} * 1.2$$

For purchased wood fuel:

$$\$/\text{MJ} * 0.335 \text{ MJ/kg} * 1.2 = \$0.0039 \text{ per liter}$$

For purchased charcoal or kerosene:

$$\$/\text{MJ} * 0.335 \text{ MJ/kg} * 1.2 = \$0.0053 \text{ per liter.}$$

Appendix I

Modeling of Flow-through Solar Pasteurization Devices

Key assumptions: The collector is assumed to behave as a first-order collector; the assumed parameters are given on the graphs. The heat exchanger is assumed to have constant thermal coupling derived by assuming that $Nu = 1$ for these low flows. Forced convection and natural convection were ignored for these calculations, implying that this is a very conservative estimate for heat exchanger performance. Counterflow at equal flow rates implies that: effectiveness = $NTU/(1+NTU)$, where $NTU = UA/C$, where C = thermal capacitance flow rate. The piping losses and heat exchanger jacket losses are derived by assuming R2-English insulation (very low values).

The Engineering Equation Solver (EES) from the University of Wisconsin was used to solve the coupled equations. The EES model used for the calculations in Section 4.4.3.2 is presented on the following pages.

{NOTE: COMMENTS ARE ENCLOSED IN BRACES
COMMENTS CAN EXTEND ACROSS MULTIPLE LINES}

{Disinfection system flow rate and temperatures; with laminar flow plate frame heat exchanger.
Un-referenced equations are from Solar Engineering, Duffie/Beckman, 2nd edition., otherwise, ref. is explicit,
e.g., Kreith, 3rd edition...}

{can solve for flow rate, given collector outlet fixed at T_dis; or can fix flow rate, and solve for temps}

{PROBLEM PARAMETERS/DEFINITIONS:}

{collector PARAMETERS::}

{3 sets listed here, remove braces to activate:}

{Non-selective:

Fr_{ta} = .77

Fr_{UI} = 1.28*5.679 {Watts/C}

{Selective:

Fr_{ta} = .76

Fr_{UI} = 4.49}

{Evacuated Tube:}

Fr_{ta} = .86

Fr_{UI} = 2.3

A_col = 1 {m²}

K_{bar} = 1. {IAM}

M_col = .5 {kg; equivalent water weight}

M_water_col = .5 {kg}

{water parameters}

rho_water = 1000 {kg/m³; use same rho_water everywhere}

C_p_water = 4180 {J/kg-C; same C_p everywhere}

mu_water = (.458*.001)*(.672) {N-s/m²; 100F pt for water, from Kreith}

Pr_water = 4.52 {100 F point for water}

k_water = (.364)*1.731 {100 F point for k of water}

{HX PARAMETERS::}

H_hx = 12*.0254 {m}

W_hx = 12*.0254 {m}

N_plates = 41

{A_hx = H_hx*W_hx*(N_plates - 1) {m²}}

hx_plate_spacing = .005 {m}

k_plate = 10 {10 = total guess; 385 for copper in W/m-C}

t_plate = .0001 {m}

R_hx_loss_eng = 2

U_hx_loss = 5.679/R_hx_loss_eng {W/C}

{PIPING PARAMETERS}

L_pipe = 1

```

d_pipe = .0254/2
R_pipe_eng = 1 {english units; based on pipe diam, not ins. diam}
U_pipe = 5.679/R_pipe_eng

{ambient conditions}

I=1000 {w/m2}
T_amb = 20 {C}
T_supply = 20 {C}

{sterilization conditions}
{T_disinf_F = 180}
T_disinf= 70 {C}
DT_disinf = T_disinf - T_amb

{Start of computations*****}

{Solution logic: choose method here:
1) require the collector to outlet at T_disinf, then determine flow rate to do so;}
T_col_out = T_disinf
{or 2) require flow rate as specified, then solve for all temps}
{Vol_flow_gpm = .1}

{I_critical = radiation needed to just get going: stagnation DT = disinf DT:}
I_critical = (T_disinf - T_amb)*FrUI/(Frta*Kbar)

{Flow relations}
C_flow = rho_water*Vol_flow*Cp_water
Vol_flow_gpm = (Vol_flow/.02832)*8*60
Vol_flow_lps = Vol_flow*1000

{COLLECTOR}
{collector warmup to T_disinf}
{DT_stag = (Frta*I*Kbar)/(FrUI)}
T_stag = T_amb + DT_stag
tau_warmup = (M_col + M_water_col)*Cp_water/(A_col*FrUI)
dt_warmup = tau_warmup*ln(DT_stag/(abs(DT_stag - DT_disinf)))
dt_warmup_min = dt_warmup/60}

{Collector steady state temperature rise at flow rate Flow, capacitance flow C_flow}
T_col_in = T_pipe_out
Q_useful = A_col*(Frta*I*Kbar - (T_col_in - T_amb)*FrUI)
DT_col = Q_useful/(C_flow)
T_col_out = T_col_in + DT_col

{HEAT EXCHANGER}
{approx. heat exch. thermal losses as a pipe of total UA of hx, at inlet to hx; then use ideal hx relations}
{Accounting for thermal losses from hx is approximate:}
T_hx_pipe_in = T_col_out
UA_hx_loss = U_hx_loss*(2*H_hx*W_hx + (N_plates-1)*hx_plate_spacing*(H_hx +

```

```

W_hx)*2)
Q_hx_loss =UA_hx_loss*(T_hx_pipe_in - T_amb)
T_hx_pipe_out = T_hx_pipe_in - Q_hx_loss/C_flow
{****alternative hx correlations to use:}
{Conduction only limit:}
h_hx_cond = k_water/(hx_plate_spacing/2)
{Look at natural convection and forced convection}
{Natural convection coefficient}
{
{storage is tilted at angle "tilt" from the horizontal}
tilt = 90
g=9.8
beta=(2.0*.0001)*1.8 {100F point}
DT=T_hx_hot_in - T_hx_cold_in
{def:}
Gr_hx=(rho_water^2*g*beta*DT*hx_plate_spacing)/mu_water^2
Ra_hx=Gr_hx*Pr_water
{vertical enclosure correlations from Incropera and DeWitt, 3rd Ed, p561}
{Nu_hx_nc_1=.42*(Ra_hx*sin(tilt))^0.25*Pr_water^0.012*(L_hx/hx_plate_spacing)^(-.3)}
h_hx_nc_1=Nu_hx_nc_1*k_water/hx_plate_spacing}
Nu_hx_nc_2 = .046*(Ra_hx*sin(tilt))^0.3333
h_hx_nc_2=Nu_hx_nc_2*k_water/hx_plate_spacing
{not done for now}
}
{Forced film coefficient}
{Velocity in heat exchanger}
Vol_flow = (N_plates-1)*hx_plate_spacing*W_hx*v_hx
D_h_hx = 4*hx_plate_spacing*W_hx/(2*hx_plate_spacing + 2*W_hx)
Re_hx = rho_water*v_hx*D_h_hx/mu_water
Nu_hx_forced = 1.86*(Re_hx*Pr_water*D_h_hx/H_hx)^.33
h_hx_forced = k_water*Nu_hx_forced/hx_plate_spacing
{****end alternative hx correlations}
{hx UA; use h-cond}
UA_hx=h_hx_cond*A_hx
{Heat exchanger effective UA and effectiveness:}
NTU=UA_hx/C_flow
{effectiveness, for counterflow hx at Cmin = Cmax:}
e_hx = NTU/(NTU +1)
{HX effectiveness fixed, not calculated:
e_hx = .85}

{Apply basic hx relations to calculate outlet temperatures}
T_hx_cold_in = T_supply
T_hx_hot_in = T_hx_pipe_out
T_hx_cold_out = e_hx*(T_hx_hot_in - T_hx_cold_in) + T_hx_cold_in
Q_hx=C_flow*(T_hx_cold_out - T_hx_cold_in)
DT_hx =T_hx_cold_out - T_hx_cold_in
T_hx_hot_out = T_hx_hot_in - DT_hx
Q_hx_ineff = C_flow*(T_hx_hot_out - T_hx_cold_in)
{LMTD=(DT_in - DT_out)/(ln(DT_in/DT_out))}
Q_2 =UA_hx *LMTD

```

$hx_eff_2 = Q / (C_pipe * (DT_in))$

{piping loss calculations}

$T_pipe_in = T_hx_cold_out$

$v_pipe = Vol_flow / (\pi * d_pipe^2 / 4)$

$T_pipe_out = T_amb + (T_pipe_in - T_amb) * \exp(-4 * U_pipe * L_pipe / (\rho_water * Cp_water * d_pipe * v_pipe))$

{approx. pipe calcs}

$UA_pipe = U_pipe * (\pi * d_pipe * L_pipe)$

$Q_pipe_loss_approx = UA_pipe * (T_pipe_in - T_amb)$

$T_pipe_out_approx = T_pipe_in - Q_pipe_loss_approx / C_flow$

{endapprox calcs}

$DT_pipe = T_pipe_in - T_pipe_out$

$Q_pipe_loss = C_flow * DT_pipe$

{heat balances, heat needed to be supplied by collector for the losses:}

$Q_loss_total = Q_hx_ineff + Q_hx_loss + Q_pipe_loss$

{Energy balance check: Collector gain = hx losses + qextra:}

$Q_imbalance = Q_useful - (Q_loss_total)$

$Q_imbalance_relative = Q_imbalance / Q_useful$

Appendix J

Comparison of Disinfection Technologies

	Chlorine Bleach	Slow Sand Filtration	Household Sand and Ceramic Filters
Effectiveness	Depends on water quality and how much bleach is added	Effectiveness increases with decreasing turbidity and increasing time-after scraping ("ripening")	Effectiveness depends on quality of ceramic or sand medium
bacteria	> 99%	99.0% to 99.9%	90% to 99.9%
viruses	> 99%	90% to 99.9%	Poor
worms	Poor	> 99.99%	99.9%
protozoa	Poor	99% to 99.9%	No data
Maintenance	None	Rake every few weeks, scrape about every 10 rakes, add new sand about every 10 scrapes	Filter cleaning periodically; unknown interval
Operation	Constant chlorine supply is needed	Trained but unskilled operator	None
Pretreatment	None assumed	Roughing filtration if turbidity > 50 NTU	None
Effect on water taste	Chlorine taste	Improves taste by removing turbidity	Improves taste by removing turbidity
Typical scale (m ³ /day)	< 1	10 to 10,000	< 1
Energy use	None	6 to 120 cm head loss	None
References	Water for People 1997	Water for People 1997; Schulz and Okun 1984; Cheremisinoff 1995	Gupta and Chadhuri 1992; Azrag 1996

	Roughing Filter	UV	MOGGOD	Flow-through Solar Pasteurization
Effectiveness	Removes up to 900 NTU of turbidity		Assuming a dose of 240 mg-min/L:	Assuming operation within safety zone of Figure 4.4.1:
bacteria	~90%	> 99%	> 99.9999%	100%
viruses	Poor	> 99%	> 99.9999%	100%
worms	90%	Poor	No data	100%
protozoa	90%	Poor	> 99.99%	100%
Maintenance	Monthly cleaning	Replace bulb @ 8000 hr., ballast @ 24,000 hr. inspect twice/year	80 maintenance hours/year	Control valve every 5 to 10 years; scaling
Operation	Trained operator	Electricity supply; no operator	Supply of salt and electricity; low-skilled operator	Untrained operator
Pretreatment	Optional: sedimentation	Roughing filtration	Optional: roughing filtration	None required, except to keep passageways clear
Effect on water taste	Removes turbidity and color	None	Chlorine taste; removes organic and sulfide odors and reduced iron and manganese	None
Typical scale (m ³ /day)	10 to 100	10	1000 to 2000	< ~ 1
Energy use	30-cm head loss	0.11 kWh/m ³	0.012 kWh/m ³	None
References	Wegelin, Schertenleib, and Boller 1991	Gadgil and Shown 1997	MIOX 1996; Chapman unpublished	Burch and Thomas 1997; Andreatta 1994