

ENERGY STAR Qualified Homes



THERMAL BYPASS CHECKLIST GUIDE

Version 2.1
Updated June 2008



TABLE OF CONTENTS

Thermal Bypass Checklist Introduction	5
General Tips and Best Practices	6
1. Overall Air Barrier and Thermal Alignment	7
1.1 Air Barrier and Thermal Alignment	7
1.2 Garage Band Joist Air Barrier	13
1.3 Attic Eave Baffles	15
1.4 Slab-edge Insulation	18
1.5 Air Barrier at all Band Joists	20
1.6 Minimize Thermal Bridging	22
2. Walls Adjoining Exterior Walls or Unconditioned Spaces	27
2.1 Wall Behind Shower/Tub	27
2.2 Wall Behind Fireplace	30
2.3 Insulated Attic Slopes for Unvented Attic Spaces	33
2.4 Attic Knee Walls	35
2.5 Skylight Shaft Walls	38
2.6 Wall Adjoining Porch Roof	40
2.7 Staircase Walls	43
2.8 Double Walls	46
3. Floors Between Conditioned and Unconditioned Spaces	49
3.1 Insulated Floor Above Garage	49
3.2 Cantilevered Floor	53
4. Shafts	57
4.1 Duct Shaft	57
4.2 Piping Shaft/Penetrations	60
4.3 Flue Shaft	62
5. Attic/Ceiling Interface	65
5.1 Attic Access Panel	65
5.2 Attic Drop-Down Stair	67
5.3 Dropped Ceiling/Soffit	70
5.4 Recessed Lighting Fixtures	73
5.5 Whole-house Fan	76
6. Common Walls Between Dwelling Units	79
6.1 Common Wall Between Dwelling Units	79
Thermal Bypass Inspection Checklist	83
Key Terms	85

THERMAL BYPASS CHECKLIST INTRODUCTION

In response to significant changes in residential energy codes and standards, the United States Environmental Protection Agency (EPA) released a new set of guidelines for ENERGY STAR qualified homes, to be implemented in 2006. A major new requirement is the Thermal Bypass Checklist.

The Thermal Bypass Checklist is a comprehensive list of building details where thermal bypass, or the movement of heat around or through insulation, frequently occurs due to missing air barriers or gaps between the air barrier and insulation. The Thermal Bypass Checklist must be completed by a certified home energy rater in order for a home to be qualified as ENERGY STAR, however, up to six items may be verified by the builder to minimize required field trips by the rater.

Below are key points regarding the implementation of the Thermal Bypass Checklist:

Key Points

1. If a state, local, or regional energy code contradicts the ENERGY STAR Thermal Bypass Checklist, precedence must be given to the state, local, or regional energy code. Precedence should also be given to guidelines set by regional ENERGY STAR programs.
2. Not every specific detail and field condition can be covered in these guidelines. EPA and the Residential Services Network (RESNET) rely on Home Energy Rating System (HERS) Providers and raters to employ their judgment when determining compliance with the general intent of the Thermal Bypass Checklist.
3. Builders may self-verify up to six items on the list; the remaining items, however, must be verified by a certified home energy rater.
4. The certified rater shall always sign the Checklist, and the builder shall only sign the checklist if the builder verified any of the items.
5. Any items found to be non-compliant with the Thermal Bypass Checklist must be corrected in order for the home to be qualified as ENERGY STAR.

A copy of the Thermal Bypass Checklist is provided at the end of this guide for reference.

GENERIC TIPS AND BEST PRACTICES

Infrared Images in Guide:

- Infrared images help reveal thermal bypass conditions by exposing hot and cold surface temperatures resulting from unintended thermal air flow. In infrared images, darker colors indicate cool temperatures, while lighter colors indicate warmer temperatures.

Builder:

- This guidance has been created to facilitate both contractor bidding and quality installation.
- Have architect or designer construction drawings include complete air barrier details and clearly delineate all thermal barrier transitions between conditioned and unconditioned space on wall sections.
- Provide drawings or scopes of work in multiple languages needed to accommodate likely field crews (e.g., English and Spanish).
- Typically, the material and installation measures required for an effective thermal enclosure involve multiple trades including the framing, air sealing, insulation and HVAC subcontractors. Therefore, it's important to coordinate the work with these trades before starting construction.
- All trades must be informed to limit penetrations being cut into blocking and other air barrier details.
- Consult with local building code officials regarding acceptable air barrier materials exposed to air spaces in attics, shafts, soffits, and dropped ceilings.

Contractor:

- Use photos for technical assistance and to ensure compliance with the Thermal Bypass Checklist.
- Share new ideas with the builder for more effectively and economically providing required air barriers.

Field Superintendent:

- Review contractor performance by verifying the work (e.g. installation) meets objectives of the Thermal Bypass Checklist and the scopes of work, and provide immediate feedback.
- Develop in-house procedures for inspection to ensure the air and thermal barriers are not compromised by other trade contractors.

Installation Criteria:

- The purpose of the thermal bypass inspection is to constructively work with builders to provide more effective thermal envelopes. If the general intent of an air barrier requirement is met, but not perfect, use good judgment before failing. Use field observations as an opportunity to help the builder be more successful in the future.

1. OVERALL AIR BARRIER AND THERMAL ALIGNMENT

Scope of Work:

Insulation shall be installed in full contact with sealed interior and exterior air barrier except for alternate to interior air barrier under Section #2 (Walls Adjoining Exterior Walls or Unconditioned Spaces).

1.1 AIR BARRIER AND THERMAL ALIGNMENT

An *air barrier* is any material that restricts the flow of air through a construction assembly. In wall assemblies, the exterior air barrier is typically a combination of sheathing and either building paper, house wrap, or rigid board insulation. The interior air barrier is often an interior finish, like gypsum board. A *thermal barrier* restricts or slows the flow of heat. This is typically accomplished through different insulation materials (e.g., fiberglass, rock wool, cellulose, polystyrene, polyurethane, vermiculite) and applications (batts, blown-in, spray foam, rigid board, and granules).

Regardless of which material and application is used, insulation is not fully effective unless it is installed properly – that is, fully aligned with a contiguous air barrier. Insulation works because it incorporates air pockets that resist the flow of heat- that is, it slows the conduction of heat. This resistance to heat flow is measured by the R-value of the material. However, most insulation (with the exception of spray foam and rigid foam board) does not stop air flow (Figure 1.1.1).

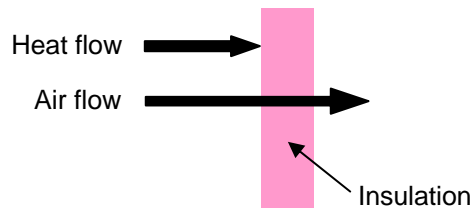

Figure 1.1.1 – Most insulation does not stop the flow of air.

Thus, for most insulation to be effective, a separate air barrier or skin is needed to stop the flow of air (Figure 1.1.2). For the air barrier itself to be effective, it must be contiguous and continuous across the entire building envelope, with all holes and cracks fully sealed, and it must be perfectly aligned with the insulation (Figure 1.1.3).

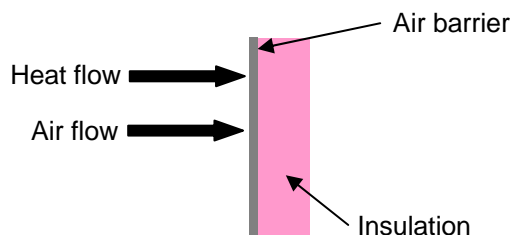

Figure 1.1.2 - Air barrier prevents the flow of air through insulation.

1.1 AIR BARRIER AND THERMAL ALIGNMENT

Generally, the Thermal Bypass Inspection Checklist requires a sealed air-barrier on all six sides of insulation (top, bottom, back, front, left, and right), however, there are a few exceptions as noted throughout the checklist. In Climate Zones 1 thru 3, there is a general exemption for the internal air barrier closest to conditioned space because the predominant direction of air-flow in hot climates is from the outside to the inside of the house. In Climate Zones 4 thru 6, the most critical air-flow is from inside the home to the outside during cold weather, therefore the internal air barrier is required.

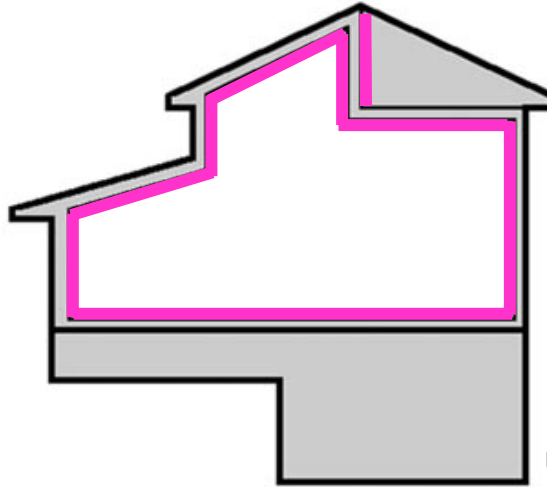

Image courtesy of Southface Energy Institute

Figure 1.1.3 - The air barrier should be contiguous and continuous over the entire building envelope. Insulation should be perfectly aligned with the air barrier.

In order for insulation to be an effective thermal barrier, it should be installed without any gaps, voids, compression, or wind intrusion. Gaps and voids allow air to flow through the insulation, decreasing its effectiveness (Figure 1.1.4). Compression reduces the effective R-value of the insulation.

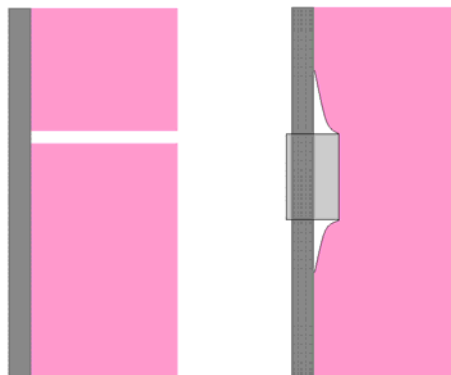

Figure 1.1.4 - Gaps (left) and voids (right) allow air to flow through insulation.

The following images depict misalignment between the air barrier and insulation that undermine the performance of the thermal enclosure.

1.1 AIR BARRIER AND THERMAL ALIGNMENT



Figure 1.1.5 – Misalignment of insulation due to compression

Figure 1.1.5 shows a common insulation installation practice called inset stapling where tabs of faced batts are stapled to the inside edges of wall framing. However, this practice commonly results in large gaps between the insulation and interior finish that will allow convective air flow around the insulation. This also facilitates air leakage at any gaps or holes in the framing. In contrast, stapling the insulation to the face of the studs would have allowed the batts to fill the framing space and be aligned with the interior finish. Note also how the insulation is also compressed around piping and wiring, resulting in a reduced R-value.



Figure 1.1.6 - Insulation installed with gaps and voids

Similarly, in Figure 1.1.6, the large gap between the insulation and where the interior ceiling finish will be installed will allow convective air flow around and through the insulation.

1.1 AIR BARRIER AND THERMAL ALIGNMENT



Image courtesy of Environments for Living

1.1.7 - Alignment of insulation and air barrier

In Figure 1.1.7, excellent insulation installation is shown with both faced and unfaced fiberglass insulation batts. This is because the batts are not compressed; there are no gaps, voids or compression; and when the interior surface is installed, the insulation will be fully aligned. Note also that the insulation is also carefully fit around piping and electrical wiring rather than being compressed in these areas, as was shown in Figure 1.1.5. Homes like this with carefully installed fiberglass insulation can be more comfortable and will have fewer moisture problems.



Image courtesy of
Environments for Living

Figure 1.1.8 - Insulation is fit around piping and wiring

Figure 1.1.8 demonstrates proper installation of fiberglass batts around piping and wiring by carefully splitting the batt.



Figure 1.1.9 - Blown cellulose insulation

Several options outside of traditional batt insulation are available. Figure 1.1.9 shows wet-spray cellulose insulation. This insulation is blown into wall assemblies with a mixture of water and glue that allows it to stay in place without falling out or settling. Since it goes in wet, it does need time to dry according to manufacturer's specifications. Other insulation materials such as fiberglass are also available for blown-in insulation. An advantage of blown-in insulation is that it inherently fills the entire wall cavity without any gaps, voids or compression.



Figure 1.1.10 - Spray foam insulation

Figure 1.1.10 shows a wall being insulated with spray foam. Spray foams are available in both open- and closed-cell configurations. All spray foam insulation acts as both an air barrier and a thermal barrier, so it is not critical that the foam be aligned with the interior finish. Properly installed, the foam application will fill holes and cracks for both a well insulated and air-tight wall assembly, making the home comfortable and reducing the likelihood of moisture problems. It should be noted that houses built to the 2006 IECC building code in Climate Zones 5 and higher must have insulation installed with a vapor retarder on the warm side to prevent moisture paths through the insulation. Since closed-cell spray foam is also a vapor barrier, it would meet this requirement. Open-cell spray foam would require a separate vapor retarder (e.g., latex paint).

KEY POINTS

Installation Criteria:

- Insulation shall be installed in full contact with the air barrier on all six sides to provide continuous alignment with the air barrier. For example, batt insulation shall be cut to fit around any wiring, pipes, or blocking and shall be correctly sized for wall width and height.
- Climate Zones 1 thru 3 are not required to have an inside air barrier at exterior wall assemblies since the predominant driving force in hot climates is from outside to inside.
- Two general exceptions to the requirement for a six-sided air barrier with insulation are at band joist insulation and at the top of ceiling insulation. Although a significant performance advantage is realized where a six-sided assembly is provided (e.g. SIPs), band joist insulation is only required to be in contact with the exterior framing and any exposed edges, and ceiling insulation is only required to be in contact with the air-barrier below (e.g. the ceiling sheetrock) and at any exposed edges. This is due to current cost effectiveness concerns with traditional construction practices. As a best practice, air barriers at band joists are discussed further in Section 1.5.

Tips and Best Practices:

- When choosing insulation, consider options that most readily achieve the proper installation requirements.
- Verify that insulation subcontractor installers are trained and/or certified in proper installation practices.

1.2 GARAGE BAND JOIST AIR BARRIER

Sealing the garage completely from the conditioned areas of the house is important from both an energy perspective because it can be a major source of heat gain and heat loss, and a health perspective due to common pollutants from car exhaust and stored materials. When the garage is attached to the house, the gaps created by joists spanning both conditioned space and the garage must be blocked off and sealed. See Figure 1.2.1 for an example of a house which blocked the joists from the garage but did not seal them.



Figure 1.2.1 – Gap between garage and conditioned space due to incomplete blocking

Creating air barriers to close gaps between the garage and the conditioned space can become increasingly difficult to construct as the joists become more irregular at their cross section. This is particularly true for I-joists and web-trusses (see Figure 1.2.2). A simple solution is to plan ahead and align the end of joists with the wall adjoining the conditioned space to allow for end blocking.

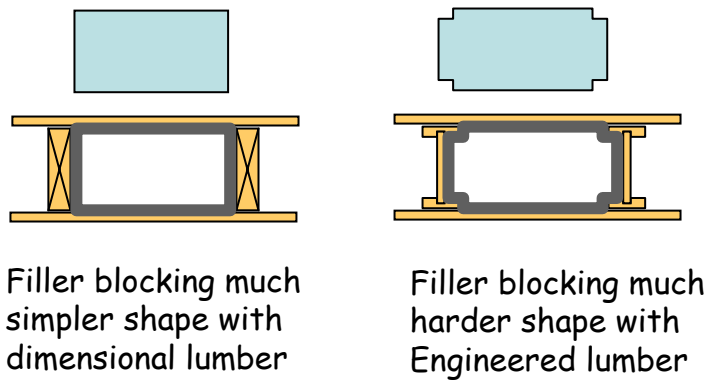

Figure 1.2.2 – Two types of joist-gaps created between garage and conditioned space

KEY POINTS

Installation Criteria:

- Ensure blocking is complete and fully sealed at all band joists between garage and conditioned space.
- Ensure insulation is installed without any gaps, voids or compression.

Tips and Best Practices:

- Instead of continuous framing extending from the garage to conditioned spaces, terminate framing at the boundary wall to the conditioned space so end-blocking can be installed.

1.3 ATTIC EAVE BAFFLES

Wind intrusion can occur at roof eaves through soffit vents. If the attic insulation is left exposed, the wind blowing through the soffit can flow through the insulation and in some cases blow it away from the edge. As a result, wind intrusion can undermine the effectiveness of the insulation and create opportunities for moisture problems.



Figure 1.3.1 - Wind intrusion from a soffit vent

In Figure 1.3.1 above, air flow coming through the soffit vent has completely blown back the insulation originally installed at the attic eave.

1.3 ATTIC EAVE BAFFLES

A baffle shall be installed at a minimum wherever soffit vents are located that extends over the top of the attic insulation to serve as an air barrier and prevent wind-washing. Ideally, baffles should be installed between all rafters or trusses because air gaps are typical between roof underlayment and fascia boards. The baffle can be any solid material such as cardboard or thin rigid insulation sheathing.



Image courtesy of MaGrann Associates

Figure 1.3.2 - Cardboard baffles

In Figure 1.3.2 above, cardboard baffles have been installed to direct the flow of air over and above the attic insulation.

1.3 ATTIC EAVE BAFFLES

KEY POINTS

Installation Criteria:

- Solid baffles shall be provided at all framing bays with soffit vents to prevent wind washing at attic insulation.

Tips and Best Practices:

- Even if soffit vents are not continuous, wind baffles are strongly recommended at all framing bays since air gaps commonly occur between roof sheathing and the fascia board. This can allow wind intrusion along the entire roof edge.

1.4 SLAB-EDGE INSULATION

While the alignment of air and thermal barriers is important throughout the home, one specific detail merits further mention. In cold climates, exposed concrete slab edges are a common source of discomfort and high utility bills. Properly insulating the slab edge can dramatically improve home performance.

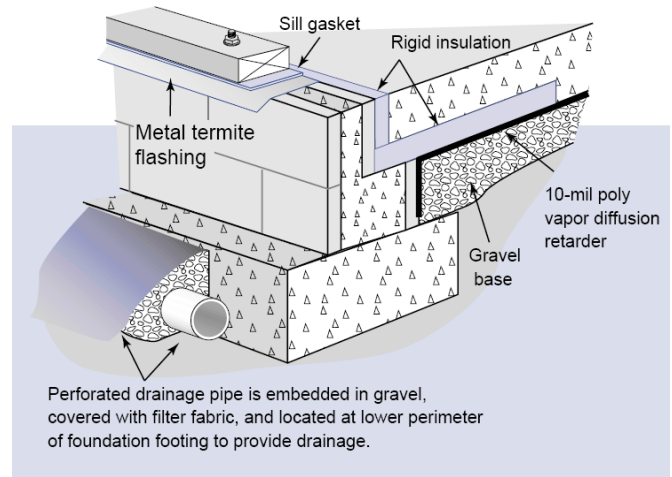
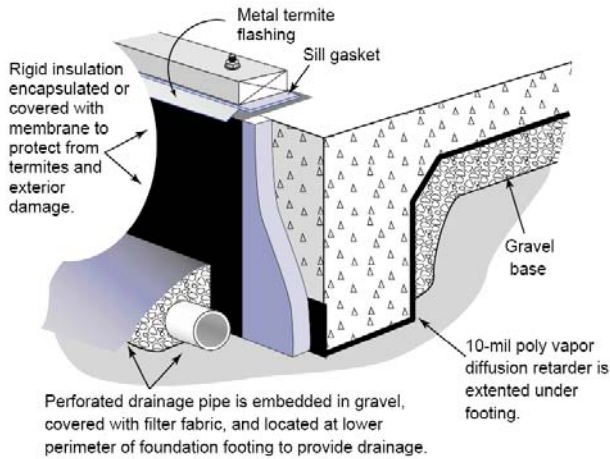

Diagrams courtesy of the US Department of Energy

Figure 1.4.1 - Options for slab insulation

There are two basic ways to insulate a slab. First, rigid insulation can be installed directly against the exterior of the slab, as shown in the detail at left in Figure 1.4.1. Note that in areas with high termite populations, builders should be careful to avoid installing foam insulation in contact with the ground. A second option is a "floating slab," which can be constructed using interior insulation, as shown in the detail at right. In both cases, insulation should be continuously aligned with the air barrier.

KEY POINTS

Installation Criteria:

- In Climate Zones 4 and higher, continuous slab insulation meeting the R-value specified in IRC 2004 shall be provided to avoid thermal bypass at exposed concrete slabs.
- A partial exemption applies to Climate Zones 4 and 5 where a maximum of 25% of the slab perimeter may be un-insulated.

Tips and Best Practices:

- Consider solutions to accommodate flooring materials and their required installation details (e.g., adhesive for sheet flooring, and nailing strips for carpet) where slab edge insulation will be exposed at exterior walls.

1.5 AIR BARRIER AT ALL BAND JOISTS

An exception to the six-side air barrier requirement discussed earlier is at band joists. However, inside air barriers at band joists are highly encouraged for Climate Zones 4 and higher and in any homes with open web truss-joist floors because as the homes are being heated, driving forces will cause heated air between the floors to flow through the band joist to the cold exterior framing. This can lead to higher utility bills, discomfort, and potential moisture problems.

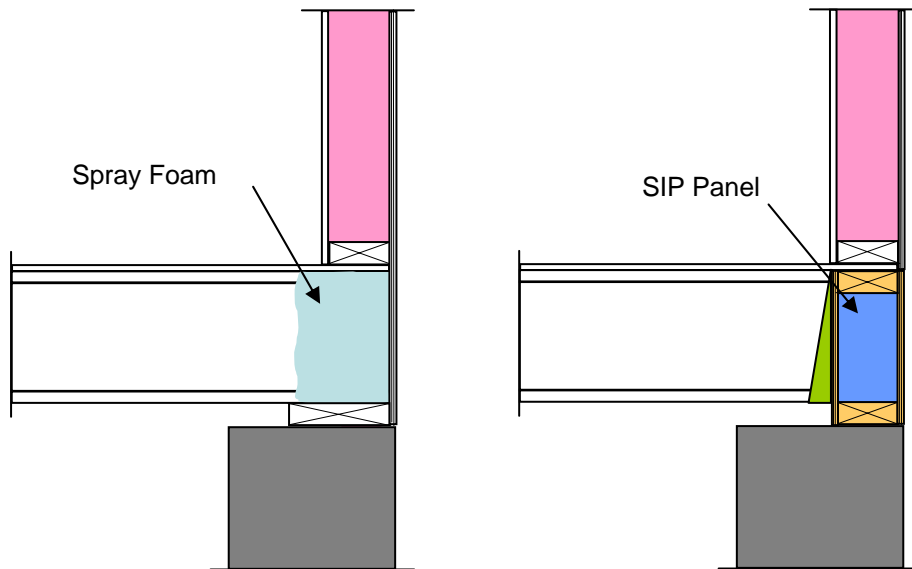

Figure 1.5.1 - Options for insulation/air barrier alignment at band joists

Figure 1.5.1 depicts two best practices for ensuring the alignment of an air barrier and thermal barrier at band joists. In the detail at the left, spray foam is used to fill the entire joist area and acts as a thermal barrier and an air barrier. At right, a small structural insulated panel (SIP) is installed, also acting as both a thermal and air barrier.

KEY POINTS

Tips and Best Practices:

- In order to eliminate higher utility bills, discomfort and potential moisture problems, inside air barriers are highly recommended for Climate Zones 4 and higher and in any home with open web truss-joist floors.

1.6 MINIMIZE THERMAL BRIDGING

Optimal Value Engineering (OVE) is one option to reduce thermal bridging through walls that uses standard building materials. In order to accomplish this, a framing plan is laid out as part of the architectural design that minimizes the studs and plates needed for structural support. For example, 2x6s spacing can typically be increased from 16" on-center to 24" on-center. Further framing reductions are possible by lining up trusses with the studs so that only one, rather than two, top plates are needed.

In addition, "California Corners" that use two instead of three studs to frame corners saves on framing and allows insulation to span the full length of the wall (see Figure 1.6.1). Similarly three-stud framing assemblies at interior/exterior wall intersections can be eliminated by using furring lattice behind the exterior wall stud (see Figure 1.6.2). This assembly reduces framing and allows for continuous insulation.

By adhering to these practices, it is possible to reduce the framing fraction from the standard 23% to around 15%. This 8% reduction in framing area would result in an 8% gain in insulation area. In addition to energy savings associated with reduced framing area, capital costs are reduced due to less framing. Unlike advanced wall systems that can also be used to reduce thermal bridging (e.g., SIPs, Insulated Concrete Forms), OVE still needs to address quality control issues with insulation installation to ensure continuous alignment with the air barrier along with no gaps, voids, and compression.

For more information see <http://www.eere.energy.gov/buildings/info/documents/pdfs/26449.pdf> or www.pathnet.org.

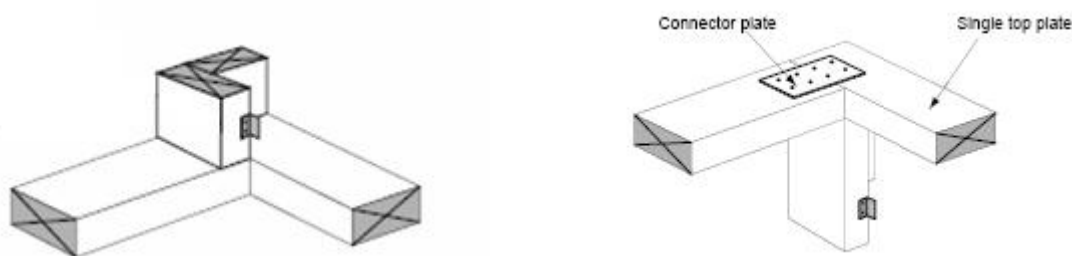

Pictures from <http://www.eere.energy.gov/buildings/info/documents/pdfs/26449.pdf>

Figure 1.6.1 – Advanced corner framing techniques

1.6 MINIMIZE THERMAL BRIDGING



Figure 1.6.2 – Advanced interior/exterior wall framing techniques

Exterior rigid insulation wall sheathing can be used to provide a complete thermal break at all wall framing (see Figure 1.6.3). The only uninsulated wall areas are the window and door openings.



Figure 1.6.3 – Complete thermal break with rigid insulation sheathing

1.6 MINIMIZE THERMAL BRIDGING



Figure 1.6.4 - Structural Insulated Panels (SIPs)

There are factory-built insulated wall assemblies readily available today that, by virtue of how they are manufactured and assembled in the field, ensure minimal thermal bridging along with full alignment of insulation with the integrated air barriers including no gaps, voids or compression. Structural Insulated Panels or SIPs (Figure 1.6.4) are whole wall panels composed of insulated foam board glued to both an internal and external layer of wood sheathing, typically OSB or plywood. This assembly will often be manufactured with precut window openings and chases.

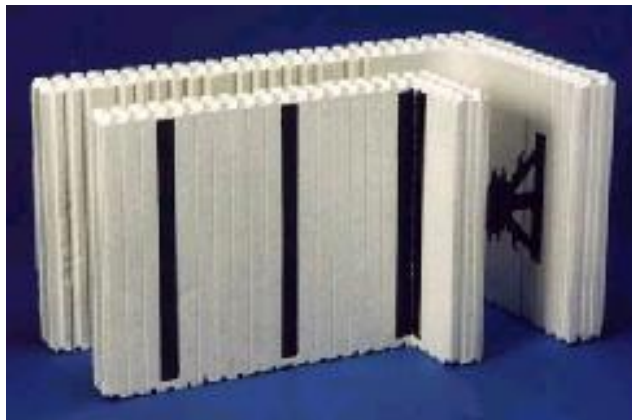

Figure 1.6.5 - Insulated Concrete Form (ICF)

Another factory-built wall system shown is Insulated Concrete Forms, or ICFs (see Figure 1.6.5). ICFs are blocks made from extruded polystyrene insulation designed to be assembled like “Lego” blocks into a complete wall assembly. Steel reinforcing rods are added and concrete is poured into the voids, resulting in a very air-tight, well-insulated, and sturdy wall. In addition to no thermal bridging, the insulation is inherently aligned with the exterior and interior air barriers with no gaps, voids or compression.

1.6 MINIMIZE THERMAL BRIDGING

KEY POINTS

Installation Criteria:

- OVE (Optimal Value Engineering) still needs to address quality control issues with insulation installation to ensure continuous alignment with the air barrier with no gaps, voids, or compression.

Tips and Best Practices:

- OVE reduces thermal bridging by laying out a framing plan that minimizes the studs and plates need for structural support.
- Two factory built assemblies that ensure thermal bridging along with full alignment of insulation and integrated air barriers with no gaps, voids or compression, are SIPs (Structurally Insulated Panels) and ICFs (Insulated Concrete Forms).

2. WALLS ADJOINING EXT. WALLS OR UNCOND. SPACES

Scope of Work:

- Fully insulated wall aligned with air barrier at both interior and exterior, **OR**
- Alternate for Climate Zones 1 thru 3, sealed exterior air barrier aligned with RESNET Grade 1 insulation fully supported
- Continuous top and bottom plates or sealed blocking

2.1 WALL BEHIND SHOWER/TUB

In the construction process for many homes, tubs and showers are installed immediately after rough framing is complete and before insulation is installed (Figure 2.1.1). As a result, it is almost impossible to properly install insulation and complete air barriers at exterior walls adjoining tubs and showers. This can lead to convective air flow that circumvents insulation.

Image courtesy of Building Science Corp.



Figure 2.1.1 - Tub installed against exterior wall without air barrier or insulation

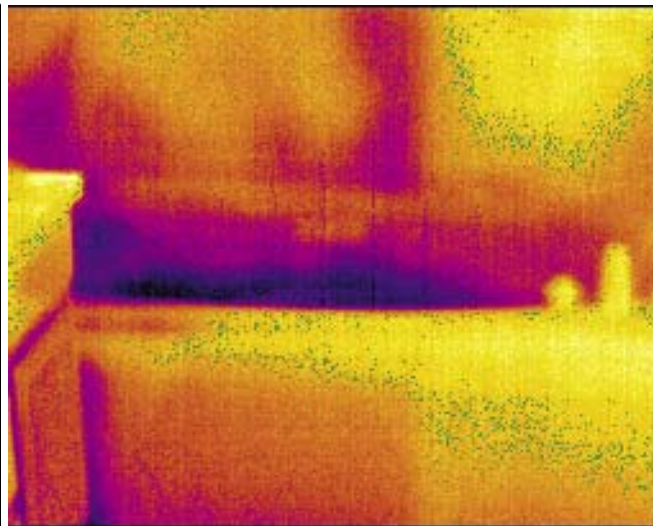

Images courtesy of Fort Collins Utilities

Figure 2.1.2 - Infrared image showing thermal bypass at tub with incomplete insulation and air barrier

The infrared image in Figure 2.1.2 shows a common problem where homeowners have tubs and showers that get cold in the winter. In this case, thermal bypass to the cold air outside the home is decreasing the temperature of the tub inside the home. If an air barrier and insulation had been properly installed behind the tub against the exterior wall, the tub would be protected by an effectively insulated wall assembly, making the bathroom more comfortable for the homeowner.

2.1 WALL BEHIND SHOWER/TUB

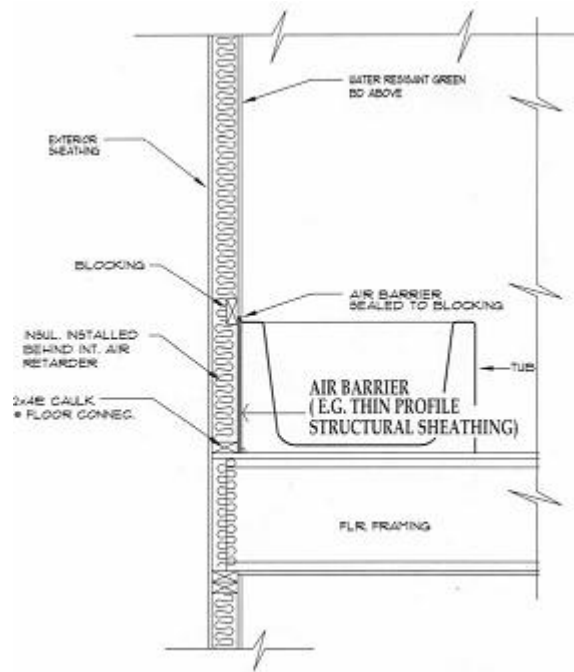

Diagram courtesy of MaGrann Associates

Figure 2.1.3 – Architectural detail of tub installation with complete air and thermal barriers



Image courtesy of Energy Services Group



Image courtesy of Building Science Corp.

Figure 2.1.4 - Two installations of air barriers at tubs adjoining exterior walls

The installation of air barriers and insulation behind tubs and showers at exterior walls can be achieved with proper planning starting with design (Figure 2.1.3). Also, shown in Figure 2.1.4, in the image at left, the builder left insulation batts and drywall for his framers and held them accountable for installing the materials where the tub was to be installed. In the home at right, the builder left a thin board sheathing product to be installed by the framer. Another option (not shown) would be to fill the cavity around the tub with spray-foam, which acts as both a thermal and air barrier. In any of these cases, the tubs will be much less likely to cause comfort or moisture problems. (Internal air-barriers for this detail are not required for Climate Zones 1 thru 3, however, insulation behind the tub or shower is still necessary).

KEY POINTS

Installation Criteria:

- Exterior walls shall be enclosed on all six sides, including a complete and continuous air barrier behind the tub. An exception is provided for Climate Zones 1 thru 3 where as an alternative to the inside air barrier, the builder can install a fully sealed and continuous exterior along with RESNET Grade 1 insulation fully supported.

Tips and Best Practices:

- Use a material that is readily available to ensure the air barrier is installed prior to setting the tub. Plywood, oriented strand board (OSB), sheathing boards, and drywall are good choices.
- Using spray foam at framing behind tubs is also an option to avoid labor installing both air barrier and insulation. However, it will need to be installed prior to setting the tub or shower.
- Insulation material and air barrier sheathing should be made available on site for installation by the framing subcontractor prior to plumbing rough-ins, or the framing subcontractor could install an air barrier behind the tub with the wall cavity left accessible for installation of loose fill or blown-in insulation by the insulation subcontractor.

2.2 WALL BEHIND FIREPLACE

Air barriers are also needed in wall chases, such as the furred out space behind fireplaces. Once framed in, they are very difficult to complete with insulation and air barriers.

**Air barrier missing at
framed exterior wall**



Image courtesy of EnergyLogic

Figure 2.2.1 - Fireplace installed without air barrier

In Figure 2.2.1 above, the fireplace has been framed and installed without an air barrier, and it will be difficult to install the insulation properly. The diagram in Figure 2.2.2 below shows an architectural detail of how the air barrier behind the fireplace wall can be installed.

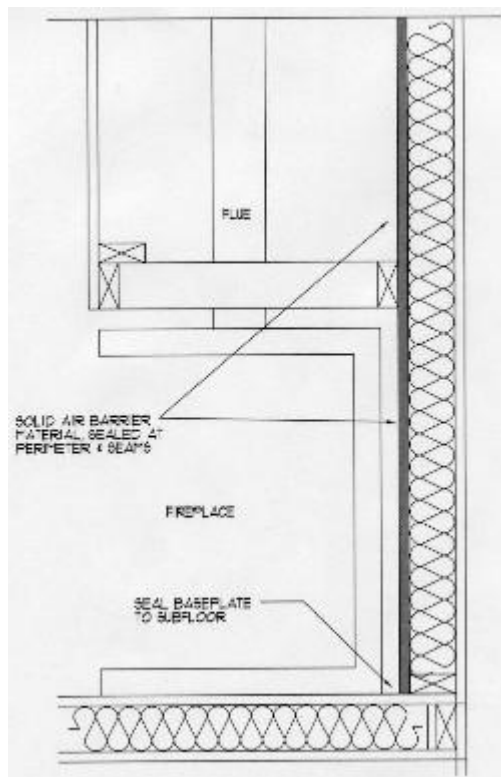

Diagram courtesy of MaGrann Associates

Figure 2.2.2 – Architectural detail of fireplace air barrier installation

2.2 WALL BEHIND FIREPLACE

One way to include an air barrier at the fireplace wall is for the builder to hold the framer responsible for installing the insulation and drywall at the fireplace shaft during the framing process when it is easily accessible.



Image courtesy of EnergyLogic



Image courtesy of Building Science Corp

Figure 2.2.3 - Fireplaces installed with air barrier and insulation

At left in Figure 2.2.3, the builder has used a thin board sheathing and insulation product that effectively locates the thermal enclosure at the exterior wall behind the fireplace. At right, the builder has used drywall and insulation for the same purpose.

An exemption to the inside air barrier requirement for Climate Zones 1 thru 3 allows for an air barrier only at the outside of the wall. This exemption exists because the prevailing driving force in hot climates moves from outside inward.

KEY POINTS

Installation Criteria:

- For Climate Zones 4 thru 8, an inside air barrier shall be installed that is fully aligned with the wall insulation, and any gaps shall be fully sealed with caulk, foam, or tape.
- As an alternate detail for Climate Zones 1 thru 3, houses may comply with the specification by ensuring a sealed and continuous air-barrier at the exterior wall along with RESNET Grade 1 insulation fully supported.
- Fire-rated caulking along with flashing or UL-rated collars must be installed continuous around any fireplace flue and wall penetration.
- Drywall, thermoply, or other air barrier materials may be used to create an interior air barrier on the exterior wall behind the fireplace.

Tips and Best Practices:

- Install insulation prior to the installation of the inside air barrier. However, this will often rely on the builder to verify proper installation of insulation and therefore complete verification of this item on the Thermal Bypass Checklist.

2.3 INSULATED ATTIC SLOPES FOR UNVENTED ATTIC SPACES

It is common practice to install HVAC ductwork and air handlers in attic spaces. One way to dramatically improve the performance of these systems is to create an unvented, conditioned attic that results in having the HVAC system located inside the conditioned space. This is accomplished by insulating the sloped attic roof and any vertical attic walls (e.g., gable ends) rather than the flat attic ceiling. This change can provide a considerable reduction in ductwork heat loss and gain.

As with all other walls adjoining exterior walls or unconditioned spaces, the inside air barrier exception applies to Climate Zones 1 thru 3, allowing as an alternate the exterior air barrier to be fully sealed along with insulation meeting RESNET Grade 1 requirements and fully supported. Thus, in Climate Zones 4 and higher, an inside air barrier is required at unvented attic insulation. In addition, the IECC requires a vapor retarder in Climate Zones 5 and higher. This can be accomplished with several different strategies, including a variety of insulation choices. One way to accomplish this is with closed-cell spray foam or with open-cell spray foam coated with a latex paint. Figure 2.3.1 below shows an unvented attic with spray foam insulation.



Figure 2.3.1 – Unvented attic with spray foam insulation at slopes and walls

2.3 INSULATED ATTIC SLOPES FOR UNVENTED ATTIC SPACES

KEY POINTS

Installation Criteria:

- Insulation shall be installed in full contact with the air barrier on all six sides to provide continuous alignment with the air barrier.
- For Climate Zones 1 thru 3, as an alternate to the interior air barrier, the exterior air barrier can be fully sealed along with RESNET Grade 1 insulation that is fully supported.

Tips and Best Practices:

- In Climate Zones 4 and higher, there are several different strategies that will accomplish this assembly, including a variety of insulation types. If chosen, spray foam insulation will act as both an air barrier and insulation in one application without any R-value restrictions due to truss framing dimensions.
- In very cold climates, closed-cell spray foam is one option to achieve an air barrier, insulation, and vapor barrier in one application.

2.4 ATTIC KNEE WALLS

Where air barriers are not installed on the attic side of attic knee walls, very hot or cold attic air can lead to thermal bypass around the knee wall insulation.

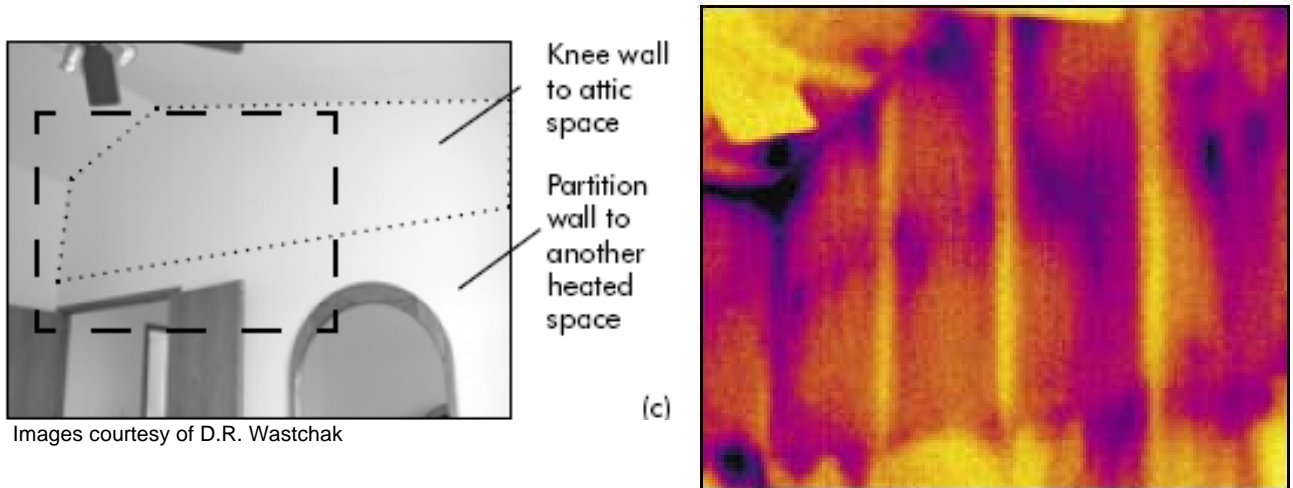

Figure 2.4.1 - Infrared image of attic knee wall detail

In infrared images, dark colors (blue, black) indicate colder surface temperatures, and lighter colors (yellow, orange) indicate warmer surface temperatures. Figure 2.4.1. shows an attic knee wall along with an infrared image taken during a cold winter day. As a result of no attic-side air barrier, there is excessive thermal bypass to the cold attic as evident by the dark color of the insulated framing bays. In fact, the R-3 wood studs appear as much brighter vertical lines with much less heat loss than the R-19 insulated bays between them. This shows clearly how important it is to include complete air barrier details as an improperly installed insulation assembly loses most of its rated R-value, thereby increasing energy bills and significantly compromising comfort.

An effective attic knee wall assembly should include a six-sided air barrier with sheathing or rigid insulation installed on the attic side. Figure 2.4.2 shows a good architectural detail for an attic knee wall including air barriers on all sides of the insulation along with top and bottom plates or blocking.

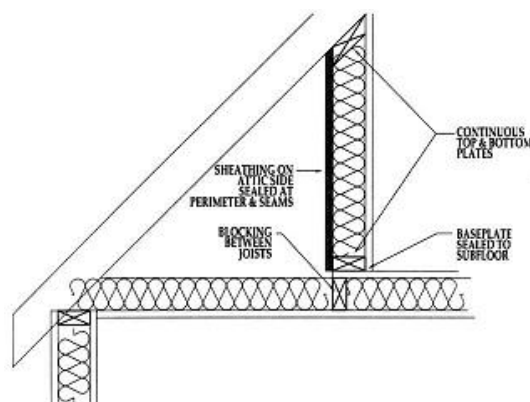

Diagram courtesy of MaGrann Associates

Figure 2.4.2 – Architectural detail for an attic knee wall

2.4 ATTIC KNEE WALLS



Images courtesy of Energy Services Group

Figure 2.4.3 - Examples of properly blocked and air sealed attic knee walls

The images in Figure 2.4.3 above show examples of attic knee walls that have been fully blocked and air sealed. Once these walls are properly insulated, the rooms will be more comfortable and less likely to suffer from comfort and moisture problems. Note: The attic access opening in the knee wall needs to be treated as an exterior door with appropriate insulation and a complete gasket seal.



Figure 2.4.4 – Attic knee wall with no exterior air barrier



Figure 2.4.5 – Attic knee wall with exterior air barrier

The images in Figure 2.4.4 and Figure 2.4.5 show a before-and-after picture of a knee wall and the installation of the appropriate knee wall air barrier.

2.4 ATTIC KNEE WALLS

KEY POINTS

Installation Criteria:

- Continuous top and bottom plates shall be installed along with an air barrier on the attic side of insulated walls, including exposed edges of insulation at joists and rafters.
- Where truss framing is used, blocking is required at the top and bottom of each framing bay.
- For houses located in Climate Zones 1 thru 3 and in houses with unfinished interior attic knee walls (e.g., storage closet), use the alternate detail to the interior side air barrier by ensuring a fully sealed and continuous air-barrier to the attic-side of the wall along with RESNET Grade 1 insulation that is fully supported.

Tips and Best Practices

- Recognize that attic knee wall barriers are only needed when adjoining an unconditioned attic.
- Acceptable materials for attic-side barriers vary significantly around the country. Be sure to confirm that the preferred material is acceptable to the local code official.
- FSK radiant barrier facing material typically meets code requirements for flame spreadability on attic-side materials.

2.5 SKYLIGHT SHAFT WALLS

Skylight shafts protruding through the ceiling and an unconditioned space need to be insulated since the shaft's walls are effectively attic knee walls adjoining an unconditioned space. Skylight shaft walls shall be insulated to the same level as attic knee walls and shall include a sealed air-barrier aligned with the insulation on both interior and exterior sides of the walls (see Figure 2.5.1). Climate Zones 1 thru 3 are exempt from the sealed interior air-barrier, but this is unlikely to be an issue since skylight shafts are almost always finished.

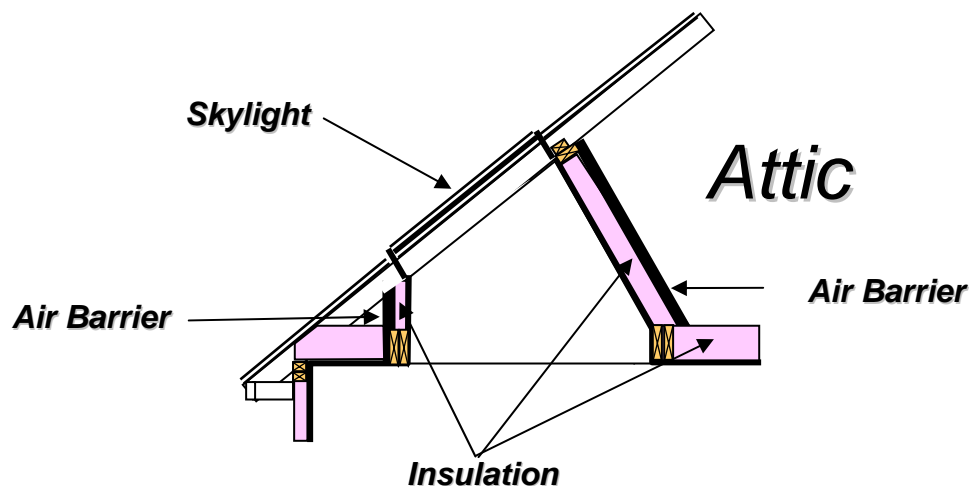

Figure 2.5.1 – Architectural detail for insulation and air barrier at skylight shaft

Light tubes such as the one pictured in Figure 2.5.2 should also be covered with insulation and an air-barrier. In fact, the light tube depicted includes approximately 30 square feet of exposed surface area to the unconditioned attic. One acceptable method for insulating the light tube is to use R-8 duct insulation with the plastic lining functioning as the exterior air-barrier. Additionally, the penetration of the light tube through the ceiling shall be sealed between conditioned and unconditioned space. See Section 4.1 and 4.2 of this document.

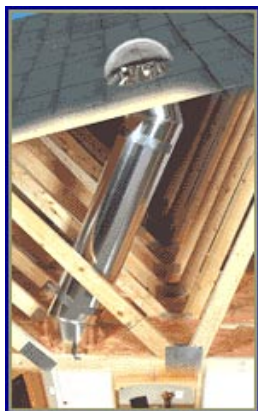

Figure 2.5.2 – Example of an un-insulated light tube

KEY POINTS

Installation Criteria:

- Light tubes can represent a significant amount of exposed surface area to unconditioned attics, and therefore need a complete insulation and air barrier assembly.

Tips and Best Practices:

- Consider using R-8 duct insulation to provide both an air barrier and insulation in one step. However, where possible, more insulation (e.g., R-13 to R-19) would be appropriate.

2.6 WALL ADJOINING PORCH ROOF

Where blocking and air sealing are missing at the intersection between conditioned space and a porch roof (as shown below in Figure 2.6.1), air can easily pass through the insulation, between the exterior and interior of the home, causing high utility bills along with potential comfort and moisture problems. This thermal bypass is evident in the infrared image in Figure 2.6.2. Here, you can see how missing air barriers can lead to cold surface areas in walls adjoining a porch roof.



Image courtesy of Energy Services Group

Figure 2.6.1 – Air barrier missing at porch roof



Image courtesy of Energy Services Group

Figure 2.6.2 - Cold air thermal bypass at a porch roof

2.6 WALL ADJOINING PORCH ROOF

To complete an air barrier at porch roofs, install blocking or another solid air barrier between the porch roof and conditioned space of the home, as shown Figures 2.6.3 (flat porch roof) and 2.6.4 (sloped porch roof) below. Once the blocking is installed, the area can be easily insulated much like a band joist (flat porch roof) or attic knee wall (sloped porch roof).



Image courtesy of Energy Services Group

Figure 2.6.3 - Appropriate blocking at intersection of flat porch roof and conditioned space



Image courtesy of Environments for Living

Figure 2.6.4 - Appropriate blocking between sloped porch roof and conditioned space

KEY POINTS

Installation Criteria:

- A complete air barrier shall be installed at the intersection of the porch roof and conditioned space.
- Where truss framing is used, blocking shall be provided at the top and bottom of each wall/roof section. Blocking shall be installed prior to insulation.

Tips and Best Practices:

- At sloped porch roofs, the porch/conditioned space intersection is effectively an attic knee wall. Follow the tips and best practices included in Section 2.4.
- At flat porch roofs, the porch/conditioned space intersection is effectively a band joist that is not required to include an interior side air barrier. However, it is highly encouraged per recommendations in Section 1.5.

2.7 STAIRCASE WALLS

Staircases adjoining exterior walls, garages, or attics (see Figure 2.7.1) need complete air barriers throughout the framed assembly. Note that Climate Zones 1 thru 3 are exempt from the interior side air barrier for this detail where the exterior air barrier is ensured to be fully sealed along with RESNET Grade 1 insulation that is fully supported. A common area missing an air barrier at staircase walls occurs at small areas under enclosed landings or bottom stairs. Once framed, staircases can be difficult to complete with insulation and air barriers so it is important to coordinate details with the framing subcontractor.



Image courtesy of Energy Services Group

Figure 2.7.1 - Staircase adjoining unconditioned attic needs to be fully blocked and sealed

2.7 STAIRCASE WALLS

An air barrier is needed at staircases where they come in contact with the exterior wall or attic above and below the stairs. This involves sealing any gaps with caulk or foam, and providing a complete air barrier assembly (see Figure 2.7.2).

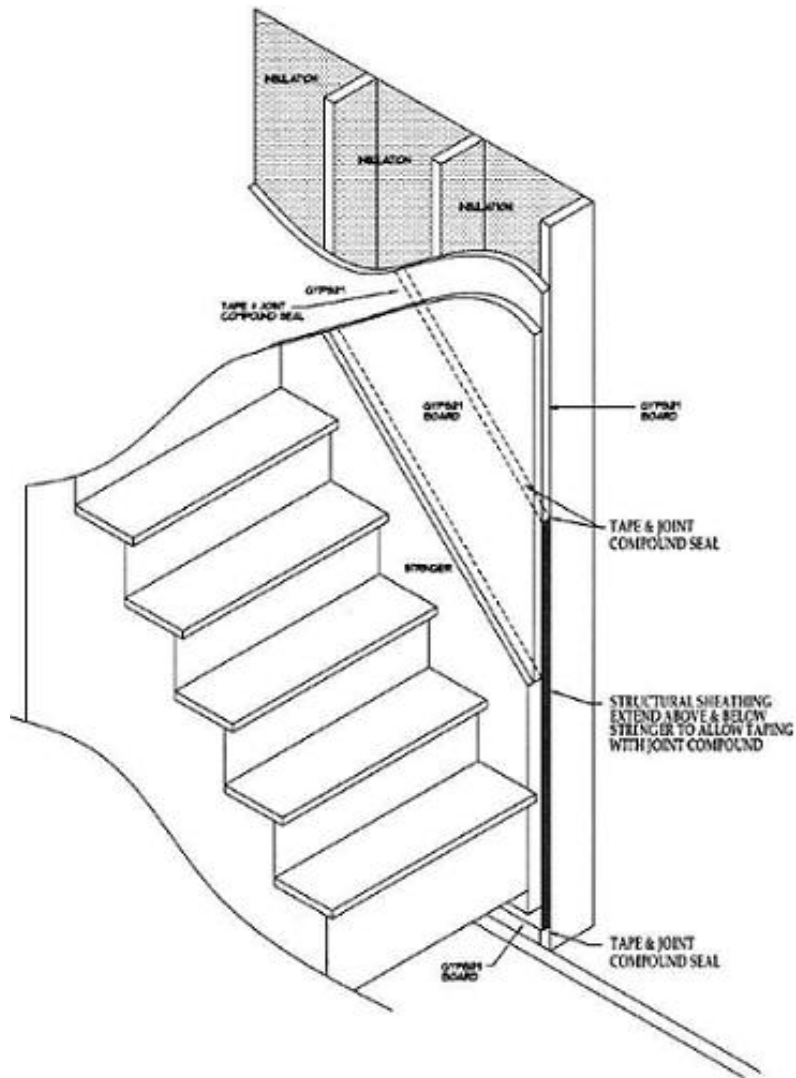

Diagram courtesy of MaGrann Associates

Figure 2.7.2 – Architectural detail for staircase with complete air barrier

2.7 STAIRCASE WALLS

KEY POINTS

Installation Criteria:

- Structural sheathing can be used to extend above and below stringers to allow for taping with joint compound.
- Air barrier shall be fully aligned with insulation and any gaps are fully sealed with caulk or foam.

Tips and Best Practices:

- If stair air barrier is complete at HERS inspection, builder verification may be needed for this item.

2.8 DOUBLE WALLS

Double walls are becoming common in some markets to provide a more dimensional architectural appearance. The insulation must be aligned with and enclosed by air barriers on all sides. There are multiple ways to accomplish this such as placing an air barrier on the exterior side of the interior wall and insulating the interior cavity (Figure 2.8.1). However, this can be very difficult to install, and it is therefore suggested that the entire wall cavity be filled with blown-in insulation or spray foam (Figure 2.8.2). If blown-in insulation is used, shelves located approximately every two feet of vertical distance up the wall should be installed to prevent excessive settling over time with such a wide unsupported area of insulation. If spray foam is used, it only needs to be the thickness required for the specified R-value without a separate air barrier since it functions as both insulation and an air barrier.

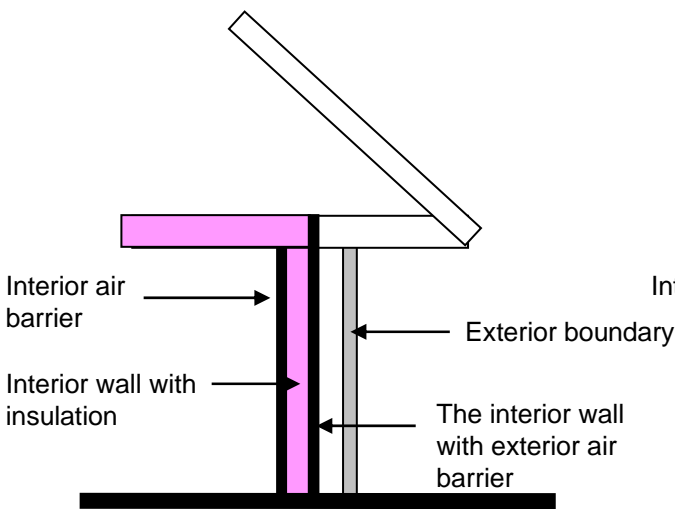

Figure 2.8.1 – Double wall with air barrier

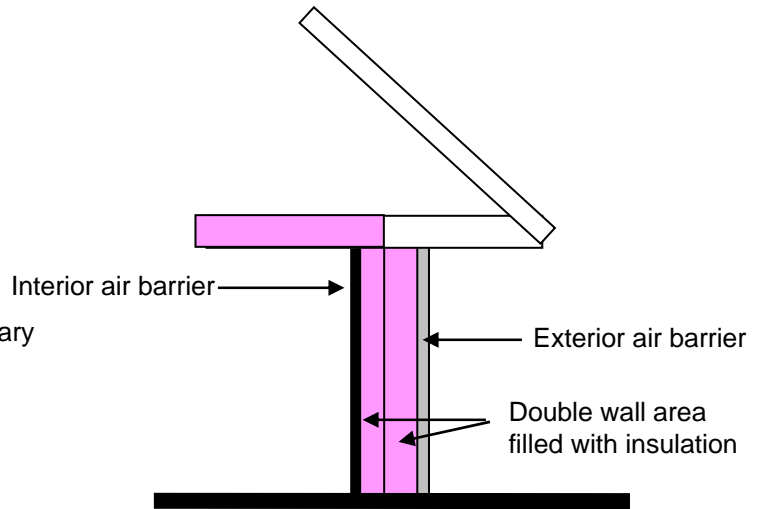

Figure 2.8.2 – Double wall with filled cavity



Figure 2.8.3 – Example of a double wall

KEY POINTS

Installation Criteria:

- Insulation shall be installed in full contact with the air barrier on all six sides to provide continuous alignment.
- For Climate Zones 1 thru 3, houses may use an alternate detail to the interior air barrier by ensuring the exterior is fully sealed along with RESNET Grade 1 insulation that is fully supported.

Tips and Best Practices:

- Fill the entire wall cavity with blown-in insulation or spray foam.
- If blown-in insulation is used, provide shelves located approximately every two feet of vertical distance up the wall to prevent excessive settling over time with such a wide unsupported area of insulation.
- If spray foam is used, it only needs to be the thickness required for the specified R-value without a separate air barrier since it functions as both insulation and an air barrier.

3. FLOORS BETWEEN CONDITIONED AND UNCONDITIONED SPACES

Scope of Work:

- Air barrier is installed at any exposed insulated edges
- Insulation is installed to maintain permanent contact with sub-floor above including necessary supports (e.g., staves for blankets, netting for blown-in)
- Blanket insulation is verified to have no gaps, voids, or compression
- Blown-in insulation is verified to have proper density with firm packing

3.1 INSULATED FLOOR ABOVE GARAGE

Cold and hot air in the garage can lead to thermal bypass if insulation is not properly installed between the garage ceiling and the sub-floor above. This can lead to hot floors in the summer and cold floors in the winter that compromise comfort. Figure 3.1.1 shows a common occurrence where insulation may have been installed in contact with the garage ceiling, but settles down leaving a large air gap between the insulation and the sub-floor above. In this detail, thermal flow can easily bypass the floor insulation rendering it ineffective.

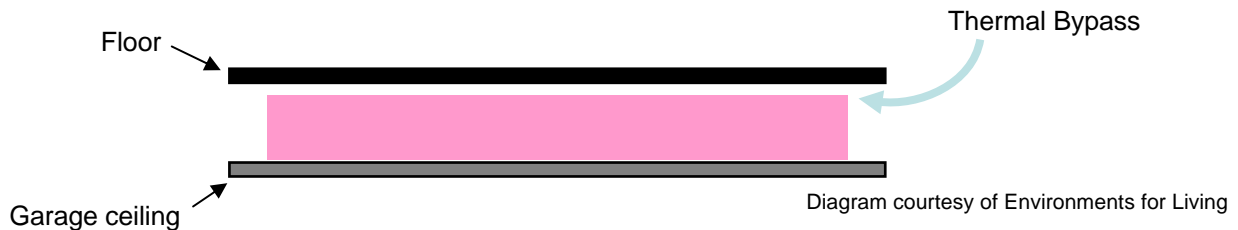

Figure 3.1.1 – Thermal bypass at garage ceiling

One solution for effectively insulated floors above the garage is to completely fill the floor framing space with insulation so it is snug against the sub-floor and ceiling below, and then provide blocking such as plywood, OSB, or rigid insulation at any exposed edges of the insulation between floor framing to stop air flow through the insulation (see Figure 3.1.2). If blown-in insulation is used, it is very important to ensure proper density to avoid settling away from the sub-floor.



Figure 3.1.2 - Alignment of insulation and air barrier at garage ceiling

Another solution for effectively insulated floors above the garage is to install spray foam insulation snug against the sub-floor to thickness needed for desired R-value. Bottom side and edge air barrier details would not be required because spray foam functions as both insulation and an air barrier. Batt or blown-in insulation properly supported (e.g., netting and metal staves respectively) can also be installed snug against the sub-floor without the bottom-side air barrier. However, complete air barriers are required at the edges of batt and blown-in insulation. These options are shown in Figure 3.1.3 on the next page.

3.1 INSULATED FLOOR ABOVE GARAGE



Figure 3.1.3 - Alignment of insulation and air barrier at garage ceiling with spray foam or faced batt insulation

Floors constructed of dimensional lumber can be easier to block, insulate and seal than those constructed with engineered framing members. With dimensional lumber, only the two open ends of the joist cavities need to be blocked and air sealed. The sub-floor and drywall ceilings below can be sealed to the framing members at the time of installation. Figure 3.1.4 illustrates blocking material locations.

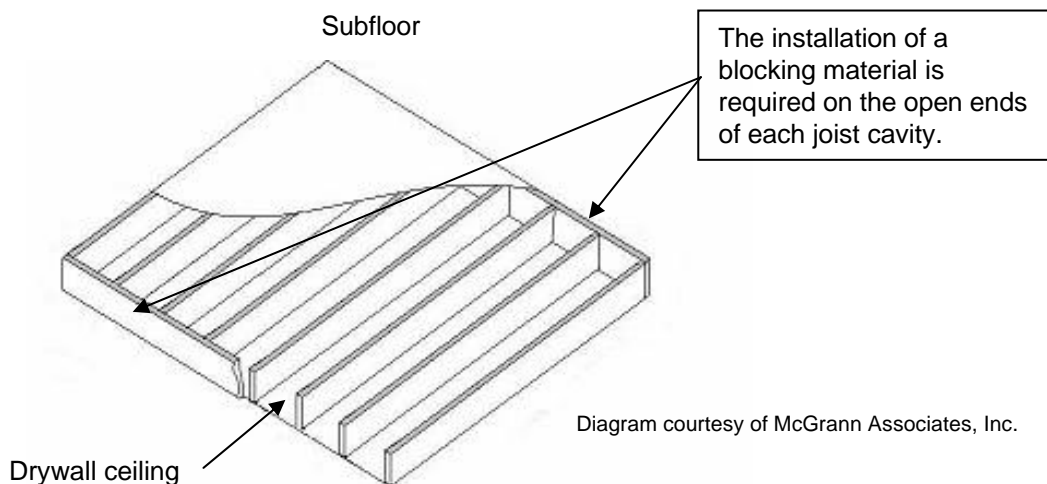

Figure 3.1.4 - Blocking for floor over garage

3.1 INSULATED FLOOR ABOVE GARAGE

Floor assemblies constructed with open web trusses can be very difficult to effectively block, insulate, and air seal. In particular, open web areas are labor-intensive to fill with batt or rigid insulation but can easily be filled with blown or spray insulation. All four edges of an open-web truss floor assembly require the installation of a sheathing material to enclose the entire floor cavity and then all joints and penetrations need to be air sealed. If the framing is continuous from garage to conditioned space, this can be extremely difficult to effectively block. Figure 3.1.5 illustrates how to enclose the floor assembly on all four sides.

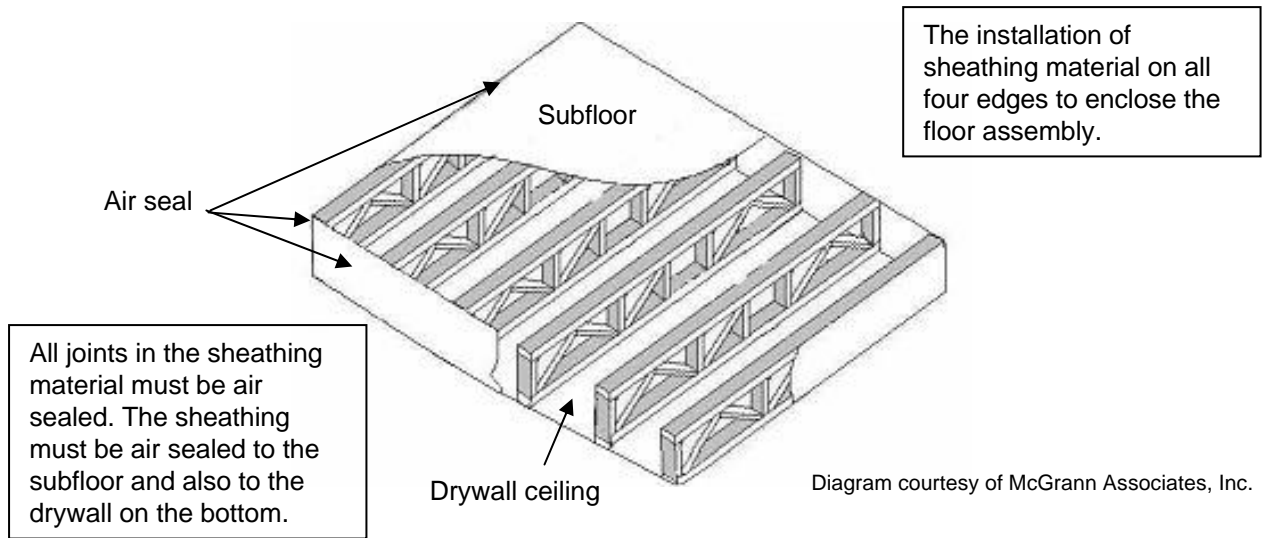

Figure 3.1.5 - Enclosing four edges of open web truss floor

3.1 INSULATED FLOOR ABOVE GARAGE

KEY POINTS

Installation Criteria:

- Until **July 1, 2008**, insulation shall be installed to maintain permanent contact with the underside of the sub-floor decking and be properly supported (e.g., metal staves for batt insulation and netting for blown-in insulation). Thereafter, the complete framing space between floors shall be filled with insulation so it is aligned with the top and bottom air barrier. If spray foam is used, the bottom surface of the foam functions as the air barrier and therefore does not need to be full depth.
- Except where spray foam insulation is used, air barriers shall be provided at any exposed edges of insulation

Tips and Best Practices:

- Before choosing to completely fill the floor cavity (as in Figure 3.1.2), make sure that the weight of the insulation will not be excessive for the drywall ceiling due to the depth of the floor framing. Check with the drywall manufacturer to determine whether netting installed for blown-in insulation effectively removes the extra weight from bearing on the drywall ceiling.
- If weight is not an issue, blown-in insulation completely filling the floor space may be the simplest and most cost-effective solution for assuring alignment with both sub-floor and ceiling, but it is critical to ensure proper density to avoid settling away from the sub-floor.
- Since spray foam functions as both insulation and an air barrier, consider using spray foam insulation to avoid completely filling thick framing space between garage and sub-floor with insulation and installing edge air barriers.
- Batt insulation may be installed with metal staves holding the insulation against the sub-floor above the garage. Any pipes in the floor system should have adequate insulation installed below them.

3.2 CANTILEVERED FLOOR

Cantilevered floor assemblies are another location where thermal bypass is common. Plywood or other soffit material typically installed at the bottom of cantilever framing is often not air sealed at the framing edges. Blocking is often missing between the cantilever and conditioned space (Figure 3.2.1), and insulation often settles away from the sub-floor resulting in a large air gap (Figure 3.2.2). Thermal bypass around the insulation is often the effect, resulting in floors that are too cold in winter and too warm in summer.

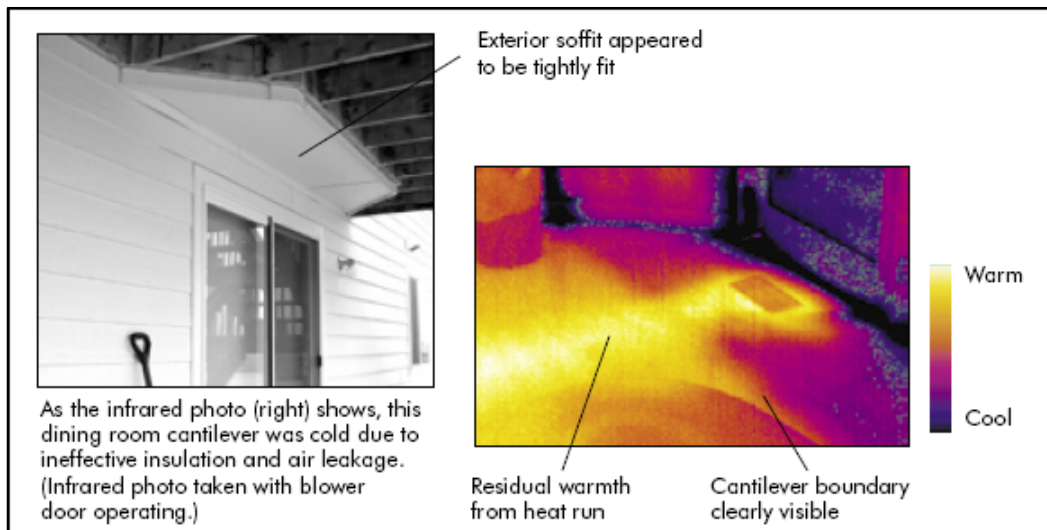

Image courtesy of Energy Services Group

Figure 3.2.1 – Cantilevered floor with no air barrier between overhang and conditioned space



Figure 3.2.2 – Insulation settling away from sub-floor



Images courtesy of Fort Collins Utilities

Figure 3.2.3 - Infrared image of a cantilevered floor without thermal bypass details

In Figure 3.2.3, the temperature differential on the cantilevered floor is clearly visible, as the floor over the cantilever is much cooler (darker colored) than the floor over conditioned space.

3.2 CANTILEVERED FLOOR

To eliminate thermal bypass at cantilevered floors, the framing space should be completely filled with insulation so that the insulation is in full contact with the sub-floor above. Also, an air barrier of thin sheathing, blocking, or rigid insulation should be added to the edge of the insulation, so that air flow is blocked between the exterior and interior of the home (Figure 3.2.4). Proper air sealing of the exterior sheathing on the bottom of the cantilevered floor is extremely important to stop air infiltration into the floor system. Not only will these proper insulation and air sealing details improve the energy efficiency, they will improve comfort, air quality, and durability of the home.

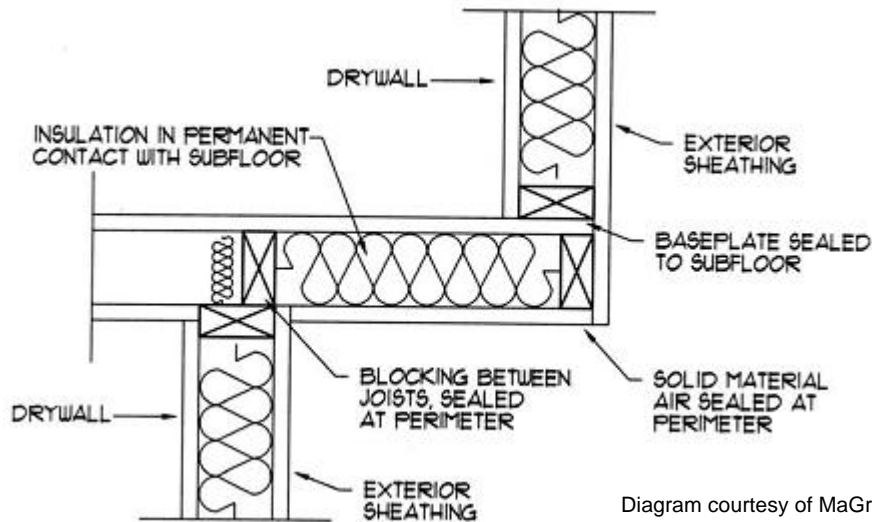

Diagram courtesy of MaGrann Associates

Figure 3.2.4 – Architectural detail for cantilevered floor assembly



Images courtesy of MaGrann Associates

Figure 3.2.5 - Proper installation of insulation under a cantilevered floor

The image at left in Figure 3.2.5 above shows insulation installed to fill the space underneath the sub-floor. In the image at right, the assembly has been blocked and air sealed below the conditioned floor above.

KEY POINTS

Installation Criteria:

- Until **July 1, 2008**, insulation shall be installed to maintain permanent contact with the underside of the sub-floor decking and be properly supported (e.g., metal staves for batt insulation and netting for blown-in insulation). Thereafter, the complete framing space between floors shall be filled with insulation so it is aligned with the top and bottom air barrier. If spray foam is used, the bottom surface of the foam functions as the air barrier and therefore does not need to be full depth.
- Except where spray foam insulation is used, air barriers shall be provided at the inside edge of the wall top plate across the cantilever.
- The air barrier shall be fully air sealed between sheathing, gaps, cracks and edges with a compressible sealant, caulk, foam, or mastic.

Tips and Best Practices:

- If the cantilever is completely closed in at inspection, builder verification may be needed for this item since the insulation will not be exposed.
- Spray foam insulation installed to desired thickness functions as both insulation and an air barrier.

4. SHAFTS

Scope of Work:

Openings to unconditioned space are fully sealed with solid blocking or flashing and any remaining gaps are sealed with caulk or foam.

4.1 DUCT SHAFT

Since it is very common to install HVAC ductwork and air handlers in attics, it is also common to find large shafts to accommodate ductwork to the conditioned space. Although it can be difficult due to its large size and odd shapes, these shafts need to be fully blocked and sealed for an effective air barrier. Figure 4.1.1 shows large gaps to the attic without blocking. Figure 4.1.2 shows a poor solution for providing an air barrier with insulation. Most insulation will not work as an air barrier because while it effectively resists thermal flow, it does not resist air flow. Figure 4.1.3 shows how to properly seal a duct shaft with a complete air barrier using solid blocking and good air sealing techniques (mastic).



Courtesy of Building Science Corp.

Figure 4.1.1 – Duct penetration to attic that needs blocking



Image courtesy of EnergyLogic

Figure 4.1.2 – Duct shaft with ineffective air barrier (insulation)



Figure 4.1.3 – Effective air barrier and sealing at duct shafts

4.1 DUCT SHAFT

Figure 4.1.4 shows a duct shaft with blocking and sealing that effectively accommodates a flue, piping and electrical wiring in the same shaft.



Image courtesy of Energy Services Group

Figure 4.1.4 - Blocking and foam air sealing in chase

KEY POINTS

Installation Criteria:

- Openings to unconditioned spaces shall be sealed with solid blocking as required and any remaining gaps shall be sealed with caulk or foam.

Tips and Best Practices:

- Since the flashing or framed caps at shafts and penetrations are typically installed by the framing subcontractors before the HVAC trades do their work, make sure subcontractors understand the importance of complete air barrier assemblies.
- Use mastic to seal cracks and gaps.

4.2 PIPING SHAFT/PENETRATIONS

Penetrations in framing can be made by plumbers, electricians, or HVAC contractors who are not always careful cutting holes between conditioned and unconditioned spaces. Unfortunately, these holes can allow excessive air leakage. Sealing duct and plumbing penetrations involves fully sealing the holes leading to unconditioned spaces with caulk or foam and providing flashing where needed for very large air spaces (see Figure 4.2.1).



Figure 4.2.1 – Typical piping penetrations leaving large holes

In Figure 4.2.2 below, only caulking is needed because the plumber has neatly cut the hole around the plastic pipe penetration.



Image courtesy of Building Science Corp.

Figure 4.2.2 - Caulking around piping penetration

KEY POINTS

Installation Criteria:

- Openings to unconditioned spaces shall be sealed with solid blocking as required and any remaining gaps shall be sealed with caulk or foam.

Tips and Best Practices:

- Work with plumbing and electrical subcontractors to make the smallest openings needed for penetrations.
- Since the flashing or framed caps at shafts and penetrations are typically installed by framers before the plumbing and electrical trades do their work, make sure subcontractors understand the importance of complete air barrier assemblies.

4.3 FLUE SHAFT

Flue penetrations into attics are more complicated because they also need code mandated combustion safety clearances with combustible framing materials. In Figure 4.3.1 below, insulation is used to fill the space between the flue and the studs. However, this is a poor detail because batt insulation is not an effective air barrier and does not meet combustion safety clearances.

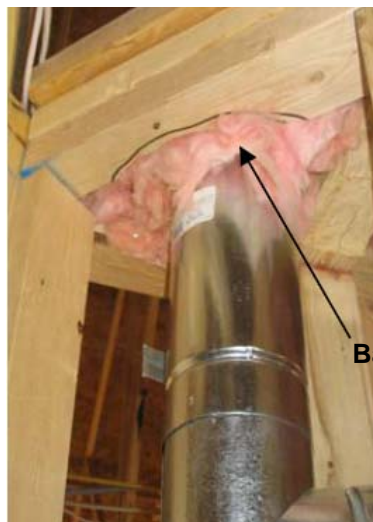

Image courtesy of EnergyLogic

Figure 4.3.1 - Insulation improperly used as an air barrier

Figure 4.3.2 shows how a flue can be properly sealed in a large opening. In this case, an OSB panel was cut to fill the air space around the flue. The flue was then fitted with a metal collar to fill the gap needed for combustion safety clearance between the OSB panel and flue.



Image courtesy of Building Science Corp.

Figure 4.3.2 - UL-rated metal collar installed around a flue shaft

4.3 FLUE SHAFT

Where acceptable to local building code officials, fire-rated foam or caulk can be used to seal any remaining gap between the flue and the air barrier. For example, in Figure 4.3.3, fire-rated caulk that is typically red in color has been used to seal the remaining gap between the flue and metal flashing.



Image courtesy of EnergyLogic

Figure 4.3.3 - Fire-rated caulk around a flue shaft

Note: Caution should always be used when installing insulation against potentially hot surfaces, for both combustible and non-combustible insulation may present a fire hazard if caused to overheat. Refer to local building codes for more information.

KEY POINTS

Installation Criteria:

- Flue openings shall be fully sealed with flashing as required and any remaining gaps sealed with fire-rated caulk or sealant.
- Combustion clearance between flue openings and combustible materials (e.g., OSB) shall be properly closed with UL-approved metal collars.

Tips and Best Practices:

- Plumbing, electrical, and HVAC trades should be informed to prevent degradation of the flue shaft air barrier assembly typically installed by the framing subcontractor.
- Special colored fire-rated foam used for sealing difficult air gaps at flue openings should be checked for acceptability with local building code officials prior to construction.

5. ATTIC/CEILING INTERFACE

Scope of Work:

- All attic penetrations and dropped ceilings include a full interior air barrier aligned with insulation with any gaps fully sealed with caulk, foam or tape
- Movable insulation fits snugly in opening and air barrier is fully gasketed

5.1 ATTIC ACCESS PANEL

Attic access panels without insulation and gaskets are essentially large holes in the house envelope, allowing thermal flow and air leakage between the conditioned home and the unconditioned attic space.

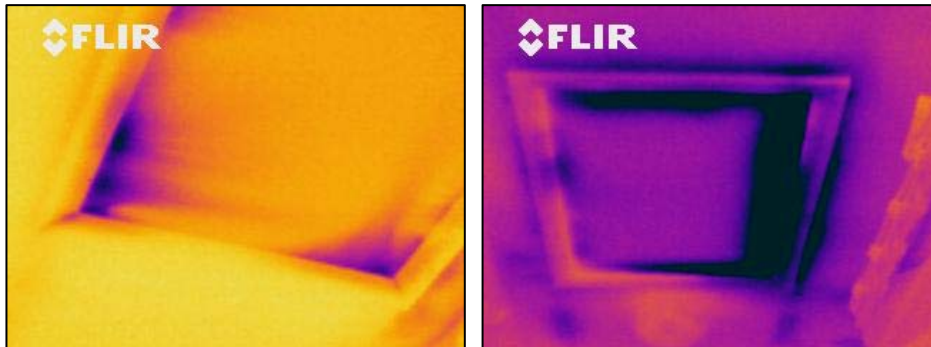

Images courtesy of Energy Services Group

Figure 5.1.1 - Infrared images of thermal bypass at attic access panels

Dark colors in the infrared images in Figure 5.1.1 reveal cold surface temperatures during winter caused by thermal bypass at access panels. The image at the left shows an insulated attic hatch with a missing or defective gasket that allows air to leak through the edges of the access panel. The attic hatch in the right image is insulated, but the dark area inside the frame indicates that the insulation does not fully cover the access panel. The resulting void allows thermal flow to the attic.

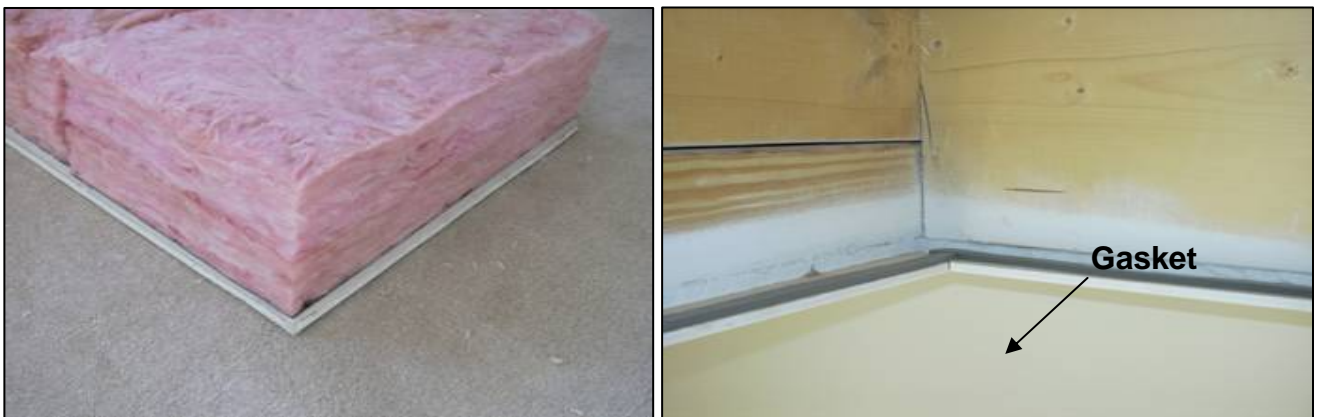

Images courtesy of Energy Services Group

Figure 5.1.2 - Example of properly insulated and sealed attic hatch

There are several relatively simple solutions for stopping thermal bypass at attic hatches. In Figure 5.1.2 above, the left image depicts an attic hatch insulated with a fiberglass batt without any gaps, voids or compression that extends all the way to the edge of the hatch. The right image shows the frame around the hatch has been fitted with a gasket for effective air sealing.

5.1 ATTIC ACCESS PANEL

KEY POINTS

Installation Criteria:

- Attic access panel shall be fully gasketed for a snug fit.
- Attic access panel shall be fitted with insulation (minimum of R-5) that fits snugly in the framed opening.

Tips and Best Practices:

- To increase durability, consider using a pre-insulated door panel or SIP panel for the attic access panel.

5.2 ATTIC DROP-DOWN STAIR

Similar to attic hatches, attic drop-down stairs represent very large thermal holes to the attic when not fully insulated and sealed. Figure 5.2.1 shows a drop-down stair installed with no insulation or gasket. The temperature of the stair is approximately ten degrees cooler than the rest of the room.

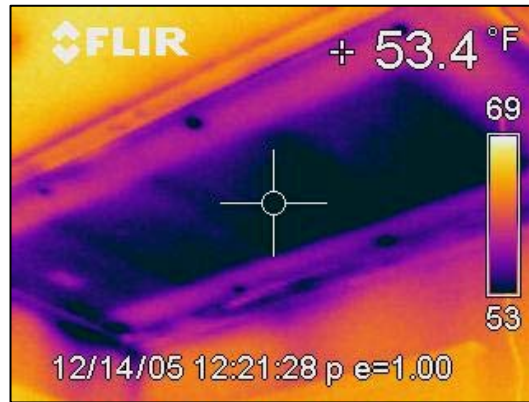

Images courtesy of Energy Services Group

Figure 5.2.1 - Infrared images of thermal bypass at attic drop-down stair

When insulating attic drop-down stairs, the insulation should not be installed between the steps as shown in Figure 5.2.2 because it blocks the stairs themselves and is typically compressed in place, undermining its effective R-value. It also creates liability for the builder because the insulation blocks the drop-down stair manufacturer's homeowner instructions and may create opportunities for people to slip while using the stairs.



Figure 5.2.2 - Improperly installed insulation is compressed and impedes the use of the drop-down attic access stair.

5.2 ATTIC DROP-DOWN STAIR

One way to properly insulate attic drop-down stairs is to construct a simple cover box and cover it with insulation (Figure 5.2.3). Insulated boxes made specifically for this purpose are available from several manufacturers (Figure 5.2.4).

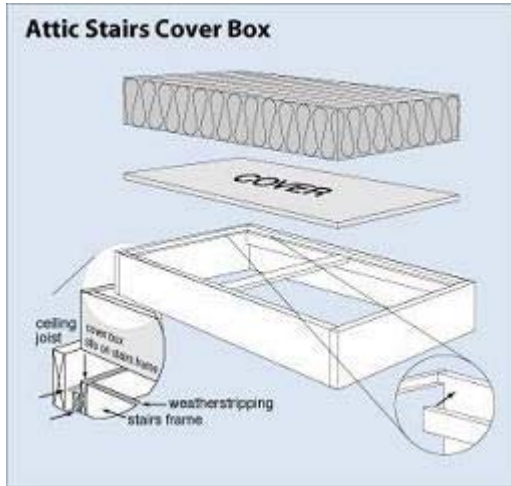

Diagram courtesy of the US Department of Energy



Figure 5.2.3 - Option for insulation of drop-down stair



Figure 5.2.4 – Insulated box made specifically for attic drop-down stair

5.2 ATTIC DROP-DOWN STAIR

KEY POINTS

Installation Criteria:

- Attic drop-down stair shall be fully gasketed for a snug fit. However, gaps in weather-stripping to accommodate hinge hardware shall be acceptable.
- Attic drop-down stair shall be fitted with minimum R-5 insulation that fits snugly in the framed opening or firmly covers the opening.

Tips and Best Practices:

- Factory made attic drop-down stair assemblies that are fully gasketed and include a rigid insulation panel much like an exterior insulated door are a great simple solution (see Figure 5.2.5 below).

Insulated Cover door:

White MFD panel, 1/8" (3mm)

Foam core polystyrene insulation
1-1/2" thick cover door : 1-1/4" (30 mm),
1" thick cover door: 3/4" (20 mm)

Solid wood edge, 3-1/2" (80 mm)

White MFD panel, 1/8" (3mm)

Factory-installed R-6 3/4"
thick, rigid, aluminum foil
faced polyisocyanate
panel.



Figure 5.2.3 – Pre-insulated/sealed attic drop-down stair assembly

5.3 DROPPED CEILING/SOFFIT

Another common thermal bypass problem in homes occurs at dropped ceilings and soffits. Framing crews build them early in the construction process often without plans for a complete air barrier assembly. During winter, driving forces cause heat to flow from the conditioned space to the dropped ceiling and then by convective flow through the insulation above where it can potentially reach cold surfaces in the attic. During the summer, driving forces result in hot attic air moving through the insulation to the dropped ceiling. In addition, thermal bypass will increase where insulation sags or has gaps because there is no air barrier to support it (see Figure 5.3.1). The results will be higher energy bills and less comfort.



Image courtesy of Maryland Energy Administration

Figure 5.3.1 - Improperly installed insulation over a dropped ceiling



Figure 5.3.2 – Infrared image of dropped ceiling without an air barrier and proper insulation

Figure 5.3.2 above shows an example of what thermal bypass at dropped ceilings in the winter looks like through an infrared camera with extensive cold surfaces showing evidence that the conditioned space is substantially connected to the unconditioned attic above.

5.3 DROPPED CEILING/SOFFIT

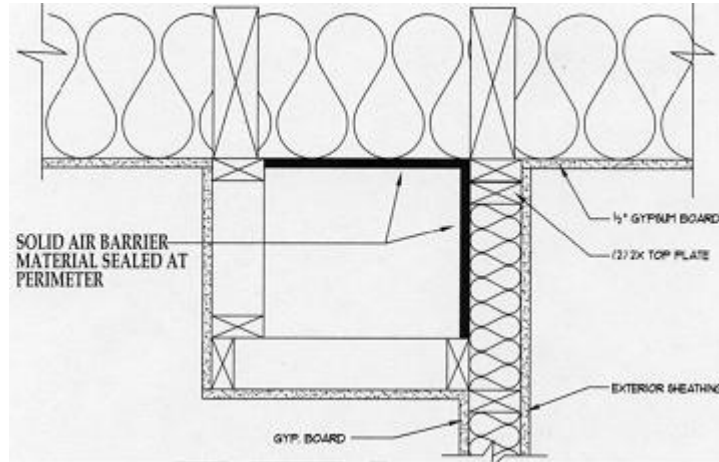

Diagram courtesy of MaGrann Associates

Figure 5.3.3 – Architectural detail illustrates proper air barrier assembly at dropped ceiling

A simple option for a complete air barrier at dropped ceilings and soffits, shown in Figure 5.3.3, is to cap the soffit with an air barrier, making the proper installation of insulation much easier for the insulation subcontractor. Note, as also shown in Figure 5.3.3, with the exception of Climate Zones 1 thru 3, an air barrier must also be included and aligned with insulation located where dropped ceilings or soffits adjoin exterior walls.



Images courtesy of Energy Services Group

Figure 5.3.4 - Air sealed soffits

The dropped ceilings shown in Figure 5.3.4 are excellent examples of a complete air barrier assembly fully sealed with foam.

KEY POINTS

Installation Criteria:

- A complete sealed air barrier shall be provided at all attic framing above soffits and dropped ceilings fully aligned with the attic insulation.
- Where drop ceilings or soffits occur at exterior walls, air barriers shall be included at the wall as well as at the attic floor with the exception for Climate Zones 1 thru 3 discussed earlier.

TIPS AND BEST PRACTICES

- Check with local building code officials prior to construction that air barrier sheathing material meets fire code requirements.
- Where acceptable to code officials, rigid foam insulation sheathing provides both an air barrier and a complete thermal break with the attic.

5.4 RECESSED LIGHTING FIXTURES

Recessed lighting penetrating into unconditioned attics can cause super excessive thermal bypass since lights get very hot and create a natural draft pulling large amounts of air through them. The results are high utility bills along with potential comfort, and moisture problems. Non-rated standard recessed lighting fixtures cannot be insulated above and around the fixture resulting in a large thermal hole to the attic almost two square in size (see Figure 5.4.1). Some recessed light fixtures are rated IC for “insulation contact,” meaning insulation can be placed over the top of the fixture. However, since insulation stops thermal flow but not air flow, the insulation above the IC fixture is rendered ineffective as evidenced by the infrared image in figure 5.4.2.

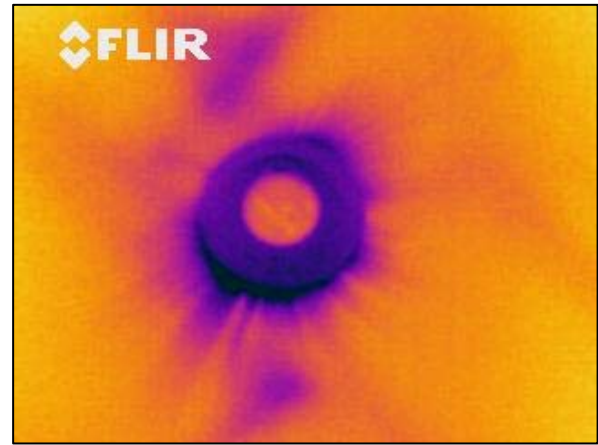
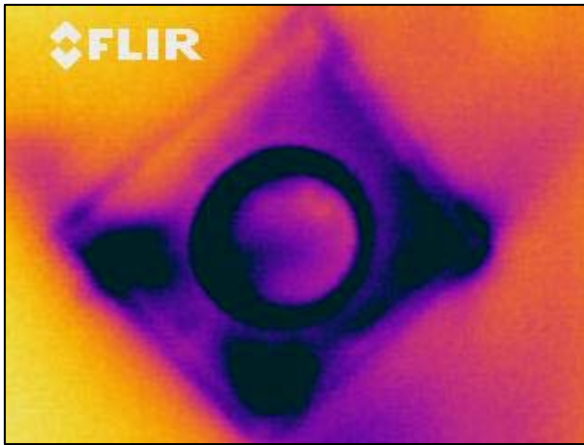

Images courtesy of Energy Services Group

Figure 5.4.1 - Infrared image of thermal bypass at non-rated recessed lighting fixture

Figure 5.4.2 - Infrared image of thermal bypass at IC recessed lighting fixture

5.4 RECESSED LIGHTING FIXTURES

A solution for energy efficient recessed lighting is to design them to not penetrate the attic/ceiling interface. This can be accomplished by locating recessed light fixtures in a dropped ceiling with an air barrier to the attic above (Figure 5.4.3). However, where recessed lighting fixtures below an unconditioned attic cannot be avoided, then “insulation contact, air-tight” (ICAT) rated fixtures must be used that are sealed tightly to the ceiling and covered with insulation. Note that some of ICAT fixtures have sealed gaskets built-in (Figure 5.4.4), while others have to be carefully installed with a separate gasket.

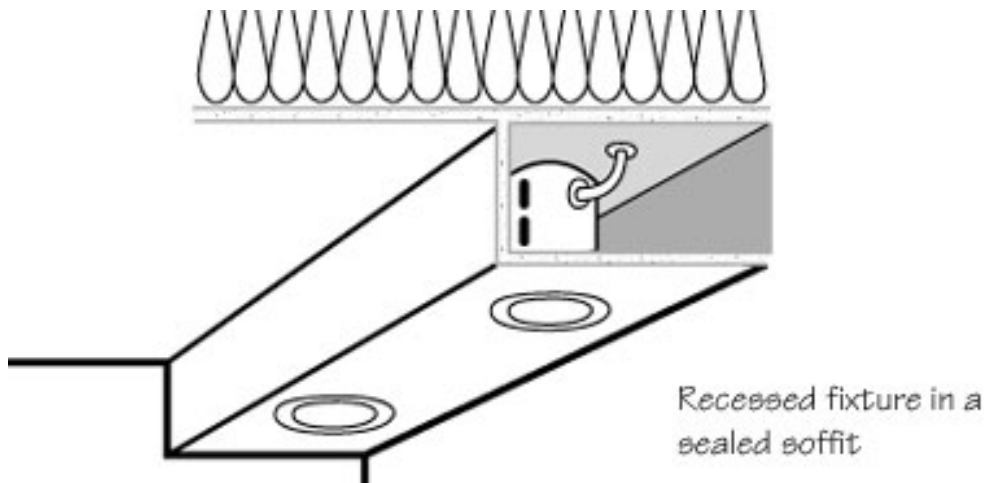

Figure 5.4.3 - Recessed light fixture in a sealed soffit

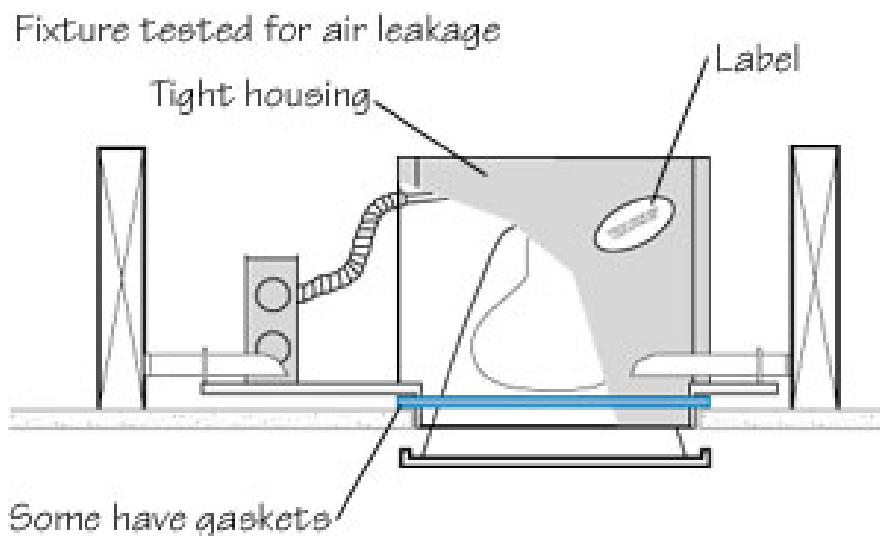

Figure 5.4.4 - ICAT-rated fixture installed with gasket

KEY POINTS

Installation Criteria:

- All recessed lighting fixtures to unconditioned attics shall be “insulation contact, airtight rated” (ICAT), and shall be sealed to drywall with gasket, caulk, or foam.

Tips and Best Practices:

- Consider using non-recessed lighting fixtures at all attic/ceiling interface locations where appropriate to design preferences.
- Install recessed lighting fixtures in dropped ceilings with a complete air barrier assembly above.
- Use ICAT fixtures that do not have air gaps in the housing assembly and with built-in gaskets .
- Where ICAT fixtures are selected that come with air gaps in the housing assembly, manually seal the gaps on the job site. However, manufacturer recommendations must be followed since lighting fixtures get very hot.
- Recognize that ICAT recessed lighting fixtures are only needed at ceilings adjoining unconditioned space.
- If gaskets are not built-in, develop a system for storing trim seal gaskets provided by the manufacturer after initial installation of the recessed cans so they are available at the end of the job.

5.5 WHOLE-HOUSE FAN

While whole-house fans are not frequently found in new construction in many parts of the country, they can provide quick night-time cooling in hot-dry climates with cool evenings. However, they represent an almost 10 square foot thermal hole to the attic because the large opening is not insulated and their metal louvers effectively transfer and leak heat between the home and unconditioned attic. This problem can be fixed with a simple insulated cover that can be constructed and gasketed to the fan to prevent the flow of heat from the attic into the conditioned space (Figure 5.5.1). However, this cover must lift automatically when the fan is switched on, or be able to be lifted without the homeowner climbing into the attic. Insulated covers that do require climbing into the attic are not allowed because they are highly unlikely to be used. As a best practice, use whole-house fans with built-in insulated covers that operate automatically and are fully sealed (Figure 5.5.2).

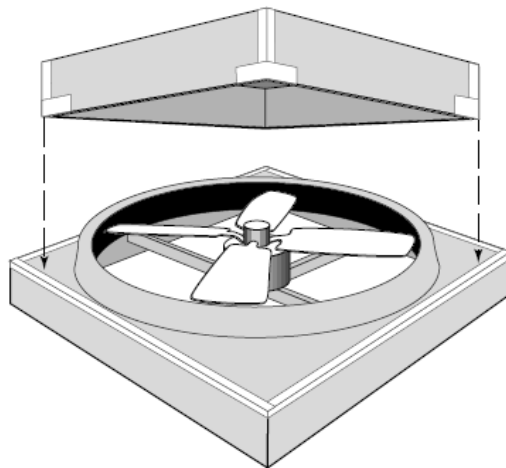

Figure 5.5.1 - Whole-house fan cover

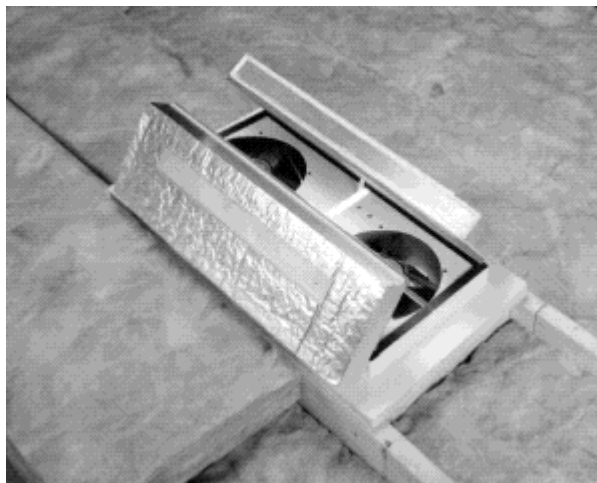

Figure 5.5.2 - Whole-house fan with built-in cover

KEY POINTS

Installation Criteria:

- Whole-house fan shall include a minimum R-5 insulated cover that is fully gasketed to the framing assembly and opens automatically or with a simple mechanism that does not require the homeowner to climb into the attic.

Tips and Best Practices:

- Select a whole-house fan with a built-in insulated cover fully gasketed to the assembly that operates automatically when the fan is turned on.
- Make sure any modifications for an insulated cover to a whole-house fan do not conflict with manufacturer requirements.
- Make sure the homeowner understands how this product works and operates with an insulated cover.

6. COMMON WALLS BETWEEN DWELLING UNITS

Scope of Work:

Gap between drywall shaft wall (common wall) and structural framing between units is sealed at all exterior boundaries.

6.1 COMMON WALLS BETWEEN DWELLING UNITS

The large air spaces at common walls between units in attached housing can be significant sources of thermal bypass. For example, the infrared image in Figure 6.1.1 shows the gap between the fire-rated assembly and the framed wall for each unit has not been sealed, resulting in excessive heat loss.

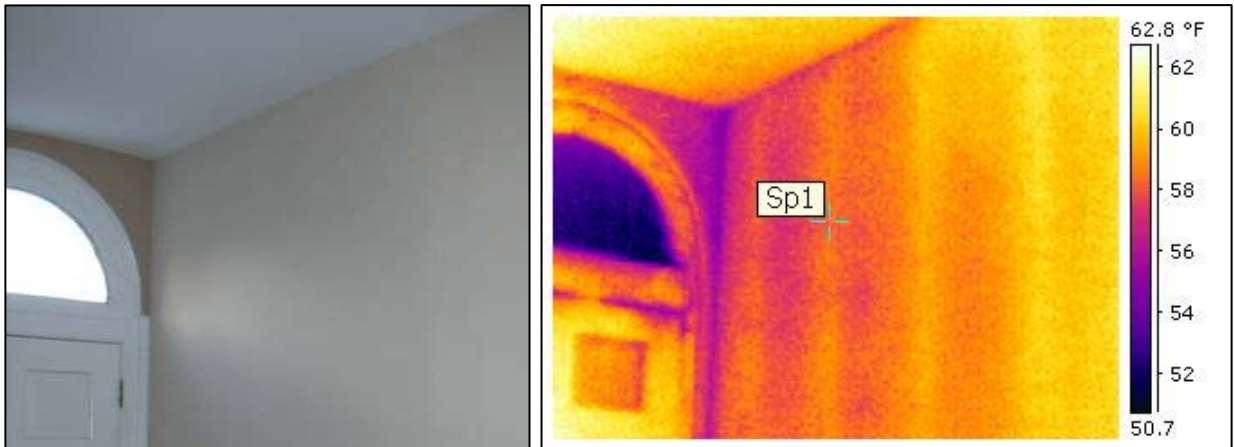

Images courtesy of Energy Services Group

Figure 6.1.1 - Infrared image of thermal bypass at a common wall



Images courtesy of Energy Services Group

Figure 6.1.2 - Poorly sealed common wall

In Figure 6.1.2, the image on the left shows an exterior view of a fire-rated assembly between two framed common walls. While this corner will be covered by “J” channel for siding, the corner will still leak since this is not an air-tight assembly. The large size of this leakage area can clearly be seen from the inside (at right), as daylight streams into the home.

6.1 COMMON WALLS BETWEEN DWELLING UNITS

A solution to thermal bypass at common walls is to air seal the gaps between the drywall and framed common walls using expanding foam (if allowed by code) or fire rated blocking or caulk (Figures 6.1.3 and 6.1.4).

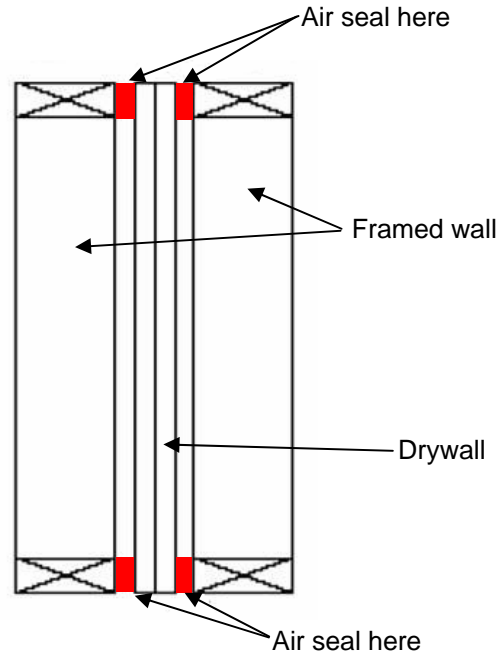

Diagram courtesy of EnergyLogic

Figure 6.1.3 – Architectural detail of air sealing at common wall



Image courtesy of MaGrann Associates

Figure 6.1.4 - Example of properly air sealed common wall with fire-rated caulking (in red)

KEY POINTS

Installation Criteria:

- Air gap between fire-rated assembly and framed walls (i.e, common wall) in duplex, townhouse, and apartment construction shall be fully sealed at all exterior boundary conditions.

Tips and Best Practices:

- Acceptable materials for air-sealing common walls can vary significantly around the country. Confirm that the preferred material is acceptable to the local code official prior to construction.
- Fireproof spray foam with a special color is a sealing material likely to be acceptable to code officials for common walls, and is highly effective for air sealing.



ENERGY STAR Qualified Homes Thermal Bypass Inspection Checklist

The Thermal Bypass Inspection Checklist must be completed for homes to earn the ENERGY STAR label. The Checklist requires visual inspection of framing areas where air barriers are commonly missed and inspection of insulation to ensure proper alignment with air barriers, thus serving as an extra check that the air and thermal barriers are continuous and complete. State, local, and regional codes, as well as regional ENERGY STAR program requirements, supersede the items specified in this Checklist.

Guidance on Completing the Thermal Bypass Inspection Checklist:

1. Accredited HERS Providers and certified home energy raters shall use their experience and discretion in verifying that each Inspection Checklist item is installed per the inspection guidelines (e.g., identifying minor defects that the Provider or rater deems acceptable versus identifying major defects that undermine the intent of the Checklist item).
2. Alternative methods of meeting the Checklist requirements may be used in completing the Checklist, if the Provider deems them to be equivalent, or more stringent, than the Inspection Checklist guidelines.
3. In the event an item on the Checklist cannot be verified by the rater, the home cannot be qualified as ENERGY STAR, unless the builder assumes responsibility for verifying that the item has met the requirements of the Checklist. This option is available at the discretion of the Provider or rater but may not be used to verify more than six (6) items on the Inspection Checklist. This responsibility will be formally acknowledged by the builder signing-off on the Checklist for the item(s) that they verified. The column titled "N/A" should be used when the checklist item is not present in the home or when local code requirements take precedent.
4. The Checklist may be completed for a batch of homes using a RESNET-approved sampling protocol when qualifying homes as ENERGY STAR. For example, if the approved sampling protocol requires rating one in seven homes, then the Checklist will be completed for the one home which was rated.
5. In the event that a Provider or rater finds an item that is inconsistent with the Checklist Inspection guidelines, the home cannot be qualified as ENERGY STAR until the item is corrected in a manner that meets the ENERGY STAR requirements. If correction of the item is not possible, the home cannot earn the ENERGY STAR label.
6. The Provider or rater is required to keep a hard copy record of the completed and signed Checklist. The signature of a builder employee is also required if the builder verified compliance with any item on the Checklist.
7. For purposes of this Checklist, an air barrier is defined as any solid material that blocks air flow between a conditioned space and an unconditioned space, including necessary sealing to block excessive air flow at edges and seams. Additional information on proper air sealing of thermal bypasses can be found on the Building America Web site (www.eere.energy.gov/buildings/building_america) and in the EEBA Builder's Guides (www.eeba.org). These references include guidance on identifying and sealing air barriers, as well as details on many of the items included in the Checklist.



ENERGY STAR Qualified Homes

Thermal Bypass Inspection Checklist

Home Address: _____		City: _____		State: _____	
Thermal Bypass	Inspection Guidelines	Corrections Needed	Builder Verified	Rater Verified	N/A
1. Overall Air Barrier and Thermal Barrier Alignment	Requirements: Insulation shall be installed in full contact with sealed interior and exterior air barrier except for alternate to interior air barrier under item no. 2 (Walls Adjoining Exterior Walls or Unconditioned Spaces)				
	All Climate Zones:				
	1.1 Overall Alignment Throughout Home	<input type="checkbox"/>	<input type="checkbox"/>	<input type="checkbox"/>	<input type="checkbox"/>
	1.2 Garage Band Joist Air Barrier (at bays adjoining conditioned space)	<input type="checkbox"/>	<input type="checkbox"/>	<input type="checkbox"/>	<input type="checkbox"/>
	1.3 Attic Eave Baffles Where Vents/Leakage Exist	<input type="checkbox"/>	<input type="checkbox"/>	<input type="checkbox"/>	<input type="checkbox"/>
	Only at Climate Zones 4 and Higher:				
	1.4 Slab-edge Insulation (A maximum of 25% of the slab edge may be uninsulated in Climate Zones 4 and 5.)	<input type="checkbox"/>	<input type="checkbox"/>	<input type="checkbox"/>	<input type="checkbox"/>
Best Practices Encouraged, Not Req'd.:					
	1.5 Air Barrier At All Band Joists (Climate Zones 4 and higher)	<input type="checkbox"/>	<input type="checkbox"/>	<input type="checkbox"/>	<input type="checkbox"/>
	1.6 Minimize Thermal Bridging (e.g., OVE framing, SIPs, ICFs)	<input type="checkbox"/>	<input type="checkbox"/>	<input type="checkbox"/>	<input type="checkbox"/>
2. Walls Adjoining Exterior Walls or Unconditioned Spaces	Requirements: • Fully insulated wall aligned with air barrier at both interior and exterior, OR • Alternate for Climate Zones 1 thru 3, sealed exterior air barrier aligned with RESNET Grade 1 Insulation fully supported • Continuous top and bottom plates or sealed blocking				
	2.1 Wall Behind Shower/Tub	<input type="checkbox"/>	<input type="checkbox"/>	<input type="checkbox"/>	<input type="checkbox"/>
	2.2 Wall Behind Fireplace	<input type="checkbox"/>	<input type="checkbox"/>	<input type="checkbox"/>	<input type="checkbox"/>
	2.3 Insulated Attic Slopes/Walls	<input type="checkbox"/>	<input type="checkbox"/>	<input type="checkbox"/>	<input type="checkbox"/>
	2.4 Attic Knee Walls	<input type="checkbox"/>	<input type="checkbox"/>	<input type="checkbox"/>	<input type="checkbox"/>
	2.5 Skylight Shaft Walls	<input type="checkbox"/>	<input type="checkbox"/>	<input type="checkbox"/>	<input type="checkbox"/>
	2.6 Wall Adjoining Porch Roof	<input type="checkbox"/>	<input type="checkbox"/>	<input type="checkbox"/>	<input type="checkbox"/>
	2.7 Staircase Walls	<input type="checkbox"/>	<input type="checkbox"/>	<input type="checkbox"/>	<input type="checkbox"/>
2.8 Double Walls	<input type="checkbox"/>	<input type="checkbox"/>	<input type="checkbox"/>	<input type="checkbox"/>	
3. Floors between Conditioned and Exterior Spaces	Requirements: • Air barrier is installed at any exposed fibrous insulation edges • Insulation is installed to maintain permanent contact with sub-floor above including necessary supports (e.g., staves for blankets, netting for blown-in) • Blanket insulation is verified to have no gaps, voids or compression. • Blown-in insulation is verified to have proper density with firm packing				
	3.1 Insulated Floor Above Garage	<input type="checkbox"/>	<input type="checkbox"/>	<input type="checkbox"/>	<input type="checkbox"/>
	3.2 Cantilevered Floor	<input type="checkbox"/>	<input type="checkbox"/>	<input type="checkbox"/>	<input type="checkbox"/>
4. Shafts	Requirements: Openings to unconditioned space are fully sealed with solid blocking or flashing and any remaining gaps are sealed with caulk or foam (provide fire-rated collars and caulking where required)				
	4.1 Duct Shaft	<input type="checkbox"/>	<input type="checkbox"/>	<input type="checkbox"/>	<input type="checkbox"/>
	4.2 Piping Shaft/Penetrations	<input type="checkbox"/>	<input type="checkbox"/>	<input type="checkbox"/>	<input type="checkbox"/>
	4.3 Flue Shaft	<input type="checkbox"/>	<input type="checkbox"/>	<input type="checkbox"/>	<input type="checkbox"/>
5. Attic/ Ceiling Interface	Requirements: • All attic penetrations and dropped ceilings include a full interior air barrier aligned with insulation with any gaps fully sealed with caulk, foam or tape • Movable insulation fits snugly in opening and air barrier is fully gasketed				
	5.1 Attic Access Panel (fully gasketed and insulated)	<input type="checkbox"/>	<input type="checkbox"/>	<input type="checkbox"/>	<input type="checkbox"/>
	5.2 Attic Drop-down Stair (fully gasketed and insulated)	<input type="checkbox"/>	<input type="checkbox"/>	<input type="checkbox"/>	<input type="checkbox"/>
	5.3 Dropped Ceiling/Soffit (full air barrier aligned with insulation)	<input type="checkbox"/>	<input type="checkbox"/>	<input type="checkbox"/>	<input type="checkbox"/>
	5.4 Recessed Lighting Fixtures (ICAT labeled and sealed to drywall)	<input type="checkbox"/>	<input type="checkbox"/>	<input type="checkbox"/>	<input type="checkbox"/>
	5.5 Whole-house Fan (insulated cover gasketed to the opening)	<input type="checkbox"/>	<input type="checkbox"/>	<input type="checkbox"/>	<input type="checkbox"/>
6. Common Walls Between Dwelling Units	Requirements: Gap between drywall shaft wall (i.e., common wall) and the structural framing between units is fully sealed at all exterior boundary conditions				
	6.1 Common Wall Between Dwelling Units	<input type="checkbox"/>	<input type="checkbox"/>	<input type="checkbox"/>	<input type="checkbox"/>
Home Energy Rating Provider: _____ Rater Inspection Date: _____ Builder Inspection Date: _____					
Home Energy Rater Company Name: _____ Builder Company Name: _____					
Home Energy Rater Signature: _____ Builder Employee Signature: _____					

KEY TERMS

Air Barrier – Any material that restricts air flow. In wall assemblies, the exterior air barrier is often a combination of sheathing and either building paper, house wrap or board insulation. The interior air barrier is typically gypsum board.

Alignment – Insulation installation condition where the insulation is in full contact with the air barrier (contiguous) and continuous across the entire thermal enclosure.

Batt Insulation – Insulation that is typically manufactured out of fiberglass or rock wool into ‘blankets’ sized for typical framing bays and manually fitted into place. They require extra diligence to ensure no gaps, voids, compression or misalignment where framing bays are not typical framing dimensions or include wiring and piping.

Blown-in Insulation – Insulation typically made from fiberglass or cellulose that is blown into construction assemblies dry or wet that inherently fills the entire framed assembly without any gaps, voids, compression or misalignment.

Cantilever - An overhang where one floor extends beyond and over a wall below thereby exposing the floor to exterior conditions.

Compression – Insulation installation condition where the full thickness is reduced, resulting in increased density and reduced air pockets that drive thermal resistance. This undermines the effective R-value of the insulation.

Convective Air Flow – As used with thermal bypass, this refers to air-flow that occurs in gaps between insulation and the air barrier due to temperature differences in and across the gap resulting in a stack effect or driving forces from more to less heat.

Floating Slab – Non-monolithic slab and foundation. This can occur where rigid slab edge insulation is placed between the foundation wall and slab leaving the slab unsupported.

FSK Radiant Barrier – A foil-coated insulation that prevents against fire spreading and smoke generation while reflecting internal or external heat. FSK insulation is commonly used in high heat areas of a building including behind fireplaces and the attic knee walls. FSK stands for Foil, Scrim, Kraft; the components of this insulation.

Fully Aligned – Condition where air barriers and thermal barrier (insulation) are contiguous (touching) and continuous across the entire building envelope.

Fully Supported – When insulation is evenly and securely held in place so that it does not bow or hang loose. Insulation that is not fully supported is more likely to be misaligned with the air barriers.

Infrared Imaging – Heat sensing camera which helps reveal thermal bypass conditions by exposing hot and cold surface temperatures revealing unintended thermal flow, air flow, and moisture flow. Darker colors indicate cool temperatures, while lighter colors indicate warmer temperatures.

Insulated Concrete Form (ICFs) – Factory-built wall system blocks that are made from extruded polystyrene insulation. Steel reinforcing rods are added and concrete is poured into the voids, creating a very air-tight, well-insulated and sturdy wall as the insulation is inherently aligned with the exterior and interior air barriers.

Insulation Contact (IC) – Rating for recessed lights allowing insulation to be placed directly over the top of the fixture.

Insulation Contact, Air-Tight (ICAT) Lighting Fixture – Rating for recessed lights that can have direct contact with insulation and constructed with air-tight assemblies to reduce thermal losses.

KEY TERMS

Misalignment – Condition where air barrier and thermal barrier (Insulation) are not contiguous (touching) and not continuous across the entire building envelope.

Optimal Value Engineering (OVE) – A strategy for reducing thermal bridging by minimizing wall framing needed for structural support. Common techniques include 2x6 framing with 24" on-center spacing, single top plates where trusses align with wall framing below, properly sized headers, two-stud corners, lattice strips at exterior/interior wall intersections, and the elimination of excessive fire blocking and window framing. This results in much more open framing for insulation to improve energy efficiency and comfort.

Rigid Insulation – Insulation typically made from polystyrene or polyurethane manufactured into 4' x 8' boards of various thicknesses. As an exterior sheathing material, rigid board insulation provides a complete thermal break assembly and can effectively shift the dew point outside of the exterior wall construction assembly.

R-value – A measure of the thermal resistance of a material. Higher R-values indicate better resistance to heat flow through material. The effective R-value of an insulation material will be reduced by gaps, voids, compression or misalignment.

Spray Foams Insulation – Insulation available in both open- and closed-cell configurations that is typically made from polyurethane. It is sprayed into construction assemblies as a liquid that expands to fill the surrounding cavity. Once dry, spray foam functions as both an air barrier and thermal barrier and effectively fill holes and cracks for both a well-insulated and air-tight wall assembly. Closed-cell spray foams are more dense and also function as a vapor barrier.

Structural Insulated Panels (SIPs) – Factory-built insulated wall assemblies that ensure full alignment of insulation with integrated air barriers. Composed of insulated foam board glued to both an internal and external layers of sheathing (typically OSB or plywood). Many SIP panels are manufactured with pre-cut window and door openings.

Thermal Barrier – Term used to describe when flow of heat is restricted or slowed. Accomplished through insulation.

Thermal Bridging – Accelerated thermal flow that occurs when materials that are poor insulators displace insulation.

Thermal Bypass Checklist – Comprehensive list of building details for ENERGY STAR Qualified Homes addressing construction details where air barriers and insulation are commonly missing.

Thermal Bypass – The movement of heat around or through insulation. This typically occurs when gaps exist between the air barrier and insulation or where air barriers are missing.

Vapor Barrier – Any material that restricts the flow of moisture. In hot climates, a vapor barrier would be installed on the exterior surface and in cold climates on the interior surface.

Wind Baffle – An object that serves as an air barrier for the purpose of blocking wind washing at attic eaves.

Wind Washing – When insulating properties of insulation are eliminated due to air-current penetration.