

Characteristics of Wind Turbines Under Normal and Fault Conditions

Preprint

E. Muljadi, C.P. Butterfield, and B. Parsons
National Renewable Energy Laboratory

A. Ellis
Public Service Company of New Mexico

*To be presented at the IEEE Power Engineering Society 2007
General Meeting
Tampa, Florida
June 24-28, 2007*

Conference Paper
NREL/CP-500-41051
February 2007

NREL is operated by Midwest Research Institute • Battelle Contract No. DE-AC36-99-GO10337



NOTICE

The submitted manuscript has been offered by an employee of the Midwest Research Institute (MRI), a contractor of the US Government under Contract No. DE-AC36-99GO10337. Accordingly, the US Government and MRI retain a nonexclusive royalty-free license to publish or reproduce the published form of this contribution, or allow others to do so, for US Government purposes.

This report was prepared as an account of work sponsored by an agency of the United States government. Neither the United States government nor any agency thereof, nor any of their employees, makes any warranty, express or implied, or assumes any legal liability or responsibility for the accuracy, completeness, or usefulness of any information, apparatus, product, or process disclosed, or represents that its use would not infringe privately owned rights. Reference herein to any specific commercial product, process, or service by trade name, trademark, manufacturer, or otherwise does not necessarily constitute or imply its endorsement, recommendation, or favoring by the United States government or any agency thereof. The views and opinions of authors expressed herein do not necessarily state or reflect those of the United States government or any agency thereof.

Available electronically at <http://www.osti.gov/bridge>

Available for a processing fee to U.S. Department of Energy and its contractors, in paper, from:

U.S. Department of Energy
Office of Scientific and Technical Information
P.O. Box 62
Oak Ridge, TN 37831-0062
phone: 865.576.8401
fax: 865.576.5728
email: <mailto:reports@adonis.osti.gov>

Available for sale to the public, in paper, from:

U.S. Department of Commerce
National Technical Information Service
5285 Port Royal Road
Springfield, VA 22161
phone: 800.553.6847
fax: 703.605.6900
email: orders@ntis.fedworld.gov
online ordering: <http://www.ntis.gov/ordering.htm>



CHARACTERISTICS OF VARIABLE SPEED WIND TURBINES UNDER NORMAL AND FAULT CONDITIONS

E. Muljadi C.P. Butterfield B. Parsons
National Renewable Energy Laboratory
1617 Cole Blvd
Golden CO 80401

A. Ellis
Public Service Company of New Mexico
Alvarado Square, MS 0604
Albuquerque NM 87158

Abstract— Variable-speed wind turbines with full power processing capability are the new technology trend for large wind power plants. In this type of turbine, there is an interface between the generator and the utility grid.

In this paper, we investigate the characteristics of a variable-speed wind turbine connected to a stiff grid or a weak grid, the role of reactive power compensation in optimizing the operation of the wind turbines, and the operation of a wind turbine under normal and fault conditions. Both steady state and dynamic analysis are presented.

Index Terms—wind turbine, wind farm, wind power plant, stability, wind energy, power system, variable-speed generation, renewable energy, low-voltage ride-through, weak grid, fault conditions.

I. INTRODUCTION

To successfully deploy wind energy, we need to have the resources and the transmission to carry the electrical energy product to the load centers. Abundant resources can be profitable only if we can generate low-cost wind energy. The transmission line, the strength of the grid, and the proximity of the wind resource to the load center are all important factors in successful wind deployment.

In an interconnected grid, the power system network and the wind power plant are interrelated. Knowing the characteristics of the wind power plant and the transmission and distribution systems is very important for identifying the problems and finding the resources to resolve the issues.

When we discuss transmission lines, we are concerned about, among other things, the stability, power transfer capability, and the losses. The stability and power transfer capability are determined partly by the impedance between the sending and the receiving ends. In the transmission lines, the resistive part of the impedance is generally much smaller than its reactance. In the sections that follow, the resistive part of the impedance is often ignored to simplify the discussion. The reactance between the two points consists of the reactance presented by the lines, the transformer, and the electric machine impedances when the line reactance is the major component of the total impedance. The line reactance is mostly determined by the line length—the geometrical distance between the wires and the ground.

Raising the voltage will significantly increase the transfer capability of the systems and reduce the losses, the voltage drop, and the per unit (p.u.) value of the reactance; however,

higher voltage transmission requires significant investment.

A large wind power plant (> 100 MW) is commonly connected to a transmission line. At the main substation, the voltage is stepped down from the transmission level to the subtransmission level through the main transformer. From the main substation, a collector system collects the power generated by the wind turbines through line feeders. The collector system impedance of many turbines can be represented by its equivalence and as a single impedance. One method to equivalence the collector system of a large wind power plant can be found in reference [1].

In Figure 1, the single-line diagram represents a wind power plant. Each wind turbine has a pad-mounted transformer to step down the voltage from the subtransmission level to the low voltage generated by the wind turbine. In the future, as wind turbines become larger, the voltage at the point of generation may be increased to medium. The transmission line connects the wind power plant to the grid or to a very large network, which can be treated as an infinite bus. The short circuit current at the point of interconnection plays an important role in the behavior of the wind power plant.

The dynamic analysis in this paper is simulated by using Power System Simulator for Engineers [2], a commonly used program in utility planning. References [3] and [4] provide a good background on dynamic analysis for wind turbines.

For a more detailed discussion of the dynamic model used in this section, see reference [5]. Figure 2 shows a single line diagram that describes the nature of the fault and the network topology in pre-fault, fault, and post-fault conditions. The transmission lines consist of two parallel paths. The fault occurs at the middle of line A, and the circuit breakers disconnect line A. The remaining line B continues to deliver the output of the wind power plant. The short circuit current (SCC) of the transmission line was originally at 10 p.u.; in the post-fault condition after line A was removed, the SCC dropped to 5 p.u.

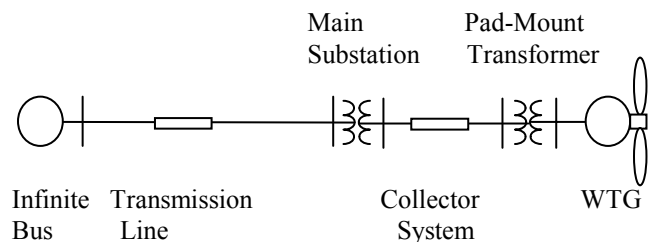

Figure 1. A typical network topology of a wind power plant.

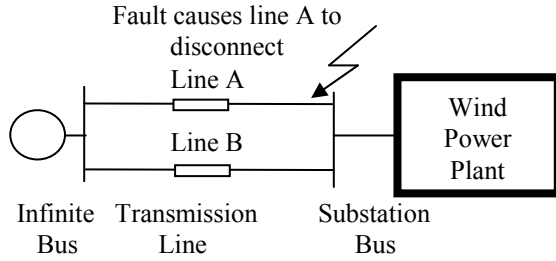

Figure 2. The location a fault on a weak grid.

Because we are interested only in the worst-case scenario, we simulate only the weak grid condition. Let us define a pre-fault condition with line A and line B, which are both on line. The SCC of both lines is 10 p.u. The wind power plant consists of wind turbines with a total capacity of 100 MW. The wind turbine is generating at its full rated capacity and the wind speed is at 125% of the rated wind speed. Because of the wind speed, the blade pitch is already deployed. Initially the wind turbine operates normally, then suddenly, a three-phase fault occurs near the main substation on line A at $t = 1$ s. The fault lasts for nine cycles, and line A is removed at the end of the fault, which creates a weaker system with an SCC of 5.0 p.u. In this simulation, the relay protections are not set up, because we want to see the nature of the wind turbine and the system while exposed to this type of fault.

In Section I, we described the nature of the fault tested in this paper. In Section II we discuss the variable-speed wind turbine generator (VSWTG). Finally, we summarize our conclusions in Section III.

II. VARIABLE-SPEED WIND TURBINE GENERATOR

In this section, we present a generic VSWTG. Although doubly fed induction generators [5-6] are commonly used by the wind industry today, in this paper we use a permanent-magnet, synchronous, variable-speed generator [7] because it represents the future of WTG capability. We assume that the WTG consists of a wind turbine connected to a generator via a gearbox or direct-drive generator. The output of the generator is connected to the utility via a power converter. The power converter provides a buffer between the utility and the generator.

A. Normal Operation

Under normal operation, the VSWTG operates at variable speed. At low to medium wind speeds it operates at optimum pitch angle (e.g., $\beta = 0^\circ$). At high wind speeds, the wind turbine operates at constant speed, and the pitch angle controls the rotor speed to be constant.

The output power of the wind turbine operating in this mode is a cube function of the rotor speed until it reaches rated speed. Once the rated speed is reached, the wind turbine is operated at constant power by controlling the pitch angle. Normally, the pitch angle controller operates very smoothly, controlling the rotor speed so it does not exceed the rated

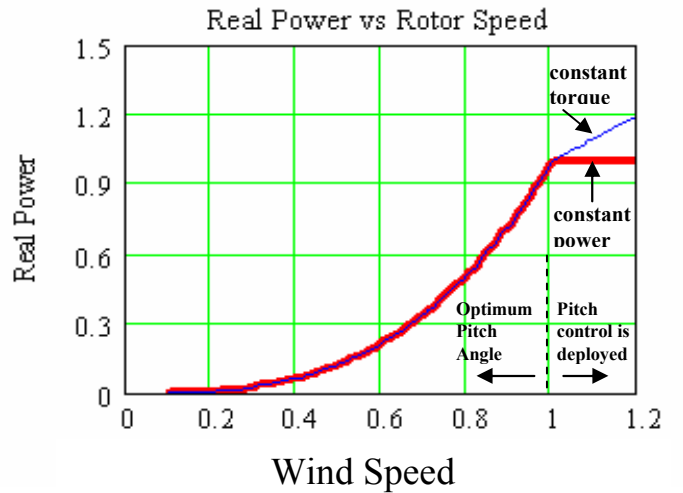

Figure 3. Power curve of a typical VSWTG.

speed. This pitch control mechanism, in effect, sheds aerodynamic power to keep the rotor speed from reaching a runaway condition. The wind turbine brakes will be deployed if the blade pitch control fails.

Figure 3 shows the power curve of the VSWTG. Because the aerodynamic efficiency of a wind turbine is maximized at a specified tip-speed ratio, it is controlled so that it operates at that specific tip-speed ratio. This condition can be achieved when the ratio of rotor speed to wind speed is constant. Two curves are shown in Figure 3. Below rated speed, the curves coincide. Above rated speed, however, the curves deviate. The thick line represents a controller that maintains constant power above rated speed; thus, above the rated speed, the torque is inversely proportional to the rotor speed. The thin line represents a controller that maintains a constant torque above rated speed, so the power increases in proportion with the speed. The constant torque capability above rated speed can better prevent the wind turbine from reaching runaway condition. However, this capability requires a good oversized power converter with an extended speed range. In practice, the pitch controller will keep the rotor speed from over-speed conditions. In most cases, the blade pitch controller of a modern wind turbine accurately limits the rotor speed at or below the rated rotor speed, thus avoiding the need for a larger power converter.

From the power converter perspective, the output of a wind turbine is limited by the generator capability and, more importantly, by the power converter capability. The generator limit is normally the thermal limit (generated mostly by losses in the windings). The power converter limit is more stringent, because power electronics are used as the building blocks of the power converter. The instantaneous value of the maximum current limit and the voltage blocking capability limit should never be violated. Thus, the power converter can be operated within the circle of current limit value. For a VSWTG, the power converter KVA limit is represented by a circle boundary (see Figure 4), which shows that the operating point can be anywhere in all quadrants as long as the tip of the complex power S_o is inside the boundary. Thus, we can generate or

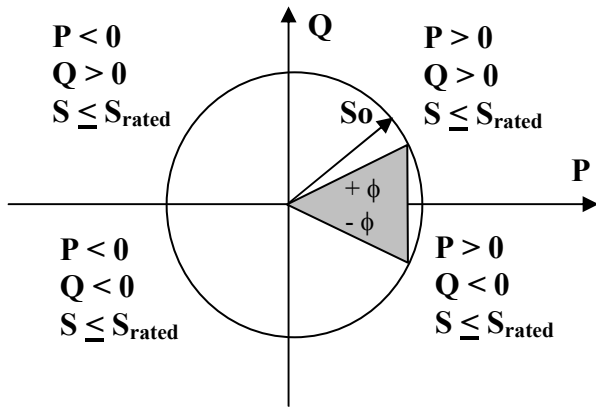
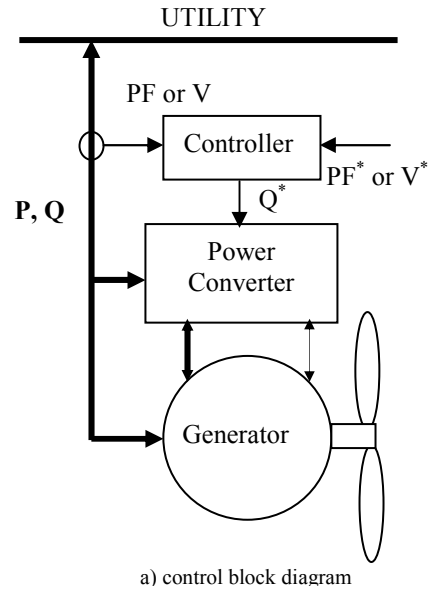

Figure 4. The operating boundary of a VSWTG with power converter.

absorb real or reactive power within the circle. Real and reactive power can be controlled independently. A modern wind turbine can usually generate rated real power with a power factor (PF) range of 0.95 leading or lagging. The shaded triangle in Figure 4 shows the capability of the turbine. Because the terms *leading* and *lagging power factor* can be confusing in a generator or in a motor mode, the term *overexcited* is used to indicate that reactive power is generated by the equipment, and *underexcited* is used to indicate that the reactive power is absorbed by the equipment.

The VSWTG is generally operated in either PF mode or voltage control mode. With a PF controller, the wind turbine is operated at a preset PF (usually unity PF) from low to high wind speeds. The voltage is controlled by other means (capacitor, SVC, Statcom, synchronous condenser, etc.). In voltage control mode, a reference voltage is used to control the reactive power output of the generator to keep the voltage constant. In a large wind farm, two control modes may be used. Some turbines may be set at voltage control mode, while other turbines may have preset power factors.

Figure 5 shows (a) the control diagram, (b) the phasor diagram for constant PF control, and (c) the constant voltage control. The wind turbine is assumed to be connected to an infinite bus V_s . Between the wind turbine and the infinite bus is a reactance X_s . The control block diagram (5a) describes the constant voltage or constant PF control. Only the major loops and components are shown for simplicity. The VSWTG has three major components: the generator, the power converter, and the controller. Both electrical power (represented by the thick wire in Fig. 5a) and the electrical signal (represented by the thin wire in Fig. 5a) are interchanged among the generator, the power converter, and the utility. The input is the wind power feeding the wind turbine blades, and the output is the electrical power entering the utility grid. There are two choices of control objectives: PF or V. The controller has an input signal PF^* or V^* as the commanded power factor or the commanded reference voltage. This value is compared to the actual value PF or V. It uses the error signal to control the power converter, so that the actual PF or V moves closer to the commanded PF^* or V^* . The output of the controller is the reactive power command Q^*



a) control block diagram

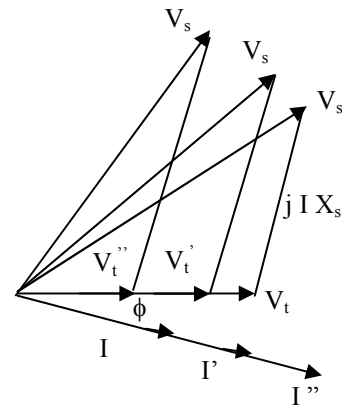

b) constant power factor control

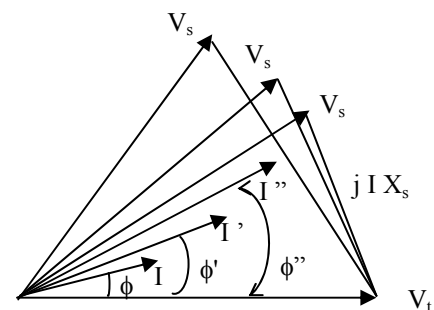

c) constant voltage control

Figure 5. Phasor and control block diagram for a VSWTG

that must be followed by the power converter to achieve the objective function ($PF = PF^*$ or $V = V^*$). The output of the power converter is connected to the generator. Another loop to control the aerodynamic power is not included in this block diagram. Arrows show that the power can flow through the power converter and the generator to include the doubly fed induction generator (DFIG), where the output power can be accessed directly from the stator winding and from the rotor winding via a power converter.

1. Constant power factor

Figure 5b shows that at constant power factor ($\cos \phi = \text{constant}$), the following can be observed:

- Current magnitude and the power angle (δ) between the wind turbine voltage V_t and the infinite bus voltage V_s increases, as the power level increases
- Terminal voltage at the wind turbine changes with the increase of power level
 - Underexcited condition (the generator absorbs reactive power), the terminal voltage decreases as the power level or wind speed increases.
 - Overexcited condition (the generator supplies reactive power), the terminal voltage increases as the power level or wind speed increases.

As an illustration, let us consider a wind turbine connected to an infinite bus through a line feeder. As the worst-case scenario, we want to consider an underexcited condition with $\text{PF} = 0.95$ with no additional reactive power compensation. Let us change the line feeder to reflect different SCCs of the lines. Figure 6 presents a set of curves showing the terminal voltage versus output power of the wind power plant. Each curve has a different SCC. A very stiff grid ($\text{SCC} = 50$) performs best when the voltage varies minimally with the increase of output power. At $\text{SCC} = 10$, the terminal voltage drops to 0.96 p.u. at rated output power.

At $\text{SCC} = 5$, the terminal voltage drops to 0.9 p.u. at rated power, and at $\text{SCC} = 2.5$, the voltage collapses at 86% rated power. Then, short circuit capabilities will be investigated ($\text{SCC} = 10, 5, \text{ and } 2.5$).

Figure 7 shows the terminal voltage for a wind power plant connected to a weak grid. As the output power increases, the voltage drops differently for the three PFs. At unity PF and 0.95 PF (under an excited condition), the voltage drops accordingly. When the wind turbine is overcompensated to 0.95 (overexcited), the terminal voltage rises as the output power increases. At unity PF, the terminal voltage drops by $< 2\%$ at rated output power. In an overexcited condition, the terminal voltage rises by $< 5\%$. The same phenomenon is also

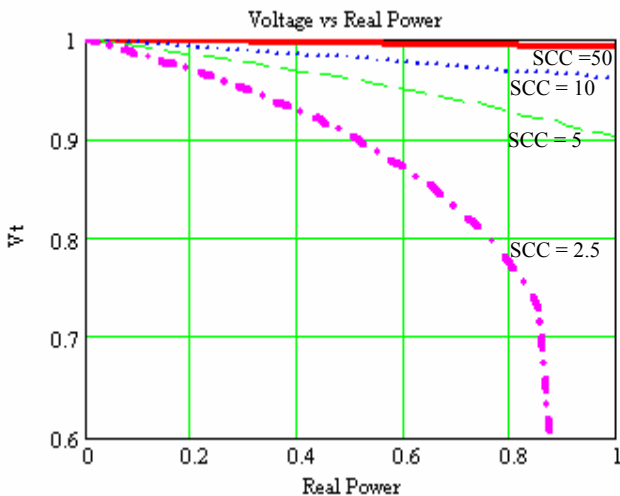

Figure 6. Terminal voltage as a function of real power for a VSWTG operated at $\text{PF} = 0.95$ under-excited

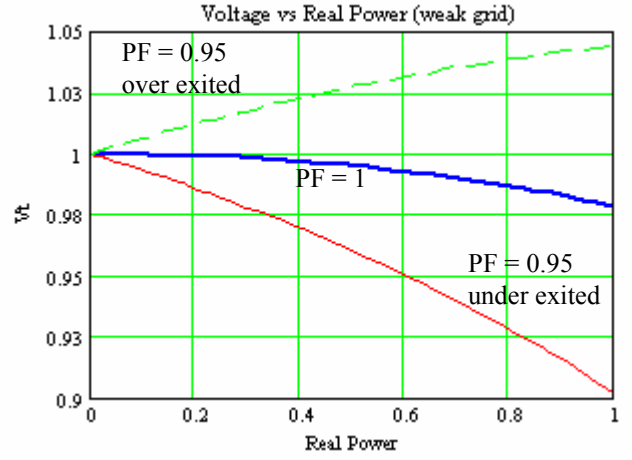

Figure 7. Terminal voltage versus real power for three PFs for a weak grid condition

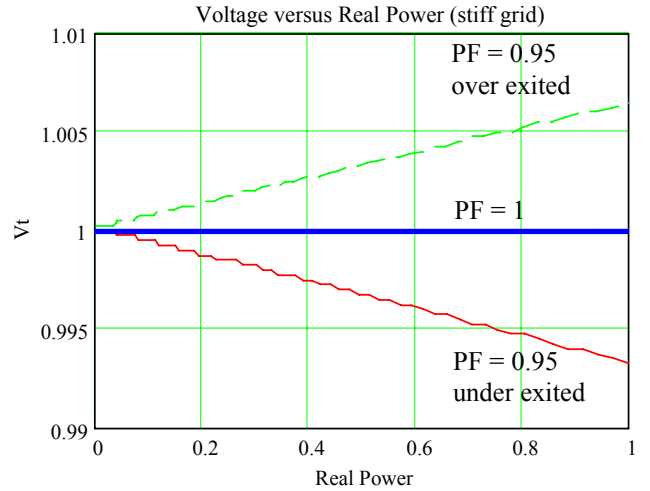

Figure 8. Terminal voltage versus real power for three PFs for a stiff grid condition

applicable to a stiff grid condition. The only difference is that the spread of voltage variation (from underexcited to overexcited) is much narrower ($\Delta V < \pm 1\%$) than in a weak grid.

Figure 8 shows the terminal voltage variation as the wind turbine is connected to a stiff grid. The spread between overexcited and underexcited conditions is much narrower for a very stiff grid.

2. Constant voltage operation

The phasor diagram that describes the constant voltage control of a VSWTG is also shown in Figure 5c. The expanded description of the voltage control concept can be found in Section II (see Figure 1, Case I). The following can be said about constant voltage control:

- Assume that $V_s = V_t = 1.0$ p.u.
- The wind turbine must be operated in an overexcited condition.
- The current magnitude and phase angle between the wind turbine voltage V_t and the infinite bus voltage

V_s increases as the power level increases.

- The phase angle (ϕ) between the voltage V_s and the current I , increases as the power level increases.
- The power angle (δ) between the voltage V_s and the voltage V_t , increases as the power level increases.
- $\phi = \delta/2$.

Let us first consider different levels of grid stiffness to illustrate the concept of constant voltage control. As shown in Figure 9, the wind turbine must generate the reactive power to keep constant voltage at its terminal. The positive value of reactive power shown in Figures 9 and 10 is chosen to represent the reactive power generated by the wind turbine. The reactive power generated to maintain constant voltage varies with the level of grid stiffness. For example, for an $SCC = 2.5$, at rated output power, a wind turbine must generate reactive power as much as 21% of rated power. At $SCC = 5$, the reactive power needed is 10% of its rated value, and at $SCC = 50$, the reactive power needed is only 1% of its rated output. Thus, it is easy to see that the stiffer the grid, the less reactive power needed to keep the voltage constant.

The control strategy can also be illustrated by plotting the PF of the operation. Figure 10 shows the PF at each operating point for constant voltage operation. For the weakest grid ($SCC = 2.5$), the wind turbine must be operated at $PF = 0.98$

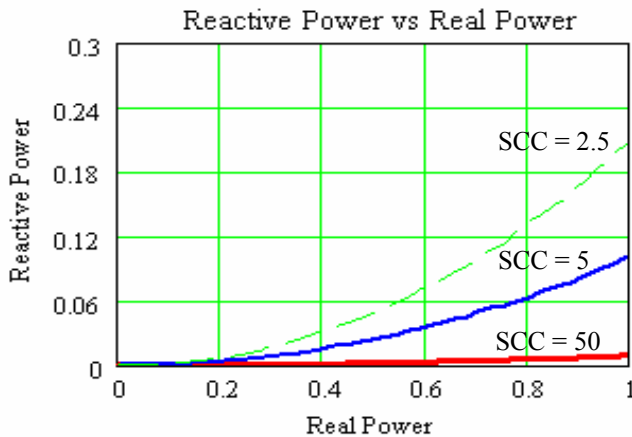

Figure 9. Terminal voltage versus real power for three different levels of grid stiffness

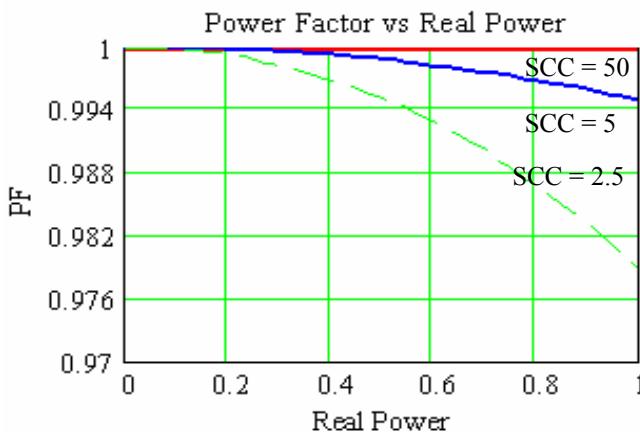

Figure 10. Operating PF to keep the terminal voltage constant for three levels of grid stiffness

(overexcited) to keep the voltage at the terminal constant. For a grid with an $SCC = 5$, the PF at rated power must be kept at 0.99 (overexcited). For a very stiff grid ($SCC = 50$), the wind turbine barely produces reactive power. Thus, we can conclude that the variable-speed wind turbine we studied can easily fulfill this requirement (power factor $= \pm 0.95$, leading and lagging).

B. Operation Under Fault

VSWTGs tend to be more forgiving in operation under a fault condition because they can vary the speed and adjust the excitation (control reactive power via power converter).

The significance of variability in speed is that the rotor of the wind turbine is a type of energy storage (kinetic energy). The kinetic energy stored is proportional to the rotational inertia and the square of rotor speed. Thus, increasing the speed to twice the original value means that the kinetic energy increment is four times higher.

The significance of adjustable excitation is that the terminal voltage can be adjusted at will (within the allowable range). Obviously, the operating point of the WTG and the severity of the fault affect the survivability of the operation. Figure 11 shows the power curve under various fault conditions. This is

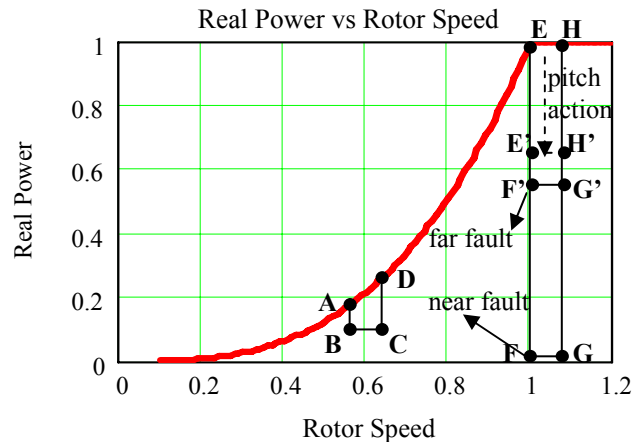

Figure 11. Power curve during fault conditions illustrated in the next two subsections.

1. Most favorable condition

The most favorable condition is a far fault when the wind turbine operates in a low wind speed condition. For a far fault, the terminal voltage is relatively high (non-zero), so it is easily corrected by the power converter. In addition, the WTG can still generate sufficient real power (there is enough generator torque to oppose aerodynamic torque), so a runaway condition is less likely. In a low wind condition, the rotational speed of the turbine is relatively low, so there is enough headroom to store kinetic energy from low rotor speed to rated rotor speed. Let us take a closer look at a far fault. Referring to Figure 11, assume that the fault occurs when the operating point of the WTG is at point A. The voltage at the terminal drops, assuming the VSWTG operates under constant voltage control, and the reactive power increases to increase the voltage to normal. If the power converter manages to control the voltage

generated to, say, 50% of pre-fault value during the fault, the electrical power or the torque will be reduced to 50% of its normal value (line BC). The power converter switches have an absolute current limit that cannot be exceeded without damaging the power semiconductor. The pitch controller is normally not operated below rated speed. The aerodynamic torque remains the same as in a pre-fault condition. The aerodynamic power (line AD) accelerates the wind turbine about 30% in a pre-fault condition. The acceleration is illustrated by the polygon ABCD. As the wind turbine accelerates, the aerodynamic power has to oppose two things: (1) the electrical torque remains during the fault; and (2) the change in kinetic energy $= 0.5 J (\omega_B^2 - \omega_A^2)$. As the speed increases, the fault will probably clear in four to nine cycles. But even if the circuit breaker fails to clear the fault, the time and torque are sufficient to reduce acceleration. Let us assume that the fault condition remains uncorrected until the rotor speed reaches rated speed. At rated speed, the pitch controller starts to control the pitch angle to limit the rotor speed.

2. Least favorable condition

The least favorable condition is a near fault, and it happens during high wind speed conditions. A near fault condition indicates that the remaining voltage at the terminal is very low, so the output power will decrease significantly to accommodate the current limit of the power converter. The generator power (represented by line FG in Figure 10) opposing the aerodynamic power (represented by line EH) will be much lower than in a normal condition. The acceleration is represented by the rectangle EFGH. At high wind speeds, the wind turbine operates at rated speed, and the pitch angle has been deployed to reduce the aerodynamic power. It is adjusted to keep the rotor speed from exceeding rated speed. Thus, the rotor speed does not have enough headroom to increase and to change the energy acquired aerodynamically into kinetic energy. In addition, the blade pitch angle is no longer zero but at a high position close to the upper limit pitch angle. The blade pitch angle also does not have enough headroom to shed aerodynamic power. The worst case is if the pitch controller fails to shed aerodynamic power. The fault is not cleared, and the rotor runaway problem can only be remedied by mechanical brakes (usually two alternative brakes must be provided to avoid this condition).

Let us back up a few steps and say that the fault is not a near fault, but is farther away from the WTG, so the voltage does not drop to zero. The generator power is illustrated by line F'G'. Now let's say that the wind speed just reaches rated wind speed, so the blade pitch is barely deployed. If the pitch controller is fast enough to reduce the aerodynamic power, the aerodynamic power can be reduced quickly, say from line EF to line E'F'. In this condition, the acceleration is illustrated by E'F'G'H', which is much smaller than the area EFGH. Thus, even at high wind speed the possibility of a runaway condition is remote.

C. Dynamic Simulation

To illustrate the dynamics of a VSWTG in a fault condition, let us use a VSWTG with a permanent-magnet generator that uses a power converter to process the electrical power and return it to the utility line. This system is commonly called full-power conversion as opposed to partial power conversion, as in a DFIG.

For this particular run, the generator is set to generate rated output power at unity PF (reactive power is set to zero). Initially, the wind turbine is operated normally when the fault occurs at $t = 1$ s. The simulation is continued up to 10 s. The duration of the fault is nine cycles. The fault occurs in the middle of two parallel high-voltage transmission lines. The fault is cleared by disconnecting one of the two parallel lines. Before the fault, the SCC of the line is 10 ($SCC = 10$); after the fault is cleared the SCC is 5 ($SCC = 5$). The wind speed during the event is set at 125% of rated wind speed, so the pitch angle has been deployed at 13° . The upper limit of the blade pitch angle is 30° and the optimal blade pitch angle is 0° .

Figure 12 shows the terminal voltage of a VSWTG operated under constant PF at $PF = 1$. The terminal voltage has some residual voltage during the fault at about 0.18 p.u.; at the fault site, the voltage drops to zero. Small drops occur on the voltage traces before and after the fault occurs because the operation is at constant PF, so there is no attempt to correct the voltage. The voltage drop is caused by the difference between $SCC = 10$ and $SCC = 5$ (a weaker grid) when one of the parallel lines is disconnected.

Figure 13 shows the real and reactive power output of the VSWTG. The real power drops to a very small value during the fault because the current limit of the power converter has been reached. With a low voltage during the fault, the maximum power that can be generated during the fault is limited by the current limit of the power converter. In the post-fault condition, there is a small reduction in output power because the voltage is reduced (see Figure 12). Because the control is set to provide a unity PF, the reactive power from the generator is set to zero.

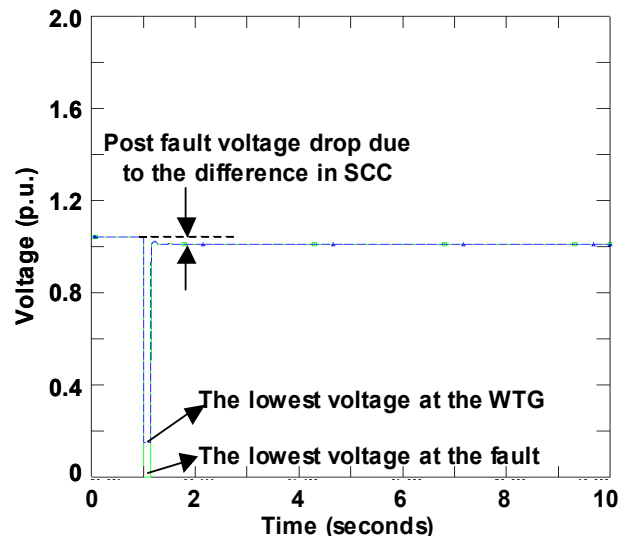

Figure 12. Terminal voltage for a VSWTG at $PF = 1$

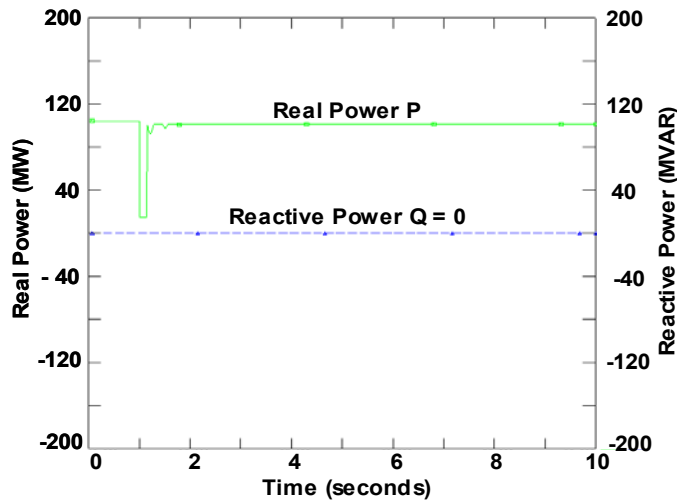

Figure 13. Real power and reactive power for a VSWTG at PF = 1

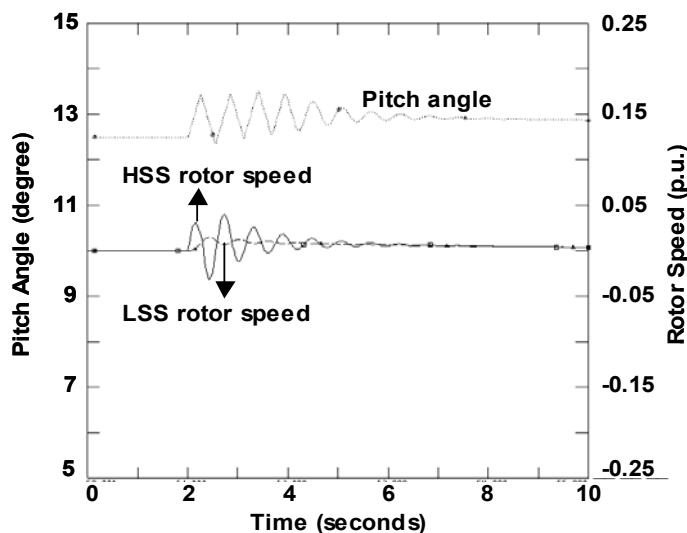

Figure 14. Low-speed shaft, high-speed shaft rotational speed, and pitch angle for a VSWTG at PF = 1

Figure 14 shows the variation of the high-speed and low-speed shaft rotational speeds. The spread of the speed variation is $< \pm 4\%$. The pitch angle varies between 12.5° and 13.5° . For this fault event, the wind turbine stabilized to normal (no runaway condition). In this example, the grid condition is considered weak ($SCC = 5$), and the duration of the nine-cycle fault is considered long (four cycles clearing time is normally used for general studies).

III. CONCLUSIONS

This paper investigates a variable-speed wind turbine. From the steady state analysis, the operation under power factor 0.95 underexcited indicates that the system will be driven to a voltage collapse at $SCC=2.5$. However, by having the capability to adjust the power factor to 0.98 overexcited, the grid condition of $SCC=2.5$ can be operated at rated voltage. This is important considering that the VSWTG we studied is capable of operating at 0.95 (under- or overexcited conditions).

Dynamic simulation performed on this VSWTG indicates that the wind turbine can survive a nine cycle fault event with

$SCC=5$. Note, the interaction between mechanical rotor oscillation and the electrical oscillation is practically non-existent. The rotor oscillation caused by a sudden change in electrical generator output power is properly damped within a short time. The pitch angle controller performs very well under fault condition.

IV. ACKNOWLEDGMENT

We acknowledge the support of the U.S. Department of Energy and Public Service Company of New Mexico.

V. REFERENCES

- [1] Muljadi, E.; Butterfield, C.P.; Ellis, A.; Mechenbier, J.; Hochheimer, J.; Young, R.; Miller, N.; Delmerico, R.; Zavdil, R.; Smith, J.C. *Equivalencing the Collector System of a Large Wind Power Plant*, presented at the IEEE Power Engineering Society Annual Meeting, Montreal, Canada, June 18 – June 22, 2006.
- [2] Shaw Power Technologies, Inc., 2004, August. PSS/E Version 3.0 Program Documentation, General Electric International, Inc. 2004, December. PSLF Version 14.2 User's Manual.
- [3] Sloopweg, H. *Wind Power: Modeling and Impact on Power System Dynamics*, Ph.D. Thesis, Technical University Delft, Delft, the Netherlands, 2003.
- [4] Tande, J.O.G.; Muljadi, E.; Carlson, O.; Pierik, J.; Estanqueiro, A.; Sørensen, P.; O'Malley, M.; Mullane, A.; Anaya-Lara, O.; and Lemstrom, B.; "Dynamic models of wind farms for power system studies—status by IEA Wind R&D Annex 21," European Wind Energy Conference & Exhibition (EWEC), London, U.K., November 22–25, 2004.
- [5] Petersson, A.; Thiringer, T.; Harnefors, L.; Petru, T.; "Modeling and Experimental Verification of Grid Interaction of a DFIG Wind Turbine", *IEEE Transactions on Energy Conversion*, Volume 20, Issue 4, Dec. 2005 Page(s): 878 – 886.
- [6] Hughes, F.M.; Anaya-Lara, O.; Jenkins, N.; Strbac, G.; "A Power System Stabilizer for DFIG-Based Wind Generation," *IEEE Transactions on Power Systems*, Volume 21, Issue 2, May 2006, Page(s):763 – 772.
- [7] Behnke, M.R.; Muljadi, E.; *Reduced Order Dynamic Model for a Variable-Speed Wind Turbine with a Synchronous Generator and Full Power Conversion Topology*, presented at the International Conference on Future Power Systems, November 16-18, 2005, Amsterdam, The Netherlands, Page(s): 1 – 6.

REPORT DOCUMENTATION PAGE

Form Approved
OMB No. 0704-0188

The public reporting burden for this collection of information is estimated to average 1 hour per response, including the time for reviewing instructions, searching existing data sources, gathering and maintaining the data needed, and completing and reviewing the collection of information. Send comments regarding this burden estimate or any other aspect of this collection of information, including suggestions for reducing the burden, to Department of Defense, Executive Services and Communications Directorate (0704-0188). Respondents should be aware that notwithstanding any other provision of law, no person shall be subject to any penalty for failing to comply with a collection of information if it does not display a currently valid OMB control number.

PLEASE DO NOT RETURN YOUR FORM TO THE ABOVE ORGANIZATION.

1. REPORT DATE (DD-MM-YYYY) February 2007		2. REPORT TYPE Conference paper		3. DATES COVERED (From - To) June 2007	
4. TITLE AND SUBTITLE Characteristics of Wind Turbines Under Normal and Fault Conditions: Preprint				5a. CONTRACT NUMBER DE-AC36-99-GO10337	
				5b. GRANT NUMBER	
				5c. PROGRAM ELEMENT NUMBER	
6. AUTHOR(S) E. Muljadi, C.P. Butterfield, B. Parsons, and A. Ellis				5d. PROJECT NUMBER NREL/CP-500-41051	
				5e. TASK NUMBER WER7.7006	
				5f. WORK UNIT NUMBER	
7. PERFORMING ORGANIZATION NAME(S) AND ADDRESS(ES) National Renewable Energy Laboratory 1617 Cole Blvd. Golden, CO 80401-3393				8. PERFORMING ORGANIZATION REPORT NUMBER NREL/CP-500-41051	
9. SPONSORING/MONITORING AGENCY NAME(S) AND ADDRESS(ES)				10. SPONSOR/MONITOR'S ACRONYM(S) NREL	
				11. SPONSORING/MONITORING AGENCY REPORT NUMBER	
12. DISTRIBUTION AVAILABILITY STATEMENT National Technical Information Service U.S. Department of Commerce 5285 Port Royal Road Springfield, VA 22161					
13. SUPPLEMENTARY NOTES					
14. ABSTRACT (Maximum 200 Words) This paper investigates the characteristics of a variable-speed wind turbine connected to a stiff grid or a weak grid, the role of reactive power compensation in optimizing the operation of the wind turbines, and the operation of a wind turbine under normal and fault conditions.					
15. SUBJECT TERMS wind turbine; variable-speed wind turbine; wind energy; systems integraion; utility grid connection					
16. SECURITY CLASSIFICATION OF:			17. LIMITATION OF ABSTRACT UL	18. NUMBER OF PAGES	19a. NAME OF RESPONSIBLE PERSON
a. REPORT Unclassified	b. ABSTRACT Unclassified	c. THIS PAGE Unclassified			19b. TELEPHONE NUMBER (Include area code)

Standard Form 298 (Rev. 8/98)
Prescribed by ANSI Std. Z39.18