

Getting Started Guide

for

HOMER Version 2.1

April 2005

National Renewable Energy Laboratory
1617 Cole Boulevard, Golden, Colorado 80401-3393
303-275-3000 • www.nrel.gov

Operated for the U.S. Department of Energy
Office of Energy Efficiency and Renewable Energy
by Midwest Research Institute • Battelle

About this Getting Started Guide

This Getting Started guide introduces you to HOMER by walking you through eleven steps. You will start by providing HOMER with information, or inputs, about power system designs that you want to consider. HOMER will simulate system configurations, create a list of feasible system designs, and sort the list by cost-effectiveness. In the final step, you will use HOMER to perform a sensitivity analysis. By going through each step in the guide, you should become familiar with the software, and develop enough experience to start using the model on your own.

It should take about an hour to complete this exercise.

The online version of this guide

You can open an online version of this guide by choosing Getting Started on HOMER's Help menu.

Checking your work as you go

Throughout the guide are illustrations that show how HOMER should look as you use the software. Be sure to compare what appears on your computer screen to the illustrations to make sure that you have correctly completed each step.

About Tips and Notes:

Throughout this guide, tips and notes provide additional information to help you better understand how HOMER works. A **note** is important information that you should read to better understand the step of the exercise that you are completing. A **tip** is supplementary information that you may find useful for your future work with HOMER, but is not essential to understand to complete the exercise.

Table of Contents

Welcome to HOMER.....	3
Step one: Formulate a question that HOMER can help answer	5
Step two: Create a new HOMER file.....	6
Step three: Build the schematic	7
Step four: Enter load details	9
Step five: Enter component details	11
Step six: Enter resource details	15
Step seven: Check inputs and correct errors.....	17
Step eight: Examine optimization results.....	20
Step nine: Refine the system design	22
Step ten: Add sensitivity variables.....	25
Step eleven: Examine sensitivity analysis results	27
Getting Started Guide summary	29
Contacts.....	30

Welcome to HOMER

What is HOMER?

HOMER, the micropower optimization model, simplifies the task of evaluating designs of both off-grid and grid-connected power systems for a variety of applications. When you design a power system, you must make many decisions about the configuration of the system: What components does it make sense to include in the system design? How many and what size of each component should you use? The large number of technology options and the variation in technology costs and availability of energy resources make these decisions difficult. HOMER's optimization and sensitivity analysis algorithms make it easier to evaluate the many possible system configurations.

How do I use HOMER?

To use HOMER, you provide the model with inputs, which describe technology options, component costs, and resource availability. HOMER uses these inputs to simulate different system configurations, or combinations of components, and generates results that you can view as a list of feasible configurations sorted by net present cost. HOMER also displays simulation results in a wide variety of tables and graphs that help you compare configurations and evaluate them on their economic and technical merits. You can export the tables and graphs for use in reports and presentations.

When you want to explore the effect that changes in factors such as resource availability and economic conditions might have on the cost-effectiveness of different system configurations, you can use the model to perform sensitivity analyses. To perform a sensitivity analysis, you provide HOMER with sensitivity values that describe a range of resource availability and component costs. HOMER simulates each system configuration over the range of values. You can use the results of a sensitivity analysis to identify the factors that have the greatest impact on the design and operation of a power system. You can also use HOMER sensitivity analysis results to answer general questions about technology options to inform planning and policy decisions.

How does HOMER work?

Simulation

HOMER simulates the operation of a system by making energy balance calculations for each of the 8,760 hours in a year. For each hour, HOMER compares the electric and thermal demand in the hour to the energy that the system can supply in that hour, and calculates the flows of energy to and from each component of the system. For systems that include batteries or fuel-powered generators, HOMER also decides for each hour how to operate the generators and whether to charge or discharge the batteries.

HOMER performs these energy balance calculations for each system configuration that you want to consider. It then determines whether a configuration is feasible, i.e., whether it can meet the electric demand under the conditions that you specify, and estimates the cost of installing and operating the system over the lifetime of the project. The system cost calculations account for costs such as capital, replacement, operation and maintenance, fuel, and interest.

Optimization

After simulating all of the possible system configurations, HOMER displays a list of configurations, sorted by net present cost (sometimes called lifecycle cost), that you can use to compare system design options.

Sensitivity Analysis

When you define sensitivity variables as inputs, HOMER repeats the optimization process for each sensitivity variable that you specify. For example, if you define wind speed as a sensitivity variable, HOMER will simulate system configurations for the range of wind speeds that you specify.

HOMER on the Internet

The HOMER Web site, www.nrel.gov/homer, contains the latest information on the model, as well as sample files, resource data, and contact information.

Step one: Formulate a question that HOMER can help answer

HOMER can answer a wide range of questions about the design of small power systems. It is useful to have a clear idea of a question that you want HOMER to help answer before you begin working with HOMER. Examples of the kinds of questions that HOMER can answer are:

- Is it cost-effective to add a wind turbine to the diesel generator in my system?
- How much will the cost of diesel fuel need to increase to make photovoltaics cost effective?
- Will my design meet a growing electric demand?
- Is it cost-effective to install a microturbine to produce electricity and heat for my grid-connected facility?

For this exercise, let us assume that diesel generators typically serve small loads in a remote area, and that we want to use HOMER to find out whether it makes sense to add wind turbines to such systems. The question we will use HOMER to help answer is: *How do changes in average wind speed and fuel price affect the feasibility of adding wind turbines to a diesel-only system design?*

Step two: Create a new HOMER file

A HOMER file contains all of the information about the technology options, component costs and resource availability required to analyze power system designs. The HOMER file also contains the results of any calculations HOMER makes as part of the optimization and sensitivity analysis processes. HOMER file names end in .hmr, for example: WindVsDiesel.hmr.

When you start HOMER, it looks for the most recently saved file and opens it. If HOMER can not find the file, it displays a blank window.

For this exercise, create a new HOMER file:

- Click New File , or choose File, New from the menu to create a new HOMER file.

HOMER displays a blank schematic on the Main Window.

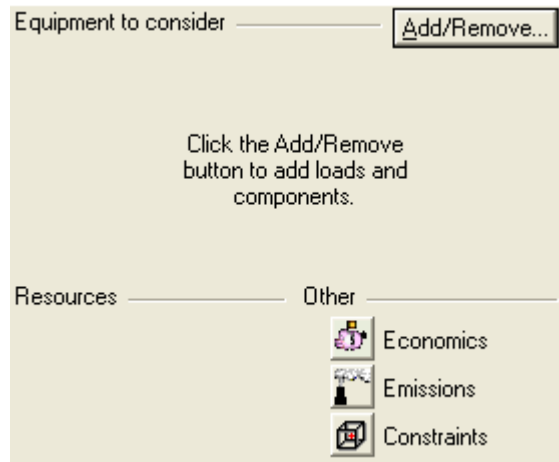

Tip: You can also open an existing HOMER file by clicking Open File .

Step three: Build the schematic

HOMER compares multiple technology options for a power system design. The schematic represents all of the technology options that you want HOMER to consider: it is not a schematic of a particular system's configuration. You build the schematic to give HOMER information about the components to consider to answer your question. The schematic may include components that are not in the optimal design.

In this exercise, HOMER will simulate systems that include wind turbine and diesel combinations to answer the question *How do changes in average wind speed and fuel price affect the feasibility of adding wind turbines to a diesel-only system design?*

1. Click Add/Remove to choose the components that you want HOMER to consider. HOMER displays all of the possible components in the Add/Remove window.
2. Select the Primary Load 1 check box.

Tip: Every system design must include either a primary load (a description of the electric demand), deferrable load, or be connected to a grid.

3. Select the Wind Turbine 1, Generator 1, and Battery check boxes.

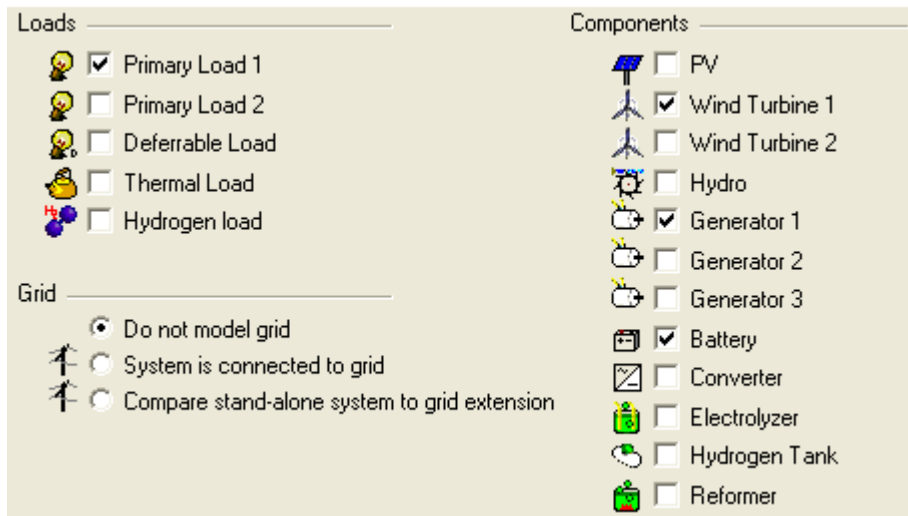

4. Click OK to return to the Main window.

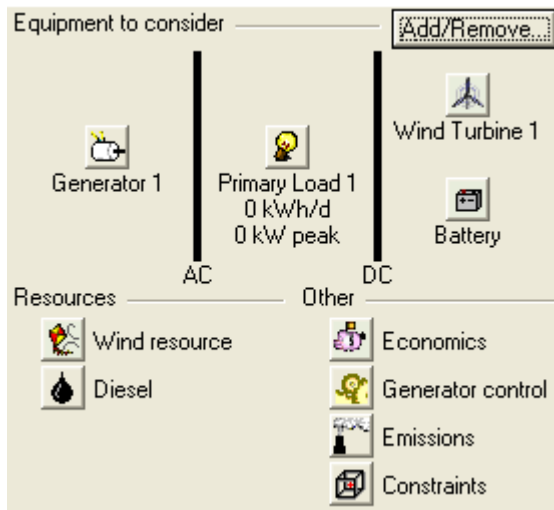

HOMER displays buttons on the schematic that represent the load and components (wind turbine, diesel generator, and battery).

In the Resources section (directly below the schematic) HOMER displays buttons for the resources that each component will use. In this case, buttons for the wind and diesel resources appear in the resources section of the schematic.

Step four: Enter load details

The load details are inputs to the HOMER simulations. The load inputs describe the electric demand that the system must serve. This section describes how to import a sample load file.

1. Click Primary Load 1  on the schematic to open Load Inputs.
2. Type Remote Load as a label for the load.

Label Load type: AC DC

3. Choose AC as the load type.
4. Choose Import hourly data file and then click the Import File button to open the sample load file Remote_Load.dmd.

Data source: Enter daily load profile(s) Import hourly data file

Note: This sample file is located in the same directory as the HOMER program (homer.exe) in a sub-directory called Sample Files.

Baseline data

Hour	Load (kW)
00:00 - 01:00	2.056
01:00 - 02:00	1.956
02:00 - 03:00	1.833
03:00 - 04:00	1.823
04:00 - 05:00	1.850
05:00 - 06:00	2.270
06:00 - 07:00	2.843
07:00 - 08:00	3.762
08:00 - 09:00	4.058
09:00 - 10:00	4.041
10:00 - 11:00	3.984
11:00 - 12:00	4.142

Annual average: 85.0 kWh/d
Annual peak: 11.49 kW
Load factor: 0.308

Month: Day type:

Add noise: Daily %
Hourly %

Load Profile (from Remote_Load.dmd)

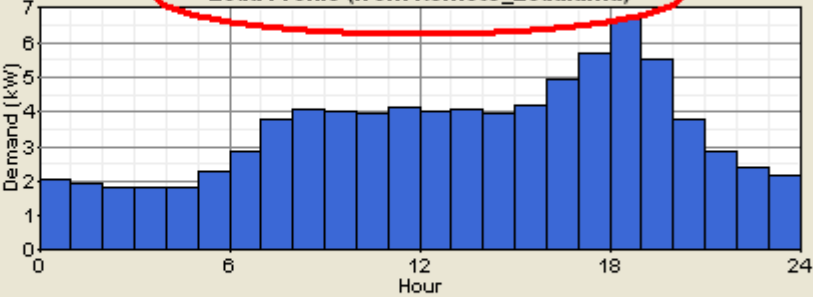

Scaled data for simulation: Scaled annual average (kWh/d) ({}). Scaled peak: 11.49 kW

Efficiency Inputs... Plot... Export... Help Cancel OK

HOMER displays the daily load profile in the table and graph. Note that the name of the imported file appears in the graph title.

Tip: You can also create a load profile by entering 24 values in the Load Profile table.

5. Click OK to return to the Main window.

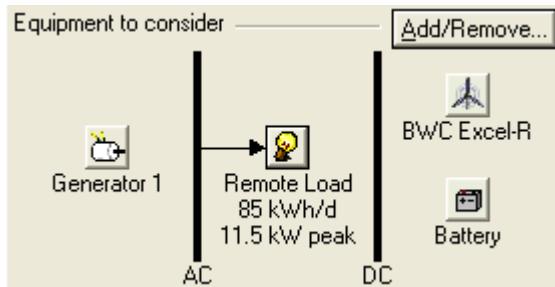

On the schematic, notice the arrow that now connects the load button to the AC bus and shows the direction of energy flow. Also note that the label you typed, "Remote Load," appears on the schematic, along with the values of the average and peak demand.

Step five: Enter component details

The component inputs describe technology options, component costs, and the sizes and numbers of each component that HOMER will use for the simulations. This section describes how to enter cost data for diesel generators, wind turbines, and batteries. The costs in this exercise may not reflect real market conditions.

1. Click Generator 1  on the schematic to open Generator Inputs.
2. In the Costs table, enter the following values: Size 1, Capital 1500, Replacement 1200, O&M 0.05. Note that O&M stands for operation and maintenance. Generator O&M costs should not include fuel costs, since HOMER calculates fuel costs separately.

Size (kW)	Capital (\$)	Replacement (\$)	O&M (\$/hr)
1.000	1500	1200	0.050

This tells HOMER that installing a diesel generator in the system initially costs \$1500 per kilowatt, that replacing the generator would cost \$1200 per kilowatt, and that it will cost \$0.05 per hour per kilowatt to operate and maintain. Notice that HOMER plots the cost curve based on the values you enter in the Costs table.

Tip: For this example, the cost curve is linear: HOMER assumes that the cost and generator size are related linearly, i.e., that the installation cost of hardware is \$1,500 for 1 kilowatt worth of diesel generation, \$3,000 for 2 kilowatts, \$4,500 for 3 kilowatts, etc. You can define a non-linear cost curve to account for quantity discounts and economies of scale by adding rows to the Costs table with values that do not follow this linear pattern. As you enter values in the table, HOMER automatically creates a blank row at the bottom of the table so that you can add additional values as needed.

3. In the Sizes to consider table, remove 0.000 and 1.000, and add 15. The values in the Sizes to consider table are called optimization variables. The table should look like the one shown below:

Size (kW)
15.000

Note: HOMER automatically adds zero and any sizes that you entered in the Costs table to the Sizes to consider table. You can leave these values in the Sizes to consider table if you want HOMER to simulate systems with these component sizes, or delete and add to them if you want HOMER to simulate different sizes.

HOMER will simulate systems with a 15 kilowatt generator. On the Cost curve, notice that HOMER displays the optimization variables as diamonds:

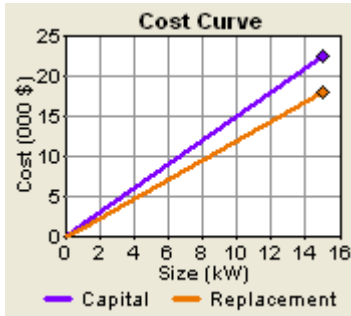

HOMER uses the values in the Costs table for the system costs calculations that are part of the simulation process to determine how much installing, operating, and maintaining the diesel generator will add to the power system's cost. The optimization variables tell HOMER how much diesel generator capacity to include in the various system configurations it will simulate.

4. Click OK to return to the Main window.
5. Click Wind Turbine 1  on the schematic to open Wind Turbine Inputs.
6. In the Turbine Type list, click Generic 10kW to select the generic 10 kilowatt wind turbine. HOMER displays the Generic turbine's power curve.

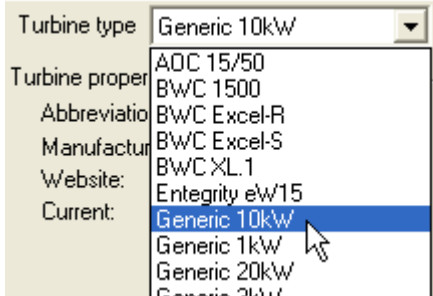

7. In the Costs table, enter the following values: Quantity 1, Capital 30000, Replacement 25000, O&M 500.

Quantity	Capital (\$)	Replacement (\$)	O&M (\$/yr)
1	30000	25000	500

Note: The O&M (operation and maintenance) cost for a wind turbine is expressed in dollars per year (\$/yr), and not in dollars per hour (\$/hr) as it is for a generator.

HOMER automatically displays 0 and 1 in the Sizes to consider table.

Sizes to consider —

Quantity
0
1

8. Click OK to return to the Main window.
9. Click Battery  on the schematic to open Battery Inputs.
10. In the Battery Type list, click Trojan L16P to select the Trojan model L16P battery. HOMER displays the battery's properties.

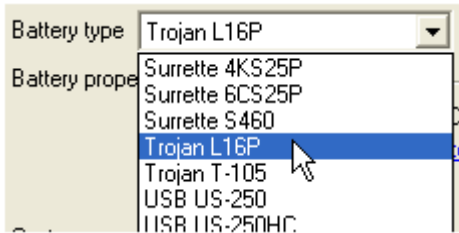

11. In the Costs table, enter the following values: Quantity 1, Capital 300, Replacement 300, O&M 20.

Costs —

Quantity	Capital (\$)	Replacement (\$)	O&M (\$/yr)
1	300	300	20.00

In the Sizes to consider table, delete 0 and 1, and add 8.

Sizes to consider —

Quantity
8

12. Click OK to return to the Main window.

You are now finished entering component information. The schematic should look like this:

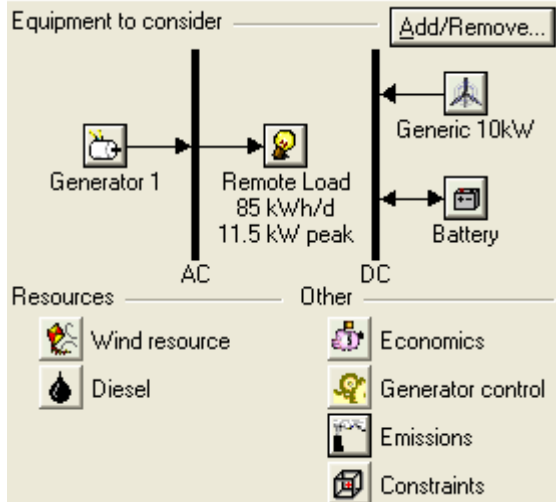

Step six: Enter resource details

The resource inputs describe the availability of solar radiation, wind, hydro, and fuel for each hour of the year. For solar, wind, and hydro resources, you can either import data from a properly formatted file, or use HOMER to synthesize hourly data from average monthly values.

This section describes how to define resource inputs for wind and fuel, which are the resources required by the two components HOMER will simulate: wind turbines and diesel generators.

1. Click Wind resource  to open the Wind resource inputs window.

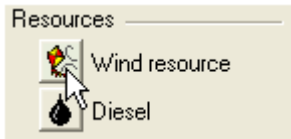

2. Choose Import hourly data file, then click Import File and open Sample_Wind_Data.wnd.

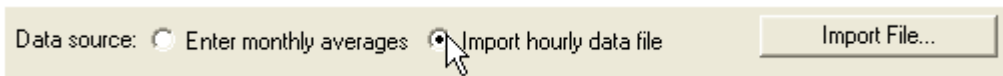

Tip: HOMER can synthesize hourly wind speeds for a whole year from 12 monthly values, a Weibull K value and the other parameters. See Help for more information.

Baseline data

Month	Wind Speed (m/s)
January	4.794
February	5.702
March	3.338
April	4.121
May	4.062
June	2.664
July	3.572
August	3.630
September	3.594
October	4.823
November	6.587
December	7.195

Annual average: 4.500

Other parameters

Altitude (m above sea level)

HOMER initially sets the scaled value equal to the baseline value.

Scaled data for simulation

Scaled annual average (m/s) 4.5 {..}

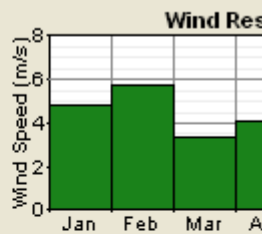

The baseline data is a set of 8,760 wind speed values that describe the wind resource for a single year. Pay special attention to the baseline annual average value (at the bottom of the wind speed table), and the scaled annual average.

HOMER uses scaled data for simulations to allow you to perform a sensitivity analysis on resource availability. To create scaled data, HOMER determines a scaling factor by dividing the scaled annual average by the baseline annual average and multiplies each baseline value by this factor. By default, HOMER sets the scaled average equal to the baseline average, which results in a scaling factor of one. You can change the scaled annual average to examine the effect of higher or lower wind speeds on the feasibility of system designs.

Note: HOMER will interpret a scaled annual average of zero to mean that there is no available wind resource.

For this exercise, the scaled annual average is the same as the annual average, so HOMER will use the baseline data for simulations. In *Step ten: Add sensitivity variables*, we will see how to use the scaled annual average to examine how wind speed variations affect the optimal system design.

- Set the anemometer height to 25 m, indicating that the wind speed data were measured at a height of 25 meters above ground.

Other parameters

Altitude (m above sea level)

Anemometer height (m)

- Click OK to return to the Main window.
- Click Diesel  (in the Resources section) to open the Diesel Inputs window.

Resources

 Wind resource

 Diesel

- Verify that the diesel price is \$0.4 per liter.

Price (\$/L)

- Click OK to return to the Main window.

Step seven: Check inputs and correct errors

HOMER checks many of the values that you enter in the input windows to see if they make technical sense. If HOMER notices values that do not make sense, it displays warning and error messages on the Main window.

For this example, HOMER displays a message suggesting that a converter should be included in the system design. A converter is a component that converts alternating current, AC, to direct current, DC, (rectifier); DC to AC (inverter); or both.

1. Click the Warning button  to view a more detailed message.

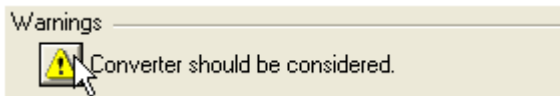



Warnings tell you that there may be a problem with one or more inputs. These problems may not prevent HOMER from running, but could indicate that there is a problem with the design of the system.

You can see on the schematic that there is no arrow between the DC bus and the load. This means that power from the DC wind turbine will not be supplied to the AC load. The warning message suggests that adding a converter to the system design would correct this problem.

Tip:  indicates a problem that will prevent HOMER from running simulations.

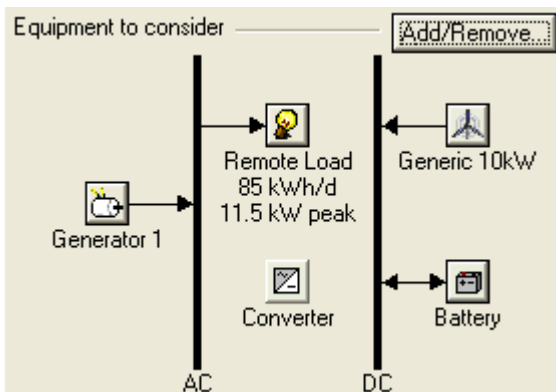
2. To add a converter to the schematic, Click Add/Remove, select the Converter check box, and click OK.



- Click Converter  on the schematic to open Converter Inputs.
- In the Costs table, enter the following values: Size 1, Capital 1000, Replacement 1000, and O&M 100.

Size (kW)	Capital (\$)	Replacement (\$)	O&M (\$/yr)
1.000	1000	1000	100

This tells HOMER that the cost of either installing or replacing a converter in the system is \$1,000 per kilowatt, and that it costs \$100 per year per kilowatt to operate and maintain the converter.

- In the Sizes to consider table, remove 1.000, and add the values 6 and 12.

Size (kW)
0.000
6.000
12.000

This tells HOMER to simulate system designs that include either no converter (0 kilowatts), a 6 kilowatt converter, or a 12 kilowatt converter. Since the peak load displayed on the schematic is 11.5 kilowatts, we can guess that a 12 kilowatt converter would meet the load for any hour that the wind turbine serves most of the load. Specifying the 6 kilowatt converter allows us to find out whether a using a smaller, less expensive converter is a more cost-effective design option.

- Click OK to return to the Main window.

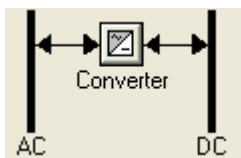

HOMER can now consider systems that deliver power from the DC wind turbine to the AC load.

Tip: Notice that the converter functions as both an inverter (converting DC to AC) and rectifier (AC to DC). This will not affect the results of an analysis of a system that only requires an inverter. You can, however, remove the rectifier component of the converter by opening the Converter Inputs window and setting Capacity relative to inverter to zero.

7. In the Main window toolbar, click Search Space  to review the optimization variables.

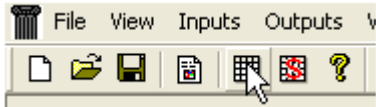

The Search Space summary table displays all of the optimization variables (sizes to consider) that you entered in the input windows for each component. You can add and remove sizes to consider for a component in this table, or by opening the input window for that component and editing the Sizes to consider table there.

	G10	Gen1	Batteries	Converter
	(Quantity)	(kW)	(Quantity)	(kW)
1	0	15.00	8	0.00
2	1			6.00
3				12.00
4				

In the table for this example, the heading G10 represents the Generic 10 kilowatt wind turbine, and Gen1 represents Generator 1.

Note: HOMER will simulate system designs for all of the combinations in the Search Summary table. For this example, HOMER will simulate 6 designs: 2 wind turbine quantities (G10), 1 diesel generator capacity (Gen1), 1 battery quantity, and 3 converter capacities, or $2 \times 1 \times 1 \times 3 = 6$ designs.

8. Click OK to return to the Main window.

Step eight: Examine optimization results

HOMER simulates system configurations with all of the combinations of components that you specified in the component inputs. HOMER discards from the results all infeasible system configurations, which are those that do not adequately meet the load given either the available resource or constraints that you have specified.

1. Click Calculate  to start the simulation.

While HOMER is running, the progress indicator shows approximately how much time remains before HOMER finishes the simulation (for this example, approximately one second).

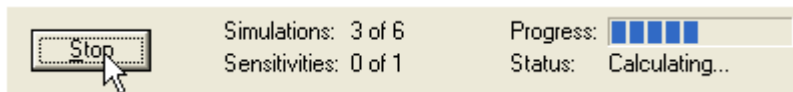

2. When HOMER is finished running the simulations, click the Optimization Results tab, and click Overall to view a table of all feasible system configurations.

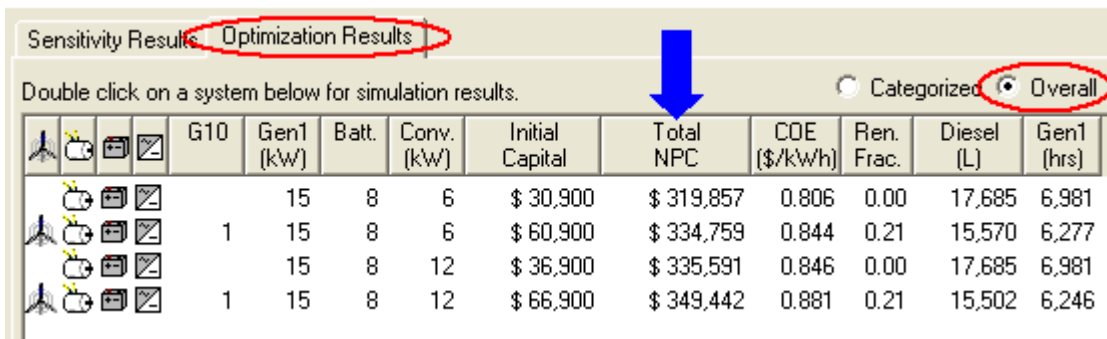

		G10	Gen1 (kW)	Batt.	Conv. (kW)	Initial Capital	Total NPC	COE (\$/kWh)	Ren. Frac.	Diesel (L)	Gen1 (hrs)
			15	8	6	\$ 30,900	\$ 319,857	0.806	0.00	17,685	6,981
		1	15	8	6	\$ 60,900	\$ 334,759	0.844	0.21	15,570	6,277
			15	8	12	\$ 36,900	\$ 335,591	0.846	0.00	17,685	6,981
		1	15	8	12	\$ 66,900	\$ 349,442	0.881	0.21	15,502	6,246

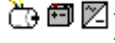
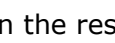



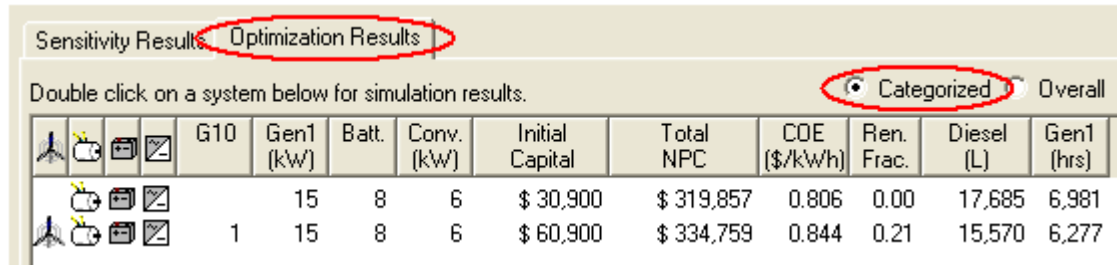



In the Overall Optimization Results table, HOMER displays a list of the four system configurations that it found to be feasible. They are listed in order (from top to bottom) of most cost-effective to least cost-effective. The cost-effectiveness of a system configuration is based on its net present cost, displayed under the heading "Total NPC" in the results tables. For this example, one diesel/battery configuration () wins over the other configurations, including two wind systems ().

- To view a table of sorted system designs, click the Optimization Results tab, and click Categorized.



Sensitivity Results **Optimization Results**

Double click on a system below for simulation results. Categorized Overall

	G10	Gen1 (kW)	Batt.	Conv. (kW)	Initial Capital	Total NPC	COE (\$/kWh)	Ren. Frac.	Diesel (L)	Gen1 (hrs)
   		15	8	6	\$ 30,900	\$ 319,857	0.806	0.00	17,685	6,981
   	1	15	8	6	\$ 60,900	\$ 334,759	0.844	0.21	15,570	6,277





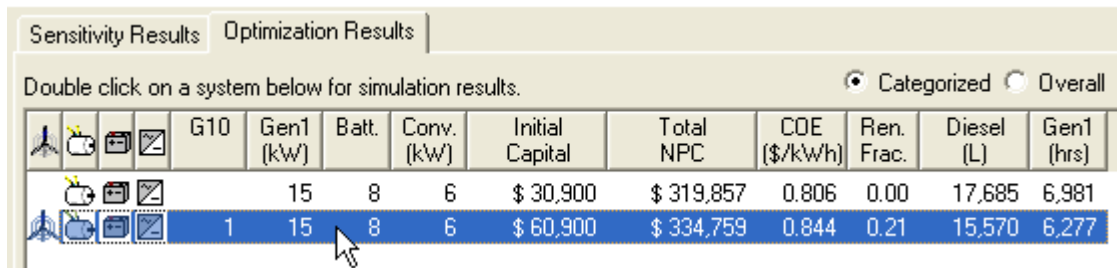



In the Categorized Optimization Results table, HOMER displays only the most cost effective configuration of each system design.

- To view the details for the most cost-effective wind/diesel/converter design, double-click the second row in the Optimization Results table.



Sensitivity Results Optimization Results

Double click on a system below for simulation results. Categorized Overall

	G10	Gen1 (kW)	Batt.	Conv. (kW)	Initial Capital	Total NPC	COE (\$/kWh)	Ren. Frac.	Diesel (L)	Gen1 (hrs)
   		15	8	6	\$ 30,900	\$ 319,857	0.806	0.00	17,685	6,981
   	1	15	8	6	\$ 60,900	\$ 334,759	0.844	0.21	15,570	6,277

In the Simulation Results window, you can view many technical and economic details about each system configuration that HOMER simulates. For this example, click the Electrical tab, and note that 16% of the total electric energy produced by the system is excess electricity, or energy that is not used by the system and goes to waste. Would including more batteries in the system design result in this excess electricity being used by the system?

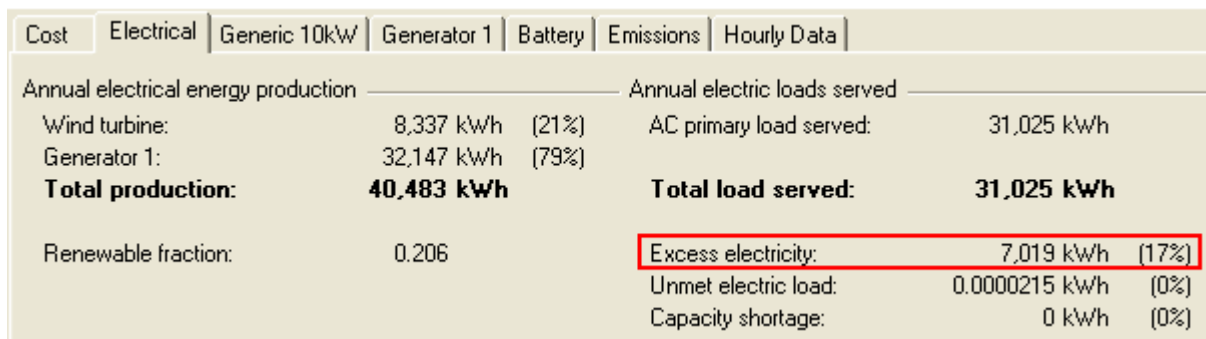

Cost	Electrical	Generic 10kW	Generator 1	Battery	Emissions	Hourly Data
Annual electrical energy production			Annual electric loads served			
Wind turbine:		8,337 kWh	(21%)	AC primary load served:		31,025 kWh
Generator 1:		32,147 kWh	(79%)	Total load served:		31,025 kWh
Total production:		40,483 kWh		Excess electricity:		7,019 kWh (17%)
Renewable fraction:		0.206		Unmet electric load:		0.0000215 kWh (0%)
				Capacity shortage:		0 kWh (0%)

- Click Close to return to the Main window.
- In the File menu, choose Save As, and save the file as Excess_Energy.hmr.

Step nine: Refine the system design

This section describes how to use the optimization results to improve the system design. For this example, we will see if adding batteries to the system design will reduce the amount of excess energy produced by the system.

1. Click Battery  on the schematic to open Battery inputs.
2. In Sizes to consider, add 16 and 24.

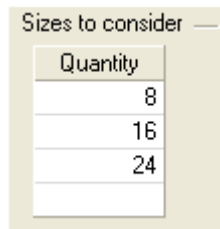

HOMER will simulate systems with 8, 16, and 24 batteries.

3. Click OK to return to the Main window.

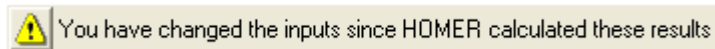

HOMER displays a warning message at the bottom of the Main window to let you know that the information in the results table does not reflect the changes you just made.

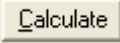
4. Click Calculate  to start the optimization process.

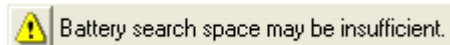

When the simulations are finished, HOMER displays the new results in the results tables, and also displays a warning message at the bottom of the Main window.

5. Click the Battery Search Space May be Insufficient Warning button .



The optimal number of batteries might be greater than the maximum number you allowed, 24. You might want to specify one or more larger numbers and run HOMER again.

The allowable numbers of batteries are found on the Battery window in the table called 'Sizes to consider', and in the Search Space window.

HOMER displays a message suggesting that you add more battery quantities to the Sizes to consider table. Since we are not sure exactly how many batteries to add, we will add a range of new battery quantities.

6. Click OK to return to the Main window.
7. In the Main window toolbar, click Search Space  to open the Search Space Summary table.
8. Add 32, 40, 48, and 56 to the number of batteries.

	G10 (Quantity)	Gen1 (kW)	Batteries (Quantity)	Converter (kW)
1	0	15.00	8	0.00
2	1		16	6.00
3			24	12.00
4			32	
5			40	
6			48	
7			56	
8				
9				

Tip: You could also add these values to the Sizes to consider tables in the Battery Inputs windows.

9. Click OK to return to the Main window.
10. Click Calculate  to start the simulation.

When the simulation process is finished, HOMER displays the new results for systems that include the battery quantities that we just added to the optimization table. This time, HOMER does not display warning messages.

As you can see in the battery column of the Categorized Optimization Results table (Batt.), the most cost-effective system configurations include 32 batteries.

11. In the Categorized Optimization Results table, double-click the wind/diesel/battery system (in the second row) to open the Simulation Results window.

Sensitivity Results		Optimization Results										
Double click on a system below for simulation results.												
										<input checked="" type="radio"/> Categorized		<input type="radio"/> Overall
Icons	G10	Gen1 (kW)	Batt. (kW)	Conv. (kW)	Initial Capital	Total NPC	COE (\$/kWh)	Ren. Frac.	Diesel (L)	Gen1 (hrs)		
		15	32	6	\$ 38,100	\$ 270,205	0.681	0.00	14,315	4,146		
	1	15	32	6	\$ 68,100	\$ 282,495	0.712	0.22	11,651	3,571		

The excess electric energy produced by the most cost-effective configuration of the wind/diesel/battery system is dramatically reduced from 17% to 3%.



Cost	Electrical	Generic 10kW	Generator 1	Battery	Emissions	Hourly Data
Annual electrical energy production			Annual electric loads served			
Wind turbine:		8,337 kWh	(22%)	AC primary load served:		31,025 kWh
Generator 1:		29,465 kWh	(78%)			
Total production:		37,801 kWh		Total load served:		31,025 kWh
Renewable fraction:		0.221		Excess electricity:		1,071 kWh (3%)
				Unmet electric load:		0.0000486 kWh (0%)
				Capacity shortage:		0 kWh (0%)

12. In the File menu, choose Save As, and save the file as Reduced_Excess.hmr.

HOMER has helped us refine the system design by adding batteries to store excess energy. However, systems with no wind are still more cost-effective than systems that use wind. Under what conditions does it make sense to include wind turbines in the system design? To understand this question, we will use HOMER to do a sensitivity analysis.

Step ten: Add sensitivity variables

In Step Five, you learned that HOMER uses scaled resource data for simulations. This section describes how to enter sensitivity values for both the wind speed scaled annual average and diesel price to perform a sensitivity analysis on these variables. The sensitivity analysis will allow you to explore how variations in average annual wind speed and diesel fuel prices affect the optimal design of the system. Another way to say this is that the analysis will show you the range of average annual wind speeds and diesel prices for which it makes sense to include wind turbines in the system design.

1. Click Wind resource  to open the Wind Resource Inputs window.
2. Click the Scaled annual average Sensitivities button  to open the Sensitivity Inputs window.

Scaled data for simulation

Scaled annual average (m/s) 

3. Add the values 4, 5, 5.5, 6, 6.5, and 7 to the Average Wind Speed sensitivities table.

Variable: Wind Data Scaled Average
Units: m/s
Link with: <none>

Values:

1	4.500	▲
2	4.000	▼
3	5.000	
4	5.500	
5	6.000	
6	6.500	
7	7.000	
8		
9		

Clear

These sensitivity values tell HOMER to simulate each system configuration using seven sets wind speed data (scaled to each average annual wind speed value in the table).

4. Click OK to return to the Wind Resource Inputs window. Notice that the number of sensitivity variables, 7, appears in between the brackets on the Sensitivities button.

Scaled annual average (m/s) 

5. Click OK to return to the Main window.

6. Click Diesel  (in the Resources section) to open the Diesel inputs window.

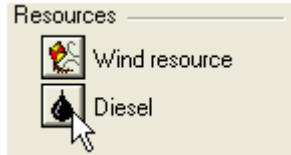

7. Click Price Sensitivities button  to open the Sensitivity Inputs window.

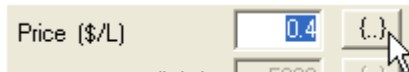

8. Add the values 0.5, 0.6, and 0.7 to the Diesel Price Sensitivities table.

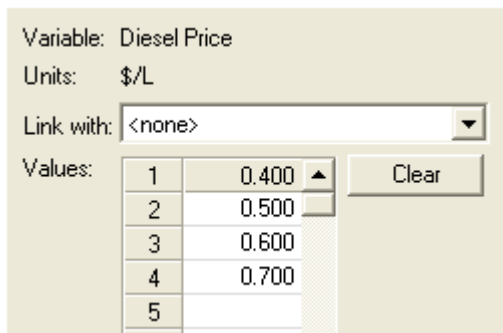

HOMER will simulate each system configuration for each diesel price value in the sensitivities table.

9. Click OK to return to the Diesel Inputs window, then click OK to return to the Main window.

Step eleven: Examine sensitivity analysis results

HOMER displays sensitivity results in graphs and tables. This section describes how to view and interpret the sensitivity results to determine under what conditions a wind/diesel system is more cost-effective than a diesel-only system.

1. Click Calculate  to start the simulation.

The progress bar indicates an estimate of the time remaining until the simulation and optimization process is complete.

Tip: You can stop HOMER at any time during the simulation process by clicking Stop.

2. Click the Optimization Results tab, and click Categorized to display the table of sorted system designs.

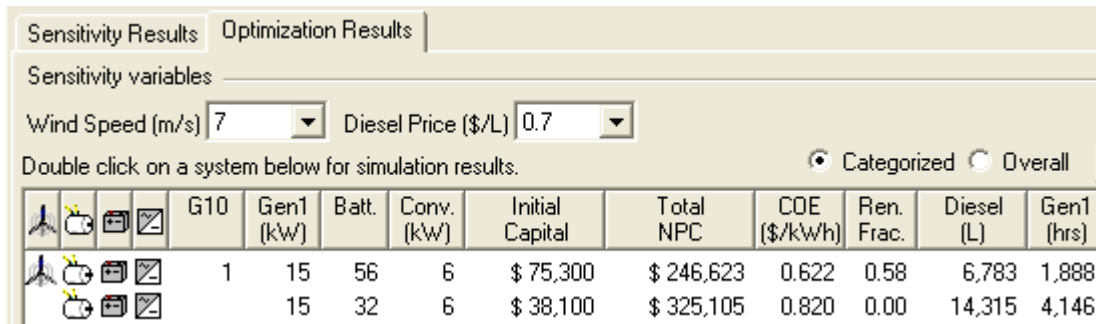

Sensitivity Results		Optimization Results									
Sensitivity variables											
Wind Speed (m/s)	7	Diesel Price (\$/L)	0.7								
Double click on a system below for simulation results.											
		<input checked="" type="radio"/> Categorized	<input type="radio"/> Overall								
	G10	Gen1 (kW)	Batt.	Conv. (kW)	Initial Capital	Total NPC	COE (\$/kWh)	Ren. Frac.	Diesel (L)	Gen1 (hrs)	
	1	15	56	6	\$ 75,300	\$ 246,623	0.622	0.58	6,783	1,888	
		15	32	6	\$ 38,100	\$ 325,105	0.820	0.00	14,315	4,146	

HOMER now displays the Wind Speed and Diesel Price sensitivity variables in the boxes above the Categorized Optimization Results table. You can see that when the average annual wind speed is 7 meters per second and the price of Diesel fuel is \$0.70 per liter, wind/diesel/battery is the optimal system type: it is more cost-effective than the system with no wind turbine.

You can explore how changes in the average annual wind speed and diesel fuel price affect the optimal system type by selecting different wind speeds and fuel prices. For example, if the diesel fuel price is \$0.70 per liter, and average annual wind speed is 4.5 meters per second or lower, system designs that include wind turbines are no longer optimal.

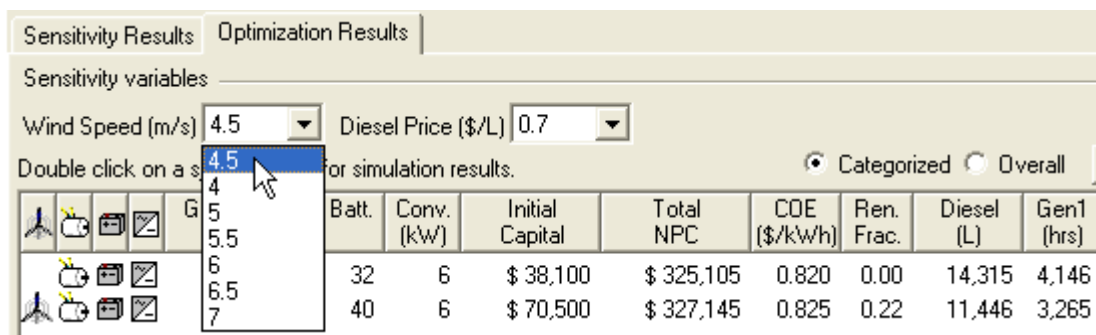

Sensitivity Results		Optimization Results									
Sensitivity variables											
Wind Speed (m/s)	4.5	Diesel Price (\$/L)	0.7								
Double click on a system below for simulation results.											
		<input checked="" type="radio"/> Categorized	<input type="radio"/> Overall								
	G10	Gen1 (kW)	Batt.	Conv. (kW)	Initial Capital	Total NPC	COE (\$/kWh)	Ren. Frac.	Diesel (L)	Gen1 (hrs)	
			32	6	\$ 38,100	\$ 325,105	0.820	0.00	14,315	4,146	
			40	6	\$ 70,500	\$ 327,145	0.825	0.22	11,446	3,265	

HOMER also displays sensitivity results in graphs, which can be a more useful way to look at the results.

3. Click the Sensitivity Results tab, and click Graphic to display the table of sorted system designs. Make the following selections:
 - In the Wind Speed list, select x-axis. In the Diesel Price list, select y-axis.
 - Under Variables to plot, select Optimal System Type in the Primary list. Select <none> in the Superimposed list.

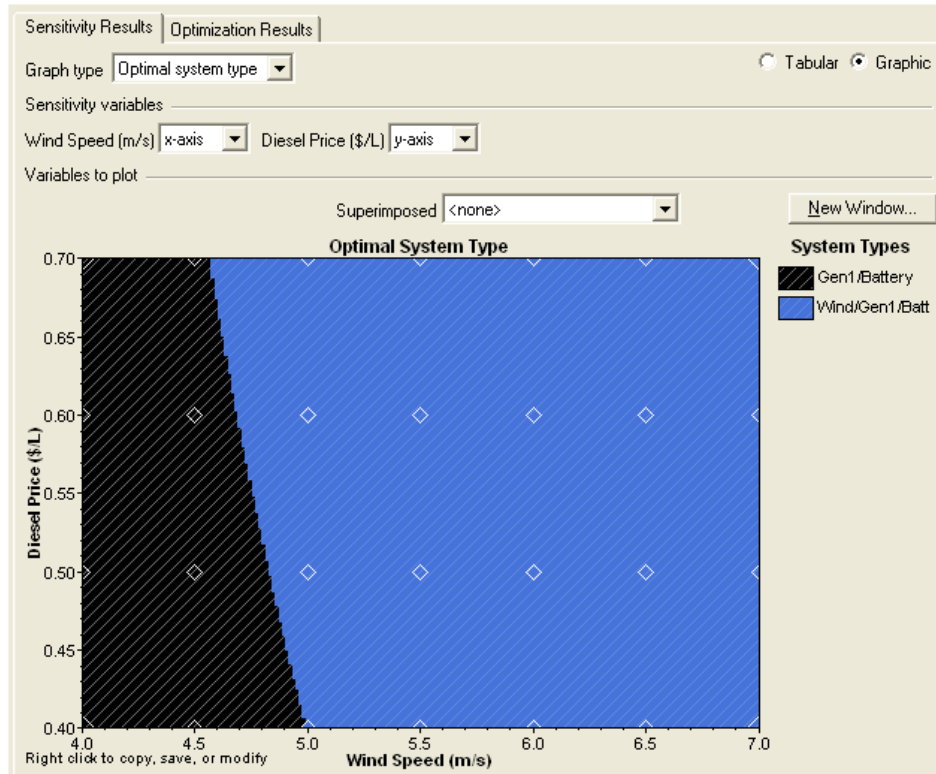

On the Optimal System Type (OST) graph, you can simultaneously see the results for all the wind speeds and fuel prices you entered. The graph shows that the optimal system design depends both on the fuel price and on the annual average wind speed.

HOMER displays the results of the simulation and optimization in a wide variety of tables and graphs. Spend some time looking at the different graphs to familiarize yourself with these tables and graphs.

Getting Started Guide summary

This section describes some main ideas to remember about HOMER as you work with the model.

- To use HOMER, you enter inputs (information about loads, components, and resources), HOMER calculates and displays results, and you examine the results in tables and graphs.
- Using HOMER is an iterative process. You can start with rough estimates of values for inputs, check results, refine your estimates and repeat the process to find reasonable values for the inputs.
- You can use HOMER to simulate a power system, optimize design options for cost-effectiveness, or to perform a sensitivity analysis on factors such as resource availability and system costs.
- HOMER is an hourly simulation model. HOMER models system components, available energy resources, and loads on an hourly basis for one year. Energy flows and costs are constant over a given hour. HOMER can synthesize hourly resource data from monthly averages that you enter in tables, or you can import measured data from properly formatted files.
- HOMER is primarily an economic model. You can use HOMER to compare different combinations of component sizes and quantities, and to explore how variations in resource availability and system costs affect the cost of installing and operating different system designs. Some important technical constraints, including bus voltage levels, intra-hour performance of components, and complex diesel generator dispatch strategies are beyond the scope of an economic model such as HOMER. NREL's design tool for hybrid power systems, Hybrid2, can simulate these and other technical constraints and is useful for further exploring design options that HOMER identifies as cost-effective.

Contacts

Peter Lilienthal, PhD
National Renewable Energy Laboratory
peter_lilienthal@nrel.gov
phone: (303) 384 - 7444
fax: (303) 384 - 7411

Tom Lambert, P.Eng.
Mistaya Engineering Inc.
tomlambert@mistaya.ca
<http://www.mistaya.ca>

Paul Gilman
National Renewable Energy Laboratory
paul_gilman@nrel.gov

<http://www.nrel.gov/homer>

National Renewable Energy Laboratory
1617 Cole Boulevard
Golden, CO 80401
USA