

Multiplexer-Induced Interference on TDR Measurements of Electrical Conductivity

P. Castiglione,* P. J. Shouse, and J. M. Wraith

ABSTRACT

The possibility of automated multiple readings of water content and bulk soil electrical conductivity represents a major benefit in soil research, and is one of the most attractive characteristics of the time domain reflectometry (TDR) technique. Coaxial multiplexers are commonly employed to monitor up to hundreds of TDR probes through computer or datalogger interface. We observed that the different probes connected to a common multiplexer or multiplexer network interfere with one another. This is due to the electronics of most multiplexers, where the different channels share a common ground, while only the central electrode is switched. The effects of the multiplexer-induced interference were investigated through tests in electrolyte solutions and in a loam soil at variable water content. We determined that the interference did not affect the signal travel time, and therefore the water content measurement, but resulted in appreciable errors in measured electrical conductivity. We also found that the interference results in a variation of the cell constant K_p , and the errors in conductivity measurements could be easily corrected by determining K_p in presence of interference. The magnitude of the interference appears to be independent of the electrical conductivity and dielectric constant of the interposing medium, while it is strongly dependent on the inter-probe spacing and probe geometry.

TIME DOMAIN REFLECTOMETRY has become an established method for measuring volumetric soil water content (θ) and bulk soil electrical conductivity (σ_a) (Noborio, 2001; Robinson et al., 2003; Topp and Ferre, 2002). In TDR measurements, a fast rising step voltage pulse is transmitted through a coaxial cable to the sample, and reflected back to the generator. The incident and reflected voltages are then recorded in the time domain by a fast sampling oscilloscope. From the analysis of the reflected voltage (waveform) it is possible to determine important dielectric properties of the sampled medium. For instance, the apparent dielectric constant (ϵ_a , which can be considered to a first approximation the static value of the dielectric constant in non-dispersive dielectrics) can be measured from the signal travel time, Δt , as follows:

$$\epsilon_a = \left(\frac{c\Delta t}{2L_c} \right)^2 \quad [1]$$

where c (m s^{-1}) is the speed of light and L_c (m) the so-called electric probe length. Commonly, the travel time is obtained with the method of the tangents (e.g.,

Heimovaara and Bouten, 1990). Topp et al. (1980) showed that ϵ_a could be related to θ , and provided an empirical formula that remains widely used.

The sample electrical resistance, R_S (Ω), is related to the attenuation of the waveform (Dalton et al., 1984). In particular, since both dielectric and ohmic dissipations affect the TDR waveform, R_S is determined by the signal attenuation at long time, or low frequency, where the effects of the dielectric dissipations (resulting from polarization phenomena) vanish. For ideal systems, where dissipations only occur in the sampled medium, transmission line theory shows that the sample conductance, $G_S = 1/R_S$ (dS), is given by (e.g., Giese and Tiemann, 1975; Topp et al., 1988):

$$G_S = \frac{1}{Z_0} \frac{1 - \rho_\infty}{1 + \rho_\infty} \quad [2]$$

Where ρ_∞ is the reflection coefficient at infinite time and Z_0 is the cable characteristic impedance (50Ω). The sample electrical conductivity, σ (dS m^{-1}), is obtained from:

$$\sigma = K_p G_S \quad [3]$$

where K_p (m^{-1}) is the cell constant, which can be estimated from the probe geometry (e.g., Spaans and Baker, 1993), or more accurately determined from calibration in electrolyte solutions of known conductivity using Eq. [3].

Equation [2] fails to account for the additional dissipations due to the coaxial cable, probe handle or any device (such as multiplexers and transient suppressors) interposed between the probe and the TDR unit (Heimovaara et al., 1995). Castiglione and Shouse (2003) showed that the additional dissipations (indicated for brevity as cable losses) could be accounted for by calibrating the system with respect to the reflection coefficients recorded in air (ρ_{air}) and with the probe short-circuited (ρ_{sc}). As an alternative to Eq. [2], they proposed the following expression for the sample conductance:

$$G_S = \frac{1}{Z_0} \frac{\rho_{\text{air}} - \rho_\infty}{\rho_\infty - \rho_{\text{sc}}} \quad [4]$$

As indicated by Eq. [4], G_S tends to zero as the measured signal approaches the waveform in air, while it tends to infinite as ρ_∞ approaches the short circuit value ρ_{sc} .

Many commercially available TDR instruments can be interfaced to a computer or datalogger to facilitate automatic data collection and analysis. The possibility of automated multiple readings is accomplished with the introduction of multi-channel switching systems, or multiplexers (Heimovaara and Bouten, 1990). Using one or more multiplexers in series, up to hundreds of

P. Castiglione and J.M. Wraith, Land Resources and Environmental Sciences Dep., Montana State University, P.O. Box 173120, Bozeman, MT 59717-3120; P.J. Shouse, USDA-ARS, George E. Brown Jr. Salinity Lab, 450 W. big Springs Road, Riverside, CA 92507. Received 1 June 2005. *Corresponding author (paoloc@montana.edu).

Published in Soil Sci. Soc. Am. J. 70:1453–1458 (2006).

Soil Physics

doi:10.2136/sssaj2005.0169

© Soil Science Society of America

677 S. Segoe Rd., Madison, WI 53711 USA

Abbreviations: TDR, time domain reflectometry.

probes can be connected to a single TDR cable tester. Most multiplexers suitable for TDR measurements (e.g., Model SDMX50, Campbell Scientific, Inc., Logan, UT; model TR-200 Dynamax, Inc., Houston, TX; Model 50S-608 BNC JFW, Industries Inc., Indianapolis, IN) feature 8 or 16 channels. Each probe is characterized by a specific address, where the signal can be routed by toggling the corresponding channel. A simple schematic of a TDR multiplexer with two channels is shown in Fig. 1. Ideally, the multiplexer should allow propagation of the signal through the different channels without inducing spurious reflections or additional attenuation in the waveform. This is accomplished by assuring a coaxial configuration (50Ω impedance) for the switching board, and by minimizing the circuit trace lengths (Evet, 1998). Inevitable impedance mismatch and series resistances are successfully accounted for by the calibration procedure described above (Eq. [4]), and usually do not represent a concern for conductivity measurements.

We found, however, that different probes connected to the same multiplexer or multiplexer network interfered with one another. This phenomenon has not been previously reported, and is due to the design of conventional coaxial multiplexers, where only the positive electrode (central pin in the BNC connector) is switched, with the different channels continuously sharing a common ground. With reference to Fig. 1, when the signal is addressed to Probe 1, the multiplexer is switched to the corresponding channel, but the ground of the two probes remains connected. As a consequence, the presence of Probe 2 in the neighboring region affects the signal transmission and hence the waveforms measured by Probe 1. Figure 2 shows an example of such interference for two probes immersed in deionized water, where the waveforms measured with both probes connected to the multiplexer (continuous line) and with only the measuring probe connected (dash line) are compared. The common ground results in a low frequency noise (Fig. 2a) characterized by a wavelength of about 70 m (3 MHz, in water). While the noise does not affect the high frequency components of the waveform, and therefore the measurement of the signal travel time (Fig. 2b), it does result in a shift of the reflection coefficient at long times, and thus in an erroneous measurement of the sample conductance (see Eq. [4]).

The objectives of this study were to investigate the key characteristics of the multiplexer-induced interference, determine the factors affecting the noise phenomenon,

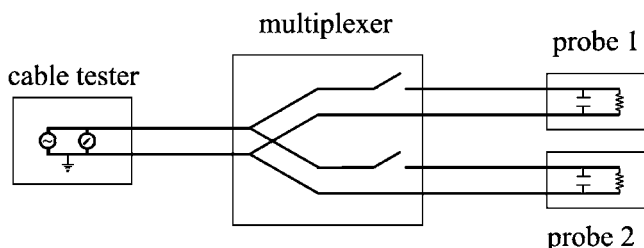

Fig. 1. Schematic representation of the switching board of a two-channel coaxial multiplexer.

and evaluate the resulting errors in σ measurements. We performed a series of tests in electrolyte solutions and a loam soil under different moisture conditions. The experiments in solutions revealed the role played by the probe geometry and the distance between measuring and interfering probe (inter-probe distance). It also appeared that the error in G_S measurements is proportional to the conductivity of the surrounding medium, and therefore that the interference results in a variation of the cell constant (see Eq. [3]). This fundamental observation suggests that, for a given arrangement of probes with common multiplexer, the errors in σ measurements can be corrected by simply determining the effective cell constant through calibration in solutions. The experiments in soil allowed us to investigate in detail the dependence of the interference magnitude on the inter-probe distance. By varying the soil moisture, these tests also aimed at disclosing the effects of the dielectric permittivity of the surrounding medium. Though more accurate experiments are needed in perfectly homogeneous media, these preliminary results suggest that the medium permittivity, and therefore the soil water content, has little impact on the multiplexer-induced interference.

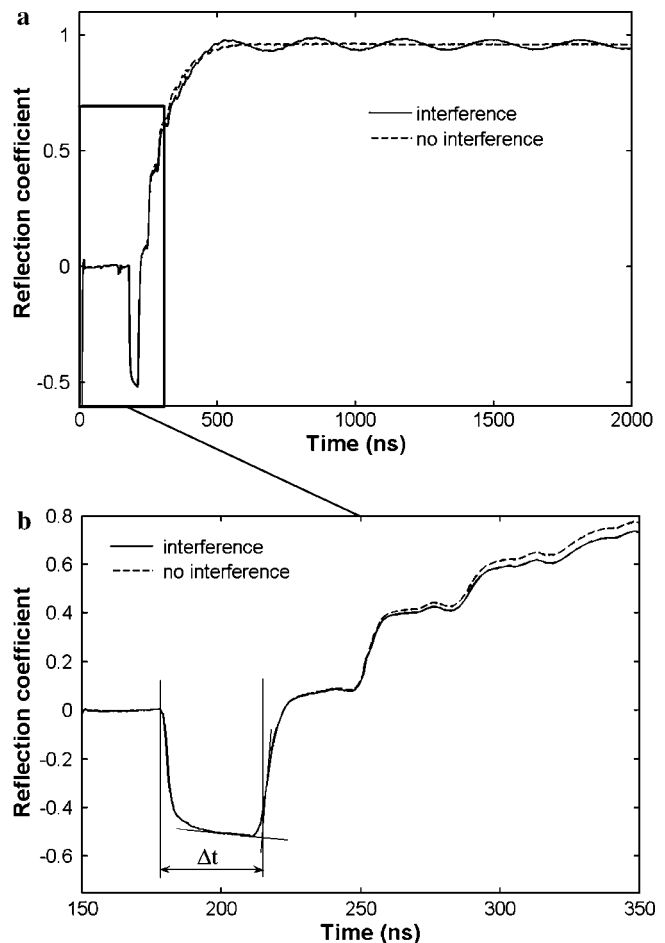

Fig. 2. (a) Low frequency noise imposed on the time-domain reflectometry waveform in deionized water when an interfering probe is connected to the multiplexer; (b) the noise does not affect the measurement of the travel time.

MATERIALS AND METHODS

In all the experiments, TDR probes were connected to a Tektronix 1502B cable tester (Tektronix, Beaverton, OR) through a single SDM50 multiplexer (Campbell Scientific, Inc., Logan, UT). The cable tester was computer-controlled by the RS232 serial port interface (SP232, Tektronix). Digital waveforms having 16384 points were collected (Heimovaara, 1994). The long time reflection coefficient (to be used in Eq. [4]) was determined from the average of records 16000 to 16100. We found that inter-probes interference did not affect the reflection coefficient values in air and in a short-circuited probe (respectively ρ_{air} and ρ_{sc} in Eq. [4]), and therefore the calibration of the system with respect to the cable losses. The experiments were performed in a temperature controlled room at 25°C.

Electrolyte Solutions

Tests in electrolyte solutions were performed in a large acrylic cylinder (24-cm diam. and 25-cm high), with three TDR probes inserted horizontally and spaced 4-cm apart on the vertical direction (Fig. 3). Two different sets of probes were used to investigate the effect of probe geometry. The first set included three-rod probes (14.7-cm long, 2.5-cm rod spacing) with 0.635-cm diam. central rod (signal) and two 0.32-cm diam. outside rods (ground). The second set comprised two-rod probes with the rods 15.0-cm long, 0.32-cm diam., and 5 cm apart.

The column was filled with different KCl electrolytic solutions, with σ ranging from 0.3 to 8.3 dS m⁻¹. The electrical conductivity of the solutions was measured independently with a standard electrical conductivity meter (YSI 32, Yellow Springs Instrument Co., Yellow Springs, OH). Probe 3 (at the lowest elevation; see Fig. 3) was chosen as measuring probe, and the electrical conductance was determined according to Eq. [4]. For each solution, measurements were taken with (i) no interference (Probes 1 and 2 disconnected from the multiplexer); (ii) inter-probe distance = 4 cm (Probes 2 and 3 connected to the multiplexer); and (iii) inter-probe distance = 8 cm (Probes 1 and 3 connected to the multiplexer).

Soil under Variable Wetness

The experiment was performed in a large insulated box (28 × 137 cm; Fig. 4) filled to a height of 10 cm with air-dried fine-loam soil (30% sand, 46% silt, 24% clay; Fine loamy, mixed, superactive, frigid Aridic Calcustolls—Headwater series). The dry bulk density was 1.19 g cm⁻³, and the weight percentage of organic C was 0.86%. Twelve three-rod probes were inserted horizontally and spaced as depicted in Fig. 5.

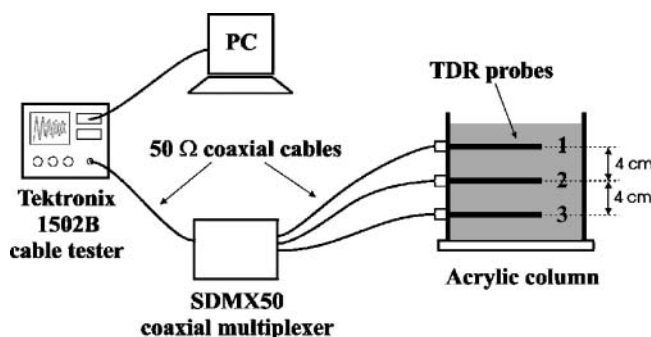

Fig. 3. Schematic of the experimental setup for three probes in an acrylic cylinder sequentially filled with deionized water and electrolyte solutions.



Fig. 4. Insulated soil container with 12 probes for evaluation of multiplexer-induced signal interference under variable probe spacings and soil water contents.

The probes (10-cm long, 1.6-mm rod diameter, 10-mm rod-to-rod spacing) were placed with the three rods aligned on a vertical plane at 5-cm soil depth (from the central rod). Probes 1 and 4 were selected as measuring locations, while all other probes were used in turn as interfering probes (Fig. 5). Five different volumetric water contents ($\theta = 0.13, 0.18, 0.26, 0.39, 0.44 \text{ m}^3 \text{ m}^{-3}$) were established by sequentially wetting the soil with a 0.5 dS m⁻¹ CaCl₂ solution uniformly across the surface. The values reported above represent the average of the water contents measured by the individual TDR probes, obtained from Eq. [1] and the Topp et al. (1980) relationship. The soil container was covered following each wetting to minimize evaporation, and allowed to equilibrate for 1 wk before measurements were taken.

RESULTS AND DISCUSSION

Electrolyte Solutions

The characteristics of the multiplexer-induced interference are different in deionized water and in electrolyte solutions. In deionized water the interference results in a low frequency noise superimposed on the waveform (Fig. 2). This characteristic is even more evident in Fig. 6, where the x - and y -axes are stretched for convenience, which illustrates the oscillations of the reflection coefficient observed with the three-rod probes immersed in deionized water. The noise appears to be

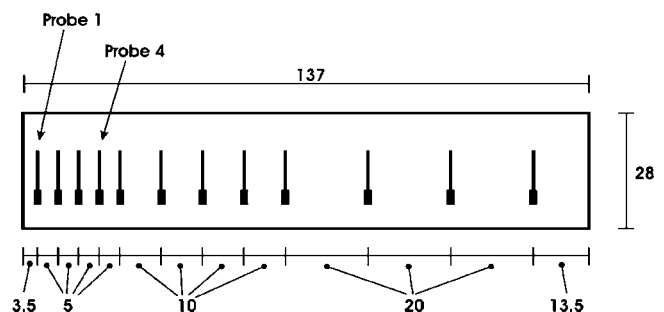

Fig. 5. Spatial relationships of time-domain reflectometry probes in the insulated soil container. Distances are in centimeters.

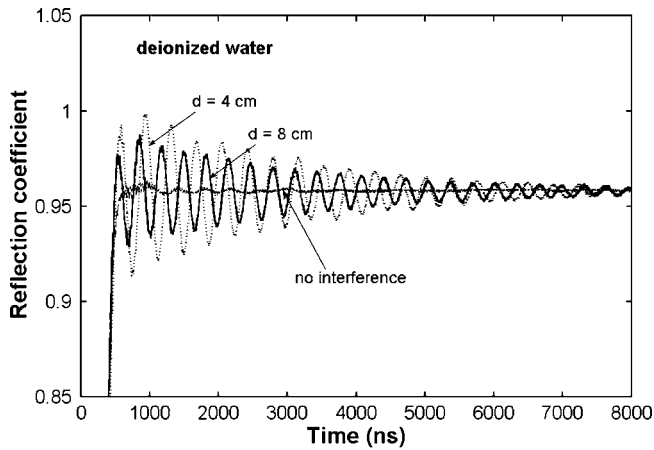

Fig. 6. Low frequency noise in deionized water caused by interfering probes at different separation (4 and 8 cm) distances.

attenuated at long time, yet not negligible. When the probes are immersed in electrolyte solutions, the sinusoidal character of the noise disappears (Fig. 7). In this case, the interference results in a reduction of the reflection coefficient as it approaches a constant value, with consequent variation of the measured conductance (Eq. [4]). For both deionized water and electrolyte solutions, the interference has no effect on the measured travel time. In water and in solution, the magnitude of the signal interference depends on the inter-probe distance ('d' in Fig. 6 and 7). As intuitively expected, the magnitude of the interference was greater for smaller inter-probe distances. We noted that the same interference observed using the procedure described above could be observed without a multiplexer, by simply connecting the grounds of the measuring and the interfering probes (i.e., by touching the BNC connectors together). This confirms the common ground between multiplexed probes as the origin of the observed signal interference. Measurements in electrolyte solutions of different concentrations revealed a fundamental characteristic of the inter-probe interference. Figure 8 shows the results obtained with the two- (solid symbols) and

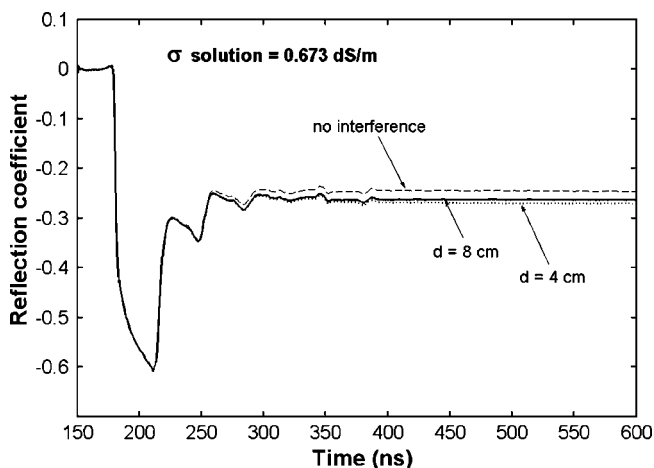

Fig. 7. Effect of inter-probe interference in 0.673 dS m^{-1} electrolytic solution. The noise results in a vertical shift of the waveform at long times.

three-rod probes (hollow symbols), both with and without interference; the inter-probe distance is 4 cm in both cases. The interference results in a persistent overestimation of the measured conductance. In particular, the ratio of the sample conductances measured with (G'_S) and without (G_S) interference:

$$q = \frac{G'_S}{G_S} \quad [5]$$

appears to be independent of the medium conductivity, and is constant for each probe geometry. In other words, the inter-probe interference simply results in a variation of the slope of the line interpolating the G_S - σ data, and therefore of the cell constant according to Eq. [3]. Denoting as K'_p the cell constant in presence of interference, the following relation therefore holds:

$$\sigma = K'_p G'_S \quad [6]$$

Equation [6] suggests that the electrical conductivity σ can be determined correctly even in presence of interference, as long as the measured conductance G'_S is multiplied by K'_p . The cell constant K'_p can be determined through calibration in solutions, provided the same interference met in actual measurements is reproduced (i.e., with the probes multiplexed and with same spatial arrangement). Errors in conductivity measurements typically arise because cell constant values determined without interference (e.g., by submerging a single probe in electrolyte solutions), are used in conjunction with disturbed conductance values G'_S .

Figure 8 also shows the absolute values of the cell constant with and without interference. The relative variation of the cell constant, defined as:

$$RV = \frac{K'_p - K_p}{K_p} \quad [7]$$

can be considered a gauge for the magnitude of the multiplexer-induced interference, and depends on both the probe geometry and inter-probe distance. The two-rod configuration appears to be more sensitive to ex-

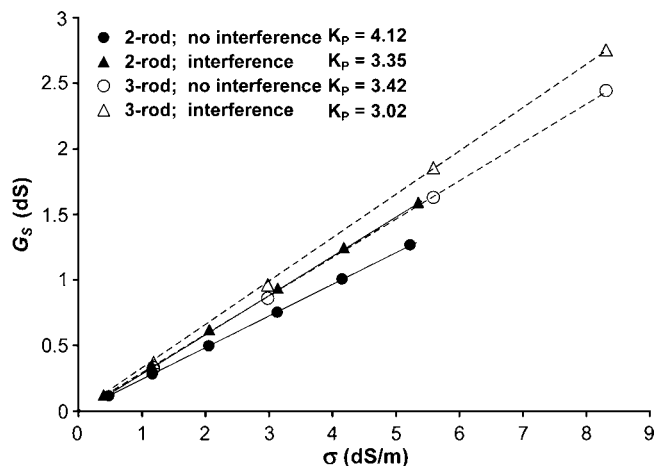

Fig. 8. Effect of inter-probe interference on electrical conductance measurements in electrolyte solutions. The interference leads to incorrect values for the probe constant (inverse of the slope of the interpolating line).

ternal interference compared with the three-rod probe. For the two-rod probes we observed a relative variation in the effective cell constant as large as 23%, compared with 13% observed for the three-rod probes.

Soil under Variable Wetnesses

Experiments in soil involve measurements of the bulk soil electrical conductivity (σ_a), for which no independent estimates are available. In this case, therefore, absolute values of the cell constant cannot be obtained. However, from Eq. [3] and [6], it follows:

$$q = \frac{G'_s}{G_s} = \frac{K_p}{K'_p} \quad [8]$$

The ratio q defined earlier thus represents the variation of the cell constant, and therefore the magnitude of the error due to interference. To investigate the dependence of the interference intensity on the inter-probe distance, q values were obtained from Eq. [8] by measuring the conductance in absence of interference (only the measuring probe connected to the multiplexer) and with one interfering probe connected to the multiplexer along with the measuring probe, and placed at different distances.

As an example, Fig. 9 shows the data recorded for $\theta = 0.26 \text{ m}^3 \text{ m}^{-3}$. The multiplexer-induced interference rapidly decreased with increasing inter-probe distance. The two probes exhibit a nearly identical response for a given inter-probe distance. The error in this case for common-ground three-rod probes placed at distances greater than 10 cm is likely acceptable (<5%) for many applications. Based on the evaluation in electrolyte solutions, however, the magnitude of the interference will depend on the probe geometry, and is expected to be substantially greater for two-rod probes. Moreover, our measurements involved only one interfering probe, while the presence of several probes connected to the same multiplexer, as is common practice, is likely to have a greater impact on the σ measurements.

Figure 10 shows the data obtained for different water contents values with Probe 1 as measuring probe. The

decrease pattern for the q in q values is evident for all data series. Although the measured q values display some variability for different water contents, the q - θ data do not display a clear and consistent trend. It must be pointed out that perfectly uniform moisture conditions are practically impossible to obtain with the methods described. In this case, the medium between measuring and interfering probe is likely heterogeneous with respect to the electrical conductivity and the dielectric permittivity. The fact that the variability in the q values is larger for smaller inter-probe distances, where the heterogeneities are more pronounced, while they smooth out for larger control volumes suggests that the data might indeed represent non-perfectly uniform moisture conditions. The observed data, therefore, do not conclusively demonstrate whether the dielectric constant (and thus the water content) plays a role in the multiplexer-induced interference, and more accurate tests are needed.

As the tests in solutions suggest, the interference effects can be accounted for by estimating the cell constant in presence of interference K'_p and then calculating σ using Eq. [6]. If, on the other hand, the data are analyzed with the cell constant obtained without interference (as is generally the case), the predicted values of bulk soil electrical conductivity will deviate from the actual values. Examples of the resulting errors are shown in Fig. 9 and 10.

CONCLUSIONS

In coaxial TDR multiplexer measurements the different transmission line channels share the same ground, while only the central electrode is switched. This causes interference among the probes, the magnitude of which is dependent on their spatial relationship and on probe geometry. We investigated the effects of this interference in electrolyte solutions and in a loam soil at different water contents. Our results show that the interference does not affect measurement of the signal travel time and thus ultimately of water content, but

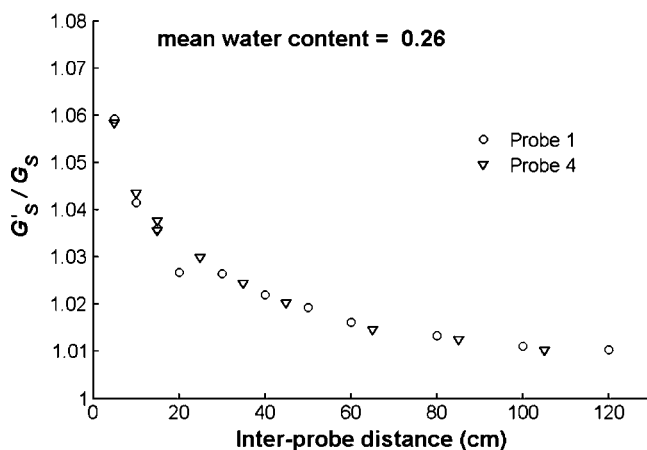

Fig. 9. Relative error in σ_a measurements for different inter-probe distances in a loam soil at soil water content of $0.26 \text{ m}^3 \text{ m}^{-3}$. Probe 1 and 4 are chosen as measuring probes.

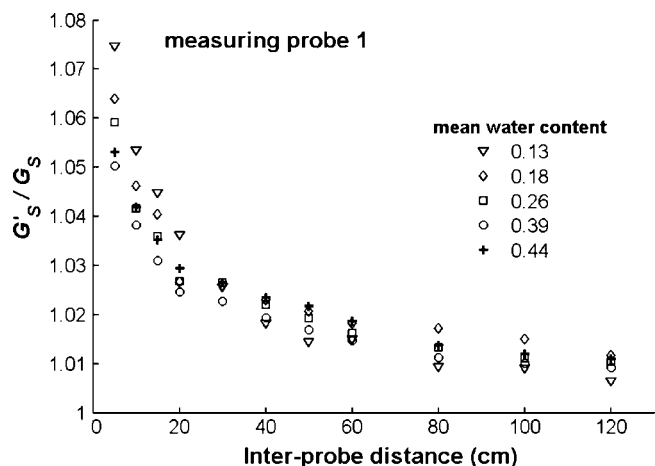

Fig. 10. Relative error in σ_a measurements for different inter-probe distances in a loam soil at different values of water content. Probe 1 is the measuring probe.

may result in appreciable errors in measured electrical conductivity. Two-rod probes were substantially more sensitive to multiplexer-induced common ground interference than were probes with three-rod geometry. Experiments in soil at different water contents showed that for three-rod probes the multiplexer-induced interference rapidly decreased with increasing inter-probe distance. The relative error is independent of the electrical conductivity of the interposed medium. As a consequence, the cell constant in multiplexed measurements will differ from that obtained by calibration in absence of interference, thus resulting in incorrect estimates of the soil electrical conductivity. We consider that it should be possible to quantitatively characterize the magnitude of multiplexer-induced signal interference with respect to probe geometry and inter-probe distance. This work is ongoing in our laboratory.

REFERENCES

- Castiglione, P., and P.J. Shouse. 2003. The effect of ohmic cable losses on time-domain reflectometry measurements of electrical conductivity. *Soil Sci. Soc. Am. J.* 67:414–424.
- Dalton, F.N., W.N. Herkelrath, D.S. Rawlins, and J.D. Rhoades. 1984. Time-domain reflectometry—Simultaneous measurement of soil-water content and electrical-conductivity with a single probe. *Science* 224:989–990.
- Evelt, S.R. 1998. Coaxial multiplexer for time domain reflectometry measurement of soil water content and bulk electrical conductivity. *ASAE Trans.* 41:361–369.
- Giese, K., and R. Tiemann. 1975. Determination of complex permittivity from thin-sample time domain reflectometry improved analysis of step response waveform. *Adv. Mol. Relax. Processes* 7:45–59.
- Heimovaara, T.J. 1994. Frequency domain analysis of time domain reflectometry waveforms. 1. Measurement of the complex dielectric permittivity of soils. *Water Resour. Res.* 30:189–199.
- Heimovaara, T.J., and W. Bouten. 1990. A computer-controlled 36-channel time domain reflectometry system for monitoring soil-water contents. *Water Resour. Res.* 26:2311–2316.
- Heimovaara, T.J., A.G. Focke, W. Bouten, and J.M. Verstraten. 1995. Assessing temporal variations in soil-water composition with time-domain reflectometry. *Soil Sci. Soc. Am. J.* 59:689–698.
- Noborio, K. 2001. Measurement of soil water content and electrical conductivity by time domain reflectometry: A review. *Comput. Electron. Agric.* 31:213–237.
- Robinson, D.A., S.B. Jones, J.M. Wraith, D. Or, and S.P. Friedman. 2003. A review of advances in dielectric and electrical conductivity measurements in soils using time domain reflectometry. *Vadose Zone J.* 2:444–475.
- Spaans, E.J.A., and J.M. Baker. 1993. Simple baluns in parallel probes for time domain reflectometry. *Soil Sci. Soc. Am. J.* 57:668–673.
- Topp, G.C., J.L. Davies, and A.P. Annan. 1980. Electromagnetic determination of soil water content: Measurements in coaxial transmission line. *Water Resour. Res.* 16:574–582.
- Topp, G.C., and P.A. Ferre. 2002. Water content. p. 434–446. *In* J.H. Dane and G.C. Topp (ed.) *Methods of soil analysis. Part 4.* SSSA Book Series No. 5. SSSA, Madison, WI.
- Topp, G.C., V. Zasovenko, S.J. Zegelin, and S.J. Zegelin. 1988. Determination of electrical conductivity using time domain reflectometry: Soil and water experiments in coaxial lines. *Water Resour. Res.* 24:945–952.