

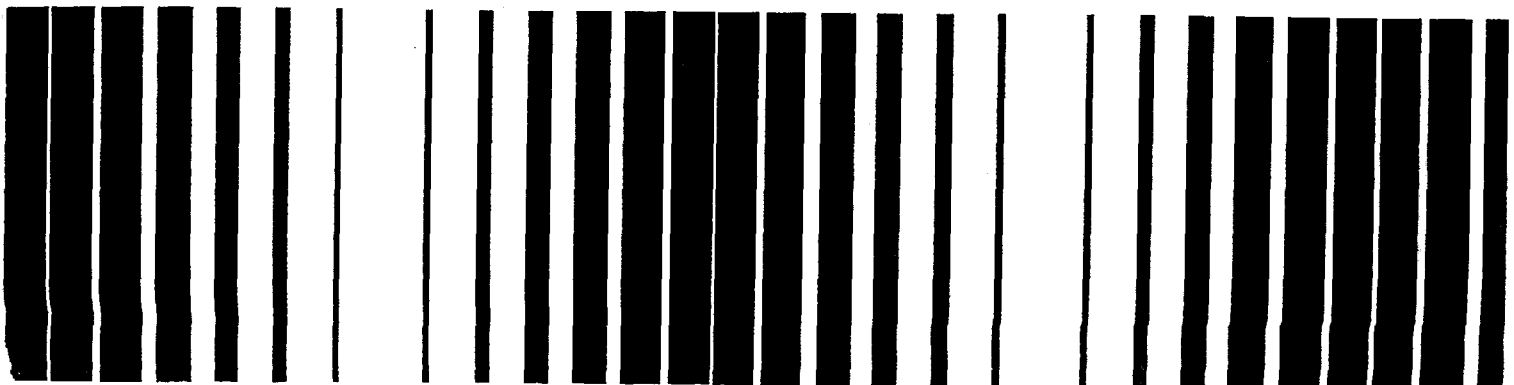

Summary Report

Control of NO_x Emissions by Reburning



EPA/625/R-96/001
February 1996

Summary Report

Control of NO_x Emissions by Reburning

**Center for Environmental Research Information
National Risk Management Research Laboratory
Office of Research and Development
U.S. Environmental Protection Agency
Cincinnati, Ohio 45268**



Printed on Recycled Paper

Notice

The information in this document has been funded wholly, or in part, by the U.S. Environmental Protection Agency (EPA). This document has been subjected to EPA's peer and administrative review and has been approved for publication as an EPA document. Mention of trade names or commercial products does not constitute endorsement or recommendation for use.

Foreword

The U.S. Environmental Protection Agency (EPA) is charged by Congress with protecting the Nation's land, air, and water resources. Under a mandate of national environmental laws, the Agency strives to formulate and implement actions leading to a compatible balance between human activities and the ability of natural systems to support and nurture life. To meet this mandate, EPA's research program is providing data and technical support for solving environmental problems today as well as building the science knowledge base necessary to manage our ecological resources wisely, understand how pollutants affect our health, and prevent or reduce environmental risks in the future.

The National Risk Management Research Laboratory (NRMRL) is the Agency's center for investigation of technologies and management approaches for reducing risks from threats to human health and the environment. NRMRL's research program focuses on methods for the prevention and control of pollution to air, land, water, and subsurface resources; protection of water quality in public water systems; remediation of contaminated sites and ground water; and prevention and control of indoor air pollution. The goal of this research effort is to catalyze development and implementation of innovative, cost-effective environmental technologies; develop scientific and engineering information needed by EPA to support regulatory and policy decisions; and provide technical support and information transfer to ensure effective implementation of environmental regulations and strategies.

This publication has been produced in support of NRMRL's strategic long-term research plan. It is published and made available by EPA's Office of Research and Development to assist the user community and to link researchers with their clients.

E. Timothy Oppelt, Director
National Risk Management Research Laboratory

Acknowledgments

This report was prepared by Radian Corporation (now Radian International LLC) as a subcontractor to Eastern Research Group, Inc. under EPA contract 68-C3-0315, Work Assignment 24. Michael L. Meadows, P.E., was principal author with assistance from Benjamin P. Kuo, Anna Roberts, and Suzette M. Puski. Greg Asbury served as Radian's Project Manager. This work was done under the direction of Justice A. Manning, P.E., EPA's Center for Environmental Research Information, with substantial assistance from Robert E. Hall, Chief, Combustion Research Branch, National Risk Management Research Laboratory. Peer reviewers included Mr. Hall and Andy Miller, EPA; John M. Pratapas and Dr. Steven F. Freeman, Gas Research Institute. Sincere appreciation is expressed to each of these persons for their interest, time and energy put into this report.

Appreciation is expressed to Combustion Engineering, Inc. and the Babcock & Wilcox Co. for allowing us to use copyrighted material from their classic publications, "Combustion Fossil Power Systems," 4th Edition, Joseph Singer, Editor, and "Steam, Its Generation and Use," 40th Edition, S.C. Stultz and J.B. Kitto, Editors, respectively.

Contents

Foreword	iii
Acknowledgments	iv
Chapter 1 Introduction	1
Background	1
Organization	2
Chapter 2 Theories of NO _x Formation and Control by Reburn	3
NO _x Formation	3
Thermal NO _x Formation	3
Fuel NO _x Formation	6
Prompt NO _x Formation	7
Factors that Affect NO _x Emissions	8
Boiler Designs	8
Tangentially-Fired Boilers	9
Wall-Fired Boilers	11
Cyclone-Fired Boilers	14
Theory of NO _x Emission Control by Reburn	16
Three-Stage Combustion	16
Main Burner Zone Heat Release Rate	17
Lower Nitrogen Content of Reburn Fuel	17
Operational Parameters	18
Reburn Fuels	18
Flue Gas Recirculation	18
O ₂ Stoichiometry	19
Residence Time	19
Temperature	20
Controls and Instruments	20
Potential Application Problems	20
Fuel Combustion Problems	20
Boiler Operating Problems	20
Reburn Fuel Availability and Cost	21
Physical Constraints	22
Particulate Control Device Constraints	22
Boiler Safety	22
Load Dispatch Range	22
Ancillary Benefits	23
Chapter 3 Example Full-Scale Demonstrations	25
Introduction	25
Public Service of Colorado - Cherokee Unit 3	25
Illinois Power Company - Hennepin Unit 1	31
City Water, Light, and Power - Lakeside Unit 7	34
Wisconsin Power & Light Company - Nelson Dewey Unit 2	39
Ohio Edison - Niles Unit 1	41

Contents (continued)

	Ladyzhin Power Station - Unit 4	43
Chapter 4	Process Economics	51
	Costing Methodology	51
	Capital Costs	51
	Operating and Maintenance Costs	53
	Busbar Cost and Cost-Effectiveness	54
	Cost Analysis	54
	Model Plants	55
	Sensitivity Analysis	55
Chapter 5	Integrated NO _x Control Technologies	63
	Reburning with Low NO _x Burners	63
	Reburning with SNCR	63
	Reburning with SCR	64
Chapter 6	References	67
Chapter 7	Bibliography	70

Figures

2-1	Effect of Equivalence Ratio on NO _x Formation	4
2-2	Effect of Equivalence Ratio on Adiabatic Combustion Temperature	5
2-3	Conversion of Fuel-Bound Nitrogen in Practical Combustors	6
2-4	Sources of NO _x Emissions from Coal.....	7
2-5	Fuel-Bound Nitrogen-to-Nitrogen Oxide in Pulverized Coal Combustion	8
2-6	Firing Pattern in a Tangentially-Fired Boiler	9
2-7	Burner Assembly of a Tangentially-Fired Boiler	10
2-8	Single-Wall and Opposed-Wall Type Wall-Fired Boilers	12
2-9	Typical Circular Burner	12
2-10	Cell Burner	13
2-11	Flow Pattern in an Arch-Fired Boiler	14
2-12	Cyclone Burner	15
2-13	Firing Arrangements Used with Cyclone-Fired Boilers	15
2-14	Conventional Firing and Gas-Fired Reburn Applied to a Wall-Fired Boiler	17
3-1	Cherokee Unit 3–LNB-Gas Reburn System Schematic	26
3-2	Cherokee Unit 3–Short-Term NO _x Emission Data	27
3-3	Cherokee Unit 3–LNB-Gas Reburning Data	28
3-4	Cherokee Unit 3–Effect of Excess Air on NO _x Emissions	29
3-5	Cherokee Unit 3–Effect of Gas Input on NO _x Emissions	30
3-6	Cherokee Unit 3–Effect of Unit Load on NO _x Emissions	31
3-7	Cherokee Unit 3–Long-Term NO _x Emission Data	32
3-8	Hennepin Unit 1–Stacked Burners of Tangentially-Fired Boiler	33
3-9	Hennepin Unit 1–Gas Reburning Data with Coal as the Primary Fuel	35

Figures (continued)

3-10	Hennepin Unit 1–Long-Term Gas Reburning Data	35
3-11	Lakeside Unit 7–GR-SI System Schematic.....	36
3-12	Lakeside Unit 7–Effect of Gas Heat Input on NO _x Emissions	37
3-13	Lakeside Unit 7–Effect of Reburn Zone Stoichiometry on NO _x Emissions	37
3-14	Lakeside Unit 7–Effect of Flue Gas Recirculation on NO _x Emissions	38
3-15	Lakeside Unit 7–Long-Term Operation Results for NO _x Reductions	39
3-16	Nelson Dewey Unit 2–Coal-Fired Reburn System Schematic	40
3-17	Nelson Dewey Unit 2–NO _x Emissions vs. Unit Load - Illinois Basin Coal	41
3-18	Nelson Dewey Unit 2–NO _x Emissions vs. Unit Load - Powder River Basin Coal	42
3-19	Niles Unit 1–Schematic of Reburn Process	44
3-20	Niles Unit 1–Variation of NO _x with Reburn Stoichiometry	45
3-21	Niles Unit 1–NO _x Emissions as a Function of Boiler Load	45
3-22	Ladyzhin Unit 4–Schematic of Reburn Design Arrangements	48
3-23	Ladyzhin Unit 4–NO _x Emissions vs. Reburn Fuel Percentage	49
3-24	Ladyzhin Unit 4–NO _x Emissions vs. Flue Gas Oxygen Content	50
3-25	Ladyzhin Unit 4–NO _x Emissions vs. Boiler Load	50
4-1	Impact of Plant Characteristics on Reburn Cost Effectiveness and Busbar Costs for Wall-Fired Boilers	52
4-2	Impact of NO _x Emission Characteristics and Heat Rate on Reburn Cost Effectiveness for Wall-Fired Boilers	58
4-3	Impact of Plant Characteristics on Reburn Cost Effectiveness and Busbar Costs for Tangentially-Fired Boilers	59
4-4	Impact of NO _x Emission Characteristics and Heat Rate on Reburn Cost Effectiveness for Tangentially-Fired Boilers	60
4-5	Impact of Plant Characteristics on Reburn Cost Effectiveness and Busbar Cost for Cyclone-Fired Boilers	60
4-6	Impact of NO _x Emission Characteristics and Heat Rate on Reburn Cost Effectiveness for Cyclone-Fired Boilers	61

Tables

3-1	Summary of Example Reburn Installations	25
3-2	Hennepin Unit 1–Fuel Analysis Comparison	34
3-3	Nelson Dewey Unit 2–Summary of Effects of Reburning on Unit Operating Parameters	43
3-4	Ladyzhin Unit 4–Fuel Analyses	46
3-5	Ladyzhin Unit 4–Flow Diagram for Boiler Combustion Performance Model	47
3-6	Ladyzhin Unit 4–Furnace Thermal Performance Summary	47
4-1	Capital and Operating Cost Components	52
4-2	Variable O&M Unit Costs	54
4-3	Costs for Natural Gas-Fired Reburn Applied to Coal-Fired Boilers	56
5-1	Costs for SNCR Applied to Coal-Fired Boilers	65
5-2	Costs for SCR Applied to Coal-Fired Boilers	66

Chapter 1 Introduction

Background

The Clean Air Act Amendments of 1990 require reduction in emissions of nitrogen oxides (NO_x) because of NO_x 's contribution to acid rain formation and identification as a precursor to ozone formation. This report covers NO_x control employing reburning technology: a new, effective method of controlling NO_x emissions from a wide range of stationary combustion sources including large, coal-fired, utility boilers. Although reburning potentially is applicable to either new or existing units, this report focuses on retrofit applications on utility boilers.

NO_x emission control technologies that are capable of achieving NO_x emission reductions from a coal-fired boiler can be classified as either combustion modifications or post-combustion flue gas treatment. Combustion modification techniques prevent the formation of NO_x during combustion or destroy the NO_x formed during primary combustion. These techniques include the use of low- NO_x burners (LNBs), overfire air (OFA), and boiler combustion optimization. Post-combustion flue gas treatment reduces the NO_x content of the flue gas through techniques such as selective catalytic reduction (SCR) and selective noncatalytic reduction (SNCR).

Reburning, as described in this report, is a combustion modification since the formation of NO_x is minimized in one portion of the boiler and a portion of the NO_x that does form is destroyed in another.

Unlike some other NO_x control approaches, reburning technology is applicable to a wide variety of the boilers and, in many cases, can be implemented within a relatively short period of time. Reburning is ideal for wet-bottom (i.e., slagging) boilers. The only other commercially available NO_x control alternative for this type of boiler is flue gas treatment, which is more costly per ton of NO_x reduction achieved. Because of reburning's applicability to a wide variety of coal-fired combustion sources, several demonstration projects have been un-

dertaken to gather data on reburning. As a result of such projects, reburning technology is offered commercially by several firms including ABB Combustion Engineering, Babcock & Wilcox (B&W), and Energy and Environmental Research Corporation (EER).

Reburning reduces NO_x emissions by completing combustion in three stages. In the first stage, NO_x formation due to interactions between the fuel and combustion air at high temperatures is controlled by reducing the burner heat release rate and the amount of oxygen present. In the second stage, additional fuel is added under reducing (oxygen-deficient) conditions to produce hydrocarbon radicals that react with the NO_x formed in the first stage to produce nitrogen gas (N_2). Additional combustion air is added in the lower-temperature third stage and combustion is completed. In retrofit applications such as discussed in Chapter 3, reburning has achieved up to 60% reduction from baseline NO_x emissions.

The concept for "reburning" was developed in the late 1960s by Dr. J.O.L. Wendt, and was first presented in 1973 at the Fourteenth Symposium (International) on Combustion (Wendt et al., 1973). Japanese investigators (Y. Takahashi, et al.) followed up on the concept and performed pilot-scale tests that showed promising results, e.g., a 50% NO_x reduction. Following those results, which were presented at the U.S.-Japan NO_x Information Exchange in Tokyo in May 1981 (Takahashi et al., 1981), U.S. researchers began an intensive investigation of reburn technology. W.S. Lanier, J.A. Mulholland, and R.E. Hall of the U.S. Environmental Protection Agency (EPA) performed research on natural gas- and oil-fired reburn systems (Mulholland and Lanier, 1985; Mulholland and Hall, 1987). At the same time EPA sponsored tests at EER on natural gas-, oil-, and coal-fired systems (U.S. EPA, 1985a; U.S. EPA, 1987; U.S. EPA, 1989). This research, performed by S. B. Greene, S. L. Chen, W. D. Clark, J. M. McCarthy, B. J. Overmoe, M. P. Heap, D. W. Pershing, and W. R. Seeker, was later supplemented by the Gas Research Institute (GRI).

As a result of this early research, full-scale demonstrations of natural gas reburn technology were initiated. The first reburn demonstration, co-sponsored by EPA, GRI, the Electric Power Research Institute (EPRI), U.S. Department of Defense (DOE), and the Ohio Coal Development Office, was performed by ABB Combustion Engineering on Ohio Edison's Niles No. 1 cyclone-fired boiler. Closely following the Niles start-up, EER began a reburn demonstration under DOE's Clean Coal Technology Program (CCTP) on the Illinois Power's Hennepin No. 1 tangentially-fired boiler. This was followed by other EER CCTP demonstrations on the City Water, Light, and Power's Lakeside No. 7 cyclone-fired boiler and Cherokee No. 3 wall-fired boiler. EPA also sponsored a gas-fired reburn demonstration on the Ladyzhin No. 4 wet-bottom boiler in Ukraine. This project was performed by ABB Combustion Engineering and, to date, is the largest boiler on which reburning has been demonstrated. Another CCTP demo was performed by B&W on Wisconsin Power & Light's Nelson Dewey No. 2 boiler. This was the first coal-fired reburn system demonstration. Each of these tests will be described in more detail later in this report.

Organization

This report serves as a summary of reburning technologies that are being tested on coal-fired, utility boilers and reflects on-going work in the field of reburning systems. The data presented in this report represent an overview of the tests occurring within the U.S. as well as abroad. This report includes results of demonstrations performed through mid-1994 and, necessarily, is not all-inclusive. In Chapter 2, the chemistry of NO_x formation in coal-fired boilers is presented along with the theoretical basis for NO_x emission control through reburning. Also in Chapter 2, an overview of various types of coal-fired boilers to which reburning may be applied is provided. Representative case studies and test data for a range of boiler types are summarized in Chapter 3. The process economics of retrofitting reburning to an existing boiler is discussed in Chapter 4. The potential for combining reburning with other NO_x emission control techniques is examined briefly in Chapter 5. A list of the references cited in this report is contained in Chapter 6. Finally, a bibliography of other available reports of interest is presented in Chapter 7.

Chapter 2

Theories of NO_x Formation and Control by Return

NO_x Formation

NO_x emissions from combustion devices commonly are considered to be comprised of nitric oxide (NO) and nitrogen dioxide (NO₂). For most combustion systems, including coal-fired boilers, significant evidence exists to show that NO is the predominant NO_x species (over 95% of the total). In recent work, other forms of nitrogen oxides, e.g., N₂O, have been identified and are being researched to characterize their contribution and their importance to the need to control total NO_x. N₂O is of concern primarily because of its impact on ozone reduction in the stratosphere. However, for purposes of emissions control, NO_x is defined as the sum of NO₂ and NO, fully converted to NO₂. This corresponds to the output of a chemiluminescence instrument, the most widely accepted NO_x measurement technique.

The formation of NO_x from a specific combustion device is determined by a complex interaction between chemical, physical, and thermal processes occurring within the device. To help simplify the understanding of NO_x formation and assist in identifying control strategies, NO_x typically is considered to form through three mechanisms:

- Thermal NO_x - formed by the oxidation of atmospheric nitrogen by free oxygen atoms in the higher-temperature regions of the combustion flame;
- Fuel NO_x - formed from chemical reactions involving nitrogen atoms chemically bound within the fuel component species; and
- Prompt NO_x - formed by chemical reactions between atmospheric nitrogen and fuel-derived hydrocarbon radicals and subsequent oxidation.

Thermal NO_x Formation

Thermal NO_x results from the oxidation of atmospheric nitrogen in the higher-temperature and air-rich regions of a combustion system. Dependent upon the type of fuel and the air mixing profiles within the combustion

device, these regions can be a distinct fuel/air flame (mixing) front, turbulent eddies of near-stoichiometric composition, or a premixed* near-stoichiometric condition. With the complex combustion processes occurring in coal-fired boilers and their wide range of design types, each of these situations is feasible and, in fact, may occur even within different regions of the same boiler.

The basic chemical mechanism occurring in each of these situations has been well characterized in sub-scale research studies and proven in full-scale combustion systems. During combustion at high temperatures in air-rich regions, oxygen radicals are formed from the dissociation of atmospheric oxygen by thermal and chemical means. These atoms react with nitrogen molecules to start the reactions that comprise the thermal NO_x formation mechanism:



Reaction 2-2 is highly temperature dependent and occurs to an appreciable extent in combustion devices of all types but only at significant rates at temperatures above 3200°F. The principal source of O atoms for this reaction is dissociation of O₂ (reaction 2-1), although other hydrocarbon/oxygen reactions can also contribute O atoms. Reactions 2-2 and 2-3 produce approximately the same amount of NO, with the first reaction being the only significant source of N atoms for the reactions 2-3 and 2-4. Reaction 2-4 is generally of lower significance in the formation scheme.

*A premixed flame exists when the reactants are mixed prior to chemical reaction.

The major factors that influence thermal NO_x formation are temperature, O atom concentrations, and residence time. However, the mixing history of hydrocarbons from coal with the combustion air and flue gas products controls the actual profiles of temperature, stoichiometry, and residence time distributions. If these parameters can be changed dramatically, thermal NO_x formation is suppressed or "quenched." This quenching is the basis for several well-proven NO_x control strategies.

For these reactions and the related reactions controlling temperatures, O_2 , and O species concentrations have been studied using thermochemical equilibrium and chemical kinetic digital computer programs. The results from these programs, showing the importance of time, temperature, and stoichiometry (oxygen availability), are shown in Figures 2-1 and 2-2 (Bagwell et al., 1971).

Calculated NO_x concentration as a function of the equivalence ratio* and time for 650°F combustion air preheat

* Equivalence ratio is defined as the actual fuel/oxidizer ratio divided by the stoichiometric fuel/oxidizer ratio, and is given the symbol of ϕ

is depicted in Figure 2-1. The NO_x formation rate is a maximum for slightly air-rich mixture ratios and decreases rapidly as the mixture becomes increasingly fuel rich. The rate of NO_x formation decreases for increasingly fuel-rich mixtures. The principal reason is that the available oxygen will react much more readily with the hydrogen and carbon than with the nitrogen. The decrease in oxygen atom concentration is more important than the secondary effect of the decreasing temperature. The temperature decay is relatively slow because the excess fuel contributes little to the total mass.

The NO_x formed in coal-fired combustion devices is primarily a burner phenomenon, since the temperature of the bulk gas is too low to support significant NO_x formation. The type of burner utilized has a predominate role in the quantity of NO_x formed during combustion. Higher-intensity burners typically generate more NO_x than lower-intensity, delayed-mixing burners. Rapid mixing (producing flame zones that are closer to an equivalence ratio of 1 and of higher temperature) affects the rate of NO_x formation. This effect of mixing on NO_x formation rate is illustrated in Figure 2-2.

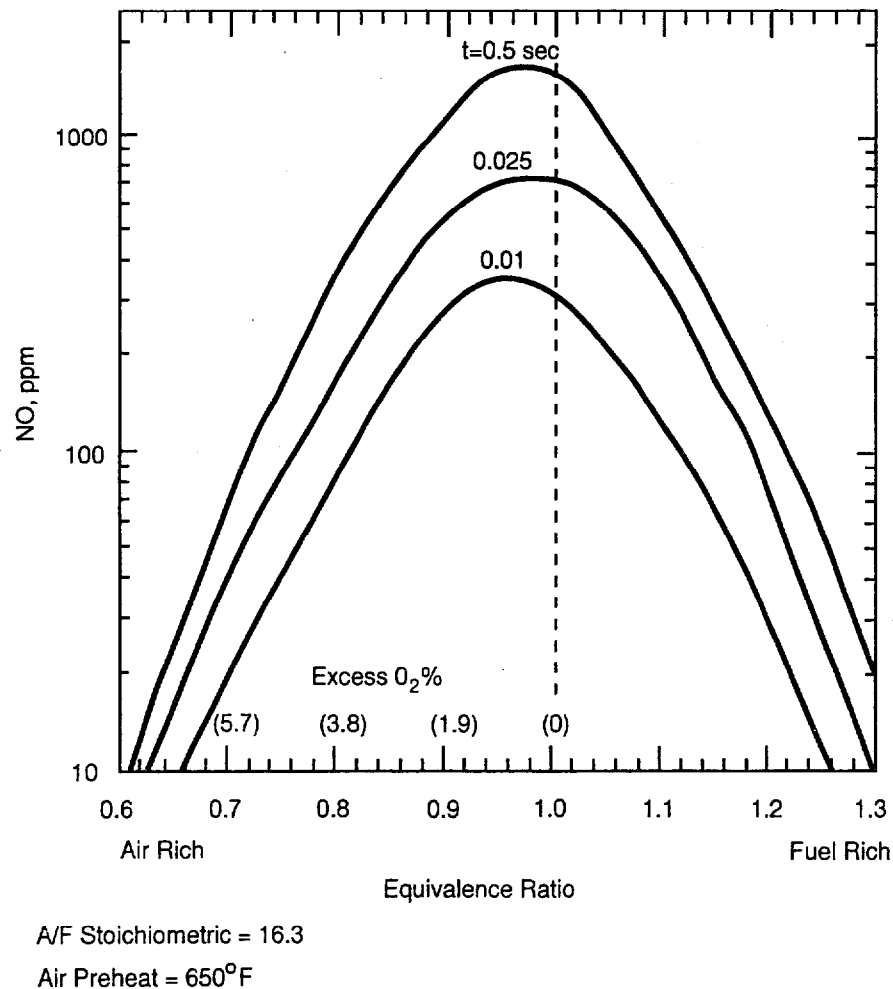

Figure 2-1. Effect of Equivalence Ratio on NO_x Formation (Bagwell, et al. 1971).

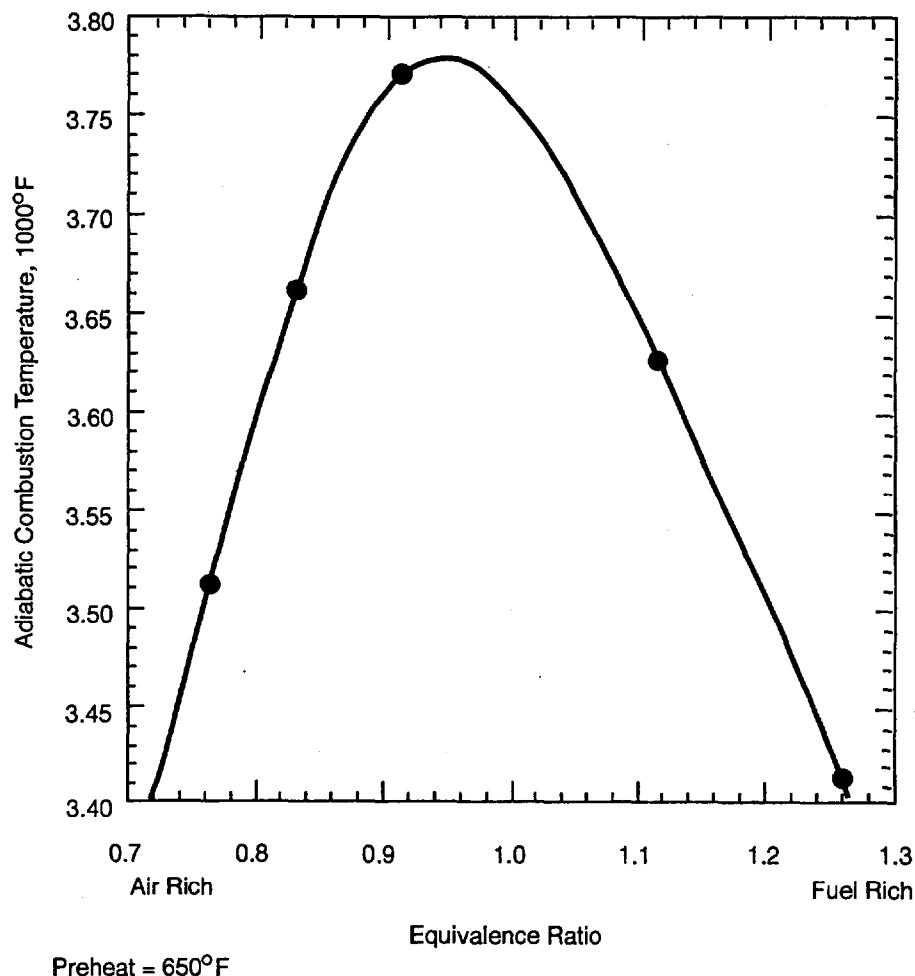

Figure 2-2. Effect of Equivalence Ratio on Adiabatic Combustion Temperature (Bagwell et al., 1971).

The role of the furnace in NO_x formation is significant, also. NO_x formation in boilers begins with the onset of combustion as turbulent eddies or pockets of air/fuel mixtures expand into the furnace. The amount of NO formed depends upon subsequent temperature and concentration time histories of the individual gas pockets. Temperature decay of the gas products results primarily from mixing with combustion air and recirculating bulk gas. Furnace design and burner spacing are factors that control the temperature and amount of recirculating bulk gas. As the temperature decreases, the NO formation rate decreases and essentially ceases when the temperature drops below approximately 2000°F.

The conceptual model described above can be used to understand and satisfactorily control formation of NO_x from coal-fired utility boilers. From a macroscopic viewpoint, NO_x emissions from coal-fired utility boilers are reduced as the boilers' combustion intensities are reduced. Combustion intensity is defined as the heat release per unit volume and time ($\text{Btu}^*/\text{ft}^3/\text{hr}$), and can be

* Btu = British thermal unit.

considered as an averaged temperature-residence time rating parameter. Specifics of these rankings will be reviewed in a later section when boiler types are discussed in order of increasing combustion intensity.

From a microscopic viewpoint, however, the actual combustion distribution function for the fuel can vary widely for individual boilers within a particular family of similar boiler types. This is because the local (microscopic) combustion profiles within the device actually dictate the overall NO_x production. Delayed-mixing burners or coal fuel splitter tips try to exploit this. Thus NO_x emission control strategies can become very specific to each boiler.

Coal-fired boilers were historically designed for high temperature combustion to ensure complete combustion of the coal, to minimize unburned carbon that could increase plume opacity and preclude fly ash sales, and to minimize the size and cost of the boiler. In the case of cyclone-fired boilers and other wet-bottom boilers, high temperatures were required to produce a free-flowing molten ash. These design factors resulted in high NO_x production

rates that research and development efforts are attempting to alleviate.

Fuel NO_x Formation

The oxidation of fuel-bound nitrogen very often is the principal source of NO_x emissions in combustion of coal and some fuel oils (natural gas contains negligible quantities of fuel-bound nitrogen compounds). The heterocyclic-ring nitrogen compounds of pyridine, piperidine, and quinoline are the most common ones found in fuel oil. Both chain and ring nitrogen-bearing compounds are found in coal. The reactions involved are not so clear cut as are reactions forming thermal NO_x. One theory proposes cyanide (CN) as an intermediate step, while another proposes that atomic N is released as the bonds are broken. The rate of conversion of the fuel-bound nitrogen to NO is dependent on the properties of the nitrogen-bearing compounds as well as their rate of evolution during combustion.

Numerous studies have been conducted to determine the percent of the total fuel-bound nitrogen converted to NO. Figure 2-3 contains data on the sensitivity of fuel-bound nitrogen conversion to stoichiometry (oxygen availability) for equivalence ratios ranging from 0.6 to 1.4 (Pohl and Sarofim, 1976). Other studies have con-

firmed this sensitivity and also have shown that the conversion is relatively insensitive to temperature variations.

During coal combustion, the burning of coal particles takes place as either volatiles released from the coal particle or as char burnout of the remaining solid material. Fuel NO can be formed in both combustion phases and is described as either volatile NO or char NO. Recent research data on coal and char oxidation show that the devolatilized nitrogen compounds amount to the major fraction of the NO produced from fuel-bound nitrogen. The char-nitrogen contribution, however, cannot be neglected.

The results of one research program (Pershing and Wendt, 1976) are shown in Figure 2-4, which illustrates the relative proportions of thermal NO and fuel NO (volatile NO + char NO) produced in the combustion of coal. The findings of the program indicate that the fuel NO comprises approximately 80% of the total NO formed in coal combustion. This illustrates the reason reducing the peak flame temperature (control of thermal NO) is relatively ineffective in reducing coal-fired NO emissions. The stoichiometry has a substantial impact on fuel NO formation. The conversion of fuel nitrogen to NO_x is reduced by delaying the addition of O₂ required to complete the combustion until after the fuel-bound nitrogen has reacted and/or until the combustion temperature has de-

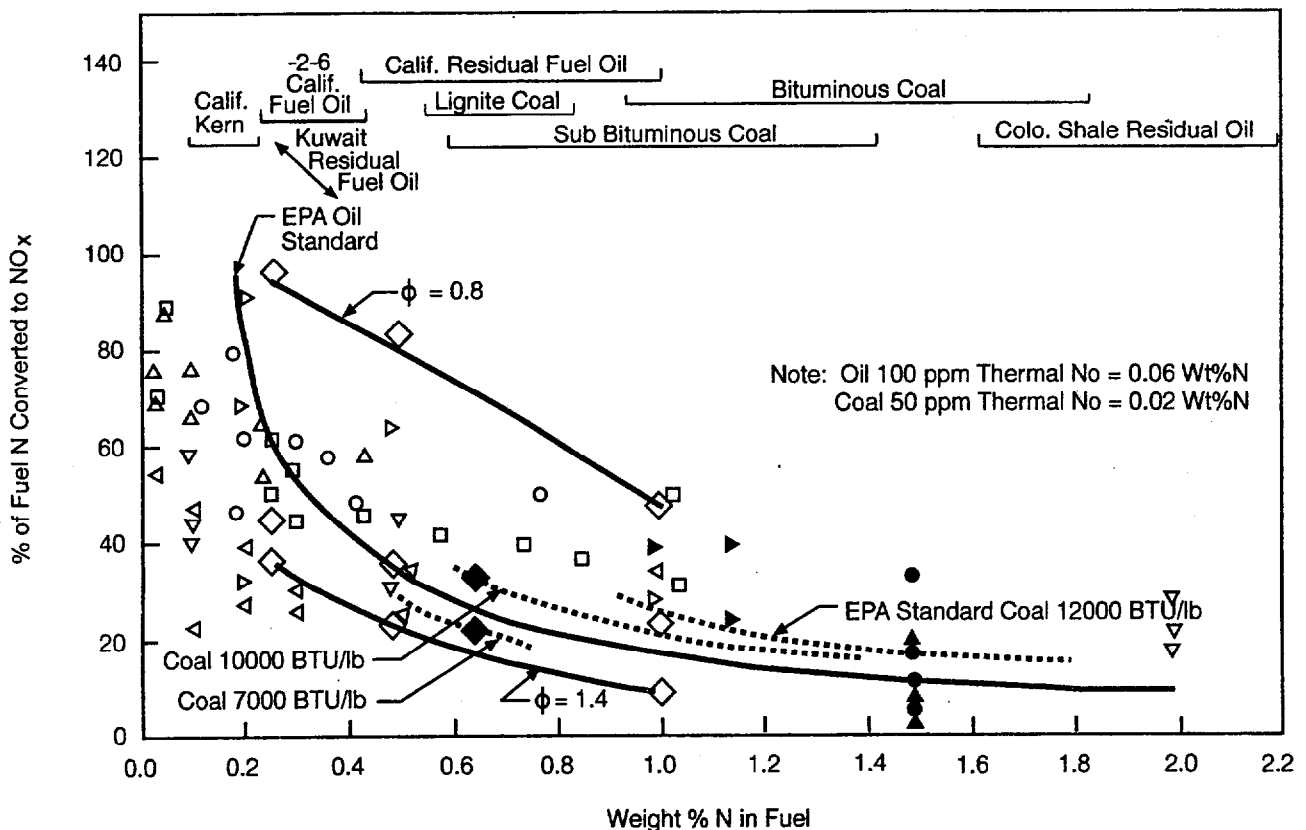

Figure 2-3. Conversion of Fuel-Bound Nitrogen in Practical Combustors (Pohl and Sarofim, 1976).

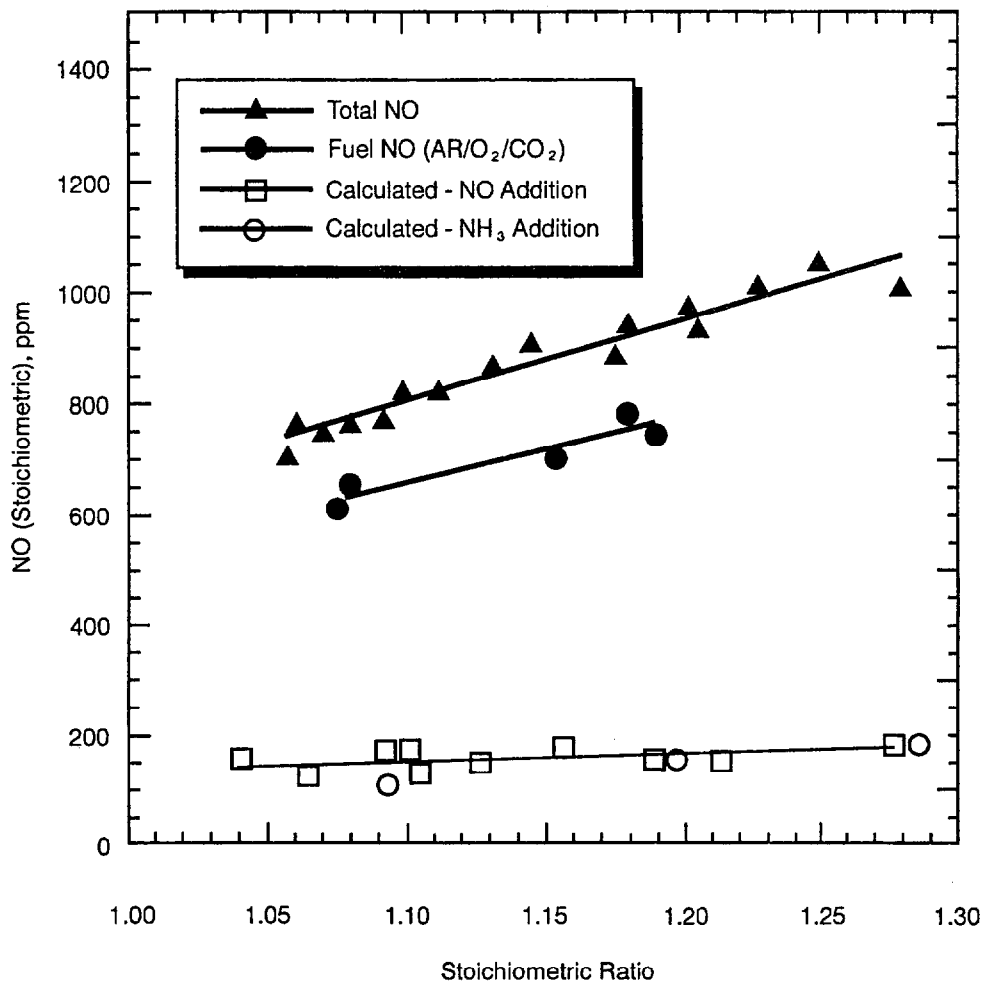

Figure 2-4. Sources of NO_x Emissions from Coal (Pershing and Wendt, 1976).

creased. In this manner the fuel-bound nitrogen oxidation occurs under fuel-rich conditions that favor the formation of N₂ and lower the conversion rate to NO_x.

During one study (Singer, 1991), fuel NO_x was measured in a large tangentially-fired coal utility boiler. Fuel NO_x formation correlated well with the fuel oxygen-to-nitrogen ratio (Figure 2-5), suggesting that fuel oxygen (or some other fuel property that correlates well with fuel oxygen) influences the percentage of fuel nitrogen converted to fuel NO_x. This corresponds to previous observations that greater levels of NO_x are found in air-rich combustion environments.

In spite of a detailed understanding of the mechanisms for fuel-bound nitrogen conversion to NO_x, the approaches used to control thermal NO_x work as well or better on the fuel-bound nitrogen, i.e., oxygen stoichiometry has a significant effect on NO_x formation and temperature has a lesser, but still important, effect. Thus, two forms of NO_x (fuel NO_x and thermal NO_x) are con-

trolled by the same methods, but for different reasons, as explained in the preceding discussion.

Prompt NO_x Formation

Prompt NO_x results from the reactions of atmospheric nitrogen and hydrocarbon radicals during combustion. As opposed to the slower thermal NO_x formation, prompt NO_x formation is rapid and occurs on a time scale comparable to the energy release reactions (i.e., within the flame). Thus, prompt NO_x formation cannot be quenched in the manner by which thermal NO_x formation is quenched. However, the contribution of prompt NO_x to the total NO_x emissions of a system is not significant (Bartok and Sarofim, 1991).

Although some uncertainty exists in the detailed mechanisms for prompt NO_x formation, the principal products of the initial reactions, hydrogen cyanide (HCN) or CN radicals, are believed to be generated during combus-

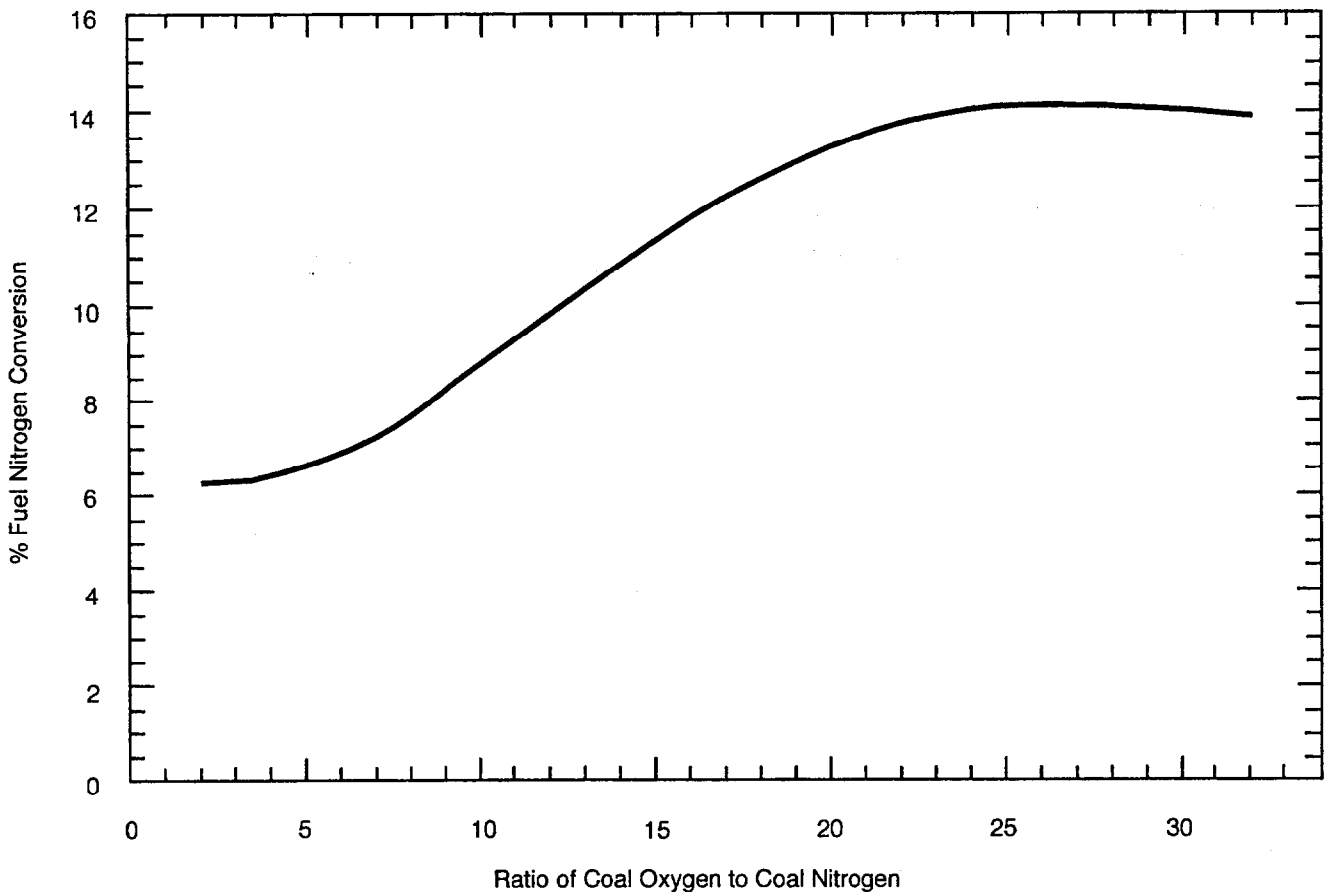
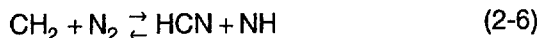
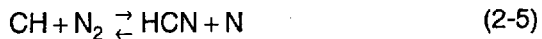

Figure 2-5. Fuel-Bound Nitrogen-to-Nitrogen Oxide in Pulverized Coal Combustion (Singer, 1991).

tion of the fuel, and the presence of hydrocarbon species is considered to be essential for the reactions to take place (Glassman, 1987). The following reactions are the most likely initiating steps for prompt NO_x :



HCN is then further reduced to form NO and other nitrogen oxides.

Measured levels of prompt NO_x for a number of hydrocarbon compounds in a premixed flame show that the maximum prompt NO_x level is reached on the fuel-rich side of stoichiometry (Glassman, 1987). On the fuel-lean side of stoichiometry, few hydrocarbon fragments are available to react with atmospheric nitrogen to form HCN, the precursor to prompt NO_x . With increasingly fuel-rich conditions, an increasing amount of HCN is formed, creating more NO_x . However, above an equivalence ratio of approximately 1.4, not enough oxygen radicals are present to react with HCN and form NO, so NO levels decrease.

Factors That Affect NO_x Emissions

The formation of thermal, fuel, and prompt NO_x in combustion systems is controlled by the interplay of equivalence ratio with combustion gas temperature, residence time, and turbulence (sometimes referred to as the "three Ts"). Of primary importance are the localized conditions within and immediately following the primary flame zone where most combustion reactions occur. In utility boilers, the equivalence ratio and the three Ts are determined by factors associated with burner and furnace design, fuel characteristics, and boiler operating conditions. Subsequent sections of this report contain a discussion of how furnace design, fuel characteristics, and boiler operating characteristics can influence baseline (or uncontrolled) NO_x emission rates.

Boiler Designs

A number of different furnace configurations are utilized in coal-fired, utility boilers. Reburn NO_x emission controls have been applied to tangentially-fired boilers, wall-fired boilers, and cyclone-fired boilers. Boilers can also

be categorized as dry-bottom (non-slugging) boilers and wet-bottom (slugging) boilers.

The majority of utility boilers in the U.S. are of the dry-bottom design. In this design, the temperature in the lower part of the furnace is kept below the initial deformation temperature of the coal ash (from 2000°F to over 2500°F depending upon the coal ash chemical composition and the oxygen stoichiometry through which the ash passes) and the ash is collected as a dry particulate. Typically, only 20 to 30% of the total ash production is collected in the bottom of the furnace as bottom ash; the remaining 70 to 80% leaves the boiler as fly ash entrained with the flue gas.

In wet-bottom boilers, the temperature in the lower part of the furnace is maintained above the fluidization temperature of the ash. This temperature also depends on the chemical composition of the ash but is typically greater than 2400°F. The majority of the ash (60 to 80%) is collected in the bottom of the furnace as molten slag. This slag is removed from the furnace and quenched in a slag tank. The remaining ash is entrained with the flue gas leaving the boiler and is removed by particulate control equipment. Wet-bottom boilers are most frequently used for coals with low ash fusion temperatures that would result in ash entering the convection portion of the boiler in a molten condition, creating severe slugging conditions.

The characteristics of the boiler designs determine the uncontrolled NO_x emissions of the boiler. In particular, the design furnace temperature and heat release rate affect the formation of thermal NO_x and fuel NO_x.

Tangentially-Fired Boilers

The tangentially-fired boiler is a dry-bottom boiler based on the concept of a single flame zone within the furnace. As shown in Figure 2-6, the fuel-air mixture in a tangentially-fired boiler projects from the four corners of the furnace along a line tangential to an imaginary cylinder located along the furnace centerline (Singer, 1991). As shown in Figure 2-7, the burners in tangentially-fired boilers are incorporated into stacked assemblies that include several levels of primary air/fuel nozzles interspersed with secondary air supply nozzles and warmup guns. The burners inject stratified layers of fuel and secondary air into a relatively low-turbulence environment. The stratification of fuel and air creates fuel-rich regions in an overall fuel-lean (i.e., air-rich) environment. Before the layers are mixed, ignition is initiated in the fuel-rich region. Near the turbulent center fireball, cooler secondary air is quickly mixed with the burning fuel-rich region, ensuring complete combustion.

The delayed mixing of fuel and combustion air reduces local peak temperatures and thermal NO_x formation. In

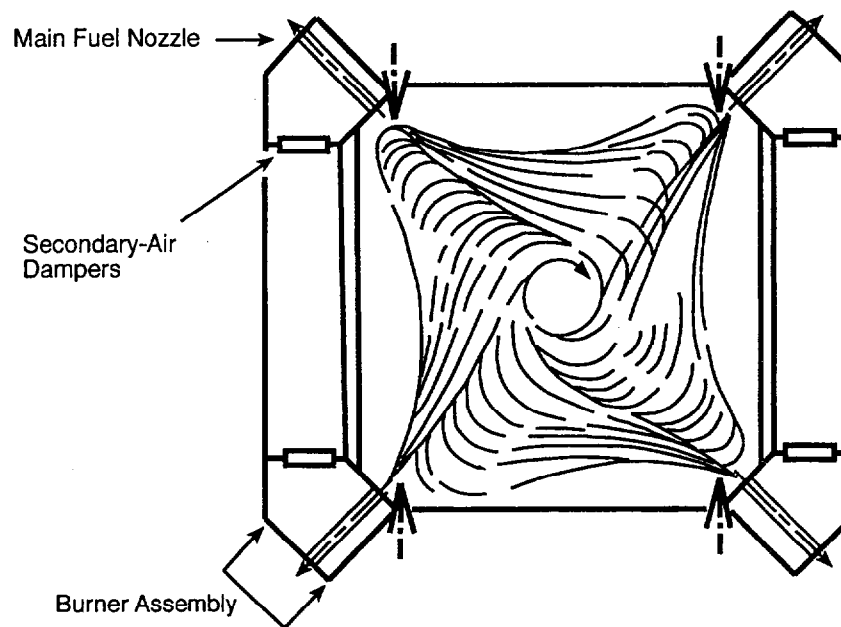

Figure 2-6. Firing Pattern in a Tangentially-Fired Boiler (Singer, 1991).

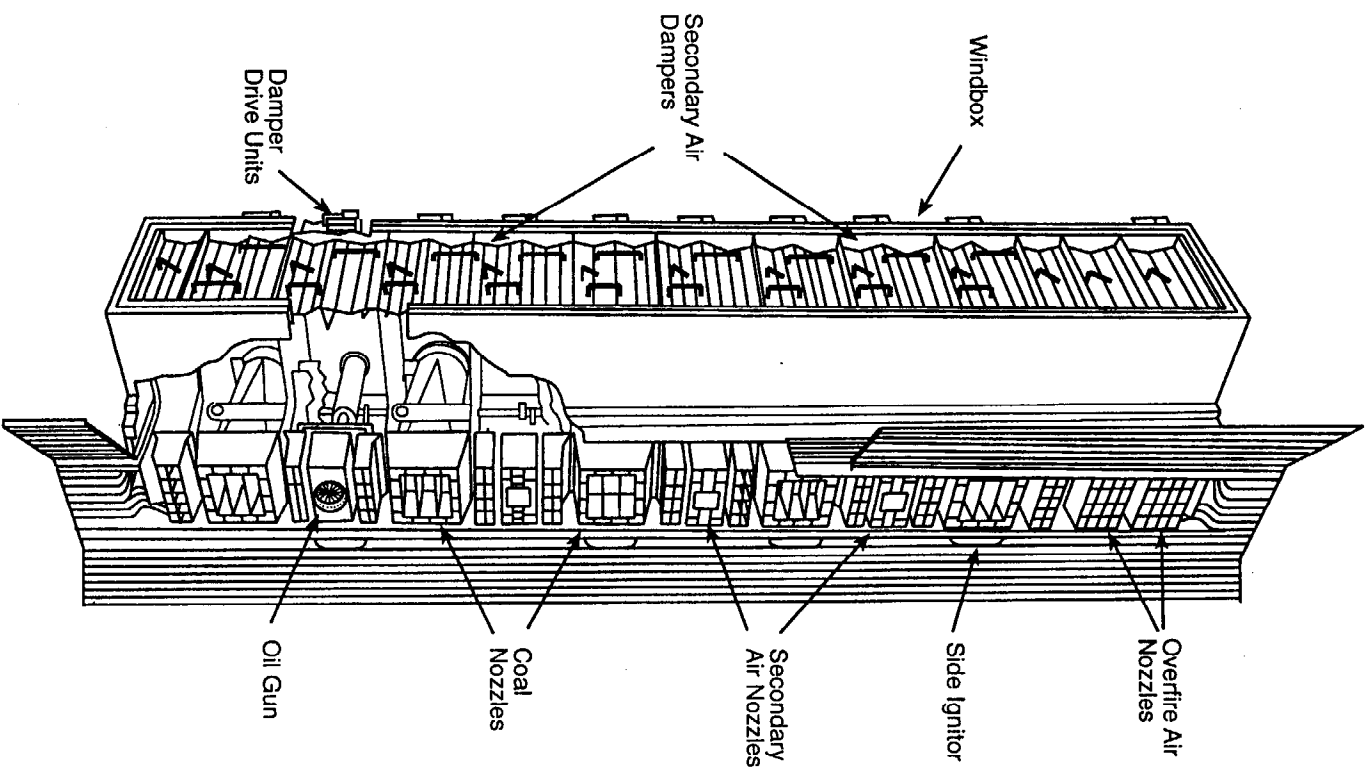

Figure 2-7. Burner Assembly of a Tangentially-Fired Boiler (Singer, 1991).

addition, the delayed mixing provides the fuel-nitrogen compounds a greater residence time in the fuel-rich environment, thus reducing fuel NO_x formation.

In a tangentially-fired boiler, the fuel and air nozzles tilt vertically in concert. This tilting allows the fireball to be moved up and down within the furnace to control the furnace exit gas temperature and provide superheated steam temperature control during variations in load. Tilting the nozzles downward also reduces NO_x formation by producing more effective heat transfer to the boiler's waterwalls.

Wall-Fired Boilers

Wall-fired boilers are characterized by multiple individual burners located on a single wall or on opposing walls of the furnace. These boilers can be of either the wet-bottom or dry-bottom design depending on the heat release rate in the boiler. In contrast to tangentially-fired boilers that produce a single flame envelope, or fireball, each of the burners in a wall-fired boiler has a relatively distinct, high-intensity flame zone. These flame zones interact with each other due to combustion gas recirculation regions set up between them. Depending on the design and location of the burners, wall-fired boilers can be subcategorized as either single-wall, opposed-wall type boilers. Other variations include cell burner, vertical-fired, arch-fired, and turbo-fired type boilers.

Single-Wall and Opposed-Wall Type Wall-Fired Boilers

The single-wall design consists of several rows of circular-type burners mounted on either the front or rear wall of the furnace (Figure 2-8). Opposed-wall units have circular burners on the front and rear walls and have a greater furnace depth.

Circular burners introduce a fuel-rich mixture of fuel and primary air into the furnace through a central nozzle (Figure 2-9) (Stultz and Kitto, 1992). Secondary air is supplied to the burner through separate adjustable inlet air vanes. In most circular burners, these air vanes are positioned tangentially to the burner centerline and impart rotation and turbulence to the secondary air. The degree of air swirl, in conjunction with the flow-shaping contour of the burner throat, establishes a recirculation pattern extending several burner throat diameters into the furnace. The high level of turbulence between the fuel and secondary air streams promotes rapid coal volatilization and creates a nearly stoichiometric combustion mixture. Under these conditions, combustion gas temperatures are high and contribute to thermal and fuel NO_x formation. In addition, the high level of turbulence causes the amount of time available for fuel reactions under reducing conditions to be relatively short, thus increasing the potential for formation of fuel NO_x .

Unlike tangentially-fired boiler designs, the burners in wall-fired boilers do not tilt. Superheated steam temperatures are instead controlled by excess air levels, heat input, flue gas recirculation, and/or steam attemperation.

Cell-Burner Type Wall-Fired Boilers

Cell-burner type units consist of two or three vertically aligned, closely spaced burners, illustrated in Figure 2-10 (Stultz and Kitto, 1992). The cell burners are mounted on opposing walls of the furnace. Cell-burner furnaces have highly turbulent, compact combustion regions. This turbulence promotes fuel-air mixing and creates a near-stoichiometric combustion mixture. As described above, these conditions promote the formation of both fuel and thermal NO_x . The close spacing of the fuel nozzles generates hotter, more turbulent flames than the flames in more widely spaced burners of other wall-fired designs. A higher heat release rate is achieved, but at relatively higher NO_x emission levels. The high heat release rate causes local temperatures to increase even further, causing thermal NO_x to increase due to its dependency on local temperature.

Vertical-, Arch-, and Turbo-Fired Boilers

Vertical- and arch-fired boilers have burners that are oriented downward. These boilers were developed primarily to burn solid fuels that are difficult to ignite, such as anthracite. They have more complex firing and operating characteristics than the previously discussed boiler types. Anthracite burned in conventional boilers would require supplemental fuel for ignition. These types of boilers eliminate that requirement.

Pulverized coal is introduced through the nozzles, with heated combustion air discharged around the fuel nozzles and through adjacent secondary ports (Figure 2-11) (Singer, 1991). Tertiary air ports are located in rows along the front and rear walls of the lower section of the furnace.

The units have long, looping flames directed into the lower furnace. Delayed introduction of the tertiary air provides the necessary air to complete combustion. The long flames allow the heat release to be spread out over a greater volume of the furnace, resulting in locally lower temperatures. The lower turbulence allows the initial stages of combustion to occur in fuel-rich environments. As a result, fuel NO_x and thermal NO_x are reduced.

Turbo-fired units have burners on opposing furnace walls firing downward into a highly turbulent combustion chamber. The turbo burners themselves are angled downward and typically are less turbulent than the circular burners in opposed-wall units. The lower combustion chamber has highly recirculating flows that exit to the main boiler region through a throat. The high-intensity, nearly adiabatic, combustion chamber region leads to high NO_x for-

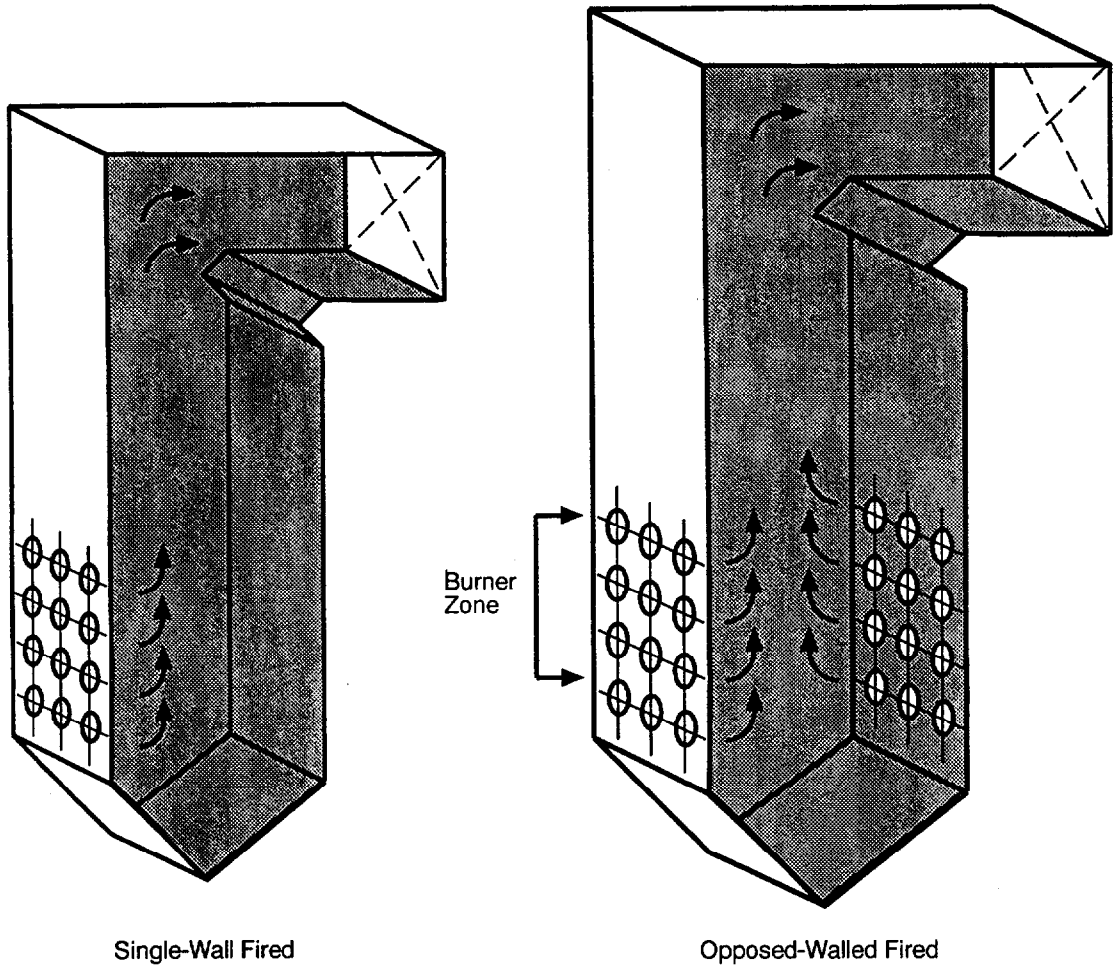

Figure 2-8. Single-Wall and Opposed-Wall Type Wall-Fired Boilers.

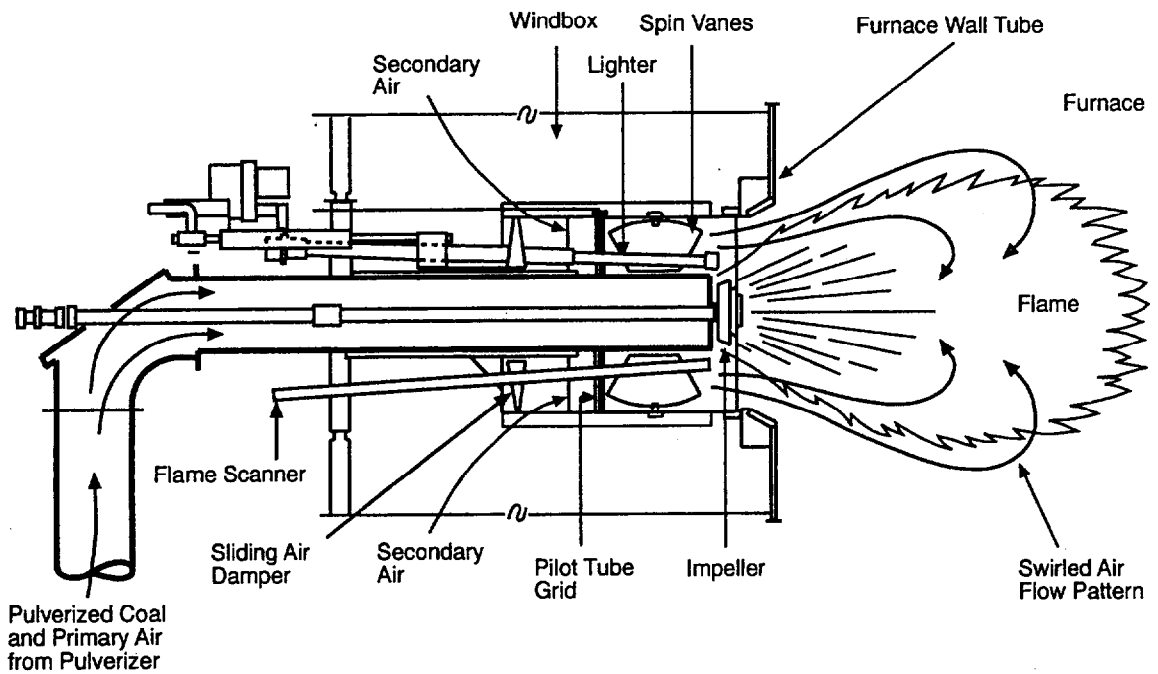

Figure 2-9. Typical Circular Burner (Stultz and Kitto, 1992).

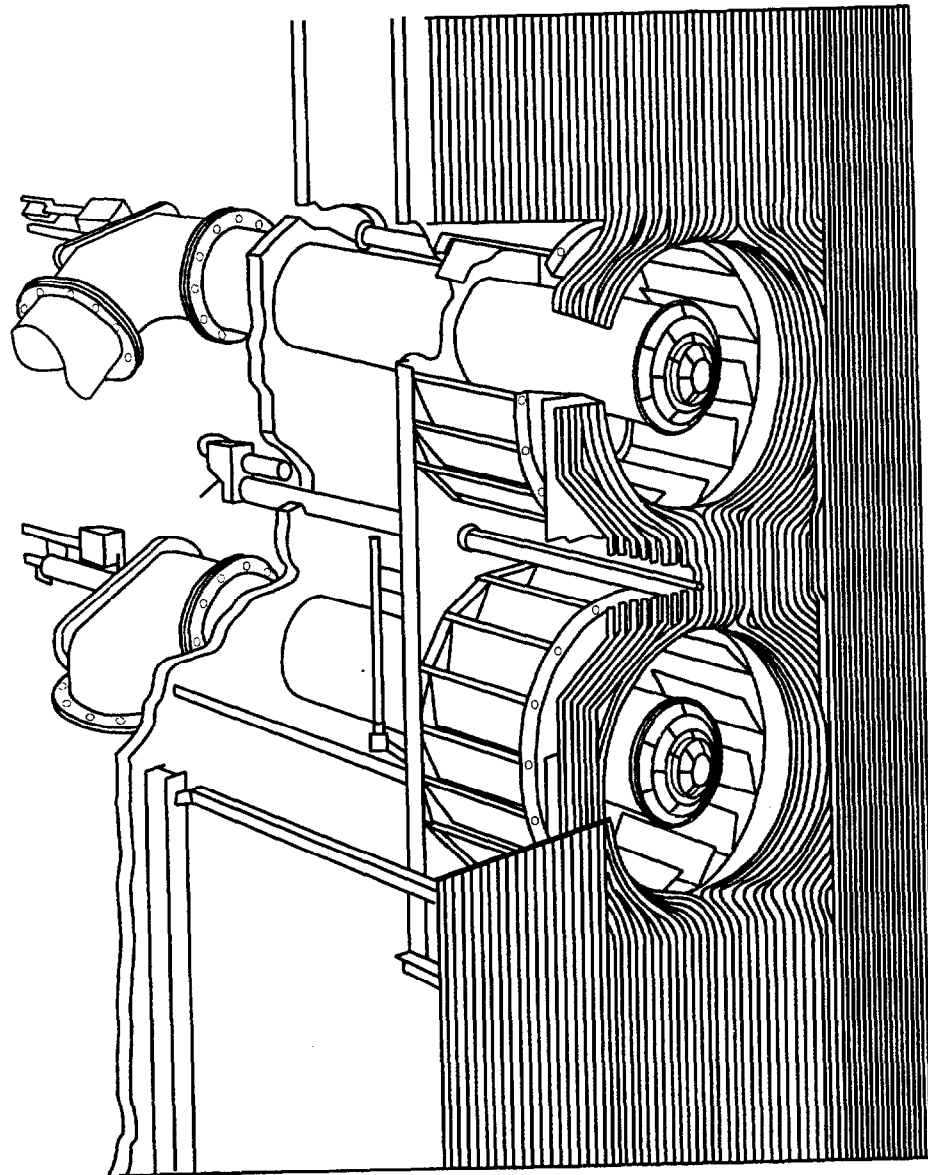

Figure 2-10. Cell Burner (Stultz and Kitto, 1992).

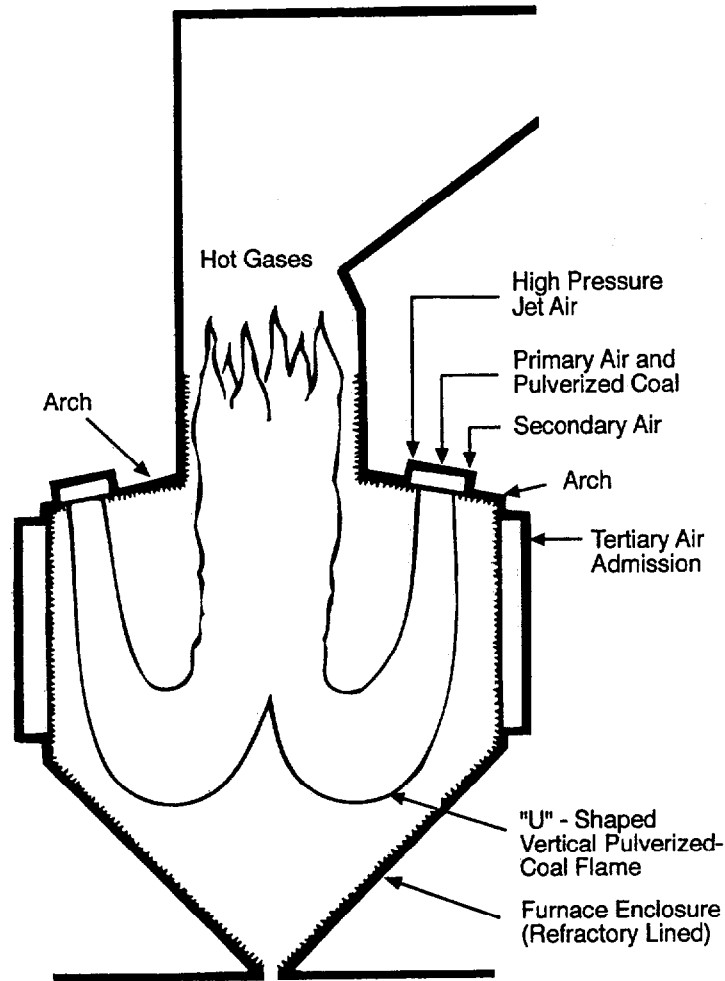

Figure 2-11. Flow Pattern in an Arch-Fired Boiler (Singer, 1991).

mation for coal firing but provides for good carbon utilization (burnout).

Cyclone-Fired Boilers

The cyclone-fired boiler is a wet-bottom boiler design that burns crushed, rather than pulverized, coal. Fuel and air are burned in horizontal cylinders, producing a spinning, high-temperature flame (Figure 2-12) (Farzan et al., 1991). Only a small amount of wall surface is present in the cylinder and this surface is partially insulated by a molten slag layer. Thus, burners in cyclone-fired boilers have a combination of high heat release rate and low heat absorption rates, which results in very high flame temperatures and the conversion of ash in the coal into a molten slag. Slag collected on the burner cylinder

walls flows out of the burners, down the furnace walls, and into a water-filled slag tank located below the furnace. The combination of high heat release rate, high combustion temperatures, and near stoichiometric fuel/air mixtures encourages formation of both thermal and fuel NO_x .

Because of their slagging design, cyclone-fired boilers are almost exclusively coal-fired, except for some units that were designed to also fire oil and natural gas (or have been converted to do so). The single-wall firing and opposed-wall firing arrangements used for cyclone firing are illustrated in Figure 2-13 (Stultz and Kitto, 1992). For smaller boilers, sufficient firing capacity usually is attained with cyclone burners located in only one wall. For large units, furnace width often can be reduced by utilizing an opposed-fired configuration.

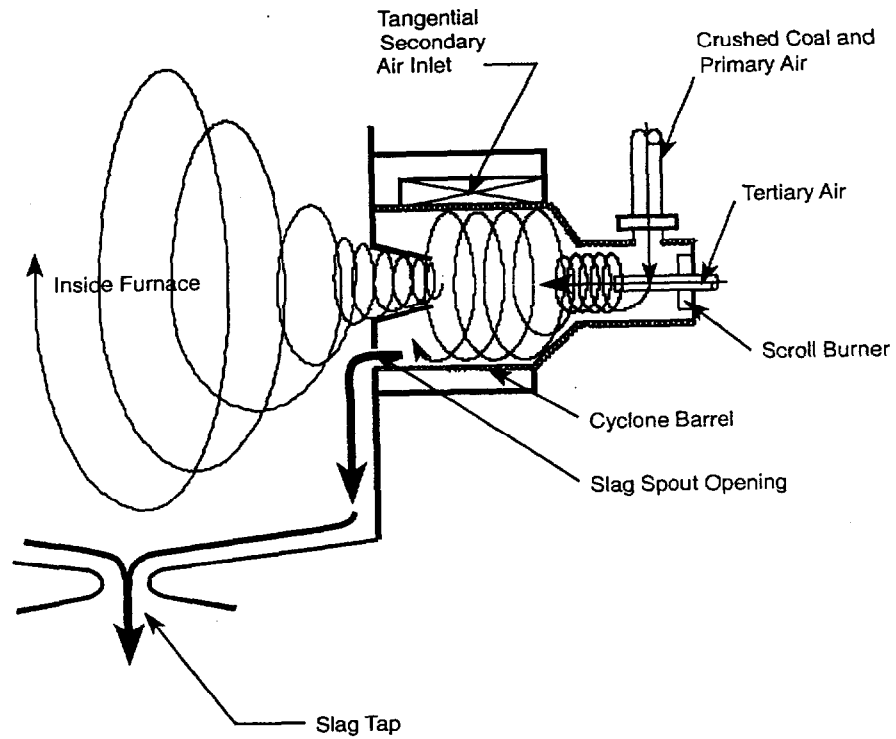

Figure 2-12. Cyclone Burner (Farzan, et al., 1991).

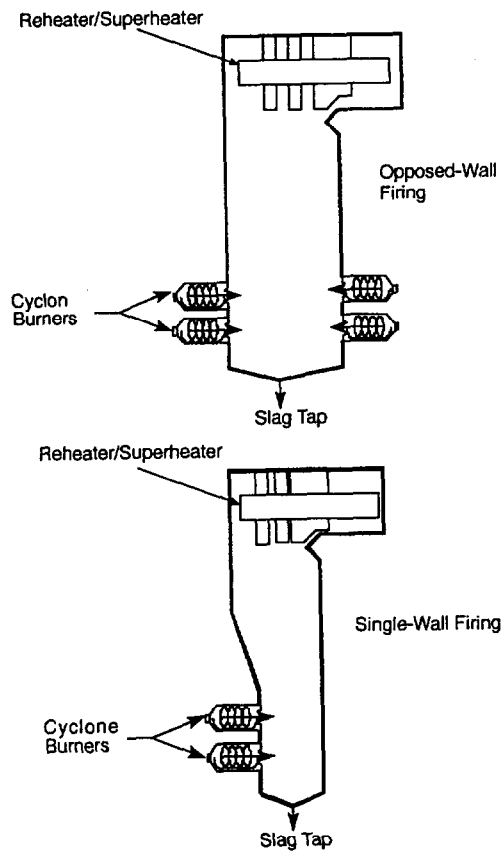

Figure 2-13. Firing Arrangements Used with Cyclone-Fired Boilers (Stultz and Kitto, 1992).

Theory of NO_x Emission Control by Reburn

Three-Stage Combustion

Reburn is a combustion hardware modification in which the NO_x produced in the main combustion zone is reduced downstream in a second combustion zone (the reburn zone). Up to 20% of the total fuel input (on a Btu per hour basis) is diverted from the main combustion zone and introduced above the top row of burners to create reducing (sub-stoichiometric) conditions in the reburn zone. The reburn fuel (which may be natural gas, oil, or pulverized coal) is injected to create a fuel-rich zone where the NO_x formed in the main combustion zone is reduced to nitrogen and water vapor. The reburn fuel may be injected alone (natural gas or oil) or with either air or recirculated flue gas to improve reburn fuel distribution in the furnace. Combustion of the fuel-rich combustion gases leaving the reburn zone is completed by injecting overfire air (called "completion air" when referring to reburn) in the burnout zone. Figure 2-14 is a simplified diagram of conventional firing and gas reburning as applied to a wall-fired boiler (GRI, 1991).

In reburning, the main combustion zone operates at relatively low oxygen stoichiometry (about 0.9 to 1.1), and receives the bulk of the fuel input (80 to 90% of total heat input). The balance of the heat input (10 to 20%) is injected above the main combustion zone through reburning injectors. The stoichiometry in the reburn zone is in the range of 0.85 to 0.95. To achieve this, the reburn fuel is injected at a stoichiometry of up to 0.4. The temperature in the reburn zone must be above 1,800°F to provide an environment for the decomposition of the reburn fuel.

Any unburned fuel leaving the reburn zone is then burned to completion in the burnout zone, where completion air (15 to 20% of the total combustion air) is introduced. The completion air ports are designed for adjustable air velocities to optimize the mixing and complete burnout of the fuel before it exits the furnace.

The kinetics involved in the reburn zone to reduce NO_x are complex and not fully understood at the present time. The chemical reactions involved in the reburning process were first proposed by J.O.L. Wendt in the late 1960s (Wendt et al, 1973). The following discussion, derived from a recent report on reburn published by the U.S. Department of Energy (Farzan and Wessel, 1991), is based on the concepts introduced in this work. The major chemical reactions are the following:

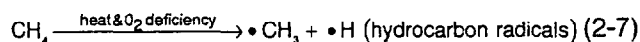

The reaction process shown in Equation 2-7 is hydrocarbon radical formation in the reburn zone. These hydrocarbon radicals are produced due to the pyrolysis of the fuel in an oxygen-deficient, high-temperature environment. The hydrocarbon radicals then mix with the combustion gases from the main combustion zone and react with NO to form CN radicals, NH₂ radicals, and other stable products (Equations 2-8 to 2-10).

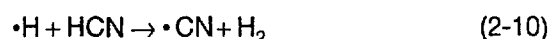
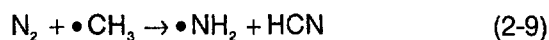
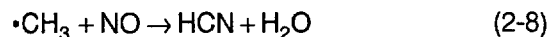

The CN and NH₂ radicals and other products can then react with NO to form N₂, thus completing the major NO_x reduction step (Equations 2-11 to 2-13).

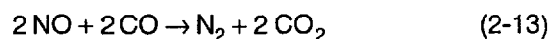
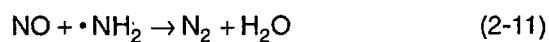

An oxygen-deficient environment is critical to these reactions. If O₂ levels are high, the NO_x reduction mechanism will not occur and other reactions will predominate (Equations 2-14 and 2-15).



To complete the combustion process, air must be introduced above the reburn zone. Conversion of HCN and ammonia compounds in the burnout zone may regenerate some of the decomposed NO_x by the reactions shown in Equations 2-16 and 2-17:

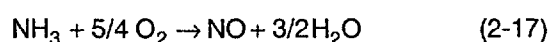
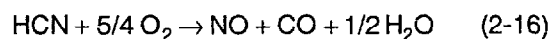

Although some additional NO_x may be formed in the burnout zone through these reactions, the net effect of the reburning process is to significantly reduce the total quantity of NO_x emitted by the boiler.

The NO_x may continue to be reduced by the HCN and NH₃ compounds by the reactions shown in Equations 2-18 and 2-19:

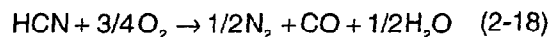

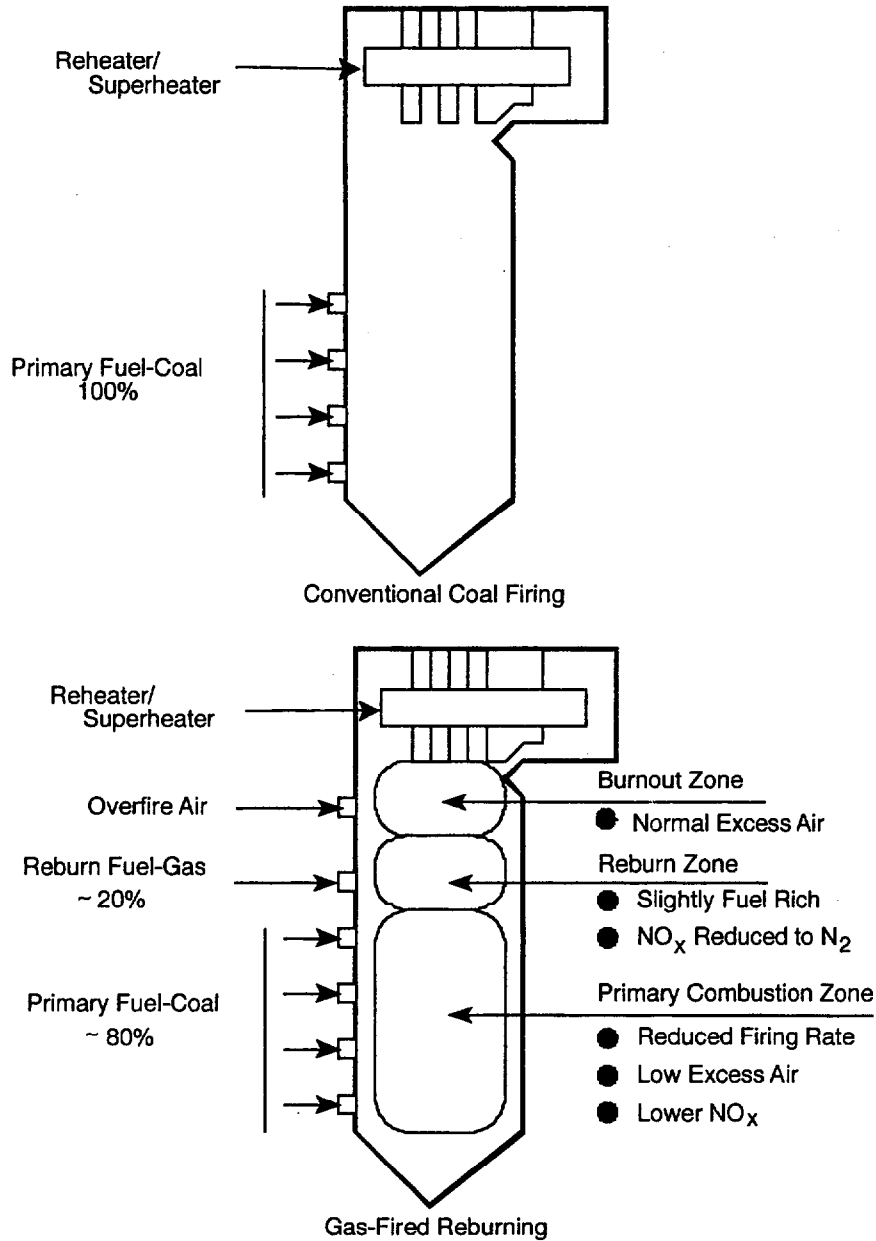
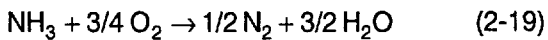

Figure 2-14. Conventional Firing and Gas-Fired Reburn Applied to a Wall-Fired Boiler (GRI, 1991).



able in boilers with high burner heat release rates such as cyclone-fired boilers, and in any type of boiler at high unit load where the heat release rate is at its peak.

Main Burner Zone Heat Release Rate

In addition to the chemical reactions resulting from three-stage combustion, reburning also reduces the formation of thermal NO_x due to the reduced fuel firing rate in the main combustion zone. As discussed previously, boilers with higher heat release rates generate relatively more thermal NO_x . By diverting 10 to 20% of the fuel to the reburn zone, the heat release rate and resulting thermal NO_x production are reduced. This effect is most notice-

Lower Nitrogen Content of Reburn Fuel

The reburn fuel need not be the same as the fuel used in the primary combustion zone, although coal-fired reburn is under active evaluation at several installations and has been demonstrated at the Wisconsin Power & Light Company's Nelson Dewey Unit 2 (see Section 3) (Yagiela et al., 1991). To date, natural gas has been most fre-

quently used as a reburn fuel for retrofit applications to coal-fired boilers. One major advantage of natural gas as a reburn fuel is that it has no significant nitrogen content. Fuel oil (especially distillate oil) also has a lower nitrogen content than coal, but to date has not been studied extensively as a reburn fuel. Because of the reduced nitrogen contents, substituting either natural gas or distillate fuel oil for a portion of the fuel input from coal (also called "co-firing") results in a proportional reduction in fuel NO_x emissions.

Operational Parameters

Operational parameters are those factors related to implementing the reburn NO_x control theory into an operational system. The most significant operational parameters that affect the performance of a reburn system are:

- Reburn fuel type;
- Flue gas recirculation (FGR);
- Fuel/O₂ stoichiometry;
- Reburn zone residence time and temperature; and
- Controls and instrumentation.

Reburn Fuels

Theoretically, the reburn fuel can be any of three basic fossil fuel types: coal, natural gas, or oil, without regard to the type of primary boiler fuel being fired. However, as stated earlier, use of a fuel with a low nitrogen content is advantageous in minimizing fuel NO_x generation.

Natural Gas

Natural gas is typically the most attractive reburn fuel because it is effectively nitrogen-free and, therefore, provides a greater potential NO_x reduction than a reburn fuel with a higher nitrogen content. The replacement of 10 to 20% of the fuel input to the boiler with a nitrogen-free fuel results in a comparable reduction in the fuel-bound nitrogen component of the total boiler NO_x emissions. Natural gas also reacts very rapidly in the reburn zone compared to the alternative fuels. However, because of the relatively lower mass of natural gas, achieving good mixing of it with the flue gas in the reburn zone is difficult. For this reason, a carrier gas such as recirculated flue gas is often used to enhance mixing while maintaining a low O₂ stoichiometry.

If it is already present onsite, natural gas is the most logical reburn fuel for existing gas-fired boilers. The relative ease of handling natural gas and installing gas-fired reburn injectors make this an obvious candidate for boilers burning other primary fuels as well. Natural gas must

be supplied via pipeline and many plants with coal-fired or oil-fired boilers utilize natural gas as an ignition or startup fuel, space heating, or for firing other units. However, if natural gas is not available onsite or not available in sufficient quantity, the cost of installing a new gas pipeline for the purpose of supplying a reburn fuel may be economically prohibitive. Even if natural gas is already available, the cost of natural gas may be higher than alternative fuels on a per energy unit basis. In these cases, an alternative reburn fuel must be evaluated.

Coal

Coal has a higher fuel-bound nitrogen level content than natural gas but is the primary fuel at a very large number of utility boilers. Pulverized coal also has the lowest cost per million Btu of any of the available reburn fuels and mixes well with the flue gas in the reburn zone. Volatile coals are more effective as a reburn fuel than low-volatile coals.

While coal may seem an obvious selection, especially at coal-fired boilers, the use of coal as a reburn fuel may have some significant disadvantages. The use of coal can be difficult if the routing of coal supply pipes to the reburn zone is restricted by work space constraints and/or maximum fuel flow rates would be exceeded. The coal particle size must be minimized to achieve rapid combustion in the reburn zone. Some boilers, such as cyclone-fired boilers, would require the addition of coal pulverizers for the reburn fuel. Firing with pulverized coal also requires the use of a carrier medium, which is typically heated air. This conflicts with optimizing NO_x reductions in the reburn zone which are achieved by minimizing oxygen concentrations in this zone. Oxygen concentrations could be minimized by utilizing FGR instead of air as a carrier gas for coal-firing in the reburn zone. The additional costs associated with using FGR as a carrier medium are discussed in a later section.

Fuel Oil

Fuel oil also has a higher fuel-bound nitrogen level than natural gas but is available at a very large number of utility boilers. Distillate fuel oil is more desirable than heavy fuel oil since it has a lower fuel-bound nitrogen content. Many coal-fired boilers have fuel oil available as a supplemental or startup fuel. No full-scale utility demonstration of NO_x emission control by reburn using fuel oil has been performed as of the writing of this document.

Flue Gas Recirculation

Flue gas taken from just ahead of the air heater may be injected into the reburn zone in conjunction with the reburn fuel. The recirculated flue gas, in lieu of combustion air, can be utilized as a carrier medium for the reburn fuel to increase the penetration and mixing of the reburn

fuel in the boiler and to cool the reburn fuel injectors. Using FGR in the reburn zone minimizes the oxygen concentration in the reburn zone of the boiler, which facilitates the control of O_2 levels in the primary combustion and burn-out zones of the boiler. FGR is also a temperature-quenching strategy in which the recirculated flue gas acts as a thermal diluent to reduce combustion temperatures in the reburn zone.

The use of FGR in a reburn system differs from the traditional uses of FGR in boilers. In some coal-fired boilers operating at peak boiler capacity, flue gas commonly is readmitted through the furnace hopper or above the windbox to control the superheated steam temperature. However, this method of FGR does not reduce NO_x emissions. Windbox FGR has only a minor effect in reducing thermal NO_x and is not effective for NO_x emission control on boilers in which fuel NO_x is a major contributor.

The degree of FGR in reburn systems is variable and depends upon the output limitation of the forced draft (FD) fan and minimum furnace temperatures. To maximize NO_x reduction, FGR is routed through the windbox to the reburn injectors, where temperature suppression can occur within the reburn zone. The effectiveness of the technique depends on the reburn fuel and flow rate. When burning heavier fuel oils or coal, less NO_x reduction would be expected than when burning natural gas because of the higher nitrogen content of the fuel.

Retrofit hardware modifications to implement FGR include new ductwork, a flue gas recirculation fan, devices to mix flue gas with combustion air, and associated controls. In addition, the FGR system itself requires a substantial maintenance program due to the high temperature environment and erosion from entrained fly ash.

Research and development is underway to determine the NO_x capabilities of reburn without FGR in order to reduce the capital cost of the plant modifications needed to implement a reburn system. These efforts are directed toward improved reburn fuel injection methods.

O₂ Stoichiometry

Typically, boilers operate at a furnace O_2 stoichiometry in the range of 1.2 to 1.3 as measured at the air heater inlet. This oxygen-rich environment facilitates higher boiler temperatures and more complete carbon burnout in the furnace. A major factor in reducing NO_x through reburning is the precise control of stoichiometries at each stage in a reburn system. While the stoichiometries are different in each of the combustion zones of a boiler employing a reburn system, the overall stoichiometry as measured at the air heater remains roughly the same.

With implementation of a reburn system, the primary combustion zone excess air is lowered to the minimum

level required to maintain flame stability. Lower primary combustion zone stoichiometries minimize the amount of reburn fuel necessary in the reburn zone to create a fuel-rich condition. Low excess air in the primary combustion zone also minimizes thermal NO_x formation by lowering the zone temperatures. Tests have shown that stoichiometries in the primary combustion zone should be maintained in the range of 1.05 to 1.15.

Considerations that limit the reduction of excess air in the primary combustion zone include flame stability, fuel type, burner type, and boiler rating. Primary combustion flames can become unstable whenever stoichiometries are lowered. Coal ash fusion temperatures are lower under reducing (sub-stoichiometric) conditions, and if combustion temperatures in a dry-bottom boiler falls below the initial softening temperature of the ash, excessive slagging or fouling of the furnace walls occurs. Slagging burners, such as cyclone-fired burners, have minimum combustion temperature requirements in order to prevent solidification (freezing) of the molten slag in the burner and lower portion of the furnace. Without sufficient O_2 in the primary combustion zone, slagging burners are unable to maintain adequate burner temperatures due to incomplete combustion. Each furnace should conduct a parametric testing program in order to determine the minimum levels of excess air in the primary combustion zone required to sustain good boiler operation.

The reburn zone is designed to operate in a fuel-rich environment. By injecting the remainder of the fuel input with little or no additional combustion air, O_2 stoichiometries of 0.85 to 0.95 are achievable in this zone. Reburn fuel flow rates can be affected by constraints in injector capacity and combustion profiles in the furnace.

The final burnout zone, or completion air zone, receives the remainder of the combustion air for the furnace. Typically, O_2 stoichiometries in this zone are 1.2 or greater to facilitate complete carbon burnout. The completion air flow rate is often dependent on the stoichiometric conditions in the previous two combustion stages.

Residence Time

A controlling factor in reducing NO_x emissions with reburn is the flue gas residence time in the reburn and burnout zones. The reburn fuel and combustion gases from the primary combustion zone must be mixed thoroughly for NO_x reduction reactions to occur. The furnace size and geometry determine the placement of reburn injectors and completion air ports, which will ultimately influence the residence time in the reburn and burnout zones. The typical minimum residence times in the reburn and burnout zones for a well-mixed boiler is 0.5 second, which is dependent on the degree of mixing achieved in these zones.

Temperature

The flue gas temperature in the burnout zone is an important factor for the regeneration or destruction of NO_x in this area. High flue gas temperature promotes the conversion of NO_x compounds to N_2 .

Controls and Instruments

Generally the retrofit of a reburn system to an existing boiler will require some modifications to the boiler control system. However, investigators have shown that, with approximate modifications, the control of that reburn system can be automated and made fail-safe.

Additional safety sensors are required to monitor the reburn zone. Safety equipment for burners generally rely on flame sensing; however, the reburn injectors do not produce a visible flame because of the low combustion temperature and limited O_2 . Natural gas combustion also does not produce a strong visible flame, which may further contribute to the lack of a visible flame in the reburn zone. Therefore, a reburn safety system consists of a comprehensive system of permissives and trips.

The permissives are a set of conditions that must be satisfied for startup and continued operation of the reburn system. Trips are critical boiler conditions that will trigger a shut-down of the reburn system. Most of the sensors required for the permissive and trip systems generally are already in place. These sensors monitor fan operating status, boiler pressure, and primary combustion flame. Some temperature sensors may need to be added to the reburn zone. Boiler insurance companies have reviewed this safety system and have determined it to be acceptable.

Potential Application Problems

Boiler manufactures rely on a vast body of design data in the design of a coal-fired boiler. Many interrelated process factors must be weighed in arriving at an optimum boiler design for a given fuel and set of operating characteristics. Existing boilers generally were not designed with the anticipation of a future reburn system installation. As a result, the application of NO_x emission control through reburn presents some characteristic problems that must be considered and overcome. The problems include the following:

- Fuel combustion problems;
- Boiler operating problems;
- Reburn fuel availability and cost;
- Physical constraints;

- Particulate control device problems; and
- Unit inflexibility.

While many of these concerns are present primarily in retrofit application of reburn technology, they must also be addressed in any application to a new boiler.

Fuel Combustion Problems

The existing configuration, spacing, and location of fuel burners were designed by the boiler manufacturer to optimize the efficiency of converting a fossil fuel's chemical energy into usable thermal energy in the steam. The process changes required by the installation of a reburn system can affect the thermal efficiency of the boiler by affecting the combustion characteristics of the fuel in a boiler. The thermal efficiency of fuel combustion can be measured by several parameters including unburned carbon in the fly ash (coal-fired boilers), hydrocarbon levels in the flue gas (oil and gas-fired boilers), and the carbon monoxide (CO) level in the flue gas. If insufficient O_2 is added in the burnout region of the boiler or if insufficient time is available for the completion of combustion, the levels of these parameters would rise. This rise would represent a loss of thermal efficiency in the boiler and necessitate increased operating costs.

Boiler Operating Problems

In addition to loss of thermal efficiency, the boiler may experience other operating problems including the following:

- Steam temperature control problems;
- Increased fly ash production in slagging boilers;
- Boiler tube corrosion;
- Increased boiler tube slagging and fouling; and
- Slag tapping problems.

The following is a brief overview of the characteristics of these problems and some of the steps that can be taken to mitigate them.

Steam Temperature Control Problems

The design of the heat transfer surfaces and of their locations in a boiler (tube walls, superheaters, and reheaters) are based on specific conditions in the boiler such as radiation, convection, and conduction from the primary combustion flame and hot flue gas. The installation of a reburn system can result in a major change in these conditions.

For example, diversion of 10 to 20% of the fuel from the main combustion zone to the reburn zone reduces the amount of heat transfer in the lower portion of the boiler and increases the amount of heat transfer in the upper portion. The ratio of heat transfer by radiation and convection can change as well. Less heat will be transferred to the boiler wall tubes while more heat will be transferred in the superheat and reheat areas. This results in changes to the superheater and reheater temperatures and may destabilize steam temperature control in the boiler.

Increased Fly Ash Production

Increased fly ash production is a particular problem for slagging boilers such as cyclone-fired boilers that use coal as the reburn fuel. Typically, only 20% of the coal ash from a cyclone-fired boiler leaves the boiler as fly ash. The rest is collected as slag in the bottom of the boiler. The diversion of coal from the cyclone burners to the reburn injectors results in the production of a higher percentage of fly ash. This fly ash will increase the erosion of tubes in the convection passes of the boiler and of the air heater surfaces. It also increases the fly ash load on the particulate control device, as discussed later.

Boiler Tube Corrosion

Waterwall tubes and superheater/reheater tubes may experience increased erosion and corrosion for reasons similar to those identified for steam control problems. Reducing conditions in the reburn zone can increase wastage or corrosion of tubes in this area. Extensive measurements of furnace tube wall conditions before and after reburn operation at Ohio Edison's Niles Unit 1 (114 MW, cyclone-fired boiler) and at Illinois Power Company's Hennepin Unit 1 (71 MW, tangentially-fired boiler) have shown tube wastage to be within normal ranges; however this issue is repeatedly raised.

Current theory holds that the tube wastage in reducing zone of coal-fired boilers is principally due to hydrogen sulfide (H_2S) attack from organic sulfur in the coal. In reburn, the coal is burned in a net-oxidizing atmosphere and all of the sulfur is oxidized. If low-sulfur fuel oil or natural gas is used as the reburn fuel, little or no sulfur is available to form H_2S in the reburn (substoichiometric) zone. In test at the two units identified above, the combustion products near the furnace wall were tested and no H_2S was found.

Increased Boiler Tube Slagging and Fouling

Increased flue gas temperatures in the convection passes, operation in reducing (substoichiometric) conditions, and increased fly ash production are all factors contributing to increased boiler tube slagging and fouling conditions. Ash will adhere to boiler tube surfaces if its temperature is above the ash softening temperature. As stated earlier, the ash softening temperature is a func-

tion of the ash chemical composition and is lower under the reducing conditions found in the reburn zone.

In a dry-bottom boiler, oxidizing (above stoichiometric) conditions and temperatures below the ash softening temperature are maintained at the boiler walls and in the convection passes to minimize slagging and fouling. Ash which does accumulate in these areas is removed with soot blowers. The reducing conditions in the reburn zone and the completion of combustion later in the boiler could result in slagging and fouling too severe for soot blowers to handle. The potential problem of tube slagging and fouling may occur in the convection passes of wet-bottom boilers as well.

While these problems remain a possibility, the tests described in Section 3, which were conducted on full-scale boilers, reported no **discernable** increase in slagging during reburn operation.

Slag Tapping Problems

In a wet bottom boiler, the temperatures in the lower furnace must be maintained above the ash melting temperature so that the ash can be collected as a molten slag. Reduced temperatures in the lower furnace can cause the slag to solidify before it can be removed. This problem can be compounded at reduced furnace loads when gas temperatures in the boiler are already reduced. The combination of lower excess air and diversion of a portion of the fuel to higher in the boiler can reduce the primary combustion temperatures which in turn can result in slag solidification. Generally, slag tap plugging results in a lengthy unit outage to remove the plugging.

While such changes in slag behavior are possible, adequate slag fluidity was maintained during the full-scale tests on cyclone-fired boilers at Niles Unit 1 and at City Water, Light, and Power's Lakeside Unit 7. These tests are summarized in Section 3.

Reburn Fuel Availability and Cost

Typically, natural gas is economically feasible as a reburn fuel only at facilities that either already have a sufficient natural gas supply at the site or have a gas pipeline in very close proximity. In comparison with other NO_x control alternatives, the incremental cost of utilizing a natural gas-fired reburn system can be unfavorable unless one of these situations exist. Also, natural gas prices and availability are seasonally dependent, with higher costs and more restricted availability occurring during the winter months. However, NO_x control for ozone precursors may also be seasonally dependent, with the highest level of control needed during the summer months. To determine the economic feasibility of natural gas as a reburn fuel, the potential user must discuss annual prices and availability with the local natural gas supplier.

Limited testing has occurred with coal as a reburn fuel; however implementation of a reburn retrofit does not affect the total quantity of coal fired significantly, only its distribution in the furnace. If coal is used as the reburn fuel, in some cases, reburning will require a finer coal particle size than produced by the existing coal preparation equipment. The fine coal particle size is required to ensure complete fuel combustion during the limited flue gas residence time available in the reburn and burnout zones. This could require additional capital cost for the installation of new or additional pulverizers.

Physical Constraints

While not many limitations exist on the installation of the equipment needed for retrofitting a reburn system on a coal-fired boiler, some physical constraints do exist, including:

- Sufficient boiler height for installation of the needed reburn injectors and completion air ports and for adequate flue gas residence time in the reburn and burnout zones;
- Sufficient room around the boiler for routing of reburn fuel lines, combustion air lines, reburn injectors, flue gas recirculation fans and ducts (if required), and other auxiliary equipment; and
- Soot blowers capable of handling increased boiler tube slagging and fouling.

Such physical constraints must be identified and quantified early in evaluating the feasibility of retrofitting a reburn system on an existing boiler.

Particulate Control Device Constraints

The production of sulfur trioxide (SO_3) during combustion of coal is a major contributor to the conductivity of the fly ash. When a lower sulfur fuel such as natural gas is used as the reburn fuel, less SO_3 is produced and the resistivity of the fly ash produced generally will increase. This increase may result in reduced particulate collection efficiency in an electrostatic precipitator. Offsetting this effect is the reduction in ash resistivity resulting from the higher moisture content of the flue gas produced by combustion of natural gas. The magnitude of each effect depends on several factors including the sulfur content of the coal and the amount of reburn fuel as a fraction of the total fuel input. Therefore, predicting the overall effect on ash resistivity that would result from a natural gas-fired reburn system is difficult prior to pilot testing. However, data from the full-scale, gas-fired reburn tests reported in Section 3 showed precipitator performance was maintained throughout the test programs.

Thus coal-fired reburn systems, a larger percentage of the total ash production of the boiler may leave the boiler as fly ash. This may be especially true for slagging boilers since they typically produce a relatively smaller amount of fly ash than dry-bottom boilers. The additional fly ash generation presents an increased load on the particulate control device (electrostatic precipitators or fabric filters). Modification of the particulate control device may be necessary to maintain the particulate emissions and stack opacity within permit limits. Likewise, the increased volume of fly ash collected may require modification of the fly ash handling equipment.

Boiler Safety

Current boiler safety equipment relies heavily on flame sensing to automatically cut off fuel flow when critical conditions occur in a boiler. Reburn fuel injectors do not introduce combustion air, which eliminates the stable visible flames that are present with the primary combustion zone burners. Pulverized coal-fired reburning might utilize air injection as a carrier media for the coal, which may or may not produce a stable visible flame. A system of "trips and permissives," as was discussed earlier, is necessary to ensure safety in the reburn zone.

Load Dispatch Range

The boiler's operating load cycle is a major operating parameter that affects the overall reduction of NO_x emissions resulting from installation of a reburn system. Generally, reburn systems operate more stably and achieve greater NO_x reductions at higher load conditions. Typically, utility boilers do not operate at peak loads constantly. Loads vary in accordance with electrical demand. The diversion of 10 to 20% of the fuel from the lower furnace to the reburn injectors can result in flame instability and an increase in the unburned carbon content of the ash. Wet-bottomed boilers will have minimum temperature constraints based on ash fusion temperatures that may limit the use of the reburn system at reduced loads. At low loads, the amount of reburn fuel injected may also be reduced, which could impede fuel/flue gas mixing at the lower reburn fuel velocity and momentum. Factors such as these may limit the turndown range of the boiler or the applicability of reburn for controlling NO_x emissions. Automation of the reburn system controls, primary fuel choice (based on ash fusion temperature), and operation with burners out of service (BOOS) can minimize the problems associated with boiler load swings and low-load operation.

During the full-scale demonstration tests of reburning discussed in Section 3, the utilities' boiler operators have been able to find safe and acceptable boiler control conditions throughout the load ranges tested.

Ancillary Benefits

The installation and operation of a natural gas-fired reburn system for NO_x control has some ancillary benefits in addition to NO_x reductions including:

- Reduced emissions of acid gases (SO₂ and HCl);
- Reduced emissions of carbon dioxide;
- Reduced fly ash loading on the particulate control device; and
- Reduced production of ash for disposal.

In comparison with coal, natural gas contains negligible quantities of nitrogen, chlorine, and sulfur, reduced carbon content, and reduced incombustible material (ash). Therefore, the replacement of 10 to 20% of the total heat input to the boiler by natural gas would achieve a proportional reduction in the emissions of pollutants related to these fuel components regardless of whether a reburn system is utilized.

In addition to the environmental aspects of reducing these constituents, the reduction in fly ash content of the flue gas leaving the boiler would reduce the load on the particulate control device, the erosion of boiler tubes and air heater elements, and the power consumption of coal handling and preparation equipment.

Chapter 3

Example Full-Scale Demonstrations

Introduction

This chapter contains five examples of full-scale demonstrations of reburning to control NO_x emissions from utility boilers. Including both U.S. and foreign installations, the examples cover a wide range of boiler designs and sizes, and two reburn fuels: natural gas and coal. The design parameters for the example applications are summarized in Table 3-1.

Public Service of Colorado - Cherokee Unit 3

Public Service of Colorado's Cherokee Unit 3 is the site of a Round 3, Clean Coal Technology Project sponsored by the DOE, the GRI, Colorado Interstate Gas, the EPRI, and EER. The project sponsors tested the effectiveness of LNBs and LNBs combined with natural gas-fired

reburning (LNB gas reburn) retrofit technologies in reducing NO_x emissions on a wall-fired boiler. The project objective was to demonstrate that the combination of gas reburning and LNB would achieve 70 to 75% NO_x reduction. Parametric testing was completed in 1993 and the unit is currently undergoing long-term testing. The information presented in this report on the testing at Cherokee Unit 3 was compiled from papers titled "Low NO_x Burners & Gas Reburning - An Integrated Advanced NO_x Reduction Technology" (Sanyal et al., 1993) and "NO_x Control by Gas Reburning in a 172 MWe Boiler" (Rindahl et al., 1994).

The Unit 3 boiler is a balanced draft, 172-MW, front wall-fired unit that typically burns Colorado, low-sulfur (~0.4% S), subbituminous coal. Three other units are at the Cherokee Station. The capacity factors of the four units and swing-load conditions allowed a wide range of operating conditions to be tested. Originally equipped with

Table 3-1. Summary of Example Reburn Installations

Utility	Unit Name	Unit Size	Boiler Type	Primary Fuel	Reburn Fuel
Public Service of Colorado	Cherokee Unit 3	172 MW	Single-wall-fired, dry bottom	Western U.S., low sulfur, subbituminous coal	Natural gas
Illinois Power Co	Hennepin Unit 1	71 MW	Tangentially-fired, dry bottom	High sulfur, Illinois bituminous coal and natural gas	Natural gas
Springfield, IL City Water, Light & Power	Lakeside Unit 7	33 MW	Single-wall cyclone, wet bottom	Medium sulfur, Illinois bituminous coal	Natural gas
Wisconsin Power & Light Co	Nelson Dewey Unit 2	100 MW	Single-wall cyclone, wet bottom	Medium sulfur, Illinois bituminous coal and Powder River Basin subbituminous coal	Pulverized Coal
Ohio Edison	Niles Unit 1	114 MW	Single-wall cyclone, wet bottom	Eastern U.S. bituminous coal	Natural gas
Vinnitsaenergo, Ukraine	Ladyzhin Unit 4	300 MW	Opposed-wall-fired, wet bottom	Ukrainian bituminous coal, and Siberian lignite and natural gas	Natural gas

Babcock & Wilcox (B&W) circular-type PL burners in a four-by-four array, Unit 3 had a total design heat input of 1650 million Btu per hour (MMBtu/hr). The air pollution control equipment included a baghouse for particulate emissions control.

Sixteen Foster Wheeler, Internal Fuel Staging, LNBs replaced the original burners for the project. The boiler had a full division wall and a radiant zone of 24 ft deep and 42 ft wide. A schematic of the LNB-gas reburn system tested is shown in Figure 3-1.

The LNB-gas reburn system involved a 3-stage burning process at various stoichiometries with the first zone as the primary burner zone. This zone was operated at 80 to 90% of the total heat input, with minimized excess air.

Approximately 2.4 m above this zone, eight 14-cm diameter natural gas injectors were installed for the reburning zone. Natural gas was injected through nozzles with 3.4% of the flue gas recycled to facilitate adequate mixing, cool the natural gas injectors, and disperse the reburn fuel. The stoichiometry in the boiler becomes fuel-rich at this point. Nozzle velocities ranged from 27.5 m/s at 50% load to 55 m/s at full load. The flow rates of the reburn fuel ranged from 10 to 25% of the total heat input of Unit 3. The final zone was a burnout zone, with six 52-cm diameter injectors for OFA. The OFA injectors were tilted 10 degrees down to facilitate dispersion and mixing. The design of the OFA system facilitated carbon burnout in an air-rich environment.

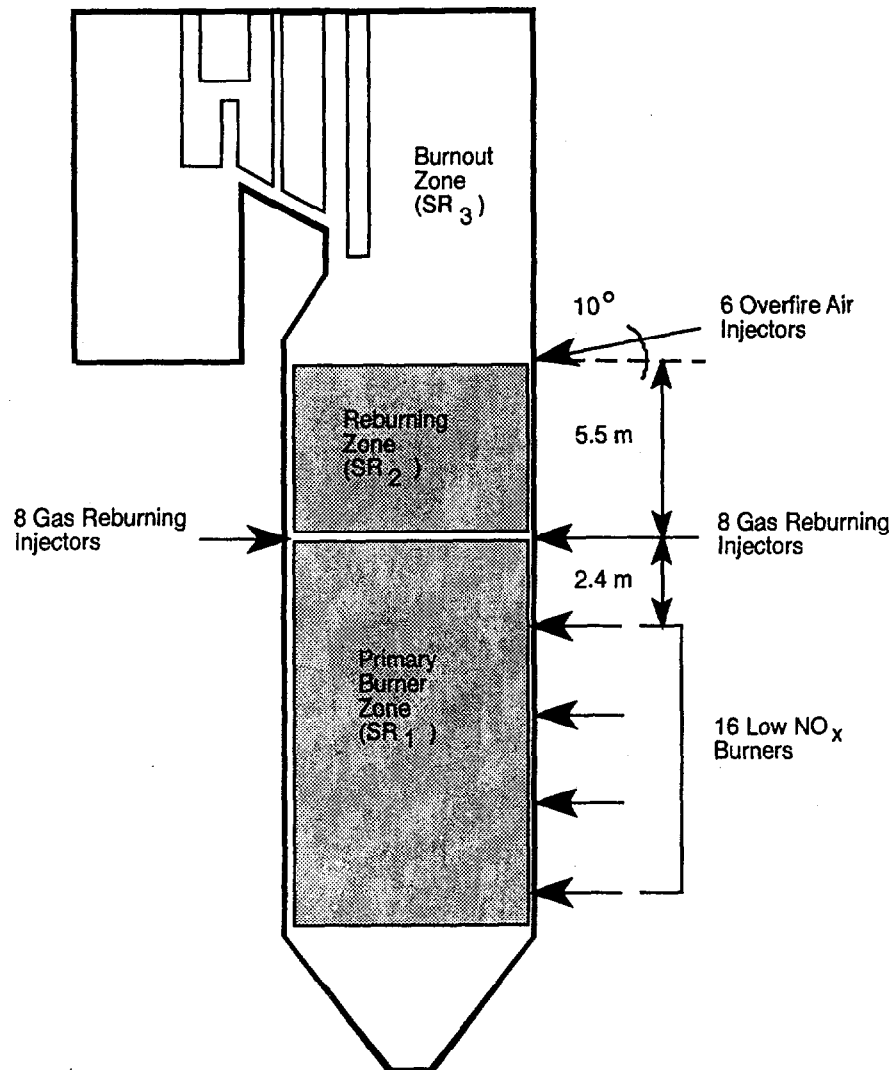

Figure 3-1. Cherokee Unit 3-LNB-Gas Reburn System Schematic (Sanyal et al., 1993).

Parametric tests were used to evaluate emission reduction sensitivity to operating parameters including zone stoichiometries, gas flow rate, OFA flow rate, flue gas recirculation rate, and load. Absolute NO_x emissions were measured for each firing configuration (Figure 3-2). The use of LNBs alone produced NO_x emission reductions of 31% from the baseline. The minimum NO_x emissions with LNB-gas reburn corresponded to reductions of 72% from baseline and 60% reduction from LNBs alone.

NO_x emissions increased linearly with increasing zone stoichiometry, with slopes varying for each case (Figure 3-3). The LNB-gas reburn tests operated at a much lower percentage of theoretical air than the baseline and LNB tests, resulting in lower NO_x emissions. The stoichiometry target for the baseline and LNB cases was an overall stoichiometry, while for the reburn case it was the LNB-gas reburn zone stoichiometry. The baseline and LNB data were obtained at about 20% excess air (120% theoretical air). For LNB-gas reburn, the minimum NO_x level occurs at a reburning zone stoichiometry of 88%

theoretical air. At this point, the reburn fuel firing rate was 20% of the total heat input to the boiler, and the overall stoichiometry was normal.

The parametric tests showed that overall excess air could be lower in the LNB-gas reburn cases than in either the baseline or the LNB cases, as seen in Figure 3-4 (Sanyal et al., 1993). Slagging, carbon loss, and corrosion were expected unless the stoichiometry in the primary burner zone (designated as SR_1 in Figure 3-1) was maintained above 1.05. This was accomplished by adjusting the stoichiometry in the reburn zone (SR_2) and the reburn fuel input (Rindahl et al., 1994).

In all cases, NO_x emissions had a linear correlation with oxygen content. Note that the sensitivity to oxygen content decreased for both the LNB and LNB-gas reburn cases, with LNB-gas reburn exhibiting the lowest sensitivity. Minimum NO_x emissions were achieved at a reburn zone stoichiometry of 0.88 and overall stoichiometry in the range of 1.2 to 1.3 (Sanyal et al., 1993).

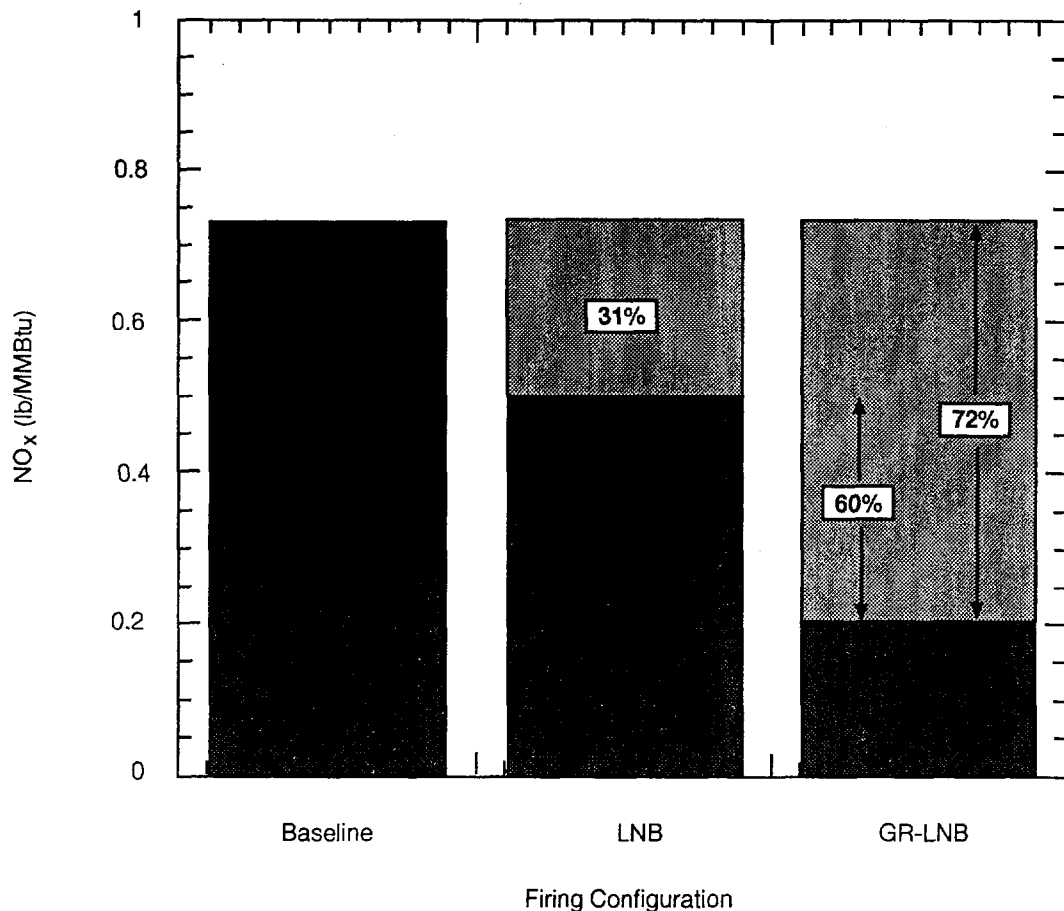

Figure 3-2. Cherokee Unit 3—Short-Term NO_x Emission Data (Sanyal et al., 1993).

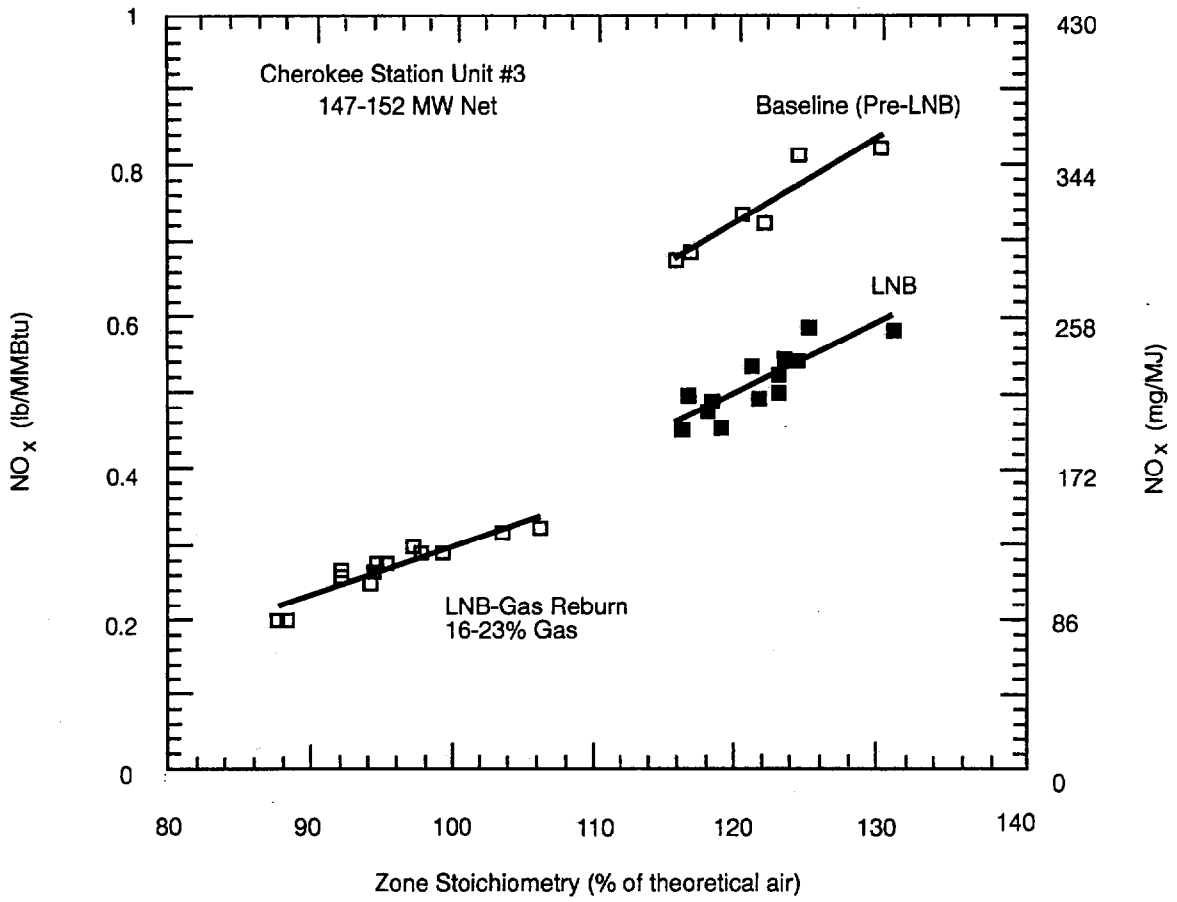

Figure 3-3. Cherokee Unit 3-LNB-Gas Reburning Data (Sanyal et al., 1993).

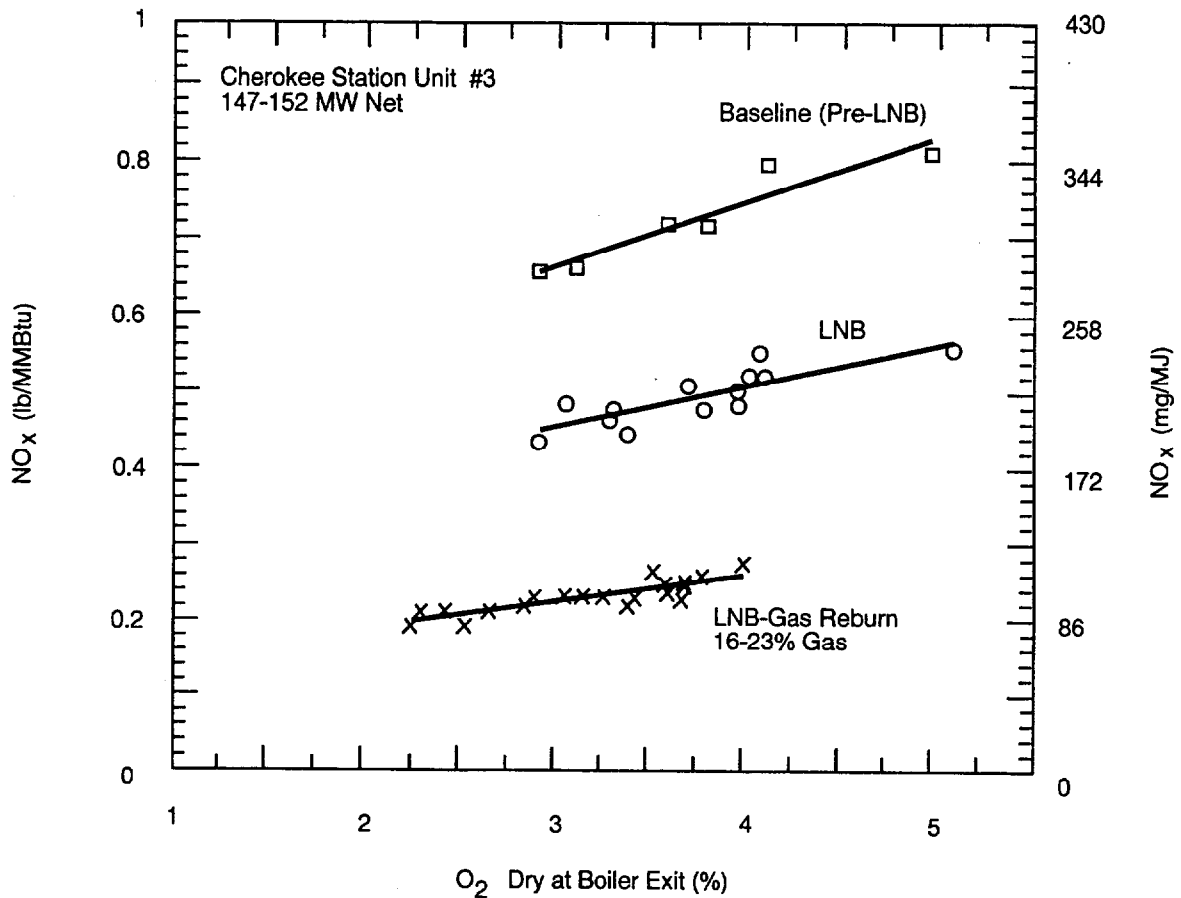

Figure 3-4. Cherokee Unit 3—Effect of Excess Air on NO_x Emissions (Sanyal et al., 1993).

In general, NO_x emissions decreased with increasing gas heat input. The greatest incremental reductions in NO_x emissions occurred at natural gas input values up to 10% of the total fuel input to the boiler. With 10 to 20% input from natural gas, the additional reductions in NO_x emissions were marginal. The correlation between natural gas input and NO_x emissions is shown in Figure 3-5.

Natural gas also reduced SO₂ and CO₂ emissions. With the low-sulfur coal typically used at Cherokee, typical SO₂ emissions are 0.65 lb/MMBtu. A gas heat input of 20%, resulted in a SO₂ emissions decrease of 20% to 0.52 lb/MMBtu, as expected by fuel substitution with natural gas essentially free from sulfur. CO₂ emissions also are reduced because natural gas has a lower carbon/hydrogen ratio than coal. At a gas heat input of 20%, the CO₂ emission was reduced by 8% (Rindahl 1994).

A linear correlation was observed between unit load and NO_x emissions for all three cases (Figure 3-6). Again the sensitivity appeared to decrease in the LNB and LNB-gas reburn configurations, with LNB-gas reburn showing the lowest sensitivity to unit load.

Overall, the parametric tests did not reveal any problems with the reburn retrofit. Even though carbon loss, flame stability, ash fusion temperature, and steam temperature control are parameters that are dependent on the overall excess air, the short-term tests at Cherokee Unit 3 demonstrated that these parameters were not adversely affected by the LNB-gas reburn retrofit.

One concern in retrofitting the LNB-gas reburn system was boiler derating. Boiler heat rate is dependent on carbon loss, auxiliary power needs, dry gas loss as a result of excess air and temperature, and latent heat loss through additional water vapor in the flue gas. Due to the higher hydrogen content in natural gas, its combustion generates more water vapor than coal combustion for the same heat input.

Carbon and dry gas losses were unchanged as a result of the testing. A minimal increase in auxiliary power occurred; however, this was offset by the reduced coal mill power consumption due to reduced coal throughput. The station staff predicted that there would be no net change in power needs. Boiler efficiency for 20% natural gas

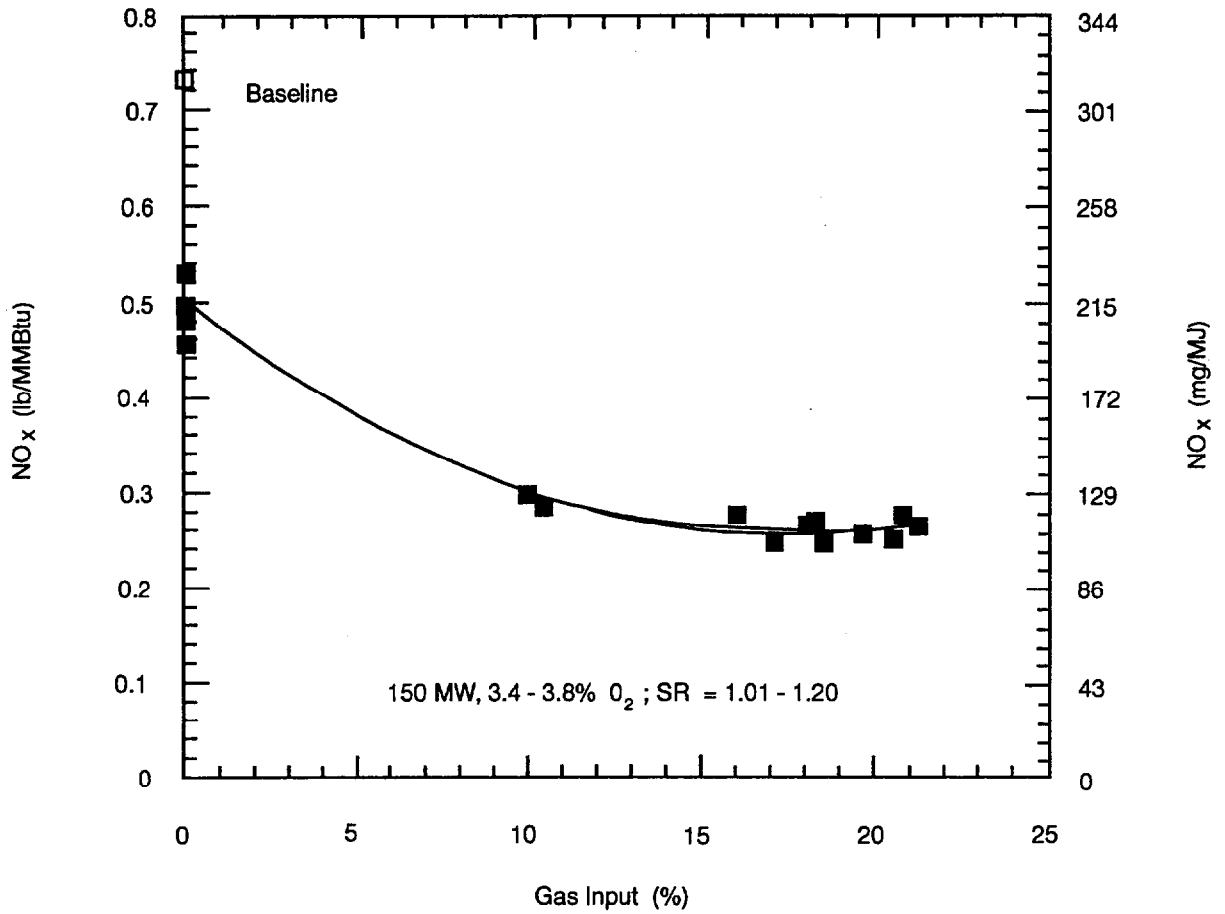

Figure 3-5. Cherokee Unit 3—Effect of Gas Input on NO_x Emissions (Sanyal et al., 1993).

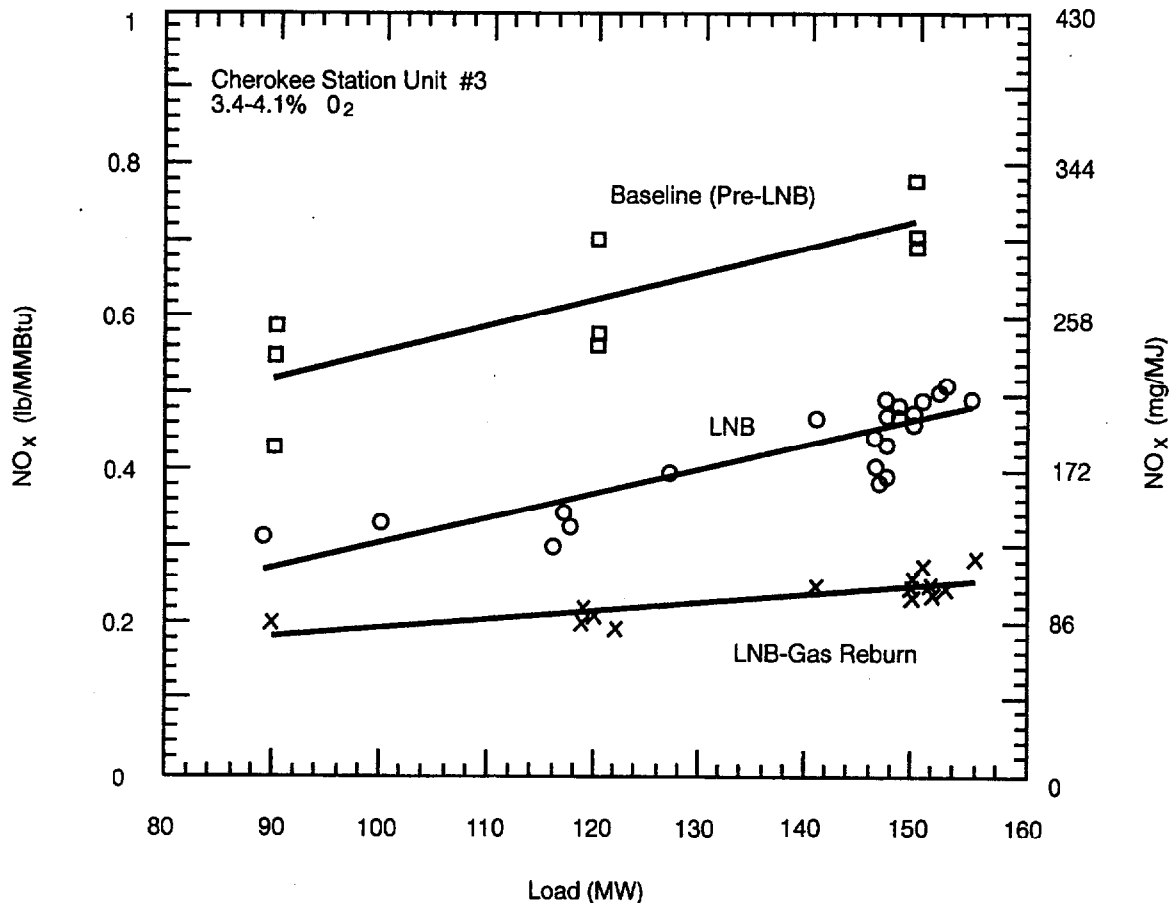

Figure 3-6. Cherokee Unit 3—Effect of Unit Load on NO_x Emissions (Sanyal et al., 1993).

firing was reduced by about 1% due to the latent heat of the additional flue gas moisture while the steam temperature was maintained through attemperation.

Long-term testing started in April 1993. The objective of the testing is to obtain operating data over an extended period of time when the unit is under routine commercial service. The long-term NO_x data obtained in the first nine months of operation are shown in Figure 3-7. The operation was load-following and operated under the following conditions:

- 82 to 159 MW net unit load;
- 5 to 19% gas heat input; and
- 2 to 6% dry O₂ concentrations.

The average NO_x concentration during the gas reburning-LNB operation was 0.26 lb/MMBtu, compared to 0.5 lb/MMBtu as the standard emission limit for dry bottom wall-fired boilers (Rindahl 1994).

The gas reburning system on Cherokee Unit 3 has been modified to eliminate flue gas recirculation to reduce

system complexity, lower furnace exit temperature, reduce operating cost, and reduce slagging. The OFA ports have been modified to optimize overfire air at low gas inputs. Additional tests will be conducted to verify the performance of the modified system. A final report on all testing is expected in early 1997.

Illinois Power Company - Hennepin Unit 1

Hennepin Unit 1 is a Combustion Engineering, tangentially-fired, balanced draft, single furnace boiler with a capacity of 71 MW. The unit is capable of achieving full load on either coal or natural gas. Unit 1 was the site of a Round 1, Clean Coal Technology Project sponsored by DOE, GRI, the Illinois Department of the Environment and Natural Resources, and EER. The objective of this project was to test the NO_x reducing efficiencies of several retrofit technologies including:

- Natural gas as a reburn fuel (both with coal and natural gas as the primary fuel);
- Bias coal/natural gas firing;

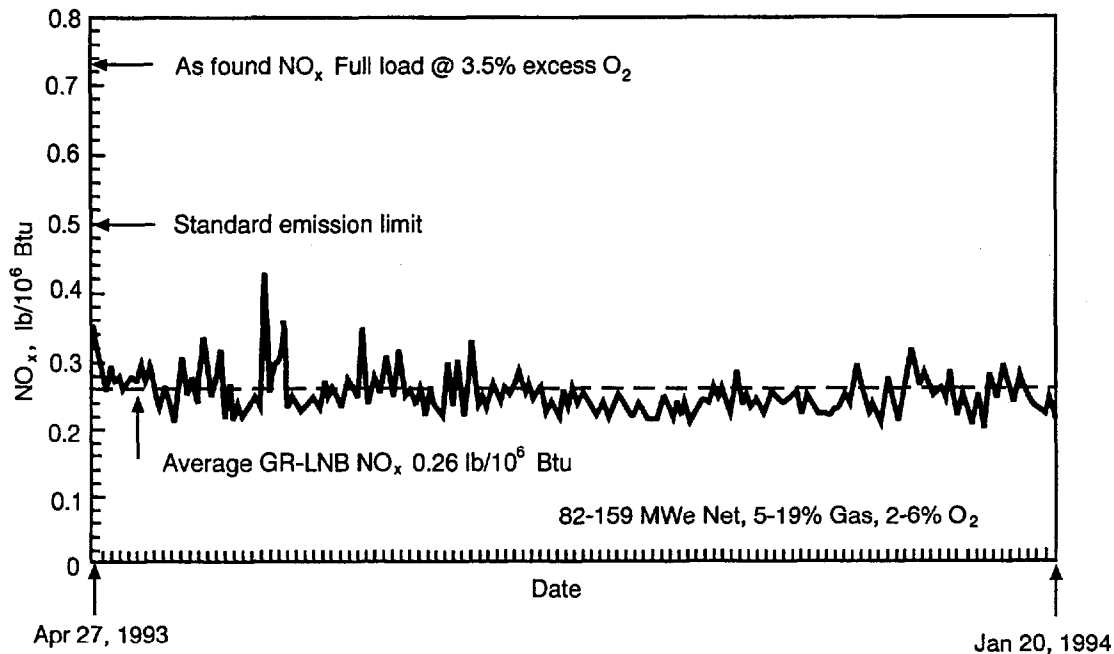

Figure 3-7. Cherokee Unit 3—Long-Term NO_x Emission Data (Sanyal et al., 1993).

- Coal/gas co-firing; and
- Gas reburn combined with sorbent injection to reduce SO₂ emissions on coal-fired boilers.

The full test matrix also consisted of several baseline performance tests for coal, gas, coal/gas co-firing, burner turndown, and coal mill turndown. Parameters were developed from pilot-scale tests.

The burner arrangement for the Hennepin boiler is typical of many tangentially-fired boilers. Fuel and air are admitted from the furnace corners in horizontal layers. In each corner of the furnace are three pulverized coal burners and two gas burners in an alternating stack (Figure 3-8), with the air distribution being controlled by dampers at each compartment. This stacked arrangement allows for various configurations of fuel choice (pulverized coal or natural gas) and staged combustion. Each of the corners has two levels of natural gas-fired ignitors and warm-up guns capable of supplying 1% and 5% of the heat input, respectively (Angello et al., 1992).

Historically, the unit has burned Illinois bituminous coal that was moderately high in sulfur (3% S), with 10% ash, 15% moisture, and a heating value of approximately 10,600 Btu/lb. Fuel analyses comparing the design fuel characteristics with pre- and post-testing averages are presented in Table 3-2 (Angello et al., 1992).

Bench- and pilot-scale studies were conducted to develop fuel compositions and operating parameters, as well as to evaluate their potential effectiveness in reducing NO_x emissions. These studies showed that major parameters of interest included oxygen stoichiometries, furnace gas temperatures, furnace residence times, and fuel/air mixing. Natural gas was reported as the most effective reburn fuel, with respect to low baseline levels of NO_x and limited residence time in the reburn zone. Parametric testing began in 1991 with natural gas as well as coal for primary combustion fuels. The information presented in this section is the result of the parametric testing conducted with coal as a primary combustion fuel. Data on natural gas as the primary combustion fuel is also available (May et al., 1994).

Baseline, uncontrolled NO_x emissions firing 100% coal were approximately 550 ppm (0.75 lb/MMBtu). Under optimum conditions for NO_x control, emissions were reduced by as much as 77% from the coal-fired baseline. A graph of NO_x emissions and reduction versus the percentage of gas heat input is shown in Figure 3-9 at the conditions that produced the best balance of performance for commercial operation. Gas reburning with 18% gas firing reduced NO_x emissions by 60 to 70% down to 0.23 to 0.30 lb/MMBtu. Even with only 10% gas firing, emissions were reduced by 55% to 0.34 lb/MMBtu (Folsom et al., 1993).

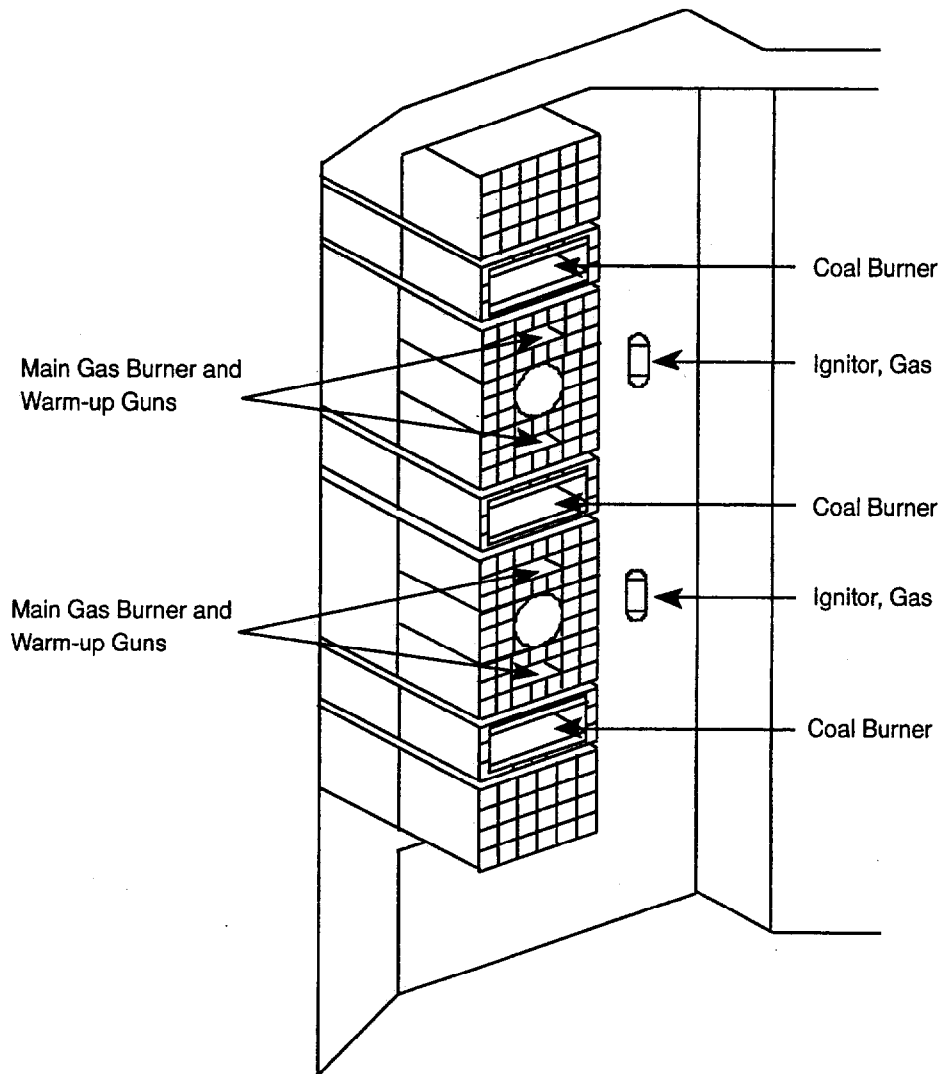

Figure 3-8. Hennepin Unit 1—Stacked Burners of Tangentially-Fired Boiler (Angello et al., 1992).

The data from parametric testing were analyzed to determine the optimum operating conditions for achieving the target emissions. Several parameters were established and the nominal operating conditions for long-term testing were:

- Coal zone stoichiometric ratio = 1.10;
- Reburning zone stoichiometric ratio = 0.90;
- Burnout zone stoichiometric ratio = 1.20; and
- Gas heat input = 18% (Keen et al., 1993).

Long-term tests were conducted in 1992, during normal commercial service. The unit was load-cycled daily, providing a particularly severe test of the process. NO_x emissions measured from January 1992 to October 1992 (no tests in May or June) showed an average reduction of

67.3% to 0.245 lb/MMBtu (Figure 3-10) (Folsom et al., 1993).

A significant reduction in CO_2 emissions was also measured, due to partial replacement of coal with natural gas. The use of 18% natural gas resulted in a theoretical CO_2 emissions reduction of 7.9% from the coal-fired baseline (Keen et al., 1993).

The effect of gas reburning on the durability of the unit was also evaluated during the long-term test. As described earlier, the reburning zone operates in oxygen deficient conditions, raising concerns that tube wastage might be accelerated due to the presence of reduced sulfur species or fluctuating oxidizing and reducing conditions. Durability evaluations were conducted throughout the test program, including both baseline and gas reburn-sorbent injection (GR-SI) operating periods. The

Table 3-2. Hennepin Unit 1 - Fuel Analysis Comparison

Parameter	Units	Original Design	Pre-Test Average	Post-Test Average
Coal				
Carbon	%	59.16	63.14	58.52
Hydrogen	%	3.97	4.28	4.06
Oxygen	%	7.46	8.50	7.65
Nitrogen	%	1.04	1.21	1.11
Sulfur	%	2.82	3.05	2.97
Moisture	%	15.99	9.06	15.07
Ash	%	9.56	10.76	10.18
HHV	Btu/lb	10,632	11,353	10,583
Theoretical Air Demand	lb air/ lb coal	7.999	8.510	7.955
Natural Gas				
CH ₄	% by vol	89.83	-	-
C ₂ H ₆	% by vol	4.29	-	-
C ₃ H ₈	% by vol	0.82	-	-
C ₄ H ₁₀	% by vol	0.00	-	-
C ₅ H ₁₂	% by vol	0.00	-	-
<C ₁₂	% by vol	0.00	-	-
CO ₂	% by vol	0.57	-	-
N ₂	% by vol	4.20	-	-
HHV	Btu/scf	1,014	-	-
Theoretical Air Demand	lb air/ scf	0.724	-	-

Source: Angello et al., 1992

measurements included direct inspection, ultrasonic tube thickness measurements, and destructive testing of tube sections. The results of the testing have detected no measurable increase in the tube wastage rate due to gas reburning or sorbent injection.

Final reports on the long-term testing conducted at Hennepin were finalized in March 1996 (EER). The Hennepin project is of major significance since the long-term results show significant (67%) NO_x reduction during normal service and load cycling. Illinois Power has decided to maintain Hennepin's reburn capacity in an effort to meet future NO_x control requirements.

City Water, Light, and Power - Lakeside Unit 7

Lakeside Unit 7 is owned and operated by the City Water, Light, and Power, the municipal utility of Springfield, IL. This unit was selected for demonstration of GR-SI as part of the DOE's Clean Coal Technology Program. This program is similar to the Illinois Power Hennepin Unit 1 GR-SI program discussed above, except applied to a cyclone-fired boiler rather than a tangentially-fired boiler. The performance goals at Lakeside were to reduce emissions of NO_x by 60% and SO₂ by 50%. The demonstration was conducted by EER, who also conducted the Hennepin GR-SI demonstration. The information presented on Lakeside Unit 7 is based primarily on a paper, "Demonstration of Gas Reburning-Sorbent Injection on a Cyclone-Fired Boiler," which was presented at the Third Annual Clean Coal Conference in September 1994 (Folsom et al., 1994).

Lakeside Unit 7 is a pressurized, 33-MW, cyclone-fired boiler that burns an Illinois bituminous coal containing 3% sulfur. The unit typically operates in cycling service with a very low capacity factor. Two 7-foot diameter cyclone burners are located side by side on the boiler front wall. As shown in Figure 3-11, the combustion gases pass through a refractory-lined primary furnace, a water-wall radiant furnace and a convection section prior to the air heater and electrostatic precipitator (Folsom et al., 1994). Baseline NO_x emissions at Lakeside Unit 7 were 1.0 lb/MMBtu.

The test program consisted of four parts. First, a series of parametric tests of gas reburning and sorbent injection was conducted. These tests were followed by GR-SI optimization tests to determine the optimum range of operating conditions and to evaluate GR-SI over a wide range of boiler operating conditions. Next, a long-term (9-month) test was conducted to determine process performance during normal load variations. During the long-term test period, extended-operations tests were conducted to determine the effects of continuous GR-SI operation on process and equipment performance and on the unit's thermal performance.

A total of 100 gas reburning parametric tests were conducted. These tests examined:

- Boiler load (20, 25, and 33 MW);
- Reburn fuel as a fraction of total heat input to the boiler (5 to 26%);
- Primary combustion zone stoichiometry (1.08 to 1.28);
- Burnout zone stoichiometry (up to 1.47); and
- FGR rates (3 to 12 %).

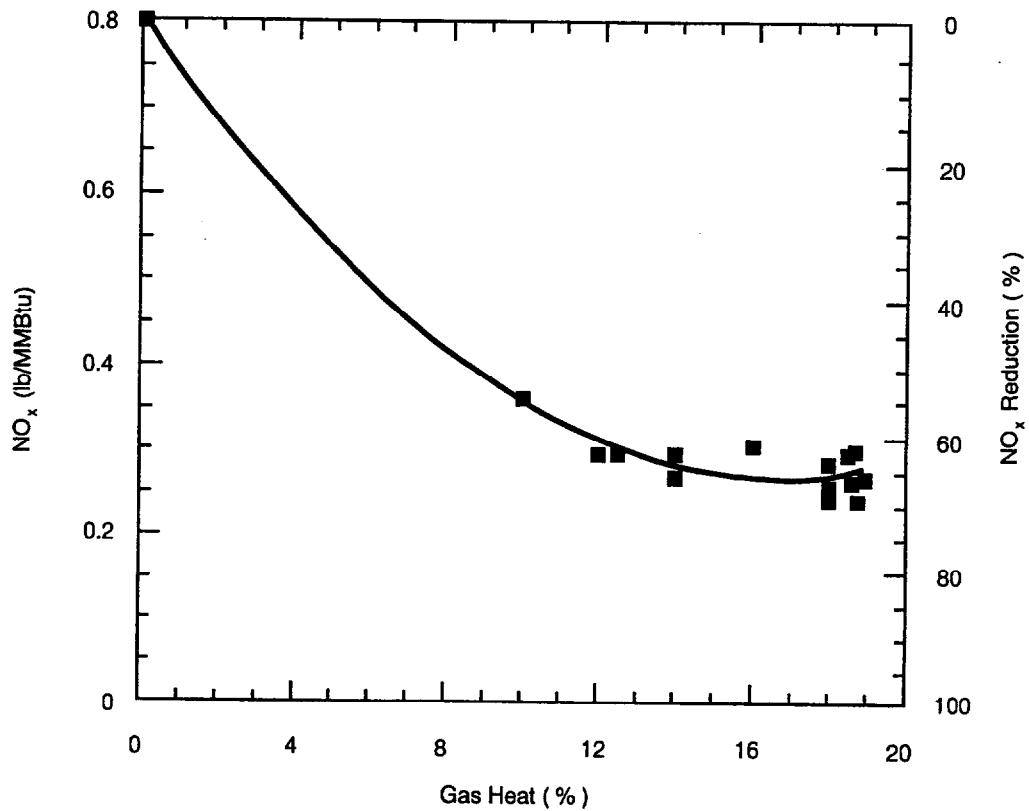

Figure 3-9. Hennepin Unit 1—Gas Reburning Data with Coal as the Primary Fuel (Folsom et al., 1993).

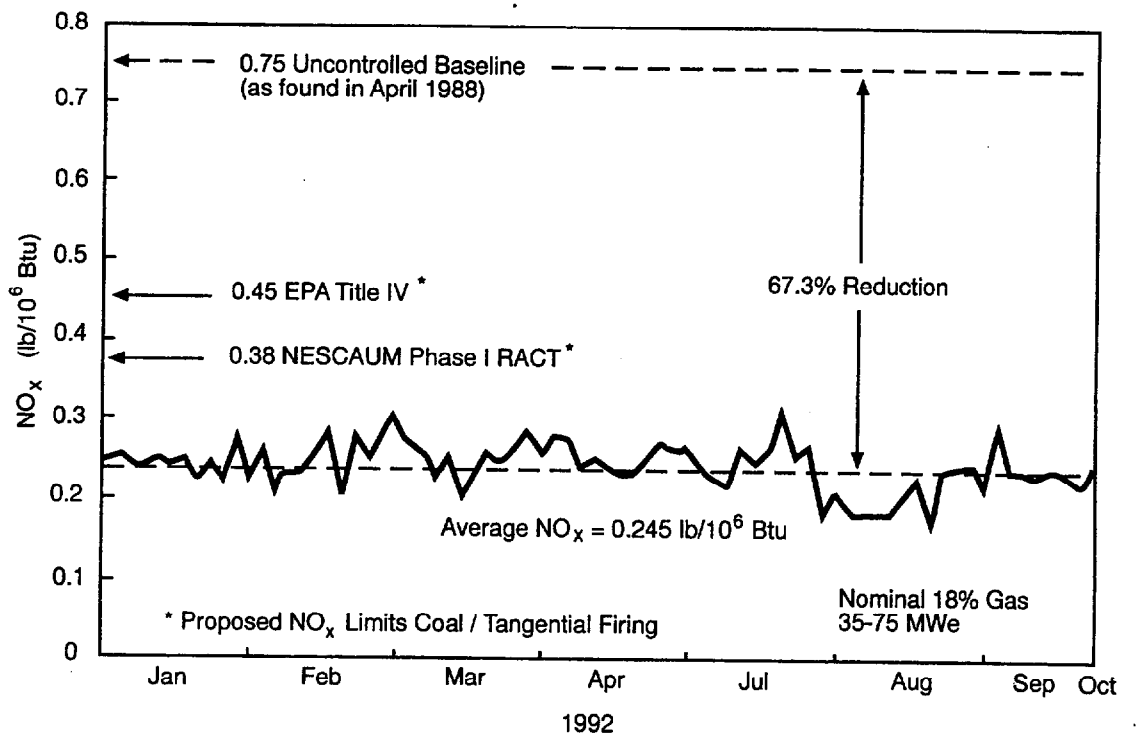

Figure 3-10. Hennepin Unit 1—Long-Term Gas Reburning Data (Folsom et al., 1993).

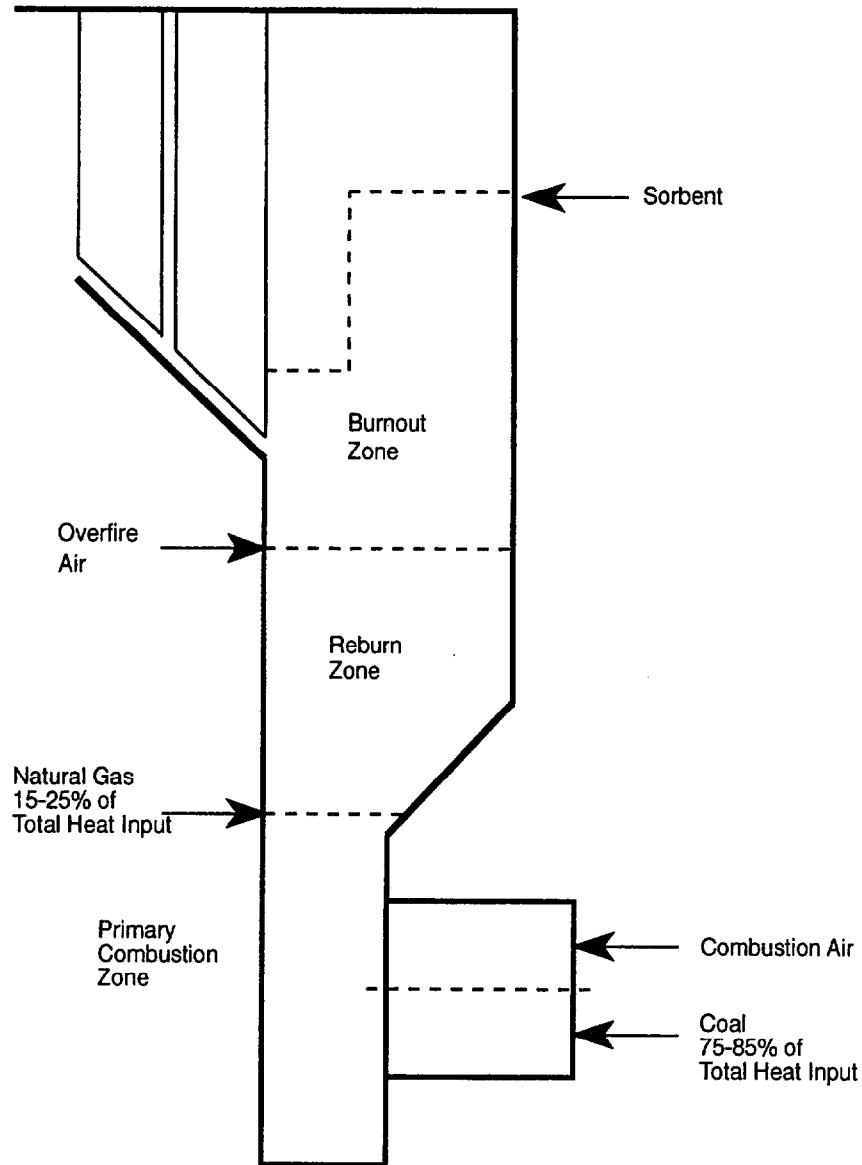

Figure 3-11. Lakeside Unit 7-GR-SI System Schematic (Folsom et al., 1994).

Optimum NO_x reduction was achieved at a reburn fuel input level of 22 to 23% and reburn zone stoichiometries between 0.90 and 0.92, as shown in Figures 3-12 and 3-13 (Folsom, 1994). The optimum NO_x reduction varied between 55 and 62% depending on unit load. At all unit loads, a reburn fuel heat input fraction of 20% or greater resulted in NO_x emissions of less than 0.4 lb/MMBtu.

As a result of the testing, a lower limit on burnout zone stoichiometry of 1.30 was established. Under some operating conditions, burnout zone stoichiometries lower than 1.30 resulted in flue gas CO levels exceeding 200 ppm, indicating incomplete combustion.

FGR was used to enhance the mixing of the reburn fuel with the flue gas in the reburn zone. Within the range tested, increasing the FGR rate improved the reduction of NO_x as shown in Figure 3-14 (Folsom, 1994).

The reburning optimization parametric testing was followed by a series of sorbent injection parametric tests designed to determine the optimum reagent ratio and sorbent injection velocity. At the conclusion of these tests, the GR-SI optimization tests were conducted to integrate the two technologies. One modification to the initial reburn system implemented during these tests was the replacement of the fuel nozzles used in the parametric tests with smaller nozzles. These smaller nozzles increased

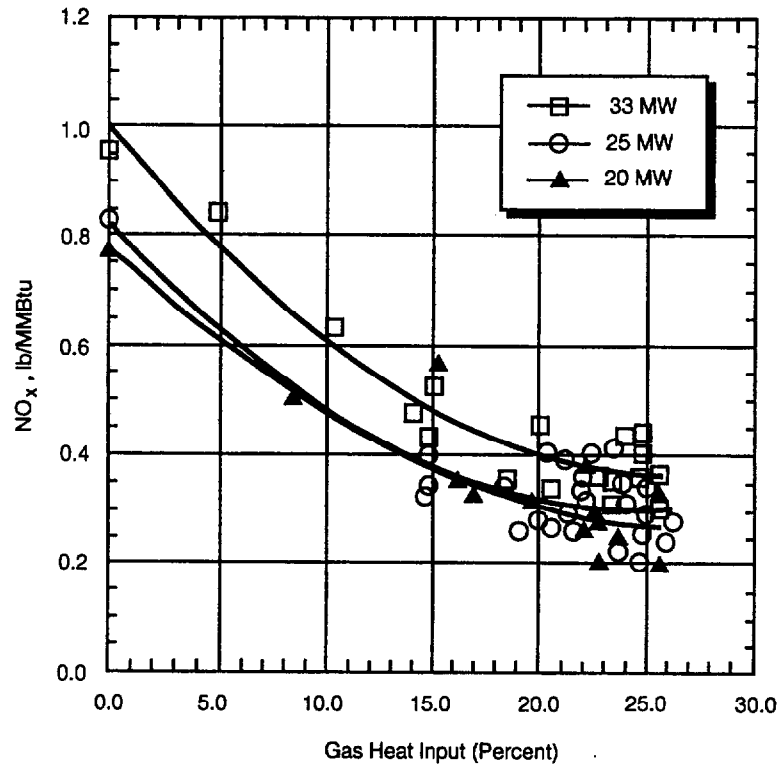

Figure 3-12. Lakeside Unit 7—Effect of Gas Heat Input on NO_x Emissions (Folsom et al., 1994).

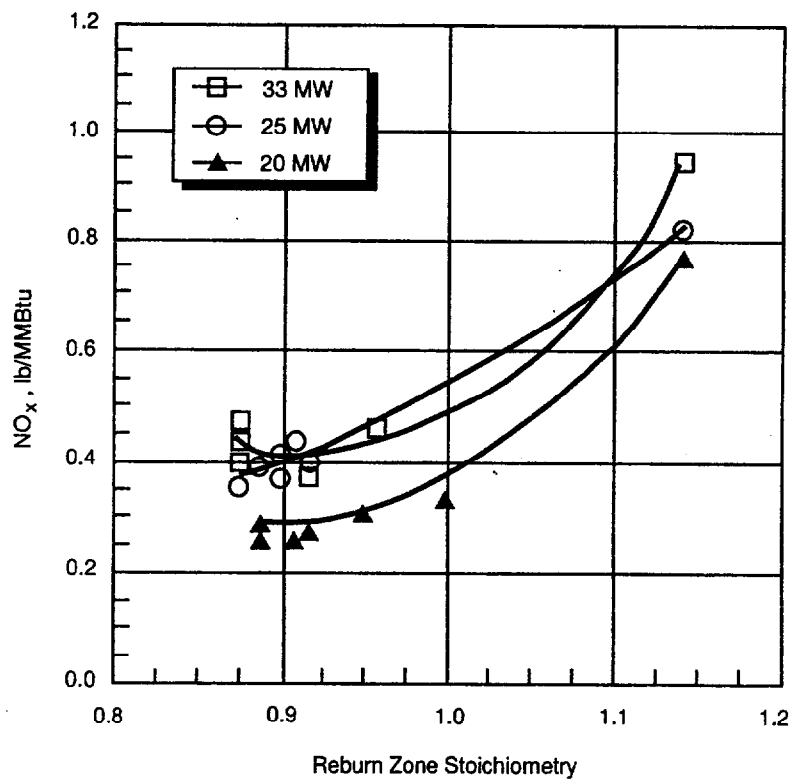

Figure 3-13. Lakeside Unit 7—Effect of Reburn Zone Stoichiometry on NO_x Emissions (Folsom et al., 1994).

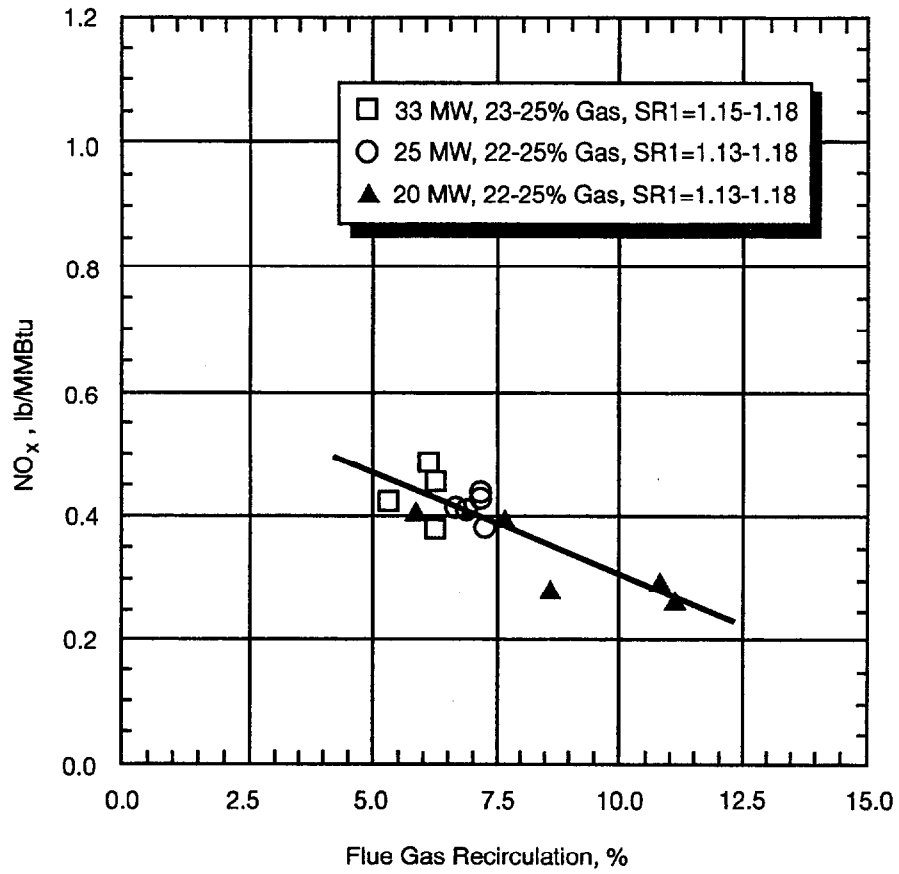

Figure 3-14. Lakeside Unit 7—Effect of Flue Gas Recirculation on NO_x Emissions (Folsom et al., 1994).

the reburning fuel penetration into the boiler and improved the mixing of the fuel with the primary combustion zone products. The decreased nozzle diameter resulted in an additional 3 to 5 % reduction in NO_x emissions at all unit loads.

The results obtained during the long-term tests confirmed that the results of the earlier tests could be maintained during normal unit cycling service. NO_x emissions measured from October 3, 1993 to June 3, 1994 show an average reduction of 62% (Figure 3-15) (Folsom, 1994). The average NO_x emission during the period of June 5, 1993 to April 4, 1994 was 0.344 lb/MMBtu.

Operation of the GR and GR-SI systems resulted in a small (0.8%) drop in the thermal efficiency of the boiler. This drop was attributed to higher moisture of flue gas produced by combustion of natural gas, and to a small increase in flue gas exit temperature due to sorbent deposition on the back pass heat transfer surfaces. No other boiler operational problems associated with reburning were experienced during the test program.

The test program team concluded that the results of the Lakeside Unit 7 demonstration test confirmed that natural gas reburning in a cyclone-fired furnace could maintain 60% NO_x reduction, consistently and reliably, without significant thermal impacts on boiler performance.

Wisconsin Power & Light Company - Nelson Dewey Unit 2

Wisconsin Power & Light Company's (WP&L's) Nelson Dewey Generating station was the site of a Round 2, Clean Coal Technology Program sponsored by DOE, EPRI, and State of Illinois Department of Environmental and Natural Resources. B&W was the prime contractor and project manager for the project. The information presented in this section was compiled from a paper titled "Update on Coal Reburning Technology for Reducing NO_x in Cyclone Boilers" (Yagiela et al., 1991). The project is a unique example of the application of reburn technology using pulverized coal as a reburn fuel. Cyclone-fired boilers represent nearly 50% of WPL's coal capacity, and are responsible for almost 75% of the utility's NO_x emissions. The objective of the project was to demonstrate that reburn could reduce NO_x emissions by 50% without disrupting the reliability and operability of the boiler.

The station has two 100-MW, B&W, cyclone-fired boilers, and each boiler has three 9-ft diameter front-wall cyclones. Steam temperatures are 1000°F at the superheater outlet (1500 psig) and 1000°F at the reheater outlet. The baseline fuel fired in the demonstration was a medium-sulfur, Illinois bituminous coal. Additional tests were fired with low-sulfur, western coal from the Powder River Basin, which is now the primary fuel at the station.

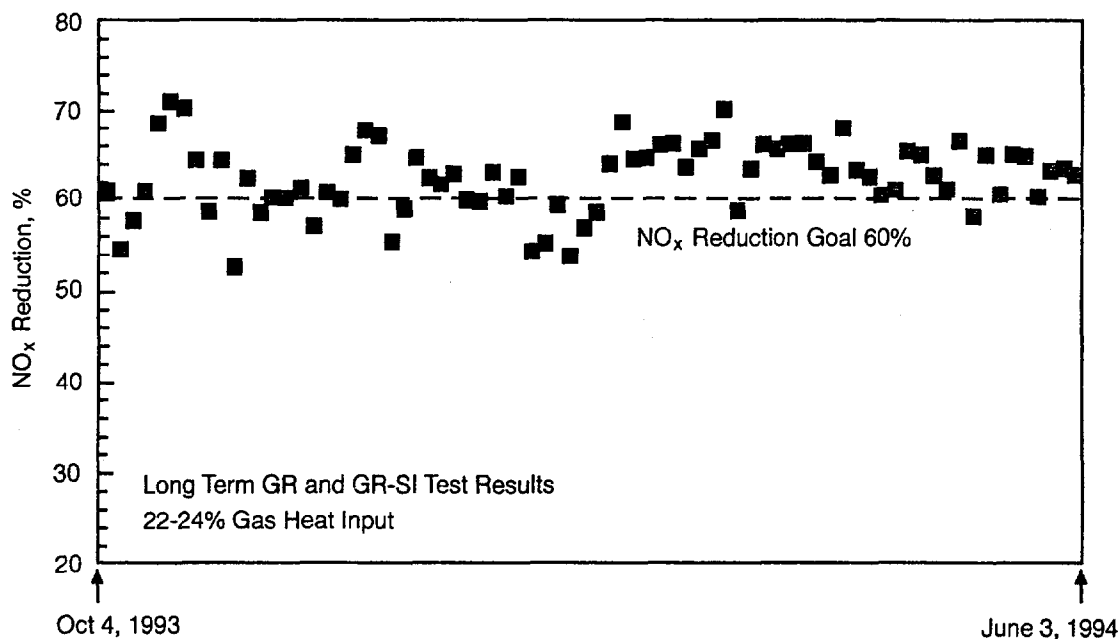

Figure 3-15. Lakeside Unit 7-Long-Term Operation Results for NO_x Reductions (Folsom et al., 1994).

A pulverized coal-fired reburn system was retrofitted to Unit 2 for the project. This installation was the first time a full-scale unit has been retrofitted with a coal-fired reburn system. The reburn system was developed from mathematical modeling of the boiler and pilot-scale testing conducted in B&W's Small Boiler Simulator (6 MMBtu/hr). Results of these initial tests characterized the boiler and were used to configure the number and locations of reburn burners and OFA ports in Unit 2 (Farzan et al., 1991). Four "S" type burners and four OFA ports were retrofitted to Unit 2. A B&W MPS-67N pulverizer with a dynamic classifier, rotating throat, and automatic spring adjustment system was installed to provide the pulverized coal for the reburn system (Newell et al., 1993). A schematic of the reburn system is presented in Figure 3-16.

Cyclone-firing was reduced from 100% of the total fuel input to a range of 65 to 80%, and the remaining coal was introduced in the reburn zone downstream at sub-stoichiometric conditions. Temperatures in the reburn zone were approximately 2500°F to minimize the formation of atmospheric NO_x from the addition of excess air.

NO_x reductions for the firing of Illinois Basin coal ranged from 33 to 50% over loads ranging from 40 MW to full load at 110 MW (Figure 3-17). The test objective of 50% reduction in NO_x emissions was met at full load; however, emissions reductions diminished at loads below 80 MW. At the minimum test conditions of 40 MW, the reduction in NO_x emissions was only 33%. The lower reduction at low loads was attributed to flame instability of the Illinois coal at a reburn zone stoichiometry of 0.9

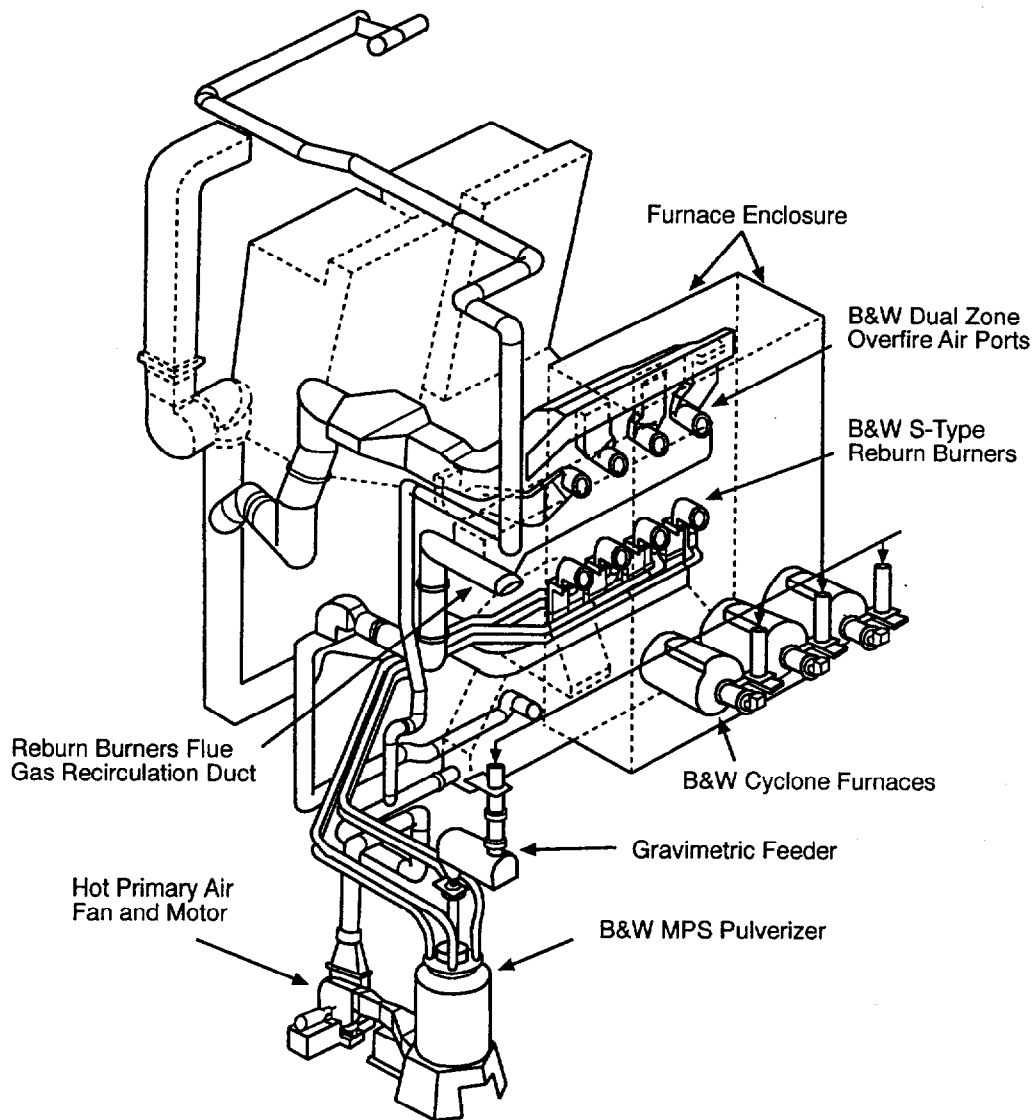

Figure 3-16. Nelson Dewey Unit 2—Coal-Fired Reburn System Schematic (Newell et al., 1993).

or less. With the reburning system in operation, NO_x emissions as low as 250 ppm (0.34 lb/MMBtu) were achieved. The fuel input from the pulverized coal burners was at 34% and the reburn zone stoichiometry was 0.89.

NO_x reduction was enhanced when burning Powder River Basin coal. The overall NO_x reduction was greater (62%), which was achieved at a lower reburn fuel heat input (30%) and a higher reburn zone stoichiometry. The reductions were consistent over the full range of loads tested (Figure 3-18). This insensitivity to load was attributed to the flame stability when burning Powder River Basin coal, even at lower unit loads with a sub-stoichiometric environment.

Several parameters were evaluated during this reburn retrofit demonstration to determine the effect of reburning on the overall power plant. These parameters included precipitator opacity, slagging and fouling, corrosion, tube temperatures, exit gas temperatures, carbon burnout, and hazardous air pollutants. A summary of the effects of the reburning retrofit on the various parameters is presented in Table 3-3. None of the evaluated parameters were severely upset as a result of the retrofit. In some cases, boiler performance was actually improved due to retrofit conditions, such as a reduction in slagging and fouling. More importantly, the reburn system was oper-

ated automatically and the boiler controls could compensate for cases of a pulverized coal reburn system shutdown.

As of July 1994, the pulverized coal reburn system had been in service for more than 2500 hours. Only two forced outages had occurred as a result of the retrofit. WP&L plans on continuing the firing of Powder River Basin coal in the reburn system. This system allows WP&L to meet NO_x emission reduction goals while maintaining the boiler's rating and burning low-sulfur coal to meet SO₂ emissions guidelines.

Ohio Edison - Niles Unit 1

Ohio Edison's Niles Generating Station was the site of a reburn system demonstration sponsored by Ohio Edison, EPA, GRI, EPRI, DOE, Ohio Coal Development Office, East Ohio Gas, and ABB Combustion Engineering. The information presented in this section was compiled from a paper titled "Long Term NO_x Emissions Results with Natural Gas Reburning on a Coal-Fired Cyclone Boiler" (Borio et al., 1993). Parametric and long-term testing were conducted as part of this research and development project on the feasibility of utilizing natural gas reburning to reduce NO_x emissions from a cyclone-fired utility boiler.

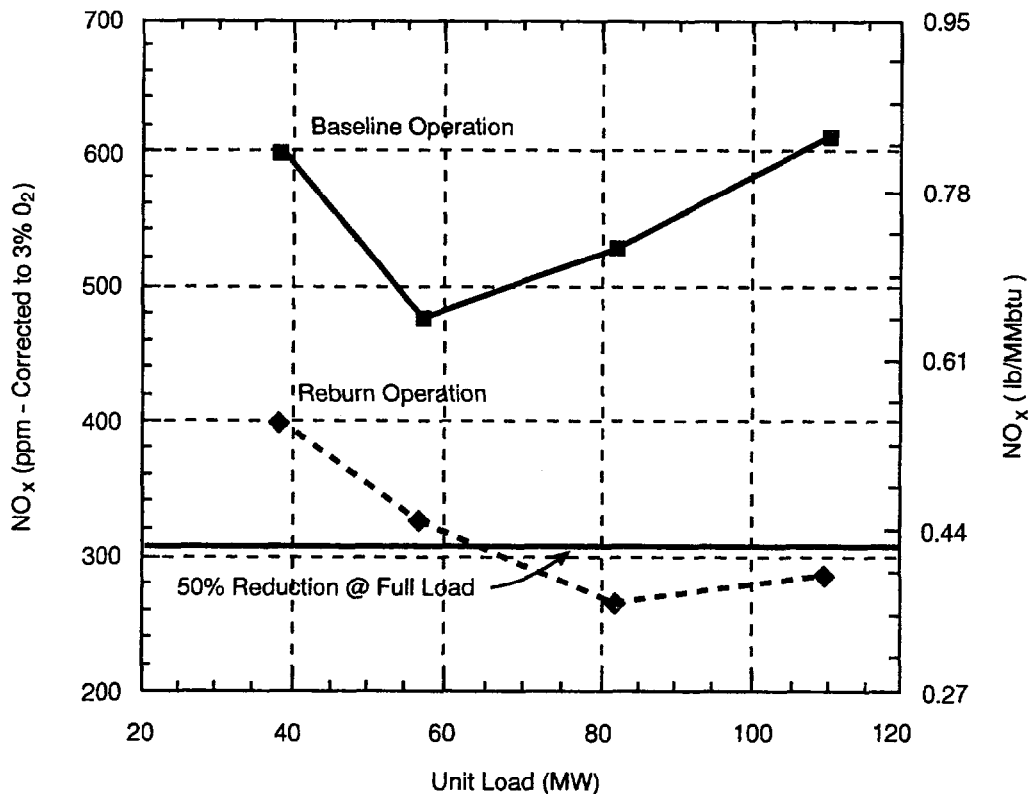

Figure 3-17. Nelson Dewey Unit 2-NO_x Emissions vs. Unit Load - Illinois Basin Coal (Newell et al., 1993).

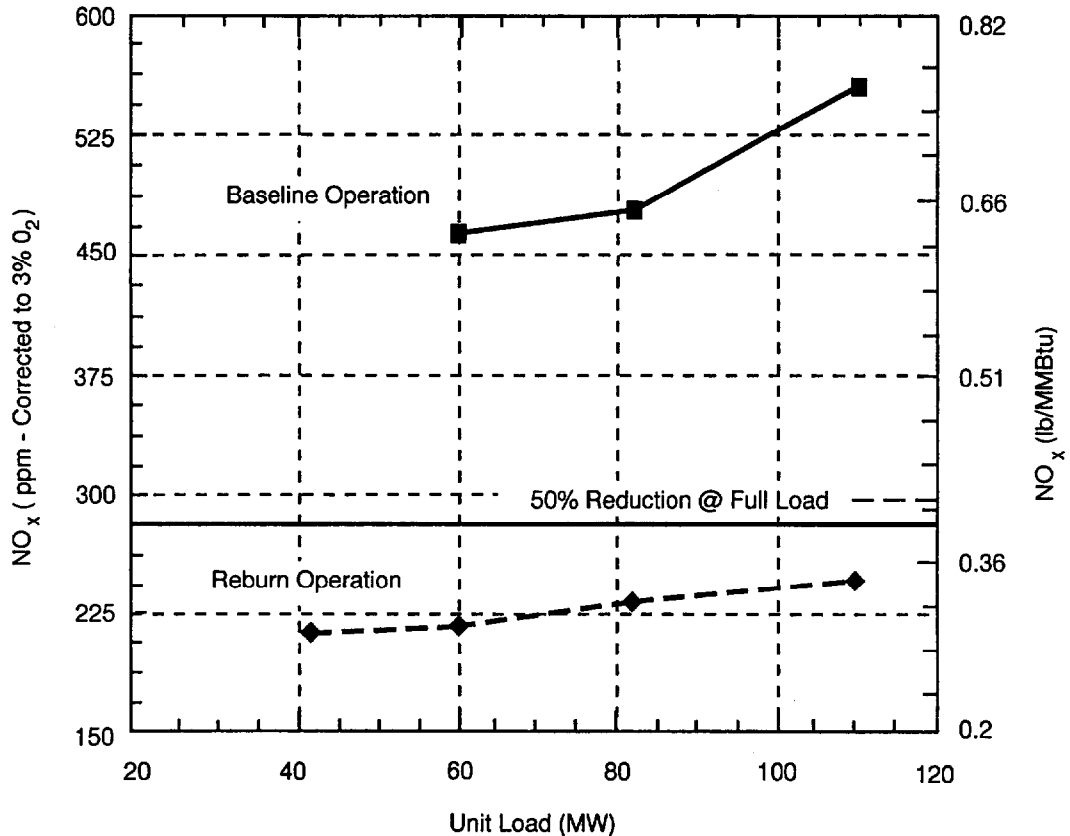

Figure 3-18. Nelson Dewey Unit 2-NO_x Emissions vs. Unit Load - Powder River Basin Coal (Newell et al., 1993).

Unit 1 is a 114-MW, cyclone-fired, pressurized, natural-circulation boiler. The four cyclone burners fire eastern bituminous coal in a single-wall fired furnace. A schematic of the boiler is shown in Figure 3-19. Combustion products from the cyclone burners pass down through the primary furnace-pass screen tubes. Five natural gas injectors were installed in the lower portion of the secondary furnace. Reburn fuel is injected under sub-stoichiometric conditions and allowed to react with the combustion products. OFA is injected toward the top of the secondary furnace to ensure carbon burnout. The flue gas then enters the boiler's convective passes.

The original design for this demonstration utilized FGR to facilitate mixing in the reburn zone. However, during parametric field testing, ash deposits on the furnace's back wall were found to be up to four times thicker than in normal boiler operation. Although NO_x emission reductions were not affected, the thicker ash deposits were an unacceptable furnace condition, and the reburn system was redesigned to operate without FGR. "Proof-of-performance" testing showed that operating the reburn without FGR eliminated the ash deposition problem. The NO_x emissions were slightly higher for the modified system, but remained within an acceptable range of the parametric test results.

The original design for the reburn system operation was for a reburn fuel heat input of 16% of total boiler heat input at loads of 80 MW or greater. For loads of less than 80 MW, the reburn heat input was to be proportionally reduced, reaching 0% at loads of 65 MW or less. These design considerations for reburn fuel heat input for loads less than 80 MW were not applied because of the need to maintain above the minimum furnace temperature requirements for slag tapping in the cyclone burners. During the long-term testing, the reburn system was utilized only at loads of 80 MW or greater due to "operator judgment" on the basis of slag tapping requirements.

During this testing, the reburn section heat input was at 16% of total heat input for approximately 50% of the tests, with the remaining tests run at between 3% and 16% of total heat input. The reburn zone was operated with a stoichiometry of approximately 0.94. Absolute NO_x emissions increased linearly with increasing reburn stoichiometries for tested load ranges (Figure 3-20). The general trend of greater absolute NO_x emissions at higher loads is offset by greater reductions from the baseline at higher loads. The reburning system effectively capped the level of NO_x emissions to 0.26 tons/hr for all loads tested (Figure 3-21).

Table 3-3. *Nelson Dewey Unit 2 - Summary of Effects of Reburning on Unit Operating Parameters*

Parameter	Anticipated Results	Actual Results
NO _x Emissions (Full Load) Illinois Basin Coal	Reduced 50% or more	Nominal 55% reduction
NO _x Emissions (Full Load) Powder River Basin Coal	Reduced 50% or more	Nominal 61% reduction
Precipitator Opacity	Up 5 to 10%	No increase from base
Slagging/Fouling	No Change	Cleaner than normal
Furnace Corrosion	No Change	No change
Header/Tube Temps	Higher 25 to 50°F	No increase from base
Furnace Exit Gas Temp	Higher by 50 to 75°F	Reduced by 100 to 150°F
SH & RH Sprays	Higher by 30%	50% of base
Carbon Carry-over Illinois Basin Coal	Higher by 10 to 15%	Higher by 10 to 15%
Carbon Carry-over Powder River Basin Coal	Higher by 10 to 15%	No change
Hazardous Air Pollutants*	No change	No change

*Arsenic, beryllium, cadmium, chromium, lead, nickel, manganese, selenium, mercury, benzene, toluene, HF, and HCl.

Source: Newell et al., 1993

As mentioned above, the original reburn system design involved the use of FGR to improve mixing of the reburn fuel and combustion gases and to cool the reburn fuel burners. The eventual long-term testing design did not utilize FGR. As a result of this redesign, significant savings were gained in capital cost.

The original design with FGR required a windbox penetration of 6 ft² for each of the five injectors, as well as the bending of 12 tubes out of plane. The redesign without FGR required a windbox penetration of only 0.2 ft² for each of five injectors, and the bending of two tubes out of plane. Water was chosen as the reburn injector cooling medium in place of the flue gas. In addition, various equipment such as a recirculation fan, controls, sections of ductwork, and a motor were no longer needed for the retrofit. Elimination of FGR from the reburn system would result in an estimated reduction in required capital of 30%. While this retrofit was successful in reducing NO_x emissions without the use of FGR, boilers with different flow patterns in the reburn zone may require FGR for adequate mixing in the reburn section.

Because some NO_x reduction efficiency was lost in the removal of the recirculated flue gas, attempts were made to return to the original reduction levels. It was thought that the natural gas reburn fuel potentially was forming soot as it was injected into the reburn zone without dilution by recirculated flue gas or combustion air. Soot formation does not reduce NO_x as well as the hydroxylation reaction which forms CH_x radicals. Water was injected with the reburn fuel to minimize soot formation and promote the hydroxylation reaction in the reburn zone. No changes in NO_x emissions reduction performance were achieved, thus water was eliminated from the reburn fuel injection.

Waterwall tube thicknesses were measured ultrasonically before and after the test program to detect any wastage. No significant increase in wastage was observed. Ultrasonic measurements indicated that corrosion in the upper areas of the secondary furnace were similar to its normal patterns. The superheater did show signs of increased wastage with the higher temperatures. Corrosion was lowest for those metal areas with increased concentrations of chromium.

The test program has been completed and the reburn system was removed in August 1992. Based on the load-cycle history of Unit 1, the annual reduction in NO_x emissions would be much less than the 47% achieved during the 3-1/2 months of testing. The facility reported that the actual NO_x emissions reduction over the 3-1/2 month testing period, when accounting for all hours of operation with or without reburning, was approximately 10%. A major factor in the overall low average was minimum ash fusion temperatures that impeded load following for the reburn system (Kanary, 1993). Suggestions for employing the reburn technology included (Borio et al., 1993):

- Accurately control the air/fuel mixtures to the cyclones;
- Eliminate the need for FGR by increasing the number of natural gas (reburn fuel) injectors;
- Use stainless in water-cooled reburn fuel guidepipes to prevent the corrosion that was experienced; and
- Use a lower fusion temperature coal to increase the load range at which the reburn system could operate.

Ladyzhin Power Station - Unit 4

Under a joint program sponsored by EPA, and the nations of Russia and Ukraine, a 300-MW, opposed-wall fired, wet-bottom boiler was retrofitted with a natural gas reburn system. The objective of the test was to determine the effectiveness of reburn technology in reducing NO_x emissions by at least 50% while minimizing any

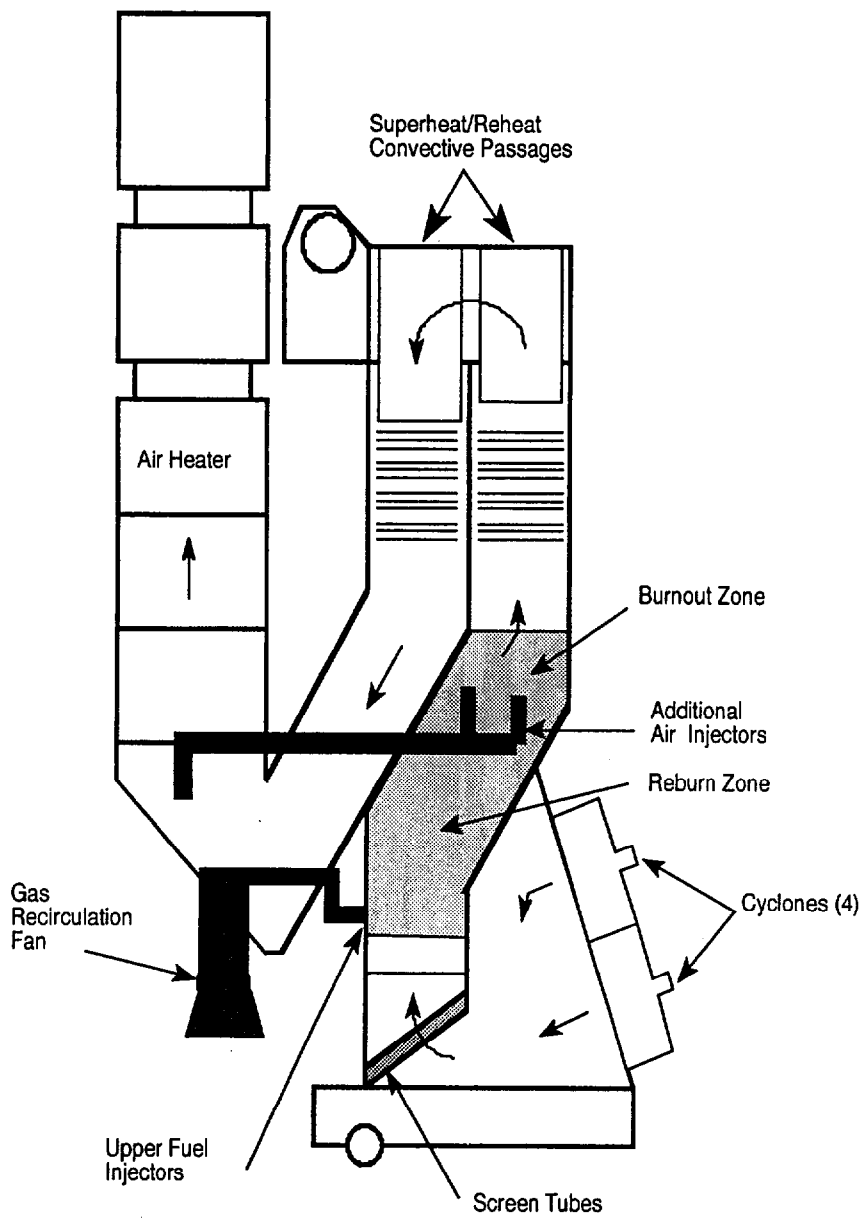

Figure 3-19. Niles Unit 1—Schematic of Reburn Process (Borio et al., 1993).

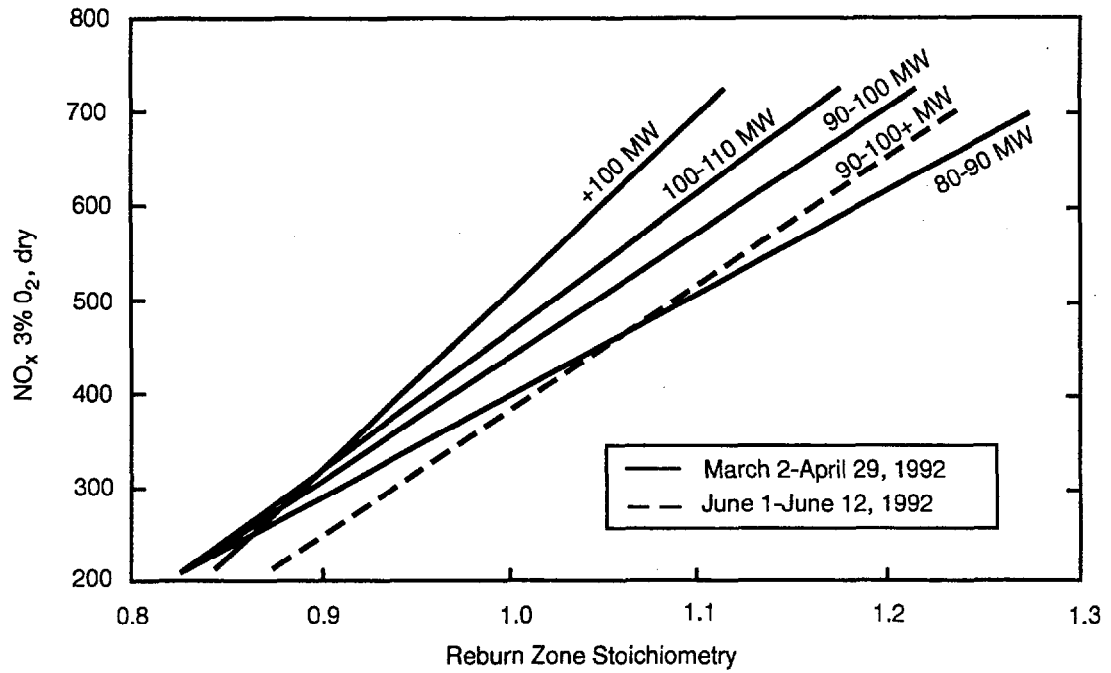

Figure 3-20. Niles Unit 1-Variation of NO_x with Reburn Stoichiometry (Borio et al., 1993).

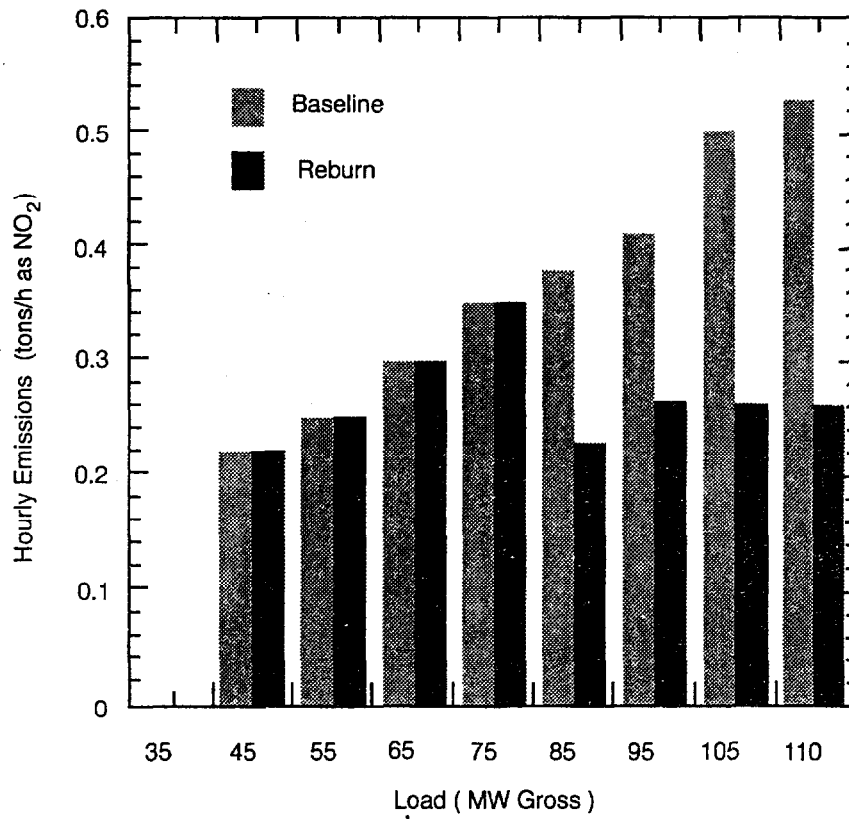

Figure 3-21. Niles Unit 1-NO_x Emissions as a Function of Boiler Load (Borio et al., 1993).

detrimental impact from the retrofit. The information presented in this section was compiled from a paper titled "Three-Stage Combustion (Reburning) Test Results from a 300 MWe Boiler in the Ukraine" (LaFlesh et al., 1993).

The boiler that was chosen as a host site is typical of at least 300 other units in Russia and Ukraine. The boiler, Unit 4, was located at the Ladyzhin Power Station near Vinnitsa, Ukraine. The boiler typically fires a high volatile, high ash, Ukrainian, bituminous coal (25 to 35% ash content); a low-ash, Siberian, brown lignite coal (4 to 10% ash content); or a blend of these fuels. An analysis of the coals is shown in Table 3-4.

Baseline NO_x emissions ranged from 370 to 730 ppm depending on various operating factors. ABB Combustion Engineering, under contract to EPA, provided a conceptual reburning system design, with the Russian and Ukrainian teams completing all other portions of the fabrication and testing. ABB Combustion Engineering's design was based on cold-flow modeling, computer modeling, analysis of engineering drawings, and results of the Ohio Edison Niles Unit I demonstrations program (cited previously).

Table 3-4. Ladyzhin Unit 4 - Fuel Analyses

Parameter	High Volatile Bituminous C -Donetz	Siberian Lignite Kansk-Achinski
Proximate Analysis		
Moisture, %	12.0	33.0
Volatile Matter, %	22.2	29.9
Fixed Carbon, %	30.6	32.4
Ash, %	35.2	4.7
Ultimate Analysis		
Moisture, %	12.0	33.0
Carbon, %	40.1	43.7
Hydrogen, %	3.0	3.0
Sulfur, %	2.9	0.2
Oxygen, %	6.0	13.5
Nitrogen, %	0.8	0.6
LHV, Btu/lb	6,864	6,738
Critical Temperatures		
Initial Deformation, °F	2,190	2,320
Softening, °F	2,440	2,350
Fusion, °F	2,520	2,398

Source: LaFlesh et al., 1993

The Ladyzhin Power Station has six 300-MW, TPP-312 boilers. These supercritical steam pressure units (3625 psig) each have 16 opposed-wall, swirl-stabilized burners and operate under slagging conditions. The slag makes up 20 to 30% by weight of the total ash, and is tapped at the bottom of the furnace. The fly ash is removed from the flue gas by electrostatic precipitators.

A 1/16-scale model was used to conduct isothermal flow modeling of the Ladyzhin unit. The model was used to optimize parameters such as configuration, size, location, number, and operating values for the reburn burners and OFA injectors. Burners and OFA injectors were assumed to be located on either the front or back wall due to equipment obstructions on the side walls. In addition, estimates were made on the potential flue gas velocities within the furnace.

Preliminary design configurations were modeled on a computer in two parts. First, a reburn configuration was evaluated independent of OFA considerations. Then, the selected reburn configuration was tested with varying OFA configurations. The input parameters are shown in Table 3-5.

Parameters of interest in the analysis included exit gas temperature, furnace hopper gas temperature, and furnace heat absorption profile. The output of the computer model included furnace gas temperature profiles and furnace absorption profiles. Operational parameters such as excess air, FGR rate, and reburn heat input were analyzed for optimal thermal performance. The values selected from the computer modeling are presented in Table 3-6. A schematic of the preliminary design is shown in Figure 3-22.

One change was made to the system after the reburn system was designed and, thus, was independent of considerations for the reburn retrofit. An aerodynamic "nose" was fitted to improve a problem with heat transfer in the boiler's convective section. This change does not appear to have had any significant effect on the reburn retrofit.

Prior to the retrofit, NO_x emissions averaged 600 ppm while at a load of 300 MW (4% O₂ at economizer outlet) and firing a blend of 90% Ukrainian coal and 10% Siberian lignite. Parametric tests were able to reduce NO_x emissions to as low as 240 ppm at a reburn heat input of 15%. NO_x emissions decreased as reburn heat input percentage increased (Figure 3-23). Decreasing excess air (shown as flue gas O₂ content after the economizer) also reduced NO_x emissions (Figure 3-24). The reburn system was operated over a load range of 200 MW to 300 MW. Absolute values of NO_x emissions had a linear relation to increasing load as shown in Figure 3-25. Parametric testing showed that at loads of 200 MW to 300 MW, the reburn system generally was able to reduce NO_x emissions by 40 to 60% (240 to 360 ppm) from a

Table 3-5. Ladyzhin Unit 4 - Flow Diagram for Boiler Combustion Performance Model

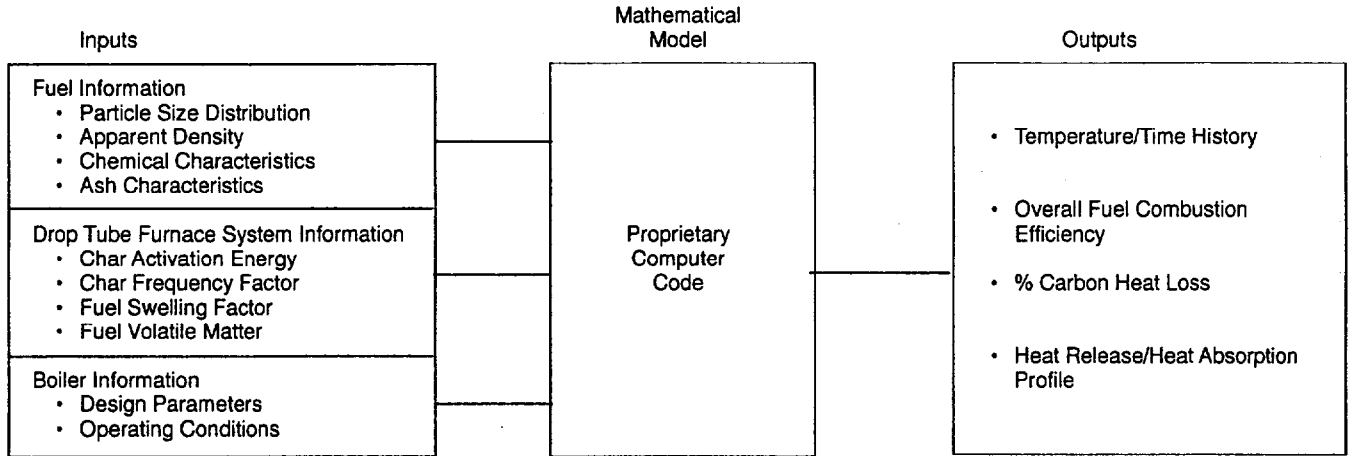

Source: LaFlesh et al., 1993

Table 3-6. Ladyzhin Unit 4 - Furnace Thermal Performance Summary

Performance Variables	Units	Baseline as Found	Preliminary Reburn Case	Optimum Reburn Case
Reburn Fuel Ratio	%	NA	20	12
Total Excess Air	%	20	20	20
Burner Zone Excess Air	%	20	20	5
Total FGR	%	18	18	21
Reburn FGR	%	NA	10	7.5
Upper Furnace FGR	%	3.2	3.2	8.7
Furnace Exit Gas Temp	°F	2,028	2,028	1,949
Furnace Heat Absorption	MMBtu	606	609	625

Source: LaFlesh et al., 1993

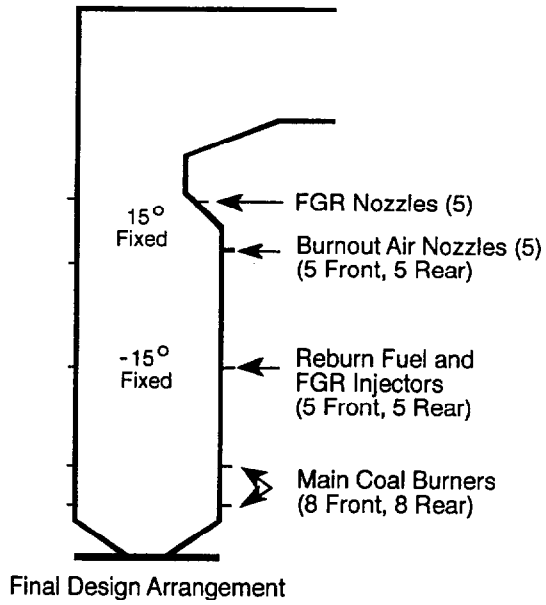
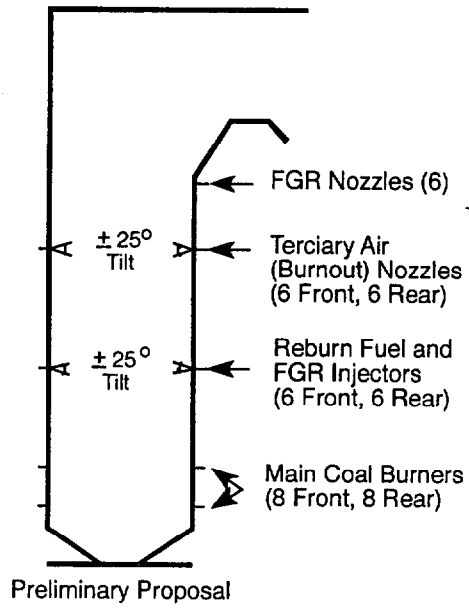

Figure 3-22. Ladyzhin Unit 4—Schematic of Reburn Design Arrangements (LaFlesh et al., 1993).

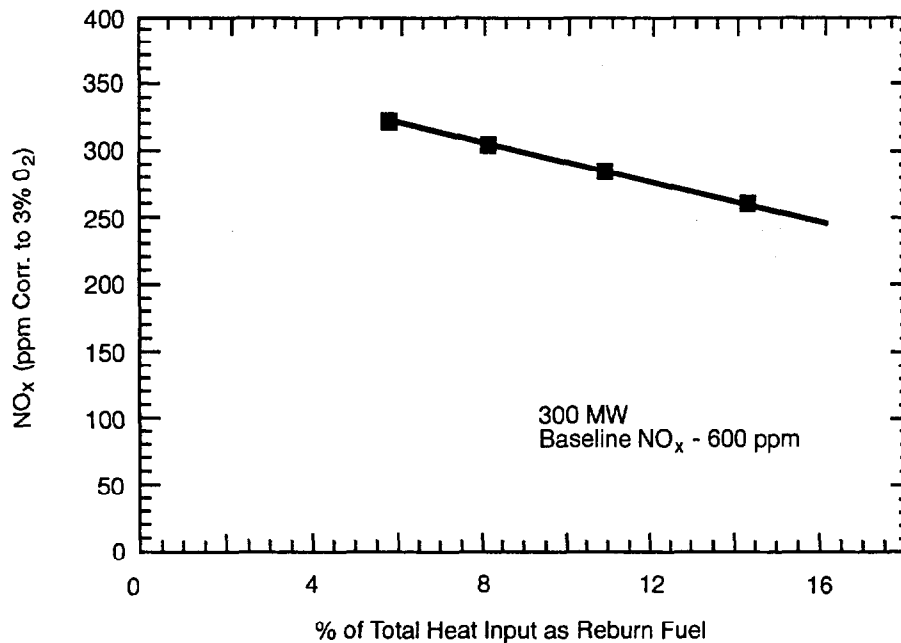

Figure 3-23. Ladyzhin Unit 4-NO_x Emissions vs. Reburn Fuel Percentage (LaFlesh et al., 1993).

baseline of 600 ppm, with an average NO_x reduction of just over 59%.

As a slagging boiler, Ladyzhin Unit 4 experienced some problems with maintaining fluid slag at reduced loads when a significant fraction of the total heat input to the boiler was directed to the reburn burners. At Ladyzhin, slag tapping was affected at loads below 200 MW. Slag tapping was unaffected at loads between 200 and 300 MW. Furnace operators commented that the boiler was "more controllable" after the retrofit.

FGR was used as a carrier gas for the reburn fuel, and to maintain burner metal temperature at 1472°F or less. Unburned carbon in the fly ash increased 1% after the retrofit. CO levels were maintained at 250 ppm or less,

with additional reductions expected with long-term testing.

Unit 4 is operating the reburn system for long-term testing to optimize operational parameters and evaluate various primary fuel compositions. Consideration is being given to installing multi-fuel reburn fuel injectors in a new reburn system design for Ladyzhin boiler No. 6. The design is being done by EER, under contract to the EPA. Partners include U.S. AID, and the U.S. Department of Energy. The multi-fuel system will be capable of firing natural gas, oil, or coal. This capability would be very important in Ukraine due to potential fuel shortages. Ladyzhin plant personnel would like to install reburn capability on all six units, as funding is available.

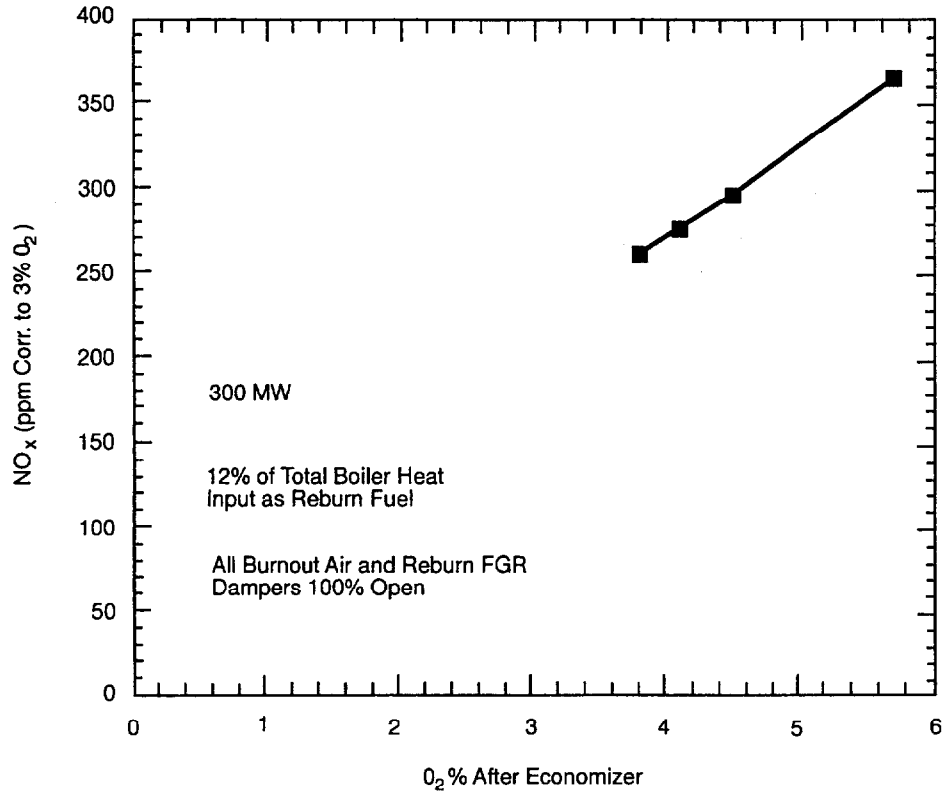

Figure 3-24. Ladyzhin Unit 4-NO_x Emissions vs. Flue Gas Oxygen Content.

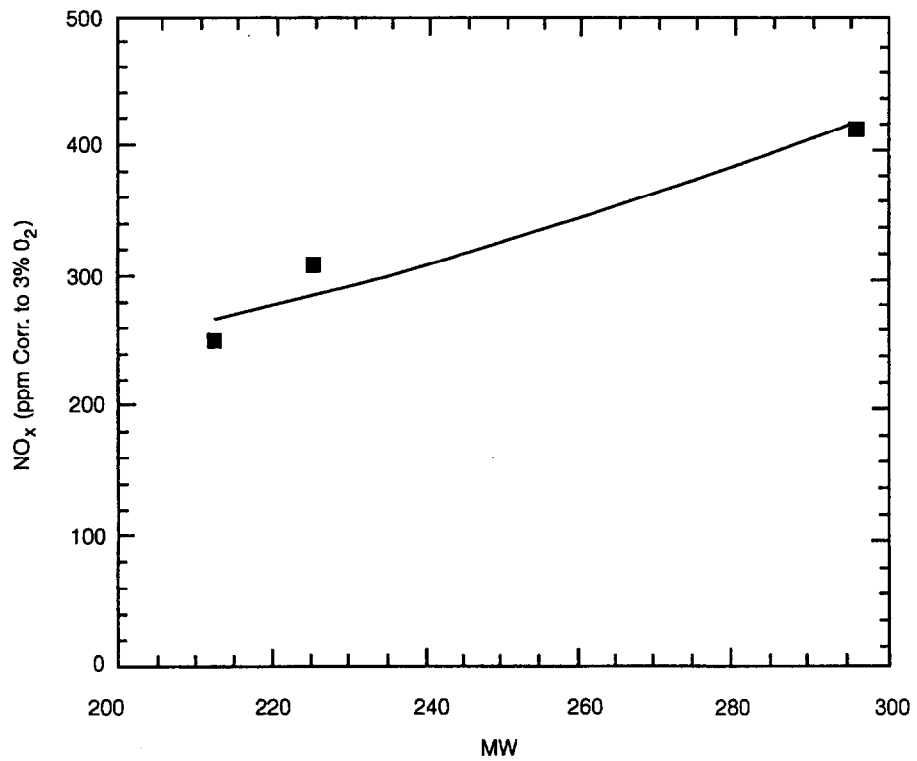

Figure 3-25. Ladyzhin Unit 4-NO_x Emissions vs. Boiler Load.

Chapter 4

Process Economics

Costing Methodology

Estimates of the capital and operating costs of using the reburning process to reduce NO_x emissions are presented in the following section. A synopsis of the procedures by which these costs were converted to busbar and cost-effectiveness estimates is also provided. The cost estimation methods closely follow the procedures used in the EPA Alternative Control Techniques (ACT) Document — NO_x Emissions from Utility Boilers (U.S. EPA, 1994), the general methodology contained in the EPRI Technical Assessment Guide (TAG) (EPRI, 1986), and the EPA's Office of Air Quality Planning and Standards (OAQPS) Costing Manual (U.S. EPA, 1990). The general framework for handling capital and annual costs is shown in Table 4-1. All costs, except where noted, are presented in 1991 dollars.

Because of the limited economic data on coal-fired reburn systems, the quantitative cost analyses are limited to gas-fired reburn installations; however, discussions of cost factors related to coal-fired reburn systems are also presented.

Capital Costs

The estimated total capital cost of a reburn system includes both direct and indirect costs. Direct costs include both costs for the basic system installation and for the retrofit needs. Indirect costs are based on a percentage of the direct costs and include several costs associated with the design and engineering of the system.

Typical capital costs for the installation of a reburn system involve reburn fuel equipment, boiler modifications, and particulate control device modifications (if required). If the reburn fuel is coal, significant adjustments may be required for the handling and preparation of the fuel, including the addition of a pulverizer. Fuel preparation costs are not required for natural gas-firing; however, installation of new gas supply lines can be extremely costly if no existing gas line to the plant is available or if the exist-

ing line has inadequate capacity. Boiler modifications include the penetration of boiler walls to install reburn fuel injectors and OFA ports. Modification or replacement of existing burners typically is not necessary, but may be included in an overall NO_x emission reduction program. Additional fans and ductwork are also necessary for flue gas recirculation and overfire air systems. Installation of reburn systems also often includes upgrade of the boiler control systems to include the new fuel and combustion air controls to ensure safe start-up, shut-down, and trip conditions. Modifications to the particulate control devices may be necessary to control the increased amount of fly ash produced when coal is used as a reburn fuel in a wet-bottom boiler.

Basic System Cost

The basic reburn system cost is the cost of purchasing and installing the system hardware directly associated with the control technology. This cost reflects the costs of the basic system components for a new application, but does not include any site-specific upgrades or modifications to existing equipment that may be required to implement the control technology at an existing plant (e.g., new ignitors, new burner management system, and waterwall or windbox modifications). Any reburn system start-up/optimization tests are also included in basic system cost. **Note:** The costs of purchasing and installing any continuous emission monitoring (CEM) equipment that may be required for determining compliance with state and federal emission limits are not included in the analysis.

The data used to estimate basic system cost were compiled in the ACT document (U.S. EPA, 1994) from utility questionnaires, vendor information, published literature, and other sources. These cost data were then compiled in a data base, examined for general trends in capital cost versus boiler rating, and statistically analyzed using linear regression to fit a functional form of:

$$\text{BSC} = a \cdot \text{MW}^b \quad (4-1)$$

Table 4-1. Capital and Operating Cost Components

Total Capital Cost	Direct Cost	Basic System Cost	Basic equipment Initial chemicals/ catalyst Installation Start-up/optimiza- tion testing
		Retrofit Cost	Scope adders Work area congestion
	Indirect Cost		General facilities Engineering Royalty fees Project contin- gency Process contin- gency
Total O&M Cost	Fixed O&M Cost		Operating labor Maintenance labor Supervisory labor Maintenance materials
	Variable O&M Cost		Energy penalty Chemicals/catalyst Electricity Water Waste disposal

where:

BSC = Basic system cost (\$/kW)

a = Constant derived from regression analysis

MW = Boiler size (MW)

b = Constant derived from regression analysis

The basic system cost was then derived using Equation 4-1 and the calculated values of "a" and "b".

Retrofit Cost Factor

In comparison with installation on a new unit, installation of NO_x controls on an existing boiler typically involves additional cost categories. These additional cost categories comprise the system retrofit cost. Retrofit costs are related to upgrades and modifications to the boiler that are required for the NO_x control system to operate as designed. These modifications and upgrades can include:

- Igniters modification or replacement;
- Waterwall modifications;
- Flame scanners;
- Coal pulverizer modifications;

- Boiler control modifications;
- Burner management modifications;
- Coal piping modifications;
- Windbox modifications;
- Structural modifications;
- Asbestos removal;
- Insulation modifications;
- Electrical system modifications;
- Flue gas recirculation fan modifications; and
- Demolition.

Additional costs are incurred when accessibility is restricted or work space is limited by the existing equipment configuration. All of these factors are included in a retrofit factor that is based as a percentage of the basic system cost as presented below in Equation 4-2.

$$RF = 1 + \frac{RC}{BSC} \quad (4-2)$$

where:

RF = Retrofit factor (dimensionless);

RC = Retrofit cost (\$/kW); and

BSC = Base system cost (\$/kW).

For example, a retrofit factor of 1.3 indicates that the retrofit cost is 30% of the basic system cost. Retrofit factors were developed based on cost data for planned or actual reburn installations on existing utility boilers. The cost data were also used to estimate low, medium, and high retrofit factors for the model boiler analysis, which are listed below:

- A low retrofit factor of 1.0 is used for a new unit or a retrofit that requires minimal or no upgrades or modifications, and if no difficulties are associated with accessibility;
- A medium retrofit factor is used for moderate equipment upgrades or modifications and/or if some difficulties exist that are associated with accessibility; and
- A high retrofit factor indicates that extensive scope adders are required and/or limited accessibility and/or work space also may be available.

Gas-fired reburn retrofit costs are primarily due to modifications and upgrading of existing equipment. Requirements for accessibility and work space are minimal for a

gas-fired reburn retrofit since burners and overfire air ports typically can be installed from inside the boiler. Coal-fired reburn retrofits can incur significant costs associated with greater accessibility and work space requirements than required for gas-fired retrofits. Gas-fired reburn systems typically are estimated with a low to medium retrofit factor while coal-fired reburn systems typically are estimated with a medium to high retrofit factor.

The total direct cost was estimated by multiplying the basic system cost by an appropriate retrofit factor.

$$TDC = BSC \cdot RF \quad (4-3)$$

where:

TDC = Total direct cost (\$/kW);

BSC = Basic system cost (\$/kW); and

RF = Retrofit factor (dimensionless).

Indirect Cost Factor

The indirect cost includes the costs of general facilities, engineering expenses, process royalty fees (if any), and contingencies. General facilities include offices, laboratories, storage areas, or other facilities required for installation or operation of the control system. Examples of general facilities required by installation of a reburn system include expansion of the boiler control room to house new computer cabinets for the boiler control system and expansion of an analytical laboratory.

Engineering expenses include the utility's internal engineering efforts as well as an architect/engineer (A&E) contractor. Engineering costs incurred by the technology vendor are included in the equipment cost and are considered direct costs.

A process royalty fee is a fee paid to the developer of a patented process technology in return for permission to use this technology. For example, a company may hold a patent on a unique process for reducing the volume of flue gas recirculation gas required to attain adequate mixing of the reburn fuel and combustion gas in the reburn zone, and the patent-holder may charge a fee for use of this technology. In some cases, especially where the patent is for a specific piece of equipment, this fee may be included in the capital cost of the equipment.

Contingencies are factors that account for the uncertainty associated with cost estimation (project contingency) and the maturity of the technology (process contingency). Project contingency is assigned based on the level of detail in the cost estimate. The total capital cost must include the costs of miscellaneous equipment and materials not included in the direct cost estimate. Project contingencies range from 5 to 50% of the direct costs, depending on the level of detail included in the direct

cost estimate, with lower contingencies associated with more detailed cost estimates. Process contingency is based on the maturity of the technology and the number of previous installations. Process contingency represents unforeseen expenses potentially incurred because of inexperience with newer technologies. Process contingencies range from 0 to over 40% of the direct costs, with higher contingencies associated with less mature technologies.

As shown in Equation 4-4, an indirect cost factor accounts for the indirect costs as a percentage of the total direct cost:

$$ICF = 1 + \frac{IC}{BSC + RC} \quad (4-4)$$

where:

ICF = Indirect cost factor (dimensionless);

IC = Indirect costs (\$/kW);

BSC = Basic system costs (\$/kW); and

RC = Retrofit costs (\$/kW).

For example, an indirect cost factor of 1.3 indicates that the indirect costs are 30% of the total direct cost (basic system cost plus retrofit cost). The indirect cost factors are based on cost data from planned and actual installations of reburn systems on various boilers.

Finally, the total capital cost is calculated by multiplying the total direct cost by the ICF.

$$TCC = (BSC + RC) \cdot ICF \quad (4-5)$$

where:

TCC = Total capital cost (\$/kW);

BSC = Basic system cost (\$/kW);

RC = Retrofit cost (\$/kW); and

ICF = Indirect cost factor (dimensionless).

Operating and Maintenance Costs

Operating and maintenance (O&M) costs include fixed and variable O&M components. Fixed O&M costs include operating, maintenance, and supervisory labor; maintenance materials; and overhead. Fixed O&M costs are assumed to be independent of the boiler capacity factor (i.e., the magnitude of these costs are the same at 50% unit load and 100% unit load). Variable O&M costs are dependent on the boiler capacity factor and include any costs incurred from energy penalties (e.g., boiler effi-

ciency losses associated with the use of natural gas as a reburn fuel), electrical power consumption, and waste disposal.

Fixed costs were not included in the analysis under the assumptions that:

- Very few moving parts are needed for gas-fired reburning; and
- Operating labor and maintenance requirements are expected to be very low for gas-fired reburning.

Cost rates for variable O&M cost estimates are listed in Table 4-2. The prices listed for coal and natural gas are estimated national average prices for the year 2000, based on the reference case analysis in the DOE's 1992 Annual Energy Outlook (U.S. DOE, 1992). Prices for solid waste and electricity are listed in 1989 dollars.

The primary factor when determining variable O&M costs for reburn systems is the cost of the reburn fuel compared to the cost of the primary fuel it replaces. This cost is a major concern with gas reburn, as the cost of natural gas is typically \$1 to \$1.50 per million Btu (MMBtu) greater than the price of coal. A small heat rate penalty also is associated with gas reburn. However, this penalty may be offset by energy savings in other areas, such as a reduction in the energy needed to process the coal that has been replaced by gas. The additional fuel costs were calculated with the fuel prices listed in Table 4-2.

Variable O&M costs also include the savings gained from sulfur dioxide (SO₂) credits because of lower SO₂ emission levels when using natural gas-fired reburn on a coal-fired boiler. The SO₂ emissions were calculated with typical sulfur and calorific content of coal (U.S. EPA 1994) and an average AP-42 emission factor for bituminous and subbituminous coal (U.S. EPA, 1985b). The SO₂ credit was assumed to be \$200/ton of SO₂ (Sanyal et al., 1992). The equation to determine savings from SO₂ credits is:

$$\text{Savings} = \text{EF} \cdot \text{Sulfur} \cdot \text{MW} \cdot \text{HR} \cdot \text{CF} \cdot \text{Credit} \cdot \text{Reburn} \cdot 2.19 \quad (4-6)$$

where:

- Savings = Savings due to SO₂ credits (\$/yr)
- EF = AP-42 SO₂ Emission Factor (lbs SO₂/ton coal/% sulfur in coal);
- Sulfur = Sulfur (%);
- MW = Unit size (MW);
- HR = Boiler net heat rate (MMBtu/kWh);
- CF = Annual capacity factor (decimal fraction);

Credit = SO₂ credit (\$/ton);

Reburn = Heat input of reburn fuel fired divided by total boiler heat input (decimal fraction); and

2.19 = Unit conversion factor.

Table 4-2. Variable O&M Unit Costs

Fuel	Cost	Unit	Reference
Coal	1.74	\$/MMBtu	U.S. DOE 1992
Natural gas	3.27	\$/MMBtu	U.S. DOE 1992
Solid Waste	9.50	\$/ton	EPRI 1986
Electricity	0.05	\$/kWh	EPRI 1986

Busbar Cost and Cost-Effectiveness

Busbar cost (mills/kWh) is defined as the sum of annualized capital costs and total O&M costs (\$/yr) divided by the annual electrical output of the boiler (kWh/yr), which provides a direct indication of the cost of the reburn system to the utility and its customers. To convert total capital cost to an annualized capital charge, the total capital cost is multiplied by an annual capital recovery factor (CRF). The CRF is based on the economic life over which the capital investment is amortized and the cost of capital (i.e., interest rate). The CRF is calculated using the following equation:

$$\text{CRF} = \frac{i(1+i)^n}{(1+i)^n - 1} \quad (4-7)$$

where:

i = Interest rate (decimal fraction) [assumed to be 0.10 (i.e., 10%)];

n = Economic life of the equipment (years);

Cost-effectiveness values indicate the total cost of a control technology per unit of NO_x removed and are calculated by dividing the total annualized capital charge and O&M expense by the annual reduction in tons of NO_x emitted from the boiler.

Cost Analysis

Cost estimates for a gas-fired reburn system are presented in this section. These estimates are based on systems installed on wall-, tangential-, and cyclone-fired boilers burning coal as the primary fuel. Limited cost data on natural gas-fired reburn for coal-fired boilers

were obtained from vendor and utility responses to a questionnaire. In response to this questionnaire, Illinois Power submitted cost data for the reburn retrofit on the 75-MW Hennepin Unit 1 boiler; and EER provided installation costs for retrofitting the reburn systems on the 33-MW City Water, Light, and Power Lakeside Unit 7 boiler and the 172-MW Public Service of Colorado Cherokee Unit 3 boiler (U.S. EPA, 1994). A regression analysis of the data showed a high degree of scatter and no obvious costing trend. Reburn costs were based on the Cherokee Unit 7 cost data because this unit is most indicative of a typical small utility boiler. Sufficient data were not available to perform a cost analysis for coal-fired reburn systems.

The economy of scale was assumed to be 0.6 for the gas-fired reburn basic cost algorithm. With this assumption, the cost coefficients in Equation 4-1 for reburn are:

$$a = 229; \text{ and}$$

$$b = -0.40.$$

The cost of installing a natural gas pipeline was not included in the analysis because it is highly dependent on site-specific parameters such as the unit's proximity to a gas line and the difficulty of installation.

In their response to the questionnaire, EER indicated that the retrofit of a gas-fired reburn system would cost 10 to 20% more than a reburn system applied to a new boiler. With this assumption, the retrofit factor was assumed to be 1.15 (Jensen, 1993). However, for the sensitivity analysis, the retrofit factor was varied from 1.0 to 1.6 to account for different retrofit difficulties on specific boilers.

The indirect costs were estimated to be 40% of the total direct cost, resulting in an indirect cost factor of 1.40 (U.S. EPA, 1994).

Annual O&M costs included both additional fuel costs from the higher price of natural gas versus coal, and utility savings on SO₂ credits from lower SO₂ emission levels when using natural gas-fired as the reburn fuel on a coal-fired boiler. The analysis was conducted assuming 18% of the total heat input was from natural gas. The SO₂ credit was assumed to be \$200 per ton of SO₂, equal to \$0.24/MMBtu based on a coal-sulfur content of 1.5% (U.S. EPA, 1994).

Model Plants

To estimate the capital cost, busbar cost, and cost-effectiveness of natural gas-fire reburn, a series of model plants were developed. These model plants reflected the projected range of size, duty cycle, retrofit difficulty, economic life, uncontrolled NO_x emissions, and controlled NO_x emissions for each major boiler type.

The capital cost, busbar cost, and cost-effectiveness for the 15 wall-, tangentially-, and cyclone-fired model boilers are listed in Table 4-3. An economic life of 20 years and a NO_x reduction efficiency of 55% were assumed for all of these boilers. The fuel price differential between coal and natural gas was varied from \$0.50 to \$2.50/MMBtu. For the 600-MW, baseload, wall-fired boiler, the estimated cost-effectiveness ranges from \$480 to \$2,080 per ton of NO_x removed. For the 100-MW, peaking, wall-fired boiler, the estimated cost-effectiveness ranges from \$3,010 to \$4,600 per ton.

Cost per ton of NO_x removed with reburn was highest for the tangentially-fired units because of the lower baseline NO_x emissions produced by this boiler type. Cost-effectiveness for the tangentially-fired units ranged from \$615 per ton to \$2,680 per ton for the 600-MW, baseload unit, and \$3,870 per ton to \$5,930 per ton for the 100-MW, peaking unit.

Cost per ton of NO_x removed was lowest for cyclone-fired boilers because this boiler type produces the highest baseline NO_x emissions. For the 600-MW, baseload, cyclone boiler, cost-effectiveness ranged from \$290 to \$1,250 per ton and for the 100-MW, peaking boiler, cost-effectiveness ranged from \$1,810 to \$2,720 per ton.

Sensitivity Analysis

In addition to the model plant analysis, sensitivity analyses were conducted to examine the effect of varying eight selected plant design and operating characteristics on busbar cost and cost-effectiveness. The results of these analyses are presented in two graphs for each of the three boiler types. The eight characteristics and their reference values are:

- Retrofit factor (RF) - 1.3;
- Fuel price differential - \$1.50/MMBtu;
- Boiler size - 400 MW;
- Capacity factor - 40%;
- Economic life - 20 years;
- Uncontrolled NO_x emission rate:
 - Tangentially-fired boilers - 0.7 lb/MMBtu,
 - Wall-fired boilers - 0.9 lb/MMBtu, and
 - Cyclone-fired boilers - 1.5 lb/MMBtu;
- NO_x reduction - 55%; and
- Unit heat rate - 11,000 Btu/KWh.

Table 4-3. Costs for Natural Gas-Fired Reburn Applied to Coal-Fired Boilers

Plant Identification	Total Capital Cost, \$/kW			Busbar Cost, mills/kWh			Cost-Effectiveness, \$/ton		
	0.50	1.50	2.50	0.50	1.50	2.50	0.50	1.50	2.50
Fuel Price Differential (\$/MMBtu)									
Wall-Fired Boilers^a									
100 MW, Peaking ^b	58.0	58.0	58.0	8.44	10.7	12.9	3,010	3,800	4,600
100 MW, Baseload ^b	58.0	58.0	58.0	1.69	3.49	5.29	753	1,560	2,360
300 MW, Cycling ^b	38.0	38.0	38.0	2.22	4.20	6.18	898	1,700	2,500
300 MW, Baseload	38.0	38.0	38.0	1.26	3.06	4.86	562	1,360	2,170
600 MW, Baseload	29.0	29.0	29.0	1.07	2.87	4.67	478	1,280	2,080
Tangentially-Fired Boilers^c									
100 MW, Peaking	58.0	58.0	58.0	8.44	10.7	12.9	3,870	4,900	5,930
100 MW, Baseload	58.0	58.0	58.0	1.69	3.49	5.29	968	2,000	3,030
300 MW, Cycling	38.0	38.0	38.0	2.22	4.20	6.18	1,150	2,190	3,220
300 MW, Baseload	38.0	38.0	38.0	1.26	3.06	4.86	722	1,750	2,790
600 MW, Baseload	29.0	29.0	29.0	1.07	2.87	4.67	615	1,650	2,680
Cyclone-Fired Boilers^d									
100 MW, Peaking	58.0	58.0	58.0	8.46	10.7	13.0	1,810	2,290	2,770
100 MW, Baseload	58.0	58.0	58.0	1.71	3.51	5.31	456	938	1,420
300 MW, Cycling	38.0	38.0	38.0	2.23	4.21	6.19	543	1,020	1,510
300 MW, Baseload	38.0	38.0	38.0	1.28	3.08	4.88	342	823	1,300
600 MW, Baseload	29.0	29.0	29.0	1.09	2.89	4.69	291	773	1,250

^aUncontrolled NO_x levels of 0.90 lb/MMBtu and a reburn NO_x reduction of 55% were used for wall-fired boilers.

^bCapacity Factor: Peaking = 10%, Baseload = 65%, and Cycling = 30%.

^cUncontrolled NO_x levels of 0.70 lb/MMBtu and a reburn NO_x reduction of 55% were used for tangentially-fired boilers.

^dUncontrolled NO_x levels of 1.5 lb/MMBtu and a reburn NO_x reduction of 55% were used for cyclone-fired boilers.

In each figure, the effects of the design and operating characteristics on cost-effectiveness and busbar cost are illustrated. Each of the curves emanating from the central point illustrates the effect of changes in the individual parameter on cost-effectiveness and busbar cost, while holding the other seven characteristics constant. Thus, each curve isolates the effect of the selected characteristic on cost-effectiveness and busbar cost.

The effects of changes in these reference plant characteristics on cost-effectiveness and busbar cost of natural gas-fire reburn applied to wall-fired boilers are shown in Figures 4-1 and 4-2. The reference boiler's cost-effectiveness and busbar cost are approximately \$1,400 per ton of NO_x removed and 3.8 mills/kWh.

Of the five parameters shown in Figure 4-1, the variation of capacity factor from 10 to 70% and variation of fuel price differential from \$0.50 to \$2.50/MMBtu have

the greatest impact on cost-effectiveness and busbar cost. The cost-effectiveness value and busbar cost are inversely related to capacity factor, and thus, as capacity factor decreases, the cost-effectiveness value and busbar cost increase. This relationship is especially noticeable at low capacity factors where a decrease of 75% in the reference plant's capacity factor (from 40% to 10%) resulted in an increase in the cost-effectiveness value and busbar cost of approximately 100%.

The cost-effectiveness value and busbar cost are linearly related to fuel price differential. An increase or decrease of \$1.00/MMBtu in the fuel price differential compared to the reference plant changed correspondingly the cost-effectiveness and busbar cost by approximately 50%.

Variations in economic life and boiler size follow a trend similar to capacity factor; however, cost-effectiveness and busbar cost are not as sensitive to these variations. For

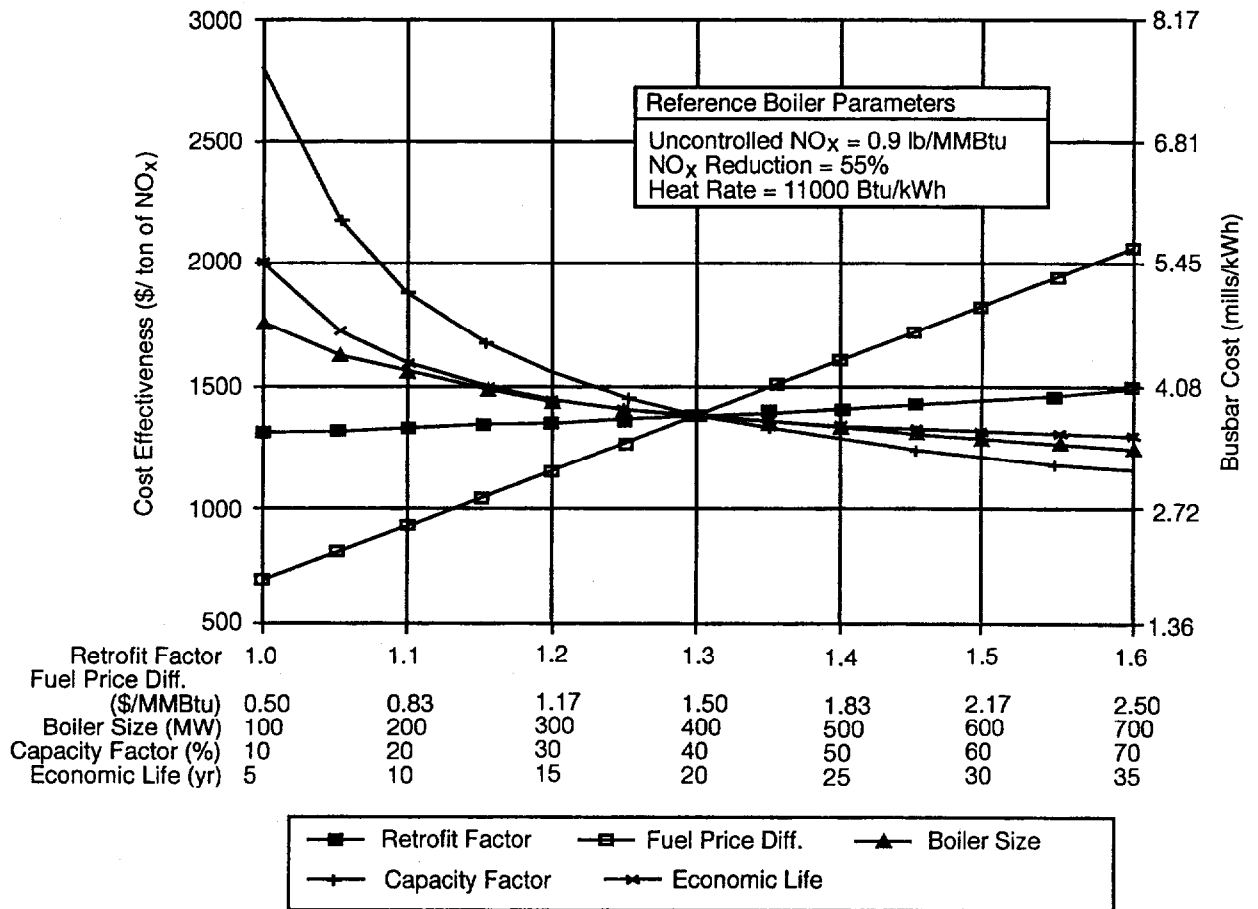

Figure 4-1. Impact of Plant Characteristics on Reburn Cost Effectiveness and Busbar Costs for Wall-Fired Boilers (U.S. EPA, 1994).

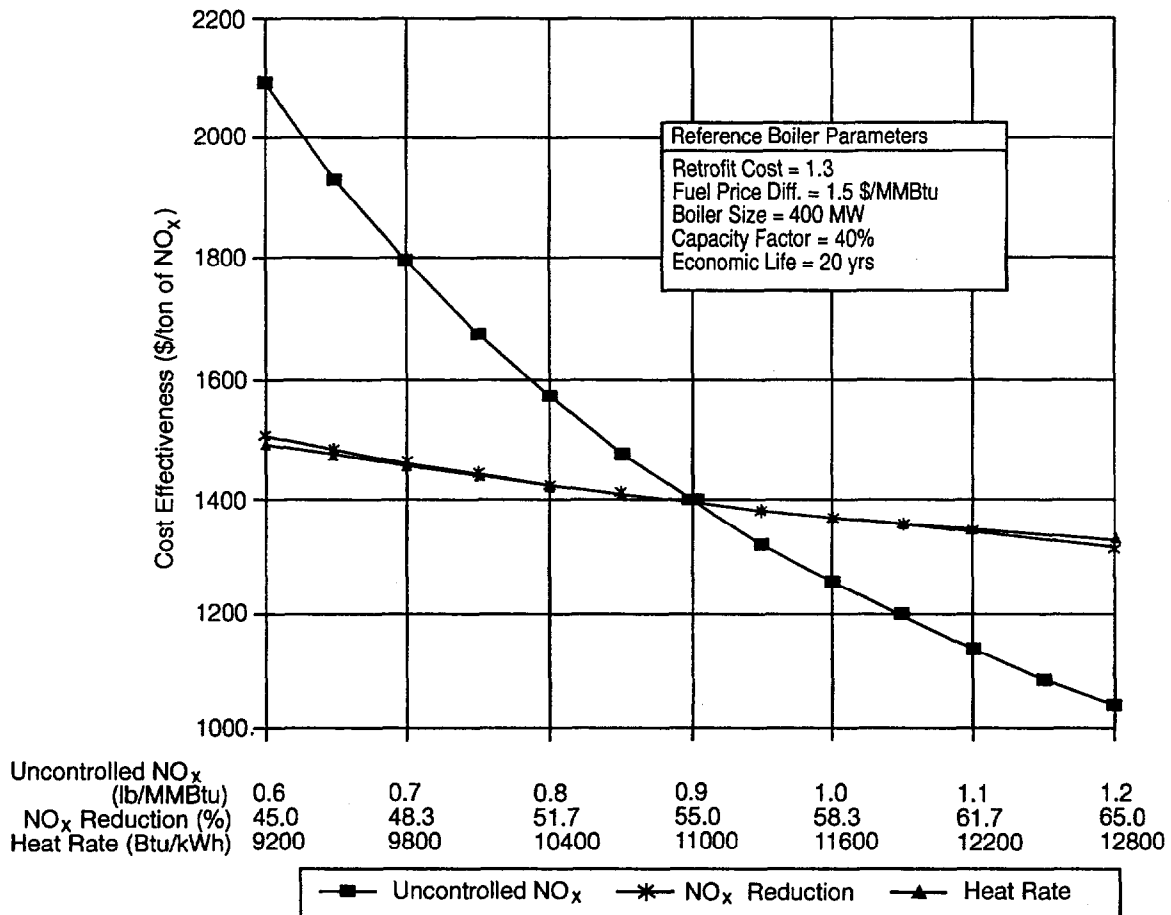

Figure 4-2. Impact of NO_x Emission Characteristics and Heat Rate on Reburn Cost Effectiveness for Wall-Fired Boilers (U.S. EPA, 1994).

example, a decrease of 75% in economic life (from 20 to 5 years) resulted in an increase in the plant's cost-effectiveness value and busbar cost by nearly 45%. Similarly, a decrease of 75% in the boiler size (from 400 to 100-MW) resulted in an increase in the plant's cost-effectiveness value and busbar cost by nearly 25%.

Variation in the retrofit factor from 1.0 to 1.6 resulted in the smallest relative percent change in cost-effectiveness and busbar cost. Increases of 0.1 in the retrofit factor resulted in a linear increase of approximately 6% in the cost-effectiveness value and busbar cost.

Of the parameters shown in Figure 4-2, the variation of uncontrolled NO_x from 0.6 to 1.2 lb/MMBtu has the greatest impact on cost-effectiveness. Uncontrolled NO_x levels exhibit an inverse relationship with the cost-effectiveness value. A 30% decrease in the reference plant's uncontrolled NO_x level (0.9 to 0.6 lb/MMBtu) resulted in an increase in the cost-effectiveness value by 50%. Variations in the NO_x reduction from 45 to 65% and heat rate from 9,200 to 12,800 Btu/kWh have less than a 6% change in cost-effectiveness.

The effects of the eight reference plant characteristics on cost-effectiveness and busbar cost of natural gas-fired reburn applied to tangentially-fired boilers are presented in Figures 4-3 and 4-4. The reference boiler's cost-effectiveness and busbar cost are approximately \$1,800 per ton of NO_x removed and 3.8 mills/kWh. The cost-effectiveness value for natural gas-fired reburn applied to tangentially-fired boilers is somewhat misleading in that it is generally higher than for a similar retrofit to wall-fired boilers. This is the result of the lower uncontrolled NO_x levels produced by tangentially-fired boilers (i.e., the fixed capital costs must be distributed over fewer tons of NO_x). The sensitivity curves follow the same general trends as the same retrofit for wall-fired boilers.

The effects of eight plant characteristics on cost-effectiveness and busbar cost of natural gas-fired reburn applied to cyclone-fired boilers are presented in Figures 4-5 and 4-6. The reference boiler's cost-effectiveness and busbar cost are approximately \$840 per ton of NO_x removed and 3.8 mills/kWh. The cost-effectiveness value for natural gas-fired reburn applied to cyclone-fired boilers is lower than a similar retrofit on wall-fired and tan-

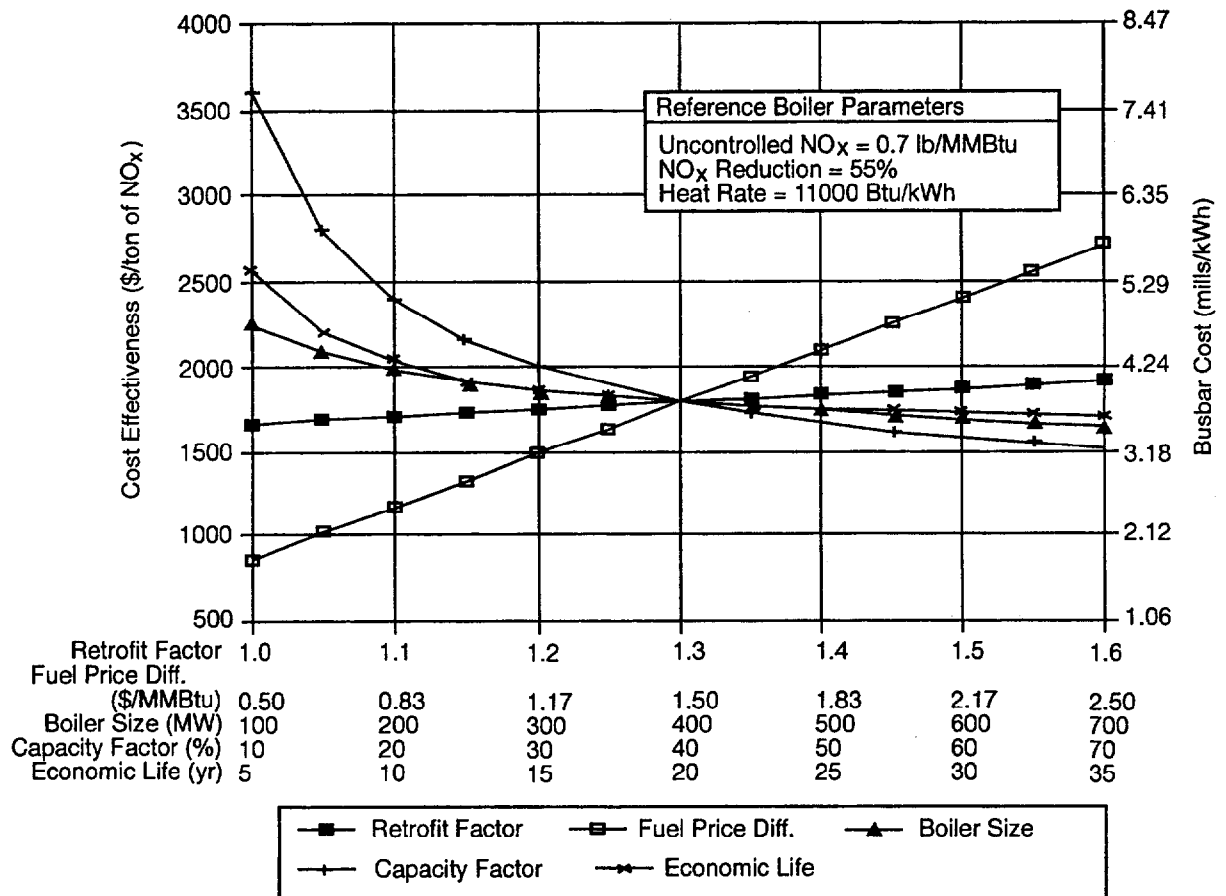

Figure 4-3. Impact of Plant Characteristics on Reburn Cost Effectiveness and Busbar Costs for Tangentially-Fired Boilers (U.S. EPA, 1994).

gentially-fired boilers because of higher uncontrolled NO_x levels in cyclone-fired boilers. The sensitivity curves follow the same general trends as the same retrofit for wall-fired boilers.

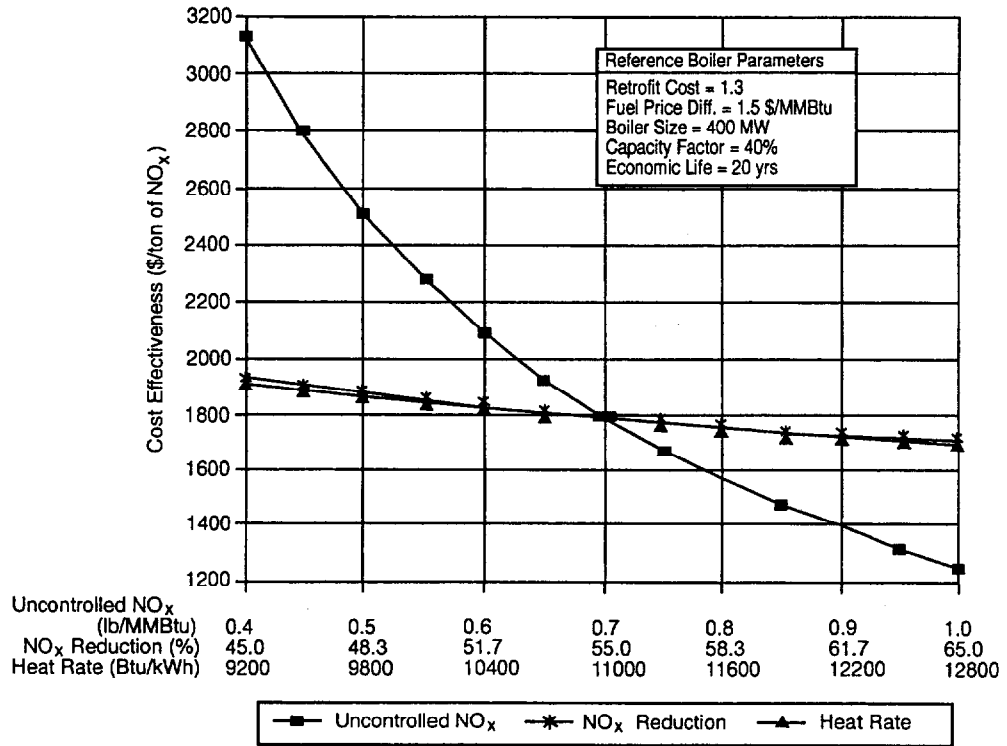

Figure 4-4. Impact of NO_x Emission Characteristics and Heat Rate on Return Cost Effectiveness for Tangentially-Fired Boilers (U.S. EPA, 1994).

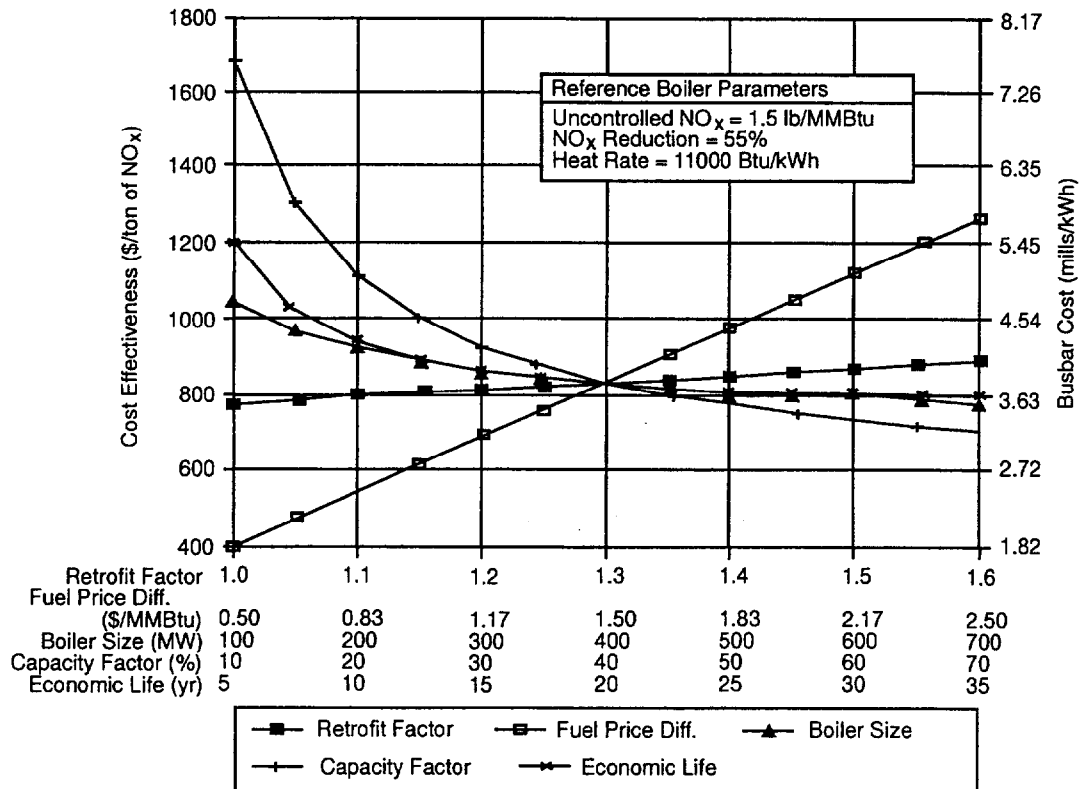

Figure 4-5. Impact of Plant Characteristics on Return Cost Effectiveness and Busbar Cost for Cyclone-Fired Boilers (U.S. EPA, 1994).

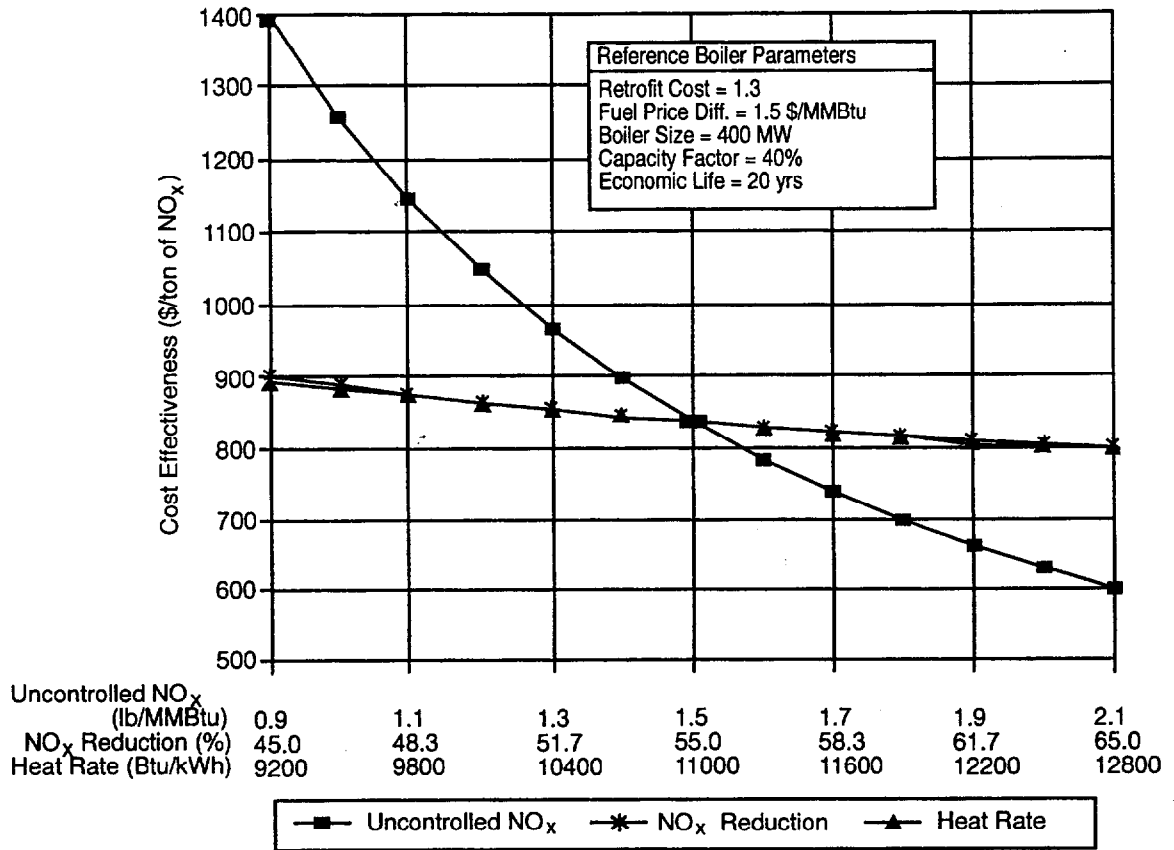

Figure 4-6. Impact of NO_x Emission Characteristics and Heat Rate on Return Cost Effectiveness for Cyclone-Fired Boilers (U.S. EPA, 1994).

Chapter 5

Integrated NO_x Control Technologies

The examples cited in Chapter 3 demonstrated that as a "stand alone" technology, reburning can reduce NO_x emissions from coal-fired boilers by 40 to 60%. However, the desired degree of NO_x emission reduction may be greater than can be attained by reburning alone in some cases. These situations may be candidates for implementation of an integrated NO_x emission control approach that combines reburning with another control technology. These other NO_x emission control technologies include LNBs, SNCR and SCR.

SNCR involves injecting ammonia or urea into the flue gas to yield nitrogen and water. The ammonia or urea must be injected into specific high-temperature zones in the upper furnace or convective pass for this method to be effective. SCR involves injecting ammonia into the flue gas in the presence of a catalyst. Selective catalytic reduction promotes the reactions by which NO_x is converted to nitrogen and water at lower temperatures than required for SNCR.

Reburning With Low NO_x Burners

The LNB-gas reburn retrofit at Public Service of Colorado's Cherokee Unit 3 is an example of the potential for lowering NO_x emissions by combining the reductions achieved through the use of low NO_x burners and reburn. As discussed in detail in Section 3, the LNBs by themselves were able to reduce NO_x emissions by 31% from baseline conditions. The combined LNB-gas reburn system reduced NO_x emissions by 72% from baseline emissions.

Reburning With SNCR

The SNCR process involves injecting ammonia (NH₃) or urea (CO(NH₂)₂) into boiler flue gas at specific temperatures. The ammonia or urea reacts with NO_x in the flue gas to produce N₂ and water.

For the ammonia-based SNCR process, ammonia is injected into the convection passes of the boiler where the flue gas temperature is 1,750 ± 90°F. Even though large quantities of O₂ are present in the flue gas, NO is a more effective oxidizing agent, so most of the NH₃ reacts with NO by the following mechanism:

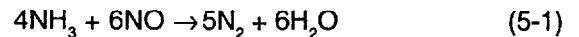

For Equation 5-1 to predominate over competing ammonia reactions, the NH₃ must be injected into the optimum temperature zone and the ammonia must be effectively mixed with the flue gas. Even under optimum conditions, an excess of ammonia must be provided to achieve a high level of NO_x reduction within a reasonable time. The amount of unused ammonia is referred to as "ammonia slip." Typical ammonia slip values, measured in the flue gas at the stack exit, are 5 to 20 parts per million (ppm), and the maximum value usually is limited by local or state air emission regulations.

In the urea-based SNCR process, an aqueous solution of urea is injected into the flue gas at one or more locations in the upper furnace or convective passes. The urea reacts with NO_x in the flue gas to form nitrogen, water, and carbon dioxide (CO₂). Aqueous urea has a maximum NO_x reduction activity at approximately 1,700 to 1,900°F. The exact reaction mechanism is not well understood because of the complexity of urea pyrolysis and the subsequent free radical reactions; however, the overall reaction mechanism is:

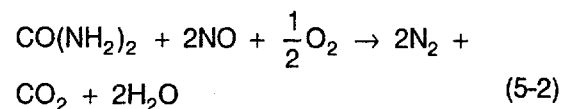

Tests of urea-based SNCR on coal-fired boilers have demonstrated reductions in baseline NO_x emissions of 40 to 70% depending on the boiler type and urea feed stoichiometry (Hunt et al., 1993; Hoffman et al., 1993; Nalco Fuel Tech, 1992).

Hardware requirements for SNCR processes include reagent storage tanks, air compressors, reagent injection grids, and an ammonia vaporizer (NH₃-based SNCR). Injection equipment such as a grid system or injection nozzles is needed at one or more locations in the upper furnace or convective passes. A carrier gas, such as steam or compressed air, is used to provide sufficient velocity through the injection nozzles to ensure thorough mixing of the reagent and flue gas. For units that vary loads frequently, multi-level injection is used.

To date, no full-scale demonstrations have occurred of a combination of reburning and SNCR on utility coal-fired boilers. The capital cost of the combined system anticipated to be approximately the sum of the costs of individual technologies. The capital cost, busbar cost, and cost effectiveness of stand-alone SNCR systems for 15 wall-, tangentially-, and cyclone-fired boilers are listed in Table 5-1 (U.S. EPA, 1994). These are the same 15 boiler models that were used previously in Table 4-3 as the examples of reburn costs. The principal benefit to be derived from combining SNCR and reburn technologies would be to increase the overall NO_x reductions with a side benefit of reducing the total ammonia/urea consumption.

Reburning With SCR

The SCR process involves injecting NH₃ into boiler flue gases in the presence of a catalyst to reduce NO_x to N₂ and water. The catalyst lowers the activation energy required to drive the NO_x reduction to completion, and, therefore, decreases the temperature at which the reaction occurs. The overall SCR reactions are:

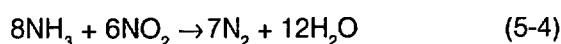
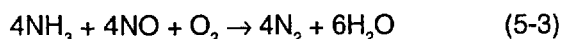

Undesirable reactions can occur in an SCR system, including the oxidation of NH₃ and SO₂ and the formation

of sulfate salts. The reaction rates of both desired and undesired reactions increase with increasing temperature. The optimal temperature range depends upon the type of catalyst.

The SCR process has been demonstrated on U.S. utility coal-fired boilers only at the pilot plant scale (Janik et al., 1993; Huang et al., 1993). These pilot plants treated fuel gas from a slipstream equivalent to approximately 1 to 2 MW of generating capacity. The results indicate that 75 to 80% NO_x reductions are possible with less than 20 ppm of ammonia slip.

The hardware for an SCR system includes the catalyst material; the ammonia system—including a vaporizer, storage tank, blower, valves, indicators, and controls; the ammonia injection grid; the SCR reactor housing (containing layers of catalyst); transition ductwork; and a continuous emission monitoring system. Anhydrous or dilute aqueous ammonia can be used; however, aqueous ammonia is safer to store and handle.

The capital cost of a combination of reburning and SCR is anticipated to be approximately equivalent to the sum of the costs of the individual technologies. The capital cost, busbar cost, and cost effectiveness of stand-alone SCR systems for 15 wall-, tangentially-, and cyclone-fired boilers are listed in Table 5-2 (U.S. EPA, 1994). The principal benefit of combining SCR and reburn technologies would be a higher percentage reducing the ammonia reduction of NO_x emissions with a side benefit of ammonia consumption relative to ammonia used in the SCR system. Because SCR requires rigid operating conditions on flue gas temperature and gas flow rate, the operation of the SCR system could impose operating restrictions on the reburn system that would limit its effectiveness. The ability of the combined systems to produce a reduced NO_x emission rate has been tested only in Japan and is not being actively promoted by any vendor at this time.

Table 5-1. Costs for SNCR Applied to Coal-Fired Boilers

Plant Identification	Total Capital Cost, \$/kW			Busbar Cost, mills/kWh			Cost-Effectiveness, \$/ton		
	140	200	260	140	200	260	140	200	260
Urea cost, \$/ton	140	200	260	140	200	260	140	200	260
Wall-Fired Boilers^a									
100 MW, Peaking ^b	14	14	14	5.47	5.86	6.25	2,160	2,320	2,470
100 MW, Baseload ^b	14	14	14	1.54	1.85	2.16	760	910	1,070
300 MW, Cycling ^b	10	10	10	1.78	2.12	2.46	800	950	1,100
300 MW, Baseload	10	10	10	1.25	1.56	1.86	610	770	920
600 MW, Baseload	9	9	9	1.14	1.45	1.76	560	720	870
Tangentially-Fired Boilers^c									
100 MW, Peaking	14	14	14	5.23	5.53	5.83	2,660	2,810	2,960
100 MW, Baseload	14	14	14	1.35	1.59	1.83	860	1,010	1,160
300 MW, Cycling	10	10	10	1.57	1.83	2.09	910	1,060	1,210
300 MW, Baseload	10	10	10	1.06	1.29	1.53	670	820	970
600 MW, Baseload	9	9	9	0.95	1.19	1.43	610	760	910
Cyclone-Fired Boilers^d									
100 MW, Peaking	14	14	14	6.18	6.84	7.50	1,460	1,620	1,780
100 MW, Baseload	14	14	14	2.10	2.63	3.16	620	780	940
300 MW, Cycling	10	10	10	2.40	2.98	3.56	650	800	960
300 MW, Baseload	10	10	10	1.81	2.34	2.87	540	690	850
600 MW, Baseload	9	9	9	1.71	2.23	2.76	510	660	820

^aUncontrolled NO_x levels of 0.90 lb/MMBtu and a SNCR NO_x reduction of 45% were used for wall-fired boilers.

^bCapacity Factor: Peaking = 10%, Baseload = 65%, and Cycling = 30%.

^cUncontrolled NO_x levels of 0.70 lb/MMBtu and a SNCR NO_x reduction of 45% were used for tangentially-fired boilers.

^dUncontrolled NO_x levels of 1.5 lb/MMBtu and a SNCR NO_x reduction of 45% were used for cyclone-fired boilers.

Source: U.S. EPA, 1994

Table 5-2. Costs for SCR Applied to Coal-Fired Boilers

Plant Identification	Total Capital Cost, \$/kW			Busbar Cost, mills/kWh			Cost-Effectiveness, \$/ton		
	2	3	4	2	3	4	2	3	4
Catalyst life (yr)									
Wall-Fired Boilers^a									
100 MW, Peaking ^b	110	110	110	43.4	37.1	33.9	9,650	8,250	7,540
100 MW, Baseload ^b	110	110	110	7.16	6.19	5.70	1,990	1,720	1,580
300 MW, Cycling ^b	86.0	86.0	86.0	13.1	11.0	9.91	3,300	2,770	2,500
300 MW, Baseload	86.0	86.0	86.0	6.34	5.36	4.88	1,760	1,490	1,360
600 MW, Baseload	75.0	75.0	75.0	6.02	5.04	4.56	1,670	1,400	1,270
Tangentially-Fired Boilers^c									
100 MW, Peaking	106	106	106	42.6	36.3	33.1	12,200	10,400	9,470
100 MW, Baseload	106	106	106	6.97	6.00	5.51	2,490	2,140	1,970
300 MW, Cycling	83.0	83.0	83.0	12.8	10.7	9.66	4,160	3,480	3,140
300 MW, Baseload	83.0	83.0	83.0	6.18	5.21	4.72	2,210	1,860	1,690
600 MW, Baseload	72.0	72.0	72.0	5.88	4.90	4.42	2,100	1,750	1,580
Cyclone-Fired Boilers^d									
100 MW, Peaking	117	117	117	44.5	38.3	35.0	5,940	5,090	4,670
100 MW, Baseload	117	117	117	7.53	6.56	6.07	1,260	1,090	1,010
300 MW, Cycling	90.0	90.0	90.0	13.5	11.4	10.3	2,040	1,720	1,560
300 MW, Baseload	90.0	90.0	90.0	6.65	5.68	5.19	1,110	947	866
600 MW, Baseload	78.0	78.0	78.0	6.31	5.34	4.85	1,050	890	809

^aUncontrolled NO_x levels of 0.90 lb/MMBtu and a SCR NO_x reduction of 80% were used for wall-fired boilers.

^bCapacity Factor: Peaking = 10%, Baseload = 65%, and Cycling = 30%.

^cUncontrolled NO_x levels of 0.70 lb/MMBtu and a SCR NO_x reduction of 80% were used for tangentially-fired boilers.

^dUncontrolled NO_x levels of 1.5 lb/MMBtu and a SCR NO_x reduction of 80% were used for cyclone-fired boilers.

Source: U.S. EPA, 1994

Chapter 6

References

- Angello, L.C., B.A. Folsom, T.M. Sommer, J.M. Pratapas, and M.S. Krueger. 1992. Field evaluation of gas cofiring as a viable dual fuel strategy. Presented at Power-Gen '92, Orlando, FL (November).
- Bagwell, F.A., K.E. Rosenthal, D.P. Teixeira, Southern California Edison Co., and B.P. Breen, N. Bayard de Volo, S.Kerho, KVB, Inc. 1971. Utility boiler operating modes for reduced nitric oxide emissions, No. 71-11. 64th Annual Meeting of the Air Pollution Control Assn., Atlantic City, NJ, (June-July).
- Bartok, W. and A. F. Sarofim, eds. 1991. Fossil fuel combustion, Chapter 4. New York, NY: John Wiley and Sons, Inc.
- Borio, R., R. Lewis, D. Steen, A. Lookman. 1993. Long term NO_x emissions results with natural gas reburning on a coal-fired boiler. Presented at 1993 EPRI/EPA Joint Symposium on Stationary Combustion NO_x Control, Bal Harbour, FL (May).
- Dieriex, R. 1993. Response to questionnaire on Hennepin Unit 1, Illinois Power Company to Radian Corporation.
- EPRI (Electric Power Research Institute). 1986. TAG™ Technical assessment guide. EPRI P4463-SR, Volume 1. Technical Evaluation Center, Palo Alto, CA (December).
- Energy & Environmental Research Corporation (EER), 1996. Enhancing the Use of Coal by Gas Reburning-Sorbent Injection, Vol. 2 - Gas Reburning-Sorbent Injection at Hennepin Unit 1, prepared for the Department of Energy, Report No. DOE/PC/79796-T38-Vol 2. NTIS No. DE95009448 (Available at 703/487-4650).
- Farzan, H. and R. A. Wessel. 1991. Mathematical and experimental pilot-scale study of coal reburning for NO_x control in cyclone boilers. Topical Report. U. S. Department of Energy. Report DOE/PC/89659-2 (June).
- Farzan H., et al. 1991. Reburning scale-up methodology for NO_x control from cyclone boilers. Presented at the International Power Generation Conference, San Diego, CA (October).
- Folsom, B., C. Hong, T. Sommer, and J.M. Pratapas. 1993. Reducing stack emissions by gas firing in coal-designed boilers - field evaluation. Presented at EPRI/EPA 1993 Joint Symposium on Stationary Combustion NO_x Control, Bal Harbour, FL (May).
- Folsom, B., A. Marquez, R. Payne, R. Keen, J. Opatrny, T. Sommer, and H.J. Ritz. 1994. Demonstration of gas reburning-sorbent injection on a cyclone-fired boiler. Presented at the Third Annual Clean Coal Conference, Chicago, IL (September).
- Gas Research Institute (GRI). 1991. Gas reburning technology review. Chicago, IL (July).
- Glassman, I. 1987. Combustion, second edition, Academic Press, Orlando, FL.
- Hoffman, J.E., et al. 1993. Post combustion NO_x control for coal fired utility boilers. Presented at the 1993 Joint Symposium on Stationary Combustion NO_x Control. Miami Beach, FL (May).
- Huang, C.M., et al. 1993. Status of SCR pilot plant tests on high sulfur coal at Tennessee Valley Authority's Shawnee Station. Presented at the 1993 Joint Symposium on Stationary Combustion NO_x Control. Miami Beach, FL (May).
- Hunt, T., et al. 1993. Selective non-catalytic operating experience using both urea and ammonia. Presented at the 1993 EPA/EPRI Joint Symposium on Stationary Combustion NO_x Control. Bal Harbor, FL (May).
- Janik, G., A. Mechtenberg, K. Zammit, and E. Cichanowicz. 1993. Status of post-FGR SCR pilot plant tests on medium sulfur coal at the New York

- Electric and Gas Kintigh Station. Presented at the 1993 Joint Symposium on Stationary Combustion NO_x Control. Miami Beach, FL (May).
- Jensen, A.D. 1993. Response to request for information on control of NO_x emissions from new or modified electric steam generating units. Letter and attachments from Energy and Environmental Research (EER) Corporation to J.A. Eddinger, U.S. Environmental Protection Agency (EPA) (February).
- Kanary, D.A. 1993. Response to questionnaire on reburn on Niles Unit 1, Ohio Edison Company.
- Keen, R.T., C.C. Hong, J.C. Opatrny, T.M. Sommer, B.A. Folsom, R. Payne, H.J. Ritz, J.M. Pratapas, T.J. May, M.S. Krueger. 1993. Enhancing the use of coal by gas reburning and sorbent injection. Presented at Second Annual Clean Coal Technology Conference, Atlanta, GA (September).
- LaFlesh, R.C., R. Lewis, R. Hall, V. Kotler, Y. Mospan. 1993. Three-stage combustion (reburning) test results from a 300 MW boiler in the Ukraine. Presented at the EPRI/EPA Joint Symposium on Stationary NO_x Control, Miami Beach, FL (May).
- Lisauskas, R. A. and A. H. Rawdon. 1982. Status of NO_x controls for Riley Stoker wall-fired and turbo-fired boilers. Presented at the 1982 EPA-EPRI Joint Symposium on Stationary NO_x Control (November).
- May, T. J., M. S. Krueger, R. T. Keen, J. C. Opatrny, C. C. Hong, T. M. Sommer, and B. A. Folsom. 1994. Gas Reburning in a tangentially fired coal boiler. Presented at NO_x Controls for Utility Boilers EPRI Workshop, Scottsdale, AZ (May).
- Mulholland, J.A. and W.S. Lanier. 1985. Application of reburning for NO_x control to a firetube package boiler. ASME's Journal of Engineering for Gas Turbines and Power. 107:7,739-743.
- Mulholland, J.A. and R.E. Hall. 1987. Fuel oil reburning application for NO_x control to a firetube package boiler. Journal of Engineering for Gas Turbines and Power. 109:4,207-214.
- Nalco Fuel Tech. 1992. SNCR NO_x control demonstration, Wisconsin Electric Power Company. Valley Power Plant, Unit 4 (March).
- Newell, R., J. Campbell, J. Wamsley, S. Gebhart, A. Yagiela, G. Maringo, H. Farzan, R. Haggard. 1993. Coal reburning application on a cyclone boiler. Presented at 1993 EPRI/EPA Joint Symposium on Stationary Combustion NO_x Control, Bal Harbour, FL (May).
- Pohl, J.H. and A.F. Sarofim, 1976. Devolatilization and oxidation of coal nitrogen. Presented at the 16th Combustion Symposium (August).
- Pershing, D.W. and J.O.L. Wendt, 1976. Pulverized coal combustion: the influence of flame temperature and coal combustion on thermal and fuel NO_x. Presented at the 16th Combustion Symposium, (August).
- Rindahl, E.G., M.E. Light, C.C. Hong, T.M. Sommer, B.A. Folsom. 1994. NO_x control by gas reburning in a 172 MW coal boiler. Presented at NO_x Controls for Utility Boilers EPRI Workshop, Scottsdale, AZ (May).
- Sanyal, A., T.M. Sommer, B.A. Folsom, L. Angello, R. Payne, and M. Ritz. 1992. Cost effective technologies for SO₂ and NO_x control. In Power-Gen '92 Conference Papers, volume 3. Orlando, FL (November).
- Sanyal, A., T.M. Sommer, C.C. Hong, B.A. Folsom, R. Payne. 1993. Low NO_x burners and gas reburning - an integrated advanced NO_x reduction technique. Presented at the Institute of Energy/International Symposium on Combustion and Emissions Control, University of Wales, College of Cardiff, UK. Energy and Environmental Research Corporation (September).
- Singer, J. G. 1991. Combustion, fossil power systems, fourth edition. Windsor, CT: Combustion Engineering, Inc.
- Stultz, S.C. and J. B. Kitto, eds. 1992. Steam, its generation and use. Barberton, OH: The Babcock & Wilcox Company.
- Takahashi, Y. 1981. Development of Mitsubishi 'MACT' in-furnace NO_x removal process. Technical Review, Mitsubishi Heavy Industries, Inc., 18:2.
- U.S. DOE (Department of Energy). 1992. Annual energy outlook 1992. DOE/EIA-0383(92). Office of Integrated Analysis and Forecasting. Washington, DC (January).
- U.S. EPA (Environmental Protection Agency). 1985a. Bench-scale process evaluation of reburning and sorbent injection for in-furnace NO_x/SO_x reduction. EPA-600/7-85/012. Air and Energy Engineering Research Laboratory, Research Triangle Park, NC (March).
- U.S. EPA (Environmental Protection Agency). 1985b. Compilation of air pollutant emission factors, fourth edition. Office of Air Quality Planning and Standards, Research Triangle Park, NC (September).
- U.S. EPA (Environmental Protection Agency). 1987. Pilot scale process evaluation of reburning for in-furnace NO_x reduction. EPA-600/7-86/048. Air and Energy Engineering Research Laboratory, Research Triangle Park, NC (December).

-
- U.S. EPA (Environmental Protection Agency). 1989. Bench-scale studies to identify process parameters controlling reburning with pulverized coal. EPA-600/7-89/005. Air and Energy Engineering Research Laboratory, Research Triangle Park, NC (May).
- U.S. EPA (Environmental Protection Agency). 1990. OAQPS Control cost manual, fourth edition, chapters 1 and 2. EPA 450/3-90-006. Office of Air Quality and Planning Standards, Research Triangle Park, NC (January).
- U.S. EPA (Environmental Protection Agency). 1994. Alternative control techniques document — NO_x emissions from utility boilers. EPA-453/R-94-023. Office of Air Quality and Planning Standards, Research Triangle Park, NC (March).
- Wendt, J.O.L., C.V. Sternling, and M.A. Matovich. 1973. Reduction of sulfur trioxide and nitrogen oxides by secondary fuel injection. Presented at the 14th Symposium (International) on Combustion, Pittsburgh, PA: Combustion Institute. p. 897.
- Yagiela, A.S., et al. 1991. Update on coal reburning technology for reducing NO_x in cyclone boilers. American Power Conference, Chicago, IL (April).

Chapter 7

Bibliography

- Gas Research Institute. 1993. Natural gas reburning: cost-effective NO_x reduction for utility boilers. GRI report number GRI-93/0059. Gas Research Institute, 8600 W. Bryn Mawr Ave., Chicago, IL 60631 (January).
- Gas Research Institute. 1993. Competitive analysis for gas-based NO_x control. GRI report number GRI-93/0484. Gas Research Institute, Chicago, IL 60631 (November).
- Gas Research Institute. 1993. Natural gas use for NO_x control in coal boilers. GRI report number GRI-93/0404. Gas Research Institute, Chicago, IL 60631 (September).
- Gas Research Institute. 1995. Proceedings of the second international gas reburn technology workshop, Malmö Sweden. Gas Research Institute, Chicago, IL 60631 (February).
- Gavin, J.J. 1994. Reburn projects meet goals. Power Generation Tech Update, Gas Research Institute, Chicago, IL 60631 (September).
- Hall, R.E., R.W. Borio, R.D. Lewis, and R. Booth. 1991. Natural gas reburning for NO_x control on a cyclone-fired boiler. 84th Annual Meeting and Exhibition, Air & Waste Management Association, Vancouver, B.C. Canada (June).
- Harding, N. S. (ed). 1993. Proceedings: Integrated natural gas technologies into coal and oil designed boilers. EPRI-TR-103469. Electric Power Research Institute, 3412 Hillview Avenue, Palo Alto, CA 94303 (June).
- LaFlesh, R.C., J.L. Marion, D.P. Towle, C.Q. Maney, G. DeMichele, S. Pasini, S. Batacchi, A. Piatanida, G. Galli, G. Mainini. 1992. Application of reburning technologies for NO_x emissions control on oil and pulverized-coal, tangentially fired boilers. ASME-91-JPGC-FACT-14. American Society of Mechanical Engineers, 345 East 47th Street, New York, NY 10017-2392 (April).
- May, T.J., E.G. Rindahl, T. Booker, R.T. Keen, M.E. Light, D.A. Engelhardt, R.Z. Beshai, T.M. Sommer, B.A. Folsom, H.J. Ritz, and J.M. Pratapas. 1994. Gas reburning in tangentially-, wall-, and cyclone-fired boilers, an introduction to second generation gas reburning. Third Annual Clean Coal Conference, Chicago IL (September).
- Opatry, J. C., R.T. Keen, M.E. Light, R.Z. Beshai, T.M. Sommer, B.A. Folsom, H.J. Ritz, and J.M. Pratapas. 1993. NO_x control by gas reburning in coal-fired utility boilers. Institute of Clean Air Companies Forum '94. Arlington, VA (November).
- Opatry, J.C., C.C. Hong, and T.M. Sommer. 1994. Second-generation gas reburning technology. Third Annual Clean Coal Technology Conference, Chicago, IL (September).
- Pratapas, J.M. and J. Bluestein. 1994. Natural gas reburn: cost effective NO_x control. Power Engineering. 98:5,47-50.
- Pratapas, J.M. 1994. Major new gas technology initiatives underway at gas research institute. IGT/EPRI Conference. Chicago, IL (June).
- Pratapas, J.M. (Undated). Deployment of gas cofiring, reburning, and seasonal switching at coal and oil-fired boilers. Gas Research Institute, Chicago, IL 60631.

United States
Environmental Protection Agency
Center for Environmental Research Information
Cincinnati, OH 45268

Official Business
Penalty for Private Use
\$300

EPA/625/R-96/001

Please make all necessary changes on the below label,
detach or copy, and return to the address in the upper
left-hand corner.

If you do not wish to receive these reports CHECK HERE ;
detach, or copy this cover, and return to the address in the
upper left-hand corner.

BULK RATE
POSTAGE & FEES PAID
EPA
PERMIT No. G-35