



U.S. Department
of Transportation

Federal Railroad
Administration

Rail Commuter Vehicle Curving Performance

Office of Research and Development
Washington, DC 20590

Susan Kristoff

Foster-Miller, Inc.
350 Second Avenue
Waltham, MA 02451-1196

NOTICE

This document is disseminated under the sponsorship of the Department of Transportation in the interest of information exchange. The United States Government assumes no liability for its contents or use thereof.

NOTICE

The United States Government does not endorse products or manufacturers. Trade or manufacturers' names appear herein solely because they are considered essential to the objective of this report.

Technical Report Documentation Page

1. Report No.		2. Government Accession No.		3. Recipient's Catalog No.	
4. Title and Subtitle Rail Commuter Passenger Vehicle Curving Performance				5. Report Date April 2002	
				6. Performing Organization Code	
7. Author(s) Susan Kristoff				8. Performing Organization Report No. DOT/FRA/ORD-02/01	
9. Performing Organization Name and Address Foster-Miller, Inc. 350 Second Avenue Waltham, MA 02451				10. Work Unit No. (TRAIS)	
				11. Contract or Grant No. DTFR-53-95-C-00049	
12. Sponsoring Agency Name and Address U.S. Department of Transportation Federal Railroad Administration Office of Research and Development 1120 Vermont Avenue, NW Washington, DC 20590				13. Type of Report and Period Covered Final Report 10/1/98 - 7/30/99	
				14. Sponsoring Agency Code	
15. Supplementary Notes					
16. Abstract This report presents results of a program to design and install a wayside wheel-rail force measurement system. The test site is capable of developing a set of measurements of lateral and vertical forces exerted between the wheel and the rail at carefully chosen locations of all wheels on a single car at two different times using strain gauge sensors and a custom data acquisition system. The measurement site is located on a high curvature number 6- turnout in Grand Central Terminal, New York City. Precisely placed weldable strain gauges are applied to the rails to measure vertical and lateral wheel loads. The wheel-rail induced forces send a signal to the wayside instrumentation, which is then conditioned, acquired, and stored. To identify the vehicle, a pair of video cameras records the image of each car's numberplate. The system can be controlled remotely and results can be retrieved via modem.					
17. Key Words passenger vehicle, derailment, curving performance, data acquisition			18. Distribution Statement Document is available to the U.S. public through the National Technical Information Service, Springfield, VA 22161. This document is also available on the FRA website at www.fra.dot.gov .		
19. Security Classif. (of this report) unclassified		20. Security Classif. (of this page) unclassified		21. No. of Pages 42	22. Price

SI* (MODERN METRIC) CONVERSION FACTORS

APPROXIMATE CONVERSIONS FROM SI UNITS

Symbol	When You Know	Multiply By	To Find	Symbol	When You Know	Multiply By	To Find	Symbol
LENGTH								
in	inches	25.4	millimeters	mm	millimeters	0.039	inches	in
ft	feet	0.305	meters	m	meters	3.28	feet	ft
yd	yards	0.914	meters	m	meters	1.09	yards	yd
mi	miles	1.61	kilometers	km	kilometers	0.621	miles	mi
AREA								
in ²	square inches	645.2	millimeters squared	mm ²	millimeters squared	0.0016	square inches	in ²
ft ²	square feet	0.093	meters squared	m ²	meters squared	10.764	square feet	ft ²
yd ²	square yards	0.836	meters squared	m ²	meters squared	1.195	square yards	ac
ac	acres	0.405	hectares	ha	hectares	2.47	acres	mi ²
mi ²	square miles	2.59	kilometers squared	km ²	kilometers squared	0.386	square miles	
VOLUME								
fl oz	fluid ounces	29.57	milliliters	ml	milliliters	0.034	fluid ounces	fl oz
gal	gallons	3.785	liters	l	liters	0.264	gallons	gal
ft ³	cubic feet	0.028	meters cubed	m ³	meters cubed	35.71	cubic feet	ft ³
yd ³	cubic yards	0.765	meters cubed	m ³	meters cubed	1.307	cubic yards	yd ³
NOTE: Volumes greater than 1000 l shall be shown in m ³ .								
MASS								
oz	ounces	28.35	grams	g	grams	0.035	ounces	oz
lb	pounds	0.454	kilograms	kg	kilograms	2.202	pounds	lb
T	short tons (2000 lb)	0.907	megagrams	Mg	megagrams	1.103	short tons (2000 lb)	T
TEMPERATURE (exact)								
°F	Fahrenheit temperature	5(F-32)/9 or (F-32)/1.8	Celsius temperature	°C	Celsius temperature	1.8C + 32	Fahrenheit temperature	°F
ILLUMINATION								
fc	foot-candles	10.76	lux	lx	lux	0.0929	foot-candles	fc
fl	foot-Lamberts	3.426	candela/m ²	cd/m ²	candela/m ²	0.2919	foot-Lamberts	fl
FORCE and PRESSURE or STRESS								
lbf	poundforce	4.45	newtons	N	newtons	0.225	poundforce	lbf
psi	poundforce per square inch	6.89	kilopascals	kPa	kilopascals	0.145	poundforce per square inch	psi

* SI is the symbol for the International System of Units (Revised January 1992)

CONTENTS

Section	Page
1. INTRODUCTION	1
1.1 Background of Problem	1
1.2 Description of Test Site	2
2. SENSOR INSTALLATION	5
2.1 Installation	5
2.2 Calibration	6
3. INSTRUMENTATION AND DATA ACQUISITION SYSTEM	9
3.1 System Design	9
3.2 System Installation and Testing	11
4. CAPTIVE CONSIST TESTING	13
5. TRAFFIC TESTING	15
6. SYSTEM UPGRADES	17
7. CONCLUSIONS AND RECOMMENDATIONS	19
7.1 Conclusions	19
7.2 Recommendations	19
APPENDIX A - CALIBRATION CURVES	21
APPENDIX B - DATA ACQUISITION EQUIPMENT LIST	35

ILLUSTRATIONS

Figure		Page
1.	Wheel/rail contact interaction variables	2
2.	Schematic of test site at Grand Central Terminal	3
3.	Gauge positions on test track	5
4.	Vertical gauge installation configuration	6
5.	Lateral gauge installation configuration	7
6.	Vertical calibration fixture	8
7.	Lateral calibration fixture	8
8.	Schematic of data acquisition system	10
9.	Sample captured peaks	12

PREFACE

The Federal Railroad Administration (FRA) has contracted with Foster-Miller, Inc. to provide test support for the Volpe National Transportation Systems Center's (Volpe Center) Rail Commuter Vehicle Performance Investigation. This report summarizes the work performed by Foster-Miller during this program. The Contracting Office's Technical Representative for this program is Dr. Thomas Tsai.

This work was performed as part of overall investigations carried out by the Volpe Center on the safety of Metro-North commuter rail vehicles for the FRA. Dr. Herbert Weinstock of the Volpe Center was the technical manager of the overall program. Foster-Miller provided test support to the Volpe Center in the analysis of slow speed curving performance of vehicles. A major goal of the test site is to determine the lateral and vertical forces generated by all wheels of a vehicle at a selected track location.

An array of strain gauges was welded to a curved section of track inside Grand Central Terminal, New York City. This site was selected because it was representative of previous derailment sites. A data acquisition system was installed in a wayside facility to monitor the gauges. A pair of cameras was mounted onto the crash wall adjacent to the test track. These cameras recorded images containing the identifying number of each car that passes. The data collected can also be retrieved via modem. In addition to the installation and calibration of the system, Foster-Miller provided support to the Volpe Center during two weeks of on-site testing. Testing was conducted using several representative vehicle types to evaluate the cause of variations in wheel/rail forces, determine the derailment tendencies between rail cars in a fleet, evaluate effects in variations in operating and equipment maintenance conditions for proneness to derailment, and to calibrate and validate analysis tools.

Foster-Miller would like to thank Mark Campbell, Dave Shanoes, Al Roman, John Wagner and Tom Murphy of Metro-North Railroad for their assistance in coordinating activities related to the curving performance investigation, and for use of their facilities and equipment. The efforts of John Zolock and Brian Marquis of the Volpe Center in technical assistance during the program were also appreciated. Thanks are also due to Steve Luna and Gene Woy of Transportation Technology Center, Inc. (TTCI) for their assistance installing and calibrating the strain gauges.

1. INTRODUCTION

This report presents the work performed for the “Rail Commuter Vehicle Curving Performance Investigation” program contracted to Foster-Miller, Inc. by the Federal Railroad Administration (FRA). Included in this report are discussions of the derailment problem, descriptions of the test site, details of the design and implementation of the instrumentation system, and a summary of the testing that has been performed at the test site.

1.1 Background of Problem

Within a recent 18 month period, the Metro-North Railroad experienced a number of low speed derailments on track that contained average curvatures ranging between 15 and 20 deg. Several components were identified as possible contributors to these derailments. One of these factors is the degradation of truck curving performance, specifically the magnitude of the lateral forces generated by the vehicles in high degree curves.

A vehicle on track generates a lateral, or outward, force when it negotiates a curve. The vehicle also produces an inherent vertical, or downward, force by nature of its weight. The ratio of the lateral to the vertical forces, or L/V ratio, is important as it can determine the derailment potential of the vehicle. Other factors, such as the coefficient of friction and the wheel/rail contact angle, determine a critical L/V ratio, known as Nadal’s Limit. Nadal’s Limit is calculated as:

$$\left(\frac{L}{V}\right)_N = \frac{\tan(\delta) - \mu}{1 + \mu \tan(\delta)}$$

where $(L/V)_N$ is the Nadal’s Limit, δ is the wheel/rail contact angle, and μ is the coefficient of friction between the wheel and the rail. These variables are illustrated in Figure 1. When the actual L/V ratio exceeds the Nadal’s Limit, wheel climb can occur which can lead to a derailment.

An increase in lateral force or decrease in vertical force can cause Nadal’s Limit to increase. The lateral force increases if the train is negotiating the track at a larger than acceptable speed, or if the gauge width of the track is too narrow. The coefficient of friction can change depending on the surface condition or rail lubrication status. The wheel/rail contact angle can vary over time due to wear of the wheel, rail, or both, or by reprofiling the worn wheel to the standard profile.

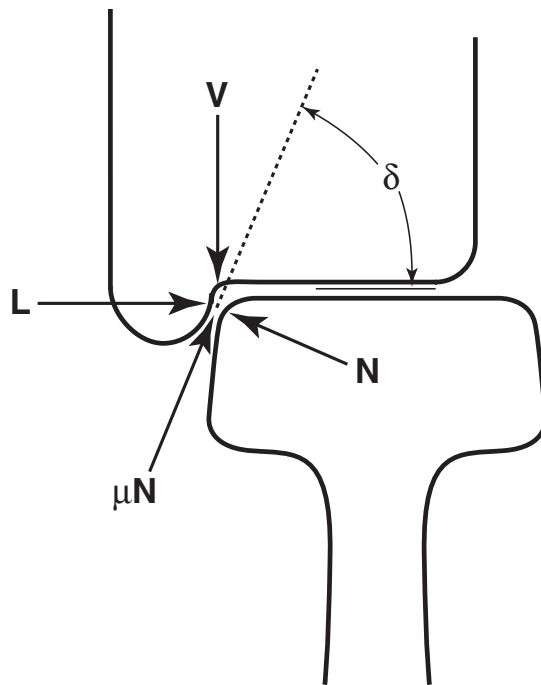

Figure 1. Wheel/rail contact interaction variables

Since the L/V ratio describes the derailment potential, it is important to find out what vehicle or track parameters cause the ratio to rise into unsafe limits. The factors can be narrowed down by measuring the lateral and vertical wheel-rail forces created by vehicles with different hardware configurations, negotiating various track conditions.

1.2 Description of Test Site

In order to measure the lateral and vertical forces produced by rail vehicles, a section of track was chosen by Metro-North and Volpe Center personnel to act as a test bed for the program. The site chosen is located within Grand Central Terminal, New York, and is representative of locations where recent derailments occurred. A schematic of the test site is illustrated in Figure 2.

This section of track connects platform tracks 20 and 21 to Ladder O between switches 411 and 405. The platforms and terminal are to the south, and the tunnel leading away from the station is to the north. The test section contains a 6-1/2 turnout, a feature common to prior derailment locations. A crash wall is located along the west side of the test section, and is about 8 ft tall. A third rail runs along the west side of the test section along most of its length.

An unused signal shack to the west across a service track is used to hold all of the data acquisition equipment and act as a base of operations during testing. The shed was upgraded to include fluorescent lighting, standard electric power, and phone service.

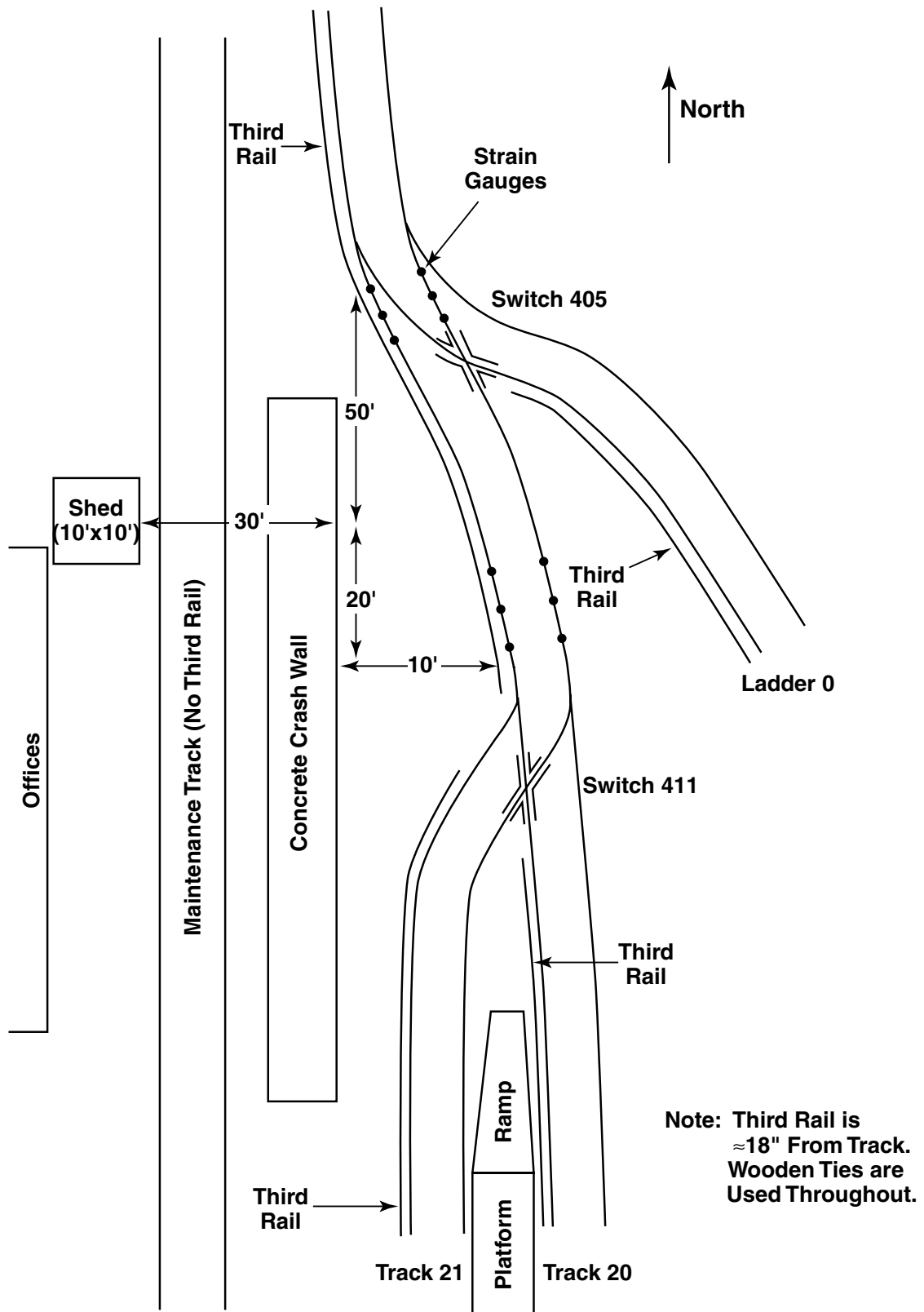

Figure 2. Schematic of test site at Grand Central Terminal

Track geometry measurements were taken prior to testing. The curvature in this section of track varies between 7 and 18 deg at the gauged locations. The cross level ranges from -0.25 to 0.6 in. and the gauge width ranges from 56.5 to 57.4 in.

The report is organized as follows. Section 2 provides a description of the strain gauge installation and calibration. Section 3 describes the data collection system. Section 4 briefly describes the captive consist testing performed on site. Section 5 outlines the traffic data that was collected. Section 6 lists the system upgrades that were performed. Finally, Section 7 provides program conclusions and recommendations for future work.

2. SENSOR INSTALLATION

With the assistance of personnel from the Transportation Technology Center, Inc. (TTCI) in Pueblo, CO, an array of strain gauges was installed and calibrated on the test section of track during the first week of December 1998. These gauges were then used to measure the lateral and vertical forces produced by the passing vehicles.

2.1 Installation

Figure 3 shows the layout of the gauge positions. At each location, there is a full bridge vertical gauge and a full bridge lateral gauge. The gauges were welded onto the rail based upon the location of the neutral axis.

The locations for gauge placement were chosen based on the axle spacing of the vehicles to be toted. Figure 3 also illustrates the gauge spacing. The spacing is such that the forces under all the wheels of a car are captured at two locations as it passes through the test section. The

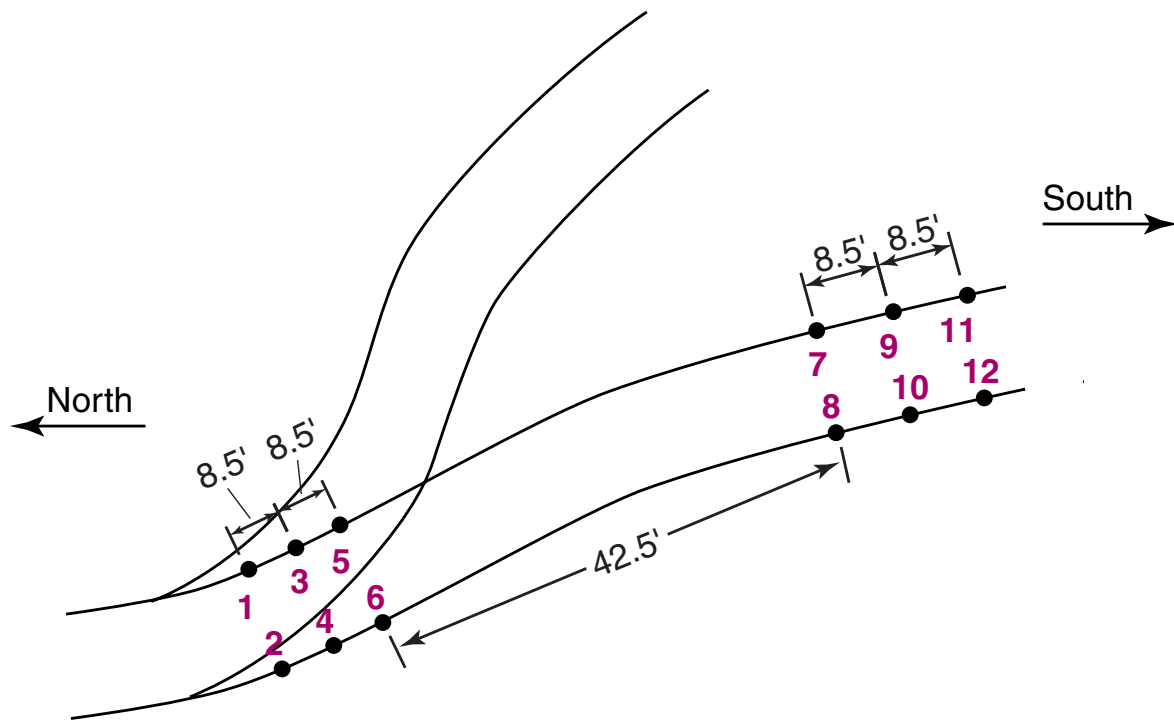

Figure 3. Gauge positions on test track

spacing between the gauges in each group is 8.5 ft, which is equal to the distance between the axles on one truck of the vehicle. The two groupings are spaced one car length or 59.5 ft apart. Consequently, when a car passes from north to south through the test section, gauge position 1, 2, 3, 4, 7, 8, 9, and 10 would be loaded during the first snapshot, and gauge position 3, 4, 5, 6, 9, 10, 11, and 12 would be loaded during the second snapshot.

Figures 4 and 5 show the rail installation configurations for the vertical and lateral gauges, respectively. After each of the gauges was installed and calibrated, the gauges were environmentally sealed over with a silicone sealant to prevent moisture from entering the gauge area. A steel protective cover was installed over each of the gauge positions, and wiring was run from each gauge location through plastic conduit to the instrumentation shack.

2.2 Calibration

After all of the gauges were installed, they were calibrated to verify that they were working accurately over the range of forces that would be experienced during testing. The forces were exerted on the rail by a configuration of hydraulic cylinders fitted with calibrated load cells. The load cells and the strain gauges were connected to a data acquisition system during calibration.

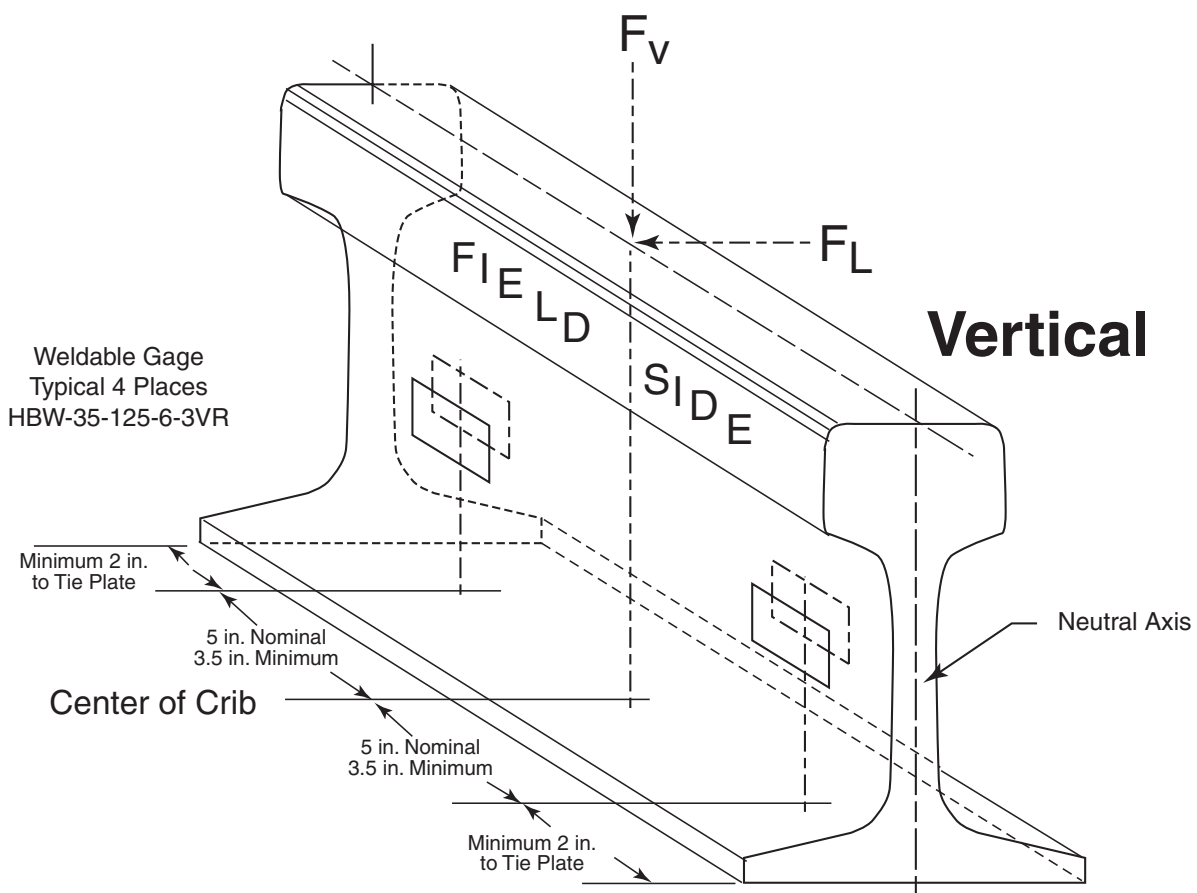

Figure 4. Vertical gauge installation configuration

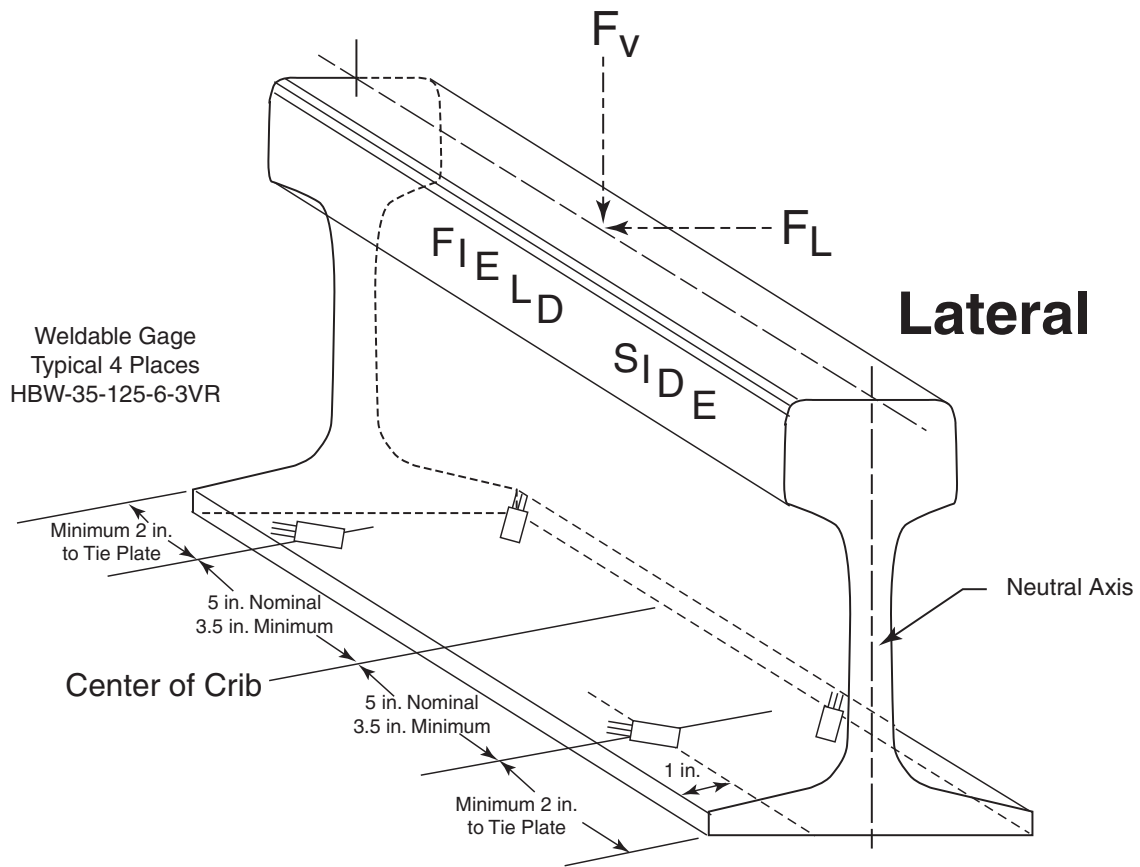

Figure 5. Lateral gauge installation configuration

As the hydraulic cylinders were loaded, the strain gauge voltage outputs were plotted versus the load to calculate the conversion factors for the gauges. Figures 6 and 7 show the fixtures used to calibrate the vertical and lateral gauges, respectively. The vertical calibration fixture consisted of a titanium a-frame. The hydraulic cylinder pushed down against the railhead to produce a vertical force. The lateral calibration fixture was placed between the gauge faces of the two rails and an outward lateral force was applied to the gauges for calibration.

After each gauge was calibrated, a conversion factor was generated to convert the voltage read from the strain gauges into a force value in thousands of pounds. These factors were entered into the data acquisition program as described later in Section 3. The calibration curves are shown in Appendix A.



Figure 6. Vertical calibration fixture



Figure 7. Lateral calibration fixture

3. INSTRUMENTATION AND DATA ACQUISITION SYSTEM

In order to collect data from the strain gauges, a data acquisition system was designed, built, and installed at the test site in Grand Central Terminal. This system would have to collect data when a vehicle passes through the test section, convert it to useful information, and store it for future retrieval. The system also had to be able to function without requiring personnel to monitor the system on site. In addition, the system needed to identify each car that passed through the test section.

3.1 System Design

There were a number of requirements that were established for the data acquisition system. These included the following:

- The system must excite the strain gauges and read the returned voltage when a vehicle passes over the test track.
- It must convert the returned voltage to units of force.
- It must write the data to a file in spreadsheet format.
- It must allow the data to be accessed via modem.
- It must identify each of the cars that pass through the test section.

A schematic of the final system design is shown in Figure 8. The system that was designed consists of several National Instruments (NI) components controlled by a data acquisition program written in the LabView visual programming language. The hardware components used in this system are listed in Appendix B.

The strain gauges on the rail are wired into a signal-conditioning unit. The signal-conditioning unit not only excites the strain gauges, but it also collects the strain data from them. The signal-conditioning unit then passes the data through the input/output (I/O) board to the main controller module, which is a Pentium processor computer running Windows 95.

A pair of cameras is mounted on the crash wall adjacent to the test section. The cameras are positioned such that they are focused on the location of the car where the identification number is located. The cameras send images to the video capture board, which in turn passes the information to the main controller module.

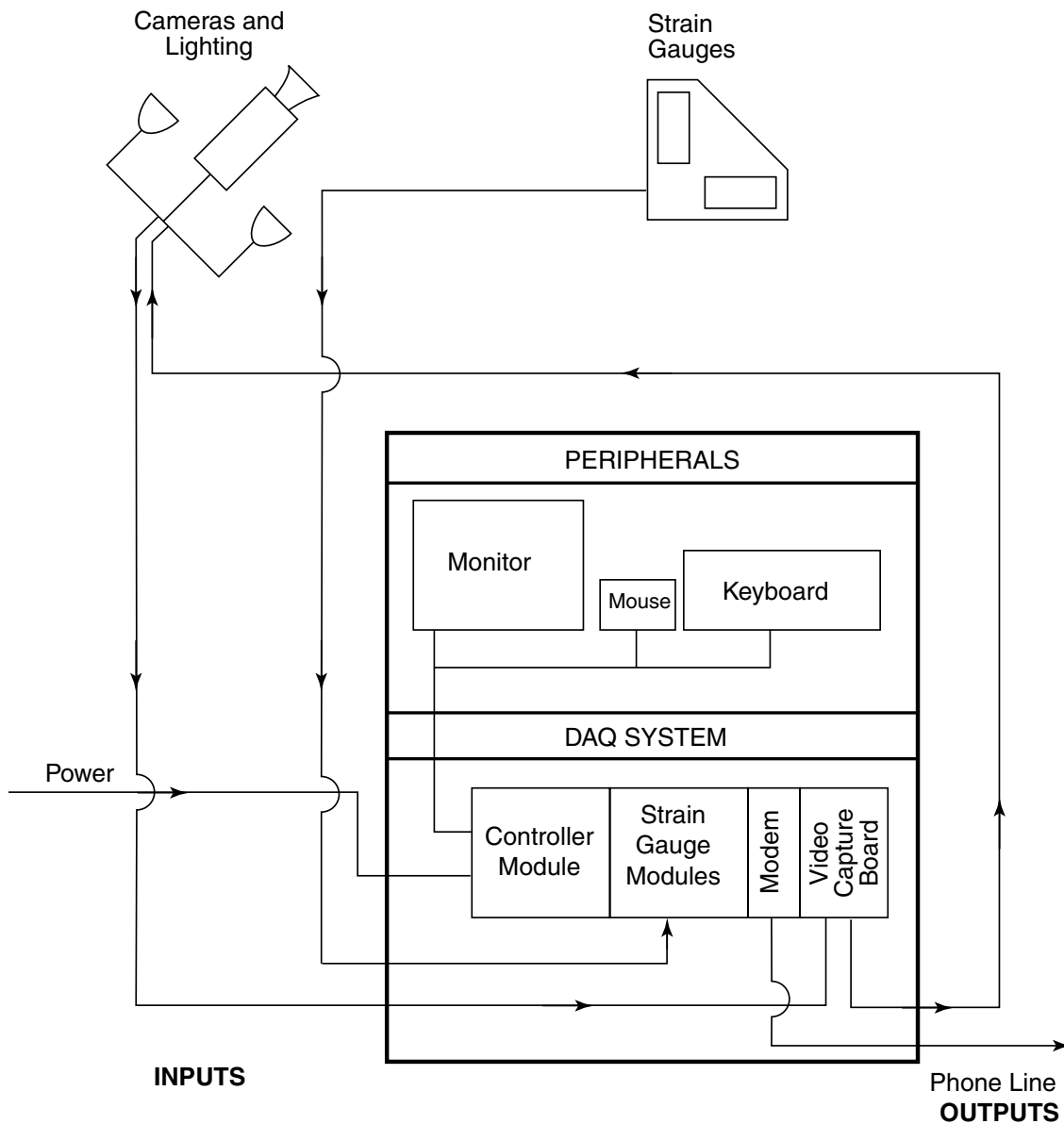

Figure 8. Schematic of data acquisition system

When the data from the strain gauges and the cameras reach the main controller module, it is processed by the data acquisition program, which is always running. The data acquisition program was written specifically for this application using the LabView software package. The program is always examining the data that enters it, but it does not record the data until certain conditions are met that confirm a car in the test section. This is done with a peak detection algorithms across the array of strain gauge data. The program verifies that the car is providing peaks on eight gauges within a very short time span. Because of the gauge array design, each car is detected twice while within the test section, providing two “snapshots” of data for each car.

Once these conditions are met, the system is “triggered.” At this point, the system converts the strain gauge data to force in units of kips, extracts the peaks from the waveforms, and computes the L/V ratio for each of the wheels. In addition, the camera images taken during the trigger event are saved to a file so that the data can be matched with the specific car. A sample curve from one vertical and one lateral gauge are shown in Figure 9 for two wheels.

It was originally desired to use a strip chart recorder to record data in the event that the system power failed or the computer crashed during the captive consist testing. Since the on-site testing was manned at all times, it was decided to forego the expense of buying or renting a strip chart recorder.

3.2 System Installation and Testing

The data acquisition hardware and associated software were initially installed during January 1999. After installation, the system was tested using normal traffic passes as well as captive consist tests to examine the behavior of the system, to look for bugs in the programming, and to determine if any components could be improved. During two weeks in January, a battery of captive consist testing was performed, and is presented in Section 4. After this testing, several modifications were made to fix problems or to improve the system. These are outlined in detail in Section 6.

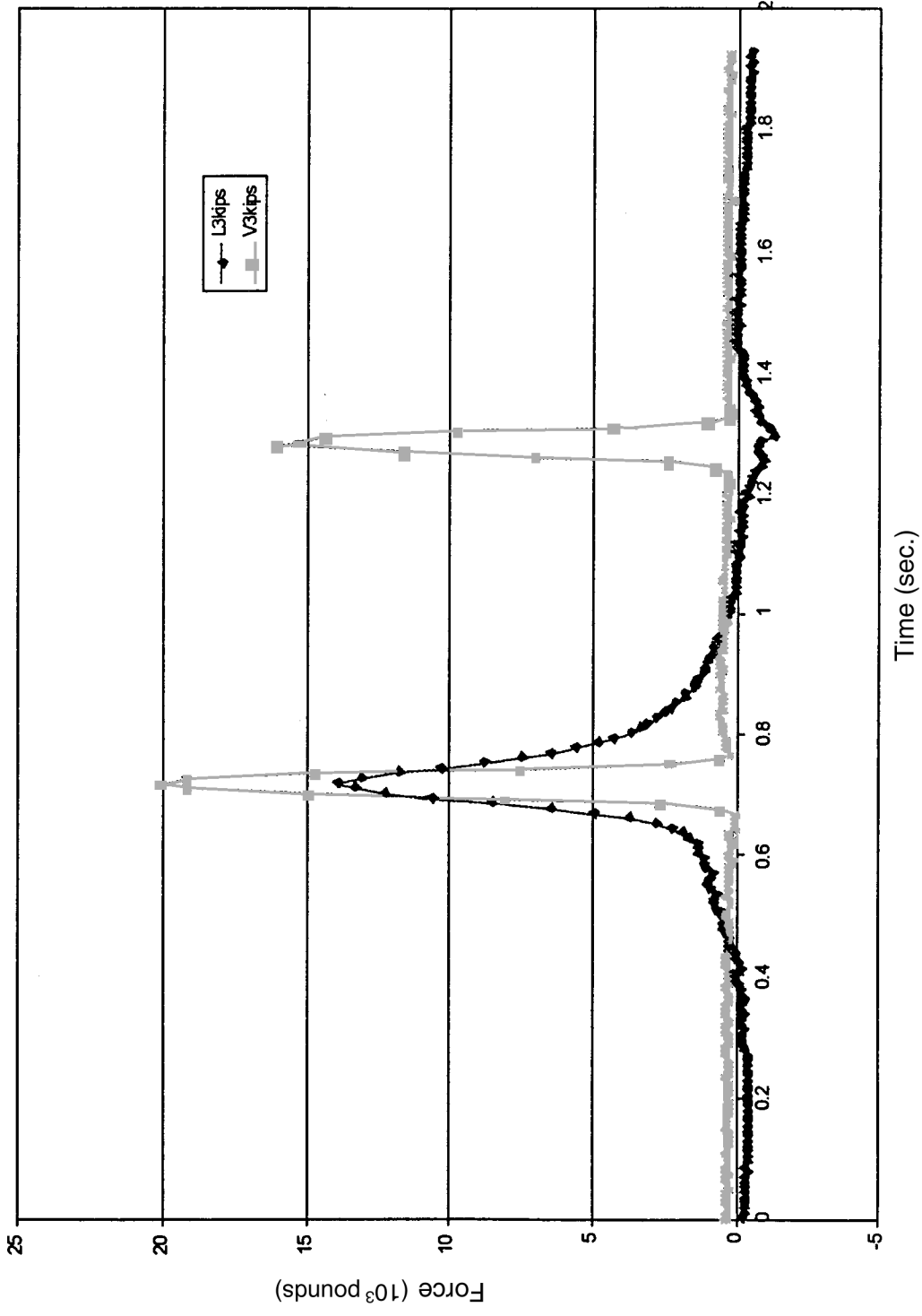

Figure 9. Sample captured peaks

4. CAPTIVE CONSIST TESTING

During two weeks in January 1999, a number of captive consist tests were performed. A captive consist is a set of train cars that are dedicated to testing, and are not being used for passenger service while the test is being run. The engineer is in contact with and directed by test personnel in terms of timing, direction, and speed for passes through the test section. For some of the tests, a dedicated consist was used. The dedicated consist was a set of cars in which many of the mechanical parameters were known, and in some cases modified. The following is a list of tests that were performed during that two-week period:

- Baselines of different vehicle types used by Metro-North (M1, M2, M3, M4, M6, ACMU, and Bombardier passenger cars; Genesis locomotive).
- Variations in longitudinal frame-journal pedestal liner clearances (0.08 to 0.33 in).
- Lubricated versus non-lubricated frame-journal pedestal liner.
- Different wheel profiles (Newly profiled AAR 1B, worn 1B, newly profiled AAR standard narrow flange, 21 week worn AAR standard, and as-is profiles).
- Changes in secondary suspension air bag stiffness.
- Variations in side bearing clearance sizes (0.15 to 0.6 in).
- Different rail lubrication conditions.
 - Dry rail.
 - HPF application to both rail crowns.
 - LCF application to both rail gauge faces.
 - HPF and LCF applications together.
- Track geometry cross-level changes (Track raised 0.75 in at gauge location No. 9 on outside rail).

During this testing, Foster-Miller provided test conduct and system operational support to the Volpe Center, who was coordinating the tests.

Of all the modifications made during this period of testing, it was found that the changes in lubrication had the most profound effect on lowering the L/V ratio. Also, since the coefficient of friction between the wheel and the rail is reduced by the application of lubricant, Nadal's Limit, as discussed in subsection 1.1, is raised, requiring a higher L/V ratio to cause a derailment.

5. TRAFFIC TESTING

Initial monitoring of regular revenue traffic was performed during the two-week captive consist testing in January 1999, described in Section 4. After the captive consist tests were completed, some modifications had to be made to the data acquisition program. Once this was completed, the system was put on-line, and data was collected from the site during February and March 1999. Approximately 3500 individual car passes were recorded during this time. Periodic traffic data was also collected during April and May during a troubleshooting sessions at the test site.

The data that has been gathered is in a relatively raw format and has been converted to engineering force units. Further processing of the data can be performed once it has been determined what types of information are desired. As an example for identifying the types of information that could be extracted from this data, a small portion of the total car passes, a block of about 18 hr, was analyzed. The information from that analysis is shown in Table 1.

Of the approximately 2400 peaks that were examined, 1.25 percent of them had L/V ratios greater than 0.8, and 0.3 percent had L/V ratios greater than 0.9. The largest peaks would obviously cause the greatest amount of concern, and the vehicles that produce these unusually high peaks should be examined. Over time, it can be determined if specific vehicle types are creating higher L/V ratios than others. If this is the case, the specific vehicle type should be carefully examined, and perhaps detailed captive consist testing can be performed.

Table 1. Example analysis of vehicle peak data

Number of Trains	20
Total Number of Cars	149
Total Number of Peaks Recorded	2,384
Absolute Maximum L	19.94
Absolute Minimum V	9.54
Absolute Maximum L/V	1.192
Total Number of L/V's > 0.8	30
Number of L/V's between 0.8 and 0.9	22
Number of L/V's between 0.9 and 1.0	5
Number of L/V's between 1.0 and 1.1	2
Number of L/V's > 1.1	1
Total Number of V's < 75 percent of Train Average	24

The gauge locations where the peaks are registered may also be a concern. For example, if peaks are occurring regularly at a specific gauge location, regardless of equipment type, there may be reasons to investigate the track at that location. In addition, low vertical load values can be examined. When a vertical load is much less than the average vertical load, it is possible that wheel lifting is occurring, which could also lead to a derailment. In the example analysis presented above, 1 percent of the wheel passes resulted in a vertical load that was less than 75 percent of the average car wheel load.

6. SYSTEM UPGRADES

After the initial installation of the data acquisition hardware and software, a number of system upgrades were performed to streamline the program, replace hardware that was performing insufficiently, and fix other problems that occurred over time. In addition, a number of activities were performed to support system development. The following is a summary of the activities performed, problems encountered and the upgrades performed throughout the program.

January 11 to 23 – Initial installation and captive consist testing:

- Installed system hardware and wired strain gauges.
- Installed acquisition program.
- Found hardware problem limiting sample rate.
- Borrowed hardware for test period.

February 8 to 11 – Program modification:

- Installed upgraded autonomous program version to reduce program loop time.
- Set up system to collect data autonomously and bi-directionally.
- Determined second camera was necessary for bi-directional vehicle identification.
- Re-checked wiring to all gauges.
- Interchanged wiring for Gauge L1 to provide proper polarity.
- Conducted several tests with regular traffic collecting data at high acquisition rates to determine if filtering algorithm is adequate.

May 10 to 11 – Program modification, new hardware installation:

- Replaced borrowed hardware with permanent replacement hardware (See Appendix A for hardware details).
- Installed upgraded program version that extracts peak wheel-rail force values and allows for a second camera input.
- Installed two new cameras (first camera was stolen).

- Discovered new program caused computer to crash when executed.

June 6 to 9 – Software upgrades, hardware troubleshooting:

- Installed updated versions of data acquisition software (LabView, IMAQ, NI-DAQ).
- Discovered new hardware problem, signals were not being read properly. Investigation narrowed problem down to SCXI signal conditioning module.

June 17 – Temporary module test:

- Brought loaned SCXI module to verify problem with original module.
- Verified that module was not functioning properly. Contacted NI to arrange for replacement of module.

July 14 to 16 – Camera spotting:

- Determined camera positioning based on number plate location (used captive consist to spot locations).

October 1 - Maintenance

- Installed replacement module.
- Set-up system to run continuously.

7. CONCLUSIONS AND RECOMMENDATIONS

7.1 Conclusions

Based on the work that was performed during this program, a number of basic conclusions can be drawn:

- A section of track in a highly utilized location can be instrumented with strain gauges, without impacting revenue operations, to obtain data on wheel-rail lateral and vertical loads.
- Strain data can be collected from a test location and analyzed autonomously without requiring personnel to be on-site to monitor the system.
- Data can be retrieved from the test site remotely via modem by simply installing an easy to use software package on the field computer and the computer to be used to retrieve the data.

Further conclusions can be drawn based upon the captive consist tests that were performed in conjunction with the Volpe Center:

- In all cases, rail lubrication provides an increase in protection from wheel climb derailment.
- Variations in wheel profile, pedestal clearance or side bearing clearance had no significant effect on the measured L/V ratios.
- Short wavelength cross-level variations cause greater than normal vertical unloading, and therefore larger L/V ratios.

7.2 Recommendations

The data acquisition system can be improved to suit just about any need imaginable. The following is a list of upgrades or improvements that could be implemented to simplify operation of the system and data analysis:

- Generation of a daily report flagging vehicles with L/V ratios greater than 0.8 and any other desired information.

- Set program parameters so that it loads and runs automatically if the computer is rebooted on purpose or by accident.
- Add additional data conversion/manipulation algorithms if other types of analyses are desired.
- Add character recognition algorithms to read car identification numbers directly from the video feed and write the numbers to the data file.
- Set up the field computer to act as a web server. In this configuration, a web page could be set up with the last day's data and archive pages of past data. This would eliminate the need to call into the site with a modem, and more than one person could access the data at once.

It is also recommended that Metro-North install a ventilation system in the instrumentation shed if the system is to be running during the summer months. The instrumentation is sensitive to temperature extremes, and airflow will prevent the system from overheating when the temperatures are high. There is no concern with low temperature extremes at this time.

APPENDIX A

CALIBRATION CURVES

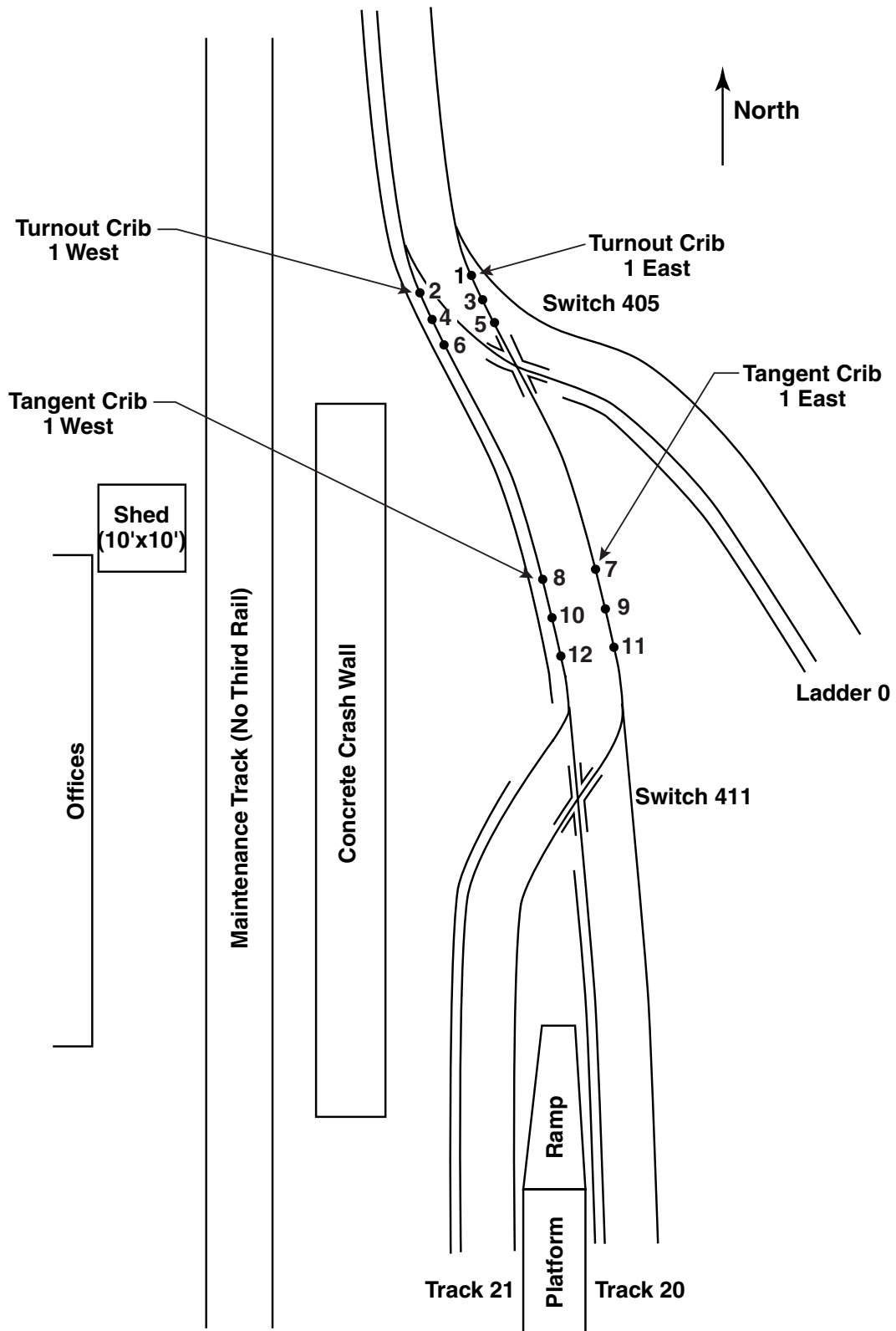

Figure A-1. Gauge crib locations

Tangent West Vertical Crib #1

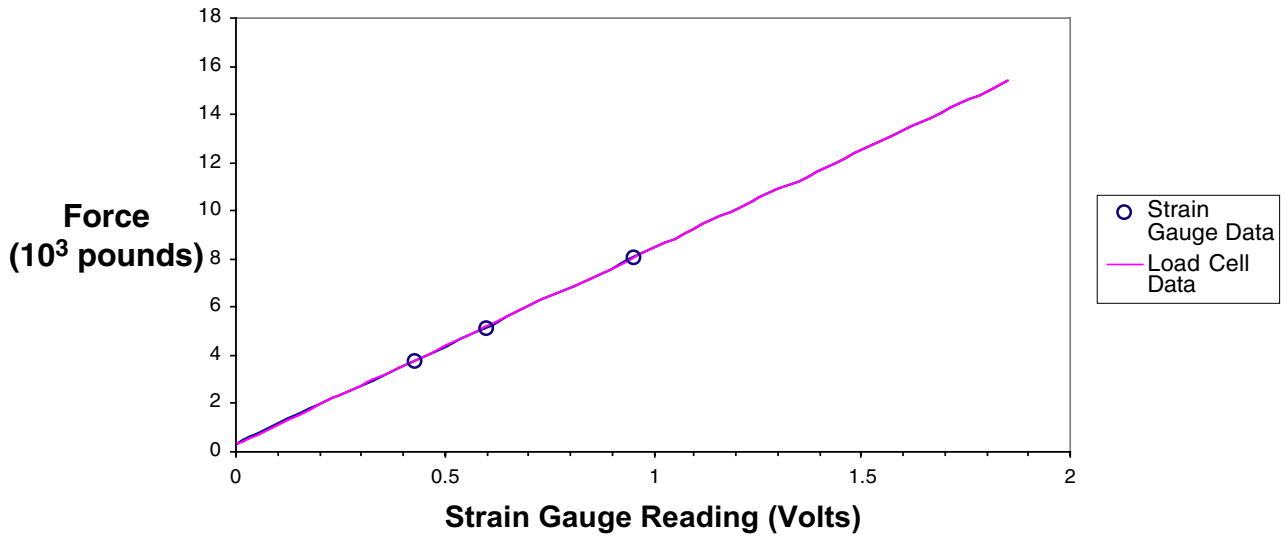

Figure A-2. Tangent west vertical crib No. 1

Tangent East Vertical Crib #1

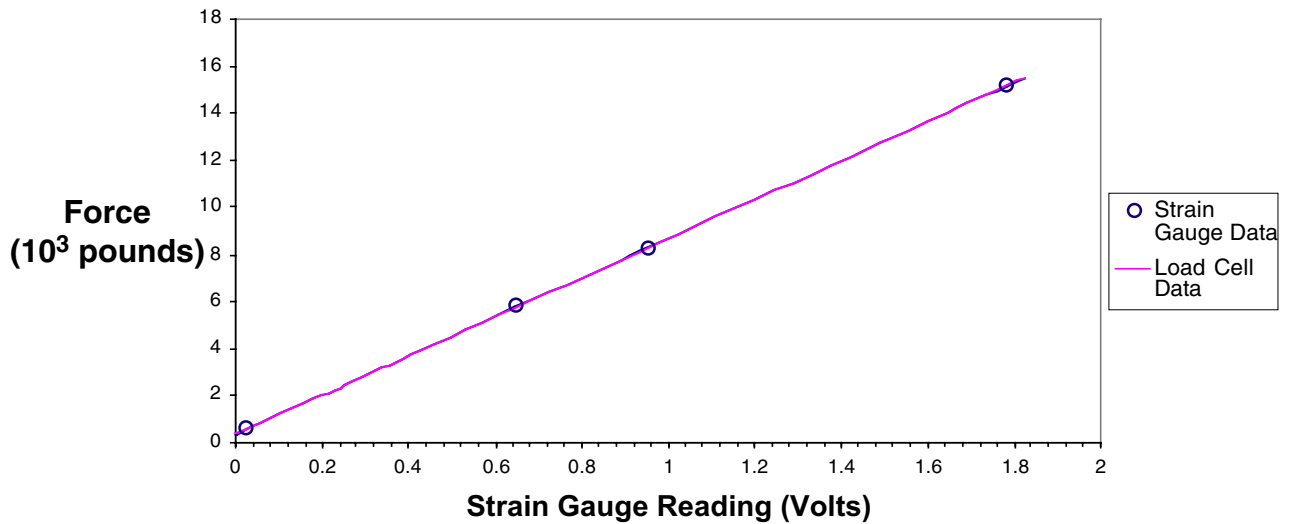

Figure A-3. Tangent east vertical crib No. 1

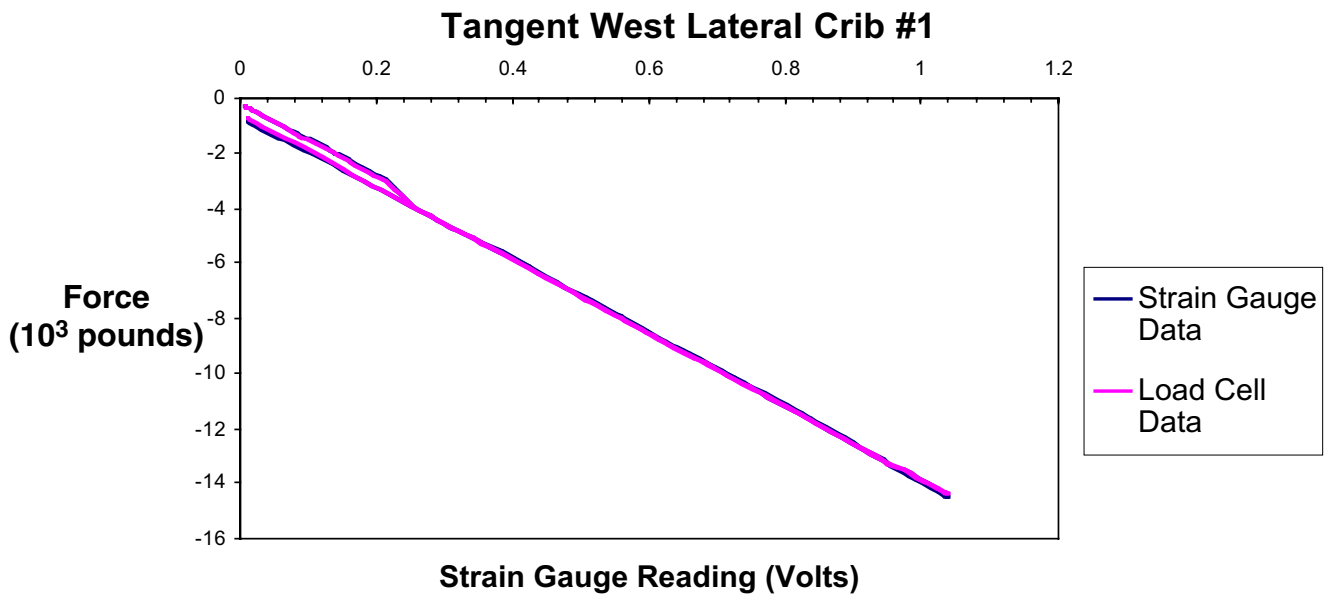

Figure A-4. Tangent west lateral crib No. 1

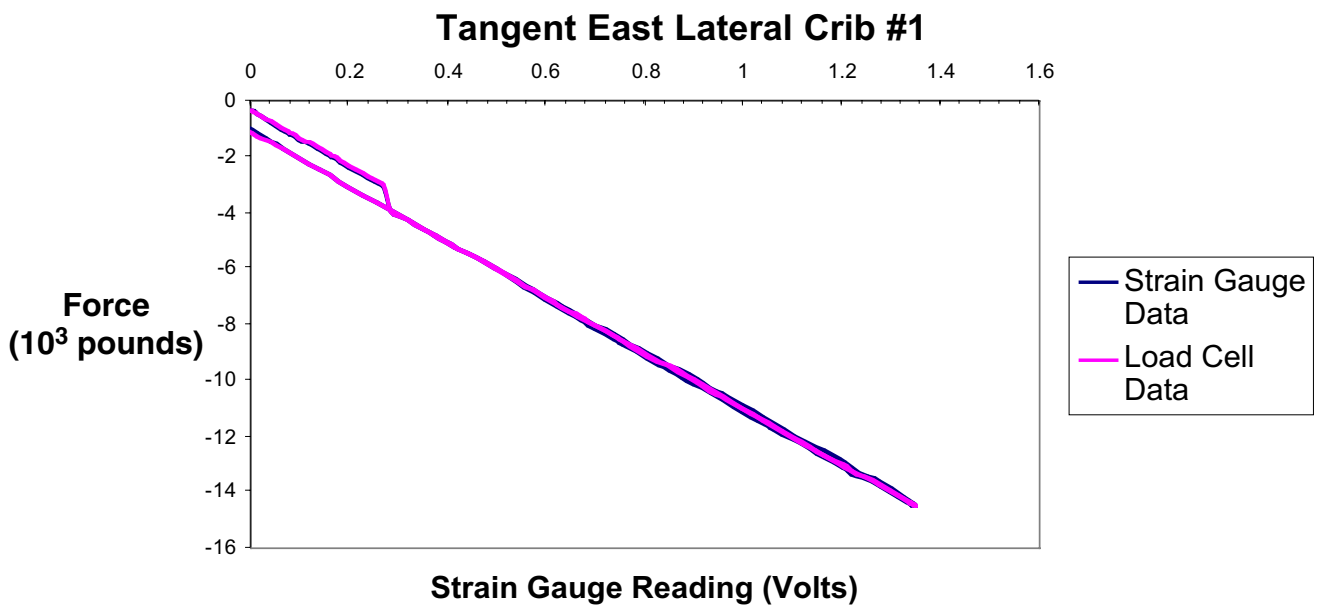

Figure A-5. Tangent east lateral crib No. 1

Tangent West Vertical Crib #2

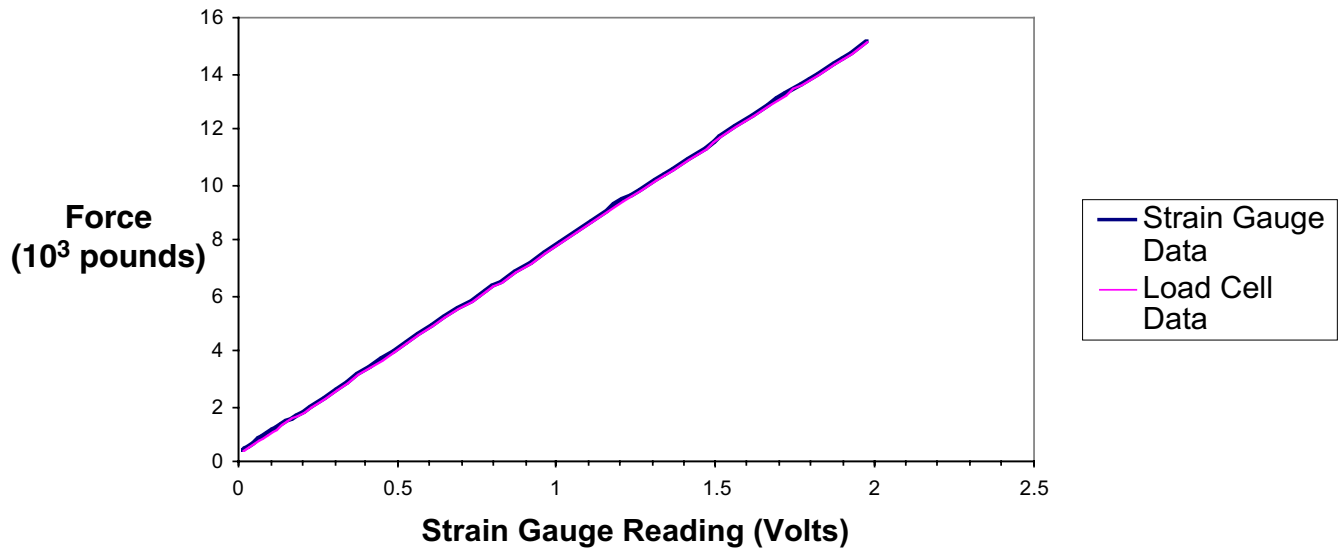

Figure A-6. Tangent west vertical crib No. 2

Tangent East Vertical Crib #2

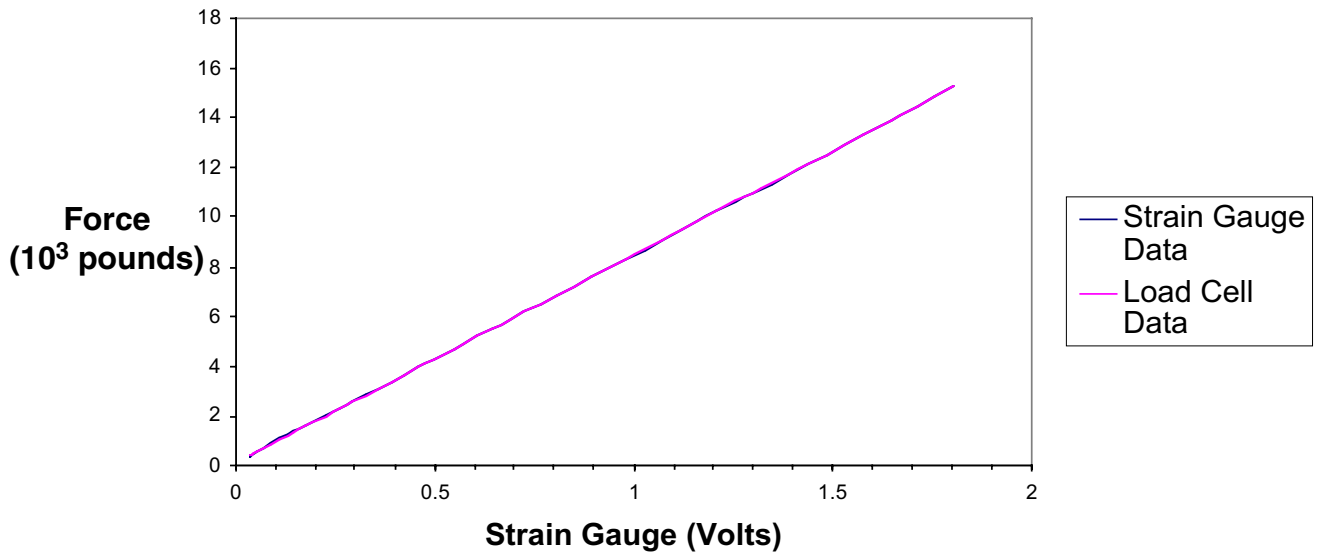

Figure A-7. Tangent east vertical crib No. 2

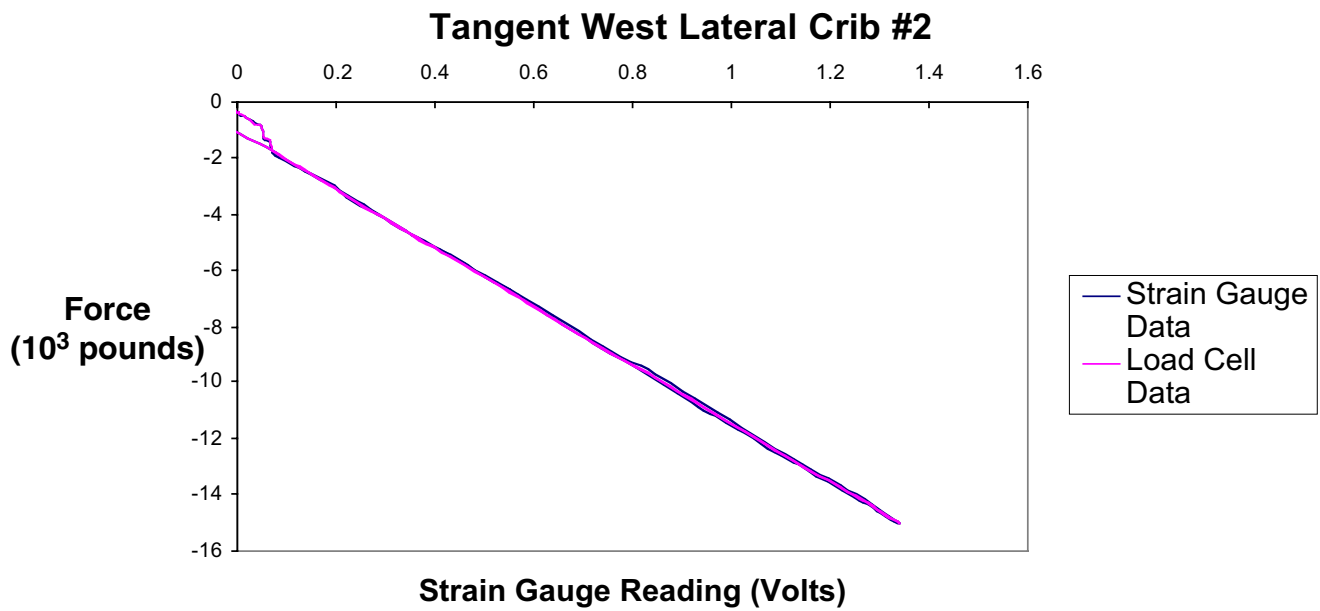

Figure A-8. Tangent west lateral crib No. 2

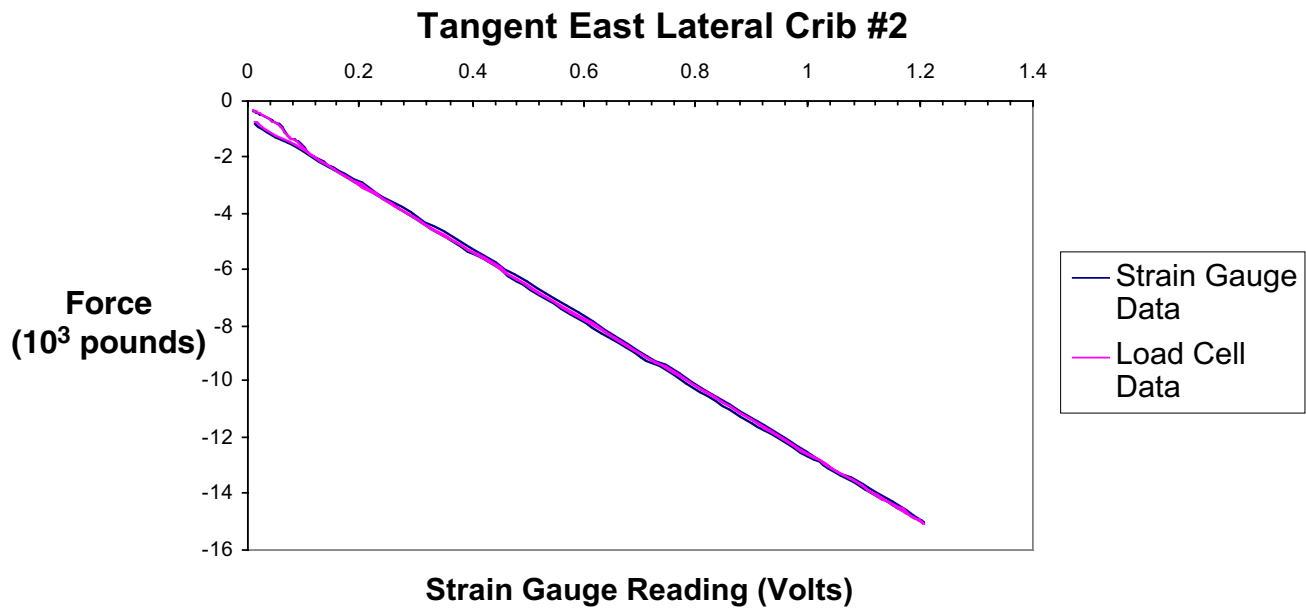

Figure A-9. Tangent east lateral crib No. 2

Tangent West Vertical Crib #3

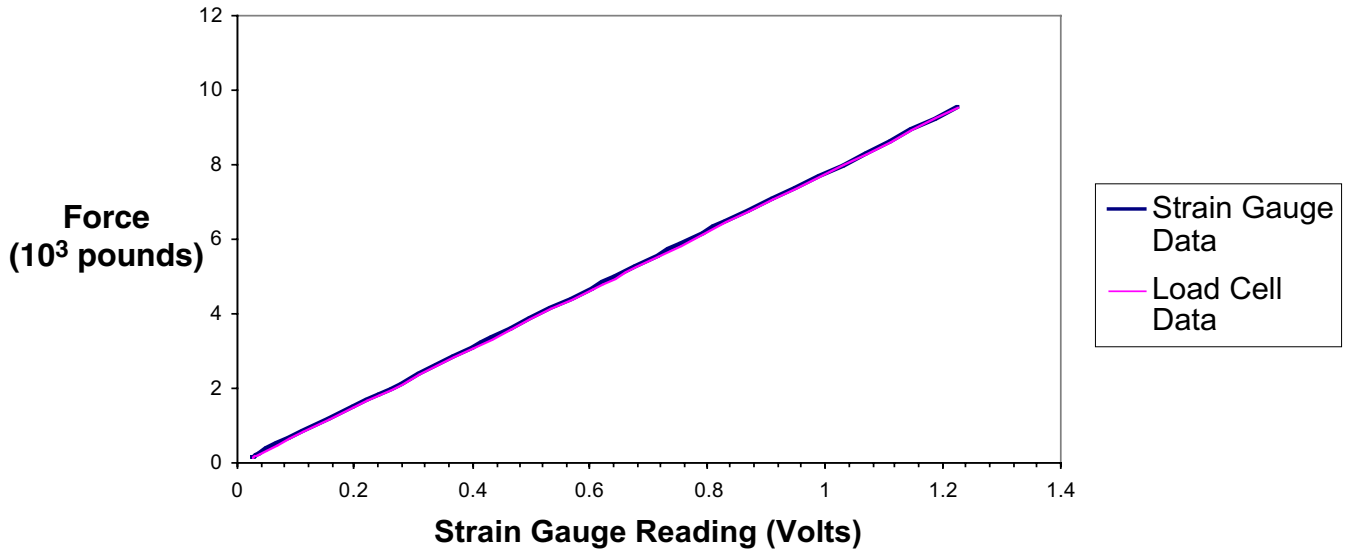

Figure A-10. Tangent west vertical crib No. 3

Tangent East Vertical Crib #3

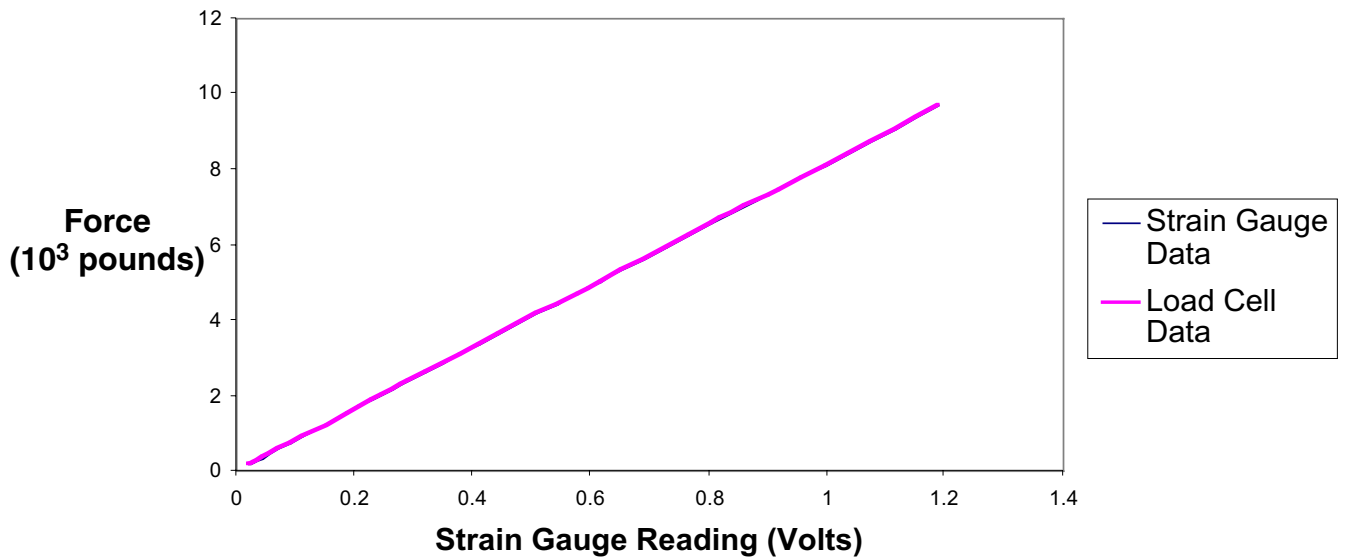

Figure A-11. Tangent east vertical crib No. 3

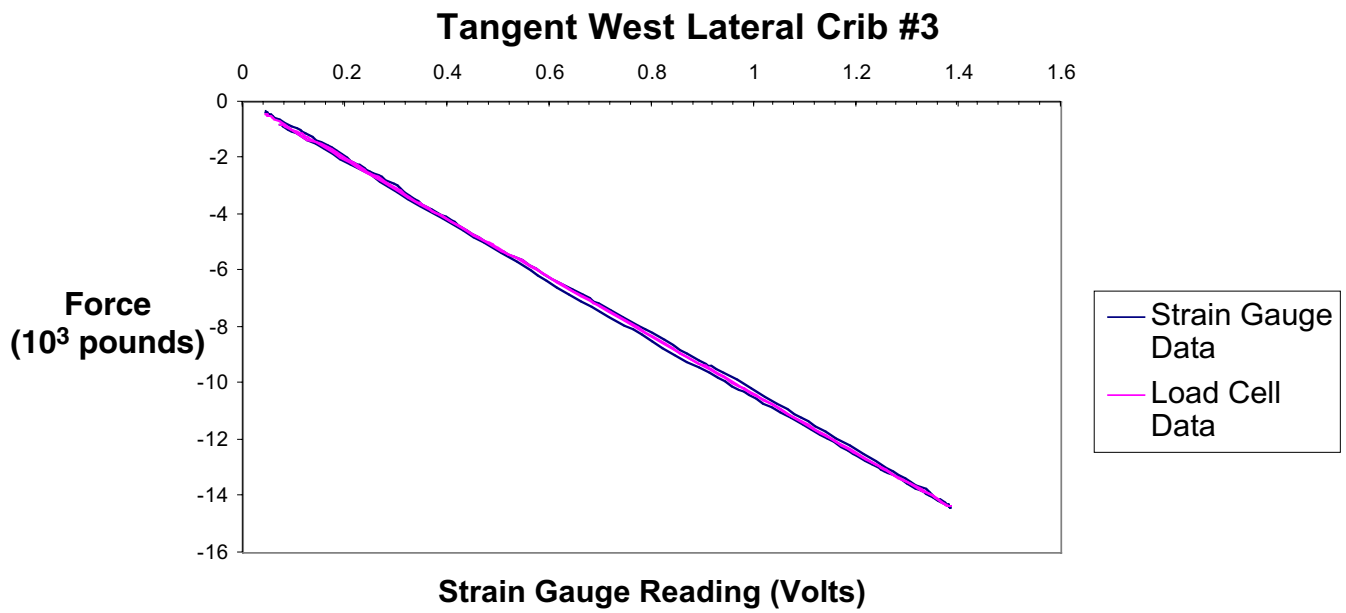

Figure A-12. Tangent west lateral crib No. 3

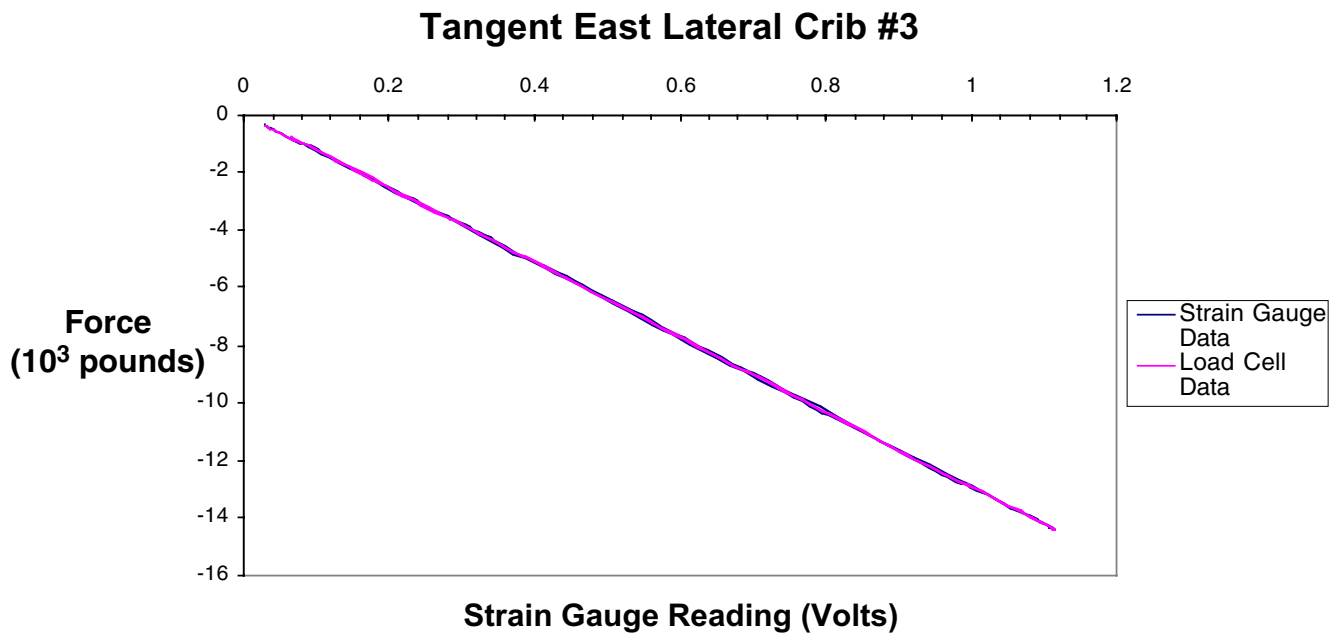

Figure A-13. Tangent east lateral crib No. 3

Turnout West Vertical Crib #1

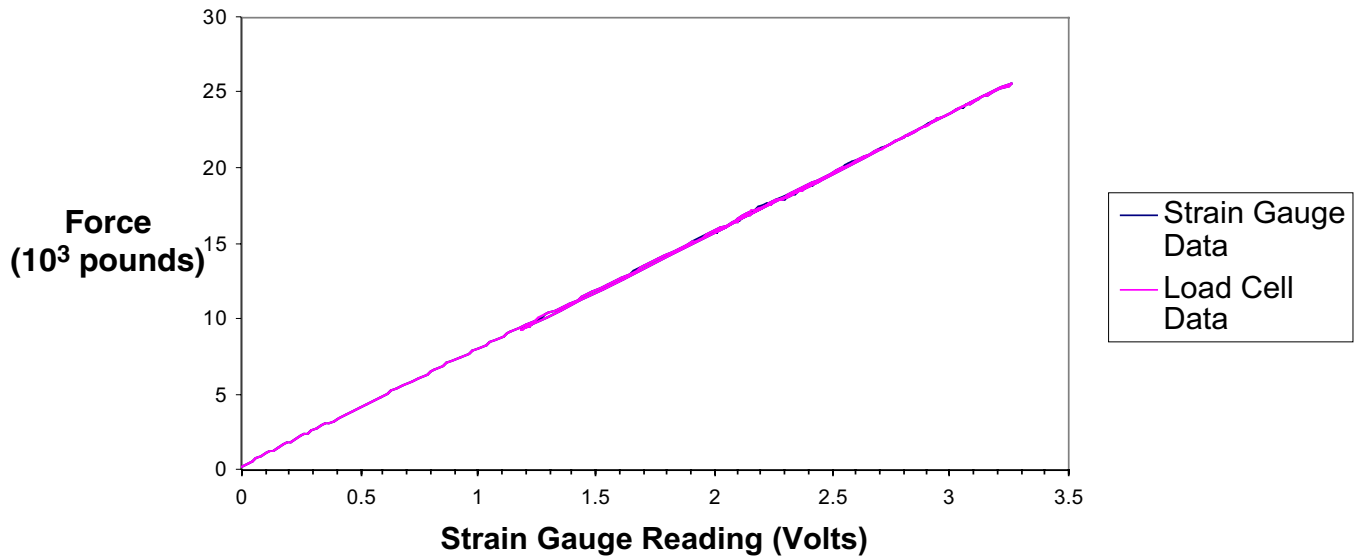

Figure A-14. Turnout west vertical crib No. 1

Turnout East Vertical Crib #1

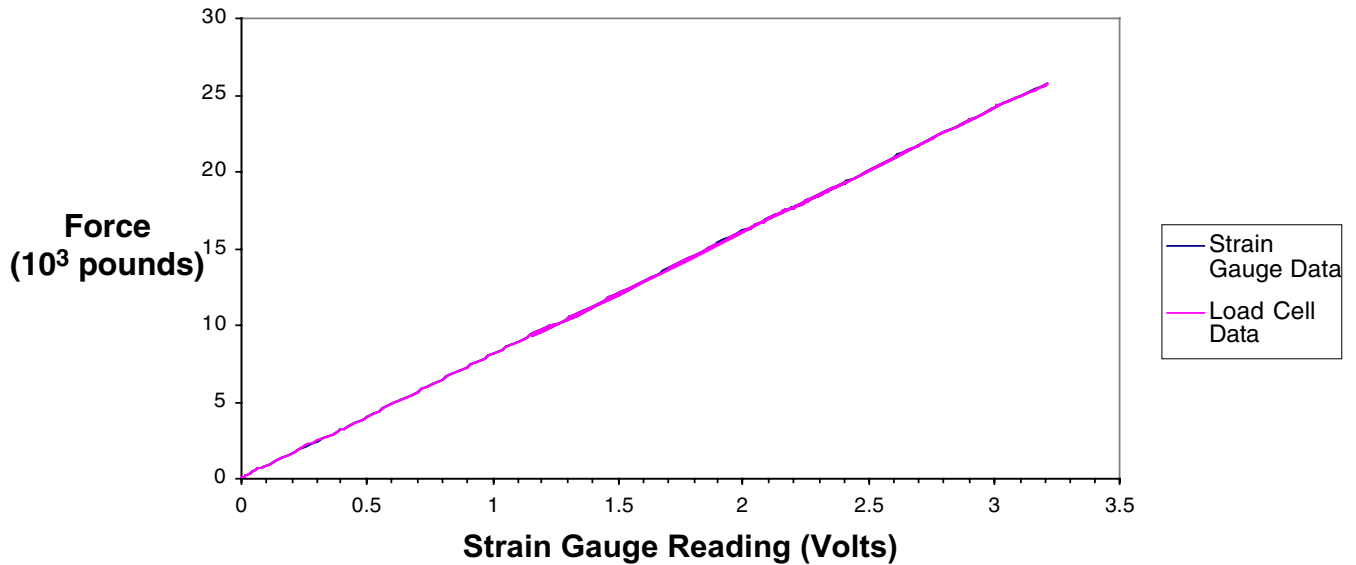

Figure A-15. Turnout east vertical crib No. 1

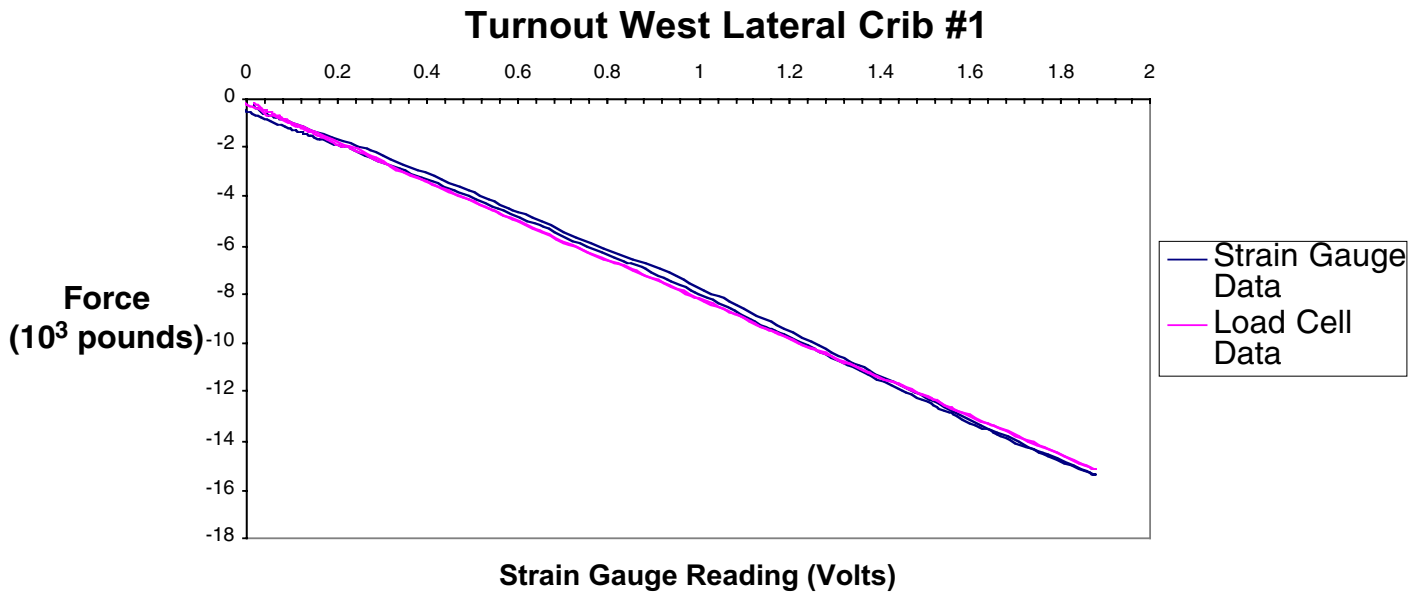

Figure A-16. Turnout west lateral crib No. 1

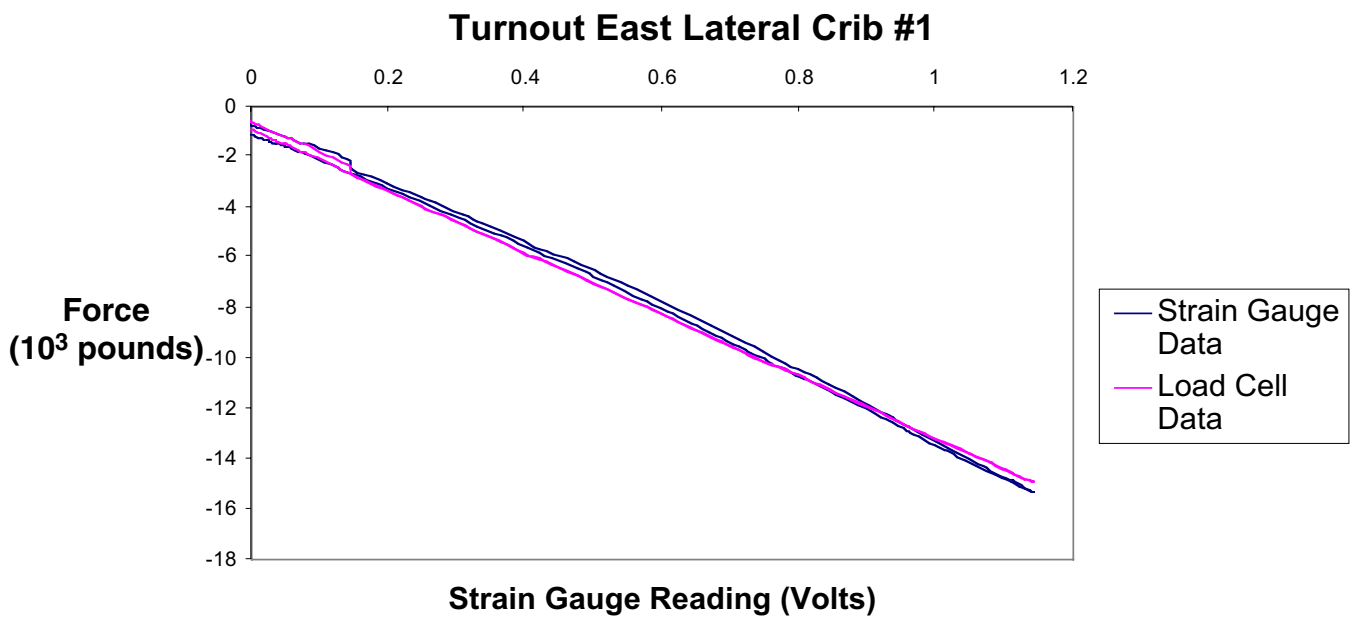

Figure A-17. Turnout east lateral crib No. 1

Turnout West Vertical Crib #2

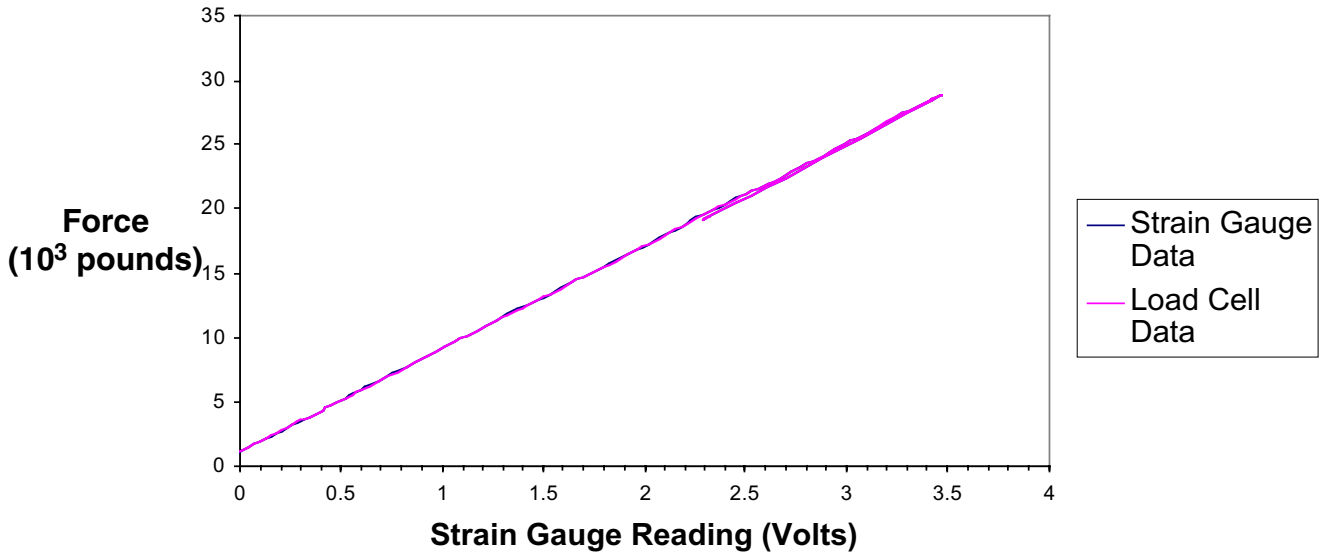

Figure A-18. Turnout west vertical crib No. 2

Turnout East Vertical Crib #2

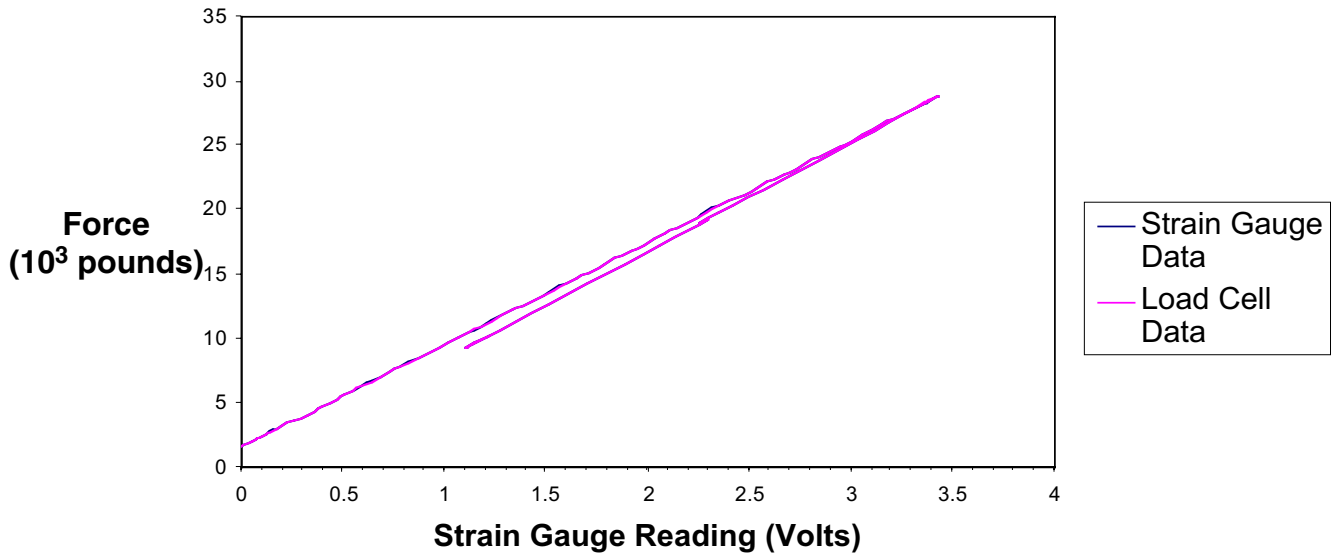

Figure A-19. Turnout east vertical crib No. 2

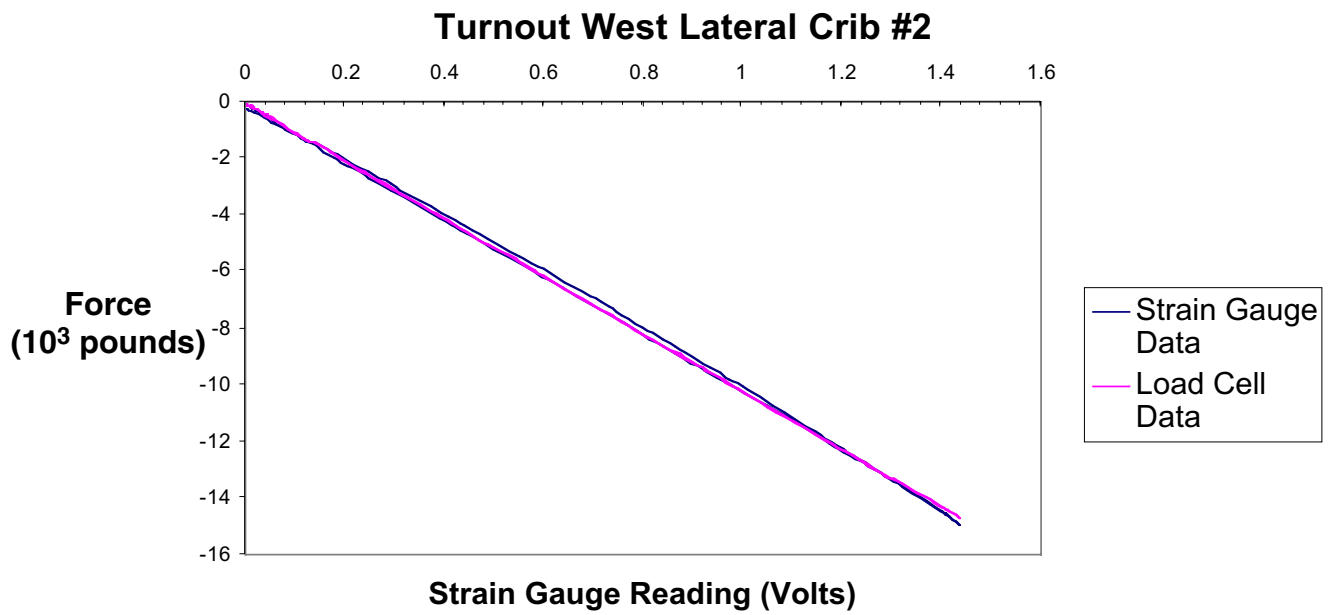

Figure A-20. Turnout west lateral crib No. 2

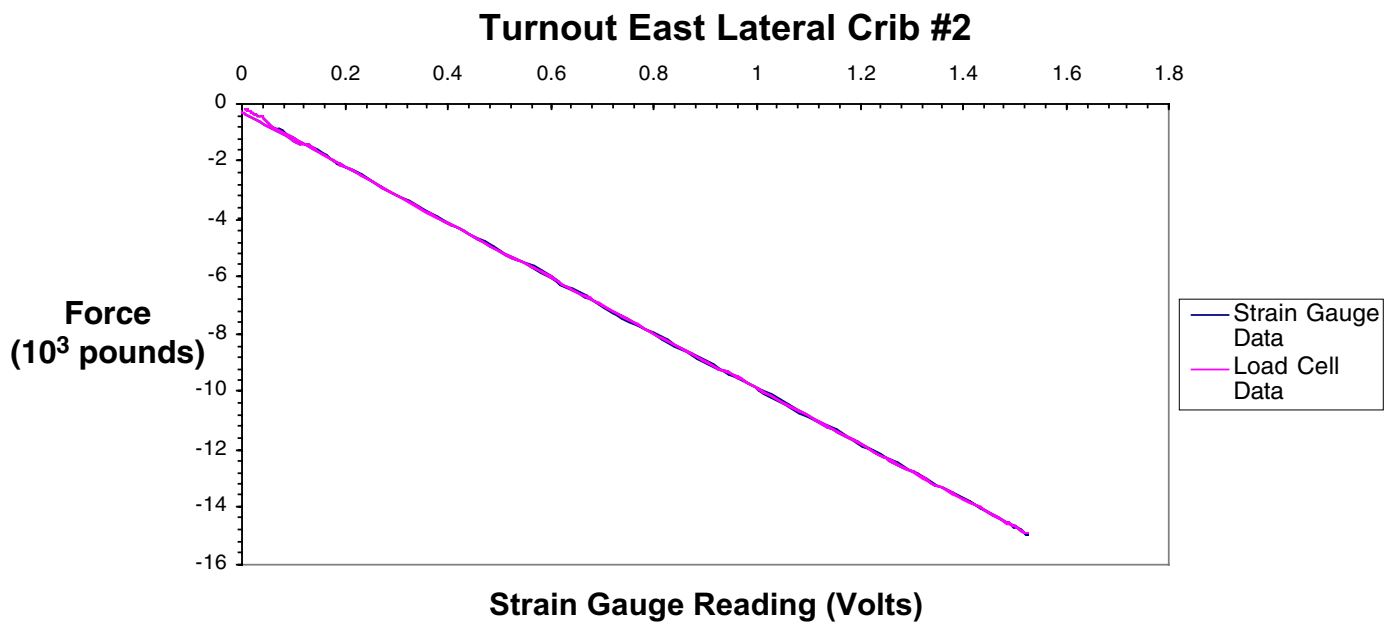

Figure A-21. Turnout east lateral crib No. 2

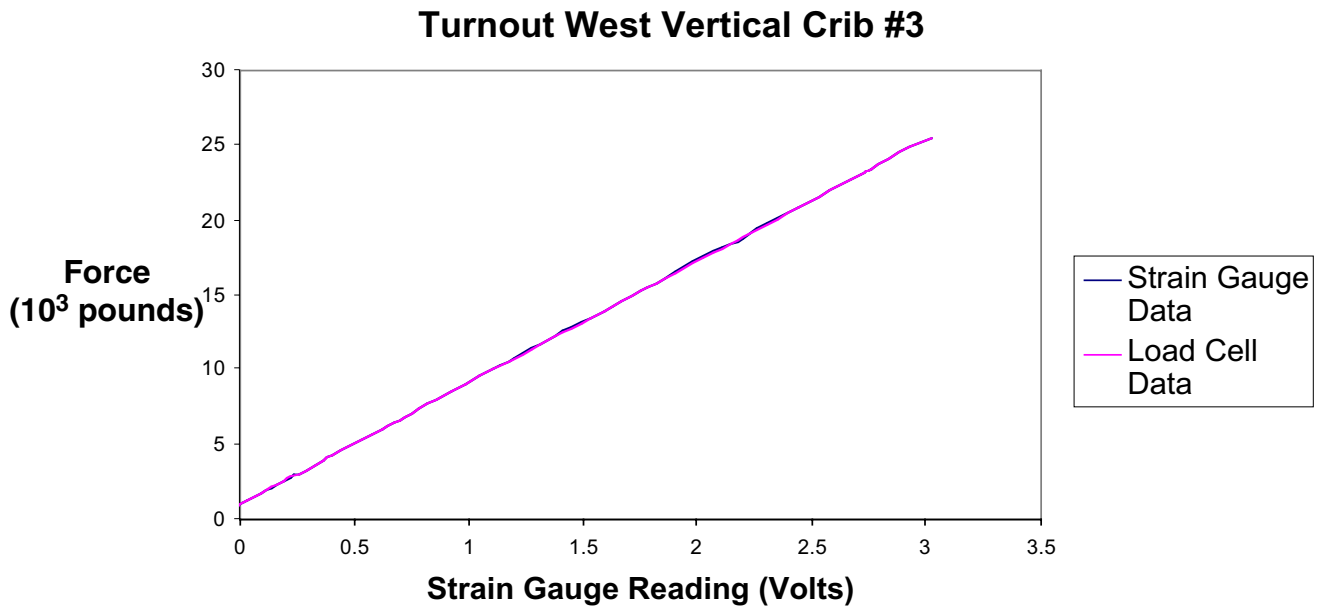

Figure A-22. Turnout west vertical crib No. 3

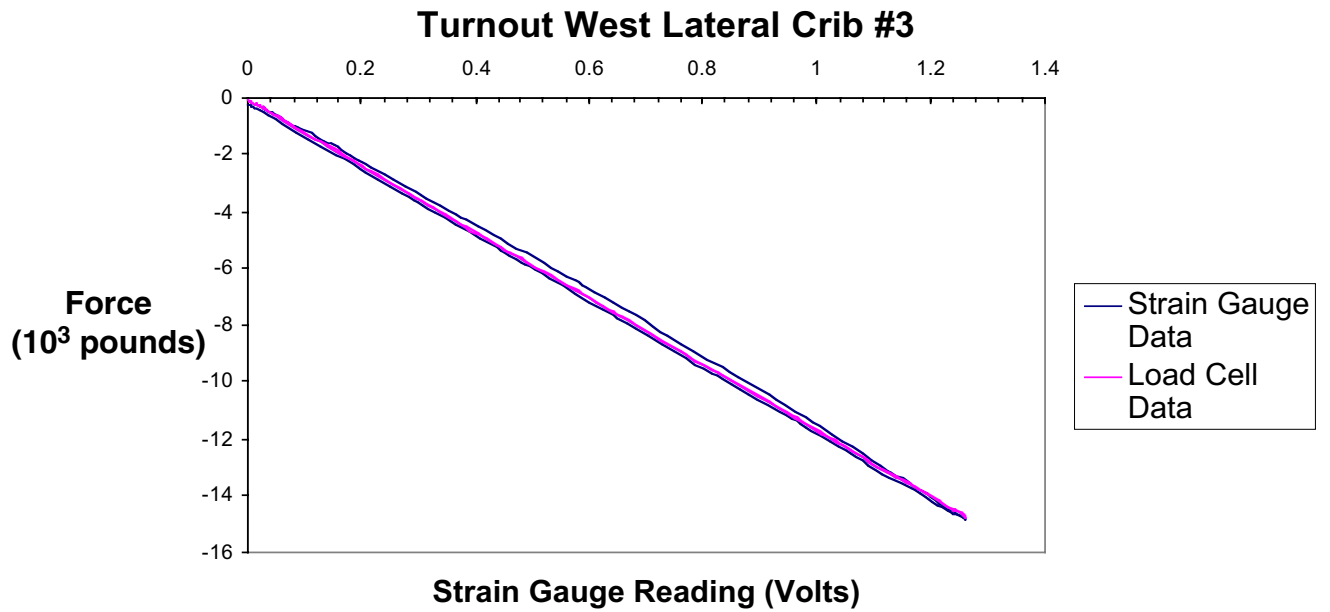

Figure A-23. Turnout west lateral crib No. 3

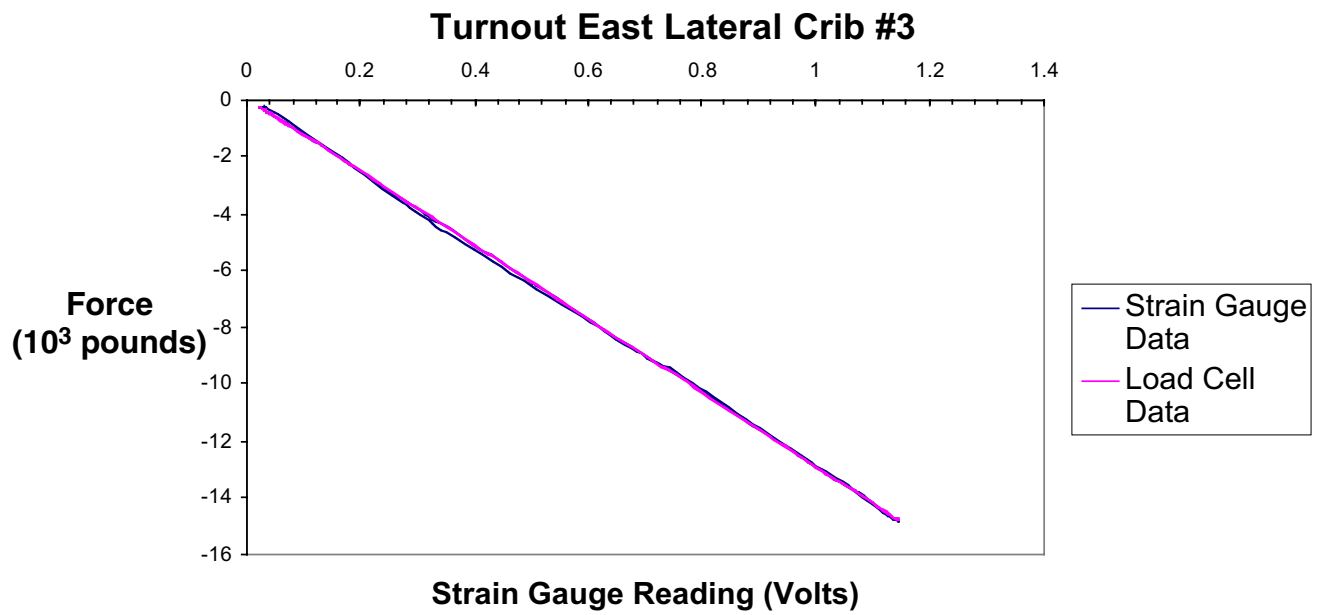

Figure A-24. Turnout east lateral crib No. 3

APPENDIX B

DATA ACQUISITION EQUIPMENT LIST (FINAL CONFIGURATION)

- National Instruments PXI 1010 chassis P/N 777570-01.
- National Instruments PXI 8155/166 controller module 166 MHz MMX Pentium 16 MB RAM, 2.2 GB HD, Windows 95 P/N 777570-01.
- National Instruments 64 MB RAM upgrade P/N 777575-64.
- National Instruments PXI 6040E I/O board, 250 kS/s, 12 bit, 16 channels. Includes NI-DAQ configuration software for Windows NT/95/98. P/N 777484-01.
- National Instruments PXI 1408 video acquisition board. Includes NI-IMAQ configuration software for Windows NT/95/98. P/N 777564-01.
- National Instruments SCXI 1100 32 channel multiplexer/amplifier P/N 776572-00.
- Stress Engineering SES-1300 Y 32 channel full bridge signal conditioning unit w/10V excitation (external power supply).
- National Instruments LabView 5.0 graphical programming software Base Package for Win NT/95/98 P/N 776671-03.
 - Monitor.
 - Mouse.
 - Keyboard.
 - External modem.
 - External zip-drive.