



U.S Department
of Transportation

**Federal Railroad
Administration**

Vehicle Proximity Alert System for Highway-Railroad Grade Crossings-Prototype Research

**Office of Research
and Development
Washington, DC 20590**

U.S. Department of Transportation
Research and Special Programs Administration
John A. Volpe National Transportation Systems Center
Cambridge, MA 02142

Safety of Highway-Railroad Grade Crossings

DOT/FRA/ORD-01/01

Final Report
April 2001

This document is available to the
public through the National Technical
Information Service, Springfield, VA 22161
This document is also availbe on
the FRA web site at www.fra.dot.gov

always expect a train

Notice

This document is disseminated under the sponsorship of the Department of Transportation in the interest of information exchange. The United States Government assumes no liability for its contents or use thereof.

Notice

The United States Government does not endorse products or manufacturers. Trade or manufacturers' names appear herein solely because they are considered essential to the objective of this report.

REPORT DOCUMENTATION PAGE*Form Approved
OMB No. 0704-0188*

Public reporting burden for this collection of information is estimated to average 1 hour per response, including the time for reviewing instructions, searching existing data sources, gathering and maintaining the data needed, and completing and reviewing the collection of information. Send comments regarding this burden estimate or any other aspect of this collection of information, including suggestions for reducing this burden, to Washington Headquarters Services, Directorate for Information Operations and Reports, 1215 Jefferson Davis Highway, Suite 1204, Arlington, VA 22202-4302, and to the Office of Management and Budget, Paperwork Reduction Project (0704-0188), Washington, DC 20503.

1. AGENCY USE ONLY (Leave blank)		2. REPORT DATE April 2001	3. REPORT TYPE AND DATES COVERED Final Report March 1994 - September 1998	
4. TITLE AND SUBTITLE Vehicle Proximity Alert System for Highway-Railroad Grade Crossings Prototype Research			5. FUNDING NUMBERS RR097/R0066	
6. AUTHOR (S) Anya Carroll, Anthony Passera, Ike Tingos				
7. PERFORMING ORGANIZATION NAME (S) AND ADDRESS (ES) U.S. Department of Transportation Research and Special Programs Administration John A. Volpe National Transportation Systems Center Cambridge, MA 02142			8. PERFORMING ORGANIZATION REPORT NUMBER DOT-VNTSC-FRA-00-05	
9. SPONSORING/MONITORING AGENCY NAME (S) AND ADDRESS (ES) U.S. Department of Transportation Federal Railroad Administration Office of Research and Development Washington, DC 20590			10. SPONSORING/MONITORING AGENCY REPORT NUMBER DOT/FRA/ORD-01/01	
11. SUPPLEMENTARY NOTES Safety of Highway-Railroad Grade Crossings series				
12a. DISTRIBUTION/AVAILABILITY STATEMENT This document is available to the public through the National Technical Information Service, Springfield, VA 22161			12b. DISTRIBUTION CODE	
13. ABSTRACT (Maximum 200 words) This report describes testing of prototype vehicle proximity alert system (VPAS) technologies, and presents and evaluates the results. The object was to determine the feasibility of VPAS for possible use in priority vehicles (i.e., emergency vehicles, school buses, vehicles carrying hazardous materials, and large trucks) to detect trains at highway-railroad grade crossings. VPAS can transmit visual and audible warnings to motorists. These warnings are designed to alert motorists in the vicinity of a grade crossing of the presence of a train approaching the crossing. Section 1072 of the Intermodal Surface Transportation Efficiency Act (ISTEA) required field testing of VPAS. The Federal Highway Administration (FHWA) in coordination with the Federal Railroad Administration (FRA) sponsored the testing. Prototype testing was conducted in January-April and November 1995 and in January 1996 at the FRA's Transportation Technology Center (TTC) in Pueblo, Colorado. Systems tested at the TTC demonstrated that the concept of VPAS for warning vehicles of a train's approach to a grade crossing is feasible, though none of the systems as tested was suitable for further testing.				
14. SUBJECT TERMS Grade crossing safety, highway-railroad grade crossings, alert systems, alarm systems, prototype testing, tests, priority vehicles, vehicle proximity alerting systems			15. NUMBER OF PAGES 133	
			16. PRICE CODE	
17. SECURITY CLASSIFICATION OF REPORT Unclassified	18. SECURITY CLASSIFICATION OF THIS PAGE Unclassified	19. SECURITY CLASSIFICATION OF ABSTRACT Unclassified	20. LIMITATION OF ABSTRACT	

METRIC/ENGLISH CONVERSION FACTORS

ENGLISH TO METRIC

METRIC TO ENGLISH

<p>LENGTH (APPROXIMATE)</p> <p>1 inch (in) = 2.5 centimeters (cm)</p> <p>1 foot (ft) = 30 centimeters (cm)</p> <p>1 yard (yd) = 0.9 meter (m)</p> <p>1 mile (mi) = 1.6 kilometers (km)</p>	<p>LENGTH (APPROXIMATE)</p> <p>1 millimeter (mm) = 0.04 inch (in)</p> <p>1 centimeter (cm) = 0.4 inch (in)</p> <p>1 meter (m) = 3.3 feet (ft)</p> <p>1 meter (m) = 1.1 yards (yd)</p> <p>1 kilometer (km) = 0.6 mile (mi)</p>
<p>AREA (APPROXIMATE)</p> <p>1 square inch (sq in, in²) = 6.5 square centimeters (cm²)</p> <p>1 square foot (sq ft, ft²) = 0.09 square meter (m²)</p> <p>1 square yard (sq yd, yd²) = 0.8 square meter (m²)</p> <p>1 square mile (sq mi, mi²) = 2.6 square kilometers (km²)</p> <p>1 acre = 0.4 hectare (he) = 4,000 square meters (m²)</p>	<p>AREA (APPROXIMATE)</p> <p>1 square centimeter (cm²) = 0.16 square inch (sq in, in²)</p> <p>1 square meter (m²) = 1.2 square yards (sq yd, yd²)</p> <p>1 square kilometer (km²) = 0.4 square mile (sq mi, mi²)</p> <p>10,000 square meters (m²) = 1 hectare (ha) = 2.5 acres</p>
<p>MASS - WEIGHT (APPROXIMATE)</p> <p>1 ounce (oz) = 28 grams (gm)</p> <p>1 pound (lb) = 0.45 kilogram (kg)</p> <p>1 short ton = 2,000 pounds (lb) = 0.9 tonne (t)</p>	<p>MASS - WEIGHT (APPROXIMATE)</p> <p>1 gram (gm) = 0.036 ounce (oz)</p> <p>1 kilogram (kg) = 2.2 pounds (lb)</p> <p>1 tonne (t) = 1,000 kilograms (kg) = 1.1 short tons</p>
<p>VOLUME (APPROXIMATE)</p> <p>1 teaspoon (tsp) = 5 milliliters (ml)</p> <p>1 tablespoon (tbsp) = 15 milliliters (ml)</p> <p>1 fluid ounce (fl oz) = 30 milliliters (ml)</p> <p>1 cup (c) = 0.24 liter (l)</p> <p>1 pint (pt) = 0.47 liter (l)</p> <p>1 quart (qt) = 0.96 liter (l)</p> <p>1 gallon (gal) = 3.8 liters (l)</p> <p>1 cubic foot (cu ft, ft³) = 0.03 cubic meter (m³)</p> <p>1 cubic yard (cu yd, yd³) = 0.76 cubic meter (m³)</p>	<p>VOLUME (APPROXIMATE)</p> <p>1 milliliter (ml) = 0.03 fluid ounce (fl oz)</p> <p>1 liter (l) = 2.1 pints (pt)</p> <p>1 liter (l) = 1.06 quarts (qt)</p> <p>1 liter (l) = 0.26 gallon (gal)</p> <p>1 cubic meter (m³) = 36 cubic feet (cu ft, ft³)</p> <p>1 cubic meter (m³) = 1.3 cubic yards (cu yd, yd³)</p>
<p>TEMPERATURE (EXACT)</p> <p>$[(x-32)(5/9)] \text{ } ^\circ\text{F} = y \text{ } ^\circ\text{C}$</p>	<p>TEMPERATURE (EXACT)</p> <p>$[(9/5)y + 32] \text{ } ^\circ\text{C} = x \text{ } ^\circ\text{F}$</p>

QUICK INCH - CENTIMETER LENGTH CONVERSION

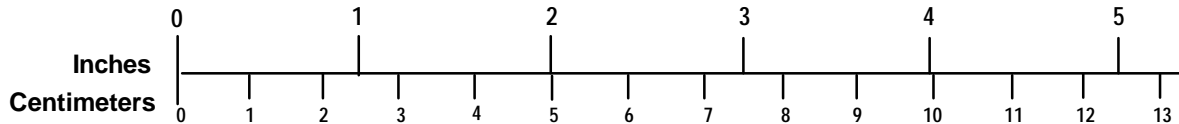

QUICK FAHRENHEIT - CELSIUS TEMPERATURE CONVERSION

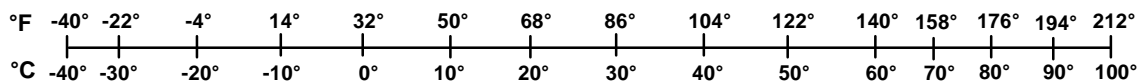

For more exact and or other conversion factors, see NIST Miscellaneous Publication 286, Units of Weights and Measures.
Price \$2.50 SD Catalog No. C13 10286

Updated 6/17/98

PREFACE

Historically, highway-railroad grade crossings have represented a major hazard to motorists. The feasibility of vehicle proximity alert systems (VPAS) is currently being examined for possible use in priority vehicles (i.e., emergency vehicles, school buses, vehicles carrying hazardous cargo, and large trucks) to alert operators of an approaching train. VPAS warnings are expected to be particularly beneficial for detecting a train approaching or traveling through the nearly 100,000 public crossings in the United States that lack active warning systems (e.g., flashing lights and gates). Future concerns may be applicable to all highway vehicles.

Section 1072 of the Intermodal Surface Transportation Efficiency Act (ISTEA) required the Secretary of Transportation to coordinate field-testing of VPAS. The Federal Railroad Administration (FRA) is co-sponsoring VPAS testing with the Federal Highway Administration (FHWA) as part of their comprehensive research program for improving safety at grade crossings. The FRA coordinated the VPAS prototype testing conducted in January, February, March, April, and November 1995 and in January 1996 at the Transportation Technology Center (TTC), Pueblo, Colorado.

In support of the FRA, the RSPA/John A. Volpe National Transportation Systems Center (Volpe Center) provided technical direction for all testing of prototype VPAS devices, which are transmitters and receivers that provide automated visual and audible warnings to motorists. The Volpe Center also directed the test planning process, evaluated the test results, recommended system upgrades, and prepared this final report. Transportation Technology Center, Inc. (TTCI), the operator of the Transportation Technology Center under contract to FRA, prepared the test implementation plan and conducted the tests.

EXECUTIVE SUMMARY

As part of a comprehensive research program for improving safety at highway-railroad grade crossings, the Federal Railroad Administration (FRA) coordinated field-testing of vehicle proximity alert system (VPAS) technologies. This testing was required by Section 1072 of the Intermodal Surface Transportation Efficiency Act (ISTEA) of 1991 to determine the feasibility and effectiveness of VPAS for detecting trains at nearby grade crossings that lack active warning systems. The ISTEA focus is on possible use of VPAS in priority vehicles (i.e., emergency vehicles, school buses, vehicles carrying hazardous materials, and large trucks).

VPAS technology can transmit visual and audible warnings to motorists. These warnings are designed to alert motorists in the vicinity of a grade crossing of the presence of a train approaching the crossing.

The VPAS prototypes were tested in the controlled environment of the Transportation Technology Center (TTC), Pueblo, Colorado. This report discusses the prototype testing, which was conducted in January, February, March, April, and November 1995 and in January 1996. Field operational testing (FOT) was not conducted because all of the systems tested required further development.

Systems Tested

Three prototype technologies were tested at TTC:

- (1) A three-point¹ system delivered by SmartStops Unlimited, Inc.
- (2) A one-point system delivered by Custom Automated Plastic System, Inc. (CAPS)—the Early Alert Response System (EARS).
- (3) A two-point system delivered by Dynamic Vehicle Safety Systems (DVSS).

¹A “point” is a VPAS component. A three-point system has three VPAS components.

One additional company submitted proposals regarding their system, but no prototypes were submitted for testing. Information on that system is presented in Appendix C.

The SmartStops system had a transceiver mounted in the test locomotive, another transceiver mounted on a pole at a crossing, and a receiver installed on the dashboard of the test vehicle. The pole-mounted transceiver decodes a signal from the locomotive, and transmits a different signal, which is collected by a vehicle receiver. The second signal is also collected by the locomotive transceiver, to inform the locomotive operator that the locomotive signal has been received and retransmitted.

EARS is an acoustic-detection system that selectively responds to the audio frequency spectrum of locomotive horns. The VPAS component consists of a microphone transducer mounted outside the vehicle and a digital signal processor mounted inside the vehicle. The processor uses an algorithm to analyze the frequency content of the audio signals received by the microphone.

The DVSS system consists of a VPAS receiver that detects radio transmissions from a freight train information system—a front- to rear-end (of train) device (FRED). A FRED system consists of two transceivers that are used to continuously transmit vital operating information between the rear and front of a train. Because the test locomotives at the TTC did not have FREDs, DVSS supplied the front-end transceiver from a FRED and installed it in the test locomotive, making the tested prototype a two-point system.

Description of Testing

Testing at the TTC was performed in four phases:

- (1) Installation, Calibration, and Checkout
- (2) Repeatability
- (3) Performance Limits
- (4) Response to Adverse Conditions

A pickup truck containing the test system's receiver served as the test vehicle for all testing. The test vehicle was parked at one location during Phases 1 and 2. It was parked at various locations and was mobile during Phases 3 and 4.

Phase 1 Testing. All system components and antennas were mounted in the appropriate locations and were adjusted according to system specifications. Several locomotive runs were performed to demonstrate and characterize the basic functionality of the equipment. Each component was calibrated to have a range of approximately 2,000 ft. (600 m).

Phase 2 Testing. All system components were actuated repeatedly (i.e., more than 500 locomotive runs per system) under the same test conditions. During each run, the locomotive signal, or horn, was first actuated 1,760 ft. (528 m) before the locomotive reached a simulated crossing and was discontinued when the locomotive was 1,760 ft. beyond the crossing. The vehicle remained stationary 500 ft. (150 m) from and perpendicular to the crossing. These tests measured three criteria:

- (1) Successful detections - The number of times an intended signal was received in the vehicle, without an interruption of more than 1.5 sec., at least 20 sec. before the train reached the crossing.
- (2) Missed detections - The number of times an intended uninterrupted signal was not received in the vehicle at least 20 sec. before the train reached the crossing.
- (3) Nuisance alarms/false alarms (NA/FA) - The number of times a non-VPAS signal was received in the vehicle.

Phase 3 Testing. System components were actuated in three different test locations having no perceptible sources of interference, to determine performance limits and range of each system's signal and receiver under "good conditions." Testing was also performed with the locomotive stationary, at different locations, while the vehicle was moving, at different speeds. These tests were performed at two different locations to provide different travel direction and terrain. At a third location, the systems were tested with the locomotive moving, at different speeds, while the vehicle was stationary, at different locations.

Phase 4 Testing. Tests were performed, at two different locations, to determine the effect of particular degrading conditions on the performance and range of each system. System components were actuated while energy interference (competing radio frequencies for the SmartStops and DVSS systems and other acoustic signals for EARS) was induced. Various tests were also performed in an area with large buildings and other structures.

Test Results

SmartStops System. During Phase 2, this system had only 16 missed detections in 501 runs with no NA/FAs. All of the missed detections occurred when the outside temperature was below 40° F (4° C). During Phase 3, locomotive signals were received at the crossing transceiver from as far away as 20,000 ft. (6 km)—10 times the calibrated distance. Signals from the crossing were received in the locomotive from 6,000 ft. (1.8 km) and in the vehicle from 5,200 ft. (1.6 km). During Phase 4, the signal showed some susceptibility to radio frequency interference but minimal susceptibility to structural interference.

EARS. This system was unable to consistently detect horn signals within a minimum acceptable range. During Phase 2, EARS had 343 missed detections in 503 runs, and had a NA/FA during 123 of those runs. The many NA/FAs indicate that EARS was unable to differentiate between train horns and all other audible noises in the acoustic frequency range. While the horn was not blowing, EARS responded to locomotive engine noise, train wheels squealing on the track, and vehicle engine and road noise. Atmospheric conditions, particularly wind speed and direction, significantly affected signal reception. Wind blowing directly from the track seemed to improve reception while wind blowing toward the track seemed to degrade reception. Performance degraded rapidly whenever the wind was blowing toward the track at more than 3 mph (5 km/h). Detection distances were particularly short during Phase 4, indicating high susceptibility to other induced acoustic signals and structural interference.

DVSS System. During Phase 2, this system successfully detected a train in each of its 594 runs with no NA/FAs. Despite a calibrated signal range of only 2,000 ft. (600 m), the DVSS receiver produced alarms when the vehicle was more than 4 mi. (6.4 km) from the locomotive.

Comparative Evaluation of Systems Tested

The performance and features of the three systems tested were compared using four categories of evaluation criteria: (1) quantitative repeatability performance, (2) quantitative overall performance, (3) qualitative overall performance, and (4) qualitative general performance. The quantitative repeatability criteria (successful detections, missed detections, and NA/FAs) were used to define the structure and format of the Phase 2 tests. Thus, the results of Phase 2 testing were expressed in terms of the repeatability criteria. Except for “signal range” (a criterion of quantitative overall performance) during Phase 3, however, the criteria in the other three groups were not used to define the structure and format of a particular test phase. They were used only to evaluate and compare the results from all four test phases. Thus, no test results were expressed in terms of those criteria.

Conclusions and Findings

The systems tested at TTCI demonstrated that the concept of VPAS for warning priority vehicles of the approach of a train to a grade crossing is feasible, though none of the systems as tested was suitable for further testing.

The SmartStops system will have to modify its system design to or will need to be modified to:

- Enable the system to detect a train at temperatures defined in military specifications.
- Significantly reduce the signal range, though the optimum range² is yet to be determined.
- Increase shielding of components from radio frequency interference.
- Include a self-test feature that notifies the motorist if any VPAS component fails.
- Provide fail-safe capability.

²The optimum range is defined as the number of other crossings receiving nuisance alarms adjacent to the target crossing. These crossings should be minimized while the probability of detection at the target crossing should be high. Determining this optimum range will require extensive study of the engineering design tradeoffs.

EARS is not considered to be a viable candidate because of its substandard performance during Phase 2 and its high susceptibility to atmospheric conditions, other acoustic signals, and structural interference during Phases 3 and 4.

In revenue service, FREDs transmit signals continuously. Therefore, the DVSS system lacks a frame of reference to the target crossing, creating a potential for signals to be received in a vehicle that is not near a crossing where a train is approaching. Excessive nuisance alarms of this type undermine the motorist's confidence in the system, and the motorist may turn off the receiver to avoid the nuisance alarm, thereby eliminating all detection capability and putting the motorist and passengers at risk.

Testing at the TTC also provided considerable insight on general VPAS designs that are appropriate for further testing and raised design issues and concerns. Radio frequency systems appear to be more suitable for a warning system than do acoustic systems, and the three-point design seems to be the most reliable. A transceiver mounted at the crossing would shorten the maximum signal range needed from the locomotive. This reduces the potential for the signal to be received in a vehicle that is not near a crossing where a train is approaching. A crossing transceiver also allows the warning zone around the crossing to be controlled and tuned according to the particular geometry and environment around the crossing, reducing the potential for energy or structural interference.

This insight has been used to formulate proposed system performance specifications and an operational test and evaluation plans for field operational testing should future prototypes prove ready for FOT.

TABLE OF CONTENTS

<u>Section</u>	<u>Page</u>
1. INTRODUCTION	1-1
1.1 Background	1-2
1.2 Program Goals and Objectives	1-3
1.3 Program Approach	1-3
2. PROTOTYPE TESTING OVERVIEW	2-1
2.1 Project Objectives	2-2
2.2 Project Approach	2-2
3. SYSTEMS SELECTED AND TESTED	3-1
3.1 Systems Initially Selected	3-1
3.2 Systems Actually Tested	3-2
3.2.1 SmartStops System	3-3
3.2.2 Early Alert Response System (EARS)	3-5
3.2.3 Dynamic Vehicle Safety Systems (DVSS) System	3-6
4. DESCRIPTION OF PROTOTYPE TESTING	4-1
4.1 Test Instrumentation	4-3
4.2 Test Procedures	4-5
4.3 Phase 1: Installation, Calibration, and Checkout	4-7
4.4 Phase 2: Repeatability	4-8
4.5 Phase 3: Performance Limits	4-9
4.5.1 Mobile-Locomotive Testing	4-10
4.5.2 Stationary-Locomotive Testing	4-10
4.6 Phase 4: System Response to Adverse Conditions	4-13
4.6.1 Induced Energy Interference	4-13
4.6.2 Structural Interference	4-14
5. PROTOTYPE TESTING RESULTS	5-1
5.1 SmartStops System	5-1
5.1.1 Phase 1	5-1
5.1.2 Phase 2	5-2
5.1.3 Phase 3	5-4
5.1.4 Phase 4	5-9
5.2 Early Alert Response System (EARS)	5-15
5.2.1 Phase 1	5-15
5.2.2 Phase 2	5-18
5.2.3 Phase 3	5-19
5.2.4 Phase 4	5-27

TABLE OF CONTENTS (cont.)

<u>Section</u>	<u>Page</u>
5.3 Dynamic Vehicle Safety Systems (DVSS).....	5-30
5.3.1 Phase 1	5-30
5.3.2 Phase 2	5-31
5.3.3 Phase 3	5-32
5.3.4 Phase 4	5-33
 6. COMPARATIVE EVALUATION OF PROTOTYPE SYSTEMS.....	 6-1
6.1 Criteria for Comparative Evaluation	6-1
6.1.1 Quantitative Repeatability Performance Criteria	6-2
6.1.2 Quantitative Overall Performance Criteria	6-3
6.1.3 Qualitative Overall Performance Criteria	6-6
6.1.4 Qualitative General Criteria.....	6-7
6.2 Comparison of the Three Systems	6-8
6.2.1 Quantitative Repeatability Performance Evaluation.....	6-8
6.2.2 Quantitative Overall Performance Evaluation.....	6-9
6.2.3 Qualitative Overall Performance Evaluation.....	6-12
6.2.4 Qualitative General Evaluation.....	6-13
 7. CONCLUSIONS AND FINDINGS	 7-1
7.1 Systems' Suitability for Field Operational Testing	7-1
7.1.1 SmartStops System	7-2
7.1.2 EARS	7-3
7.1.3 DVSS System.....	7-3
7.2 Recommended System Upgrades	7-4
7.3 General Issues and Concerns for Future Testing.....	7-4
7.4 Preliminary System Performance Guidelines	7-5
7.4.1 Physical Considerations	7-6
7.4.2 Operational Considerations.....	7-7
7.5 Proposed Operational Test and Evaluation Plan for Field Operational Testing.	7-9
 Appendices	
A. Intermodal Surface Transportation Efficiency Act (ISTEA) Section 1072.....	A-1
B. CBD Announcement Soliciting VPAS	B-1
C. Information Submitted by Vendors of Selected Systems	C-1
D. Daily Weather Reports and Test Results: Examples	D-1

LIST OF FIGURES

<u>Figure</u>	<u>Page</u>
3-1. VPAS Technologies.....	3-2
3-2. SmartStops System Signal Transmission.....	3-4
3-3. SmartStops System Locomotive Transceiver.....	3-4
3-4. SmartStops System Locomotive Transceiver Antenna.....	3-4
3-5. SmartStops Crossing Transceiver.....	3-5
3-6. SmartStops Crossing Transceiver Antenna.....	3-5
3-7. SmartStops Vehicle Receiver.....	3-5
3-8. EARS Signal Reception.....	3-6
3-9. EARS Microphone.....	3-6
3-10. EARS Digital Signal Processor.....	3-6
3-11. DVSS System Signal Transmission.....	3-7
4-1. TTC Test Site Aerial Photograph.....	4-2
4-2. Location of Test Zones at TTC.....	4-3
4-3. Instrumentation in the Locomotive.....	4-6
4-4. Instrumentation in the Vehicle.....	4-6
4-5. Zone A Test Area.....	4-7
4-6. Zone A Test-Bed Setup.....	4-8
4-7. Zone B Test-Bed Setup.....	4-11
4-8. Zone C Test-Bed Setup.....	4-12
4-9. Zone D Test-Bed Setup.....	4-12
4-10. Zone E Test Area.....	4-14
4-11. TTC Radio Tower and Bridge.....	4-15
5-1. SmartStops System RFI Testing in Zone E.....	5-12
5-2. SmartStops System Signal Masking Testing in Zone E.....	5-13
5-3. Locations of Measured Output Signal of Test Locomotive Horn.....	5-16
5-4. Measured Sound Intensity of Nathan P5 Horn.....	5-17
5-5. Single Horn Test Plot.....	5-19
5-6. EARS Testing in Zone E.....	5-29

LIST OF FIGURES (cont.)

<u>Figure</u>	<u>Page</u>
5-7. DVSS System Testing in Zone E.....	5-34
6-1. Minimum Range Required for the SmartStops System.....	6-4
6-2. Minimum Range Required for EARS and the DVSS System	6-5
7-1. Detection Probability Confidence Limit Curve.....	7-10

LIST OF TABLES

<u>Table</u>	<u>Page</u>
5-1. SmartStops System Phase 2 Test Results	5-3
5-2. SmartStops System Phase 3 Mobile-Locomotive Test Results	5-6
5-3. SmartStops System Phase 3 Stationary-Locomotive Test Results	5-8
5-4. SmartStops System Phase 4 Zone B RFI Test Results	5-9
5-5. SmartStops System Phase 4 Antenna Position Test Results.....	5-11
5-6. SmartStops System Phase 4 Zone E RFI Test Results	5-13
5-7. SmartStops System Phase 4 Signal Masking Test Results	5-14
5-8. EARS Phase 2 Test Results	5-20
5-9. EARS Phase 2 Initial Signal Detection by Horn Blast	5-20
5-10. EARS Phase 3 Mobile-Locomotive Test Results	5-22
5-11. EARS Phase 3 Stationary-Locomotive Zone C Test Results	5-24
5-12. EARS Phase 3 Stationary-Locomotive Zone D Test Results	5-25
5-13. EARS Phase 4 Engine-Noise Interference Test Results.....	5-28
5-14. EARS Phase 4 Zone E Test Results.....	5-29
5-15. DVSS System Phase 2 Test Results.....	5-31
5-16. DVSS System Phase 3 Mobile-Locomotive Test Results	5-33
5-17. DVSS System Phase 4 Test Results.....	5-35
6-1. Quantitative Repeatability Performance Evaluation	6-9
6-2. Quantitative Overall Performance Evaluation.....	6-10
6-3. Qualitative Overall Performance Evaluation	6-12
6-4. Qualitative General Evaluation.....	6-14

ABBREVIATIONS

AAR	Association of American Railroads
ALD	Automatic location detector
CBD	Commerce Business Daily
CSB	Center Services Building
cm	Centimeters
DTMF	Dual-tone multiple frequency
DVSS	Dynamic Vehicle Safety Systems
EARS	Early Alert Response System
FA	False alarm (caused by natural environment)
FM	Frequency modulation
FHWA	Federal Highway Administration
FOT	Field operational testing
FRA	Federal Railroad Administration
FRED	Front- to rear-end (of train) device
ft	Feet
FTA	Federal Transit Administration
GPS	Global Positioning System
HRI	Highway-Rail Intersection
Hz	Hertz
in	Inches
IRIG	Inter-Range Instrumentation Group
ISTEA	Intermodal Surface Transportation Efficiency Act of 1991
J	Joules
JPO	Joint Program Office
km	Kilometer(s)
km/h	Kilometers per hour
m	Meter(s)
MHz	Megahertz
mi	Mile(s)
min	Minute(s)
mph	Miles per hour

ABBREVIATIONS (cont.)

NA	Nuisance alarm
NA/FA	Nuisance alarm or false alarm
NHTSA	National Highway Traffic Safety Administration
PTC	Positive Train Control
RDL	Rail Dynamics Laboratory
RF	Radio frequency
RFI	Radio frequency interference
RPI	Railroad Progress Institute
sec	Second(s)
TTC	Transportation Technology Center
TTCI	Transportation Technology Center, Inc. (wholly owned subsidiary of AAR and operator of the TTC)
VDC	Voltage direct current
VPAS	Vehicle Proximity Alert System
~	Approximately

DEFINITIONS

Attenuation	Reduction in signal strength caused by natural or man-made environment.
Calibration	A process in Phase I testing involving standardization of measurement instruments.
Common time base	The reference time base for all significant measured quantities.
Comparative evaluations	Comparison of different VPAS technologies according to established categories of technical and performance characteristics. In the absence of adequate size of statistical samples, system performance is compared when exposed to similar operating time, conditions, and environment.
Component noise	Audible noise levels caused by operating VPAS components in the locomotive, at the crossing, or in the vehicle.
Critical component failure	The malfunction of any component that prevents the system from warning a motorist.
Energy interference	Change in the operating environment caused by competing radio frequencies or by other acoustic signals that could possibly degrade the operation of an electrical system or component or degrade a signal transmission.
Fail-safe capability	Ability of a system to sound and display a continuous warning in the vehicle whenever there is a critical component failure.

DEFINITIONS (cont.)

False alarm	An alarm in the receiving vehicle not produced by any signal source.
Front- to rear-end (of train) device	A monitoring/transmission device, consisting of two transceivers, that records status information (brake pipe pressure, speed, etc.) at the end of a train and transmits it to the operations control panel at the front of the train.
Intermittent signal	A continuous interruption in reception at a receiver or transceiver of more than 1.5 sec.
Man-made environment	Non-natural environment (e.g., energy sources and blocking infrastructure) that may generate interference.
Missed detection	Absence of or interruption in an alarm in the receiving vehicle within a prescribed amount of time following an intended signal.
Multipath	Non-line-of-sight signals reflected from nearby surfaces (buildings, vehicles, etc.) causing fading or reinforcement of the warning signal.
Natural environment	The variations in temperature, humidity, precipitation, wind, terrain, etc. in the system's expected geographical operating region.
Nuisance alarm	An alarm in the receiving vehicle produced by a signal source other than an intended signal (This includes sources other than VPAS signals, and VPAS signals that are received in vehicles that are not near a crossing where a train is approaching.).

DEFINITIONS (cont.)

One-point system	A VPAS with a component in only a motor vehicle.
Prototype system	An emerging technology that is manufactured on a limited basis strictly for research and test purposes.
Radio frequency interference (RFI)	Change in the operating environment caused by a competing radio signal that could possibly degrade the operation of an RF system or component or degrade an RF signal transmission.
Railroad infrastructure	Railroad equipment or systems.
Response time	The amount of time for an alarm to be received in a motor vehicle after a warning signal is sent from the intended source.
Roadway geometry	The physical characteristics of the roadway surface, including grade, curvature, super elevation, and rates of change in these characteristics with respect to the distance along the roadway, and often in relation to track intersection.
Signal coverage	The area around the transmitter in which the signal can be received.
Signal masking	A loss of signal caused by an obstruction (e.g., a building or a hill in the transmission path). The blocking or attenuation of line-of-sight signals by buildings, foliage, etc.
Signal range	The maximum distance from the signal source that the signal can be received.

DEFINITIONS (cont.)

Structural interference	Change in the physical operating environment caused by shading and reflections of a transmitted signal that could alter signal transmission.
Successful detection	A continuous alarm in the receiving vehicle produced by an intended signal within a prescribed amount of time following a signal.
Test Phase 1	System installation, calibration, and checkout performed in Zone A.
Test Phase 2	Repeatability testing, performed in Zone A, consisting of at least 500 test runs per system.
Test Phase 3	Testing of performance limits under random conditions with the locomotive mobile (in Zone B) and with the locomotive stationary (in Zones C and D).
Test Phase 4	Testing of system response to adverse conditions: induced interference (in Zone B) and buildings and other structures (in Zone E).
Three-point system	A VPAS with a component in a motor vehicle, another component at a crossing, and a third component in a locomotive or a wayside train detection device.
Track geometry	The physical characteristics of the track surface, including grade, curvature, super elevation, and rates of change in these characteristics with respect to the distance along the track.

DEFINITIONS (cont.)

Two-point system

A VPAS with a component in a motor vehicle and another component at a crossing or in a locomotive.

VPAS

An automated system designed to warn vehicles in the vicinity of a grade crossing of a train approaching the crossing.

1. INTRODUCTION

Highway-railroad grade crossings represent a major hazard to motorists. In 1996, there were 4,257 accidents at the approximately 269,000 crossings (164,000 public and 105,000 private) in the United States, not including public transit crossings. These accidents resulted in 488 fatalities and 1,610 injuries. Additionally, there were 128 incidents at transit crossings, leading to 18 fatalities and 198 injuries.¹ Grade crossing accidents pose a risk to motorists, train crews and passengers, and neighboring communities. This risk is greatly magnified when high-speed passenger trains or hazardous materials (either on a train, in a motor vehicle, or at trackside) are involved. Therefore, grade crossing accidents are a multimodal safety concern to various US DOT administrations.

Because of the multimodal nature of grade crossing safety, the Federal Highway Administration (FHWA) Joint Program Office (JPO) has established the Highway-Rail Intersection (HRI) user service within the Travel and Traffic Management area of the Intelligent Transportation System (ITS) initiative. The JPO will coordinate future work of four US DOT agencies: The Federal Railroad Administration (FRA), the Federal Transit Administration (FTA), The National Highway Traffic Safety Administration (NHTSA), and FHWA.

The FRA is currently conducting a comprehensive research program for improving grade crossing safety in the ITS arena, which includes development and assessment of countermeasures and warning devices such as vehicle proximity alert systems (VPAS) and four-quadrant gates with obstruction detection.

This report describes the testing of VPAS devices, and presents and evaluates those results. VPAS technology transmits visual and audible warnings to receivers in motor vehicles. These warnings are designed to alert motorists in the vicinity of a grade crossing to the presence of a train approaching the crossing in sufficient time for them to safely stop their vehicles.

¹ Federal Railroad Administration (FRA) Office of Safety. *Highway-Rail Crossing Accident/Incident and Inventory Bulletin* No. 18, September 1996 and No. 19, August 1997; and the Railroad Accident Incident Reporting System (RAIRS) database, 1996.

The feasibility of VPAS is currently being explored for use in emergency vehicles (e.g., ambulances, fire trucks, police cars), as well as other types of priority vehicles such as school buses, vehicles carrying hazardous cargo, and large trucks. VPAS warnings are expected to be particularly beneficial for detecting a train approaching or traveling through the nearly 100,000 public crossings in the United States that lack active warning systems (e.g., flashing lights and gates). Future concerns may be applicable to all highway vehicles. A separate report will be issued on the second stage (field operational testing) when that stage is completed.

1.1 Background

Section 1072 of the Intermodal Surface Transportation Efficiency Act (ISTEA) of 1991, which appears in Appendix A, required the Secretary of Transportation to coordinate field testing of VPAS concepts and comparable systems. The intent is to determine the feasibility and effectiveness of VPAS technology in priority vehicles (i.e., emergency vehicles, school buses, vehicles carrying hazardous materials, large trucks, etc.) for detecting trains at nearby grade crossings. FHWA requested support from the FRA to conduct the tests. The FRA, in turn, requested support from the Transportation Technology Center, Inc. (TTCI), TTC's operator—the Association of American Railroads (AAR), and the RSPA/John A. Volpe National Transportation Systems Center (Volpe Center).

On July 26, 1993, FHWA published an announcement (Appendix B) in the Commerce Business Daily (CBD) soliciting information about VPAS and comparable systems for consideration in field testing and evaluation as a grade crossing warning system. A 60-day response time was provided. A copy of the announcement was also published in the monthly newsletters of AAR and the Railroad Progress Institute (RPI). Eleven formal proposals were received and evaluated by a joint committee of FHWA and FRA members. Four systems, representing three basic approaches, were selected for testing. The information supplied by the vendors of those four systems appears in Appendix C. Submitters of that information were required to provide an operating prototype system for use in field tests.

1.2 Program Goals and Objectives

FHWA uses a broad set of goals and objectives as a national guideline for evaluating new transportation-related concepts.

The goals are to evaluate the following aspects of the grade crossing protection system (i.e., VPAS) under demonstration: (1) its performance, (2) its impact on the overall transportation system, (3) acceptance by user groups (e.g., motorists, train operators, railroad companies, and rail labor groups), (4) costs, (5) benefits, and (6) institutional and legal issues. The first goal (performance evaluation) is the primary focus of the VPAS test program. The remaining evaluation goals will be addressed should any of the prototypes prove reliable.

The standard objectives of a performance evaluation are to assess (1) the system's ability to perform as designed, (2) the system's ability to perform consistently, and (3) all system failures.

1.3 Program Approach

To properly evaluate the impact of VPAS on the overall transportation system and the impact of the real-world operating environment on VPAS, the test program has to include a realistic application on working railroads. However, because of the risk involved in placing prototype systems in an operational test at highway-railroad grade crossings, a two-stage test approach was developed. The initial stage (prototype testing) was conducted in the controlled environment at the TTC. This provided a cost-effective method for screening out technologies that are not viable and for detecting problems with those that are viable. The prototypes that proved viable would then be considered for field operational testing (FOT) on working railroads in a cross-section of urban, suburban, and rural environments for the second stage of the program. Both stages of testing are designed to satisfy FHWA's goal of performance evaluation and the related objectives. The prototype testing, which is the subject of this report, focuses on collection of technical data on equipment performance. Collection of performance data during

FOT would address implementation issues in a real-world environment. Field operational testing may also provide data to help satisfy the other FHWA goals.

2. PROTOTYPE TESTING OVERVIEW

Prototype testing was conducted in January, February, March, April, and November 1995 and in January 1996 at the TTC, Pueblo, Colorado. FHWA sponsored the tests, the FRA coordinated the testing, AAR conducted the tests, and the Volpe Center provided technical direction for the testing and evaluated the results. Specifically:

- The FRA (1) assisted the FHWA Office of Highway Safety with the solicitation for and review of VPAS information, and (2) reviewed and approved the test implementation plan.
- AAR (1) prepared the test implementation plan, (2) installed all of the required instrumentation and associated hardware, (3) coordinated logistics with vendors of the systems tested, (4) conducted the tests, (5) collected data during the tests, including information on the weather, other test conditions, and performance of the systems tested in accordance with the test implementation plan, (6) provided all data for each test conducted, (7) prepared a separate letter report on the test procedures and results for each system, and (8) prepared a final report on all of the prototype testing.
- The Volpe Center (1) provided technical direction during preparation of the test implementation plan, (2) observed and provided technical support for all testing, (3) detected and recommended ways to correct deficiencies in test procedures and prototype equipment during testing, (4) evaluated all data acquisition routines, and (5) evaluated performance and suitability for field operational testing of each system, and recommended upgrades for suitable systems.

2.1 Project Objectives

The prototype testing was intended to test each system under similar conditions to determine:

- (1) The baseline performance characteristics of each system
 - Installation requirements for each VPAS component
 - Ability to consistently provide adequate warning of the presence of a train when train speed and motor vehicle location are fixed
 - Ability to detect the presence of a train and provide adequate warning under “normal” operating conditions and various combinations of stationary location and speed of both the locomotive and the motor vehicle
 - The effects of adverse operating environments on signal transmission and reception
 - Relative maintainability of each system during testing
 - Overall operability of each system in terms of ease of use, annoyance factors, etc.
- (2) Suitability of each system for field operational testing
 - Overall performance and viability of design
 - Need for system upgrades

2.2 Project Approach

The approach used at the TTC was to identify different test zones and test phases (which are described in Chapter 4) for determining the performance characteristics listed in Section 2.1.

To determine the systems' ability to consistently provide adequate warning of the presence of a train, adequate warning first had to be established. There is a tradeoff between having a warning signal received early enough to give a motorist ample time to react and avoid an approaching train and an excessively long warning time that creates a high probability of nuisance, which could negatively affect motorist behavior.

FHWA standards require at least 20 sec. of warning time at grade crossings with active signals on tracks where trains operate at speeds of 20 mph (32 km/h) or higher.² However, studies have shown that a longer warning time may be desirable. The United Kingdom requires at least 27 sec. of warning time. Japan and Australia require 25 sec. at gated crossings, and Germany requires 22 sec. Although there is no standard for maximum warning time in the United States, some countries (e.g., the United Kingdom, Sweden, and West Germany) do have maximum limits.³ Studies have shown that as warning time increases so do the instances of motorists' ignoring the warnings.⁴

The approach to testing consistency in providing adequate warning was to make 20 sec. the minimum acceptable warning time, but to design the test zone to provide a 30-sec. warning for a train approaching at 40 mph (64 km/h). Thus, the train approach limit used for the simulated grade crossing during adequate warning testing was 1,760 ft. (528 m), and the test motor vehicle was parked 500 ft. (150 m) from the crossing. Each system was tested repeatedly under these specifications.

The important issue in evaluating performance, both under normal conditions and under adverse conditions is to assess the systems' signal range and coverage. These criteria must be sufficient to ensure adequate warning time, but must also be controlled to minimize the likelihood of nuisance alarms.

²FHWA. *Manual on Uniform Traffic Control Devices*. U.S. Government Printing Office: Washington, D.C. 1988, p. 8C-7.

³S.H. Richards, R.A. Margiotta, and G.A. Evans. *Warning Time Requirements at Railroad-Highway Grade Crossings with Active Traffic Control*. Final Report. FHWA-SA-91-007. University of Tennessee Transportation Center. February 1991.

⁴Ibid.

Designed signal range will always have to exceed the minimum required range to ensure that the required range is achieved with regularity. The optimum range and coverage depends on the desired probability of successful warning, i.e., desired regularity. As the desired probability of successful detection is increased, the designed range and coverage must also be increased. These increases, in turn, increase the potential for nuisance alarms.

To evaluate performance under normal conditions, tests were performed in three different zones having different terrain. One segment was conducted with the test locomotive moving at different speeds while the motor vehicle remained stationary at different locations. Another segment was conducted with the vehicle moving at different speeds while the locomotive remained stationary at different locations. The speeds and locations used varied from system to system depending on the perceived strengths and weaknesses of each system.

To assess the effects of adverse operating environments, energy interference was induced during one segment of testing, and another segment was conducted in a test zone containing large buildings and other structures to provide structural interference. During both of these test segments, specific testing was tailored to each individual system to provide maximum potential for disruption to each.

3. SYSTEMS SELECTED AND TESTED

VPAS technologies are classified in terms of the number of VPAS components (points) used:

- One-point system A VPAS with a component in only a motor vehicle. A warning receiver is installed in the vehicle to collect a signal from an existing railroad infrastructure.
- Two-point system A VPAS with a component in a motor vehicle and another component in a locomotive or at trackside. A receiver in the vehicle collects a warning signal from a transmitting device in the locomotive or from a transmitter in a trackside device that senses the locomotive's approach.
- Three-point system A VPAS with a component in a motor vehicle, another component at a crossing, and a third component in a locomotive or at trackside. A transceiver at the crossing collects a warning signal from a transmitter in the locomotive or at trackside, and retransmits the warning, which is collected by a receiver in the vehicle.

One 1-point system, eight 2-point systems, and two 3-point systems were proposed for testing. Two categories of 2-point systems were proposed. Five of the 2-point systems called for a transmitter in the locomotive while the other three proposed a trackside transmitter. Thus, four categories of systems were proposed. Eleven companies submitted proposals.

3.1 Systems Initially Selected

Four systems were originally chosen for testing at the TTC—one from each of the four categories of proposed systems (see Figure 3-1):

- (1) A one-point system proposed by Custom Automated Plastic System Inc.—the Early Alert Response System (EARS).

- (2) A two-point system with the transmitter in the locomotive proposed by RF Solutions—TrakAlert.
- (3) A two-point system with the transmitter at trackside proposed by TRW.
- (4) A three-point system proposed by SmartStops.

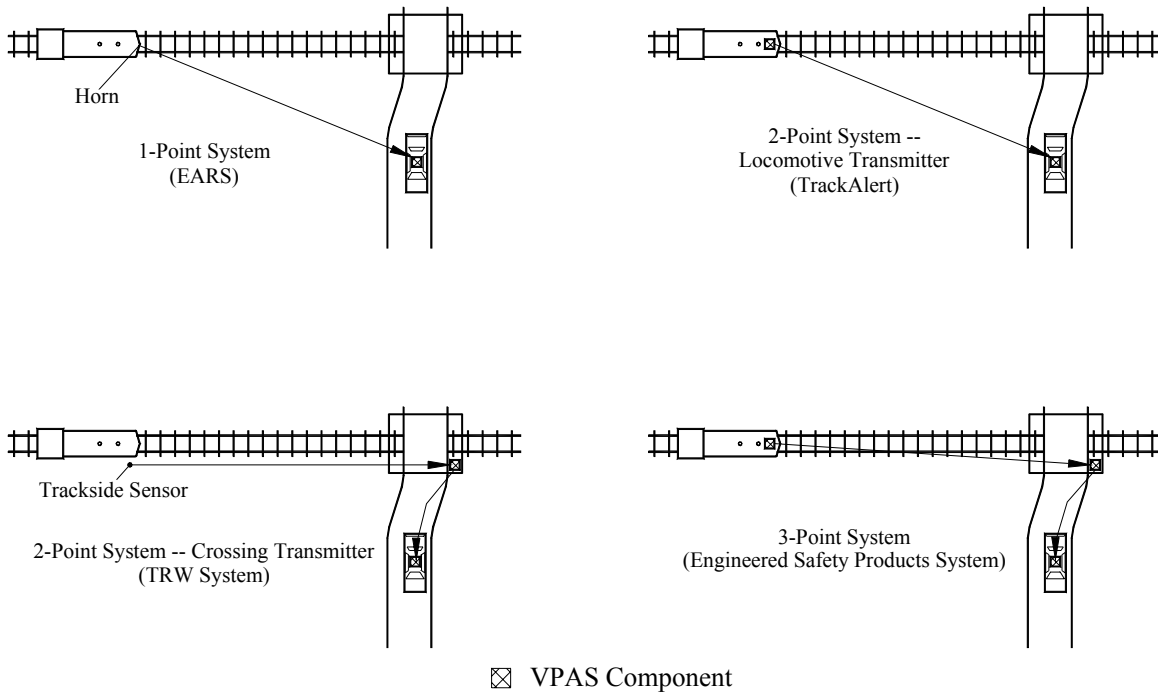

Figure 3-1. VPAS Technologies

3.2 Systems Actually Tested

Before testing was scheduled, TRW withdrew its candidate system. RF Solutions was unable to produce a working prototype of the TrakAlert system for scheduled testing. Dynamic Vehicle Safety Systems (DVSS) proposed a two-point system with a locomotive transmitter for testing. The DVSS system was accepted and subsequently tested. Before testing began, the parent company of the three-point system changed from Engineered Safety Products to SmartStops Unlimited, Inc.

Thus, the following three prototypes were actually tested at TTC:

- (1) A three-point system delivered by SmartStops Unlimited, Inc. (formerly Engineered Safety Products).
- (2) A one-point system delivered by Custom Automated Plastic System Inc.—EARS.
- (3) A two-point system with the transmitter in the locomotive delivered by DVSS.

3.2.1 SmartStops System

As shown in [Figure 3-2](#), this system consisted of a transceiver mounted in a locomotive, another transceiver mounted on a pole at a crossing, and a receiver installed in a motor vehicle. The transceivers use an RF signal, operating at 151.7 MHz, and dual-tone multiple frequency (DTMF) codes. An unregulated 12-VDC battery powers the receiver. The transceiver installed in the locomotive is shown in [Figure 3-3](#), the mounted antenna for the locomotive transceiver is shown in [Figure 3-4](#), the transceiver mounted at the crossing is shown in [Figure 3-5](#), the mounted antenna for the crossing transceiver is shown in [Figure 3-6](#), the receiver is shown in [Figure 3-7](#).

The locomotive transceiver transmits its signal at a constant rate when the locomotive is operating. As the locomotive approaches a crossing, the pole-mounted transceiver decodes the DTMF signal from the locomotive. If the appropriate code is received, the pole-mounted transceiver transmits another signal, which is coded differently from the locomotive signal. The signal from the pole-mounted transceiver is collected by any motor vehicle with a receiver within range of the crossing, and an alarm is sounded and displayed in the vehicle. That signal is also collected by the locomotive transceiver, which displays a message to the locomotive operator that the locomotive signal has been received at the crossing and a second signal has been transmitted.



Figure 3-5. SmartStops Crossing Transceiver



Figure 3-6. SmartStops Crossing Transceiver Antenna



Figure 3-7. SmartStops Vehicle Receiver

3.2.2 Early Alert Response System (EARS)

EARS is an acoustic-detection system that selectively responds to the audio frequency spectrum of locomotive horns as shown in Figure 3-8. The VPAS component consists of a microphone transducer mounted outside the vehicle (shown in Figure 3-9) and a digital signal processor (shown in Figure 3-10) mounted inside the vehicle. The processor uses an algorithm to analyze the frequency content of the audio signals received by the microphone transducer. When the appropriate frequencies are recognized, both a visual and an audio warning signal are generated in the vehicle. The primary power source for the system is the unregulated 12 VDC vehicle battery.

EARS was originally designed to visually inform hearing-impaired motorists of the proximity of an emergency vehicle. The microphone receives an audible frequency signal transmitted by the siren, the signal is analyzed to determine the type of siren, and a visual alarm and an audible alarm are activated. The system was adjusted to allow the detection of locomotive horns.

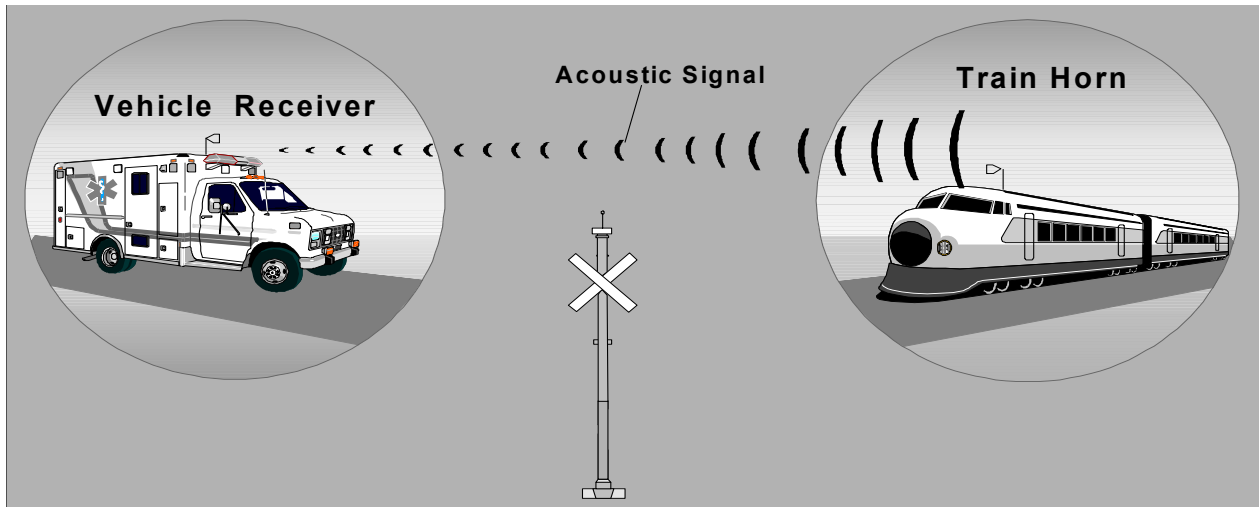

Figure 3-8. EARS Signal Reception



Figure 3-9. EARS Microphone



Figure 3-10. EARS Digital Signal Processor

3.2.3 Dynamic Vehicle Safety Systems (DVSS) System

This system consists of a VPAS receiver that detects radio transmissions from a freight train information system—a front- to rear-end (of train) device (FRED). A FRED system consists of two transceivers that are used to continuously transmit vital operating information (brake pipe pressure, speed, etc.) between the rear and front of a train.

Because the test locomotives at TTC were not equipped with FREDs, DVSS supplied the front-end transceiver from a FRED used in commercial freight service and installed it in the test locomotive. The FRED supplied by DVSS, which was used only for transmitting during testing, is similar to ones used on most Class 1 railroads. FREDs operate at 452 MHz to 458 MHz. A signal transmission diagram for the DVSS system appears in Figure 3-11.

When a warning signal is received in the vehicle, a visual alarm and an audible alarm are activated. Because of the continuous transmission by the FRED, reception of a warning signal by the VPAS receiver is not confined to the vicinity of a crossing where a train is approaching.

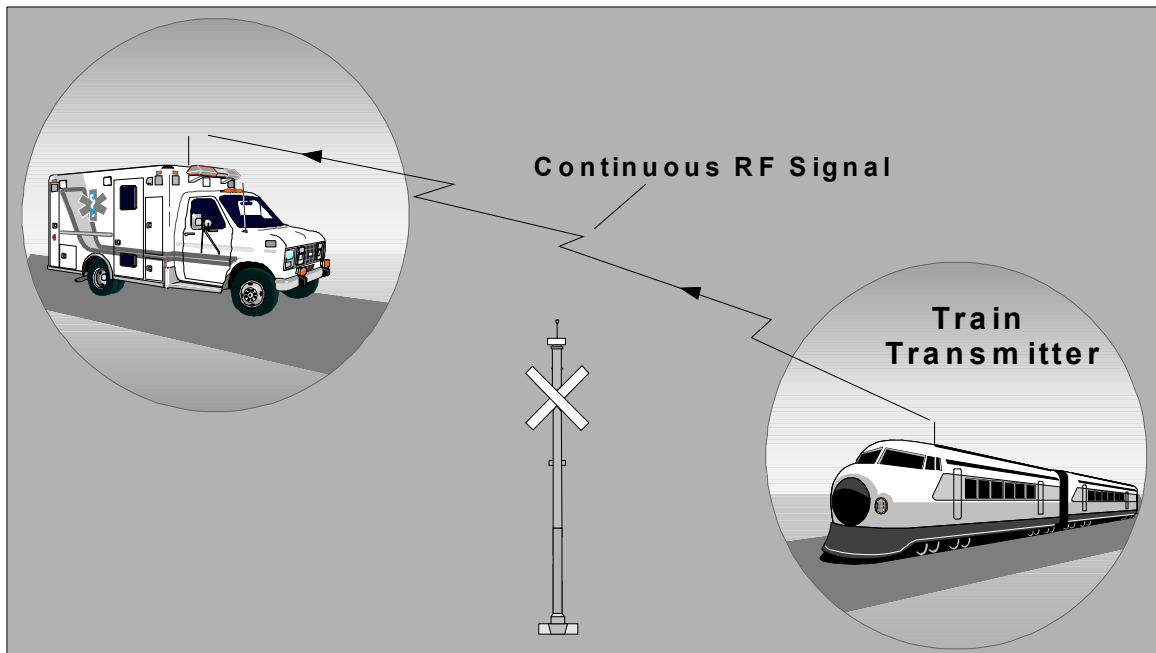

Figure 3-11. DVSS System Signal Transmission

4. DESCRIPTION OF PROTOTYPE TESTING

Testing at TTC was performed in four phases:

- (1) **Installation, Calibration, and Checkout** - All system components and antennas were mounted in the appropriate locations and were adjusted according to system specifications, and several locomotive runs were performed to demonstrate and characterize the basic functionality of the equipment. See Section 4.3 for a detailed description of Phase 1 testing.
- (2) **Repeatability** - All system components were actuated repeatedly (i.e., more than 500 locomotive runs per system) under the same test conditions (i.e., test zone, train speed, and vehicle location), to determine the relative detection performance of each system's signal and receiver over an extended period. See Section 4.4 for a detailed description of Phase 2 testing.
- (3) **Performance Limits** - System components were actuated in different test locations using various combinations of locomotive and vehicle locations, to determine performance limits and range of each system's signal and receiver under "good conditions." See Section 4.5 for a detailed description of Phase 3 testing.
- (4) **Response to Adverse Conditions** - System components were actuated while energy interference was induced and in an area with large structures, to determine the effect of particular degrading conditions on the performance and range of each system. See Section 4.6 for a detailed description of Phase 4 testing.

The TTC test site (shown in Figure 4-1) is located in a generally flat, semi-arid, high-altitude open area with little vegetation in Pueblo, Colorado. This area is subject to heavy sustained gusting winds and sudden shifts in wind speed and direction. It is also subject to wide fluctuations in temperature between daytime and nighttime. Since the testing was regularly conducted during pre-dawn hours as well as mid-day, the temperature swings during testing were

a factor. Since all of the tests were also conducted during winter or late fall, the test temperatures ranged from subfreezing to 70s° F (25° C), and the precipitation consisted of snow, rain, and a mixture of both. Although weather was not a formal test variable in any of the test phases, it was always considered to be a factor that could affect system performance and was monitored regularly, as discussed in Section 4.2.



Figure 4-1. TTC Test Site Aerial Photograph

A map of the TTC test site and the VPAS test zones appears in Figure 4-2. The only obstructions to wind and signal transmissions at the test site are the buildings and other structures in the TTC core area in test Zone E. Phase 1 and 2 testing was conducted in Zone A. Phase 3 was conducted in two segments: one in Zone B and the other in Zones C and D. Phase 4 was also conducted in two segments: one in Zone B and the other in Zone E.

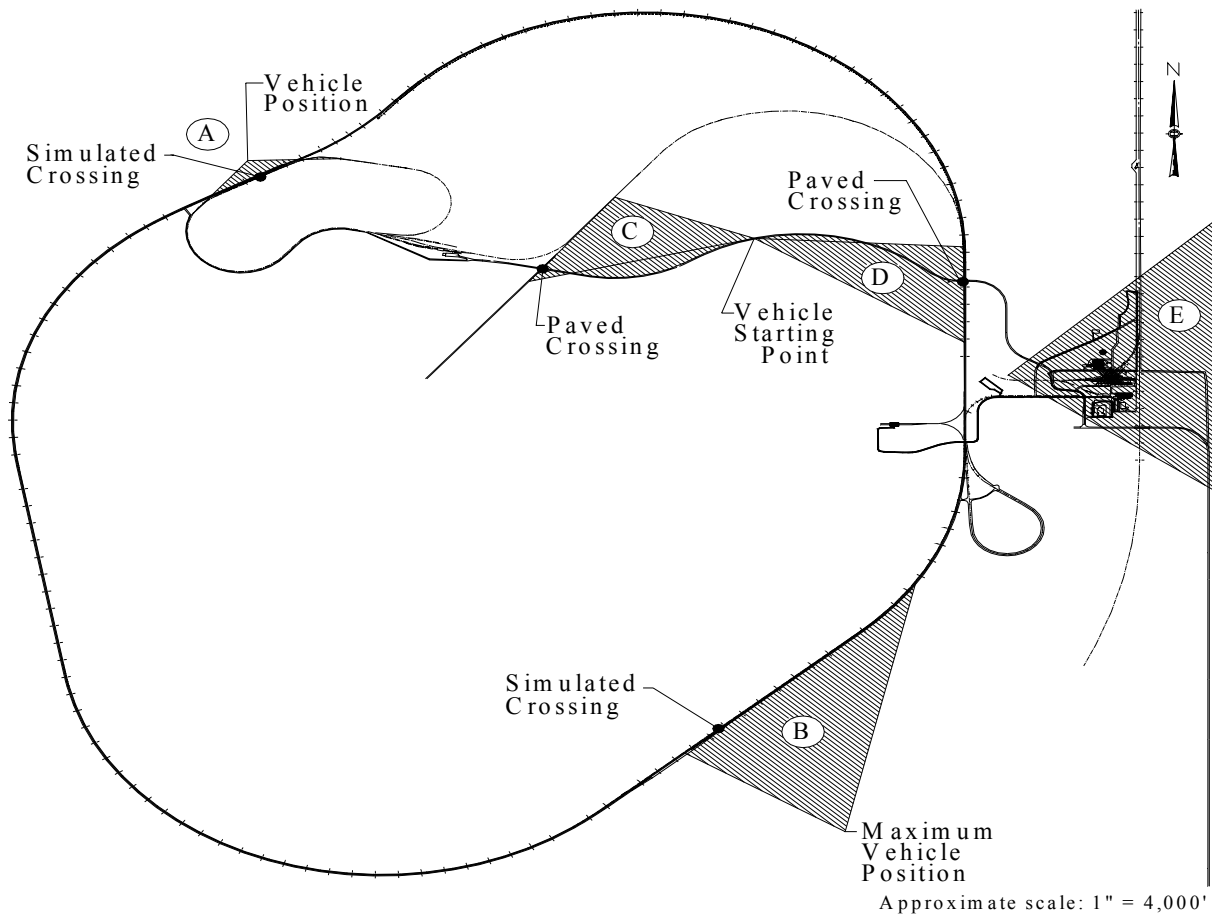

Figure 4-2. Location of Test Zones at TTC

A pickup truck containing the test system’s receiver served as the test vehicle for all testing. The test vehicle was parked at one location during Phases 1 and 2. It was parked at various locations and was mobile during Phases 3 and 4.

4.1 Test Instrumentation

Simulated grade crossings were used for tests performed while the locomotive was moving, in Zones A and B. The crossing and a shed to house the data collection equipment were located in Zone A. A paved crossing was already in place in Zone C and in Zone D.

During Phases 1 and 2, automatic location detectors (ALDs) were used to activate and deactivate the VPAS transmitter in the locomotive and the locomotive horn (when testing the acoustic-

detection system, EARS) at designated locations. ALDs reflect light from a continuously operating optical sensor (which includes a light-output device) in the locomotive. The reflected light from the ALD triggered the transmitter or horn on and off when the locomotive passed. This automated the data collection process; limited the amount of data collected, and consistently defined the test zone boundaries. Use of ALDs provided at least 30 sec. of warning time from the initial locomotive transmission until the locomotive reached the crossing.

Markers were installed along the paved road in Zone C and in Zone D at 0.1-mi. (160 m) intervals from the track. These were used (instead of ALDs) as points of reference for data collection when the vehicle was mobile during Phase 3 testing. When the vehicle reached a marker, the driver gave a command via radio to activate the data collection equipment. Markers were used instead of time intervals because vehicle speed varied.

The data collection system, which was designed before the test systems were chosen, was somewhat generic and flexible to accommodate the different VPAS designs. The hardware consisted of off-the-shelf 486 laptop computers, data acquisition boards, cables, and sensors.

A stand-alone data collection system was installed at each VPAS equipment site. The 486-laptop-based systems operated continuously, had real-time capability to alert test personnel of events, and used an eight-channel analog-to-digital converter, intra-range instrumentation group (IRIG) time cards, ALDs, data acquisition software, and the Global Positioning System (GPS). The IRIG time cards on each data acquisition system used the same GPS time reference. GPS PC cards were used to develop a common time base between data acquisition nodes. The GPS was used only to provide a time reference; it was not used to determine vehicle location. The combination of ALDs and train speed was used to determine the distance of the locomotive from the crossing.

The laptop computers were programmed to receive a common GPS time reference in conjunction with other signals received from the VPAS components in the vehicle, in the locomotive, and at the crossing. All the information stored on the laptops was later entered into a computer located at TTC for further analysis at the end of each day's testing. Computer time was correlated with

GPS time as a backup in case the GPS lost its signal. In some instances, the mean and standard deviation of the data were estimated. Test results were not evaluated on an absolute scale; the goal was comparative results for all of the systems tested.

The locomotive data collection equipment was located on a table in the bungalow; see [Figure 4-3](#). The crossing data collection equipment was located on a table in the shed during testing in Zone A and in a van during testing in the other zones. The vehicle data collection equipment was housed in the vehicle; see [Figure 4-4](#).

4.2 Test Procedures

Plots of local weather conditions (precipitation, wind speed and direction, actual and wind chill temperatures, relative humidity, and barometric pressure) were generated every 15 minutes during all testing; an example of these plots for each system is included in Appendix D.

Visibility and rate of precipitation were noted daily. Raw test data were depicted graphically for each test run; two examples of raw data graphs are also included in Appendix D. The test manager certified the daily test record at the end of each day. The sampling rate of the data acquisition systems was established at 2 samples per sec. before the prototype testing began, and was increased to 5 samples per sec. during the initial phase of testing on February 1, 1995. The following documentation was requested from the manufacturer of each system tested:

- (1) Make, model, and serial number of each component
- (2) Electrical schematics and electromechanical block diagrams
- (3) System specifications

4.3 Phase 1: Installation, Calibration, and Checkout

Each system was delivered ready to install. The equipment was installed and calibrated by the system vendor's representatives under supervision of instrumentation personnel at the TTC.

Installation included mounting antennas where needed (e.g., on the vehicle, on the locomotive, at the crossing) and provision of special power supplies to accommodate power supply limitations of any of the VPAS components. Each system component was calibrated to have a range of approximately 2,000 ft. (600 m).

Phase 1 testing was performed with the locomotive moving in Zone A at speeds up to 40 mph (64 km/h) while the vehicle remained stationary on a straight roadway approximately 500 ft. (150 m) from and perpendicular to a simulated crossing; see Figures 4-5 and 4-6. The locomotive's test zone boundary was 1,760 ft. (528 m) on both sides of the crossing. An ALD was installed at each end of the zone and at midpoint of the crossing, activating the locomotive transmitter or horn when the locomotive entered the zone and shutting it off when the locomotive exited.



Figure 4-5. Zone A Test Area

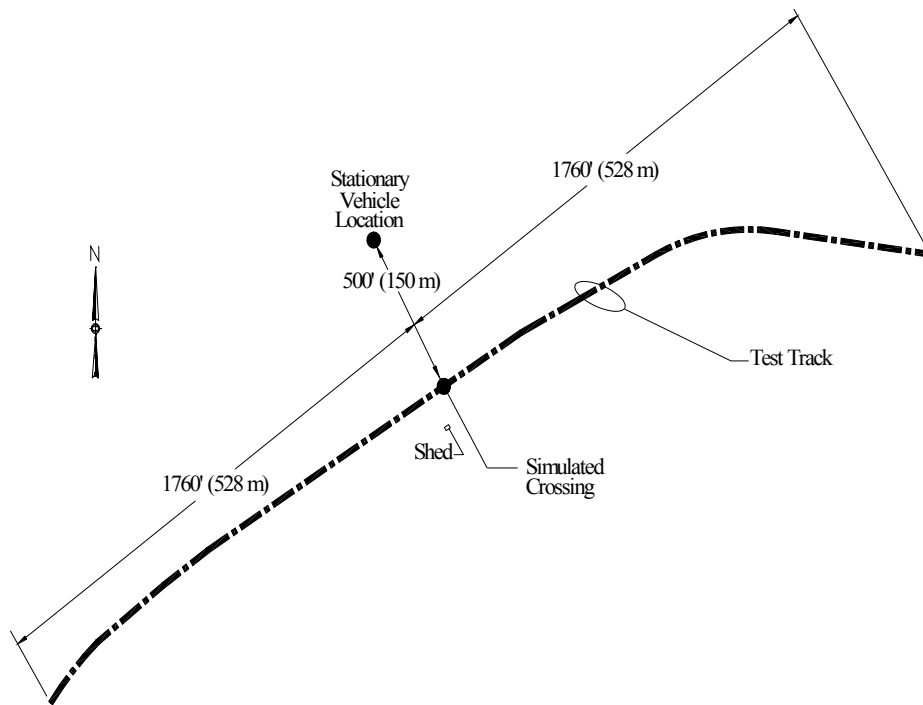

Figure 4-6. Zone A Test-Bed Setup

Several passes of the locomotive were made for each system, until the vendor’s representative felt that the vendor’s specifications had been met. Each system had to provide at least a 20-second warning to a stationary vehicle located approximately 500 ft. (150 m) from a grade crossing, regardless of train speed.

4.4 Phase 2: Repeatability

Phase 2 tests involved repeated actuation of the vehicle receiver and any wayside transceivers by a passing locomotive traveling at approximately 40 mph (64 km/h) while the vehicle remained stationary. These tests were performed in both travel directions.

The locomotive made more than 500 passes for each system. The tests were performed in Zone A using the same test bed and vehicle position as used for Phase 1 (shown in Figure 4-6). That is, an ALD was located 1,760 ft. (528 m) on each side of the crossing, and the vehicle was stationary approximately 500 ft. (150 m) from and perpendicular to the simulated crossing.

Combined with the Phase 2 train speed of 40 mph (64 km/h), the ALD that activated the locomotive signal provided approximately 30 sec. of warning time. Warning time was calculated from the time the vehicle received a signal to the instant the locomotive passed the mid-point of the crossing.

These tests measured three parameters for each system:

- (1) Successful detections - The number of times an intended signal was received in the vehicle, without an interruption of more than 1.5 sec., at least 20 sec. before the train reached the crossing.⁵
- (2) Missed detections - The number of times an intended signal was not received in the vehicle. Missed detections were divided into three categories:
 - (a) No detection
 - (b) Intermittent signal - continuous interruption in reception of more than 1.5 seconds
 - (c) Less than 20 sec. warning time
- (3) Nuisance alarms/false alarms (NA/FA) - The number of times a non-VPAS signal was received in the vehicle.

4.5 Phase 3: Performance Limits

The objective of Phase 3 was to determine each system's performance limits in an open area without any perceptible energy interference. Range of reception was assessed for each system before any Phase 3 test runs were performed for that system. The test runs were conducted in two segments—one with the locomotive moving and the vehicle stationary, and the other with the locomotive stationary and the vehicle moving.

⁵Though the length of the test zone was designed to provide 30 sec. of warning time, the warning time of 20 sec. prescribed in the FHWA's *Manual on Uniform Traffic Control Devices* was used as the criterion for successful detection.

4.5.1 Mobile-Locomotive Testing

The segment with the locomotive moving was performed in Zone B; see Figure 4-7. The train traveled from northeast to southwest at different speeds. The vehicle remained stationary at different distances perpendicular to the simulated crossing east of the track. The locomotive runs began 3,000 to 6,000 ft. (900 to 1,800 m) before the crossing, depending on the system tested, and continued for 1,000 ft. (300 m) past the crossing. The number of test runs performed, the starting positions and speeds of the locomotive, and the vehicle locations varied from system to system to accommodate differences in system designs.

4.5.2 Stationary-Locomotive Testing

The segment with the locomotive stationary was performed with the vehicle traveling at different speeds, including two test runs when the vehicle was also stationary. Test runs were performed with the locomotive at different distances from a paved crossing, to determine both train detection sensitivity and the range at which warnings reach the vehicle. The number of test runs performed, the locomotive locations, and vehicle speeds varied from system to system to accommodate differences in system designs. These tests were performed in two groups (in two different test zones), to test detection and reception at opposite directions of vehicle travel and different terrain. The vehicle route in each test zone was 1 mi. (1600 m) long ending at a paved crossing, and had markers along the road every 0.1 mi. (160 m).

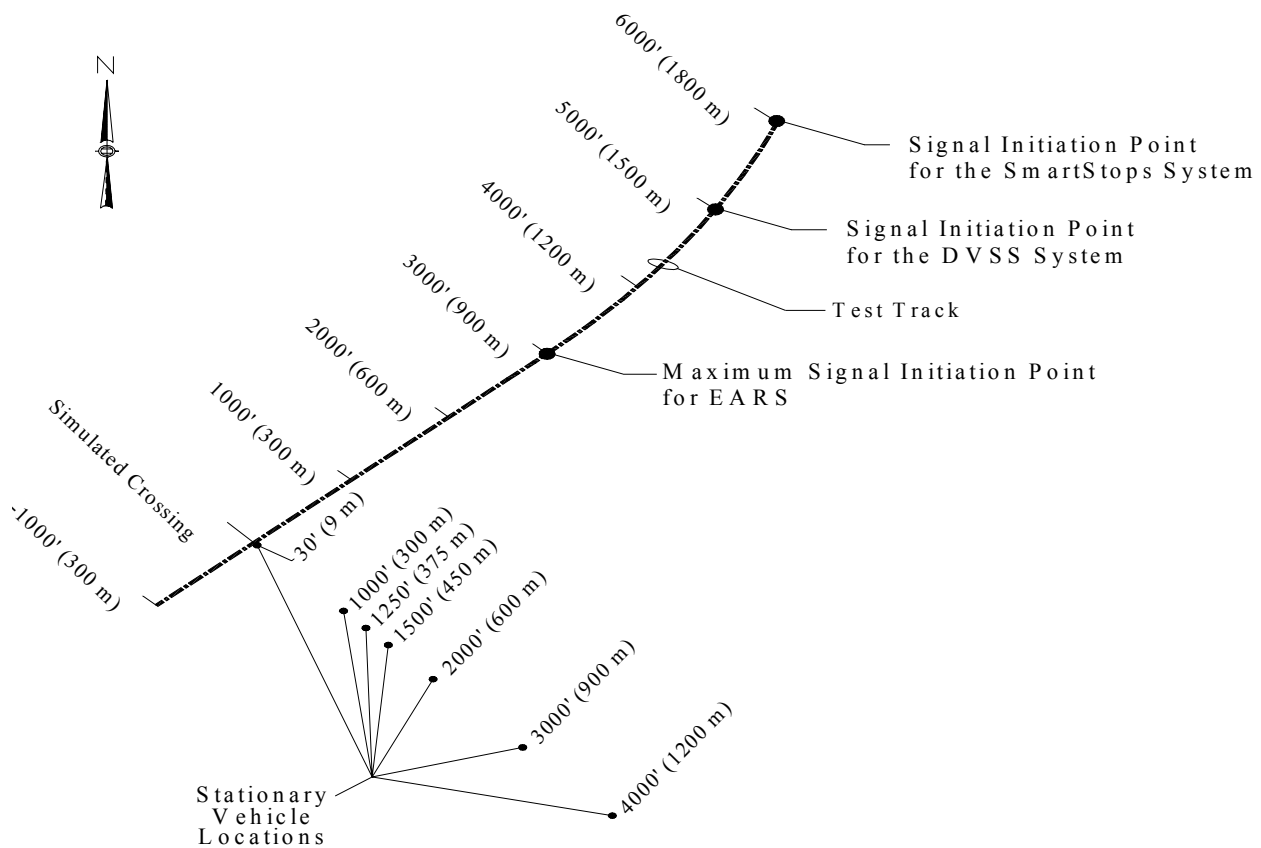

Figure 4-7. Zone B Test-Bed Setup

One group of stationary-locomotive test runs was performed in Zone C (see [Figure 4-8](#)) with the vehicle traveling west toward the test track. The vehicle route was downhill with the vehicle in direct line of sight of the crossing for most of the route, although the centerline of the paved road was not perpendicular to the track.

The other group of runs was performed in Zone D (see [Figure 4-9](#)) with the vehicle traveling east toward the test track. The vehicle route was uphill with the vehicle beyond the line of sight of the crossing until the last 0.3 mi. (0.5 km) before the crossing. The grade of the hill spanning Zones C and D is gradual and generally uniform along the 2-mi. (3.2 km) length of paved road between the two paved crossings. The elevation change between the two crossings is approximately 100 ft. (30 m).

4.6 Phase 4: System Response to Adverse Conditions

This phase measured system response to particular degrading conditions that may influence system performance. These conditions included energy interference (RFI for the RF systems and other acoustic signals for the acoustic-detection system), multipath, and signal masking. It must be noted, however, that RFI testing at TTC is limited, and TTC does not have the structures, vehicles, and trees needed to adequately simulate the potential for multipath and signal masking present in a densely populated urban environment.

Testing was conducted in two segments. One of the segments involved introducing other acoustic signals or RF signals to interfere with signal transmission and reception. The other segment involved assessing the effects of buildings and other structures on signal transmission and reception.

4.6.1 Induced Energy Interference

The scheduled testing of this segment was performed in Zone B (see Figure 4-7) while the vehicle was stationary. Specific tests and methods of introducing energy interference varied from system to system to accommodate differences in system designs and to test the most likely failure modes, which were identified for each system during the previous test phases. The locomotive was stationary during some of the test runs, and was mobile at varying speeds during others. Tests of the acoustic-detection system introduced other acoustic signals and other horn signals to cause interference. Hand-held FM transceivers were used in testing of the two RF systems to create RFI at a similar frequency to the system's operating frequency. The antennas for those two systems were also moved from their normal positions to try to degrade system performance.

4.6.2 Structural Interference

This segment was conducted in Zone E (see Figure 4-10). The buildings and vehicles in the core area, the TTC radio transmission tower, and the TTC bridge were used to cause shading and reflection of the transmitted signal. (The buildings are shown in Figure 4-1; the radio tower and the bridge are shown in Figure 4-11.) The vehicle was parked at different locations among the buildings and at different distances from the simulated crossing, and the locomotive approached at different speeds (from the north during some runs and from the south during others) and at times was stationary under or near the radio tower or the bridge. The number of test runs performed, the train speed and travel direction, and the locomotive and vehicle locations varied from system to system to accommodate differences in system designs. During SmartStops system testing, the vehicle was mobile through the complex of buildings for two runs, and the crossing antenna was moved to different locations.

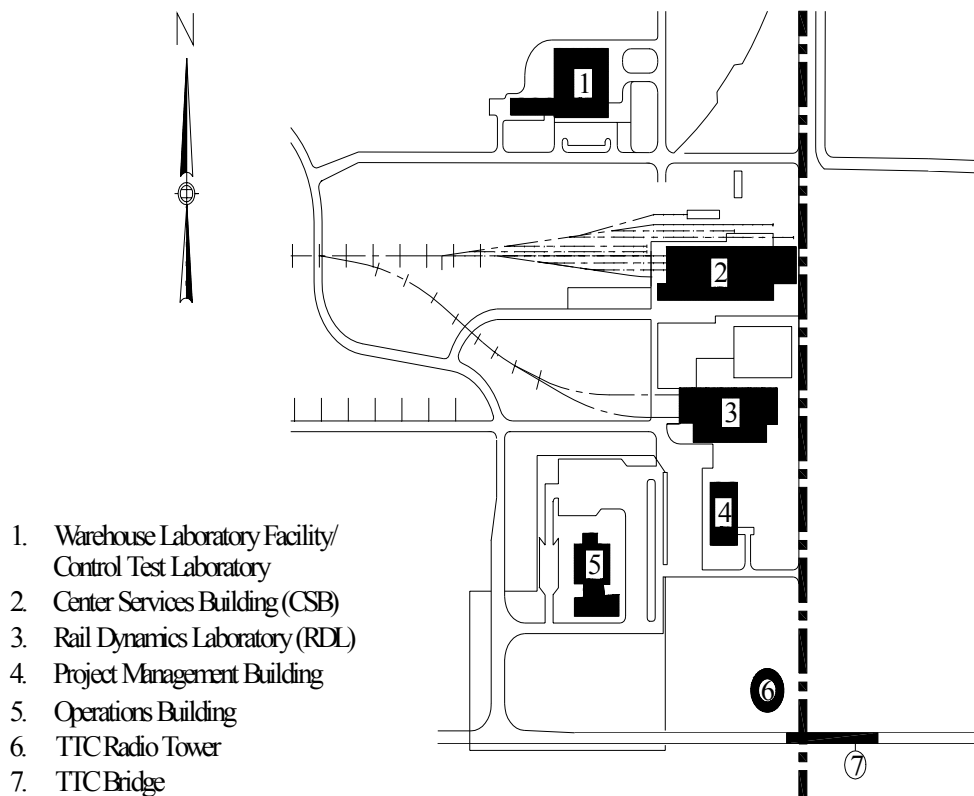

Figure 4-10. Zone E Test Area

5. PROTOTYPE TESTING RESULTS

The SmartStops system was tested in January and February 1995. EARS was tested in March and April 1995. The DVSS system was tested in November 1995 and January 1996. This chapter describes the various tests performed and their results.

5.1 SmartStops System

As mentioned in Section 3.2.1, the SmartStops system was a three-point RF system, with a receiver in the vehicle and transceivers in the locomotive and at the crossing. The crossing antenna was mounted on a pole 12 ft. (3.6 m) above the ground at the crossing of each test site. The transmission from the crossing back to the locomotive represents a self-test feature.

5.1.1 Phase 1

This system was installed on January 26, 1995. Representatives from SmartStops installed all three VPAS components in less than two hours. The entire system was delivered ready to install, but power supply limitations necessitated power adjustments at each component. The locomotive transceiver and the transceiver at the crossing required 110 VAC, 60 Hz power, though the crossing transceiver was powered by batteries during the first two days of testing before 110 VAC power was installed. The vehicle receiver required the vehicle's 12 VDC power source. Additionally, vertical antennas were mounted on the roof of the locomotive, on a pole 12 ft. (3.6 m) above the ground at the crossing, and on the roof of the vehicle.

The system was calibrated to have a locomotive-to-crossing range of approximately 2,000 ft. (600 m). Though the minimum detection range required of a vehicle is only 500 ft. (150 m) from the crossing, the retransmission range from the crossing was also calibrated at 2,000 ft. (600 m) to provide a signal back to the locomotive. Air temperature at calibration was 45° F (7° C).

Phase 1 testing continued for several days following installation, until February 2. The locomotive made several passes, in Zone A (see Figure 4-6 for test-bed setup), traveling at speeds of 20, 30, and 40 mph (32, 48, and 64 km/h). The results from Phase 1 testing indicated that the SmartStops system was operating properly and was ready for Phase 2 testing. Additionally, the data-collection equipment, the trackside triggering system (ALDs), and other instrumentation functioned as desired during Phase 1.

5.1.2 Phase 2

Phase 2 testing, as described in Section 4.4, was performed on nine different test days between February 3 and 15, 1995 in Zone A (see Figure 4-6 for test-bed setup). A total of 501 train passes were made at 40 mph (64 km/h). Table 5-1 summarizes the results of each day's testing. Testing on the first six days began shortly before or after sunrise and usually continued until late morning. On the last three days, however, testing began shortly before midnight and continued into the next day, until sunrise on two of those test days. The date on which testing began is used as the reference date in Table 5-1.

All of the 16 missed detections occurred when the outside temperature was below 40° F (4° C). Eleven of the missed detections occurred on successive runs between 5:45 AM and 6:30 AM on the last test day when the outside temperature was approximately 10° F (-12° C) and the relative humidity was above 90 percent.

Troubleshooting. Given the apparent relationship between cold temperatures and unsuccessful performance of the SmartStops system, TTC test personnel conducted additional tests to assess the effects of cold weather on the system's performance. This troubleshooting began in the evening of the day (February 15) that the scheduled Phase 2 testing was completed. These tests were conducted in Zone A using the Phase 2 format.

Temperature changes were induced inside the vehicle. The associated responses of the receiver were observed and documented, and the temperatures inside the vehicle and inside the receiver case at the time of each response were recorded. Because these tests involved purposefully

manipulating the environment in the vehicle, their results are not included in the overall results of Phase 2, and the passes are not considered as part of the total passes made during Phase 2.

Table 5-1. SmartStops System Phase 2 Test Results

Date	Direction *	Test runs	Successful detections	Missed detections			NA/FA
				No detection	Intermittent Signal	<20 sec. warning	
2/03	CCW	56	54	0	2	0	0
2/06	CW	38	36	2	0	0	0
2/07	CW	51	51	0	0	0	0
2/08	CCW	63	63	0	0	0	0
2/09	CCW	52	52	0	0	0	0
2/10	CW	17	17	0	0	0	0
2/12	CCW	86	86	0	0	0	0
2/13	CCW	19	19	0	0	0	0
2/14	CW	119	107	2	6	4	0
Total		501	485	4	8	4	0

*The directions of train travel (clockwise and counterclockwise) noted in this table refer to the directions on the loop that contains the Zone A track segment (see Figure 4-2). The CW direction is roughly southwest to northeast, and the CCW direction is roughly northeast to southwest.

The initial temperature when the troubleshooting began at 9:45 PM was 26° F (-3° C) inside the vehicle and 33° F (1° C) inside the receiver case. The heater inside the vehicle was turned on, and the system was operated as the temperature in the vehicle rose. Signal reception was intermittent until the temperature in the vehicle and in the case reached 44° F (7° C). At that point, the signal became steady, and test runs were initiated. Following 30 runs with only one missed detection, the heater was turned off, and the windows were rolled down to lower the temperature. Eight runs were completed with successful detections while the temperature was dropping. The warning time during the next run was only 17 sec. Following that run, the

temperature dropped to 24° F (-4° C) inside the vehicle and 30° F (-1° C) inside the case. There was no detection during the next 10 runs. During those 10 runs, the windows were closed, and the heater was turned on. The receiver fully recovered when the vehicle temperature reached approximately 40° F (4° C). This cycle was repeated with similar results. When the temperature dropped again, signal intermittence occurred during 11 of 13 runs, and 8 of those were consecutive. Each of the last five runs had successful detections, at a vehicle temperature of approximately 40° F (4° C).

The troubleshooting tests were stopped just before 7:00 AM on February 16. A total of 77 runs were performed. There were 53 successful detections, 11 no detections, 12 intermittent signals, 1 insufficient warning, and 1 NA/FA. The vast majority of the successful runs were at vehicle internal temperatures above 40° F (4° C). In general, signal reception became intermittent (i.e., was continuously interrupted for more than 1.5 sec.) below that temperature and deteriorated progressively as the temperature dropped.

5.1.3 Phase 3

A total of 21 runs were performed with the locomotive in motion in Zone B on February 21 and February 22 (see Figure 4-7 for test-bed setup). A total of 10 runs were performed with the locomotive stationary in Zones C and D on February 24 (see Figures 4-8 and 4-9, respectively, for test-bed setup).

On February 21, before the mobile-locomotive testing began, the signal range between the locomotive and the crossing was measured in Zone B. The locomotive was positioned at the simulated crossing and began backing up in a counterclockwise direction on the large circumferential track that passes through Zone B (see Figure 4-2) while the locomotive and crossing transceivers transmitted continuously. Despite the vendor's range calibration of approximately 2,000 ft. (600 m), the signal range from the locomotive to the crossing was at least 20,000 ft. (6.0 km), and the range of the return signal from the crossing to the locomotive was approximately 6,000 ft. (1.8 km).

The crossing transceiver was still receiving an intermittent signal from the locomotive at the maximum distance of approximately 20,000 ft. (6.0 km), as the signal travels, from the simulated crossing in Zone B. Signal intermittence did not begin until the locomotive was approximately 18,000 ft. (5.4 km) from the crossing. The return signal from the crossing became intermittent when the locomotive was approximately 5,000 ft. (1,500 m) from the crossing, and was lost at approximately 6,500 ft. (1,950 m).

Mobile-Locomotive Testing. Locomotive transmission for the 21 test runs in Zone B was initiated approximately 6,000 ft. (1,800 m) before the simulated crossing. The runs were performed at train speeds of 10, 30, or 60 mph (16, 48, or 96 km/h) with the vehicle located 1,000, 1,250, 1,500, 2,000, 3,000, or 4,000 ft. (300, 375, 450, 600, 900, or 1,200 m) from the crossing. The combinations of train speed and vehicle location for each run and the results appear in Table 5-2.

Based on the test results, the maximum range from the crossing to the vehicle was 2,000 ft. (600 m), as only excessively intermittent signals (or no signals) were received in the vehicle when parked 3,000 and 4,000 ft. (900 and 1,200 m) from the crossing. Changes in train speed, with the vehicle stationary and perpendicular to the crossing, had no apparent effect on system performance.

Stationary-Locomotive Testing. Six of the ten runs with the locomotive stationary were performed in Zone C with the vehicle traveling west, i.e., downhill toward the paved crossing with the vehicle in direct line of sight of the crossing for most of the route. These runs were performed at a vehicle speed of 30 or 50 mph (48 or 80 km/h) with the locomotive 50, 900, or 1,750 ft. (15, 270, or 525 m) north of the crossing and facing south. One run was performed at each combination of vehicle speed and locomotive location.

Table 5-2. SmartStops System Phase 3 Mobile-Locomotive Test Results

Run	Train speed mph (km/h)	Vehicle location ft. (m)	Signal Reception	
			@ vehicle	@ crossing (X) @ locomotive (L)
1	10 (16)	1000 (300)	Intermittent: 11 4 > 4 sec., longest ~ 8 sec.	Intermittent @ L until L was 4200 ft. (1260 m) from X
2	30 (48)	1000 (300)	Intermittent: 6 1 ~ 10 sec., 5 < 2 sec.	No reception @ L until L was 4500 ft. (1350 m) from X
3	60 (96)	1000 (300)	Intermittent: 2 both < 4 sec.	Intermittent @ L until L was 4700 ft. (1410 m) from X
4	10 (16)	1000 (300)	Intermittent: 21 2 > 4 sec., longest 6.75 sec.	Intermittent @ L until L was 5000 ft. (1500 m) from X
5	30 (48)	1000 (300)	Intermittent: 3 all < 2 sec.	Intermittent @ L until L was 4700 ft. (1410 m) from X
6	60 (96)	1000 (300)	Intermittent: 7 all < 3 sec. all when L was > 5000 ft. (1500 m) from X	Intermittent @ X until L was 5000 ft. (1500m) from X; Intermittent @ L until L was 2000 ft. (600m) from X
7	10 (16)	2000 (600)	Intermittent: 69 3 > 4 sec., longest 5.77 sec.	No reception @ L until L was 4700 ft. (1410 m) from X
8	30 (48)	2000 (600)	No reception until L was 2700 ft. (810 m) from X Intermittent rest: 28 5 > 4 sec., 2 > 10 sec.	Intermittent @ L until L was 4000 ft. (1200 m) from X
9	60 (96)	2000 (600)	Intermittent last 3500 ft. (1050 m): 17 3 ~ 5 sec.	Intermittent @ L until L was 4200 ft. (1260 m) from X

Table 5-2. SmartStops System Phase 3 Mobile-Locomotive Test Results (cont.)

Run	Train speed	Vehicle location	Signal Reception	
10	10 mph (16 km/h)	3000 ft. (900 m)	Intermittent throughout the run: 30, 10 > 10 sec., 4 > 1 min, 2 > 2 min @ vehicle*	Intermittent @ L until L was 4700 ft. (1410 m) from X @ crossing (X) @ locomotive (L)
11	30 mph (48 km/h)	3000 ft. (900 m)	Intermittent throughout the run: 15, 6 > 10 sec., longest 40 sec.	Intermittent @ L until L was 4700 ft. (1410 m) from X
12	60 mph (96 km/h)	3000 ft. (900 m)	No reception	Intermittent @ L until L was 4300 ft. (1290 m) from X
13	10 mph (16 km/h)	4000 ft. (1200 m)	Intermittent for ~1 min continuous	Intermittent @ L until L was 4700 ft. (1410 m) from X
14	30 mph (48 km/h)	4000 ft. (1200 m)	No reception	No data
15	60 mph (96 km/h)	4000 ft. (1200 m)	No reception	No data
16	10 mph (16 km/h)	1500 ft. (450 m)	Intermittent: 17 4 > 4 sec., longest ~ 6 sec.	Intermittent @ L until L was 4700 ft. (1410 m) from X
17	30 mph (48 km/h)	1500 ft. (450 m)	Intermittent: 13 1 > 4 sec., ~5 sec.	Intermittent @ L until L was 3400 ft. (1020 m) from X
18	60 mph (96 km/h)	1500 ft. (450 m)	Intermittent: 4 all < 4 sec.	Intermittent @ L until L was 4300 ft. (1290 m) from X
19	10 mph (16 km/h)	1250 ft. (375 m)	Intermittent: 10 1 > 4 sec., ~6 sec.	Intermittent @ L until L was 4700 ft. (1410 m) from X
20	30 mph (48 km/h)	1250 ft. (375 m)	Intermittent: 4 1 > 2 sec., ~5 sec.	Intermittent @ L until L was 4300 ft. (1290 m) from X
21	60 mph (96 km/h)	1250 ft. (375 m)	Intermittent: 4 all < 3 sec.	Intermittent @ L until L was 2500 ft. (750 m) from X

*This column describes the signal received in the vehicle. It gives the total number of disruptions that were longer than 1.5 sec. and summary information about the length of the disruptions. For example, during Run 1, there were 11 disruptions, 4 of those were longer than 4 sec., and the longest one was approximately 8 sec. For example, in Run 11, there were 15 disruptions that occurred throughout the run—6 of them were longer than 10 sec. and the longest one was 40 sec.

The last four runs were performed in Zone D with the vehicle traveling east, i.e., uphill toward the paved crossing with the vehicle beyond the line of sight of the crossing until it was within 0.3 mi (0.5 km) of the crossing. These runs were performed at a vehicle speed of 30 or 50 mph (48 or 80 km/h) with the locomotive 100 or 1,750 ft. (30 or 525 m) south of the crossing and facing north. One run was performed at each combination of vehicle speed and locomotive location.

During each of the 10 runs with the vehicle moving, the signal was received in the vehicle immediately after signal transmission was initiated, when the vehicle was approximately 1 mi. (1.6 km) from the crossing. This change in range—from the 2,000 ft. (600 m) determined during the stationary-vehicle segment of Phase 3—cannot be explained, but it should be noted that the topography of the locations was different. The reception was continuous at all points during all 10 runs, except for several very brief disruptions; see Table 5-3. There was no indication of reduced performance caused by differences in elevation or surrounding terrain.

Table 5-3. SmartStops System Phase 3 Stationary-Locomotive Test Results

Run	Zone	Vehicle speed	Locomotive location	Signal reception @ vehicle
1	C	30 mph (48 km/h)	1750 ft. (525 m)	1 disruption, < 2 sec.
2	C	50 mph (80 km/h)	1750 ft. (525 m)	2 disruptions, < 2 sec.
3	C	30 mph (48 km/h)	900 ft. (270 m)	3 disruptions, < 2 sec.
4	C	50 mph (80 km/h)	900 ft. (270 m)	2 disruptions, < 2 sec.
5	C	30 mph (48 km/h)	50 ft. (15 m)	Continuous
6	C	50 mph (80 km/h)	50 ft. (15 m)	2 disruptions, < 2 sec.
7	D	30 mph (48 km/h)	100 ft. (30 m)	Continuous
8	D	50 mph (80 km/h)	100 ft. (30 m)	Continuous
9	D	30 mph (48 km/h)	1750 ft. (525 m)	3 disruptions, < 2 sec.
10	D	50 mph (80 km/h)	1750 ft. (525 m)	Continuous

5.1.4 Phase 4

Thirteen runs were conducted in Zone B on February 23 (see Figure 4-7 for test-bed setup).

Thirteen more runs were conducted in Zone E on February 27 (see Figure 4-10 for test area).

Induced Energy Interference. During each of the 13 runs performed in Zone B, the locomotive was traveling at 30 mph (48 km/h) while the vehicle was stationary 1,000 ft. (300 m) from the simulated crossing. Each run began when the locomotive was approximately 4,000 ft. (1,200 m) from the crossing and continued for 1,000 ft. (300 m) past the crossing. The first seven runs tested the system’s susceptibility to RFI. The last six runs tested the effects of antenna position.

During the seven RFI runs in Zone B, a hand-held FM transceiver generating 6 w of power was programmed to the same transmission frequency (151.7 MHz) used by the VPAS and to a nearby frequency (148 MHz), to introduce RFI. The interfering transceiver was held at different locations, turned on when the locomotive was approximately 3,500 ft. (1050 m) from the crossing, and remained on until the locomotive was 1,000 ft. (300 m) past the crossing. The location of the interfering transceiver, the frequency used, and the results appear in Table 5-4.

Table 5-4. SmartStops System Phase 4 Zone B RFI Test Results

Run	Location of Interference	Frequency of interference	Signal reception @ crossing (X), @ locomotive (L), @ vehicle (V)*
1	In L cab	148 MHz	Intermittent @ L until L was 860 ft. (258 m) from X
2	Near X antenna	148 MHz	Minor intermittence @ X, @ L, @ V
3	Near X antenna	151.7 MHz	Severe intermittence @ X, @ L, @ V until L was 2000 ft. (600 m) from X
4	@ X antenna	151.7 MHz	No reception @ X, @ L, @ V
5	@ X antenna	148 MHz	No reception @ X, @ L, @ V
6	Near V antenna	148 MHz	Minor intermittence @ L, @ V
7	Near V antenna	151.7 MHz	Minor intermittence @ L No reception @ V

*This column describes the signal received at the crossing, the locomotive, and the vehicle. It includes the total number of disruptions at the vehicle that were longer than 1.5 sec. and summary information about the length of the disruptions.

Inducing interference at the crossing antenna prevented signal reception at all three components. Inducing interference at the vehicle antenna prevented signal reception in the vehicle. None of the other signal disruptions during these tests were significant. Despite the intermittence during the first run, reception in the locomotive was sufficient for self-test purposes.

During the last six runs of the induced energy interference segment, the three VPAS antennas were moved to different locations in different combinations. The descriptions and results of those runs appear in Table 5-5. The only signal disruption that would prevent adequate warning in the vehicle occurred during runs 4 and 5. Placing the locomotive antenna in the generator housing and placing the crossing antenna in the signal bungalow (run 4) prevented any reception in the vehicle.

Structural Interference. The first four of the 13 runs performed in Zone E tested RFI using the TTC radio transmission tower to introduce a similar frequency to that used by the SmartStops system. The last nine runs tested signal masking and reflections caused by buildings.

For the four RFI runs in Zone E, the crossing antenna was installed (off track) approximately 550 ft. (165 m) west of the test track and approximately 475 ft. (142.5 m) from the radio tower. The locomotive remained stationary on the test track opposite the tower so that the tower was between the locomotive and crossing antennas. The tower (shown in Figure 4-11) is 150 ft. (45 m) high and was operating at approximately 45 w of its 100-w power capability on six different channels between 170 and 173 MHz. During each of the first three runs, TTC's operations control center (OCC) transmitted at 170.75 MHz for approximately 30 sec., and the vehicle was stationary—at the crossing antenna for the first two and 560 ft. (168 m) north of the crossing antenna for the third. During the fourth run, the vehicle traveled around and between the buildings, and the OCC discontinued its transmission. Signals were received successfully during all four runs except for a momentary loss of reception in the vehicle at Marker 8 during the fourth run. Figure 5-1 shows locomotive, crossing, and vehicle locations for all four runs. Table 5-6 summarizes the test configuration and results.

Table 5-5. SmartStops System Phase 4 Antenna Position Test Results

Run	Antenna position			Signal reception @ crossing (X), @ locomotive (L), @ vehicle (V)*
	Locomotive	Crossing	Vehicle	
1	Inside cab	Normal	Normal	Minor intermittence @ L Intermittent @ V: 2 < 2 sec.
2	Inside generator housing	Normal	Normal	Minor intermittence @ L Intermittent @ V: 4, all < 3 sec.
3	Inside generator housing	@ ground behind signal bungalow	Normal	Severe intermittence @ L until L was 2000 ft. (600m) from X Intermittent @ V: 4, all < 3 sec.
4	Inside generator housing	Inside signal bungalow	Normal	No reception @ X until L was 3300 ft. (990 m) from X No reception @ L until 1000 ft. (300 m) of X No reception @ V
5	Normal	Normal	In bed	Intermittent @ V until L was 1400 ft. (420m) from X: 10, all < 4 sec.
6	Normal	Normal	Inside	Major intermittence @ V when L was 2000-3000 ft. (600-900 m) from X: 10, 2 > 4 sec., ~6 sec. & ~ 8 sec.

*This column describes the signal received at the crossing, the locomotive, and the vehicle. It includes the total number of disruptions at the vehicle that were longer than 1.5 sec. and summary information about the length of the disruptions. For example, during Run 3, the return signal in the locomotive was severely intermittent until the locomotive was within 2,000 ft. of the crossing, and there were four disruptions at the vehicle, all of which were shorter than 3 sec.

The first eight of the nine signal masking trials were performed with the locomotive traveling at 30 mph (48 km/h) with the vehicle parked in different locations. During the last trial, the locomotive was stationary (within direct line of sight of the antenna) while the vehicle traveled around the core area. The crossing antenna remained approximately 550 ft. (165 m) west of the test track opposite the tower during the first four runs. Following the fourth trial, the crossing antenna was moved between the Center Services Building (CSB) and the Rail Dynamics

Laboratory (RDL) approximately 500 ft. (150 m) from the test track. Figure 5-2 shows locomotive, crossing, and vehicle locations for the signal masking trials.

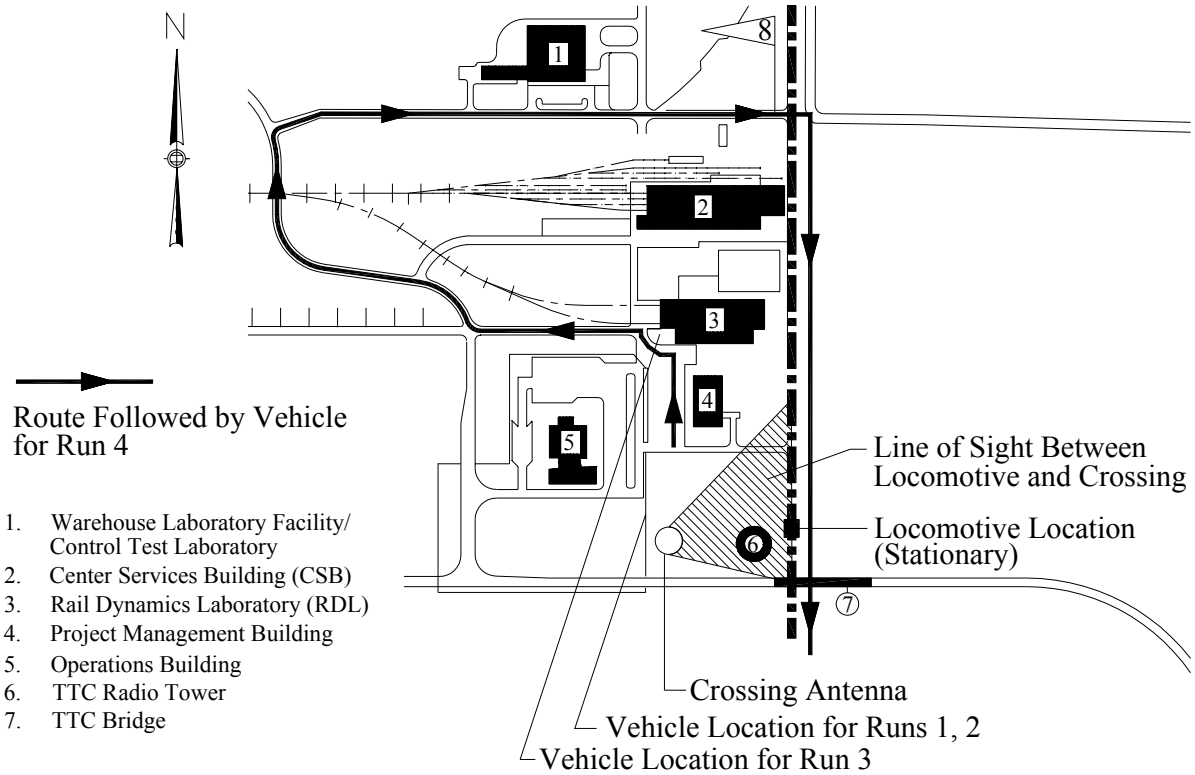

Figure 5-1. SmartStops System RFI Testing in Zone E

There were minor signal disruptions at the vehicle receiver during each of the first eight signal masking trials. There were intermittent signals and momentary loss of reception during the last run as the vehicle traveled between Markers 8 and 14; see Figure 5-2. Table 5-7 summarizes the test configuration and the signal reception at the vehicle for each masking test.

Table 5-6. SmartStops System Phase 4 Zone E RFI Test Results

Run	Vehicle Location	OCC transmission	Signal reception @ crossing (X), @ locomotive (L), @ vehicle (V) *
1	@ X antenna	@ 170.75 MHz	Successful @ X, @ L, @ V
2	@ X antenna	@ 170.75 MHz	Successful @ X, @ L, @ V
3	560 ft. (168 m) north of X	@ 170.75 MHz	Successful @ X, @ L, @ V
4	Mobile	None (tower only)	Successful @ X, @ L Intermittent @ V: 23, 3 >5 sec.-- ~6 sec., ~10 sec., ~11 sec.

*This column describes the signal received at the crossing, the locomotive, and the vehicle. It includes the total number of disruptions at the vehicle that were longer than 1.5 sec. and summary information about the length of the disruptions. For example, during Run 4, the signal was detected successfully at the crossing and in the locomotive, but there were 23 disruptions at the vehicle. Only three of those disruptions were longer than 5 sec.; they were approximately 6 sec., approximately 10 sec., and approximately 11 sec.

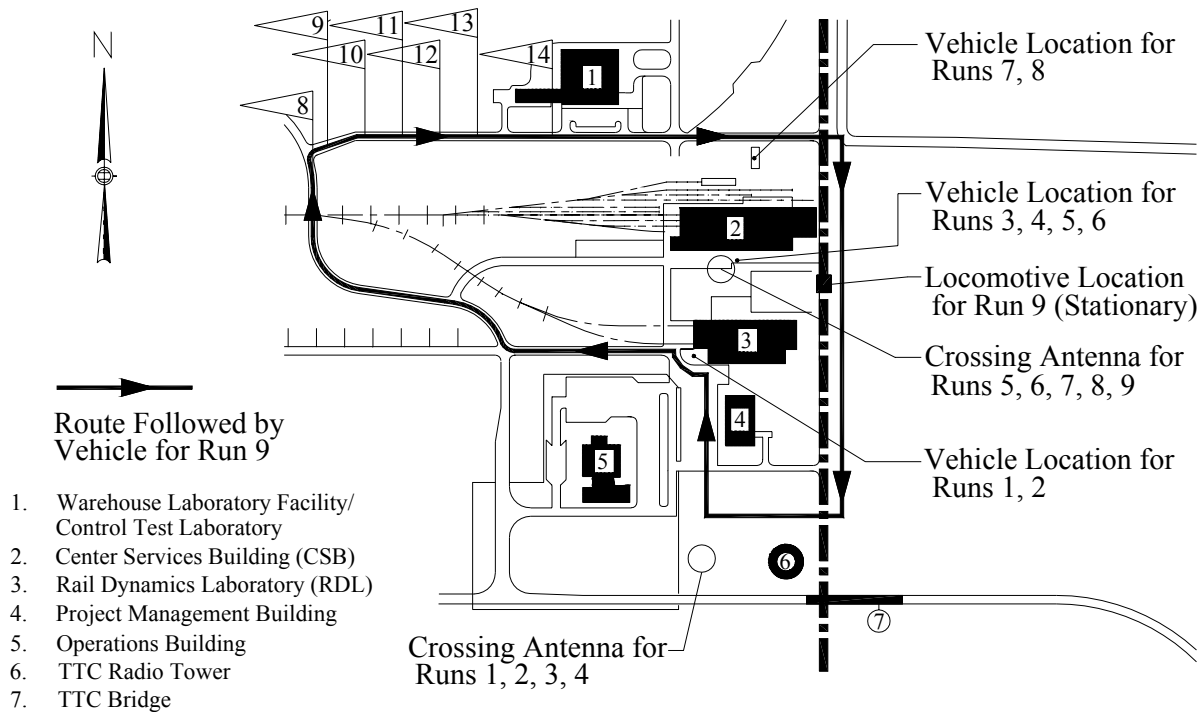

Figure 5-2. SmartStops System Signal Masking Testing in Zone E

Table 5-7. SmartStops System Phase 4 Signal Masking Test Results

Run	Locomotive approach	Vehicle location	Crossing location	Signal reception @ vehicle*
1	Southbound	560 ft. (168 m) north of crossing	West of tower	Intermittent: 16, all but 1 (3.7 sec.) < 3 sec.
2	Northbound	560 ft. (168 m) north of crossing	West of tower	Intermittent: 11, all but 1 (3.7 sec.) < 3 sec.
3	Northbound	Between CSB & RDL	West of tower	Intermittent: 13, all but 1 (4.7 sec.) < 3 sec.
4	Northbound	Between CSB & RDL	West of tower	Intermittent: 9, all < 3 sec.
5	Southbound	@ crossing antenna	Between CSB & RDL	Intermittent: 7, all but 1 (2.6 sec.) < 2 sec.
6	Northbound	@ crossing antenna	Between CSB & RDL	Intermittent: 2, both < 2 sec.
7	Southbound	150+ ft. (45+m) north of CSB	Between CSB & RDL	Intermittent: 9, all < 3 sec.
8	Northbound	150+ ft. (45+m) north of CSB	Between CSB & RDL	Intermittent: 3, all < 3 sec.
9	Stationary	Mobile	Between CSB & RDL	Intermittent: 32, 2 >5 sec. ~7.5 sec., ~10 sec.

*This column describes the signal received in the vehicle. It includes the total number of disruptions at the vehicle that were longer than 1.5 sec., and summary information about the length of the disruptions. For example, during Run 1, the signal was disrupted 16 times. All of the disruptions except one were shorter than 3 sec., that disruption was 3.7 sec.

5.2 Early Alert Response System (EARS)

EARS is a one-point acoustic-detection system consisting of a microphone transducer and digital processor that, during testing at TTC, detected the signal from a new Nathan P5 horn mounted on the test locomotive.

5.2.1 Phase 1

On March 7, 1995, the horn was mounted on the locomotive, and the horn's acoustics were measured. The measurements were taken about 4 ft. (1.2 m) above ground at 25 discrete locations, as shown in Figure 5-3.

Figure 5-4 shows the measured output signal of the test locomotive horn in dB⁶ as a function of range and coverage over the 180° area forward of the locomotive.⁷ The horn measurements were taken while the locomotive was idling. The measurements shown in Figure 5-4 were extracted from the original measurements, which included the background noise caused by the engine idle.

⁶Since these tests are independent of a human's ability to hear, measurements are specified in dB and not dBA (A-weighted).

⁷The smooth curve between these measured points is generated by the cubic-spline method, which is a classical method for putting a smooth curve through known data points. It uses a third order polynomial to interpolate between each pair of data points.

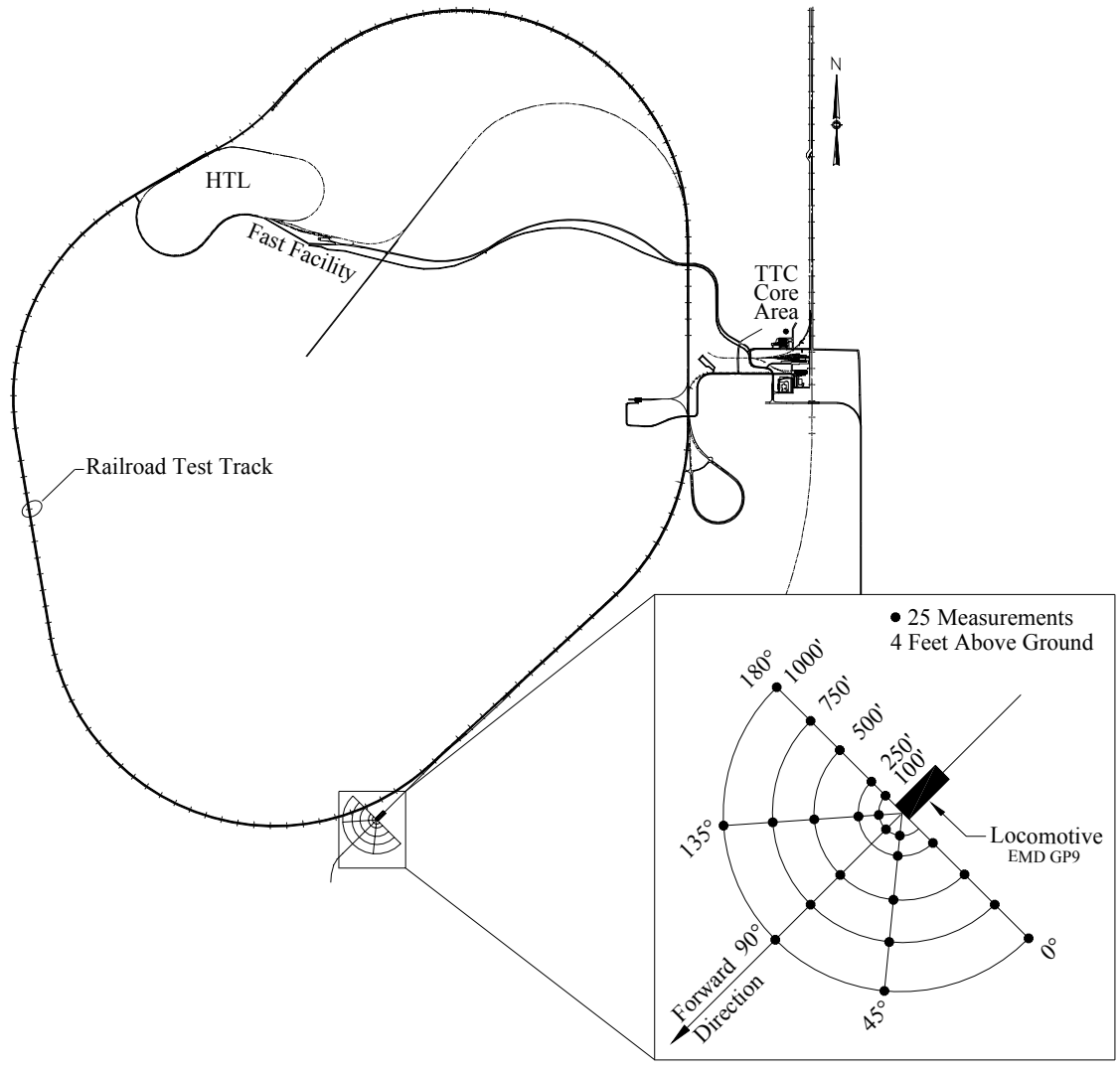

Figure 5-3. Locations of Measured Output Signal of Test Locomotive Horn

Nathan P5 Horn	
Horn #	Frequency Hz
1	227.18
2	329.60
3	391.90
4	440.00
5	554.30

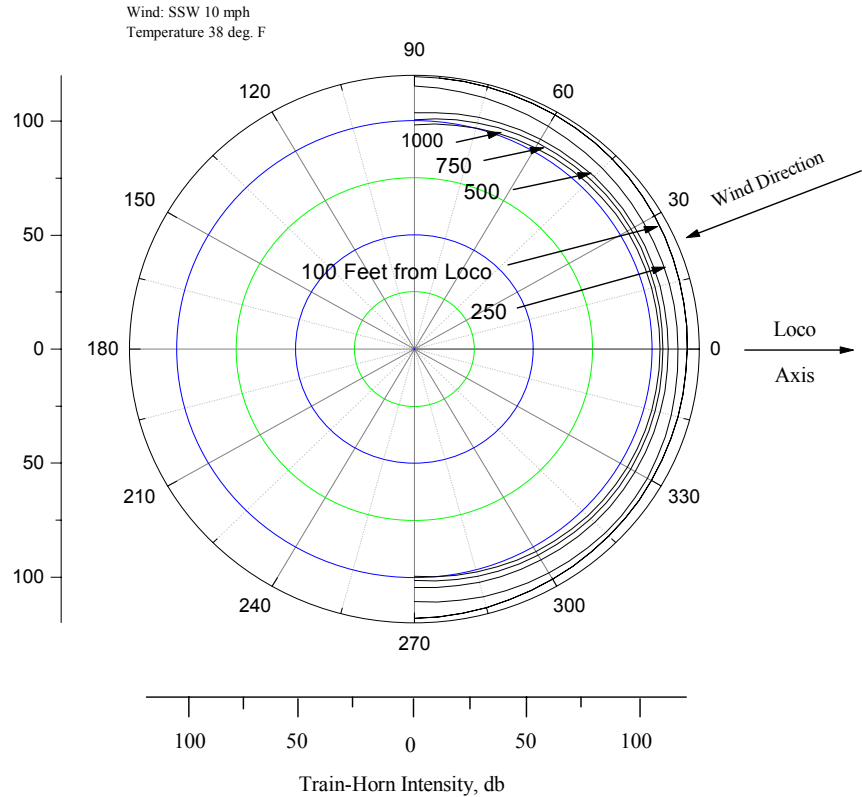

Figure 5-4. Measured Sound Intensity of Nathan P5 Horn*

EARS was installed on March 13. Installation consisted of installing the digital signal processor (shown in Figure 3-10) inside the vehicle, mounting the microphone on the outside of the rear window, and connecting the microphone to the digital signal processor and to the vehicle's 12-VDC battery. The only special or additional equipment required was a data acquisition system. Following installation, preliminary checkout was performed in Zone C with the locomotive stationary 500 ft. (150 m) from the paved crossing and the vehicle parked at the crossing.

EARS was calibrated in Zone A (see Figure 4-6 for the test-bed setup) on March 14. With the vehicle stationary on a straight roadway 500 ft. (150 m) from and perpendicular to the crossing, the locomotive horn was sounded from different stationary positions progressively farther from the crossing until EARS could no longer detect the train horn. The maximum distance between the locomotive and the crossing for which a signal was received in the vehicle was 1,500 ft. (450 m).

* Relative amplitude is equivalent to the max spectral output of all five horns.

It was believed that reception was attenuated by wind and other adverse atmospheric conditions.⁸ The background noise at the microphone during testing was approximately 74 dB. With the vehicle in the same position, the locomotive then made three passes, at 20 mph, 30 mph, and 40 mph (32, 48, and 64 km/h). The results from Phase I testing indicated that EARS was operating properly and was ready for Phase II testing.

5.2.2 Phase 2

Phase 2 testing was conducted on seven different days between March 15 to 23. To create the best possible condition for system performance, the microphone was moved to the windshield of the vehicle, as shown in Figure 3-9. A single approach warning horn cycle was triggered by an ALD during each train pass when the locomotive was approximately 1,760 ft. (528 m) from the crossing—a distance of 1,830 ft. (549 m) between the locomotive and the vehicle, which was parked 500 ft. (150 m) from and perpendicular to the crossing. The horn cycle consisted of four horn blasts (long-long-short-long). Figure 5-5 shows the time history of a single horn cycle generated for the tests.

As shown in Table 5-8, less than one-third of the runs had successful detections, though the vast majority of the missed detections had detections that provided less than 20 sec. of initial train approach warning time. Table 5-9 shows the horn blast during which the first detection for each run occurred. To provide at least 20 sec. of warning time, detection had to occur on the first blast. The suspected causes of the late detections were wind speed, wind direction, and background noise. There was insufficient foliage to cause attenuation. Additionally, nearly one-fourth of the runs had NA/FAs.

⁸Acoustic signals from a train horn are attenuated by atmospherics (e.g., wind, precipitation, humidity, and temperature) at distances beyond 300 ft. (90 m). The main effect of atmospherics is refraction produced by vertical gradients of wind and temperature. Precipitation and humidity can attenuate signals at high frequencies and long distances through air absorption. Sound waves are also deflected when they strike an object.

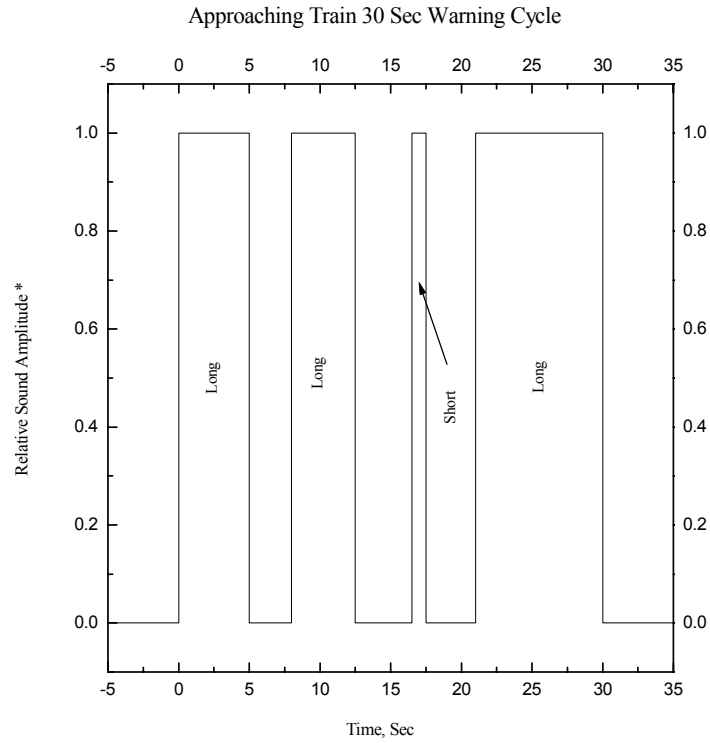

Figure 5-5. Single Horn Test Plot

* Vertical axis amplitude 1.0 = max db sound amplitude.

5.2.3 Phase 3

Fifteen Phase 3 runs were performed with the locomotive in motion in Zone B on March 28 (see Figure 4-7 for test-bed setup). A total of 35 runs were performed with the locomotive stationary in Zones C and D on March 29 and 31 (see Figures 4-8 and 4-9, respectively, for test-bed setups).

Table 5-8. EARS Phase 2 Test Results

Date	Direction *	Number of Test runs	Successful detections	Missed detections			NA/FA
				No detection	Intermittent Signal	<20 sec. warning	
3/15	CCW	30	0	15	0	15	1
3/16	CCW	75	13	14	0	48	17
3/17	CCW	52	8	2	0	42	9
3/20	CCW	65	22	0	0	43	22
3/21	CW	113	51	1	0	61	34
3/22	CW	109	58	7	0	44	28
3/23	CW	59	8	1	0	50	12
Total		503	160	40	0	303	123

*The directions of train travel (clockwise and counterclockwise) noted in this table refer to the directions on the loop that contains the Zone B track segment (see Figure 4-2). The CW direction is roughly southwest to northeast, and the CCW direction is roughly northeast to southwest.

Table 5-9. EARS Phase 2 Initial Signal Detection by Horn Blast

Date	First blast	Second blast	Third blast	Fourth blast
3/15	0	1	0	14
3/16	13	7	2	39
3/17	8	4	0	38
3/20	22	18	8	17
3/21	51	22	13	26
3/22	58	17	19	8
3/23	8	22	8	20
Total	160	91	50	162

On March 28, before mobile-locomotive testing began, measurements were taken on the Zone B track segment to determine reception range and reasonable test-zone boundaries. Both the vehicle and the locomotive were stationary at the simulated crossing. The vehicle was approximately 15 ft. (4.5 m) from the track with the microphone (which was mounted on the windshield) facing the locomotive. The vehicle remained in that position while the locomotive was moved back and stopped at 1,000-ft. (300-m) increments from the crossing. Two horn cycles were triggered at each location. The horn signal was received in the vehicle on the first blast when the locomotive was at the crossing and at 1,000 and 2,000 ft. (300 and 600 m) from the crossing, but was not received until the fourth blast of the second cycle at 3,000 ft. (900 m). The train was then moved forward 500 ft. (150 m). The signal was received on the fourth blast of the first cycle.

Mobile-Locomotive Testing. Before this test segment began, the microphone was moved from the windshield to the rear window. The first 11 of the 15 test runs were made with the vehicle facing the track (i.e., the microphone facing away from the track). For the next two runs, the vehicle was turned in the opposite direction so the microphone faced the track. The vehicle was turned back to face the track (with the microphone again facing away from the track) for the last two runs. The 15 runs were performed at train speeds of 10, 30, or 60 mph (16, 48, or 96 km/h) while the vehicle was stationary at the crossing or 1,000, 1,500, or 2,000 ft. (300, 450, or 600 m) from the crossing.

The horn cycle was triggered approximately 2,000 ft. (600 m) before the crossing for the first four runs and approximately 3,000 ft. (900 m) before the crossing for the rest of the runs. During each run, the horn cycle was triggered repeatedly until the train reached the crossing. If the train horn was detected in the vehicle, the locomotive's location relative to the crossing at first detection was recorded. Those data (as well as the train speed, vehicle location, direction that the microphone was facing, and locomotive location when the horn was first triggered) for each run appear in Table 5-10.

Table 5-10. EARS Phase 3 Mobile-Locomotive Test Results

Run	Train speed, mph (km/h)	Vehicle location, ft. (m)	Microphone face	Locomotive from crossing @ 1st horn, ft. (m)	Locomotive from crossing @ 1st detection, ft. (m)
1	10 (16)	@ crossing	Away	2000 ft. (600 m)	~ 2000 ft. (600 m)
2	10 (16)	@ crossing	Away	2000 ft. (600 m)	~ 2000 ft. (600 m)
3	30 (48)	@ crossing	Away	2000 ft. (600 m)	~ 2000 ft. (600 m)
4	30 (48)	@ crossing	Away	2000 ft. (600 m)	~ 1800 ft. (540 m)
5	60 (96)	@ crossing	Away	3000 ft. (900 m)	~ 1000 ft. (300 m)
6	60 (96)	@ crossing	Away	3000 ft. (900 m)	~ 1500 ft. (450 m)
7	10 (16)	1000 ft. (300 m)	Away	3000 ft. (900 m)	~ 2800 ft. (840 m)
8	30 (48)	1000 ft. (300 m)	Away	3000 ft. (900 m)	~ 2300 ft. (690 m)
9	60 (96)	1000 ft. (300 m)	Away	3000 ft. (900 m)	~ 1000 ft. (300 m)
10	10 (16)	2000 ft. (600 m)	Away	3000 ft. (900 m)	No detection
11	30 (48)	2000 ft. (600 m)	Away	3000 ft. (900 m)	No detection
12	30 (48)	2000 ft. (600 m)	Track	3000 ft. (900 m)	~ 1500 ft. (450 m)
13	10 (16)	1500 ft. (450 m)	Track	3000 ft. (900 m)	~ 2000 ft. (600 m)
14	30 (48)	1500 ft. (450 m)	Away	3000 ft. (900 m)	No detection
15	60 (96)	1500 ft. (450 m)	Away	3000 ft. (900 m)	No detection

The detection in run 7, when the locomotive was 2,800 ft. (840 m) from the crossing and the vehicle was 1,000 ft. (300 m) from the crossing, represents a detection range of approximately 3,000 ft. (900 m).

The results of runs 10 through 15 show the effect of microphone placement on performance. There were no detections with the microphone facing away from the track—during runs 10, 11, 14, and 15, with the vehicle 2,000 ft. and 1,500 ft. (600 m and 450 m) from the crossing—while the signal was readily detected with the microphone facing the track from the same distances

(during runs 12 and 13). However, because the vehicle was stationary during these runs, there was no background and wind noise, which would be present if the vehicle were moving.

Stationary-Locomotive Testing. The first 14 runs with the locomotive stationary were performed in Zone C, and the last 21 runs were performed in Zone D. All of the runs in Zone C and the first 13 runs in Zone D were performed on March 29. The wind speed was generally steady throughout the testing that day at less than 10 mph (16 km/h). The wind direction was primarily from the southeast, though more easterly toward the end of the test period. Very light snow fell throughout the period. The microphone was mounted at the top of the rear window.

During testing in Zone C, the locomotive faced north at the paved crossing 100 or 500 ft. (30 or 150 m) south of the crossing. The first 5 runs in Zone C were performed with the vehicle stationary and facing west. Two horn cycles were triggered for each run. During the next five runs, the vehicle traveled west, i.e., downhill toward the paved crossing with the vehicle in direct line of sight of the crossing, at 20 or 30 mph (32 or 48 km/h). The locomotive horn was triggered when the vehicle was 0.3 mi (0.5 km) from the crossing. The wind was blowing at 2 to 3 mph (3 to 5 km/h) from the southeast, which was almost directly behind the vehicle. Because EARS had difficulty receiving the signals, the last four runs were performed with the vehicle traveling in the opposite direction, to test the effect of the wind on signal transmission. The vehicle started those four runs approximately 1,500 ft. (450 m) west of the Zone C test track, in direct line of sight of the crossing, and traveled east directly into a 9-mph (14.5-km/h) wind. The locomotive was 500 ft. (150 m) south of the crossing. The horn signal was initiated when the vehicle was 1,000 ft. (300 m) from the track. As shown in Table 5-11, signal reception was much better during the last four runs.

In Zone D, the vehicle traveled east, i.e., uphill toward the paved crossing. The vehicle was in direct line of sight of the crossing when it was within 0.3 mi (0.5 km) of the crossing. The horn was triggered at that point for each of the 21 runs. The combinations of locomotive location and vehicle speed for each run in Zone D and the results appear in Table 5-12.

Table 5-11. EARS Phase 3 Stationary-Locomotive Zone C Test Results

Run	Vehicle location or speed	Locomotive location	Wind direction	Initial detection @ vehicle (horn blast & cycle or distance from crossing)
1	Next to Crossing	100 ft. S (30 m)	Toward track	1st blast of 1st cycle
2	500 ft. (150 m)	100 ft. S (30 m)	Toward track	3rd blast of 2nd cycle
3	1000 ft. (300 m)	100 ft. S (30 m)	Toward track	No detection
4	Next to Crossing	100 ft. S (30 m)	Toward track	1st blast of 1st cycle
5	500 ft. (150 m)	100 ft. S (30 m)	Toward track	No detection
6	30 mph (48 km/h)	100 ft. S (30 m)	Toward Track	No detection
7	30 mph (48 km/h)	100 ft. S (30 m)	Toward track	No detection
8	30 mph (48 km/h)	500 ft. S (150 m)	Toward track	No detection
9	20 mph (32 km/h)	At Crossing	Toward track	~50 ft. (15 m)
10	20 mph (32 km/h)	At Crossing	Toward track	~ 30 ft. (9 m)
11	30 mph (48 km/h)	500 ft. S (150 m)	From track	~ 500 ft. (150 m)
12	30 mph (48 km/h)	500 ft. S (150 m)	From track	~ 500 ft. (150 m)
13	30 mph (48 km/h)	500 ft. S (150 m)	From track	~ 700 ft. (210 m)
14	30 mph (48 km/h)	500 ft. S (150 m)	From track	~ 800 ft. (240 m)

Table 5-12. EARS Phase 3 Stationary-Locomotive Zone D Test Results

Run	Vehicle speed	Locomotive location	Wind direction	Initial detection @ vehicle (horn blast & cycle or distance from crossing)
1	30 mph (48 km/h)	500 ft. N (150 m)	From track	~ 500 ft. (150 m)
2	30 mph (48 km/h)	500 ft. N (150 m)	From track	~ 450 ft. (135 m)
3	50 mph (80 km/h)	500 ft. N (150 m)	From track	No detection
4	50 mph (80 km/h)	500 ft. N (150 m)	From track	No detection
5	30 mph (48 km/h)	1000 ft. N (300 m)	From track	No detection
6	30 mph (48 km/h)	1000 ft. N (300 m)	From track	No detection
7	30 mph (48 km/h)	100 ft. N (30 m)	From track	~ 550 ft. (165 m)
8	30 mph (48 km/h)	100 ft. N (30 m)	From track	~ 550 ft. (165 m)
9*	30 mph (48 km/h)	100 ft. N (30 m)	From track	No detection
10*	30 mph (48 km/h)	100 ft. N (30 m)	From track	No detection
11*	30 mph (48 km/h)	100 ft. N (30 m)	From track	~ 550 ft. (165 m)
12*	30 mph (48 km/h)	100 ft. N (30 m)	From track	No detection
13*	30 mph (48 km/h)	100 ft. N (30 m)	From track	No detection
14	30 mph (48 km/h)	150 ft. S (45 m)	Toward track	No detection
15	30 mph (48 km/h)	150 ft. S (45 m)	Toward track	No detection

Table 5-12. EARS Phase 3 Stationary-Locomotive Zone D Test Results (cont'd)

Run	Vehicle speed	Locomotive location	Wind direction	Initial detection @ vehicle (horn blast & cycle or distance from crossing)
16	30 mph (48 km/h)	500 ft. S (150 m)	Toward track	No detection
17	30 mph (48 km/h)	500 ft. S (150 m)	Toward track	No detection
18	30 mph (48 km/h)	1000 ft. S (300 m)	Toward track	No detection
19	15 mph (24 km/h)	500 ft. S (150 m)	Toward track	~ 900 ft. (270 m)
20	15 mph (24 km/h)	1000 ft. S (300 m)	Toward track	No detection
21	10 mph (16 km/h)	At crossing	Toward track	~ 600 ft. (180 m)

*The microphone was moved from its normal position (top of rear window) to the following locations:

9. Top of vehicle
10. Windshield
11. Driver's rear view mirror
12. Driver's window
13. Bottom of rear window

During the 13 runs performed in Zone D on March 29, the wind blew toward the vehicle (i.e., from the southeast and east) at 4 to 7 mph (6.5 to 11 km/h). The vehicle traveled at 30 or 50 mph (48 or 80 km/h). The locomotive faced south 100, 500, or 1,000 ft. (30, 150, or 300 m) north of the paved crossing. The microphone was mounted in different locations for the last five runs on March 29—on top of the vehicle, on the windshield, on the driver's rear view mirror, on the driver's window, and at the bottom of the rear window, respectively for runs 9 through 13.

The last 8 runs in Zone D were performed on March 31 with the microphone at the top of the rear window. The vehicle traveled at 10, 15, or 30 mph (16, 24, or 48 km/h). The wind blew generally from the west and southwest (opposite from the direction during the earlier Zone D testing) at approximately 2 mph (3 km/h). The locomotive faced north at the crossing at 150,

500, or 1,000 ft. (45, 150, or 300 m) south of the crossing (opposite from the earlier Zone D tests).

5.2.4 Phase 4

Thirteen Phase 4 runs were conducted in Zone B on March 28 (see Figure 4-7 for test-bed setup). Five runs were conducted in Zone E on April 3 (see Figure 4-10 for test area).

Induced Energy Interference. Other acoustic signals were induced during testing in Zone B by having the locomotive in throttle 6 (T6) or idling. Seven of the runs were performed with the locomotive moving northeast to southwest at 10, 30, or 60 mph (16, 48, or 96 km/h). The horn cycle was initiated approximately 3,000 ft. (900 m) before the crossing and was repeated until the train reached the crossing. The locomotive was stationary for the other six runs—at the crossing or at 1,000, 1,500, or 2,000 ft. (300, 450, or 600 m) north of the crossing. The vehicle remained stationary perpendicular to the track for all 13 runs—at the crossing or at 500 or 1,000 ft. (150 or 300 m) from the crossing. The microphone, which was mounted on the rear window of the vehicle, was facing the track during each run. The wind was blowing generally from the southwest at less than 2 mph (3 km/h). The combinations of train speed (or location) and vehicle location and results of these runs appear in Table 5-13.

The detection distances during these runs were shorter than those during the Phase 3 tests in Zone B (see Table 5-10) though the microphone faced away from the track during most of those runs and the wind conditions—from the east at 3 to 5 mph (5 to 8 km/h)—were slightly less favorable. Thus, it can be concluded that induced acoustic signals from the locomotive significantly reduced the EARS reception range. The effect was most evident during the first run, as there was no detection while the vehicle was stationary just behind the stationary locomotive with the microphone facing the locomotive.

Additionally, signals from horns other than the test locomotive horn were actuated in Zone B during this test segment. These tests were informal, there were no scheduled test runs, and no

data were collected. Nevertheless, the EARS receiver detected these nuisance signals on several occasions.

Table 5-13. EARS Phase 4 Engine-Noise Interference Test Results

Run	Train speed, mph (km/h), or location	Vehicle location, ft. (m)	Initial reception @ vehicle (horn blast & cycle or locomotive distance from crossing)
1	T6 @ crossing	@ crossing	No detection
2	T6 1000 ft. (300 m)	@ crossing	1st blast of 2nd cycle
3	T6 2000 ft. (600 m)	@ crossing	No detection
4	T6 1500 ft. (450 m)	@ crossing	No detection
5	T6 10 ft. (16 m)	1000 ft. (300 m)	~ 100 ft. (30 m)
6	T6 30 ft. (48 m)	1000 ft. (300 m)	~ 500 ft. (150 m)
7	Idle 30 ft. (48 m)	1000 ft. (300 m)	~ 100 ft. (30 m)
8	T6 10 ft. (16 m)	500 ft. (150 m)	~ 600 ft. (180 m)
9	T6 30 ft. (48 m)	500 ft. (150 m)	~ 500 ft. (150 m)
10	T6 60 ft. (96 m)	500 ft. (150 m)	~ 500 ft. (150 m)
11	Idle 60 ft. (96 m)	500 ft. (150 m)	~ 500 ft. (150 m)
12	Idle @ crossing	500 ft. (150 m)	1st blast of 1st cycle
13	Idle @ crossing *	500 ft. (150 m)	1st blast of 1st cycle

*The locomotive was inside the tunnel at the crossing in Zone B for run 13.

Structural Interference. During the five runs in Zone E, the vehicle was stationary 200 ft. (60 m), at two different locations, west of the test track while the locomotive traveled north to south at 30 or 50 mph (48 or 80 km/h); see Figure 5-6. Each run began approximately 1.25 mi. (2 km) before the vehicle and continued approximately 0.75 mi. (1.2 km) past the vehicle. The combinations of train speed and vehicle location for each run and the results appear in Table 5-14.

The detection distances during these runs were shorter than those during the Phase 3 mobile-

locomotive tests in Zone B (see Table 5-10). These data indicate that the buildings and other structures significantly reduced the EARS reception range. However, the reception range is also influenced by wind direction and the direction that the microphone was facing.

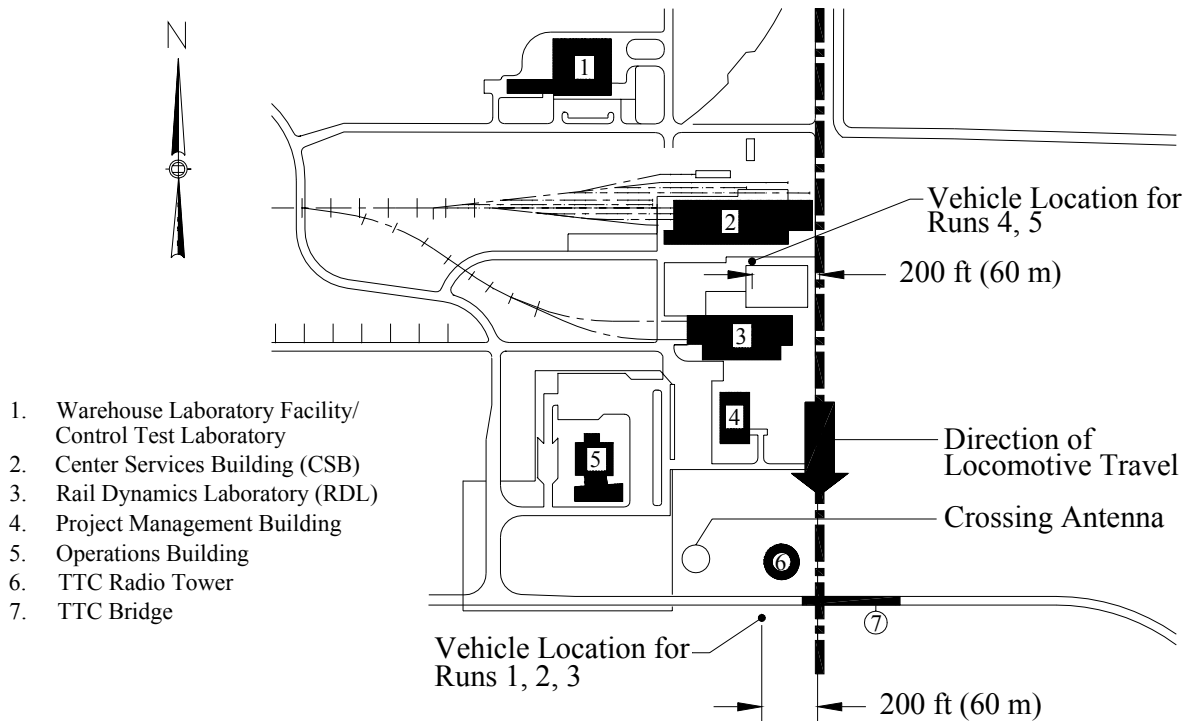

Figure 5-6. EARS Testing in Zone E

Table 5-14. EARS Phase 4 Zone E Test Results

Run	Train speed, mph (km/h)	Vehicle location	Locomotive distance from crossing @ initial detection
1	30 mph (48 km/h)	South of bridge	~ 300 ft. (90 m)
2	50 mph (80 km/h)	South of bridge	~ 50 ft. (30 m)
3	30 mph (48 km/h)	South of bridge	~ 100 ft. (30 m)
4	30 mph (48 km/h)	Between RDL & CSB	~ 550 ft. (165 m)
5	30 mph (48 km/h)	Between RDL & CSB	No detection

5.3 Dynamic Vehicle Safety Systems (DVSS) System

The DVSS system was tested as a two-point system. It consisted of a DVSS receiver and the head-end transceiver of a FRED. Only the transmitter part of the transceiver was used during testing. Because this prototype was approved for testing late in the test program, the test regimes for Phase 3 and Phase 4 were significantly reduced.

5.3.1 Phase 1

The DVSS system was installed, calibrated, and tested on November 13, 1995. DVSS delivered the vehicle receiver and a FRED transceiver ready to install. The vehicle receiver had to be modified slightly to allow monitoring by the TTC instrumentation equipment. No external antenna was needed for the receiver. Installation of the transceiver consisted of mounting a vertical antenna on the locomotive and supplying 74 VDC power to the transceiver. Installation of the receiver required supplying 12 VDC power, but no special antenna was required for the vehicle because the antenna was built into the receiver unit. The range and coverage were not determined for either the locomotive or the vehicle antennas. Although the transmitted signal from the locomotive would normally run continuously, the signal was initiated at the test-zone boundary by the ALD (for a 30-sec. warning depending on the exact speed of the locomotive) for test purposes.

Several passes were made with the locomotive in Zone A (see Figure 4-6 for test-bed setup). The results of those tests indicated that the DVSS system was operating properly and the system was ready for Phase 2 testing.

5.3.2 Phase 2

Phase 2 testing, which is summarized in Table 5-15, was conducted between November 14 and November 28. During the tests, TTC personnel triggered the FRED transceiver on and off as the train entered and exited the test zone. The warning time provided by the transceiver to the vehicle was very consistent. The warning was received within 1 sec. after the locomotive entered the test zone, demonstrating very good repeatability of train detection. Each pass produced a successful detection, and there were no nuisance alarms or false alarms.

Table 5-15. DVSS System Phase 2 Test Results

Date	Direction*	Test runs	Successful detections	Missed detections	NA/FA
11/14	CCW	42	42	0	0
11/15	CW	79	79	0	0
11/16	CW	83	83	0	0
11/17	CW	33	33	0	0
11/20	CCW	77	77	0	0
11/21	CCW	73	73	0	0
11/27	CCW	123	123	0	0
11/28	CW	84	84	0	0
	Total	594	594	0	0

*The directions of train travel (clockwise and counterclockwise) noted in this table refer to the directions on the loop that contains the Zone B track segment (see Figure 4-2). The CW direction is roughly southwest to northeast, and the CCW direction is roughly northeast to southwest.

5.3.3 Phase 3

Eight runs were performed with the locomotive stationary and the vehicle moving in Zone C on January 17, 1996 (see Figure 4-8 for test-bed setup). Twenty-three runs were performed with the locomotive in motion and the vehicle stationary in Zone B on January 23 (see Figure 4-7 for test-bed setup).

On January 16, before testing began, the signal range of the system was measured in Zone C. Despite the vendor's range calibration of approximately 2,000 ft. (600 m), the vehicle received a signal when it was more than 1.8 mi. (approximately 3 km) from the crossing.

The actual signal range of the system was determined during an unscheduled test on January 17, following completion of the day's Phase 3 and 4 testing. With the locomotive stationary in Zone E, the vehicle was driven along the TTC access road toward Pueblo, which is generally southwest of TTC. The signal started to become intermittent approximately 2.0 mi. (3.2 km) from the locomotive. The vehicle was between 4.0 and 4.5 mi (6.4 and 7.2 km) before the signal was permanently lost.

Stationary-Locomotive Testing. During the eight stationary-locomotive runs, the vehicle traveled west, i.e., downhill toward the paved crossing with the vehicle in direct line of sight of the crossing, at 30 or 50 mph (48 or 80 km/h). The locomotive was located 100, 750, 1,500, or 2,500 ft. (30, 225, 450, or 750 m) north of the crossing and was facing south. One run was performed at each combination of vehicle speed and train location. Because of the long signal range discovered the previous day, the vehicle began its route at the test track in Zone D, and signal transmission was initiated when the vehicle was 1.5 mi (2.4 km) from the Zone C crossing, i.e., 0.5 mi (0.8 km) before the normal Zone C starting point. During each of the eight runs, the signal was received immediately. On several occasions, however, the received signal was intermittent. The signal was masked by rolling hills on the paved road between the locomotive and the vehicle.

The other scheduled portion of the Phase 3 stationary-locomotive test segment (in Zone D with the vehicle traveling uphill toward the east) was not performed for the DVSS system.

Mobile-Locomotive Testing. Signal transmission for the 23 test runs in Zone B was initiated when the locomotive was approximately 5,000 ft. (1,500 m) from the simulated crossing. The runs were performed at train speeds of 15, 35, or 60 mph (24, 56, or 96 km/h) with the vehicle located 30, 1,000, 2,000, 3,000, or 4,000 ft. (9, 300, 600, 900, or 1,200 m) from the crossing. The signal was received immediately and was continuous during each of the 23 runs, demonstrating a range of 6,400 ft. (1,920 m) at the maximum vehicle distance of 4,000 ft. (1,200 m) from the crossing. The number of runs performed at each combination of train speed and vehicle location appears in Table 5-16.

Table 5-16. DVSS System Phase 3 Mobile-Locomotive Test Results*

Vehicle distance from crossing	Train speed			
	15 mph (24 km/h)	35 mph (56 km/h)	60 mph (96 km/h)	Reverse @ 30 mph (48 km/h)
30 ft. (9 m)	1	1	1	0
1000 ft. (300 m)	2	2	2	0
2000 ft. (600 m)	1	1	1	0
3000 ft. (900 m)	1	2	2	1
4000 ft. (1200 m)	1	1	3	0

*Matrix shows the number of runs performed at each combination of vehicle distance and train speed. Total number of runs = 23.

5.3.4 Phase 4

Phase 4 testing was performed on January 17. Eight runs were performed in Zone E (shown in Figure 4-10) to test the effect of buildings on signal transmission and reception. Following those runs, limited RFI testing was performed in Zone E.

Structural Interference. Figure 5-7 shows the locomotive and vehicle locations for all eight runs. The locomotive was stationary during the first six runs while the vehicle traveled a circuitous route around and between the buildings in the core area. The locomotive was parked under the TTC radio transmission tower for the first two runs, and was moved south of the TTC bridge for the next four runs. After the third run, the transmitter antenna, which is normally mounted on the roof of the locomotive, was remounted inside the locomotive cab. The locomotive was moving, from north to south, during the last two runs while the vehicle was stationary south of and next to the RDL. The transmitter antenna was moved back to the roof of the locomotive for those two runs.

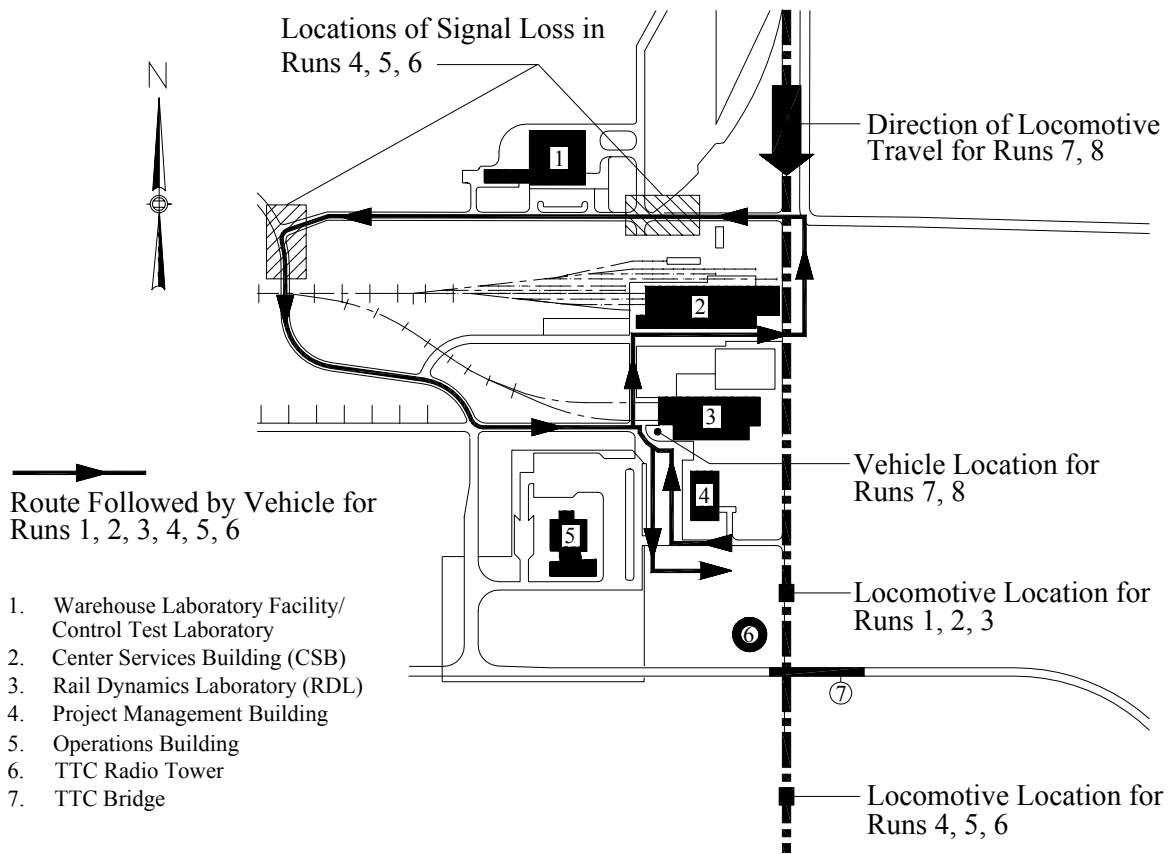

Figure 5-7. DVSS System Testing in Zone E

There was no loss of signal during the five runs when the transmitter antenna was in its normal position. The signal was lost in two locations during each of the three runs when the antenna was inside the locomotive cab (runs 4, 5, and 6). Table 5-17 summarizes the test configuration for and the results of each run.

Induced Energy Interference. The scheduled Phase 4 test runs in Zone B for the DVSS system were not held. RFI testing consisted of efforts to introduce RFI using a hand-held FM transceiver programmed to the standard TTC radio frequency of approximately 172 MHz while both the locomotive and the vehicle were stationary in Zone E. Intermittent loss of signal was observed when the hand-held transceiver was turned on within 12 in. (31 cm) of the vehicle receiver. No equipment was available to generate frequencies in the 452-MHz range of the DVSS system.

Table 5-17. DVSS System Phase 4 Test Results

Run	Locomotive location	Vehicle location	Transmitter antenna location	Signal reception
1	Under tower	Mobile	On roof	No loss
2	Under tower	Mobile	On roof	No loss
3	South of bridge	Mobile	On roof	No loss
4	South of bridge	Mobile	In cab	Lost twice
5	South of bridge	Mobile	In cab	Lost twice
6	South of bridge	Mobile	In cab	Lost twice
7	Mobile	Next to RDL	On roof	No loss
8	Mobile	Next to RDL	On roof	No loss

6. COMPARATIVE EVALUATION OF PROTOTYPE SYSTEMS

A number of criteria were developed for conducting a comparative evaluation of the system performance and features observed during the testing discussed in Chapter 5. Section 6.1 describes those criteria, and Section 6.2 provides results or ratings for each of the three systems according to each criterion.

6.1 Criteria for Comparative Evaluation

The evaluation criteria were separated into four categories:

- (1) Quantitative repeatability performance
 - Number of successful detections in Phase 2
 - Number of missed detections in Phase 2
 - Number of test runs in Phase 2 having nuisance alarms or false alarms (NA/FAs)

- (2) Quantitative overall performance
 - Number of critical component failures and time to restore service
 - Signal range and coverage
 - Primary power requirements
 - Extent and type of periodic self-test capability
 - Extent of fail-safe capability

- (3) Qualitative overall performance
 - Speed of response
 - Resistance to energy interference
 - Resistance to structural interference
 - Acceptability of component acoustic noise levels

- (4) Qualitative general
- Protection of VPAS components from vandalism and tampering
 - Protection of VPAS components from mechanical shock and vibration
 - Effectiveness of vehicle alarms
 - Ease of installation and calibration
 - Unforeseen operational considerations

6.1.1 Quantitative Repeatability Performance Criteria

These criteria are the three system performance parameters (successful detections, missed detections, and NA/FAs) that were counted during Phase 2. These criteria were counted only during Phase 2 because successful detections and missed detections would be misleading during the portions of Phases 3 and 4 in which test distances were beyond the desired signal range. Comparison of successful and missed detections would also be difficult for Phases 3 and 4 because specific tests varied from system to system. Though comparison of NA/FAs would be valid for Phases 3 and 4, data for that criterion are incomplete for Phase 4 testing of EARS, and are unavailable for Phase 3 and 4 testing of the DVSS system.

A **successful detection** is an alarm produced in the receiving vehicle by an intended signal, while both the locomotive and the vehicle are in the test zone, within a prescribed amount of time. Though the length of the test zone was designed to provide 30 sec. of warning time, the warning time of 20 sec. prescribed in the FHWA's 1986 version of the *Manual on Uniform Traffic Control Devices* was used as the criterion for successful detection.

A **missed detection** is the absence of a continuous alarm in the receiving vehicle, while both the locomotive and the vehicle are in the test zone, within a prescribed amount of time following an intended signal. This includes intermittent signals and alarms and a warning time of less than 20 sec.

Nuisance alarms (NA) and **false alarms (FA)** were combined in one category (NA/FA) because FAs could not be reliably distinguished from NAs during testing at TTC, even though there is a definite theoretical difference between an NA and an FA. An NA is an alarm in the receiving vehicle produced by a signal source other than the intended signal. The NAs of concern during repeatability testing were those caused by non-VPAS signals. (VPAS signals that are received in vehicles that are not near a crossing where a train is approaching are also considered NAs). An FA is an alarm in the receiving vehicle not produced by any signal source. It is usually the result of a basic design flaw.

6.1.2 Quantitative Overall Performance Criteria

These criteria are parameters of system performance other than repeatability parameters that were counted, measured, or identified as being present or absent during all phases of testing. These criteria were (1) number of critical component failures and time to restore service, (2) range and coverage, (3) primary power requirements, (4) extent and type of periodic self-test capability, and (5) extent of fail-safe capability.

A **critical component failure** refers to the malfunction of any component that prevents the system from making a successful detection until the component is repaired or replaced.

Signal range refers to the maximum distance from the signal source that the signal can be received. The minimum signal range required for a system with a VPAS component at the crossing (i.e., the SmartStops system) is shown in Figure 6-1, and the minimum range required for a system without a VPAS component at the crossing (i.e., EARS and the DVSS system) is shown in Figure 6-2. A range that is below minimum makes successful detection difficult if not impossible. As the range exceeds the maximum, the potential for nuisance alarms (i.e., a VPAS signal received in a vehicle that is not near a crossing where a train is approaching) increases.

Coverage refers to the area around the transmitter in which the signal can be received. Ideally, range and coverage should be measured for each system under the following environmental conditions:

- Different track-crossing geometries
- Masking by structures, bridges, etc.
- Atmospheric losses caused by scattering, absorption, etc.
- Man-made background interference (hand-held FM transceivers, engine noise, etc.)
- Operating ambient temperature range, including direct solar heating
- Terrain variations, blowing vegetation, trees, dust, sand, birds, animals, etc.
- Train-induced vibrations and noise
- Sustained winds of 50 mph (80 km/h) with gusts up to 65 mph (104 km/h) while train/vehicle was moving
- Humidity extremes

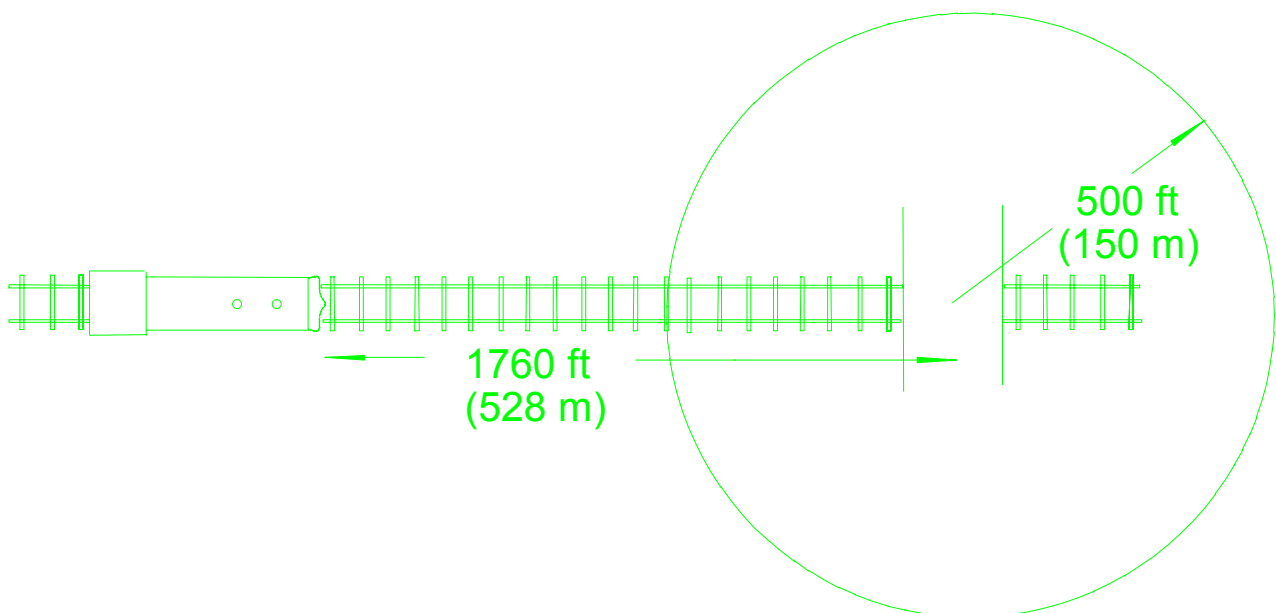

Figure 6-1. Minimum Range Required for the SmartStops System

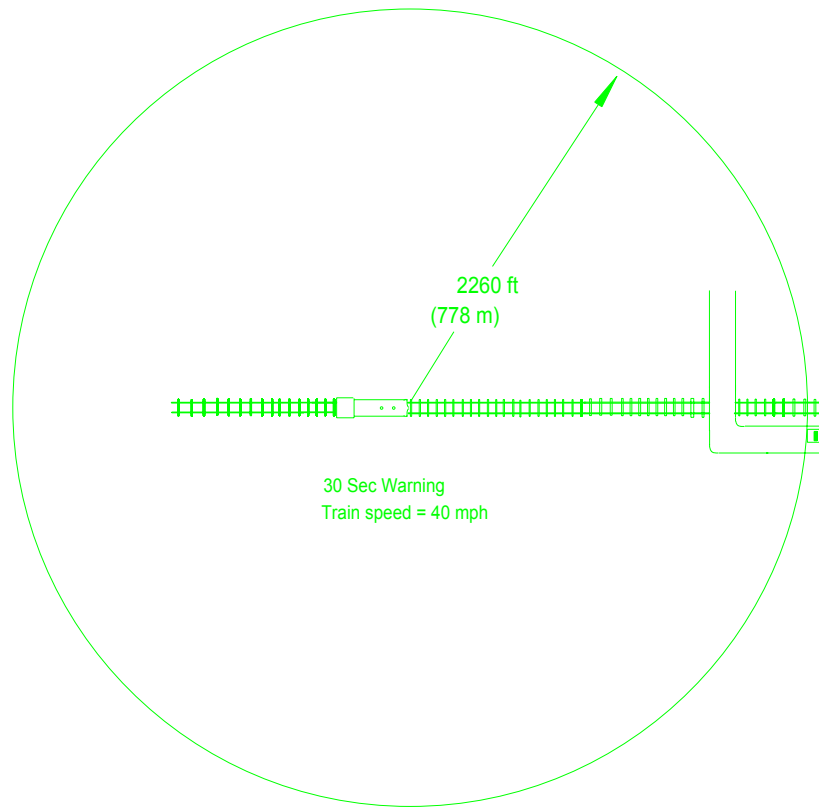

Figure 6-2. Minimum Range Required for EARS and the DVSS System

However, it was not possible to collect those data for each system under all conditions. Thus, the data used for the range and coverage criteria was the maximum range of each VPAS component's signal recorded during any of the tests.

Primary power requirements refer to the type and quality of electrical power needed to operate each VPAS component. When components required a type of power not available at the TTC test site, power supplies had to be installed by the system vendors.

Self-test capability is a system function that checks each VPAS component to determine whether it is operating correctly. This capability should include signals into the input transducer and out of the output transducer. Each component should have a periodic self-test mode that provides a constant audible signal and light to the train operator and to the motorist when any VPAS component fails. Self-test features are needed to inform the motorist when the system is not working properly.

Fail-safe capability ensures that a constant warning will be given even if critical components fail.

6.1.3 Qualitative Overall Performance Criteria

These criteria are aspects of system performance for which judgment ratings were assigned. The ratings are based on observations made or data collected during all applicable phases of testing. All of these criteria except “speed of response” are rated high, medium, or low (or none where applicable). A rating of “high” is always the most desirable. Speed of response is rated as acceptable or unacceptable.

Speed of response refers to the time elapsed between the initiation of a signal broadcast in a locomotive and the initial sounding and display of a warning in the vehicle. This is considered a qualitative criterion because the exact amount of response time was not measured for each test run.

Energy interference refers to a change in the operating environment caused by competing radio frequencies or by other acoustic signals that could possibly degrade the operation of an electrical system, electrical component, or of a signal transmission. Such interference can cause nuisance alarms or saturate the input transducer, thereby attenuating or preventing signal reception. Since the applicable types of energy interference were induced to disrupt operation of each system in Phase 4, ratings for this criterion are based only on testing during the induced energy interference segment of Phase 4. This criterion is rated according to the system’s ability to successfully detect a train when sources of the interference are present. That is, a rating of “high” indicates very little or no disruption.

Structural interference refers to a change in the operating environment caused by shading and reflections of a transmitted signal that could possibly alter signal transmission. Measures of these changes include multipath and signal masking. Multipath refers to reflection of non-line-of-sight signals from nearby surfaces. Signal masking refers to blocking or attenuation of line-of-sight signals by natural or man-made obstructions. Since there were few natural obstructions

at TTC and the buildings and other structures needed to cause multipath and signal masking were present only in the TTC core area, ratings for this criterion are based only on testing during the structural interference segment of Phase 4. This criterion is rated according to the system's ability to successfully detect a train when sources of the interference are present. That is, a rating of "high" indicates very little or no disruption.

Component acoustic noise level refers to the amount of noise distraction to the locomotive operator and the motorist caused by the VPAS component in the locomotive and the vehicle, respectively, when the component is not in alarm mode. This is a human factors criterion, not a detection criterion. These noise levels are rated according to their acceptability. That is, a rating of "high" indicates very little or no noise.

6.1.4 Qualitative General Criteria

These criteria are important features of the system that do not affect its performance. These features, which were assigned judgment ratings, are indicators of system durability, warning effectiveness, user acceptance, and operational impacts. The first three of these criteria are rated high, medium, or low (or none where applicable). A rating of "high" is always the most desirable. "Ease of installation" is rated as easy, moderately easy, moderately difficult, or difficult. "Unforeseen operational considerations" are listed.

Maximum **protection from vandalism and tampering** requires that all VPAS components be locked in a metal enclosure and all exposed wiring be encased in a metal conduit. A rating of "high" indicates that both of these conditions were fully met. A rating of "medium" indicates that one or parts of both of them were met. A rating of "low" indicates that part of only one of them was met. A rating of "none" indicates exposed components and exposed wiring. (Additionally, any transducers at trackside must be out of range from human contact. Because TTC personnel mounted the SmartStops crossing transceiver, its location could not be considered.)

Maximum **protection from mechanical shock and vibration** requires that the VPAS components have non-moving parts, that they be mounted on a structure (e.g., a breadboard) that is well anchored, and that the structure is practically free of vibration from the base that it is mounted on. A rating of “high” indicates that all of these conditions were met. A rating of “medium” indicates that one or two of them were met. A rating of “low” indicates that none of them was met.

The **effectiveness of the alarms in vehicles** is determined by their location, volume (which includes brightness of visual alarms and loudness of audible alarms), and distinctiveness. Because TTC personnel installed the alarms in the test vehicle, their location could not be considered. Thus, the alarms were rated subjectively by the participants for volume and distinctiveness.

Ease of installation considers the number of VPAS components and antennas that must be installed, their location, and the complexity of their mounting and wiring schemes.

Unforeseen operational considerations refer to unanticipated difficulties that were encountered during testing that must be addressed before any further testing can be approved. These were noted and described.

6.2 Comparison of the Three Systems

The following subsections discuss the three systems tested in terms of each criterion explained in Section 6.1 and matrices that list a brief definition of each criterion and the corresponding result or rating for each system tested.

6.2.1 Quantitative Repeatability Performance Evaluation

Both the DVSS system and the SmartStops system demonstrated very good repeatability while EARS was quite inconsistent. As shown in Table 6-1, the DVSS system had a 100 percent

successful detection rate with no NA/FAs, and the SmartStops system had a very high successful detection rate with no NA/FAs. As explained in Section 5.1.2, the SmartStops system had a 100 percent successful detection rate when the outside temperature was above 40° F (4° C), but became progressively more inconsistent as the temperature dropped beyond that point. EARS, on the other hand, successfully detected the horn signal during less than one-third of its runs and had a NA/FA during nearly one-quarter of those runs.

Table 6-1. Quantitative Repeatability Performance Evaluation

Criterion	SmartStops system	EARS	DVSS system
Successful detections ¹	485 (96.8%)	160 (31.8%)	594 (100%)
Missed detections ²	16 (3.2%)	343 (68.2%)	0
NA/FAs ³	0	123	0

¹ Number (percentage) of times in Phase 2 an intended signal was received continuously in the vehicle at least 20 sec. before the train reached the crossing.

² Number (percentage) of times in Phase 2 an intended signal was not received continuously in the vehicle at least 20 sec. before the train reached the crossing.

³ Number of times in Phase 2 that a non-VPAS signal was received in the vehicle. (FAs could not be distinguished from NAs.)

6.2.2 Quantitative Overall Performance Evaluation

As shown in Table 6-2, no critical components failed on any of the systems tested at TTC. Though the SmartStops system was very inconsistent in cold weather and EARS was very inconsistent in general, none of their essential operating components had to be repaired or replaced to enable successful detection.

Table 6-2. Quantitative Overall Performance Evaluation

Criterion	SmartStops system	EARS	DVSS system
Critical Component Failures	None	None	None
Signal range ¹	L-X: 20000 ft. (6.0 km) X-L: 6000 ft. (1.8 km) X-V: 5280 ft. (1.6 km)	L-V: 3000 ft. (900 m)	L-V: 4.0-4.5 mi (6.4-7.2 km)
Primary power requirements ²	LT & XT: 110 VAC, 60 Hz VR: 12 VDC	VR: 12 VDC	LT: 74 VDC VR: 12 VDC
Periodic self-test capability ³	L-X: Yes X-V: No	No	No
Fail-safe capability ⁴	None	None	None

¹ Maximum range of the system measured during testing from locomotive to crossing (L-X), from crossing to locomotive (X-L), from crossing to vehicle (X-V), or from locomotive to vehicle (L-V), as applicable.

² Type of power needed to operate the locomotive transceiver (LT), crossing transceiver (XT), and vehicle receiver (VR), as applicable.

³ A feature within the system that checks each VPAS component to determine whether it is operating correctly: yes or no.

⁴ Ability of system to generate and maintain warnings despite critical failures: high, medium, low, none.

Both the SmartStops system and the DVSS system had maximum signal ranges that far exceeded their minimum required ranges while the maximum range of EARS was quite compatible with the minimum required range of 2,260 ft. (678 m). However, the EARS signal reception was very inconsistent in both Phase 2 and Phase 3 testing. Wind seemed to degrade EARS performance whether the train was moving or stationary or the vehicle was moving or stationary.

Performance degraded rapidly whenever the wind speed exceeded 3 mph (5 km/h), depending on the direction of the wind. As demonstrated during the stationary-locomotive segment of Phase 3, wind blowing directly from the track seemed to improve reception while wind blowing toward the track seemed to degrade reception.

The 110-VAC, 60-Hz power supply required to operate the SmartStops locomotive transceiver is not standard in locomotive cabs. Power usually available in locomotives consists of both 72 VDC and three-phase 480 VAC. The power supplies required by the other SmartStops VPAS components and those of the other two systems seem to be generally available at the particular sources.

The SmartStops return signal from the crossing transceiver to the locomotive transceiver is a self-test feature. It informs the train operator that the signal was received at the crossing. However, the SmartStops system had no self-test capability for the motorist. EARS had no system periodic self-test capability for the motorist. An external wired plug had to be manually removed from EARS for this test, and the test did not go from the input-transducer input to the output-transducer output, making it complete. The DVSS system had no periodic self-test capability. Although operating FRED systems do have error-checking capability between the front-end and rear-end transceivers, only a front-end FRED transceiver was supplied for testing. The DVSS receiver had no periodic self-test capability while the vehicle was moving.

None of the systems had fail-safe capability.

6.2.3 Qualitative Overall Performance Evaluation

As shown in Table 6-3, all three of the systems had acceptable response times.

Table 6-3. Qualitative Overall Performance Evaluation

Criterion	SmartStops System	EARS	DVSS System
Response time ¹	Acceptable	Acceptable	Acceptable
Resistance to energy interference ²	High	Low	Unknown
Resistance to structural interference ³	High	Low	High
Acceptability of component noise ⁴	V: High L: Medium	V: High L: N.A.	V: High L: High

¹ Time between initiation of signal and indication of warning in the vehicle: acceptable or unacceptable.

² Resistance of VPAS components and signals to RFI or engine noise: high, medium, low.

³ Resistance of VPAS signals to multipath and signal masking: high, medium, low.

⁴ Acceptability of acoustic noise levels to the motorist in the vehicle (V) and to the operator in the locomotive (L) caused by the receiver or transceiver: high, medium, low.

Introduction of RFI with a frequency close to the SmartStops system's operating frequency at the crossing antenna and near the vehicle antenna prevented reception in the vehicle while introduction of RFI at the same frequency in other locations caused no significant disruption. Major manipulation of SmartStops antennas prevented reception, but reception was adequate with lesser manipulation. EARS signal reception was significantly limited by other acoustic signals. RFI testing of the DVSS system was incomplete. The equipment (e.g., cellular telephones and high-frequency walkie-talkies) needed to generate RFI near the high frequency (452 MHz) used by the DVSS system was unavailable during testing. The equipment available generated RFI at frequencies up to only 171 MHz.

Minor multipath problems were evident when buildings masked the SmartStops system's signal. The only signal masking encountered with the DVSS system was when the antenna was

mounted inside the locomotive cab, and it was limited. However, EARS signal reception was very limited in Zone E. The longest detection distance was less than 600 ft. (180 m) even though the vehicle was stationary during all the runs.

No noise distraction was produced by any of the vehicle receivers when they were not in alarm mode. The SmartStops transceiver produced some noise distraction to occupants of the locomotive cab. EARS did not have a locomotive component. The front-end FRED transceiver provided by DVSS produced no noise.

6.2.4 Qualitative General Evaluation

As shown in Table 6-4, all of the three systems, as tested, had little protection from vandalism and tampering. Although all three receivers, both locomotive transceivers, and the crossing transceiver were in metal cases, none of the cases had locks, and all of the components had exposed wiring.

All three SmartStops components had moving parts, though they were mounted on a breadboard that was securely anchored to a base that produced minimal vibration. The EARS receiver, the front-end FRED provided by DVSS, and the DVSS receiver all had solid-state parts and were mounted on a breadboard that was securely anchored to a base that produced minimal vibration. Each of the systems had a properly functioning audio alarm and a properly functioning visual alarm. However, none of the alarms had a high volume or was otherwise distinctive.

The SmartStops system required installation of a component and an antenna in/on the locomotive, in/on the vehicle, and on a pole at trackside. The trackside component and antenna had to be installed in each of the five test zones and at two different locations in Zone E. Power adjustments were also required at the SmartStops locomotive component because the power required for that component differed from the power supply used in the test locomotive. On the other hand, EARS required installation of only the digital processor in the vehicle and the microphone on the vehicle, and the DVSS system required only a receiver in the vehicle and a front-end FRED in and an antenna on the locomotive. The power required to operate the EARS receiver

and the DVSS transmitter (i.e., the FRED unit) was compatible with that used in the test vehicle and locomotive, respectively. Thus, neither EARS nor the DVSS system required any power adjustments.

There were no unforeseen operational considerations for any of the systems.

Table 6-4. Qualitative General Evaluation

Criterion	SmartStops system	EARS	DVSS system
Protection from vandalism/tampering ¹	low	low	low
Protection from mechanical shock & vibration ²	V: medium L: medium X: medium	V: high L: N.A.	V: high L: high
Vehicle alarm Effectiveness ³	Audio: low Visual: low	Audio: low Visual: low	Audio: low Visual: low
Ease of Installation ⁴	Moderately difficult	Easy	Easy
Unforeseen operational Considerations ⁵	None	None	None

¹ Degree of security of all exposed components and all exposed wiring: high, medium, low, none.

² Level of effectiveness of structural features to protect the VPAS components in the vehicle (V), in the locomotive (L), and at the crossing (X) from mechanical shock and vibration: high, medium, low.

³ Type of alarms and level of their effectiveness: high, medium, low.

⁴ Easy, moderately easy, moderately difficult, difficult.

⁵ List and description of all unforeseen issues.

7. CONCLUSIONS AND FINDINGS

The systems tested at TTC demonstrated that the concept of VPAS for possibly warning emergency vehicles of the approach of a train to a grade crossing is feasible, though none of the systems as tested are currently suitable for further testing. The SmartStops system, however, warrants consideration for the next stage of testing, though a number of upgrades will be required. Untested systems that may meet the design requirements have also been identified. Additionally, the testing at TTC provided considerable insight on general VPAS designs that are appropriate for further testing and raised design issues and concerns. This insight has been used to generate preliminary system performance specifications and a proposed operational test and evaluation plan for field operational testing.

7.1 Systems' Suitability for Field Operational Testing

Despite the deficiencies of the SmartStops system mentioned in Section 6.2, it performed consistently and robustly during all phases of testing. Since the deficiencies can probably be corrected, the SmartStops system is certainly a possible candidate for field operational testing. EARS, on the other hand, is not considered to be a viable candidate because of its substandard performance during Phase 2 and its high susceptibility to atmospheric, other acoustic signals, and structural interference during Phases 3 and 4. Although the DVSS system provided a 100 percent successful detection rate during Phase 2 and demonstrated robust performance during the other test phases, the excessive signal range associated with FRED units demonstrates the need for supplemental components that are used to limit train detection to the vicinity of the grade crossing.

7.1.1 SmartStops System

Though the SmartStops system's range was consistently sufficient, it was also excessive. The range of this system creates a high potential for nuisance alarms at any other crossing in the area. That is, a signal intended for the crossing that a train is approaching can be received by all SmartStops crossing transceivers in a radius of up to, or possibly exceeding, 20,000 ft. (6 km) and can then be retransmitted from any, or all, of those locations to any receiving vehicle within a radius of up to 6,000 ft. (1.8 km). Thus, the signal range would have to be reduced, though the optimum range⁹ is yet to be determined. Excessive nuisance alarms of this type undermine the motorist's confidence in the system, and the motorist is likely to turn off the receiver to avoid the nuisance alarm, thereby eliminating all detection capability and putting the motorist and passengers at risk.

The SmartStops system is also unable to consistently detect signals at ambient temperatures below 40° F (4° C). Any system accepted for further testing would have to be able to detect signals at military specifications.

Additionally, the system's susceptibility to RFI during Phase 4 testing, though low, is unacceptable and would also have to be reduced.

However, the signal masking and multipath that was experienced during testing in Zone E is to be expected and does not need to be addressed. In most RF systems, the desired path of the signal is usually the shortest one between the transmitter and receiver; errors result from the admixture with reflected signals that have traveled longer distances and often over variable paths. Consequently, the direct signal at the receiver will be either reinforced or attenuated, giving some variability in desired performance.

⁹The optimum range is where the number of other crossings receiving nuisance alarms from the target crossing is minimized while the probability of detection at the target crossing is high. Determining this optimum range will require extensive study of the engineering design tradeoffs.

7.1.2 EARS

EARS was unable to consistently detect horn signals within a minimum acceptable range. Atmospheric conditions, particularly wind speed and direction, significantly affected signal reception. As evidenced by the numerous NA/FAs during Phase 2 testing, EARS was not able to differentiate between train horns and all other audible noises in the acoustic frequency range. While the horn was not blowing, EARS responded to audible noises such as:

- (1) Locomotive engine noise
- (2) Train wheels squealing on the track
- (3) Vehicle horn and vehicle engine noise
- (4) Vehicle road noise

7.1.3 DVSS System

At TTC, the DVSS system was activated and deactivated by ALDs. However, in revenue service or controlled field testing, the FRED on locomotives would not be triggered on and off as the train approached the crossing. Transmission of FRED signals (i.e., alarms) is continuous. Therefore, the system lacks a frame of reference to the crossing.

The DVSS receiver listens for a coded signal in a certain frequency band. If the receiver produces an alarm, the motorist would only know that a train is nearby (within a few miles). Thus, any receiving vehicle traveling within the range of an operating FRED would provide an alarm regardless of the vehicle's proximity to a grade crossing. Given the range of the DVSS system as tested at TTC, there is potential for continuous alarms in any vehicle that is within 4 to 5 mi. (6.4 to 8 km) of an operating train that is equipped with a FRED. Even if the signal range could be significantly reduced to the minimum acceptable range, many vehicles that are not near a crossing would still receive the signal. This is particularly likely on roadways that parallel railways. Thus, any system (such as the DVSS system) that uses FREDs for train detection and signal transmission has an inherent excessive nuisance alarm potential that cannot be corrected without the use of additional equipment.

7.2 Recommended System Upgrades

SmartStops has proposed a new design that would replace the locomotive transceiver with a trackside component. A transducer would detect an approaching train and trigger the radio connection to the crossing transceiver, which would relay the signal to the vehicle receiver. By eliminating the need for a VPAS component in the locomotive, this design change should significantly reduce the range problems associated with the locomotive transceiver. Eliminating the need for a VPAS component in the locomotive would also eliminate the issue of power supply compatibility with the locomotive, and would relieve the train operator of the burden of activating signals.

In its new design, SmartStops must ensure that the signal range of the new trackside component is minimized to prevent signals from being received by transceivers at crossings other than the crossing that the train is approaching. The range of the crossing transceiver will also have to be decreased without any reduction in detection capability at the crossing or at the vehicle.

To qualify for field operational testing, SmartStops will also have to design a complete self-test feature and demonstrate fail-safe capability. Adequate RFI shielding of components against energy that is conducted or radiated would have to be provided. The system will also have to be redesigned to be able to detect signals at military specifications.

Further testing at TTC may be required to verify that a redesigned SmartStops system can qualify for field operational testing.

7.3 General Issues and Concerns for Future Testing

RF systems appear to be more suitable for a warning system than do acoustic systems. Furthermore, acoustic signals are generated by an indefinite number of sources, and the frequency content and amplitude of the train horn cannot be readily differentiated under many

everyday scenarios. The background noise usually present within a wide audible spectrum of train horns is a limiting factor for any acoustic system.

The three-point design seems to be the most reliable RF design. It has definite advantages over one- and two-point designs. The transceiver mounted at the crossing allows the range and coverage of the locomotive signal to be set separately, i.e., a range and coverage that are different from those of the signal transmitted to the vehicle. This allows the warning zone around the crossing to be controlled and tuned according to the particular geometry and environment around the crossing. The geometry and the surrounding environment of the crossing can significantly degrade the performance of some VPAS equipment. A separate range and coverage for the locomotive allows the minimum warning time to be based on the speed and distance of the locomotive from the crossing instead of the distance to the vehicle, which can vary from crossing to crossing.

Additionally, locating the transducer that initiates the signal at trackside instead of in the locomotive also has advantages, as discussed in Section 7.2. However, because power may not be available at all crossings, a trackside component requiring power may not be appropriate for all applications.

Systems proposed for additional prototype testing or field operational testing should have an operating frequency that is approved for either railroad or ITS applications.

7.4 Preliminary System Performance Guidelines

Guidelines for future VPAS fall into two groups: (1) physical and (2) operational. These should include:

- VPAS dynamic performance, human factors, and deployment needs
- System design, development, and testing considerations
- Desired driver warning successes, reliability, cost, and program schedule

- VPAS capabilities that are maintainable
- Operating and storage conditions that are exposed to natural and man-made environments

If the resulting driver warning reliability is not considered adequate, a redundant system operating simultaneously with the primary system can greatly increase the probability of a successful warning. Redundant systems will significantly increase the overall probability of a successful warning. For example, if each system has a probability of detection of 0.99, the combined probability would be 0.9999. However, the likelihood of nuisance alarms will also increase. Simultaneous operation of two systems is also more costly.

7.4.1 Physical Considerations

Systems accepted for additional prototype testing or field operational testing should have an operating frequency that is approved for either railroad or ITS applications. The vehicle receiver shall operate off a 12 VDC unregulated vehicle battery. The outer case of each component, cables, and connectors should be able to resist penetration by sand and dust. Each system component should have periodic self-test capability.

The system should have an automatic reclosure device that protects against induced common- and/or normal-mode transient voltages induced by cloud-to-ground lightning in the vicinity (not a direct hit). It should be a “no fault” device that considers energy levels up to 33 J and shunts transient voltages to ground without causing failure of equipment or the protective device. Circuit design, where possible, shall be selected assuming a maximum 25-ohm ground condition. System enclosures should have at least 100 dB shielding effectiveness against EMI, and the EMI gaskets should be fluid resistant. EMI from the VPAS vehicle electrical, lighting, and ignition systems (including other vehicles in the vicinity of the VPAS system) should be considered as part of the ambient background noise.

Protection from mechanical shock and vibration should be provided to minimize the impact of the railroad or vehicle environment on all VPAS components. That is, the VPAS components

should have non-moving parts that are mounted on a structure (e.g., a breadboard) that is well anchored. System components should also be tamperproof. All exposed wiring above ground should be encased in a metal conduit, and any transducers at trackside should be elevated and out of range from human contact.

7.4.2 Operational Considerations

Performance during any further testing will be measured in terms of the repeatability criteria used in Phase 2 of testing at TTC. Tested systems will be expected to successfully detect a train without false alarms under the following weather/climate conditions:

- Radial ice accretion up to 1/2 in. (13 mm)
- Snow accumulation up to 1 ft. (0.3 m) on operating vehicles and locomotives
- Relative humidity of 95 percent at 80° to 95° F (27° to 35° C) with no condensation on the in-vehicle components, although some condensation on crossing components is tolerable
- An ambient temperature range of -35° to 120° F (-37° to 49° C) except when exposed to direct radiation from the sun
- Rainfall of 4 in (10 cm) per hr
- Blowing snow of 4 to 6 lb/ft²/hr
- Winds with ground speeds up to 80 mph (128 km/h) and gusts up to 200 mph (320 km/h)

Some temperature shock capability (such as the rate of 3° F/min) is recommended, as components mounted under the hood of a vehicle and elsewhere could experience higher than ambient temperatures. A sun shield may be necessary.

To meet the very low tolerance limits for missed detections and nuisance alarms, manufacturers/vendors should address the following concerns while designing candidate systems:

- Accidental reverse of any dc polarity
- Potential hazards to electronic equipment resulting from mishandling or misapplication of external power sources through open and loose leads, during installation, testing, or repair
- Expected attenuation at the system operating frequency and the nominal design ranges during the first exposure to heavy rain at the test site
- Potential for nuisance alarms at any new test site from various sources, e.g., catenary, track power circuits, or hotel power on coaches
- Potential degradation in performance when VPAS components that are exposed to fluids found in and on vehicles and locomotives and at trackside

7.5 Proposed Operational Test and Evaluation Plan for Field Operational Testing

All systems delivered for field operational testing should be installed as they will be deployed, and should be operated off all the intended primary power sources (regulated or unregulated), in the locomotive as part of a Positive Train Control (PTC) system along the wayside, at the crossing, and in the vehicle. Test systems should also be operated over the range of natural and man-made environmental conditions. Range and coverage should be measured for each system under the following environmental conditions:

- Different track-crossing geometries
- Multiple trains passing through a crossing
- Masking by structures, bridges, etc.
- Atmospheric losses caused by scattering, absorption, etc.
- Man-made background interference (hand-held FM transceivers, engine noise, etc.)
- Ambient temperature range, including direct solar heating
- Terrain variations, blowing vegetation, trees, dust, sand, birds, animals, etc.
- Train-induced vibrations and noise
- Sustained winds of 50 mph (80 km/h) and gusts up to 65 mph (104 km/h) while train/vehicle was moving

This plan proposes testing at a grade crossing in each of three different man-made environments: rural, urban, and suburban. It will also require testing during different times of the year and possibly in different geographic areas, to provide a variety of weather and climate conditions.

The sample size needed depends on the desired probability of a successful warning and the desired level of confidence for achieving that probability. Using these two values, curves can be developed that will provide guidelines for sample size and for evaluation of the results. The following values seem to be appropriate for field operational testing (see Figure 7-1):

- Probability of success of the VPAS system = 0.99
- Confidence Limit for Probability of Success of 0.99 = 0.95

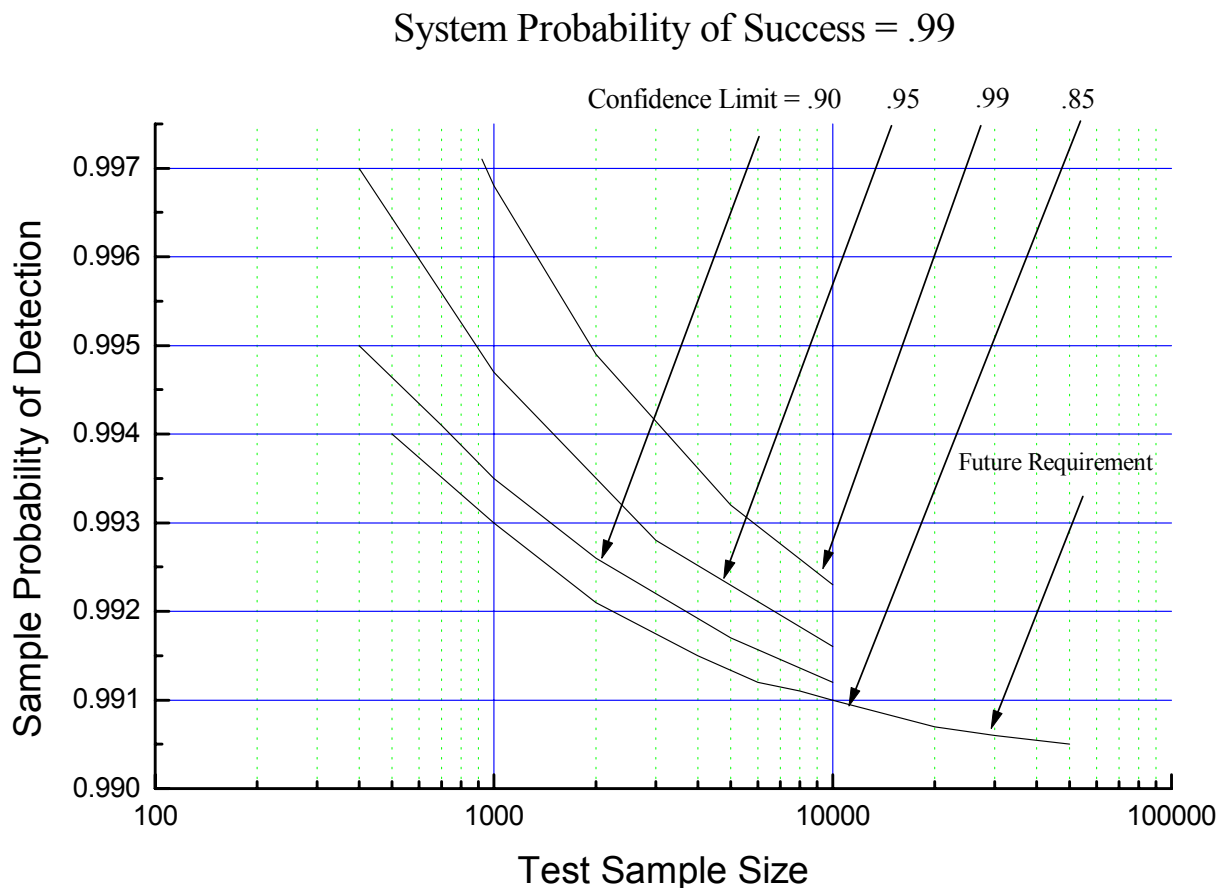

Figure 7-1. Detection Probability Confidence Limit Curve

Based on these assumptions, at least 2,000 samples should be collected at each crossing. Data should be analyzed as testing proceeds to determine whether 2,000 samples are sufficient. If the rate of successful detections is below the confidence limit curve, additional testing may provide more insight into the system performance. The alternative would be to lower the performance requirements (i.e., accept a lower probability of success and/or lower confidence limit).

The duration of testing will depend on the sample size, the sampling rate of the data collection system(s), the method of data collection, and an estimate of the mean-time between critical failures (MTBCF) based on an exponential probability function. The sampling rate should be

fast enough to capture enough detail to reproduce the signal. The most efficient data collection method would be unsupervised recording devices mounted on a telephone pole near a grade crossing. These devices would measure the performance of the VPAS receiver, thereby eliminating the need for data collection systems in a motor vehicle. Collecting data in a motor vehicle with a driver on board (the method used at TTC) would take much longer than the unsupervised method, depending on the size of the sample and the test fleet of locomotives and motor vehicles. Mean-time between critical failures includes down time following a failure, and down time is partially dependent on the availability of replacement.

Another issue in determining sample size and duration of testing is definition of a sample. During Phase 2 testing at TTC, data were collected when a VPAS-equipped motor vehicle and a locomotive were within a fixed distance from the crossing, and test personnel were able to position the vehicle and the locomotive and to control their movement. This control will not be possible during field operational testing.

Other planning issues to be addressed are the number of vehicles to be equipped with receivers, the number of locomotives to be equipped with transceivers (if the test system has a VPAS component in the locomotive), and the type and number of data collection units needed for each test crossing. Decisions regarding these issues will also affect the duration of testing and its cost. The obvious tradeoff is between the need for timely information and the resources available.

The locomotives used for testing should be part of a commuter rail or freight railroad fleet that operates according to a timetable, which will enable test personnel to estimate arrival times at the test crossings. The data collection system used should not load the electronic circuitry or alter system performance.

An example containing three crossings has been developed. The crossings are on separate Massachusetts Bay Transportation Authority (MBTA) commuter rail routes in metropolitan Boston. (The three crossings could also be located on one route if it passes through an urban, a suburban, and a rural setting.)

Route # 1 - Attleboro/Stoughton Line (assumed urban crossing):

- Select one crossing between South Station (in Boston) and Stoughton. (This segment has two-way traffic.)
- Use at least five locomotives equipped with VPAS transceivers (if required by system design).
- Conduct 68 crossing cycles per day (Monday through Friday, between 5:15 A.M. and 12:52 A.M.).

Route # 2 - Worcester/Framingham Line (assumed suburban crossing):

- Select one crossing between Newton and Framingham. (This segment has two-way traffic.)
- Use at least five locomotives equipped with VPAS transceivers (if required by system design).
- Conduct 34 crossing cycles per day (Monday through Friday, between 5:45 A.M. and 12:48 A.M.).

Route # 3 - Franklin Line (assumed rural crossing):

- Select one crossing between routes 128 and I-495. (This segment has two-way traffic.)
- Use at least 6 locomotives equipped with VPAS transceivers (if required by the system design).
- Conduct 35 crossing cycles per day (Monday through Friday, between 3:50 A.M. and 12:49 A.M.).

Totals for MBTA example:

- 16 locomotives equipped with VPAS transceivers (if required by system design)
- 12 motor vehicles equipped with VPAS receivers
- 6 crossings equipped with VPAS transceivers (if required by system design)
- A maximum of 137 (34 + 35 + 68) crossing cycles per day

If only unsupervised recording devices at each crossing collected data, data collection would take:

- 30 business days (approximately 6 weeks) on the Attleboro/Stoughton Line.
- 59 business days (approximately 12 weeks) on the Worcester/Framingham line
- 58 business days (approximately 12 weeks) on the Franklin line

If all the data samples were collected in a motor vehicle with a driver on board, the testing would take approximately 6 years on the Attleboro/Stoughton line, 12 years on the Worcester/Framingham line, and 12 years on the Franklin line. That is, the data collection method used at TTC would take roughly 50 times as long as the unsupervised method.

APPENDIX A

INTERMODAL SURFACE TRANSPORTATION EFFICIENCY ACT (ISTEA) SECTION 1072

Vehicle Proximity Alert Systems

The Secretary shall coordinate the field testing of the vehicle proximity alert system and comparable systems to determine their feasibility for use by priority vehicles as an effective railroad-highway grade crossing safety device. In the event the vehicle proximity alert or a comparable system proves to be technologically and economically feasible, the Secretary shall develop and implement appropriate programs under section 130 of title 23, United States Code, to provide for installation of such devices where appropriate.

This page is intentionally left blank

APPENDIX B

CBD ANNOUNCEMENT SOLICITING VPAS

3140974

VEHICLE PROXIMITY ALERT SYSTEM POC

Contact Robert Robel, HCP-32, (202) 366-4227 SPECIAL NOTICE SECTION OF THE COMMERCE BUSINESS DAILY.

This is a special announcement to solicit information about vehicle proximity alert systems (VPAS) for use at railroad/highway grade crossings. Section 1072 of the Intermodal Surface Transportation Efficiency Act of 1991 directs the Secretary of Transportation to coordinate the field testing and evaluation of a VPAS and comparable systems. The VPAS is a “train approaching” warning system designed to alert drivers of priority vehicles (emergency vehicles, school buses, hazardous material trucks, etc.) of the approach of a train at a rail/highway crossing not equipped with active railroad warning devices. If this type of in-vehicle warning system is determined through testing to be economically and technically feasible, the Secretary would develop and implement programs to provide the warning systems at appropriate railroad/highway crossings.

The Federal Highway Administration (FHWA), therefore, is interested in receiving information about any available system that would meet the specific functions of a VPAS. Submitted information should be in sufficient detail to allow a determination of its capability to perform as intended. Systems considered in the opinion of the FHWA to possess the best likelihood of success will be field tested and evaluated by the Government. Submitters of selected systems will be responsible for providing an operating prototype system for use in the field tests or for providing funds to have a prototype built.

Information on VPAS type systems should be sent within 60 days of the date of this special announcement to the FHWA, Office of Highway Safety (HHS-11), 400 7th Street S.W., Washington, D.C. 20590. Please include the name, address, and telephone number of individuals to be contacted regarding your submission. Also, include information about any patents or intent to patent regarding the submitted VPAS type system. Design details will be kept confidential. This is not a formal solicitation. However, concerns that respond should furnish detailed data concerning their capabilities.

This page is intentionally left blank

APPENDIX C

INFORMATION SUBMITTED BY VENDORS OF SELECTED SYSTEMS

This appendix contains information submitted by the vendors of the four systems selected for prototype testing:

- (1) The Early Alert Response System (EARS) proposed by Custom Automated Plastic System Inc. (CAPS) C-3
- (2) TrakAlert proposed by RF Solutions C-17
- (3) The system proposed by TRW..... C-41
- (4) The system proposed by Engineered Safety Products (SmartStops Unlimited, Inc.) C-64

APPENDIX D

DAILY WEATHER REPORTS AND TESTS RESULTS: EXAMPLES

SmartStops System

EARS

DVSS System

SmartStops System Testing on February 21

EARS Testing on March 28