

**DEPARTMENT OF TRANSPORTATION****Federal Aviation Administration****14 CFR Part 60**

[Docket No. FAA-2002-12461; Notice No. 07-14]

RIN 2120-AJ12

**Flight Simulation Training Device Initial and Continuing Qualification and Use****AGENCY:** Federal Aviation Administration (FAA), DOT.**ACTION:** Notice of Proposed Rulemaking (NPRM).

**SUMMARY:** The FAA proposes to amend the Qualification Performance Standards (QPS) for flight simulation training devices (FSTD) and add a new level of simulation for helicopter flight training devices (FTD). The FAA proposes to codify existing practice by requiring all existing FSTD visual scenes that are beyond the number required for qualification to meet specified requirements. The proposal also reorganizes certain sections of the QPS appendices and provides additional information on validation tests, established parameters for tolerances, acceptable data formats, and the use of alternative data sources. The proposed changes would ensure that the training and testing environment is accurate and realistic, would codify existing practice, and would provide greater harmonization with the international standards document for simulation. None of these proposed technical requirements would apply to simulators qualified before May 30, 2008, except for the proposal to codify existing practice regarding certain visual scene requirements. The over-all impact of this proposal would result in minimal to no cost increases for manufacturers and sponsors.

**DATES:** Send your comments on or before December 21, 2007.**ADDRESSES:** You may send comments identified by Docket Number FAA-2002-12461 using any of the following methods:

- *Federal eRulemaking Portal:* Go to <http://www.regulations.gov> and follow the online instructions for sending your comments electronically.
- *Mail:* Send comments to the Docket Management Facility; U.S. Department of Transportation, 1200 New Jersey Avenue, SE., West Building Ground Floor, Room W12-140, Washington, DC 20590-0001.
- *Hand Delivery or Courier:* Bring comments to the Docket Management

Facility in Room W12-140 of the West Building Ground Floor at 1200 New Jersey Avenue, SE., Washington, DC, between 9 a.m. and 5 p.m., Monday through Friday, except Federal holidays.

- *Fax:* Fax comments to the Docket Management Facility at 202-493-2251.

*Privacy Act:* We will post all comments we receive, without change, to <http://www.regulations.gov>, including any personal information you provide. Anyone is able to search the electronic form of all comments received into any of our dockets by the name of the individual submitting the comment (or signing the comment, if submitted on behalf of an association, business, labor union, etc.). You may review DOT's complete Privacy Act Statement in the **Federal Register** published on April 11, 2000 (65 FR 19477-78) or you may visit <http://DocketInfo.dot.gov>.

*Docket:* To read background documents or comments received, go to <http://www.regulations.gov> at any time and follow the online instructions for accessing the docket. Or, go to the Docket Management Facility in Room W12-140 of the West Building Ground Floor at 1200 New Jersey Avenue, SE., Washington, DC, between 9 a.m. and 5 p.m., Monday through Friday, except Federal holidays.

**FOR FURTHER INFORMATION CONTACT:** Edward Cook, Air Transportation Division (AFS-200), Flight Standards Service, Federal Aviation Administration, 100 Hartsfield Centre Parkway, Suite 400, Atlanta, GA 30354; telephone: 404-832-4700.

**SUPPLEMENTARY INFORMATION:** Part 60 was originally added to Title 14 of the Code of Federal Regulations on October 30, 2006, with an effective date of October 30, 2007. In a document published in the Rules and Regulations section of this issue of the **Federal Register**, the effective date was delayed until May 30, 2008. This proposed rule would change the appendices of Part 60 originally published on October 30, 2006.

Later in this preamble under the Additional Information section, we discuss how you can comment on this proposal and how we will handle your comments. Included in this discussion is related information about the docket, privacy, and the handling of proprietary or confidential business information. We also discuss how you can get a copy of this proposal and related rulemaking documents.

**Authority for This Rulemaking**

The FAA's authority to issue rules regarding aviation safety is found in Title 49 of the United States Code.

Subtitle I, Section 106 describes the authority of the FAA Administrator. Subtitle VII, Aviation Programs, describes in more detail the scope of the agency's authority. This rulemaking is promulgated under the authority described in Subtitle VII, Part A, subpart I, 49 U.S.C. 44701. Under that section, the FAA is charged with regulating air commerce in a way that best promotes safety.

**Table of Contents**

- I. Summary of the Proposal
- II. Qualification Performance Standards (QPS) Amendment Process
- III. Background
  - A. Current Qualification Requirements
  - B. Harmonization with International Standards
  - C. Compliance
- IV. The Proposal
  - A. Visual Scenes and Airport Models; Class I, Class II, and Class III Airports; and the FSTD Directive for Class II Visual Scenes and Airport Models
  - B. New Requirements for Objective Testing Standards
  - C. New Requirements for Motion Systems for Full Flight Simulators and Level 7 Helicopter Flight Training Devices
  - D. New Requirements for Visual Systems for Level C and D Full Flight Simulators
  - E. New Requirements for Sound Systems for Level D Simulators
  - F. New Requirements for Subjective Testing Standards for Visual Scenes and Airport Models
  - G. New Level 7 Helicopter FSTD Requirements
  - H. Quality Management Systems
  - I. New Information on Operation and Testing Requirements for FSTDs
- V. Regulatory Notices and Analyses

**I. Summary of the Proposal**

The primary purpose of this NPRM is to ensure that the training and testing environment is accurate and realistic and provide greater harmonization with the international standards document for simulation. The proposed requirements are expected to reduce expenses and workload for simulator sponsors by avoiding conflicting compliance standards. These modifications incorporate technological advances in, encourage innovation of, and standardize the initial and continuing qualification requirements for FSTDs that are consistent with the requirements recently established by the international flight simulation community.

The secondary purpose of this rulemaking project is to reorganize, simplify, and improve the readability of the QPS appendices. This proposal also clarifies and codifies certain standards presently contained in advisory circulars. In addition, the FAA proposes to amend the Qualification Performance



Standards (QPS) for flight simulation training devices (FSTD) and add a new level of simulation for helicopter flight training devices (FTD).

The FAA is proposing the following improvements to its FSTD qualification requirements:

- Provide a listing of the tasks for which a simulator may be qualified.
- Require the collection of objective test data during currently required aircraft certification testing for specific FSTD functions, including: Idle and emergency descents, and pitch trim rates for use in airplane simulators; engine inoperative rejected takeoffs for use in helicopter simulators; and takeoffs, hover, vertical climbs, and normal landings for use in helicopter flight training devices.
- Provide in the QPS additional information for sponsors on the testing requirements for FSTDs, including the use of alternative data sources when complete flight test data are not available or lesser technically complex levels of simulation are being developed.
- Clarify and standardize existing requirements for motion, visual, and sound systems, including subjective buffeting motions, visual scene content, and sound replication.
- By FSTD Directive require each Class II visual scene or airport model available in any FFS, regardless of the original qualification date, to meet the requirements described in Table A3C (Appendix A, Attachment 3) or Table C3C (Appendix C, Attachment 3), as appropriate.
- Clarify existing Quality Management System (QMS) requirements by removing non-regulatory information.

Except for the FSTD Directive, manufacturers and sponsors would not be required to incorporate any of the changes listed above for existing FSTDs. The appendices and attachments to part 60 affected by this proposal would only apply to FSTDs that come into service after part 60 is effective (currently May 30, 2008). The proposed changes to the QMS program would eliminate potentially confusing information that addresses the voluntary portions of a QMS program. The FAA anticipates that this proposal would result in minimal to no cost increases for manufacturers and sponsors.

## II. Qualification Performance Standards (QPS) Amendment Process

The part 60 Final Rule contains six QPS appendices: Appendix A—Airplane Full Flight Simulators; Appendix B—Airplane Flight Training Devices; Appendix C—Helicopter Full

Flight Simulators; Appendix D—Helicopter Flight Training Devices; Appendix E—Quality Management Systems for Flight Simulation Training Devices; and Appendix F—Definitions and Abbreviations for Flight Simulation Training Devices.

The QPS amendment process is faster than the traditional rulemaking process. It is designed to allow modifications to be implemented in a substantially shortened timeframe. In the part 60 Final Rule published October 30, 2006, (71 FR 63392), the FAA explained that the “fast track” QPS amendment process would be used to incorporate technical changes to flight simulation standards. The FAA anticipated QPS amendments based on several factors such as analysis of incident and accident data or changes in aircraft or simulation technology. Changes to the QPS documents are published in the **Federal Register** as an NPRM unless “good cause” exists under the Administrative Procedure Act (APA), which would warrant the FAA publishing a change to a QPS document without following the standard notice and comment procedures. Under the APA, in order for the FAA to issue a rule without following notice and comment procedures, the FAA would have to make a good cause finding that following notice and comment procedures would be impracticable, unnecessary, or contrary to the public interest.

Although proposed QPS amendments are published in the **Federal Register** for public comment, the authority for final review and issuance of the NPRM has been delegated from the Administrator to the Director of Flight Standards Service. The delegation of authority facilitates timely implementation of improved technological advances. This delegation of authority is exercised in conjunction with the Office of the Chief Counsel. If at any time during the amendment process the Administrator, Chief Counsel, or the Director of Flight Standards Service determines that a proposed amendment is not appropriate for the streamlined process, the rulemaking project would proceed in accordance with the agency’s normal rulemaking procedures.

## III. Background

### A. Current Qualification Requirements

The FAA issued Part 60 to promote standardization and accountability for FSTD maintenance, qualification, and evaluation. The regulation codified the standards contained in advisory circulars and implemented the QPS format. The QPS appendices allow

regulatory requirements and information to be presented in one location. This promotes ease of use and greater insight about the FAA’s intent behind the regulation and the required and approved methods of compliance.

### B. Harmonization With International Standards

During the development of the part 60 Final Rule, the international community also began updating flight simulation standards.<sup>1</sup> However, many of the changes recommended by the international community were beyond the scope of the part 60 NPRM and could not be included in the final rule. Rather than delay its efforts or issue a supplemental notice of proposed rulemaking, the FAA determined that the fastest approach would be to publish the part 60 Final Rule, delay the effective date, and amend the technical requirements under the expedited QPS amendment process. This approach avoided increased expenses, greater workload, and conflicting compliance requirements for sponsors who would be required to comply with part 60.

The majority of the proposed additions to the QPS provide information to the sponsors on objective tests. The information included explains why the tests are necessary, how to stage the simulator, and how to arrange other equipment to conduct the tests efficiently and produce optimum results. This information would be beneficial for simulator manufacturers and users.

The proposal clarifies and codifies the standards for motion, and visual and sound systems. The proposal also permits a new higher level of simulation for helicopter FTDs. The proposal adds 2 tables of material for operations tasks and system tasks, which are used as a reference when developing the statement of qualification for the FSTD. The proposal also includes a set of tables describing visual scene and airport model requirements for FSTD qualification.

Some of the proposed changes are marginally more stringent than the requirements in the October 30, 2006,

<sup>1</sup> The international community began releasing its recommendations with the publication of the International Civil Aviation Organization’s Manual of Criteria for the Qualification of Flight Simulators (Document 9625) in 1994. The Joint Aviation Authorities of Europe issued JAA-STD-1A (Synthetic Training Device—document for airplane flight simulators) in 1998, followed by updates in 1999, 2001, and 2003. The first ICAO update of Document 9625 was in January of 2004 and the most recent consideration for update is the release of JAR-FSTD-A and JAR-FSTD-H documents in the late spring of 2005 for European national regulatory authorities to begin their review and consideration.

Final Rule. For example, a simulator qualified at Level C or Level D after May 30, 2008, would have the field of view and system capacity requirements for the visual system increased by 20 percent over the present requirement. The proposed requirements are consistent with international standards, which simulator manufacturers are currently following. This change improves the quality of simulation necessary to train and evaluate flight crewmembers. Other proposed changes are more flexible than the requirements prescribed in the October 30, 2006, Final Rule. For example, the tolerance for displacement in the control system "freeplay" test in helicopter simulators was increased from 0.10 inches to 0.15 inches, allowing additional space to adapt aircraft and non-aircraft hardware for use in the simulator.<sup>2</sup> This change was based on the FAA's belief that a 0.10 inch tolerance would create an undue hardship on sponsors because it would require constant adjustment of the controls to maintain the close tolerance. The change from 0.10 inches to 0.15 inches is large enough to minimize the hardship on sponsors, and small enough to continue providing pilots with an accurate controller feel.

Other than this change to the visual scene requirement, the requirements of this proposal would not apply to current simulators. In all instances the overall costs applicable to new simulators are minimal to none. The most expensive change being proposed is the increase in horizontal field of view for some visual system applications.

### C. Compliance

With the exception of QMS requirements and any FSTD Directives, simulators qualified prior to May 30, 2008, are not required to meet QPS requirements as long as the simulator continues to meet the requirements contained in the Master Qualification Test Guide that was developed when the simulator was originally qualified.

## IV. The Proposal

### A. Visual Scenes and Airport Models; Class I, Class II, and Class III Airports; and the FSTD Directive for Class II Visual Scenes and Airport Models

Current part 60 contains requirements for the number of visual scenes or airport models that must be included for full flight simulator (FFS) qualification and a description of what the visual scenes or airport models must contain. Included in this proposal is a codification of existing practice for

visual scene quality, environmental effects, visual feature recognition, and scene control and management capability. Also included is the codification of existing practice for updating visual scenes and airport visual models, including the identification of other aspects of the airport environment that would have to correspond with the visual scene or model.

The proposal establishes the requirements for Class I, Class II, and Class III visual scenes and airport models already covered by ACs issued by the FAA. For circling approaches, all of the proposed requirements would apply to the runway used for the initial approach and to the runway of intended landing. Additional proposed requirements include an accurate visual relationship between the scenes or airport models and other aspects of the airport environment, an accurate visual relationship of the aircraft and associated equipment, scene quality assessment features, and control of these scenes or models that the instructor is able to exercise. The FAA believes these requirements are necessary to ensure realistic and accurate depiction of airports and visual scenes incorporated in simulators for FAA-approved training programs.

Additional visual scenes or airport models beyond those necessary for simulator qualification may be used for various training program applications, including Line Oriented Flight Training, and are important for flight training and testing. Historically, these additional visual scenes or airport models were not routinely evaluated or required to meet any standardized criteria. This led to qualified simulators containing visual scenes or airport models that may have been incorrect or may have contained inappropriate visual references. To prevent this from occurring in the future, the FAA proposes to issue FSTD Directive (FD) Number 1. All FDs issued would be found in the FSTD Directive Attachments: Appendix A, Attachment 6; Appendix B, Attachment 5, Appendix C, Attachment 5, and Appendix D, Attachment 5. FD Number 1 is not contained in Appendix B or in Appendix D because no existing level of FSTD in Appendix B or Appendix D requires a visual system. Proposed FD Number 1 would require each simulator sponsor to verify that each Class II visual scene or airport model available in the FFS, regardless of the original qualification basis and regardless of the initial qualification date, meets the requirements in 14 CFR part 60, Appendix A, Attachment 3, Table A3C or Appendix C, Attachment 3, Table

C3C, as applicable. FD Number 1 would apply to all FSTDs with visual systems containing visual scenes or airport models used as part of an FAA-approved curriculum that are available for use and are beyond the minimum number of required visual scenes or airport models required for qualification at the stated level. This FSTD Directive would not require visual scenes or airport models to contain details beyond the design capability of the existing qualified visual system. The availability of the scene or model in the FFS would serve as the sponsor's verification that the requirements were met. Therefore, a reporting requirement for these scenes or models would not be necessary. Currently, visual scenes and airport models available in any FFS that would be classified as Class II are likely to already meet the requirements being proposed. Additionally, each visual scene or airport model classified as Class II would be beyond the number of visual scenes or airport models required for qualification. In the event any Class II visual scene or airport model is found by the sponsor to be deficient in some way, the sponsor could remove that scene or model from the FFS library without jeopardizing the qualification status of the FFS. Alternately, the sponsor, at his or her option, may elect to bring the deficient aspect into compliance and retain the availability of that scene or model. Each sponsor has a full year to review each FFS during normal training, checking, or testing activities and determine the preferred course of action. For these reasons, the FAA has determined that in a few cases the cost for complying with this proposal would be minimal and in many cases there would be no cost to the sponsor.

In addition to the proposed requirements for Class II visual scenes and models, the FAA also proposes to allow the continuation of the use of visual scenes or airport models that have been approved by the Training Program Approval Authority (TPAA) for specific purposes. Examples of approved activities include specific airport or runway qualification, very low visibility operations training, including Surface Movement Guidance System (SMGS) operations, or use of a specific airport visual model aligned with an instrument procedure for another airport for instrument training. At the end of the interim period, all Class III visual scenes and airport models must be classified as either a Class I or a Class II visual scene or airport model or be removed from availability at the simulator Instructor

<sup>2</sup> See Appendix C of this part, Table C2A, item 2.a.6.

Operating Stations (IOS). Class III visual scenes and airport models may continue to be used after the end of the interim period if they are part of a training program specifically approved by the TPAA or other regulatory authority that uses a task and capability analysis as the basis for approval of this specific media element, (i.e., the specific scene or model selected for use in that program). Because any visual scene or airport model that may be classified as Class III is likely to already have some form of a task and capability analysis completed and is already specifically approved by the TPAA, the FAA has determined that in many cases there would be no cost for complying with this proposal. However, if a task and capability analysis is required or if modification to the visual scene is necessary, then the cost would be minimal.

#### *B. New Requirements for Objective Testing Standards*

The FAA proposes to revise the objective testing requirements for certain simulation performance areas. These revisions are necessary to clarify the instructions and requirements for certain tests contained in the final rule. In addition to changing the requirements for certain tests, the FAA also proposes several new tests that were not included in the final rule. The revised tests impact the following simulation performance areas:

1. Idle and emergency descents for airplane simulators.
2. Pitch trim rates for airplane simulators.
3. Landing test requirements: autopilot landings and ground effect demonstration for airplane simulators.
4. Takeoffs, hover, vertical climbs, and normal landings in helicopter flight training devices.
5. Spiral stability tests for both airplane and helicopter simulators.
6. Engine inoperative rejected takeoffs for helicopter simulators.
7. Motion System tests for airplane and helicopter simulators and for helicopter flight training devices.
8. Visual System tests for airplane and helicopter simulators and for helicopter flight training devices.
9. Sound System tests for airplane and helicopter simulators.

An example of a revised requirement is the spiral stability test for airplane and helicopter simulators. Under the proposal, an additional parameter must be measured to achieve the required results. For airplanes, the spiral stability test must be conducted in an additional flight configuration (approach or landing) instead of being conducted in cruise configuration only. For

helicopters, the final rule required the helicopter to maintain the correct trend during the spiral stability test, whereas this proposal would require the helicopter to meet a specific roll or bank angle during the test. These additional parameters provide a more complete and accurate evaluation of the simulator, and ensure better replication of aircraft performance. The data that would be used to validate simulator performance and handling in these areas is obtained from lateral-directional stability tests conducted during normal aircraft certification flight testing. The data for these additional parameters are either regularly available or can be made available simply by activating the recording equipment when the test is begun.

Another example of the revised requirements is the inclusion of an alternative method for validating control dynamics for the pitch, roll, and yaw control tests for airplane simulators.<sup>3</sup> The alternative method would not change the requirements that the simulator must meet for qualification, but would allow the validation tests for control dynamics to be conducted on the ground rather than in-flight. The FAA believes this change would provide an equivalent level of safety, while conserving resources and providing greater flexibility for manufacturers and sponsors.

These proposed requirements affect only those FSTDs that will be coming into service after May 30, 2008, and some proposed changes may be marginally more stringent than the requirements in the October 30, 2006, Final Rule, while some are less stringent. Where the proposed requirements are marginally more stringent than the current requirements the cost would be minimal.

#### *C. New Requirements for Motion Systems for Full Flight Simulators and Level 7 Helicopter Flight Training Devices*

This proposal adds tables describing the motion vibration that must be displayed by the FSTD. The FAA proposes on-set motion cueing capability for airplane and helicopter FFSs and Level 7 helicopter FTDs. For the FFSs, the proposal includes a requirement that the motion cueing must be provided by a platform motion system. For the Level 7 helicopter FTDs, the proposal would allow a method other than a platform motion system to be used, such as the use of a large, bass speaker located beneath the pilot's seat

with sufficient response to provide vibration cues to the pilot. The proposal also eliminates certain requirements for ranges and rates of motion system response for helicopter simulators. However, the proposal would require additional tests that capture the motion system "signature." The signature is a simultaneous recording of motion system responses captured while conducting required objective tests. The signature is recorded and may be compared to signatures captured in subsequent evaluations to determine if any differences exist. Any differences would be corrected to return the motion system back to its original system operation. Signature testing would apply to airplane and helicopter simulators.

The October 30, 2006, Final Rule does not contain motion system testing requirements for airplane flight simulators. However, current practice (under the Advisory Circular) includes motion system testing that consists of "frequency response," "leg balance," and "turn around check." This proposal codifies that current practice and adds the motion system benchmarking of a "motion cueing performance signature" and "characteristic motion vibrations," both of which are also proposed for helicopter simulators. Motion cueing performance signature and characteristic motion vibrations for airplane flight simulators and helicopter simulators are already recorded during the conduct of other required objective and subjective testing for these simulators, thereby eliminating any cost.

The proposal also requires the recording of motion cueing performance signature and characteristic motion vibrations for simulators and Level 7 helicopter FTDs. The proposal only requires that the motion cueing performance signature and the characteristic motion vibrations be recorded while currently required tests are being conducted. The motion cueing performance signature is the motion system response recorded during certain objective tests. The characteristic motion vibrations are the motion system response recorded during certain subjective tests.

These proposed requirements would provide for more comprehensive simulator assessments. The additional cost for implementation would be either negligible or no cost. These requirements would also harmonize with the international standards document.

<sup>3</sup> See Appendix A of this part, Attachment 2, para. 4.

#### *D. New Requirements for Visual Systems for Level C and D Full Flight Simulators*

The FAA proposes technical changes for visual systems on Level C and Level D simulators. For example, the FAA proposes that the surface resolution of objects in the visual scene must be able to be visually “resolved” at 2 arc minutes rather than 3 arc minutes. Also, the horizontal field of view requirements would be increased from 150° to 180°. The FAA believes these requirements would provide better training to pilots by improving visual cues and better replicating the outside views. These changes would also be consistent with the current international standards. The requirements of this proposal would not apply to current simulators and the overall costs applicable to new simulators are minimal to none.

#### *E. New Requirements for Sound Systems for Level D Simulators*

The FAA proposes new sound testing requirements for new Level D simulators. These requirements would specify basic and special case sound tests, and would be consistent with existing FAA advisory material, FAA regulations, and the standards developed by the international simulation working group. The proposal contains a standardized list of sounds that would be recorded and compared during initial and subsequent qualification evaluations. All new level D simulators would be tested for frequency response and background noise. There would also be specific tests based on whether the simulator is replicating a jet powered aircraft or a propeller powered aircraft. These tests would ensure accuracy in the overall sound quality of the device. This proposal codifies existing practice of measuring sounds and will result in no additional cost to the sponsor. These changes would also be consistent with the current international standards. The FAA has always required Level D simulators to have sounds recorded. These sounds are then measured and compared between the aircraft and the simulator and adjusted until they match to within stated tolerances. However, under current requirements there are inconsistencies with what sounds are to be recorded and what tolerances should be applied. The proposal specifies the portions of the flight envelope that must be recorded, therefore eliminating the previous inconsistencies.

#### *F. New Requirements for Subjective Testing Standards for Visual Scenes and Airport Models*

The proposed requirements for visual scene and airport models for FFSs would codify existing advisory material, and include the following:

1. Scene content—1 airport scene required for Level A and B; 3 airport scenes required for Level C and D. The scenes must contain specific details, both on-airport and off-airport.
2. Visual scene management.
3. Visual scene recognition.
4. Airport model content.
5. Surrounding visual features consistent with the airport environment.
6. The quality of visual scene, including correct color and realistic textural cues.
7. Instructor control of environment, airport selection, and lighting.

These requirements would be necessary to ensure a training environment that provides accurate simulation and allows pilots to practice skills using visual scenes and models encountered in actual operations. These requirements would be particularly helpful for pilots with lower flight experience levels.

In addition to codifying standards for the required visual scenes and airport models, the FAA also proposes requirements for visual scenes and airport models that are included in the device by the sponsor, but are not required for the qualification level. In the past, there were no established standards for optional scenes or airport models that a sponsor may have incorporated in an FSTD. This created inconsistencies in approval methods and in the training credits issued for tasks completed in a device that had capability beyond what was required for the stated qualification level. By establishing minimum requirements for these optional scenes and models, the FAA would be requiring the sponsor of each FSTD to meet at least the minimum content, and the device may be eligible for additional training credits for pilots.

The visual scenes and airport models currently available in any FFS that would be classified as Class II are beyond the number of visual scenes or airport models required for qualification and are likely to already meet the requirements being proposed. As previously described, in the event any Class II visual scene or airport model is found by the sponsor to be deficient in some way, the sponsor could remove that scene or model from the FFS library without jeopardizing the qualification status of the FFS. However, the sponsor,

at his option, may elect to bring the deficient aspect into compliance and retain the availability of that scene or model. Each sponsor has a full year to review each FFS during normal training, checking, or testing activities and determine the preferred course of action. For these reasons, the FAA has determined that in a few cases the cost for complying with this proposal would be minimal and in many cases there would be no cost to the sponsor.

#### *G. New Level 7 Helicopter FSTD Requirements*

The FAA is proposing a Level 7 Helicopter FTD QPS. There are currently no Level 7 helicopter FTDs. The standards proposed for this device would insure the quality of simulation necessary for the training and evaluation of flight crewmembers. The Level 7 FTD QPS would contain specific requirements for visual and motion systems. For example, the device would have to provide a visual system with a field of view of 150° x 40° for both pilots simultaneously and a motion cueing system that may consist of a platform motion system, a seat shaker system, or a strategically located bass speaker of sufficient response to provide an indication of rotor vibration and vibration changes with changes in RPM or collective input. The Level 7 device would expand the training capability for helicopter students. Because the Level 7 FTD is a new voluntary training option and would not be required for compliance with any training, testing or checking requirements, the proposal would not impose any additional cost on sponsors or manufacturers.

#### *H. Quality Management Systems*

The October 30, 2006, Final Rule established a Quality Management System (QMS) for FSTDs. The QMS is divided into two separate categories—a mandatory program and a voluntary program. This proposal would remove the details regarding the voluntary program from Appendix E. The proposal also clarifies the obligation of sponsors to be consistent in their conduct of internal assessments and clarifies the potential for increase in internal audit intervals.

Under the proposal, the National Simulator Program Manager (NSPM) would conduct continuing qualification evaluations of each FSTD every 12 months unless the NSPM becomes aware of discrepancies or performance problems with the device that warrants more frequent evaluations. The continuing qualification evaluations frequency could be extended beyond the 12-month interval if: (1) The sponsor

implements a voluntary QMS program; and (2) the NSPM determines that the administration of the QMS program and the FSTD performance justifies less frequent evaluations. However, in no case would the frequency of continuing qualification evaluations exceed 36 months.

#### *I. New Information on Operation and Testing Requirements for FSTDs*

The QPS material attached to this proposed rule adds 11 paragraphs of information to better explain the operation and testing requirements for FSTDs. The paragraphs provide information on the use of alternative data sources, alternative engines data, alternative avionics data, and engineering simulators to provide validation data. There are also information paragraphs on motion systems, sound systems, simulator qualifications for new or derivative airplanes, validation test tolerances, validation data roadmap, transport delay testing, and validation test data presentation.

#### **V. Regulatory Notices and Analyses**

##### **Privacy Impact Statement for Proposed 14 CFR Part 60, Appendices A Through F**

##### *Legal Requirements*

Section 522 of the Consolidated Appropriations Act of 2005 instructs DOT to conduct a privacy impact assessment (PIA) of proposed rules that will affect the privacy of individuals. The PIA should identify potential threats relating to the collection, handling, use, sharing and security of the data, the measures identified to mitigate these threats, and the rationale for the final decisions made for the rulemaking as a result of conducting the PIA.

##### *Definitions*

*Sponsor* means a certificate holder who seeks or maintains FSTD qualification and is responsible for the prescribed actions as prescribed in this part and the QPS for the appropriate FSTD and qualification level.

*Certificate holder* means a person issued a certificate under parts 119, 141, or 142 of this chapter or a person holding an approved course of training for flight engineers in accordance with part 63 of this chapter.

*Individual* means a living human being, specifically including a citizen of the United States or an alien lawfully admitted for permanent residence.

*Personally Identifiable Information (PII)* is any information that permits the identity of an individual to whom the

information applies to be reasonably inferred by either direct or indirect means, singly or in combination with other data. Examples of PII include but are not limited to physical and online contact information, Social Security number or driver's license number.

*Privacy Impact Assessment* is an analysis of how a rulemaking would impact the way information is handled in order to ensure data handling conforms to applicable legal, regulatory, and policy requirements regarding privacy, determine the risks and effects the rulemaking will have on collecting, maintaining and sharing PII, and examine and evaluate protections and alternative processes for handling information to mitigate potential privacy risks.

Requirements for the Submission and Retention of PII as Part of Compliance With Proposed 14 CFR part 60, Flight Simulation Training Device Initial and Continuing Qualification and Use

The FAA proposes to amend the QPS requirements for FSTDs. Compliance with the QPS requirements is the responsibility of the FSTD sponsor. There are approximately 60 FSTD sponsors.

The proposed rule does not require sponsors to submit PII to the FAA or to maintain PII in their own records. However, the FAA recognizes that certain PII may be contained in a sponsor's records, including information about individuals who have used a particular FSTD. This information may include the person's name, employer, duty position, and type ratings. The FAA may request a sponsor to disclose this PII for investigation, compliance, or enforcement purposes. For example, the FAA may request the sponsor to provide the names of all individuals trained on a specific device if the FAA discovered that the device was not adequately simulating the aircraft and determined that those individuals needed to be retrained or reevaluated.

The FAA protects PII in accordance with "*Privacy Act Notice DOT/FAA 847—Aviation Records on Individuals (formerly General Air Transportation Records on Individuals)*." The Privacy Act Notice is available at <http://cio.ost.dot.gov/DOT/OST/Documents/files/records.html>.

The FAA did not conduct a PIA for this rulemaking because there are no new requirements for PII as part of these QPS amendments. In August 2004, the FAA released a PIA for airmen certification records. The PIA addresses the methodology the agency uses to collect, store, distribute, and protect PII

for certificated airmen, including pilots. The PIA is available at [http://www.dot.gov/pia/faa\\_rms.htm](http://www.dot.gov/pia/faa_rms.htm). This PIA would apply to any PII the FAA may receive from a sponsor in the course of exercising its oversight authority.

For more information or for comments and concerns on our privacy practices, please contact our Privacy Officer, Carla Mauney at [carla.mauney@faa.gov](mailto:carla.mauney@faa.gov), or by phone at (202) 267-9895.

##### Paperwork Reduction Act

Information collection requirements associated with this NPRM have been approved previously by the Office of Management and Budget (OMB) under the provisions of the Paperwork Reduction Act of 1995 (44 U.S.C. 3507(d)) and have been assigned OMB Control Number 2120-0680.

##### International Compatibility

In keeping with U.S. obligations under the Convention on International Civil Aviation, it is FAA policy to comply with International Civil Aviation Organization (ICAO) Standards and Recommended Practices to the maximum extent practicable. The FAA has reviewed the corresponding ICAO Standards and Recommended Practices and has identified no differences with these proposed regulations.

##### Economic Assessment, Initial Regulatory Flexibility Determination, Trade Impact Assessment, and Unfunded Mandates Assessment

Changes to Federal regulations must undergo several economic analyses. First, Executive Order 12866 directs that each Federal agency shall propose or adopt a regulation only upon a reasoned determination that the benefits of the intended regulation justify its costs. Second, the Regulatory Flexibility Act of 1980 (Pub. L. 96-354) requires agencies to analyze the economic impact of regulatory changes on small entities. Third, the Trade Agreements Act (Pub. L. 96-39) prohibits agencies from setting standards that create unnecessary obstacles to the foreign commerce of the United States. In developing U.S. standards, the Trade Act requires agencies to consider international standards and, where appropriate, that they be the basis of U.S. standards. Fourth, the Unfunded Mandates Reform Act of 1995 (Pub. L. 104-4) requires agencies to prepare a written assessment of the costs, benefits, and other effects of proposed or final rules that include a Federal mandate likely to result in the expenditure by State, local, or tribal governments, in the aggregate, or by the private sector, of \$100 million or more annually (adjusted

for inflation with base year of 1995). This portion of the preamble summarizes the FAA's analysis of the economic impacts of this proposed rule.

Department of Transportation Order DOT 2100.5 prescribes policies and procedures for simplification, analysis, and review of regulations. If the expected cost impact is so minimal that a proposed or final rule does not warrant a full evaluation, this order permits that a statement to that effect and the basis for it to be included in the preamble if a full regulatory evaluation of the cost and benefits is not prepared. Such a determination has been made for this proposed rule. The reasoning for this determination follows:

The FAA proposes to codify existing practice by requiring all existing FSTD visual scenes beyond the number required for qualification to meet specified requirements. The proposal also reorganizes certain sections of the QPS appendices and provides additional information on validation tests, established parameters for tolerances, acceptable data formats, and the use of alternative data sources. The proposed changes would ensure that the training and testing environment is accurate and realistic, would codify existing practice, and would provide greater harmonization with the international standards document for simulation. None of these proposed technical requirements would apply to simulators qualified before May 30, 2008, except for the proposal to codify existing practice regarding certain visual scene requirements. The overall impact of this proposal would result in minimal to no cost increases for manufacturers and sponsors.

The FAA has, therefore, determined that this proposed rule is not a "significant regulatory action" as defined in section 3(f) of Executive Order 12866, and is not "significant" as defined in DOT's Regulatory Policies and Procedures.

#### Regulatory Flexibility Determination

The Regulatory Flexibility Act of 1980 (Pub. L. 96-354) (RFA) establishes "as a principle of regulatory issuance that agencies shall endeavor, consistent with the objectives of the rule and of applicable statutes, to fit regulatory and informational requirements to the scale of the businesses, organizations, and governmental jurisdictions subject to regulation. To achieve this principle, agencies are required to solicit and consider flexible regulatory proposals and to explain the rationale for their actions to assure that such proposals are given serious consideration." The RFA covers a wide-range of small entities,

including small businesses, not-for-profit organizations, and small governmental jurisdictions.

Agencies must perform a review to determine whether a rule will have a significant economic impact on a substantial number of small entities. If the agency determines that it will, the agency must prepare a regulatory flexibility analysis as described in the RFA.

However, if an agency determines that a rule is not expected to have a significant economic impact on a substantial number of small entities, section 605(b) of the RFA provides that the head of the agency may so certify and a regulatory flexibility analysis is not required. The certification must include a statement providing the factual basis for this determination, and the reasoning should be clear.

The FAA proposes to codify existing practice by requiring all existing FSTD visual scenes beyond the number required for qualification to meet specified requirements. The proposal also reorganizes certain sections of the QPS appendices and provides additional information on validation tests, established parameters for tolerances, acceptable data formats, and the use of alternative data sources. The proposed changes would ensure that the training and testing environment is accurate and more realistic, would codify existing practice, and would provide greater harmonization with the international standards document for simulation. None of these proposed technical requirements would apply to simulators qualified before May 30, 2008, except for the proposal to codify existing practice regarding certain visual scene requirements. The overall impact of this proposal would result in minimal to no cost increases for manufacturers and sponsors. Therefore the FAA certifies that this proposed rule would not have a significant economic impact on a substantial number of small entities. The FAA solicits comments regarding this determination.

#### International Trade Impact Assessment

The Trade Agreements Act of 1979 (Pub. L. 96-39) prohibits Federal agencies from establishing any standards or engaging in related activities that create unnecessary obstacles to the foreign commerce of the United States. Legitimate domestic objectives, such as safety, are not considered unnecessary obstacles. The statute also requires consideration of international standards and, where appropriate, that they be the basis for U.S. standards. The FAA has assessed the potential effect of this proposed rule

and has determined that it would impose the same costs on domestic and international entities and thus has a neutral trade impact.

#### Unfunded Mandates Assessment

Title II of the Unfunded Mandates Reform Act of 1995 (Pub. L. 104-4) requires each Federal agency to prepare a written statement assessing the effects of any Federal mandate in a proposed or final agency rule that may result in an expenditure of \$100 million or more (adjusted annually for inflation with the base year 1995) in any one year by State, local, and tribal governments, in the aggregate, or by the private sector; such a mandate is deemed to be a "significant regulatory action." The FAA currently uses an inflation-adjusted value of \$128.1 million in lieu of \$100 million. This proposed rule does not contain such a mandate.

#### Executive Order 13132, Federalism

The FAA has analyzed this notice of proposed rulemaking under the principles and criteria of Executive Order 13132, Federalism. We determined that this proposal will not have a substantial direct effect on the States, on the relationship between the national Government and the States, or on the distribution of power and responsibilities among the various levels of government. Therefore, we determined that this proposed rule will not have federalism implications.

#### Environmental Analysis

FAA Order 1050.1E identifies FAA actions that are categorically excluded from preparation of an environmental assessment or environmental impact statement under the National Environmental Policy Act in the absence of extraordinary circumstances. The FAA has determined this proposed rule action qualifies for the categorical exclusion identified in paragraph 312f and involves no extraordinary circumstances.

#### Regulations That Significantly Affect Energy Supply, Distribution, or Use

The FAA has analyzed this proposed rule under Executive Order 13211, Actions Concerning Regulations that Significantly Affect Energy Supply, Distribution, or Use (May 18, 2001). We have determined that it is not a "significant energy action" under the executive order because it is not a "significant regulatory action" under Executive Order 12866, and it is not likely to have a significant adverse effect on the supply, distribution, or use of energy.

## Additional Information

## Comments Invited

The FAA invites interested persons to participate in this rulemaking by submitting written comments, data, or views. We also invite comments relating to the economic, environmental, energy, or federalism impacts that might result from adopting the proposals in this document. The most helpful comments reference a specific portion of the proposal, explain the reason for any recommended change, and include supporting data. To ensure the docket does not contain duplicate comments, please send only one copy of written comments, or if you are filing comments electronically, please submit your comments only one time.

We will file in the docket all comments we receive, as well as a report summarizing each substantive public contact with FAA personnel concerning this proposed rulemaking. Before acting on this proposal, we will consider all comments we receive on or before the closing date for comments. We will consider comments filed after the comment period has closed if it is possible to do so without incurring expense or delay. We may change this proposal in light of the comments we receive.

## Proprietary or Confidential Business Information

Do not file in the docket information that you consider to be proprietary or confidential business information. Send or deliver this information directly to the person identified in the **FOR FURTHER INFORMATION CONTACT** section of this document. You must mark the information that you consider proprietary or confidential. If you send the information on a disk or CD-ROM, mark the outside of the disk or CD-ROM and also identify electronically within the disk or CD-ROM the specific information that is proprietary or confidential.

Under 14 CFR 11.35(b), when we are aware of proprietary information filed with a comment, we do not place it in the docket. We hold it in a separate file to which the public does not have access, and we place a note in the docket that we have received it. If we receive a request to examine or copy this information, we treat it as any other request under the Freedom of Information Act (5 U.S.C. 552). We process such a request under the DOT procedures found in 49 CFR part 7.

## Availability of Rulemaking Documents

You can get an electronic copy of rulemaking documents using the Internet by—

1. Searching the Federal eRulemaking Portal (<http://www.regulations.gov>);
2. Visiting the FAA's Regulations and Policies Web page at [http://www.faa.gov/regulations\\_policies/](http://www.faa.gov/regulations_policies/); or
3. Accessing the Government Printing Office's Web page at <http://www.gpoaccess.gov/fr/index.html>.

You can also get a copy by sending a request to the Federal Aviation Administration, Office of Rulemaking, ARM-1, 800 Independence Avenue, SW., Washington, DC 20591, or by calling (202) 267-9680. Make sure to identify the docket number, notice number, or amendment number of this rulemaking.

**List of Subjects in 14 CFR Part 60**

Airmen, Aviation safety, Reporting and recordkeeping requirements.

**The Proposed Amendment**

In consideration of the foregoing, the Federal Aviation Administration proposes to further amend the final rule amending part 60 of Title 14 of the Code of Federal Regulations, as published at 71 FR 63392 on October 30, 2006, as follows:

**PART 60—FLIGHT SIMULATION TRAINING DEVICE INITIAL AND CONTINUING QUALIFICATION AND USE**

1. The authority citation for part 60 continues to read as follows:

**Authority:** 49 U.S.C. 106(g), 40113, and 44701.

2. Part 60, published at 71 FR 63392 on October 30, 2006 is amended by revising appendices A–F to read as follows:

**Appendix A to Part 60—Qualification Performance Standards for Airplane Full Flight Simulators***Begin Information*

This appendix establishes the standards for Airplane Full Flight Simulator (FFS) evaluation and qualification. The Flight Standards Service, National Simulator Program Manager (NSPM), is responsible for the development, application, and implementation of the standards contained within this appendix. The procedures and criteria specified in this appendix will be used by the NSPM, or a person assigned by the NSPM, when conducting airplane FFS evaluations.

**Table of Contents**

1. Introduction

2. Applicability (§§ 60.1 and 60.2)
  3. Definitions (§ 60.3)
  4. Qualification Performance Standards (§ 60.4)
  5. Quality Management System (§ 60.5)
  6. Sponsor Qualification Requirements (§ 60.7)
  7. Additional Responsibilities of the Sponsor (§ 60.9)
  8. FSTD Use (§ 60.11)
  9. FSTD Objective Data Requirements (§ 60.13)
  10. Special Equipment and Personnel Requirements for Qualification of the FSTD (§ 60.14)
  11. Initial (and Upgrade) Qualification Requirements (§ 60.15)
  12. Additional Qualifications for a Currently Qualified FSTD (§ 60.16)
  13. Previously Qualified FSTDs (§ 60.17)
  14. Inspection, Continuing Qualification Evaluation, and Maintenance Requirements (§ 60.19)
  15. Logging FSTD Discrepancies (§ 60.20)
  16. Interim Qualification of FSTDs for New Airplane Types or Models (§ 60.21)
  17. Modifications to FSTDs (§ 60.23)
  18. Operations with Missing, Malfunctioning, or Inoperative Components (§ 60.25)
  19. Automatic Loss of Qualification and Procedures for Restoration of Qualification (§ 60.27)
  20. Other Losses of Qualification and Procedures for Restoration of Qualification (§ 60.29)
  21. Recordkeeping and Reporting (§ 60.31)
  22. Applications, Logbooks, Reports, and Records: Fraud, Falsification, or Incorrect Statements (§ 60.33)
  23. Specific Full Flight Simulator Compliance Requirements (§ 60.35)
  24. [Reserved]
  25. FSTD Qualification on the Basis of a Bilateral Aviation Safety Agreement (BASA) (§ 60.37)
- Attachment 1 to Appendix A to Part 60—General Simulator Requirements  
Attachment 2 to Appendix A to Part 60—Full Flight Simulator Objective Tests  
Attachment 3 to Appendix A to Part 60—Simulator Subjective Evaluation  
Attachment 4 to Appendix A to Part 60—Sample Documents  
Attachment 5 to Appendix A to Part 60—Simulator Qualification Requirements for Windshear Training Program Use  
Attachment 6 to Appendix A to Part 60—FSTD Directives Applicable to Airplane Flight Simulators

**End Information****1. Introduction****Begin Information**

a. This appendix contains background information as well as regulatory and informative material as described later in this section. To assist the reader in determining what areas are required and what areas are permissive, the text in this appendix is divided into two sections: "QPS Requirements" and "Information." The QPS Requirements sections contain details regarding compliance with the part 60 rule



language. These details are regulatory, but are found only in this appendix. The Information sections contain material that is advisory in nature, and designed to give the user general information about the regulation.

b. Questions regarding the contents of this publication should be sent to the U.S. Department of Transportation, Federal Aviation Administration, Flight Standards Service, National Simulator Program Staff, AFS-205, 100 Hartsfield Centre Parkway, Suite 400, Atlanta, Georgia, 30354. Telephone contact numbers for the NSP are: phone, 404-832-4700; fax, 404-761-8906. The general email address for the NSP office is: [9-aso-avr-sim-team@faa.gov](mailto:9-aso-avr-sim-team@faa.gov). The NSP Internet Web Site address is: [http://www.faa.gov/safety/programs\\_initiatives/aircraft\\_aviation/nsp/](http://www.faa.gov/safety/programs_initiatives/aircraft_aviation/nsp/). On this Web Site you will find an NSP personnel list with telephone and email contact information for each NSP staff member, a list of qualified flight simulation devices, advisory circulars, a description of the qualification process, NSP policy, and an NSP "In-Works" section. Also linked from this site are additional information sources, handbook bulletins, frequently asked questions, a listing and text of the Federal Aviation Regulations, Flight Standards Inspector's handbooks, and other FAA links.

c. The NSPM encourages the use of electronic media for all communication, including any record, report, request, test, or statement required by this appendix. The electronic media used must have adequate security provisions and be acceptable to the NSPM. The NSPM recommends inquiries on system compatibility, and minimum system requirements are also included on the NSP Web site.

d. Related Reading References.

- (1) 14 CFR part 60.
- (2) 14 CFR part 61.
- (3) 14 CFR part 63.
- (4) 14 CFR part 119.
- (5) 14 CFR part 121.
- (6) 14 CFR part 125.
- (7) 14 CFR part 135.
- (8) 14 CFR part 141.
- (9) 14 CFR part 142.
- (10) Advisory Circular (AC) 120-28C,

Criteria for Approval of Category III Landing Weather Minima.

(11) AC 120-29, Criteria for Approving Category I and Category II Landing Minima for part 121 operators.

(12) AC 120-35B, Line Operational Simulations: Line-Oriented Flight Training, Special Purpose Operational Training, Line Operational Evaluation.

(13) AC 120-41, Criteria for Operational Approval of Airborne Wind Shear Alerting and Flight Guidance Systems.

(14) AC 120-57A, Surface Movement Guidance and Control System (SMGS).

(15) AC 150/5300-13, Airport Design.

(16) AC 150/5340-1G, Standards for Airport Markings.

(17) AC 150/5340-4C, Installation Details for Runway Centerline Touchdown Zone Lighting Systems.

(18) AC 150/5340-19, Taxiway Centerline Lighting System.

(19) AC 150/5340-24, Runway and Taxiway Edge Lighting System.

(20) AC 150/5345-28D, Precision Approach Path Indicator (PAPI) Systems.

(21) International Air Transport Association document, "Flight Simulator Design and Performance Data Requirements," as amended.

(22) AC 25-7, as amended, Flight Test Guide for Certification of Transport Category Airplanes.

(23) AC 23-8A, as amended, Flight Test Guide for Certification of Part 23 Airplanes.

(24) International Civil Aviation Organization (ICAO) Manual of Criteria for the Qualification of Flight Simulators, as amended.

(25) Airplane Flight Simulator Evaluation Handbook, Volume I, as amended and Volume II, as amended, The Royal Aeronautical Society, London, UK.

(26) FAA Publication FAA-S-8081 series (Practical Test Standards for Airline Transport Pilot Certificate, Type Ratings, Commercial Pilot, and Instrument Ratings).

(27) The FAA Aeronautical Information Manual (AIM). An electronic version of the AIM is on the Internet at <http://www.faa.gov/atpubs>.

## End Information

## 2. Applicability (§§ 60.1 and 60.2)

### Begin Information

No additional regulatory or informational material applies to § 60.1, Applicability, or to § 60.2, Applicability of sponsor rules to persons who are not sponsors and who are engaged in certain unauthorized activities.

### End Information

## 3. Definitions (§ 60.3)

### Begin Information

See Appendix F of this part for a list of definitions and abbreviations from part 1 and part 60, including the appropriate appendices of part 60.

### End Information

## 4. Qualification Performance Standards (§ 60.4)

### Begin Information

No additional regulatory or informational material applies to § 60.4, Qualification Performance Standards.

### End Information

## 5. Quality Management System (§ 60.5)

### Begin Information

See Appendix E of this part for additional regulatory and informational material regarding Quality Management Systems.

### End Information

## 6. Sponsor Qualification Requirements (§ 60.7)

### Begin Information

a. The intent of the language in § 60.7(b) is to have a specific FFS, identified by the sponsor, used at least once in an FAA-approved flight training program for the airplane simulated during the 12-month period described. The identification of the specific FFS may change from one 12-month period to the next 12-month period as long as the sponsor sponsors and uses at least one FFS at least once during the prescribed period. No minimum number of hours or minimum FFS periods are required.

b. The following examples describe acceptable operational practices:

(1) Example One.

(a) A sponsor is sponsoring a single, specific FFS for its own use, in its own facility or elsewhere—this single FFS forms the basis for the sponsorship. The sponsor uses that FFS at least once in each 12-month period in the sponsor's FAA-approved flight training program for the airplane simulated. This 12-month period is established according to the following schedule:

(i) If the FFS was qualified prior to May 30, 2008, the 12-month period begins on the date of the first continuing qualification evaluation conducted in accordance with § 60.19 after May 30, 2008, and continues for each subsequent 12-month period;

(ii) A device qualified on or after May 30, 2008, will be required to undergo an initial or upgrade evaluation in accordance with § 60.15. Once the initial or upgrade evaluation is complete, the first continuing qualification evaluation will be conducted within 6 months. The 12-month continuing qualification evaluation cycle begins on that date and continues for each subsequent 12-month period.

(b) There is no minimum number of hours of FFS use required.

(c) The identification of the specific FFS may change from one 12-month period to the next 12-month period as long as the sponsor sponsors and uses at least one FFS at least once during the prescribed period.

(2) Example Two.

(a) A sponsor sponsors an additional number of FFSs, in its facility or elsewhere. Each additionally sponsored FFS must be—

(i) Used by the sponsor in the sponsor's FAA-approved flight training program for the airplane simulated (as described in § 60.7(d)(1)); OR

(ii) Used by another FAA certificate holder in that other certificate holder's FAA-approved flight training program for the airplane simulated (as described in § 60.7(d)(1)). This 12-month period is established in the same manner as in example one; OR

(iii) Provided a statement each year from a qualified pilot, (after having flown the airplane, not the subject FFS or another FFS, during the preceding 12-month period) stating that the subject FFSs performance and handling qualities represent the airplane (as described in § 60.7(d)(2)). This statement is provided at least once in each 12-month period established in the same manner as in example one.

(b) No minimum number of hours of FFS use is required.

(3) Example Three.

(a) A sponsor in New York (in this example, a Part 142 certificate holder) establishes "satellite" training centers in Chicago and Moscow.

(b) The satellite function means that the Chicago and Moscow centers must operate under the New York center's certificate (in accordance with all of the New York center's practices, procedures, and policies; e.g., instructor and/or technician training/checking requirements, record keeping, QMS program).

(c) All of the FFSs in the Chicago and Moscow centers could be dry-leased (i.e., the certificate holder does not have and use FAA-approved flight training programs for the FFSs in the Chicago and Moscow centers) because—

(i) Each FFS in the Chicago center and each FFS in the Moscow center is used at least once each 12-month period by another FAA certificate holder in that other certificate holder's FAA-approved flight training program for the airplane (as described in § 60.7(d)(1)); or

(ii) A statement is obtained from a qualified pilot (having flown the airplane, not the subject FFS or another FFS during the preceding 12-month period) stating that the performance and handling qualities of each FFS in the Chicago and Moscow centers represents the airplane (as described in § 60.7(d)(2)).

#### End Information

### 7. Additional Responsibilities of the Sponsor (§ 60.9)

#### Begin Information

The phrase "as soon as practicable" in § 60.9(a) means without unnecessarily disrupting or delaying beyond a reasonable time the training, evaluation, or experience being conducted in the FSTD.

#### End Information

### 8. FSTD Use (§ 60.11)

#### Begin Information

No additional regulatory or informational material applies to § 60.11, Simulator Use.

#### End Information

### 9. FSTD Objective Data Requirements (§ 60.13)

#### Begin QPS Requirements

a. Flight test data used to validate FFS performance and handling qualities must have been gathered in accordance with a flight test program containing the following:

(1) A flight test plan consisting of:

(a) The maneuvers and procedures required for aircraft certification and simulation programming and validation.

(b) For each maneuver or procedure—

(i) The procedures and control input the flight test pilot and/or engineer used.

(ii) The atmospheric and environmental conditions.

(iii) The initial flight conditions.

(iv) The airplane configuration, including weight and center of gravity.

(v) The data to be gathered.

(vi) All other information necessary to recreate the flight test conditions in the FFS.

(2) Appropriately qualified flight test personnel.

(3) An understanding of the accuracy of the data to be gathered using appropriate alternative data sources, procedures, and instrumentation that is traceable to a recognized standard as described in Attachment 2, Table A2E.

(4) Appropriate and sufficient data acquisition equipment or system(s), including appropriate data reduction and analysis methods and techniques, as would be acceptable to the FAA's Aircraft Certification Service.

b. The data, regardless of source, must be presented:

(1) In a format that supports the FFS validation process;

(2) In a manner that is clearly readable and annotated correctly and completely;

(3) With resolution sufficient to determine compliance with the tolerances set forth in Attachment 2, Table A2A of this appendix.

(4) With any necessary instructions or other details provided, such as yaw damper or throttle position; and

(5) Without alteration, adjustments, or bias; however the data may be re-scaled, digitized, or otherwise manipulated to fit the desired presentation.

c. After completion of any additional flight test, a flight test report must be submitted in support of the validation data. The report must contain sufficient data and rationale to support qualification of the FFS at the level requested.

d. As required by § 60.13(f), the sponsor must notify the NSPM when it becomes aware that an addition to, an amendment to, or a revision of data that may relate to FFS performance or handling characteristics is available. The data referred to in this paragraph are those data that are used to validate the performance, handling qualities, or other characteristics of the aircraft, including data related to any relevant changes occurring after the type certificate was issued. The sponsor must—

(1) Within 10 calendar days, notify the NSPM of the existence of this data; and

(2) Within 45 calendar days, notify the NSPM of—

(a) The schedule to incorporate this data into the FFS; or

(b) The reason for not incorporating this data into the FFS.

e. In those cases where the objective test results authorize a "snapshot test" or a "series of snapshot tests" results in lieu of a time-history result, the sponsor or other data provider must ensure that a steady state condition exists at the instant of time captured by the "snapshot." The steady state condition must exist from 4 seconds prior to, through 1 second following, the instant of time captured by the snapshot.

#### End QPS Requirements

#### Begin Information

f. The FFS sponsor is encouraged to maintain a liaison with the manufacturer of the aircraft being simulated (or with the holder of the aircraft type certificate for the aircraft being simulated if the manufacturer is no longer in business), and, if appropriate, with the person having supplied the aircraft data package for the FFS in order to facilitate the notification required by § 60.13(f).

g. It is the intent of the NSPM that for new aircraft entering service, at a point well in advance of preparation of the Qualification Test Guide (QTG), the sponsor should submit to the NSPM for approval, a descriptive document (a validation data roadmap) containing the plan for acquiring the validation data, including data sources. This document should clearly identify sources of data for all required tests, a description of the validity of these data for a specific engine type and thrust rating configuration, and the revision levels of all avionics affecting the performance or flying qualities of the aircraft. Additionally, this document should provide other information, such as the rationale or explanation for cases where data or data parameters are missing, instances where engineering simulation data are used or where flight test methods require further explanations. It should also provide a brief narrative describing the cause and effect of any deviation from data requirements. The aircraft manufacturer may provide this document.

h. There is no requirement for any flight test data supplier to submit a flight test plan or program prior to gathering flight test data. However, the NSPM notes that inexperienced data gatherers often provide data that is irrelevant, improperly marked, or lacking adequate justification for selection. Other problems include inadequate information regarding initial conditions or test maneuvers. The NSPM has been forced to refuse these data submissions as validation data for an FFS evaluation. It is for this reason that the NSPM recommends that any data supplier not previously experienced in this area review the data necessary for programming and for validating the performance of the FFS, and discuss the flight test plan anticipated for acquiring such data with the NSPM well in advance of commencing the flight tests.

i. The NSPM will consider, on a case-by-case basis, whether or not to approve supplemental validation data derived from flight data recording systems such as a Quick Access Recorder or Flight Data Recorder.

#### End Information

### 10. Special Equipment and Personnel Requirements for Qualification of the FSTDs (§ 60.14)

#### Begin Information

a. In the event that the NSPM determines that special equipment or specifically qualified persons will be required to conduct

an evaluation, the NSPM will make every attempt to notify the sponsor at least one (1) week, but in no case less than 72 hours, in advance of the evaluation. Examples of special equipment include spot photometers, flight control measurement devices, and sound analyzers. Examples of specially qualified personnel include individuals specifically qualified to install or use any special equipment when its use is required.

b. Examples of a special evaluation include an evaluation conducted after an FFS is moved, at the request of the TPAA, or as a result of comments received from users of the FFS that raise questions about the continued qualification or use of the FFS.

#### End Information

### 11. Initial (and Upgrade) Qualification Requirements (§ 60.15)

#### Begin QPS Requirements

a. In order to be qualified at a particular qualification level, the FFS must:

(1) Meet the general requirements listed in Attachment 1;

(2) Meet the objective testing requirements listed in Attachment 2; and

(3) Satisfactorily accomplish the subjective tests listed in Attachment 3.

b. The request described in § 60.15(a) must include all of the following:

(1) A statement that the FFS meets all of the applicable provisions of this part and all applicable provisions of the QPS.

(2) A confirmation that the sponsor will forward to the NSPM the statement described in § 60.15(b) in such time as to be received no later than 5 business days prior to the scheduled evaluation and may be forwarded to the NSPM via traditional or electronic means.

(3) A qualification test guide (QTG), acceptable to the NSPM, that includes all of the following:

(a) Objective data obtained from aircraft testing or another approved source.

(bi) Correlating objective test results obtained from the performance of the FFS as prescribed in the appropriate QPS.

(c) The result of FFS subjective tests prescribed in the appropriate QPS.

(d) A description of the equipment necessary to perform the evaluation for initial qualification and the continuing qualification evaluations.

c. The QTG described in paragraph (a)(3) of this section, must provide the documented proof of compliance with the simulator objective tests in Attachment 2, Table A2A of this appendix.

d. The QTG is prepared and submitted by the sponsor, or the sponsor's agent on behalf of the sponsor, to the NSPM for review and approval, and must include, for each objective test:

(1) Parameters, tolerances, and flight conditions;

(2) Pertinent and complete instructions for the conduct of automatic and manual tests;

(3) A means of comparing the FFS test results to the objective data;

(4) Any other information as necessary, to assist in the evaluation of the test results;

(5) Other information appropriate to the qualification level of the FFS.

e. The QTG described in paragraphs (a)(3) and (b) of this section, must include the following:

(1) A QTG cover page with sponsor and FAA approval signature blocks (see Attachment 4, Figure A4C, for a sample QTG cover page).

(2) A continuing qualification evaluation requirements page. This page will be used by the NSPM to establish and record the frequency with which continuing qualification evaluations must be conducted and any subsequent changes that may be determined by the NSPM in accordance with § 60.19. See Attachment 4, Figure A4G, for a sample Continuing Qualification Evaluation Requirements page.

(3) An FFS information page that provides the information listed in this paragraph (see Attachment 4, Figure A4B, for a sample FFS information page). For convertible FFSs, the sponsor must submit a separate page for each configuration of the FFS.

(a) The sponsor's FFS identification number or code.

(b) The airplane model and series being simulated.

(c) The aerodynamic data revision number or reference.

(d) The source of the basic aerodynamic model and the aerodynamic coefficient data used to modify the basic model.

(e) The engine model(s) and its data revision number or reference.

(f) The flight control data revision number or reference.

(g) The flight management system identification and revision level.

(h) The FFS model and manufacturer.

(i) The date of FFS manufacture.

(j) The FFS computer identification.

(k) The visual system model and manufacturer, including display type.

(l) The motion system type and manufacturer, including degrees of freedom.

(4) A Table of Contents.

(5) A log of revisions and a list of effective pages.

(6) A list of all relevant data references.

(7) A glossary of terms and symbols used (including sign conventions and units).

(8) Statements of compliance and capability (SOCs) with certain requirements. SOC's must provide references to the sources of information that show the capability of the FFS to comply with the requirement, a rationale explaining how the referenced material is used, mathematical equations and parameter values used, and the conclusions reached; i.e., that the FFS complies with the requirement.

(9) Recording procedures or equipment required to accomplish the objective tests.

(10) The following information for each objective test designated in Attachment 2, Table A2A, as applicable to the qualification level sought:

(a) Name of the test.

(b) Objective of the test.

(c) Initial conditions.

(d) Manual test procedures.

(e) Automatic test procedures (if applicable).

(f) Method for evaluating FFS objective test results.

(g) List of all relevant parameters driven or constrained during the automatically conducted test(s).

(h) List of all relevant parameters driven or constrained during the manually conducted test(s).

(i) Tolerances for relevant parameters.

(j) Source of Validation Data (document and page number).

(k) Copy of the Validation Data (if located in a separate binder, a cross reference for the identification and page number for pertinent data location must be provided).

(l) Simulator Objective Test Results as obtained by the sponsor. Each test result must reflect the date completed and must be clearly labeled as a product of the device being tested.

f. A convertible FFS is addressed as a separate FFS for each model and series airplane to which it will be converted and for the FAA qualification level sought. If a sponsor seeks qualification for two or more models of an airplane type using a convertible FFS, the sponsor must submit a QTG for each airplane model, or a QTG for the first airplane model and a supplement to that QTG for each additional airplane model. The NSPM will conduct evaluations for each airplane model.

g. Form and manner of presentation of objective test results in the QTG:

(1) The sponsor's FFS test results must be recorded in a manner acceptable to the NSPM, that allows easy comparison of the FFS test results to the validation data (e.g., use of a multi-channel recorder, line printer, cross plotting, overlays, transparencies).

(2) FFS results must be labeled using terminology common to airplane parameters as opposed to computer software identifications.

(3) Validation data documents included in a QTG may be photographically reduced only if such reduction will not alter the graphic scaling or cause difficulties in scale interpretation or resolution.

(4) Scaling on graphical presentations must provide the resolution necessary to evaluate the parameters shown in Attachment 2, Table A2A of this appendix.

(5) Tests involving time histories, data sheets (or transparencies thereof) and FFS test results must be clearly marked with appropriate reference points to ensure an accurate comparison between the FFS and the airplane with respect to time. Time histories recorded via a line printer are to be clearly identified for cross plotting on the airplane data. Over-plots must not obscure the reference data.

h. The sponsor may elect to complete the QTG objective and subjective tests at the manufacturer's facility or at the sponsor's training facility. If the tests are conducted at the manufacturer's facility, the sponsor must repeat at least one-third of the tests at the sponsor's training facility in order to substantiate FFS performance. The QTG must be clearly annotated to indicate when and where each test was accomplished. Tests conducted at the manufacturer's facility and at the sponsor's training facility must be conducted after the FFS is assembled with systems and sub-systems functional and operating in an interactive manner. The test results must be submitted to the NSPM.

i. The sponsor must maintain a copy of the MQTG at the FFS location.

j. All FFSs for which the initial qualification is conducted after May 30, 2014, must have an electronic MQTG (eMQTG) including all objective data obtained from airplane testing, or another approved source (reformatted or digitized), together with correlating objective test results obtained from the performance of the FFS (reformatted or digitized) as prescribed in this appendix. The eMQTG must also contain the general FFS performance or demonstration results (reformatted or digitized) prescribed in this appendix, and a description of the equipment necessary to perform the initial qualification evaluation and the continuing qualification evaluations. The eMQTG must include the original validation data used to validate FFS performance and handling qualities in either the original digitized format from the data supplier or an electronic scan of the original time-history plots that were provided by the data supplier. A copy of the eMQTG must be provided to the NSPM.

k. All other FFSs not covered in subparagraph "j" must have an electronic copy of the MQTG by May 30, 2014. A copy of the eMQTG must be provided to the NSPM. This may be provided by an electronic scan presented in a Portable Document File (PDF), or similar format acceptable to the NSPM.

l. During the initial (or upgrade) qualification evaluation conducted by the NSPM, the sponsor must also provide a person who is a user of the device (e.g., a qualified pilot or instructor pilot with flight time experience in that aircraft) and knowledgeable about the operation of the aircraft and the operation of the FFS.

#### End QPS Requirements

#### Begin Information

m. Only those FFSs that are sponsored by a certificate holder as defined in Appendix F will be evaluated by the NSPM. However, other FFS evaluations may be conducted on a case-by-case basis as the Administrator deems appropriate, but only in accordance with applicable agreements.

n. The NSPM will conduct an evaluation for each configuration, and each FFS must be evaluated as completely as possible. To ensure a thorough and uniform evaluation, each FFS is subjected to the general simulator requirements in Attachment 1, the objective tests listed in Attachment 2, and the subjective tests listed in Attachment 3 of this appendix. The evaluations described herein will include, but not necessarily be limited to the following:

(1) Airplane responses, including longitudinal and lateral-directional control responses (see Attachment 2 of this appendix);

(2) Performance in authorized portions of the simulated airplane's operating envelope, to include tasks evaluated by the NSPM in the areas of surface operations, takeoff, climb, cruise, descent, approach, and landing as well as abnormal and emergency operations (see Attachment 2 of this appendix);

(3) Control checks (see Attachment 1 and Attachment 2 of this appendix);

(4) Flight deck configuration (see Attachment 1 of this appendix);

(5) Pilot, flight engineer, and instructor station functions checks (see Attachment 1 and Attachment 3 of this appendix);

(6) Airplane systems and sub-systems (as appropriate) as compared to the airplane simulated (see Attachment 1 and Attachment 3 of this appendix);

(7) FFS systems and sub-systems, including force cueing (motion), visual, and aural (sound) systems, as appropriate (see Attachment 1 and Attachment 2 of this appendix); and

(8) Certain additional requirements, depending upon the qualification level sought, including equipment or circumstances that may become hazardous to the occupants. The sponsor may be subject to Occupational Safety and Health Administration requirements.

o. The NSPM administers the objective and subjective tests, which includes an examination of functions. The tests include a qualitative assessment of the FFS by an NSP pilot. The NSP evaluation team leader may assign other qualified personnel to assist in accomplishing the functions examination and/or the objective and subjective tests performed during an evaluation when required.

(1) Objective tests provide a basis for measuring and evaluating FFS performance and determining compliance with the requirements of this part.

(2) Subjective tests provide a basis for:

(a) Evaluating the capability of the FFS to perform over a typical utilization period;

(b) Determining that the FFS satisfactorily simulates each required task;

(c) Verifying correct operation of the FFS controls, instruments, and systems; and

(d) Demonstrating compliance with the requirements of this part.

p. The tolerances for the test parameters listed in Attachment 2 of this appendix reflect the range of tolerances acceptable to the NSPM for FFS validation and are not to be confused with design tolerances specified for FFS manufacture. In making decisions regarding tests and test results, the NSPM relies on the use of operational and engineering judgment in the application of data (including consideration of the way in which the flight test was flown and way the data was gathered and applied) data presentations, and the applicable tolerances for each test.

q. In addition to the scheduled continuing qualification evaluation, each FFS is subject to evaluations conducted by the NSPM at any time without prior notification to the sponsor. Such evaluations would be accomplished in a normal manner (i.e., requiring exclusive use of the FFS for the conduct of objective and subjective tests and an examination of functions) if the FFS is not being used for flight crewmember training, testing, or checking. However, if the FFS were being used, the evaluation would be conducted in a non-exclusive manner. This non-exclusive evaluation will be conducted by the FFS evaluator accompanying the check airman, instructor, Aircrew Program

Designee (APD), or FAA inspector aboard the FFS along with the student(s) and observing the operation of the FFS during the training, testing, or checking activities.

r. Problems with objective test results are handled as follows:

(1) If a problem with an objective test result is detected by the NSP evaluation team during an evaluation, the test may be repeated or the QTG may be amended.

(2) If it is determined that the results of an objective test do not support the level requested but do support a lower level, the NSPM may qualify the FFS at that lower level. For example, if a Level D evaluation is requested and the FFS fails to meet sound test tolerances, it could be qualified at Level C.

s. After an FFS is successfully evaluated, the NSPM issues a Statement of Qualification (SOQ) to the sponsor. The NSPM recommends the FFS to the TPAA, who will approve the FFS for use in a flight training program. The SOQ will be issued at the satisfactory conclusion of the initial or continuing qualification evaluation and will list the tasks for which the FSTD is qualified, referencing the tasks described in Table A1B in attachment 1. However, it is the sponsor's responsibility to obtain TPAA approval prior to using the FSTD in an FAA-approved flight training program.

t. Under normal circumstances, the NSPM establishes a date for the initial or upgrade evaluation within ten (10) working days after determining that a complete QTG is acceptable. Unusual circumstances may warrant establishing an evaluation date before this determination is made. A sponsor may schedule an evaluation date as early as 6 months in advance. However, there may be a delay of 45 days or more in rescheduling and completing the evaluation if the sponsor is unable to meet the scheduled date. See Attachment 4, Figure A4A, Sample Request for Initial, Upgrade, or Reinstatement Evaluation.

u. The numbering system used for objective test results in the QTG should closely follow the numbering system set out in Attachment 2, FFS Objective Tests, Table A2A.

v. Contact the NSPM or visit the NSPM Web site for additional information regarding the preferred qualifications of pilots used to meet the requirements of § 60.15(d).

w. Examples of the exclusions for which the FFS might not have been subjectively tested by the sponsor or the NSPM and for which qualification might not be sought or granted, as described in § 60.15(g)(6), include windshear training and circling approaches.

#### End Information

### 12. Additional Qualifications for a Currently Qualified FSTD (§ 60.16)

#### Begin Information

No additional regulatory or informational material applies to § 60.16, Additional Qualifications for a Currently Qualified FFS.

#### End Information

**13. Previously Qualified FSTDs (§ 60.17)****Begin QPS Requirements**

a. In instances where a sponsor plans to remove an FFS from active status for a period of less than two years, the following procedures apply:

(1) The NSPM must be notified in writing and the notification must include an estimate of the period that the FFS will be inactive;

(2) Continuing Qualification evaluations will not be scheduled during the inactive period;

(3) The NSPM will remove the FFS from the list of qualified FSTDs on a mutually established date not later than the date on which the first missed continuing qualification evaluation would have been scheduled;

(4) Before the FFS is restored to qualified status, it must be evaluated by the NSPM. The evaluation content and the time required to accomplish the evaluation is based on the number of continuing qualification evaluations and sponsor-conducted quarterly inspections missed during the period of inactivity.

(5) The sponsor must notify the NSPM of any changes to the original scheduled time out of service;

b. Simulators qualified prior to May 30, 2008, are not required to meet the general simulation requirements, the objective test requirements or the subjective test requirements of attachments 1, 2, and 3 of this appendix as long as the simulator continues to meet the test requirements contained in the MQTG developed under the original qualification basis.

c. After [date 1 year after effective date of the final rule] each visual scene or airport model beyond the minimum required for the FSTD qualification level that is installed in and available for use in a qualified FSTD must meet the requirements described in attachment 3 of this appendix.

**End QPS Requirements****Begin Information**

d. Other certificate holders or persons desiring to use an FFS may contract with FFS sponsors to use FFSs previously qualified at a particular level for an airplane type and approved for use within an FAA-approved flight training program. Such FFSs are not required to undergo an additional qualification process, except as described in § 60.16.

e. Each FFS user must obtain approval from the appropriate TPAA to use any FFS in an FAA-approved flight training program.

f. The intent of the requirement listed in § 60.17(b), for each FFS to have a Statement of Qualification within 6 years, is to have the availability of that statement (including the configuration list and the limitations to authorizations) to provide a complete picture of the FFS inventory regulated by the FAA. The issuance of the statement will not require any additional evaluation or require any adjustment to the evaluation basis for the FFS.

g. Downgrading of an FFS is a permanent change in qualification level and will

necessitate the issuance of a revised Statement of Qualification to reflect the revised qualification level, as appropriate. If a temporary restriction is placed on an FFS because of a missing, malfunctioning, or inoperative component or on-going repairs, the restriction is not a permanent change in qualification level. Instead, the restriction is temporary and is removed when the reason for the restriction has been resolved.

h. It is not the intent of the NSPM to discourage the improvement of existing simulation (e.g., the “updating” of a visual system to a newer model, or the replacement of the IOS with a more capable unit) by requiring the “updated” device to meet the qualification standards current at the time of the update. Depending on the extent of the update, the NSPM may require that the updated device be evaluated and may require that an evaluation include all or a portion of the elements of an initial evaluation. However, the standards against which the device would be evaluated are those that are found in the MQTG for that device.

i. The NSPM will determine the evaluation criteria for an FSTD that has been removed from active status. The criteria will be based on the number of continuing qualification evaluations and quarterly inspections missed during the period of inactivity. For example, if the FFS were out of service for a 1 year period, it would be necessary to complete the entire QTG, since all of the quarterly evaluations would have been missed. The NSPM will also consider how the FFS was stored, whether parts were removed from the FFS and whether the FFS was disassembled.

j. The FFS will normally be requalified using the FAA-approved MQTG and the criteria that was in effect prior to its removal from qualification. However, inactive periods of 2 years or more will require requalification under the standards in effect and current at the time of requalification.

**End Information****14. Inspection, Continuing Qualification Evaluation, and Maintenance Requirements (§ 60.19)****Begin QPS Requirements**

a. The sponsor must conduct a minimum of four evenly spaced inspections throughout the year. The objective test sequence and content of each inspection must be developed by the sponsor and must be acceptable to the NSPM.

b. The description of the functional preflight inspection must be contained in the sponsor's QMS.

c. Record “functional preflight” in the FFS discrepancy log book or other acceptable location, including any item found to be missing, malfunctioning, or inoperative.

d. During the continuing qualification evaluation conducted by the NSPM, the sponsor must also provide a person knowledgeable about the operation of the aircraft and the operation of the FFS.

e. The NSPM will conduct continuing qualification evaluations every 12 months unless:

(1) The NSPM becomes aware of discrepancies or performance problems with the device that warrants more frequent evaluations; or

(2) The sponsor implements a QMS that justifies less frequent evaluations. However, in no case shall the frequency of a continuing qualification evaluation exceed 36 months.

**End QPS Requirements****Begin Information**

f. The sponsor's test sequence and the content of each quarterly inspection required in § 60.19(a)(1) should include a balance and a mix from the objective test requirement areas listed as follows:

(1) Performance.

(2) Handling qualities.

(3) Motion system (where appropriate).

(4) Visual system (where appropriate).

(5) Sound system (where appropriate).

(6) Other FFS systems.

g. If the NSP evaluator plans to accomplish specific tests during a normal continuing qualification evaluation that requires the use of special equipment or technicians, the sponsor will be notified as far in advance of the evaluation as practical; but not less than 72 hours. Examples of such tests include latencies, control dynamics, sounds and vibrations, motion, and/or some visual system tests.

h. The continuing qualification evaluations, described in § 60.19(b), will normally require 4 hours of FFS time. However, flexibility is necessary to address abnormal situations or situations involving aircraft with additional levels of complexity (e.g., computer controlled aircraft). The sponsor should anticipate that some tests may require additional time. The continuing qualification evaluations will consist of the following:

(1) Review of the results of the quarterly inspections conducted by the sponsor since the last scheduled continuing qualification evaluation.

(2) A selection of approximately 8 to 15 objective tests from the MQTG that provide an adequate opportunity to evaluate the performance of the FFS. The tests chosen will be performed either automatically or manually and should be able to be conducted within approximately one-third (1/3) of the allotted FFS time.

(3) A subjective evaluation of the FFS to perform a representative sampling of the tasks set out in attachment 3 of this appendix. This portion of the evaluation should take approximately two-thirds (2/3) of the allotted FFS time.

(4) An examination of the functions of the FFS may include the motion system, visual system, sound system, instructor operating station, and the normal functions and simulated malfunctions of the airplane systems. This examination is normally accomplished simultaneously with the subjective evaluation requirements.

**End Information****15. Logging FSTDs Discrepancies (§ 60.20)**

**Begin Information**

No additional regulatory or informational material applies to § 60.20. Logging FFS Discrepancies.

**End Information****16. Interim Qualification of FSTDs for New Airplane Types or Models (§ 60.21)****Begin Information**

No additional regulatory or informational material applies to § 60.21, Interim Qualification of FFSs for New Airplane Types or Models.

**End Information****17. Modifications to FSTDs (§ 60.23)****Begin QPS Requirements**

a. The notification described in § 60.23(c)(2) must include a complete description of the planned modification, with a description of the operational and engineering effect the proposed modification will have on the operation of the FFS and the results that are expected with the modification incorporated.

b. Prior to using the modified FFS:

(1) All the applicable objective tests completed with the modification incorporated, including any necessary updates to the MQTG (e.g., accomplishment of FSTD Directives) must be acceptable to the NSPM; and

(2) The sponsor must provide the NSPM with a statement signed by the MR that the factors listed in § 60.15(b) are addressed by the appropriate personnel as described in that section.

**End QPS Requirements****Begin Information**

FSTD Directives are considered modifications of an FFS. See Attachment 4 for a sample index of effective FSTD Directives. See Attachment 6 for a list of all effective FSTD Directives applicable to Airplane FFSs.

**End Information****18. Operation with Missing, Malfunctioning, or Inoperative Components (§ 60.25)****Begin Information**

a. The sponsor's responsibility with respect to § 60.25(a) is satisfied when the sponsor fairly and accurately advises the user of the current status of an FFS, including any missing, malfunctioning, or inoperative (MMI) component(s).

b. If the 29th or 30th day of the 30-day period described in § 60.25(b) is on a Saturday, a Sunday, or a holiday, the FAA will extend the deadline until the next business day.

c. In accordance with the authorization described in § 60.25(b), the sponsor may

develop a discrepancy prioritizing system to accomplish repairs based on the level of impact on the capability of the FFS. Repairs having a larger impact on FFS capability to provide the required training, evaluation, or flight experience will have a higher priority for repair or replacement.

**End Information****19. Automatic Loss of Qualification and Procedures for Restoration of Qualification (§ 60.27)****Begin Information**

If the sponsor provides a plan for how the FFS will be maintained during its out-of-service period (e.g., periodic exercise of mechanical, hydraulic, and electrical systems; routine replacement of hydraulic fluid; control of the environmental factors in which the FFS is to be maintained) there is a greater likelihood that the NSPM will be able to determine the amount of testing required for requalification.

**End Information****20. Other Losses of Qualification and Procedures for Restoration of Qualification (§ 60.29)****Begin Information**

If the sponsor provides a plan for how the FFS will be maintained during its out-of-service period (e.g., periodic exercise of mechanical, hydraulic, and electrical systems; routine replacement of hydraulic fluid; control of the environmental factors in which the FFS is to be maintained) there is a greater likelihood that the NSPM will be able to determine the amount of testing required for requalification.

**End Information****21. Recordkeeping and Reporting (§ 60.31)****Begin QPS Requirements**

a. FSTD modifications can include hardware or software changes. For FSTD modifications involving software programming changes, the record required by § 60.31(a)(2) must consist of the name of the aircraft system software, aerodynamic model, or engine model change, the date of the change, a summary of the change, and the reason for the change.

b. If a coded form for recordkeeping is used, it must provide for the preservation and retrieval of information with appropriate security or controls to prevent the inappropriate alteration of such records after the fact.

**End QPS Requirements****22. Applications, Logbooks, Reports, and Records: Fraud, Falsification, or Incorrect Statements (§ 60.33)****Begin Information**

No additional regulatory or informational material applies to § 60.33, Applications, Logbooks, Reports, and Records: Fraud, Falsification, or Incorrect Statements.

**23. Specific Full Flight Simulator Compliance Requirements (§ 60.35)**

No additional regulatory or informational material applies to § 60.35, Specific FFS Compliance Requirements.

**24. [Reserved]****25. FSTD Qualification on the Basis of a Bilateral Aviation Safety Agreement (BASA) (§ 60.37)**

No additional regulatory or informational material applies to § 60.37, FSTD Qualification on the Basis of a Bilateral Aviation Safety Agreement (BASA).

**End Information****Attachment 1 to Appendix A to Part 60—  
General Simulator Requirements****Begin QPS Requirements****1. Requirements**

a. Certain requirements included in this appendix must be supported with a Statement of Compliance and Capability (SOC), which may include objective and subjective tests. The SOC will confirm that the requirement was satisfied, and describe how the requirement was met, such as gear modeling approach or coefficient of friction sources. The requirements for SOCs and tests are indicated in the "General Simulator Requirements" column in Table A1A of this appendix.

b. Table A1A describes the requirements for the indicated level of FFS. Many devices include operational systems or functions that exceed the requirements outlined in this section. However, all systems will be tested and evaluated in accordance with this appendix to ensure proper operation.

**End QPS Requirements****Begin Information****2. Discussion**

a. This attachment describes the general simulator requirements for qualifying an airplane FFS. The sponsor should also consult the objective tests in attachment 2 and the examination of functions and subjective tests listed in attachment 3 to determine the complete requirements for a specific level simulator.

b. The material contained in this attachment is divided into the following categories:

- (1) General flight deck configuration.
- (2) Simulator programming.
- (3) Equipment operation.

(4) Equipment and facilities for instructor/evaluator functions.  
 (5) Motion system.  
 (6) Visual system.  
 (7) Sound system.  
 c. Table A1A provides the standards for the General Simulator Requirements.  
 d. Table A1B provides the tasks that the sponsor will examine to determine whether

the FSTD satisfactorily meets the requirements for flight crew training, testing, and experience, and provides the tasks for which the simulator may be qualified.  
 e. Table A1C provides the functions that an instructor/check airman must be able to control in the simulator.  
 f. It is not required that all of the tasks that appear on the List of Qualified Tasks (part of

the SOQ) be accomplished during the initial or continuing qualification evaluation.

**End Information**

**TABLE A1A.—MINIMUM SIMULATOR REQUIREMENTS**

<<<QPS requirements>>>		Simulator levels				Information
Number	General simulator requirements	A	B	C	D	Notes
<b>1. General Flight Deck Configuration</b>						
1.a. ....	The simulator must have a flight deck that is a replica of the airplane simulated with controls, equipment, observable flight deck indicators, circuit breakers, and bulkheads properly located, functionally accurate and replicating the airplane. The direction of movement of controls and switches must be identical to the airplane. Pilot seats must allow the occupant to achieve the design "eye position" established for the airplane being simulated. Equipment for the operation of the flight deck windows must be included, but the actual windows need not be operable. Additional equipment such as fire axes, extinguishers, and spare light bulbs must be available in the FFS but may be relocated to a suitable location as near as practical to the original position. Fire axes, landing gear pins, and any similar purpose instruments need only be represented in silhouette. An SOC is required.	X	X	X	X	For simulator purposes, the flight deck consists of all that space forward of a cross section of the flight deck at the most extreme aft setting of the pilots' seats, including additional required crewmember duty stations and those required bulkheads aft of the pilot seats. For clarification, bulkheads containing only items such as landing gear pin storage compartments, fire axes or extinguishers, spare light bulbs, and aircraft document pouches are not considered essential and may be omitted.
1.b. ....	Those circuit breakers that affect procedures or result in observable flight deck indications must be properly located and functionally accurate. An SOC is required.	X	X	X	X	
<b>2. Programming</b>						
2.a. ....	A flight dynamics model that accounts for various combinations of drag and thrust normally encountered in flight must correspond to actual flight conditions, including the effect of change in airplane attitude, thrust, drag, altitude, temperature, gross weight, moments of inertia, center of gravity location, and configuration. An SOC is required.	X	X	X	X	
2.b. ....	The simulator must have the computer capacity, accuracy, resolution, and dynamic response needed to meet the qualification level sought. An SOC is required.	X	X	X	X	
2.c. ....	Surface operations must be represented to the extent that allows turns within the confines of the runway and adequate controls on the landing and roll-out from a crosswind approach to a landing. A subjective test is required.	X				
2.d. ....	Ground handling and aerodynamic programming must include the following: A subjective test is required for each.					
2.d.1. ...	Ground effect .....		X	X	X	Ground effect includes modeling that accounts for roundout, flare, touchdown, lift, drag, pitching moment, trim, and power while in ground effect.



TABLE A1A.—MINIMUM SIMULATOR REQUIREMENTS—Continued

<<<QPS requirements>>>		Simulator levels				Information
Number	General simulator requirements	A	B	C	D	Notes
2.d.2. ...	Ground reaction .....		X	X	X	Ground reaction includes modeling that accounts for strut deflections, tire friction, and side forces. This is the reaction of the airplane upon contact with the runway during landing, and may differ with changes in factors such as gross weight, airspeed, or rate of descent on touchdown.
2.d.3. ...	Ground handling characteristics, including aerodynamic and ground reaction modeling including steering inputs, operations with crosswind, braking, thrust reversing, deceleration, and turning radius.		X	X	X	
2.e. ....	The simulator must employ windshear models that provide training for recognition of windshear phenomena and the execution of recovery procedures. Models must be available to the instructor/evaluator for the following critical phases of flight: (1) Prior to takeoff rotation. (2) At liftoff. (3) During initial climb. (4) On final approach, below 500 ft AGL.					
	The QTG must reference the FAA Windshear Training Aid or present alternate airplane related data, including the implementation method(s) used. If the alternate method is selected, wind models from the Royal Aerospace Establishment (RAE), the Joint Airport Weather Studies (JAWS) Project and other recognized sources may be implemented, but must be supported and properly referenced in the QTG. Only those simulators meeting these requirements may be used to satisfy the training requirements of part 121 pertaining to a certificate holder's approved low-altitude windshear flight training program as described in § 121.409. Objective tests are required for qualification; see Attachment 2 and Attachment 5 of this appendix. A subjective test is required.			X	X	If desired, Level A and B simulators may qualify for windshear training by meeting these standards; see Attachment 5 of this appendix. Windshear models may consist of independent variable winds in multiple simultaneous components. The FAA Windshear Training Aid presents one acceptable means of compliance with simulator wind model requirements.
2.f. ....	The simulator must provide for manual and automatic testing of simulator hardware and software programming to determine compliance with simulator objective tests as prescribed in Attachment 2. An SOC is required.			X	X	Automatic "flagging" of out-of-tolerance situations is encouraged.
2.g. ....	Relative responses of the motion system, visual system, and flight deck instruments, measured by latency tests or transport delay tests. Motion onset should occur before the start of the visual scene change (the start of the scan of the first video field containing different information) but must occur before the end of the scan of that video field. Instrument response may not occur prior to motion onset. Test results must be within the following limits.					The intent is to verify that the simulator provides instrument, motion, and visual cues that are, within the stated time delays, like the airplane responses. For airplane response, acceleration in the appropriate, corresponding rotational axis is preferred.
2.g.1. ...	300 milliseconds of the airplane response.	X	X			
	Objective Tests are required.					
2.g.2. ...	150 milliseconds of the airplane response. Objective Tests are required.			X	X	

TABLE A1A.—MINIMUM SIMULATOR REQUIREMENTS—Continued

<<<QPS requirements>>>		Simulator levels				Information
Number	General simulator requirements	A	B	C	D	Notes
2.h. ....	The simulator must accurately reproduce the following runway conditions: (1) Dry. (2) Wet. (3) Icy. (4) Patchy Wet. (5) Patchy Icy. (6) Wet on Rubber Residue in Touchdown Zone.					
	An SOC is required.					
	Objective tests are required only for dry, wet, and icy runway conditions; see Attachment 2.					
	Subjective tests are required for patchy wet, patchy icy, and wet on rubber residue in touchdown zone conditions; see Attachment 3.			X	X	
2.i. ....	The simulator must simulate: (1) Brake and tire failure dynamics, including anti-skid failure. (2) Decreased brake efficiency due to high brake temperatures, if applicable. An SOC is required.			X	X	Simulator pitch, side loading, and directional control characteristics should be representative of the airplane.
2.j. ....	The simulator must replicate the effects of airframe and engine icing. A Subjective Test is required.			X	X	
2.k. ....	The aerodynamic modeling in the simulator must include: (1) Low-altitude level-flight ground effect; (2) Mach effect at high altitude; (3) Normal and reverse dynamic thrust effect on control surfaces; (4) Aeroelastic representations; and (5) Nonlinearities due to sideslip. An SOC is required and must include references to computations of aeroelastic representations and of nonlinearities due to sideslip.				X	See Attachment 2, paragraph 4, for further information on ground effect.
2.l. ....	The simulator must have aerodynamic and ground reaction modeling for the effects of reverse thrust on directional control, if applicable. An SOC is required.		X	X	X	

**3. Equipment Operation**

3.a. ....	All relevant instrument indications involved in the simulation of the airplane must automatically respond to control movement or external disturbances to the simulated airplane; e.g., turbulence or windshear. Numerical values must be presented in the appropriate units. A subjective test is required.	X	X	X	X	
3.b. ....	Communications, navigation, caution, and warning equipment must be installed and operate within the tolerances applicable for the airplane. A subjective test is required.	X	X	X	X	See Attachment 3 for further information regarding long-range navigation equipment.
3.c. ....	Simulated airplane systems must operate as the airplane systems operate under normal, abnormal, and emergency operating conditions on the ground and in flight. A subjective test is required.	X	X	X	X	

TABLE A1A.—MINIMUM SIMULATOR REQUIREMENTS—Continued

<<<QPS requirements>>>		Simulator levels				Information
Number	General simulator requirements	A	B	C	D	Notes
3.d. ....	The simulator must provide pilot controls with control forces and control travel that correspond to the simulated airplane. The simulator must also react in the same manner as in the airplane under the same flight conditions. A objective test is required.	X	X	X	X	
3.e. ....	Simulator control feel dynamics must replicate the airplane. This must be determined by comparing a recording of the control feel dynamics of the simulator to airplane measurements. For initial and upgrade qualification evaluations, the control dynamic characteristics must be measured and recorded directly from the flight deck controls, and must be accomplished in takeoff, cruise, and landing flight conditions and configurations. Objective tests are required.			X	X	
<b>4. Instructor or Evaluator Facilities</b>						
4.a. ....	In addition to the flight crewmember stations, the simulator must have at least two suitable seats for the instructor/check airman and FAA inspector. These seats must provide adequate vision to the pilot's panel and forward windows. All seats other than flight crew seats need not represent those found in the airplane, but must be adequately secured to the floor and equipped with similar positive restraint devices. A subjective test is required.	X	X	X	X	The NSPM will consider alternatives to this standard for additional seats based on unique flight deck configurations.
4.b. ....	The simulator must have controls that enable the instructor/evaluator to control all required system variables and insert all abnormal or emergency conditions into the simulated airplane systems as described in the sponsor's FAA-approved training program; or as described in the relevant operating manual as appropriate. A subjective test is required.	X	X	X	X	
4.c. ....	The simulator must have instructor controls for environmental conditions including wind speed and direction. A subjective test is required.	X	X	X	X	
4.d. ....	The simulator must provide the instructor or evaluator the ability to present ground and air hazards. A subjective test is required.			X	X	For example, another airplane crossing the active runway or converging airborne traffic.
<b>5. Motion System</b>						
5.a. ....	The simulator must have motion (force) cues perceptible to the pilot that are representative of the motion in an airplane. A subjective test is required.	X	X	X	X	For example, touchdown cues should be a function of the rate of descent (RoD) of the simulated airplane.
5.b. ....	The simulator must have a motion (force cueing) system with a minimum of three degrees of freedom (at least pitch, roll, and heave). An SOC is required.	X	X			
5.c. ....	The simulator must have a motion (force cueing) system that produces cues at least equivalent to those of a six-degrees-of-freedom, synergistic platform motion system (i.e., pitch, roll, yaw, heave, sway, and surge). An SOC is required.			X	X	
5.d. ....	The simulator must provide for the recording of the motion system response time. An SOC is required.	X	X	X	X	

TABLE A1A.—MINIMUM SIMULATOR REQUIREMENTS—Continued

<<<QPS requirements>>>		Simulator levels				Information
Number	General simulator requirements	A	B	C	D	Notes
5.e. ....	The simulator must provide motion effects programming to include: (1) Thrust effect with brakes set. (2) Runway rumble, oleo deflections, effects of ground speed, uneven runway, centerline lights, and taxiway characteristics. (3) Buffets on the ground due to spoiler/speedbrake extension and thrust reversal. (4) Bumps associated with the landing gear. (5) Buffet during extension and retraction of landing gear. (6) Buffet in the air due to flap and spoiler/speedbrake extension. (7) Approach-to-Stall buffet. (8) Representative touchdown cues for main and nose gear. (9) Nosewheel scuffing, if applicable. (10) Mach and maneuver buffet.		X	X	X	
	A subjective test is required.					
5.f. ....	The simulator must provide characteristic motion vibrations that result from operation of the airplane if the vibration marks an event or airplane state that can be sensed in the flight deck. An objective test is required.				X	The simulator should be programmed and instrumented in such a manner that the characteristic buffet modes can be measured and compared to airplane data.
<b>6. Visual System</b>						
6.a. ....	The simulator must have a visual system providing an out-of-the-flight deck view. A subjective test is required.	X	X	X	X	
6.b. ....	The simulator must provide a continuous collimated field of view of at least 45° horizontally and 30° vertically per pilot seat or the number of degrees necessary to meet the visual ground segment requirement, whichever is greater. Both pilot seat visual systems must be operable simultaneously. The minimum horizontal field of view coverage must be plus and minus one-half (1/2) of the minimum continuous field of view requirement, centered on the zero degree azimuth line relative to the aircraft fuselage. Additional field of view capability may be added at the sponsor's discretion provided the minimum fields of view are retained. An SOC must explain the geometry of the installation. An SOC is required.	X	X			
6.c. ....	(Reserved)					
6.d. ....	The simulator must provide a continuous collimated visual field of view of at least 176° horizontally and 36° vertically or the number of degrees necessary to meet the visual ground segment requirement, whichever is greater. The minimum horizontal field of view coverage must be plus and minus one-half (1/2) of the minimum continuous field of view requirement, centered on the zero degree azimuth line relative to the aircraft fuselage. Additional field of view capability may be added at the sponsor's discretion provided the minimum fields of view are retained. An SOC must explain the geometry of the installation. An SOC is required.			X	X	The horizontal field of view is traditionally described as a 180° field of view. However, the field of view is technically no less than 176°.

TABLE A1A.—MINIMUM SIMULATOR REQUIREMENTS—Continued

<<<QPS requirements>>>		Simulator levels				Information
Number	General simulator requirements	A	B	C	D	Notes
6.e. ....	The visual system must be free from optical discontinuities and artifacts that create non-realistic cues. A subjective test is required.	X	X	X	X	Non-realistic cues might include image “swimming” and image “roll-off,” that may lead a pilot to make incorrect assessments of speed, acceleration, or situational awareness.
6.f. ....	The simulator must have operational landing lights for night scenes. Where used, dusk (or twilight) scenes require operational landing lights. A subjective test is required.	X	X	X	X	
6.g. ....	The simulator must have instructor controls for the following: (1) Visibility in statute miles (km) and runway visual range (RVR) in ft.(m). (2) Airport selection. (3) Airport lighting.					
	A subjective test is required.	X	X	X	X	
6.h. ....	The simulator must provide visual system compatibility with dynamic response programming. A subjective test is required.	X	X	X	X	
6.i. ....	The simulator must show that the segment of the ground visible from the simulator flight deck is the same as from the airplane flight deck (within established tolerances) when at the correct airspeed, in the landing configuration, at a main wheel height of 100 feet (30 meters) above the touchdown zone, and with visibility of 1,200 ft (350 m) RVR. An SOC is required. An objective test is required.	X	X	X	X	This will show the modeling accuracy of RVR, glideslope, and localizer for a given weight, configuration, and speed within the airplane’s operational envelope for a normal approach and landing.
6.j. ....	The simulator must provide visual cues necessary to assess sink rates (provide depth perception) during takeoffs and landings, to include: (1) Surface on runways, taxiways, and ramps. (2) Terrain features. A subjective test is required.		X	X	X	
6.k. ....	The simulator must provide for accurate portrayal of the visual environment relating to the simulator attitude. A subjective test is required.	X	X	X	X	Visual attitude vs. simulator attitude is a comparison of pitch and roll of the horizon as displayed in the visual scene compared to the display on the attitude indicator.
6.l. ....	The simulator must provide for quick confirmation of visual system color, RVR, focus, and intensity. An SOC is required. A subjective test is required.			X	X	
6.m. ....	The simulator must be capable of producing at least 10 levels of occulting. A subjective test is required.			X	X	
6.n. ....	Night Visual Scenes. When used in training, testing, or checking activities, the simulator must provide night visual scenes with sufficient scene content to recognize the airport, the terrain, and major landmarks around the airport. The scene content must allow a pilot to successfully accomplish a visual landing. Scenes must include a definable horizon and typical terrain characteristics such as fields, roads and bodies of water and surfaces illuminated by airplane landing lights. A subjective test is required.	X	X	X	X	

TABLE A1A.—MINIMUM SIMULATOR REQUIREMENTS—Continued

<<<QPS requirements>>>		Simulator levels				Information
Number	General simulator requirements	A	B	C	D	Notes
6.o. ....	Dusk (or Twilight) Visual Scenes. When used in training, testing, or checking activities, the simulator must provide dusk (or twilight) visual scenes with sufficient scene content to recognize the airport, the terrain, and major landmarks around the airport. The scene content must allow a pilot to successfully accomplish a visual landing. Dusk (or twilight) scenes, as a minimum, must provide full color presentations of reduced ambient intensity, sufficient surfaces with appropriate textural cues that include self-illuminated objects such as road networks, ramp lighting and airport signage, to conduct a visual approach, landing and airport movement (taxi). Scenes must include a definable horizon and typical terrain characteristics such as fields, roads and bodies of water and surfaces illuminated by airplane landing lights. If provided, directional horizon lighting must have correct orientation and be consistent with surface shading effects. Total night or dusk (twilight) scene content must be comparable in detail to that produced by 10,000 visible textured surfaces and 15,000 visible lights with sufficient system capacity to display 16 simultaneously moving objects. An SOC is required. A subjective test is required.			X	X	
6.p. ....	Daylight Visual Scenes. The simulator must provide daylight visual scenes with sufficient scene content to recognize the airport, the terrain, and major landmarks around the airport. The scene content must allow a pilot to successfully accomplish a visual landing. Any ambient lighting must not "washout" the displayed visual scene. Total daylight scene content must be comparable in detail to that produced by 10,000 visible textured surfaces and 6,000 visible lights with sufficient system capacity to display 16 simultaneously moving objects. The visual display must be free of apparent quantization and other distracting visual effects while the simulator is in motion.				X	Brightness capability may be demonstrated with a test pattern of white light using a spot photometer.
	Note: These requirements are mandatory for level D, and applicable to any level of simulator equipped with a "daylight" visual system.					
	An SOC is required.					
	A subjective test is required.					
6.q. ....	The simulator must provide operational visual scenes that portray physical relationships known to cause landing illusions to pilots.				X	For example: short runways, landing approaches over water, uphill or downhill runways, rising terrain on the approach path, unique topographic features.
	A subjective test is required.					
6.r. ....	The simulator must provide special weather representations of light, medium, and heavy precipitation near a thunderstorm on takeoff and during approach and landing. Representations need only be presented at and below an altitude of 2,000 ft. (610 m) above the airport surface and within 10 miles (16 km) of the airport.				X	
	A subjective test is required.					
6.s. ....	The simulator must present visual scenes of wet and snow-covered runways, including runway lighting reflections for wet conditions, partially obscured lights for snow conditions, or suitable alternative effects.				X	

TABLE A1A.—MINIMUM SIMULATOR REQUIREMENTS—Continued

<<<QPS requirements>>>		Simulator levels				Information
Number	General simulator requirements	A	B	C	D	Notes
	A subjective test is required.					
6.t. ....	The simulator must present realistic color and directionality of all airport lighting.				X	
	A subjective test is required.					
<b>7. Sound System</b>						
7.a. ....	The simulator must provide flight deck sounds that result from pilot actions that correspond to those that occur in the airplane.	X	X	X	X	
7.b. ....	Volume control, if installed, must have an indication of the sound level setting.	X	X	X	X	
7.c. ....	The simulator must accurately simulate the sound of precipitation, windshield wipers, and other significant airplane noises perceptible to the pilot during normal operations, and include the sound of a crash (when the simulator is landed in an unusual attitude or in excess of the structural gear limitations); normal engine and thrust reversal sounds; and the sounds of flap, gear, and spoiler extension and retraction.			X	X	
	An SOC is required.					
	A subjective test is required.					
7.d. ....	The simulator must provide realistic amplitude and frequency of flight deck noises and sounds. Simulator performance must be recorded, compared to amplitude and frequency of the same sounds recorded in the airplane, and be made a part of the QTG.				X	
	Objective tests are required.					

TABLE A1B.—TABLE OF TASKS VS. SIMULATOR LEVEL

<<<QPS requirements>>>		<<Information>>				
Number	Subjective requirements In order to be qualified at the simulator qualification level indicated, the simulator must be able to perform at least the tasks associated with that level of qualification.	Simulator levels				Notes
		A	B	C	D	
<b>1. Preflight Procedures</b>						
1.a. ....	Preflight Inspection (flight deck only) .....	X	X	X	X	
1.b. ....	Engine Start .....	X	X	X	X	
1.c. ....	Taxiing .....			X	X	
1.d. ....	Pre-takeoff Checks .....	X	X	X	X	
<b>2. Takeoff and Departure Phase</b>						
2.a. ....	Normal and Crosswind Takeoff .....			X	X	
2.b. ....	Instrument Takeoff .....	X	X	X	X	
2.c. ....	Engine Failure During Takeoff .....	A	X	X	X	
2.d. ....	Rejected Takeoff .....	X	X	X	X	
2.e. ....	Departure Procedure .....	X	X	X	X	
<b>3. Inflight Maneuvers</b>						



TABLE A1B.—TABLE OF TASKS VS. SIMULATOR LEVEL—Continued

<<<QPS requirements>>					<<Information>>	
Number	Subjective requirements In order to be qualified at the simulator qualification level indicated, the simulator must be able to perform at least the tasks associated with that level of qualification.	Simulator levels				Notes
		A	B	C	D	
3.a. ....	Steep Turns .....	X	X	X	X	
3.b. ....	Approaches to Stalls .....	X	X	X	X	
3.c. ....	Engine Failure—Multiengine Airplane .....	X	X	X	X	
3.d. ....	Engine Failure—Single-Engine Airplane .....	X	X	X	X	
3.e. ....	Specific Flight Characteristics incorporated into the user's FAA approved flight training program.	A	A	A	A	
3.f. ....	Recovery From Unusual Attitudes .....	X	X	X	X	Within the normal flight envelope supported by applicable simulation validation data.

**4. Instrument Procedures**

4.a. ....	Standard Terminal Arrival/Flight Management System Arrivals Procedures	X	X	X	X	
4.b. ....	Holding .....	X	X	X	X	
4.c. ....	Precision Instrument.					
4.c.1. ....	All engines operating .....	X	X	X	X	e.g., Autopilot, Manual (Flt. Dir. Assisted), Manual (Raw Data).
4.c.2. ....	One engine inoperative .....	X	X	X	X	e.g., Manual (Flt. Dir. Assisted), Manual (Raw Data).
4.d. ....	d. Non-precision Instrument Approach .....	X	X	X	X	e.g., NDB, VOR, VOR/DME, VOR/TAC, RNAV, LOC, LOC/BC, ADF, and SDF.
4.e. ....	e. Circling Approach .....	X	X	X	X	Specific authorization required.
4.f. ....	Missed Approach.					
4.f.1. ....	Normal .....	X	X	X	X	
4.f.2. ....	One engine Inoperative .....	X	X	X	X	

**5. Landings and Approaches to Landings**

5.a. ....	Normal and Crosswind Approaches and Landings .....		R	X	X	
5.b. ....	Landing From a Precision/Non-Precision Approach .....		R	X	X	
5.c. ....	Approach and Landing with (Simulated) Engine Failure—Multiengine Airplane.		R	X	X	
5.d. ....	Landing From Circling Approach .....		R	X	X	
5.e. ....	Rejected Landing .....	X	X	X	X	
5.f. ....	Landing From a No Flap or a Nonstandard Flap Configuration Approach ...		R	X	X	

**6. Normal and Abnormal Procedures**

6.a. ....	Engine (including shutdown and restart) .....	X	X	X	X	
6.b. ....	Fuel System .....	X	X	X	X	
6.c. ....	Electrical System .....	X	X	X	X	
6.d. ....	Hydraulic System .....	X	X	X	X	
6.e. ....	Environmental and Pressurization Systems .....	X	X	X	X	

TABLE A1B.—TABLE OF TASKS VS. SIMULATOR LEVEL—Continued

<<<QPS requirements>>>					<<<Information>>>	
Number	Subjective requirements In order to be qualified at the simulator qualification level indicated, the simulator must be able to perform at least the tasks associated with that level of qualification.	Simulator levels				Notes
		A	B	C	D	
6.f. ....	Fire Detection and Extinguisher Systems .....	X	X	X	X	
6.g. ....	Navigation and Avionics Systems .....	X	X	X	X	
6.h. ....	Automatic Flight Control System, Electronic Flight Instrument System, and Related Subsystems.	X	X	X	X	
6.i. ....	Flight Control Systems .....	X	X	X	X	
6.j. ....	Anti-ice and Deice Systems .....	X	X	X	X	
6.k. ....	Aircraft and Personal Emergency Equipment .....	X	X	X	X	
<b>7. Emergency Procedures</b>						
7.a. ....	Emergency Descent (Max. Rate) .....	X	X	X	X	
7.b. ....	Inflight Fire and Smoke Removal .....	X	X	X	X	
7.c. ....	Rapid Decompression .....	X	X	X	X	
7.d. ....	Emergency Evacuation .....	X	X	X	X	
<b>8. Postflight Procedures</b>						
8.a. ....	After-Landing Procedures .....	X	X	X	X	
8.b. ....	Parking and Securing .....	X	X	X	X	

“A”—indicates that the system, task, or procedure may be examined if the appropriate aircraft system or control is simulated in the FSTD and is working properly.  
 “R”—indicates that the simulator may be qualified for this task for recurrent training.  
 “X”—indicates that the simulator must be able to perform this task for this level of qualification.

TABLE A1C.—TABLE OF SIMULATOR SYSTEM TASKS

<<<QPS requirements>>>					<<<Information>>>	
Number	Subjective requirements In order to be qualified at the simulator qualification level indicated, the simulator must be able to perform at least the tasks associated with that level of qualification.	Simulator levels				Notes
		A	B	C	D	
<b>1. Instructor Operating Station (IOS), as appropriate</b>						
1.a. ....	Power switch(es) .....	X	X	X	X	
1.b. ....	Airplane conditions .....	X	X	X	X	e.g., GW, CG, Fuel loading and Systems.
1.c. ....	Airports / Runways .....	X	X	X	X	e.g., Selection, Surface, Presets, Lighting controls.
1.d. ....	Environmental controls .....	X	X	X	X	e.g., Clouds, Visibility, RVR, Temp, Wind, Ice, Snow, Rain, and Windshear.
1.e. ....	Airplane system malfunctions (Insertion/deletion) ....	X	X	X	X	
1.f. ....	Locks, Freezes, and Repositioning .....	X	X	X	X	
<b>2. Sound Controls</b>						
2.a. ....	On/off/adjustment .....	X	X	X	X	
<b>3. Motion/Control Loading System</b>						
3.a. ....	On /off/emergency stop .....	X	X	X	X	
<b>4. Observer Seats/Stations</b>						

TABLE A1C.—TABLE OF SIMULATOR SYSTEM TASKS—Continued

<<<QPS requirements>>>					<<<Information>>>	
Number	Subjective requirements In order to be qualified at the simulator qualification level indicated, the simulator must be able to perform at least the tasks associated with that level of qualification.	Simulator levels				Notes
		A	B	C	D	
4.a. ....	Position/Adjustment/Positive restraint system .....	X	X	X	X	

**Attachment 2 to Appendix A to Part 60—  
Full Flight Simulator Objective Tests**

**TABLE OF CONTENTS**

Paragraph No.	Title
1. ....	Introduction.
2. ....	Test Requirements. Table A2A, Objective Tests.
3. ....	General.
4. ....	Control Dynamics.
5. ....	Ground Effect.
6. ....	Motion System.
7. ....	Sound System.
8. ....	Additional Information About Flight Simulator Qualification for New or Derivative Airplanes.
9. ....	Engineering Simulator—Validation Data.
10. ....	[Reserved].
11. ....	Validation Test Tolerances.
12. ....	Validation Data Roadmap.
13. ....	Acceptance Guidelines for Alternative Engines Data.
14. ....	Acceptance Guidelines for Alternative Avionics (Flight-Related Computers and Controllers).
15. ....	Transport Delay Testing.
16. ....	Continuing Qualification Evaluations—Validation Test Data Presentation.
17. ....	Alternative Data Sources, Procedures, and Instrumentation: Level A and Level B Simulators Only.

Conditions Column of Table A2A, are defined as follows:

- (1) Ground—on ground, independent of airplane configuration;
  - (2) Take-off—gear down with flaps/slats in any certified takeoff position;
  - (3) First segment climb—gear down with flaps/slats in any certified takeoff position (normally not above 50 ft AGL);
  - (4) Second segment climb—gear up with flaps/slats in any certified takeoff position (normally between 50 ft and 400 ft AGL);
  - (5) Clean—flaps/slats retracted and gear up;
  - (6) Cruise—clean configuration at cruise altitude and airspeed;
  - (7) Approach—gear up or down with flaps/slats at any normal approach position as recommended by the airplane manufacturer; and
  - (8) Landing—gear down with flaps/slats in any certified landing position.
- b. The format for numbering the objective tests in Appendix A, Attachment 2, Table A2A, and the objective tests in Appendix B, Attachment 2, Table B2A, is identical. However, each test required for FFSs is not necessarily required for FTDs. Also, each test required for FTDs is not necessarily required for FFSs. Therefore, when a test number (or series of numbers) is not required, the term “Reserved” is used in the table at that location. Following this numbering format provides a degree of commonality between the two tables and substantially reduces the potential for confusion when referring to objective test numbers for either FFSs or FTDs.
- c. The reader is encouraged to review the Airplane Flight Simulator Evaluation Handbook, Volumes I and II, published by the Royal Aeronautical Society, London, UK, and FAA Advisory Circulars (AC) 25–7, as may be amended, Flight Test Guide for Certification of Transport Category Airplanes, and (AC) 23–8, as may be amended, Flight Test Guide for Certification of Part 23 Airplanes, for references and examples regarding flight testing requirements and techniques.
- d. If relevant winds are present in the objective data, the wind vector should be clearly noted as part of the data presentation, expressed in conventional terminology, and related to the runway being used for the test.

**End Information**

**Begin QPS Requirements**

**2. Test Requirements**

a. The ground and flight tests required for qualification are listed in Table of A2A, FFS

Objective Tests. Computer generated simulator test results must be provided for each test except where an alternative test is specifically authorized by the NSPM. If a flight condition or operating condition is required for the test but does not apply to the airplane being simulated or to the qualification level sought, it may be disregarded (e.g., an engine out missed approach for a single-engine airplane or a maneuver using reverse thrust for an airplane without reverse thrust capability). Each test result is compared against the validation data described in § 60.13 and in this appendix. Although use of a driver program designed to automatically accomplish the tests is encouraged for all simulators and required for Level C and Level D simulators, it must be possible to conduct each test manually while recording all appropriate parameters. The results must be produced on an appropriate recording device acceptable to the NSPM and must include simulator number, date, time, conditions, tolerances, and appropriate dependent variables portrayed in comparison to the validation data. Time histories are required unless otherwise indicated in Table A2A. All results must be labeled using the tolerances and units given.

b. Table A2A in this attachment sets out the test results required, including the parameters, tolerances, and flight conditions for simulator validation. Tolerances are provided for the listed tests because mathematical modeling and acquisition and development of reference data are often inexact. All tolerances listed in the following tables are applied to simulator performance. When two tolerance values are given for a parameter, the less restrictive may be used unless otherwise indicated.

c. Certain tests included in this attachment must be supported with a Statement of Compliance and Capability (SOC). In Table A2A, requirements for SOC are indicated in the “Test Details” column.

d. When operational or engineering judgment is used in making assessments for flight test data applications for simulator validity, such judgment must not be limited to a single parameter. For example, data that exhibit rapid variations of the measured parameters may require interpolations or a “best fit” data selection. All relevant parameters related to a given maneuver or flight condition must be provided to allow overall interpretation. When it is difficult or impossible to match simulator to airplane data throughout a time history, differences must be justified by providing a comparison of other related variables for the condition being assessed.

**Begin Information**

**1. Introduction**

a. For the purposes of this attachment, the flight conditions specified in the Flight

e. It is not acceptable to program the FFS so that the mathematical modeling is correct only at the validation test points. Unless otherwise noted, simulator tests must represent airplane performance and handling qualities at operating weights and centers of gravity (CG) typical of normal operation. If a test is supported by airplane data at one extreme weight or CG, another test supported by airplane data at mid-conditions or as close as possible to the other extreme must be included. Certain tests that are relevant only at one extreme CG or weight condition need not be repeated at the other extreme. Tests of handling qualities must include validation of augmentation devices.

f. When comparing the parameters listed to those of the airplane, sufficient data must also be provided to verify the correct flight condition and airplane configuration changes. For example, to show that control force is within the parameters for a static stability test, data to show the correct airspeed, power, thrust or torque, airplane configuration, altitude, and other appropriate datum identification parameters must also be given. If comparing short period dynamics, normal acceleration may be used to establish a match to the airplane, but airspeed, altitude, control input, airplane configuration, and other appropriate data must also be given. If comparing landing gear change dynamics, pitch, airspeed, and altitude may be used to establish a match to the airplane, but landing gear position must also be provided. All airspeed values must be properly annotated (e.g., indicated versus calibrated). In addition, the same variables must be used for comparison (e.g., compare inches to inches rather than inches to centimeters).

g. The QTG provided by the sponsor must clearly describe how the simulator will be set up and operated for each test. Each simulator subsystem may be tested independently, but overall integrated testing of the simulator must be accomplished to assure that the total simulator system meets the prescribed standards. A manual test procedure with explicit and detailed steps for completing each test must also be provided.

h. For previously qualified simulators, the tests and tolerances of this attachment may

be used in subsequent continuing qualification evaluations for any given test if the sponsor has submitted a proposed MQTG revision to the NSPM and has received NSPM approval.

i. Simulators are evaluated and qualified with an engine model simulating the airplane data supplier's flight test engine. For qualification of alternative engine models (either variations of the flight test engines or other manufacturers' engines) additional tests with the alternative engine models may be required. This Attachment contains guidelines for alternative engines.

j. For testing Computer Controlled Airplane (CCA) simulators, or other highly augmented airplane simulators, flight test data is required for the Normal (N) and/or Non-normal (NN) control states, as indicated in this Attachment. Where test results are independent of control state, Normal or Non-normal control data may be used. All tests in Table A2A require test results in the Normal control state unless specifically noted otherwise in the Test Details section following the CCA designation. The NSPM will determine what tests are appropriate for airplane simulation data. When making this determination, the NSPM may require other levels of control state degradation for specific airplane tests. Where Non-normal control states are required, test data must be provided for one or more Non-normal control states, and must include the least augmented state. Where applicable, flight test data must record Normal and Non-normal states for:

- (1) Pilot controller deflections or electronically generated inputs, including location of input; and
- (2) Flight control surface positions unless test results are not affected by, or are independent of, surface positions.

k. Tests of handling qualities must include validation of augmentation devices. FFSs for highly augmented airplanes will be validated both in the unaugmented configuration (or failure state with the maximum permitted degradation in handling qualities) and the augmented configuration. Where various levels of handling qualities result from failure states, validation of the effect of the failure is necessary. Requirements for testing will be mutually agreed to between the

sponsor and the NSPM on a case-by-case basis.

l. Some tests will not be required for airplanes using airplane hardware in the simulator flight deck (e.g., "side stick controller"). These exceptions are noted in Section 2 "Handling Qualities" in Table A2A of this attachment. However, in these cases, the sponsor must provide a statement that the airplane hardware meets the appropriate manufacturer's specifications and the sponsor must have supporting information to that fact available for NSPM review.

m. For objective test purposes, "Near maximum" gross weight is a weight chosen by the sponsor or data provider that is not less than the basic operating weight (BOW) of the airplane being simulated plus 80% of the difference between the maximum certificated gross weight (either takeoff weight or landing weight, as appropriate for the test) and the BOW. "Light" gross weight is a weight chosen by the sponsor or data provider that is not more than 120% of the BOW of the airplane being simulated or as limited by the minimum practical operating weight of the test airplane. "Medium" gross weight is a weight chosen by the sponsor or data provider that is within 10 percent of the average of the numerical values of the BOW and the maximum certificated gross weight. (Note: BOW is the empty weight of the aircraft plus the weight of the following: normal oil quantity; lavatory servicing fluid; potable water; required crewmembers and their baggage; and emergency equipment. (References: Advisory Circular 120-27, "Aircraft Weight and Balance;" and FAA-H-8083-1, "Aircraft Weight and Balance Handbook.")

n. In those cases where the objective test results authorize a "snapshot test" or a "series of snapshot tests" results in lieu of a time-history result, the sponsor or other data provider must ensure that a steady state condition exists at the instant of time captured by the "snapshot." The steady state condition must exist from 4 seconds prior to, through 1 second following, the instant of time captured by the snapshot.

**End QPS Requirements**

TABLE A2A.—FULL FLIGHT SIMULATOR (FFS) OBJECTIVE TESTS

<<<QPS requirements>>>								Information notes	
Test		Tolerance	Flight conditions	Test details	Simulator level				
Number	Title				A	B	C		D
<b>1. Performance</b>									
1.a. ....	Taxi								
1.a.1. ....	Minimum Radius Turn	±3 ft (0.9 m) or 20% of airplane turn radius.	Ground .....	Record both Main and Nose gear turning radius. This test is to be accomplished without the use of brakes and only minimum thrust, except for airplanes requiring asymmetric thrust or braking to turn.		X	X	X	

TABLE A2A.—FULL FLIGHT SIMULATOR (FFS) OBJECTIVE TESTS—Continued

<<<QPS requirements>>>								Information notes	
Test		Tolerance	Flight conditions	Test details	Simulator level				
Number	Title				A	B	C		D
1.a.2. ....	Rate of Turn vs. Nosewheel Steering Angle (NWA).	±10% or ±2°/sec. turn rate.	Ground .....	Record a minimum of two speeds, greater than minimum turning radius speed, with a spread of at least 5 knots ground-speed.		X	X	X	
1.b. ....	Takeoff			All commonly used takeoff flap settings are to be demonstrated at least once in the tests for minimum unstick (1.b.3.), normal takeoff (1.b.4.), critical engine failure on takeoff (1.b.5.), or crosswind takeoff (1.b.6.).					
1.b.1. ....	Ground Acceleration Time and Distance.	±5% time and distance or ±5% time and ±200 ft (61 m) of distance.	Takeoff .....	Record acceleration time and distance for a minimum of 80% of the time from brake release to $V_R$ . Preliminary aircraft certification data may be used..	X	X	X	X	May be combined with normal takeoff (1.b.4.) or rejected takeoff (1.b.7.). Plotted data should be shown using appropriate scales for each portion of the maneuver.
1.b.2. ....	Minimum Control Speed—ground ( $V_{mcg}$ ) using aerodynamic controls only (per applicable airworthiness standard) or alternative low speed engine inoperative test to demonstrate ground control characteristics.	±25% of maximum airplane lateral deviation or ±5 ft (1.5 m). Additionally, for those simulators of airplanes with reversible flight control systems: Rudder pedal force; ±10% or ±5 lb (2.2 daN).	Takeoff .....	Engine failure speed must be within ±1 knot of airplane engine failure speed. Engine thrust decay must be that resulting from the mathematical model for the engine variant applicable to the full flight simulator under test. If the modeled engine is not the same as the airplane manufacturer's flight test engine, a further test may be run with the same initial conditions using the thrust from the flight test data as the driving parameter.	X	X	X	X	If a $V_{mcg}$ test is not available an acceptable alternative is a flight test snap engine deceleration to idle at a speed between $V_1$ and $V_1 - 10$ knots, followed by control of heading using aerodynamic control only. Recovery should be achieved with the main gear on the ground. To ensure only aerodynamic control is used, nosewheel steering should be disabled (i.e., castored) or the nosewheel held slightly off the ground.
1.b.3. ....	Minimum Unstick Speed ( $V_{mu}$ ) or equivalent test to demonstrate early rotation takeoff characteristics.	±3 kts airspeed ±1.5° pitch angle.	Takeoff .....	Record main landing gear strut compression or equivalent air/ground signal. Record from 10 kt before start of rotation until at least 5 seconds after the occurrence of main gear lift-off.	X	X	X	X	$V_{mu}$ is defined as the minimum speed at which the last main landing gear leaves the ground. Main landing gear strut compression or equivalent air/ground signal should be recorded. If a $V_{mu}$ test is not available, alternative acceptable flight tests are a constant high-altitude take-off run through main gear lift-off or an early rotation take-off.

TABLE A2A.—FULL FLIGHT SIMULATOR (FFS) OBJECTIVE TESTS—Continued

<<<QPS requirements>>>								Information notes	
Test		Tolerance	Flight conditions	Test details	Simulator level				
Number	Title				A	B	C		D
1.b.4. ....	Normal Takeoff .....	±3 kts airspeed ±1.5° pitch angle ±1.5° angle of attack ±20 ft (6 m) height. Additionally, for those simulators of airplanes with reversible flight control systems: Stick/Column Force; ±10% or ±5 lb (2.2 daN).	Takeoff .....	Record takeoff profile from brake release to at least 200 ft (61 m) above ground level (AGL). If the airplane has more than one certificated takeoff configurations, a different configuration must be used for each weight. Data are required for a takeoff weight at near maximum takeoff weight with a mid-center of gravity and for a light takeoff weight with an aft center of gravity, as defined in Appendix F.	X	X	X	X	This test may be used for ground acceleration time and distance (1.b.1.). Plotted data should be shown using appropriate scales for each portion of the maneuver.
1.b.5. ....	Critical Engine Failure on Takeoff.	±3 kts airspeed ±1.5° pitch angle, ±1.5° angle of attack, ±20 ft (6 m) height, ±3° heading angle, ±2° bank angle, ±2° sideslip angle. Additionally, for those simulators of airplanes with reversible flight control systems: Stick/ Column Force; ±10% or ±5 lb (2.2 daN); Wheel Force; ±10% or ±3 lb (1.3 daN); and Rudder Pedal Force; ±10% or ±5 lb (2.2 daN).	Takeoff .....	Record takeoff profile at near maximum takeoff weight from prior to engine failure to at least 200 ft (61 m) AGL. Engine failure speed must be within ±3 kts of airplane data.	X	X	X	X	
1.b.6. ....	Crosswind Takeoff .....	±3 kts airspeed, ±1.5° pitch angle, ±1.5° angle of attack, ±20 ft (6 m) height, ±2° bank angle, ±2° sideslip angle; ±3° heading angle. Correct trend at groundspeeds below 40 kts. for rudder/pedal and heading. Additionally, for those simulators of airplanes with reversible flight control systems: Stick/Column Force; ±10% or ±5 lb (2.2 daN) stick/column force, ±10% or ±3 lb (1.3daN) wheel force, ±10% or ±5 lb (2.2 daN) rudder pedal force.	Takeoff .....	Record takeoff profile from brake release to at least 200 ft (61 m) AGL. Requires test data, including information on wind profile for a crosswind component of at least 60% of the maximum wind measured at 33 ft (10 m) above the runway.	X	X	X	X	In those situations where a maximum crosswind or a maximum demonstrated crosswind is not known, contact the NSPM.

TABLE A2A.—FULL FLIGHT SIMULATOR (FFS) OBJECTIVE TESTS—Continued

<<<QPS requirements>>>								Information notes	
Test		Tolerance	Flight conditions	Test details	Simulator level				
Number	Title				A	B	C		D
1.b.7. ....	Rejected Takeoff .....	±5% time or ±1.5 sec ±7.5% distance or ±250 ft (±76 m).	Takeoff .....	Record time and distance from brake release to full stop. Speed for initiation of the reject must be at least 80% of V <sub>r</sub> speed. The airplane must be at or near the maximum takeoff gross weight. Use maximum braking effort, auto or manual.	X	X	X	X	Autobrakes will be used where applicable.
1.b.8. ....	Dynamic Engine Failure After Takeoff.	±20% or ±2°/sec body angular rates.	Takeoff .....	Engine failure speed must be within ±3 Kts of airplane data. Record Hands Off from 5 secs. before to at least 5 secs. after engine failure or 30° Bank, whichever occurs first. Engine failure may be a snap deceleration to idle. (CCA: Test in Normal and Non-normal control state.)			X	X	For safety considerations, airplane flight test may be performed out of ground effect at a safe altitude, but with correct airplane configuration and airspeed.
1.c. ....	Climb								
1.c.1. ....	Normal Climb, all engines operating.	±3 kts airspeed, ±5% or ±100 FPM (0.5 m/Sec.) climb rate.	Clean .....	Flight test data is preferred, however, airplane performance manual data is an acceptable alternative. Record at nominal climb speed and mid-initial climb altitude. Flight simulator performance must be recorded over an interval of at least 1,000 ft. (300 m).	X	X	X	X	
1.c.2. ....	One engine Inoperative	±3 kts airspeed, ±5% or ±100 FPM (0.5 m/Sec.) climb rate, but not less than the climb gradient requirements of 14 CFR part 23 or part 25, as appropriate.	For part 23 airplanes, in accordance with part 23. For part 25 airplanes, Second Segment Climb.	Flight test data is preferred, however, airplane performance manual data is an acceptable alternative. Test at weight, altitude, or temperature limiting conditions. Record at nominal climb speed. Flight simulator performance must be recorded over an interval of at least 1,000 ft. (300 m).	X	X	X	X	
1.c.3. ....	One Engine Inoperative En route Climb.	±10% time, ±10% distance, ±10% fuel used.	Clean .....	Record results for at least a 5,000 ft (1550 m) climb segment. Flight test data or airplane performance manual data may be used.			X	X	



TABLE A2A.—FULL FLIGHT SIMULATOR (FFS) OBJECTIVE TESTS—Continued

<<<QPS requirements>>>								Information notes	
Test		Tolerance	Flight conditions	Test details	Simulator level				
Number	Title				A	B	C		D
1.c.4. ....	One Engine Inoperative Approach Climb (if operations in icing conditions are authorized).	$\pm 3$ kts airspeed, $\pm 5\%$ or $\pm 100$ FPM (0.5 m/Sec.) climb rate, but not less than the climb gradient requirements of 14 CFR parts 23 or 25 climb gradient, as appropriate.	Approach .....	Record results at near maximum gross landing weight as defined in Appendix F. Flight test data or airplane performance manual data may be used. Flight simulator performance must be recorded over an interval of at least 1,000 ft. (300 m).	X	X	X	X	The airplane should be configured with all anti-ice and de-ice systems operating normally, with the gear up and go-around flaps set. All icing accountability considerations should be applied in accordance with the aircraft certification or authorization for an approach in icing conditions.
1.d. ....	Cruise/Descent								
1.d.1. ....	Level flight acceleration.	$\pm 5\%$ Time .....	Cruise .....	Record results for a minimum of 50 kts speed increase using maximum continuous thrust rating or equivalent.	X	X	X	X	
1.d.2. ....	Level flight deceleration.	$\pm 5\%$ Time .....	Cruise .....	Record results for a minimum of 50 kts. speed decrease using idle power.	X	X	X	X	
1.d.3. ....	Cruise performance ....	$\pm 0.05$ EPR or $\pm 5\%$ of $N_1$ , or $\pm 5\%$ of Torque, $\pm 5\%$ of fuel flow.	Cruise .....	May be a single snapshot showing instantaneous fuel flow or a minimum of 2 consecutive snapshots with a spread of at least 3 minutes in steady flight.			X	X	
1.d.4. ....	Idle descent .....	$\pm 3$ kt airspeed, $\pm 5\%$ or $\pm 200$ ft/min (1.0m/sec) descent rate.	Clean .....	Record a stabilized, idle power descent at normal descent speed at mid-altitude. Flight simulator performance must be recorded over an interval of at least 1,000 ft. (300 m).	X	X	X	X	
1.d.5. ....	Emergency descent ....	$\pm 5$ kt airspeed, $\pm 5\%$ or $\pm 300$ ft/min (1.5m/s) descent rate.	N/A .....	Performance must be recorded over an interval of at least 3,000 ft (900 m).	X	X	X	X	The stabilized descent should be conducted with speed brakes extended, if applicable, at mid-altitude and near $V_{mo}$ speed or in accordance with emergency descent procedures.
1.e. ....	Stopping								



TABLE A2A.—FULL FLIGHT SIMULATOR (FFS) OBJECTIVE TESTS—Continued

<<<QPS requirements>>>								Information notes	
Test		Tolerance	Flight conditions	Test details	Simulator level				
Number	Title				A	B	C		D
1.f.1. ....	Acceleration .....	$\pm 10\% T_i$ and $\pm 10\% T_i$ , or $\pm 0.25$ sec.	Approach or landing ...	Record engine power ( $N_1$ , $N_2$ , EPR, Torque) from flight idle to go-around power for a rapid (slam) throttle movement.	X	X	X	X	$T_i$ is the total time from initial throttle movement until reaching a 10% response of engine power. $T_i$ is the total time from initial throttle movement to reaching 90% of go around power.
1.f.2. ....	Deceleration .....	$\pm 10\% T_i$ and $\pm 10\% T_i$ , or $\pm 0.25$ sec.	Ground .....	Record engine power ( $N_1$ , $N_2$ , EPR, Torque) from Max T/O power to 90% decay of Max T/O power for a rapid (slam) throttle movement.	X	X	X	X	$T_i$ is the total time from initial throttle movement until reaching a 10% response of engine power. $T_i$ is the total time from initial throttle movement to reaching 90% decay of maximum takeoff power.
<b>2. Handling Qualities</b>									
	For simulators requiring Static or Dynamic tests at the controls (i.e., column, wheel, rudder pedal), special test fixtures will not be required during initial or upgrade evaluations if the sponsor's QTG/ MQTG shows both test fixture results and the results of an alternative approach, such as computer plots produced concurrently, that provide satisfactory agreement. Repeat of the alternative method during the initial or upgrade evaluation would then satisfy this test requirement. For initial and upgrade evaluations, the control dynamic characteristics must be measured at and recorded directly from the flight deck controls, and must be accomplished in takeoff, cruise, and landing flight conditions and configurations. Testing of position versus force is not applicable if forces are generated solely by use of airplane hardware in the full flight simulator								Contact the NSPM for clarification of any issue regarding airplanes with reversible controls.
2.a. ....	Static Control Tests								
2.a.1.a. ....	Pitch Controller Position vs. Force and Surface Position Calibration.	$\pm 2$ lb (0.9 daN) breakout, $\pm 10\%$ or $\pm 5$ lb (2.2 daN) force, $\pm 2^\circ$ elevator.	Ground .....	Record results for an uninterrupted control sweep to the stops.	X	X	X	X	Test results should be validated (where possible) with in-flight data from tests such as longitudinal static stability or stalls. Static and dynamic flight control tests should be accomplished at the same feel or impact pressures.
2.a.1.b. ....	(Reserved)								
2.a.2.a. ....	Roll Controller Position vs. Force and Surface Position Calibration.	$\pm 2$ lb (0.9 daN) breakout, $\pm 10\%$ or $\pm 3$ lb (1.3 daN) force, $\pm 2^\circ$ aileron, $\pm 3^\circ$ spoiler angle.	Ground .....	Record results for an uninterrupted control sweep to the stops.	X	X	X	X	Test results should be validated with in-flight data from tests such as engine out trims, steady state or sideslips. Static and dynamic flight control tests should be accomplished at the same feel or impact pressures.
2.a.2.b. ....	(Reserved)								
2.a.3.a. ....	Rudder Pedal Position vs. Force and Surface Position Calibration.	$\pm 5$ lb (2.2 daN) breakout, $\pm 10\%$ or $\pm 5$ lb (2.2 daN) force, $\pm 2^\circ$ rudder angle.	Ground .....	Record results for an uninterrupted control sweep to the stops.	X	X	X	X	Test results should be validated with in-flight data from tests such as engine out trims, steady state or sideslips. Static and dynamic flight control tests should be accomplished at the same feel or impact pressures.

TABLE A2A.—FULL FLIGHT SIMULATOR (FFS) OBJECTIVE TESTS—Continued

Test		<<<QPS requirements>>>				Information notes				
Number	Title	Tolerance	Flight conditions	Test details	Simulator level					
					A		B	C	D	
2.a.3.b. ....	(Reserved)									
2.a.4. ....	Nosewheel Steering Controller Force and Position Calibration.	±2 lb (0.9 daN) break-out, ±10% or ±3 lb (1.3 daN) force, ±2° nosewheel angle.	Ground .....	Record results of an uninterrupted control sweep to the stops.	X	X	X	X		
2.a.5. ....	Rudder Pedal Steering Calibration.	±2° nosewheel angle ..	Ground .....	Record results of an uninterrupted control sweep to the stops.	X	X	X	X		
2.a.6. ....	Pitch Trim Indicator vs. Surface Position Calibration.	±0.5° of computed trim surface angle.	Ground .....	.....	X	X	X	X	The purpose of the test is to compare full flight simulator against design data or equivalent.	
2.a.7. ....	Pitch Trim Rate .....	±10% trim rate (°/sec)	Ground and approach	The trim rate must be checked using the pilot primary trim (ground) and using the autopilot or pilot primary trim in flight at go-around flight conditions.	X	X	X	X		
2.a.8. ....	Alignment of Flight Deck Throttle Lever vs. Selected Engine Parameter.	±5° of throttle lever angle, or ±3% N1, or ±0.03 EPR, or ±3% maximum rated manifold pressure, or ±3% torque. For propeller-driven airplanes where the propeller control levers do not have angular travel, a tolerance of ±0.8 inch (±2 cm) applies.	Ground .....	Requires simultaneous recording for all engines. The tolerances apply against airplane data and between engines. In the case of propeller powered airplanes, if a propeller lever is present, it must also be checked. For airplanes with throttle "detents," all detents must be presented. May be a series of snapshot test results.	X	X	X	X		
2.a.9. ....	Brake Pedal Position vs. Force and Brake System Pressure Calibration.	±5 lb (2.2 daN) or 10% force, ±150 psi (1.0 MPa) or ±10% brake system pressure.	Ground .....	Hydraulic system pressure must be related to pedal position through a ground static test.	X	X	X	X	Full flight simulator computer output results may be used to show compliance.	
2.b. ....	Dynamic Control Tests									
	Tests 2.b.1., 2.b.2., and 2.b.3. are not applicable if dynamic response is generated solely by use of airplane hardware in the full flight simulator. Power setting is that required for level flight unless otherwise specified.									

TABLE A2A.—FULL FLIGHT SIMULATOR (FFS) OBJECTIVE TESTS—Continued

<<<QPS requirements>>>								Information notes	
Test		Tolerance	Flight conditions	Test details	Simulator level				
Number	Title				A	B	C		D
2.b.1. ....	Pitch Control .....	<p>For underdamped systems: <math>\pm 10\%</math> of time from 90% of initial displacement (<math>0.9 A_d</math>) to first zero crossing and <math>\pm 10 (n+1)\%</math> of period thereafter. <math>\pm 10\%</math> amplitude of first overshoot applied to all overshoots greater than 5% of initial displacement (<math>.05 A_d</math>). <math>\pm 1</math> overshoot (first significant overshoot must be matched).</p> <p>For overdamped systems: <math>\pm 10\%</math> of time from 90% of initial displacement (<math>0.9 A_d</math>) to 10% of initial displacement (<math>0.1 A_d</math>).</p> <p>For the alternate method see paragraph 4 of this attachment.</p> <p>The slow sweep is the equivalent to the static test 2.a.1. For the moderate and rapid sweeps: <math>\pm 2</math> lb (<math>0.9</math> daN) or <math>\pm 10\%</math> dynamic increment above the static force.</p>	Takeoff, Cruise, and Landing.	Data must show normal control displacement in both directions. Tolerances apply against the absolute values of each period (considered independently). Normal control displacement for this test is 25% to 50% of full throw or 25% to 50% of the maximum allowable pitch controller deflection for flight conditions limited by the maneuvering load envelope.			X	X	"n" is the sequential period of a full cycle of oscillation. Refer to paragraph 4 of this attachment for more information. Static and dynamic flight control tests should be accomplished at the same feel or impact pressures.
2.b.2. ....	Roll Control .....	<p>For underdamped systems: <math>\pm 10\%</math> of time from 90% of initial displacement (<math>0.9 A_d</math>) to first zero crossing, and <math>\pm 10 (n+1)\%</math> of period thereafter.</p> <p><math>\pm 10\%</math> amplitude of first overshoot, applied to all overshoots greater than 5% of initial displacement (<math>.05 A_d</math>), <math>\pm 1</math> overshoot (first significant overshoot must be matched).</p> <p>For overdamped systems: <math>\pm 10\%</math> of time from 90% of initial displacement (<math>0.9 A_d</math>) to 10% of initial displacement (<math>0.1 A_d</math>).</p> <p>For the alternate method see paragraph 4 of this attachment.</p> <p>The slow sweep is the equivalent to the static test 2.a.2. For the moderate and rapid sweeps: <math>\pm 2</math> lb (<math>0.9</math> daN) or <math>\pm 10\%</math> dynamic increment above the static force.</p>	Takeoff, Cruise, and Landing.	Data must show normal control displacement in both directions. Tolerances apply against the absolute values of each period (considered independently). Normal control displacement for this test is 25% to 50% of full throw or 25% to 50% of maximum allowable roll controller deflection for flight conditions limited by the maneuvering load envelope.			X	X	"n" is the sequential period of a full cycle of oscillation. Refer to paragraph 4 of this attachment for more information. Static and dynamic flight control tests should be accomplished at the same feel or impact pressures.

TABLE A2A.—FULL FLIGHT SIMULATOR (FFS) OBJECTIVE TESTS—Continued

<<<QPS requirements>>>								Information notes	
Test		Tolerance	Flight conditions	Test details	Simulator level				
Number	Title				A	B	C		D
2.b.3. ....	Yaw Control .....	<p>For underdamped systems: <math>\pm 10\%</math> of time from 90% of initial displacement (<math>0.9 A_d</math>) to first zero crossing, and <math>\pm 10 (n+1)\%</math> of period thereafter.</p> <p><math>\pm 10\%</math> amplitude of first overshoot applied to all overshoots greater than 5% of initial displacement (<math>.05 A_d</math>).</p> <p><math>\pm 1</math> overshoot (first significant overshoot must be matched).</p> <p>For overdamped systems: <math>\pm 10\%</math> of time from 90% of initial displacement (<math>0.9 A_d</math>) to 10% of initial displacement (<math>0.1 A_d</math>).</p> <p>For the alternate method (see paragraph 4 of this attachment). The slow sweep is the equivalent to the static test 2.a.3. For the moderate and rapid sweeps: <math>\pm 2</math> lb (<math>0.9</math> daN) or <math>\pm 10\%</math> dynamic increment above the static force.</p>	Takeoff, Cruise, and Landing.	Data must show normal control displacement in both directions. Tolerances apply against the absolute values of each period (considered independently). Normal control displacement for this test is 25% to 50% of full throw.			X	X	"n" is the sequential period of a full cycle of oscillation. Refer to paragraph 4 of this attachment for more information. Static and dynamic flight control tests should be accomplished at the same feel or impact pressures.
2.b.4. ....	Small Control Inputs—Pitch.	$\pm 0.15^\circ/\text{sec}$ body pitch rate or $\pm 20\%$ of peak body pitch rate applied throughout the time history.	Approach or Landing ..	Control inputs must be typical of minor corrections made while established on an ILS approach course, using from $0.5^\circ/\text{sec}$ to $2^\circ/\text{sec}$ pitch rate. The test must be in both directions, showing time history data from 5 seconds before until at least 5 seconds after initiation of control input. <b>CCA:</b> Test in normal and non-normal control states.			X	X	

TABLE A2A.—FULL FLIGHT SIMULATOR (FFS) OBJECTIVE TESTS—Continued

<<<QPS requirements>>>								Information notes		
Test		Tolerance	Flight conditions	Test details	Simulator level					
Number	Title				A	B	C		D	
2.b.5. ....	Small Control Inputs—Roll.	±0.15°/sec body roll rate or ±20% of peak body roll rate applied throughout the time history.	Approach or landing ...	Control inputs must be typical of minor corrections made while established on an ILS approach course, using from 0.5°/sec to 2°/sec roll rate. The test may be run in only one direction; however, for airplanes that exhibit non-symmetrical behavior, the test must include both directions. Time history data must be recorded from 5 seconds before until at least 5 seconds after initiation of control input. <b>CCA:</b> Test in normal and non-normal control states.			X	X		
2.b.6. ....	Small Control Inputs—Yaw.	±0.15°/sec body yaw rate or ±20% of peak body yaw rate applied throughout the time history.	Approach or landing ...	Control inputs must be typical of minor corrections made while established on an ILS approach course, using from 0.5°/sec to 2°/sec yaw rate. The test may be run in only one direction; however, for airplanes that exhibit non-symmetrical behavior, the test must include both directions. Time history data must be recorded from 5 seconds before until at least 5 seconds after initiation of control input. <b>CCA:</b> Test in normal and non-normal control states.			X	X		
2.c. ....	Longitudinal Control Tests									
	Power setting is that required for level flight unless otherwise specified.									
2.c.1. ....	Power Change Dynamics.	±3 kt airspeed, ±100 ft (30 m) altitude, ±20% or ±1.5° pitch angle.	Approach .....	Power is changed from the thrust setting required for approach or level flight to maximum continuous thrust or go-around power setting. Record the uncontrolled free response from at least 5 seconds before the power change is initiated to 15 seconds after the power change is completed. <b>CCA:</b> Test in Normal and Non-normal control states.	X	X	X	X		

TABLE A2A.—FULL FLIGHT SIMULATOR (FFS) OBJECTIVE TESTS—Continued

<<<QPS requirements>>>								Information notes	
Test		Tolerance	Flight conditions	Test details	Simulator level				
Number	Title				A	B	C		D
2.c.2. ....	Flap/Slat Change Dynamics.	±3 kt airspeed, ±100 ft (30 m) altitude, ±20% or ±1.5° pitch angle.	Takeoff through initial flap retraction, and approach to landing.	Record the uncontrolled free response from at least 5 seconds before the configuration change is initiated to 15 seconds after the configuration change is completed. <b>CCA:</b> Test in normal and non-normal control states.	X	X	X	X	
2.c.3. ....	Spoiler/Speedbrake Change Dynamics.	±3 kt airspeed, ±100 ft (30 m) altitude, ±20% or ±1.5° pitch angle.	Cruise .....	Record the uncontrolled free response from at least 5 seconds before the configuration change is initiated to 15 seconds after the configuration change is completed. Record results for both extension and retraction. <b>CCA:</b> Test in normal and non-normal control states.	X	X	X	X	
2.c.4. ....	Gear Change Dynamics.	±3 kt airspeed, ±100 ft (30 m) altitude, ±20% or ±1.5° pitch angle.	Takeoff (retraction), and Approach (extension).	Record the time history of uncontrolled free response for a time increment from at least 5 seconds before the configuration change is initiated to 15 seconds after the configuration change is completed. <b>CCA:</b> Test in normal and non-normal control states.	X	X	X	X	
2.c.5. ....	Longitudinal Trim .....	±0.5° trim surface angle ±1° elevator ±1° pitch angle ±5% net thrust or equivalent.	Cruise, Approach, and Landing.	Record steady-state condition with wings level and thrust set for level flight. May be a series of snapshot tests. <b>CCA:</b> Test in normal and non-normal control states.	X	X	X	X	



TABLE A2A.—FULL FLIGHT SIMULATOR (FFS) OBJECTIVE TESTS—Continued

<<<QPS requirements>>>								Information notes	
Test		Tolerance	Flight conditions	Test details	Simulator level				
Number	Title				A	B	C		D
2.c.6. ....	Longitudinal Maneuvering Stability (Stick Force/g).	±5 lb (±2.2 daN) or ±10% pitch controller force. Alternative method: ±1° or ±10% change of elevator.	Cruise, Approach, and Landing.	Continuous time history data or a series of snapshot tests may be used. Record results up to 30° of bank for approach and landing configurations. Record results for up to 45° of bank for the cruise configuration. The force tolerance is not applicable if forces are generated solely by the use of airplane hardware in the full flight simulator. The alternative method applies to airplanes that do not exhibit “stick-force-per-g” characteristics. <b>CCA:</b> Test in Normal and Non-normal control states.	X	X	X	X	
2.c.7. ....	Longitudinal Static Stability.	±5 lb (±2.2 daN) or ±10% pitch controller force. Alternative method: ±1° or ±10% change of elevator.	Approach .....	Record results for at least 2 speeds above and 2 speeds below trim speed. May be a series of snapshot test results. The force tolerance is not applicable if forces are generated solely by the use of airplane hardware in the full flight simulator. The alternative method applies to airplanes that do not exhibit speed stability characteristics. <b>CCA:</b> Test in Normal or Non-normal control states.	X	X	X	X	
2.c.8. ....	Stall Characteristics ....	±3 kt airspeed for initial buffet, stall warning, and stall speeds. ±2° bank for speeds greater than stick shaker or initial buffet. Additionally, for those simulators with reversible flight control systems: ±10% or ±5 lb (2.2 daN)) Stick/Column force (prior to “g break” only).	Second Segment Climb, and Approach or Landing.	The stall maneuver must be entered with thrust at or near idle power and wings level (1g). Record the stall warning signal and initial buffet, if applicable. Time history data must be recorded for full stall and initiation of recovery. The stall warning signal must occur in the proper relation to buffet/stall. Full flight simulators of airplanes exhibiting a sudden pitch attitude change or “g break” must demonstrate this characteristic. <b>CCA:</b> Test in Normal and Non-normal control states.	X	X	X	X	

TABLE A2A.—FULL FLIGHT SIMULATOR (FFS) OBJECTIVE TESTS—Continued

<<<QPS requirements>>>								Information notes	
Test		Tolerance	Flight conditions	Test details	Simulator level				
Number	Title				A	B	C		D
2.c.9. ....	Phugoid Dynamics .....	±10% period, ±10% of time to 1/2 or double amplitude or ±.02 of damping ratio.	Cruise .....	The test must include whichever is less of the following: Three full cycles (six overshoots after the input is completed), or the number of cycles sufficient to determine time to 1/2 or double amplitude. <b>CCA:</b> Test in Non-normal control states.	X	X	X	X	
2.c.10. ....	Short Period Dynamics	±1.5° pitch angle or ±2°/sec pitch rate, ±0.10g acceleration.	Cruise .....	<b>CCA:</b> Test in Normal and Non-normal control states.		X	X	X	
2.c.11. ....	(Reserved)								
2.d. ....	Lateral Directional Tests								
	Power setting is that required for level flight unless otherwise specified.								
2.d.1. ....	Minimum Control Speed, Air ( $V_{mca}$ or $V_{mcl}$ ), per Applicable Airworthiness Standard or Low Speed Engine Inoperative Handling Characteristics in the Air.	±3 kt airspeed .....	Takeoff or Landing (whichever is most critical in the airplane).	Takeoff thrust must be used on the operating engine(s). A time history or a series of snapshot tests may be used. <b>CCA:</b> Test in Normal and Non-normal control states.	X	X	X	X	Low Speed Engine Inoperative Handling may be governed by a performance or control limit that prevents demonstration of $V_{mca}$ in the conventional manner.
2.d.2. ....	Roll Response (Rate)	±10% or ±2°/sec roll rate. Additionally, for those simulators of airplanes with reversible flight control systems: ±10% or ±3lb (1.3 daN) wheel force.	Cruise, and Approach or Landing.	Record results for normal roll controller deflection (about one-third of maximum roll controller travel). May be combined with step input of flight deck roll controller test (2.d.3.).	X	X	X	X	
2.d.3. ....	Roll Response to Flight deck Roll Controller Step Input.	±10% or ±2° bank angle.	Approach or Landing ..	Record from initiation of roll through 10 seconds after control is returned to neutral and released. May be combined with roll response (rate) test (2.d.2). <b>CCA:</b> Test in Normal and Non-normal control states.	X	X	X	X	With wings level, apply a step roll control input using approximately one-third of the roll controller travel. When reaching approximately 20° to 30° of bank, abruptly return the roll controller to neutral and allow approximately 10 seconds of airplane free response.
2.d.4. ....	Spiral Stability .....	Correct trend and ±2° or ±10% bank angle in 20 seconds. Alternate test requires correct trend and ±2° aileron.	Cruise, and Approach or Landing.	Record results for both directions. Airplane data averaged from multiple tests may be used. As an alternate test, demonstrate the lateral control required to maintain a steady turn with a bank angle of 28° to 32°. <b>CCA:</b> Test in Normal and Non-normal control states.	X	X	X	X	

TABLE A2A.—FULL FLIGHT SIMULATOR (FFS) OBJECTIVE TESTS—Continued

<<<QPS requirements>>>								Information notes	
Test		Tolerance	Flight conditions	Test details	Simulator level				
Number	Title				A	B	C		D
2.d.5. ....	Engine Inoperative Trim.	$\pm 1^\circ$ rudder angle or $\pm 1^\circ$ tab angle or equivalent pedal, $\pm 2^\circ$ sideslip angle.	Second Segment Climb, and Approach or Landing.	May be a series of snapshot tests.	X	X	X	X	The test should be performed in a manner similar to that for which a pilot is trained to trim an engine failure condition. Second segment climb test should be at takeoff thrust. Approach or landing test should be at thrust for level flight.
2.d.6. ....	Rudder Response .....	$\pm 2^\circ/\text{sec}$ or $\pm 10\%$ yaw rate..	Approach or Landing ..	Record results for stability augmentation system ON and OFF. A rudder step input of 20%–30% rudder pedal throw is used. <b>CCA:</b> Test in Normal and Non-normal control states.	X	X	X	X	
2.d.7. ....	Dutch Roll, (Yaw Damper OFF).	$\pm 0.5$ sec or $\pm 10\%$ of period, $\pm 10\%$ of time to $1/2$ or double amplitude or $\pm 0.02$ of damping ratio. $\pm 20\%$ or $\pm 1$ sec of time difference between bank and sideslip.	Cruise, and Approach or Landing.	Record results for at least 6 complete cycles with stability augmentation OFF. <b>CCA:</b> Test in Non-normal control states.	X	X	X	X	
2.d.8. ....	Steady State Sideslip	For given rudder position $\pm 2^\circ$ bank angle, $\pm 1^\circ$ sideslip angle, $\pm 10\%$ or $\pm 2^\circ$ aileron, $\pm 10\%$ or $\pm 5^\circ$ spoiler or equivalent roll, controller position or force. Additionally, for those simulators of airplanes with reversible flight control systems: $\pm 10\%$ or $\pm 3$ lb (1.3 daN) wheel force $\pm 10\%$ or $\pm 5$ lb (2.2 daN) rudder pedal force.	Approach or Landing ..	May be a series of snapshot test results using at least two rudder positions. Propeller driven airplanes must test in each direction.	X	X	X	X	
2.e. ....	Landings								
2.e.1. ....	Normal Landing .....	$\pm 3$ kt airspeed, $\pm 1.5^\circ$ pitch angle, $\pm 1.5^\circ$ angle of attack, $\pm 10\%$ or $\pm 10$ ft (3 m) height. Additionally, for those simulators of airplanes with reversible flight control systems: $\pm 10\%$ or $\pm 5$ lbs ( $\pm 2.2$ daN) stick/column force	Landing .....	Record results from a minimum of 200 ft (61 m) AGL to nose-wheel touchdown. <b>CCA:</b> Test in Normal and Non-normal control states.		X	X	X	Tests should be conducted with two normal landing flap settings (if applicable). One should be at or near maximum certificated landing weight. The other should be at light or medium landing weight.

TABLE A2A.—FULL FLIGHT SIMULATOR (FFS) OBJECTIVE TESTS—Continued

<<<QPS requirements>>>								Information notes	
Test		Tolerance	Flight conditions	Test details	Simulator level				
Number	Title				A	B	C		D
2.e.2. ....	Minimum Flap Landing	±3 kt airspeed, ±1.5° pitch angle, ±1.5° angle of attack, ±10% or ±10 ft (3 m) height. Additionally, for those simulators of airplanes with reversible flight control systems: ±10% or ±5 lbs (2.2 daN) stick/column force.	Minimum Certified Landing Flap Configuration.	Record results from a minimum of 200 ft (61 m) AGL to nosewheel touch-down with airplane at or near Maximum Landing Weight.			X	X	
2.e.3. ....	Crosswind Landing .....	±3 kt airspeed, ±1.5° pitch angle, ±1.5° angle of attack, ±10% or ±10 ft (3 m) height ±2° bank angle, ±2° sideslip angle ±3° heading angle. Additionally, for those simulators of airplanes with reversible flight control systems: ±10% or ±3 lb (1.3 daN) wheel force ±10% or ±5 lb (2.2 daN) rudder pedal force.	Landing .....	Record results from a minimum of 200 ft (61 m) AGL, through nosewheel touch-down, to 50% decrease in main landing gear touchdown speed. Test data must include information on wind profile, for a crosswind component of 60% of the maximum wind measured at 33 ft (10 m) above the runway.		X	X	X	In those situations where a maximum crosswind or a maximum demonstrated crosswind is not known, contact the NSPM.
2.e.4. ....	One Engine Inoperative Landing.	±3 kt airspeed, ±1.5° pitch angle, ±1.5° angle of attack, ±10% height or ±10 ft (3 m); ±2° bank angle, ±2° sideslip angle, ±3° heading.	Landing .....	Record results from a minimum of 200 ft (61 m) AGL, through nosewheel touch-down, to 50% decrease in main landing gear touchdown speed or less.		X	X	X	
2.e.5. ....	Autopilot landing (if applicable).	±5 ft (1.5 m) flare height, ±0.5 sec $T_f$ , or ±10% $T_f$ , ±140 ft/min (0.7 m/sec) rate of descent at touch-down. ±10 ft (3 m) lateral deviation during rollout.	Landing .....	If autopilot provides rollout guidance, record lateral deviation from touch-down to a 50% decrease in main landing gear touchdown speed or less. Time of autopilot flare mode engage and main gear touch-down must be noted.		X	X	X	$T_f$ = duration of flare.
2.e.6. ....	All engines operating, autopilot, go around.	±3 kt airspeed, ±1.5° pitch angle, ±1.5° angle of attack.	.....	Normal, all-engines-operating, Go Around with the autopilot engaged (if applicable) at medium landing weight. <b>CCA:</b> Test in Normal and Non-normal control states.		X	X	X	

TABLE A2A.—FULL FLIGHT SIMULATOR (FFS) OBJECTIVE TESTS—Continued

Test		<<<QPS requirements>>>				Information notes			
Number	Title	Tolerance	Flight conditions	Test details	Simulator level				
					A		B	C	D
2.e.7. ....	One engine inoperative go around.	±3 kt airspeed, ±1.5° pitch angle, ±1.5° angle of attack, ±2° bank angle, ±2° slideslip angle.	.....	The one engine inoperative go around is required at near maximum certificated landing weight with the critical engine inoperative using manual controls. If applicable, an additional engine inoperative go around test must be accomplished with the autopilot engaged. <b>CCA:</b> Test in Normal and Non-normal control states.		X	X	X	
2.e.8. ....	Directional control (rudder effectiveness) with symmetric reverse thrust.	±2°/sec yaw rate ±5 kts airspeed.	Landing .....	Record results starting from a speed approximating touchdown speed to the minimum thrust reverser operation speed. With full reverse thrust, apply yaw control in both directions until reaching minimum thrust reverser operation speed.		X	X	X	
2.e.9. ....	Directional control (rudder effectiveness) with asymmetric reverse thrust.	±5 kt airspeed, ±3° heading angle.	Landing .....	Maintain heading with yaw control with full reverse thrust on the operating engine(s). Record results starting from a speed approximating touchdown speed to a speed at which control of yaw cannot be maintained or until reaching minimum thrust reverser operation speed, whichever is higher. The tolerance applies to the low speed end of the data recording.		X	X	X	
2.f. ....	Ground Effect								
	Test to demonstrate Ground Effect.	±1° elevator ±0.5° stabilizer angle, ±5% net thrust or equivalent, ±1° angle of attack, ±10% height or ±5 ft (1.5 m), ±3 kt airspeed, ±1° pitch angle.	Landing .....	The Ground Effect model must be validated by the test selected and a rationale must be provided for selecting the particular test.		X	X	X	See paragraph on Ground Effect in this attachment for additional information.
2.g. ....	Windshear								
	Four tests, two takeoff and two landing, with one of each conducted in still air and the other with windshear active to demonstrate windshear models.	See Attachment 5 .....	Takeoff and Landing ...	Requires windshear models that provide training in the specific skills needed to recognize windshear phenomena and to execute recovery procedures. See Attachment 5 for tests, tolerances, and procedures.			X	X	See Attachment 5 for information related to Level A and B simulators.
2.h. ....	Flight Maneuver and Envelope Protection Functions								

TABLE A2A.—FULL FLIGHT SIMULATOR (FFS) OBJECTIVE TESTS—Continued

<<<QPS requirements>>>								Information notes	
Test		Tolerance	Flight conditions	Test details	Simulator level				
Number	Title				A	B	C		D
The requirements of tests h(1) through (6) of this attachment are applicable to computer controlled airplanes only. Time history results are required for simulator response to control inputs during entry into envelope protection limits including both normal and degraded control states if the function is different. Set thrust as required to reach the envelope protection function.									
2.h.1. ....	Overspeed .....	±5 kt airspeed .....	Cruise .....	.....		X	X	X	
2.h.2. ....	Minimum Speed .....	±3 kt airspeed .....	Takeoff, Cruise, and Approach or Landing.	.....		X	X	X	
2.h.3. ....	Load Factor .....	±0.1g normal load factor.	Takeoff, Cruise .....	.....		X	X	X	
2.h.4. ....	Pitch Angle .....	±1.5° pitch angle .....	Cruise, Approach .....	.....		X	X	X	
2.h.5. ....	Bank Angle .....	±2° or ±10% bank angle.	Approach .....	.....		X	X	X	
2.h.6. ....	Angle of Attack .....	±1.5° angle of attack ...	Second Segment Climb, and Approach or Landing.	.....		X	X	X	
<b>3. Motion System</b>									
3.a. ....	Frequency response								
		Based on Simulator Capability.	N/A .....	The test must demonstrate frequency response of the motion system.	X	X	X	X	This test is not required as part of continuing qualification evaluations, and should be part of the MQTG.
3.b. ....	Leg balance								
		Based on Simulator Capability.	N/A .....	Required as part of MQTG but not required to be scheduled as part of continuing qualification evaluations. The test must demonstrate motion system leg balance as specified by the applicant for flight simulator qualification.	X	X	X	X	
3.c. ....	Turn-around check								
		Based on Simulator Capability.	N/A .....	Required as part of MQTG but not required to be scheduled as part of continuing qualification evaluations. The test must demonstrate a smooth turn-around (shift to opposite direction of movement) of the motion system as specified by the applicant for flight simulator qualification.	X	X	X	X	
3.d. ....	Motion system repeatability								

TABLE A2A.—FULL FLIGHT SIMULATOR (FFS) OBJECTIVE TESTS—Continued

Test		<<<QPS requirements>>>				Simulator level				Information notes
Number	Title	Tolerance	Flight conditions	Test details	A	B	C	D		
		With the same input signal, the test results must be repeatable to within ±0.05g actual platform linear acceleration.	Accomplished in both the "ground" mode and in the "flight" mode of the motion system operation.	A demonstration is required and must be made part of the MQTG. The assessment procedures must be designed to ensure that the motion system hardware and software (in normal flight simulator operating mode) continue to perform as originally qualified.	X	X	X	X	This test ensures that motion system hardware and software (in normal flight simulator operating mode) continue to perform as originally qualified. Performance changes from the original baseline can be readily identified with this information.	
3.e. ....	Motion cueing performance signature.									
	Required as part of MQTG but not required as part of continuing evaluations.								These tests should be run with the motion buffet mode disabled. See paragraph 5.d., of this attachment, Motion cueing performance signature.	
3.e.1. ....	Takeoff rotation (V <sub>R</sub> to V <sub>2</sub> ).	As specified by the sponsor for flight simulator qualification.	Ground .....	Pitch attitude due to initial climb must dominate over cab tilt due to longitudinal acceleration.	X	X	X	X	Associated with test 1.b.4.	
3.e.2. ....	Engine failure between V <sub>1</sub> and V <sub>R</sub> .	As specified by the sponsor for flight simulator qualification.	Ground .....	.....	X	X	X	X	Associated with test 1.b.5.	
3.e.3. ....	Pitch change during go-around.	As specified by the sponsor for flight simulator qualification.	Flight .....	.....		X	X	X	Associated with test 2.e.6.	
3.e.4. ....	Configuration changes	As specified by the sponsor for flight simulator qualification.	Flight .....	.....	X	X	X	X	Associated with tests 2.c.2. and 2.c.4.	
3.e.5. ....	Power change dynamics.	As specified by the sponsor for flight simulator qualification.	Flight .....	.....	X	X	X	X	Associated with test 2.c.1.	
3.e.6. ....	Landing flare .....	As specified by the sponsor for flight simulator qualification.	Flight .....	.....		X	X	X	Associated with test 2.e.1.	
3.e.7. ....	Touchdown bump .....	As specified by the sponsor for flight simulator qualification.	Ground .....	.....			X	X	Associated with test 2.e.1.	
3.f. ....	Characteristic motion vibrations									
	The recorded test results for characteristic buffets must allow the comparison of relative amplitude versus frequency.									
3.f.1. ....	Thrust effect with brakes set.	Simulator test results must exhibit the overall appearance and trends of the airplane data, with at least three (3) of the predominant frequency "spikes" being present within ±2 Hz.	Ground .....	The test must be conducted within 5% of the maximum possible thrust with brakes set.				X		





TABLE A2A.—FULL FLIGHT SIMULATOR (FFS) OBJECTIVE TESTS—Continued

<<<QPS requirements>>>								Information notes	
Test		Tolerance	Flight conditions	Test details	Simulator level				
Number	Title				A	B	C		D
		300 ms (or less) after airplane response.	Take-off, cruise, and approach or landing.	One test is required in each axis (pitch, roll and yaw) for each of the three conditions (take-off, cruise, and approach or landing).	X	X			The visual scene or test pattern used during the response testing should be representative of the system capacities required to meet the daylight, twilight (dusk/dawn) and/or night visual capability as appropriate.
		150 ms (or less) after airplane response.	Take-off, cruise, and approach or landing.	One test is required in each axis (pitch, roll and yaw) for each of the three conditions (take-off, cruise, and approach or landing).			X	X	
4.a.2. ....	Transport Delay								
		300 ms (or less) after controller movement.	N/A .....	A separate test is required in each axis (pitch, roll, and yaw).	X	X			If Transport Delay is the chosen method to demonstrate relative responses, the sponsor and the NSPM will use the latency values to ensure proper simulator response when reviewing those existing tests where latency can be identified (e.g., short period, roll response, rudder response).
		150 ms (or less) after controller movement.	N/A .....	A separate test is required in each axis (pitch, roll, and yaw).			X	X	
4.b. ....	Field of View								
4.b.1. ....	Continuous collimated visual field of view.	Continuous collimated field of view providing at least 45° horizontal and 30° vertical field of view for each pilot seat. Both pilot seat visual systems must be operable simultaneously.	N/A .....	Required as part of MQTG but not required as part of continuing evaluations.	X	X			A vertical field of view of 30° may be insufficient to meet visual ground segment requirements.
4.b.2. ....	(Reserved)								



TABLE A2A.—FULL FLIGHT SIMULATOR (FFS) OBJECTIVE TESTS—Continued

<<<QPS requirements>>>								Information notes	
Test		Tolerance	Flight conditions	Test details	Simulator level				
Number	Title				A	B	C		D
		Not less than six (6) foot-lamberts (20 cd/m <sup>2</sup> ).	N/A .....	Measure the brightness of a white square while superimposing a highlight on that white square. The use of calligraphic capabilities to enhance the raster brightness is acceptable; however, measuring lightpoints is not acceptable. This requirement is applicable to any level of simulator equipped with a daylight visual system.			X	X	Measurements should be made using a 1° spot photometer and a raster drawn test pattern filling the entire visual scene (all channels) with a test pattern of black and white squares, 5° per square, with a white square in the center of each channel.
4.f. ....	Surface resolution								
		Not greater than two (2) arc minutes.	N/A .....	An SOC is required and must include the relevant calculations and an explanation of those calculations. This requirement is applicable to any level of simulator equipped with a daylight visual system.			X	X	The eye will subtend two arc minutes when positioned on a 3° glide slope, 6,876 ft slant range from the centrally located threshold of a black runway surface painted with white threshold bars that are 16 ft wide with 4-foot gaps between the bars.
4.g. ....	Light point size								
		Not greater than five (5) arc-minutes.	N/A .....	An SOC is required and must include the relevant calculations and an explanation of those calculations. This requirement is applicable to any level of simulator equipped with a daylight visual system.			X	X	Light point size should be measured using a test pattern consisting of a centrally located single row of light points reduced in length until modulation is just discernible in each visual channel. A row of 48 lights will form a 4° angle or less.
4.h. ....	Light point contrast ratio								
4.h.1. ....	For Level A and B simulators.	Not less than 10:1 .....	N/A .....	An SOC is required and must include the relevant calculations.	X	X			A 1° spot photometer is used to measure a square of at least 1° filled with light points (where light point modulation is just discernible) and compare the results to the measured adjacent background. During contrast ratio testing, simulator aft-cab and flight deck ambient light levels should be zero.

TABLE A2A.—FULL FLIGHT SIMULATOR (FFS) OBJECTIVE TESTS—Continued

<<<QPS requirements>>>								Information notes	
Test		Tolerance	Flight conditions	Test details	Simulator level				
Number	Title				A	B	C		D
4.h.2. ....	For Level C and D simulators.	Not less than 25:1 .....	N/A .....	An SOC is required and must include the relevant calculations.			X	X	A 1° spot photometer is used to measure a square of at least 1° filled with light points (where light point modulation is just discernible) and compare the results to the measured adjacent background. During contrast ratio testing, simulator aft-cab and flight deck ambient light levels should be zero.
4.i. ....	Visual ground segment								
		The visible segment in the simulator must be within 20% of the segment computed to be visible from the airplane flight deck. The tolerance(s) may be applied at either or both ends of the displayed segment. However, lights and ground objects computed to be visible from the airplane flight deck at the near end of the visible segment must be visible in the simulator.	Landing configuration, trimmed for appropriate airspeed, at 100 ft (30 m) above the touchdown zone, on glide slope with an RVR value set at 1,200 ft (350 m).	The QTG must contain appropriate calculations and a drawing showing the pertinent data used to establish the airplane location and the segment of the ground that is visible considering design eyepoint, the airplane attitude, flight deck cut-off angle, and a visibility of 1,200 ft (350 m) RVR. Simulator performance must be measured against the QTG calculations. The data submitted must include at least the following: (1) Static airplane dimensions as follows: (i) Horizontal and vertical distance from main landing gear (MLG) to glideslope reception antenna. (ii) Horizontal and vertical distance from MLG to pilot's eyepoint. (iii) Static flight deck cutoff angle.	X	X	X	X	Pre-position for this test is encouraged but may be achieved via manual or autopilot control to the desired position.
				(2) Approach data as follows: (i) Identification of runway. (ii) Horizontal distance from runway threshold to glideslope intercept with runway. (iii) Glideslope angle. (iv) Airplane pitch angle on approach. (3) Airplane data for manual testing: (i) Gross weight. (ii) Airplane configuration.					

TABLE A2A.—FULL FLIGHT SIMULATOR (FFS) OBJECTIVE TESTS—Continued

<<<QPS requirements>>>								Information notes	
Test		Tolerance	Flight conditions	Test details	Simulator level				
Number	Title				A	B	C		D
				(iii) Approach air-speed. If non-homogenous fog is used to obscure visibility, the vertical variation in horizontal visibility must be described and be included in the slant range visibility calculation used in the computations.					
<b>5. Sound System</b>									
The sponsor will not be required to repeat the airplane tests (i.e., tests 5.a.1. through 5.a.8. (or 5.b.1. through 5.b.9.) and 5.c., as appropriate) during continuing qualification evaluations if frequency response and background noise test results are within tolerance when compared to the initial qualification evaluation results, and the sponsor shows that no software changes have occurred that will affect the airplane test results. If the frequency response test method is chosen and fails, the sponsor may elect to fix the frequency response problem and repeat the test or the sponsor may elect to repeat the airplane tests. If the airplane tests are repeated during continuing qualification evaluations, the results may be compared against initial qualification evaluation results or airplane master data.									
<b>5.a. Turbo-jet airplanes</b>									
5.a.1.	Ready for engine start	±5 dB per 1/3 octave band.	Ground	Normal conditions prior to engine start with the Auxiliary Power Unit operating, if appropriate.				X	
5.a.2.	All engines at idle	±5 dB per 1/3 octave band.	Ground	Normal condition prior to takeoff.				X	
5.a.3.	All engines at maximum allowable thrust with brakes set.	±5 dB per 1/3 octave band.	Ground	Normal condition prior to takeoff.				X	
5.a.4.	Climb	±5 dB per 1/3 octave band.	En-route climb	Medium altitude				X	
5.a.5.	Cruise	±5 dB per 1/3 octave band.	Cruise	Normal cruise configuration.				X	
5.a.6.	Speedbrake/spoilers extended (as appropriate).	±5 dB per 1/3 octave band.	Cruise	Normal and constant speedbrake deflection for descent at a constant airspeed and power setting.				X	
5.a.7.	Initial approach	±5 dB per 1/3 octave band.	Approach	Constant airspeed, gear up, flaps and slats, as appropriate.				X	
5.a.8.	Final approach	±5 dB per 1/3 octave band.	Landing	Constant airspeed, gear down, full flaps.				X	
<b>5.b. Propeller airplanes</b>									
5.b.1.	Ready for engine start	±5 dB per 1/3 octave band.	Ground	Normal conditions prior to engine start with the Auxiliary Power Unit operating, if appropriate.				X	
5.b.2.	All propellers feathered	±5 dB per 1/3 octave band.	Ground	Normal condition prior to takeoff.				X	
5.b.3.	Ground idle or equivalent.	±5 dB per 1/3 octave band.	Ground	Normal condition prior to takeoff.				X	
5.b.4.	Flight idle or equivalent	±5 dB per 1/3 octave band.	Ground	Normal condition prior to takeoff.				X	

TABLE A2A.—FULL FLIGHT SIMULATOR (FFS) OBJECTIVE TESTS—Continued

<<<QPS requirements>>>								Information notes	
Test		Tolerance	Flight conditions	Test details	Simulator level				
Number	Title				A	B	C		D
5.b.5. ....	All engines at maximum allowable power with brakes set.	±5 dB per 1/3 octave band.	Ground .....	Normal condition prior to takeoff.				X	
5.b.6. ....	Climb .....	±5 dB per 1/3 octave band.	En-route climb .....	Medium altitude .....				X	
5.b.7. ....	Cruise .....	±5 dB per 1/3 octave band.	Cruise .....	Normal cruise configuration.				X	
5.b.8. ....	Initial approach .....	±5 dB per 1/3 octave band.	Approach .....	Constant airspeed, gear up, flaps extended as appropriate, RPM as per operating manual.				X	
5.b.9. ....	Final Approach .....	±5 dB per 1/3 octave band.	Landing .....	Constant airspeed, gear down, full flaps, RPM as per operating manual.				X	
5.c. ....	Special cases								
		±5 dB per 1/3 octave band.	As appropriate .....	.....				X	These special cases are identified as particularly significant during critical phases of flight and ground operations for a specific airplane type or model.
5.d. ....	Background noise								
		±3 dB per 1/3 octave band.	.....	Results of the background noise at initial qualification must be included in the MQTG. Measurements must be made with the simulation running, the sound muted and a "dead" flight deck.				X	The simulated sound will be evaluated to ensure that the background noise does not interfere with training, testing, or checking.
5.e. ....	Frequency response								

TABLE A2A.—FULL FLIGHT SIMULATOR (FFS) OBJECTIVE TESTS—Continued

Test		<<<QPS requirements>>>				Information notes			
Number	Title	Tolerance	Flight conditions	Test details	Simulator level				
					A		B	C	D
		±5 dB on three (3) consecutive bands when compared to initial evaluation; and ±2 dB when comparing the average of the absolute differences between initial and continuing qualification evaluation.	.....	Applicable only to Continuing Qualification Evaluations. If frequency response plots are provided for each channel at the initial qualification evaluation, these plots may be repeated at the continuing qualification evaluation with the following tolerances applied: (a) The continuing qualification 1/3 octave band amplitudes must not exceed ±5 dB for three consecutive bands when compared to initial results. (b) The average of the sum of the absolute differences between initial and continuing qualification results must not exceed 2 dB (refer to table A.2.B. in this attachment).				X	Measurements are compared to those taken during initial qualification evaluation.

**Begin Information**

**3. General.**

a. If relevant winds are present in the objective data, the wind vector should be clearly noted as part of the data presentation, expressed in conventional terminology, and related to the runway being used for test near the ground.

b. The reader is encouraged to review the Airplane Flight Simulator Evaluation Handbook, Volumes I and II, published by the Royal Aeronautical Society, London, UK, and FAA Advisory Circulars (AC) 25-7, as may be amended, Flight Test Guide for Certification of Transport Category Airplanes, and (AC) 23-8, as may be amended, Flight Test Guide for Certification of Part 23 Airplanes, for references and examples regarding flight testing requirements and techniques.

**4. Control Dynamics**

a. General. The characteristics of an airplane flight control system have a major effect on handling qualities. A significant consideration in pilot acceptability of an airplane is the "feel" provided through the flight controls. Considerable effort is expended on airplane feel system design so that pilots will be comfortable and will consider the airplane desirable to fly. In order for an FFS to be representative, it should "feel" like the airplane being simulated. Compliance with this requirement is determined by comparing a recording of

the control feel dynamics of the FFS to actual airplane measurements in the takeoff, cruise and landing configurations.

(1) Recordings such as free response to an impulse or step function are classically used to estimate the dynamic properties of electromechanical systems. In any case, it is only possible to estimate the dynamic properties as a result of being able to estimate true inputs and responses. Therefore, it is imperative that the best possible data be collected since close matching of the FFS control loading system to the airplane system is essential. The required dynamic control tests are described in Table A2A of this attachment.

(2) For initial and upgrade evaluations, the QPS requires that control dynamics characteristics be measured and recorded directly from the flight controls (Handling Qualities—Table A2A). This procedure is usually accomplished by measuring the free response of the controls using a step or impulse input to excite the system. The procedure should be accomplished in the takeoff, cruise and landing flight conditions and configurations.

(3) For airplanes with irreversible control systems, measurements may be obtained on the ground if proper pitot-static inputs are provided to represent airspeeds typical of those encountered in flight. Likewise, it may be shown that for some airplanes, takeoff, cruise, and landing configurations have like effects. Thus, one may suffice for another. In either case, engineering validation or airplane manufacturer rationale should be

submitted as justification for ground tests or for eliminating a configuration. For FFSs requiring static and dynamic tests at the controls, special test fixtures will not be required during initial and upgrade evaluations if the QTG shows both test fixture results and the results of an alternate approach (e.g., computer plots that were produced concurrently and show satisfactory agreement). Repeat of the alternate method during the initial evaluation would satisfy this test requirement.

b. Control Dynamics Evaluation. The dynamic properties of control systems are often stated in terms of frequency, damping and a number of other classical measurements. In order to establish a consistent means of validating test results for FFS control loading, criteria are needed that will clearly define the measurement interpretation and the applied tolerances. Criteria are needed for underdamped, critically damped and overdamped systems. In the case of an underdamped system with very light damping, the system may be quantified in terms of frequency and damping. In critically damped or overdamped systems, the frequency and damping are not readily measured from a response time history. Therefore, the following suggested measurements may be used:

(1) For Level C and D simulators. Tests to verify that control feel dynamics represent the airplane should show that the dynamic damping cycles (free response of the controls) match those of the airplane within

specified tolerances. The NSPM recognizes that several different testing methods may be used to verify the control feel dynamic response. The NSPM will consider the merits of testing methods based on reliability and consistency. One acceptable method of evaluating the response and the tolerance to be applied is described below for the underdamped and critically damped cases. A sponsor using this method to comply with the QPS requirements should perform the tests as follows:

(a) Underdamped response. Two measurements are required for the period, the time to first zero crossing (in case a rate limit is present) and the subsequent frequency of oscillation. It is necessary to measure cycles on an individual basis in case there are non-uniform periods in the response. Each period will be independently compared to the respective period of the airplane control system and, consequently, will enjoy the full tolerance specified for that period. The damping tolerance will be applied to overshoots on an individual basis. Care should be taken when applying the tolerance to small overshoots since the significance of such overshoots becomes questionable. Only those overshoots larger than 5 per cent of the total initial displacement should be considered. The residual band, labeled  $T(A_d)$  on Figure A2A is  $\pm 5$  percent of the initial displacement amplitude  $A_d$  from the steady state value of the oscillation. Only oscillations outside the residual band are considered significant. When comparing FFS data to airplane data, the process should begin by overlaying or aligning the FFS and airplane steady state values and then comparing amplitudes of oscillation peaks, the time of the first zero crossing and individual periods of oscillation. The FFS should show the same number of significant overshoots to within one when compared against the airplane data. The procedure for

evaluating the response is illustrated in Figure A2A.

(b) Critically damped and overdamped response. Due to the nature of critically damped and overdamped responses (no overshoots), the time to reach 90 percent of the steady state (neutral point) value should be the same as the airplane within  $\pm 10$  percent. Figure A2B illustrates the procedure.

(c) Special considerations. Control systems that exhibit characteristics other than classical overdamped or underdamped responses should meet specified tolerances. In addition, special consideration should be given to ensure that significant trends are maintained.

(2) Tolerances.

(a) The following table summarizes the tolerances, T, for underdamped systems, and "n" is the sequential period of a full cycle of oscillation. See Figure A2A of this attachment for an illustration of the referenced measurements.

T(P <sub>0</sub> )	.....	$\pm 10\%$ of P <sub>0</sub>
T(P <sub>1</sub> )	.....	$\pm 20\%$ of P <sub>1</sub>
T(P <sub>2</sub> )	.....	$\pm 30\%$ of P <sub>2</sub>
T(P <sub>n</sub> )	.....	$\pm 10(n+1)\%$ of P <sub>n</sub>
T(A <sub>n</sub> )	.....	$\pm 10\%$ of A <sub>1</sub>
T(A <sub>d</sub> )	.....	$\pm 5\%$ of A <sub>d</sub> = residual band
Significant		First overshoot and $\pm 1$ subsequent overshoots.

(b) The following tolerance applies to critically damped and overdamped systems only. See Figure A2B for an illustration of the reference measurements:

T(P <sub>0</sub> )	.....	$\pm 10\%$ of P <sub>0</sub>
--------------------	-------	------------------------------

**End Information**

**Begin QPS Requirement**

c. Alternative method for control dynamics evaluation.

(1) An alternative means for validating control dynamics for aircraft with

hydraulically powered flight controls and artificial feel systems is by the measurement of control force and rate of movement. For each axis of pitch, roll, and yaw, the control must be forced to its maximum extreme position for the following distinct rates. These tests are conducted under normal flight and ground conditions.

(a) Static test—Slowly move the control so that a full sweep is achieved within 95 to 105 seconds. A full sweep is defined as movement of the controller from neutral to the stop, usually aft or right stop, then to the opposite stop, then to the neutral position.

(b) Slow dynamic test—Achieve a full sweep within 8–12 seconds.

(c) Fast dynamic test—Achieve a full sweep within 3–5 seconds.

**Note:** Dynamic sweeps may be limited to forces not exceeding 100 lbs. (44.5 daN).

(d) Tolerances

(i) Static test; see Table A2A, Full Flight Simulator (FFS) Objective Tests, Items 2.a.1., 2.a.2., and 2.a.3.

(ii) Dynamic test  $\pm 2$  lbs (0.9 daN) or  $\pm 10\%$  on dynamic increment above static test.

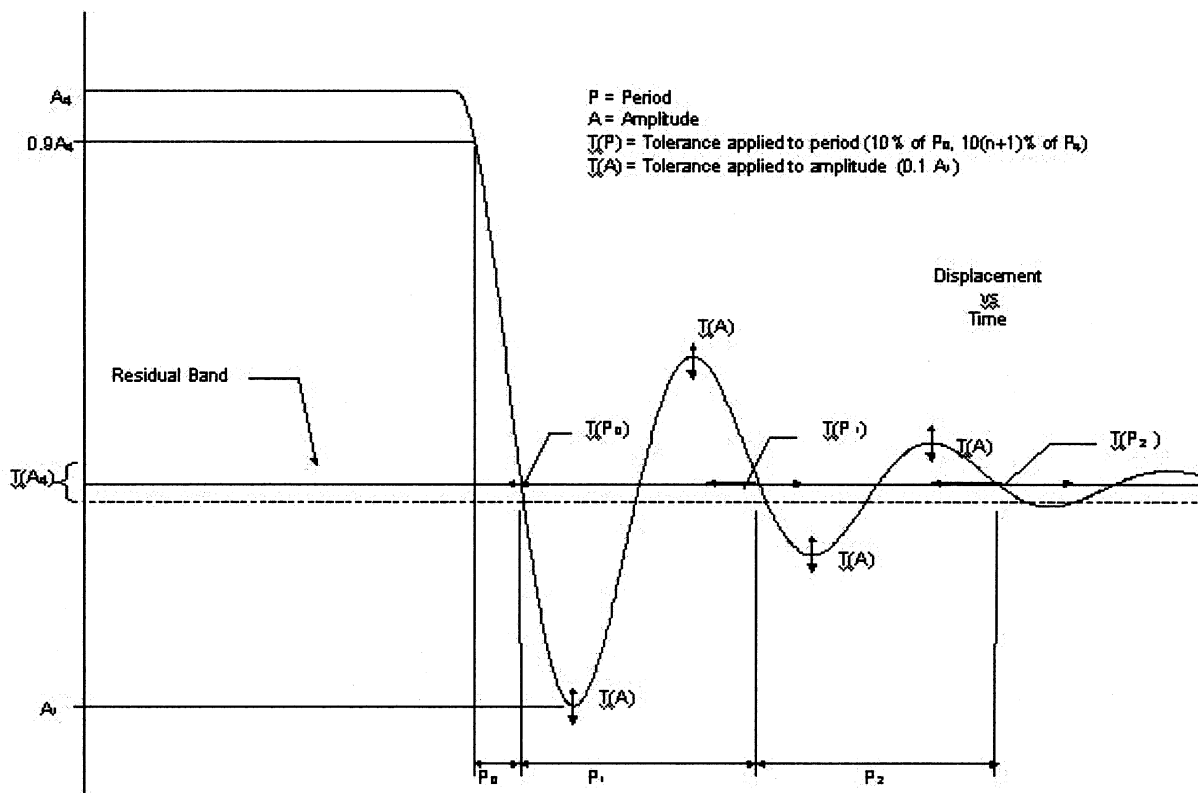
**End QPS Requirement**

**Begin Information**

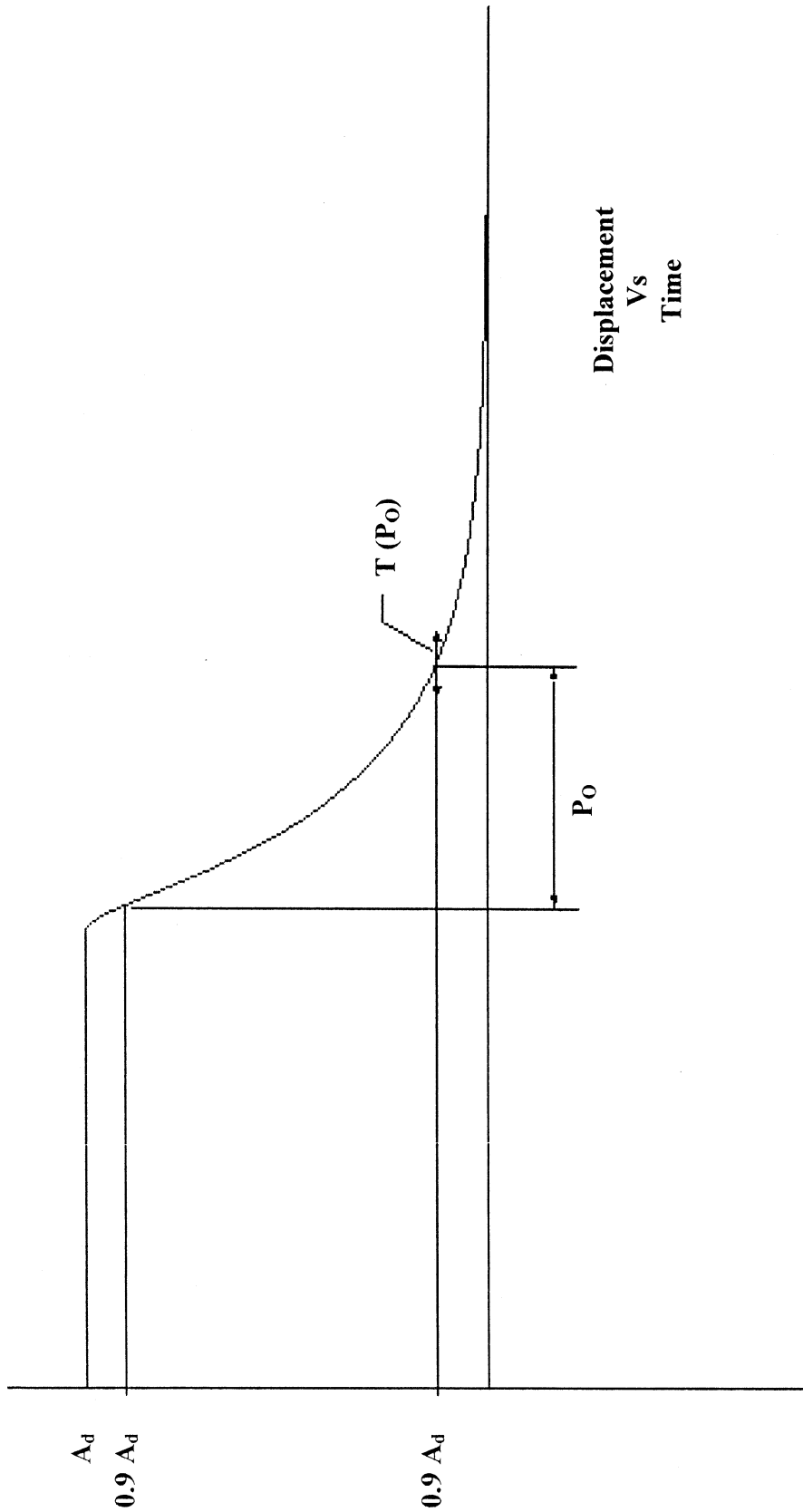
d. The FAA is open to alternative means such as the one described above. The alternatives should be justified and appropriate to the application. For example, the method described here may not apply to all manufacturers' systems and certainly not to aircraft with reversible control systems. Each case is considered on its own merit on an ad hoc basis. If the FAA finds that alternative methods do not result in satisfactory performance, more conventionally accepted methods will have to be used.

**BILLING CODE 4910-13-P**





**Figure A2A**  
**Underdamped Step Response**



**Figure A2B**  
 Critically Damped and Overdamped Step Response

BILLING CODE 4910-13-C

**5. Ground Effect**

a. For an FFS to be used for take-off and landing (not applicable to Level A simulators

in that the landing maneuver may not be credited in a Level A simulator) it should reproduce the aerodynamic changes that occur in ground effect. The parameters

chosen for FFS validation should indicate these changes.

(1) A dedicated test should be provided that will validate the aerodynamic ground effect characteristics.

(2) The organization performing the flight tests may select appropriate test methods and procedures to validate ground effect. However, the flight tests should be performed with enough duration near the ground to sufficiently validate the ground-effect model.

b. The NSPM will consider the merits of testing methods based on reliability and consistency. Acceptable methods of validating ground effect are described below. If other methods are proposed, rationale should be provided to conclude that the tests performed validate the ground-effect model. A sponsor using the methods described below to comply with the QPS requirements should perform the tests as follows:

(1) Level fly-bys. The level fly-bys should be conducted at a minimum of three altitudes within the ground effect, including one at no more than 10% of the wingspan above the ground, one each at approximately 30% and 50% of the wingspan where height refers to main gear tire above the ground. In addition, one level-flight trim condition should be conducted out of ground effect (e.g., at 150% of wingspan).

(2) Shallow approach landing. The shallow approach landing should be performed at a glide slope of approximately one degree with negligible pilot activity until flare.

c. The lateral-directional characteristics are also altered by ground effect. For example, because of changes in lift, roll damping is affected. The change in roll damping will affect other dynamic modes usually evaluated for FFS validation. In fact, Dutch roll dynamics, spiral stability, and roll-rate for a given lateral control input are altered by ground effect. Steady heading sideslips will also be affected. These effects should be accounted for in the FFS modeling. Several tests such as crosswind landing, one engine inoperative landing, and engine failure on take-off serve to validate lateral-directional ground effect since portions of these tests are accomplished as the aircraft is descending through heights above the runway at which ground effect is an important factor.

## 6. Motion System

### a. General.

(1) Pilots use continuous information signals to regulate the state of the airplane. In concert with the instruments and outside-world visual information, whole-body motion feedback is essential in assisting the pilot to control the airplane dynamics, particularly in the presence of external disturbances. The motion system should meet basic objective performance criteria, and should be subjectively tuned at the pilot's seat position to represent the linear and angular accelerations of the airplane during a prescribed minimum set of maneuvers and conditions. The response of the motion cueing system should also be repeatable.

(2) The Motion System tests in Section 3 of Table A2A are intended to qualify the FFS motion cueing system from a mechanical performance standpoint. Additionally, the list of motion effects provides a representative sample of dynamic conditions

that should be present in the flight simulator. An additional list of representative, training-critical maneuvers, selected from Section 1 (Performance tests), and Section 2 (Handling Qualities tests), in Table A2A, that should be recorded during initial qualification (but without tolerance) to indicate the flight simulator motion cueing performance signature have been identified (reference Section 3.e). These tests are intended to help improve the overall standard of FFS motion cueing.

b. Motion System Checks. The intent of test 3a, Frequency Response, test 3b, Leg Balance, and test 3c, Turn-Around Check, as described in the Table of Objective Tests, is to demonstrate the performance of the motion system hardware, and to check the integrity of the motion set-up with regard to calibration and wear. These tests are independent of the motion cueing software and should be considered robotic tests.

c. Motion System Repeatability. The intent of this test is to ensure that the motion system software and motion system hardware have not degraded or changed over time. This diagnostic test should be completed during continuing qualification checks in lieu of the robotic tests. This will allow an improved ability to determine changes in the software or determine degradation in the hardware. The following information delineates the methodology that should be used for this test.

(1) Input: The inputs should be such that rotational accelerations, rotational rates, and linear accelerations are inserted before the transfer from airplane center of gravity to pilot reference point with a minimum amplitude of 5 deg/sec/sec, 10 deg/sec and 0.3 g, respectively, to provide adequate analysis of the output.

(2) Recommended output:

(a) Actual platform linear accelerations; the output will comprise accelerations due to both the linear and rotational motion acceleration;

(b) Motion actuators position.

d. Motion Cueing Performance Signature.

(1) Background. The intent of this test is to provide quantitative time history records of motion system response to a selected set of automated QTG maneuvers during initial qualification. This is not intended to be a comparison of the motion platform accelerations against the flight test recorded accelerations (i.e., not to be compared against airplane cueing). If there is a modification to the initially qualified motion software or motion hardware (e.g., motion washout filter, simulator payload change greater than 10%) then a new baseline may need to be established.

(2) Test Selection. The conditions identified in Section 3.e. in Table A2A are those maneuvers where motion cueing is the most discernible. They are general tests applicable to all types of airplanes and should be completed for motion cueing performance signature at any time acceptable to the NSPM prior to or during the initial qualification evaluation, and the results included in the MQTG.

(3) Priority. Motion system should be designed with the intent of placing greater importance on those maneuvers that directly influence pilot perception and control of the

airplane motions. For the maneuvers identified in section 3.e. in Table A2A, the flight simulator motion cueing system should have a high tilt co-ordination gain, high rotational gain, and high correlation with respect to the airplane simulation model.

(4) Data Recording. The minimum list of parameters provided should allow for the determination of the flight simulator's motion cueing performance signature for the initial qualification evaluation. The following parameters are recommended as being acceptable to perform such a function:

(a) Flight model acceleration and rotational rate commands at the pilot reference point;

(b) Motion actuators position;

(c) Actual platform position;

(d) Actual platform acceleration at pilot reference point.

e. Motion Vibrations.

(1) Presentation of results. The characteristic motion vibrations may be used to verify that the flight simulator can reproduce the frequency content of the airplane when flown in specific conditions. The test results should be presented as a Power Spectral Density (PSD) plot with frequencies on the horizontal axis and amplitude on the vertical axis. The airplane data and flight simulator data should be presented in the same format with the same scaling. The algorithms used for generating the flight simulator data should be the same as those used for the airplane data. If they are not the same then the algorithms used for the flight simulator data should be proven to be sufficiently comparable. As a minimum, the results along the dominant axes should be presented and a rationale for not presenting the other axes should be provided.

(2) Interpretation of results. The overall trend of the PSD plot should be considered while focusing on the dominant frequencies. Less emphasis should be placed on the differences at the high frequency and low amplitude portions of the PSD plot. During the analysis, certain structural components of the flight simulator have resonant frequencies that are filtered and may not appear in the PSD plot. If filtering is required, the notch filter bandwidth should be limited to 1 Hz to ensure that the buffet feel is not adversely affected. In addition, a rationale should be provided to explain that the characteristic motion vibration is not being adversely affected by the filtering. The amplitude should match airplane data as described below. However, if the PSD plot was altered for subjective reasons, a rationale should be provided to justify the change. If the plot is on a logarithmic scale, it may be difficult to interpret the amplitude of the buffet in terms of acceleration. For example, a  $1 \times 10^{-3}$  grams<sup>2</sup>/Hz would describe a heavy buffet and may be seen in the deep stall regime. Alternatively, a  $1 \times 10^{-6}$  grams<sup>2</sup>/Hz buffet is almost not perceivable; but may represent a flap buffet at low speed. The previous two examples differ in magnitude by 1000. On a PSD plot this represents three decades (one decade is a change in order of magnitude of 10; and two decades is a change in order of magnitude of 100).

## 7. Sound System

a. General. The total sound environment in the airplane is very complex, and changes

with atmospheric conditions, airplane configuration, airspeed, altitude, and power settings. Flight deck sounds are an important component of the flight deck operational environment and provide valuable information to the flight crew. These aural cues can either assist the crew (as an indication of an abnormal situation), or hinder the crew (as a distraction or nuisance). For effective training, the flight simulator should provide flight deck sounds that are perceptible to the pilot during normal and abnormal operations, and comparable to those of the airplane. The flight simulator operator should carefully evaluate background noises in the location where the device will be installed. To demonstrate compliance with the sound requirements, the objective or validation tests in this attachment were selected to provide a representative sample of normal static conditions typically experienced by a pilot.

b. Alternate propulsion. For FFS with multiple propulsion configurations, any condition listed in Table A2A of this attachment should be presented for evaluation as part of the QTG if identified by the airplane manufacturer or other data supplier as significantly different due to a change in propulsion system (engine or propeller).

c. Data and Data Collection System.

(1) Information provided to the flight simulator manufacturer should be presented

in the format suggested by the International Air Transport Association (IATA) "Flight Simulator Design and Performance Data Requirements," as amended. This information should contain calibration and frequency response data.

(2) The system used to perform the tests listed in Table A2A should comply with the following standards:

(a) The specifications for octave, half octave, and third octave band filter sets may be found in American National Standards Institute (ANSI) S1.11-1986;

(b) Measurement microphones should be type WS2 or better, as described in International Electrotechnical Commission (IEC) 1094-4-1995.

(3) Headsets. If headsets are used during normal operation of the airplane they should also be used during the flight simulator evaluation.

(4) Playback equipment. Playback equipment and recordings of the QTG conditions should be provided during initial evaluations.

(5) Background noise.

(a) Background noise is the noise in the flight simulator that is not associated with the airplane, but is caused by the flight simulator's cooling and hydraulic systems and extraneous noise from other locations in the building. Background noise can seriously impact the correct simulation of airplane sounds and should be kept below the

airplane sounds. In some cases, the sound level of the simulation can be increased to compensate for the background noise. However, this approach is limited by the specified tolerances and by the subjective acceptability of the sound environment to the evaluation pilot.

(b) The acceptability of the background noise levels is dependent upon the normal sound levels in the airplane being represented. Background noise levels that fall below the lines defined by the following points, may be acceptable:

- (i) 70 dB @ 50 Hz;
- (ii) 55 dB @ 1000 Hz;
- (iii) 30 dB @ 16 kHz

**(Note):** These limits are for unweighted 1/3 octave band sound levels. Meeting these limits for background noise does not ensure an acceptable flight simulator. Airplane sounds that fall below this limit require careful review and may require lower limits on background noise.)

(6) Validation testing. Deficiencies in airplane recordings should be considered when applying the specified tolerances to ensure that the simulation is representative of the airplane. Examples of typical deficiencies are:

- (a) Variation of data between tail numbers;
- (b) Frequency response of microphones;
- (c) Repeatability of the measurements.

TABLE A2B.—EXAMPLE OF RECURRENT FREQUENCY RESPONSE TEST TOLERANCE

Band center frequency	Initial results (dB SPL)	Recurrent results (dB SPL)	Absolute difference
50	75.0	73.8	1.2
63	75.9	75.6	0.3
80	77.1	76.5	0.6
100	78.0	78.3	0.3
125	81.9	81.3	0.6
160	79.8	80.1	0.3
200	83.1	84.9	1.8
250	78.6	78.9	0.3
315	79.5	78.3	1.2
400	80.1	79.5	0.9
500	80.7	79.8	0.9
630	81.9	80.4	1.5
800	73.2	74.1	0.9
1000	79.2	80.1	0.9
1250	80.7	82.8	2.1
1600	81.6	78.6	3.0
2000	76.2	74.4	1.8
2500	79.5	80.7	1.2
3150	80.1	77.1	3.0
4000	78.9	78.6	0.3
5000	80.1	77.1	3.0
6300	80.7	80.4	0.3
8000	84.3	85.5	1.2
10000	81.3	79.8	1.5
12500	80.7	80.1	0.6
16000	71.1	71.1	0.0
Average		1.1	

**End Information****8. Additional Information About Flight Simulator Qualification for New or Derivative Airplanes**

a. Typically, an airplane manufacturer's approved final data for performance, handling qualities, systems or avionics is not available until well after a new or derivative airplane has entered service. However, flight crew training and certification often begins several months prior to the entry of the first airplane into service. Consequently, it may be necessary to use preliminary data provided by the airplane manufacturer for interim qualification of flight simulators.

b. In these cases, the NSPM may accept certain partially validated preliminary airplane and systems data, and early release ("red label") avionics data in order to permit the necessary program schedule for training, certification, and service introduction.

c. Simulator sponsors seeking qualification based on preliminary data should consult the NSPM to make special arrangements for using preliminary data for flight simulator qualification. The sponsor should also consult the airplane and flight simulator manufacturers to develop a data plan and flight simulator qualification plan.

d. The procedure to be followed to gain NSPM acceptance of preliminary data will vary from case to case and between airplane manufacturers. Each airplane manufacturer's new airplane development and test program is designed to suit the needs of the particular project and may not contain the same events or sequence of events as another manufacturer's program, or even the same manufacturer's program for a different airplane. Therefore, there cannot be a prescribed invariable procedure for acceptance of preliminary data, but instead there should be a statement describing the final sequence of events, data sources, and validation procedures agreed by the simulator sponsor, the airplane manufacturer, the flight simulator manufacturer, and the NSPM.

**Note:** A description of airplane manufacturer-provided data needed for flight simulator modeling and validation is to be found in the IATA Document "Flight Simulator Design and Performance Data Requirements," as amended.

e. The preliminary data should be the manufacturer's best representation of the airplane, with assurance that the final data will not significantly deviate from the preliminary estimates. Data derived from these predictive or preliminary techniques should be validated available sources including, at least, the following:

(1) Manufacturer's engineering report. The report should explain the predictive method used and illustrate past success of the method on similar projects. For example, the manufacturer could show the application of the method to an earlier airplane model or predict the characteristics of an earlier model and compare the results to final data for that model.

(2) Early flight test results. This data is often derived from airplane certification tests, and should be used to maximum

advantage for early flight simulator validation. Certain critical tests that would normally be done early in the airplane certification program should be included to validate essential pilot training and certification maneuvers. These include cases where a pilot is expected to cope with an airplane failure mode or an engine failure. Flight test data that will be available early in the flight test program will depend on the airplane manufacturer's flight test program design and may not be the same in each case. The flight test program of the airplane manufacturer should include provisions for generation of very early flight test results for flight simulator validation.

f. The use of preliminary data is not indefinite. The airplane manufacturer's final data should be available within 12 months after the airplane's first entry into service or as agreed by the NSPM, the simulator sponsor, and the airplane manufacturer. When applying for interim qualification using preliminary data, the simulator sponsor and the NSPM should agree on the update program. This includes specifying that the final data update will be installed in the flight simulator within a period of 12 months following the final data release, unless special conditions exist and a different schedule is acceptable. The flight simulator performance and handling validation would then be based on data derived from flight tests. Initial airplane systems data should be updated after engineering tests. Final airplane systems data should also be used for flight simulator programming and validation.

g. Flight simulator avionics should stay essentially in step with airplane avionics (hardware and software) updates. The permitted time lapse between airplane and flight simulator updates should be minimal. It may depend on the magnitude of the update and whether the QTG and pilot training and certification are affected. Differences in airplane and flight simulator avionics versions and the resulting effects on flight simulator qualification should be agreed between the simulator sponsor and the NSPM. Consultation with the flight simulator manufacturer is desirable throughout the qualification process.

h. The following describes an example of the design data and sources that might be used in the development of an interim qualification plan.

(1) The plan should consist of the development of a QTG based upon a mix of flight test and engineering simulation data. For data collected from specific airplane flight tests or other flights, the required design model or data changes necessary to support an acceptable Proof of Match (POM) should be generated by the airplane manufacturer.

(2) For proper validation of the two sets of data, the airplane manufacturer should compare their simulation model responses against the flight test data, when driven by the same control inputs and subjected to the same atmospheric conditions as recorded in the flight test. The model responses should result from a simulation where the following systems are run in an integrated fashion and are consistent with the design data released to the flight simulator manufacturer:

- (a) Propulsion
- (b) Aerodynamics;
- (c) Mass properties;
- (d) Flight controls;
- (e) Stability augmentation; and
- (f) Brakes/landing gear.

i. A qualified test pilot should be used to assess handling qualities and performance evaluations for the qualification of flight simulators of new airplane types.

**End Information****Begin QPS Requirement****9. Engineering Simulator—Validation Data**

a. When a fully validated simulation (i.e., validated with flight test results) is modified due to changes to the simulated airplane configuration, the airplane manufacturer or other acceptable data supplier must coordinate with the NSPM to supply validation data from an "audited" engineering simulator/simulation to selectively supplement flight test data. The NSPM must be provided an opportunity to audit the use of the engineering simulation or the engineering simulator during the acquisition of the data that will be used as validation data. Audited data may be used for changes that are incremental in nature. Manufacturers or other data suppliers should be able to demonstrate that the predicted changes in aircraft performance are based on acceptable aeronautical principles with proven success history and valid outcomes. This should include comparisons of predicted and flight test validated data.

b. Airplane manufacturers or other acceptable data suppliers seeking to use an engineering simulator for simulation validation data as an alternative to flight-test derived validation data, must contact the NSPM and provide the following:

(1) A description of the proposed aircraft changes, a description of the proposed simulation model changes, and the use of an integral configuration management process, including an audit of the actual simulation model modifications that includes a step-by-step description leading from the original model(s) to the current model(s).

(2) A schedule for review by the NSPM of the proposed plan and the subsequent validation data to establish acceptability of the proposal.

(3) Information that demonstrates an ability to qualify the FFS in which this data is to be used in accordance with the criteria contained in § 60.15.

c. To be qualified to supply engineering simulator validation data, for aerodynamic, engine, flight control, or ground handling models, an airplane manufacturer or other acceptable data supplier must:

(1) Be able to verify their ability to:

- (a) Develop and implement high fidelity simulation models; and

- (b) Predict the handling and performance characteristics of an airplane with sufficient accuracy to avoid additional flight test activities for those handling and performance characteristics.

(2) Have an engineering simulator that:

- (a) Is a physical entity, complete with a flight deck representative of the simulated class of airplane;

- (b) Has controls sufficient for manual flight;
- (c) Has models that run in an integrated manner;
- (d) Has fully flight-test validated simulation models as the original or baseline simulation models;
- (e) Has an out-of-the-flight deck visual system;
- (f) Has actual avionics boxes interchangeable with the equivalent software simulations to support validation of released software;
- (g) Uses the same models as released to the training community (which are also used to produce stand-alone proof-of-match and checkout documents);
- (h) Is used to support airplane development and certification; and
- (i) Has been found to be a high fidelity representation of the airplane by the manufacturer's pilots (or other acceptable data supplier), certificate holders, and the NSPM.

(3) Use the engineering simulator to produce a representative set of integrated proof-of-match cases.

(4) Use a configuration control system covering hardware and software for the operating components of the engineering simulator.

(5) Demonstrate that the predicted effects of the change(s) are within the provisions of subparagraph "a" of this section, and confirm that additional flight test data are not required.

#### d. Additional Requirements for Validation Data

(1) When used to provide validation data, an engineering simulator must meet the simulator standards currently applicable to training simulators except for the data package.

(2) The data package used should be:

(a) Comprised of the engineering predictions derived from the airplane design, development, or certification process;

(b) Based on acceptable aeronautical principles with proven success history and valid outcomes for aerodynamics, engine operations, avionics operations, flight control applications, or ground handling;

(c) Verified with existing flight-test data; and

(d) Applicable to the configuration of a production airplane, as opposed to a flight-test airplane.

(3) Where engineering simulator data are used as part of a QTG, an essential match must exist between the training simulator and the validation data.

(4) Training flight simulator(s) using these baseline and modified simulation models must be qualified to at least internationally

recognized standards, such as contained in the ICAO Document 9625, the "Manual of Criteria for the Qualification of Flight Simulators."

#### End QPS Requirement

### 10. [Reserved]

#### Begin QPS Requirement

##### 11. Validation Test Tolerances

###### a. Non-Flight-Test Tolerances

(1) If engineering simulator data or other non-flight-test data are used as an allowable form of reference validation data for the objective tests listed in Table A2A of this attachment, the data provider must supply a well-documented mathematical model and testing procedure that enables a replication of the engineering simulation results within 20% of the corresponding flight test tolerances.

#### End QPS Requirement

#### Begin Information

###### b. Background

(1) The tolerances listed in Table A2A of this attachment are designed to measure the quality of the match using flight-test data as a reference.

(2) Good engineering judgment should be applied to all tolerances in any test. A test is failed when the results fall outside of the prescribed tolerance(s).

(3) Engineering simulator data are acceptable because the same simulation models used to produce the reference data are also used to test the flight training simulator (i.e., the two sets of results should be "essentially" similar).

(4) The results from the two sources may differ for the following reasons:

(a) Hardware (avionics units and flight controls);

(b) Iteration rates;

(c) Execution order;

(d) Integration methods;

(e) Processor architecture;

(f) Digital drift, including:

(i) Interpolation methods;

(ii) Data handling differences; and

(iii) Auto-test trim tolerances.

(5) Any differences must be within 20% of the flight test tolerances. The reasons for any differences, other than those listed above, should be explained.

(6) Guidelines are needed for the application of tolerances to engineering-simulator-generated validation data because:

(a) Flight-test data are often not available due to sound technical reasons;

(b) Alternative technical solutions are being advanced; and

(c) High costs.

#### 12. Validation Data Roadmap.

a. Airplane manufacturers or other data suppliers should supply a validation data roadmap (VDR) document as part of the data package. A VDR document contains guidance material from the airplane validation data supplier recommending the best possible sources of data to be used as validation data in the QTG. A VDR is of special value when requesting interim qualification, qualification of simulators for airplanes certificated prior to 1992, and qualification of alternate engine or avionics fits. A sponsor seeking to have a device qualified in accordance with the standards contained in this QPS appendix should submit a VDR to the NSPM as early as possible in the planning stages. The NSPM is the final authority to approve the data to be used as validation material for the QTG. The NSPM and the Joint Aviation Authorities' Synthetic Training Devices Advisory Board have committed to maintain a list of agreed VDRs.

b. The VDR should identify (in matrix format) sources of data for all required tests. It should also provide guidance regarding the validity of these data for a specific engine type, thrust rating configuration, and the revision levels of all avionics affecting airplane handling qualities and performance. The VDR should include rationale or explanation in cases where data or parameters are missing, engineering simulation data are to be used, flight test methods require explanation, or there is any deviation from data requirements. Additionally, the document should refer to other appropriate sources of validation data (e.g., sound and vibration data documents).

c. The VDR table shown in Table A2C depicts a generic roadmap matrix identifying sources of validation data for an abbreviated list of tests. A complete matrix should address all test conditions.

d. Two examples of rationale pages are presented in Appendix F of the IATA "Flight Simulator Design and Performance Data Requirements." These illustrate the type of airplane and avionics configuration information and descriptive engineering rationale used to describe data anomalies, provide alternative data, or provide an acceptable basis for obtaining deviations from QTG validation requirements.

#### End Information

ICAO of IATA #	Test Description	Validation Source	Validation Document					Comments
		Source						
	Notes: 1. Only one page is shown; and some test conditions were deleted for brevity; 2. Relevant regulatory material should be consulted and all applicable tests addressed; 3. Validation source, document and comments provided herein are for reference only and do not constitute approval for use	Aircraft Flight Test Data <sup>*2</sup> Engineering Simulator Data (DEF-73 Engines)	Doc # xxx123, Rev. A Aerodynamics POM	Doc # xxx456, NEW Flight Controls POM	Doc # xxx789, Rev. B Ground Handling POM	Doc # xxx321, Rev. C Propulsion POM	Doc # xxx654, Rev. A Integrated POM	Doc # xxx987, NEW Appendix to this VDR
	CCA Mode <sup>*1</sup>							
1.a.1	Minimum Radius Turn	X		D71				
1.a.2	Rate of Turn vs. Nosewheel Angle (2 speeds)	X		D71				
1.b.1	Ground Acceleration Time and Distance	X		d73			D73	Primary data contained in IPOM
1.b.2	Minimum Control Speed, Ground (Vmcg)	x	X	d71			D73	See engineering rationale for test data in VDR
1.b.3	Minimum Unstick Speed (Vmu)	X		D71				
1.b.4	Normal Takeoff	X		d73			D73	Primary data contained in IPOM
1.b.5	Critical Engine Failure on Takeoff	X		d71			D73	Alternate engine thrust rating flight test data in VDR
1.b.6	Crosswind Takeoff	X		d71			D73	Alternate engine thrust rating flight test data in VDR
1.b.7	Rejected Takeoff	X		D71			R	Test procedure anomaly, see rationale
1.b.8	Dynamic Engine Failure After Takeoff	X	X				D73	No flight test data available; see rationale
1.c.1	Normal Climb - All Engine	X		d71			D71	Primary data contained in IPOM
1.c.2	Climb - Engine-Out, Second Segment	X		d71			D73	Alternate engine thrust rating flight test data in VDR
1.c.3	Climb - Engine-Out, Enroute	X		d71			D73	AFM data available (73K)
1.c.4	Engine-Out Approach Climb	X		D71				
1.c.5.a	Level Flight Acceleration	x	X	d73			D73	Eng sim data w/ modified EEC accel rate in VDR
1.c.5.b	Level Flight Deceleration	x	X	d73			D73	Eng sim data w/ modified EEC decel rate in VDR
1.d.1	Cruise Performance	X		D71				
1.e.1.a	Stopping Time & Distance (Wheel Brakes / Light weight)		X	D71			d73	No flight test data available; see rationale
1.e.1.b	Stopping Time & Distance (Wheel Brakes / Med weight)	X	x	D71			d73	
1.e.1.c	Stopping Time & Distance (Wheel Brakes / Heavy weight)	X	x	D71			d73	
1.e.2.a	Stopping Time & Distance (Reverse Thrust / Light weight)	X	x	D71			d73	
1.e.2.b	Stopping Time & Distance (Reverse Thrust / Med weight)		X	d71			D73	No flight test data available; see rationale

\*1 CCA mode must be described for each test condition.

\*2 If more than one aircraft type (e.g., derivative and baseline) are used as validation data, more columns may be necessary.

Table A2C - Validation Data Roadmap

BILLING CODE 4910-13-C

**Begin Information**

**13. Acceptance Guidelines for Alternative Engines Data**

- a. Background
  - (1) For a new airplane type, the majority of flight validation data are collected on the first airplane configuration with a "baseline" engine type. These data are then used to validate all flight simulators representing that airplane type.
  - (2) Additional flight test validation data may be needed for flight simulators representing an airplane with engines of a different type than the baseline, or for engines with thrust rating that is different from previously validated configurations.
  - (3) When a flight simulator with alternate engines is to be qualified, the QTG should contain tests against flight test validation data for selected cases where engine differences are expected to be significant.
- b. Approval Guidelines for Validating Alternate Engine Applications.
  - (1) The following guidelines apply to flight simulators representing airplanes with alternate engine applications or with more than one engine type or thrust rating.
  - (2) Validation tests can be segmented into two groups, those that are dependent on engine type or thrust rating and those that are not.
  - (3) For tests that are independent of engine type or thrust rating, the QTG can be based on validation data from any engine application. Tests in this category should be designated as independent of engine type or thrust rating.
  - (4) For tests that are affected by engine type, the QTG should contain selected

- engine-specific flight test data sufficient to validate that particular airplane-engine configuration. These effects may be due to engine dynamic characteristics, thrust levels or engine-related airplane configuration changes. This category is primarily characterized by variations between different engine manufacturers' products, but also includes differences due to significant engine design changes from a previously flight-validated configuration within a single engine type. See Table A2D, Alternate Engine Validation Flight Tests in this section for a list of acceptable tests.
- (5) The validation data should be based on flight test data, except where other data are specifically allowed. If certification of the flight characteristics of the airplane with a new thrust rating (regardless of percentage change) does require certification flight testing with a comprehensive stability and control flight instrumentation package, then the conditions described in Table A2D in this section should be obtained from flight testing and presented in the QTG. Flight test data, other than throttle calibration data, are not required if the new thrust rating is certified on the airplane without need for a comprehensive stability and control flight instrumentation package.
- (6) As a supplement to the engine-specific flight tests listed in Table A2D and baseline engine-independent tests, additional engine-specific engineering validation data should be provided in the QTG, as appropriate, to facilitate running the entire QTG with the alternate engine configuration. The sponsor and the NSPM should agree in advance on the specific validation tests to be supported by engineering simulation data.
- (7) A matrix or VDR should be provided with the QTG indicating the appropriate validation data source for each test.

- (8) The flight test conditions in Table A2D are appropriate and should be sufficient to validate implementation of alternate engines in a flight simulator.

**End Information**

**Begin QPS Requirement**

- c. Test Requirements
  - (1) The QTG must contain selected engine-specific flight test data sufficient to validate the alternative thrust level when:
    - (a) the engine type is the same, but the thrust rating exceeds that of a previously flight-test validated configuration by five percent (5%) or more; or
    - (b) the engine type is the same, but the thrust rating is less than the lowest previously flight-test validated rating by fifteen percent (15%) or more.
  - (2) Flight test data is not required if the thrust increase is greater than 5%, but flight tests have confirmed that the thrust increase does not change the airplane's flight characteristics.
  - (3) Throttle calibration data (i.e., commanded power setting parameter versus throttle position) must be provided to validate all alternate engine types and engine thrust ratings that are higher or lower than a previously validated engine. Data from a test airplane or engineering test bench with the correct engine controller (both hardware and software) are required.

**End QPS Requirement**

**Begin QPS Requirement**

TABLE A2D.—ALTERNATIVE ENGINE VALIDATION FLIGHT TESTS

Test Number	Test description	Alternative engine type	Alternative thrust rating <sup>2</sup>
1.b.1., 1.b.4. ....	Normal take-off/ground acceleration time and distance .....	X	X
1.b.2. ....	V <sub>mca</sub> , if performed for airplane certification .....	X	X
1.b.5. ....	Engine-out take-off.		
1.b.8. ....	Dynamic engine failure after take-off.		
	Either test may be performed .....	X	
1.b.7. ....	Rejected take-off if performed for airplane certification .....	X	
1.d.1. ....	Cruise performance .....	X	
1.f.1., 1.f.2. ....	Engine acceleration and deceleration .....	X	X
2.a.7. ....	Throttle calibration <sup>1</sup> .....	X	X
2.c.1. ....	Power change dynamics (acceleration) .....	X	X
2.d.1. ....	V <sub>mca</sub> if performed for airplane certification .....	X	X
2.d.5. ....	Engine inoperative trim .....	X	X
2.e.1. ....	Normal landing .....	X	

<sup>1</sup> Must be provided for all changes in engine type or thrust rating; see paragraph 12.b.(7).  
<sup>2</sup> See paragraphs 12.b.(5) through 12.b.(8), for a definition of applicable thrust ratings.

**End QPS Requirement**

**Begin Information**

**14. Acceptance Guidelines for Alternative Avionics (Flight-Related Computers and Controllers)**

- a. Background

- (1) For a new airplane type, the majority of flight validation data are collected on the first airplane configuration with a "baseline" flight-related avionics ship-set; (see subparagraph b.(2) in this paragraph). These data are then used to validate all flight simulators representing that airplane type.
- (2) Additional validation data may be required for flight simulators representing an airplane with avionics of a different

hardware design than the baseline, or a different software revision than previously validated configurations.

- (3) When a flight simulator with additional or alternate avionics configurations is to be qualified, the QTG should contain tests against validation data for selected cases where avionics differences are expected to be significant.



b. Approval Guidelines for Validating Alternate Avionics

(1) The following guidelines apply to flight simulators representing airplanes with a revised avionics configuration, or more than one avionics configuration.

(2) The baseline validation data should be based on flight test data, except where other data are specifically allowed (e.g., engineering flight simulator data).

(3) The airplane avionics can be segmented into two groups, systems or components whose functional behavior contributes to the aircraft response presented in the QTG results, and systems that do not. The following avionics are examples of contributory systems for which hardware design changes or software revisions may lead to significant differences in the aircraft response relative to the baseline avionics configuration: flight control computers and controllers for engines, autopilot, braking system, nose wheel steering system, and high lift system. Related avionics such as stall warning and augmentation systems should also be considered.

(4) The acceptability of validation data used in the QTG for an alternative avionics fit should be determined as follows:

(a) For changes to an avionics system or component that do not affect QTG validation test response, the QTG test can be based on validation data from the previously validated avionics configuration.

(b) For an avionics change to a contributory system, where a specific test is not affected by the change (e.g., the avionics change is a Built In Test Equipment (BITE) update or a modification in a different flight phase), the QTG test can be based on validation data from the previously-validated avionics configuration. The QTG should include authoritative justification (e.g., from the airplane manufacturer or system supplier) that this avionics change does not affect the test.

(c) For an avionics change to a contributory system, the QTG may be based on validation data from the previously-validated avionics configuration if no new functionality is added and the impact of the avionics change on the airplane response is based on acceptable aeronautical principles with proven success history and valid outcomes. This should be supplemented with avionics-specific validation data from the airplane manufacturer's engineering simulation, generated with the revised avionics configuration. The QTG should also include an explanation of the nature of the change and its effect on the airplane response.

(d) For an avionics change to a contributory system that significantly affects some tests in the QTG or where new functionality is added, the QTG should be based on validation data from the previously validated avionics configuration and supplemental avionics-specific flight test data sufficient to validate the alternate avionics revision. Additional flight test validation data may not be needed if the avionics changes were certified without the need for testing with a comprehensive flight

instrumentation package. The airplane manufacturer should coordinate flight simulator data requirements, in advance with the NSPM.

(5) A matrix or "roadmap" should be provided with the QTG indicating the appropriate validation data source for each test. The roadmap should include identification of the revision state of those contributory avionics systems that could affect specific test responses if changed.

#### 15. Transport Delay Testing

a. This paragraph explains how to determine the introduced transport delay through the flight simulator system so that it does not exceed a specific time delay. The transport delay should be measured from control inputs through the interface, through each of the host computer modules and back through the interface to motion, flight instrument, and visual systems. The transport delay should not exceed the maximum allowable interval.

b. Four specific examples of transport delay are:

(1) Simulation of classic non-computer controlled airplanes;

(2) Simulation of computer controlled airplanes using real airplane black boxes;

(3) Simulation of computer controlled airplanes using software emulation of airplane boxes;

(4) Simulation using software avionics or re-hosted instruments.

c. Figure A2C illustrates the total transport delay for a non-computer-controlled airplane or the classic transport delay test. Since there are no airplane-induced delays for this case, the total transport delay is equivalent to the introduced delay.

d. Figure A2D illustrates the transport delay testing method using the real airplane controller system.

e. To obtain the induced transport delay for the motion, instrument and visual signal, the delay induced by the airplane controller should be subtracted from the total transport delay. This difference represents the introduced delay and should not exceed the standards prescribed in Table A1A.

f. Introduced transport delay is measured from the flight deck control input to the reaction of the instruments and motion and visual systems (See Figure A2C).

g. The control input may also be introduced after the airplane controller system and the introduced transport delay measured directly from the control input to the reaction of the instruments, and simulator motion and visual systems (See Figure A2D).

h. Figure A2E illustrates the transport delay testing method used on a flight simulator that uses a software emulated airplane controller system.

i. It is not possible to measure the introduced transport delay using the simulated airplane controller system architecture for the pitch, roll and yaw axes. Therefore, the signal should be measured directly from the pilot controller. The flight simulator manufacturer should measure the

total transport delay and subtract the inherent delay of the actual airplane components because the real airplane controller system has an inherent delay provided by the airplane manufacturer. The flight simulator manufacturer should ensure that the introduced delay does not exceed the standards prescribed in Table A1A.

j. Special measurements for instrument signals for flight simulators using a real airplane instrument display system instead of a simulated or re-hosted display. For flight instrument systems, the total transport delay should be measured and the inherent delay of the actual airplane components subtracted to ensure that the introduced delay does not exceed the standards prescribed in Table A1A.

(1) Figure A2FA illustrates the transport delay procedure without airplane display simulation. The introduced delay consists of the delay between the control movement and the instrument change on the data bus.

(2) Figure A2FB illustrates the modified testing method required to measure introduced delay due to software avionics or re-hosted instruments. The total simulated instrument transport delay is measured and the airplane delay should be subtracted from this total. This difference represents the introduced delay and should not exceed the standards prescribed in Table A1A. The inherent delay of the airplane between the data bus and the displays is indicated in figure A2FA. The display manufacturer should provide this delay time.

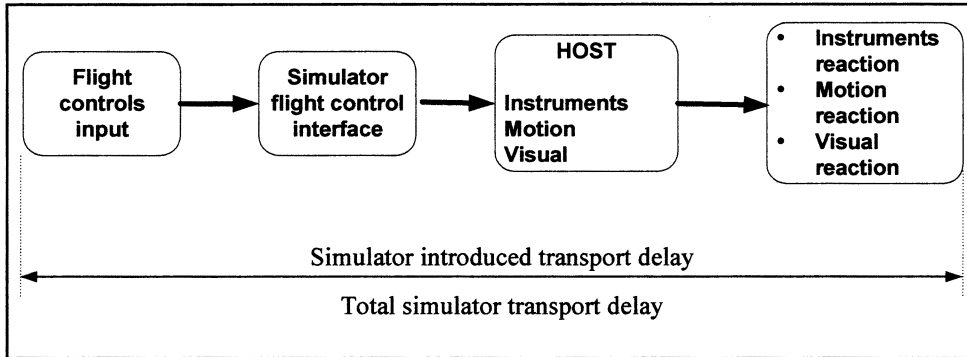
k. Recorded signals. The signals recorded to conduct the transport delay calculations should be explained on a schematic block diagram. The flight simulator manufacturer should also provide an explanation of why each signal was selected and how they relate to the above descriptions.

l. Interpretation of results. Flight simulator results vary over time from test to test due to "sampling uncertainty." All flight simulators run at a specific rate where all modules are executed sequentially in the host computer. The flight controls input can occur at any time in the iteration, but these data will not be processed before the start of the new iteration. For example, a flight simulator running at 60 Hz may have a difference of as much as 16.67 msec between test results. This does not mean that the test has failed. Instead, the difference is attributed to variations in input processing. In some conditions, the host simulator and the visual system do not run at the same iteration rate, so the output of the host computer to the visual system will not always be synchronized.

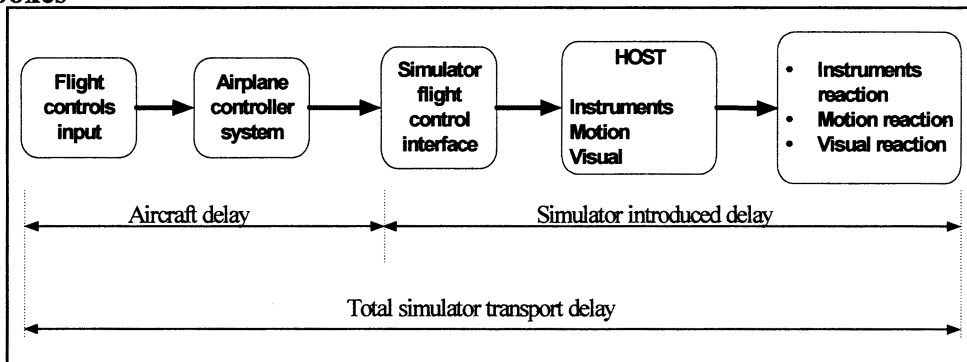
m. The transport delay test should account for both daylight and night modes of operation of the visual system. In both cases, the tolerances prescribed in Table A1A must be met and the motion response should occur before the end of the first video scan containing new information.

BILLING CODE 4910-13-P

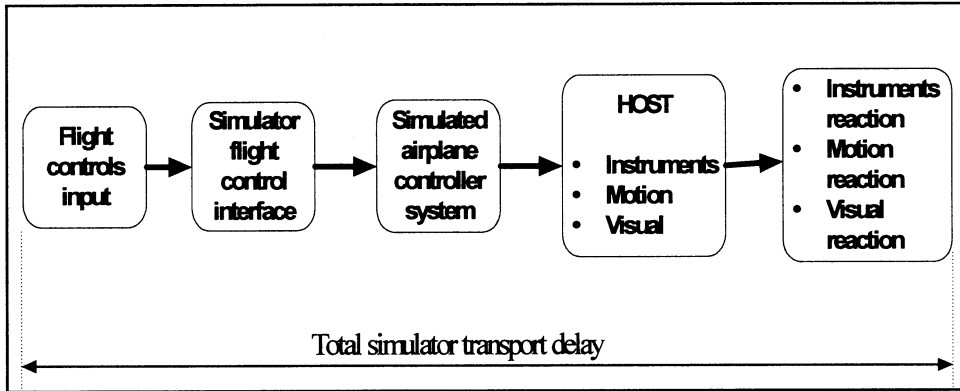
**Figure A2C**  
**Transport Delay for simulation of classic non-computer controlled airplanes.**



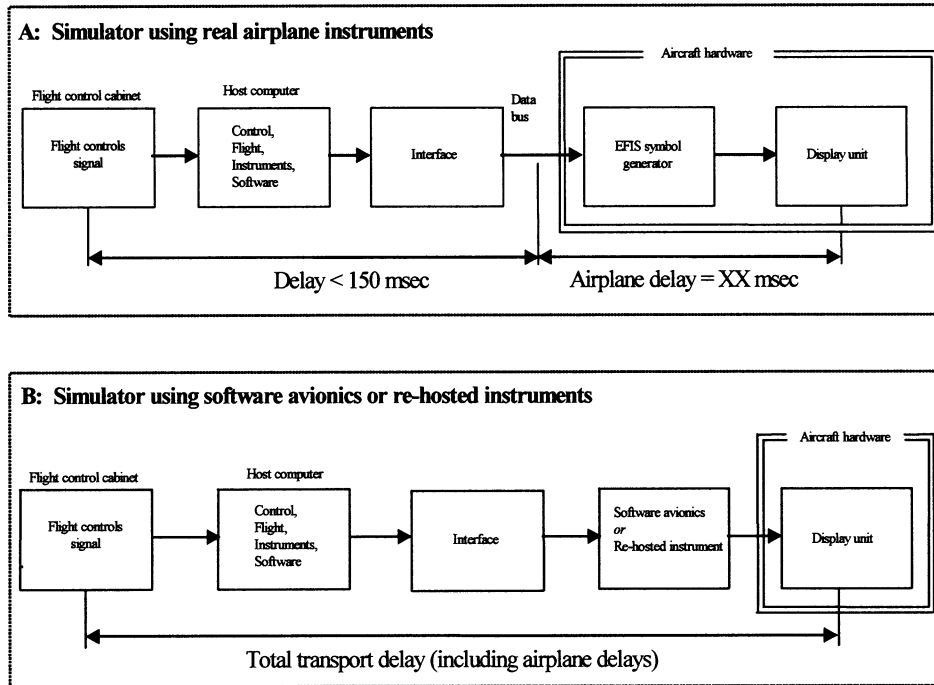
**Figure A2D**  
**Transport Delay for simulation of computer controlled airplanes using real airplane black boxes**



**Figure A2E**  
**Transport Delay for simulation of computer controlled airplanes using software emulation of airplane boxes**



**Figure A2FA and A2FB**  
**Transport delay for simulation of airplanes using real or re-hosted instrument drivers**



**End Information**

BILLING CODE 4910-13-C

**Begin Information**

**16. Continuing Qualification Evaluations—Validation Test Data Presentation**

a. Background

(1) The MQTG is created during the initial evaluation of a flight simulator. This is the master document, as amended, to which flight simulator continuing qualification evaluation test results are compared.

(2) The currently accepted method of presenting continuing qualification

evaluation test results is to provide flight simulator results over-plotted with reference data. Test results are carefully reviewed to determine if the test is within the specified tolerances. This can be a time consuming process, particularly when reference data exhibits rapid variations or an apparent anomaly requiring engineering judgment in the application of the tolerances. In these cases, the solution is to compare the results to the MQTG. The continuing qualification results are compared to the results in the MQTG for acceptance. The flight simulator operator and the NSPM should look for any change in the flight simulator performance since initial qualification.

b. Continuing Qualification Evaluation Test Results Presentation

(1) Flight simulator operators are encouraged to over-plot continuing qualification validation test results with MQTG flight simulator results recorded during the initial evaluation and as amended. Any change in a validation test will be readily apparent. In addition to plotting continuing qualification validation test and MQTG results, operators may elect to plot reference data as well.

(2) There are no suggested tolerances between flight simulator continuing qualification and MQTG validation test results. Investigation of any discrepancy between the MQTG and continuing

qualification flight simulator performance is left to the discretion of the flight simulator operator and the NSPM.

(3) Differences between the two sets of results, other than variations attributable to repeatability issues that cannot be explained, should be investigated.

(4) The flight simulator should retain the ability to over-plot both automatic and manual validation test results with reference data.

**End Information**

**Begin QPS Requirements**

**17. Alternative Data Sources, Procedures, and Instrumentation: Level A and Level B Simulators Only**

a. Sponsors are not required to use the alternative data sources, procedures, and instrumentation. However, any sponsor choosing to use alternative sources must comply with the requirements in Table A2E.

**End QPS Requirements**

**Begin Information**

b. It has become standard practice for experienced simulator manufacturers to use modeling techniques to establish data bases for new simulator configurations while awaiting the availability of actual flight test data. The data generated from the aerodynamic modeling techniques is then compared to the flight test data when it becomes available. The results of such comparisons have become increasingly consistent, indicating that these techniques, applied with the appropriate experience, are dependable and accurate for the development of aerodynamic models for use in Level A and Level B simulators.

c. Based on this history of successful comparisons, the NSPM has concluded that

those who are experienced in the development of aerodynamic models may use modeling techniques to alter the method for acquiring flight test data for Level A or Level B simulators.

d. The information in Table A2E (Alternative Data Sources, Procedures, and Instrumentation) is presented to describe an acceptable alternative to data sources for simulator modeling and validation and an acceptable alternative to the procedures and instrumentation traditionally used to gather such modeling and validation data.

(1) Alternative data sources that may be used for part or all of a data requirement are the Airplane Maintenance Manual, the Airplane Flight Manual (AFM), Airplane Design Data, the Type Inspection Report (TIR), Certification Data or acceptable supplemental flight test data.

(2) The sponsor should coordinate with the NSPM prior to using alternative data sources in a flight test or data gathering effort.

e. The NSPM position regarding the use of these alternative data sources, procedures, and instrumentation is based on the following presumptions:

(1) Data gathered through the alternative means does not require angle of attack (AOA) measurements or control surface position measurements for any flight test. However, AOA can be sufficiently derived if the flight test program ensures the collection of acceptable level, unaccelerated, trimmed flight data. All of the simulator time history tests that begin in level, unaccelerated, and trimmed flight, including the three basic trim tests and "fly-by" trims, can be a successful validation of angle of attack by comparison with flight test pitch angle. (Note: Due to the criticality of angle of attack in the development of the ground effects model, particularly critical for normal landings and landings involving cross-control input applicable to Level B simulators, stable "fly-by" trim data will be the acceptable norm for

normal and cross-control input landing objective data for these applications.)

(2) The use of a rigorously defined and fully mature simulation controls system model that includes accurate gearing and cable stretch characteristics (where applicable), determined from actual aircraft measurements. Such a model does not require control surface position measurements in the flight test objective data in these limited applications.

f. The sponsor is urged to contact the NSPM for clarification of any issue regarding airplanes with reversible control systems. Table A2E is not applicable to Computer Controlled Aircraft full flight simulators.

g. Utilization of these alternate data sources, procedures, and instrumentation (Table A2E) does not relieve the sponsor from compliance with the balance of the information contained in this document relative to Level A or Level B FFSSs.

h. The term "inertial measurement system" is used in the following table to include the use of a functional global positioning system (GPS).

i. Synchronized video for the use of alternative data sources, procedures, and instrumentation should have:

(1) Sufficient resolution to allow magnification of the display to make appropriate measurement and comparisons; and

(2) Sufficient size and incremental marking to allow similar measurement and comparison. The detail provided by the video should provide sufficient clarity and accuracy to measure the necessary parameter(s) to at least 1/2 of the tolerance authorized for the specific test being conducted and allow an integration of the parameter(s) in question to obtain a rate of change.

**End Information**

TABLE A2E.—ALTERNATIVE DATA SOURCES, PROCEDURES, AND INSTRUMENTATION  
<<<QPS requirements>>>

Table of objective tests Test reference number and title	Sim level		Alternative data sources, procedures, and instrumentation	Notes and reminders
	A	B		

The standards in this table are required if the data gathering methods described in paragraph 9 of Appendix A are not used.

1.a.1. Performance. Taxi. Minimum Radius turn.	X	X	TIR, AFM, or Design data may be used .....	
1.a.2. Performance. Taxi Rate of Turn vs. Nosewheel Steering Angle.		X	Data may be acquired by using a constant tiller position, measured with a protractor or full rudder pedal application for steady state turn, and synchronized video of heading indicator. If less than full rudder pedal is used, pedal position must be recorded.	A single procedure may not be adequate for all airplane steering systems, therefore appropriate measurement procedures must be devised and proposed for NSPM concurrence.
1.b.1. Performance. Takeoff. Ground Acceleration Time and Distance.	X	X	Preliminary certification data may be used. Data may be acquired by using a stop watch, calibrated airspeed, and runway markers during a takeoff with power set before brake release. Power settings may be hand recorded. If an inertial measurement system is installed, speed and distance may be derived from acceleration measurements.	

TABLE A2E.—ALTERNATIVE DATA SOURCES, PROCEDURES, AND INSTRUMENTATION—Continued  
 <<<QPS requirements>>>

Table of objective tests Test reference number and title	Sim level		Alternative data sources, procedures, and instrumentation	Notes and reminders
	A	B		
1.b.2. Performance. Takeoff. Minimum Control Speed-ground ( $V_{mcg}$ ) using aerodynamic controls only (per applicable airworthiness standard) or low speed, engine inoperative ground control characteristics.	X	X	Data may be acquired by using an inertial measurement system and a synchronized video of calibrated airplane instruments and force/position measurements of flight deck controls.	Rapid throttle reductions at speeds near $V_{mcg}$ may be used while recording appropriate parameters. The nose wheel must be free to caster, or equivalently freed of sideforce generation.
1.b.3. Performance. Takeoff. Minimum Unstick Speed ( $V_{mu}$ ) or equivalent test to demonstrate early rotation takeoff characteristics.	X	X	Data may be acquired by using an inertial measurement system and a synchronized video of calibrated airplane instruments and the force/position measurements of flight deck controls.	
1.b.4. Performance. Takeoff. Normal Takeoff.	X	X	Data may be acquired by using an inertial measurement system and a synchronized video of calibrated airplane instruments and force/position measurements of flight deck controls. AOA can be calculated from pitch attitude and flight path.	
1.b.5. Performance. Takeoff. Critical Engine Failure during Takeoff.	X	X	Data may be acquired by using an inertial measurement system and a synchronized video of calibrated airplane instruments and force/position measurements of flight deck controls.	Record airplane dynamic response to engine failure and control inputs required to correct flight path.
1.b.6. Performance. Takeoff. Crosswind Takeoff.	X	X	Data may be acquired by using an inertial measurement system and a synchronized video of calibrated airplane instruments and force/position measurements of flight deck controls.	The "1:7 law" to 100 feet (30 meters) is an acceptable wind profile.
1.b.7. Performance. Takeoff. Rejected Takeoff.	X	X	Data may be acquired with a synchronized video of calibrated airplane instruments, thrust lever position, engine parameters, and distance (e.g., runway markers). A stop watch is required.	
1.c.1. Performance. Climb. Normal Climb all engines operating.	X	X	Data may be acquired with a synchronized video of calibrated airplane instruments and engine power throughout the climb range.	
1.c.2. Performance. Climb. One Engine Inoperative Climb.	X	X	Data may be acquired with a synchronized video of calibrated airplane instruments and engine power throughout the climb range.	
1.c.4. Performance. Climb. One Engine Inoperative Approach Climb (if operations in icing conditions are authorized).	X	X	Data may be acquired with a synchronized video of calibrated airplane instruments and engine power throughout the climb range.	
1.d.1. Cruise/Descent. Level flight acceleration.	X	X	Data may be acquired with a synchronized video of calibrated airplane instruments, thrust lever position, engine parameters, and elapsed time.	
1.d.2. Cruise/Descent. Level flight deceleration.	X	X	Data may be acquired with a synchronized video of calibrated airplane instruments, thrust lever position, engine parameters, and elapsed time.	
1.d.4. Cruise/Descent. Idle descent ..	X	X	Data may be acquired with a synchronized video of calibrated airplane instruments, thrust lever position, engine parameters, and elapsed time.	
1.d.5. Cruise/Descent. Emergency Descent.	X	X	Data may be acquired with a synchronized video of calibrated airplane instruments, thrust lever position, engine parameters, and elapsed time.	
1.e.1. Performance. Stopping. Deceleration time and distance, using manual application of wheel brakes and no reverse thrust on a dry runway.	X	X	Data may be acquired during landing tests using a stop watch, runway markers, and a synchronized video of calibrated airplane instruments, thrust lever position and the pertinent parameters of engine power.	
1.e.2. Performance. Ground. Deceleration Time and Distance, using reverse thrust and no wheel brakes.	X	X	Data may be acquired during landing tests using a stop watch, runway markers, and a synchronized video of calibrated airplane instruments, thrust lever position and pertinent parameters of engine power.	
1.f.1. Performance. Engines. Acceleration.	X	X	Data may be acquired with a synchronized video recording of engine instruments and throttle position.	

TABLE A2E.—ALTERNATIVE DATA SOURCES, PROCEDURES, AND INSTRUMENTATION—Continued  
 <<<QPS requirements>>>

Table of objective tests Test reference number and title	Sim level		Alternative data sources, procedures, and instrumentation	Notes and reminders
	A	B		
1.f.2. Performance. Engines. Deceleration.	X	X	Data may be acquired with a synchronized video recording of engine instruments and throttle position.	
2.a.1.a. Handling Qualities. Static Control Checks. Pitch Controller Position vs. Force and Surface Position Calibration.	X	X	Surface position data may be acquired from flight data recorder (FDR) sensor or, if no FDR sensor, at selected, significant column positions (encompassing significant column position data points), acceptable to the NSPM, using a control surface protractor on the ground (for airplanes with reversible control systems, this function should be accomplished with winds less than 5 kts.). Force data may be acquired by using a hand held force gauge at the same column position data points.	
2.a.2.a. Handling Qualities. Static Control Checks. Roll Controller Position vs. Force and Surface Position Calibration.	X	X	Surface position data may be acquired from flight data recorder (FDR) sensor or, if no FDR sensor, at selected, significant wheel positions (encompassing significant wheel position data points), acceptable to the NSPM, using a control surface protractor on the ground (for airplanes with reversible control systems, this function should be accomplished with winds less than 5 kts.). Force data may be acquired by using a hand held force gauge at the same wheel position data points.	
2.a.3.a. Handling Qualities. Static Control Checks. Rudder Pedal Position vs. Force and Surface Position Calibration.	X	X	Surface position data may be acquired from flight data recorder (FDR) sensor or, if no FDR sensor, at selected, significant rudder pedal position data points), acceptable to the NSPM, using a control surface protractor on the ground (for airplanes with reversible control systems, this function should be accomplished with winds less than 5 kts.). Force data may be acquired by using a hand held force gauge at the same rudder pedal position data points.	
2.a.4. Handling Qualities. Static Control Checks. Nosewheel Steering Controller Force and Position.	X	X	Breakout data may be acquired with a hand held force gauge. The remainder of the force to the stops may be calculated if the force gauge and a protractor are used to measure force after breakout for at least 25% of the total displacement capability.	
2.a.5. Handling Qualities. Static Control Checks. Rudder Pedal Steering Calibration.	X	X	Data may be acquired through the use of force pads on the rudder pedals and a pedal position measurement device, together with design data for nose wheel position.	
2.a.6. Handling Qualities. Static Control Checks. Pitch Trim Indicator vs. Surface Position Calibration.	X	X	Data may be acquired through calculations.	
2.a.7. Handling qualities. Static control tests. Pitch trim rate.	X	X	Data may be acquired by using a synchronized video of pitch trim indication and elapsed time through range of trim indication.	
2.a.8. Handling Qualities. Static Control tests. Alignment of Flight deck Throttle Lever Angle vs. Selected engine parameter.	X	X	Data may be acquired through the use of a temporary throttle quadrant scale to document throttle position. Use a synchronized video to record steady state instrument readings or hand-record steady state engine performance readings.	
2.a.9. Handling qualities. Static control tests. Brake pedal position vs. force and brake system pressure calibration.	X	X	Use of design or predicted data is acceptable. Data may be acquired by measuring deflection at "zero" and "maximum" and calculating deflections between the extremes using the airplane design data curve.	
2.c.1. Handling qualities. Longitudinal control tests. Power change dynamics.	X	X	Data may be acquired by using an inertial measurement system and a synchronized video of calibrated airplane instruments and throttle position.	

TABLE A2E.—ALTERNATIVE DATA SOURCES, PROCEDURES, AND INSTRUMENTATION—Continued  
 <<<QPS requirements>>>

Table of objective tests Test reference number and title	Sim level		Alternative data sources, procedures, and instrumentation	Notes and reminders
	A	B		
2.c.2. Handling qualities. Longitudinal control tests. Flap/slat change dynamics.	X	X	Data may be acquired by using an inertial measurement system and a synchronized video of calibrated airplane instruments and flap/slat position.	
2.c.3. Handling qualities. Longitudinal control tests. Spoiler/speedbrake change dynamics.	X	X	Data may be acquired by using an inertial measurement system and a synchronized video of calibrated airplane instruments and spoiler/speedbrake position.	
2.c.4. Handling qualities. Longitudinal control tests. Gear change dynamics.	X	X	Data may be acquired by using an inertial measurement system and a synchronized video of calibrated airplane instruments and gear position.	
2.c.5. Handling qualities. Longitudinal control tests. Longitudinal trim.	X	X	Data may be acquired through use of an inertial measurement system and a synchronized video of flight deck controls position (previously calibrated to show related surface position) and the engine instrument readings.	
2.c.6. Handling qualities. Longitudinal control tests. Longitudinal maneuvering stability (stick force/g).	X	X	Data may be acquired through the use of an inertial measurement system and a synchronized video of calibrated airplane instruments; a temporary, high resolution bank angle scale affixed to the attitude indicator; and a wheel and column force measurement indication.	
2.c.7. Handling qualities. Longitudinal control tests. Longitudinal static stability.	X	X	Data may be acquired through the use of a synchronized video of airplane flight instruments and a hand held force gauge.	
2.c.8. Handling qualities. Longitudinal control tests. Stall characteristics.	X	X	Data may be acquired through a synchronized video recording of a stop watch and calibrated airplane airspeed indicator. Hand-record the flight conditions and airplane configuration.	Airspeeds may be cross checked with those in the TIR and AFM.
2.c.9. Handling qualities. Longitudinal control tests. Phugoid dynamics.	X	X	Data may be acquired by using an inertial measurement system and a synchronized video of calibrated airplane instruments and force/position measurements of flight deck controls.	
2.c.10. Handling qualities. Longitudinal control tests. Short period dynamics.		X	Data may be acquired by using an inertial measurement system and a synchronized video of calibrated airplane instruments and force/position measurements of flight deck controls.	
2.d.1. Handling qualities. Lateral directional tests. Minimum control speed, air ( $V_{mca}$ or $V_{mci}$ ), per applicable airworthiness standard or Low speed engine inoperative handling characteristics in the air.	X	X	Data may be acquired by using an inertial measurement system and a synchronized video of calibrated airplane instruments and force/position measurements of flight deck controls.	
2.d.2. Handling qualities. Lateral directional tests. Roll response (rate).	X	X	Data may be acquired by using an inertial measurement system and a synchronized video of calibrated airplane instruments and force/position measurements of flight deck lateral controls.	May be combined with step input of flight deck roll controller test, 2.d.3.
2.d.3. Handling qualities. Lateral directional tests. Roll response to flight deck roll controller step input.	X	X	Data may be acquired by using an inertial measurement system and a synchronized video of calibrated airplane instruments and force/position measurements of flight deck lateral controls.	
2.d.4. Handling qualities. Lateral directional tests. Spiral stability.	X	X	Data may be acquired by using an inertial measurement system and a synchronized video of calibrated airplane instruments; force/position measurements of flight deck controls; and a stop watch.	

TABLE A2E.—ALTERNATIVE DATA SOURCES, PROCEDURES, AND INSTRUMENTATION—Continued  
 <<<QPS requirements>>>

Table of objective tests Test reference number and title	Sim level		Alternative data sources, procedures, and instrumentation	Notes and reminders
	A	B		
2.d.5. Handling qualities. Lateral directional tests. Engine inoperative trim.	X	X	Data may be hand recorded in-flight using high resolution scales affixed to trim controls that have been calibrated on the ground using protractors on the control/trim surfaces with winds less than 5 kts. OR Data may be acquired during second segment climb (with proper pilot control input for an engine-out condition) by using a synchronized video of calibrated airplane instruments and force/position measurements of flight deck controls.	Trimming during second segment climb is not a certification task and should not be conducted until a safe altitude is reached.
2.d.6. Handling qualities. Lateral directional tests. Rudder response.	X	X	Data may be acquired by using an inertial measurement system and a synchronized video of calibrated airplane instruments and force/position measurements of rudder pedals.	
2.d.7. Handling qualities. Lateral directional tests. Dutch roll (yaw damper OFF).	X	X	Data may be acquired by using an inertial measurement system and a synchronized video of calibrated airplane instruments and force/position measurements of flight deck controls.	
2.d.8. Handling qualities. Lateral directional tests. Steady state sideslip.	X	X	Data may be acquired by using an inertial measurement system and a synchronized video of calibrated airplane instruments and force/position measurements of flight deck controls. Ground track and wind corrected heading may be used for sideslip angle.	
2.e.1. Handling qualities. Landings. Normal landing.		X	Data may be acquired by using an inertial measurement system and a synchronized video of calibrated airplane instruments and force/position measurements of flight deck controls.	
2.e.3. Handling qualities. Landings. Crosswind landing.		X	Data may be acquired by using an inertial measurement system and a synchronized video of calibrated airplane instruments and force/position measurements of flight deck controls.	
2.e.4. Handling qualities. Landings. One engine inoperative landing.		X	Data may be acquired by using an inertial measurement system and a synchronized video of calibrated airplane instruments and the force/position measurements of flight deck controls. Normal and lateral accelerations may be recorded in lieu of AOA and sideslip.	
2.e.5. Handling qualities. Landings. Autopilot landing (if applicable).		X	Data may be acquired by using an inertial measurement system and a synchronized video of calibrated airplane instruments and force/position measurements of flight deck controls. Normal and lateral accelerations may be recorded in lieu of AOA and sideslip.	
2.e.6. Handling qualities. Landings. All engines operating, autopilot, go around.		X	Data may be acquired by using an inertial measurement system and a synchronized video of calibrated airplane instruments and force/position measurements of flight deck controls. Normal and lateral accelerations may be recorded in lieu of AOA and sideslip.	
2.e.7. Handling qualities. Landings. One engine inoperative go around.		X	Data may be acquired by using an inertial measurement system and a synchronized video of calibrated airplane instruments and force/position measurements of flight deck controls. Normal and lateral accelerations may be recorded in lieu of AOA and sideslip.	
2.e.8. Handling qualities. Landings. Directional control (rudder effectiveness with symmetric thrust).		X	Data may be acquired by using an inertial measurement system and a synchronized video of calibrated airplane instruments and force/position measurements of flight deck controls. Normal and lateral accelerations may be recorded in lieu of AOA and sideslip.	
2.e.9. Handling qualities. Landings. Directional control (rudder effectiveness with asymmetric reverse thrust).		X	Data may be acquired by using an inertial measurement system and a synchronized video of calibrated airplane instruments and force/position measurements of flight deck controls. Normal and lateral accelerations may be recorded in lieu of AOA and sideslip.	



TABLE A2E.—ALTERNATIVE DATA SOURCES, PROCEDURES, AND INSTRUMENTATION—Continued

&lt;&lt;&lt;QPS requirements&gt;&gt;&gt;

Table of objective tests Test reference number and title	Sim level		Alternative data sources, procedures, and instrumentation	Notes and reminders
	A	B		
2.f. Handling qualities. Ground effect. Test to demonstrate ground effect.		X	Data may be acquired by using calibrated airplane instruments, an inertial measurement system, and a synchronized video of calibrated airplane instruments and force/position measurements of flight deck controls.	

**End Information****Attachment 3 to Appendix A to Part 60—  
Simulator Subjective Evaluation****Begin QPS Requirements****1. Requirements**

a. Except for special use visual scenes and airport models described below, all visual scenes and airport models required by this part must be representations of real-world, operational airports or representations of fictional airports and must meet the requirements set out in Tables A3B and A3C of this attachment, as appropriate.

b. If fictional airports are used, the sponsor must ensure that navigational aids and all appropriate maps, charts, and other navigational reference material for the fictional airports (and surrounding areas as necessary) are compatible, complete, and accurate with respect to the visual presentation and scene content of the visual model of this fictional airport. An SOC must be submitted that addresses navigation aid installation and performance and other criteria (including obstruction clearance protection) for all instrument approaches to the fictional airports that are available in the simulator. The SOC must reference and account for information in the terminal instrument procedures manual and the construction and availability of the required maps, charts, and other navigational material. This material must be clearly marked "for training purposes only."

c. When the simulator is being used by an instructor or evaluator for purposes of training, checking, or testing under this chapter, only visual scenes and airport models classified as Class I, Class II, or Class III may be available to the instructor or evaluator. The classifications are as follows:

(1) Class I (whether modeling real world airports or fictional airports), for those visual scenes and airport models used for simulator qualification at a specified level. These visual scenes and airport models must meet the minimum requirements in Table A3B of this attachment, be evaluated by the NSPM, be listed on the Statement of Qualification (SOQ), and be available for use at the simulator IOS.

(2) Class II (whether modeling real world airports or fictional airports), for those visual scenes and airport models that are in excess of those used for simulator qualification at a specified level. These visual scenes and airport models must meet the minimum requirements set out in Table A3C of this

attachment. These visual scenes and airport models may be made available on the simulator IOS without further involvement of the NSPM or the TPAA.

(3) For an interim period ending [date 2 years after the effective date of the final rule], Class III visual scenes and airport models (whether modeling real world airports, generic airports, or fictional airports) may be approved for specific purposes by the TPAA or a foreign regulatory authority for a foreign user of the device. Examples of approved activities include specific airport or runway qualification, very low visibility operations training, including Surface Movement Guidance System (SMGS) operations, or use of a specific airport visual model aligned with an instrument procedure for another airport for instrument training. At the end of the interim period, all Class III visual scenes and airport models must be classified as either a Class I or a Class II visual scene or airport model or be removed from availability at the simulator IOS. However, Class III visual scenes and airport models may continue to be used after the end of the interim period if they are part of a training program specifically approved by the TPAA or other regulatory authority that uses a task and capability analysis as the basis for approval of this specific media element, (i.e., the specific scene or model selected for use in that program).

d. When a person sponsors an FSTD maintained by a person other than a U.S. certificate holder, the sponsor is accountable for that FSTD originally meeting, and continuing to meet, the criteria under which it was originally qualified and the appropriate Part 60 criteria, including the visual scenes and airport models that may be used by instructors or evaluators for purposes of training, checking, or testing under this chapter.

e. Neither Class II nor Class III airport visual models are required to appear on the SOQ. However, the sponsor is responsible for ensuring the FSTD originally meets, and continues to meet, the visual scene and airport model requirements for Class II or Class III visual scenes and airport models that may be used by instructors or evaluators for training, checking, or testing under this chapter.

f. When the visual scenes and airport models represent real world airports and a permanent change is made to that real world airport (e.g., a new runway, an extended taxiway, a new lighting system, a runway closure) without a written extension grant from the NSPM (described below), an update

to that visual scene or airport model must be made in accordance with the following time limits:

(1) For a new airport runway, a runway extension, a new airport taxiway, a taxiway extension, or a runway/taxiway closure—within 60 days of the opening for use of the new airport runway, runway extension, new airport taxiway, or taxiway extension; or within 60 days of the closure of the runway or taxiway.

(2) For a new or modified approach light system—within 30 days of the activation of the new or modified approach light system.

(3) For other facility or structural changes on the airport (e.g., new terminal, relocation of Air Traffic Control Tower)—within 6 months of the opening of the new or changed facility or structure.

g. If a sponsor desires an extension to the time limit for an update to a visual scene or airport model, the sponsor must provide a written extension request to the POI/TCPM stating the reason for the update delay and a proposed completion date. A copy of this request must also be sent to the NSPM. The sponsor will forward a copy of the POI/TCPM's response to the NSPM. If the POI/TCPM has granted an extension, the NSPM will issue an extension authorization, not to exceed an additional 12 months.

**End QPS Requirements****Begin Information****2. Discussion**

a. The subjective tests provide a basis for evaluating the capability of the simulator to perform over a typical utilization period; determining that the simulator accurately simulates each required maneuver, procedure, or task; and verifying correct operation of the simulator controls, instruments, and systems. The items listed in the following Tables are for simulator evaluation purposes only. They may not be used to limit or exceed the authorizations for use of a given level of simulator as described on the Statement of Qualification or as may be approved by the TPAA.

b. The tests in Table A3A, Operations Tasks, in this attachment, address pilot functions, including maneuvers and procedures (called flight tasks), and are divided by flight phases. The performance of these tasks by the NSPM includes an operational examination of the visual system and special effects. There are flight tasks included to address some features of advanced technology airplanes and

innovative training programs. For example, “high angle-of-attack maneuvering” is included to provide a required alternative to “approach to stalls” for airplanes employing flight envelope protection functions.

c. The tests in Table A3A, Operations Tasks, and Table A3G, Instructor Operating Station of this attachment, address the overall function and control of the simulator including the various simulated environmental conditions; simulated airplane system operations (normal, abnormal, and emergency); visual system displays; and special effects necessary to meet flight crew training, evaluation, or flight experience requirements.

d. All simulated airplane systems functions will be assessed for normal and, where appropriate, alternate operations. Normal, abnormal, and emergency operations associated with a flight phase will be assessed during the evaluation of flight tasks or events within that flight phase. Simulated airplane systems are listed separately under “Any Flight Phase” to ensure appropriate attention to systems checks. Operational navigation systems (including inertial navigation systems, global positioning systems, or other long-range systems) and the associated electronic display systems will be evaluated if installed. The NSP pilot will include in his report to the TPAA, the effect of the system operation and any system limitation.

e. Simulators demonstrating a satisfactory circling approach will be qualified for the circling approach maneuver and may be approved for such use by the TPAA in the sponsor’s FAA-approved flight training program. To be considered satisfactory, the circling approach will be flown at maximum gross weight for landing, with minimum

visibility for the airplane approach category, and must allow proper alignment with a landing runway at least 90 (different from the instrument approach course while allowing the pilot to keep an identifiable portion of the airport in sight throughout the maneuver (reference—14 CFR 91.175(e)).

f. At the request of the TPAA, the NSPM may assess a device to determine if it is capable of simulating certain training activities in a sponsor’s training program, such as a portion of a Line Oriented Flight Training (LOFT) scenario. Unless directly related to a requirement for the qualification level, the results of such an evaluation would not affect the qualification level of the simulator. However, if the NSPM determines that the simulator does not accurately simulate that training activity, the simulator would not be approved for that training activity.

g. The FAA intends to allow the use of Class III visual scenes and airport models on a limited basis when the sponsor provides the TPAA (or other regulatory authority) an appropriate analysis of the skills, knowledge, and abilities (SKAs) necessary for competent performance of the tasks in which this particular media element is used. The analysis should describe the ability of the FSTD/visual media to provide an adequate environment in which the required SKAs may be satisfactorily performed and learned. The analysis should also include the specific media element, such as the visual scene or airport model. Additional sources of information on the conduct of task and capability analysis may be found on the FAA’s Advanced Qualification Program (AQP) Web site at: [http://www.faa.gov/education\\_research/training/aqp/](http://www.faa.gov/education_research/training/aqp/).

h. Previously qualified simulators with certain early generation Computer Generated Image (CGI) visual systems, are limited by the capability of the Image Generator or the display system used. These systems are:

(1) Early CGI visual systems that are excepted from the requirement of including runway numbers as a part of the specific runway marking requirements are:

- (a) Link NVS and DNVS.
- (b) Novoview 2500 and 6000.
- (c) FlightSafety VITAL series up to, and including, VITAL III, but not beyond.
- (d) Redifusion SP1, SP1T, and SP2.

(2) Early CGI visual systems are excepted from the requirement of including runway numbers unless the runways are used for LOFT training sessions. These LOFT airport models require runway numbers but only for the specific runway end (one direction) used in the LOFT session. The systems required to display runway numbers only for LOFT scenes are:

- (a) FlightSafety VITAL IV.
- (b) Redifusion SP3 and SP3T.
- (c) Link-Miles Image II.
- (3) The following list of previously qualified CGI and display systems are incapable of generating blue lights. These systems are not required to have accurate taxi-way edge lighting:
  - (a) Redifusion SP1.
  - (b) FlightSafety Vital IV.
  - (c) Link-Miles Image II and Image IIT
  - (d) XKD displays (even though the XKD image generator is capable of generating blue colored lights, the display cannot accommodate that color).

**End Information**

TABLE A3A.—FUNCTIONS AND SUBJECTIVE TESTS

<<<QPS requirements>>>					
Number	Operation tasks	Simulator level			
		A	B	C	D
	Tasks in this table are subject to evaluation if appropriate for the airplane simulated as indicated in the SOQ Configuration List or the level of simulator qualification involved. Items not installed or not functional on the simulator and, therefore, not appearing on the SOQ Configuration List, are not required to be listed as exceptions on the SOQ.				
1. ....	Preparation for Flight ..... Preflight. Accomplish a functions check of all switches, indicators, systems, and equipment at all crewmembers’ and instructors’ stations and determine that the flight deck design and functions are identical to that of the airplane simulated.	X	X	X	X
2. ....	Surface Operations (Pre-Take-Off)				
2.a. ....	Engine Start				
2.a.1. ....	Normal start .....	X	X	X	X
2.a.2. ....	Alternate start procedures .....	X	X	X	X
2.a.3. ....	Abnormal starts and shutdowns (e.g., hot/hung start, tail pipe fire) .....	X	X	X	X
2.b. ....	Pushback/Powerback				
2.c. ....	Taxi				
2.c.1. ....	Thrust response .....	X	X	X	X

TABLE A3A.—FUNCTIONS AND SUBJECTIVE TESTS—Continued

<<<QPS requirements>>>					
Number	Operation tasks	Simulator level			
		A	B	C	D
2.c.2. ....	Power lever friction .....	X	X	X	X
2.c.3. ....	Ground handling .....	X	X	X	X
2.c.4. ....	Nose wheel scuffing .....			X	X
2.c.5. ....	Brake operation (normal and alternate/emergency) .....	X	X	X	X
2.c.6. ....	Brake fade (if applicable) .....	X	X	X	X
3. ....	Take-off				
3.a. ....	Normal				
3.a.1. ....	Airplane/engine parameter relationships .....	X	X	X	X
3.a.2. ....	Acceleration characteristics (motion) .....	X	X	X	X
3.a.3. ....	Nose wheel and rudder steering .....	X	X	X	X
3.a.4. ....	Crosswind (maximum demonstrated) .....	X	X	X	X
3.a.5. ....	Special performance (e.g., reduced $V_1$ , max de-rate, short field operations) .....	X	X	X	X
3.a.6. ....	Low visibility take-off .....	X	X	X	X
3.a.7. ....	Landing gear, wing flap leading edge device operation .....	X	X	X	X
3.a.8. ....	Contaminated runway operation .....			X	X
3.b. ....	Abnormal/emergency				
3.b.1. ....	Rejected Take-off .....	X	X	X	X
3.b.2. ....	Rejected special performance (e.g., reduced $V_1$ , max de-rate, short field operations) .....	X	X	X	X
3.b.3. ....	With failure of most critical engine at most critical point, continued take-off .....	X	X	X	X
3.b.4. ....	With wind shear .....	X	X	X	X
3.b.5. ....	Flight control system failures, reconfiguration modes, manual reversion and associated handling .....	X	X	X	X
3.b.6. ....	Rejected takeoff with brake fade .....			X	X
3.b.7. ....	Rejected, contaminated runway .....			X	X
3.b.8. ....	Propulsion System Malfunction: .....			X	X
	(i) Prior to $V_1$ decision speed				
	(ii) Between $V_1$ and $V_r$ (rotation speed)				
	(iii) Between $V_r$ and 500 feet above ground level				
4. ....	Climb				
4.a. ....	Normal .....	X	X	X	X
4.b. ....	One or more engines inoperative .....	X	X	X	X
5. ....	Cruise				
5.a. ....	Performance characteristics (speed vs. power) .....	X	X	X	X
5.b. ....	High altitude handling .....	X	X	X	X
5.c. ....	High Mach number handling (Mach tuck, Mach buffet) and recovery (trim change) .....	X	X	X	X
5.d. ....	Overspeed warning (in excess of $V_{mo}$ or $M_{mo}$ ) .....	X	X	X	X
5.e. ....	High IAS handling .....	X	X	X	X

TABLE A3A.—FUNCTIONS AND SUBJECTIVE TESTS—Continued

<<<QPS requirements>>>					
Number	Operation tasks	Simulator level			
		A	B	C	D
6. ....	Maneuvers				
6.a. ....	High angle of attack, approach to stalls, stall warning, buffet, and g-break (take-off, cruise, approach, and landing configuration).	X	X	X	X
6.b. ....	Flight envelope protection (high angle of attack, bank limit, overspeed, etc.)	X	X	X	X
6.c. ....	Turns with/without speedbrake/spoilers deployed	X	X	X	X
6.d. ....	Normal and steep turns	X	X	X	X
6.e. ....	In flight engine shutdown and restart (assisted and windmill)	X	X	X	X
6.f. ....	Maneuvering with one or more engines inoperative, as appropriate	X	X	X	X
6.g. ....	Specific flight characteristics (e.g., direct lift control)	X	X	X	X
6.h. ....	Flight control system failures, reconfiguration modes, manual reversion and associated handling	X	X	X	X
7. ....	Descent				
7.a. ....	Normal	X	X	X	X
7.b. ....	Maximum rate (clean and with speedbrake, etc.)	X	X	X	X
7.c. ....	With autopilot	X	X	X	X
7.d. ....	Flight control system failures, reconfiguration modes, manual reversion and associated handling	X	X	X	X
8. ....	Instrument Approaches And Landing. Those instrument approach and landing tests relevant to the simulated airplane type are selected from the following list. Some tests are made with limiting wind velocities, under windshear conditions, and with relevant system failures, including the failure of the Flight Director. If Standard Operating Procedures allow use of autopilot for non-precision approaches, evaluation of the autopilot will be included. Level A simulators are not authorized to credit the landing maneuver.				
8.a. ....	Precision				
8.a.1. ....	PAR	X	X	X	X
8.a.2. ....	CAT I/GBAS (ILS/MLS) published approaches	X	X	X	X
	(i) Manual approach with/without flight director including landing	X	X	X	X
	(ii) Autopilot/autothrottle coupled approach and manual landing	X	X	X	X
	(iii) Manual approach to DH and go-around all engines	X	X	X	X
	(iv) Manual one engine out approach to DH and go-around	X	X	X	X
	(v) Manual approach controlled with and without flight director to 30 m (100 ft) below CAT I minima	X	X	X	X
	A. With cross-wind (maximum demonstrated)	X	X	X	X
	B. With windshear	X	X	X	X
	(vi) Autopilot/autothrottle coupled approach, one engine out to DH and go-around	X	X	X	X
	(vii) Approach and landing with minimum/standby electrical power	X	X	X	X
8.a.3. ....	CAT II/GBAS (ILS/MLS) published approaches	X	X	X	X
	(i) Autopilot/autothrottle coupled approach to DH and landing	X	X	X	X
	(ii) Autopilot/autothrottle coupled approach to DH and go-around	X	X	X	X
	(iii) Autocoupled approach to DH and manual go-around	X	X	X	X

TABLE A3A.—FUNCTIONS AND SUBJECTIVE TESTS—Continued

<<<QPS requirements>>>					
Number	Operation tasks	Simulator level			
		A	B	C	D
	(iv) Category II published approach (auto-coupled, autothrottle) .....	X	X	X	X
8.a.4. ....	CAT III/GBAS (ILS/MLS) published approaches .....	X	X	X	X
	(i) Autopilot/autothrottle coupled approach to land and rollout .....	X	X	X	X
	(ii) Autopilot/autothrottle coupled approach to DH/Alert Height and go-around .....	X	X	X	X
	(iii) Autopilot/autothrottle coupled approach to land and rollout with one engine out .....	X	X	X	X
	(iv) Autopilot/autothrottle coupled approach to DH/Alert Height and go-around with one engine out .....	X	X	X	X
	(v) Autopilot/autothrottle coupled approach (to land or to go around) .....	X	X	X	X
	A. With generator failure .....	X	X	X	X
	B. With 10 knot tail wind .....	X	X	X	X
	C. With 10 knot crosswind .....	X	X	X	X
8.b. ....	Non-precision				
8.b.1. ....	NDB .....	X	X	X	X
8.b.2. ....	VOR, VOR/DME, VOR/TAC .....	X	X	X	X
8.b.3. ....	RNAV (GNSS/GPS) .....	X	X	X	X
8.b.4. ....	ILS LLZ (LOC), LLZ(LOC)/BC .....	X	X	X	X
8.b.5. ....	ILS offset localizer .....	X	X	X	X
8.b.6. ....	Direction finding facility (ADF/SDF) .....	X	X	X	X
8.b.7. ....	Airport surveillance radar (ASR) .....	X	X	X	X
9. ....	Visual Approaches (Visual Segment) And Landings. Flight simulators with visual systems, which permit completing a special approach procedure in accordance with applicable regulations, may be approved for that particular approach procedure.				
9.a. ....	Maneuvering, normal approach and landing, all engines operating with and without visual approach aid guidance.	X	X	X	X
9.b. ....	Approach and landing with one or more engines inoperative .....	X	X	X	X
9.c. ....	Operation of landing gear, flap/slats and speedbrakes (normal and abnormal) .....	X	X	X	X
9.d. ....	Approach and landing with crosswind (max. demonstrated) .....	X	X	X	X
9.e. ....	Approach to land with windshear on approach .....	X	X	X	X
9.f. ....	Approach and landing with flight control system failures, reconfiguration modes, manual reversion and associated handling (most significant degradation which is probable).	X	X	X	X
9.g. ....	Approach and landing with trim malfunctions .....	X	X	X	X
9.g.1. ....	Longitudinal trim malfunction .....	X	X	X	X
9.g.2. ....	Lateral-directional trim malfunction .....	X	X	X	X
9.h. ....	Approach and landing with standby (minimum) electrical/hydraulic power .....	X	X	X	X
9.i. ....	Approach and landing from circling conditions (circling approach) .....	X	X	X	X
9.j. ....	Approach and landing from visual traffic pattern .....	X	X	X	X
9.k. ....	Approach and landing from non-precision approach .....	X	X	X	X
9.l. ....	Approach and landing from precision approach .....	X	X	X	X

TABLE A3A.—FUNCTIONS AND SUBJECTIVE TESTS—Continued

<<<QPS requirements>>>					
Number	Operation tasks	Simulator level			
		A	B	C	D
9.m. ....	Approach procedures with vertical guidance (APV), e.g., SBAS .....	X	X	X	X
10. ....	Missed Approach				
10.a. ....	All engines .....	X	X	X	X
10.b. ....	One or more engine(s) out .....	X	X	X	X
10.c. ....	With flight control system failures, reconfiguration modes, manual reversion and associated handling	X	X	X	X
11. ....	Surface Operations (Landing roll and taxi)				
11.a. ....	Spoiler operation .....	X	X	X	X
11.b. ....	Reverse thrust operation .....	X	X	X	X
11.c. ....	Directional control and ground handling, both with and without reverse thrust .....		X	X	X
11.d. ....	Reduction of rudder effectiveness with increased reverse thrust (rear pod-mounted engines) .....		X	X	X
11.e. ....	Brake and anti-skid operation with dry, patchy wet, wet on rubber residue, and patchy icy conditions ..			X	X
11.f. ....	Brake operation, to include auto-braking system where applicable .....	X	X	X	X
12. ....	Any Flight Phase				
12.a. ....	Airplane and engine systems operation.				
12.a.1. ....	Air conditioning and pressurization (ECS) .....	X	X	X	X
12.a.2. ....	De-icing/anti-icing .....	X	X	X	X
12.a.3. ....	Auxiliary power unit (APU) .....	X	X	X	X
12.a.4. ....	Communications .....	X	X	X	X
12.a.5. ....	Electrical .....	X	X	X	X
12.a.6. ....	Fire and smoke detection and suppression .....	X	X	X	X
12.a.7. ....	Flight controls (primary and secondary) .....	X	X	X	X
12.a.8. ....	Fuel and oil, hydraulic and pneumatic .....	X	X	X	X
12.a.9. ....	Landing gear .....	X	X	X	X
12.a.10. ....	Oxygen .....	X	X	X	X
12.a.11. ....	Engine .....	X	X	X	X
12.a.12. ....	Airborne radar .....	X	X	X	X
12.a.13. ....	Autopilot and Flight Director .....	X	X	X	X
12.a.14. ....	Collision avoidance systems. (e.g., (E)GPWS, TCAS) .....	X	X	X	X
12.a.15. ....	Flight control computers including stability and control augmentation .....	X	X	X	X
12.a.16. ....	Flight display systems .....	X	X	X	X
12.a.17. ....	Flight management computers .....	X	X	X	X
12.a.18. ....	Head-up guidance, head-up displays .....	X	X	X	X
12.a.19. ....	Navigation systems .....	X	X	X	X
12.a.20. ....	Stall warning/avoidance .....	X	X	X	X
12.a.21. ....	Wind shear avoidance equipment .....	X	X	X	X

TABLE A3A.—FUNCTIONS AND SUBJECTIVE TESTS—Continued

<<<QPS requirements>>>					
Number	Operation tasks	Simulator level			
		A	B	C	D
12.a.22. ....	Automatic landing aids .....	X	X	X	X
12.b. ....	Airborne procedures				
12.b.1. ....	Holding .....	X	X	X	X
12.b.2. ....	Air hazard avoidance. (Traffic, Weather) .....			X	X
12.b.3. ....	Windshear .....			X	X
12.b.4. ....	Effects of airframe ice .....			X	X
12.c. ....	Engine shutdown and parking				
12.c.1. ....	Engine and systems operation .....	X	X	X	X
12.c.2. ....	Parking brake operation .....	X	X	X	X

TABLE A3B.—FUNCTIONS AND SUBJECTIVE TESTS—VISUAL SCENE CONTENT FOR QUALIFICATION AT THE STATED LEVEL

Number	Class I visual scenes/visual models	Simulator level			
		A	B	C	D

This table specifies the minimum airport visual model content and functionality to qualify a simulator at the indicated level. This table applies only to the airport scenes required for simulator qualification; i.e., one airport scene for Level A and Level B simulators; three airport scenes for Level C and Level D simulators.

**Begin QPS Requirements**

1. ....	Functional test content requirements for Level A and Level B simulators. The following is the minimum airport model content requirement to satisfy visual capability tests, and provides suitable visual cues to allow completion of all functions and subjective tests described in this attachment for simulators at Levels A and B.				
1.a. ....	A minimum of one (1) representative airport model. This model identification must be acceptable to the sponsor's TPAA, selectable from the IOS, and listed on the Statement of Qualification.	X	X		
1.b. ....	The fidelity of the visual scene must be sufficient for the aircrew to visually identify the airport; determine the position of the simulated airplane within a night visual scene; successfully accomplish take-offs, approaches, and landings; and maneuver around the airport on the ground as necessary.	X	X		
1.c. ....	Runways: .....	X	X		
1.c.1.	Visible runway number .....	X	X		
1.c.2.	Runway threshold elevations and locations must be modeled to provide sufficient correlation with airplane systems (e.g., altimeter).	X	X		
1.c.3.	Runway surface and markings .....	X	X		
1.c.4.	Lighting for the runway in use including runway edge and centerline .....	X	X		
1.c.5.	Lighting, visual approach aid and approach lighting of appropriate colors .....	X	X		
1.c.6.	Representative taxiway lights .....	X	X		
2. ....	Functional test content requirements for Level C and Level D simulators. The following is the minimum airport model content requirement to satisfy visual capability tests, and provide suitable visual cues to allow completion of all functions and subjective tests described in this attachment for simulators at Levels C and D. Not all of the elements described in this section must be found in a single airport scene. However, all of the elements described in this section must be found throughout a combination of the three (3) airport models described in item 2.a.				
2.a. ....	A minimum of three (3) representative airport models. The model identifications must be acceptable to the sponsor's TPAA, selectable from the IOS, and listed on the Statement of Qualification.			X	X
2.a.1.	Night and Twilight (Dusk) scenes required .....			X	X

TABLE A3B.—FUNCTIONS AND SUBJECTIVE TESTS—VISUAL SCENE CONTENT FOR QUALIFICATION AT THE STATED LEVEL—Continued

Number	Class I visual scenes/visual models	Simulator level			
		A	B	C	D
2.a.2.	Daylight scenes required .....				X
2.b. ....	Two parallel runways and one crossing runway, displayed simultaneously; at least two of the runways must be able to be lighted fully and simultaneously. NOTE: This requirement may be demonstrated at either a fictional airport or a real-world airport. However, if a fictional airport is used, this airport must be listed on the Statement of Qualification.			X	X
2.c. ....	Runway threshold elevations and locations must be modeled to provide sufficient correlation with airplane systems (e.g., HGS, GPS, altimeter); slopes in runways, taxiways, and ramp areas must not cause distracting or unrealistic effects, including pilot eye-point height variation.			X	X
2.d. ....	Representative airport buildings, structures and lighting .....			X	X
2.e. ....	At least one useable gate, at the appropriate height (required only for those airplanes that typically operate from terminal gates).			X	X
2.f. ....	Representative moving and static gate clutter (e.g., other airplane, power carts, tugs, fuel trucks, and additional gates).			X	X
2.g. ....	Representative gate/apron markings (e.g., hazard markings, lead-in lines, gate numbering) and lighting .....			X	X
2.h. ....	Representative runway markings, lighting, and signage, including a windsock that gives appropriate wind cues.			X	X
2.i. ....	Representative taxiway markings, lighting, and signage necessary for position identification, and to taxi from parking to a designated runway and return to parking.			X	X
2.j. ....	A low visibility taxi route (e.g., Surface Movement Guidance Control System, follow-me truck, daylight taxi lights) must also be demonstrated.				X
2.k. ....	Representative moving and static ground traffic (e.g., vehicular and airplane), including the capability to present ground hazards (e.g., another airplane crossing the active runway).			X	X
2.l. ....	Representative moving airborne traffic, including the capability to present air hazards (e.g., airborne traffic on a possible collision course).			X	X
2.m. ....	Representative depiction of terrain and obstacles as well as significant and identifiable natural and cultural features, within 25 NM of the reference airport.			X	X
2.n. ....	Appropriate approach lighting systems and airfield lighting for a VFR circuit and landing, non-precision approaches and landings, and Category I, II and III precision approaches and landings.			X	X
2.o. ....	Representative gate docking aids or a marshaller .....			X	X
2.p. ....	Portrayal of physical relationships known to cause landing illusions (e.g., short runways, landing approaches over water, uphill or downhill runways, rising terrain on the approach path). This requirement may be met by a Statement of Compliance and Capability (SOC) and a demonstration of two landing illusions. The illusions are not required to be beyond the normal operational capabilities of the airplane being simulated. The demonstrated illusions must be available to the instructor or check airman at the IOS for training, testing, checking, or experience activities.				X
2.q. ....	Portrayal of runway surface contaminants, including runway lighting reflections when wet and partially obscured lights when snow is present, or suitable alternative effects.				X
3. ....	Visual scene management. The following are the minimum visual scene management requirements for simulators at Levels A, B, C, and D.				
3.a. ....	Runway and approach lighting must fade into view in accordance with the environmental conditions set in the simulator, and the distance from the object.	X	X	X	X
3.b. ....	The direction of strobe lights, approach lights, runway edge lights, visual landing aids, runway centerline lights, threshold lights, and touchdown zone lights must be replicated.	X	X	X	X
4. ....	Visual feature recognition. The following are the minimum distances at which runway features must be visible for simulators at Levels A, B, C, and D. Distances are measured from runway threshold to an airplane aligned with the runway on an extended 3° glide-slope in simulated meteorological conditions that recreate the minimum distances for visibility. For circling approaches, all tests apply to the runway used for the initial approach and to the runway of intended landing.				



TABLE A3B.—FUNCTIONS AND SUBJECTIVE TESTS—VISUAL SCENE CONTENT FOR QUALIFICATION AT THE STATED LEVEL—Continued

Number	Class I visual scenes/visual models	Simulator level			
		A	B	C	D
4.a. ....	Runway definition, strobe lights, approach lights, and runway edge white lights from 5 sm (8 km) of the runway threshold.	X	X	X	X
4.b. ....	Visual Approach Aid lights (VASI or PAPI) from 5 sm (8 km) of the runway threshold .....			X	X
4.c. ....	Visual Approach Aid lights (VASI or PAPI) from 3 sm (5 km) of the runway threshold .....	X	X		
4.d. ....	Runway centerline lights and taxiway definition from 3 sm (5 km) .....	X	X	X	X
4.e. ....	Threshold lights and touchdown zone lights from 2 sm (3 km) .....	X	X	X	X
4.f. ....	Runway markings within range of landing lights for night scenes as required by the surface resolution test on day scenes.	X	X	X	X
4.g. ....	For circling approaches, the runway of intended landing and associated lighting should fade into view in a non-distracting manner.	X	X	X	X
5. ....	Airport model content. The following sets out the minimum requirements for what must be provided in an airport visual model and also identifies the other aspects of the airport environment that must correspond with that model for simulators at Levels A, B, C, and D. For circling approaches, all tests apply to the runway used for the initial approach and to the runway of intended landing. If all runways in an airport model used to meet the requirements of this attachment are not designated as "in use," then the "in use" runways must be listed on the Statement of Qualification (e.g., KORD, Rwys 9R, 14L, 22R). Models of airports with more than one runway must have all significant runways not "in-use" visually depicted for airport and runway recognition purposes. The use of white or off white light strings that identify the runway threshold, edges, and ends for twilight and night scenes are acceptable for this requirement. Rectangular surface depictions are acceptable for daylight scenes. A visual system's capabilities must be balanced between providing airport models with an accurate representation of the airport and a realistic representation of the surrounding environment.				
5.a. ....	The surface and markings for each "in-use" runway must include the following:				
5.a.1.	Threshold markings .....	X	X	X	X
5.a.2.	Runway numbers .....	X	X	X	X
5.a.3.	Touchdown zone markings .....	X	X	X	X
5.a.4.	Fixed distance markings .....	X	X	X	X
5.a.5.	Edge markings .....	X	X	X	X
5.a.6.	Centerline stripes .....	X	X	X	X
5.b. ....	Each runway designated as an "in-use" runway must include the following detail that is either modeled using airport pictures, construction drawings and maps, U.S. National Imagery and Mapping Agency, or other data, or modeled in accordance with published regulatory material. Sponsors are not required to provide every detail of a runway, but the detail that is provided should be correct within reasonable limits				
5.b.1.	The lighting for each "in-use" runway must include the following:				
	(i) Threshold lights .....	X	X	X	X
	(ii) Edge lights .....	X	X	X	X
	(iii) End lights .....	X	X	X	X
	(iv) Centerline lights, if appropriate .....	X	X	X	X
	(v) Touchdown zone lights, if appropriate .....	X	X	X	X
	(vi) Leadoff lights, if appropriate .....	X	X	X	X
	(vii) Appropriate visual landing aid(s) for that runway .....	X	X	X	X
	(viii) Appropriate approach lighting system for that runway .....	X	X	X	X
5.b.2.	The taxiway surface and markings associated with each "in-use" runway must include the following:				
	(i) Edge .....	X	X	X	X

TABLE A3B.—FUNCTIONS AND SUBJECTIVE TESTS—VISUAL SCENE CONTENT FOR QUALIFICATION AT THE STATED LEVEL—Continued

Number	Class I visual scenes/visual models	Simulator level			
		A	B	C	D
	(ii) Centerline .....	X	X	X	X
	(iii) Runway hold lines .....	X	X	X	X
	(iv) ILS critical area marking .....	X	X	X	X
5.b.3.	The taxiway lighting associated with each “in-use” runway must include the following:				
	(i) Edge .....	X	X	X	
	(ii) Centerline, if appropriate .....	X	X	X	X
	(iii) Runway hold and ILS critical area lights .....	X	X	X	X
	(iv) Edge lights of correct color .....				X
5.b.4.	Airport signage associated with each “in-use” runway must include the following:				
	(i) Distance remaining signs, if appropriate .....	X	X	X	X
	(ii) Signs at intersecting runways and taxiways .....	X	X	X	X
	(iii) Signs described in items “2h” and “2i” of this table .....	X	X	X	X
5.b.5.	Required visual model correlation with other aspects of the airport environment simulation:				
	(i) The airport model must be properly aligned with the navigational aids that are associated with operations at the runway “in-use”.	X	X	X	X
	(ii) The simulation of runway contaminants must be correlated with the displayed runway surface and lighting where applicable.				X
6. ....	Correlation with airplane and associated equipment. The following are the minimum correlation comparisons that must be made for simulators at Levels A, B, C, and D.				
6.a. ....	Visual system compatibility with aerodynamic programming .....	X	X	X	X
6.b. ....	Visual cues to assess sink rate and depth perception during landings .....	X	X	X	X
6.c. ....	Accurate portrayal of environment relating to flight simulator attitudes .....	X	X	X	X
6.d. ....	The visual scene must correlate with integrated airplane systems, where fitted (e.g. terrain, traffic and weather avoidance systems and Head-up Guidance System (HGS)).	X	X	X	X
6.e. ....	Representative visual effects for each visible, own-ship, airplane external light(s) .....	X	X	X	X
6.f. ....	The effect of rain removal devices .....				X
7. ....	Scene quality. The following are the minimum scene quality tests that must be conducted for simulators at Levels A, B, C, and D.				
7.a. ....	Surfaces and textural cues must be free from apparent quantization (aliasing) .....			X	X
7.b. ....	System capable of portraying full color realistic textural cues .....			X	X
7.c. ....	The system light points must be free from distracting jitter, smearing or streaking .....	X	X	X	X
7.d. ....	Demonstration of occulting through each channel of the system in an operational scene .....	X	X		
7.e. ....	Demonstration of a minimum of ten levels of occulting through each channel of the system in an operational scene.			X	X
7.f. ....	System capable of providing focus effects that simulate rain .....				X
7.g. ....	System capable of providing focus effects that simulate light point perspective growth .....			X	X
7.h. ....	System capable of six discrete light step controls (0–5) .....	X	X	X	X
8. ....	Environmental effects. The following are the minimum environmental effects that must be available in simulators at Levels A, B, C, and D.				

TABLE A3B.—FUNCTIONS AND SUBJECTIVE TESTS—VISUAL SCENE CONTENT FOR QUALIFICATION AT THE STATED LEVEL—Continued

Number	Class I visual scenes/visual models	Simulator level			
		A	B	C	D
8.a. ....	The displayed scene corresponding to the appropriate surface contaminants and including runway lighting reflections for wet, partially obscured lights for snow, or alternative effects.				X
8.a.1.	Special weather representations which include:				
	(i) The sound, motion and visual effects of light, medium and heavy precipitation near a thunderstorm on take-off, approach, and landings at and below an altitude of 2,000 ft (600 m) above the airport surface and within a radius of 10 sm (16 km) from the airport.				X
	(ii) One airport with a snow scene to include terrain snow and snow-covered taxiways and runways .....				X
8.b. ....	In-cloud effects such as variable cloud density, speed cues and ambient changes .....			X	X
8.c. ....	The effect of multiple cloud layers representing few, scattered, broken and overcast conditions giving partial or complete obstruction of the ground scene.			X	X
8.d. ....	Visibility and RVR measured in terms of distance. Visibility/RVR checked at 2,000 ft (600 m) above the airport and at two heights below 2000ft with at least 500 ft. of separation between the measurements. The measurements must be taken within a radius of 10 sm (16 km) from the airport.	X	X	X	X
8.e. ....	Patchy fog giving the effect of variable RVR .....				X
8.f. ....	Effects of fog on airport lighting such as halos and defocus .....			X	X
8.g. ....	Effect of own-ship lighting in reduced visibility, such as reflected glare, including landing lights, strobes, and beacons.			X	X
8.h. ....	Wind cues to provide the effect of blowing snow or sand across a dry runway or taxiway selectable from the instructor station.				X
9. ....	Instructor control of the following: The following are the minimum instructor controls that must be available in simulators at Levels A, B, C, and D.				
9.a. ....	Environmental effects, e.g., cloud base, cloud effects, cloud density, visibility in statute miles/ kilometers and RVR in feet/meters.	X	X	X	X
9.b. ....	Airport selection .....	X	X	X	X
9.c. ....	Airport lighting, including variable intensity .....	X	X	X	X
9.d. ....	Dynamic effects including ground and flight traffic .....			X	X
<b>End QPS Requirement</b>					
<b>Begin Information</b>					
10. ....	An example of being able to “combine two airport models to achieve two “in-use” runways: One runway designated as the “in use” runway in the first model of the airport, and the second runway designated as the “in use” runway in the second model of the same airport. For example, the clearance is for the ILS approach to Runway 27, Circle to Land on Runway 18 right. Two airport visual models might be used: the first with Runway 27 designated as the “in use” runway for the approach to runway 27, and the second with Runway 18 Right designated as the “in use” runway. When the pilot breaks off the ILS approach to runway 27, the instructor may change to the second airport visual model in which runway 18 Right is designated as the “in use” runway, and the pilot would make a visual approach and landing. This process is acceptable to the FAA as long as the temporary interruption due to the visual model change is not distracting to the pilot.				
11. ....	Sponsors are not required to provide every detail of a runway, but the detail that is provided should be correct within reasonable limits.				
<b>End Information</b>					

TABLE A3C.—FUNCTIONS AND SUBJECTIVE TESTS

Visual Scene Content; Additional Visual Models Beyond Minimum Required for Qualification

Number	Class II visual scenes/visual models	Simulator level			
		A	B	C	D

This table specifies the minimum airport visual model content and functionality necessary to add airport visual models to a simulator's visual model library, beyond those necessary for qualification at the stated level, without the necessity of further involvement of the NSPM or TPA.

**Begin QPS Requirements**

1. ....	Visual scene management. The following is the minimum visual scene management requirements for simulators at Levels A, B, C, and D.				
1.a.	The direction of strobe lights, approach lights, runway edge lights, visual landing aids, runway centerline lights, threshold lights, and touchdown zone lights on the "in-use" runway must be replicated.	X	X	X	X
2. ....	Visual feature recognition. The following are the minimum distances at which runway features must be visible for simulators at Levels A, B, C, and D. Distances are measured from runway threshold to an airplane aligned with the runway on an extended 3° glide-slope in simulated meteorological conditions that recreate the minimum distances for visibility. For circling approaches, all requirements of this section apply to the runway used for the initial approach and to the runway of intended landing.				
2.a.	Runway definition, strobe lights, approach lights, and runway edge white lights from 5 sm (8 km) from the runway threshold.	X	X	X	X
2.b.	Visual Approach Aid lights (VASI or PAPI) from 5 sm (8 km) from the runway threshold .....			X	X
2.c.	Visual Approach Aid lights (VASI or PAPI) from 3 sm (5 km) from the runway threshold .....	X	X		
2.d.	Runway centerline lights and taxiway definition from 3 sm (5 km) from the runway threshold .....	X	X	X	X
2.e.	Threshold lights and touchdown zone lights from 2 sm (3 km) from the runway threshold .....	X	X	X	X
2.f.	Runway markings within range of landing lights for night scenes and as required by the surface resolution requirements on day scenes.	X	X	X	X
2.g.	For circling approaches, the runway of intended landing and associated lighting must fade into view in a non-distracting manner.	X	X	X	X
3. ....	Airport model content. The following prescribes the minimum requirements for what must be provided in an airport visual model and identifies other aspects of the airport environment that must correspond with that model for simulators at Levels A, B, C, and D. The detail must be modeled using airport pictures, construction drawings and maps, or other data, or modeled in accordance with published regulatory material; however, this does not require that airport models contain details that are beyond the designed capability of the currently qualified visual system. For circling approaches, all requirements of this section apply to the runway used for the initial approach and to the runway of intended landing.				
3.a.	The surface and markings for each "in-use" runway:				
3.a.1. ...	Threshold markings .....	X	X	X	X
3.a.2. ...	Runway numbers .....	X	X	X	X
3.a.3. ...	Touchdown zone markings .....	X	X	X	X
3.a.4. ...	Fixed distance markings .....	X	X	X	X
3.a.5. ...	Edge markings .....	X	X	X	X
3.a.6. ...	Centerline stripes .....	X	X	X	X
3.b.	The lighting for each "in-use" runway:				
3.b.1. ...	Threshold lights .....	X	X	X	X
3.b.2. ...	Edge lights .....	X	X	X	X
3.b.3. ...	End lights .....	X	X	X	X
3.b.4. ...	Centerline lights .....	X	X	X	X
3.b.5. ...	Touchdown zone lights, if appropriate .....	X	X	X	X
3.b.6. ...	Leadoff lights, if appropriate .....	X	X	X	X
3.b.7. ...	Appropriate visual landing aid(s) for that runway .....	X	X	X	X

TABLE A3C.—FUNCTIONS AND SUBJECTIVE TESTS—Continued

Visual Scene Content; Additional Visual Models Beyond Minimum Required for Qualification					
Number	Class II visual scenes/visual models	Simulator level			
		A	B	C	D
3.b.8. ...	Appropriate approach lighting system for that runway .....	X	X	X	X
3.c.	The taxiway surface and markings associated with each "in-use" runway:				
3.c.1. ....	Edge .....	X	X	X	X
3.c.2. ....	Centerline .....	X	X	X	X
3.c.3. ....	Runway hold lines .....	X	X	X	X
3.c.4. ....	ILS critical area markings .....	X	X	X	X
3.d.	The taxiway lighting associated with each "in-use" runway:				
3.d.1. ...	Edge .....			X	X
3.d.2. ...	Centerline .....	X	X	X	X
3.d.3. ...	Runway hold and ILS critical area lights .....	X	X	X	X
4. ....	Required visual model correlation with other aspects of the airport environment simulation. The following are the minimum visual model correlation tests that must be conducted for simulators at Levels A, B, C, and D.				
4.a.	The airport model must be properly aligned with the navigational aids that are associated with operations at the "in-use" runway.	X	X	X	X
4.b.	Slopes in runways, taxiways, and ramp areas must not cause distracting or unrealistic effects .....	X	X	X	X
5. ....	Correlation with airplane and associated equipment. The following are the minimum correlation comparisons that must be made for simulators at Levels A, B, C, and D.				
5.a.	Visual system compatibility with aerodynamic programming .....	X	X	X	X
5.b.	Accurate portrayal of environment relating to flight simulator attitudes .....	X	X	X	X
5.c.	Visual cues to assess sink rate and depth perception during landings .....		X	X	X
5.d.	Visual effects for each visible, own-ship, airplane external light(s) .....		X	X	X
6. ....	Scene quality. The following are the minimum scene quality tests that must be conducted for simulators at Levels A, B, C, and D.				
6.a.	Surfaces and textural cues should be free from apparent quantization (aliasing) .....			X	X
6.b.	Correct color and realistic textural cues .....				X
6.c.	Light points free from distracting jitter, smearing or streaking .....	X	X	X	X
7. ....	Instructor controls of the following: The following are the minimum instructor controls that must be available in simulators at Levels A, B, C, and D.				
7.a.	Environmental effects, e.g., cloud base (if used), cloud effects, cloud density, visibility in statute miles/kilometers and RVR in feet/meters.	X	X	X	X
7.b.	Airport selection .....	X	X	X	X
7.c.	Airport lighting including variable intensity .....	X	X	X	X
7.d.	Dynamic effects including ground and flight traffic .....			X	X
<b>End QPS Requirements</b>					
<b>Begin Information</b>					
8. ....	Sponsors are not required to provide every detail of a runway, but the detail that is provided must be correct within the capabilities of the system.	X	X	X	X
<b>End Information</b>					

TABLE A3D.—FUNCTIONS AND SUBJECTIVE TESTS

<<<QPS requirements>>>						
Number	Motion system effects	Simulator level				Information
		A	B	C	D	
1.	Runway rumble, oleo deflection, ground speed, uneven runway, runway and taxiway centerline light characteristics: Procedure: After the airplane has been pre-set to the takeoff position and then released, taxi at various speeds with a smooth runway and note the general characteristics of the simulated runway rumble effects of oleo deflections. Repeat the maneuver with a runway roughness of 50%, then with maximum roughness. The associated motion vibrations should be affected by ground speed and runway roughness.		X	X	X	If time permits, different gross weights can also be selected, which may also affect the associated vibrations depending on airplane type. The associated motion effects for the above tests should also include an assessment of the effects of rolling over centerline lights, surface discontinuities of uneven runways, and various taxiway characteristics.
2. ....	Buffets on the ground due to spoiler/speedbrake extension and reverse thrust: Procedure: Perform a normal landing and use ground spoilers and reverse thrust—either individually or in combination—to decelerate the simulated airplane. Do not use wheel braking so that only the buffet due to the ground spoilers and thrust reversers is felt.		X	X	X	
3. ....	Bumps associated with the landing gear: Procedure: Perform a normal take-off paying special attention to the bumps that could be perceptible due to maximum oleo extension after lift-off. When the landing gear is extended or retracted, motion bumps can be felt when the gear locks into position.		X	X	X	
4. ....	Buffet during extension and retraction of landing gear: Procedure: Operate the landing gear. Check that the motion cues of the buffet experienced represent the actual airplane.		X	X	X	
5. ....	Buffet in the air due to flap and spoiler/speedbrake extension and approach to stall buffet: Procedure: Perform an approach and extend the flaps and slats with airspeeds deliberately in excess of the normal approach speeds. In cruise configuration, verify the buffets associated with the spoiler/speedbrake extension. The above effects can also be verified with different combinations of spoiler/speedbrake, flap, and landing gear settings to assess the interaction effects.		X	X	X	
6. ....	Approach to stall buffet: Procedure: Conduct an approach-to-stall with engines at idle and a deceleration of 1 knot/second. Check that the motion cues of the buffet, including the level of buffet increase with decreasing speed, are representative of the actual airplane.		X	X	X	
7. ....	Touchdown cues for main and nose gear: Procedure: Conduct several normal approaches with various rates of descent. Check that the motion cues for the touchdown bumps for each descent rate are representative of the actual airplane.		X	X	X	
8. ....	Nose wheel scuffing: Procedure: Taxi at various ground speeds and manipulate the nose wheel steering to cause yaw rates to develop that cause the nose wheel to vibrate against the ground (“scuffing”). Evaluate the speed/nose wheel combination needed to produce scuffing and check that the resultant vibrations are representative of the actual airplane.		X	X	X	

TABLE A3D.—FUNCTIONS AND SUBJECTIVE TESTS—Continued

<<<QPS requirements>>>						
Number	Motion system effects	Simulator level				Information
		A	B	C	D	
9. ....	Thrust effect with brakes set: Procedure: Set the brakes on at the take-off point and increase the engine power until buffet is experienced. Evaluate its characteristics. Confirm that the buffet increases appropriately with increasing engine thrust.		X	X	X	This effect is most discernible with wing-mounted engines.
10. ....	Mach and maneuver buffet: Procedure: With the simulated airplane trimmed in 1 g flight while at high altitude, increase the engine power so that the Mach number exceeds the documented value at which Mach buffet is experienced. Check that the buffet begins at the same Mach number as it does in the airplane (for the same configuration) and that buffet levels are representative of the actual airplane. For certain airplanes, maneuver buffet can also be verified for the same effects. Maneuver buffet can occur during turning flight at conditions greater than 1 g, particularly at higher altitudes.		X	X	X	
11. ....	Tire failure dynamics: Procedure: Simulate a single tire failure and a multiple tire failure.			X	X	The pilot may notice some yawing with a multiple tire failure selected on the same side. This should require the use of the rudder to maintain control of the airplane. Dependent on airplane type, a single tire failure may not be noticed by the pilot and should not have any special motion effect. Sound or vibration may be associated with the actual tire losing pressure.
12. ....	Engine malfunction and engine damage: Procedure: The characteristics of an engine malfunction as stipulated in the malfunction definition document for the particular flight simulator must describe the special motion effects felt by the pilot. The associated engine instruments should vary according to the nature of the malfunction and replicate the effects of the airframe vibration.		X	X	X	
13. ....	Tail strikes and engine pod strikes: Procedure: Tail-strikes can be checked by over-rotation of the airplane at a speed below Vr while performing a takeoff. The effects can also be verified during a landing. The motion effect should be felt as a noticeable bump. If the tail strike affects the airplane angular rates, the cueing provided by the motion system should have an associated effect. Excessive banking of the airplane during its take-off/landing roll can cause a pod strike. The motion effect should be felt as a noticeable bump. If the pod strike affects the airplane angular rates, the cueing provided by the motion system should have an associated effect.		X	X	X	

TABLE A3E.—FUNCTIONS AND SUBJECTIVE TESTS

<<<QPS requirements>>>					
Number	Sound system	Simulator level			
		A	B	C	D
The following checks are performed during a normal flight profile with motion system ON.					
1. ....	Precipitation .....			X	X
2. ....	Rain removal equipment .....			X	X
3. ....	Significant airplane noises perceptible to the pilot during normal operations .....			X	X

TABLE A3E.—FUNCTIONS AND SUBJECTIVE TESTS—Continued

<<<QPS requirements>>>					
Number	Sound system	Simulator level			
		A	B	C	D
4. ....	Abnormal operations for which there are associated sound cues including, engine malfunctions, landing gear/tire malfunctions, tail and engine pod strike and pressurization malfunction.			X	X
5. ....	Sound of a crash when the flight simulator is landed in excess of limitations .....			X	X

TABLE A3F.—FUNCTIONS AND SUBJECTIVE TESTS

<<<QPS requirements>>>					
Number	Sound effects	Simulator level			
		A	B	C	D
This table specifies the minimum special effects necessary for the specified simulator level.					
1. ....	Braking Dynamics: Representations of the dynamics of brake failure (flight simulator pitch, side-loading, and directional control characteristics representative of the airplane), including antiskid and decreased brake efficiency due to high brake temperatures (based on airplane related data), sufficient to enable pilot identification of the problem and implementation of appropriate procedures.			X	X
2. ....	Effects of Airframe and Engine Icing: Required only for those airplanes authorized for operations in known icing conditions ..... Procedure: With the simulator airborne, in a clean configuration, nominal altitude and cruise airspeed, autopilot on and auto-throttles off, engine and airfoil anti-ice/de-ice systems deactivated; activate icing conditions at a rate that allows monitoring of simulator and systems response. Icing recognition will include an increase in gross weight, airspeed decay, change in simulator pitch attitude, change in engine performance indications (other than due to airspeed changes), and change in data from pitot/static system. Activate heating, anti-ice, or de-ice systems independently. Recognition will include proper effects of these systems, eventually returning the simulated airplane to normal flight.			X	X

TABLE A3G.—FUNCTIONS AND SUBJECTIVE TESTS

<<<OPS requirements>>>					
Number	Instructor operating station (IOS) (as appropriate)	Simulator level			
		A	B	C	D
Functions in this table are subject to evaluation only if appropriate for the airplane and/or the system is installed on the specific simulator					
1. ....	Simulator Power Switch(es) .....	X	X	X	X
2. ....	Airplane conditions				
2.a.	Gross weight, center of gravity, fuel loading and allocation .....	X	X	X	X
2.b.	Airplane systems status .....	X	X	X	X
2.c.	Ground crew functions (e.g., ext. power, push back) .....	X	X	X	X
3. ....	Airports				
3.a.	Number and selection .....	X	X	X	X
3.b.	Runway selection .....	X	X	X	X
3.c.	Runway surface condition (e.g., rough, smooth, icy, wet) .....			X	X
3.d.	Preset positions (e.g., ramp, gate, #1 for takeoff, takeoff position, over FAF) .....	X	X	X	X
3.e.	Lighting controls .....	X	X	X	X
4. ....	Environmental controls				
4.a.	Visibility (statute miles (kilometers)) .....	X	X	X	X



TABLE A3G.—FUNCTIONS AND SUBJECTIVE TESTS—Continued

<<<OPS requirements>>>					
Number	Instructor operating station (IOS) (as appropriate)	Simulator level			
		A	B	C	D
4.b.	Runway visual range (in feet (meters))	X	X	X	X
4.c.	Temperature	X	X	X	X
4.d.	Climate conditions (e.g., ice, snow, rain)	X	X	X	X
4.e.	Wind speed and direction	X	X	X	X
4.f.	Windshear			X	X
4.g.	Clouds (base and tops)	X	X	X	X
5. ....	Airplane system malfunctions (Inserting and deleting malfunctions into the simulator)	X	X	X	X
6. ....	Locks, Freezes, and Repositioning				
6.a.	Problem (all) freeze/release	X	X	X	X
6.b.	Position (geographic) freeze/release	X	X	X	X
6.c.	Repositioning (locations, freezes, and releases)	X	X	X	X
6.d.	Ground speed control	X	X	X	X
7. ....	Remote IOS	X	X	X	X
8. ....	Sound Controls. On/off/adjustment	X	X	X	X
9. ....	Motion/Control Loading System				
9.a.	On/off/emergency stop	X	X	X	X
9.b.	Crosstalk (motion response in a given degree of freedom not perceptible in other degrees of freedom)	X	X	X	X
9.c.	Smoothness (no perceptible "turn-around bump" as the direction of motion reverses with the simulator being "flown" normally).	X	X	X	X
10. ....	Observer Seats/Stations. Position/Adjustment/Positive restraint system	X	X	X	X

**Begin Information**

**1. Introduction**

a. The following is an example test schedule for an Initial/Upgrade evaluation that covers the majority of the requirements set out in the Functions and Subjective test requirements. It is not intended that the schedule be followed line by line, rather, the example should be used as a guide for preparing a schedule that is tailored to the airplane, sponsor, and training task.

b. Functions and subjective tests should be planned. This information has been organized as a reference document with the considerations, methods, and evaluation notes for each individual aspect of the simulator task presented as an individual item. In this way the evaluator can design his or her own test plan, using the appropriate sections to provide guidance on method and evaluation criteria. Two aspects should be present in any test plan structure:

(1) An evaluation of the simulator to determine that it replicates the aircraft and performs reliably for an uninterrupted period

equivalent to the length of a typical training session.

(2) The simulator should be capable of operating reliably after the use of training device functions such as repositions or malfunctions.

c. A detailed understanding of the training task will naturally lead to a list of objectives that the simulator should meet. This list will form the basis of the test plan. Additionally, once the test plan has been formulated, the initial conditions and the evaluation criteria should be established. The evaluator should consider all factors that may have an influence on the characteristics observed during particular training tasks in order to make the test plan successful.

**2. Events**

- a. Initial Conditions.
  - (1) Airport.
  - (2) QNH.
  - (3) Temperature.
  - (4) Wind/Crosswind.
  - (5) Zero Fuel Weight /Fuel /Gross Weight /Center of Gravity.
- b. Initial Checks.
  - (1) Documentation of Simulator.

- (a) Simulator Acceptance Test Manuals.
- (b) Simulator Approval Test Guide.
- (c) Technical Logbook Open Item List.
- (d) Daily Functional Pre-flight Check.
- (2) Documentation of User/Carrier Flight

**Logs.**

- (a) Simulator Operating/Instructor Manual.
- (b) Difference List (Aircraft/Simulator).
- (c) Flight Crew Operating Manuals.
- (d) Performance Data for Different Fields.
- (e) Crew Training Manual.
- (f) Normal/Abnormal/Emergency

**Checklists.**

- (3) Simulator External Checks.
  - (a) Appearance and Cleanliness.
  - (b) Stairway/Access Bridge.
  - (c) Emergency Rope Ladders.
  - (d) "Motion On"/"Flight in Progress"

**Lights.**

- (4) Simulator Internal Checks.
  - (a) Cleaning/Disinfecting Towels (for cleaning oxygen masks).
  - (b) Flight deck Layout (compare with difference list).
  - (5) Equipment.
    - (a) Quick Donning Oxygen Masks.
    - (b) Head Sets.
    - (c) Smoke Goggles.

- (d) Sun Visors.
- (e) Escape Rope.
- (f) Chart Holders.
- (g) Flashlights.
- (h) Fire Extinguisher (inspection date).
- (i) Crash Axe.
- (j) Gear Pins.
- c. Power Supply And APU Start Checks.
  - (1) Batteries and Static Inverter.
  - (2) APU Start with Battery.
  - (3) APU Shutdown using Fire Handle.
  - (4) External Power Connection.
  - (5) APU Start with External Power.
  - (6) Abnormal APU Start/Operation.
- d. Flight deck Checks.
  - (1) Flight deck Preparation Checks.
  - (2) FMC Programming.
- Checks.
  - Communications and Navigational Aids Checks.
  - e. Engine Start.
    - (1) Before Start Checks.
    - (2) Battery start with Ground Air Supply Unit.
    - (3) Engine Crossbleed Start.
    - (4) Normal Engine Start.
    - (5) Abnormal Engine Starts.
    - (6) Engine Idle Readings.
    - (7) After Start Checks.
  - f. Taxi Checks.
    - (1) Pushback/Powerback.
    - (2) Taxi Checks.
    - (3) Ground Handling Check:
      - (a) Power required to initiate ground roll.
      - (b) Thrust response.
      - (c) Nose Wheel and Pedal Steering.
      - (d) Nosewheel Scuffing.
      - (e) Perform 180 degree turns.
      - (f) Brakes Response and Differential Braking using Normal, Alternate and Emergency.
        - (g) Brake Systems.
        - (h) Eye height and fore/aft position.
    - (4) Runway Roughness.
  - g. Visual Scene—Ground Assessment.
    - Select 3 different visual models and perform the following checks with Day, Dusk and Night selected, as appropriate:
      - (1) Visual Controls.
        - (a) Daylight, Dusk, Night Scene Controls.
        - (b) Flight deck "Daylight" ambient lighting.
          - (c) Environment Light Controls.
          - (d) Runway Light Controls.
          - (e) Taxiway Light Controls.
      - (2) Scene Content.
        - (a) Ramp area for buildings, gates, airbridges, maintenance ground Equipment, parked aircraft.
        - (b) Daylight shadows, night time light pools.
        - (c) Taxiways for correct markings, taxiway/runway, marker boards, CAT I and II/III hold points, taxiway shape/grass areas, taxiway light (positions and colors).
        - (d) Runways for correct markings, lead-off lights, boards, runway slope, runway light positions, and colors, directionality of runway lights.
        - (e) Airport environment for correct terrain and, significant features.
        - (f) Visual scene aliasing, color, and occulting levels.
        - (3) Ground Traffic Selection.
        - (4) Environment Effects.
          - (a) Low cloud scene.
          - (i) Rain:

- (A) Runway surface scene.
- (B) Windshield wiper—operation and sound.
  - (ii) Hail:
    - (A) Runway surface scene
    - (B) Windshield wiper—operation and sound.
  - (b) Lightning/thunder.
  - (c) Snow/ice runway surface scene.
  - (d) Fog.
  - h. Takeoff.
    - Select one or several of the following test cases:
      - (1) T/O Configuration Warnings.
      - (2) Engine Takeoff Readings.
      - (3) Rejected Takeoff (Dry/Wet/Icy Runway) and check the following:
        - (a) Autobrake function.
        - (b) Anti-skid operation.
        - (c) Motion/visual effects during deceleration.
        - (d) Record stopping distance (use runway plot or runway lights remaining).
          - Continue taxiing along the runway while applying brakes and check the following:
            - (e) Center line lights alternating red/white for 2000 feet/600 meters.
            - (f) Center line lights all red for 1000 feet/300m.
          - (g) Runway end, red stop bars.
          - (h) Braking fade effect.
          - (i) Brake temperature indications.
        - (4) Engine Failure between VI and V2
        - (5) Normal Takeoff:
          - (a) During ground roll check the following:
            - (i) Runway rumble.
            - (ii) Acceleration cues.
            - (iii) Groundspeed effects.
            - (iv) Engine sounds.
            - (v) Nosewheel and rudder pedal steering.
          - (b) During and after rotation, check the following:
            - (i) Rotation characteristics.
            - (ii) Column force during rotation.
            - (iii) Gear uplock sounds/bumps.
            - (iv) Effect of slat/flap retraction during climbout
          - (6) Crosswind Takeoff (check the following):
            - (a) Tendency to turn into or out of the wind.
            - (b) Tendency to lift upwind wing as airspeed increase
            - (7) Windshear during Takeoff (check the following):
              - (a) Controllable during windshear encounter.
              - (b) Performance adequate when using correct techniques.
              - (c) Windshear Indications satisfactory.
              - (d) Motion cues satisfactory (particularly turbulence).
            - (8) Normal Takeoff with Control Malfunction
            - (9) Low Visibility T/O (check the following):
              - (a) Visual cues.
              - (b) Flying by reference to instruments.
              - (c) SID Guidance on LNAV
          - i. Climb Performance.
            - Select one or several of the following test cases
              - (1) Normal Climb—Climb while maintaining recommended speed profile and note fuel, distance and time.
              - (2) Single Engine Climb—Trim aircraft in a zero wheel climb at V2

- Note: Up to 5° bank towards the operating engine(s) is permissible. Climb for 3 minutes and note fuel, distance, and time. Increase speed toward en route climb speed and retract flaps. Climb for 3 minutes and note fuel, distance, and time.
- j. Systems Operation During Climb.
  - Check normal operation and malfunctions as appropriate for the following systems
    - (1) Air conditioning/Pressurization/Ventilation.
    - (2) Autoflight.
    - (3) Communications.
    - (4) Electrical.
    - (5) Fuel.
    - (6) Icing Systems.
    - (7) Indicating and Recording systems.
    - (8) Navigation/FMS.
    - (9) Pneumatics.
- k. Cruise Checks.
  - Select one or several of the following test cases:
    - (1) Cruise Performance.
    - (2) High Speed/High Altitude Handling (check the following):
      - (a) Overspeed warning.
      - (b) High Speed buffet.
      - (c) Aircraft control satisfactory.
      - (d) Envelope limiting functions on Computer Controlled Airplanes.
        - Reduce airspeed to below level flight buffet onset speed, start a turn, and check the following:
          - (e) High Speed buffet increases with G loading.
            - Reduce throttles to idle and start descent, deploy the speedbrake, and check the following:
              - (f) Speedbrake indications.
              - (g) Symmetrical deployment.
              - (h) Airframe buffet.
              - (i) Aircraft response hands off.
          - (3) Yaw Damper Operation.
            - Switch off yaw dampers and autopilot.
              - Initiate a Dutch roll and check the following:
                - (a) Aircraft dynamics.
                - (b) Simulator motion effects.
              - Switch on yaw dampers, re-initiate a Dutch roll and check the following:
                - (c) Damped aircraft dynamics.
                - (4) APU Operation.
                - (5) Engine Gravity Feed.
                - (6) Engine Shutdown and Driftdown
        - Check: FMC operation Aircraft performance.
        - (7) Engine Relight.
      - l. Descent.
        - Select one of the following test cases:
          - (1) Normal Descent Descend while maintaining recommended speed profile and note fuel, distance And time.
          - (2) Cabin Depressurization/Emergency Descent.
            - m. Medium Altitude Checks.
              - Select one or several of the following test cases:
                - (1) High Angle of Attack/Stall. Trim the aircraft at 1.4 Vs, establish 1 kt/sec<sup>2</sup> deceleration rate, and check the following—
                  - (a) System displays/operation satisfactory.
                  - (b) Handling characteristics satisfactory.
                  - (c) Stall and Stick shaker speed.
                  - (d) Buffet characteristics and onset speed.
                  - (e) Envelope limiting functions on Computer Controlled Airplanes.
                    - Recover to straight and level flight and check the following:

(f) Handling characteristics satisfactory.  
 (2) Turning Flight.  
 Roll aircraft to left, establish a 30° to 45° bank angle, and check the following:  
 (a) Stick force required, satisfactory.  
 (b) Wheel requirement to maintain bank angle.  
 (c) Slip ball response, satisfactory.  
 (d) Time to turn 180°.  
 Roll aircraft from 45° bank one way to 45° bank the opposite direction while maintaining altitude and airspeed—check the following:  
 (e) Controllability during maneuver.  
 (3) Degraded flight controls.  
 (4) Holding Procedure (check the following):  
 (a) FMC operation.  
 (b) Auto pilot auto thrust performance.  
 (5) Storm Selection (check the following):  
 (a) Weather radar controls.  
 (b) Weather radar operation.  
 (c) Visual scene corresponds with WXR pattern. (Fly through storm center, and check the following:)  
 (d) Aircraft enters cloud.  
 (e) Aircraft encounters representative turbulence.  
 (f) Rain/hail sound effects evident.  
 As aircraft leaves storm area, check the following:  
 (g) Storm effects disappear.  
 (6) TCAS (check the following):  
 (a) Traffic appears on visual display.  
 (b) Traffic appears on TCAS display(s).  
 As conflicting traffic approaches, take relevant avoiding action, and check the following:  
 (c) Visual and TCAS system displays.  
 n. Approach And Landing.  
 Select one or several of the following test cases while monitoring flight control and hydraulic systems for normal operation and with malfunctions selected:  
 (1) Flaps/Gear Normal Operation. Check the following:  
 (a) Time for extension/retraction.  
 (b) Buffet characteristics.  
 (2) Normal Visual Approach and Landing.  
 Fly a normal visual approach and landing—check the following:  
 (a) Aircraft handling.  
 (b) Spoiler operation.  
 (c) Reverse thrust operation.  
 (d) Directional control on the ground.  
 (e) Touchdown cues for main and nose wheel.  
 (f) Visual cues.  
 (g) Motion cues.  
 (h) Sound cues.  
 (i) Brake and Anti-skid operation.  
 (3) Flaps/Gear Abnormal Operation or with hydraulic malfunctions.  
 (4) Abnormal Wing Flaps/Slats Landing.  
 (5) Manual Landing with Control Malfunction  
 (a) Aircraft handling.  
 (b) Aircraft handling.  
 (c) Radio Aids and instruments.  
 (d) Visual scene content and cues.  
 (e) Motion cues.  
 (f) Sound cues.  
 (6) Non-precision Approach—All Engines Operating.  
 (a) Aircraft handling.  
 (b) Aircraft handling.

(c) Radio Aids and instruments.  
 (d) Visual scene content and cues.  
 (e) Motion cues.  
 (f) Sound cues.  
 (7) Circling Approach.  
 (a) Aircraft handling.  
 (b) Aircraft handling.  
 (c) Radio Aids and instruments.  
 (d) Visual scene content and cues.  
 (e) Motion cues.  
 (f) Sound cues.  
 (8) Non-precision Approach—One Engine Inoperative.  
 (a) Aircraft handling.  
 (b) Aircraft handling.  
 (c) Radio Aids and instruments.  
 (d) Visual scene content and cues.  
 (e) Motion cues.  
 (f) Sound cues.  
 (9) One Engine Inoperative Go-around.  
 (a) Aircraft handling.  
 (b) Aircraft handling.  
 (c) Radio Aids and instruments.  
 (d) Visual scene content and cues.  
 (e) Motion cues.  
 (f) Sound cues.  
 (10) CAT I Approach and Landing with raw-data ILS.  
 (a) Aircraft handling.  
 (b) Aircraft handling.  
 (c) Radio Aids and instruments.  
 (d) Visual scene content and cues.  
 (e) Motion cues.  
 (f) Sound cues.  
 (11) CAT I Approach and Landing with Limiting Crosswind.  
 (a) Aircraft handling.  
 (b) Aircraft handling.  
 (c) Radio Aids and instruments.  
 (d) Visual scene content and cues.  
 (e) Motion cues.  
 (f) Sound cues.  
 (12) CAT I Approach with Windshear.  
 Check the following:  
 (a) Controllable during windshear encounter.  
 (b) Performance adequate when using correct techniques.  
 (c) Windshear indications/warnings.  
 (d) Motion cues (particularly turbulence).  
 (13) CAT II Approach and Automatic Go-Around.  
 (14) CAT III Approach and Landing—System Malfunctions.  
 (15) CAT III Approach and Landing—1 Engine Inoperative.  
 (16) GPWS evaluation.  
 o. Visual Scene—In-Flight Assessment.  
 Select three (3) different visual models and perform the following checks with “day,” “dusk,” and “night” (as appropriate) selected. Reposition the aircraft at or below 2000 feet within 10 nm of the airfield. Fly the aircraft around the airport environment and assess control of the visual system and evaluate the visual scene content as described below:  
 (1) Visual Controls.  
 (a) Daylight, Dusk, Night Scene Controls.  
 (b) Flight deck ambient lighting during “daylight” conditions.  
 (c) Environment Light Controls.  
 (d) Runway Light Controls.  
 (e) Taxiway Light Controls.  
 (f) Approach Light Controls.  
 (2) Scene Content.

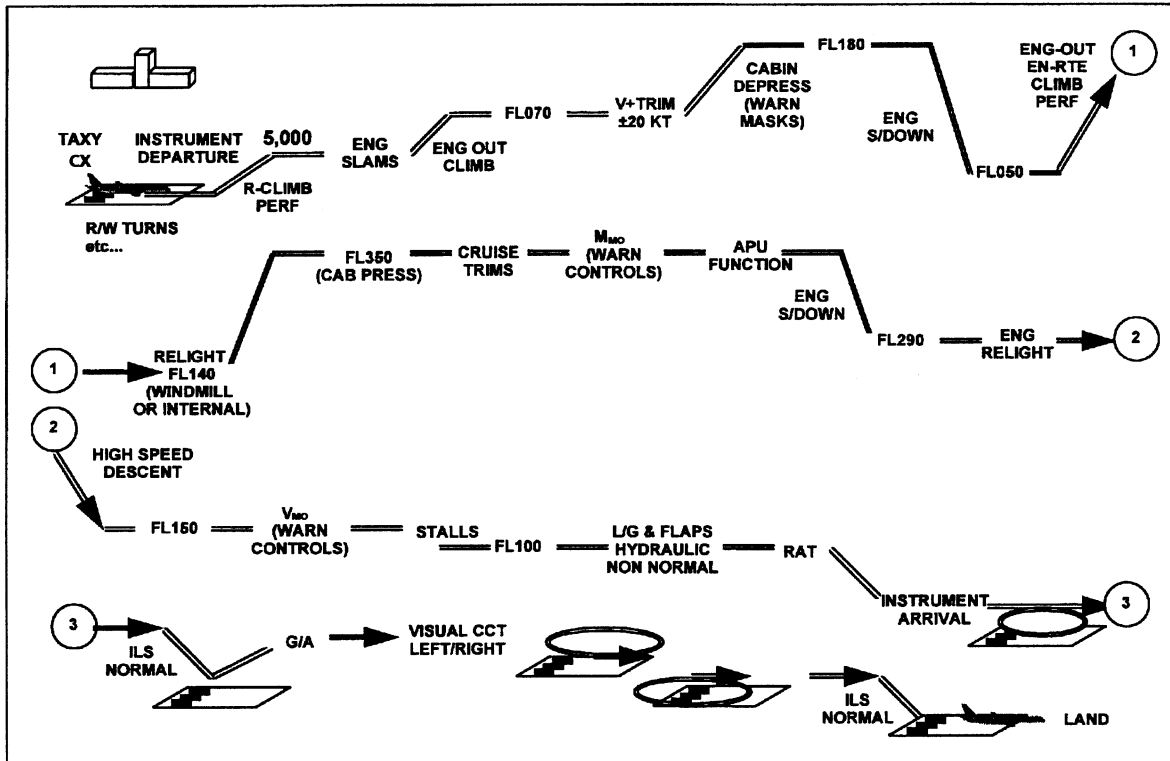
(a) Airport environment for correct terrain and significant features.  
 (b) Runways for correct markings, runway slope, directionality of runway lights.  
 (c) Visual scene for aliasing, colour, and occulting.  
 Reposition the aircraft to a long, final approach for an “ILS runway.” Select flight freeze when the aircraft is 5-statute miles (sm)/8-kilometers (km) out and on the glide slope. Check the following:  
 (3) Scene content.  
 (a) Airfield features.  
 (b) Approach lights.  
 (c) Runway definition.  
 (d) Runway definition.  
 (e) Runway edge lights and VASI lights.  
 (f) Strobe lights.  
 Release flight freeze. Continue flying the approach with NP engaged. Select flight freeze when aircraft is 3 sm/5 km out and on the glide slope. Check the following:  
 (4) Scene Content.  
 (a) Runway centerline light.  
 (b) Taxiway definition and lights.  
 Release flight freeze and continue flying the approach with A/P engaged. Select flight freeze when aircraft is 2 sm/3 km out and on the glide slope. Check the following:  
 (5) Scene content.  
 (a) Runway threshold lights.  
 (b) Touchdown zone lights.  
 At 200 ft radio altitude and still on glide slope, select Flight Freeze. Check the following:  
 (6) Scene content.  
 (a) Runway markings.  
 Set the weather to Category I conditions and check the following:  
 (7) Scene content.  
 (a) Visual ground segment.  
 Set the weather to Category II conditions, release Flight Freeze, re-select Flight Freeze at 100 feet radio altitude, and check the following:  
 (8) Scene content.  
 (a) Visual ground segment.  
 Select night/dusk (twilight) conditions and check the following:  
 (9) Scene content.  
 (a) Runway markings visible within landing light lobes.  
 Set the weather to Category III conditions, release Flight Freeze, re-select Flight Freeze at 50 feet radio altitude and check the following:  
 (10) Scene content.  
 (a) Visual ground segment.  
 Set WX to “missed approach” conditions, release Flight Freeze, re-select Flight Freeze at 15 feet radio altitude, and check the following:  
 (11) Scene content.  
 (a) Visual ground segment.  
 When on the ground, stop the aircraft. Set 0 feet RVR, ensure strobe/beacon lights are switched on and check the following:  
 (12) Scene content.  
 (a) Visual effect of strobe and beacon.  
 Reposition to final approach, set weather to “Clear,” continue approach for an automatic landing, and check the following:  
 (13) Scene content.  
 (a) Visual cues during flare to assess sink rate.  
 (b) Visual cues during flare to assess Depth perception.

- (c) Flight deck height above ground.
- p. After Landing Operations.
- (1) After Landing Checks.
- (2) Taxi back to gate. Check the following:

- (a) Visual model satisfactory.
- (b) Parking brake operation satisfactory.
- (3) Shutdown Checks.
- q. Crash Function.

- (1) Gear-up Crash.
- (2) Excessive rate of descent Crash.
- (3) Excessive bank angle Crash.

Typical Subjective Continuing Qualification Evaluation Profile (2 hours)



End Information

Attachment 4 to Appendix A to Part 60—Sample Documents

Table of Contents

Title of Sample

Figure A4A—Sample Letter, Request for Initial, Upgrade, or Reinstatement Evaluation.

Figure A4B—Attachment: FSTD Information Form

Figure A4C—Sample Qualification Test Guide Cover Page

Figure A4D—Sample Statement of Qualification—Certificate

Figure A4E—Sample Statement of Qualification—Configuration List

Figure A4F—Sample Statement of Qualification—List of Qualified Tasks

Figure A4G—Sample Continuing Qualification Evaluation Requirements Page

Figure A4H—Sample MQTG Index of Effective FSTD Directives

BILLING CODE 4910-13-P

**Attachment 4 to Appendix A to Part 60—  
Figure A4A – Sample Letter , Request for Initial, Upgrade, or Reinstatement Evaluation  
INFORMATION**

Date \_\_\_\_\_

Edward D. Cook, Ph.D.  
Manager, National Simulator Program  
Federal Aviation Administration  
100 Hartsfield Centre Parkway  
Suite 400  
Atlanta, GA 30354

Dear Dr. Cook:

**RE: Request for Initial/Upgrade Evaluation Date**

This is to advise you of our intent to request an (initial or upgrade) evaluation of our (FSTD Manufacturer), (Aircraft Type/Level) Flight Simulation Training Device (FSTD), (FAA ID Number, if previously qualified), located in (City, State) at the (Facility) on (Proposed Evaluation Date). (The proposed evaluation date shall not be more than 180 days following the date of this letter.) The FSTD will be sponsored by (Name of Training Center/Air Carrier), FAA Designator (4 Letter Code). The FSTD will be sponsored as follows: (Select One)

- The FSTD will be used within the sponsor's FAA approved training program and placed on the sponsor's Training/Operations Specifications.
- The FSTD will be used for dry lease only.

We agree to provide the formal request for the evaluation to your staff as follows: (check one)

- For QTG tests run at the factory, not later, than 45 days prior to the proposed evaluation date with the additional "1/3 on-site" tests provided not later than 14 days prior to the proposed evaluation date.
- For QTG tests run on-site, not later than 30 days prior to the proposed evaluation date.

We understand that the formal request will contain the following documents:

1. Sponsor's Letter of Request (*Company Compliance Letter*).
2. Principal Operations Inspector (POI) or Training Center Program Manager's (TCPM) endorsement.
3. Complete QTG.

If we are unable to meet the above requirements, we understand this may result in a significant delay, perhaps 45 days or more, in rescheduling and completing the evaluation. (The sponsor should add additional comments as necessary).

Please contact (Name Telephone and Fax Number of Sponsor's Contact) to confirm the date for this initial evaluation. We understand a member of your National Simulator Program staff will respond to this request within 14 days.

A copy of this letter of intent has been provided to (Name), the Principal Operations Inspector (POI) and/or Training Center Program Manager (TCPM).

**Attachment 4 to Appendix A to Part 60—  
Figure A4A – Sample Letter , Request for Initial, Upgrade, or Reinstatement Evaluation  
INFORMATION**

Sincerely,

Attachment: FSTD Information Form  
cc: POI/TCPM

**Attachment 4 to Appendix A to Part 60—  
Figure A4B – Sample Letter , Request for Initial, Upgrade, or Reinstatement Evaluation  
Attachment: FSTD Information Form  
INFORMATION**

|  |                                       |  |  |
|--|---------------------------------------|--|--|
| Date: _____  |                                       |  |  |
| <b>Section 1. FSTD Information and Characteristics</b>   |                                       |  |  |
| Sponsor Name: _____  |                                       | FSTD Location: _____                           |  |
| Address: _____<br>_____  |                                       | Physical Address: _____<br>_____               |  |
| City: _____  |                                       | City: _____                                    |  |
| State: _____   |                                       | State: _____                                   |  |
| Country: _____   |                                       | Country: _____                                 |  |
| ZIP: _____   |                                       | ZIP: _____                                     |  |
| Manager _____  |                                       |  |  |
| Sponsor ID No:<br>(Four Letter FAA Designator) _____   |                                       | Nearest Airport:<br>(Airport Designator) _____ |  |
| Type of Evaluation Requested: <input type="checkbox"/> Initial <input type="checkbox"/> Upgrade <input type="checkbox"/> Recurrent <input type="checkbox"/> Special <input type="checkbox"/> Reinstatement |                                       |  |  |
| Qualification Basis: _____   | <input type="checkbox"/> A            | <input type="checkbox"/> B                     | <input type="checkbox"/> Interim C <input type="checkbox"/> C <input type="checkbox"/> D |
|  | <input type="checkbox"/> 6            | <input type="checkbox"/> 7                     | <input type="checkbox"/> Provisional Status  |
| Initial Qualification:<br>(If Applicable)  | Date: _____ Level _____               | Manufacturer's Identification/Serial No: _____ |  |
| Upgrade Qualification:<br>(If Applicable)  | Date: _____ Level _____<br>MM/DD/YYYY | <input type="checkbox"/> eQTG                  |  |
| <b>Other Technical Information:</b>  |                                       |  |  |
| FAA FSTD ID No:<br>(If Applicable)   | _____                                 | FSTD Manufacturer:                             | _____  |
| Convertible FSTD:  | <input type="checkbox"/> Yes:         | Date of Manufacture:                           | _____<br>MM/DD/YYYY  |
| Related FAA ID No.<br>(If Applicable)  | _____                                 | Sponsor FSTD ID No:                            | _____  |
| Airplane model/series:   | _____                                 | Source of aerodynamic model:                   | _____  |
| Engine model(s) and data revision:   | _____                                 | Source of aerodynamic coefficient data:        | _____  |
| FMS identification and revision level:   | _____                                 | Aerodynamic data revision number:              | _____  |
| Visual system manufacturer/model:  | _____                                 | Visual system display:                         | _____  |
| Flight control data revision:  | _____                                 | FSTD computer(s) identification:               | _____  |
| Motion system manufacturer/type:   | _____                                 |  |  |
| National Aviation Authority (NAA):<br>(If Applicable)  | _____                                 |  | _____  |
| NAA FSTD ID No:  | _____                                 | Last NAA Evaluation Date:                      | _____  |

**Attachment 4 to Appendix A to Part 60—  
Figure A4B – Sample Letter , Request for Initial, Upgrade, or Reinstatement Evaluation  
Attachment: FSTD Information Form  
INFORMATION**

|   |  |   |   |
|---|--|---|---|
| NAA Qualification Level:  | _____  |   |   |
| NAA Qualification Basis:  | _____  |   |   |
| Visual System Manufacturer and Type:                            | _____  | Motion System Manufacturer and Type:  | _____   |
| Aircraft Make/Model/Series:                                     | _____  | FSTD Seats Available:   | _____   |
| Aircraft Equipment  | ENGINE TYPE(S):<br>_____   | Flight Instrumentation:<br><input type="checkbox"/> EFIS <input type="checkbox"/> HUD <input type="checkbox"/> HGS <input type="checkbox"/> EFVS<br><input type="checkbox"/> TCAS <input type="checkbox"/> GPWS <input type="checkbox"/> Plain View<br><input type="checkbox"/> GPS <input type="checkbox"/> FMS Type: _____<br><input type="checkbox"/> WX Radar <input type="checkbox"/> Other: _____ | Engine Instrumentation:<br><input type="checkbox"/> EICAS <input type="checkbox"/> FADEC<br><input type="checkbox"/> Other: _____ |
| Airport Models:   | 3.6.1 _____<br><i>Airport Designator</i>   | 3.6.2 _____<br><i>Airport Designator</i>  | 3.6.3 _____<br><i>Airport Designator</i>  |
| Circle to Land:   | 3.7.1 _____<br><i>Airport Designator</i>   | 3.7.2 _____<br><i>Approach</i>  | 3.7.3 _____<br><i>Landing Runway</i>  |
| Visual Ground Segment   | 3.8.1 _____<br><i>Airport Designator</i>   | 3.8.2 _____<br><i>Approach</i>  | 3.8.3 _____<br><i>Landing Runway</i>  |
| <b>Section 2. Supplementary Information</b>                     |  |   |   |
| FAA Training Program Approval Authority:                        | <input type="checkbox"/> POI <input type="checkbox"/> TCPM <input type="checkbox"/> Other: _____ |   |   |
| Name:   | _____  | Office:   | _____   |
| Tel:  | _____  | Fax:  | _____   |
| Email:  | _____  |   |   |
| <b>FSTD Scheduling Person:</b>                                  |  |   |   |
| Name:   | _____  |   |   |
| Address 1:  | _____  | Address 2   | _____   |
| City:   | _____  | State:  | _____   |
| ZIP:  | _____  | Email:  | _____   |
| Tel:  | _____  | Fax:  | _____   |
| <b>FSTD Technical Contact:</b>                                  |  |   |   |
| Name:   | _____  |   |   |
| Address 1:  | _____  | Address 2   | _____   |
| City:   | _____  | State:  | _____   |
| ZIP:  | _____  | Email:  | _____   |
| Tel:  | _____  | Fax:  | _____   |
| <b>Section 3. Training, Testing and Checking Considerations</b> |  |   |   |
| Area/Function/Maneuver  | Requested  | Remarks   |   |
| Private Pilot - Training / Checks: (142)                        | <input type="checkbox"/>   | _____   |   |



**Attachment 4 to Appendix A to Part 60—  
Figure A4B – Sample Letter , Request for Initial, Upgrade, or Reinstatement Evaluation  
Attachment: FSTD Information Form  
INFORMATION**

|  |                          |       |
|--|--------------------------|-------|
| Commercial Pilot - Training /Checks:(142)  | <input type="checkbox"/> | _____ |
| Multi-Engine Rating - Training / Checks (142)  | <input type="checkbox"/> | _____ |
| Instrument Rating -Training / Checks (142)   | <input type="checkbox"/> | _____ |
| Type Rating - Training / Checks (135/121/142)  | <input type="checkbox"/> | _____ |
| Proficiency Checks (135/121/142)   | <input type="checkbox"/> | _____ |
| CAT I: (RVR 2400/1800 ft. DH200 ft)  | <input type="checkbox"/> | _____ |
| CAT II: (RVR 1200 ft. DH 100 ft)   | <input type="checkbox"/> | _____ |
| CAT III * (lowest minimum) _____ RVR _____ ft.<br>* State CAT III ( $\leq 700$ ft.), CAT IIIb ( $\leq 150$ ft.), or CAT IIIc (0 ft.) | <input type="checkbox"/> | _____ |
| Circling Approach  | <input type="checkbox"/> | _____ |
| Windshear Training:  | <input type="checkbox"/> | _____ |
| Windshear Training IAW 121.409(d) (121 Turbojets Only)   | <input type="checkbox"/> | _____ |
| Generic Unusual Attitudes and Recoveries within the Normal Flight Envelope   | <input type="checkbox"/> | _____ |
| Specific Unusual Attitudes Recoveries  | <input type="checkbox"/> | _____ |
| Auto-coupled Approach/Auto Go Around   | <input type="checkbox"/> | _____ |
| Auto-land / Roll Out Guidance  | <input type="checkbox"/> | _____ |
| TCAS/ACAS I / II   | <input type="checkbox"/> | _____ |
| WX-Radar   | <input type="checkbox"/> | _____ |
| HUD  | <input type="checkbox"/> | _____ |
| HGS  | <input type="checkbox"/> | _____ |
| EFVS   | <input type="checkbox"/> | _____ |
| Future Air Navigation Systems  | <input type="checkbox"/> | _____ |
| GPWS / EGPWS   | <input type="checkbox"/> | _____ |
| ETOPS Capability   | <input type="checkbox"/> | _____ |
| GPS  | <input type="checkbox"/> | _____ |
| SMGCS  | <input type="checkbox"/> | _____ |
| Helicopter Slope Landings  | <input type="checkbox"/> | _____ |
| Helicopter External Load Operations  | <input type="checkbox"/> | _____ |
| Helicopter Pinnacle Approach to Landings   | <input type="checkbox"/> | _____ |
| Helicopter Night Vision Maneuvers  | <input type="checkbox"/> | _____ |
| Helicopter Category A Takeoffs   | <input type="checkbox"/> | _____ |

**Attachment 4 to Appendix A to Part 60—  
Figure A4C – Sample Qualification Test Guide Cover Page  
INFORMATION**

SPONSOR NAME

SPONSOR ADDRESS

FAA QUALIFICATION TEST GUIDE

(SPECIFIC AIRPLANE MODEL)

*for example*

Stratos BA797-320A

(Type of Simulator)

(Simulator Identification Including Manufacturer, Serial Number, Visual System Used)

(Simulator Level)

(Qualification Performance Standard Used)

(Simulator Location)

FAA Initial Evaluation

Date: \_\_\_\_\_

\_\_\_\_\_ Date: \_\_\_\_\_  
(Sponsor)

\_\_\_\_\_ Date: \_\_\_\_\_  
Manager, National  
Simulator Program, FAA

**Attachment 4 to Appendix A to Part 60—  
Figure A4D – Sample Statement of Qualification - Certificate  
INFORMATION**

**Federal Aviation Administration  
National Simulator Program**



***Certificate of Qualification***

**This is to certify that representatives of the National Simulator Program  
Completed an evaluation of the**

**Go-Fast Airlines  
Farnsworth Z-100 Full Flight Simulator  
FAA Identification Number 999**

**And pursuant to 14 CFR Part 60 found it to meet its original qualification basis, AC  
120-40B (MM/DD/YY)**

**The Master Qualification Test Guide and the attached  
Configuration List and Restrictions List  
Provide the Qualification Basis for this device to operate at  
**Level D**  
Until April 30, 2010**

**Unless sooner rescinded or extended by the National Simulator Program Manager**

March 15, 2009

(date)

B. Williamson

(for the NSPM)

**Attachment 4 to Appendix A to Part 60—  
Figure A4E – Sample Statement of Qualification; Configuration List  
INFORMATION**

**STATEMENT OF QUALIFICATION  
CONFIGURATION LIST**

|  |  |  |  |
|--|--|--|--|
| Date: _____  |  |  |  |
| <b>Section 1. FSTD Information and Characteristics</b>   |  |  |  |
| Sponsor Name: _____  |  | FSTD Location: _____   |  |
| Address: _____<br>_____  |  | Physical Address: _____<br>_____   |  |
| City: _____  |  | City: _____  |  |
| State: _____   |  | State: _____   |  |
| Country: _____   |  | Country: _____   |  |
| ZIP: _____   |  | ZIP: _____   |  |
| Manager _____  |  |  |  |
| Sponsor ID No:<br>(Four Letter FAA Designator) _____   |  | Nearest Airport:<br>(Airport Designator) _____   |  |
| Type of Evaluation Requested: <input type="checkbox"/> Initial <input type="checkbox"/> Upgrade <input type="checkbox"/> Recurrent <input type="checkbox"/> Special <input type="checkbox"/> Reinstatement |  |  |  |
| Qualification Basis: _____   |  | <input type="checkbox"/> A <input type="checkbox"/> B <input type="checkbox"/> Interim C <input type="checkbox"/> C <input type="checkbox"/> D |  |
| _____ <input type="checkbox"/> 6 <input type="checkbox"/> 7  |  | <input type="checkbox"/> Provisional Status  |  |
| Initial Qualification:<br>(If Applicable)  |  | Date: _____ Level _____  |  |
| Upgrade Qualification:<br>(If Applicable)  |  | Date: _____ Level _____<br>MM/DD/YYYY  |  |
| Manufacturer's Identification/Serial No: _____   |  | <input type="checkbox"/> eQTG  |  |
| <b>Other Technical Information:</b>  |  |  |  |
| FAA FSTD ID No:<br>(If Applicable) _____   |  | FSTD Manufacturer: _____   |  |
| Convertible FSTD: <input type="checkbox"/> Yes:  |  | Date of Manufacture: _____<br>MM/DD/YYYY   |  |
| Related FAA ID No.<br>(If Applicable) _____  |  | Sponsor FSTD ID No: _____  |  |
| Aircraft model/series: _____   |  | Source of aerodynamic model: _____   |  |
| Engine model(s) and data revision: _____   |  | Source of aerodynamic coefficient data: _____  |  |
| FMS identification and revision level: _____   |  | Aerodynamic data revision number: _____  |  |
| Visual system manufacturer/model: _____  |  | Visual system display: _____   |  |
| Flight control data revision: _____  |  | FSTD computer(s) identification: _____   |  |
| Motion system manufacturer/type: _____   |  |  |  |
| National Aviation Authority (NAA):<br>(If Applicable) _____  |  |  |  |
| NAA FSTD ID No: _____  |  | Last NAA Evaluation Date: _____  |  |

**Attachment 4 to Appendix A to Part 60—  
Figure A4E – Sample Statement of Qualification; Configuration List  
INFORMATION**

|   |  |   |  |   |
|---|--|---|--|---|
| NAA Qualification Level:  |  | _____   | _____                                    | _____   |
| NAA Qualification Basis:  |  | _____   | _____                                    | _____   |
| Visual System Manufacturer and Type:                            |  | _____   | Motion System Manufacturer and Type:     | _____   |
| Aircraft Make/Model/Series:                                     |  | _____   | FSTD Seats Available:                    | _____   |
| Aircraft Equipment  | ENGINE TYPE(S):<br>_____                 | Flight Instrumentation:<br><input type="checkbox"/> EFIS <input type="checkbox"/> HUD <input type="checkbox"/> HGS <input type="checkbox"/> EFVS<br><input type="checkbox"/> TCAS <input type="checkbox"/> GPWS <input type="checkbox"/> Plain View<br><input type="checkbox"/> GPS <input type="checkbox"/> FMS Type: _____<br><input type="checkbox"/> WX Radar <input type="checkbox"/> Other: _____ |  | Engine Instrumentation:<br><input type="checkbox"/> EICAS <input type="checkbox"/> FADEC<br><input type="checkbox"/> Other: _____ |
| Airport Models:   | 3.6.1 _____<br><i>Airport Designator</i> | 3.6.2 _____<br><i>Airport Designator</i>  | 3.6.3 _____<br><i>Airport Designator</i> |   |
| Circle to Land:   | 3.7.1 _____<br><i>Airport Designator</i> | 3.7.2 _____<br><i>Approach</i>  | 3.7.3 _____<br><i>Landing Runway</i>     |   |
| Visual Ground Segment   | 3.8.1 _____<br><i>Airport Designator</i> | 3.8.2 _____<br><i>Approach</i>  | 3.8.3 _____<br><i>Landing Runway</i>     |   |
| <b>Section 2. Supplementary Information</b>                     |  |   |  |   |
| FAA Training Program Approval Authority:                        |  | <input type="checkbox"/> POI <input type="checkbox"/> TCPM <input type="checkbox"/> Other: _____  |  |   |
| Name:   | _____                                    | Office:   | _____                                    |   |
| Tel:  | _____                                    | Fax:  | _____                                    |   |
| Email:  | _____                                    |   |  |   |
| FSTD Scheduling Person:   |  |   |  |   |
| Name:   | _____                                    |   | _____                                    |   |
| Address 1:  | _____                                    |   | Address 2                                | _____   |
| City:   | _____                                    |   | State:                                   | _____   |
| ZIP:  | _____                                    |   | Email:                                   | _____   |
| Tel:  | _____                                    |   | Fax:                                     | _____   |
| FSTD Technical Contact:   |  |   |  |   |
| Name:   | _____                                    |   | _____                                    |   |
| Address 1:  | _____                                    |   | Address 2                                | _____   |
| City:   | _____                                    |   | State:                                   | _____   |
| ZIP:  | _____                                    |   | Email:                                   | _____   |
| Tel:  | _____                                    |   | Fax:                                     | _____   |
| <b>Section 3. Training, Testing and Checking Considerations</b> |  |   |  |   |
| Area/Function/Maneuver  |  | Requested   | Remarks                                  |   |
| Private Pilot - Training / Checks: (142)                        |  | <input type="checkbox"/>  | _____                                    |   |
| Commercial Pilot - Training /Checks:(142)                       |  | <input type="checkbox"/>  | _____                                    |   |

**Attachment 4 to Appendix A to Part 60—  
Figure A4E – Sample Statement of Qualification; Configuration List  
INFORMATION**

|  |                          |       |
|--|--------------------------|-------|
| Multi-Engine Rating - Training / Checks (142)  | <input type="checkbox"/> | _____ |
| Instrument Rating - Training / Checks (142)  | <input type="checkbox"/> | _____ |
| Type Rating - Training / Checks (135/121/142)  | <input type="checkbox"/> | _____ |
| Proficiency Checks (135/121/142)   | <input type="checkbox"/> | _____ |
| CAT I: (RVR 2400/1800 ft. DH200 ft)  | <input type="checkbox"/> | _____ |
| CAT II: (RVR 1200 ft. DH 100 ft)   | <input type="checkbox"/> | _____ |
| CAT III * (lowest minimum) _____ RVR _____ ft.<br>* State CAT III ( $\leq 700$ ft.), CAT IIIb ( $\leq 150$ ft.), or CAT IIIc (0 ft.) | <input type="checkbox"/> | _____ |
| Circling Approach  | <input type="checkbox"/> | _____ |
| Windshear Training:  | <input type="checkbox"/> | _____ |
| Windshear Training IAW 121.409(d) (121 Turbojets Only)   | <input type="checkbox"/> | _____ |
| Generic Unusual Attitudes and Recoveries within the Normal Flight Envelope   | <input type="checkbox"/> | _____ |
| Specific Unusual Attitudes Recoveries  | <input type="checkbox"/> | _____ |
| Auto-coupled Approach/Auto Go Around   | <input type="checkbox"/> | _____ |
| Auto-land / Roll Out Guidance  | <input type="checkbox"/> | _____ |
| TCAS/ACAS I / II   | <input type="checkbox"/> | _____ |
| WX-Radar   | <input type="checkbox"/> | _____ |
| HUD  | <input type="checkbox"/> | _____ |
| HGS  | <input type="checkbox"/> | _____ |
| EFVS   | <input type="checkbox"/> | _____ |
| Future Air Navigation Systems  | <input type="checkbox"/> | _____ |
| GPWS / EGPWS   | <input type="checkbox"/> | _____ |
| ETOPS Capability   | <input type="checkbox"/> | _____ |
| GPS  | <input type="checkbox"/> | _____ |
| SMGCS  | <input type="checkbox"/> | _____ |
| Helicopter Slope Landings  | <input type="checkbox"/> | _____ |
| Helicopter External Load Operations  | <input type="checkbox"/> | _____ |
| Helicopter Pinnacle Approach to Landings   | <input type="checkbox"/> | _____ |
| Helicopter Night Vision Maneuvers  | <input type="checkbox"/> | _____ |
| Helicopter Category A Takeoffs   | <input type="checkbox"/> | _____ |

**Attachment 4 to Appendix A to Part 60—  
Figure A4F – Sample Statement of Qualification – List of Qualified Tasks  
INFORMATION**

**STATEMENT of QUALIFICATION  
List of Qualified Tasks**

**Go Fast Airline Training -- Farnsworth Z-100 -- Level D -- FAA ID# 999**

**The FSTD is qualified to perform all of the Maneuvers, Procedures, Tasks, and Functions Listed in Appendix A, Attachment 1, Table A1B, Minimum FSTD Requirements In Effect on [mm/dd/yyyy] except for the following listed Tasks or Functions.**

Qualified for all tasks in Table A1B, for which the sponsor has requested qualification, except for the following:

- 3.e(1)(i) NDB approach
- 3.f. Recovery from Unusual Attitudes
- 4.3. Circling Approach

Additional tasks for which this FSTD is qualified (i.e., in addition to the list in Table A1B)

1. Enhanced Visual System
2. Windshear Training IAW Section 121.409(d).

The airport visual models evaluated for qualification at this level are:

1. Atlanta Hartsfield International Airport (KATL)
2. Miami International Airport (KMIA)
3. Dallas/Ft. Worth Regional Airport (KDFW)

**Attachment 4 to Appendix A to Part 60—  
Figure A4G – Sample Continuing Qualification Evaluation Requirements Page  
INFORMATION**

|  |   |
|--|---|
| <b>Recurrent Evaluation Requirements</b><br><i>Completed at conclusion of Initial Evaluation</i>                       |   |
| Recurrent Evaluations to be conducted each<br><br>____ (fill in) ____ months<br><br>Allotting _____ hours of FTD time. | Recurrent evaluations are due as follows:<br><br>____ (month) ____ and ____ (month) ____ and ____ (month) ____<br>(enter or strike out, as appropriate) |
| Signed: _____<br>NSPM / Evaluation Team Leader   | _____<br>Date   |

|  |   |
|--|---|
| <b>Revision:</b><br>Based on (enter reasoning):<br><br>_____   |   |
| Recurrent Evaluations are to be conducted each<br><br>____ (fill in) ____ months. Allotting _____ hours. | Recurrent evaluations are due as follows:<br><br>____ (month) ____ and ____ (month) ____ and ____ (month) ____<br>(enter or strike out, as appropriate) |
| Signed: _____<br>NSPM Evaluation Team Leader   | _____<br>Date   |

|  |   |
|--|---|
| <b>Revision:</b><br>Based on (enter reasoning):<br><br>_____   |   |
| Recurrent Evaluations are to be conducted each<br><br>____ (fill in) ____ months. Allotting _____ hours. | Recurrent evaluations are due as follows:<br><br>____ (month) ____ and ____ (month) ____ and ____ (month) ____<br>(enter or strike out, as appropriate) |
| Signed: _____<br>NSPM Evaluation Team Leader   | _____<br>Date   |

(Repeat as Necessary)





#### 4. Demonstrations

a. The sponsor must identify one survivable takeoff windshear training model and one survivable approach windshear training model. The wind components of the survivable models must be presented in graphical format so that all components of the windshear are shown, including initiation point, variance in magnitude, and time or distance correlations. The simulator must be operated at the same gross weight, airplane configuration, and initial airspeed in all of the following situations:

- (1) Takeoff—through calm air.
- (2) Takeoff—through the first selected survivable windshear.
- (3) Approach—through calm air.
- (4) Approach—through the second selected survivable windshear.

b. In each of these four situations, at an "initiation point" (i.e., where windshear onset is or should be recognized), the recommended procedures for windshear recovery are applied and the results are recorded as specified in paragraph 5 of this attachment.

c. These recordings are made without inserting programmed random turbulence. Turbulence that results from the windshear model is to be expected, and no attempt may be made to neutralize turbulence from this source.

d. The definition of the models and the results of the demonstrations of all four (4) cases described in paragraph 4.a of this attachment, must be made a part of the MQTG.

#### 5. Recording Parameters

a. In each of the four MQTG cases, an electronic recording (time history) must be made of the following parameters:

- (1) Indicated or calibrated airspeed.
- (2) Indicated vertical speed.
- (3) Pitch attitude.
- (4) Indicated or radio altitude.
- (5) Angle of attack.
- (6) Elevator position.
- (7) Engine data (thrust,  $N_1$ , or throttle position).

(8) Wind magnitudes (simple windshear model assumed).

b. These recordings must be initiated at least 10 seconds prior to the initiation point, and continued until recovery is complete or ground contact is made.

#### 6. Equipment Installation and Operation

All windshear warning, caution, or guidance hardware installed in the simulator must operate as it operates in the airplane. For example, if a rapidly changing wind speed and/or direction would have caused a windshear warning in the airplane, the simulator must respond equivalently without instructor/evaluator intervention.

#### 7. Qualification Test Guide

a. All QTG material must be forwarded to the NSPM.

b. A simulator windshear evaluation will be scheduled in accordance with normal procedures. Recurrent evaluation schedules will be used to the maximum extent possible.

c. During the on-site evaluation, the evaluator will ask the operator to run the

performance tests and record the results. The results of these on-site tests will be compared to those results previously approved and placed in the QTG or MQTG, as appropriate.

d. QTGs for new (or MQTGs for upgraded) simulators must contain or reference the information described in paragraphs 2, 3, 4, and 5 of this attachment.

#### End QPS Requirements

#### Begin Information

##### 8. Subjective Evaluation

The NSPM will fly the simulator in at least two of the available windshear scenarios to subjectively evaluate simulator performance as it encounters the programmed windshear conditions.

a. One scenario will include parameters that enable the pilot to maintain a satisfactory flightpath.

b. One scenario will include parameters that will not enable the pilot to maintain a satisfactory flightpath (crash).

c. Other scenarios may be examined at the NSPM's discretion.

##### 9. Qualification Basis

The addition of windshear programming to a simulator in order to comply with the qualification for required windshear training does not change the original qualification basis of the simulator.

##### 10. Demonstration Repeatability

For the purposes of demonstration repeatability, it is recommended that the simulator be flown by means of the simulator's autodriven function (for those simulators that have autodriven capability) during the demonstrations.

#### End Information

#### Attachment 6 to Appendix A to Part 60—FSTD Directives Applicable To Airplane Flight Simulators

##### Flight Simulation Training Device (FSTD) Directive (FD)

FSTD Directive Number 1. Applicable to all Full Flight Simulators (FFS), regardless of the original qualification basis and qualification date (original or upgrade), having Class-II visual scenes or airport models available.

*Agency:* Federal Aviation Administration (FAA), DOT

*Action:* This is a retroactive requirement to have all Class II visual scenes or airport models meet current requirements.

*Summary:* Notwithstanding the authorization listed in paragraph 13b in Appendices A and C, this FSTD Directive (FD) requires each sponsor to ensure that, by [date 1 year after effective date of the final rule], each Class II visual scene or airport model available in an FFS, meets the requirements of 14 CFR part 60, Appendix A, Attachment 3, Table A3C, or Appendix C, Attachment 3, Table C3C, as applicable. The completion of this requirement will not require a report. The fact that the scene or

model is available in the FFS is the sponsor's testament that the requirements are met.

*Dates:* This FD becomes effective on [effective date of the final rule].

*For Further Information Contact:* Ed Cook, Senior Advisor to the Division Manager, Air Transportation Division, AFS-200, 800 Independence Ave, SW., Washington, DC, 20591; telephone: (404) 832-4701; fax: (404) 761-8906.

##### *Specific Requirements:*

1. Part 60 requires that each FSTD be:

a. Sponsored by a person holding or applying for an FAA operating certificate under Part 119, Part 141, or Part 142, or holding or applying for an FAA-approved training program under Part 63, Appendix C, for flight engineers, and

b. Evaluated and issued a Statement of Qualification for a specific FSTD level.

2. Full flight simulators (FFS) also require the installation of a visual system that is capable of providing an out-of-the-flight-deck view of visual scenes or airport models. To be qualified, each FFS must have available for use a minimum number of visual scenes or airport models that have certain features. These are called Class I visual scenes or airport models, the required features of which are listed in Part 60. Additional scenes or models that are beyond those necessary for qualification may also be used for various additional training program applications, including Line Oriented Flight Training, are classified as Class II. However, historically these visual scenes or airport models were not routinely evaluated or required to meet any standardized criteria. This has led to qualified simulators containing visual scenes or airport models being used to meet FAA-approved training, testing, or checking requirements with potentially incorrect or inappropriate visual references.

3. To prevent this from occurring in the future, by [date 1 year after effective date of the final rule], each FSTD sponsor must assure that each Class II visual scene or airport model available in a qualified FFS meets the requirements found in 14 CFR part 60, Appendix A, Attachment 3, Table A3C or Appendix C, Attachment 3, Table C3C, as applicable. These references describe the requirements for visual scene management and the minimum distances from which runway or landing area features must be visible for all levels of simulator. The visual scene or airport model must provide, for each "in-use runway" or "in-use landing area," runway or landing area surface and markings, runway or landing area lighting, taxiway surface and markings, and taxiway lighting. Additional requirements include correlation of the visual scenes or airport models with other aspects of the airport environment, correlation of the aircraft and associated equipment, scene quality assessment features, and the control of these scenes or models the instructor must be able to exercise.

4. For circling approaches, all requirements of this section apply to the runway used for the initial approach and to the runway of intended landing.

5. The details in these scenes or models must be developed using airport pictures, construction drawings and maps, or other

similar data, or developed in accordance with published regulatory material. However, this FD does not require that visual scenes or airport models contain details that are beyond the initially designed capability of the visual system, as currently qualified. The recognized limitations to visual systems are as follows:

a. Visual systems not required to have runway numbers as a part of the specific runway marking requirements are:

- (1) Link NVS and DNVS.
- (2) Novoview 2500 and 6000.
- (3) FlightSafety VITAL series up to, and including, VITAL III, but not beyond.

(4) Redifusion SP1, SP1T, and SP2.

b. Visual systems required to display runway numbers only for LOFT scenes are:

- (1) FlightSafety VITAL IV.
- (2) Redifusion SP3 and SP3T.
- (3) Link-Miles Image II.

c. Visual systems not required to have accurate taxiway edge lighting are:

- (1) Redifusion SP1.
- (2) FlightSafety Vital IV.
- (3) Link-Miles Image II and Image IIT.
- (4) XKD displays (even though the XKD image generator is capable of generating blue colored lights, the display cannot accommodate that color).

6. A copy of this Directive must be filed in the Master Qualification Test Guide in the designated FSTD Directive Section, and its inclusion must be annotated on the Index of Effective FSTD Directives chart. See Attachment 4, Appendices A through D for a sample MQTG Index of Effective FSTD Directives chart.

#### Appendix B to Part 60—Qualification Performance Standards for Airplane Flight Training Devices

##### Begin Information

This appendix establishes the standards for Airplane Flight Training Device (FTD) evaluation and qualification at Level 4, Level 5, or Level 6. The Flight Standards Service, National Simulator Program Manager (NSPM), is responsible for the development, application, and implementation of the standards contained within this appendix. The procedures and criteria specified in this appendix will be used by the NSPM, or a person or persons assigned by the NSPM when conducting airplane FTD evaluations.

##### Table of Contents

1. Introduction.
2. Applicability (§§ 60.1 and 60.2).
3. Definitions (§ 60.3).
4. Qualification Performance Standards (§ 60.4).
5. Quality Management System (§ 60.5).
6. Sponsor Qualification Requirements (§ 60.7).
7. Additional Responsibilities of the Sponsor (§ 60.9).
8. FSTD Use (§ 60.11).
9. FSTD Objective Data Requirements (§ 60.13).
10. Special Equipment and Personnel Requirements for Qualification of the FSTD (§ 60.14).
11. Initial (and Upgrade) Qualification Requirements (§ 60.15).

12. Additional Qualifications for Currently Qualified FSTDs (§ 60.16).
  13. Previously Qualified FSTDs (§ 60.17).
  14. Inspection, Continuing Qualification Evaluation, and Maintenance Requirements (§ 60.19).
  15. Logging FSTD Discrepancies (§ 60.20).
  16. Interim Qualification of FSTDs for New Airplane Types or Models (§ 60.21).
  17. Modifications to FSTDs (§ 60.23).
  18. Operations with Missing, Malfunctioning, or Inoperative Components (§ 60.25).
  19. Automatic Loss of Qualification and Procedures for Restoration of Qualification (§ 60.27).
  20. Other Losses of Qualification and Procedures for Restoration of Qualification (§ 60.29).
  21. Record Keeping and Reporting (§ 60.31).
  22. Applications, Logbooks, Reports, and Records: Fraud, Falsification, or Incorrect Statements (§ 60.33).
  23. [Reserved]
  24. Levels of FTD.
  25. FSTD Qualification on the Basis of a Bilateral Aviation Safety Agreement (BASA) (§ 60.37).
- Attachment 1 to Appendix B to Part 60—General FTD Requirements.
- Attachment 2 to Appendix B to Part 60—Flight Training Device (FTD) Objective Tests.
- Attachment 3 to Appendix B to Part 60—Flight Training Device (FTD) Subjective Evaluation.
- Attachment 4 to Appendix B to Part 60—Sample Documents.
- Attachment 5 to Appendix B to Part 60—FSTD Directives.

#### End Information

##### 1. Introduction

##### Begin Information

a. This appendix contains background information as well as regulatory and informative material as described later in this section. To assist the reader in determining what areas are required and what areas are permissive, the text in this appendix is divided into two sections: “QPS Requirements” and “Information.” The QPS Requirements sections contain details regarding compliance with the part 60 rule language. These details are regulatory, but are found only in this appendix. The Information sections contain material that is advisory in nature, and designed to give the user general information about the regulation.

b. Questions regarding the contents of this publication should be sent to the U.S. Department of Transportation, Federal Aviation Administration, Flight Standards Service, National Simulator Program Staff, AFS-205, 100 Hartsfield Centre Parkway, Suite 400, Atlanta, Georgia, 30354. Telephone contact numbers for the NSP are: phone, 404-832-4700; fax, 404-761-8906. The general email address for the NSP office is: [9-aso-avr-sim-team@faa.gov](mailto:9-aso-avr-sim-team@faa.gov). The NSP Internet Web Site address is: [http://www.faa.gov/safety/programs\\_initiatives/aircraft\\_aviation/ntp/](http://www.faa.gov/safety/programs_initiatives/aircraft_aviation/ntp/). On this Web Site you will find an NSP personnel list with telephone and email contact information for

each NSP staff member, a list of qualified flight simulation devices, advisory circulars, a description of the qualification process, NSP policy, and an NSP “In-Works” section. Also linked from this site are additional information sources, handbook bulletins, frequently asked questions, a listing and text of the Federal Aviation Regulations, Flight Standards Inspector’s handbooks, and other FAA links.

c. The NSPM encourages the use of electronic media for all communication, including any record, report, request, test, or statement required by this appendix. The electronic media used must have adequate security provisions and be acceptable to the NSPM. The NSPM recommends inquiries on system compatibility, and minimum system requirements are also included on the NSP Web site.

d. Related Reading References.

- (1) 14 CFR part 60.
- (2) 14 CFR part 61.
- (3) 14 CFR part 63.
- (4) 14 CFR part 119.
- (5) 14 CFR part 121.
- (6) 14 CFR part 125.
- (7) 14 CFR part 135.
- (8) 14 CFR part 141.
- (9) 14 CFR part 142.
- (10) Advisory Circular (AC) 120-28C, Criteria for Approval of Category III Landing Weather Minima.

(11) AC 120-29, Criteria for Approving Category I and Category II Landing Minima for part 121 operators.

(12) AC 120-35B, Line Operational Simulations: Line-Oriented Flight Training, Special Purpose Operational Training, Line Operational Evaluation.

(13) AC 120-41, Criteria for Operational Approval of Airborne Wind Shear Alerting and Flight Guidance Systems.

(14) AC 120-57A, Surface Movement Guidance and Control System (SMGS).

(15) AC 150/5300-13, Airport Design.

(16) AC 150/5340-1G, Standards for Airport Markings.

(17) AC 150/5340-4C, Installation Details for Runway Centerline Touchdown Zone Lighting Systems.

(18) AC 150/5340-19, Taxiway Centerline Lighting System.

(19) AC 150/5340-24, Runway and Taxiway Edge Lighting System.

(20) AC 150/5345-28D, Precision Approach Path Indicator (PAPI) Systems.

(21) International Air Transport Association document, “Flight Simulator Design and Performance Data Requirements,” as amended.

(22) AC 25-7, as amended, Flight Test Guide for Certification of Transport Category Airplanes.

(23) AC 23-8A, as amended, Flight Test Guide for Certification of Part 23 Airplanes.

(24) International Civil Aviation Organization (ICAO) Manual of Criteria for the Qualification of Flight Simulators, as amended.

(25) Airplane Flight Simulator Evaluation Handbook, Volume I, as amended and Volume II, as amended, The Royal Aeronautical Society, London, UK.

(26) FAA Publication FAA-S-8081 series (Practical Test Standards for Airline

Transport Pilot Certificate, Type Ratings, Commercial Pilot, and Instrument Ratings).

(27) The FAA Aeronautical Information Manual (AIM). An electronic version of the AIM is on the Internet at <http://www.faa.gov/atpubs>.

#### End Information

## 2. Applicability (§§ 60.1 and 60.2)

#### Begin Information

No additional regulatory or informational material applies to § 60.1, Applicability, or to § 60.2, Applicability of sponsor rules to person who are not sponsors and who are engaged in certain unauthorized activities.

### 3. Definitions (§ 60.3)

See Appendix F of this part for a list of definitions and abbreviations from part 1, part 60, and the QPS appendices of part 60.

### 4. Qualification Performance Standards (§ 60.4)

No additional regulatory or informational material applies to § 60.4, Qualification Performance Standards.

### 5. Quality Management System (§ 60.5)

Additional regulatory material and informational material regarding Quality Management Systems for FTDs may be found in appendix E of this part.

#### End Information

## 6. Sponsor Qualification Requirements (§ 60.7)

#### Begin Information

a. The intent of the language in § 60.7(b) is to have a specific FTD, identified by the sponsor, used at least once in an FAA-approved flight training program for the airplane simulated during the 12-month period described. The identification of the specific FTD may change from one 12-month period to the next 12-month period as long as that sponsor sponsors and uses at least one FTD at least once during the prescribed period. There is no minimum number of hours or minimum FTD periods required.

b. The following examples describe acceptable operational practices:

#### (1) Example One.

(a) A sponsor is sponsoring a single, specific FTD for its own use, in its own facility or elsewhere—this single FTD forms the basis for the sponsorship. The sponsor uses that FTD at least once in each 12-month period in that sponsor's FAA-approved flight training program for the airplane simulated. This 12-month period is established according to the following schedule:

(i) If the FTD was qualified prior to May 30, 2008, the 12-month period begins on the date of the first continuing qualification evaluation conducted in accordance with § 60.19 after (60 days after date of publication of the final rule in the **Federal Register**) and continues for each subsequent 12-month period;

(ii) A device qualified on or after May 30, 2008, will be required to undergo an initial or upgrade evaluation in accordance with § 60.15. Once the initial or upgrade evaluation is complete, the first continuing qualification evaluation will be conducted within 6 months. The 12 month continuing qualification evaluation cycle begins on that date and continues for each subsequent 12-month period.

(b) There is no minimum number of hours of FTD use required.

(c) The identification of the specific FTD may change from one 12-month period to the next 12-month period as long as that sponsor sponsors and uses at least one FTD at least once during the prescribed period.

#### (2) Example Two.

(a) A sponsor sponsors an additional number of FTDs, in its facility or elsewhere. Each additionally sponsored FTD must be—

(i) Used by the sponsor in the sponsor's FAA-approved flight training program for the airplane simulated (as described in § 60.7(d)(1)); or

(ii) Used by another FAA certificate holder in that other certificate holder's FAA-approved flight training program for the airplane simulated (as described in § 60.7(d)(1)). This 12-month period is established in the same manner as in example one; or

(iii) Provided a statement each year from a qualified pilot, (after having flown the airplane, not the subject FTD or another FTD, during the preceding 12-month period) stating that the subject FTD's performance and handling qualities represent the airplane (as described in § 60.7(d)(2)). This statement is provided at least once in each 12-month period established in the same manner as in example one.

(b) There is no minimum number of hours of FTD use required.

#### (3) Example Three.

(a) A sponsor in New York (in this example, a Part 142 certificate holder) establishes "satellite" training centers in Chicago and Moscow.

(b) The satellite function means that the Chicago and Moscow centers must operate under the New York center's certificate (in accordance with all of the New York center's practices, procedures, and policies; e.g., instructor and/or technician training/checking requirements, record keeping, QMS program).

(c) All of the FTDs in the Chicago and Moscow centers could be dry-leased (i.e., the certificate holder does not have and use FAA-approved flight training programs for the FTDs in the Chicago and Moscow centers) because—

(i) Each FTD in the Chicago center and each FTD in the Moscow center is used at least once each 12-month period by another FAA certificate holder in that other certificate holder's FAA-approved flight training program for the airplane (as described in § 60.7(d)(1)); or

(ii) A statement is obtained from a qualified pilot (having flown the airplane, not the subject FTD or another FTD during the preceding 12-month period) stating that the performance and handling qualities of each FTD in the Chicago and Moscow centers

represents the airplane (as described in § 60.7(d)(2)).

#### End Information

## 7. Additional Responsibilities of the Sponsor (§ 60.9)

#### Begin Information

The phrase "as soon as practicable" in § 60.9(a) means without unnecessarily disrupting or delaying beyond a reasonable time the training, evaluation, or experience being conducted in the FSTD.

### 8. FSTD Use (§ 60.11)

No additional regulatory or informational material applies to § 60.11, FSTD use.

#### End Information

## 9. FSTD Objective Data Requirements (§ 60.13)

#### Begin QPS Requirements

a. Flight test data used to validate FTD performance and handling qualities must have been gathered in accordance with a flight test program containing the following:

#### (1) A flight test plan consisting of:

(a) The maneuvers and procedures required for aircraft certification and simulation programming and validation.

(b) For each maneuver or procedure—  
(i) The procedures and control input the flight test pilot and/or engineer used.

(ii) The atmospheric and environmental conditions.

(iii) The initial flight conditions.

(iv) The airplane configuration, including weight and center of gravity.

(v) The data to be gathered.

(vi) All other information necessary to recreate the flight test conditions in the FTD.

(2) Appropriately qualified flight test personnel.

(3) An understanding of the accuracy of the data to be gathered using appropriate alternative data sources, procedures, and instrumentation that is traceable to a recognized standard as described in Attachment 2, Table B2F.

(4) Appropriate and sufficient data acquisition equipment or system(s), including appropriate data reduction and analysis methods and techniques, as would be acceptable to the FAA's Aircraft Certification Service.

b. The data, regardless of source, must be presented:

(1) In a format that supports the FTD validation process;

(2) In a manner that is clearly readable and annotated correctly and completely;

(3) With resolution sufficient to determine compliance with the tolerances set forth in Attachment 2, Table B2A appendix.

(4) With any necessary guidance information provided; and

(5) Without alteration, adjustments, or bias; however the data may be re-scaled, digitized, or otherwise manipulated to fit the desired presentation.

c. After completion of any additional flight test, a flight test report must be submitted in support of the validation data. The report must contain sufficient data and rationale to support qualification of the FTD at the level requested.

d. As required by § 60.13(f), the sponsor must notify the NSPM when it becomes aware that an addition to or a revision of the flight related data or airplane systems related data is available if this data is used to program and operate a qualified FTD. The data referred to in this sub-section are those data that are used to validate the performance, handling qualities, or other characteristics of the aircraft, including data related to any relevant changes occurring after the type certification is issued. The sponsor must—

(1) Within 10 calendar days, notify the NSPM of the existence of this data; and

(2) Within 45 calendar days, notify the NSPM of—

(i) The schedule to incorporate this data into the FTD; or

(ii) The reason for not incorporating this data into the FTD.

e. In those cases where the objective test results authorize a “snapshot test” or a “series of snapshot test results” in lieu of a time-history result, the sponsor or other data provider must ensure that a steady state condition exists at the instant of time captured by the “snapshot.” The steady state condition must exist from 4 seconds prior to, through 1 second following, the instant of time captured by the snap shot.

#### End QPS Requirements

#### Begin Information

f. The FTD sponsor is encouraged to maintain a liaison with the manufacturer of the aircraft being simulated (or with the holder of the aircraft type certificate for the aircraft being simulated if the manufacturer is no longer in business), and if appropriate, with the person having supplied the aircraft data package for the FTD in order to facilitate the notification described in this paragraph.

g. It is the intent of the NSPM that for new aircraft entering service, at a point well in advance of preparation of the Qualification Test Guide (QTG), the sponsor should submit to the NSPM for approval, a descriptive document (a validation data roadmap) containing the plan for acquiring the validation data, including data sources. This document should clearly identify sources of data for all required tests, a description of the validity of these data for a specific engine type and thrust rating configuration, and the revision levels of all avionics affecting the performance or flying qualities of the aircraft. Additionally, this document should provide other information such as the rationale or explanation for cases where data or data parameters are missing, instances where engineering simulation data are used, or where flight test methods require further explanations. It should also provide a brief narrative describing the cause and effect of any deviation from data requirements. The aircraft manufacturer may provide this document.

h. There is no requirement for any flight test data supplier to submit a flight test plan or program prior to gathering flight test data. However, the NSPM notes that inexperienced data gatherers often provide data that is irrelevant, improperly marked, or lacking adequate justification for selection. Other problems include inadequate information regarding initial conditions or test maneuvers. The NSPM has been forced to refuse these data submissions as validation data for an FTD evaluation. It is for this reason that the NSPM recommends that any data supplier not previously experienced in this area review the data necessary for programming and for validating the performance of the FTD and discuss the flight test plan anticipated for acquiring such data with the NSPM well in advance of commencing the flight tests.

i. The NSPM will consider, on a case-by-case basis, whether to approve supplemental validation data derived from flight data recording systems such as a Quick Access Recorder or Flight Data Recorder.

#### End Information

### 10. Special Equipment and Personnel Requirements for Qualification of the FSTD (§ 60.14)

#### Begin Information

a. In the event that the NSPM determines that special equipment or specifically qualified persons will be required to conduct an evaluation, the NSPM will make every attempt to notify the sponsor at least one (1) week, but in no case less than 72 hours, in advance of the evaluation. Examples of special equipment include flight control measurement devices, accelerometers, or oscilloscopes. Examples of specially qualified personnel include individuals specifically qualified to install or use any special equipment when its use is required.

b. Examples of a special evaluation include an evaluation conducted after: an FTD is moved; at the request of the TPAA; or as a result of comments received from users of the FTD that raise questions about the continued qualification or use of the FTD.

#### End Information

### 11. Initial (and Upgrade) Qualification Requirements (§ 60.15)

#### Begin QPS Requirement

a. In order to be qualified at a particular qualification level, the FTD must:

(1) Meet the general requirements listed in Attachment 1;

(2) Meet the objective testing requirements listed in Attachment 2 (Level 4 FTDs do not require objective tests); and

(3) Satisfactorily accomplish the subjective tests listed in Attachment 3.

b. The request described in § 60.15(a) must include all of the following:

(1) A statement that the FTD meets all of the applicable provisions of this part and all applicable provisions of the QPS.

(2) A confirmation that the sponsor will forward to the NSPM the statement described in § 60.15(b) in such time as to be received no later than 5 business days prior to the scheduled evaluation and may be forwarded to the NSPM via traditional or electronic means.

(3) Except for a Level 4 FTD, a qualification test guide (QTG), acceptable to the NSPM, that includes all of the following:

(a) Objective data obtained from aircraft testing or another approved source.

(b) Correlating objective test results obtained from the performance of the FTD as prescribed in the appropriate QPS.

(c) The result of FTD subjective tests prescribed in the appropriate QPS.

(d) A description of the equipment necessary to perform the evaluation for initial qualification and the continuing qualification evaluations.

c. The QTG described in paragraph a(3) of this section, must provide the documented proof of compliance with the FTD objective tests in Attachment 2, Table B2A of this appendix.

d. The QTG is prepared and submitted by the sponsor, or the sponsor's agent on behalf of the sponsor, to the NSPM for review and approval, and must include, for each objective test:

(1) Parameters, tolerances, and flight conditions;

(2) Pertinent and complete instructions for conducting automatic and manual tests;

(3) A means of comparing the FTD test results to the objective data;

(4) Any other information as necessary to assist in the evaluation of the test results;

(5) Other information appropriate to the qualification level of the FTD.

e. The QTG described in paragraphs (a)(3) and (b) of this section, must include the following:

(1) A QTG cover page with sponsor and FAA approval signature blocks (see Attachment 4, Figure B4C, for a sample QTG cover page).

(2) A continuing qualification evaluation requirements page. This page will be used by the NSPM to establish and record the frequency with which continuing qualification evaluations must be conducted and any subsequent changes that may be determined by the NSPM in accordance with § 60.19. See Attachment 4, Figure B4G, for a sample Continuing Qualification Evaluation Requirements page.

(3) An FTD information page that provides the information listed in this paragraph, if applicable (see Attachment 4, Figure B4B, for a sample FTD information page). For convertible FTDs, the sponsor must submit a separate page for each configuration of the FTD.

(a) The sponsor's FTD identification number or code.

(b) The airplane model and series being simulated.

(c) The aerodynamic data revision number or reference.

(d) The source of the basic aerodynamic model and the aerodynamic coefficient data used to modify the basic model.

(e) The engine model(s) and its data revision number or reference.

(f) The flight control data revision number or reference.

(g) The flight management system identification and revision level.

(h) The FTD model and manufacturer.

(i) The date of FTD manufacture.

(j) The FTD computer identification.

(k) The visual system model and manufacturer, including display type.

(l) The motion system type and manufacturer, including degrees of freedom.

(4) A Table of Contents.

(5) A log of revisions and a list of effective pages.

(6) List of all relevant data references.

(7) A glossary of terms and symbols used (including sign conventions and units).

(8) Statements of compliance and capability (SOCs) with certain requirements. SOCs must provide references to the sources of information that show the capability of the FTD to comply with the requirement, a rationale explaining how the referenced material is used, mathematical equations and parameter values used, and the conclusions reached; i.e., that the FTD complies with the requirement.

(9) Recording procedures or equipment required to accomplish the objective tests.

(10) The following information for each objective test designated in Attachment 2, as applicable to the qualification level sought:

(a) Name of the test.

(b) Objective of the test.

(c) Initial conditions.

(d) Manual test procedures.

(e) Automatic test procedures (if applicable).

(f) Method for evaluating FTD objective test results.

(g) List of all relevant parameters driven or constrained during the automatic test(s).

(h) List of all relevant parameters driven or constrained during the manual test(s).

(i) Tolerances for relevant parameters.

(j) Source of Validation Data (document and page number).

(k) Copy of the Validation Data (if located in a separate binder, a cross reference for the identification and page number for pertinent data location must be provided).

(l) FTD Objective Test Results as obtained by the sponsor. Each test result must reflect the date completed and must be clearly labeled as a product of the device being tested.

f. A convertible FTD is addressed as a separate FTD for each model and series airplane to which it will be converted and for the FAA qualification level sought. The NSPM will conduct an evaluation for each configuration. If a sponsor seeks qualification for two or more models of an airplane type using a convertible FTD, the sponsor must provide a QTG for each airplane model, or a QTG for the first airplane model and a supplement to that QTG for each additional airplane model. The NSPM will conduct evaluations for each airplane model.

g. The form and manner of presentation of objective test results in the QTG must include the following:

(1) The sponsor's FTD test results must be recorded in a manner acceptable to the NSPM, that allows easy comparison of the FTD test results to the validation data (e.g.,

use of a multi-channel recorder, line printer, cross plotting, overlays, transparencies).

(2) FTD results must be labeled using terminology common to airplane parameters as opposed to computer software identifications.

(3) Validation data documents included in a QTG may be photographically reduced only if such reduction will not alter the graphic scaling or cause difficulties in scale interpretation or resolution.

(4) Scaling on graphical presentations must provide the resolution necessary to evaluate the parameters shown in Attachment 2, Table B2A of this appendix.

(5) Tests involving time histories, data sheets (or transparencies thereof) and FTD test results must be clearly marked with appropriate reference points to ensure an accurate comparison between FTD and airplane with respect to time. Time histories recorded via a line printer are to be clearly identified for cross-plotting on the airplane data. Over-plots may not obscure the reference data.

h. The sponsor may elect to complete the QTG objective and subjective tests at the manufacturer's facility or at the sponsor's training facility. If the tests are conducted at the manufacturer's facility, the sponsor must repeat at least one-third of the tests at the sponsor's training facility in order to substantiate FTD performance. The QTG must be clearly annotated to indicate when and where each test was accomplished. Tests conducted at the manufacturer's facility and at the sponsor's training facility must be conducted after the FTD is assembled with systems and sub-systems functional and operating in an interactive manner. The test results must be submitted to the NSPM.

i. The sponsor must maintain a copy of the MQTG at the FTD location.

j. All FTDs for which the initial qualification is conducted after May 30, 2014, must have an electronic MQTG (eMQTG) including all objective data obtained from airplane testing, or another approved source (reformatted or digitized), together with correlating objective test results obtained from the performance of the FTD (reformatted or digitized) as prescribed in this appendix. The eMQTG must also contain the general FTD performance or demonstration results (reformatted or digitized) prescribed in this appendix, and a description of the equipment necessary to perform the initial qualification evaluation and the continuing qualification evaluations. The eMQTG must include the original validation data used to validate FTD performance and handling qualities in either the original digitized format from the data supplier or an electronic scan of the original time-history plots that were provided by the data supplier. A copy of the eMQTG must be provided to the NSPM.

k. All other FTDs (not covered in subparagraph "j") must have an electronic copy of the MQTG by and after May 30, 2014. A copy of the eMQTG must be provided to the NSPM. This may be provided by an electronic scan presented in a Portable Document File (PDF), or similar format acceptable to the NSPM.

l. During the initial (or upgrade) qualification evaluation conducted by the

NSPM, the sponsor must also provide a person knowledgeable about the operation of the aircraft and the operation of the FTD.

## End QPS Requirements

### Begin Information

m. Only those FTDs that are sponsored by a certificate holder as defined in Appendix F will be evaluated by the NSPM. However, other FTD evaluations may be conducted on a case-by-case basis as the Administrator deems appropriate, but only in accordance with applicable agreements.

n. The NSPM will conduct an evaluation for each configuration, and each FTD must be evaluated as completely as possible. To ensure a thorough and uniform evaluation, each FTD is subjected to the general FTD requirements in Attachment 1, the objective tests listed in Attachment 2, and the subjective tests listed in Attachment 3 of this appendix. The evaluations described herein will include, but not necessarily be limited to the following:

(1) Airplane responses, including longitudinal and lateral-directional control responses (see Attachment 2 of this appendix);

(2) Performance in authorized portions of the simulated airplane's operating envelope, to include tasks evaluated by the NSPM in the areas of surface operations, takeoff, climb, cruise, descent, approach and landing, as well as abnormal and emergency operations (see Attachment 2 of this appendix);

(3) Control checks (see Attachment 1 and Attachment 2 of this appendix);

(4) Flight deck configuration (see Attachment 1 of this appendix);

(5) Pilot, flight engineer, and instructor station functions checks (see Attachment 1 and Attachment 3 of this appendix);

(6) Airplane systems and sub-systems (as appropriate) as compared to the airplane simulated (see attachment 1 and attachment 3 of this appendix);

(7) FTD systems and sub-systems, including force cueing (motion), visual, and aural (sound) systems, as appropriate (see Attachment 1 and Attachment 2 of this appendix); and

(8) Certain additional requirements, depending upon the qualification level sought, including equipment or circumstances that may become hazardous to the occupants. The sponsor may be subject to Occupational Safety and Health Administration requirements.

o. The NSPM administers the objective and subjective tests, which includes an examination of functions. The tests include a qualitative assessment of the FTD by an NSP pilot. The NSP evaluation team leader may assign other qualified personnel to assist in accomplishing the functions examination and/or the objective and subjective tests performed during an evaluation when required.

(1) Objective tests provide a basis for measuring and evaluating FTD performance and determining compliance with the requirements of this part.

(2) Subjective tests provide a basis for:

(a) Evaluating the capability of the FTD to perform over a typical utilization period;

(b) Determining that the FTD satisfactorily simulates each required task;

(c) Verifying correct operation of the FTD controls, instruments, and systems; and

(d) Demonstrating compliance with the requirements of this part.

p. The tolerances for the test parameters listed in Attachment 2 of this appendix reflect the range of tolerances acceptable to the NSPM for FTD validation and are not to be confused with design tolerances specified for FTD manufacture. In making decisions regarding tests and test results, the NSPM relies on the use of operational and engineering judgment in the application of data (including consideration of the way in which the flight test was flown and way the data was gathered and applied) data presentations, and the applicable tolerances for each test.

q. In addition to the scheduled continuing qualification evaluation, each FTD is subject to evaluations conducted by the NSPM at any time without prior notification to the sponsor. Such evaluations would be accomplished in a normal manner (i.e., requiring exclusive use of the FTD for the conduct of objective and subjective tests and an examination of functions) if the FTD is not being used for flight crewmember training, testing, or checking. However, if the FTD were being used, the evaluation would be conducted in a non-exclusive manner. This non-exclusive evaluation will be conducted by the FTD evaluator accompanying the check airman, instructor, Aircrew Program Designee (APD), or FAA inspector aboard the FTD along with the student(s) and observing the operation of the FTD during the training, testing, or checking activities.

r. Problems with objective test results are handled as follows:

(1) If a problem with an objective test result is detected by the NSP evaluation team during an evaluation, the test may be repeated or the QTG may be amended.

(2) If it is determined that the results of an objective test do not support the qualification level requested but do support a lower level, the NSPM may qualify the FTD at a lower level. For example, if a Level 6 evaluation is requested, but the FTD fails to meet the spiral stability test tolerances, it could be qualified at Level 5.

s. After an FTD is successfully evaluated, the NSPM issues a Statement of Qualification (SOQ) to the sponsor. The NSPM recommends the FTD to the TPAA, who will approve the FTD for use in a flight training program. The SOQ will be issued at the satisfactory conclusion of the initial or continuing qualification evaluation and will list the tasks for which the FTD is qualified, referencing the tasks described in Table B1B in attachment 1. However, it is the sponsor's responsibility to obtain TPAA approval prior to using the FTD in an FAA-approved flight training program.

t. Under normal circumstances, the NSPM establishes a date for the initial or upgrade evaluation within ten (10) working days after determining that a complete QTG is acceptable. Unusual circumstances may warrant establishing an evaluation date before this determination is made. A sponsor may schedule an evaluation date as early as

6 months in advance. However, there may be a delay of 45 days or more in rescheduling and completing the evaluation if the sponsor is unable to meet the scheduled date. See Attachment 4, Figure B4A, Sample Request for Initial, Upgrade, or Reinstatement Evaluation.

u. The numbering system used for objective test results in the QTG should closely follow the numbering system set out in Attachment 2, FTD Objective Tests, Table B2A.

v. Contact the NSPM or visit the NSPM Web site for additional information regarding the preferred qualifications of pilots used to meet the requirements of § 60.15(d).

w. Examples of the exclusions for which the FTD might not have been subjectively tested by the sponsor or the NSPM and for which qualification might not be sought or granted, as described in § 60.15(g)(6), include engine out maneuvers or circling approaches.

#### **12. Additional Qualifications for Currently Qualified FSTDs (§ 60.16)**

No additional regulatory or informational material applies to § 60.16, Additional Qualifications for a Currently Qualified FTD.

#### **End Information**

#### **13. Previously Qualified FSTDs (§ 60.17)**

##### **Begin QPS Requirements**

a. In instances where a sponsor plans to remove an FTD from active status for a period of less than two years, the following procedures apply:

(1) The NSPM must be notified in writing and the notification must include an estimate of the period that the FTD will be inactive;

(2) Continuing Qualification evaluations will not be scheduled during the inactive period;

(3) The NSPM will remove the FTD from the list of qualified FSTDs on a mutually established date not later than the date on which the first missed continuing qualification evaluation would have been scheduled;

(4) Before the FTD is restored to qualified status, it must be evaluated by the NSPM. The evaluation content and the time required to accomplish the evaluation is based on the number of continuing qualification evaluations and sponsor-conducted quarterly inspections missed during the period of inactivity.

(5) The sponsor must notify the NSPM of any changes to the original scheduled time out of service;

b. FTDs qualified prior to May 30, 2008, and replacement FTD systems, are not required to meet the general FTD requirements, the objective test requirements, and the subjective test requirements of Attachments 1, 2, and 3 of this appendix as long as the FTD continues to meet the test requirements contained in the MQTG developed under the original qualification basis.

c. [Reserved]

##### **End QPS Requirements**

##### **Begin Information**

d. Other certificate holders or persons desiring to use an FTD may contract with FTD sponsors to use FTDs previously qualified at a particular level for an airplane type and approved for use within an FAA-approved flight training program. Such FTDs are not required to undergo an additional qualification process, except as described in § 60.16.

e. Each FTD user must obtain approval from the appropriate TPAA to use any FTD in an FAA-approved flight training program.

f. The intent of the requirement listed in § 60.17(b), for each FTD to have a Statement of Qualification within 6 years, is to have the availability of that statement (including the configuration list and the limitations to authorizations) to provide a complete picture of the FTD inventory regulated by the FAA. The issuance of the statement will not require any additional evaluation or require any adjustment to the evaluation basis for the FTD.

g. Downgrading of an FTD is a permanent change in qualification level and will necessitate the issuance of a revised Statement of Qualification to reflect the revised qualification level, as appropriate. If a temporary restriction is placed on an FTD because of a missing, malfunctioning, or inoperative component or on-going repairs, the restriction is not a permanent change in qualification level. Instead, the restriction is temporary and is removed when the reason for the restriction has been resolved.

h. It is not the intent of the NSPM to discourage the improvement of existing simulation (e.g., the "updating" of a control loading system, or the replacement of the IOS with a more capable unit) by requiring the "updated" device to meet the qualification standards current at the time of the update. Depending on the extent of the update, the NSPM may require that the updated device be evaluated and may require that an evaluation include all or a portion of the elements of an initial evaluation. However, the standards against which the device would be evaluated are those that are found in the MQTG for that device.

i. The NSPM will determine the evaluation criteria for an FTD that has been removed from active status for a prolonged period. The criteria will be based on the number of continuing qualification evaluations and quarterly inspections missed during the period of inactivity. For example, if the FTD were out of service for a 1 year period, it would be necessary to complete the entire QTG, since all of the quarterly evaluations would have been missed. The NSPM will also consider how the FTD was stored, whether parts were removed from the FTD and whether the FTD was disassembled.

j. The FTD will normally be requalified using the FAA-approved MQTG and the criteria that was in effect prior to its removal from qualification. However, inactive periods of 2 years or more will require requalification under the standards in effect and current at the time of requalification.

##### **End Information**

#### 14. Inspection, Continuing Qualification, Evaluation, and Maintenance Requirements (§ 60.19)

##### Begin QPS Requirement

a. The sponsor must conduct a minimum of four evenly spaced inspections throughout the year. The objective test sequence and content of each inspection in this sequence must be developed by the sponsor and must be acceptable to the NSPM.

b. The description of the functional preflight inspection must be contained in the sponsor's QMS.

c. Record "functional preflight" in the FTD discrepancy log book or other acceptable location, including any item found to be missing, malfunctioning, or inoperative.

d. During the continuing qualification evaluation conducted by the NSPM, the sponsor must also provide a person knowledgeable about the operation of the aircraft and the operation of the FTD.

##### End QPS Requirements

##### Begin Information

e. The sponsor's test sequence and the content of each quarterly inspection required in § 60.19(a)(1) should include a balance and a mix from the objective test requirement areas listed as follows:

- (1) Performance.
- (2) Handling qualities.
- (3) Motion system (where appropriate).
- (4) Visual system (where appropriate).
- (5) Sound system (where appropriate).
- (6) Other FTD systems.

f. If the NSP evaluator plans to accomplish specific tests during a normal continuing qualification evaluation that requires the use of special equipment or technicians, the sponsor will be notified as far in advance of the evaluation as practical; but not less than 72 hours. Examples of such tests include latencies, control sweeps, or motion or visual system tests.

g. The continuing qualification evaluations described in § 60.19(b) will normally require 4 hours of FTD time. However, flexibility is necessary to address abnormal situations or situations involving aircraft with additional levels of complexity (e.g., computer controlled aircraft). The sponsor should anticipate that some tests may require additional time. The continuing qualification evaluations will consist of the following:

(1) Review of the results of the quarterly inspections conducted by the sponsor since the last scheduled continuing qualification evaluation.

(2) A selection of approximately 8 to 15 objective tests from the MQTG that provide an adequate opportunity to evaluate the performance of the FTD. The tests chosen will be performed either automatically or manually and should be able to be conducted within approximately one-third ( $\frac{1}{3}$ ) of the allotted FTD time.

(3) A subjective evaluation of the FTD to perform a representative sampling of the tasks set out in attachment 3 of this appendix. This portion of the evaluation should take approximately two-thirds ( $\frac{2}{3}$ ) of the allotted FTD time.

(4) An examination of the functions of the FTD may include the motion system, visual system, sound system as applicable, instructor operating station, and the normal functions and simulated malfunctions of the airplane systems. This examination is normally accomplished simultaneously with the subjective evaluation requirements.

h. The requirement established in § 60.19(b)(4) regarding the frequency of NSPM-conducted continuing qualification evaluations for each FTD is typically 12 months. However, the establishment and satisfactory implementation of an approved QMS for a sponsor will provide a basis for adjusting the frequency of evaluations to exceed 12-month intervals.

#### 15. Logging FSTD Discrepancies (§ 60.20)

No additional regulatory or informational material applies to § 60.20. Logging FTD Discrepancies.

#### 16. Interim Qualification of FSTDs for New Airplane Types or Models (§ 60.21)

No additional regulatory or informational material applies to § 60.21. Interim Qualification of FTDs for New Airplane Types or Models.

##### End Information

#### 17. Modifications to FSTDs (§ 60.23)

##### Begin QPS Requirements

a. The notification described in § 60.23(c)(2) must include a complete description of the planned modification, with a description of the operational and engineering effect the proposed modification will have on the operation of the FTD and the results that are expected with the modification incorporated.

b. Prior to using the modified FTD:

- (1) All the applicable objective tests completed with the modification incorporated, including any necessary updates to the MQTG (e.g., accomplishment of FSTD Directives) must be acceptable to the NSPM; and

(2) The sponsor must provide the NSPM with a statement signed by the MR that the factors listed in § 60.15(b) are addressed by the appropriate personnel as described in that section.

##### End QPS Requirements

##### Begin Information

c. FSTD Directives are considered modification of an FTD. See Attachment 4 for a sample index of effective FSTD Directives. See Attachment 6 for a list of all effective FSTD Directives applicable to Airplane FTDs.

##### End Information

#### 18. Operation with Missing, Malfunctioning, or Inoperative Components (§ 60.25)

##### Begin Information

a. The sponsor's responsibility with respect to § 60.25(a) is satisfied when the sponsor fairly and accurately advises the user of the current status of an FTD, including any missing, malfunctioning, or inoperative (MMI) component(s).

b. If the 29th or 30th day of the 30-day period described in § 60.25(b) is on a Saturday, a Sunday, or a holiday, the FAA will extend the deadline until the next business day.

c. In accordance with the authorization described in § 60.25(b), the sponsor may develop a discrepancy prioritizing system to accomplish repairs based on the level of impact on the capability of the FTD. Repairs having a larger impact on the FTD's ability to provide the required training, evaluation, or flight experience will have a higher priority for repair or replacement.

##### End Information

#### 19. Automatic Loss of Qualification and Procedures for Restoration of Qualification (§ 60.27)

##### Begin Information

If the sponsor provides a plan for how the FTD will be maintained during its out-of-service period (e.g., periodic exercise of mechanical, hydraulic, and electrical systems; routine replacement of hydraulic fluid; control of the environmental factors in which the FTD is to be maintained) there is a greater likelihood that the NSPM will be able to determine the amount of testing that required for requalification.

##### End Information

#### 20. Other Losses of Qualification and Procedures for Restoration of Qualification (§ 60.29)

##### Begin Information

If the sponsor provides a plan for how the FTD will be maintained during its out-of-service period (e.g., periodic exercise of mechanical, hydraulic, and electrical systems; routine replacement of hydraulic fluid; control of the environmental factors in which the FTD is to be maintained) there is a greater likelihood that the NSPM will be able to determine the amount of testing that required for requalification.

##### End Information

#### 21. Recordkeeping and Reporting (§ 60.31)

##### Begin QPS Requirements

a. FTD modifications can include hardware or software changes. For FTD modifications involving software programming changes, the record required by § 60.31(a)(2) must consist of the name of the aircraft system software, aerodynamic model, or engine model change, the date of the change, a summary of the change, and the reason for the change.



b. If a coded form for record keeping is used, it must provide for the preservation and retrieval of information with appropriate security or controls to prevent the inappropriate alteration of such records after the fact.

**End QPS Requirements**

**22. Applications, Logbooks, Reports, and Records: Fraud, Falsification, or Incorrect Statements (§ 60.33)**

**Begin Information**

No additional regulatory or informational material applies to § 60.33, Applications, Logbooks, Reports, and Records: Fraud, Falsification, or Incorrect Statements.

**End Information**

**23. [Reserved]**

**24. Levels of FTD**

**Begin Information**

a. The following is a general description of each level of FTD. Detailed standards and tests for the various levels of FTDs are fully defined in Attachments 1 through 3 of this appendix.

(1) *Level 4.* A device that may have an open airplane-specific flight deck area, or an enclosed airplane-specific flight deck and at least one operating system. Air/ground logic is required (no aerodynamic programming required). All displays may be flat/LCD panel representations or actual representations of displays in the aircraft. All controls, switches, and knobs may be touch sensitive activation (not capable of manual manipulation of the flight controls) or may physically replicate the aircraft in control operation.

(2) *Level 5.* A device that may have an open airplane-specific flight deck area, or an enclosed airplane-specific flight deck and a generic aerodynamic program with at least one operating system and control loading that is representative of the simulated airplane only at an approach speed and

configuration. All displays may be flat/LCD panel representations or actual representations of displays in the aircraft. Primary and secondary flight controls (*e.g.*, rudder, aileron, elevator, flaps, spoilers/speed brakes, engine controls, landing gear, nose wheel steering, trim, brakes) must be physical controls. All other controls, switches, and knobs may be touch sensitive activation.

(3) *Level 6.* A device that has an enclosed airplane-specific flight deck and aerodynamic program with all applicable airplane systems operating and control loading that is representative of the simulated airplane throughout its ground and flight envelope and significant sound representation. All displays may be flat/LCD panel representations or actual representations of displays in the aircraft, but all controls, switches, and knobs must physically replicate the aircraft in control operation.

**End Information**

**25. FSTD Qualification on the Basis of a Bilateral Aviation Safety Agreement (BASA) (§ 60.37)**

**Begin Information**

No additional regulatory or informational material applies to § 60.37, FSTD Qualification on the Basis of a Bilateral Aviation Safety Agreement (BASA).

**End Information**

**Attachment 1 to Appendix B to Part 60—General FTD Requirements**

**Begin QPS Requirements**

**1. Requirements**

a. Certain requirements included in this appendix must be supported with a Statement of Compliance and Capability (SOC), which may include objective and subjective tests. The SOC will confirm that the requirement was satisfied, and describe how the requirement was met. The

requirements for SOC and tests are indicated in the “General FTD Requirements” column in Table B1A of this appendix.

b. Table B1A describes the requirements for the indicated level of FTD. Many devices include operational systems or functions that exceed the requirements outlined in this section. In any event, all systems will be tested and evaluated in accordance with this appendix to ensure proper operation.

**End QPS Requirements**

**Begin Information**

**2. Discussion**

a. This attachment describes the general requirements for qualifying Level 4 through Level 6 FTDs. The sponsor should also consult the objectives tests in Attachment 2 and the examination of functions and subjective tests listed in Attachment 3 to determine the complete requirements for a specific level FTD.

b. The material contained in this attachment is divided into the following categories:

- (1) General flight deck configuration.
- (2) Programming.
- (3) Equipment operation.
- (4) Equipment and facilities for instructor/evaluator functions.
- (5) Motion system.
- (6) Visual system.
- (7) Sound system.

c. Table B1A provides the standards for the General FTD Requirements.

d. Table B1B provides the tasks that the sponsor will examine to determine whether the FSTD satisfactorily meets the requirements for flight crew training, testing, and experience, and provides the tasks for which the simulator may be qualified.

e. Table B1C provides the functions that an instructor/check airman must be able to control in the simulator.

f. It is not required that all of the tasks that appear on the List of Qualified Tasks (part of the SOQ) be accomplished during the initial or continuing qualification evaluation.

**End Information**

**TABLE B1A.—MINIMUM FTD REQUIREMENTS**

| <<<QPS requirements>>> |                          |           |   | <<Information>> |       |
|------------------------|--------------------------|-----------|---|-----------------|-------|
| Number                 | General FTD requirements | FTD level |   |                 | Notes |
|                        |                          | 4         | 5 | 6               |       |

**1. General Flight Deck Configuration**

TABLE B1A.—MINIMUM FTD REQUIREMENTS—Continued

| <<<QPS requirements>>> |  | <<Information>> |   |   |   |
|------------------------|--|-----------------|---|---|---|
| Number                 | General FTD requirements   | FTD level       |   |   | Notes   |
|                        |  | 4               | 5 | 6 |   |
| 1.a. ....              | The FTD must have a flight deck that is a replica of the airplane simulated with controls, equipment, observable flight deck indicators, circuit breakers, and bulkheads properly located, functionally accurate and replicating the airplane. The direction of movement of controls and switches must be identical to that in the airplane. Pilot seat(s) must afford the capability for the occupant to be able to achieve the design "eye position." Equipment for the operation of the flight deck windows must be included, but the actual windows need not be operable. Fire axes, extinguishers, and spare light bulbs must be available in the flight simulator, but may be relocated to a suitable location as near as practical to the original position. Fire axes, landing gear pins, and any similar purpose instruments need only be represented in silhouette.<br>An SOC is required. |                 |   | X | For FTD purposes, the flight deck consists of all that space forward of a cross section of the fuselage at the most extreme aft setting of the pilots' seats including additional, required flight crewmember duty stations and those required bulkheads aft of the pilot seats. For clarification, bulkheads containing only items such as landing gear pin storage compartments, fire axes or extinguishers, spare light bulbs, aircraft documents pouches are not considered essential and may be omitted. |
| 1.b. ....              | The FTD must have equipment (e.g., instruments, panels, systems, circuit breakers, and controls) simulated sufficiently for the authorized training/checking events to be accomplished. The installed equipment must be located in a spatially correct location and may be in a flight deck or an open flight deck area. Additional equipment required for the authorized training/checking events must be available in the FTD, but may be located in a suitable location as near as practical to the spatially correct position. Actuation of equipment must replicate the appropriate function in the airplane. Fire axes, landing gear pins, and any similar purpose instruments need only be represented in silhouette.<br>An SOC is required.  | X               | X |   |   |
| <b>2. Programming</b>  |  |                 |   |   |   |
| 2.a. ....              | The FTD must provide the proper effect of aerodynamic changes for the combinations of drag and thrust normally encountered in flight. This must include the effect of change in airplane attitude, thrust, drag, altitude, temperature, and configuration.<br>Level 6 additionally requires the effects of changes in gross weight and center of gravity.<br>Level 5 requires only generic aerodynamic programming.<br>An SOC is required.   |                 | X | X |   |
| 2.b. ....              | The FTD must have the computer (analog or digital) capability (i.e., capacity, accuracy, resolution, and dynamic response) needed to meet the qualification level sought.<br>An SOC is required.   | X               | X | X |   |

TABLE B1A.—MINIMUM FTD REQUIREMENTS—Continued

| <<<QPS requirements>>>        |  |           |   | <<Information>> |  |
|-------------------------------|--|-----------|---|-----------------|--|
| Number                        | General FTD requirements   | FTD level |   |                 | Notes  |
|                               |  | 4         | 5 | 6               |  |
| 2.c. ....                     | <p>Relative responses of the flight deck instruments must be measured by latency tests, or transport delay tests, and may not exceed 300 milliseconds. The instruments must respond to abrupt input at the pilot's position within the allotted time, but not before the time when the airplane would respond under the same conditions.</p> <ul style="list-style-type: none"> <li>• Latency: The FTD instrument and, if applicable, the motion system and the visual system response must not be prior to that time when the airplane responds and may respond up to 300 milliseconds after that time under the same conditions.</li> <li>• Transport Delay: As an alternative to the Latency requirement, a transport delay objective test may be used to demonstrate that the FTD system does not exceed the specified limit. The sponsor must measure all the delay encountered by a step signal migrating from the pilot's control through all the simulation software modules in the correct order, using a handshaking protocol, finally through the normal output interfaces to the instrument display and, if applicable, the motion system, and the visual system.</li> </ul> <p>An objective test is required.</p> |           | X | X               | The intent is to verify that the FTD provides instrument cues that are, within the stated time delays, like the airplane responses. For airplane response, acceleration in the appropriate, corresponding rotational axis is preferred. Additional information regarding Latency and Transport Delay testing may be found in Appendix A, Attachment 2, paragraph 14. |
| <b>3. Equipment Operation</b> |  |           |   |                 |  |
| 3.a. ....                     | <p>All relevant instrument indications involved in the simulation of the airplane must automatically respond to control movement or external disturbances to the simulated airplane; e.g., turbulence or winds.</p> <p>A subjective test is required.</p>  |           | X | X               |  |
| 3.b. ....                     | <p>Navigation equipment must be installed and operate within the tolerances applicable for the airplane.</p> <p>Level 6 must also include communication equipment (inter-phone and air/ground) like that in the airplane and, if appropriate to the operation being conducted, an oxygen mask microphone system.</p> <p>Level 5 need have only that navigation equipment necessary to fly an instrument approach.</p> <p>A subjective test is required.</p>  |           | X | X               |  |
| 3.c. ....                     | <p>Installed systems must simulate the applicable airplane system operation, both on the ground and in flight. Installed systems must be operative to the extent that applicable normal, abnormal, and emergency operating procedures included in the sponsor's training programs can be accomplished.</p> <p>Level 6 must simulate all applicable airplane flight, navigation, and systems operation.</p> <p>Level 5 must have at least functional flight and navigational controls, displays, and instrumentation.</p> <p>Level 4 must have at least one airplane system installed and functional.</p> <p>A subjective test is required.</p>   | X         | X | X               |  |
| 3.d. ....                     | <p>The lighting environment for panels and instruments must be sufficient for the operation being conducted.</p> <p>A subjective test is required.</p>   | X         | X | X               | Back-lighted panels and instruments may be installed but are not required.   |
| 3.e. ....                     | <p>The FTD must provide control forces and control travel that correspond to the airplane being simulated. Control forces must react in the same manner as in the airplane under the same flight conditions.</p> <p>An objective test is required.</p>   |           |   | X               |  |

TABLE B1A.—MINIMUM FTD REQUIREMENTS—Continued

| <<<QPS requirements>>>                       |   |           |   | <<Information>> |  |
|--|---|-----------|---|-----------------|--|
| Number                                       | General FTD requirements  | FTD level |   |                 | Notes  |
|  |   | 4         | 5 | 6               |  |
| 3.f. ....                                    | The FTD must provide control forces and control travel of sufficient precision to manually fly an instrument approach.<br>A subjective test is required.  |           | X |                 |  |
| <b>4. Instructor or Evaluator Facilities</b> |   |           |   |                 |  |
| 4.a. ....                                    | In addition to the flight crewmember stations, suitable seating arrangements for an instructor/check airman and FAA Inspector must be available. These seats must provide adequate view of crewmember's panel(s).<br>A subjective test is required.   | X         | X | X               | These seats need not be a replica of an aircraft seat and may be as simple as an office chair placed in an appropriate position. |
| 4.b. ....                                    | The FTD must have instructor controls that permit activation of normal, abnormal, and emergency conditions as may be appropriate. Once activated, proper system operation must result from system management by the crew and not require input from the instructor controls.<br>A subjective test is required.  | X         | X | X               |  |
| <b>5. Motion System (not required)</b>       |   |           |   |                 |  |
| 5.a. ....                                    | The FTD may have a motion system, if desired, although it is not required. If a motion system is installed and additional training, testing, or checking credits are being sought on the basis of having a motion system, the motion system operation may not be distracting and must be coupled closely to provide integrated sensory cues. The motion system must also respond to abrupt input at the pilot's position within the allotted time, but not before the time when the airplane would respond under the same conditions.<br>A subjective test is required. |           | X | X               | The motion system standards set out in part 60, Appendix A for at least Level A simulators are acceptable.                       |
| 5.b. ....                                    | If a motion system is installed, it must be measured by latency tests or transport delay tests and may not exceed 300 milliseconds. Instrument response may not occur prior to motion onset.<br>An objective test is required.  |           |   | X               | The motion system standards set out in part 60, Appendix A for at least Level A simulators are acceptable.                       |
| <b>6. Visual System</b>                      |   |           |   |                 |  |
| 6.a. ....                                    | The FTD may have a visual system, if desired, although it is not required. If a visual system is installed, it must meet the following criteria:  | X         | X | X               |  |
| 6.a.1. ...                                   | The visual system must respond to abrupt input at the pilot's position.<br>An SOC is required.<br>A subjective test is required.  |           | X | X               |  |
| 6.a.2. ...                                   | The visual system must be at least a single channel, non-collimated display.<br>An SOC is required.<br>A subjective test is required.   | X         | X | X               |  |
| 6.a.3. ...                                   | The visual system must provide at least a field of view of 18° vertical/24° horizontal for the pilot flying.<br>An SOC is required.   | X         | X | X               |  |
| 6.a.4. ...                                   | The visual system must provide for a maximum parallax of 10° per pilot.<br>An SOC is required.  | X         | X | X               |  |
| 6.a.5. ...                                   | The visual scene content may not be distracting .....<br>An SOC is required.<br>A subjective test is required.  | X         | X | X               |  |

TABLE B1A.—MINIMUM FTD REQUIREMENTS—Continued

| <<<QPS requirements>>> |   |           |   | <<Information>> |  |
|------------------------|---|-----------|---|-----------------|--|
| Number                 | General FTD requirements  | FTD level |   |                 | Notes  |
|                        |   | 4         | 5 | 6               |  |
| 6.a.6. ...             | The minimum distance from the pilot's eye position to the surface of a direct view display may not be less than the distance to any front panel instrument.<br>An SOC is required.  | X         | X | X               |  |
| 6.a.7. ...             | The visual system must provide for a minimum resolution of 5 arc-minutes for both computed and displayed pixel size.<br>An SOC is required.   | X         | X | X               |  |
| 6.b. ....              | If a visual system is installed and additional training, testing, or checking credits are being sought on the basis of having a visual system, a visual system meeting the standards set out for at least a Level A FFS (see Appendix A of this part) will be required. A "direct-view," non-collimated visual system (with the other requirements for a Level A visual system met) may be considered satisfactory for those installations where the visual system design "eye point" is appropriately adjusted for each pilot's position such that the parallax error is at or less than 10° simultaneously for each pilot.<br>An SOC is required.<br>An objective test is required. |           |   | X               | Directly projected, non-collimated visual displays may prove to be unacceptable for dual pilot applications. |
| <b>7. Sound System</b> |   |           |   |                 |  |
| 7.a. ....              | The FTD must simulate significant flight deck sounds resulting from pilot actions that correspond to those heard in the airplane.   |           |   | X               |  |

TABLE B1B.—TABLE OF TASKS VS. FTD LEVEL

| <<<QPS requirements>>>                |  |           |   | <<Information>> |       |
|---------------------------------------|--|-----------|---|-----------------|-------|
| Number                                | Subjective requirements<br>In order to be qualified at the FTD qualification level indicated, the FTD must be able to perform at least the tasks associated with that level of qualification.<br>See Notes 1 and 2 at the end of the Table | FTD level |   |                 | Notes |
|                                       |  | 4         | 5 | 6               |       |
| <b>1. Preflight Procedures</b>        |  |           |   |                 |       |
| 1.a. ....                             | Preflight Inspection (flight deck only) .....  | A         | A | X               |       |
| 1.b. ....                             | Engine Start .....   | A         | A | X               |       |
| 1.c. ....                             | Pre-takeoff Checks .....   | A         | A | X               |       |
| <b>2. Takeoff and Departure Phase</b> |  |           |   |                 |       |
| 2.a. ....                             | Rejected Takeoff (requires visual system) .....  |           |   | A               |       |
| 2.b. ....                             | Departure Procedure .....  |           | X | X               |       |
| <b>3. In-flight Maneuvers</b>         |  |           |   |                 |       |
| 3.a. ....                             | a. Steep Turns .....   |           | X | X               |       |
| 3.b. ....                             | b. Approaches to Stalls .....  |           | A | X               |       |
| 3.c. ....                             | c. Engine Failure (procedures only)—Multiengine Airplane   |           | A | X               |       |
| 3.d. ....                             | d. Engine Failure (procedures only)—Single-Engine Airplane.  |           | A | X               |       |
| 3.e. ....                             | e. Specific Flight Characteristics incorporated into the user's FAA approved flight training program.  | A         | A | A               |       |

TABLE B1B.—TABLE OF TASKS VS. FTD LEVEL—Continued

| <<<QPS requirements>>>                   |  | <<Information>> |   |   |  |
|--|--|-----------------|---|---|--|
| Number                                   | Subjective requirements<br>In order to be qualified at the FTD qualification level indicated, the FTD must be able to perform at least the tasks associated with that level of qualification.<br>See Notes 1 and 2 at the end of the Table | FTD level       |   |   | Notes  |
|  |  | 4               | 5 | 6 |  |
| <b>4. Instrument Procedures</b>          |  |                 |   |   |  |
| 4.a. ....                                | Standard Terminal Arrival/Flight Management System Arrival.  |                 | A | X |  |
| 4.b. ....                                | Holding .....  |                 | A | X |  |
| 4.c. ....                                | Precision Instrument, all engines operating .....  |                 | A | X | e.g., Autopilot, Manual (Flt. Dir. Assisted), Manual (Raw Data).   |
| 4.d. ....                                | Non-precision Instrument, all engines operating .....  |                 | A | X | e.g., NDB, VOR, VOR/DME, VOR/TAC, RNAV, LOC, LOC/BC, ADF, and SDF. |
| 4.e. ....                                | Circling Approach (requires visual system) .....   |                 |   | A |  |
| 4.f. ....                                | Missed Approach .....  |                 | A | X |  |
| <b>5. Normal and Abnormal Procedures</b> |  |                 |   |   |  |
| 5.a. ....                                | Engine (including shutdown and restart procedures only) ..   | A               | A | X |  |
| 5.b. ....                                | Fuel System .....  | A               | A | X |  |
| 5.c. ....                                | Electrical System .....  | A               | A | X |  |
| 5.d. ....                                | Hydraulic System .....   | A               | A | X |  |
| 5.e. ....                                | Environmental and Pressurization Systems .....   | A               | A | X |  |
| 5.f. ....                                | Fire Detection and Extinguisher Systems .....  | A               | A | X |  |
| 5.g. ....                                | Navigation and Avionics Systems .....  | A               | A | X |  |
| 5.h. ....                                | Automatic Flight Control System, Electronic Flight Instrument System, and Related Subsystems.  | A               | A | X |  |
| 5.i. ....                                | Flight Control Systems .....   | A               | A | X |  |
| 5.j. ....                                | Anti-ice and Deice Systems .....   | A               | A | X |  |
| 5.k. ....                                | Aircraft and Personal Emergency Equipment  | A               | A | X |  |
| <b>6. Emergency Procedures</b>           |  |                 |   |   |  |
| 6.a. ....                                | Emergency Descent (maximum rate) .....   |                 | A | X |  |
| 6.b. ....                                | Inflight Fire and Smoke Removal .....  |                 | A | X |  |
| 6.c. ....                                | Rapid Decompression .....  |                 | A | X |  |
| 6.d. ....                                | Emergency Evacuation .....   | A               | A | X |  |
| <b>7. Postflight Procedures</b>          |  |                 |   |   |  |
| 7.a. ....                                | After-Landing Procedures .....   | A               | A | X |  |
| 7.b. ....                                | Parking and Securing .....   | A               | A | X |  |

**Note 1:** An "A" in the table indicates that the system, task, or procedure, although not required to be present, may be examined if the appropriate airplane system is simulated in the FTD and is working properly.

**Note 2:** Items not installed or not functional on the FTD and not appearing on the SOQ Configuration List, are not required to be listed as exceptions on the SOQ.

TABLE B1C.—TABLE OF TASKS VS. FTD LEVEL

| <<<QPS requirements>>>                       |  | <<Information>> |   |   |   |
|--|--|-----------------|---|---|---|
| Number                                       | Subject requirements<br>In order to be qualified at the FTD qualification level indicated, the FTD must be able to perform at least the tasks associated with that level of qualification. | FTD level       |   |   | Notes   |
|  |  | 4               | 5 | 6 |   |
| <b>1. Instructor Operating Station (IOS)</b> |  |                 |   |   |   |
| 1.a. ....                                    | Power switch(es) .....   | X               | X | X |   |
| 1.b. ....                                    | Airplane conditions .....  | A               | X | X | e.g., GW, CG, Fuel loading, Systems, Ground Crew.     |
| 1.c. ....                                    | Airports/Runways .....   | X               | X | X | e.g., Selection, Surface, Presets, Lighting controls. |
| 1.d. ....                                    | Environmental controls .....   | X               | X | X | e.g., Temp, Wind.                                     |
| 1.e. ....                                    | Airplane system malfunctions (Insertion/deletion) .....  | A               | X | X |   |
| 1.f. ....                                    | Locks, Freezes, and Repositioning .....  | X               | X | X |   |
| 1.g. ....                                    | Sound Controls. (On/off/adjustment) .....  | X               | X | X |   |
| 1.h. ....                                    | Motion/Control Loading System, as appropriate. On/off/emergency stop.  | A               | X | X |   |
| <b>2. Observer Seats/Stations</b>            |  |                 |   |   |   |
| 2.a. ....                                    | Position/Adjustment/Positive restraint system .....  | X               | X | X |   |

**Attachment 2 to Appendix B to Part 60—Flight Training Device (FTD) Objective Tests**

**Begin Information**

**1. Discussion**

a. For the purposes of this attachment, the flight conditions specified in the Flight Conditions Column of Table B2A, are defined as follows:

- (1) Ground—on ground, independent of airplane configuration;
- (2) Take-off—gear down with flaps/slats in any certified takeoff position;
- (3) First segment climb—gear down with flaps/slats in any certified takeoff position (normally not above 50 ft AGL);
- (4) Second segment climb—gear up with flaps/slats in any certified takeoff position (normally between 50 ft and 400 ft AGL);
- (5) Clean—flaps/slats retracted and gear up;
- (6) Cruise—clean configuration at cruise altitude and airspeed;
- (7) Approach—gear up or down with flaps/slats at any normal approach position as recommended by the airplane manufacturer; and
- (8) Landing—gear down with flaps/slats in any certified landing position.

b. The format for numbering the objective tests in Appendix A, Attachment 2, Table A2A, and the objective tests in Appendix B, Attachment 2, Table B2A, is identical. However, each test required for FFSs is not necessarily required for FTDs. Also, each test required for FTDs is not necessarily required for FFSs. Therefore, when a test number (or series of numbers) is not required, the term “Reserved” is used in the table at that location. Following this numbering format

provides a degree of commonality between the two tables and substantially reduces the potential for confusion when referring to objective test numbers for either FFSs or FTDs.

c. The reader is encouraged to review the Airplane Flight Simulator Evaluation Handbook, Volumes I and II, published by the Royal Aeronautical Society, London, UK, and FAA Advisory Circulars (AC) 25–7, as may be amended, Flight Test Guide for Certification of Transport Category Airplanes, and (AC) 23–8, as may be amended, Flight Test Guide for Certification of Part 23 Airplanes, for references and examples regarding flight testing requirements and techniques.

d. If relevant winds are present in the objective data, the wind vector should be clearly noted as part of the data presentation, expressed in conventional terminology, and related to the runway being used for the test.

e. A Level 4 FTD does not require objective tests and therefore, Level 4 is not addressed in the following table.

**End Information**

**Begin QPS Requirements**

**2. Test Requirements**

a. The ground and flight tests required for qualification are listed in Table B2A Objective Tests. Computer generated FTD test results must be provided for each test except where an alternate test is specifically authorized by the NSPM. If a flight condition or operating condition is required for the test but does not apply to the airplane being simulated or to the qualification level sought, it may be disregarded (e.g., an engine out

missed approach for a single-engine airplane; a maneuver using reverse thrust for an airplane without reverse thrust capability). Each test result is compared against the validation data described in § 60.13, and in Appendix B. The results must be produced on an appropriate recording device acceptable to the NSPM and must include FTD number, date, time, conditions, tolerances, and appropriate dependent variables portrayed in comparison to the validation data. Time histories are required unless otherwise indicated in Table B2A. All results must be labeled using the tolerances and units given.

b. Table B2A in this attachment sets out the test results required, including the parameters, tolerances, and flight conditions for FTD validation. Tolerances are provided for the listed tests because mathematical modeling and acquisition and development of reference data are often inexact. All tolerances listed in the following tables are applied to FTD performance. When two tolerance values are given for a parameter, the less restrictive may be used unless otherwise indicated.

c. Certain tests included in this attachment must be supported with a Statement of Compliance and Capability (SOC). In Table B2A, requirements for SOCs are indicated in the “Test Details” column.

d. When operational or engineering judgment is used in making assessments for flight test data applications for FTD validity, such judgment may not be limited to a single parameter. For example, data that exhibit rapid variations of the measured parameters may require interpolations or a “best fit” data section. All relevant parameters related to a given maneuver or flight condition must be provided to allow overall interpretation.

When it is difficult or impossible to match FTD to airplane data throughout a time history, differences must be justified by providing a comparison of other related variables for the condition being assessed.

e. It is not acceptable to program the FTD so that the mathematical modeling is correct only at the validation test points. Unless noted otherwise, tests must represent airplane performance and handling qualities at operating weights and centers of gravity (CG) typical of normal operation. If a test is supported by aircraft data at one extreme weight or CG, another test supported by aircraft data at mid-conditions or as close as possible to the other extreme is necessary. Certain tests that are relevant only at one extreme CG or weight condition need not be repeated at the other extreme. The results of the tests for Level 6 are expected to be indicative of the device's performance and handling qualities throughout all of the following:

- (1) The airplane weight and CG envelope;
- (2) The operational envelope; and
- (3) Varying atmospheric ambient and environmental conditions—including the extremes authorized for the respective airplane or set of airplanes.

f. When comparing the parameters listed to those of the airplane, sufficient data must also be provided to verify the correct flight condition and airplane configuration changes. For example, to show that control force is within the parameters for a static stability test, data to show the correct airspeed, power, thrust or torque, airplane configuration, altitude, and other appropriate datum identification parameters must also be given. If comparing short period dynamics, normal acceleration may be used to establish a match to the airplane, but airspeed, altitude, control input, airplane configuration, and other appropriate data must also be given. If comparing landing gear change dynamics, pitch, airspeed, and altitude may be used to establish a match to the airplane, but landing gear position must

also be provided. All airspeed values must be properly annotated (e.g., indicated versus calibrated). In addition, the same variables must be used for comparison (e.g., compare inches to inches rather than inches to centimeters).

g. The QTG provided by the sponsor must clearly describe how the FTD will be set up and operated for each test. Each FTD subsystem may be tested independently, but overall integrated testing of the FTD must be accomplished to assure that the total FTD system meets the prescribed standards. A manual test procedure with explicit and detailed steps for completing each test must also be provided.

h. In those cases where the objective test results authorize a "snapshot test" or a "series of snapshot test results" in lieu of a time-history result, the sponsor or other data provider must ensure that a steady state condition exists at the instant of time captured by the "snapshot." The steady state condition must exist from 4 seconds prior to, through 1 second following, the instant of time captured by the snapshot.

i. For previously qualified FTDs, the tests and tolerances of this attachment may be used in subsequent continuing qualification evaluations for any given test if the sponsor has submitted a proposed MQTG revision to the NSPM and has received NSPM approval.

j. FTDs are evaluated and qualified with an engine model simulating the airplane data supplier's flight test engine. For qualification of alternative engine models (either variations of the flight test engines or other manufacturer's engines) additional tests with the alternative engine models may be required. This Attachment contains guidelines for alternative engines.

k. Testing Computer Controlled Airplane (CCA) simulators, or other highly augmented airplane simulators, flight test data is required for the Normal (N) and/or Non-normal (NN) control states, as indicated in this Attachment. Where test results are independent of control state, Normal or Non-

normal control data may be used. All tests in Table A2A require test results in the Normal control state unless specifically noted otherwise in the Test Details section following the CCA designation. The NSPM will determine what tests are appropriate for airplane simulation data. When making this determination, the NSPM may require other levels of control state degradation for specific airplane tests. Where Non-normal control states are required, test data must be provided for one or more Non-normal control states, and must include the least augmented state. Where applicable, flight test data must record Normal and Non-normal states for:

(1) Pilot controller deflections or electronically generated inputs, including location of input; and

(2) Flight control surface positions unless test results are not affected by, or are independent of, surface positions.

l. Tests of handling qualities must include validation of augmentation devices. FTDs for highly augmented airplanes will be validated both in the unaugmented configuration (or failure state with the maximum permitted degradation in handling qualities) and the augmented configuration. Where various levels of handling qualities result from failure states, validation of the effect of the failure is necessary. Requirements for testing will be mutually agreed to between the sponsor and the NSPM on a case-by-case basis.

m. Some tests will not be required for airplanes using airplane hardware in the FTD flight deck (e.g., "side stick controller"). These exceptions are noted in Section 2 "Handling Qualities" in Table B2A of this attachment. However, in these cases, the sponsor must provide a statement that the airplane hardware meets the appropriate manufacturer's specifications and the sponsor must have supporting information to that fact available for NSPM review.

**End QPS Requirements**

TABLE B2A.—FLIGHT TRAINING DEVICE (FTD) OBJECTIVE TESTS

| <<<QPS requirements>>> |                           |                    |                   |  |           |   |  |
|------------------------|---------------------------|--------------------|-------------------|--|-----------|---|--|
| Test                   |                           | Tolerances         | Flight conditions | Test details   | FTD level |   | <<Information>>  |
| Number                 | Title                     |                    |                   |  | 5         | 6 |  |
| <b>1. Performance</b>  |                           |                    |                   |  |           |   |  |
| 1.a. ....              | (Reserved)                |                    |                   |  |           |   |  |
| 1.b. ....              | Takeoff                   |                    |                   |  |           |   |  |
| 1.b.1. ....            | Ground Acceleration Time. | ±5% time or ±1 sec | Takeoff .....     | Record acceleration time for a minimum of 80% of the segment from brake release to V <sub>R</sub> . Preliminary aircraft certification data may be used. |           | X | This test is required only if RTO training credit is sought. |
| 1.b.2. through 1.b.6.  | (Reserved)                |                    |                   |  |           |   |  |



TABLE B2A.—FLIGHT TRAINING DEVICE (FTD) OBJECTIVE TESTS—Continued

| <<<QPS requirements>>>       |  |  |                      |   |           |   |   |
|------------------------------|--|--|----------------------|---|-----------|---|---|
| Test                         |  | Tolerances   | Flight conditions    | Test details  | FTD level |   | <<Information>>   |
| Number                       | Title  |  |                      |   | 5         | 6 | Notes   |
| 1.b.7. ....                  | Rejected Takeoff ....  | ±3% time or ±1 second.   | Dry Runway .....     | Record time for at least 80% of the segment from initiation of the Rejected Takeoff to full stop.   |           | X |   |
| 1.b.8. ....                  | (Reserved)   |  |                      |   |           |   |   |
| 1.c. ....                    | Climb  |  |                      |   |           |   |   |
| 1.c.1. ....                  | Normal Climb all engines operating.  | ±3 kt airspeed, ±5% or ±100 ft/min (0.5 m/sec) climb rate.             | Clean .....          | Flight test data or airplane performance manual data may be used. Record at nominal climb speed and at nominal altitude. May be a snapshot test result. FTD performance must be recorded over an interval of at least 1,000 ft (300 m). | X         | X |   |
| 1.c.2. through 1.c.4.        | (Reserved)   |  |                      |   |           |   |   |
| 1.d. ....                    | (Reserved)   |  |                      |   |           |   |   |
| 1.e. ....                    | (Reserved)   |  |                      |   |           |   |   |
| 1.f. ....                    | Engines  |  |                      |   |           |   |   |
| 1.f.1. ....                  | Acceleration .....   | Level 6: ±10% T <sub>t</sub> , or ±0.25 sec.<br>Level 5: ±1 sec .....  | Approach or Landing. | Record engine power (N <sub>1</sub> , N <sub>2</sub> , EPR, Torque, Manifold Pressure) from idle to maximum takeoff power for a rapid (slam) throttle movement.   | X         | X | T <sub>t</sub> is the total time from initial throttle movement to reaching 90% of go around power.                       |
| 1.f.2. ....                  | Deceleration .....   | Level 6: ±10% T <sub>t</sub> , or ±0.25 sec.<br>Level 5: ±1 sec .....  | Ground .....         | Record engine power (N <sub>1</sub> , N <sub>2</sub> , EPR, Torque, Manifold Pressure) from maximum takeoff power to idle for a rapid (slam) throttle movement.   | X         | X | T <sub>t</sub> is the total time from initial throttle movement to reaching 90% decay of maximum takeoff power.           |
| <b>2. Handling Qualities</b> |  |  |                      |   |           |   |   |
|                              | For FTDs requiring Static tests at the controls (i.e., column, wheel, rudder pedal), special test fixtures will not be required during initial or upgrade evaluations if the sponsor's QTG/MQTG shows both test fixture results and the results of an alternative approach, such as computer plots produced concurrently, that show satisfactory agreement. Repeat of the alternative method during the initial or upgrade evaluation would then satisfy this test requirement |  |                      |   |           |   | Testing of position versus force is not applicable if forces are generated solely by use of airplane hardware in the FTD. |
| 2.a. ....                    | Static Control Tests   |  |                      |   |           |   |   |
| 2.a.1.a. ..                  | Pitch Controller Position vs. Force and Surface Position Calibration.  | ±2 lb (0.9 daN) breakout, ±10% or ±5 lb (2.2 daN) force, ±2° elevator. | Ground .....         | Record results for an uninterrupted control sweep to the stops.   |           | X |   |

TABLE B2A.—FLIGHT TRAINING DEVICE (FTD) OBJECTIVE TESTS—Continued

| <<<QPS requirements>>> |  |  |                           |  |           |   |  |
|------------------------|--|--|---------------------------|--|-----------|---|--|
| Test                   |  | Tolerances   | Flight conditions         | Test details   | FTD level |   | <<Information>>  |
| Number                 | Title  |  |                           |  | 5         | 6 | Notes  |
| 2.a.1.b. ..            | Pitch Controller Position vs. Force.                                 | $\pm 2$ lb (0.9 daN) breakout, $\pm 10\%$ or $\pm 5$ lb (2.2 daN) force.   | As determined by sponsor. | Record results during initial qualification evaluation for an uninterrupted control sweep to the stops. The recorded tolerances apply to subsequent comparisons on continuing qualification evaluations. | X         |   | Applicable only on continuing qualification evaluations. The intent is to design the control feel for Level 5 to be able to manually fly an instrument approach; and not to compare results to flight test or other such data. |
| 2.a.2.a. ..            | Roll Controller Position vs. Force and Surface Position Calibration. | $\pm 2$ lb (0.9 daN) breakout, $\pm 10\%$ or $\pm 3$ lb (1.3 daN) force, $\pm 2^\circ$ aileron, $\pm 3^\circ$ spoiler angle. | Ground .....              | Record results for an uninterrupted control sweep to the stops.  |           | X |  |
| 2.a.2.b. ..            | Roll Controller Position vs. Force.                                  | $\pm 2$ lb (0.9 daN) breakout, $\pm 10\%$ or $\pm 3$ lb (1.3 daN) force.   | As determined by sponsor. | Record results during initial qualification evaluation for an uninterrupted control sweep to the stops. The recorded tolerances apply to subsequent comparisons on continuing qualification evaluations. | X         |   | Applicable only on continuing qualification evaluations. The intent is to design the control feel for Level 5 to be able to manually fly an instrument approach; and not to compare results to flight test or other such data. |
| 2.a.3.a. ..            | Rudder Pedal Position vs. Force and Surface Position Calibration.    | $\pm 5$ lb (2.2 daN) breakout, $\pm 10\%$ or $\pm 5$ lb (2.2 daN) force, $\pm 27^\circ$ rudder angle.                        | Ground .....              | Record results for an uninterrupted control sweep to the stops.  |           | X |  |
| 2.a.3.b. ..            | Rudder Pedal Position vs. Force.                                     | $\pm 5$ lb (2.2 daN) breakout, $\pm 10\%$ or $\pm 5$ lb (2.2 daN) force.   | As determined by sponsor. | Record results during initial qualification evaluation for an uninterrupted control sweep to the stops. The recorded tolerances apply to subsequent comparisons on continuing qualification evaluations. | X         |   | Applicable only on continuing qualification evaluations. The intent is to design the control feel for Level 5 to be able to manually fly an instrument approach; and not to compare results to flight test or other such data. |
| 2.a.4. ....            | Nosewheel Steering Controller Force.                                 | $\pm 2$ lb (0.9 daN) breakout, $\pm 10\%$ or $\pm 3$ lb (1.3 daN) force.   | Ground .....              | Record results of an uninterrupted control sweep to the stops.   |           | X |  |
| 2.a.5. ....            | Rudder Pedal Steering Calibration.                                   | $\pm 2^\circ$ nosewheel angle.   | Ground .....              | Record results of an uninterrupted control sweep to the stops.   |           | X |  |

TABLE B2A.—FLIGHT TRAINING DEVICE (FTD) OBJECTIVE TESTS—Continued

| <<<QPS requirements>>>  |  |   |   |  |           |   |  |
|---|--|---|---|--|-----------|---|--|
| Test  |  | Tolerances  | Flight conditions   | Test details   | FTD level |   | <<Information>>  |
| Number  | Title  |   |   |  | 5         | 6 | Notes  |
| 2.a.6. ....   | Pitch Trim Indicator vs. Surface Position Calibration.                 | $\pm 0.5^\circ$ of computed trim surface angle.   | Ground .....  |  |           | X | The purpose of the test is to compare the FTD against design data or equivalent. |
| 2.a.7. ....   | (Reserved)   |   |   |  |           |   |  |
| 2.a.8. ....   | Alignment of Flight deck Throttle Lever vs. Selected Engine Parameter. | $\pm 5^\circ$ of throttle lever angle or $\pm 0.8$ in (2 cm) for power control without angular travel, or $\pm 3\%$ N1, or $\pm 0.03$ EPR, or $\pm 3\%$ maximum rated manifold pressure, or $\pm 3\%$ torque. | Ground .....  | Requires simultaneous recording for all engines. The tolerances apply against airplane data and between engines. In the case of propeller powered airplanes, if a propeller lever is present, it must also be checked. For airplanes with throttle "detents," all detents must be presented. May be a series of snapshot test results. |           | X |  |
| 2.a.9. ....   | Brake Pedal Position vs. Force.  | $\pm 5$ lb (2.2 daN) or 10% force.  | Ground .....  | Two data points are required: Zero and maximum deflection. Computer output results may be used to show compliance.   |           | X | Test not required unless RTO credit is sought.                                   |
| 2.b. ....   | (Reserved)   |   |   |  |           |   |  |
| 2.c. ....   | Longitudinal Control Tests   |   |   |  |           |   |  |
| Power setting is that required for level flight unless otherwise specified. |  |   |   |  |           |   |  |
| 2.c.1. ....   | Power Change Force.  | $\pm 5$ lb (2.2 daN) or, $\pm 20\%$ force.  | Approach .....  | May be a series of snapshot test results. Power change dynamics test as described in test 2.c.1 of Table A2A of this part will be accepted.  | X         | X |  |
| 2.c.2. ....   | Flap/Slat Change Force.  | $\pm 5$ lb (2.2 daN) or, $\pm 20\%$ force.  | Takeoff through initial flap retraction, and approach to landing. | May be a series of snapshot test results. Flap/Slat change dynamics test as described in test 2.c.2 of Table A2A of this part will be accepted.  | X         | X |  |
| 2.c.3. ....   | (Reserved)   |   |   |  |           |   |  |
| 2.c.4. ....   | Gear Change Force  | $\pm 5$ lb (2.2 daN) or, $\pm 20\%$ force.  | Takeoff (retraction) and Approach (extension).                    | May be a series of snapshot test results. Gear change dynamics test as described in test 2.c.4 of Table A2A of this part will be accepted.   | X         | X |  |
| 2.c.5. ....   | Longitudinal Trim ....   | $\pm 0.5^\circ$ trim surface angle $\pm 1^\circ$ elevator $\pm 1^\circ$ pitch angle $\pm 5\%$ net thrust or equivalent.   | Cruise, Approach, and Landing.                                    | Record steady-state condition with wings level and thrust set for level flight. May be a series of snapshot tests. Level 5 may use equivalent stick and trim controllers in lieu of elevator and trim surface.   | X         | X |  |

TABLE B2A.—FLIGHT TRAINING DEVICE (FTD) OBJECTIVE TESTS—Continued

| <<<QPS requirements>>> |   |   |  |  |           |   |                 |
|------------------------|---|---|--|--|-----------|---|-----------------|
| Test                   |   | Tolerances  | Flight conditions                              | Test details   | FTD level |   | <<Information>> |
| Number                 | Title   |   |  |  | 5         | 6 | Notes           |
| 2.c.6. ....            | Longitudinal Maneuvering Stability (Stick Force/g). | ±5 lb (±2.2 daN) or ±10% pitch controller force Alternative method: ±1° or ±10% change of elevator.     | Cruise, Approach, and Landing.                 | Continuous time history data or a series of snapshot tests may be used. Record results up to 30° of bank for approach and landing configurations. Record results for up to 45° of bank for the cruise configuration. The force tolerance is not applicable if forces are generated solely by the use of airplane hardware in the FTD. The alternative method applies to airplanes that do not exhibit “stick-force-per-g” characteristics. |           | X |                 |
| 2.c.7. ....            | Longitudinal Static Stability.                      | ±5 lb (±2.2 daN) or ±10% pitch controller force. Alternative method: ±1° or ±10% change of elevator.    | Approach .....                                 | May be a series of snapshot test results. Record results for at least 2 speeds above and 2 speeds below trim speed. The force tolerance is not applicable if forces are generated solely by the use of airplane hardware in the FTD. The alternative method applies to airplanes that do not exhibit speed stability characteristics. Level 5 must exhibit positive static stability, but need not comply with the numerical tolerance.    | X         | X |                 |
| 2.c.8. ....            | Stall Warning (actuation of stall warning device.). | ±3 kts. airspeed, ±2° bank for speeds greater than actuation of stall warning device or initial buffet. | Second Segment Climb, and Approach or Landing. | The stall maneuver must be entered with thrust at or near idle power and wings level (1g). Record the stall warning signal and initial buffet if applicable.   | X         | X |                 |
| 2.c.9.a. ..            | Phugoid Dynamics ..                                 | ±10% period, ±10% of time to ½ or double amplitude or ±.02 of damping ratio.                            | Cruise .....                                   | The test must include whichever is less of the following: Three full cycles (six overshoots after the input is completed), or the number of cycles sufficient to determine time to ½ or double amplitude.  | X         |   |                 |
| 2.c.9.b. ..            | Phugoid Dynamics ..                                 | ±10% period, Representative damping.  | Cruise .....                                   | The test must include whichever is less of the following: Three full cycles (six overshoots after the input is completed), or the number of cycles sufficient to determine representative damping.   | X         |   |                 |
| 2.c.10. ...            | Short Period Dynamics.                              | ±1.5° pitch angle or ±2°/sec pitch rate, ±0.10g acceleration..  | Cruise .....                                   |  |           | X |                 |
| 2.d. ....              | Lateral Directional Tests                           |   |  |  |           |   |                 |

TABLE B2A.—FLIGHT TRAINING DEVICE (FTD) OBJECTIVE TESTS—Continued

| <<<QPS requirements>>>  |  |  |                                  |  |           |   |   |
|---|--|--|----------------------------------|--|-----------|---|---|
| Test  |  | Tolerances   | Flight conditions                | Test details   | FTD level |   | <<Information>>   |
| Number  | Title  |  |                                  |  | 5         | 6 | Notes   |
| Power setting is that required for level flight unless otherwise specified. |  |  |                                  |  |           |   |   |
| 2.d.1. ....   | (Reserved)   |  |                                  |  |           |   |   |
| 2.d.2. ....   | Roll Response (Rate).                                    | $\pm 10\%$ or $\pm 2^\circ/\text{sec}$ roll rate.  | Cruise, and Approach or Landing. | Record results for normal roll controller deflection (one-third of maximum roll controller travel). May be combined with step input of flight deck roll controller test (see 2.d.3.).                | X         | X |   |
| 2.d.3. ....   | Roll Response to Flight deck Roll Controller Step Input. | $\pm 10\%$ or $\pm 2^\circ$ bank angle.  | Approach or Landing.             | Record from initiation of roll through 10 seconds after control is returned to neutral and released. May be combined with roll response (rate) test (see 2.d.2.).                                    |           | X |   |
| 2.d.4.a. ..   | Spiral Stability .....                                   | Correct trend and $\pm 3^\circ$ or $\pm 10\%$ bank angle in 30 seconds.  | Cruise .....                     | Record results for both directions. As an alternate test, demonstrate the lateral control required to maintain a steady turn with a bank angle of $30^\circ$ .                                       |           | X | Airplane data averaged from multiple tests in same direction may be used. |
| 2.d.4.b. ..   | Spiral Stability .....                                   | Correct trend .....  | Cruise .....                     |  | X         |   | Airplane data averaged from multiple tests in same direction may be used. |
| 2.d.5. ....   | (Reserved)   |  |                                  |  |           |   |   |
| 2.d.6.a. ..   | Rudder Response ...                                      | $\pm 2^\circ/\text{sec}$ or $\pm 10\%$ yaw rate.   | Approach or Landing.             | A rudder step input of 20%–30% rudder pedal throw must be used. Not required if rudder input and response is shown in Dutch Roll test (test 2.d.7.).   |           | X |   |
| 2.d.6.b. ..   | Rudder Response ...                                      | Roll rate $\pm 2^\circ/\text{sec}$ , bank angle $\pm 3^\circ$ .  | Approach or Landing.             | May be roll response to a given rudder deflection.   | X         |   |   |
| 2.d.7. ....   | Dutch Roll (Yaw Damper OFF).                             | $\pm 0.5$ sec. or $\pm 10\%$ of period, $\pm 10\%$ of time to $1/2$ or double amplitude or $\pm 0.02$ of damping ratio.  | Cruise, and Approach or Landing. | Record results for at least 6 complete cycles with stability augmentation OFF, or the number of cycles sufficient to determine time to $1/2$ or double amplitude.                                    |           | X |   |
| 2.d.8. ....   | Steady State Sideslip.                                   | For given rudder position $\pm 2^\circ$ bank angle, $\pm 1^\circ$ sideslip angle, $\pm 10\%$ or $\pm 2^\circ$ aileron, $\pm 10\%$ or $\pm 5^\circ$ spoiler or equivalent roll, controller position or force. | Approach or Landing.             | May be a series of snapshot test results. Propeller driven airplanes must test in each direction. Sideslip angle is matched only for repeatability and only on continuing qualification evaluations. | X         | X |   |
| 2.e. through 2.h.   | (Reserved)   |  |                                  |  |           |   |   |
| <b>3. (Reserved)</b>  |  |  |                                  |  |           |   |   |

TABLE B2A.—FLIGHT TRAINING DEVICE (FTD) OBJECTIVE TESTS—Continued

| <<<QPS requirements>>>             |                       |   |  |   |           |   |   |
|------------------------------------|-----------------------|---|--|---|-----------|---|---|
| Test                               |                       | Tolerances                                  | Flight conditions                          | Test details  | FTD level |   | <<Information>>   |
| Number                             | Title                 |   |  |   | 5         | 6 | Notes   |
| <b>4. (Reserved)</b>               |                       |   |  |   |           |   |   |
| <b>5. (Reserved)</b>               |                       |   |  |   |           |   |   |
| <b>6. FTD System Response Time</b> |                       |   |  |   |           |   |   |
| 6.a. ....                          | Latency               |   |  |   |           |   |   |
|                                    | .....                 | 300 ms (or less) after airplane response.   | Take-off, cruise, and approach or landing. | One test is required in each axis (pitch, roll and yaw) for each of the three conditions (take-off, cruise, and approach or landing). | X         | X |   |
|                                    | Transport Delay ..... | .....                                       | .....                                      | .....   |           |   | If Transport Delay is the chosen method to demonstrate relative responses, the sponsor and the NSPM will use the latency values to ensure proper simulator response when reviewing those existing tests where latency can be identified (e.g., short period, roll response, rudder response). |
|                                    |                       | 300 ms (or less) after controller movement. | N/A .....                                  | A separate test is required in each axis (pitch, roll, and yaw).  | X         | X |   |

**Begin Information**

**3. For Additional Information on the Following Topics, Please Refer to Appendix A, Attachment 2, and the Indicated Paragraph Within That Attachment**

- Control Dynamics, paragraph 3.
- Motion System, paragraph 5.
- Sound System, paragraph 6.
- Engineering Simulator Validation Data, paragraph 8.
- Approval Guidelines for Engineering Simulator Validation Data, paragraph 9.
- Validation Test Tolerances, paragraph 10.
- Validation Data Road Map, paragraph 11.
- Acceptance Guidelines for Alternative Engines Data, paragraph 12.
- Acceptance Guidelines for Alternative Avionics, paragraph 13.
- Transport Delay Testing, paragraph 14.
- Continuing Qualification Evaluation Validation Data Presentation, paragraph 15.

**End Information**

**4. Alternative Objective Data for FTD Level 5**

**Begin QPS Requirements**

a. This paragraph (including the following tables) is relevant only to FTD Level 5. It is provided because this level is required to simulate the performance and handling characteristics of a set of airplanes with similar characteristics, such as normal airspeed/altitude operating envelope and the same number and type of propulsion systems (engines).

b. Tables B2B through B2E reflect FTD performance standards that are acceptable to the FAA. A sponsor must demonstrate that a device performs within these parameters, as applicable. If a device does not meet the established performance parameters for some or for all of the applicable tests listed in Tables B2B through B2E, the sponsor may use NSP accepted flight test data for comparison purposes for those tests.

c. Sponsors using the data from Tables B2B through B2E must comply with the following:

- (1) Submit a complete QTG, including results from all of the objective tests appropriate for the level of qualification

sought as set out in Table B2A. The QTG must highlight those results that demonstrate that the performance of the FTD is within the allowable performance ranges indicated in Tables B2B through B2E, as appropriate.

(2) The QTG test results must include all relevant information concerning the conditions under which the test was conducted; e.g., gross weight, center of gravity, airspeed, power setting, altitude (climbing, descending, or level), temperature, configuration, and any other parameter that impacts the conduct of the test.

(3) The test results become the validation data against which the initial and all subsequent recurrent evaluations are compared. These subsequent evaluations will use the tolerances listed in Table B2A.

(4) Subjective testing of the device must be performed to determine that the device performs and handles like an airplane within the appropriate set of airplanes.

**End QPS Requirements**

**Begin Information**

- d. The reader is encouraged to consult the Airplane Flight Simulator Evaluation

Handbook, Volumes I and II, published by the Royal Aeronautical Society, London, UK, and FAA Advisory Circulars (AC) 25-7, Flight Test Guide for Certification of Transport Category Airplanes, and (AC) 23-

8A, Flight Test Guide for Certification of Part 23 Airplanes, as amended, for references and examples regarding flight testing requirements and techniques.

End Information

TABLE B2B.—ALTERNATIVE DATA SOURCE FOR FTD LEVEL 5 SMALL, SINGLE ENGINE (RECIPROCATING) AIRPLANE

| <<<QPS requirement>>>  |   |  |
|--|---|--|
| The performance parameters in this table must be used to program the FTD if flight test data is not used to program the FTD. |   |  |
| Number   | Applicable test<br>Title and procedure  | Authorized performance range             |
| <b>1. Performance</b>  |   |  |
| 1.c. ....  | Climb   |  |
| 1.c.1. ....  | Normal climb with nominal gross weight, at best rate-of-climb airspeed.   | Climb rate = 500–1200 fpm (2.5–6 m/sec). |
| 1.f. ....  | Engines   |  |
| 1.f.1. ....  | Acceleration; idle to takeoff power .....   | 2–4 Seconds.                             |
| 1.f.2. ....  | Deceleration; takeoff power to idle .....   | 2–4 Seconds.                             |
| <b>2. Handling Qualities</b>   |   |  |
| 2.c. ....  | Longitudinal Tests  |  |
| 2.c.1. ....  | Power change force  |  |
|  | (a) Trim for straight and level flight at 80% of normal cruise airspeed with necessary power. Reduce power to flight idle. Do not change trim or configuration. After stabilized, record column force necessary to maintain original airspeed.  | 5–15 lbs (2.2–6.6 daN) of force (Pull).  |
|  | OR  |  |
|  | (b) Trim for straight and level flight at 80% of normal cruise airspeed with necessary power. Add power to maximum setting. Do not change trim or configuration. After stabilized, record column force necessary to maintain original airspeed.   | 5–15 lbs (2.2–6.6 daN) of force (Push).  |
| 2.c.2. ....  | Flap/slat change force.   |  |
|  | (a) Trim for straight and level flight with flaps fully retracted at a constant airspeed within the flaps-extended airspeed range. Do not adjust trim or power. Extend the flaps to 50% of full flap travel. After stabilized, record stick force necessary to maintain original airspeed.    | 5–15 lbs (2.2–6.6 daN) of force (Pull).  |
|  | OR  |  |
|  | (b) Trim for straight and level flight with flaps extended to 50% of full flap travel, at a constant airspeed within the flaps-extended airspeed range. Do not adjust trim or power. Retract the flaps to zero. After stabilized, record stick force necessary to maintain original airspeed. | 5–15 lbs (2.2–6.6 daN) of force (Push).  |
| 2.c.4. ....  | Gear change force   |  |
|  | (a) Trim for straight and level flight with landing gear retracted at a constant airspeed within the landing gear-extended airspeed range. Do not adjust trim or power. Extend the landing gear. After stabilized, record stick force necessary to maintain original airspeed.                | 2–12 lbs (0.88–5.3 daN) of force (Pull). |
|  | OR  |  |
|  | (b) Trim for straight and level flight with landing gear extended, at a constant airspeed within the landing gear-extended airspeed range. Do not adjust trim or power. Retract the landing gear. After stabilized, record stick force necessary to maintain original airspeed.               | 2–12 lbs (0.88–5.3 daN) of force (Push). |

TABLE B2B.—ALTERNATIVE DATA SOURCE FOR FTD LEVEL 5 SMALL, SINGLE ENGINE (RECIPROCATING) AIRPLANE—Continued

<<<QPS requirement>>>  
The performance parameters in this table must be used to program the FTD if flight test data is not used to program the FTD.

| Applicable test                    |   | Authorized performance range  |
|------------------------------------|---|---|
| Number                             | Title and procedure   |   |
| 2.c.5. ....                        | Longitudinal trim .....   | Must be able to trim longitudinal stick force to “zero” in each of the following configurations: cruise; approach; and landing. |
| 2.c.7. ....                        | Longitudinal static stability .....   | Must exhibit positive static stability.   |
| 2.c.8. ....                        | Stall warning (actuation of stall warning device) with nominal gross weight; wings level; and a deceleration rate of not more than three (3) knots per second   | 40–60 knots; ±5° of bank.   |
|                                    | (a) Landing configuration .....   |   |
|                                    | (b) Clean configuration .....   | Landing configuration speed + 10–20%.   |
| 2.c.9.b.                           | Phugoid dynamics .....  | Must have a phugoid with a period of 30–60 seconds. May not reach ½ or double amplitude in less than 2 cycles.                  |
| 2.d. ....                          | Lateral Directional Tests   |   |
| 2.d.2. ....                        | Roll response (rate) .....<br>Roll rate must be measured through at least 30° of roll.<br>Aileron control must be deflected ⅓ (33.3 percent) of maximum travel.   | Must have a roll rate of 4°–25°/second.   |
| 2.d.4.b.                           | Spiral stability .....<br>Cruise configuration and normal cruise airspeed. Establish a 20°–30° bank. When stabilized, neutralize the aileron control and release. Must be completed in both directions of turn. | Initial bank angle (±5°) after 20 seconds.  |
| 2.d.6.b.                           | Rudder response .....<br>Use 25 percent of maximum rudder deflection. (Applicable to approach or landing configuration.)  | 2°–6°/second yaw rate.  |
| 2.d.7. ....                        | Dutch roll, yaw damper off. (Applicable to cruise and approach configurations.)   | A period of 2–5 seconds; and ½–2 cycles.  |
| 2.d.8. ....                        | Steady state sideslip .....<br>Use 50 percent rudder deflection. (Applicable to approach and landing configurations.)   | 2°–10° of bank; 4°–10° of sideslip; and 2°–10° of aileron.  |
| <b>6. FTD System Response Time</b> |   |   |
| 6.a. ....                          | Latency .....<br>Flight deck instrument systems response to an abrupt pilot controller input. One test is required in each axis (pitch, roll, yaw).   | 300 milliseconds or less.   |

TABLE B2C.—ALTERNATIVE DATA SOURCE FOR FTD LEVEL 5 SMALL, MULTI-ENGINE (RECIPROCATING) AIRPLANE

<<<QPS requirement>>>  
The performance parameters in this table must be used to program the FTD if flight test data is not used to program the FTD.

| Applicable test       |   | Authorized performance range   |
|-----------------------|---|--|
| Number                | Title and procedure   |  |
| <b>1. Performance</b> |   |  |
| 1.c. ....             | Climb   |  |
| 1.c.1. ....           | Normal climb with nominal gross weight, at best rate-of-climb airspeed. | Climb airspeed = 95–115 knots.<br>Climb rate = 500–1500 fpm (2.5–7.5 m/sec). |
| 1.f. ....             | Engines   |  |
| 1.f.1. ....           | Acceleration; idle to takeoff power .....                               | 2–5 seconds.   |
| 1.f.2. ....           | Deceleration; takeoff power to idle .....                               | 2–5 seconds.   |



TABLE B2C.—ALTERNATIVE DATA SOURCE FOR FTD LEVEL 5 SMALL, MULTI-ENGINE (RECIPROCATING) AIRPLANE—  
Continued

| <<<QPS requirement>>>  |   |   |
|--|---|---|
| The performance parameters in this table must be used to program the FTD if flight test data is not used to program the FTD. |   |   |
| Applicable test  |   | Authorized performance range  |
| Number   | Title and procedure   |   |
| <b>2. Handling Qualities</b>   |   |   |
| 2.c. ....  | Longitudinal Tests  |   |
| 2.c.1. ....  | Power change force  |   |
|  | (a) Trim for straight and level flight at 80% of normal cruise airspeed with necessary power. Reduce power to flight idle. Do not change trim or configuration. After stabilized, record column force necessary to maintain original airspeed.  | 10–25 lbs (2.2–6.6 daN) of force (Pull).  |
|  | OR  |   |
|  | (b) Trim for straight and level flight at 80% of normal cruise airspeed with necessary power. Add power to maximum setting. Do not change trim or configuration. After stabilized, record column force necessary to maintain original airspeed.   | 5–15 lbs (2.2–6.6 daN) of force (Push).   |
| 2.c.2. ....  | Flap/slat change force  |   |
|  | (a) Trim for straight and level flight with flaps fully retracted at a constant airspeed within the flaps-extended airspeed range. Do not adjust trim or power. Extend the flaps to 50% of full flap travel. After stabilized, record stick force necessary to maintain original airspeed.    | 5–15 lbs (2.2–6.6 daN) of force (Pull).   |
|  | OR  |   |
|  | (b) Trim for straight and level flight with flaps extended to 50% of full flap travel, at a constant airspeed within the flaps-extended airspeed range. Do not adjust trim or power. Retract the flaps to zero. After stabilized, record stick force necessary to maintain original airspeed. | 5–15 lbs (2.2–6.6 daN) of force (Push).   |
| 2.c.4. ....  | Gear change force   |   |
|  | (a) Trim for straight and level flight with landing gear retracted at a constant airspeed within the landing gear-extended airspeed range. Do not adjust trim or power. Extend the landing gear. After stabilized, record stick force necessary to maintain original airspeed.                | 2–12 lbs (0.88–5.3 daN) of force (Pull).  |
|  | OR  |   |
|  | (b) Trim for straight and level flight with landing gear extended, at a constant airspeed within the landing gear-extended airspeed range. Do not adjust trim or power. Retract the landing gear. After stabilized, record stick force necessary to maintain original airspeed.               | 2–12 lbs (0.88–5.3 daN) of force (Push).  |
| 2.c.4. ....  | Longitudinal trim .....   | Must be able to trim longitudinal stick force to “zero” in each of the following configurations: cruise; approach; and landing. |
| 2.c.7. ....  | Longitudinal static stability .....   | Must exhibit positive static stability.   |
| 2.c.8. ....  | Stall warning (actuation of stall warning device) with nominal gross weight; wings level; and a deceleration rate of not more than three (3) knots per second   |   |
|  | (a) Landing configuration .....   | 60–90 knots; $\pm 5^\circ$ of bank.   |
|  | (b) Clean configuration .....   | Landing configuration speed + 10–20%.   |
| 2.c.9.b.   | Phugoid dynamics .....  | Must have a phugoid with a period of 30–60 seconds. May not reach $\frac{1}{2}$ or double amplitude in less than 2 cycles.      |
| 2.d. ....  | Lateral Directional Tests   |   |

TABLE B2C.—ALTERNATIVE DATA SOURCE FOR FTD LEVEL 5 SMALL, MULTI-ENGINE (RECIPROCATING) AIRPLANE—  
Continued

<<<QPS requirement>>>  
The performance parameters in this table must be used to program the FTD if flight test data is not used to program the FTD.

| Applicable test                    |   | Authorized performance range                                     |
|------------------------------------|---|--|
| Number                             | Title and procedure   |  |
| 2.d.2. ....                        | Roll response .....<br>Roll rate must be measured through at least 30° of roll. Aileron control must be deflected 1/3 (33.3 percent) of maximum travel.   | Must have a roll rate of 4°–25°/second.                          |
| 2.d.4.b.                           | Spiral stability .....<br>Cruise configuration and normal cruise airspeed. Establish a 20°–30° bank. When stabilized, neutralize the aileron control and release. Must be completed in both directions of turn. | Initial bank angle (±5°) after 20 seconds.                       |
| 2.d.6.b.                           | Rudder response .....<br>Use 25 percent of maximum rudder deflection. (Applicable to approach or landing configuration.)  | 3°–6°/second yaw rate.   |
| 2.d.7. ....                        | Dutch roll, yaw damper off. (Applicable to cruise and approach configurations.)   | A period of 2–5 seconds; and 1/2–2 cycles.                       |
| 2.d.8. ....                        | Steady state sideslip .....<br>Use 50 percent rudder deflection. (Applicable to approach and landing configurations.)   | 2°–10° of bank; 4–10 degrees of sideslip; and 2°–10° of aileron. |
| <b>6. FTD System Response Time</b> |   |  |
| 6.a. ....                          | Flight deck instrument systems response to an abrupt pilot controller input. One test is required in each axis (pitch, roll, yaw).  | 300 milliseconds or less.  |

TABLE B2D.—ALTERNATIVE DATA SOURCE FOR FTD LEVEL 5 SMALL, SINGLE ENGINE (TURBO-PROPELLER) AIRPLANE

<<<QPS requirement>>>  
The performance parameters in this table must be used to program the FTD in flight test data is not used to program the FTD.

| Applicable test              |   | Authorized performance range   |
|------------------------------|---|--|
| Number                       | Title and procedure   |  |
| <b>1. Performance</b>        |   |  |
| 1.c. ....                    | Climb   |  |
| 1.c.1. ....                  | Normal climb with nominal gross weight, at best rate-of-climb airspeed.   | Climb airspeed = 95–115 knots.<br>Climb rate = 800–1800 fpm (4–9 m/sec). |
| 1.f. ....                    | Engines   |  |
| 1.f.1. ....                  | Acceleration; idle to takeoff power .....   | 4–8 Seconds.   |
| 1.f.2. ....                  | Deceleration; takeoff power to idle .....   | 3–7 Seconds.   |
| <b>2. Handling Qualities</b> |   |  |
| 2.c. ....                    | Longitudinal Tests  |  |
| 2.c.1. ....                  | Power change force  |  |
|                              | (a) Trim for straight and level flight at 80% of normal cruise airspeed with necessary power. Reduce power to flight idle. Do not change trim or configuration. After stabilized, record column force necessary to maintain original airspeed.  | 8 lbs (3.5 daN) of Push force—8 lbs (3.5 daN) of Pull force.             |
|                              | OR  |  |
|                              | (b) Trim for straight and level flight at 80% of normal cruise airspeed with necessary power. Add power to maximum setting. Do not change trim or configuration. After stabilized, record column force necessary to maintain original airspeed. | 12–22 lbs (5.3–9.7 daN) of force (Push).                                 |
| 2.c.2. ....                  | Flap/slat change force  |  |

TABLE B2D.—ALTERNATIVE DATA SOURCE FOR FTD LEVEL 5 SMALL, SINGLE ENGINE (TURBO-PROPELLER) AIRPLANE—  
Continued

| <<<QPS requirement>>>  |   |   |
|--|---|---|
| The performance parameters in this table must be used to program the FTD in flight test data is not used to program the FTD. |   |   |
| Applicable test  |   | Authorized performance range  |
| Number   | Title and procedure   |   |
|  | (a) Trim for straight and level flight with flaps fully retracted at a constant airspeed within the flaps-extended airspeed range. Do not adjust trim or power. Extend the flaps to 50% of full flap travel. After stabilized, record stick force necessary to maintain original airspeed.    | 5–15 lbs (2.2–6.6 daN) of force (Pull).   |
|  | OR  |   |
|  | (b) Trim for straight and level flight with flaps extended to 50% of full flap travel, at a constant airspeed within the flaps-extended airspeed range. Do not adjust trim or power. Retract the flaps to zero. After stabilized, record stick force necessary to maintain original airspeed. | 5–15 lbs (2.2–6.6 daN) of force (Push).   |
| 2.c.4. ....  | Gear change force   |   |
|  | (a) Trim for straight and level flight with landing gear retracted at a constant airspeed within the landing gear-extended airspeed range. Do not adjust trim or power. Extend the landing gear. After stabilized, record stick force necessary to maintain original airspeed.                | 2–12 lbs (0.88–5.3 daN) of force (Pull).  |
|  | OR  |   |
|  | (b) Trim for straight and level flight with landing gear extended, at a constant airspeed within the landing gear-extended airspeed range. Do not adjust trim or power. Retract the landing gear. After stabilized, record stick force necessary to maintain original airspeed.               | 2–12 lbs (0.88–5.3 daN) of force (Push).  |
| 2.b.5. ....  | Longitudinal trim .....   | Must be able to trim longitudinal stick force to “zero” in each of the following configurations: cruise; approach; and landing. |
| 2.c.7. ....  | Longitudinal static stability .....   | Must exhibit positive static stability.   |
| 2.c.8. ....  | Stall warning (actuation of stall warning device) with nominal gross weight; wings level; and a deceleration rate of not more than three (3) knots per second.  |   |
|  | (a) Landing configuration .....   | 60–90 knots; $\pm 5^\circ$ of bank.   |
|  | (b) Clean configuration .....   | Landing configuration speed + 10–20%.   |
| 2.c.8.b.   | Phugoid dynamics .....  | Must have a phugoid with a period of 30–60 seconds. May not reach $\frac{1}{2}$ or double amplitude in less than 2 cycles.      |
| 2.d. ....  | Lateral Directional Tests   |   |
| 2.d.2. ....  | Roll response .....   | Must have a roll rate of $4^\circ$ – $25^\circ$ /second.  |
|  | Roll rate must be measured through at least $30^\circ$ of roll. Aileron control must be deflected $\frac{1}{3}$ (33.3 percent) of maximum travel.   |   |
| 2.d.4.b.   | Spiral stability .....  | Initial bank angle ( $\pm 5^\circ$ ) after 20 seconds.  |
|  | Cruise configuration and normal cruise airspeed. Establish a $20^\circ$ – $30^\circ$ bank. When stabilized, neutralize the aileron control and release. Must be completed in both directions of turn.   |   |
| 2.d.6.b.   | Rudder response .....   | $3^\circ$ – $6^\circ$ /second yaw rate.   |
|  | Use 25 percent of maximum rudder deflection. (Applicable to approach or landing configuration.)   |   |
| 2.d.7. ....  | Dutch roll, yaw damper off. (Applicable to cruise and approach configurations.)   | A period of 2–5 seconds; and $\frac{1}{2}$ –3 cycles.   |
| 2.d.8. ....  | Steady state sideslip .....   | $2^\circ$ – $10^\circ$ of bank; $4^\circ$ – $10^\circ$ of sideslip; and $2^\circ$ – $10^\circ$ of aileron.                      |
|  | Use 50 percent rudder deflection. (Applicable to approach and landing configurations.)  |   |

TABLE B2D.—ALTERNATIVE DATA SOURCE FOR FTD LEVEL 5 SMALL, SINGLE ENGINE (TURBO-PROPELLER) AIRPLANE—Continued

<<<QPS requirement>>>

The performance parameters in this table must be used to program the FTD in flight test data is not used to program the FTD.

| Applicable test                    |  | Authorized performance range |
|------------------------------------|--|------------------------------|
| Number                             | Title and procedure  |                              |
| <b>6. FTD System Response Time</b> |  |                              |
| 6.a. ....                          | Flight deck instrument systems response to an abrupt pilot controller input. One test is required in each axis (pitch, roll, yaw). | 300 milliseconds or less.    |

TABLE B2E.—ALTERNATIVE DATA SOURCE FOR FTD LEVEL 5 MULTI-ENGINE (TURBO-PROPELLER) AIRPLANE

<<<QPS requirement>>>

The performance parameters in this table must be used to program the FTD in flight test data is not used to program the FTD.

| Applicable test              |   | Authorized performance range   |
|------------------------------|---|--|
| Number                       | Title and procedure   |  |
| <b>1. Performance</b>        |   |  |
| 1.c. ....                    | Climb.  |  |
| 1.b.1. ....                  | Normal climb with nominal gross weight, at best rate-of-climb airspeed.   | Climb airspeed = 120–140 knots.<br>Climb rate = 1000–3000 fpm (5–15 m/sec) |
| 1.f. ....                    | Engines   |  |
| 1.f.1. ....                  | Acceleration; idle to takeoff power .....   | 2–6 Seconds.   |
| 1.f.2. ....                  | Deceleration; takeoff power to idle .....   | 1–5 Seconds.   |
| <b>2. Handling Qualities</b> |   |  |
| 2.c. ....                    | Longitudinal Tests  |  |
| 2.c.1. ....                  | Power change force  |  |
|                              | (a) Trim for straight and level flight at 80% of normal cruise airspeed with necessary power. Reduce power to flight idle. Do not change trim or configuration. After stabilized, record column force necessary to maintain original airspeed.  | 8 lbs (3.5 daN) of Push force to 8 lbs (3.5 daN) of Pull force.            |
|                              | OR  |  |
|                              | (b) Trim for straight and level flight at 80% of normal cruise airspeed with necessary power. Add power to maximum setting. Do not change trim or configuration. After stabilized, record column force necessary to maintain original airspeed.   | 12–22 lbs (5.3–9.7 daN) of force (Push).                                   |
| 2.c.2. ....                  | Flap/slat change force  |  |
|                              | (a) Trim for straight and level flight with flaps fully retracted at a constant airspeed within the flaps-extended airspeed range. Do not adjust trim or power. Extend the flaps to 50% of full flap travel. After stabilized, record stick force necessary to maintain original airspeed.    | 5–15 lbs (2.2–6.6 daN) of force (Pull).                                    |
|                              | OR  |  |
|                              | (b) Trim for straight and level flight with flaps extended to 50% of full flap travel, at a constant airspeed within the flaps-extended airspeed range. Do not adjust trim or power. Retract the flaps to zero. After stabilized, record stick force necessary to maintain original airspeed. | 5–15 lbs (2.2–6.6 daN) of force (Push).                                    |
| 2.c.4. ....                  | Gear change force   |  |

TABLE B2E.—ALTERNATIVE DATA SOURCE FOR FTD LEVEL 5 MULTI-ENGINE (TURBO-PROPELLER) AIRPLANE—Continued

<<<QPS requirement>>>  
The performance parameters in this table must be used to program the FTD in flight test data is not used to program the FTD.

| Applicable test                    |  | Authorized performance range  |
|------------------------------------|--|---|
| Number                             | Title and procedure  |   |
|                                    | (a) Trim for straight and level flight with landing gear retracted at a constant airspeed within the landing gear-extended airspeed range. Do not adjust trim or power. Extend the landing gear. After stabilized, record stick force necessary to maintain original airspeed. | 2–12 lbs (0.88–5.3 daN) of force (Pull).  |
|                                    | OR   |   |
|                                    | b) Trim for straight and level flight with landing gear extended, at a constant airspeed within the landing gear-extended airspeed range. Do not adjust trim or power. Retract the landing gear. After stabilized, record stick force necessary to maintain original airspeed. | 2–12 lbs (0.88–5.3 daN) of force (Push).  |
| 2.b.5. ....                        | Longitudinal trim .....  | Must be able to trim longitudinal stick force to “zero” in each of the following configurations: cruise; approach; and landing. |
| 2.c.7. ....                        | Longitudinal static stability .....  | Must exhibit positive static stability.   |
| 2.c.8. ....                        | Stall warning (actuation of stall warning device) with nominal gross weight; wings level; and a deceleration rate of not more than three (3) knots per second.<br>(a) Landing configuration .....  | 80–100 knots; ±5° of bank.<br>Landing configuration speed + 10–20%.   |
|                                    | (b) Clean configuration .....  |   |
| 2.c.8.b.                           | Phugoid dynamics .....   | Must have a phugoid with a period of 30–60 seconds. May not reach ½ or double amplitude in less than 2 cycles.                  |
| 2.d. ....                          | Lateral Directional Tests  |   |
| 2.d.2. ....                        | Roll response .....<br>Roll rate must be measured through at least 30° of roll. Aileron control must be deflected ⅓ (33.3 percent) of maximum travel.  | Must have a roll rate of 4–25 degrees/second.   |
| 2.d.4.b.                           | Spiral stability .....<br>Cruise configuration and normal cruise airspeed. Establish a 20°–30° bank. When stabilized, neutralize the aileron control and release. Must be completed in both directions of turn.  | Initial bank angle (±5°) after 20 seconds.  |
| 2.d.6.b.                           | Rudder response .....<br>Use 25 percent of maximum rudder deflection. (Applicable to approach or landing configuration.)   | 3°–6°/second yaw rate.  |
| 2.d.7. ....                        | Dutch roll, yaw damper off. (Applicable to cruise and approach configurations.)  | A period of 2–5 seconds; and ½–2 cycles.  |
| 2.d.8. ....                        | Steady state sideslip .....<br>Use 50 percent rudder deflection. (Applicable to approach and landing configurations.)  | 2°–10° of bank;<br>4°–10° of sideslip; and<br>2°–10° of aileron.  |
| <b>6. FTD System Response Time</b> |  |   |
| 6.a. ....                          | Flight deck instrument systems response to an abrupt pilot controller input. One test is required in each axis (pitch, roll, yaw).   | 300 milliseconds or less.   |

**End QPS Requirements**

**Begin QPS Requirements**

**5. Alternative Data Sources, Procedures, and Instrumentation: Level 6 FTD Only**

a. Sponsors are not required to use the alternative data sources, procedures, and instrumentation. However, any sponsor

choosing to use alternative sources must comply with the requirements in Table B2F.

**End QPS Requirements**

**Begin Information**

b. It has become standard practice for experienced FTD manufacturers to use such techniques as a means of establishing data bases for new FTD configurations while

awaiting the availability of actual flight test data; and then comparing this new data with the newly available flight test data. The results of such comparisons have, as reported by some recognized and experienced simulation experts, become increasingly consistent and indicate that these techniques, applied with appropriate experience, are becoming dependably accurate for the development of aerodynamic models for use in Level 6 FTDs.

c. In reviewing this history, the NSPM has concluded that, with proper care, those who are experienced in the development of aerodynamic models for FTD application can successfully use these modeling techniques to acceptably alter the method by which flight test data may be acquired and, when applied to Level 6 FTDs, does not compromise the quality of that simulation.

d. The information in the table that follows (Table of Alternative Data Sources, Procedures, and Information: Level 6 FTD Only) is presented to describe an acceptable alternative to data sources for Level 6 FTD modeling and validation, and an acceptable alternative to the procedures and instrumentation found in the flight test methods traditionally accepted for gathering modeling and validation data.

(1) Alternative data sources that may be used for part or all of a data requirement are the Airplane Maintenance Manual, the Airplane Flight Manual (AFM), Airplane Design Data, the Type Inspection Report

(TIR), Certification Data or acceptable supplemental flight test data.

(2) The NSPM recommends that use of the alternative instrumentation noted in Table B2F be coordinated with the NSPM prior to employment in a flight test or data gathering effort.

e. The NSPM position regarding the use of these alternative data sources, procedures, and instrumentation is based on three primary preconditions and presumptions regarding the objective data and FTD aerodynamic program modeling.

(1) Data gathered through the alternative means does not require angle of attack (AOA) measurements or control surface position measurements for any flight test. AOA can be sufficiently derived if the flight test program insures the collection of acceptable level, unaccelerated, trimmed flight data. Angle of attack may be validated by conducting the three basic "fly-by" trim tests. The FTD time history tests should begin in level, unaccelerated, and trimmed flight, and the

results should be compared with the flight test pitch angle.

(2) A simulation controls system model should be rigorously defined and fully mature. It should also include accurate gearing and cable stretch characteristics (where applicable) that are determined from actual aircraft measurements. Such a model does not require control surface position measurements in the flight test objective data for Level 6 FTD applications.

f. Table B2F is not applicable to Computer Controlled Aircraft FTDs.

g. Utilization of these alternate data sources, procedures, and instrumentation does not relieve the sponsor from compliance with the balance of the information contained in this document relative to Level 6 FTDs.

h. The term "inertial measurement system" allows the use of a functional global positioning system (GPS).

**End Information**

**TABLE B2F.—ALTERNATIVE DATA SOURCES, PROCEDURES, AND INSTRUMENTATION LEVEL 6 FTD**

| <<<QPS requirements>>>   |   |  |
|--|---|--|
| The standards in this table are required if the data gathering methods described in paragraph 9 of Appendix B are not used.          |   |  |
| Objective test reference number and title  | Alternative data sources, procedures, and instrumentation   | Notes and reminders                          |
| 1.b.1. ....<br>Performance<br>Takeoff<br>Ground acceleration time.   | Data may be acquired through a synchronized video recording of a stop watch and the calibrated airplane airspeed indicator. Hand-record the flight conditions and airplane configuration.   | This test is required only if RTO is sought. |
| 1.b.7. ....<br>Performance<br>Takeoff<br>Rejected takeoff.   | Data may be acquired through a synchronized video recording of a stop watch and the calibrated airplane airspeed indicator. Hand-record the flight conditions and airplane configuration.   | This test is required only if RTO is sought. |
| 1.c.1. ....<br>Performance<br>Climb<br>Normal climb all engines operating.   | Data may be acquired with a synchronized video of calibrated airplane instruments and engine power throughout the climb range.  |  |
| 1.f.1. ....<br>Performance<br>Engines<br>Acceleration.   | Data may be acquired with a synchronized video recording of engine instruments and throttle position.   |  |
| 1.f.2. ....<br>Performance<br>Engines<br>Deceleration.   | Data may be acquired with a synchronized video recording of engine instruments and throttle position.   |  |
| 2.a.1.a. ....<br>Handling qualities<br>Static control tests<br>Pitch controller position vs. force and surface position calibration. | Surface position data may be acquired from flight data recorder (FDR) sensor or, if no FDR sensor, at selected, significant column positions (encompassing significant column position data points), acceptable to the NSPM, using a control surface protractor on the ground (for airplanes with reversible control systems, this function should be accomplished with winds less than 5 kt). Force data may be acquired by using a hand held force gauge at the same column position data points. |  |

TABLE B2F.—ALTERNATIVE DATA SOURCES, PROCEDURES, AND INSTRUMENTATION LEVEL 6 FTD—Continued

| <<<QPS requirements>>>   |   |   |
|--|---|---|
| The standards in this table are required if the data gathering methods described in paragraph 9 of Appendix B are not used.  |   |   |
| Objective test reference number and title  | Alternative data sources, procedures, and instrumentation   | Notes and reminders   |
| 2.a.2.a. ....<br>Handling qualities<br>Static control tests<br>Wheel position vs. force and surface position calibration.  | Surface position data may be acquired from flight data recorder (FDR) sensor or, if no FDR sensor, at selected, significant column positions (encompassing significant column position data points), acceptable to the NSPM, using a control surface protractor on the ground (for airplanes with reversible control systems, this function should be accomplished with winds less than 5 kt). Force data may be acquired by using a hand held force gauge at the same column position data points. |   |
| 2.a.3.a. ....<br>Handling qualities<br>Static control tests<br>Rudder pedal position vs. force and surface position calibration.   | Surface position data may be acquired from flight data recorder (FDR) sensor or, if no FDR sensor, at selected, significant column positions (encompassing significant column position data points), acceptable to the NSPM, using a control surface protractor on the ground (for airplanes with reversible control systems, this function should be accomplished with winds less than 5 kt). Force data may be acquired by using a hand held force gauge at the same column position data points. |   |
| 2.a.4. ....<br>Handling qualities<br>Static control tests<br>Nosewheel steering force.   | Breakout data may be acquired with a hand held force gauge. The remainder of the force to the stops may be calculated if the force gauge and a protractor are used to measure force after breakout for at least 25% of the total displacement capability.   |   |
| 2.a.5. ....<br>Handling qualities<br>Static control tests<br>Rudder pedal steering calibration.  | Data may be acquired through the use of force pads on the rudder pedals and a pedal position measurement device, together with design data for nose wheel position.   |   |
| 2.a.6. ....<br>Handling qualities<br>Static control tests<br>Pitch trim indicator vs. surface position calibration.  | Data may be acquired through calculations.  |   |
| 2.a.8. ....<br>Handling qualities<br>Static control tests<br>Alignment of power lever angle vs. selected engine parameter (e.g., EPR, N <sub>1</sub> , Torque, Manifold pressure). | Data may be acquired through the use of a temporary throttle quadrant scale to document throttle position. Use a synchronized video to record steady state instrument readings or hand-record steady state engine performance readings.   |   |
| 2.a.9. ....<br>Handling qualities<br>Static control tests<br>Brake pedal position vs. force.   | Use of design or predicted data is acceptable. Data may be acquired by measuring deflection at "zero" and at "maximum."   |   |
| 2.c.1. ....<br>Handling qualities<br>Longitudinal control tests<br>Power change force.   | Data may be acquired by using an inertial measurement system and a synchronized video of the calibrated airplane instruments, throttle position, and the force/position measurements of flight deck controls.   | Power change dynamics test is acceptable using the same data acquisition methodology.     |
| 2.c.2. ....<br>Handling qualities<br>Longitudinal control tests<br>Flap/slat change force.   | Data may be acquired by using an inertial measurement system and a synchronized video of calibrated airplane instruments, flap/slat position, and the force/position measurements of flight deck controls.  | Flap/slat change dynamics test is acceptable using the same data acquisition methodology. |
| 2.c.4. ....<br>Handling qualities<br>Longitudinal control tests<br>Gear change force.  | Data may be acquired by using an inertial measurement system and a synchronized video of the calibrated airplane instruments, gear position, and the force/position measurements of flight deck controls.   | Gear change dynamics test is acceptable using the same data acquisition methodology.      |

TABLE B2F.—ALTERNATIVE DATA SOURCES, PROCEDURES, AND INSTRUMENTATION LEVEL 6 FTD—Continued

| <<<QPS requirements>>>   |   |   |
|--|---|---|
| The standards in this table are required if the data gathering methods described in paragraph 9 of Appendix B are not used.                                |   |   |
| Objective test reference number and title  | Alternative data sources, procedures, and instrumentation   | Notes and reminders   |
| 2.c.5. ....<br>Handling qualities<br>Longitudinal control tests<br>Longitudinal trim.  | Data may be acquired through use of an inertial measurement system and a synchronized video of flight deck controls position (previously calibrated to show related surface position) and engine instrument readings.   |   |
| 2.c.6. ....<br>Handling qualities<br>Longitudinal control tests<br>Longitudinal maneuvering stability (stick force/g).                                     | Data may be acquired through the use of an inertial measurement system and a synchronized video of the calibrated airplane instruments; a temporary, high resolution bank angle scale affixed to the attitude indicator; and a wheel and column force measurement indication. |   |
| 2.c.7. ....<br>Handling qualities.<br>Longitudinal control tests<br>Longitudinal static stability.   | Data may be acquired through the use of a synchronized video of the airplane flight instruments and a hand held force gauge.  |   |
| 2.c.8. ....<br>Handling qualities<br>Longitudinal control tests<br>Stall Warning (activation of stall warning device).                                     | Data may be acquired through a synchronized video recording of a stop watch and the calibrated airplane airspeed indicator. Hand-record the flight conditions and airplane configuration.   | Airspeeds may be cross checked with those in the TIR and AFM. |
| 2.c.9.a. ....<br>Handling qualities. Longitudinal control tests<br>Phugoid dynamics.   | Data may be acquired by using an inertial measurement system and a synchronized video of the calibrated airplane instruments and the force/position measurements of flight deck controls.   |   |
| 2.c.10. ....<br>Handling qualities<br>Longitudinal control tests<br>Short period dynamics.   | Data may be acquired by using an inertial measurement system and a synchronized video of the calibrated airplane instruments and the force/position measurements of flight deck controls.   |   |
| 2.c.11. ....<br>Handling qualities<br>Longitudinal control tests<br>Gear and flap/slat operating times.  | May use design data, production flight test schedule, or maintenance specification, together with an SOC.   |   |
| 2.d.2. ....<br>Handling qualities<br>Lateral directional tests<br>Roll response (rate).  | Data may be acquired by using an inertial measurement system and a synchronized video of the calibrated airplane instruments and the force/position measurements of flight deck lateral controls.   |   |
| 2.d.3. ....<br>Handling qualities<br>Lateral directional tests<br>(a) Roll overshoot<br>OR<br>(b) Roll response to flight deck roll controller step input. | Data may be acquired by using an inertial measurement system and a synchronized video of the calibrated airplane instruments and the force/position measurements of flight deck lateral controls.   |   |
| 2.d.4. ....<br>Handling qualities<br>Lateral directional tests<br>Spiral stability.  | Data may be acquired by using an inertial measurement system and a synchronized video of the calibrated airplane instruments; the force/position measurements of flight deck controls; and a stop watch.  |   |
| 2.d.6.a. ....<br>Handling qualities<br>Lateral directional tests<br>Rudder response.   | Data may be acquired by using an inertial measurement system and a synchronized video of the calibrated airplane instruments; the force/position measurements of rudder pedals.   |   |
| 2.d.7. ....<br>Handling qualities<br>Lateral directional tests<br>Dutch roll, (yaw damper OFF).  | Data may be acquired by using an inertial measurement system and a synchronized video of the calibrated airplane instruments and the force/position measurements of flight deck controls.   |   |



TABLE B2F.—ALTERNATIVE DATA SOURCES, PROCEDURES, AND INSTRUMENTATION LEVEL 6 FTD—Continued

<<<QPS requirements>>>

The standards in this table are required if the data gathering methods described in paragraph 9 of Appendix B are not used.

| Objective test reference number and title  | Alternative data sources, procedures, and instrumentation   | Notes and reminders |
|--|---|---------------------|
| 2.d.8. ....<br>Handling qualities<br>Lateral directional tests<br>Steady state sideslip. | Data may be acquired by using an inertial measurement system and a synchronized video of the calibrated airplane instruments and the force/position measurements of flight deck controls. |                     |

**Attachment 3 to Appendix B to Part 60—Flight Training Device (FTD) Subjective Evaluation**

**Begin Information**

**1. Discussion**

a. The subjective tests provide a basis for evaluating the capability of the FTD to perform over a typical utilization period. The items listed in the Table of Functions and Subjective Tests are used to determine whether the FTD competently simulates each required maneuver, procedure, or task; and verifying correct operation of the FTD controls, instruments, and systems. The tasks do not limit or exceed the authorizations for

use of a given level of FTD as described on the Statement of Qualification or as may be approved by the TPAA. All items in the following paragraphs are subject to examination.

b. All simulated airplane systems functions will be assessed for normal and, where appropriate, alternate operations. Simulated airplane systems are listed separately under “Any Flight Phase” to ensure appropriate attention to systems checks. Operational navigation systems (including inertial navigation systems, global positioning systems, or other long-range systems) and the associated electronic display systems will be evaluated if installed. The NSP pilot will include in his report to the TPAA, the effect

of the system operation and any system limitation.

c. At the request of the TPAA, the NSP Pilot may assess the FTD for a special aspect of a sponsor’s training program during the functions and subjective portion of an evaluation. Such an assessment may include a portion of a specific operation (e.g., a Line Oriented Flight Training (LOFT) scenario) or special emphasis items in the sponsor’s training program. Unless directly related to a requirement for the qualification level, the results of such an evaluation would not affect the qualification of the FTD.

**End Information**

TABLE B3A.—TABLE OF FUNCTIONS AND SUBJECTIVE TESTS LEVEL 6 FTD

<<<QPS requirements>>>

| Number  | Operations tasks  |
|---|---|
| Tasks in this table are subject to evaluation if appropriate for the airplane system or systems simulated as indicated in the SOQ Configuration List as defined in Appendix B, Attachment 2 of this part. |   |
| <b>1. Preflight</b>   |   |
|   | Accomplish a functions check of all installed switches, indicators, systems, and equipment at all crewmembers’ and instructors’ stations, and determine that the flight deck (or flight deck area) design and functions replicate the appropriate airplane. |
| <b>2. Surface Operations (pre-takeoff)</b>  |   |
| 2.a. ....   | Engine start:   |
| 2.a.1. ....   | Normal start.   |
| 2.a.2. ....   | Alternative procedures start.   |
| 2.a.3. ....   | Abnormal procedures start/shut down.  |
| 2.b. ....   | Pushback/Powerback (powerback requires visual system).  |
| <b>3. Takeoff (requires appropriate visual system as set out in Table B1A, item 6; Appendix B, Attachment 1.)</b>   |   |
| 3.a. ....   | Instrument takeoff:   |
| 3.a.1. ....   | Engine checks (e.g., engine parameter relationships, propeller/mixture controls).   |
| 3.a.2. ....   | Acceleration characteristics.   |
| 3.a.3. ....   | Nosewheel/rudder steering.  |
| 3.a.4. ....   | Landing gear, wing flap, leading edge device operation.   |
| 3.b. ....   | Rejected takeoff:   |
| 3.b.1. ....   | Deceleration characteristics.   |
| 3.b.2. ....   | Brakes/engine reverser/ground spoiler operation.  |

TABLE B3A.—TABLE OF FUNCTIONS AND SUBJECTIVE TESTS LEVEL 6 FTD—Continued

| <<<QPS requirements>>>         |   |
|--------------------------------|---|
| Number                         | Operations tasks  |
| 3.b.3. ....                    | Nosewheel/rudder steering.  |
| <b>4. In-Flight Operations</b> |   |
| 4.a. ....                      | Normal climb.   |
| 4.b. ....                      | Cruise:   |
| 4.b.1. ....                    | Demonstration of performance characteristics (speed vs. power).   |
| 4.b.2. ....                    | Normal turns.   |
| 4.b.3. ....                    | Demonstration of high altitude handling.                          |
| 4.b.4. ....                    | Demonstration of high airspeed handling/overspeed warning.        |
| 4.b.5. ....                    | Demonstration of Mach effects on control and trim.                |
| 4.b.6. ....                    | Steep turns.  |
| 4.b.7. ....                    | In-Flight engine shutdown (procedures only).                      |
| 4.b.8. ....                    | In-Flight engine restart (procedures only).                       |
| 4.b.9. ....                    | Specific flight characteristics.                                  |
| 4.b.10. ..                     | Response to loss of flight control power.                         |
| 4.b.11. ..                     | Response to other flight control system failure modes.            |
| 4.b.12. ..                     | Operations during icing conditions.                               |
| 4.b.13. ..                     | Effects of airframe/engine icing.                                 |
| 4.c. ....                      | Other flight phase:   |
| 4.c.1. ....                    | Approach to stalls in the following configurations:               |
| 4.c.1.a.                       | Cruise.   |
| 4.c.1.b.                       | Takeoff or approach.  |
| 4.c.1.c.                       | Landing.  |
| 4.c.2. ....                    | High angle of attack maneuvers in the following configurations:   |
| 4.c.2.a.                       | Cruise.   |
| 4.c.2.b.                       | Takeoff or approach.  |
| 4.c.2.c.                       | Landing.  |
| 4.c.3. ....                    | Slow flight   |
| 4.c.4. ....                    | Holding.  |
| <b>5. Approaches</b>           |   |
| 5.a.                           |   |
| 5.a.1. ....                    | With use of autopilot and autothrottle, as applicable.            |
| 5.a.2. ....                    | Without use of autopilot and autothrottle, as applicable.         |
| 5.a.3. ....                    | With 10 knot tail wind.   |
| 5.a.4. ....                    | With 10 knot crosswind.   |
| 5.b. ....                      | Precision Instrument Approaches:                                  |
| 5.b.1. ....                    | With use of autopilot, autothrottle, and autoland, as applicable. |

TABLE B3A.—TABLE OF FUNCTIONS AND SUBJECTIVE TESTS LEVEL 6 FTD—Continued

| <<<QPS requirements>>>   |  |
|--|--|
| Number   | Operations tasks   |
| 5.b.2. ....  | Without use of autopilot, autothrottle, and autoland, as applicable. |
| 5.b.3. ....  | With 10 knot tail wind.  |
| 5.b.4. ....  | With 10 knot crosswind.  |
| <b>6. Missed Approach</b>  |  |
| 6.a. ....  | Manually controlled.   |
| 6.b. ....  | Automatically controlled (if applicable).                            |
| <b>7. Any Flight Phase, as appropriate</b>   |  |
| 7.a. ....  | Normal system operation (installed systems).                         |
| 7.b. ....  | Abnormal/Emergency system operation (installed systems).             |
| 7.c. ....  | Flap operation.  |
| 7.d. ....  | Landing gear operation.  |
| 7.e. ....  | Engine Shutdown and Parking.   |
| 7.e.1. ....  | Systems operation.   |
| 7.e.2. ....  | Parking brake operation.   |
| <b>8. Instructor Operating Station (IOS), as appropriate. Functions in this section are subject to evaluation only if appropriate for the airplane and/or installed on the specific FTD involved</b> |  |
| 8.a. ....  | Power Switch(es).  |
| 8.b. ....  | Airplane conditions.   |
| 8.b.1. ....  | Gross weight, center of gravity, and fuel loading and allocation.    |
| 8.b.2. ....  | Airplane systems status.   |
| 8.b.3. ....  | Ground crew functions (e.g., external power, push back).             |
| 8.c. ....  | Airports.  |
| 8.c.1. ....  | Selection.   |
| 8.c.2. ....  | Runway selection.  |
| 8.c.3. ....  | Preset positions (e.g., ramp, over FAF).                             |
| 8.d. ....  | Environmental controls.  |
| 8.d.1. ....  | Temperature.   |
| 8.d.2. ....  | Climate conditions (e.g., ice, rain).                                |
| 8.d.3. ....  | Wind speed and direction.  |
| 8.e. ....  | Airplane system malfunctions.  |
| 8.e.1. ....  | Insertion/deletion.  |
| 8.e.2. ....  | Problem clear.   |
| 8.f. ....  | Locks, Freezes, and Repositioning.                                   |
| 8.f.1. ....  | Problem (all) freeze/release.  |
| 8.f.2. ....  | Position (geographic) freeze/release.                                |
| 8.f.3. ....  | Repositioning (locations, freezes, and releases).                    |

TABLE B3A.—TABLE OF FUNCTIONS AND SUBJECTIVE TESTS LEVEL 6 FTD—Continued

| <<<QPS requirements>>>  |                           |
|---|---------------------------|
| Number  | Operations tasks          |
| 8.f.4. ....   | Ground speed control.     |
| 8.f.5. ....   | Remote IOS, if installed. |
| <b>9. Sound Controls. On/off/adjustment</b>                             |                           |
| <b>10. Control Loading System (as applicable) On/off/emergency stop</b> |                           |
| <b>11. Observer Stations</b>  |                           |
| 11.a. ....  | Position.                 |
| 11.b. ....  | Adjustments.              |

**End QPS Requirements**

TABLE B3B.—TABLE OF FUNCTIONS AND SUBJECTIVE TESTS LEVEL 5 FTD

| <<<QPS requirements>>>  |   |
|---|---|
| Number  | Operations tasks  |
| Tasks in this table are subject to evaluation if appropriate for the airplane system or systems simulated as indicated in the SOQ Configuration List as defined in Appendix B, Attachment 2 of this part. |   |
| <b>1. Preflight</b>   |   |
|   | Accomplish a functions check of all installed switches, indicators, systems, and equipment at all crewmembers' and instructors' stations, and determine that the flight deck (or flight deck area) design and functions replicate the appropriate airplane. |
| <b>2. Surface Operations (pre-takeoff)</b>  |   |
| 2.a. ....   | Engine start (if installed):  |
| 2.a.1. ....   | Normal start.   |
| 2.a.2. ....   | Alternative procedures start.   |
| 2.a.3. ....   | Abnormal/Emergency procedures start/shut down.  |
| <b>3. In-Flight Operations</b>  |   |
| 3.a. ....   | Normal climb.   |
| 3.b. ....   | Cruise:   |
| 3.b.1. ....   | Performance characteristics (speed vs. power).  |
| 3.b.2. ....   | Normal turns.   |
| 3.c. ....   | Normal descent.   |
| <b>4. Approaches</b>  |   |
| 4.a. ....   | Coupled instrument approach maneuvers (as applicable for the systems installed).  |
| <b>5. Any Flight Phase</b>  |   |
| 5.a. ....   | Normal system operation (Installed systems).  |
| 5.b. ....   | Abnormal/Emergency system operation (installed systems).  |
| 5.c. ....   | Flap operation.   |
| 5.d. ....   | Landing gear operation.   |
| 5.e. ....   | Engine Shutdown and Parking (if installed).   |
| 5.e.1. ....   | Systems operation.  |

TABLE B3B.—TABLE OF FUNCTIONS AND SUBJECTIVE TESTS LEVEL 5 FTD—Continued

| <<<QPS requirements>>>                       |   |
|--|---|
| Number                                       | Operations tasks                                  |
| 5.e.2. ....                                  | Parking brake operation.                          |
| <b>6. Instructor Operating Station (IOS)</b> |   |
| 6.a. ....                                    | Power Switch(es).                                 |
| 6.b. ....                                    | Preset positions—ground, air.                     |
| 6.c. ....                                    | Airplane system malfunctions (Installed systems). |
| 6.c.1. ....                                  | Insertion/deletion.                               |
| 6.c.2. ....                                  | Problem clear.                                    |

TABLE B3C.—TABLE OF FUNCTIONS AND SUBJECTIVE TESTS LEVEL 4 FTD

| <<<QPS requirements>>>  |  |
|---|--|
| Number  | Operations tasks   |
| Tasks in this table are subject to evaluation if appropriate for the airplane system or systems simulated as indicated in the SOQ Configuration List as defined in Appendix B, Attachment 2 of this part. |  |
| 1. ....   | Level 4 FTDs are required to have at least one operational system. The NSPM will accomplish a functions check of all installed systems, switches, indicators, and equipment at all crewmembers' and instructors' stations, and determine that the flight deck (or flight deck area) design and functions replicate the appropriate airplane. |

**Attachment 4 to Appendix B to Part 60—  
Sample Documents**

**Begin Information**

**Table of Contents**

Title of Sample

Figure B4A Sample Letter, Request for Initial, Upgrade, or Reinstatement Evaluation

Figure B4B Attachment: FSTD Information Form

Figure B4C Sample Qualification Test Guide Cover Page

Figure B4D Sample Statement of Qualification—Certificate

Figure B4E Sample Statement of Qualification—Configuration List

Figure B4F Sample Statement of Qualification—List of Qualified Tasks

Figure B4G Sample Continuing Qualification Evaluation Requirements Page

Figure B4H Sample MQTG Index of Effective FSTD Directives

**BILLING CODE 4910-13-P**

**Attachment 4 to Appendix B to Part 60—  
Figure B4A – Sample Letter , Request for Initial, Upgrade, or Reinstatement  
Evaluation.  
INFORMATION**

Date \_\_\_\_\_

Edward D. Cook, Ph.D.  
Manager, National Simulator Program  
Federal Aviation Administration  
100 Hartsfield Centre Parkway  
Suite 400  
Atlanta, GA 30354

Dear Dr. Cook:

**RE: Request for Initial/Upgrade Evaluation Date**

This is to advise you of our intent to request an (initial or upgrade) evaluation of our (FSTD Manufacturer), (Aircraft Type/Level) Flight Simulation Training Device (FSTD), (FAA ID Number, if previously qualified), located in (City, State) at the (Facility) on (Proposed Evaluation Date). (The proposed evaluation date shall not be more than 180 days following the date of this letter.) The FSTD will be sponsored by (Name of Training Center/Air Carrier), FAA Designator (4 Letter Code). The FSTD will be sponsored as follows; (Select One)

- The FSTD will be used within the sponsor's FAA approved training program and placed on the sponsor's Training/Operations Specifications.
- The FSTD will be used for dry lease only.

We agree to provide the formal request for the evaluation to your staff as follows: (check one)

- For QTG tests run at the factory, not later, than 45 days prior to the proposed evaluation date with the additional "1/3 on-site" tests provided not later than 14 days prior to the proposed evaluation date.
- For QTG tests run on-site, not later than 30 days prior to the proposed evaluation date.

We understand that the formal request will contain the following documents:

4. Sponsor's Letter of Request (*Company Compliance Letter*).
5. Principal Operations Inspector (POI) or Training Center Program Manager's (TCPM) endorsement.
6. Complete QTG.

If we are unable to meet the above requirements, we understand this may result in a significant delay, perhaps 45 days or more, in rescheduling and completing the evaluation.

(The sponsor should add additional comments as necessary).

Please contact (Name Telephone and Fax Number of Sponsor's Contact) to confirm the date for this initial evaluation. We understand a member of your National Simulator Program staff will respond to this request within 14 days.

A copy of this letter of intent has been provided to (Name), the Principal Operations Inspector

**Attachment 4 to Appendix B to Part 60—  
Figure B4A – Sample Letter , Request for Initial, Upgrade, or Reinstatement  
Evaluation.  
INFORMATION**

(POI) and/or Training Center Program Manager (TCPM).

Sincerely,

Attachment: FSTD Information and Characteristics Form

cc: POI/TCPM

**Attachment 4 to Appendix B to Part 60—  
Figure B4B – Sample Letter , Request for Initial, Upgrade, or Reinstatement  
Evaluation  
Attachment: FSTD Information Form  
INFORMATION**

|  |   |  |  |
|--|---|--|--|
| Date: _____  |   |  |  |
| <b>Section 1. FSTD Information and Characteristics</b>   |   |  |  |
| Sponsor Name: _____  |   | FSTD Location: _____                           |  |
| Address: _____   |   | Physical Address: _____                        |  |
| City: _____  |   | City: _____                                    |  |
| State: _____   |   | State: _____                                   |  |
| Country: _____   |   | Country: _____                                 |  |
| ZIP: _____   |   | ZIP: _____                                     |  |
| Manager: _____   |   |  |  |
| Sponsor ID No:<br>(Four Letter FAA Designator) _____   |   | Nearest Airport:<br>(Airport Designator) _____ |  |
| Type of Evaluation Requested: <input type="checkbox"/> Initial <input type="checkbox"/> Upgrade <input type="checkbox"/> Recurrent <input type="checkbox"/> Special <input type="checkbox"/> Reinstatement |   |  |  |
| Qualification Basis: _____   | <input type="checkbox"/> A                    | <input type="checkbox"/> B                     | <input type="checkbox"/> Interim C <input type="checkbox"/> C <input type="checkbox"/> D |
|  | <input type="checkbox"/> 6                    | <input type="checkbox"/> 7                     | <input type="checkbox"/> Provisional Status  |
| Initial Qualification:<br>(If Applicable)  | Date: _____ Level _____                       | Manufacturer's Identification/Serial No:       | _____  |
| Upgrade Qualification:<br>(If Applicable)  | Date: _____ Level _____<br>MM/DD/YYYY         | <input type="checkbox"/> eQTG                  |  |
| <b>Other Technical Information:</b>  |   |  |  |
| FAA FSTD ID No:<br>(If Applicable)   | _____   | FSTD Manufacturer:                             | _____  |
| Convertible FSTD:  | <input type="checkbox"/> Yes:                 | Date of Manufacture:                           | _____<br>MM/DD/YYYY  |
| Related FAA ID No.<br>(If Applicable)  | _____   | Sponsor FSTD ID No:                            | _____  |
| Aircraft model/series: _____   | Source of aerodynamic model: _____            |  |  |
| Engine model(s) and data revision: _____   | Source of aerodynamic doefficient data: _____ |  |  |
| FMS identification and revision level: _____   | Aerodynamic data revision number: _____       |  |  |
| Visual system manufacturer/model: _____  | Visual system display: _____                  |  |  |
| Flight control data revision: _____  | FSTD computer(s) identification: _____        |  |  |
| Motion system manufacturer/type: _____   |   |  |  |
| National Aviation Authority (NAA):<br>(If Applicable)  | _____   |  | _____  |
| NAA FSTD ID No:  | _____   | Last NAA Evaluation Date:                      | _____  |



**Attachment 4 to Appendix B to Part 60—  
Figure B4B – Sample Letter , Request for Initial, Upgrade, or Reinstatement  
Evaluation  
Attachment: FSTD Information Form  
INFORMATION**

|   |  |   |   |
|---|--|---|---|
| NAA Qualification Level:                    | _____  |   |   |
| NAA Qualification Basis:                    | _____  |   |   |
| Visual System Manufacturer and Type:        | _____  | Motion System Manufacturer and Type:  | _____   |
| Aircraft Make/Model/Series:                 | _____  | FSTD Seats Available:   | _____   |
| Aircraft Equipment                          | ENGINE TYPE(S):<br>_____   | Flight Instrumentation:<br><input type="checkbox"/> EFIS <input type="checkbox"/> HUD <input type="checkbox"/> HGS <input type="checkbox"/> EFVS<br><input type="checkbox"/> TCAS <input type="checkbox"/> GPWS <input type="checkbox"/> Plain View<br><input type="checkbox"/> GPS <input type="checkbox"/> FMS Type: _____<br><input type="checkbox"/> WX Radar <input type="checkbox"/> Other: _____ | Engine Instrumentation:<br><input type="checkbox"/> EICAS <input type="checkbox"/> FADEC<br><input type="checkbox"/> Other: _____ |
| Airport Models:                             | 3.6.1 _____<br><i>Airport Designator</i>   | 3.6.2 _____<br><i>Airport Designator</i>  | 3.6.3 _____<br><i>Airport Designator</i>  |
| Circle to Land:                             | 3.7.1 _____<br><i>Airport Designator</i>   | 3.7.2 _____<br><i>Approach</i>  | 3.7.3 _____<br><i>Landing Runway</i>  |
| Visual Ground Segment                       | 3.8.1 _____<br><i>Airport Designator</i>   | 3.8.2 _____<br><i>Approach</i>  | 3.8.3 _____<br><i>Landing Runway</i>  |
| <b>Section 2. Supplementary Information</b> |  |   |   |
| FAA Training Program Approval Authority:    | <input type="checkbox"/> POI <input type="checkbox"/> TCPM <input type="checkbox"/> Other: _____ |   |   |
| Name:                                       | _____  | Office:   | _____   |
| Tel:  | _____  | Fax:  | _____   |
| Email:                                      | _____  |   |   |
| <b>FSTD Scheduling Person:</b>              |  |   |   |
| Name:                                       | _____  |   |   |
| Address 1:                                  | _____  | Address 2:  | _____   |
| City:                                       | _____  | State:  | _____   |
| ZIP:  | _____  | Email:  | _____   |
| Tel:  | _____  | Fax:  | _____   |
| <b>FSTD Technical Contact:</b>              |  |   |   |
| Name:                                       | _____  |   |   |
| Address 1:                                  | _____  | Address 2:  | _____   |
| City:                                       | _____  | State:  | _____   |
| ZIP:  | _____  | Email:  | _____   |
| Tel:  | _____  | Fax:  | _____   |

**Attachment 4 to Appendix B to Part 60—  
Figure B4B – Sample Letter , Request for Initial, Upgrade, or Reinstatement  
Evaluation  
Attachment: FSTD Information Form  
INFORMATION**

| <b>Section 3. Training, Testing and Checking Considerations</b>  |                          |                |
|--|--------------------------|----------------|
| <u>Area/Function/Maneuver</u>  | <b>Requested</b>         | <b>Remarks</b> |
| Private Pilot - Training / Checks: (142)   | <input type="checkbox"/> | _____          |
| Commercial Pilot - Training /Checks:(142)  | <input type="checkbox"/> | _____          |
| Multi-Engine Rating - Training / Checks (142)  | <input type="checkbox"/> | _____          |
| Instrument Rating -Training / Checks (142)   | <input type="checkbox"/> | _____          |
| Type Rating - Training / Checks (135/121/142)  | <input type="checkbox"/> | _____          |
| Proficiency Checks (135/121/142)   | <input type="checkbox"/> | _____          |
| CAT I: (RVR 2400/1800 ft. DH200 ft)  | <input type="checkbox"/> | _____          |
| CAT II: (RVR 1200 ft. DH 100 ft)   | <input type="checkbox"/> | _____          |
| CAT III * (lowest minimum) _____ RVR _____ ft.<br>* State CAT III ( $\leq 700$ ft.), CAT IIIb ( $\leq 150$ ft.), or CAT IIIc (0 ft.) | <input type="checkbox"/> | _____          |
| Circling Approach  | <input type="checkbox"/> | _____          |
| Windshear Training:  | <input type="checkbox"/> | _____          |
| Windshear Training IAW 121.409(d) (121 Turbojets Only)   | <input type="checkbox"/> | _____          |
| Generic Unusual Attitudes and Recoveries within the Normal Flight Envelope   | <input type="checkbox"/> | _____          |
| Specific Unusual Attitudes Recoveries  | <input type="checkbox"/> | _____          |
| Auto-coupled Approach/Auto Go Around   | <input type="checkbox"/> | _____          |
| Auto-land / Roll Out Guidance  | <input type="checkbox"/> | _____          |
| TCAS/ACAS I / II   | <input type="checkbox"/> | _____          |
| WX-Radar   | <input type="checkbox"/> | _____          |
| HUD  | <input type="checkbox"/> | _____          |
| HGS  | <input type="checkbox"/> | _____          |
| EFVS   | <input type="checkbox"/> | _____          |
| Future Air Navigation Systems  | <input type="checkbox"/> | _____          |
| GPWS / EGPWS   | <input type="checkbox"/> | _____          |
| ETOPS Capability   | <input type="checkbox"/> | _____          |
| GPS  | <input type="checkbox"/> | _____          |
| SMGCS  | <input type="checkbox"/> | _____          |
| Helicopter Slope Landings  | <input type="checkbox"/> | _____          |
| Helicopter External Load Operations  | <input type="checkbox"/> | _____          |
| Helicopter Pinnacle Approach to Landings   | <input type="checkbox"/> | _____          |
| Helicopter Night Vision Maneuvers  | <input type="checkbox"/> | _____          |
| Helicopter Category A Takeoffs   | <input type="checkbox"/> | _____          |

**Attachment 4 to Appendix B to Part 60—  
Figure B4C – Sample Qualification Test Guide Cover Page  
INFORMATION**

SPONSOR NAME

SPONSOR ADDRESS

FAA QUALIFICATION TEST GUIDE

(SPECIFIC AIRPLANE MODEL)

*for example*

Stratos BA797-320A

(Type of FTD)

(FTD Identification Including Manufacturer, Serial Number, Visual System Used)

(FTD Level)

(Qualification Performance Standard Used)

(FTD Location)

FAA Initial Evaluation

Date: \_\_\_\_\_

\_\_\_\_\_  
(Sponsor) Date: \_\_\_\_\_

\_\_\_\_\_  
Manager, National  
Simulator Program, FAA Date: \_\_\_\_\_

**Attachment 4 to Appendix B to Part 60—  
Figure B4D – Sample Statement of Qualification - Certificate  
INFORMATION**

**Federal Aviation Administration  
National Simulator Program**



***Certificate of Qualification***

**This is to certify that representatives of the National Simulator Program  
Completed an evaluation of the**

**Go-Fast Airlines  
Farnsworth Z-100 Flight Training Device  
FAA Identification Number 998**

**And pursuant to 14 CFR Part 60 found it to meet its original qualification basis, AC  
120-45A (MM/DD/YY)**

**The Master Qualification Test Guide and the attached  
Configuration List and Restrictions List  
Provide the Qualification Basis for this device to operate at**

**Level 6  
Until March 31, 2010**

**Unless sooner rescinded or extended by the National Simulator Program Manager**

February 15, 2009

(date)

B. Williamson

(for the NSPM)

**Attachment 4 to Appendix B to Part 60—  
Figure B4E – Sample Statement of Qualification; Configuration List  
INFORMATION**

**CERTIFICATE OF QUALIFICATION  
CONFIGURATION LIST**

|  |   |  |  |
|--|---|--|--|
| Date: _____  |   |  |  |
| <b>Section 1. FSTD Information and Characteristics</b> |   |  |  |
| Sponsor Name: _____                                    |   | FSTD Location: _____   |  |
| Address: _____<br>_____                                |   | Physical Address: _____<br>_____   |  |
| City: _____  |   | City: _____  |  |
| State: _____   |   | State: _____   |  |
| Country: _____   |   | Country: _____   |  |
| ZIP: _____   |   | ZIP: _____   |  |
| Manager _____  |   |  |  |
| Sponsor ID No:<br>(Four Letter FAA Designator) _____   |   | Nearest Airport:<br>(Airport Designator) _____   |  |
| <b>Type of Evaluation Requested:</b>                   |   |  |  |
|  |   | <input type="checkbox"/> Initial <input type="checkbox"/> Upgrade <input type="checkbox"/> Recurrent <input type="checkbox"/> Special <input type="checkbox"/> Reinstatement |  |
| Qualification Basis: _____                             | <input type="checkbox"/> A                    | <input type="checkbox"/> B   | <input type="checkbox"/> Interim C <input type="checkbox"/> C <input type="checkbox"/> D |
|  | <input type="checkbox"/> 6                    | <input type="checkbox"/> 7   | <input type="checkbox"/> Provisional Status  |
| Initial Qualification:<br>(If Applicable)              | Date: _____ Level _____                       | Manufacturer's Identification/Serial No: _____   |  |
| Upgrade Qualification:<br>(If Applicable)              | Date: _____ Level _____<br>MM/DD/YYYY         | <input type="checkbox"/> eQTG  |  |
| <b>Other Technical Information:</b>                    |   |  |  |
| FAA FSTD ID No:<br>(If Applicable)                     | _____   | FSTD Manufacturer:   | _____  |
| Convertible FSTD:                                      | <input type="checkbox"/> Yes:                 | Date of Manufacture:   | _____<br>MM/DD/YYYY  |
| Related FAA ID No.<br>(If Applicable)                  | _____   | Sponsor FSTD ID No: _____  |  |
| Aircraft model/series: _____                           | Source of aerodynamic model: _____            |  |  |
| Engine model(s) and data revision: _____               | Source of aerodynamic coefficient data: _____ |  |  |
| FMS identification and revision level: _____           | Aerodynamic data revision number: _____       |  |  |
| Visual system manufacturer/model: _____                | Visual system display: _____                  |  |  |
| Flight control data revision: _____                    | FSTD computer(s) identification: _____        |  |  |
| Motion system manufacturer/type: _____                 |   |  |  |
| National Aviation Authority (NAA):<br>(If Applicable)  | _____   |  | _____  |
| NAA FSTD ID No:  | _____   | Last NAA Evaluation Date:  | _____  |

**Attachment 4 to Appendix B to Part 60—  
Figure B4E – Sample Statement of Qualification; Configuration List  
INFORMATION**

|   |  |   |   |
|---|--|---|---|
| NAA Qualification Level:  | _____  |   |   |
| NAA Qualification Basis:  | _____  |   |   |
| Visual System Manufacturer and Type:                            | _____  | Motion System Manufacturer and Type:  | _____   |
| Aircraft Make/Model/Series:                                     | _____  | FSTD Seats Available:   | _____   |
| Aircraft Equipment  | ENGINE TYPE(S):<br>_____   | Flight Instrumentation:<br><input type="checkbox"/> EFIS <input type="checkbox"/> HUD <input type="checkbox"/> HGS <input type="checkbox"/> EFVS<br><input type="checkbox"/> TCAS <input type="checkbox"/> GPWS <input type="checkbox"/> Plain View<br><input type="checkbox"/> GPS <input type="checkbox"/> FMS Type: _____<br><input type="checkbox"/> WX Radar <input type="checkbox"/> Other: _____ | Engine Instrumentation:<br><input type="checkbox"/> EICAS <input type="checkbox"/> FADEC<br><input type="checkbox"/> Other: _____ |
| Airport Models:   | 3.6.1 _____<br><i>Airport Designator</i>   | 3.6.2 _____<br><i>Airport Designator</i>  | 3.6.3 _____<br><i>Airport Designator</i>  |
| Circle to Land:   | 3.7.1 _____<br><i>Airport Designator</i>   | 3.7.2 _____<br><i>Approach</i>  | 3.7.3 _____<br><i>Landing Runway</i>  |
| Visual Ground Segment   | 3.8.1 _____<br><i>Airport Designator</i>   | 3.8.2 _____<br><i>Approach</i>  | 3.8.3 _____<br><i>Landing Runway</i>  |
| <b>Section 2. Supplementary Information</b>                     |  |   |   |
| FAA Training Program Approval Authority:                        | <input type="checkbox"/> POI <input type="checkbox"/> TCPM <input type="checkbox"/> Other: _____ |   |   |
| Name:   | _____  | Office:   | _____   |
| Tel:  | _____  | Fax:  | _____   |
| Email:  | _____  |   |   |
| <b>FSTD Scheduling Person:</b>                                  |  |   |   |
| Name:   | _____  |   |   |
| Address 1:  | _____  | Address 2   | _____   |
| City:   | _____  | State:  | _____   |
| ZIP:  | _____  | Email:  | _____   |
| Tel:  | _____  | Fax:  | _____   |
| <b>FSTD Technical Contact:</b>                                  |  |   |   |
| Name:   | _____  |   |   |
| Address 1:  | _____  | Address 2   | _____   |
| City:   | _____  | State:  | _____   |
| ZIP:  | _____  | Email:  | _____   |
| Tel:  | _____  | Fax:  | _____   |
| <b>Section 3. Training, Testing and Checking Considerations</b> |  |   |   |
| Area/Function/Maneuver  | Requested  | Remarks   |   |
| Private Pilot - Training / Checks: (142)                        | <input type="checkbox"/>   | _____   |   |
| Commercial Pilot - Training /Checks:(142)                       | <input type="checkbox"/>   | _____   |   |

**Attachment 4 to Appendix B to Part 60—  
Figure B4E – Sample Statement of Qualification; Configuration List  
INFORMATION**

|  |                          |       |
|--|--------------------------|-------|
| <b>Multi-Engine Rating - Training / Checks (142)</b>   | <input type="checkbox"/> | _____ |
| <b>Instrument Rating - Training / Checks (142)</b>   | <input type="checkbox"/> | _____ |
| <b>Type Rating - Training / Checks (135/121/142)</b>   | <input type="checkbox"/> | _____ |
| <b>Proficiency Checks (135/121/142)</b>  | <input type="checkbox"/> | _____ |
| <b>CAT I: (RVR 2400/1800 ft. DH200 ft)</b>   | <input type="checkbox"/> | _____ |
| <b>CAT II: (RVR 1200 ft. DH 100 ft)</b>  | <input type="checkbox"/> | _____ |
| <b>CAT III * (lowest minimum) _____ RVR _____ ft.<br/>* State CAT III (<math>\leq 700</math> ft.), CAT IIIb (<math>\leq 150</math> ft.), or CAT IIIc (0 ft.)</b> | <input type="checkbox"/> | _____ |
| <b>Circling Approach</b>   | <input type="checkbox"/> | _____ |
| <b>Windshear Training:</b>   | <input type="checkbox"/> | _____ |
| <b>Windshear Training IAW 121.409(d) (121 Turbojets Only)</b>  | <input type="checkbox"/> | _____ |
| <b>Generic Unusual Attitudes and Recoveries within the Normal Flight Envelope</b>  | <input type="checkbox"/> | _____ |
| <b>Specific Unusual Attitudes Recoveries</b>   | <input type="checkbox"/> | _____ |
| <b>Auto-coupled Approach/Auto Go Around</b>  | <input type="checkbox"/> | _____ |
| <b>Auto-land / Roll Out Guidance</b>   | <input type="checkbox"/> | _____ |
| <b>TCAS/ACAS I / II</b>  | <input type="checkbox"/> | _____ |
| <b>WX-Radar</b>  | <input type="checkbox"/> | _____ |
| <b>HUD</b>   | <input type="checkbox"/> | _____ |
| <b>HGS</b>   | <input type="checkbox"/> | _____ |
| <b>EFVS</b>  | <input type="checkbox"/> | _____ |
| <b>Future Air Navigation Systems</b>   | <input type="checkbox"/> | _____ |
| <b>GPWS / EGPWS</b>  | <input type="checkbox"/> | _____ |
| <b>ETOPS Capability</b>  | <input type="checkbox"/> | _____ |
| <b>GPS</b>   | <input type="checkbox"/> | _____ |
| <b>SMGCS</b>   | <input type="checkbox"/> | _____ |
| <b>Helicopter Slope Landings</b>   | <input type="checkbox"/> | _____ |
| <b>Helicopter External Load Operations</b>   | <input type="checkbox"/> | _____ |
| <b>Helicopter Pinnacle Approach to Landings</b>  | <input type="checkbox"/> | _____ |
| <b>Helicopter Night Vision Maneuvers</b>   | <input type="checkbox"/> | _____ |
| <b>Helicopter Category A Takeoffs</b>  | <input type="checkbox"/> | _____ |

**Attachment 4 to Appendix B to Part 60—  
Figure B4F – Sample Statement of Qualification;– List of Qualified Tasks  
INFORMATION**

**CERTIFICATE OF QUALIFICATION  
List of Qualified Tasks**

**Go Fast Airline Training -- Farnsworth Z-100 -- Level D -- FAA ID# 999**

**The FSTD is qualified to perform all of the tasks listed in  
Appendix 1, Table B1B  
for its assigned level of qualification *except* for the following listed tasks.**

**Qualified for all tasks in Table B1B, for which the sponsor has requested qualification,  
except for the following:**

- 4.e. Circling Approach
- 6. (a) Emergency Descent (maximum rate)
- 6. (b) Inflight Fire and Smoke Removal
- 6. (c) Rapid Decompression
- 6. (d) Emergency Evacuation

**Additional tasks for which this FSTD is qualified (i.e., in addition to the list in Table B1B):**

NONE



**Attachment 4 to Appendix B to Part 60—  
Figure B4G – Sample Continuing Qualification Evaluation Requirements Page  
INFORMATION**

|   |  |
|---|--|
| <b>Recurrent Evaluation Requirements</b><br><i>Completed at conclusion of Initial Evaluation</i>                            |  |
| Recurrent Evaluations to be conducted each<br><u>  (fill in)  </u> months<br><br>Allotting <u>      </u> hours of FTD time. | Recurrent evaluations are due as follows:<br><br><u>  (month)  </u> and <u>  (month)  </u> and <u>  (month)  </u><br>(enter or strike out, as appropriate) |
| Signed: _____<br>NSPM / Evaluation Team Leader  | _____<br>Date  |

|   |  |
|---|--|
| <b>Revision:</b><br>Based on (enter reasoning):   |  |
|   |  |
| Recurrent Evaluations are to be conducted each<br><u>  (fill in)  </u> months. Allotting <u>      </u> hours. | Recurrent evaluations are due as follows:<br><br><u>  (month)  </u> and <u>  (month)  </u> and <u>  (month)  </u><br>(enter or strike out, as appropriate) |
| Signed: _____<br>NSPM Evaluation Team Leader  | _____<br>Date  |

|   |  |
|---|--|
| <b>Revision:</b><br>Based on (enter reasoning):   |  |
|   |  |
| Recurrent Evaluations are to be conducted each<br><u>  (fill in)  </u> months. Allotting <u>      </u> hours. | Recurrent evaluations are due as follows:<br><br><u>  (month)  </u> and <u>  (month)  </u> and <u>  (month)  </u><br>(enter or strike out, as appropriate) |
| Signed: _____<br>NSPM Evaluation Team Leader  | _____<br>Date  |

(Repeat as Necessary)



**Begin Information**

a. This appendix contains background information as well as regulatory and informative material as described later in this section. To assist the reader in determining what areas are required and what areas are permissive, the text in this appendix is divided into two sections: "QPS Requirements" and "Information." The QPS Requirements sections contain details regarding compliance with the part 60 rule language. These details are regulatory, but are found only in this appendix. The Information sections contain material that is advisory in nature, and designed to give the user general information about the regulation.

b. Questions regarding the contents of this publication should be sent to the U.S. Department of Transportation, Federal Aviation Administration, Flight Standards Service, National Simulator Program Staff, AFS-205, 100 Hartsfield Centre Parkway, Suite 400, Atlanta, Georgia 30354. Telephone contact numbers for the NSP are: phone, 404-832-4700; fax, 404-761-8906. The general e-mail address for the NSP office is: [9-aso-avr-sim-team@faa.gov](mailto:9-aso-avr-sim-team@faa.gov). The NSP Internet Web Site address is: [http://www.faa.gov/safety/programs\\_initiatives/aircraft\\_aviation/nsp/](http://www.faa.gov/safety/programs_initiatives/aircraft_aviation/nsp/). On this Web Site you will find an NSP personnel list with telephone and e-mail contact information for each NSP staff member, a list of qualified flight simulation devices, advisory circulars, a description of the qualification process, NSP policy, and an NSP "In-Works" section. Also linked from this site are additional information sources, handbook bulletins, frequently asked questions, a listing and text of the Federal Aviation Regulations, Flight Standards Inspector's handbooks, and other FAA links.

c. The NSPM encourages the use of electronic media for all communication, including any record, report, request, test, or statement required by this appendix. The electronic media used must have adequate security provisions and be acceptable to the NSPM. The NSPM recommends inquiries on system compatibility, and minimum system requirements are also included on the NSP Web site.

d. Related Reading References.

(1) 14 CFR part 60.

(2) 14 CFR part 61.

(3) 14 CFR part 63.

(4) 14 CFR part 119

(5) 14 CFR part 121.

(6) 14 CFR part 125

(7) 14 CFR part 135.

(8) 14 CFR part 141.

(9) 14 CFR part 142.

(10) AC 120-35B, Line Operational Simulations: Line-Oriented Flight Training, Special Purpose Operational Training, Line Operational Evaluation.

(11) AC 120-57A, Surface Movement Guidance and Control System (SMGS).

(12) AC 150/5300-13, Airport Design.

(13) AC 150/5340-1G, Standards for Airport Markings.

(14) AC 150/5340-4C, Installation Details for Runway Centerline Touchdown Zone Lighting Systems.

(15) AC 150/5340-19, Taxiway Centerline Lighting System.

(16) AC 150/5340-24, Runway and Taxiway Edge Lighting System.

(17) AC 150/5345-28D, Precision Approach Path Indicator (PAPI) Systems.

(18) AC 150/5390-2B, Heliport Design.

(19) International Air Transport Association document, "Flight Simulator Design and Performance Data Requirements," as amended.

(20) AC 29-2B, Flight Test Guide for Certification of Transport Category Rotorcraft.

(21) AC 27-1A, Flight Test Guide for Certification of Normal Category Rotorcraft.

(22) International Civil Aviation Organization (ICAO) Manual of Criteria for the Qualification of Flight Simulators, as amended.

(23) Airplane Flight Simulator Evaluation Handbook, Volume I, as amended and Volume II, as amended, The Royal Aeronautical Society, London, UK.

(24) FAA Publication FAA-S-8081 series (Practical Test Standards for Airline Transport Pilot Certificate, Type Ratings, Commercial Pilot, and Instrument Ratings).

(25) The FAA Aeronautical Information Manual (AIM). An electronic version of the AIM is on the Internet at <http://www.faa.gov/atpubs>.

**End Information****2. Applicability (§§ 60.1 and 60.2)****Begin Information**

No additional regulatory or informational material applies to § 60.1, Applicability, or to § 60.2, Applicability of sponsor rules to persons who are not sponsors and who are engaged in certain unauthorized activities.

**End Information****3. Definitions (§ 60.3)****Begin Information**

See Appendix F of this part for a list of definitions and abbreviations from part 1 and part 60, including the appropriate appendices of part 60.

**End Information****4. Qualification Performance Standards (§ 60.4)****Begin Information**

No additional regulatory or informational material applies to § 60.4, Qualification Performance Standards.

**End Information****5. Quality Management System (§ 60.5)****Begin Information**

See Appendix E of this part for additional regulatory and informational material regarding Quality Management Systems.

**End Information****6. Sponsor Qualification Requirements (§ 60.7)****Begin Information**

a. The intent of the language in § 60.7(b) is to have a specific FFS, identified by the sponsor, used at least once in an FAA-approved flight training program for the helicopter simulated during the 12-month period described. The identification of the specific FFS may change from one 12-month period to the next 12-month period as long as that sponsor sponsors and uses at least one FFS at least once during the prescribed period. There is no minimum number of hours or minimum FFS periods required.

b. The following examples describe acceptable operational practices:

(1) Example One.

(a) A sponsor is sponsoring a single, specific FFS for its own use, in its own facility or elsewhere—this single FFS forms the basis for the sponsorship. The sponsor uses that FFS at least once in each 12-month period in that sponsor's FAA-approved flight training program for the helicopter simulated. This 12-month period is established according to the following schedule:

(i) If the FFS was qualified prior to May 30, 2008, the 12-month period begins on the date of the first continuing qualification evaluation conducted in accordance with § 60.19 after (60 days after date of publication of the final rule in the **Federal Register**) and continues for each subsequent 12-month period;

(ii) A device qualified on or after May 30, 2008, will be required to undergo an initial or upgrade evaluation in accordance with § 60.15. Once the initial or upgrade evaluation is complete, the first continuing qualification evaluation will be conducted within 6 months. The 12-month continuing qualification evaluation cycle begins on that date and continues for each subsequent 12-month period.

(b) There is no minimum number of hours of FFS use required.

(c) The identification of the specific FFS may change from one 12-month period to the next 12-month period as long as that sponsor sponsors and uses at least one FFS at least once during the prescribed period.

(2) Example Two.

(a) A sponsor sponsors an additional number of FFSs, in its facility or elsewhere. Each additionally sponsored FFS must be—

(i) Used by the sponsor in the sponsor's FAA-approved flight training program for the helicopter simulated (as described in § 60.7(d)(1)); or

(ii) Used by another FAA certificate holder in that other certificate holder's FAA-approved flight training program for the helicopter simulated (as described in § 60.7(d)(1)). This 12-month period is established in the same manner as in example one; or

(iii) Provided a statement each year from a qualified pilot, (after having flown the helicopter, not the subject FFS or another

FFS, during the preceding 12-month period) stating that the subject FFS's performance and handling qualities represent the helicopter (as described in § 60.7(d)(2)). This statement is provided at least once in each 12-month period established in the same manner as in example one.

(b) There is no minimum number of hours of FFS use required.

(3) Example Three.

(a) A sponsor in New York (in this example, a Part 142 certificate holder) establishes "satellite" training centers in Chicago and Moscow.

(b) The satellite function means that the Chicago and Moscow centers must operate under the New York center's certificate (in accordance with all of the New York center's practices, procedures, and policies; e.g., instructor and/or technician training/checking requirements, record keeping, QMS program).

(c) All of the FFSs in the Chicago and Moscow centers could be dry-leased (i.e., the certificate holder does not have and use FAA-approved flight training programs for the FFSs in the Chicago and Moscow centers) because—

(i) Each FFS in the Chicago center and each FFS in the Moscow center is used at least once each 12-month period by another FAA certificate holder in that other certificate holder's FAA-approved flight training program for the helicopter (as described in § 60.7(d)(1)); or

(ii) A statement is obtained from a qualified pilot (having flown the helicopter, not the subject FFS or another FFS during the preceding 12-month period) stating that the performance and handling qualities of each FFS in the Chicago and Moscow centers represent the helicopter (as described in § 60.7(d)(2)).

#### End Information

### 7. Additional Responsibilities of the Sponsor (§ 60.9)

#### Begin Information

The phrase "as soon as practicable" in § 60.9(a) means without unnecessarily disrupting or delaying beyond a reasonable time the training, evaluation, or experience being conducted in the FSTD.

#### End Information

### 8. FSTD Use (§ 60.11)

#### Begin Information

No additional regulatory or informational material applies to § 60.11, FSTD Use.

#### End Information

### 9. FSTD Objective Data Requirements (§ 60.13)

#### Begin QPS Requirements

a. Flight test data used to validate FFS performance and handling qualities must

have been gathered in accordance with a flight test program containing the following:

(1) A flight test plan consisting of:

- (a) The maneuvers and procedures required for aircraft certification and simulation programming and validation
- (b) For each maneuver or procedure—
  - (i) The procedures and control input the flight test pilot and/or engineer used.
  - (ii) The atmospheric and environmental conditions.
  - (iii) The initial flight conditions.
  - (iv) The helicopter configuration, including weight and center of gravity.
  - (v) The data to be gathered.
  - (vi) All other information necessary to recreate the flight test conditions in the FFS.

(2) Appropriately qualified flight test personnel.

(3) An understanding of the accuracy of the data to be gathered using appropriate alternative data sources, procedures, and instrumentation that is traceable to a recognized standard as described in Attachment 2, Table C2D.

(4) Appropriate and sufficient data acquisition equipment or system(s), including appropriate data reduction and analysis methods and techniques, as would be acceptable to the FAA's Aircraft Certification Service.

b. The data, regardless of source, must be presented:

- (1) in a format that supports the FFS validation process;
- (2) in a manner that is clearly readable and annotated correctly and completely;
- (3) with resolution sufficient to determine compliance with the tolerances set forth in Attachment 2, Table C2A of this appendix.
- (4) with any necessary instructions or other details provided, such as yaw damper or throttle position; and
- (5) without alteration, adjustments, or bias; however the data may be rescaled, digitized, or otherwise manipulated to fit the desired presentation.

c. After completion of any additional flight test, a flight test report must be submitted in support of the validation data. The report must contain sufficient data and rationale to support qualification of the FFS at the level requested.

d. As required by § 60.13(f), the sponsor must notify the NSPM when it becomes aware that an addition to, an amendment to, or a revision of data that may relate to FFS performance or handling characteristics is available. The data referred to in this paragraph are those data that are used to validate the performance, handling qualities, or other characteristics of the aircraft, including data related to any relevant changes occurring after the type certificate was issued. The sponsor must—

- (1) Within 10 calendar days, notify the NSPM of the existence of this data; and
- (2) Within 45 calendar days, notify the NSPM of—

(a) The schedule to incorporate this data into the FFS; or

(b) The reason for not incorporating this data into the FFS.

e. In those cases where the objective test results authorize a "snapshot test" or a "series of snapshot test results" in lieu of a

time-history result, the sponsor or other data provider must ensure that a steady state condition exists at the instant of time captured by the "snapshot." The steady state condition must exist from 4 seconds prior to, through 1 second following, the instant of time captured by the snapshot.

#### End QPS Requirements

#### Begin Information

f. The FFS sponsor is encouraged to maintain a liaison with the manufacturer of the aircraft being simulated (or with the holder of the aircraft type certificate for the aircraft being simulated if the manufacturer is no longer in business), and, if appropriate, with the person who supplied the aircraft data package for the FFS in order to facilitate the notification required by § 60.13(f).

g. It is the intent of the NSPM that for new aircraft entering service, at a point well in advance of preparation of the Qualification Test Guide (QTG), the sponsor should submit to the NSPM for approval, a descriptive document (a validation data roadmap) containing the plan for acquiring the validation data, including data sources. This document should clearly identify sources of data for all required tests, a description of the validity of these data for a specific engine type and thrust rating configuration, and the revision levels of all avionics affecting the performance or flying qualities of the aircraft. Additionally, this document should provide other information, such as the rationale or explanation for cases where data or data parameters are missing, instances where engineering simulation data are used or where flight test methods require further explanations. It should also provide a brief narrative describing the cause and effect of any deviation from data requirements. The aircraft manufacturer may provide this document.

h. There is no requirement for any flight test data supplier to submit a flight test plan or program prior to gathering flight test data. However, the NSPM notes that inexperienced data gatherers often provide data that is irrelevant, improperly marked, or lacking adequate justification for selection. Other problems include inadequate information regarding initial conditions or test maneuvers. The NSPM has been forced to refuse these data submissions as validation data for an FFS evaluation. It is for this reason that the NSPM recommends that any data supplier not previously experienced in this area review the data necessary for programming and for validating the performance of the FFS, and discuss the flight test plan anticipated for acquiring such data with the NSPM well in advance of commencing the flight tests.

i. The NSPM will consider, on a case-by-case basis, whether to approve supplemental validation data derived from flight data recording systems such as a Quick Access Recorder or Flight Data Recorder.

#### End Information

## 10. Special Equipment and Personnel Requirements for Qualification of the FSTD (§ 60.14)

### Begin Information

a. In the event that the NSPM determines that special equipment or specifically qualified persons will be required to conduct an evaluation, the NSPM will make every attempt to notify the sponsor at least one (1) week, but in no case less than 72 hours, in advance of the evaluation. Examples of special equipment include spot photometers, flight control measurement devices, and sound analyzers. Examples of specially qualified personnel include individuals specifically qualified to install or use any special equipment when its use is required.

b. Examples of a special evaluation include an evaluation conducted after an FFS is moved, at the request of the TPAA, or as a result of comments received from users of the FFS that raise questions about the continued qualification or use of the FFS.

### End Information

## 11. Initial (and Upgrade) Qualification Requirements (§ 60.15)

### Begin QPS Requirements

a. In order to be qualified at a particular qualification level, the FFS must:

(1) Meet the general requirements listed in Attachment 1;

(2) Meet the objective testing requirements listed in Attachment 2; and

(3) Satisfactorily accomplish the subjective tests listed in Attachment 3.

b. The request described in § 60.15(a) must include all of the following:

(1) A statement that the FFS meets all of the applicable provisions of this part and all applicable provisions of the QPS.

(2) A confirmation that the sponsor will forward to the NSPM the statement described in § 60.15(b) in such time as to be received no later than 5 business days prior to the scheduled evaluation and may be forwarded to the NSPM via traditional or electronic means.

(3) A qualification test guide (QTG), acceptable to the NSPM, that includes all of the following:

(a) Objective data obtained from aircraft testing or another approved source.

(b) Correlating objective test results obtained from the performance of the FFS as prescribed in the appropriate QPS.

(c) The result of FFS subjective tests prescribed in the appropriate QPS.

(d) A description of the equipment necessary to perform the evaluation for initial qualification and the continuing qualification evaluations.

c. The QTG described in paragraph (a)(3) of this section, must provide the documented proof of compliance with the simulator objective tests in Attachment 2, Table C2A of this appendix.

d. The QTG is prepared and submitted by the sponsor, or the sponsor's agent on behalf of the sponsor, to the NSPM for review and

approval, and must include, for each objective test:

(1) Parameters, tolerances, and flight conditions.

(2) Pertinent and complete instructions for the conduct of automatic and manual tests.

(3) A means of comparing the FFS test results to the objective data.

(4) Any other information as necessary, to assist in the evaluation of the test results.

(5) Other information appropriate to the qualification level of the FFS.

e. The QTG described in paragraphs (a)(3) and (b) of this section, must include the following:

(1) A QTG cover page with sponsor and FAA approval signature blocks (see Attachment 4, Figure C4C, for a sample QTG cover page).

(2) A continuing qualification evaluation schedule requirements page. This page will be used by the NSPM to establish and record the frequency with which continuing qualification evaluations must be conducted and any subsequent changes that may be determined by the NSPM in accordance with § 60.19. See Attachment 4, Figure C4G, for a sample Continuing Qualification Evaluation Requirements page.

(3) An FFS information page that provides the information listed in this paragraph (see Attachment 4, Figure C4B, for a sample FFS information page). For convertible FFSs, the sponsor must submit a separate page for each configuration of the FFS.

(a) The sponsor's FFS identification number or code.

(b) The helicopter model and series being simulated.

(c) The aerodynamic data revision number or reference.

(d) The source of the basic aerodynamic model and the aerodynamic coefficient data used to modify the basic model.

(e) The engine model(s) and its data revision number or reference.

(f) The flight control data revision number or reference.

(g) The flight management system identification and revision level.

(h) The FFS model and manufacturer.

(i) The date of FFS manufacture.

(j) The FFS computer identification.

(k) The visual system model and manufacturer, including display type.

(l) The motion system type and manufacturer, including degrees of freedom.

(4) A Table of Contents.

(5) A log of revisions and a list of effective pages.

(6) List of all relevant data references.

(7) A glossary of terms and symbols used (including sign conventions and units).

(8) Statements of compliance and capability (SOCs) with certain requirements. SOCs must provide references to the sources of information that show the capability of the FFS to comply with the requirement, a rationale explaining how the referenced material is used, mathematical equations and parameter values used, and the conclusions reached; *i.e.*, that the FFS complies with the requirement.

(9) Recording procedures or equipment required to accomplish the objective tests.

(10) The following information for each objective test designated in Attachment 2,

Table C2A, as applicable to the qualification level sought:

(a) Name of the test.

(b) Objective of the test.

(c) Initial conditions.

(d) Manual test procedures.

(e) Automatic test procedures (if applicable).

(f) Method for evaluating FFS objective test results.

(g) List of all relevant parameters driven or constrained during the automatically conducted test(s).

(h) List of all relevant parameters driven or constrained during the manually conducted test(s).

(i) Tolerances for relevant parameters.

(j) Source of Validation Data (document and page number).

(k) Copy of the Validation Data (if located in a separate binder, a cross reference for the identification and page number for pertinent data location must be provided).

(l) Simulator Objective Test Results as obtained by the sponsor. Each test result must reflect the date completed and must be clearly labeled as a product of the device being tested.

f. A convertible FFS is addressed as a separate FFS for each model and series helicopter to which it will be converted and for the FAA qualification level sought. If a sponsor seeks qualification for two or more models of a helicopter type using a convertible FFS, the sponsor must submit a QTG for each helicopter model, or a QTG for the first helicopter model and a supplement to that QTG for each additional helicopter model. The NSPM will conduct evaluations for each helicopter model.

g. Form and manner of presentation of objective test results in the QTG:

(1) The sponsor's FFS test results must be recorded in a manner acceptable to the NSPM, that allows easy comparison of the FFS test results to the validation data (e.g., use of a multi-channel recorder, line printer, cross plotting, overlays, transparencies).

(2) FFS results must be labeled using terminology common to helicopter parameters as opposed to computer software identifications.

(3) Validation data documents included in a QTG may be photographically reduced only if such reduction will not alter the graphic scaling or cause difficulties in scale interpretation or resolution.

(4) Scaling on graphical presentations must provide the resolution necessary to evaluate the parameters shown in Attachment 2, Table C2A of this appendix.

(5) Tests involving time histories, data sheets (or transparencies thereof) and FFS test results must be clearly marked with appropriate reference points to ensure an accurate comparison between the FFS and the helicopter with respect to time. Time histories recorded via a line printer are to be clearly identified for cross plotting on the helicopter data. Over-plots must not obscure the reference data.

h. The sponsor may elect to complete the QTG objective and subjective tests at the manufacturer's facility or at the sponsor's training facility. If the tests are conducted at the manufacturer's facility, the sponsor must

repeat at least one-third of the tests at the sponsor's training facility in order to substantiate FFS performance. The QTG must be clearly annotated to indicate when and where each test was accomplished. Tests conducted at the manufacturer's facility and at the sponsor's training facility must be conducted after the FFS is assembled with systems and sub-systems functional and operating in an interactive manner. The test results must be submitted to the NSPM.

i. The sponsor must maintain a copy of the MQTG at the FFS location.

j. All FFSs for which the initial qualification is conducted after May 30, 2014, must have an electronic MQTG (eMQTG) including all objective data obtained from helicopter testing, or another approved source (reformatted or digitized), together with correlating objective test results obtained from the performance of the FFS (reformatted or digitized) as prescribed in this appendix. The eMQTG must also contain the general FFS performance or demonstration results (reformatted or digitized) prescribed in this appendix, and a description of the equipment necessary to perform the initial qualification evaluation and the continuing qualification evaluations. The eMQTG must include the original validation data used to validate FFS performance and handling qualities in either the original digitized format from the data supplier or an electronic scan of the original time-history plots that were provided by the data supplier. A copy of the eMQTG must be provided to the NSPM.

k. All other FFSs not covered in subparagraph "j" must have an electronic copy of the MQTG by May 30, 2014. A copy of the eMQTG must be provided to the NSPM. This may be provided by an electronic scan presented in a Portable Document File (PDF), or similar format acceptable to the NSPM.

l. During the initial (or upgrade) qualification evaluation conducted by the NSPM, the sponsor must also provide a person who is a user of the device (e.g., a qualified pilot or instructor pilot with flight time experience in that aircraft) and knowledgeable about the operation of the aircraft and the operation of the FFS.

#### End QPS Requirements

#### Begin Information

m. Only those FFSs that are sponsored by a certificate holder as defined in Appendix F will be evaluated by the NSPM. However, other FFS evaluations may be conducted on a case-by-case basis as the Administrator deems appropriate, but only in accordance with applicable agreements.

n. The NSPM will conduct an evaluation for each configuration, and each FFS must be evaluated as completely as possible. To ensure a thorough and uniform evaluation, each FFS is subjected to the general simulator requirements in Attachment 1, the objective tests listed in Attachment 2, and the subjective tests listed in Attachment 3 of this appendix. The evaluations described herein will include, but not necessarily be limited to the following:

(1) Helicopter responses, including longitudinal and lateral-directional control responses (see Attachment 2 of this appendix).

(2) Performance in authorized portions of the simulated helicopter's operating envelope, to include tasks evaluated by the NSPM in the areas of surface operations, takeoff, climb, cruise, descent, approach, and landing as well as abnormal and emergency operations (see Attachment 2 of this appendix).

(3) Control checks (see Attachment 1 and Attachment 2 of this appendix).

(4) Flight deck configuration (see Attachment 1 of this appendix).

(5) Pilot, flight engineer, and instructor station functions checks (see Attachment 1 and Attachment 3 of this appendix).

(6) Helicopter systems and sub-systems (as appropriate) as compared to the helicopter simulated (see Attachment 1 and Attachment 3 of this appendix).

(7) FFS systems and sub-systems, including force cueing (motion), visual, and aural (sound) systems, as appropriate (see Attachment 1 and Attachment 2 of this appendix).

(8) Certain additional requirements, depending upon the qualification level sought, including equipment or circumstances that may become hazardous to the occupants. The sponsor may be subject to Occupational Safety and Health Administration requirements.

o. The NSPM administers the objective and subjective tests, which includes an examination of functions. The tests include a qualitative assessment of the FFS by an NSP pilot. The NSP evaluation team leader may assign other qualified personnel to assist in accomplishing the functions examination and/or the objective and subjective tests performed during an evaluation when required.

(1) Objective tests provide a basis for measuring and evaluating FFS performance and determining compliance with the requirements of this part.

(2) Subjective tests provide a basis for:

(a) Evaluating the capability of the FFS to perform over a typical utilization period;

(b) Determining that the FFS satisfactorily simulates each required task;

(c) Verifying correct operation of the FFS controls, instruments, and systems; and

(d) Demonstrating compliance with the requirements of this part.

p. The tolerances for the test parameters listed in Attachment 2 of this appendix reflect the range of tolerances acceptable to the NSPM for FFS validation and are not to be confused with design tolerances specified for FFS manufacture. In making decisions regarding tests and test results, the NSPM relies on the use of operational and engineering judgment in the application of data (including consideration of the way in which the flight test was flown and way the data was gathered and applied), data presentations, and the applicable tolerances for each test.

q. In addition to the scheduled continuing qualification evaluation, each FFS is subject to evaluations conducted by the NSPM at any time without prior notification to the

sponsor. Such evaluations would be accomplished in a normal manner (i.e., requiring exclusive use of the FFS for the conduct of objective and subjective tests and an examination of functions) if the FFS is not being used for flight crewmember training, testing, or checking. However, if the FFS were being used, the evaluation would be conducted in a non-exclusive manner. This non-exclusive evaluation will be conducted by the FFS evaluator accompanying the check airman, instructor, Aircrew Program Designee (APD), or FAA inspector aboard the FFS along with the student(s) and observing the operation of the FFS during the training, testing, or checking activities.

r. Problems with objective test results are handled as follows:

(1) If a problem with an objective test result is detected by the NSP evaluation team during an evaluation, the test may be repeated or the QTG may be amended.

(2) If it is determined that the results of an objective test do not support the level requested but do support a lower level, the NSPM may qualify the FFS at that lower level. For example, if a Level D evaluation is requested and the FFS fails to meet sound test tolerances, it could be qualified at Level C.

s. After an FFS is successfully evaluated, the NSPM issues a certificate of qualification (COQ) to the sponsor. The NSPM recommends the FFS to the TPAA, who will approve the FFS for use in a flight training program. The COQ will be issued at the satisfactory conclusion of the initial or continuing qualification evaluation and will list the tasks for which the FSTD is qualified, referencing the tasks described in Table C1B in attachment 1. However, it is the sponsor's responsibility to obtain TPAA approval prior to using the FSTD in an FAA-approved flight training program.

t. Under normal circumstances, the NSPM establishes a date for the initial or upgrade evaluation within ten (10) working days after determining that a complete QTG is acceptable. Unusual circumstances may warrant establishing an evaluation date before this determination is made. A sponsor may schedule an evaluation date as early as 6 months in advance. However, there may be a delay of 45 days or more in rescheduling and completing the evaluation if the sponsor is unable to meet the scheduled date. See Attachment 4, Figure C4A, Sample Request for Initial, Upgrade, or Reinstatement Evaluation.

u. The numbering system used for objective test results in the QTG should closely follow the numbering system set out in Attachment 2, FFS Objective Tests, Table C2A.

v. Contact the NSPM or visit the NSPM Web site for additional information regarding the preferred qualifications of pilots used to meet the requirements of § 60.15(d).

w. Examples of the exclusions for which the FFS might not have been subjectively tested by the sponsor or the NSPM and for which qualification might not be sought or granted, as described in § 60.15(g)(6), include takeoffs and landing from slopes and pinnacles.

**End Information****12. Additional Qualifications for a Currently Qualified FSTD (§ 60.16)**

No additional regulatory or informational material applies to § 60.16, Additional Qualifications for a Currently Qualified FFS.

**13. Previously Qualified FSTDs (§ 60.17)****Begin QPS Requirements**

a. In instances where a sponsor plans to remove an FFS from active status for a period of less than two years, the following procedures apply:

(1) The NSPM must be notified in writing and the notification must include an estimate of the period that the FFS will be inactive.

(2) Continuing Qualification evaluations will not be scheduled during the inactive period.

(3) The NSPM will remove the FFS from the list of qualified FSTDs on a mutually established date not later than the date on which the first missed continuing qualification evaluation would have been scheduled.

(4) Before the FFS is restored to qualified status, it must be evaluated by the NSPM. The evaluation content and the time required to accomplish the evaluation is based on the number of continuing qualification evaluations and sponsor-conducted quarterly inspections missed during the period of inactivity.

(5) The sponsor must notify the NSPM of any changes to the original scheduled time out of service.

b. Simulators qualified prior to May 30, 2008, are not required to meet the general simulation requirements, the objective test requirements, and the subjective test requirements of attachments 1, 2, and 3, of this appendix as long as the simulator continues to meet the test requirements contained in the MQTG developed under the original qualification basis.

c. After (1 year after date of publication of the final rule in the **Federal Register**) each visual scene or airport model beyond the minimum required for the FSTD qualification level that is installed in and available for use in a qualified FSTD must meet the requirements described in Attachment 3 of this appendix.

**End QPS Requirements****Begin Information**

d. Other certificate holders or persons desiring to use an FFS may contract with FFS sponsors to use FFSs previously qualified at a particular level for a helicopter type and approved for use within an FAA-approved flight training program. Such FFSs are not required to undergo an additional qualification process, except as described in § 60.16.

e. Each FFS user must obtain approval from the appropriate TPAA to use any FFS in an FAA-approved flight training program.

f. The intent of the requirement listed in § 60.17(b), for each FFS to have a Statement

of Qualification within 6 years, is to have the availability of that statement (including the configuration list and the limitations to authorizations) to provide a complete picture of the FFS inventory regulated by the FAA. The issuance of the statement will not require any additional evaluation or require any adjustment to the evaluation basis for the FFS.

g. Downgrading of an FFS is a permanent change in qualification level and will necessitate the issuance of a revised Statement of Qualification to reflect the revised qualification level, as appropriate. If a temporary restriction is placed on an FFS because of a missing, malfunctioning, or inoperative component or on-going repairs, the restriction is not a permanent change in qualification level. Instead, the restriction is temporary and is removed when the reason for the restriction has been resolved.

h. It is not the intent of the NSPM to discourage the improvement of existing simulation (e.g., the “updating” of a visual system to a newer model, or the replacement of the IOS with a more capable unit) by requiring the “updated” device to meet the qualification standards current at the time of the update. Depending on the extent of the update, the NSPM may require that the updated device be evaluated and may require that an evaluation include all or a portion of the elements of an initial evaluation. However, the standards against which the device would be evaluated are those that are found in the MQTG for that device.

i. The NSPM will determine the evaluation criteria for an FSTD that has been removed from active status. The criteria will be based on the number of continuing qualification evaluations and quarterly inspections missed during the period of inactivity. For example, if the FFS were out of service for a 1 year period, it would be necessary to complete the entire QTG, since all of the quarterly evaluations would have been missed. The NSPM will also consider how the FFS was stored, whether parts were removed from the FFS and whether the FFS was disassembled.

j. The FFS will normally be requalified using the FAA-approved MQTG and the criteria that was in effect prior to its removal from qualification. However, inactive periods of 2 years or more will require requalification under the standards in effect and current at the time of requalification.

**End Information****14. Inspection, Continuing Qualification Evaluation, and Maintenance Requirements (§ 60.19)****Begin QPS Requirements**

a. The sponsor must conduct a minimum of four evenly spaced inspections throughout the year. The objective test sequence and content of each inspection must be developed by the sponsor and must be acceptable to the NSPM.

b. The description of the functional preflight inspection must be contained in the sponsor's QMS.

c. Record “functional preflight” in the FFS discrepancy log book or other acceptable

location, including any item found to be missing, malfunctioning, or inoperative.

d. During the continuing qualification evaluation conducted by the NSPM, the sponsor must also provide a person knowledgeable about the operation of the aircraft and the operation of the FFS.

e. The NSPM will conduct continuing qualification evaluations every 12 months unless:

(1) The NSPM becomes aware of discrepancies or performance problems with the device that warrants more frequent evaluations; or

(2) The sponsor implements a QMS that justifies less frequent evaluations. However, in no case shall the frequency of a continuing qualification evaluation exceed 36 months.

**End QPS Requirements****Begin Information**

f. The sponsor's test sequence and the content of each quarterly inspection required in § 60.19(a)(1) should include a balance and a mix from the objective test requirement areas listed as follows:

- (1) Performance.
- (2) Handling qualities.
- (3) Motion system (where appropriate).
- (4) Visual system (where appropriate).
- (5) Sound system (where appropriate).
- (6) Other FFS systems.

g. If the NSP evaluator plans to accomplish specific tests during a normal continuing qualification evaluation that requires the use of special equipment or technicians, the sponsor will be notified as far in advance of the evaluation as practical; but not less than 72 hours. Examples of such tests include latencies, control dynamics, sounds and vibrations, motion, and/or some visual system tests.

h. The continuing qualification evaluations, described in § 60.19(b), will normally require 4 hours of FFS time. However, flexibility is necessary to address abnormal situations or situations involving aircraft with additional levels of complexity (e.g., computer controlled aircraft). The sponsor should anticipate that some tests may require additional time. The continuing qualification evaluations will consist of the following:

(1) Review of the results of the quarterly inspections conducted by the sponsor since the last scheduled continuing qualification evaluation.

(2) A selection of approximately 8 to 15 objective tests from the MQTG that provide an adequate opportunity to evaluate the performance of the FFS. The tests chosen will be performed either automatically or manually and should be able to be conducted within approximately one-third (1/3) of the allotted FFS time.

(3) A subjective evaluation of the FFS to perform a representative sampling of the tasks set out in attachment 3 of this appendix. This portion of the evaluation should take approximately two-thirds (2/3) of the allotted FFS time.

(4) An examination of the functions of the FFS may include the motion system, visual system, sound system, instructor operating

station, and the normal functions and simulated malfunctions of the simulated helicopter systems. This examination is normally accomplished simultaneously with the subjective evaluation requirements.

#### End Information

### 15. Logging FSTD Discrepancies (§ 60.20)

#### Begin Information

No additional regulatory or informational material applies to § 60.20. Logging FFS Discrepancies.

#### End Information

### 16. Interim Qualification of FSTDs for New Helicopter Types or Models (§ 60.21)

#### Begin Information

No additional regulatory or informational material applies to § 60.21, Interim Qualification of FFSs for New Helicopter Types or Models.

#### End Information

### 17. Modifications to FSTDs (§ 60.23)

#### Begin QPS Requirements

a. The notification described in § 60.23(c)(2) must include a complete description of the planned modification, with a description of the operational and engineering effect the proposed modification will have on the operation of the FFS and the results that are expected with the modification incorporated.

b. Prior to using the modified FFS:  
(1) All the applicable objective tests completed with the modification incorporated, including any necessary updates to the MQTG (e.g., accomplishment of FSTD Directives) must be acceptable to the NSPM; and

(2) The sponsor must provide the NSPM with a statement signed by the MR that the factors listed in § 60.15(b) are addressed by the appropriate personnel as described in that section.

#### End QPS Requirements

#### Begin Information

(3) FSTD Directives are considered modifications of an FFS. See Attachment 4 for a sample index of effective FSTD Directives. See Attachment 6 for a list of all effective FSTD Directives applicable to Helicopter FFSs.

#### End Information

### 18. Operation with Missing, Malfunctioning, or Inoperative Components (§ 60.25)

#### Begin Information

a. The sponsor's responsibility with respect to § 60.25(a) is satisfied when the sponsor fairly and accurately advises the user of the current status of an FFS, including any missing, malfunctioning, or inoperative (MMI) component(s).

b. If the 29th or 30th day of the 30-day period described in § 60.25(b) is on a Saturday, a Sunday, or a holiday, the FAA will extend the deadline until the next business day.

c. In accordance with the authorization described in § 60.25(b), the sponsor may develop a discrepancy prioritizing system to accomplish repairs based on the level of impact on the capability of the FFS. Repairs having a larger impact on FFS capability to provide the required training, evaluation, or flight experience will have a higher priority for repair or replacement.

#### End Information

### 19. Automatic Loss of Qualification and Procedures for Restoration of Qualification (§ 60.27)

#### Begin Information

If the sponsor provides a plan for how the FFS will be maintained during its out-of-service period (e.g., periodic exercise of mechanical, hydraulic, and electrical systems; routine replacement of hydraulic fluid; control of the environmental factors in which the FFS is to be maintained) there is a greater likelihood that the NSPM will be able to determine the amount of testing required for requalification.

#### End Information

### 20. Other Losses of Qualification and Procedures for Restoration of Qualification (§ 60.29)

#### Begin Information

If the sponsor provides a plan for how the FFS will be maintained during its out-of-service period (e.g., periodic exercise of mechanical, hydraulic, and electrical systems; routine replacement of hydraulic fluid; control of the environmental factors in which the FFS is to be maintained) there is a greater likelihood that the NSPM will be able to determine the amount of testing required for requalification.

#### End Information

### 21. Recordkeeping and Reporting (§ 60.31)

#### Begin QPS Requirements

a. FSTD modifications can include hardware or software changes. For FSTD modifications involving software programming changes, the record required by § 60.31(a)(2) must consist of the name of the aircraft system software, aerodynamic model, or engine model change, the date of the

change, a summary of the change, and the reason for the change.

b. If a coded form for record keeping is used, it must provide for the preservation and retrieval of information with appropriate security or controls to prevent the inappropriate alteration of such records after the fact.

#### End QPS Requirements

### 22. Applications, Logbooks, Reports, and Records: Fraud, Falsification, or Incorrect Statements (§ 60.33)

#### Begin Information

No additional regulatory or informational material applies to § 60.33, Applications, Logbooks, Reports, and Records: Fraud, Falsification, or Incorrect Statements.

#### 23. [Reserved]

#### 24. [Reserved]

### 25. FSTD Qualification on the Basis of a Bilateral Aviation Safety Agreement (BASA) (§ 60.37)

No additional regulatory or informational material applies to § 60.37, FSTD Qualification on the Basis of a Bilateral Aviation Safety Agreement (BASA).

#### End Information

### Attachment 1 to Appendix C to Part 60—General Simulator Requirements

#### Begin QPS Requirements

##### 1. Requirements

a. Certain requirements included in this appendix must be supported with a Statement of Compliance and Capability (SOC), which may include objective and subjective tests. The SOC will confirm that the requirement was satisfied, and describe how the requirement was met, such as gear modeling approach or coefficient of friction sources. The requirements for SOCs and tests are indicated in the "General Simulator Requirements" column in Table C1A of this appendix.

b. Table C1A describes the requirements for the indicated level of FFS. Many devices include operational systems or functions that exceed the requirements outlined in this section. However, all systems will be tested and evaluated in accordance with this appendix to ensure proper operation.

#### End QPS Requirements

#### Begin Information

##### 2. Discussion

a. This attachment describes the general simulator requirements for qualifying a helicopter FFS. The sponsor should also consult the objective tests in Attachment 2 and the examination of functions and subjective tests listed in Attachment 3 to determine the complete requirements for a specific level simulator.



b. The material contained in this attachment is divided into the following categories:

- (1) General flight deck configuration.
- (2) Simulator programming.
- (3) Equipment operation.
- (4) Equipment and facilities for instructor/evaluator functions.
- (5) Motion system.
- (6) Visual system.
- (7) Sound system.

c. Table C1A provides the standards for the General Simulator Requirements.

d. Table C1B provides the tasks that the sponsor will examine to determine whether the FSTD satisfactorily meets the requirements for flight crew training, testing, and experience, and provides the tasks for which the simulator may be qualified.

e. Table C1C provides the functions that an instructor/check airman must be able to control in the simulator.

f. It is not required that all of the tasks that appear on the List of Qualified Tasks (part of the SOQ) be accomplished during the initial or continuing qualification evaluation.

g. Table C1A addresses only Levels B, C, and D helicopter simulators because there are no Level A Helicopter simulators.

**End Information 1**

**TABLE C1A.—MINIMUM SIMULATOR REQUIREMENTS**

| Number                                      | <<<QPS requirements>>>  | Simulator levels |   |   | <<<Information>>>   |
|---|---|------------------|---|---|---|
|   | General Simulator Requirements  | B                | C | D | Notes   |
| <b>1. General Flight Deck Configuration</b> |   |                  |   |   |   |
| 1.a. ....                                   | The simulator must have a flight deck that is a replica of the helicopter being simulated. The simulator must have controls, equipment, observable flight deck indicators, circuit breakers, and bulkheads properly located, functionally accurate and replicating the helicopter. The direction of movement of controls and switches must be identical to that in the helicopter. Pilot seats must afford the capability for the occupant to be able to achieve the design “eye position” established for the helicopter being simulated. Equipment for the operation of the flight deck windows must be included, but the actual windows need not be operable. Fire axes, extinguishers, and spare light bulbs must be available in the FFS but may be relocated to a suitable location as near as practical to the original position. Fire axes, landing gear pins, and any similar purpose instruments need only be represented in silhouette.<br>An SOC is required. | X                | X | X | For simulator purposes, the flight deck consists of all that space forward of a cross section of the fuselage at the most extreme aft setting of the pilots’ seats including additional, required flight crewmember duty stations and those required bulkheads aft of the pilot seats. For clarification, bulkheads containing only items such as landing gear pin storage compartments, fire axes or extinguishers, spare light bulbs, and aircraft documents pouches are not considered essential and may be omitted. |
| 1.b. ....                                   | Those circuit breakers that affect procedures and/or result in observable flight deck indications must be properly located and functionally accurate<br>An SOC is required.   | X                | X | X |   |
| <b>2. Programming</b>                       |   |                  |   |   |   |
| 2.a. ....                                   | A flight dynamics model that accounts for various combinations of drag and thrust normally encountered in flight must correspond to actual flight conditions, including the effect of change in helicopter attitude, thrust, drag, altitude, temperature, gross weight, moments of inertia, center of gravity location, and configuration.<br>An SOC is required.   | X                | X | X |   |
| 2.b. ....                                   | The simulator must have the computer capacity, accuracy, resolution, and dynamic response needed to meet the qualification level sought.<br>An SOC is required.   | X                | X | X |   |
| 2.c. ....                                   | Ground handling and aerodynamic programming must include the following:<br>A subjective test is required.   |                  |   |   |   |
| 2.c.1. ....                                 | Ground effect .....<br><br>Level B does not require hover programming.<br>An SOC is required.   | X                | X | X | Applicable areas include flare and touch down from a running landing as well as for in-ground-effect (IGE) hover. A reasonable simulation of ground effect includes modeling of lift, drag, pitching moment, trim, and power while in ground effect.  |

TABLE C1A.—MINIMUM SIMULATOR REQUIREMENTS—Continued

| Number      | <<<QPS requirements>>>  | Simulator levels |   |   | <<Information>>  |
|-------------|---|------------------|---|---|--|
|             | General Simulator Requirements  | B                | C | D | Notes  |
| 2.c.2. .... | Ground reaction .....<br><br>Level B does not require hover programming.<br>An SOC is required.   | X                | X | X | Reaction of the helicopter upon contact with the landing surface during landing (e.g., strut deflection, tire or skid friction, side forces) may differ with changes in gross weight, airspeed, rate of descent on touchdown, and slide slip.                      |
| 2.d. ....   | The simulator must provide for manual and automatic testing of simulator hardware and software programming to determine compliance with simulator objective tests as prescribed in Attachment 2.<br>An SOC is required.   |                  | X | X | This may include an automated system, which could be used for conducting at least a portion of the QTG tests. Automatic “flagging” of out-of-tolerance situations is encouraged.   |
| 2.e. ....   | The relative responses of the motion system, visual system, and flight deck instruments must be measured by latency tests or transport delay tests. Motion onset should occur before the start of the visual scene change (the start of the scan of the first video field containing different information) but must occur before the end of the scan of that video field. Instrument response may not occur prior to motion onset. Test results must be within the following limits: |                  |   |   | The intent is to verify that the simulator provides instrument, motion, and visual cues that are like the helicopter responses within the stated time delays. For helicopter response, acceleration in the appropriate corresponding rotational axis is preferred. |
| 2.e.1. .... | Response must be within 150 milliseconds of the helicopter response.<br>Objective Tests are required.<br>See Attachment 2 for Transport Delay and Latency Tests.  | X                |   |   |  |
| 2.e.2. .... | Response must be within 100 milliseconds of the helicopter response.<br>Objective Tests are required.<br>See Attachment 2 for Transport Delay and Latency Tests.  |                  | X | X |  |
| 2.f. ....   | The simulator must simulate brake and tire failure dynamics (including antiskid failure, if appropriate).<br><br>An SOC is required.  |                  | X | X | Simulator pitch, side loading, and directional control characteristics should be representative of the helicopter.   |
| 2.g. ....   | The aerodynamic modeling in the simulator must include:<br>(1) Ground effect,<br>(2) Effects of airframe and rotor icing (if applicable),<br>(3) Aerodynamic interference effects between the rotor wake and fuselage,<br>(4) Influence of the rotor on control and stabilization systems,<br>(5) Representations of settling with power, and<br>(6) Retreating blade stall..<br>An SOC is required.<br>A demonstration of icing effects (if applicable) is required.                 |                  | X | X | See Attachment 2 for further information on ground effect.   |
| 2.h. ....   | The simulator must provide for realistic mass properties, including gross weight, center of gravity, and moments of inertia as a function of payload and fuel loading.<br><br>An SOC is required and must include a range of tabulated target values to enable a subjective test of the mass properties model to be conducted from the instructor's station.  | X                | X | X |  |

### 3. Equipment Operation

TABLE C1A.—MINIMUM SIMULATOR REQUIREMENTS—Continued

| Number    | <<<QPS requirements>>><br>General Simulator Requirements  | Simulator levels |   |   | <<Information>><br>Notes  |
|-----------|---|------------------|---|---|---|
|           |   | B                | C | D |   |
| 3.a. .... | All relevant instrument indications involved in the simulation of the helicopter must automatically respond to control movement or external disturbances to the simulated helicopter; e.g., turbulence or windshear. Numerical values, must be presented in the appropriate units.<br>A subjective test is required.  | X                | X | X |   |
| 3.b. .... | Communications, navigation, caution, and warning equipment must be installed and operate within the tolerances applicable for the helicopter being simulated.<br>A subjective test is required.   | X                | X | X | See Attachment 3 for further information regarding long-range navigation equipment. |
| 3.c. .... | Simulated helicopter systems must operate as the helicopter systems would operate under normal, abnormal, and emergency operating conditions on the ground and in flight.<br>A subjective test is required.   | X                | X | X |   |
| 3.d. .... | The simulator must provide pilot controls with control forces and control travel that correspond to the simulated helicopter. The simulator must also react in the same manner as the helicopter under the same flight conditions.<br>An objective test is required.  | X                | X | X |   |
| 3.e. .... | Simulator control feel dynamics must replicate the helicopter simulated. This must be determined by comparing a recording of the control feel dynamics of the simulator to helicopter measurements. For initial and upgrade evaluations, the control dynamic characteristics must be measured and recorded directly from the flight deck controls, and must be accomplished in takeoff, cruise, and landing conditions and configurations.<br>Objective tests are required. |                  | X | X |   |

**4. Instructor/Evaluator Facilities**

|           |  |   |   |   |   |
|-----------|--|---|---|---|---|
| 4.a. .... | In addition to the flight crewmember stations, the simulator must have at least two suitable seats for the instructor/check airman and FAA inspector. These seats must provide adequate vision to the pilot's panel and forward windows. All seats other than flight crew seats need not represent those found in the helicopter but must be adequately secured to the floor and equipped with similar positive restraint devices.<br>A subjective test is required. | X | X | X | The NSPM will consider alternatives to this standard for additional seats based on unique flight deck configurations. |
| 4.b. .... | The simulator must have controls that enable the instructor/evaluator to control all required system variables and insert all abnormal or emergency conditions into the simulated helicopter systems as described in the sponsor's FAA-approved training program, or as described in the relevant operating manual as appropriate.<br>A subjective test is required.   | X | X | X |   |
| 4.c. .... | The simulator must have instructor controls for environmental conditions including wind speed and direction.<br>A subjective test is required.   | X | X | X |   |
| 4.d. .... | The simulator must provide the instructor or evaluator the ability to present ground and air hazards.<br>A subjective test is required.  |   | X | X | For example, another aircraft crossing the active runway and converging airborne traffic.                             |

TABLE C1A.—MINIMUM SIMULATOR REQUIREMENTS—Continued

| Number                  | <<<QPS requirements>>><br>General Simulator Requirements   | Simulator levels |   |   | <<Information>><br>Notes   |
|-------------------------|--|------------------|---|---|--|
|                         |  | B                | C | D |  |
| 4.e. ....               | The simulator must provide the instructor or evaluator the ability to present the effect of re-circulating dust or snow conditions that develop as a result of rotor downwash.<br>A subjective test is required.   |                  | X | X | This is a selectable condition that is not required for all operations on or near the ground.  |
| <b>5. Motion System</b> |  |                  |   |   |  |
| 5.a. ....               | The simulator must have motion (force) cues perceptible to the pilot that are representative of the motion in a helicopter.<br>A subjective test is required.  | X                | X | X | For example, touchdown cues should be a function of the rate of descent (RoD) of the simulated helicopter.   |
| 5.b. ....               | The simulator must have a motion (force cueing) system with a minimum of three degrees of freedom (at least pitch, roll, and heave).<br>An SOC is required.  | X                |   |   |  |
| 5.c. ....               | The simulator must have a motion (force cueing) system that produces cues at least equivalent to those of a six-degrees-of-freedom, synergistic platform motion system (i.e., pitch, roll, yaw, heave, sway, and surge).<br>An SOC is required.  |                  | X | X |  |
| 5.d. ....               | The simulator must provide for the recording of the motion system response time.<br>An SOC is required.  | X                | X | X |  |
| 5.e. ....               | The simulator must provide motion effects programming to include the following:<br>(1) Runway rumble, oleo deflections, effects of ground speed, uneven runway, characteristics.<br>(2) Buffets due to transverse flow effects.<br>(3) Buffet during extension and retraction of landing gear.<br>(4) Buffet due to retreating blade stall.<br>(5) Buffet due to settling with power.<br>(6) Representative cues resulting from touchdown.<br>(7) Rotor vibrations.<br>A subjective test is required for each. | X                | X | X |  |
|                         | (8) Tire failure dynamics .....<br>(9) Engine malfunction and engine damage.<br>(10) Airframe ground strike.<br>A subjective test is required for each.  |                  | X | X |  |
|                         | (11) Motion vibrations that result from atmospheric disturbances.  |                  |   | X | For air turbulence, general purpose disturbance models that approximate demonstrable flight test data are acceptable.                                      |
| 5.f. ....               | The simulator must provide characteristic motion vibrations that result from operation of the helicopter (for example, retreating blade stall, extended landing gear, settling with power) in so far as vibration marks an event or helicopter state, which can be sensed in the flight deck.<br>A subjective test is required.<br>An objective test is required.  |                  |   | X | The simulator should be programmed and instrumented in such a manner that the characteristic buffet modes can be measured and compared to helicopter data. |
| 6. ....                 | <b>Visual System</b> .....   |                  |   |   | Additional horizontal field of view capability may be added at the sponsor's discretion provided the minimum field of view is retained.                    |
| 6.a. ....               | The simulator must have a visual system providing an out-of-the-flight deck view.<br>A subjective test is required.  | X                | X | X |  |

TABLE C1A.—MINIMUM SIMULATOR REQUIREMENTS—Continued

| Number    | <<<QPS requirements>>><br>General Simulator Requirements  | Simulator levels |   |   | <<Information>>  |
|-----------|---|------------------|---|---|--|
|           |   | B                | C | D | Notes  |
| 6.b. .... | The simulator must provide a continuous field of view of at least 75° horizontally and 30° vertically per pilot seat. Both pilot seat visual systems must be operable simultaneously. The minimum horizontal field of view coverage must be plus and minus one-half (1/2) of the minimum continuous field of view requirement, centered on the zero degree azimuth line relative to the aircraft fuselage. An SOC must explain the geometry of the installation.<br>An SOC is required.   | X                |   |   |  |
| 6.c. .... | The simulator must provide a continuous visual field of view of at least 146° horizontally and 36° vertically per pilot seat. Both pilot seat visual systems must be operable simultaneously. Horizontal field of view is centered on the zero degree azimuth line relative to the aircraft fuselage. The minimum horizontal field of view coverage must be plus and minus one-half (1/2) of the minimum continuous field of view requirement, centered on the zero degree azimuth line relative to the aircraft fuselage. An SOC must explain the geometry of the installation. Capability for a field of view in excess of the minimum is not required for qualification at Level C. However, where specific tasks require extended fields of view beyond the 146° by 36° (e.g., to accommodate the use of "chin windows" where the accommodation is either integral with or separate from the primary visual system display), then the extended fields of view must be provided. When considering the installation and use of augmented fields of view, the sponsor must meet with the NSPM to determine the training, testing, checking, and experience tasks for which the augmented field of view capability may be required.<br>An SOC is required.<br>A subjective test is required.                          |                  | X |   | Optimization of the vertical field of view may be considered with respect to the specific helicopter flight deck cut-off angle. The sponsor may request the NSPM to evaluate the FFS for specific authorization(s) for the following:<br>(1) Specific areas within the database needing higher resolution to support landings, take-offs and ground cushion exercises and training away from a heliport, including elevated heliport, helidecks and confined areas.<br>(2) For cross-country flights, sufficient scene details to allow for ground to map navigation over a sector length equal to 30 minutes at an average cruise speed.<br>(3) For offshore airborne radar approaches (ARA), harmonized visual/radar representations of installations. |
| 6.d. .... | The simulator must provide a continuous visual field of view of at least 176° horizontally and 56° vertically per pilot seat. Both pilot seat visual systems must be operable simultaneously. Horizontal field of view is centered on the zero degree azimuth line relative to the aircraft fuselage. The minimum horizontal field of view coverage must be plus and minus one-half (1/2) of the minimum continuous field of view requirement, centered on the zero degree azimuth line relative to the aircraft fuselage. An SOC must explain the geometry of the installation. Capability for a field of view in excess of the minimum is not required for qualification at the Zero Flight Time (ZFT) level. However, where specific tasks require extended fields of view beyond the 176° by 56° (e.g., to accommodate the use of "chin windows" where the accommodation is either integral with or separate from the primary visual system display), then the extended fields of view must be provided. When considering the installation and use of augmented fields of view, the sponsor must meet with the NSPM to determine the training, testing, checking, and experience tasks for which the augmented field of view capability may be required.<br>An SOC is required.<br>An objective test is required. |                  |   | X | Optimization of the vertical field of view may be considered with respect to the specific airplane flight deck cut-off angle. The sponsor may request the NSPM to evaluate the FFS for specific authorization(s) for the following:<br>(1) Specific areas within the database needing higher resolution to support landings, take-offs and ground cushion exercises and training away from a heliport, including elevated heliport, helidecks and confined areas.<br>(2) For cross-country flights, sufficient scene details to allow for ground to map navigation over a sector length equal to 30 minutes at an average cruise speed.<br>(3) For offshore airborne radar approaches (ARA), harmonized visual/radar representations of installations.   |
| 6.e. .... | The visual system must be free from optical discontinuities and artifacts that create non-realistic cues.<br><br>A subjective test is required.   | X                | X | X | Non-realistic cues might include image "swimming" and image "roll-off," that may lead a pilot to make incorrect assessments of speed, acceleration and/or situational awareness.   |

TABLE C1A.—MINIMUM SIMULATOR REQUIREMENTS—Continued

| Number    | <<<QPS requirements>>>  | Simulator levels |   |   | <<Information>>  |
|-----------|---|------------------|---|---|--|
|           | General Simulator Requirements  | B                | C | D | Notes  |
| 6.f. .... | The simulator must have operational landing lights for night scenes. Where used, dusk (or twilight) scenes require operational landing lights.<br>A subjective test is required.  | X                | X | X |  |
| 6.g. .... | The simulator must have instructor controls for the following:<br>(1) Visibility in statute miles (kilometers) and runway visual range (RVR) in ft. (meters).<br>(2) Airport or landing area selection.<br>(3) Airport or landing area lighting.<br>A subjective test is required.  | X                | X | X |  |
| 6.h. .... | Each airport scene displayed must include the following:<br>(1) Airport runways and taxiways.<br>(2) Runway definition:<br>(a) Runway surface and markings.<br>(b) Lighting for the runway in use, including runway threshold, edge, centerline, touchdown zone, VASI (or PAPI), and approach lighting of appropriate colors, as appropriate.<br>(c) Taxiway lights.<br>A subjective test is required.  | X                | X | X |  |
| 6.i. .... | The distances at which runway features are visible, as measured from runway threshold to a helicopter aligned with the runway on an extended 3° glide slope must not be less than listed below:<br>(1) Runway definition, strobe lights, approach lights, runway edge white lights and VASI or PAPI system lights from 5 statute miles (8 km) of the runway threshold.<br>(2) Runway centerline lights and taxiway definition from 3 statute miles (4.8 km).<br>(3) Threshold lights and touchdown zone lights from 2 statute miles (3.2 km).<br>(4) Runway markings within range of landing lights for night scenes and as required by three (3) arc-minutes resolution on day scenes.<br>A subjective test is required. | X                | X | X |  |
| 6.j. .... | The simulator must provide visual system compatibility with dynamic response programming.<br>A subjective test is required.   | X                | X | X |  |
| 6.k. .... | The simulator must show that the segment of the ground visible from the simulator flight deck is the same as from the helicopter flight deck (within established tolerances) when at the correct airspeed and altitude, at a main wheel height of 100 feet (30 meters) above the touchdown zone.<br>An SOC is required.<br>An objective test is required.   | X                | X | X | This will show the modeling accuracy of the scene with respect to a pre-determined position from the end of the runway "in use." |
| 6.l. .... | The simulator must provide visual cues necessary to assess rate of change of height, height AGL, and translational displacement and rates during takeoffs and landings.<br>A subjective test is required.   | X                |   |   |  |
| 6.m. .... | The simulator must have night and dusk (or twilight) visual scene capability, including general terrain characteristics and significant landmarks, free from apparent quantization. The dusk (or twilight) scene must enable identification of a visible horizon and general terrain characteristics.<br>A subjective test is required.   |                  | X | X | Examples of general terrain characteristics are fields, roads, and bodies of water.  |

TABLE C1A.—MINIMUM SIMULATOR REQUIREMENTS—Continued

| Number    | <<<QPS requirements>>>  | Simulator levels               |   |   | <<Information>>   |
|-----------|---|--------------------------------|---|---|---|
|           |   | General Simulator Requirements | B | C |   |
| 6.n. .... | The simulator must provide visual cues necessary to assess rate of change of height, height AGL, as well as translational displacement and rates during takeoff, low altitude/low airspeed maneuvering, hover, and landing.<br>A subjective test is required.   |                                | X | X |   |
| 6.o. .... | The simulator must provide for accurate portrayal of the visual environment relating to the simulator attitude.<br>A subjective test is required.   | X                              | X | X | Visual attitude vs. simulator attitude is a comparison of pitch and roll of the horizon as displayed in the visual scene compared to the display on the attitude indicator. |
| 6.p. .... | The simulator must provide for quick confirmation of visual system color, RVR, focus, and intensity.<br>An SOC is required.<br>A subjective test is required.   |                                | X | X |   |
| 6.q. .... | The simulator must be capable of producing at least 10 levels of occulting.<br>A subjective test is required.   |                                | X | X |   |
| 6.r. .... | Night Visual Scenes. The simulator must provide night visual scenes with sufficient scene content to recognize the airport, the terrain, and major landmarks around the airport. The scene content must allow a pilot to successfully accomplish a visual landing. Night scenes, as a minimum, must provide presentations of sufficient surfaces with appropriate textural cues that include self-illuminated objects such as road networks, ramp lighting, and airport signage, to conduct a visual approach, a landing, and airport movement (taxi). Scenes must include a definable horizon and typical terrain characteristics such as fields, roads and bodies of water and surfaces illuminated by airplane landing lights.   | X                              | X | X |   |
| 6.s. .... | Dusk (Twilight) Visual Scenes. The simulator must provide dusk (or twilight) visual scenes with sufficient scene content to recognize the airport, the terrain, and major landmarks around the airport. The scene content must allow a pilot to successfully accomplish a visual landing. Dusk (or twilight) scenes, as a minimum, must provide full color presentations of reduced ambient intensity, sufficient surfaces with appropriate textural cues that include self-illuminated objects such as road networks, ramp lighting and airport signage, to conduct a visual approach, landing and airport movement (taxi). Scenes must include a definable horizon and typical terrain characteristics such as fields, roads and bodies of water and surfaces illuminated by representative aircraft lighting (e.g., landing lights). If provided, directional horizon lighting must have correct orientation and be consistent with surface shading effects. Total scene content must be comparable in detail to that produced by 10,000 visible textured surfaces and 15,000 visible lights with sufficient system capacity to display 16 simultaneously moving objects.<br>An SOC is required. |                                | X | X |   |

TABLE C1A.—MINIMUM SIMULATOR REQUIREMENTS—Continued

| Number    | <<<QPS requirements>>>   | Simulator levels |   |   | <<Information>>  |
|-----------|--|------------------|---|---|--|
|           | General Simulator Requirements   | B                | C | D | Notes  |
| 6.t. .... | Daylight Visual Scenes. The simulator must have daylight visual scenes with sufficient scene content to recognize the airport, the terrain, and major landmarks around the airport. The scene content must allow a pilot to successfully accomplish a visual landing. No ambient lighting may "washout" the displayed visual scene. Total scene content must be comparable in detail to that produced by 10,000 visible textured surfaces and 6,000 visible lights with sufficient system capacity to display 16 simultaneously moving objects. The visual display must be free of apparent quantization and other distracting visual effects while the simulator is in motion.<br>Note: These requirements are applicable to any level of simulator equipped with a daylight visual system. An SOC is required. |                  |   | X |  |
|           | A subjective test is required.<br>Objective tests are required.  |                  |   |   |  |
| 6.w. .... | The simulator must provide operational visual scenes that portray physical relationships known to cause landing illusions to pilots.<br>A subjective test is required.   |                  |   | X | For example: short runways, landing approaches over water, uphill or downhill runways, rising terrain on the approach path, unique topographic features. |
| 6.x. .... | The simulator must provide special weather representations of light, medium, and heavy precipitation near a thunderstorm on takeoff and during approach and landing. Representations need only be presented at and below an altitude of 2,000 ft. (610 m) above the airport surface and within 10 miles (16 km) of the airport.<br>A subjective test is required.  |                  |   | X |  |
| 6.y. .... | The simulator must present visual scenes of wet and snow-covered runways, including runway lighting reflections for wet conditions, and partially obscured lights for snow conditions.<br>A subjective test is required.   |                  |   | X | The NSPM will consider suitable alternative effects.   |
| 6.z. .... | The simulator must present realistic color and directionality of all airport lighting.<br>A subjective test is required.   |                  |   | X |  |
| 7.a. .... | The simulator must provide flight deck sounds that result from pilot actions that correspond to those that occur in the helicopter.  | X                | X | X |  |
| 7.b. .... | Volume control, if installed, must have an indication of the sound level setting.  | X                | X | X |  |
| 7.c. .... | The simulator must accurately simulate the sound of precipitation, windshield wipers, and other significant helicopter noises perceptible to the pilot during normal and abnormal operations, and include the sound of a crash (when the simulator is landed in an unusual attitude or in excess of the structural gear limitations); normal engine sounds; and the sounds of gear extension and retraction.<br>An SOC is required.<br>A subjective test is required.  |                  | X | X |  |
| 7.d. .... | The simulator must provide realistic amplitude and frequency of flight deck noises and sounds. Simulator performance must be recorded, compared to amplitude and frequency of the same sounds recorded in the helicopter, and made a part of the QTG.<br>An objective test is required.  |                  |   | X |  |



TABLE C1B.—TABLE OF TASKS VS. SIMULATOR LEVEL

| Number                                | <<<QPS requirements>>><br>Subjective Requirements<br>The simulator must be able to perform the tasks associated with that level of qualification. | Simulator levels |   |   | Information |
|---------------------------------------|---|------------------|---|---|-------------|
|                                       |   | B                | C | D | Notes       |
| <b>1. Preflight Procedures</b>        |   |                  |   |   |             |
| 1.a. ....                             | Preflight Inspection (Flight deck only) switches, indicators, systems, and equipment .....  | X                | X | X |             |
| 1.b. ....                             | APU/Engine start and run-up.  |                  |   |   |             |
| 1.b.1. ...                            | Normal start procedures .....   | X                | X | X |             |
| 1.b.2. ...                            | Alternate start procedures .....  | X                | X | X |             |
| 1.b.3. ...                            | Abnormal starts and shutdowns (hot start, hung start) .....   | X                | X | X |             |
| 1.c. ....                             | Taxiing—Ground .....  | X                | X | X |             |
| 1.d. ....                             | Taxiing—Hover .....   | X                | X | X |             |
| 1.e. ....                             | Pre-takeoff Checks .....  | X                | X | X |             |
| <b>2. Takeoff and Departure Phase</b> |   |                  |   |   |             |
| 2.a. ....                             | Normal takeoff  |                  |   |   |             |
| 2.a.1. ...                            | From ground .....   | X                | X | X |             |
| 2.a.2. ...                            | From hover .....  | X                | X | X |             |
| 2.a.3. ...                            | Running .....   | X                | X | X |             |
| 2.b. ....                             | Instrument .....  | X                | X | X |             |
| 2.c. ....                             | Powerplant Failure During Takeoff .....   | X                | X | X |             |
| 2.d. ....                             | Rejected Takeoff .....  | X                | X | X |             |
| 2.e. ....                             | Instrument Departure .....  | X                | X | X |             |
| <b>3. Climb</b>                       |   |                  |   |   |             |
| 3.a. ....                             | Normal .....  | X                | X | X |             |
| 3.b. ....                             | Obstacle clearance .....  | X                | X | X |             |
| 3.c. ....                             | Vertical .....  | X                | X | X |             |
| 3.d. ....                             | One engine inoperative .....  | X                | X | X |             |
| <b>4. In-flight Maneuvers</b>         |   |                  |   |   |             |
| 4.a. ....                             | Turns (timed, normal, steep) .....  | X                | X | X |             |
| 4.b. ....                             | Powerplant Failure—Multiengine Helicopters .....  | X                | X | X |             |
| 4.c. ....                             | Powerplant Failure—Single-Engine Helicopters .....  | X                | X | X |             |
| 4.d. ....                             | Recovery From Unusual Attitudes .....   | X                | X | X |             |
| 4.e. ....                             | Settling with Power .....   | X                | X | X |             |
| 4.f. ....                             | Specific Flight Characteristics incorporated into the user's FAA approved flight training program.  | A                | A | A |             |
| <b>5. Instrument Procedures</b>       |   |                  |   |   |             |
| 5.a. ....                             | Instrument Arrival .....  | X                | X | X |             |
| 5.b. ....                             | Holding .....   | X                | X | X |             |
| 5.c. ....                             | Precision Instrument Approach   |                  |   |   |             |
| 5.c.1. ....                           | Normal—All engines operating .....  | X                | X | X |             |

TABLE C1B.—TABLE OF TASKS VS. SIMULATOR LEVEL—Continued

| Number   | <<<QPS requirements>>>  | Simulator levels |   |   | Information |
|--|---|------------------|---|---|-------------|
|  | Subjective Requirements<br>The simulator must be able to perform the tasks associated with that level of qualification.                                       | B                | C | D | Notes       |
| 5.c.2. ....                                    | Manually controlled—One or more engines inoperative .....   | X                | X | X |             |
| 5.d. ....                                      | Non-precision Instrument Approach .....   | X                | X | X |             |
| 5.e. ....                                      | Missed Approach   |                  |   |   |             |
| 5.e.1. ...                                     | All engines operating .....   | X                | X | X |             |
| 5.e.2. ...                                     | One or more engines inoperative .....   | X                | X | X |             |
| 5.e.3. ...                                     | Stability augmentation system failure .....   | X                | X | X |             |
| <b>6. Landings and Approaches to Landings</b>  |   |                  |   |   |             |
| 6.a. ....                                      | Visual Approaches (normal, steep, shallow) .....  | X                | X | X |             |
| 6.b. ....                                      | Landings  |                  |   |   |             |
| 6.b.1. ...                                     | Normal/crosswind  |                  |   |   |             |
| 6.b.1.a.                                       | Running .....   | X                | X | X |             |
| 6.b.1.b.                                       | From Hover .....  | X                | X | X |             |
| 6.b.2. ...                                     | One or more engines inoperative .....   | X                | X | X |             |
| 6.b.3. ...                                     | Rejected Landing .....  | X                | X | X |             |
| <b>7. Normal and Abnormal Procedures</b>       |   |                  |   |   |             |
| 7.a. ....                                      | Powerplant .....  | X                | X | X |             |
| 7.b. ....                                      | Fuel System .....   | X                | X | X |             |
| 7.c. ....                                      | Electrical System .....   | X                | X | X |             |
| 7.d. ....                                      | Hydraulic System .....  | X                | X | X |             |
| 7.e. ....                                      | Environmental System(s) .....   | X                | X | X |             |
| 7.f. ....                                      | Fire Detection and Extinguisher Systems .....   | X                | X | X |             |
| 7.g. ....                                      | Navigation and Aviation Systems .....   | X                | X | X |             |
| 7.h. ....                                      | Automatic Flight Control System, Electronic Flight Instrument System, and Related Sub-systems.  | X                | X | X |             |
| 7.i. ....                                      | Flight Control Systems .....  | X                | X | X |             |
| 7.j. ....                                      | Anti-ice and Deice Systems .....  | X                | X | X |             |
| 7.k. ....                                      | Aircraft and Personal Emergency Equipment .....   | X                | X | X |             |
| 7.l. ....                                      | Special Missions tasks (e.g., Night Vision goggles, Forward Looking Infrared System, External Loads and as may be listed on the Statement of Qualification.). | A                | A | X |             |
| <b>8. Emergency Procedures (as applicable)</b> |   |                  |   |   |             |
| 8.a. ....                                      | Emergency Descent .....   | X                | X | X |             |
| 8.b. ....                                      | Inflight Fire and Smoke Removal .....   | X                | X | X |             |
| 8.c. ....                                      | Emergency Evacuation .....  | X                | X | X |             |
| 8.d. ....                                      | Ditching .....  | X                | X | X |             |
| 8.e. ....                                      | Autorotative Landing .....  | X                | X | X |             |
| 8.f. ....                                      | Retreating blade stall recovery .....   | X                | X | X |             |

TABLE C1B.—TABLE OF TASKS VS. SIMULATOR LEVEL—Continued

| Number                          | <<<QPS requirements>>>  |  |  | Simulator levels |   |   | Information |
|---------------------------------|---|--|--|------------------|---|---|-------------|
|                                 | Subjective Requirements<br>The simulator must be able to perform the tasks associated with that level of qualification. |  |  | B                | C | D | Notes       |
| 8.g. ....                       | Mast bumping .....  |  |  | X                | X | X |             |
| 8.h. ....                       | Loss of tail rotor effectiveness .....  |  |  | X                | X | X |             |
| <b>9. Postflight Procedures</b> |   |  |  |                  |   |   |             |
| 9.a. ....                       | After-Landing Procedures .....  |  |  | X                | X | X |             |
| 9.b. ....                       | Parking and Securing  |  |  |                  |   |   |             |
| 9.b.1. ...                      | Rotor brake operation .....   |  |  | X                | X | X |             |
| 9.b.2. ...                      | Abnormal/emergency procedures .....   |  |  | X                | X | X |             |

Note: An "A" in the table indicates that the system, task, or procedure may be examined if the appropriate aircraft system or control is simulated in the FSTD and is working properly.

TABLE C1C.—TABLE OF TASKS VS. SIMULATOR LEVEL

| Number         | <<<QPS requirements>>>   |                  |   |   | Information notes  |
|----------------|--|------------------|---|---|--|
|                | Subjective requirements<br>The simulator must be able to perform the tasks associated with that level of qualification | Simulator levels |   |   |  |
|                |  | B                | C | D |  |
| <b>1. ....</b> | <b>Instructor Operating Station (IOS), as appropriate</b>  |                  |   |   |  |
| 1.a. ....      | Power switch(es) .....   | X                | X | X |  |
| 1.b. ....      | Helicopter conditions .....  | X                | X | X | e.g., GW, CG, Fuel loading, Systems, Ground Crew.                          |
| 1.c. ....      | Airports/Heliports/Helicopter Landing Areas .....  | X                | X | X | e.g., Selection, Surface, Presets, Lighting controls.                      |
| 1.d. ....      | Environmental controls .....   | X                | X | X | e.g., Clouds, Visibility, RVR, Temp, Wind, Ice, Snow, Rain, and Windshear. |
| 1.e. ....      | Helicopter system malfunctions (Insertion/deletion) .....  | X                | X | X |  |
| 1.f. ....      | Locks, Freezes, and Repositioning .....  | X                | X | X |  |
| <b>2. ....</b> | <b>Sound Control</b>   |                  |   |   |  |
| 2.a. ....      | On/off/adjustment .....  | X                | X | X |  |
| <b>3. ....</b> | <b>Motion/Control Loading System</b>   |                  |   |   |  |
| 3.a. ....      | On/off/emergency stop .....  | X                | X | X |  |
| <b>4. ....</b> | <b>Observer Seats/Stations</b>   |                  |   |   |  |
| 4.a. ....      | Position/Adjustment/Positive restraint system .....  | X                | X | X |  |

Attachment 2 to Appendix C to Part 60—Full Flight Simulator Objective Tests

Begin Information

TABLE OF CONTENTS

| Paragraph No. | Title                      |
|---------------|----------------------------|
| 1. ....       | Introduction.              |
| 2. ....       | Test Requirements.         |
|               | Table C2A, Objective Test. |

TABLE OF CONTENTS—Continued

| Paragraph No. | Title   |
|---------------|---|
| 3. ....       | General.  |
| 4. ....       | Control Dynamics.   |
| 5. ....       | [Reserved].   |
| 6. ....       | Motion System.  |
| 7. ....       | Sound System.   |
| 8. ....       | Additional Information About Flight Simulator Qualification for New or Derivative Helicopter.   |
| 9. ....       | Engineering Simulator—Validation Data.  |
| 10. ....      | [Reserved].   |
| 11. ....      | Validation Test Tolerances.   |
| 12. ....      | Validation Data Roadmap.  |
| 13. ....      | Acceptance Guidelines for Alternative Engines Data.   |
| 14. ....      | Acceptance Guidelines for Alternative Avionics (Flights-Related Computers and Controllers).     |
| 15. ....      | Transport Delay Testing.  |
| 16. ....      | Continuing Qualification Evaluations—Validation Test Data Presentation.                         |
| 17. ....      | Alternative Data Sources, Procedures, and Instrumentation: Level A and Level B Simulators Only. |

**1. Introduction**

a. If relevant winds are present in the objective data, the wind vector (magnitude and direction) should be clearly noted as part of the data presentation, expressed in conventional terminology, and related to the runway being used for the test.

b. The NSPM will not evaluate any simulator unless the required SOC indicates that the motion system is designed and manufactured to safely operate within the simulator’s maximum excursion, acceleration, and velocity capabilities (see Motion System in the following table).

c. Table C2A addresses helicopter simulators at Levels B, C, and D because there are no Level A Helicopter simulators.

**End Information**

**Begin QPS Requirements**

**2. Test Requirements**

A. The ground and flight tests required for qualification are listed in Table C2A. FFS Objective Tests. Computer generated simulator tests results must be provided for each test except where an alternative test is specifically authorized by the NSPM. If a flight condition or operating condition is required for the test but does not apply to the helicopter being simulated or to be qualification level sought, it may be disregarded (e.g., an engine out missed approached for a single-engine helicopter, or a hover test for a Level B simulator) Each test result if compared against the validation data described in § 6013 and in this appendix. Although use of a driver program designed to automatically accomplish the test is

encouraged for all simulators and required for level C and Level D simulators, each test must be able to be accomplished manually while recording all appropriate parameters. The request must be produced on an appropriate recording device accepted to the NSPM and must include simulator number, data, time, condition, tolerances, and appropriate dependent variables portrayed in comparison to the validation data. Time histories are required unless otherwise indicated in Table C2A. All results must be labeled using the tolerances and units given.

b. Table C2A sets out the test results required, including the parameters, tolerances, and flight conditions for simulator validation. Tolerances are provided for the listed tests because mathematical modeling and acquisition/development of reference data are often inexact. All tolerances listed in the following tables are applied to simulator performance. When two tolerance values are given for a parameter, the less restrictive value may be used unless otherwise indicated.

c. Certain tests included in this attachment must be supported with a Statement of Compliance and Capability (SOC). In Table C2A, requirements for SOCs are indicated in the “Test Details” column.

d. When operational or engineering judgment is used in making assessments for flight test data applications for simulator validity, such judgment may not be limited to a single parameter. For example, data that exhibit rapid variations of the measured parameters may require interpolations or a “best fit” data selection. All relevant parameters related to a given maneuver or flight condition must be provided to allow

overall interpretation. When it is difficult or impossible to match simulator to helicopter data throughout a time history, differences must be justified by providing a comparison of other related variables for the condition being assessed.

e. The FFS may not be programmed so that the mathematical modeling is correct only at the validation test points. Unless noted otherwise, simulator tests must represent helicopter performance and handling qualities at operating weights and centers of gravity (CG) typical of normal operation. If a test is supported by helicopter data at one extreme weight or CG, another test supported by helicopter data at mid-conditions or as close as possible to the other extreme must be included. Certain tests that are relevant only at one extreme CG or weight condition need not be repeated at the other extreme. Tests of handling qualities must include validation of augmentation devices.

f. When comparing the parameters listed to those of the helicopter, sufficient data must also be provided to verify the correct flight condition and helicopter configuration changes. For example, to show that control force is within ±0.5 pound (0.22 daN) in a static stability test, data to show the correct airspeed, power, thrust or torque, helicopter configuration, altitude, and other appropriate datum identification parameters must also be given. If comparing short period dynamics, normal acceleration may be used to establish a match to the helicopter, but airspeed, altitude, control input, helicopter configuration, and other appropriate data must also be given. All airspeed values must be properly annotated (e.g., indicated versus calibrated). In addition, the same variables

must be used for comparison (e.g., compare inches to inches rather than inches to centimeters).

g. The QTG provided by the sponsor must clearly describe how the simulator will be set up and operated for each test. Each simulator subsystem may be tested independently, but overall integrated testing of the simulator must be accomplished to assure that the total simulator system meets the prescribed standards. A manual test procedure with explicit and detailed steps for completing each test must also be provided.

h. In those cases where the objective test results authorize a "snapshot test" or a "series of snapshot test results" in lieu of a time-history result, the sponsor or other data provider must ensure that a steady state condition exists at the instant of time captured by the "snapshot." The steady state condition must exist from 4 seconds prior to, through 1 second following, the instant of time captured by the snap shot.

i. For previously qualified simulators, the tests and tolerances of this attachment may be used in subsequent continuing qualification evaluations for any given test if the sponsor has submitted a proposed MQTG revision to the NSPM and has received NSPM approval.

j. Motion System Tests:

(a) The minimum excursions, accelerations, and velocities for pitch, roll, and yaw must be measurable about a single, common reference point and must be

achieved by driving one degree of freedom at a time.

(b) The minimum excursions, accelerations, and velocities for heave, sway, and surge may be measured about different, identifiable reference points and must be achieved by driving one degree of freedom at a time.

k. Tests of handling qualities must include validation of augmentation devices. FFSs for highly augmented helicopters will be validated both in the unaugmented configuration (or failure state with the maximum permitted degradation in handling qualities) and the augmented configuration. Where various levels of handling qualities result from failure states, validation of the effect of the failure is necessary. For those performance and static handling qualities tests where the primary concern is control position in the unaugmented configuration, unaugmented data are not required if the design of the system precludes any effect on control position. In those instances where the unaugmented helicopter response is divergent and non-repeatable, it may not be feasible to meet the specified tolerances. Alternative requirements for testing will be mutually agreed upon by the sponsor and the NSPM on a case-by-case basis.

l. Some tests will not be required for helicopters using helicopter hardware in the simulator flight deck (e.g., "helicopter modular controller"). These exceptions are noted in Table C2A of this attachment. However, in these cases, the sponsor must

provide a statement that the helicopter hardware meets the appropriate manufacturer's specifications and the sponsor must have supporting information to that fact available for NSPM review.

m. For objective test purposes, "Near maximum" gross weight is a weight chosen by the sponsor or data provider that is not less than the basic operating weight (BOW) of the helicopter being simulated plus 80% of the difference between the maximum certificated gross weight (either takeoff weight or landing weight, as appropriate for the test) and the BOW. "Light" gross weight is a weight chosen by the sponsor or data provider that is not more than 120% of the BOW of the helicopter being simulated or as limited by the minimum practical operating weight of the test helicopter. "Medium" gross weight is a weight chosen by the sponsor or data provider that is within 10 percent of the average of the numerical values of the BOW and the maximum certificated gross weight. (Note: BOW is the empty weight of the aircraft plus the weight of the following: normal oil quantity; lavatory servicing fluid; potable water; required crewmembers and their baggage; and emergency equipment. (References: Advisory Circular 120-27, "Aircraft Weight and Balance;" and FAA-H-8083-1, "Aircraft Weight and Balance Handbook.").

**End QPS Requirements**

**TABLE C2A.—FULL FLIGHT SIMULATOR (FFS) OBJECTIVE TESTS**

| <<<QPS requirements>>> |   |   |   |  |                 |   | <<Information>> |       |
|------------------------|---|---|---|--|-----------------|---|-----------------|-------|
| Test                   |   | Tolerance(s)  | Flight condition  | Test details   | Simulator level |   |                 | Notes |
| Number                 | Title   |   |   |  | B               | C | D               |       |
| <b>1. Performance</b>  |   |   |   |  |                 |   |                 |       |
| 1.a. ....              | Engine Assessment                               |   |   |  |                 |   |                 |       |
| 1.a.1. ....            | Start Operations                                |   |   |  |                 |   |                 |       |
| 1.a.1.a. ..            | Engine start and acceleration (transient).      | Light Off Time—±10% or ±1 sec., Torque—±5%, Rotor Speed—±3%, Fuel Flow—±10%, Gas Generator Speed—±5%, Power Turbine Speed—±5%, Gas Turbine Temp.—±30°C. | Ground with the Rotor Brake Used and Not Used, if applicable. | Record each engine start from the initiation of the start sequence to steady state idle and from steady state idle to operating RPM. | X               | X | X               |       |
| 1.a.1.b. ..            | Steady State Idle and Operating RPM conditions. | Torque—±3%, Rotor Speed—±1.5%, Fuel Flow—±5%, Gas Generator Speed—±2%, Power Turbine Speed—±2%, Turbine Gas Temp.—±20°C.                                | Ground .....  | Record both steady state idle and operating RPM conditions. May be a series of snapshot tests.                                       | X               | X | X               |       |
| 1.a.2. ....            | Power Turbine Speed Trim.                       | ±10% of total change of power turbine speed, or ±0.5% change of rotor speed.  | Ground .....  | Record engine response to trim system actuation in both directions.  | X               | X | X               |       |
| 1.a.3. ....            | Engine and Rotor Speed Governing.               | Torque—±5%, Rotor Speed—1.5%.   | Climb and descent ....  | Record results using a step input to the collective. May be conducted concurrently with climb and descent performance tests.         | X               | X | X               |       |
| 1.b. ....              | Surface Operations                              |   |   |  |                 |   |                 |       |

TABLE C2A.—FULL FLIGHT SIMULATOR (FFS) OBJECTIVE TESTS—Continued

| <<<QPS requirements>>> |  |  |   |   |                 |   | <<Information>> |       |
|------------------------|--|--|---|---|-----------------|---|-----------------|-------|
| Test                   |  | Tolerance(s)   | Flight condition                              | Test details  | Simulator level |   |                 | Notes |
| Number                 | Title  |  |   |   | B               | C | D               |       |
| 1.b.1. ....            | Minimum Radius Turn .....  | ±3 ft. (0.9m) or 20% of helicopter turn radius.  | Ground .....                                  | If brakes are used, brake pedal position and brake system pressure must be matched to the helicopter flight test value.   | X               | X | X               |       |
| 1.b.2. ....            | Rate of Turn vs. Pedal Deflection, Brake Application, or Nosewheel Angle, as applicable. | ±10% or ±2°/sec. Turn Rate .....   | Ground Takeoff .....                          | If brakes are used, brake pedal position and brake system pressure must be matched to the helicopter flight test value.   | X               | X | X               |       |
| 1.b.3. ....            | Taxi .....   | Pitch Angle—±1.5°, Torque—±3%, Longitudinal Control Position—±5%, Lateral Control Position—±5%, Directional Control Position ±5%, Collective Control Position—±5%.   | Ground .....                                  | Record results for control position and pitch attitude during ground taxi for a specific ground speed, wind speed and direction, and density altitude.  | X               | X | X               |       |
| 1.b.4. ....            | Brake Effectiveness .....  | ±10% of time and distance .....  | Ground .....                                  |   | X               | X | X               |       |
| 1.c. ....              | Takeoff  |  |   |   |                 |   |                 |       |
| 1.c.1. ....            | All Engines .....  | Airspeed—±3 kt, Altitude—±20 ft (6.1m), Torque—±3%, Rotor Speed—±1.5%, Vertical Velocity—±100 fpm (0.50m/sec) or 10%, Pitch Attitude—±1.5°, Bank Attitude—±2°, Heading—±2°, Longitudinal Control Position—±10%, Lateral Control Position—±10%, Directional Control Position—±10%, Collective Control Position—±10%.. | Ground/Takeoff and Initial Segment of Climb.  | Record results of takeoff flight path as appropriate to helicopter model simulated (running takeoff for Level B, takeoff from a hover for Level C and D). For Level B, the criteria apply only to those segments at airspeeds above effective translational lift. Results must be recorded from the initiation of the takeoff to at least 200 ft (61m) AGL. | X               | X | X               |       |
| 1.c.2. ....            | One Engine Inoperative continued takeoff.  | Airspeed—±3 kt, Altitude—±20 ft (6.1m), Torque—±3%, Rotor Speed—±1.5%, Vertical Velocity—±100 fpm (0.50m/sec) or 10%, Pitch Attitude—±1.5°, Bank Attitude—±2°, Heading—±2°, Longitudinal Control Position— ±10%, Lateral Control Position—±10%, Directional Control Position—±10%, Collective Control Position—±10%. | Ground/Takeoff; and Initial Segment of Climb. | Record takeoff flight path as appropriate to helicopter model simulated. Results must be recorded from the initiation of the takeoff to at least 200 ft (61m) AGL.  | X               | X | X               |       |
| 1.c.3. ....            | One Engine inoperative, rejected takeoff.  | Airspeed ± 3 kt; Altitude ± 20 ft (6.1m), Torque ± 3%, Rotor Speed ± 1.5%, Pitch Attitude ± 1.5°, Roll angle ± 1.5°, Heading ± 2°, Longitudinal Control Position ± 10%, Lateral Control Position ± 10%, Directional Control Position ± 10%, Collective Control Position ± 10%, Distance: ± 7.5% or ± 30m (100ft).    | Ground, Takeoff .....                         | Time history from the takeoff point to touchdown. Test conditions near limiting performance.  |                 | X | X               |       |
| 1.d. ....              | Hover  |  |   |   |                 |   |                 |       |

TABLE C2A.—FULL FLIGHT SIMULATOR (FFS) OBJECTIVE TESTS—Continued

| <<<QPS requirements>>> |  |   |   |   |                 |   | <<Information>> |   |
|------------------------|--|---|---|---|-----------------|---|-----------------|---|
| Test                   |  | Tolerance(s)  | Flight condition  | Test details  | Simulator level |   |                 | Notes   |
| Number                 | Title  |   |   |   | B               | C | D               |   |
|                        | Performance .....  | Torque—±3%, Pitch Attitude—±1.5°, Bank Attitude—±1.5°, Longitudinal Control Position—±5%, Lateral Control Position—±5%, Directional Control Position—±5%, Collective Control Position—±5%.  | In Ground Effect (IGE); and Out of Ground Effect (OGE).   | Record results for light and heavy gross weights. May be a series of snapshot tests.  |                 | X | X               |   |
| 1.e. ....              | Vertical Climb   |   |   |   |                 |   |                 |   |
|                        | Performance .....  | Vertical Velocity—±100 fpm (0.50 m/sec) or ±10%, Directional Control Position—±5%, Collective Control Position—±5%.   | From OGE Hover .....  | Record results for light and heavy gross weights. May be a series of snapshot tests.  |                 | X | X               |   |
| 1.f. ....              | Level Flight   |   |   |   |                 |   |                 |   |
|                        | Performance and Trimmed Flight Control Positions.              | Torque—±3%, Pitch Attitude—±1.5°, Sideslip Angle—±2°, Longitudinal Control Position—±5%, Lateral Control Position—±5%, Directional Control Position—±5%, Collective Control Position—±5%.   | Cruise (Augmentation On and Off).   | Record results for two gross weight and CG combinations with varying trim speeds throughout the airspeed envelope. May be a series of snapshot tests.   | X               | X | X               | This test validates performance at speeds above maximum endurance airspeed. |
| 1.g. ....              | Climb  |   |   |   |                 |   |                 |   |
|                        | Performance and Trimmed Flight Control Positions.              | Vertical Velocity—±100 fpm (6.1m/sec) or ±10%, Pitch Attitude—±1.5°, Sideslip Angle—±2°, Longitudinal Control Position—±5%, Lateral Control Position—±5%, Directional Control Position—±5%, Collective Control Position—±5%.        | All engines operating; One engine inoperative; Augmentation System(s) On and Off.                                 | Record results for two gross weight and CG combinations. The data presented must be for normal climb power conditions. May be a series of snapshot tests.   | X               | X | X               |   |
| 1.h. ....              | Descent  |   |   |   |                 |   |                 |   |
| 1.h.1. ....            | Descent Performance and Trimmed Flight Control Positions.      | Torque—±3%, Pitch Attitude—±1.5°, Sideslip Angle—±2°, Longitudinal Control Position—±5%, Lateral Control Position—±5%, Directional Control Position—±5%, Collective Control Position—±5%.   | At or near 1,000 fpm (5 m/sec) rate of descent (RoD) at normal approach speed. Augmentation System(s) On and Off. | Results must be recorded for two gross weight and CG combinations. May be a series of snapshot tests.   | X               | X | X               |   |
| 1.h.2. ....            | Autorotation Performance and Trimmed Flight Control Positions. | Pitch Attitude—±1.5°, Sideslip Angle—±2°, Longitudinal Control Position—±5%, Lateral Control Position—±5%, Directional Control Position—±5%, Collective Control Position—±5%, Vertical Velocity ±100 fpm or 10%, Rotor Speed ±1.5%. | Steady descents. Augmentation System(s) On and Off.   | Record results for two gross weight conditions. Data must be recorded for normal operating RPM. (Rotor speed tolerance applies only if collective control position is full down.) Data must be recorded for speeds from 50 kts, ±5 kts through at least maximum glide distance airspeed. May be a series of snapshot tests. | X               | X | X               |   |
| 1.i. ....              | Autorotation   |   |   |   |                 |   |                 |   |

TABLE C2A.—FULL FLIGHT SIMULATOR (FFS) OBJECTIVE TESTS—Continued

| <<<QPS requirements>>> |                              |   |                       |  |                 |   | <<Information>> |       |
|------------------------|------------------------------|---|-----------------------|--|-----------------|---|-----------------|-------|
| Test                   |                              | Tolerance(s)  | Flight condition      | Test details   | Simulator level |   |                 | Notes |
| Number                 | Title                        |   |                       |  | B               | C | D               |       |
|                        | Entry .....                  | Rotor Speed—±3%, Pitch Attitude ±2°, Roll Attitude—±3°, Yaw Attitude—±5°, Airspeed—±5 kts, Vertical Velocity—±200 fpm (1.00 m/sec) or 10%.  | Cruise or Climb ..... | Record results of a rapid throttle reduction to idle. If the cruise condition is selected, comparison must be made for the maximum range airspeed. If the climb condition is selected, comparison must be made for the maximum rate of climb airspeed at or near maximum continuous power. |                 | X | X               |       |
| 1.j. ....              | Landing                      |   |                       |  |                 |   |                 |       |
| 1.j.1. ....            | All Engines .....            | Airspeed—±3 kts., Altitude—±20 ft (6.1 m), Torque—±3%, Rotor Speed—±1.5%, Pitch Attitude—±1.5°, Bank Attitude—±1.5°, Heading—±2°, Longitudinal Control Position—±10%, Lateral Control Position—±10%, Directional Control Position—±10%, Collective Control Position—±10%. | Approach .....        | Record results of the approach and landing profile as appropriate to the helicopter model simulated (running landing for Level B, or approach to a hover for Level C and D). For Level B, the criteria apply only to those segments at airspeeds above effective translational lift.       | X               | X | X               |       |
| 1.j.2. ....            | One Engine Inoperative ...   | Airspeed—±3 kts, Altitude—±20 ft (6.1 m), Torque—±3%, Rotor Speed—±1.5%, Pitch Attitude—±1.5°, Bank Attitude—±1.5°, Heading—±2°, Longitudinal Control Position—±10%, Lateral Control Position—±10%, Directional Control Position—±10%, Collective Control Position—±10%.  | Approach .....        | Record results for both Category A and Category B approaches and landing as appropriate to helicopter model simulated. For Level B, the criteria apply only to those segments at airspeeds above effective translational lift.   | X               | X | X               |       |
| 1.j.3. ....            | Balked Landing .....         | Airspeed—±3 kts, Altitude—±20 ft (6.1 m), Torque—±3%, Rotor Speed—±1.5%, Pitch Attitude—±1.5°, Bank Attitude—±1.5°, Heading—±2°, Longitudinal Control Position—±10%, Lateral Control Position—±10%, Directional Control Position—±10%, Collective Control Position—±10%.  | Approach .....        | Record the results for the maneuver initiated from a stabilized approach at the landing decision point (LDP).  | X               | X | X               |       |
| 1.j.4. ....            | Autorotational Landing ..... | Torque—±3%, Rotor Speed—±3%, Vertical Velocity—±100 fpm (0.50 m/sec) or 10%, Pitch Attitude—±2°, Bank Attitude—±2°, Heading—±5°, Longitudinal Control Position—±10%, Lateral Control Position—±10%, Directional Control Position—±10%, Collective Control Position—±10%.  | Landing .....         | Record the results of an autorotational deceleration and landing from a stabilized autorotational descent, to touch down.  |                 | X | X               |       |

2. Handling Qualities

2.a. .... Control System Mechanical Characteristics



TABLE C2A.—FULL FLIGHT SIMULATOR (FFS) OBJECTIVE TESTS—Continued

| <<<QPS requirements>>> |   |  |  |   |                 |   | <<Information>> |   |
|------------------------|---|--|--|---|-----------------|---|-----------------|---|
| Test                   |   | Tolerance(s)   | Flight condition   | Test details  | Simulator level |   |                 | Notes   |
| Number                 | Title   |  |  |   | B               | C | D               |   |
|                        | For simulators requiring Static or Dynamic tests at the controls (i.e., cyclic, collective, and pedal), special test fixtures will not be required during initial or upgrade evaluations if the sponsor's QTG/MQTG shows both test fixture results and the results of an alternative approach, such as computer plots produced concurrently showing satisfactory agreement. Repeat of the alternative method during the initial or upgrade evaluation would then satisfy this test requirement. For initial and upgrade evaluations, the control dynamic characteristics must be measured at and recorded directly from the flight deck controls, and must be accomplished in hover, climb, cruise, and autorotation. |  |  |   |                 |   |                 |   |
| 2.a.1. ....            | Cyclic .....  | Breakout—±0.25 lbs (0.112 daN) or 25%; Force—±1.0 lb (0.224 daN) or 10%.   | Ground; Static conditions with the hydraulic system (if applicable) pressurized; supplemental hydraulic pressurization system may be used. Trim On and Off. Friction Off Augmentation (if applicable) On and Off.  | Record results for an uninterrupted control sweep to the stops. (This test does not apply if aircraft hardware modular controllers are used.) | X               | X | X               | Contact the NSPM for clarification of any issue regarding helicopters with reversible controls or where the required validation data is not attainable.   |
| 2.a.2. ....            | Collective/Pedals .....   | Breakout—±0.5 lb (0.224 daN) or 25%; Force—±1.0 lb (0.224 daN) or 10%.   | Ground; Static conditions with the hydraulic system (if applicable) pressurized; supplemental hydraulic pressurization system may be used. Trim On and Off. Friction Off. Augmentation (if applicable) On and Off. | Record results for an uninterrupted control sweep to the stops.   | X               | X | X               | Flight Test Data for this test does not require the rotor to be engaged/turning. The phrase "if applicable" regarding stability augmentation systems means if a stability augmentation system is available and if this system may be operational on the ground under static conditions as described here."                    |
| 2.a.3. ....            | Brake Pedal Force vs. Position.   | ±5 lbs (2.224 daN) or 10% .....  | Ground; Static conditions.   | .....   | X               | X | X               |   |
| 2.a.4. ....            | Trim System Rate (all applicable systems).  | Rate—±10% .....  | Ground; Static conditions. Trim On, Friction Off.  | The tolerance applies to the recorded value of the trim rate.   | X               | X | X               |   |
| 2.a.5. ....            | Control Dynamics (all axes).  | ±10% of time for first zero crossing and ±10 (N+1)% of period thereafter, ±10% of amplitude of first overshoot, 20% of amplitude of 2nd and subsequent overshoots greater than 5% of initial displacement, ±1 overshoot. | Hover/Cruise, Trim On, Friction Off.   | Results must be recorded for a normal control displacement in both directions in each axis.   |                 | X | X               | Typically, control displacement of 25% to 50% is necessary for proper excitation. Control Dynamics for irreversible control systems may be evaluated in a ground/static condition. Additional information on control dynamics is found later in this attachment. "N" is the sequential period of a full cycle of oscillation. |

TABLE C2A.—FULL FLIGHT SIMULATOR (FFS) OBJECTIVE TESTS—Continued

| <<<QPS requirements>>> |                                   |  |   |   |                 |   | <<Information>> |  |
|------------------------|-----------------------------------|--|---|---|-----------------|---|-----------------|--|
| Test                   |                                   | Tolerance(s)   | Flight condition  | Test details  | Simulator level |   |                 | Notes  |
| Number                 | Title                             |  |   |   | B               | C | D               |  |
| 2.a.6. ....            | Control System Freeplay           | ±2% control displacement, but not to exceed ±0.15 in.  | Ground; Static conditions; with the hydraulic system (if applicable) pressurized; supplemental hydraulic pressurization system may be used. | Record and compare results for all controls.  | X               | X | X               | Flight Test Data for this test does not require the rotor to be engaged/turning.   |
| 2.b. ....              | Low Airspeed Handling Qualities   |  |   |   |                 |   |                 |  |
| 2.b.1. ....            | Trimmed Flight Control Positions. | Torque—±3%, Pitch Attitude—±1.5°, Bank Attitude—±2°, Longitudinal Control Position—±5%. Lateral Control Position—±5%, Directional Control Position—±5%, Collective Control Position—±5%. | Translational Flight IGE—Sideward, rearward, and forward flight. Augmentation On and Off.   | Record results for several airspeed increments to the translational airspeed limits and for 45 kts forward airspeed. May be a series of snapshot tests. |                 | X | X               |  |
| 2.b.2. ....            | Critical Azimuth .....            | Torque—±3%, Pitch Attitude—±1.5°, Bank Attitude—±2°, Longitudinal Control Position—±5%, Lateral Control Position—±5%, Directional Control Position—±5%, Collective Control Position—±5%. | Stationary Hover. Augmentation On and Off.  | Record results for three relative wind directions (including the most critical case) in the critical quadrant. May be a series of snapshot tests.       |                 | X | X               |  |
| 2.b.3. ....            | Control Response                  |  |   |   |                 |   |                 |  |
| 2.b.3.a. ..            | Longitudinal .....                | Pitch Rate—±10% or ±2°/sec, Pitch Attitude Change—±10% or 1.5°.  | Hover. Augmentation On and Off.   | Record results for a step control input. The Off-axis response must show correct trend for unaugmented cases.   |                 | X | X               | This is a “short time” test conducted in a hover, in ground effect, without entering translational flight, to provide better visual reference. |
| 2.b.3.b. ..            | Lateral .....                     | Roll Rate—±10% or ±3°/sec. Roll Attitude Change—±10% or ±3°.   | Hover Augmentation On and Off.  | Record results for a step control input. The Off-axis response must show correct trend for unaugmented cases.   |                 | X | X               | This is a “short time” test conducted in a hover, in ground effect, without entering translational flight, to provide better visual reference. |
| 2.b.3.c. ..            | Directional .....                 | Yaw Rate—±10% or ±2°/sec, Heading Change—±10% or ±2°.  | Hover Augmentation On and Off.  | Record results for a step control input. The Off-axis response must show correct trend for unaugmented cases.   |                 | X | X               | This is a “short time” test conducted in a hover, in ground effect, without entering translational flight, to provide better visual reference. |
| 2.b.3.d. ..            | Vertical .....                    | Normal Acceleration—±0.1 g .....   | Hover .....   | Record results for a step control input. The Off-axis response must show correct trend for unaugmented cases.   |                 | X | X               |  |
| 2.c. ....              | Longitudinal Handling Qualities   |  |   |   |                 |   |                 |  |

TABLE C2A.—FULL FLIGHT SIMULATOR (FFS) OBJECTIVE TESTS—Continued

| <<<QPS requirements>>> |  |   |   |   |                 |   | <<Information>> |   |
|------------------------|--|---|---|---|-----------------|---|-----------------|---|
| Test                   |  | Tolerance(s)  | Flight condition  | Test details  | Simulator level |   |                 | Notes   |
| Number                 | Title                                      |   |   |   | B               | C | D               |   |
| 2.c.1. ....            | Control Response .....                     | Pitch Rate— $\pm 10\%$ or $\pm 2^\circ/\text{sec}$ , Pitch Attitude Change— $\pm 10\%$ or $\pm 1.5^\circ$ .   | Cruise Augmentation On and Off.                         | Results must be recorded for two cruise airspeeds to include minimum power required speed. Record data for a step control input. The Off-axis response must show correct trend for unaugmented cases.   | X               | X | X               |   |
| 2.c.2. ....            | Static Stability .....                     | Longitudinal Control Position: $\pm 10\%$ of change from trim or $\pm 0.25$ in (6.3 mm) or Longitudinal Control Force: $\pm 0.5$ lb (0.223 daN) or $\pm 10\%$ .   | Cruise or Climb, Autorotation, Augmentation On and Off. | Record results for a minimum of two speeds on each side of the trim speed. May be a series of snapshot tests.   | X               | X | X               |   |
| 2.c.3. ....            | Dynamic Stability                          |   |   |   |                 |   |                 |   |
| 2.c.3.a. ..            | Long Term Response .....                   | $\pm 10\%$ of calculated period, $\pm 10\%$ of time to $\frac{1}{2}$ or double amplitude, or $\pm 0.02$ of damping ratio. For non-periodic responses, the time history must be matched within $\pm 10\%$ pitch; and $\pm 10\%$ airspeed over a 20-sec period following release of the controls. | Cruise Augmentation On and Off.                         | For periodic responses, record results for three full cycles (6 overshoots after input completed) or that sufficient to determine time to $\frac{1}{2}$ or double amplitude, whichever is less. For non-periodic responses, the test may be terminated prior to 20 sec if the test pilot determines that the results are becoming uncontrollably divergent. | X               | X | X               | The response may be unrepeatable throughout the stated time for certain helicopters. In these cases, the test should show at least that a divergence is identifiable. For example: displacing the cyclic for a given time normally excites this test or until a given pitch attitude is achieved and then return the cyclic to the original position. |
| 2.c.3.b. ..            | Short Term Response .....                  | $\pm 1.5^\circ$ Pitch or $\pm 2^\circ/\text{sec}$ , Pitch Rate. $\pm 0.1$ g Normal Acceleration.  | Cruise or Climb. Augmentation On and Off.               | Record results for at least two airspeeds.  | X               | X | X               | A control doublet inserted at the natural frequency of the aircraft normally excites this test.   |
| 2.c.4. ....            | Maneuvering Stability .....                | Longitudinal Control Position—10% of change from trim or $\pm 0.25$ in. (6.3 mm) or Longitudinal Control Forces— $\pm 0.5$ lb. (0.223 daN) or $\pm 10\%$ .  | Cruise or Climb. Augmentation On and Off.               | Record results for at least two airspeeds at $30^\circ$ - $45^\circ$ roll angle. The force may be shown as a cross plot for irreversible systems. May be a series of snapshot tests.  | X               | X | X               |   |
| 2.d. ....              | Lateral and Directional Handling Qualities |   |   |   |                 |   |                 |   |
| 2.d.1. ....            | Control Response                           |   |   |   |                 |   |                 |   |
| 2.d.1.a. ..            | Lateral .....                              | Roll Rate— $\pm 10\%$ or $\pm 3^\circ/\text{sec}$ ., Roll Attitude Change— $\pm 10\%$ or $\pm 3^\circ$ .  | Cruise Augmentation On and Off.                         | Record results for at least two airspeeds, including the speed at or near the minimum power required airspeed. Record results for a step control input. The Off-axis response must show correct trend for unaugmented cases.  | X               | X | X               |   |

TABLE C2A.—FULL FLIGHT SIMULATOR (FFS) OBJECTIVE TESTS—Continued

| <<<QPS requirements>>> |   |  |  |  |                 |   | <<Information>> |   |
|------------------------|---|--|--|--|-----------------|---|-----------------|---|
| Test                   |   | Tolerance(s)   | Flight condition   | Test details   | Simulator level |   |                 | Notes                                   |
| Number                 | Title                                     |  |  |  | B               | C | D               |   |
| 2.d.1.b. ...           | Directional .....                         | Yaw Rate—±10% or ±2°/sec., Yaw Attitude Change—±10% or ±2°.  | Cruise Augmentation On and Off.  | Record data for at least two air-speeds, including the speed at or near the minimum power required air-speed. Record results for a step control input. The Off-axis response must show correct trend for unaugmented cases.  | X               | X | X               |   |
| 2.d.2. ....            | Directional Static Stability              | Lateral Control Position—±10% of change from trim or ±0.25 in. (6.3 mm) or Lateral Control Force—±0.5 lb. (0.223 daN) or 10%, Roll Attitude—±1.5, Directional Control Position—±10% of change from trim or ±0.25 in. (6.3 mm) or Directional Control Force—±1 lb. (0.448 daN) or 10%, Longitudinal Control Position—±10% of change from trim or ±0.25 in. (6.3 mm), Vertical Velocity—±100 fpm (0.50m/sec) or 10%. | Cruise; or Climb (may use Descent instead of Climb if desired), Augmentation On and Off. | Record results for at least two sideslip angles on either side of the trim point. The force may be shown as a cross plot for irreversible systems. May be a series of snapshot tests.  | X               | X | X               | This is a steady heading sideslip test. |
| 2.d.3. ....            | Dynamic Lateral and Directional Stability |  |  |  |                 |   |                 |   |
| 2.d.3.a. ...           | Lateral-Directional Oscillations.         | ±0.5 sec. or ±10% of period, ±10% of time to 1/2 or double amplitude or ±0.02 of damping ratio, ±20% or ±1 sec of time difference between peaks of bank and sideslip. For non-periodic responses, the time history must be matched within ±10% yaw; ±10% roll angle, and ±10% airspeed, over a 20 sec period roll angle following release of the controls.   | Cruise or Climb. Augmentation On/Off.  | Record results for at least two air-speeds. The test must be initiated with a cyclic or a pedal doublet input. Record results for six full cycles (12 overshoots after input completed) or that sufficient to determine time to or double amplitude, whichever is less. For non-periodic response, the test may be terminated prior to 20 sec if the test pilot determines that the results are becoming uncontrollably divergent. | X               | X | X               |   |
| 2.d.3.b. ...           | Spiral Stability .....                    | ±2° or ±10% roll angle .....   | Cruise or Climb. Augmentation On and Off.  | Record the results of a release from pedal only or cyclic only turns for 20 sec. Results must be recorded from turns in both directions. Terminate check at zero roll angle or when the test pilot determines that the attitude is becoming uncontrollably divergent.  | X               | X | X               |   |

TABLE C2A.—FULL FLIGHT SIMULATOR (FFS) OBJECTIVE TESTS—Continued

| <<<QPS requirements>>>  |                             |  |   |  |                 |   | <<Information>> |       |
|-------------------------|-----------------------------|--|---|--|-----------------|---|-----------------|-------|
| Test                    |                             | Tolerance(s)   | Flight condition                          | Test details   | Simulator level |   |                 | Notes |
| Number                  | Title                       |  |   |  | B               | C | D               |       |
| 2.d.3.c. ..             | Adverse/Proverse Yaw ....   | Correct Trend, $\pm 2^\circ$ transient sideslip angle. | Cruise or Climb. Augmentation On and Off. | Record the time history of initial entry into cyclic only turns, using only a moderate rate for cyclic input. Results must be recorded for turns in both directions.   | X               | X | X               |       |
| <b>3. Motion System</b> |                             |  |   |  |                 |   |                 |       |
| 3.a. ....               | Frequency Response          |  |   |  |                 |   |                 |       |
|                         |                             | Based on Simulator Capability ...                      | N/A .....                                 | Required as part of MQTG but not required as part of continuing qualification evaluations. The test must demonstrate frequency response of the motion system as specified by the applicant for flight simulator qualification.   | X               | X | X               |       |
| 3.b. ....               | Leg Balance                 |  |   |  |                 |   |                 |       |
|                         | Leg Balance .....           | Based on Simulator Capability ...                      | N/A .....                                 | Required as part of MQTG but not required as part of continuing evaluations. The test must demonstrate motion system leg balance as specified by the applicant for flight simulator qualification.   | X               | X | X               |       |
| 3.c. ....               | Turn Around                 |  |   |  |                 |   |                 |       |
|                         | Turn Around .....           | Based on Simulator Capability ...                      | N/A .....                                 | Required as part of MQTG but not required as part of continuing qualification evaluations. The test must demonstrate a smooth turn-around (shift to opposite direction of movement) of the motion system as specified by the applicant for flight simulator qualification. | X               | X | X               |       |
| 3.d. ....               | Motion System Repeatability |  |   |  |                 |   |                 |       |

TABLE C2A.—FULL FLIGHT SIMULATOR (FFS) OBJECTIVE TESTS—Continued

| <<<QPS requirements>>> |  |  |   |  |                 |   | <<Information>> |   |
|------------------------|--|--|---|--|-----------------|---|-----------------|---|
| Test                   |  | Tolerance(s)   | Flight condition  | Test details   | Simulator level |   |                 | Notes   |
| Number                 | Title  |  |   |  | B               | C | D               |   |
|                        |  | With the same input signal, the test results must be repeatable to within ±0.05g actual platform linear acceleration in each axis. | Accomplished in both the "ground" mode and in the "flight" mode of the motion system operation. | Required as part of the MQTG and at each continuing qualification evaluation. The test is accomplished by injecting a motion signal to generate movement of the platform. The input must be such that the rotational accelerations, rotational rates, and linear accelerations are inserted before the transfer from helicopter center of gravity to the pilot reference point with a minimum amplitude of 5°/sec/sec, 10°/sec and 0.3g, respectively. | X               | X | X               | See Paragraph 5.c. in this attachment for additional information. Note: if there is no difference in the model for "ground" and "flight" operation of the motion system, this should be described in an SOC and will not require tests in both modes. |
| 3.e. ....              | Motion Cueing Performance Signature  |  |   |  |                 |   |                 |   |
|                        |  |  |   | Required as part of MQTG but not required as part of continuing qualification evaluations. These tests must be run with the motion buffet mode disabled.   |                 |   |                 | See paragraph 5.d., of this attachment, Motion cueing performance signature.  |
| 3.e.1. ....            | Takeoff (all engines) .....  | As specified by the sponsor for flight simulator qualification.  | Ground .....  | Pitch attitude due to initial climb should dominate over cab tilt due to longitudinal acceleration.  | X               | X | X               | Associated to test number 1.c.1.  |
| 3.e.2. ....            | Hover performance (IGE and OGE).   | As specified by the sponsor for flight simulator qualification.  | Ground .....  | .....  |                 | X | X               | Associated to test number 1.d.  |
| 3.e.3. ....            | Autorotation (entry) .....   | As specified by the sponsor for flight simulator qualification.  | Flight .....  | .....  |                 | X | X               | Associated to test number 1.i.  |
| 3.e.4. ....            | Landing (all engines) .....  | As specified by the sponsor for flight simulator qualification.  | Flight .....  | .....  | X               | X | X               | Associated to test number 1.j.1.  |
| 3.e.5. ....            | Autorotation (landing) .....   | As specified by the sponsor for flight simulator qualification.  | Flight .....  | .....  |                 | X | X               | Associated to test number 1.j.4.  |
| 3.e.6. ....            | Control Response   |  |   |  |                 |   |                 |   |
| 3.e.6.a. ..            | Longitudinal .....   | As specified by the sponsor for flight simulator qualification.  | Flight .....  | .....  | X               | X | X               | Associated to test number 2.c.1.  |
| 3.e.6.b. ..            | Lateral .....  | As specified by the sponsor for flight simulator qualification.  | Ground .....  | .....  | X               | X | X               | Associated to test number 2.d.1.a.  |
| 3.e.6.c. ..            | Directional .....  | As specified by the sponsor for flight simulator qualification.  | .....   | .....  | X               | X | X               | Associated to test number 2.d.1.c.  |
| 3.f. ....              | Characteristic Motion Cues—For all of the following tests, the simulator test results must exhibit the overall appearance and trends of the helicopter data, with at least three (3) of the predominant frequency "spikes" being present within ±2 Hz. |  |   |  |                 |   |                 |   |
| 3.f.1. ....            | Thrust effect with brakes set.   | .....  | Ground .....  | The test must be conducted within 5% of the maximum possible thrust with brakes set.   |                 |   | X               |   |

TABLE C2A.—FULL FLIGHT SIMULATOR (FFS) OBJECTIVE TESTS—Continued

| <<<QPS requirements>>>  |   |   |                                    |   |                 |   | <<Information>> |   |
|-------------------------|---|---|------------------------------------|---|-----------------|---|-----------------|---|
| Test                    |   | Tolerance(s)                                | Flight condition                   | Test details  | Simulator level |   |                 | Notes   |
| Number                  | Title   |   |                                    |   | B               | C | D               |   |
| 3.f.2. ....             | Buffet with landing gear extended.  | .....                                       | Flight .....                       | The test must be conducted at an airspeed below landing gear limiting air-speed.  |                 |   | X               | The airspeed selected for this test should be within the range where the operator typically conducts operations with the landing gear extended.   |
| 3.f.3. ....             | Buffet at approach-to-stall   | .....                                       | Flight .....                       | The test must be conducted for approach to stall. Post stall characteristics are not required.  |                 |   | X               |   |
| 3.f.4. ....             | Buffet at high airspeeds ...  | .....                                       | Flight .....                       | .....   |                 |   | X               |   |
| 3.f.5. ....             | In-flight vibrations .....  | .....                                       | Flight (clean configuration).      | .....   |                 |   | X               |   |
| 3.f.6. ....             | Thrust effect with brakes set.  | .....                                       | Ground .....                       | The test must be conducted within 5% of the maximum possible thrust with brakes set.  |                 |   | X               |   |
| <b>4. Visual System</b> |   |   |                                    |   |                 |   |                 |   |
| 4.a. ....               | Visual System Response Time: (Choose either test 4.a.1. or 4.a.2. to satisfy test 4.a., Visual System Response Time Test. This test is also sufficient for motion system response timing and flight deck instrument response timing.) |   |                                    |   |                 |   |                 |   |
| 4.a.1. ....             | Latency   |   |                                    |   |                 |   |                 |   |
|                         |   | 150 ms (or less) after helicopter response. | Takeoff, climb, and descent.       | One test is required in each axis (pitch, roll and yaw) for each of the three conditions (take-off, cruise, and approach or landing). | X               |   |                 |   |
|                         |   | 100 ms (or less) after helicopter response. | Climb, cruise, descent, and hover. | One test is required in each axis (pitch, roll and yaw) for each of the three conditions (take-off, cruise, and approach or landing). |                 | X | X               |   |
| 4.a.2. ....             | Transport Delay   |   |                                    |   |                 |   |                 |   |
|                         |   |   |                                    |   |                 |   |                 | If Transport Delay is the chosen method to demonstrate relative responses, the sponsor and the NSPM will use the latency values to ensure proper simulator response when reviewing those existing tests where latency can be identified (e.g., short period, roll response, rudder response). |
|                         |   | 150 ms (or less) after controller movement. | N/A .....                          | A separate test is required in each axis (pitch, roll, and yaw).  | X               |   |                 |   |

TABLE C2A.—FULL FLIGHT SIMULATOR (FFS) OBJECTIVE TESTS—Continued

| <<<QPS requirements>>> |                              |   |                  |  |                 |   | <<Information>> |   |
|------------------------|------------------------------|---|------------------|--|-----------------|---|-----------------|---|
| Test                   |                              | Tolerance(s)  | Flight condition | Test details   | Simulator level |   |                 | Notes   |
| Number                 | Title                        |   |                  |  | B               | C | D               |   |
|                        |                              | 100 ms (or less) after controller movement.   | N/A .....        | A separate test is required in each axis (pitch, roll, and yaw).   |                 | X | X               |   |
| 4.b. ....              | Field of View                |   |                  |  |                 |   |                 |   |
| 4.b.1. ....            | Continuous field of view ... | The simulator must provide a continuous field of view of at least 75° horizontally and 30° vertically per pilot seat or the number of degrees necessary to meet the visual ground segment requirement, whichever is greater. Both pilot seat visual systems must be operable simultaneously. Wide-angle systems providing cross-flight deck viewing (for both pilots simultaneously) must provide a minimum field of view of at least 146° horizontally and 36° vertically. Any geometric error between the Image Generator eye point and the pilot eye point must be 8° or less. | N/A .....        | An SOC is required and must explain the geometry of the installation. Additional horizontal field of view capability may be added at the sponsor's discretion provided the minimum field of view is retained.  | X               |   |                 | Horizontal field of view is centered on the zero degree azimuth line relative to the aircraft fuselage. Field of view may be measured using a visual test pattern filling the entire visual scene (all channels) with a matrix of black and white 5° squares. |
| 4.b.2. ....            | Continuous field of view ... | The simulator must provide a continuous field of view of at least 146° horizontally and 36° vertically or the number of degrees necessary to meet the visual ground segment requirement, whichever is greater. The minimum horizontal field of view coverage must be plus and minus one-half (½) of the minimum continuous field of view requirement, centered on the zero degree azimuth line relative to the aircraft fuselage. Any geometric error between the Image Generator eye point and the pilot eye point must be 8° or less.   | N/A .....        | An SOC is required and must explain the geometry of the installation. Horizontal field of view of at least 146° (including not less than 73° measured either side of the center of the design eye point). Additional horizontal field of view capability may be added at the sponsor's discretion provided the minimum field of view is retained. Vertical field of view of at least 36° measured from the pilot's and co-pilot's eye point. |                 | X |                 | Horizontal field of view is centered on the zero degree azimuth line relative to the aircraft fuselage. Field of view may be measured using a visual test pattern filling the entire visual scene (all channels) with a matrix of black and white 5° squares. |



TABLE C2A.—FULL FLIGHT SIMULATOR (FFS) OBJECTIVE TESTS—Continued

| <<<QPS requirements>>> |                              |  |                  |   |                 |   | <<Information>> |   |
|------------------------|------------------------------|--|------------------|---|-----------------|---|-----------------|---|
| Test                   |                              | Tolerance(s)   | Flight condition | Test details  | Simulator level |   |                 | Notes   |
| Number                 | Title                        |  |                  |   | B               | C | D               |   |
| 4.b.3. ....            | Continuous field of view ... | Continuous field of view of at least 176° horizontal and 56° vertical field of view for each pilot simultaneously. Any geometric error between the Image Generator eye point and the pilot eye point must be 8° or less. | N/A .....        | An SOC is required and must explain the geometry of the installation. Horizontal field of view is centered on the zero degree azimuth line relative to the aircraft fuselage. Horizontal field of view must be at least 176° (including not less than 88° either side of the center of the design eye point). Additional horizontal field of view capability may be added at the sponsor's discretion provided the minimum field of view is retained. Vertical field of view must not be less than a total of 56° measured from the pilot's and co-pilot's eye point. |                 |   | X               | The horizontal field of view is traditionally described as a 180° field of view. However, the field of view is technically no less than 176°. Field of view may be measured using a visual test pattern filling the entire visual scene (all channels) with a matrix of black and white 5° squares.   |
| 4.c. ....              | Surface contrast ratio ..... | Not less than 5:1 .....  | N/A .....        | The ratio is calculated by dividing the brightness level of the center, bright square (providing at least 2 foot-lamberts or 7 cd/m <sup>2</sup> ) by the brightness level of any adjacent dark square.   |                 |   | X               | Measurements may be made using a 1° spot photometer and a raster drawn test pattern filling the entire visual scene (all channels) with a test pattern of black and white squares, 5 per square, with a white square in the center of each channel. During contrast ratio testing, simulator aft-cab and flight deck ambient light levels should be zero. |
| 4.d. ....              | Highlight brightness .....   | Not less than six (6) foot-lamberts (20 cd/m <sup>2</sup> ).   | N/A .....        | Measure the brightness of the center, white square while superimposing a highlight on that white square. The use of calligraphic capabilities to enhance the raster brightness is acceptable; however, measuring light points is not acceptable.  |                 |   | X               | Measurements may be made using a 1° spot photometer and a raster drawn test pattern filling the entire visual scene (all channels) with a test pattern of black and white squares, 5 per square, with a white square in the center of each channel.   |

TABLE C2A.—FULL FLIGHT SIMULATOR (FFS) OBJECTIVE TESTS—Continued

| <<<QPS requirements>>> |                               |  |                  |  |                 |   | <<Information>> |   |
|------------------------|-------------------------------|--|------------------|--|-----------------|---|-----------------|---|
| Test                   |                               | Tolerance(s)                           | Flight condition | Test details   | Simulator level |   |                 | Notes   |
| Number                 | Title                         |  |                  |  | B               | C | D               |   |
| 4.e. ....              | Surface resolution .....      | Not greater than two (2) arc minutes.  | N/A .....        | An SOC is required and must include the appropriate calculations and an explanation of those calculations. |                 | X | X               | The eye will subtend two (2) arc minutes when positioned on a 3° glide slope, 6,876 ft slant range from the centrally located threshold of a black runway surface painted with white threshold bars that are 16 ft wide with 4-foot gaps between the bars. This requirement is the same as 4 arc minutes per optical line pair. |
| 4.f. ....              | Light point size .....        | Not greater than five (5) arc-minutes. | N/A .....        | An SOC is required and must include the relevant calculations and an explanation of those calculations.    |                 | X | X               | Light point size may be measured using a test pattern consisting of a centrally located single row of light points reduced in length until modulation is just discernible in each visual channel. A row of 48 lights will form a 4° angle or less.  |
| 4.g. ....              | Light point contrast ratio .. | .....                                  | .....            | .....  |                 |   |                 | A 1° spot photometer may be used to measure a square of at least 1° filled with light points (where light point modulation is just discernible) and compare the results to the measured adjacent background. During contrast ratio testing, simulator aft-cab and flight deck ambient light levels should be zero.              |
| 4.g.1. ....            | .....                         | Not less than 10:1 .....               | N/A .....        | An SOC is required and must include the relevant calculations.   | X               |   |                 |   |
| 4.g.2. ....            | .....                         | Not less than 25:1 .....               | N/A .....        | An SOC is required and must include the relevant calculations.   |                 | X | X               |   |
| 4.h. ....              | Visual ground segment         |  |                  |  |                 |   |                 |   |

TABLE C2A.—FULL FLIGHT SIMULATOR (FFS) OBJECTIVE TESTS—Continued

| <<<QPS requirements>>> |       |  |   |   |                 | <<Information>> |   |  |
|------------------------|-------|--|---|---|-----------------|-----------------|---|--|
| Test                   |       | Tolerance(s)   | Flight condition  | Test details  | Simulator level |                 |   | Notes  |
| Number                 | Title |  |   |   | B               | C               | D |  |
|                        |       | The visible segment in the simulator must be within 20% of the segment computed to be visible from the helicopter flight deck. The tolerance(s) may be applied at either or both ends of the displayed segment. However, lights and ground objects computed to be visible from the helicopter flight deck at the near end of the visible segment must be visible in the simulator. | Landing configuration, trimmed for appropriate airspeed, at 100 ft (30m) above the touchdown zone, on glide slope with an RVR value set at 1,200 ft (350m). | The QTG must contain appropriate calculations and a drawing showing the data used to establish the helicopter location and the segment of the ground that is visible considering design eyepoint, the helicopter attitude, flight deck cut-off angle, and a visibility of 1200 ft (350 m) RVR. Simulator performance must be measured against the QTG calculations.<br>The data submitted must include at least the following:<br>(1) Static helicopter dimensions as follows:<br>(i) Horizontal and vertical distance from main landing gear (MLG) to glideslope reception antenna.<br>(ii) Horizontal and vertical distance from MLG to pilot's eyepoint.<br>(iii) Static flight deck cutoff angle.<br>(2) Approach data as follows:<br>(i) Identification of runway.<br>(ii) Horizontal distance from runway threshold to glideslope intercept with runway.<br>(iii) Glideslope angle.<br>(iv) Helicopter pitch angle on approach.<br>(3) Helicopter data for manual testing:<br>(i) Gross weight.<br>(ii) Helicopter configuration.<br>(iii) Approach airspeed.<br>If non-homogenous fog is used to obscure visibility, the vertical variation in horizontal visibility must be described and be included in the slant range visibility calculation used in the computations. | X               | X               | X | Pre-position for this test is encouraged, and may be achieved via manual or autopilot control to the desired position. |

## 5. Sound System

TABLE C2A.—FULL FLIGHT SIMULATOR (FFS) OBJECTIVE TESTS—Continued

| <<<QPS requirements>>> |   |   |                      |  |                 |   | <<Information>> |  |
|------------------------|---|---|----------------------|--|-----------------|---|-----------------|--|
| Test                   |   | Tolerance(s)  | Flight condition     | Test details   | Simulator level |   |                 | Notes  |
| Number                 | Title   |   |                      |  | B               | C | D               |  |
|                        |   | The sponsor will not be required to repeat the helicopter tests (i.e., tests 5.a.1. through 5.a.8. (or 5.b.1. through 5.b.9.) and 5.c., as appropriate) during continuing qualification evaluations if frequency response and background noise test results are within tolerance when compared to the initial qualification evaluation results, and the sponsor shows that no software changes have occurred that will affect the helicopter test results. If the frequency response test method is chosen and fails, the sponsor may elect to fix the frequency response problem and repeat the test or the sponsor may elect to repeat the helicopter tests. If the helicopter tests are repeated during continuing qualification evaluations, the results may be compared against initial qualification evaluation results or helicopter master data |                      |  |                 |   |                 |  |
| 5.a. ....              | Basic requirements  |   |                      |  |                 |   |                 |  |
| 5.a.1. ....            | Ready for engine start ....   | ± 5 dB per 1/3 octave band .....  | Ground .....         | Normal condition prior to engine start. The APU should be on if appropriate.   |                 |   | X               |  |
| 5.a.2. ....            | All engines at idle; rotor not turning (if applicable) and rotor turning. | ± 5 dB per 1/3 octave band .....  | Ground .....         | Normal condition prior to lift-off.  |                 |   | X               |  |
| 5.a.3. ....            | Hover .....   | ±5 dB per 1/3 octave band .....   | Hover .....          | .....  |                 |   | X               |  |
| 5.a.4. ....            | Climb .....   | ± 5 dB per 1/3 octave band .....  | En-route climb ..... | Medium altitude .....  |                 |   | X               |  |
| 5.a.5. ....            | Cruise .....  | ± 5 dB per 1/3 octave band .....  | Cruise .....         | Normal cruise configuration.   |                 |   | X               |  |
| 5.a.6. ....            | Final approach .....  | ± 5 dB per 1/3 octave band .....  | Landing .....        | Constant airspeed, gear down.  |                 |   | X               |  |
| 5.b. ....              | Special cases   |   |                      |  |                 |   |                 |  |
|                        |   | ± 5 dB per 1/3 octave band .....  | As appropriate ..... | .....  |                 |   | X               | These special cases are identified as particularly significant during critical phases of flight and ground operations for a specific helicopter type or model. |
| 5.c. ....              | Background noise  |   |                      |  |                 |   |                 |  |
|                        |   | ±3 dB per 1/3 octave band .....   | As appropriate ..... | Results of the background noise at initial qualification must be included in the MQTG. Measurements must be made with the simulation running, the sound muted, and a "dead" flight deck. |                 |   | X               | The simulated sound will be evaluated to ensure that the background noise does not interfere with training, testing, or checking.                              |
| 5.d. ....              | Frequency response  |   |                      |  |                 |   |                 |  |

TABLE C2A.—FULL FLIGHT SIMULATOR (FFS) OBJECTIVE TESTS—Continued

| Test   |       | <<<QPS requirements>>>   |                  |  |                 | <<Information>> |   |   |
|--------|-------|--|------------------|--|-----------------|-----------------|---|---|
| Number | Title | Tolerance(s)   | Flight condition | Test details   | Simulator level |                 |   | Notes   |
|        |       |  |                  |  | B               | C               | D |   |
|        |       | ±5 dB on three (3) consecutive bands when compared to initial evaluation; and ± 2 dB when comparing the average of the absolute differences between initial and continuing qualification evaluation. | .....            | Applicable only to Continuing Qualification Evaluations.<br>If frequency response plots are provided for each channel at the initial evaluation, these plots may be repeated at the continuing qualification evaluation with the following tolerances applied:<br>(a) The continuing qualification 1/3 octave band amplitudes should not exceed ± 5 dB for three consecutive bands when compared to initial results.<br>(b) The average of the sum of the absolute differences between initial and continuing qualification results must not exceed 2 dB (refer to table C2C in Appendix C). |                 |                 | X | Measurements are compared to those taken during initial qualification evaluation. |

**Begin Information**

**3. General**

a. If relevant winds are present in the objective data, the wind vector should be clearly noted as part of the data presentation, expressed in conventional terminology, and related to the runway being used for test near the ground.

b. The reader is encouraged to review the Airplane Flight Simulator Evaluation Handbook, Volumes I and II, published by the Royal Aeronautical Society, London, UK, and FAA Advisory Circulars (AC) 25-7, as may be amended, Flight Test Guide for Certification of Transport Category Airplanes, and (AC) 23-8, as may be amended, Flight Test Guide for Certification of Part 23 Airplanes, for references and examples regarding flight testing requirements and techniques.

**4. Control Dynamics**

a. General. The characteristics of a helicopter flight control system have a major effect on the handling qualities. A significant consideration in pilot acceptability of a helicopter is the "feel" provided through the flight controls. Considerable effort is expended on helicopter feel system design so that pilots will be comfortable and will consider the helicopter desirable to fly. In order for an FFS to be representative, it should "feel" like the helicopter being simulated. Compliance with this requirement is determined by comparing a recording of the control feel dynamics of the FFS to actual

helicopter measurements in the takeoff, cruise and landing configurations.

(1) Recordings such as free response to an impulse or step function are classically used to estimate the dynamic properties of electromechanical systems. In any case, it is only possible to estimate the dynamic properties as a result of only being able to estimate true inputs and responses. Therefore, it is imperative that the best possible data be collected since close matching of the FFS control loading system to the helicopter system is essential. The required dynamic control tests are described in Table C2A of this attachment.

(2) For initial and upgrade evaluations, the QPS requires that control dynamics characteristics be measured and recorded directly from the flight controls (Handling Qualities—Table C2A). This procedure is usually accomplished by measuring the free response of the controls using a step or impulse input to excite the system. The procedure should be accomplished in the takeoff, cruise and landing flight conditions and configurations.

(3) For helicopters with irreversible control systems, measurements may be obtained on the ground if proper pilot-static inputs are provided to represent airspeeds typical of those encountered in flight. Likewise, it may be shown that for some helicopters, hover, climb, cruise, and autorotation have like effects. Thus, one may suffice for another. If either or both considerations apply, engineering validation or helicopter manufacturer rationale should be submitted as justification for ground tests or for

eliminating a configuration. For FFSs requiring static and dynamic tests at the controls, special test fixtures will not be required during initial and upgrade evaluations if the QTG shows both test fixture results and the results of an alternate approach (e.g., computer plots that were produced concurrently and show satisfactory agreement). Repeat of the alternate method during the initial evaluation would satisfy this test requirement.

b. Control Dynamics Evaluations. The dynamic properties of control systems are often stated in terms of frequency, damping, and a number of other classical measurements. In order to establish a consistent means of validating test results for FFS control loading, criteria are needed that will clearly define the measurement interpretation and the applied tolerances. Criteria are needed for underdamped, critically damped and overdamped systems. In the case of an underdamped system with very light damping, the system may be quantified in terms of frequency and damping. In critically damped or overdamped systems, the frequency and damping are not readily measured from a response time history. Therefore, the following suggested measurements may be used:

(1) For Levels C and D simulators. Tests to verify that control feel dynamics represent the helicopter should show that the dynamic damping cycles (free response of the controls) match those of the helicopter within specified tolerances. The NSPM recognizes that several different testing

methods may be used to verify the control feel dynamic response. The NSPM will consider the merits of testing methods based on reliability and consistency. One acceptable method of evaluating the response and the tolerance to be applied is described below for the underdamped and critically damped cases. A sponsor using this method to comply with the QPS requirements should perform the tests as follows:

(a) Underdamped Response. Two measurements are required for the period, the time to first zero crossing (in case a rate limit is present) and the subsequent frequency of oscillation. It is necessary to measure cycles on an individual basis in case there are non-uniform periods in the response. Each period will be independently compared to the respective period of the helicopter control system and, consequently, will enjoy the full tolerance specified for that period. The damping tolerance will be applied to overshoots on an individual basis. Care should be taken when applying the tolerance to small overshoots since the significance of such overshoots becomes questionable. Only those overshoots larger than 5 percent of the total initial displacement should be considered significant. The residual band, labeled T(A<sub>d</sub>) on Figure C2A is ±5 percent of the initial displacement amplitude A<sub>d</sub> from the steady state value of the oscillation. Only oscillations outside the residual band are considered significant. When comparing FFS data to helicopter data, the process should begin by overlaying or aligning the FFS and airplane steady state values and then comparing amplitudes of oscillation peaks, the time of the first zero crossing, and individual periods of oscillation. The FFS should show the same number of significant overshoots to within one when compared against the helicopter airplane data. The procedure for evaluating the response is illustrated in Figure C2A.

(b) Critically damped and Overdamped Response. Due to the nature of critically

damped and overdamped responses (no overshoots), the time to reach 90 percent of the steady state (neutral point) value should be the same as the helicopter within ±10 percent. The simulator response must be critically damped also. Figure C2B illustrates the procedure.

(c) Special considerations. Control systems that exhibit characteristics other than classical overdamped or underdamped responses should meet specified tolerances. In addition, special consideration should be given to ensure that significant trends are maintained.

(2) Tolerances.

(a) The following summarizes the tolerances, "T" for underdamped systems, and "n" is the sequential period of a full cycle of oscillation. See Figure C2A of this attachment for an illustration of the referenced measurements.

|                          |   |
|--------------------------|---|
| T(P <sub>0</sub> ) ..... | ±10% of P <sub>0</sub> .                      |
| T(P <sub>1</sub> ) ..... | ±20% of P <sub>1</sub> .                      |
| T(P <sub>2</sub> ) ..... | ±30% of P <sub>2</sub> .                      |
| T(P <sub>n</sub> ) ..... | ±10(n+1)% of P <sub>n</sub> .                 |
| T(A <sub>n</sub> ) ..... | ±10% of A <sub>1</sub> .                      |
| T(A <sub>d</sub> ) ..... | ±5% of A <sub>d</sub> = residual band.        |
| Significant overshoots.  | First overshoot and ±1 subsequent overshoots. |

(b) The following tolerance applies to critically damped and overdamped systems only. See Figure C2B for an illustration of the reference measurements:

|                          |                          |
|--------------------------|--------------------------|
| T(P <sub>0</sub> ) ..... | ±10% of P <sub>0</sub> . |
|--------------------------|--------------------------|

End Information

Begin QPS Requirement

c. Alternative method for control dynamics evaluation.

(1) An alternative means for validating control dynamics for aircraft with hydraulically powered flight controls and

artificial feel systems is by the measurement of control force and rate of movement. For each axis of pitch, roll, and yaw, the control must be forced to its maximum extreme position for the following distinct rates. These tests are conducted under normal flight and ground conditions.

(a) Static test—Slowly move the control so that a full sweep is achieved within 95–105 seconds. A full sweep is defined as movement of the controller from neutral to the stop, usually aft or right stop, then to the opposite stop, then to the neutral position.

(b) Slow dynamic test—Achieve a full sweep within 8–12 seconds.

(c) Fast dynamic test—Achieve a full sweep in within 3–5 seconds.

**Note:** Dynamic sweeps may be limited to forces not exceeding 100 lbs. (44.5 daN).

(d) Tolerances.

(i) Static test—see Table C2A, Full Flight Simulator (FFS) Objective Tests, Items 2.a.1., 2.a.2., and 2.a.3.

(ii) Dynamic test ±2 lbs (0.9 daN) or ±10% on dynamic increment above static test.

End QPS Requirement

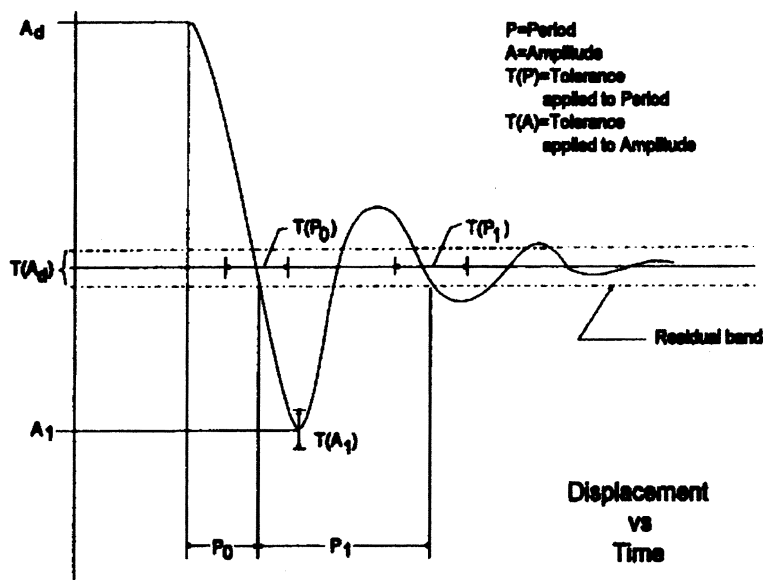
Begin Information

d. The FAA is open to alternative means that are justified and appropriate to the application. For example, the method described here may not apply to all manufacturers' systems and certainly not to aircraft with reversible control systems. Each case is considered on its own merit on an ad hoc basis. If the FAA finds that alternative methods do not result in satisfactory performance, more conventionally accepted methods will have to be used.

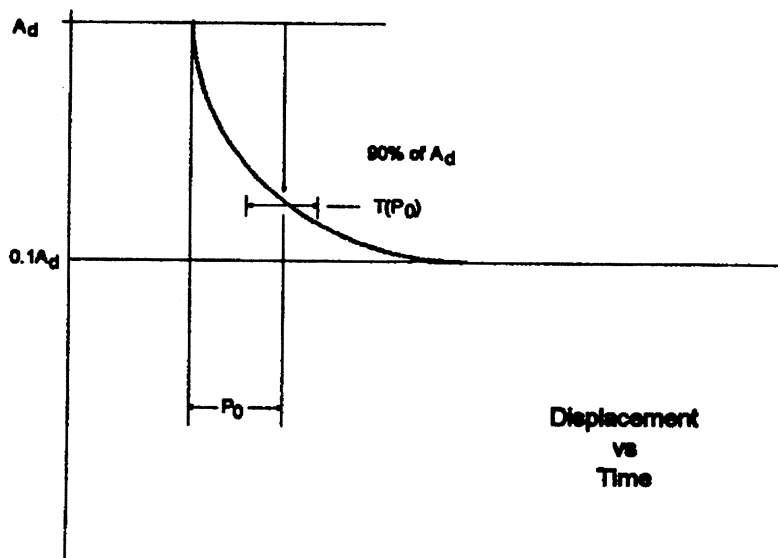
**BILLING CODE 4910-13-P**

End Information

Attachment 2 to Appendix C to Part 60—  
Figure C2A. Under-Damped Step Response



Attachment 2 to Appendix C to Part 60—  
Figure C2B. Critically-Damped Step Response



BILLING CODE 4910-13-C

End Information

5. [Reserved]

Begin Information

6. Motion System

a. General.

(1) Pilots use continuous information signals to regulate the state of the helicopter. In concert with the instruments and outside-world visual information, whole-body motion feedback is essential in assisting the pilot to control the helicopter dynamics,

particularly in the presence of external disturbances. The motion system should meet basic objective performance criteria, and be subjectively tuned at the pilot's seat position to represent the linear and angular accelerations of the helicopter during a prescribed minimum set of maneuvers and conditions. The response of the motion cueing system should be repeatable.

(2) The Motion System tests in Section 3 of Table C2A are intended to qualify the FFS motion cueing system from a mechanical performance standpoint. Additionally, the list of motion effects provides a representative sample of dynamic conditions that should be present in the flight simulator. An additional list of representative, training-critical maneuvers, selected from Section 1, (Performance tests) and Section 2, (Handling Qualities tests) in Table C2A, that should be recorded during initial qualification (but without tolerance) to indicate the flight simulator motion cueing performance signature have been identified (reference Section 3.e). These tests are intended to help improve the overall standard of FFS motion cueing.

b. Motion System Checks. The intent of test 3a, Frequency Response, test 3b, Leg Balance, and test 3c, Turn-Around Check, as described in the Table of Objective Tests, is to demonstrate the performance of the motion system hardware, and to check the integrity of the motion set-up with regard to calibration and wear. These tests are independent of the motion cueing software and should be considered robotic tests.

c. Motion System Repeatability. The intent of this test is to ensure that the motion system software and motion system hardware have not degraded or changed over time. This diagnostic test should be completed during continuing qualification checks in lieu of the robotic tests. This will allow an improved ability to determine changes in the software or determine degradation in the hardware. The following information delineates the methodology that should be used for this test.

(1) Input: The inputs should be such that rotational accelerations, rotational rates, and linear accelerations are inserted before the transfer from helicopter center of gravity to pilot reference point with a minimum amplitude of 5 deg/sec/sec, 10 deg/sec and 0.3 g, respectively, to provide adequate analysis of the output.

(2) Recommended output:

(a) Actual platform linear accelerations; the output will comprise accelerations due to both the linear and rotational motion acceleration;

(b) Motion actuators position.

d. Motion Cueing Performance Signature.

(1) Background. The intent of this test is to provide quantitative time history records of motion system response to a selected set of automated QTG maneuvers during initial

qualification. It is not intended to be a comparison of the motion platform accelerations against the flight test recorded accelerations (*i.e.*, not to be compared against helicopter cueing). If there is a modification to the initially qualified motion software or motion hardware (*e.g.*, motion washout filter, simulator payload change greater than 10%) then a new baseline may need to be established.

(2) Test Selection. The conditions identified in Section 3.e. in Table C2A are those maneuvers where motion cueing is the most discernible. They are general tests applicable to all types of helicopters and should be completed for motion cueing performance signature at any time acceptable to the NSPM prior to or during the initial qualification evaluation, and the results included in the MQTG.

(3) Priority. Motion system should be designed with the intent of placing greater importance on those maneuvers that directly influence pilot perception and control of the helicopter motions. For the maneuvers identified in section 3.e. in Table C2A, the flight simulator motion cueing system should have a high tilt co-ordination gain, high rotational gain, and high correlation with respect to the helicopter simulation model.

(4) Data Recording. The minimum list of parameters provided should allow for the determination of the flight simulator's motion cueing performance signature for the initial qualification evaluation. The following parameters are recommended as being acceptable to perform such a function:

(a) Flight model acceleration and rotational rate commands at the pilot reference point;

(b) Motion actuators position;

(c) Actual platform position;

(d) Actual platform acceleration at pilot reference point.

e. Motion Vibrations.

(1) Presentation of results. The characteristic motion vibrations may be used to verify that the flight simulator can reproduce the frequency content of the helicopter when flown in specific conditions. The test results should be presented as a Power Spectral Density (PSD) plot with frequencies on the horizontal axis and amplitude on the vertical axis. The helicopter data and flight simulator data should be presented in the same format with the same scaling. The algorithms used for generating the flight simulator data should be the same as those used for the helicopter data. If they

are not the same then the algorithms used for the flight simulator data should be proven to be sufficiently comparable. As a minimum the results along the dominant axes should be presented and a rationale for not presenting the other axes should be provided.

(2) Interpretation of results. The overall trend of the PSD plot should be considered while focusing on the dominant frequencies. Less emphasis should be placed on the differences at the high frequency and low amplitude portions of the PSD plot. During the analysis, certain structural components of the flight simulator have resonant frequencies that are filtered and may not appear in the PSD plot. If filtering is required, the notch filter bandwidth should be limited to 1 Hz to ensure that the buffet feel is not adversely affected. In addition, a rationale should be provided to explain that the characteristic motion vibration is not being adversely affected by the filtering. The amplitude should match helicopter data as described below. However, if the PSD plot was altered for subjective reasons, a rationale should be provided to justify the change. If the plot is on a logarithmic scale it may be difficult to interpret the amplitude of the buffet in terms of acceleration. For example, a  $1 \times 10^{-3}$  grams<sup>2</sup>/Hz would describe a heavy buffet and may be seen in the deep stall regime. Alternatively, a  $1 \times 10^{-6}$  grams<sup>2</sup>/Hz buffet is almost imperceptible; but may represent a flap buffet at low speed. The previous two examples differ in magnitude by 1000. On a PSD plot this represents three decades (one decade is a change in order of magnitude of 10; and two decades is a change in order of magnitude of 100).

f. Table C2B, Motion System Recommendations for Level C and Level D Helicopter Simulators, contains a description of the parameters that should be present in a ZFT level simulator motion system to provide adequate on-set motion cues to helicopter pilots. The information provided covers the six axes of motion (pitch, roll, yaw, vertical, lateral, and longitudinal) and addresses displacement, velocity, and acceleration. Also included is information about the parameters for initial rotational and linear acceleration. The parameters listed in this table apply only to ZFT level simulators, and are presented here as recommended targets for motion system capability. They are not requirements.

TABLE C2B.—MOTION SYSTEM RECOMMENDATIONS FOR LEVEL C AND LEVEL D HELICOPTER SIMULATORS

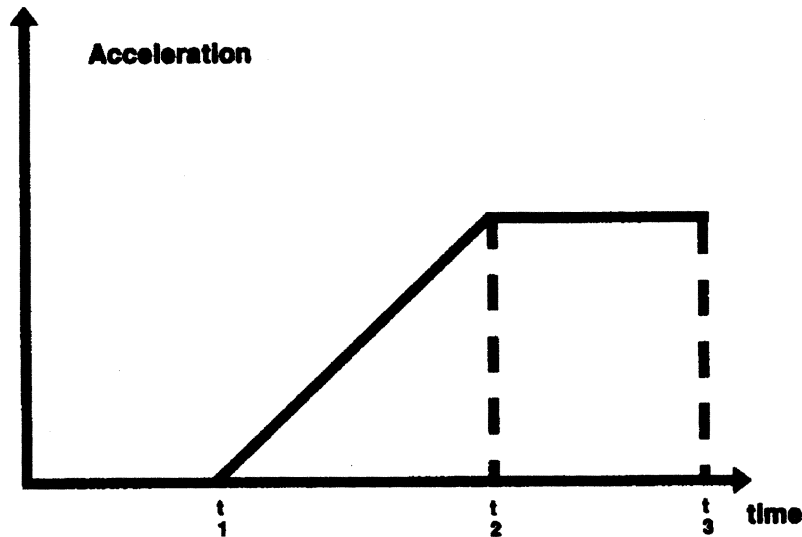
|        |                        |                          |
|--------|------------------------|--------------------------|
| a.     | Motion System Envelope |                          |
| a.1.   | Pitch                  |                          |
| a.1.a. | Displacement           | ±25°.                    |
| a.1.b. | Velocity               | ±20°/sec.                |
| a.1.c. | Acceleration           | ±100°/sec <sup>2</sup> . |
| a.2.   | Roll                   |                          |
| a.2.a. | Displacement           | ±25°.                    |
| a.2.b. | Velocity               | ±20°/sec.                |
| a.2.c. | Acceleration           | ±100°/sec <sup>2</sup> . |
| a.3.   | Yaw                    |                          |
| a.3.a. | Displacement           | ±25°.                    |
| a.3.b. | Velocity               | ±20°/sec.                |
| a.3.c. | Acceleration           | ±100°/sec <sup>2</sup> . |
| a.4.   | Vertical               |                          |
| a.4.a. | Displacement           | ±34 in.                  |



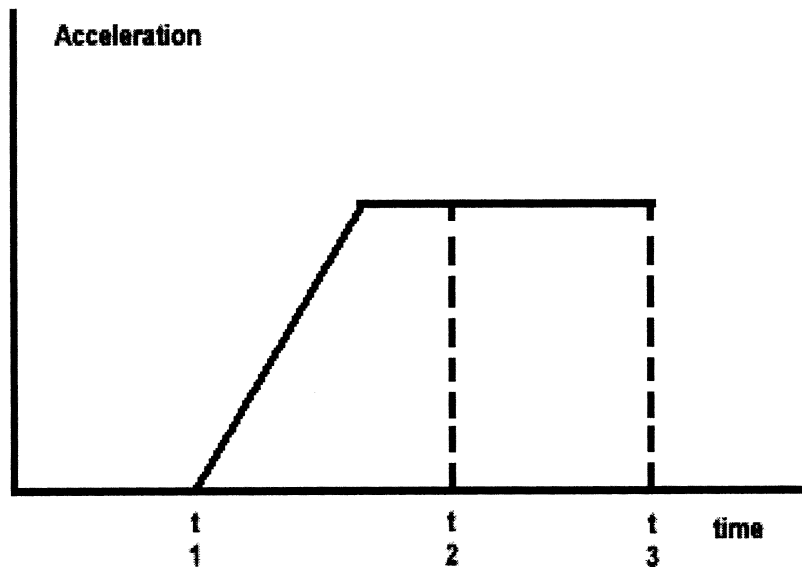
TABLE C2B.—MOTION SYSTEM RECOMMENDATIONS FOR LEVEL C AND LEVEL D HELICOPTER SIMULATORS—Continued

|            |                                       |                                       |
|------------|---------------------------------------|---------------------------------------|
| a.4.b. ... | Velocity .....                        | ±24 in.                               |
| a.4.c. ... | Acceleration .....                    | ±0.8 g.                               |
| a.5. ....  | Lateral                               |                                       |
| a.5.a. ... | Displacement .....                    | ±45 in.                               |
| a.5.b. ... | Velocity .....                        | ±28 in/sec.                           |
| a.5.c. ... | Acceleration .....                    | ±0.6 g.                               |
| a.6. ....  | Longitudinal                          |                                       |
| a.6.a. ... | Displacement .....                    | ±34 in.                               |
| a.6.b. ... | Velocity .....                        | ±28 in/sec.                           |
| a.6.c. ... | Acceleration .....                    | ±0.6 g.                               |
| a.7. ....  | Initial Rotational Acceleration Ratio |                                       |
|            | .....                                 | All axes 300°/ sec <sup>2</sup> /sec. |
| a.8. ....  | Initial Linear Acceleration Ratio     |                                       |
| a.8.a. ... | Vertical .....                        | ±6g/sec.                              |
| a.8.b. ... | Lateral .....                         | ±3g/sec.                              |
| a.8.c. ... | Longitudinal .....                    | ±3g/sec.                              |

**Attachment 2 to Appendix C to Part 60—  
Figure C2C. Acceleration Test Signals**



**Attachment 2 to Appendix C to Part 60—  
Figure C2D. Test Signal Characteristics**



**BILLING CODE 4910-13-C**

**Note:** Motion system baseline performance repeatability tests should be repeated if the simulator weight changes for any reason (i.e., visual change or structural change). The new results should be used for future comparison.

**7. Sound System**

a. General. The total sound environment in the helicopter is very complex, and changes with atmospheric conditions, helicopter configuration, airspeed, altitude, and power settings. Flight deck sounds are an important component of the flight deck operational environment and provide valuable information to the flight crew. These aural

cues can either assist the crew (as an indication of an abnormal situation), or hinder the crew (as a distraction or nuisance). For effective training, the flight simulator should provide flight deck sounds that are perceptible to the pilot during normal and abnormal operations, and that are comparable to those of the helicopter. The flight simulator operator should carefully evaluate background noises in the location where the device will be installed. To demonstrate compliance with the sound requirements, the objective or validation tests in this attachment were selected to provide a representative sample of normal static conditions typically experienced by a pilot.

b. Alternate propulsion. For FFS with multiple propulsion configurations, any condition listed in Table C2A in this attachment should be presented for evaluation as part of the QTG if identified by the helicopter manufacturer or other data supplier as significantly different due to a change in propulsion system (engine or propeller).

c. Data and Data Collection System.  
(1) Information provided to the flight simulator manufacturer should be presented in the format suggested by the "International Air Transport Association (IATA) Flight Simulator Design and Performance Data Requirements," as amended. This

information should contain calibration and frequency response data.

(2) The system used to perform the tests listed in Table C2A should comply with the following standards:

(a) The specifications for octave, half octave, and third octave band filter sets may be found in American National Standards Institute (ANSI) S1.11-1986.

(b) Measurement microphones should be type WS2 or better, as described in International Electrotechnical Commission (IEC) 1094-4-1995.

(3) Headsets. If headsets are used during normal operation of the helicopter they should also be used during the flight simulator evaluation.

(4) Playback equipment. Playback equipment and recordings of the QTG conditions should be provided during initial evaluations.

(5) Background noise.

(a) Background noise is the noise in the flight simulator that is not associated with the helicopter, but is caused by the flight simulator's cooling and hydraulic systems and extraneous noise from other locations in the building. Background noise can seriously impact the correct simulation of helicopter sounds, and should be kept below the helicopter sounds. In some cases, the sound level of the simulation can be increased to compensate for the background noise.

However, this approach is limited by the specified tolerances and by the subjective acceptability of the sound environment to the evaluation pilot.

(b) The acceptability of the background noise levels is dependent upon the normal sound levels in the helicopter being represented. Background noise levels that fall

below the lines defined by the following points, may be acceptable:

- (i) 70 dB @ 50 Hz;
- (ii) 55 dB @ 1000 Hz;
- (iii) 30 dB @ 16 kHz.

(Note: These limits are for unweighted 1/3 octave band sound levels. Meeting these limits for background noise does not ensure an acceptable flight simulator. Helicopter sounds that fall below this limit require careful review and may require lower limits on background noise.)

(6) Validation testing. Deficiencies in helicopter recordings should be considered when applying the specified tolerances to ensure that the simulation is representative of the helicopter. Examples of typical deficiencies are:

- (a) Variation of data between tail numbers.
- (b) Frequency response of microphones.
- (c) Repeatability of the measurements.

TABLE C2C.—EXAMPLE OF RECURRENT FREQUENCY RESPONSE TEST TOLERANCE

| Band center frequency | Initial results (dB SPL) | Recurrent results (dB SPL) | Absolute difference |
|-----------------------|--------------------------|----------------------------|---------------------|
| 50                    | 75.0                     | 73.8                       | 1.2                 |
| 63                    | 75.9                     | 75.6                       | 0.3                 |
| 80                    | 77.1                     | 76.5                       | 0.6                 |
| 100                   | 78.0                     | 78.3                       | 0.3                 |
| 125                   | 81.9                     | 81.3                       | 0.6                 |
| 160                   | 79.8                     | 80.1                       | 0.3                 |
| 200                   | 83.1                     | 84.9                       | 1.8                 |
| 250                   | 78.6                     | 78.9                       | 0.3                 |
| 315                   | 79.5                     | 78.3                       | 1.2                 |
| 400                   | 80.1                     | 79.5                       | 0.9                 |
| 500                   | 80.7                     | 79.8                       | 0.9                 |
| 630                   | 81.9                     | 80.4                       | 1.5                 |
| 800                   | 73.2                     | 74.1                       | 0.9                 |
| 1000                  | 79.2                     | 80.1                       | 0.9                 |
| 1250                  | 80.7                     | 82.8                       | 2.1                 |
| 1600                  | 81.6                     | 78.6                       | 3.0                 |
| 2000                  | 76.2                     | 74.4                       | 1.8                 |
| 2500                  | 79.5                     | 80.7                       | 1.2                 |
| 3150                  | 80.1                     | 77.1                       | 3.0                 |
| 4000                  | 78.9                     | 78.6                       | 0.3                 |
| 5000                  | 80.1                     | 77.1                       | 3.0                 |
| 6300                  | 80.7                     | 80.4                       | 0.3                 |
| 8000                  | 84.3                     | 85.5                       | 1.2                 |
| 10000                 | 81.3                     | 79.8                       | 1.5                 |
| 12500                 | 80.7                     | 80.1                       | 0.6                 |
| 16000                 | 71.1                     | 71.1                       | 0.0                 |
|                       | Average                  |                            | 1.1                 |

**8. Additional Information About Flight Simulator Qualification for New or Derivative Helicopters**

a. Typically, a helicopter manufacturer's approved final data for performance, handling qualities, systems or avionics is not available until well after a new or derivative helicopter has entered service. However, flight crew training and certification often begins several months prior to the entry of the first helicopter into service. Consequently, it may be necessary to use preliminary data provided by the helicopter manufacturer for interim qualification of flight simulators.

b. In these cases, the NSPM may accept certain partially validated preliminary

helicopter and systems data, and early release "red label" avionics data in order to permit the necessary program schedule for training, certification, and service introduction.

c. Simulator sponsors seeking qualification based on preliminary data should consult the NSPM to make special arrangements for using preliminary data for flight simulator qualification. The sponsor should also consult the helicopter and flight simulator manufacturers to develop a data plan and flight simulator qualification plan.

d. The procedure to be followed to gain NSPM acceptance of preliminary data will vary from case to case and between helicopter manufacturers. Each helicopter

manufacturer's new helicopter development and test program is designed to suit the needs of the particular project and may not contain the same events or sequence of events as another manufacturer's program or even the same manufacturer's program for a different helicopter. Therefore, there cannot be a prescribed invariable procedure for acceptance of preliminary data; instead there should be a statement describing the final sequence of events, data sources, and validation procedures agreed by the simulator sponsor, the helicopter manufacturer, the flight simulator manufacturer, and the NSPM. Note: A description of helicopter manufacturer-provided data needed for flight simulator

modeling and validation is to be found in the IATA Document "Flight Simulator Design and Performance Data Requirements," as amended.

e. The preliminary data should be the manufacturer's best representation of the helicopter, with assurance that the final data will not deviate significantly from the preliminary estimates. Data derived from these predictive or preliminary techniques should be validated by available sources including, at least, the following:

(1) Manufacturer's engineering report. The report should explain the predictive method used and illustrate past success of the method on similar projects. For example, the manufacturer could show the application of the method to an earlier helicopter model or predict the characteristics of an earlier model and compare the results to final data for that model.

(2) Early flight test results. This data is often derived from helicopter certification tests and should be used to maximum advantage for early flight simulator validation. Certain critical tests that would normally be done early in the helicopter certification program should be included to validate essential pilot training and certification maneuvers. These tests include cases where a pilot is expected to cope with a helicopter failure mode or an engine failure. The early data available will depend on the helicopter manufacturer's flight test program design and may not be the same in each case. The flight test program of the helicopter manufacturer should include provisions for generation of very early flight tests results for flight simulator validation.

f. The use of preliminary data is not indefinite. The helicopter manufacturer's final data should be available within 12 months after the helicopter first entry into service or as agreed by the NSPM, the simulator sponsor, and the helicopter manufacturer. When applying for interim qualification using preliminary data, the simulator sponsor and the NSPM should agree on the update program. This includes specifying that the final data update will be installed in the flight simulator within a period of 12 months following the final data release, unless special conditions exist and a different schedule is acceptable. The flight simulator performance and handling validation would then be based on data derived from flight tests. Initial helicopter systems data should be updated after engineering tests. Final helicopter systems data should also be used for flight simulator programming and validation.

g. Flight simulator avionics should stay essentially in step with helicopter avionics (hardware and software) updates. The permitted time lapse between helicopter and flight simulator updates should be minimal. It may depend on the magnitude of the update and whether the QTG and pilot training and certification are affected. Differences in helicopter and flight simulator avionics versions and the resulting effects on flight simulator qualification should be agreed between the simulator sponsor and the NSPM. Consultation with the flight simulator manufacturer is desirable throughout the qualification process.

h. The following describes an example of the design data and sources that might be used in the development of an interim qualification plan.

(1) The plan should consist of the development of a QTG based upon a mix of flight test and engineering simulation data. For data collected from specific helicopter flight tests or other flights the required design model or data changes necessary to support an acceptable Proof of Match (POM) should be generated by the helicopter manufacturer.

(2) For proper validation of the two sets of data, the helicopter manufacturer should compare their simulation model responses against the flight test data, when driven by the same control inputs and subjected to the same atmospheric conditions as recorded in the flight test. The model responses should result from a simulation where the following systems are run in an integrated fashion and are consistent with the design data released to the flight simulator manufacturer:

- (a) Propulsion.
- (b) Aerodynamics.
- (c) Mass properties.
- (d) Flight controls.
- (e) Stability augmentation.
- (f) Brakes/landing gear.

i. A qualified test pilot should be used to assess handling qualities and performance evaluations for the qualification of flight simulators of new helicopter types.

#### End Information

#### Begin QPS Requirement

#### 9. Engineering Simulator—Validation Data

a. When a fully validated simulation (i.e., validated with flight test results) is modified due to changes to the simulated helicopter configuration, the helicopter manufacturer or other acceptable data supplier must coordinate with the NSPM to supply validation data from an "audited" engineering simulator/simulation to selectively supplement flight test data. The NSPM must be provided an opportunity to audit the use of the engineering simulation or the engineering simulator during the acquisition of the data that will be used as validation data. Audited data may be used for changes that are incremental in nature. Manufacturers or other data suppliers should be able to demonstrate that the predicted changes in helicopter performance are based on acceptable aeronautical principles with proven success history and valid outcomes. This should include comparisons of predicted and flight test validated data.

b. Helicopter manufacturers or other acceptable data suppliers seeking to use an engineering simulator for simulation validation data as an alternative to flight-test derived validation data, must contact the NSPM and provide the following:

(1) A description of the proposed aircraft changes, a description of the proposed simulation model changes, and the use of an integral configuration management process, including an audit of the actual simulation model modifications that includes a step-by-step description leading from the original model(s) to the current model(s).

(2) A schedule for review by the NSPM of the proposed plan and the subsequent

validation data to establish acceptability of the proposal.

(3) Information that demonstrates an ability to qualify the FFS in which this data is to be used in accordance with the criteria contained in § 60.15.

c. To be qualified to supply engineering simulator validation data, for aerodynamic, engine, flight control, or ground handling models, a helicopter manufacturer or other acceptable data supplier must:

- (1) Be able to verify their ability to:
  - (a) Develop and implement high fidelity simulation models; and
  - (b) Predict the handling and performance characteristics of a helicopter with sufficient accuracy to avoid additional flight test activities for those handling and performance characteristics.
- (2) Have an engineering simulator that:
  - (a) Is a physical entity, complete with a flight deck representative of the simulated class of helicopter;
  - (b) Has controls sufficient for manual flight;
  - (c) Has models that run in an integrated manner;
  - (d) Had fully flight-test validated simulation models as the original or baseline simulation models;
  - (e) Has an out-of-the-flight deck visual system;
  - (f) Has actual avionics boxes interchangeable with the equivalent software simulations to support validation of released software;

(g) Uses the same models as released to the training community (which are also used to produce stand-alone proof-of-match and checkout documents);

(h) Is used to support helicopter development and certification; and

(i) Has been found to be a high fidelity representation of the helicopter by the manufacturer's pilots (or other acceptable data supplier), certificate holders, and the NSPM.

(3) Use the engineering simulator to produce a representative set of integrated proof-of-match cases.

(4) Use a configuration control system covering hardware and software for the operating components of the engineering simulator.

(5) Demonstrate that the predicted effects of the change(s) are within the provisions of sub-paragraph "a" of this section, and confirm that additional flight test data are not required.

d. Additional Requirements for Validation Data

(1) When used to provide validation data, an engineering simulator must meet the simulator standards currently applicable to training simulators except for the data package.

(2) The data package used must be:

- (a) Comprised of the engineering predictions derived from the helicopter design, development, or certification process;
- (b) Based on acceptable aeronautical principles with proven success history and valid outcomes for aerodynamics, engine operations, avionics operations, flight control applications, or ground handling;
- (c) Verified with existing flight-test data; and

(d) Applicable to the configuration of a production helicopter, as opposed to a flight-test helicopter.

(3) Where engineering simulator data are used as part of a QTG, an essential match must exist between the training simulator and the validation data.

(4) Training flight simulator(s) using these baseline and modified simulation models must be qualified to at least internationally recognized standards, such as contained in the ICAO Document 9625, the "Manual of Criteria for the Qualification of Flight Simulators."

#### End QPS Requirement

### 10. [Reserved]

#### Begin QPS Requirement

##### 11. Validation Test Tolerances

a. Non-Flight-Test Tolerances. If engineering simulator data or other non-flight-test data are used as an allowable form of reference validation data for the objective tests listed in Table C2A of this attachment, the data provider must supply a well-documented mathematical model and testing procedure that enables a replication of the engineering simulation results within 20% of the corresponding flight test tolerances.

#### End QPS Requirement

#### Begin Information

##### b. Background

(1) The tolerances listed in Table C2A of this attachment are designed to measure the quality of the match using flight-test data as a reference.

(2) Good engineering judgment should be applied to all tolerances in any test. A test

is failed when the results fall outside of the prescribed tolerance(s).

(3) Engineering simulator data are acceptable because the same simulation models used to produce the reference data are also used to test the flight training simulator (i.e., the two sets of results should be "essentially" similar).

(4) The results from the two sources may differ for the following reasons:

(a) Hardware (avionics units and flight controls);

(b) Iteration rates;

(c) Execution order;

(d) Integration methods;

(e) Processor architecture;

(f) Digital drift, including;

(i) Interpolation methods;

(ii) Data handling differences;

(iii) Auto-test trim tolerances.

(5) Any differences must be within 20% of the flight test tolerances. The reasons for any differences, other than those listed above, should be explained.

(6) Guidelines are needed for the application of tolerances to engineering-simulator-generated validation data because:

(a) Flight-test data are often not available due to sound technical reasons;

(b) Alternative technical solutions are being advanced; and

(c) The costs are high.

##### 12. Validation Data Roadmap

a. Helicopter manufacturers or other data suppliers should supply a validation data roadmap (VDR) document as part of the data package. A VDR document contains guidance material from the helicopter validation data supplier recommending the best possible sources of data to be used as validation data in the QTG. A VDR is of special value when requesting interim qualification, qualification of simulators for helicopters certificated prior to 1992, and qualification of alternate engine or avionics fits. A sponsor seeking to have a

device qualified in accordance with the standards contained in this QPS appendix should submit a VDR to the NSPM as early as possible in the planning stages. The NSPM is the final authority to approve the data to be used as validation material for the QTG. The NSPM and the Joint Aviation Authorities' Synthetic Training Devices Advisory Board have committed to maintain a list of agreed VDRs.

b. The VDR should identify (in matrix format) sources of data for all required tests. It should also provide guidance regarding the validity of these data for a specific engine type, thrust rating configuration, and the revision levels of all avionics affecting helicopter handling qualities and performance. The VDR should include rationale or explanation in cases where data or parameters are missing, engineering simulation data are to be used, flight test methods require explanation, or where there is any deviation from data requirements. Additionally, the document should refer to other appropriate sources of validation data (e.g., sound and vibration data documents).

c. The VDR table shown in Table C2D depicts a generic roadmap matrix identifying sources of validation data for an abbreviated list of tests. A complete matrix should address all test conditions.

d. Two examples of rationale pages are presented in Appendix F of IATA Flight Simulator Design and Performance Data Requirements document. These illustrate the type of helicopter and avionics configuration information and descriptive engineering rationale used to describe data anomalies, provide alternative data, or provide an acceptable basis for obtaining deviations from QTG validation requirements.

#### End Information

BILLING CODE 4910-13-P

| ICAO or IATA # | Test Description   | Validation Source  | Validation Document                      |  |   |  |  |   | Comments   |
|----------------|--|--|--|--|---|--|--|---|--|
|                |  |  | Aerodynamics POM<br>Doc # xxx123, Rev. A | Flight Controls POM<br>Doc # xxx456, NEW | Ground Handling POM<br>Doc # xxx789, Rev. B | Propulsion POM<br>Doc # xxx321, Rev. C | Integrated POM<br>Doc # xxx654, Rev. A | Appendix to this VDR<br>Doc # xxx987, NEW |  |
|                | Notes: 1. Only one page is shown; and some test conditions were deleted for brevity;<br>2. Relevant regulatory material should be consulted and all applicable tests addressed;<br>3. Validation source, document and comments provided herein are for reference only and do not constitute approval for use | Aircraft Flight Test Data *2<br>Engineering Simulator Data (DEF-73 Engines)<br>CCA Mode *1 |  |  |   |  |  |   | D71 = Engine Type: DEF-71, Thrust Rating: 71.5K<br>D73 = Engine Type: DEF-73, Thrust Rating: 73K<br><br><b>BOLD</b> upper case denotes primary validation source<br>Lower case denotes alternate validation source<br>R = Rationale included in the VDR Appendix |
| 1.a.1          | Minimum Radius Turn  | X  |  | D71                                      |   |  |  |   |  |
| 1.a.2          | Rate of Turn vs. Nosewheel Angle (2 speeds)  | X  |  | D71                                      |   |  |  |   |  |
| 1.b.1          | Ground Acceleration Time and Distance  | X  |  | d73                                      |   |  |  |   | Primary data contained in IPOM   |
| 1.b.2          | Minimum Control Speed, Ground (Vmcg)   | X  | X  |  |   |  |  | D73                                       | See engineering rationale for test data in VDR   |
| 1.b.3          | Minimum Unstick Speed (Vmu)  | X  |  | D71                                      |   |  |  |   |  |
| 1.b.4          | Normal Takeoff   | X  |  | d73                                      |   |  |  |   | Primary data contained in IPOM   |
| 1.b.5          | Critical Engine Failure on Takeoff   | X  |  | d71                                      |   |  |  | D73                                       | Alternate engine thrust rating flight test data in VDR   |
| 1.b.6          | Crosswind Takeoff  | X  |  | d71                                      |   |  |  | D73                                       | Alternate engine thrust rating flight test data in VDR   |
| 1.b.7          | Rejected Takeoff   | X  |  | D71                                      |   |  |  | R   | Test procedure anomaly, see rationale  |
| 1.b.8          | Dynamic Engine Failure After Takeoff   | X  | X  |  |   |  |  | D73                                       | No flight test data available, see rationale   |
| 1.c.1          | Normal Climb - All Engine  | X  |  | d71                                      |   |  |  | D71                                       | Primary data contained in IPOM   |
| 1.c.2          | Climb - Engine-Out, Second Segment   | X  | X  | d71                                      |   |  |  | D73                                       | Alternate engine thrust rating flight test data in VDR   |
| 1.c.3          | Climb - Engine-Out, Enroute  | X  | X  | d71                                      |   |  |  | D73                                       | AFM data available (73K)   |
| 1.c.4          | Engine-Out Approach Climb  | X  | X  | d71                                      |   |  |  |   |  |
| 1.c.5.a        | Level Flight Acceleration  | X  | X  | d73                                      |   |  |  | D73                                       | Eng sim data w/ modified EEC accel rate in VDR   |
| 1.c.5.b        | Level Flight Deceleration  | X  | X  | d73                                      |   |  |  | D73                                       | Eng sim data w/ modified EEC decel rate in VDR   |
| 1.d.1          | Cruise Performance   | X  |  | D71                                      |   |  |  |   |  |
| 1.e.1.a        | Stopping Time & Distance (Wheel Brakes / Light weight)   |  | X  | D71                                      |   |  |  | d73                                       | No flight test data available, see rationale   |
| 1.e.1.b        | Stopping Time & Distance (Wheel Brakes / Med weight)   |  | X  | D71                                      |   |  |  | d73                                       |  |
| 1.e.1.c        | Stopping Time & Distance (Wheel Brakes / Heavy weight)   |  | X  | D71                                      |   |  |  | d73                                       |  |
| 1.e.2.a        | Stopping Time & Distance (Reverse Thrust / Light weight)   |  | X  | D71                                      |   |  |  | d73                                       |  |
| 1.e.2.b        | Stopping Time & Distance (Reverse Thrust / Med weight)   |  | X  | d71                                      |   |  |  | D73                                       | No flight test data available, see rationale   |

\*1 CCA mode must be desc4ribed for each test condition.

\*2 If more than one aircraft type (e.g., derivative and baseline) are used as validation data, more columns may be necessary.

Table C2D - Validation Data Roadmap

BILLING CODE 4910-13-C

Begin Information

13. [Reserved]

14. Acceptance Guidelines for Alternative Avionics (Flight-Related Computers and Controllers)

a. Background

(1) For a new helicopter type, the majority of flight validation data are collected on the first helicopter configuration with a "baseline" flight-related avionics ship-set; (see subparagraph b.(2) in this paragraph.)

These data are then used to validate all flight simulators representing that helicopter type.

(2) Additional validation data may be needed for flight simulators representing a helicopter with avionics of a different hardware design than the baseline, or a different software revision than that of previously validated configurations.

(3) When a flight simulator with additional or alternate avionics configurations is to be qualified, the QTG should contain tests against validation data for selected cases where avionics differences are expected to be significant. b. Approval Guidelines For Validating Alternate Avionics

(1) The following guidelines apply to flight simulators representing helicopters with a revised avionics configuration, or more than one avionics configuration.

(2) The baseline validation data should be based on flight test data, except where other data are specifically allowed (e.g., engineering flight simulator data).

(3) The helicopter avionics can be segmented into two groups, systems or components whose functional behavior contributes to the aircraft response presented in the QTG results, and systems that do not. The following avionics are examples of contributory systems for which hardware design changes or software revisions may

lead to significant differences in the aircraft response relative to the baseline avionics configuration: flight control computers and controllers for engines, autopilot, braking system, and nose wheel steering system, if applicable. Related avionics such as augmentation systems should also be considered.

(4) The acceptability of validation data used in the QTG for an alternative avionics fit should be determined as follows:

(a) For changes to an avionics system or component that do not affect QTG validation test response, the QTG test can be based on validation data from the previously validated avionics configuration.

(b) For an avionics change to a contributory system, where a specific test is not affected by the change (e.g., the avionics change is a Built In Test Equipment (BITE) update or a modification in a different flight phase), the QTG test can be based on validation data from the previously-validated avionics configuration. The QTG should include authoritative justification (e.g., from the helicopter manufacturer or system supplier) that this avionics change does not affect the test.

(c) For an avionics change to a contributory system, the QTG may be based on validation data from the previously-validated avionics configuration if no new functionality is added and the impact of the avionics change on the helicopter response is based on acceptable aeronautical principles with proven success history and valid outcomes. This should be supplemented with avionics-specific validation data from the helicopter manufacturer's engineering simulation, generated with the revised avionics configuration. The QTG should include an explanation of the nature of the change and its effect on the helicopter response.

(d) For an avionics change to a contributory system that significantly affects some tests in the QTG, or where new functionality is added, the QTG should be based on validation data from the previously validated avionics configuration and supplemental avionics-specific flight test data sufficient to validate the alternate avionics revision. Additional flight test validation data may not be needed if the avionics changes were certified without the need for testing with a comprehensive flight instrumentation package. The helicopter manufacturer should coordinate flight simulator data requirements in advance with the NSPM.

(5) A matrix or "roadmap" should be provided with the QTG indicating the appropriate validation data source for each test. The roadmap should include identification of the revision state of those contributory avionics systems that could affect specific test responses.

## 15. Transport Delay Testing

a. This paragraph describes how to determine the introduced transport delay through the flight simulator system so that it does not exceed a specific time delay. The transport delay should be measured from control inputs through the interface, through each of the host computer modules and back through the interface to motion, flight instrument, and visual systems. The transport delay should not exceed the maximum allowable interval.

b. Four specific examples of transport delay are:

(1) Simulation of classic non-computer controlled helicopters;

(2) Simulation of computer controlled helicopters using real helicopter black boxes;

(3) Simulation of computer controlled helicopters using software emulation of helicopter boxes;

(4) Simulation using software avionics or re-hosted instruments.

c. Figure C2C illustrates the total transport delay for a non-computer-controlled helicopter or the classic transport delay test. Since there are no helicopter-induced delays for this case, the total transport delay is equivalent to the introduced delay.

d. Figure C2D illustrates the transport delay testing method using the real helicopter controller system.

e. To obtain the induced transport delay for the motion, instrument and visual signal, the delay induced by the helicopter controller should be subtracted from the total transport delay. This difference represents the introduced delay and should not exceed the standards prescribed in Table C1A.

f. Introduced transport delay is measured from the flight deck control input to the reaction of the instruments and motion and visual systems (See Figure C2C).

g. The control input may also be introduced after the helicopter controller system input and the introduced transport delay may be measured directly from the control input to the reaction of the instruments, and simulator motion and visual systems (See Figure C2D).

h. Figure C2E illustrates the transport delay testing method used on a flight simulator that uses a software emulated helicopter controller system.

i. It is not possible to measure the introduced transport delay using the simulated helicopter controller system architecture for the pitch, roll and yaw axes. Therefore, the signal should be measured directly from the pilot controller. The flight simulator manufacturer should measure the total transport delay and subtract the inherent delay of the actual helicopter components because the real helicopter controller system has an inherent delay provided by the helicopter manufacturer. The

flight simulator manufacturer should ensure that the introduced delay does not exceed the standards prescribed in Table C1A.

j. Special measurements for instrument signals for flight simulators using a real helicopter instrument display system instead of a simulated or re-hosted display. For flight instrument systems, the total transport delay should be measured and the inherent delay of the actual helicopter components subtracted to ensure that the introduced delay does not exceed the standards prescribed in Table C1A.

(1) Figure C2FA illustrates the transport delay procedure without airplane display simulation. The introduced delay consists of the delay between the control movement and the instrument change on the data bus.

(2) Figure C2FB illustrates the modified testing method required to measure introduced delay due to software avionics or re-hosted instruments. The total simulated instrument transport delay is measured and the helicopter delay should be subtracted from this total. This difference represents the introduced delay and should not exceed the standards prescribed in Table C1A. The inherent delay of the helicopter between the data bus and the displays is indicated in figure C2FA. The display manufacturer should provide this delay time.

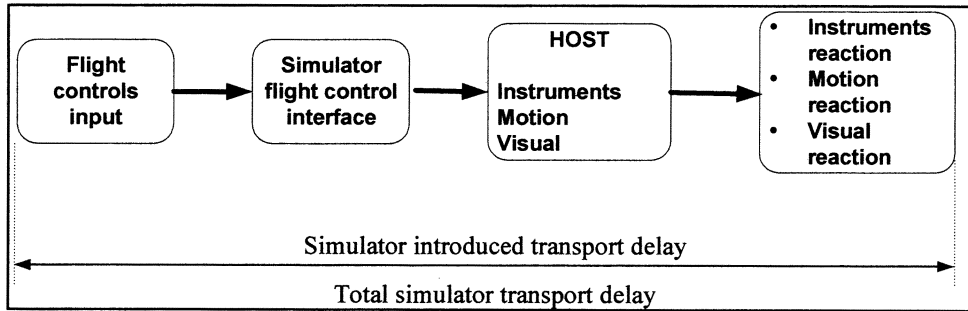
k. Recorded signals. The signals recorded to conduct the transport delay calculations should be explained on a schematic block diagram. The flight simulator manufacturer should also provide an explanation of why each signal was selected and how they relate to the above descriptions.

l. Interpretation of results. Flight simulator results vary over time from test to test due to "sampling uncertainty." All flight simulators run at a specific rate where all modules are executed sequentially in the host computer. The flight controls input can occur at any time in the iteration, but these data will not be processed before the start of the new iteration. For example, a flight simulator running at 60 Hz may have a difference of as much as 16.67 msec between results. This does not mean that the test has failed. Instead, the difference is attributed to variation in input processing. In some conditions, the host simulator and the visual system do not run at the same iteration rate, so the output of the host computer to the visual system will not always be synchronized.

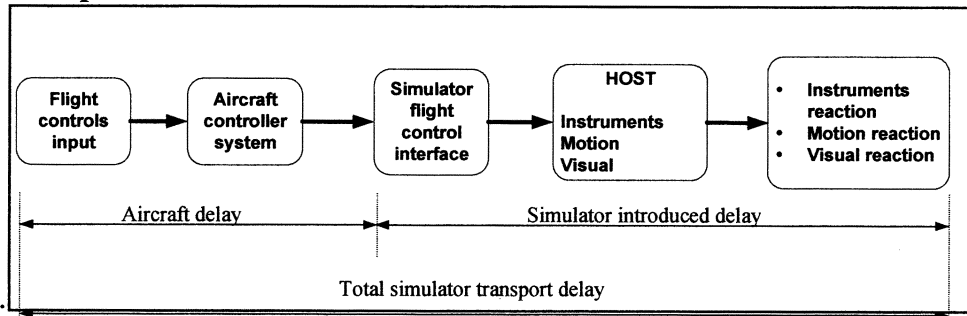
m. The transport delay test should account for both daylight and night modes of operation of the visual system. In both cases, the tolerances prescribed in Table C1A should be met and the motion response should occur before the end of the first video scan containing new information.

**BILLING CODE 4910-13-P**

**Figure C2E**  
**Transport Delay for simulation of classic non-computer controlled helicopters.**

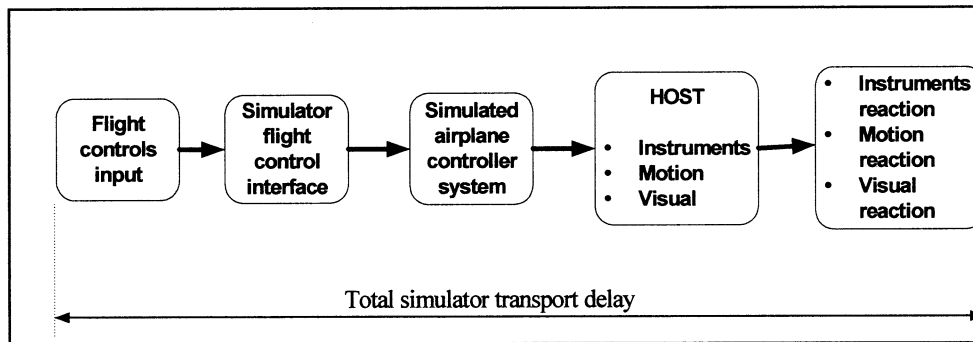


**Figure C2F**  
**Transport Delay for simulation of computer controlled helicopters using real helicopter black boxes**

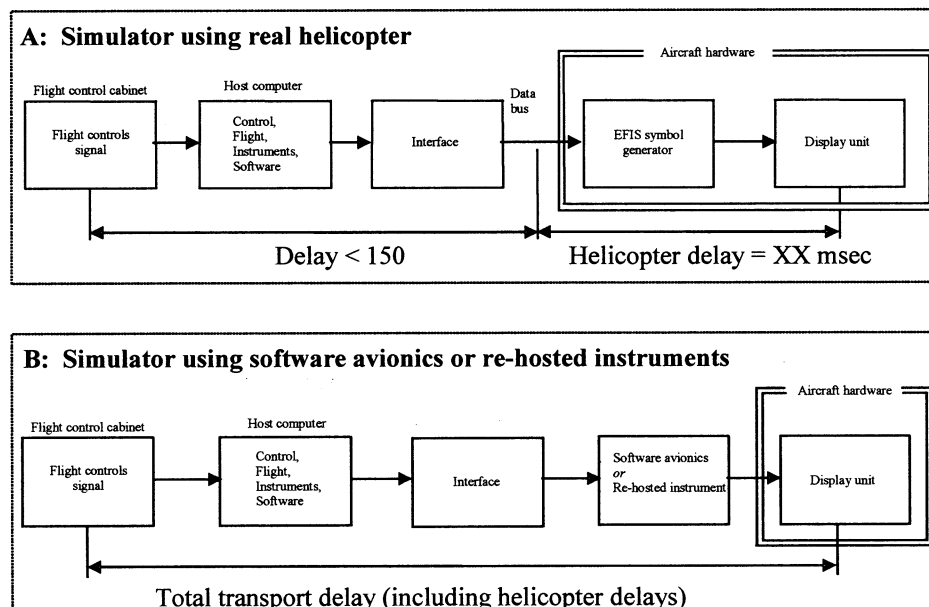




**Figure C2G**  
**Transport Delay for simulation of computer controlled helicopters using software emulation of helicopter boxes**



**Figure C2HA and C2HB**  
**Transport delay for simulation of helicopters using real or re-hosted instrument drivers**



BILLING CODE 4910-13-C

**16. Continuing Qualification Evaluations—Validation Test Data Presentation**

a. Background.

(1) The MQTG is created during the initial evaluation of a flight simulator. This is the master document, as amended, to which flight simulator continuing qualification evaluation test results are compared.

(2) The currently accepted method of presenting continuing qualification evaluation test results is to provide flight simulator results over-plotted with reference data. Test results are carefully reviewed to determine if the test is within the specified tolerances. This can be a time consuming process, particularly when reference data

exhibits rapid variations or an apparent anomaly requiring engineering judgment in the application of the tolerances. In these cases, the solution is to compare the results to the MQTG. The continuing qualification results are compared to the results in the MQTG for acceptance. The flight simulator operator and the NSPM should look for any change in the flight simulator performance since initial qualification.

b. Continuing Qualification Evaluation Test Results Presentation.

(1) Flight simulator operators are encouraged to over-plot continuing qualification validation test results with MQTG flight simulator results recorded during the initial evaluation and as amended.

Any change in a validation test will be readily apparent. In addition to plotting continuing qualification validation test and MQTG results, operators may elect to plot reference data.

(2) There are no suggested tolerances between flight simulator continuing qualification and MQTG validation test results. Investigation of any discrepancy between the MQTG and continuing qualification flight simulator performance is left to the discretion of the flight simulator operator and the NSPM.

(3) Differences between the two sets of results, other than variations attributable to repeatability issues that cannot be explained should be investigated.

(4) The flight simulator should retain the ability to over-plot both automatic and manual validation test results with reference data.

**End Information**

**Begin QPS Requirements**

**17. Alternative Data Sources, Procedures, and Instrumentation: Level B Simulators Only**

a. Sponsors are not required to use the alternative data sources, procedures, and instrumentation. However, any sponsor choosing to use alternative sources must comply with the requirements in Table C2E.

**End QPS Requirements**

**Begin Information**

b. It has become standard practice for experienced simulator manufacturers to use such techniques as a means of establishing data bases for new simulator configurations while awaiting the availability of actual flight test data. The data generated from the aerodynamic modeling techniques is then compared to the flight test data when it becomes available. The results of such comparisons have become increasingly consistent, indicating that these techniques, applied with appropriate experience, are dependable and accurate for the development of aerodynamic models for use in Level B simulators.

c. Based on this history of successful comparisons, the NSPM has concluded that those who are experienced in the

development of aerodynamic models for simulator application can successfully use these modeling techniques to alter the method for acquiring flight test data for Level B simulators.

d. The information in Table C2E (Alternative Data Sources, Procedures, and Information) is presented to describe an acceptable alternative to data sources for simulator modeling and validation and an acceptable alternative to the procedures and instrumentation traditionally used to gather such modeling and validation data.

(1) Alternative data sources that may be used for part or all of a data requirement are the Helicopter Maintenance Manual, the Rotorcraft Flight Manual (RFM), Helicopter Design Data, the Type Inspection Report (TIR), Certification Data or acceptable supplemental flight test data.

(2) The sponsor should coordinate with the NSPM prior to using alternative data sources in a flight test or data gathering effort.

e. The NSPM position on the use of these alternative data sources, procedures, and instrumentation is based on the use of a rigorously defined and fully mature simulation controls system model that includes accurate gearing and cable stretch characteristics (where applicable), determined from actual aircraft measurements. The model does not require control surface position measurements in the flight test objective data in these limited applications.

f. Data may be acquired by using an inertial measurement system and a synchronized video of the calibrated helicopter instruments, including the inclinometer; the force/position measurements of flight deck

controls; and a clear visual directional reference for a known magnetic bearing (e.g., a runway centerline). Ground track and wind corrected heading may be used for sideslip angle.

g. The sponsor is urged to contact the NSPM for clarification of any issue regarding helicopters with reversible control systems. This table is not applicable to Computer Controlled Aircraft flight simulators.

h. Use of these alternate data sources, procedures, and instrumentation does not relieve the sponsor from compliance with the balance of the information contained in this document relative to Level B FFSs.

i. The term "inertial measurement system" is used in table C2E include the use of a functional global positioning system (GPS).

j. Synchronized video for the use of alternative data sources, procedures, and instrumentation should have:

(1) sufficient resolution to allow magnification of the display to make appropriate measurement and comparisons; and

(2) sufficient size and incremental marking to allow similar measurement and comparison. The detail provided by the video should provide sufficient clarity and accuracy to measure the necessary parameter(s) to at least 1/2 of the tolerance authorized for the specific test being conducted and allow an integration of the parameter(s) in question to obtain a rate of change.

**End Information**

**TABLE C2E.—ALTERNATIVE DATA SOURCES, PROCEDURES, AND INSTRUMENTATION**

[The standards in this table are required if the data gathering methods described in paragraph 9 of Appendix C are not used.]

| QPS requirements  |              |   |                     |
|---|--------------|---|---------------------|
| Table of objective tests  | Level B only | Alternative data sources, procedures, and instrumentation   | Notes and reminders |
| Test reference number and title                                       |              |   |                     |
| 1.a.1.a. Performance. Engine Start and Accelerations.                 | X            | Data may be acquired using a synchronized video recording of all engine instruments, start buttons, means for fuel introduction and means for moving from "idle" to "flight." A stopwatch is necessary. |                     |
| 1.a.1.b. Performance. Steady State Idle and Operating RPM Conditions. | X            | Data may be acquired using a synchronized video recording of all engine instruments, and include the status of the means for moving from "idle" to "flight."  |                     |
| 1.a.2. Performance. Power Turbine Speed Trim.                         | X            | Data may be acquired using a synchronized video recording of all engine instruments. Speed trim actuator position may be hand recorded.   |                     |
| 1.a.3. Performance. Engine and Rotor Speed Governing.                 | X            | Data may be acquired by using a synchronized video of the calibrated helicopter instruments and the force/position measurements of flight deck controls.  |                     |
| 1.b.1. Performance. On Surface Taxi. Minimum Radius turn.             | X            | TIR, AFM, or Design data may be used.   |                     |

TABLE C2E.—ALTERNATIVE DATA SOURCES, PROCEDURES, AND INSTRUMENTATION—Continued  
 [The standards in this table are required if the data gathering methods described in paragraph 9 of Appendix C are not used.]

| QPS requirements   |              |   |   |
|--|--------------|---|---|
| Table of objective tests   | Level B only | Alternative data sources, procedures, and instrumentation   | Notes and reminders   |
| Test reference number and title  |              |   |   |
| 1.b.2. Performance. On Surface Taxi Rate of Turn vs. Nosewheel Steering Angle. | X            | Data may be acquired by using a constant tiller position (measured with a protractor), or full pedal application for steady state turn, and synchronized video of heading indicator. If less than full pedal is used, pedal position must be recorded.  | A single procedure may not be adequate for all rotorcraft steering systems. Appropriate measurement procedures must be devised and proposed for NSPM concurrence. |
| 1.b.3 Performance. Taxi .....  | X            | Data may be acquired by using a synchronized video of the calibrated helicopter instruments and the force/position measurements of flight deck controls.  |   |
| 1.b.4. Performance. Brake .....  | X            | Data may be acquired using a stopwatch and a means for measuring distance such as runway distance markers conforming with runway distance marker standards.   |   |
| 1.c.1. Performance. Running Takeoff ....                                       | X            | Preliminary certification data may be used. Data may be acquired by using a synchronized video of the calibrated helicopter instruments and the force/position measurements of flight deck controls. Collective, cyclic, and pedal position time history should be recorded from the start of collective movement through to normal climb. Indicated torque settings may be hand recorded at the moment of lift-off and in a steady normal climb. |   |
| 1.c.2 Performance. One Engine Inoperative (OEI), continued takeoff.            | X            | Data may be acquired by using a synchronized video of the calibrated helicopter instruments and the force/position measurements of flight deck controls. Collective, cyclic, and pedal position time history should be recorded from the start of collective movement through to normal OEI climb. Indicated torque settings may be hand recorded at the moment of lift-off and in a steady normal OEI climb.                                     |   |
| 1.f. Performance. Level Flight. Trimmed Flight Control Positions.              | X            | Data may be acquired by using a synchronized video of the calibrated helicopter instruments and the force/position measurements of flight deck controls.  |   |
| 1.g. Performance. Normal Climb. Trimmed Flight Control Positions.              | X            | Data may be acquired by using a synchronized video of the calibrated helicopter instruments and the force/position measurements of flight deck controls.  |   |
| 1.h.1. Descent Performance and Trimmed Flight Control Positions.               | X            | Data may be acquired by using a synchronized video of the calibrated helicopter instruments and the force/position measurements of flight deck controls.  |   |
| 1.h.2. Autorotation Performance and Trimmed Flight Control Positions.          | X            | Data may be acquired by using a synchronized video of the calibrated helicopter instruments and the force/position measurements of flight deck controls.  |   |
| 1.j.1. Performance. Running Landing All Engines.                               | X            | Data may be acquired by using a synchronized video of the calibrated helicopter instruments and the force/position measurements of flight deck controls.  |   |

TABLE C2E.—ALTERNATIVE DATA SOURCES, PROCEDURES, AND INSTRUMENTATION—Continued  
 [The standards in this table are required if the data gathering methods described in paragraph 9 of Appendix C are not used.]

| QPS requirements  |              |   |                     |
|---|--------------|---|---------------------|
| Table of objective tests  | Level B only | Alternative data sources, procedures, and instrumentation   | Notes and reminders |
| Test reference number and title   |              |   |                     |
| 1.j.2. Performance. Running Landing One Engine Inoperative.                             | X            | Data may be acquired by using a synchronized video of the calibrated helicopter instruments and the force/position measurements of flight deck controls.  |                     |
| 1.j.3. Performance. Balked Landing .....  | X            | Data may be acquired by using a synchronized video of the calibrated helicopter instruments and the force/position measurements of flight deck controls. The synchronized video must record the time of the "balk landing" decision.      |                     |
| 2.a.1. Handling Qualities. Static Control Checks. Cyclic Controller Position vs. Force. | X            | Control positions can be obtained using continuous control position recordings. Force data may be acquired by using a hand held force gauge so that the forces can be cross-plotted against control position in each of the control axes. |                     |
| 2.a.2. Handling Qualities. Static Control Checks. Collective/Pedals vs. Force.          | X            | Control positions can be obtained using continuous control position recordings. Force data may be acquired by using a hand held force gauge so that the forces can be cross-plotted against control position in each of the control axes. |                     |
| 2.a.3. Handling Qualities. Brake Pedal Force vs. Position.                              | X            | Brake pedal positions can be obtained using continuous position recordings. Force data may be acquired by using a hand held force gauge so that the forces can be cross-plotted against brake pedal position.                             |                     |
| 2.a.4. Handling Qualities. Trim System Rate (all applicable systems).                   | X            | Control positions can be obtained using continuous control position recordings plotted against time to provide rate in each applicable system.  |                     |
| 2.a.6. Handling Qualities. Control System Freeplay.                                     | X            | Data may be acquired by direct measurement.   |                     |
| 2.c.1. Longitudinal Handling qualities. Control Response.                               | X            | Data may be acquired by using an inertial measurement system, a synchronized video of the calibrated helicopter instruments and the force/position measurements of flight deck controls.  |                     |
| 2.c.2. Longitudinal Handling qualities. Static Stability.                               | X            | Data may be acquired by using an inertial measurement system, a synchronized video of the calibrated helicopter instruments and the force/position measurements of flight deck controls.  |                     |
| 2.c.3.a Longitudinal Handling qualities. Dynamic Stability, Long Term Response.         | X            | Data may be acquired by using an inertial measurement system, a synchronized video of the calibrated helicopter instruments and the force/position measurements of flight deck controls.  |                     |
| 2.c.3.b. Longitudinal Handling qualities. Dynamic Stability, Short Term Response.       | X            | Data may be acquired by using an inertial measurement system, a synchronized video of the calibrated helicopter instruments and the force/position measurements of flight deck controls.  |                     |

TABLE C2E.—ALTERNATIVE DATA SOURCES, PROCEDURES, AND INSTRUMENTATION—Continued  
 [The standards in this table are required if the data gathering methods described in paragraph 9 of Appendix C are not used.]

| QPS requirements   |              |  |                     |
|--|--------------|--|---------------------|
| Table of objective tests   | Level B only | Alternative data sources, procedures, and instrumentation  | Notes and reminders |
| Test reference number and title  |              |  |                     |
| 2.c.4. Longitudinal Handling qualities. Maneuvering stability.   | X            | Data may be acquired by using an inertial measurement system, a synchronized video of the calibrated helicopter instruments and the force/position measurements of flight deck controls.                   |                     |
| 2.d.1.a Lateral Handling qualities. Control Response.  | X            | Data may be acquired by using an inertial measurement system, a synchronized video of the calibrated helicopter instruments and the force/position measurements of flight deck controls.                   |                     |
| 2.d.1.b Directional Handling qualities. Control response.  | X            | Data may be acquired by using an inertial measurement system and a synchronized video of calibrated helicopter instruments and force/position measurements of flight deck directional controls.            |                     |
| 2.d.2. Handling qualities. Directional Static Stability.   | X            | Data may be acquired by using an inertial measurement system and a synchronized video of calibrated helicopter instruments and force/position measurements of flight deck directional controls.            |                     |
| 2.d.3.a Handling qualities Dynamic Lateral and Directional Stability Lateral-Directional Oscillations. | X            | Data may be acquired by using an inertial measurement system and a synchronized video of the calibrated helicopter instruments, the force/position measurements of flight deck controls, and a stop watch. |                     |
| 2.d.3.b. Handling qualities Dynamic Lateral and Directional Stability Spiral Stability.                | X            | Data may be acquired by using an inertial measurement system and a synchronized video of the calibrated helicopter instruments, the force/position measurements of flight deck controls, and a stop watch. |                     |
| 2.d.3.c Handling qualities. Dynamic Lateral and Directional Stability. Adverse/Proverse Yaw.           | X            | Data may be acquired by using an inertial measurement system and a synchronized video of the calibrated helicopter instruments, the force/position measurements of flight deck controls.                   |                     |

## Begin Information

### 18. Visual Display Systems

a. Basic principles of an FSTD collimated display:

(1) The essential feature of a collimated display is that light rays coming from a given point in a picture are parallel. There are two main implications of the parallel rays:

(a) The viewer's eyes focus at infinity and have zero convergence, providing a cue that the object is distant; and

(b) The angle to any given point in the picture does not change when viewed from a different position so the object behaves geometrically as though it were located at a significant distance from the viewer. These cues are self-consistent, and are appropriate for any object that has been modelled as being at a significant distance from the viewer.

(2) In an ideal situation the rays are perfectly parallel, but most implementations provide only an approximation to the ideal. Typically, an FSTD display provides an image located not closer than about 20–33 ft (6–10 m) from the viewer, with the distance varying over the field of view. A schematic representation of a collimated display is provided in Figure C2A.

(3) Collimated displays are well suited to many simulation applications as the area of interest is relatively distant from the observer so the angles to objects should remain independent of viewing position. Consider the view of the runway seen by the flight crew lined up on an approach. In the real world, the runway is distant and the light rays from the runway to the eyes are parallel. The runway appears to be straight ahead to both crew members. This situation is well simulated by a collimated display and is presented in Figure C2B. Note that the distance to the runway has been shortened

for clarity. If drawn to scale, the runway would be farther away and the rays from the two seats would be closer to being parallel.

(4) While the horizontal field of view of a collimated display can be extended to approximately 210°–220°, the vertical field of view has been limited to about 40°–45°. These limitations result from tradeoffs in optical quality and interference between the display components and flight deck structures, but were sufficient to meet FSTD regulatory approval for Helicopter FSTDs. However, recent designs have been introduced with vertical fields of view of up to 60° for helicopter applications.

b. Basic principles of an FSTD dome (or non-collimated) display:

(1) The situation in a dome display is shown in Figure C2C. As the angles can be correct for only one eye point at a time, the visual system in the figure has been aligned for the right seat eye point position. The runway appears to be straight ahead of the

aircraft for this viewer. For the left seat viewer, however, the runway appears to be somewhat to the right of the aircraft. As the aircraft is still moving towards the runway, the perceived velocity vector will be directed towards the runway and this will be interpreted as the aircraft having some yaw offset.

(2) The situation is substantially different for near field objects encountered in helicopter operations close to the ground. In those cases, objects that should be interpreted as being close to the viewer will be misinterpreted as being distant in a collimated display. The errors can actually be reduced in a dome display.

(3) The field of view possible with a dome display can be larger than that of a collimated display. Depending on the configuration, a field of view of 240° by 90° is possible and can be exceeded.

c. Additional display considerations

(1) While the situations described above are for discrete viewing positions, the same arguments can be extended to moving eye points produced by the viewer's head movement. In the real world, the parallax effects resulting from head movement provide distance cues. The effect is particularly strong for relative movement of flight deck structure in the near field and modelled objects in the distance. Collimated displays will provide accurate parallax cues for distant objects, but increasingly inaccurate cues for near field objects. The situation is reversed for dome displays.

(2) Stereopsis cues resulting from the different images presented to each eye for objects relatively close to the viewer also provide depth cues. Again, the collimated and dome displays provide more or less

accurate cues depending on the modelled distance of the objects being viewed.

d. Training implications

(1) In view of the basic principles described above, it is clear that neither display approach provides a completely accurate image for all possible object distances. The sponsor should consider the training role of the FSTD when configuring the display system to make the optimum choice. Factors that should be considered include relative importance of training tasks at low altitudes, the role of the two crew members in the flying tasks, and the field of view required for specific training tasks.

**BILLING CODE 4910-13-P**

---

**End Information**

## Plan Views of Collimated and Dome (or Non-collimated) Visual Display Systems

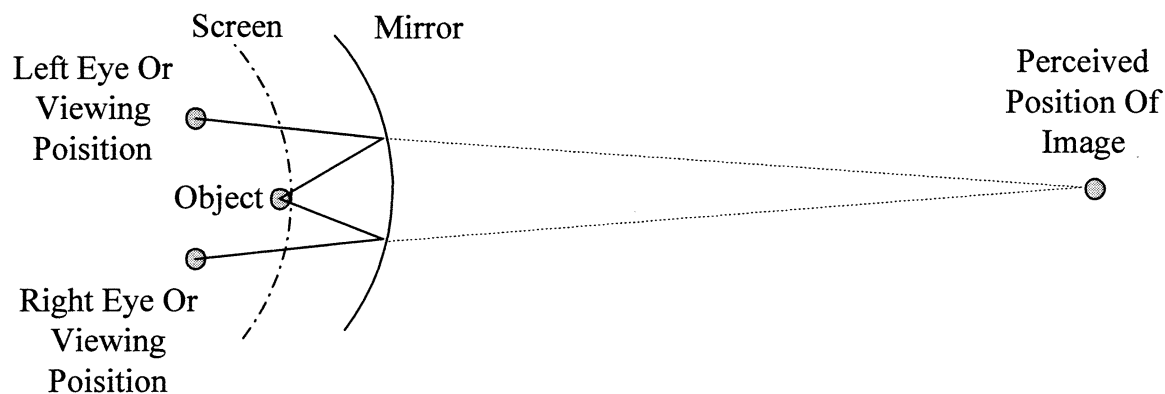


Figure C2I - Collimated display

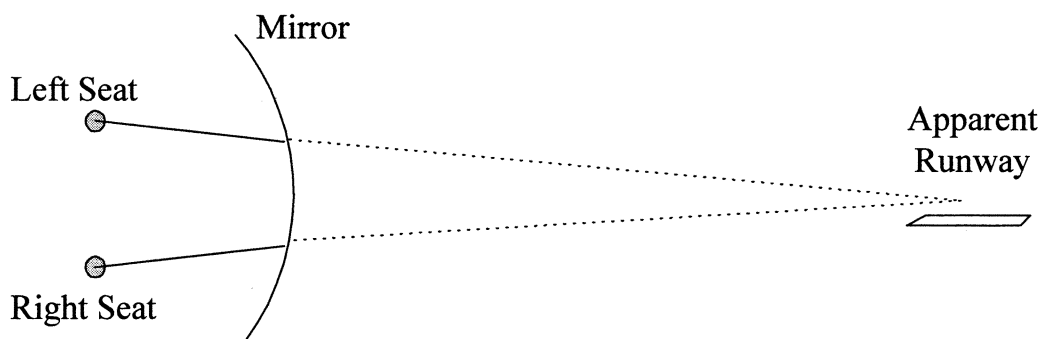


Figure C2J - Runway view in a collimated display

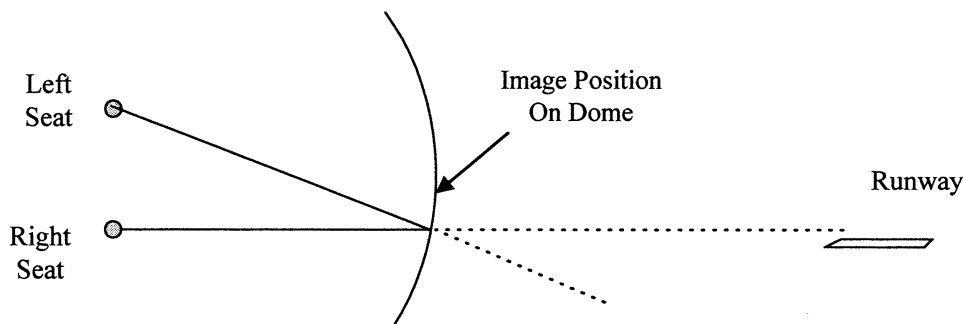


Figure C2K - Runway view in a dome display

BILLING CODE 4910-13-C

### Attachment 3 to Appendix C to Part 60— Simulator Subjective Evaluation

#### Begin QPS Requirements

##### 1. Requirements

a. Except for special use visual scenes and airport models described below, all visual scenes and airport models required by this part must be representations of real-world,

operational airports or representations of fictional airports and must meet the requirements set out in Tables C3B and C3C of this attachment, as appropriate.

b. If fictional airports are used, the sponsor must ensure that navigational aids and all appropriate maps, charts, and other navigational reference material for the fictional airports (and surrounding areas as necessary) are compatible, complete, and accurate with respect to the visual presentation and scene content of the visual

model of this fictional airport. An SOC must be submitted that addresses navigation aid installation and performance and other criteria (including obstruction clearance protection) for all instrument approaches to the fictional airports that are available in the simulator. The SOC must reference and account for information in the terminal instrument procedures manual and the construction and availability of the required maps, charts, and other navigational material.

This material must be clearly marked “for training purposes only.”

c. When the simulator is being used by an instructor or evaluator for purposes of training, checking, or testing under this chapter, only visual scenes and airport models classified as Class I, Class II, or Class III may be available to the instructor or evaluator. The classifications are as follows:

(1) Class I (whether modeling real world airports or fictional airports), for those visual scenes and airport models used for simulator qualification at a specified level. These visual scenes and airport models must meet the minimum requirements in Table C3B of this attachment, be evaluated by the NSPM, be listed on the Statement of Qualification (SOQ), and be available for use at the simulator IOS.

(2) Class II (whether modeling real world airports or fictional airports), for those visual scenes and airport models that are in excess of those used for simulator qualification at a specified level. These visual scenes and airport models must meet the minimum requirements set out in Table C3C of this attachment. These visual scenes and airport models may be made available on the simulator IOS without further involvement of the NSPM or the TPAA.

(3) For an interim period (ending 2 years after the publication of the final rule in the **Federal Register**), Class III visual scenes and airport models (whether modeling real world airports, generic airports, or fictional airports) may be approved for specific purposes by the TPAA or a foreign regulatory authority for a foreign user of the device. Examples of approved activities include specific airport or runway qualification, very low visibility operations training, including Surface Movement Guidance System (SMGS) operations, or use of a specific airport visual model aligned with an instrument procedure for another airport for instrument training. At the end of the interim period, all Class III visual scenes and airport models must be classified as either a Class I or a Class II visual scene or airport model or be removed from availability at the simulator IOS. However, Class III visual scenes and airport models may continue to be used after the end of the interim period if they are part of a training program specifically approved by the TPAA or other regulatory authority that uses a task and capability analysis as the basis for approval of this specific media element, (i.e., the specific scene or model selected for use in that program).

d. When a person sponsors an FSTD maintained by a person other than a U.S. certificate holder, the sponsor is accountable for that FSTD originally meeting, and continuing to meet, the criteria under which it was originally qualified and the appropriate part 60 criteria, including the visual scenes and airport models that may be used by instructors or evaluators for purposes of training, checking, or testing under this chapter.

e. Neither Class II nor Class III airport visual models are required to appear on the SOQ. However, the sponsor is accountable that the FSTD originally meets, and continues to meet, the visual scene and airport model requirements for Class II or

Class III visual scenes and airport models that may be used by instructors or evaluators for training, checking, or testing under this chapter.

f. When the visual scenes and airport models represent real world airports and a permanent change is made to that real world airport (e.g., a new runway, an extended taxiway, a new lighting system, a runway closure) without a written extension grant from the NSPM (described below), an update to that visual scene or airport model must be made in accordance with the following time limits:

(1) For a new airport runway, a runway extension, a new airport taxiway, a taxiway extension, or a runway/taxiway closure—within 60 days of the opening for use of the new airport runway, runway extension, new airport taxiway, or taxiway extension; or within 60 days of the closure of the runway or taxiway.

(2) For a new or modified approach light system—within 30 days of the activation of the new or modified approach light system.

(3) For other facility or structural changes on the airport (e.g., new terminal, relocation of Air Traffic Control Tower)—within 6 months of the opening of the new or changed facility or structure.

g. If a sponsor desires an extension to the time limit for an update to a visual scene or airport model, the sponsor must provide a written extension request to the POI/TCPM stating the reason for the update delay and a proposed completion date. A copy of this request must also be sent to the NSPM. The sponsor will forward a copy of the POI/TCPM's response to the NSPM. If the POI/TCPM has granted an extension, the NSPM will issue an extension authorization, not to exceed an additional 12 months.

#### End QPS Requirements

#### Begin Information

#### 2. Discussion

a. The subjective tests provide a basis for evaluating the capability of the simulator to perform over a typical utilization period; determining that the simulator competently simulates each required maneuver, procedure, or task; and verifying correct operation of the simulator controls, instruments, and systems. The items listed in the following Tables are for simulator evaluation purposes only. They may not be used to limit or exceed the authorizations for use of a given level of simulator as described on the Statement of Qualification or as may be approved by the TPAA. All items in the following paragraphs are subject to an examination.

b. The tests in Table C3A, Operations Tasks, in this attachment address pilot functions, including maneuvers and procedures (called flight tasks), and are divided by flight phases. The performance of these tasks by the NSPM includes an operational examination of the visual system and special effects. There are flight tasks included to address some features of advanced technology helicopters and innovative training programs.

c. The tests in Table C3A, Operations Tasks, and Table C3G, Instructor Operating

Station, in this attachment address the overall function and control of the simulator including the various simulated environmental conditions; simulated helicopter system operation (normal, abnormal, and emergency); visual system displays; and special effects necessary to meet flight crew training, evaluation, or flight experience requirements.

d. All simulated helicopter systems functions will be assessed for normal and, where appropriate, alternate operations. Normal, abnormal, and emergency operations associated with a flight phase will be assessed during the evaluation of flight tasks or events within that flight phase. Simulated helicopter systems are listed separately under “Any Flight Phase” to ensure appropriate attention to systems checks. Operational navigation systems (including inertial navigation systems, global positioning systems, or other long-range systems) and the associated electronic display systems will be evaluated if installed. The NSP pilot will include in his report to the TPAA, the effect of the system operation and any system limitation.

e. Simulators demonstrating a satisfactory circling approach will be qualified for the circling approach maneuver and may be approved for such use by the TPAA in the sponsor's FAA-approved flight training program. To be considered satisfactory, the circling approach will be flown at maximum gross weight for landing, with minimum visibility for the helicopter approach category, and must allow proper alignment with a landing runway at least 90° different from the instrument approach course while allowing the pilot to keep an identifiable portion of the airport in sight throughout the maneuver (reference—14 CFR 91.175(e)).

f. At the request of the TPAA, the NSP Pilot may assess the simulator for a special aspect of a sponsor's training program during the functions and subjective portion of an evaluation. Such an assessment may include a portion of a Line Oriented Flight Training (LOFT) scenario or special emphasis items in the sponsor's training program. Unless directly related to a requirement for the qualification level, the results of such an evaluation would not affect the qualification of the simulator.

g. This appendix addresses helicopter simulators at Levels B, C, and D because there are no Level A Helicopter simulators.

h. The FAA intends to allow the use of Class III visual scenes and airport models on a limited basis when the sponsor provides the TPAA (or other regulatory authority) an appropriate analysis of the skills, knowledge, and abilities (SKAs) necessary for competent performance of the tasks in which this particular media element is used. The analysis should describe the ability of the FSTD/visual media to provide an adequate environment in which the required SKAs may be satisfactorily performed and learned. The analysis should also include the specific media element, such as the visual scene or airport model. Additional sources of information on the conduct of task and capability analysis may be found on the FAA's Advanced Qualification Program (AQP) Web site at: [http://www.faa.gov/education\\_research/training/aqp/](http://www.faa.gov/education_research/training/aqp/).



i. Previously qualified simulators with certain early generation Computer Generated Image (CGI) visual systems, are limited by the capability of the Image Generator or the display system used. These systems are:

- (1) Early CGI visual systems that are exempt from the necessity of including runway numbers as a part of the specific runway marking requirements are:
  - (a) Link NVS and DNVS.
  - (b) Novoview 2500 and 6000.
  - (c) FlightSafety VITAL series up to, and including, VITAL III, but not beyond.
  - (d) Rediffusion SP1, SP1T, and SP2.

(2) Early CGI visual systems are excepted from the necessity of including runway numbers unless the runways used for LOFT training sessions. These LOFT airport models require runway numbers, but only for the specific runway end (one direction) used in the LOFT session. The systems required to display runway numbers only for LOFT scenes are:

- (a) FlightSafety VITAL IV.
- (b) Rediffusion SP3 and SP3T.
- (c) Link-Miles Image II.
- (3) The following list of previously qualified CGI and display systems are

incapable of generating blue lights. These systems are not required to have accurate taxi-way edge lighting are:

- (a) Rediffusion SP1 and SP1T.
- (b) FlightSafety Vital IV.
- (c) Link-Miles Image II and Image IIT
- (d) XKD displays (even though the XKD image generator is capable of generating blue colored lights, the display cannot accommodate that color).

**End Information**

TABLE C3A.—FUNCTIONS AND SUBJECTIVE TESTS

| <<<QPS requirements>>> |                  |                 |   |   |
|------------------------|------------------|-----------------|---|---|
| Number                 | Operations tasks | Simulator level |   |   |
|                        |                  | B               | C | D |

Tasks in this table are subject to evaluation if appropriate for the airplane simulated as indicated in the SOQ Configuration List or the level of simulator qualification involved. Items not installed or not functional on the simulator and, therefore, not appearing on the SOQ Configuration List, are not required to be listed as exceptions on the SOQ.

**1. Preparation for Flight**

|           |   |   |   |   |
|-----------|---|---|---|---|
| 1.a. .... | Flight deck check: switches, indicators, systems, and equipment ..... | X | X | X |
|-----------|---|---|---|---|

**2. APU/Engine start and run-up**

|           |   |   |   |   |
|-----------|---|---|---|---|
| 2.a. .... | Normal start procedures .....                                     | X | X | X |
| 2.b. .... | Alternate start procedures .....                                  | X | X | X |
| 2.c. .... | Abnormal starts and shutdowns (e.g., hot start, hung start) ..... | X | X | X |
| 2.d. .... | Rotor engagement .....  | X | X | X |
| 2.e. .... | System checks .....   | X | X | X |

**3. Taxiing—Ground**

|             |   |   |   |   |
|-------------|---|---|---|---|
| 3.a. ....   | Power required to taxi .....                          | X | X | X |
| 3.b. ....   | Brake effectiveness .....                             | X | X | X |
| 3.c. ....   | Ground handling .....                                 | X | X | X |
| 3.d. ....   | Water handling (if applicable) .....                  |   | X | X |
| 3.e. ....   | Abnormal/emergency procedures:                        |   |   |   |
| 3.e.1. .... | Brake system failure .....                            | X | X | X |
| 3.e.2. .... | Ground resonance .....                                |   | X | X |
| 3.e.3. .... | Dynamic rollover .....                                |   | X | X |
| 3.e.4. .... | Deployment of emergency floats/water landing .....    |   | X | X |
| 3.e.5. .... | Others listed on the Statement of Qualification ..... | A | X | X |

**4. Taxiing—Hover**

|             |                          |   |   |   |
|-------------|--------------------------|---|---|---|
| 4.a. ....   | Takeoff to a hover ..... | X | X | X |
| 4.b. ....   | Instrument response:     |   |   |   |
| 4.b.1. .... | Engine instruments ..... | X | X | X |
| 4.b.2. .... | Flight instruments ..... | X | X | X |
| 4.b.3. .... | Hovering turns .....     | X | X | X |

TABLE C3A.—FUNCTIONS AND SUBJECTIVE TESTS—Continued

| <<<QPS requirements>>>                 |   |                 |   |   |
|--|---|-----------------|---|---|
| Number                                 | Operations tasks                                      | Simulator level |   |   |
|  |   | B               | C | D |
| 4.c. ....                              | Hover power checks:                                   |                 |   |   |
| 4.c.1. ....                            | In ground effect (IGE) .....                          | X               | X | X |
| 4.c.2. ....                            | Out of ground effect (OGE) .....                      | X               | X | X |
| 4.d. ....                              | Crosswind/tailwind hover .....                        | X               | X | X |
| 4.e. ....                              | Translating tendency .....                            | X               | X | X |
| 4.f. ....                              | External load operations:                             |                 |   |   |
| 4.f.1. ....                            | Hookup .....  |                 | X | X |
| 4.f.2. ....                            | Release .....   |                 | X | X |
| 4.f.3. ....                            | Winch operations .....                                |                 | X | X |
| 4.g. ....                              | Abnormal/emergency procedures:                        |                 |   |   |
| 4.g.1. ....                            | Engine failure .....                                  | X               | X | X |
| 4.g.2. ....                            | Fuel governing system failure .....                   | X               | X | X |
| 4.g.3. ....                            | Settling with power (OGE) .....                       | X               | X | X |
| 4.g.4. ....                            | Hovering autorotation .....                           |                 | X | X |
| 4.g.5. ....                            | Stability augmentation system failure .....           | X               | X | X |
| 4.g.6. ....                            | Directional control malfunction .....                 | X               | X | X |
| 4.g.7. ....                            | Loss of tail rotor effectiveness (LTE) .....          |                 | X | X |
| 4.g.8. ....                            | Others listed on the Statement of Qualification ..... | A               | X | X |
| 4.h. ....                              | Pre-takeoff checks .....                              | X               | X | X |
| <b>5. Takeoff/Translational Flight</b> |   |                 |   |   |
| 5.a. ....                              | Forward (up to effective translational lift) .....    |                 | X | X |
| 5.b. ....                              | Sideward (up to limiting airspeed) .....              |                 | X | X |
| 5.c. ....                              | Rearward (up to limiting airspeed) .....              |                 | X | X |
| <b>6. Takeoff and Departure Phase</b>  |   |                 |   |   |
| 6.a. ....                              | Normal .....  | X               | X | X |
| 6.a.1. ....                            | From ground .....                                     | X               | X | X |
| 6.a.2. ....                            | From hover .....                                      | X               | X | X |
| 6.a.2.a. ....                          | Cat A .....   | X               | X | X |
| 6.a.2.b. ....                          | Cat B .....   | X               | X | X |
| 6.a.3. ....                            | Running .....   | X               | X | X |
| 6.a.4. ....                            | Crosswind/tailwind .....                              | X               | X | X |
| 6.a.5. ....                            | Maximum performance .....                             | X               | X | X |
| 6.a.6. ....                            | Instrument .....                                      | X               | X | X |
| 6.a.7. ....                            | Takeoff from a confined area .....                    | X               | X | X |
| 6.a.8. ....                            | Takeoff from a pinnacle/platform .....                | X               | X | X |

TABLE C3A.—FUNCTIONS AND SUBJECTIVE TESTS—Continued

| <<<QPS requirements>>> |   |                 |   |   |
|------------------------|---|-----------------|---|---|
| Number                 | Operations tasks  | Simulator level |   |   |
|                        |   | B               | C | D |
| 6.a.9. ....            | Takeoff from a slope .....  | X               | X | X |
| 6.a.10. ....           | External load operations .....  |                 | X | X |
| 6.b. ....              | Abnormal/emergency procedures .....                                   | X               | X | X |
| 6.b.1. ....            | Takeoff with engine failure after critical decision point (CDP) ..... | X               | X | X |
| 6.b.1.a. ....          | Cat A .....   |                 | X | X |
| 6.b.1.b. ....          | Cat B .....   |                 | X | X |
| 6.c. ....              | Rejected takeoff:   |                 |   |   |
| 6.c.1. ....            | Land .....  | X               | X | X |
| 6.c.2. ....            | Water (if appropriate) .....  | X               | X | X |
| 6.d. ....              | Instrument departure .....  | X               | X | X |
| 6.e. ....              | Others as listed on the Statement of Qualification .....              | A               | X | X |
| <b>7. Climb</b>        |   |                 |   |   |
| 7.a. ....              | Normal .....  | X               | X | X |
| 7.b. ....              | Obstacle clearance .....  | X               | X | X |
| 7.c. ....              | Vertical .....  |                 | X | X |
| 7.d. ....              | One engine inoperative .....  | X               | X | X |
| 7.e. ....              | Others as listed on the Statement of Qualification .....              | A               | X | X |
| <b>8. Cruise</b>       |   |                 |   |   |
| 8.a. ....              | Performance .....   | X               | X | X |
| 8.b. ....              | Flying qualities .....  | X               | X | X |
| 8.c. ....              | Turns .....   | X               | X | X |
| 8.c.1. ....            | Timed .....   | X               | X | X |
| 8.c.2. ....            | Normal .....  | X               | X | X |
| 8.c.3. ....            | Steep .....   | X               | X | X |
| 8.d. ....              | Accelerations and decelerations .....                                 | X               | X | X |
| 8.e. ....              | High speed vibrations .....   | X               | X | X |
| 8.f. ....              | (Reserved)  |                 |   |   |
| 8.g. ....              | Abnormal/emergency procedures .....                                   | X               | X | X |
| 8.g.1. ....            | Engine fire .....   | X               | X | X |
| 8.g.2. ....            | Engine failure .....  | X               | X | X |
| 8.g.3. ....            | Inflight engine shutdown and restart .....                            | X               | X | X |
| 8.g.4. ....            | Fuel governing system failures .....                                  | X               | X | X |
| 8.g.5. ....            | Directional control malfunction .....                                 | X               | X | X |
| 8.g.6. ....            | Hydraulic failure .....   | X               | X | X |
| 8.g.7. ....            | Stability system failure .....  | X               | X | X |

TABLE C3A.—FUNCTIONS AND SUBJECTIVE TESTS—Continued

| <<<QPS requirements>>> |   |                 |   |   |
|------------------------|---|-----------------|---|---|
| Number                 | Operations tasks  | Simulator level |   |   |
|                        |   | B               | C | D |
| 8.g.8. ....            | Rotor vibrations .....                                    | X               | X | X |
| 8.g.9. ....            | Recovery from unusual altitudes .....                     | X               | X | X |
| <b>9. Descent</b>      |   |                 |   |   |
| 9.a. ....              | Normal .....  | X               | X | X |
| 9.b. ....              | Maximum rate .....  | X               | X | X |
| 9.c. ....              | Autorotative:   |                 |   |   |
| 9.c.1. ....            | Straight-in .....   | X               | X | X |
| 9.c.2. ....            | With turn .....   | X               | X | X |
| 9.d. ....              | External Load .....                                       |                 | X | X |
| <b>10. Approach</b>    |   |                 |   |   |
| 10.a. ....             | Non-precision .....                                       | X               | X | X |
| 10.a.1. ....           | All engines operating .....                               | X               | X | X |
| 10.a.2. ....           | One or more engines inoperative .....                     | X               | X | X |
| 10.a.3. ....           | Approach procedures .....                                 | X               | X | X |
| 10.a.3.a. ....         | NDB .....   | X               | X | X |
| 10.a.3.b. ....         | VOR, RNAV, TACAN .....                                    | X               | X | X |
| 10.a.3.c. ....         | ASR .....   | X               | X | X |
| 10.a.3.d. ....         | Circling .....  | X               | X | X |
| 10.a.3.e. ....         | Helicopter only .....                                     | X               | X | X |
| 10.a.4. ....           | Missed approach .....                                     | X               | X | X |
| 10.a.4.a. ....         | All engines operating .....                               | X               | X | X |
| 10.a.4.b. ....         | One or more engines inoperative .....                     | X               | X | X |
| 10.b. ....             | Precision .....   | X               | X | X |
| 10.b.1. ....           | All engines operating .....                               | X               | X | X |
| 10.b.2. ....           | Manually controlled—one or more engines inoperative ..... | X               | X | X |
| 10.b.3. ....           | Approach procedures .....                                 | X               | X | X |
| 10.b.3.a. ....         | PAR .....   | X               | X | X |
| 10.b.3.b. ....         | MLS .....   | X               | X | X |
| 10.b.3.c. ....         | ILS .....   | X               | X | X |
| 10.b.3.c. ....         | (1) Manual (raw data) .....                               | X               | X | X |
| 10.b.3.c. ....         | (2) Flight director only .....                            | X               | X | X |
| 10.b.3.c. ....         | Autopilot*only .....                                      | X               | X | X |
| 10.b.3.c. ....         | Cat I .....   | X               | X | X |
| 10.b.3.c. ....         | Cat II .....  | X               | X | X |
| 10.b.4. ....           | Missed approach:  |                 |   |   |

TABLE C3A.—FUNCTIONS AND SUBJECTIVE TESTS—Continued

| <<<QPS requirements>>>                         |  |                 |   |   |
|--|--|-----------------|---|---|
| Number   | Operations tasks   | Simulator level |   |   |
|  |  | B               | C | D |
| 10.b.4.a. ....                                 | All engines operating .....                              | X               | X | X |
| 10.b.4.b. ....                                 | One or more engines inoperative .....                    | X               | X | X |
| 10.b.4.c. ....                                 | Stability system failure .....                           | X               | X | X |
| 10.c. ....                                     | Others as listed on the Statement of Qualification ..... | A               | X | X |
| <b>11. Landings and Approaches to Landings</b> |  |                 |   |   |
| 11.a. ....                                     | Visual approaches:                                       |                 |   |   |
| 11.a.1. ....                                   | Normal .....   | X               | X | X |
| 11.a.2. ....                                   | Steep .....  | X               | X | X |
| 11.a.3. ....                                   | Shallow .....  | X               | X | X |
| 11.a.4. ....                                   | Crosswind .....  | X               | X | X |
| 11.a.5. ....                                   | Category A profile .....                                 |                 | X | X |
| 11.a.6. ....                                   | Category B profile .....                                 |                 | X | X |
| 11.a.7. ....                                   | External Load .....                                      |                 | X | X |
| 11.b. ....                                     | Abnormal/emergency procedures:                           |                 |   |   |
| 11.b.1. ....                                   | Directional control failure .....                        | X               | X | X |
| 11.b.2. ....                                   | Hydraulics failure .....                                 | X               | X | X |
| 11.b.3. ....                                   | Fuel governing failure .....                             | X               | X | X |
| 11.b.4. ....                                   | Autorotation .....                                       | X               | X | X |
| 11.b.5. ....                                   | Stability system failure .....                           | X               | X | X |
| 11.b.6. ....                                   | Others listed on the Statement of Qualification .....    | A               | X | X |
| 11.c. ....                                     | Landings:  |                 |   |   |
| 11.c.1. ....                                   | Normal .....   | X               | X | X |
| 11.c.1.a. ....                                 | Running .....  | X               | X | X |
| 11.c.1.b. ....                                 | From Hover .....   | X               | X | X |
| 11.c.2. ....                                   | Pinnacle/platform .....                                  | X               | X | X |
| 11.c.3. ....                                   | Confined area .....                                      | X               | X | X |
| 11.c.4. ....                                   | Slope .....  |                 | X | X |
| 11.c.5. ....                                   | Crosswind .....  | X               | X | X |
| 11.c.6. ....                                   | Tailwind .....   | X               | X | X |
| 11.c.7. ....                                   | Rejected Landing .....                                   | X               | X | X |
| 11.c.8. ....                                   | Abnormal/emergency procedures:                           |                 |   |   |
| 11.c.8.a. ....                                 | From autorotation .....                                  |                 | X | X |
| 11.c.8. ....                                   | One or more engines inoperative .....                    | X               | X | X |
| 11.c.8. ....                                   | Directional control failure .....                        | X               | X | X |
| 11.c.8. ....                                   | Hydraulics failure .....                                 | X               | X | X |

TABLE C3A.—FUNCTIONS AND SUBJECTIVE TESTS—Continued

| <<<QPS requirements>>>      |  |                 |   |   |
|-----------------------------|--|-----------------|---|---|
| Number                      | Operations tasks   | Simulator level |   |   |
|                             |  | B               | C | D |
| 11.c.8. ....                | Stability augmentation system failure .....                      | X               | X | X |
| 11.c.8. ....                | Other (as may be listed on the Statement of Qualification) ..... | A               | X | X |
| <b>12. Any Flight Phase</b> |  |                 |   |   |
| 12.a.1. ....                | Air conditioning .....   | X               | X | X |
| 12.a.2. ....                | Anti-icing/deicing .....   | X               | X | X |
| 12.a.3. ....                | Auxiliary power-plant .....                                      | X               | X | X |
| 12.a.4. ....                | Communications .....   | X               | X | X |
| 12.a.5. ....                | Electrical .....   | X               | X | X |
| 12.a.6. ....                | Fire detection and suppression .....                             | X               | X | X |
| 12.a.7. ....                | Stabilizer .....   | X               | X | X |
| 12.a.8. ....                | Flight controls .....  | X               | X | X |
| 12.a.9. ....                | Fuel and oil .....   | X               | X | X |
| 12.a.10. ....               | Hydraulic .....  | X               | X | X |
| 12.a.11. ....               | Landing gear .....   | X               | X | X |
| 12.a.12. ....               | Oxygen .....   | X               | X | X |
| 12.a.13. ....               | Pneumatic .....  | X               | X | X |
| 12.a.14. ....               | Powerplant .....   | X               | X | X |
| 12.a.15. ....               | Flight control computers .....                                   | X               | X | X |
| 12.a.16. ....               | Stability and control augmentation .....                         | X               | X | X |
| 12.b. ....                  | Flight management and guidance system:                           |                 |   |   |
| 12.b.1. ....                | Airborne radar .....   | X               | X | X |
| 12.b.2. ....                | Automatic landing aids .....                                     | X               | X | X |
| 12.b.3. ....                | Autopilot .....  | X               | X | X |
| 12.b.4. ....                | Collision avoidance system .....                                 | X               | X | X |
| 12.b.5. ....                | Flight data displays .....                                       | X               | X | X |
| 12.b.6. ....                | Flight management computers .....                                | X               | X | X |
| 12.b.7. ....                | Heads-up displays .....  | X               | X | X |
| 12.b.8. ....                | Navigation systems .....   | X               | X | X |
| 12.c. ....                  | Airborne procedures:   |                 |   |   |
| 12.c.1. ....                | Holding .....  | X               | X | X |
| 12.c.2. ....                | Air hazard avoidance .....                                       | X               | X | X |
| 12.c.3. ....                | Retreating blade stall recovery .....                            | X               | X | X |
| 12.c.4. ....                | Mast bumping .....   | X               | X | X |
| 12.c.5. ....                | Loss of directional control .....                                | X               | X | X |
| 12.c.6. ....                | Loss of tail rotor effectiveness .....                           |                 | X | X |

TABLE C3A.—FUNCTIONS AND SUBJECTIVE TESTS—Continued

| <<<QPS requirements>>>                 |   |                 |   |   |
|--|---|-----------------|---|---|
| Number                                 | Operations tasks                                      | Simulator level |   |   |
|  |   | B               | C | D |
| 12.c.7. ....                           | Others listed on the Statement of Qualification ..... | A               | X | X |
| <b>13. Engine Shutdown and Parking</b> |   |                 |   |   |
| 13.a. ....                             | Engine and systems operation .....                    | X               | X | X |
| 13.b. ....                             | Parking brake operation .....                         | X               | X | X |
| 13.c. ....                             | Rotor brake operation .....                           | X               | X | X |
| 13.d. ....                             | Abnormal/emergency procedures .....                   | X               | X | X |

**Note:** An “A” in the table indicates that the system, task, or procedure may be examined if the appropriate aircraft system or control is simulated in the FFS and is working properly.

TABLE C3B.—FUNCTIONS AND SUBJECTIVE TESTS

| <<<QPS requirements>>> |  |                 |   |   |
|------------------------|--|-----------------|---|---|
| Number                 | Visual scene content requirements for qualification at the stated level<br>Class I visual scenes/visual models | Simulator level |   |   |
|                        |  | B               | C | D |

This table specifies the minimum airport visual model content and functionality to qualify a simulator at the indicated level. This table applies only to the airport scenes required for simulator qualification; i.e., two helicopter landing area models for Level B simulators; four helicopter landing area models for Level C and Level D simulators.

|                |   |   |  |  |
|----------------|---|---|--|--|
| <b>1. ....</b> | <b>Functional test content requirements for Non-Zero Flight Time (NZFT) Level simulators</b><br>The following is the minimum airport/landing area model content requirement to satisfy visual capability tests, and provides suitable visual cues to allow completion of all functions and subjective tests described in this attachment for simulators at Level B.   |   |  |  |
| 1.a. ....      | A minimum of one (1) representative airport and one (1) representative helicopter landing area model. The airport and the helicopter landing area may be contained within the same model. If this option is selected, the approach path to the airport runway(s) and the approach path to the helicopter landing area must be different. The model(s) used to meet the following requirements may be demonstrated at either a fictional or a real-world airport or helicopter landing area, but each must be acceptable to the sponsor’s TPAA, selectable from the IOS, and listed on the Statement of Qualification. | X |  |  |
| 1.b. ....      | The fidelity of the visual scene must be sufficient for the aircrew to visually identify the airport and/or helicopter landing area; determine the position of the simulated helicopter within the visual scene; successfully accomplish take-offs, approaches, and landings; and maneuver around the airport on the ground, or hover taxi, as necessary.   | X |  |  |
| 1.c. ....      | Runways:  |   |  |  |
| 1.c.1. ...     | Visible runway number .....   | X |  |  |
| 1.c.2. ...     | Runway threshold elevations and locations must be modeled to provide sufficient correlation with helicopter systems (e.g., altimeter).  | X |  |  |
| 1.c.3. ...     | Runway surface and markings .....   | X |  |  |
| 1.c.4. ...     | Lighting for the runway in use including runway edge and centerline .....   | X |  |  |
| 1.c.5. ...     | Lighting, visual approach aid (VASI or PAPI) and approach lighting of appropriate colors .....  | X |  |  |
| 1.c.6. ...     | Representative taxiway lights .....   | X |  |  |
| 1.d. ....      | Other helicopter landing area:  |   |  |  |
| 1.d.1. ...     | Standard heliport designation (“H”) marking, properly sized and oriented .....  | X |  |  |
| 1.d.2. ...     | Perimeter markings for the Touchdown and Lift-Off Area (TLOF) or the Final Approach and Takeoff Area (FATO), as appropriate.  | X |  |  |
| 1.d.3. ...     | Perimeter lighting for the TLOF or the FATO areas, as appropriate. ....   | X |  |  |

TABLE C3B.—FUNCTIONS AND SUBJECTIVE TESTS—Continued

<<< QPS requirements >>>

| Number     | Visual scene content requirements for qualification at the stated level<br>Class I visual scenes/visual models   | Simulator level |   |   |
|------------|--|-----------------|---|---|
|            |  | B               | C | D |
| 1.d.4. ... | Appropriate markings and lighting to allow movement from the runway or helicopter landing area to another part of the landing facility.  | X               |   |   |
| 2. ....    | <b>Functional test content requirements for Level C and Level D simulators</b><br>The following is the minimum airport/landing area model content requirement to satisfy visual capability tests, and provide suitable visual cues to allow completion of all functions and subjective tests described in this attachment for simulators at Level C and Level D. Not all of the elements described in this section must be found in a single airport/landing area scene. However, all of the elements described in this section must be found throughout a combination of the four (4) airport/landing area models described in item 2.a. The representations of the hazards (as described in 2.d.) must be “hard objects” that interact as such if contacted by the simulated helicopter. Additionally, surfaces on which the helicopter lands must be “hard surfaces.” The model(s) used to meet the following requirements must be demonstrated at either a fictional or a real-world airport or helicopter landing area, and each must be acceptable to the sponsor’s TPAA, selectable from the IOS, and listed on the Statement of Qualification. |                 |   |   |
| 2.a. ....  | There must be at least the following airport/helicopter landing areas  |                 |   |   |
| 2.a.1. ... | At least one (1) representative airport .....  |                 | X | X |
| 2.a.2. ... | At least three representative non-airport landing areas, as follows:   |                 |   |   |
| 2.a.2.a.   | At least one (1) representative helicopter landing area situated on a substantially elevated surface with respect to the surrounding structures or terrain (e.g., building top, offshore oil rig).   |                 | X | X |
| 2.a.2.b.   | At least one (1) helicopter landing area that meets the definition of a “confined landing area” .....  |                 | X | X |
| 2.a.2.c.   | At least one (1) helicopter landing area on a sloped surface where the slope is at least 2½° .....   |                 | X | X |
| 2.b. ....  | For each of the airport/helicopter landing areas described in 2.a., the simulator must be able to provide at least the following:  |                 |   |   |
| 2.b.1. ... | A night and twilight (dusk) environment .....  |                 | X | X |
| 2.b.2. ... | A daylight environment .....   |                 | X | X |
| 2.c. ....  | Non-airport helicopter landing areas must have the following:  |                 |   |   |
| 2.c.1. ... | Representative buildings, structures, and lighting within appropriate distances .....  |                 | X | X |
| 2.c.2. ... | Representative moving and static clutter (e.g., other aircraft, power carts, tugs, fuel trucks) .....  |                 | X | X |
| 2.c.3. ... | Representative depiction of terrain and obstacles as well as significant and identifiable natural and cultural features, within 25 NM of the reference landing area.   |                 | X | X |
| 2.c.4. ... | Standard heliport designation (“H”) marking, properly sized and oriented .....   |                 | X | X |
| 2.c.5. ... | Perimeter markings for the Touchdown and Lift-Off Area (TLOF) or the Final Approach and Takeoff Area (FATO), as appropriate.   |                 | X | X |
| 2.c.6. ... | Perimeter lighting for the TLOF or the FATO areas, as appropriate .....  |                 | X | X |
| 2.c.7. ... | Appropriate markings and lighting to allow movement from the area to another part of the landing facility, if appropriate  |                 | X | X |
| 2.c.8. ... | Representative markings, lighting, and signage, including a windsock that gives appropriate wind cues .....  |                 | X | X |
| 2.c.9. ... | Appropriate markings, lighting, and signage necessary for position identification, and to allow movement from the landing area to another part of the landing facility.  |                 | X | X |
| 2.c.10.    | Representative moving and static ground traffic (e.g., vehicular and aircraft), including the ability to present surface hazards (e.g., conflicting traffic, vehicular or aircraft, on or approaching the landing area).   |                 | X | X |
| 2.c.11.    | Portrayal of landing surface contaminants, including lighting reflections when wet and partially obscured lights when snow is present, or suitable alternative effects.  |                 | X | X |
| 2.d. ....  | All of the following three (3) hazards must be presented in a combination of the three (3) non-airport landing areas (described in item 2.a.2.) and each of these non-airport landing areas must have at least one of the following hazards:   |                 |   |   |
| 2.d.1. ... | Other airborne traffic .....   |                 | X | X |
| 2.d.2. ... | Buildings, trees, or other vertical obstructions in the immediate landing area .....   |                 | X | X |



TABLE C3B.—FUNCTIONS AND SUBJECTIVE TESTS—Continued

| <<< QPS requirements >>> |   |                 |   |   |
|--------------------------|---|-----------------|---|---|
| Number                   | Visual scene content requirements for qualification at the stated level<br>Class I visual scenes/visual models  | Simulator level |   |   |
|                          |   | B               | C | D |
| 2.d.3. ...               | Suspended wires in the immediate landing area .....   |                 | X | X |
| 2.e. ....                | Airport applications. Each airport must have the following:   |                 |   |   |
| 2.e.1. ...               | At least one runway designated as “in-use,” appropriately marked and capable of being lighted fully .....   |                 | X | X |
| 2.e.2. ...               | Runway threshold elevations and locations must be modeled to provide sufficient correlation with helicopter systems (e.g., HGS, GPS, altimeter); slopes in runways, taxiways, and ramp areas may not cause distracting or unrealistic effects, including pilot eye-point height variation.  |                 | X | X |
| 2.e.3. ...               | Appropriate approach lighting systems and airfield lighting for a VFR circuit and landing, non-precision approaches and landings, and precision approaches and landings, as appropriate.  |                 | X | X |
| 2.e.4. ...               | Representative taxiway lights .....   |                 |   | X |
| <b>3. ....</b>           | <b>Visual scene management</b><br>The following is the minimum visual scene management requirements for simulators at the NZFT and ZFT levels.  |                 |   |   |
| 3.a. ....                | Runway and helicopter landing area approach lighting must fade into view in accordance with the environmental conditions set in the simulator.  | X               | X | X |
| 3.b. ....                | The direction of strobe lights, approach lights, runway edge lights, visual landing aids, runway centerline lights, threshold lights, touchdown zone lights, and TLOF or FATO lights must be replicated.  | X               | X | X |
| <b>4. ....</b>           | <b>Visual feature recognition</b><br>The following are the minimum distances at which runway features must be visible for simulators at the NZFT and ZFT simulator levels. Distances are measured from runway threshold or a helicopter landing area to a helicopter aligned with the runway or helicopter landing area on an extended 3° glide-slope in simulated meteorological conditions. For circling approaches, all tests apply to the runway used for the initial approach and to the runway of intended landing.   |                 |   |   |
| 4.a. ....                | For runways: runway definition, strobe lights, approach lights, and runway edge lights from 5 sm (8 km) of the runway threshold.  | X               | X | X |
| 4.b. ....                | For runways: centerline lights and taxiway definition from 3 sm (5 km) .....  | X               | X | X |
| 4.c. ....                | For runways: Visual Approach Aid lights (VASI or PAPI) from 3 sm (5 km) of the threshold .....  | X               | X | X |
| 4.d. ....                | For runways: Visual Approach Aid lights (VASI or PAPI) from 5 sm (8 km) of the threshold .....  |                 | X | X |
| 4.e. ....                | For runways: runway threshold lights and touchdown zone lights from 2 sm (3 km) .....   | X               | X | X |
| 4.f. ....                | For runways and helicopter landing areas: markings within range of landing lights for night/twilight scenes and the surface resolution test on daylight scenes, as required.  | X               | X | X |
| 4.g. ....                | For circling approaches, the runway of intended landing and associated lighting must fade into view in a non-distracting manner.  | X               | X | X |
| 4.h. ....                | For helicopter landing areas: landing direction lights and raised FATO lights from 1 sm (1.5 km) .....  | X               | X | X |
| 4.i. ....                | For helicopter landing areas: Flush mounted FATO lights, TOFL lights, and the lighted windsock from 0.5 sm (750 m) ..   |                 |   | X |
| 4.j. ....                | Hover taxiway lighting (yellow/blue/yellow cylinders) from TOFL area .....  |                 |   | X |
| <b>5. ....</b>           | <b>Airport or Helicopter Landing Area Model Content</b><br>The following prescribes the minimum requirements for an airport/helicopter landing area visual model and identifies other aspects of the environment that must correspond with that model for simulators at Level B, Level C, and Level D. For circling approaches, all tests apply to the runway used for the initial approach and to the runway of intended landing. If all runways or landing areas in a visual model used to meet the requirements of this attachment are not designated as “in use,” then the “in use” runways/landing areas must be listed on the Statement of Qualification (e.g., KORD, Rwy 9R, 14L, 22R). Models of airports or helicopter landing areas with more than one runway or landing area must have all significant runways or landing areas not “in-use” visually depicted for airport runway/landing area recognition purposes. The use of white or off-white light strings that identify the runway or landing area for twilight and night scenes are acceptable for this requirement; and rectangular surface depictions are acceptable for daylight scenes. A visual system’s capabilities must be balanced between providing visual models with an accurate representation of the airport and a realistic representation of the surrounding environment. Each runway or helicopter landing area designated as an “in-use” runway or area must include the following detail that is either modeled using airport/heliport pictures, construction drawings and maps, U.S. National Imagery and Mapping Agency data, or other data, or modeled in accordance with published regulatory material. |                 |   |   |
| 5.a. ....                | The surface and markings for each “in-use” runway or helicopter landing area must include the following:  |                 |   |   |

TABLE C3B.—FUNCTIONS AND SUBJECTIVE TESTS—Continued

| <<< QPS requirements >>> |   |                 |   |   |
|--------------------------|---|-----------------|---|---|
| Number                   | Visual scene content requirements for qualification at the stated level<br>Class I visual scenes/visual models  | Simulator level |   |   |
|                          |   | B               | C | D |
| 5.a.1. ...               | For airports: runway threshold markings, runway numbers, touchdown zone markings, fixed distance markings, runway edge markings, and runway centerline stripes.                           | X               | X | X |
| 5.a.2. ...               | For helicopter landing areas: markings for standard heliport identification (“H”) and TOFL, FATO, and safety areas .....  | X               | X | X |
| 5.b. ....                | The lighting for each “in-use” runway or helicopter landing area must include the following:  |                 |   |   |
| 5.b.1. ...               | For airports: runway approach, threshold, edge, end, centerline (if applicable), touchdown zone (if applicable), leadoff, and visual landing aid lights or light systems for that runway. | X               | X | X |
| 5.b.2. ...               | For helicopter landing areas: landing direction, raised and flush FATO, TOFL, windsock lighting .....   | X               | X | X |
| 5.c. ....                | The taxiway surface and markings associated with each “in-use” runway or helicopter landing area must include the following:  |                 |   |   |
| 5.c.1. ...               | For airports: taxiway edge, centerline (if appropriate), runway hold lines, and ILS critical area(s) .....  | X               | X | X |
| 5.c.2. ...               | For helicopter landing areas: taxiways, taxi routes, and aprons .....   | X               | X | X |
| 5.d. ....                | The taxiway lighting associated with each “in-use” runway or helicopter landing area must include the following:  |                 |   |   |
| 5.d.1. ...               | For airports: runway edge, centerline (if appropriate), runway hold lines, ILS critical areas .....   | X               | X | X |
| 5.d.2. ...               | For helicopter landing areas: taxiways, taxi routes, and aprons .....   | X               | X | X |
| 5.d.3. ...               | For airports: taxiway lighting of correct color .....   |                 |   | X |
| 5.e. ....                | Airport signage associated with each “in-use” runway or helicopter landing area must include the following:   |                 |   |   |
| 5.e.1. ...               | For airports: signs for runway distance remaining, intersecting runway with taxiway, and intersecting taxiway with taxiway.   | X               | X | X |
| 5.e.2. ...               | For helicopter landing areas: as may be appropriate for the model used .....  | X               | X | X |
| 5.f. ....                | Required visual model correlation with other aspects of the airport or helicopter landing environment simulation:   |                 |   |   |
| 5.f.1. ....              | The airport or helicopter landing area model must be properly aligned with the navigational aids that are associated with operations at the “in-use” runway or helicopter landing area.   | X               | X | X |
| 5.f.2. ....              | The simulation of runway or helicopter landing area contaminants must be correlated with the displayed runway surface and lighting where applicable.                                      |                 | X | X |
| 6. ....                  | <b>Correlation with helicopter and associated equipment</b><br>The following are the minimum correlation comparisons that must be made for simulators at Level B, Level C, and Level D.   |                 |   |   |
| 6.a. ....                | Visual system compatibility with aerodynamic programming .....  | X               | X | X |
| 6.b. ....                | Visual cues to assess sink rate and depth perception during landings .....  | X               | X | X |
| 6.c. ....                | Accurate portrayal of environment relating to flight simulator attitudes .....  | X               | X | X |
| 6.d. ....                | The visual scene must correlate with integrated helicopter systems, where fitted (e.g., terrain, traffic and weather avoidance systems and Head-up Guidance System (HGS)).                | X               | X | X |
| 6.e. ....                | Representative visual effects for each visible, own-ship, helicopter external light(s) .....  | X               | X | X |
| 6.f. ....                | The effect of rain removal devices .....  |                 | X | X |
| 7. ....                  | <b>Scene quality</b><br>The following are the minimum scene quality tests that must be conducted for simulators at Level B, Level C, and Level D.   |                 |   |   |
| 7.a. ....                | Surfaces and textural cues must be free from apparent quantization (aliasing) .....   |                 | X | X |
| 7.b. ....                | System capable of portraying full color realistic textural cues .....   |                 | X | X |
| 7.c. ....                | The system light points must be free from distracting jitter, smearing or streaking .....   | X               | X | X |
| 7.d. ....                | Demonstration of occulting through each channel of the system in an operational scene .....   | X               | X | X |

TABLE C3B.—FUNCTIONS AND SUBJECTIVE TESTS—Continued

| <<< QPS requirements >>>   |   |                 |   |   |
|----------------------------|---|-----------------|---|---|
| Number                     | Visual scene content requirements for qualification at the stated level<br>Class I visual scenes/visual models  | Simulator level |   |   |
|                            |   | B               | C | D |
| 7.e. ....                  | Demonstration of a minimum of ten levels of occulting through each channel of the system in an operational scene .....  |                 | X | X |
| 7.f. ....                  | System capable of providing focus effects that simulate rain .....  |                 | X | X |
| 7.g. ....                  | System capable of providing focus effects that simulate light point perspective growth .....  |                 | X | X |
| 7.h. ....                  | Runway light controls capable of six discrete light steps (0–5) .....   | X               | X | X |
| <b>8. ....</b>             | <b>Environmental effects</b><br>The following are the minimum environmental effects that must be available in simulators at Level B, Level C, and Level D.  |                 |   |   |
| 8.a. ....                  | The displayed scene corresponding to the appropriate surface contaminants and include appropriate lighting reflections for wet, partially obscured lights for snow, or alternative effects.   |                 |   | X |
| 8.b. ....                  | Special weather representations which include:  |                 |   |   |
| 8.b.1. ...                 | The sound, motion and visual effects of light, medium and heavy precipitation near a thunderstorm on take-off, approach, and landings at and below an altitude of 2,000 ft (600 m) above the surface and within a radius of 10 sm (16 km) from the airport or helicopter landing area.  |                 |   | X |
| 8.b.2. ...                 | One airport or helicopter landing area with a snow scene to include terrain snow and snow-covered surfaces .....  |                 |   | X |
| 8.c. ....                  | In-cloud effects such as variable cloud density, speed cues and ambient changes .....   |                 | X | X |
| 8.d. ....                  | The effect of multiple cloud layers representing few, scattered, broken and overcast conditions giving partial or complete obstruction of the ground scene.   |                 | X | X |
| 8.e. ....                  | Visibility and RVR measured in terms of distance. Visibility/RVR checked at 2,000 ft (600 m) above the airport or helicopter landing area and at two heights below 2,000 ft with at least 500 ft of separation between the measurements. The measurements must be taken within a radius of 10 sm (16 km) from the airport or helicopter landing area.   | X               | X | X |
| 8.f. ....                  | Patchy fog giving the effect of variable RVR .....  |                 |   | X |
| 8.g. ....                  | Effects of fog on airport lighting such as halos and defocus .....  |                 | X | X |
| 8.h. ....                  | Effect of own-ship lighting in reduced visibility, such as reflected glare, including landing lights, strobes, and beacons ...  |                 | X | X |
| 8.i. ....                  | Wind cues to provide the effect of blowing snow or sand across a dry runway or taxiway selectable from the instructor station.  |                 |   | X |
| 8.j. ....                  | “White-out” or “Brown-out” effects due to rotor downwash beginning at a distance above the ground equal to the rotor diameter.  |                 |   | X |
| <b>9. ....</b>             | <b>Instructor control of the following:</b><br>The following are the minimum instructor controls that must be available in simulators at the NZFT and ZFT simulator levels.   |                 |   |   |
| 9.a. ....                  | Environmental effects, e.g. cloud base, cloud effects, cloud density, visibility in statute miles/kilometers and RVR in feet/meters.  | X               | X | X |
| 9.b. ....                  | Airport or helicopter landing area selection .....  | X               | X | X |
| 9.c. ....                  | Airport or helicopter landing area lighting, including variable intensity .....   | X               | X | X |
| 9.d. ....                  | Dynamic effects including ground and flight traffic .....   |                 | X | X |
| <b>End QPS Requirement</b> |   |                 |   |   |
| <b>Begin Information</b>   |   |                 |   |   |
| 10. ....                   | An example of being able to combine two airport models to achieve two “in-use” runways: One runway designated as the “in-use” runway in the first model of the airport, and the second runway designated as the “in-use” runway in the second model of the same airport. For example, the clearance is for the ILS approach to Runway 27, Circle to Land on Runway 18 right. Two airport visual models might be used: the first with Runway 27 designated as the “in use” runway for the approach to runway 27, and the second with Runway 18 Right designated as the “in use” runway. When the pilot breaks off the ILS approach to runway 27, the instructor may change to the second airport visual model in which runway 18 Right is designated as the “in use” runway, and the pilot would make a visual approach and landing. This process is acceptable to the FAA as long as the temporary interruption due to the visual model change is not distracting to the pilot. |                 |   |   |

TABLE C3B.—FUNCTIONS AND SUBJECTIVE TESTS—Continued

| <<<QPS requirements>>> |  |                 |   |   |
|------------------------|--|-----------------|---|---|
| Number                 | Visual scene content requirements for qualification at the stated level<br>Class I visual scenes/visual models                             | Simulator level |   |   |
|                        |  | B               | C | D |
| 11. ....               | Sponsors are not required to provide every detail of a runway, but the detail that is provided should be correct within reasonable limits. |                 |   |   |

**End Information**

TABLE C3C.—FUNCTIONS AND SUBJECTIVE TESTS

| <<<QPS requirements>>> |   |                 |   |   |
|------------------------|---|-----------------|---|---|
| Number                 | Visual scene content additional visual models beyond minimum required for qualification<br>Class II visual scenes/visual models | Simulator level |   |   |
|                        |   | B               | C | D |

This table specifies the minimum airport or helicopter landing area visual model content and functionality necessary to add visual models to a simulator's visual model library (i.e., beyond those necessary for qualification at the stated level) without the necessity of further involvement of the NSPM or TPAAs.

|             |  |   |   |   |
|-------------|--|---|---|---|
| 1. ....     | <b>Visual scene management</b><br>The following is the minimum visual scene management requirements for simulators at Levels B, C, and D.  |   |   |   |
| 1.a. ....   | The installation and direction of the following lights must be replicated for the "in-use" surface:  |   |   |   |
| 1.a.1. .... | For "in-use" runways: Strobe lights, approach lights, runway edge lights, visual landing aids, runway centerline lights, threshold lights, and touchdown zone lights.  | X | X | X |
| 1.a.2. .... | For "in-use" helicopter landing areas: Ground level TLOF perimeter lights, elevated TLOF perimeter lights (if applicable), Optional TLOF lights (if applicable), ground FATO perimeter lights, elevated TLOF lights (if applicable), landing direction lights.   | X | X | X |
| 2. ....     | <b>Visual feature recognition</b><br>The following are the minimum distances at which runway or landing area features must be visible for simulators at Level B, C, and D. Distances are measured from runway threshold or a helicopter landing area to an aircraft aligned with the runway or helicopter landing area on a 3° glide-slope from the aircraft to the touchdown point, in simulated meteorological conditions. For circling approaches, all tests apply to the runway used for the initial approach and to the runway of intended landing. |   |   |   |
| 2.a. ....   | For Runways:   |   |   |   |
| 2.a.1. .... | Strobe lights, approach lights, and edge lights from 5 sm (8 km) of the threshold .....  | X | X | X |
| 2.a.2. .... | Centerline lights and taxiway definition from 3 sm (5 km) .....  | X | X | X |
| 2.a.3. .... | Visual Approach Aid lights (VASI or PAPI) from 3 sm (5 km) of the threshold .....  | X | X | X |
| 2.a.4. .... | Visual Approach Aid lights (VASI or PAPI) from 5 sm (8 km) of the threshold .....  | X | X | X |
| 2.a.5. .... | Threshold lights and touchdown zone lights from 2 sm (3 km) .....  | X | X | X |
| 2.a.6. .... | Markings within range of landing lights for night/twilight (dusk) scenes and as required by the surface resolution test on daylight scenes.  | X | X | X |
| 2.a.7. .... | For circling approaches, the runway of intended landing and associated lighting must fade into view in a non-distracting manner.   | X | X | X |
| 2.b. ....   | For Helicopter landing areas:  |   |   |   |
| 2.b.1. .... | Landing direction lights and raised FATO lights from 1 sm (1.5 km) .....   | X | X | X |
| 2.b.2. .... | Flush mounted FATO lights, TOFL lights, and the lighted windsock from 0.5 sm (750 m) .....   |   | X | X |
| 2.b.3. .... | Hover taxiway lighting (yellow/blue/yellow cylinders) from TOFL area .....   |   | X | X |
| 2.b.4. .... | Markings within range of landing lights for night/twilight (dusk) scenes and as required by the surface resolution test on daylight scenes.  | X | X | X |
| 3. ....     | <b>Airport or Helicopter Landing Area Model Content</b>  |   |   |   |

TABLE C3C.—FUNCTIONS AND SUBJECTIVE TESTS—Continued

| <<<QPS requirements>>> |  |                 |   |   |
|------------------------|--|-----------------|---|---|
| Number                 | Visual scene content additional visual models beyond minimum required for qualification<br>Class II visual scenes/visual models  | Simulator level |   |   |
|                        |  | B               | C | D |
|                        | The following prescribes the minimum requirements for what must be provided in an airport visual model and identifies other aspects of the airport environment that must correspond with that model for simulators at Level B, C, and D. The detail must be modeled using airport pictures, construction drawings and maps, or other data, or modeled in accordance with published regulatory material; however, this does not require that airport or helicopter landing area models contain details that are beyond the designed capability of the currently qualified visual system. For circling approaches, all requirements of this section apply to the runway used for the initial approach and to the runway of intended landing. |                 |   |   |
| 3.a. ....              | The surface and markings for each "in-use" runway or helicopter landing area must include the following:   |                 |   |   |
| 3.a.1. ....            | For airports: Runway threshold markings, runway numbers, touchdown zone markings, fixed distance markings, runway edge markings, and runway centerline stripes.  | X               | X | X |
| 3.a.2. ....            | For helicopter landing areas: Standard heliport marking ("H"), TOFL, FATO, and safety areas .....  | X               | X | X |
| 3.b. ....              | The lighting for each "in-use" runway or helicopter landing area must include the following:   |                 |   |   |
| 3.b.1. ....            | For airports: Runway approach, threshold, edge, end, centerline (if applicable), touchdown zone (if applicable), leadoff, and visual landing aid lights or light systems for that runway.  | X               | X | X |
| 3.b.2. ....            | For helicopter landing areas: Landing direction, raised and flush FATO, TOFL, windsock lighting .....  | X               | X | X |
| 3.c. ....              | The taxiway surface and markings associated with each "in-use" runway or helicopter landing area must include the following:   |                 |   |   |
| 3.c.1. ....            | For airports: Taxiway edge, centerline (if appropriate), runway hold lines, and ILS critical area(s) .....   | X               | X | X |
| 3.c.2. ....            | For helicopter landing areas: Taxiways, taxi routes, and aprons .....  | X               | X | X |
| 3.d. ....              | The taxiway lighting associated with each "in-use" runway or helicopter landing area must include the following:   |                 |   |   |
| 3.d.1. ....            | For airports: Runway edge, centerline (if appropriate), runway hold lines, ILS critical areas .....  | X               | X | X |
| 3.d.2. ....            | For helicopter landing areas: Taxiways, taxi routes, and aprons .....  | X               | X | X |
| 3.d.3. ....            | For airports: Taxiway lighting of correct color .....  |                 |   | X |
| <b>4. ....</b>         | <b>Required visual model correlation with other aspects of the airport environment simulation</b><br>The following are the minimum visual model correlation tests that must be conducted for simulators at the NZFT and ZFT simulator levels.  |                 |   |   |
| 4.a. ....              | The airport model must be properly aligned with the navigational aids that are associated with operations at the "in-use" runway.  | X               | X | X |
| 4.b. ....              | Slopes in runways, taxiways, and ramp areas must not cause distracting or unrealistic effects .....  | X               | X | X |
| <b>5. ....</b>         | <b>Correlation with helicopter and associated equipment</b><br>The following are the minimum correlation comparisons that must be made for simulators at Level B, C, and D.  |                 |   |   |
| 5.a. ....              | Visual system compatibility with aerodynamic programming .....   | X               | X | X |
| 5.b. ....              | Accurate portrayal of environment relating to flight simulator attitudes .....   | X               | X | X |
| 5.c. ....              | Visual cues to assess sink rate and depth perception during landings .....   | X               | X | X |
| <b>6. ....</b>         | <b>Scene quality</b><br>The following are the minimum scene quality tests that must be conducted for simulators at Level B, C, and D.  |                 |   |   |
| 6.a. ....              | Light points free from distracting jitter, smearing or streaking .....   | X               | X | X |
| 6.b. ....              | Surfaces and textural cues free from apparent quantization (aliasing) .....  |                 | X | X |
| 6.c. ....              | Correct color and realistic textural cues .....  |                 |   | X |
| <b>7. ....</b>         | <b>Instructor controls of the following:</b><br>The following are the minimum instructor controls that must be available in simulators at the NZFT and ZFT simulator levels.   |                 |   |   |
| 7.a. ....              | Environmental effects, e.g., cloud base (if used), cloud effects, cloud density, visibility in statute miles/kilometers and RVR in feet/meters.  | X               | X | X |

TABLE C3C.—FUNCTIONS AND SUBJECTIVE TESTS—Continued

| <<<QPS requirements>>>      |  |                 |   |   |
|-----------------------------|--|-----------------|---|---|
| Number                      | Visual scene content additional visual models beyond minimum required for qualification<br>Class II visual scenes/visual models  | Simulator level |   |   |
|                             |  | B               | C | D |
| 7.b. ....                   | Airport/Heliport selection .....   | X               | X | X |
| 7.c. ....                   | Airport lighting including variable intensity .....  | X               | X | X |
| 7.d. ....                   | Dynamic effects including ground and flight traffic .....  |                 | X | X |
| <b>End QPS Requirements</b> |  |                 |   |   |
| <b>Begin Information</b>    |  |                 |   |   |
| 8. ....                     | Sponsors are not required to provide every detail of a runway or helicopter landing area, but the detail that is provided must be correct within the capabilities of the system. | X               | X | X |
| <b>End Information</b>      |  |                 |   |   |

TABLE C3D.—FUNCTIONS AND SUBJECTIVE TESTS

| <<<QPS requirements>>> |   |                 |   |   |   |
|------------------------|---|-----------------|---|---|---|
| Number                 | Motion system effects   | Simulator level |   |   | Information   |
|                        |   | B               | C | D |   |
| 1. ....                | <b>Runway rumble, oleo deflection, ground speed, uneven runway, runway and taxiway centerline light characteristics:</b><br>Procedure: After the helicopter has been pre-set to the takeoff position and then released, taxi at various speeds with a smooth runway and note the general characteristics of the simulated runway rumble effects of oleo deflections. Repeat the maneuver with a runway roughness of 50%, then with maximum roughness. The associated motion vibrations should be affected by ground speed and runway roughness. | X               | X | X | If time permits, different gross weights can also be selected as this may also affect the associated vibrations depending on helicopter type. The associated motion effects for the above tests should also include an assessment of the effects of rolling over centerline lights, surface discontinuities of uneven runways, and various taxiway characteristics. |
| 2. ....                | <b>Friction Drag from Skid-type Landing Gear:</b><br>Procedure: Perform a running takeoff or a running landing and note an increase in a fuselage vibration (as opposed to rotor vibration) due to the friction of dragging the skid along the surface. This vibration will lessen as the ground speed decreases.   |                 | X | X |   |
| 3. ....                | <b>Rotor Out-of-Track and/or Out-of-Balance condition:</b><br>Procedure: Select the malfunction or condition from the IOS. Start the engine(s) normally and check for an abnormal vibration for an Out-of-Track condition and check for an abnormal vibration for an Out-of-Balance condition.  | X               | X | X | Does not require becoming airborne. The abnormal vibration for Out-of-Track and Out-of-Balance conditions should be recognized in the frequency range of the inverse of the period for each; i.e., 1/P for vertical vibration, and 1/P for lateral vibration.   |
| 4. ....                | <b>Bumps associated with the landing gear:</b><br>Procedure: Perform a normal take-off paying special attention to the bumps that could be perceptible due to maximum oleo extension after lift-off.  | X               | X | X | When the landing gear is extended or retracted, motion bumps can be felt when the gear locks into position.   |
| 5. ....                | <b>Buffet during extension and retraction of landing gear:</b><br>Procedure: Operate the landing gear. Check that the motion cues of the buffet experienced represent the actual helicopter.  | X               | X | X |   |
| 6. ....                | <b>Failure of Dynamic Vibration Absorber or similar system as appropriate for the helicopter (e.g., droop stop or static stop):</b>   | X               | X | X |   |

TABLE C3D.—FUNCTIONS AND SUBJECTIVE TESTS—Continued

| <<<QPS requirements>>> |  |                 |   |   |  |
|------------------------|--|-----------------|---|---|--|
| Number                 | Motion system effects  | Simulator level |   |   | Information  |
|                        |  | B               | C | D |  |
|                        | Procedure: May be accomplished any time the rotor is engaged. Select the appropriate failure at the IOS, note an appropriate increase in vibration and check that the vibration intensity and frequency increases with an increase in RPM and an increase in collective application.   |                 |   |   |  |
| 7. ....                | <b>Tail Rotor Drive Failure:</b><br>Procedure: With the engine(s) running and the rotor engaged—select the malfunction and note the immediate increase of medium frequency vibration.  | X               | X | X | The tail rotor operates in the medium frequency range, normally estimated by multiplying the tail rotor gear box ratio by the main rotor RPM. The failure can be recognized by an increase in the vibrations in this frequency range.  |
| 8. ....                | <b>Touchdown cues for main and nose gear:</b><br>Procedure: Conduct several normal approaches with various rates of descent. Check that the motion cues for the touchdown bumps for each descent rate are representative of the actual helicopter.   | X               | X | X |  |
| 9. ....                | <b>Tire failure dynamics:</b><br>Procedure: Simulate a single tire failure and a multiple tire failure.  |                 | X | X | The pilot may notice some yawing with a multiple tire failure selected on the same side. This should require the use of the pedal to maintain control of the helicopter. Dependent on helicopter type, a single tire failure may not be noticed by the pilot and may not cause any special motion effect. Sound or vibration may be associated with the actual tire losing pressure. |
| 10. ....               | <b>Engine malfunction and engine damage:</b><br>Procedure: The characteristics of an engine malfunction as prescribed in the malfunction definition document for the particular flight simulator must describe the special motion effects felt by the pilot. The associated engine instruments should also vary according to the nature of the malfunction.  | X               | X | X |  |
| 11. ....               | <b>Tail boom strikes:</b><br>Procedure: Tail-strikes can be checked by over-rotation of the helicopter at a quick stop or autorotation to the ground.  | X               | X | X | The motion effect should be felt as a noticeable nose down pitching moment.  |
| 12. ....               | <b>Settling with Power:</b><br>Procedure: To enter the maneuver, reduce power below hover power. Hold altitude with aft cyclic until the airspeed approaches 20 knots. Then allow the sink rate to increase to 300 feet per minute or more as the attitude is adjusted to obtain an airspeed of less than 10 knots.  |                 | X | X | When the aircraft begins to shudder, the application of additional up collective increases the vibration and sink rate.  |
| 13. ....               | <b>Retreating Blade Stall:</b><br>Procedure: To enter the maneuver, increase forward airspeed; the effect should be recognized when the forward speed is equal to the speed of the retreating blade. The onset can be felt through the development of a low frequency vibration, pitching up of the nose, and a roll in the direction of the retreating blade. High weight, low rotor RPM, high density altitude, turbulence or steep, abrupt turns are all conducive to retreating blade stall at high forward airspeeds. |                 | X | X | Correct recovery from retreating blade stall requires the collective to be lowered first, which reduces blade angles and the angle of attack. Aft cyclic can then be used to slow the helicopter.  |

TABLE C3D.—FUNCTIONS AND SUBJECTIVE TESTS—Continued

| <<<QPS requirements>>> |   |                 |   |   |             |
|------------------------|---|-----------------|---|---|-------------|
| Number                 | Motion system effects   | Simulator level |   |   | Information |
|                        |   | B               | C | D |             |
| 14. ....               | <p><b>Translational Lift Effects:</b><br/>                     Procedure: From a stabilized in-ground-effect (IGE) Hover begin a forward acceleration. When passing through the effective translational lift range, the noticeable effect will be a nose pitch-up, increase in the rate of climb, and a temporary increase vibration level (in some cases this vibration may be pronounced). This effect is experienced again upon deceleration through the appropriate speed range. During deceleration, the pitch and rate of climb will have the reverse effect, but there will be a similar, temporary increase in vibration level.</p> | X               | X | X |             |

TABLE C3E.—FUNCTIONS AND SUBJECTIVE TESTS

| <<<QPS requirements>>>   |   |                 |   |   |
|--|---|-----------------|---|---|
| Number   | Sound system  | Simulator level |   |   |
|  |   | B               | C | D |
| The following checks are performed during a normal flight profile, motion system ON. |   |                 |   |   |
| 1. ....  | Precipitation .....   |                 | X | X |
| 2. ....  | Rain removal equipment .....  |                 | X | X |
| 3. ....  | Helicopter noises used by the pilot for normal helicopter operation .....   |                 | X | X |
| 4. ....  | Abnormal operations for which there are associated sound cues, including engine malfunctions, landing gear or tire malfunctions, tail boom. |                 | X | X |
| 5. ....  | Sound of a crash when the flight simulator is landed in excess of limitations .....   |                 | X | X |

TABLE C3F.—FUNCTIONS AND SUBJECTIVE TESTS

| <<<QPS requirements>>>  |   |                 |   |   |
|---|---|-----------------|---|---|
| Number  | Special effects   | Simulator level |   |   |
|   |   | B               | C | D |
| This table specifies the minimum special effects necessary for the specified simulator level. |   |                 |   |   |
| 1. ....   | <p><b>Braking Dynamics:</b><br/>                     Representations of the dynamics of brake failure (flight simulator pitch, side-loading, and directional control characteristics representative of the helicopter), including antiskid and decreased brake efficiency due to high brake temperatures (based on helicopter related data), sufficient to enable pilot identification of the problem and implementation of appropriate procedures.</p>   |                 | X | X |
| 2. ....   | <p><b>Effects of Airframe and Engine Icing:</b><br/> <b>Required only for those helicopters authorized for operations in known icing conditions.</b><br/>                     Procedure: With the simulator airborne, in a clean configuration, nominal altitude and cruise airspeed, autopilot on and auto-throttles off, engine and airfoil anti-ice/de-ice systems deactivated; activate icing conditions at a rate that allows monitoring of simulator and systems response.<br/>                     Icing recognition will include an increase in gross weight, airspeed decay, change in simulator pitch attitude, change in engine performance indications (other than due to airspeed changes), and change in data from pitot/static system, or rotor out-of-track/balance. Activate heating, anti-ice, or de-ice systems independently. Recognition will include proper effects of these systems, eventually returning the simulated helicopter to normal flight.</p> |                 | X | X |

TABLE C3G.—FUNCTIONS AND SUBJECTIVE TESTS

| <<<QPS requirements>>> |  |                 |   |   |
|------------------------|--|-----------------|---|---|
| Number                 | Instructor operating station (IOS)<br>(As appropriate) | Simulator level |   |   |
|                        |  | B               | C | D |

Functions in this table are subject to evaluation only if appropriate for the helicopter or the system is installed on the specific simulator.



TABLE C3G.—FUNCTIONS AND SUBJECTIVE TESTS—Continued

| <<<QPS requirements>>> |  |                 |   |   |
|------------------------|--|-----------------|---|---|
| Number                 | Instructor operating station (IOS)<br>(As appropriate)                         | Simulator level |   |   |
|                        |  | B               | C | D |
| 1. ....                | <b>Simulator Power Switch(es)</b> .....  | X               | X | X |
| 2. ....                | <b>Helicopter conditions</b>   |                 |   |   |
| 2.a. ....              | Gross weight, center of gravity, fuel loading and allocation .....             | X               | X | X |
| 2.b. ....              | Helicopter systems status .....  | X               | X | X |
| 2.c. ....              | Ground crew functions .....  | X               | X | X |
| 3. ....                | <b>Airports/Heliports</b>  |                 |   |   |
| 3.a. ....              | Number and selection .....   | X               | X | X |
| 3.b. ....              | Runway or landing area selection .....   | X               | X | X |
| 3.c. ....              | Landing surface conditions (rough, smooth, icy, wet, dry, snow) .....          | X               | X | X |
| 3.d. ....              | Preset positions .....   | X               | X | X |
| 3.e. ....              | Lighting controls .....  | X               | X | X |
| 4. ....                | <b>Environmental controls</b>  |                 |   |   |
| 4.a. ....              | Visibility (statute miles/kilometers) .....                                    | X               | X | X |
| 4.b. ....              | Runway visual range (in feet/meters) .....                                     | X               | X | X |
| 4.c. ....              | Temperature .....  | X               | X | X |
| 4.d. ....              | Climate conditions .....   | X               | X | X |
| 4.e. ....              | Wind speed and direction .....   | X               | X | X |
| 4.f. ....              | Windshear .....  |                 | X | X |
| 5. ....                | <b>Helicopter system malfunctions</b> (Insertion/deletion) .....               | X               | X | X |
| 6. ....                | <b>Locks, Freezes, and Repositioning</b>                                       |                 |   |   |
| 6.a. ....              | Problem (all) freeze/release .....   | X               | X | X |
| 6.b. ....              | Position (geographic) freeze/release .....                                     | X               | X | X |
| 6.c. ....              | Repositioning (locations, freezes, and releases) .....                         | X               | X | X |
| 6.d. ....              | Ground speed control .....   | X               | X | X |
| 7. ....                | <b>Remote IOS</b> .....  | X               | X | X |
| 8. ....                | <b>Sound Controls.</b> On/off/adjustment .....                                 | X               | X | X |
| 9. ....                | <b>Motion/Control Loading System</b>   |                 |   |   |
| 9.a. ....              | <b>On/off/emergency stop.</b>  | X               | X | X |
| 10. ....               | <b>Observer Seats/Stations.</b> Position/Adjustment/Positive restraint system. | X               | X | X |

**Attachment 4 to Appendix C to Part 60—  
Sample Documents**

**Table of Contents**

Title of Sample

Figure C4A Sample Letter, Request for Initial, Upgrade, or Reinstatement Evaluation.

Figure C4B Attachment: FSTD Information Form

Figure C4C Sample Qualification Test Guide Cover Page

Figure C4D Sample Statement of Qualification—Certificate

Figure C4E Sample Statement of Qualification—Configuration List

Figure C4F Sample Statement of Qualification List of Qualified Tasks

Figure C4G Sample Continuing Qualification Evaluation Requirements Page

Figure C4H Sample MQTG Index of Effective FSTD Directives

**BILLING CODE 4910-13-P**

**Attachment 4 to Appendix C to Part 60—  
Figure C4A – Sample Letter , Request for Initial, Upgrade, or Reinstatement Evaluation  
INFORMATION**

Date \_\_\_\_\_

Charles A. Spillner  
Manager, National Simulator Program  
Federal Aviation Administration  
100 Hartsfield Centre Parkway  
Suite 400  
Atlanta, GA 30354

Dear Mr. Spillner:

**RE: Request for Initial/Upgrade Evaluation Date**

This is to advise you of our intent to request an (initial or upgrade) evaluation of our (FSTD Manufacturer), (Aircraft Type/Level) Flight Simulation Training Device (FSTD), (FAA ID Number, if previously qualified), located in (City, State) at the (Facility) on (Proposed Evaluation Date). (The proposed evaluation date shall not be more than 180 days following the date of this letter.) The FSTD will be sponsored by (Name of Training Center/Air Carrier), FAA Designator (4 Letter Code). The FSTD will be sponsored as follows; (Select One)

- The FSTD will be used within the sponsor's FAA approved training program and placed on the sponsor's Training/Operations Specifications.
- The FSTD will be used for dry lease only.

We agree to provide the formal request for the evaluation to your staff as follows: (check one)

- For QTG tests run at the factory, not later, than 45 days prior to the proposed evaluation date with the additional "1/3 on-site" tests provided not later than 14 days prior to the proposed evaluation date.
- For QTG tests run on-site, not later than 30 days prior to the proposed evaluation date.

We understand that the formal request will contain the following documents:

7. Sponsor's Letter of Request (*Company Compliance Letter*).
8. Principal Operations Inspector (POI) or Training Center Program Manager's (TCPM) endorsement.
9. Complete QTG.

If we are unable to meet the above requirements, we understand this may result in a significant delay, perhaps 45 days or more, in rescheduling and completing the evaluation.

(The sponsor should add additional comments as necessary).

Please contact (Name Telephone and Fax Number of Sponsor's Contact) to confirm the date for this initial evaluation. We understand a member of your National Simulator Program staff will respond to this request within 14 days.

**Attachment 4 to Appendix C to Part 60—  
Figure C4A – Sample Letter , Request for Initial, Upgrade, or Reinstatement Evaluation  
INFORMATION**

A copy of this letter of intent has been provided to (Name), the Principal Operations Inspector (POI) and/or Training Center Program Manager (TCPM).

Sincerely,

Attachment: FSTD Information Form  
cc: POI/TCPM

**Attachment 4 to Appendix C to Part 60—  
Figure C4B – Sample Letter , Request for Initial, Upgrade, or Reinstatement Evaluation  
Attachment: FSTD Information Form  
INFORMATION**

|  |   |  |  |
|--|---|--|--|
| Date: _____  |   |  |  |
| <b>Section 1. FSTD Information and Characteristics</b> |   |  |  |
| Sponsor Name: _____                                    |   | FSTD Location: _____   |  |
| Address: _____   |   | Physical Address: _____  |  |
| City: _____  |   | City: _____  |  |
| State: _____   |   | State: _____   |  |
| Country: _____   |   | Country: _____   |  |
| ZIP: _____   |   | ZIP: _____   |  |
| Manager _____  |   |  |  |
| Sponsor ID No:<br>(Four Letter FAA Designator) _____   |   | Nearest Airport:<br>(Airport Designator) _____   |  |
| Type of Evaluation Requested: _____                    |   |  |  |
|  |   | <input type="checkbox"/> Initial <input type="checkbox"/> Upgrade <input type="checkbox"/> Recurrent <input type="checkbox"/> Special <input type="checkbox"/> Reinstatement |  |
| Qualification Basis: _____                             | <input type="checkbox"/> A                    | <input type="checkbox"/> B   | <input type="checkbox"/> Interim C <input type="checkbox"/> C <input type="checkbox"/> D |
|  | <input type="checkbox"/> 6                    | <input type="checkbox"/> 7   | <input type="checkbox"/> Provisional Status  |
| Initial Qualification:<br>(If Applicable)              | Date: _____ Level _____                       | Manufacturer's Identification/Serial No: _____   |  |
| Upgrade Qualification:<br>(If Applicable)              | Date: _____ Level _____<br>MM/DD/YYYY         | <input type="checkbox"/> eQTG  |  |
| <b>Other Technical Information:</b>                    |   |  |  |
| FAA FSTD ID No:<br>(If Applicable)                     | _____   | FSTD Manufacturer:   | _____  |
| Convertible FSTD:                                      | <input type="checkbox"/> Yes:                 | Date of Manufacture:   | MM/DD/YYYY   |
| Related FAA ID No.<br>(If Applicable)                  | _____   | Sponsor FSTD ID No:  | _____  |
| Aircraft model/series: _____                           | Source of aerodynamic model: _____            |  |  |
| Engine model(s) and data revision: _____               | Source of aerodynamic doefficient data: _____ |  |  |
| FMS identification and revision level: _____           | Aerodynamic data revision number: _____       |  |  |
| Visual system manufacturer/model: _____                | Visual system display: _____                  |  |  |
| Flight control data revision: _____                    | FSTD computer(s) identification: _____        |  |  |
| Motion system manufacturer/type: _____                 |   |  |  |
| National Aviation Authority (NAA):<br>(If Applicable)  | _____   |  | _____  |
| NAA FSTD ID No:  | _____   | Last NAA Evaluation Date:  | _____  |
| NAA Qualification Level:                               | _____   |  |  |
| NAA Qualification Basis:                               | _____   |  |  |

**Attachment 4 to Appendix C to Part 60—  
Figure C4B – Sample Letter , Request for Initial, Upgrade, or Reinstatement Evaluation  
Attachment: FSTD Information Form  
INFORMATION**

|   |  |   |  |
|---|--|---|--|
| Visual System<br>Manufacturer and<br>Type:                      | _____  | Motion System<br>Manufacturer and<br>Type:  | _____  |
| Aircraft<br>Make/Model/Series:                                  | _____  | FSTD Seats<br>Available:  | _____  |
| Aircraft<br>Equipment   | ENGINE TYPE(S):<br>_____   | Flight Instrumentation:<br><input type="checkbox"/> EFIS <input type="checkbox"/> HUD <input type="checkbox"/> HGS <input type="checkbox"/> EFVS<br><input type="checkbox"/> TCAS <input type="checkbox"/> GPWS <input type="checkbox"/> Plain View<br><input type="checkbox"/> GPS <input type="checkbox"/> FMS Type: _____<br><input type="checkbox"/> WX Radar <input type="checkbox"/> Other: _____ | Engine<br>Instrumentation:<br><input type="checkbox"/> EICAS <input type="checkbox"/> FADEC<br><input type="checkbox"/> Other: _____ |
| <b>Section 2. Supplementary Information</b>                     |  |   |  |
| FAA Training Program Approval Authority:                        | <input type="checkbox"/> POI <input type="checkbox"/> TCPM <input type="checkbox"/> Other: _____ |   |  |
| Name:   | _____  | Office:   | _____  |
| Tel:  | _____  | Fax:  | _____  |
| Email:  | _____  |   |  |
| <b>FSTD Scheduling Person:</b>                                  |  |   |  |
| Name:   | _____  |   |  |
| Address 1:  | _____  | Address 2   | _____  |
| City:   | _____  | State:  | _____  |
| ZIP:  | _____  | Email:  | _____  |
| Tel:  | _____  | Fax:  | _____  |
| <b>FSTD Technical Contact:</b>                                  |  |   |  |
| Name:   | _____  |   |  |
| Address 1:  | _____  | Address 2   | _____  |
| City:   | _____  | State:  | _____  |
| ZIP:  | _____  | Email:  | _____  |
| Tel:  | _____  | Fax:  | _____  |
| <b>Section 3. Training, Testing and Checking Considerations</b> |  |   |  |
| Area/Function/Maneuver  | Requested  | Remarks   |  |
| Private Pilot - Training / Checks: (142)                        | <input type="checkbox"/>   | _____   |  |
| Commercial Pilot - Training /Checks:(142)                       | <input type="checkbox"/>   | _____   |  |
| Multi-Engine Rating - Training / Checks (142)                   | <input type="checkbox"/>   | _____   |  |
| Instrument Rating -Training / Checks (142)                      | <input type="checkbox"/>   | _____   |  |
| Type Rating - Training / Checks (135/121/142)                   | <input type="checkbox"/>   | _____   |  |
| Proficiency Checks (135/121/142)                                | <input type="checkbox"/>   | _____   |  |
| CAT I: (RVR 2400/1800 ft. DH200 ft)                             | <input type="checkbox"/>   | _____   |  |
| CAT II: (RVR 1200 ft. DH 100 ft)                                | <input type="checkbox"/>   | _____   |  |

**Attachment 4 to Appendix C to Part 60—  
Figure C4B – Sample Letter , Request for Initial, Upgrade, or Reinstatement Evaluation  
Attachment: FSTD Information Form  
INFORMATION**

|  |                          |       |
|--|--------------------------|-------|
| CAT III * (lowest minimum) _____ RVR _____ ft.<br>* State CAT III ( $\leq 700$ ft.), CAT IIIb ( $\leq 150$ ft.), or CAT IIIc (0 ft.) | <input type="checkbox"/> | _____ |
| <b>Circling Approach</b>   | <input type="checkbox"/> | _____ |
| <b>Windshear Training:</b>   | <input type="checkbox"/> | _____ |
| <b>Windshear Training LAW 121.409(d) (121 Turbojets Only)</b>  | <input type="checkbox"/> | _____ |
| <b>Generic Unusual Attitudes and Recoveries within the Normal Flight Envelope</b>  | <input type="checkbox"/> | _____ |
| <b>Specific Unusual Attitudes Recoveries</b>   | <input type="checkbox"/> | _____ |
| <b>Auto-coupled Approach/Auto Go Around</b>  | <input type="checkbox"/> | _____ |
| <b>Auto-land / Roll Out Guidance</b>   | <input type="checkbox"/> | _____ |
| <b>TCAS/ACAS I / II</b>  | <input type="checkbox"/> | _____ |
| <b>WX-Radar</b>  | <input type="checkbox"/> | _____ |
| <b>HUD</b>   | <input type="checkbox"/> | _____ |
| <b>HGS</b>   | <input type="checkbox"/> | _____ |
| <b>EFVS</b>  | <input type="checkbox"/> | _____ |
| <b>Future Air Navigation Systems</b>   | <input type="checkbox"/> | _____ |
| <b>GPWS / EGPWS</b>  | <input type="checkbox"/> | _____ |
| <b>ETOPS Capability</b>  | <input type="checkbox"/> | _____ |
| <b>GPS</b>   | <input type="checkbox"/> | _____ |
| <b>SMGCS</b>   | <input type="checkbox"/> | _____ |
| <b>Helicopter Slope Landings</b>   | <input type="checkbox"/> | _____ |
| <b>Helicopter External Load Operations</b>   | <input type="checkbox"/> | _____ |
| <b>Helicopter Pinnacle Approach to Landings</b>  | <input type="checkbox"/> | _____ |
| <b>Helicopter Night Vision Maneuvers</b>   | <input type="checkbox"/> | _____ |
| <b>Helicopter Category A Takeoffs</b>  | <input type="checkbox"/> | _____ |

**Attachment 4 to Appendix C to Part 60—  
Figure C4C – Sample Qualification Test Guide Cover Page  
INFORMATION**

SPONSOR NAME

SPONSOR ADDRESS

FAA QUALIFICATION TEST GUIDE

(SPECIFIC Helicopter MODEL)

*for example*

**Farnsworth Z-100**

(Type of Simulator)

(Simulator Identification Including Manufacturer, Serial Number, Visual System Used)

(Simulator Level)

(Qualification Performance Standard Used)

(Simulator Location)

FAA Initial Evaluation

Date: \_\_\_\_\_

\_\_\_\_\_ Date: \_\_\_\_\_  
(Sponsor)

\_\_\_\_\_ Date: \_\_\_\_\_  
Manager, National  
Simulator Program, FAA

**Attachment 4 to Appendix C to Part 60—  
Figure C4D – Sample Statement of Qualification - Certificate**

**INFORMATION**

**Federal Aviation Administration  
National Simulator Program**



***Certificate of Qualification***

**This is to certify that representatives of the National Simulator Program  
Completed an evaluation of the**

**Go-Fast Airlines  
Farnsworth Z-100 Full Flight Simulator  
FAA Identification Number 0999**

**And pursuant to 14 CFR Part 60 found it to meet its original qualification basis, AC  
120-63 (MM/DD/YY)**

**The Master Qualification Test Guide and the attached  
Configuration List and List of Qualified Tasks  
Provide the Qualification Basis for this device to operate at**

**Level D**

**Until April 30, 2010**

**Unless sooner rescinded or extended by the National Simulator Program Manager**

March 15, 2009

(date)

C. Nordlie

(for the NSPM)



**Attachment 4 to Appendix C to Part 60—  
Figure C4E – Sample Statement of Qualification; Configuration List**

**INFORMATION  
STATEMENT of QUALIFICATION  
CONFIGURATION LIST**

|  |   |   |  |
|--|---|---|--|
| Date: _____  |   |   |  |
| <b>Section 1. FSTD Information and Characteristics</b>   |   |   |  |
| Sponsor Name: _____  |   | FSTD Location: _____                            |  |
| Address: _____   |   | Physical Address: _____                         |  |
| City: _____  |   | City: _____                                     |  |
| State: _____   |   | State: _____                                    |  |
| Country: _____   |   | Country: _____                                  |  |
| ZIP: _____   |   | ZIP: _____                                      |  |
| Manager: _____   |   |   |  |
| Sponsor ID No:<br><i>(Four Letter FAA Designator)</i>  |   | Nearest Airport:<br><i>(Airport Designator)</i> |  |
| Type of Evaluation Requested: <input type="checkbox"/> Initial <input type="checkbox"/> Upgrade <input type="checkbox"/> Recurrent <input type="checkbox"/> Special <input type="checkbox"/> Reinstatement |   |   |  |
| Qualification Basis: _____   | <input type="checkbox"/> A                    | <input type="checkbox"/> B                      | <input type="checkbox"/> Interim C <input type="checkbox"/> C <input type="checkbox"/> D |
|  | <input type="checkbox"/> 6                    | <input type="checkbox"/> 7                      | <input type="checkbox"/> Provisional Status  |
| Initial Qualification:<br><i>(If Applicable)</i>   | Date: _____ Level _____                       | Manufacturer's Identification/Serial No: _____  |  |
| Upgrade Qualification:<br><i>(If Applicable)</i>   | Date: _____ Level _____<br>MM/DD/YYYY         | <input type="checkbox"/> eQTG                   |  |
| <b>Other Technical Information:</b>  |   |   |  |
| FAA FSTD ID No:<br><i>(If Applicable)</i>  | _____   | FSTD Manufacturer:                              | _____  |
| Convertible FSTD:  | <input type="checkbox"/> Yes:                 | Date of Manufacture:                            | MM/DD/YYYY   |
| Related FAA ID No.<br><i>(If Applicable)</i>   | _____   | Sponsor FSTD ID No: _____                       |  |
| Aircraft model/series: _____   | Source of aerodynamic model: _____            |   |  |
| Engine model(s) and data revision: _____   | Source of aerodynamic coefficient data: _____ |   |  |
| FMS identification and revision level: _____   | Aerodynamic data revision number: _____       |   |  |
| Visual system manufacturer/model: _____  | Visual system display: _____                  |   |  |
| Flight control data revision: _____  | FSTD computer(s) identification: _____        |   |  |
| Motion system manufacturer/type: _____   |   |   |  |
| National Aviation Authority (NAA):<br><i>(If Applicable)</i>   | _____   |   | _____  |
| NAA FSTD ID No:  | _____   | Last NAA Evaluation Date:                       | _____  |
| NAA Qualification Level:   | _____   |   |  |
| NAA Qualification Basis:   | _____   |   |  |

**Attachment 4 to Appendix C to Part 60—  
Figure C4E – Sample Statement of Qualification; Configuration List**

**INFORMATION**

|   |  |  |  |
|---|--|--|--|
| <b>Visual System<br/>Manufacturer and<br/>Type:</b>             | _____  | <b>Motion System<br/>Manufacturer and<br/>Type:</b>  | _____  |
| <b>Aircraft<br/>Make/Model/Series:</b>                          | _____  | <b>FSTD Seats<br/>Available:</b>   | _____  |
| <b>Aircraft<br/>Equipment</b>                                   | <b>ENGINE TYPE(S):</b><br>_____  | <b>Flight Instrumentation:</b><br><input type="checkbox"/> EFIS <input type="checkbox"/> HUD <input type="checkbox"/> HGS <input type="checkbox"/> EFVS<br><input type="checkbox"/> TCAS <input type="checkbox"/> GPWS <input type="checkbox"/> Plain View<br><input type="checkbox"/> GPS <input type="checkbox"/> FMS Type: _____<br><input type="checkbox"/> WX Radar <input type="checkbox"/> Other: _____ | <b>Engine<br/>Instrumentation:</b><br><input type="checkbox"/> EICAS <input type="checkbox"/> FADEC<br><input type="checkbox"/> Other: _____ |
| <b>Airport Models:</b>  | 3.6.1 _____<br><i>Airport Designator</i>   | 3.6.2 _____<br><i>Airport Designator</i>   | 3.6.3 _____<br><i>Airport Designator</i>   |
| <b>Circle to Land:</b>  | 3.7.1 _____<br><i>Airport Designator</i>   | 3.7.2 _____<br><i>Approach</i>   | 3.7.3 _____<br><i>Landing Runway</i>   |
| <b>Visual Ground Segment</b>                                    | 3.8.1 _____<br><i>Airport Designator</i>   | 3.8.2 _____<br><i>Approach</i>   | 3.8.3 _____<br><i>Landing Runway</i>   |
| <b>Section 2. Supplementary Information</b>                     |  |  |  |
| <b>FAA Training Program Approval Authority:</b>                 | <input type="checkbox"/> POI <input type="checkbox"/> TCPM <input type="checkbox"/> Other: _____ |  |  |
| <b>Name:</b>  | _____  | <b>Office:</b>   | _____  |
| <b>Tel:</b>   | _____  | <b>Fax:</b>  | _____  |
| <b>Email:</b>   | _____  |  |  |
| <b>FSTD Scheduling Person:</b>                                  |  |  |  |
| <b>Name:</b>  | _____  |  |  |
| <b>Address 1:</b>   | _____  | <b>Address 2</b>   | _____  |
| <b>City:</b>  | _____  | <b>State:</b>  | _____  |
| <b>ZIP:</b>   | _____  | <b>Email:</b>  | _____  |
| <b>Tel:</b>   | _____  | <b>Fax:</b>  | _____  |
| <b>FSTD Technical Contact:</b>                                  |  |  |  |
| <b>Name:</b>  | _____  |  |  |
| <b>Address 1:</b>   | _____  | <b>Address 2</b>   | _____  |
| <b>City:</b>  | _____  | <b>State:</b>  | _____  |
| <b>ZIP:</b>   | _____  | <b>Email:</b>  | _____  |
| <b>Tel:</b>   | _____  | <b>Fax:</b>  | _____  |
| <b>Section 3. Training, Testing and Checking Considerations</b> |  |  |  |
| <b>Area/Function/Maneuver</b>                                   | <b>Requested</b>   | <b>Remarks</b>   |  |
| <b>Private Pilot - Training / Checks: (142)</b>                 | <input type="checkbox"/>   | _____  |  |
| <b>Commercial Pilot - Training /Checks:(142)</b>                | <input type="checkbox"/>   | _____  |  |
| <b>Multi-Engine Rating - Training / Checks (142)</b>            | <input type="checkbox"/>   | _____  |  |
| <b>Instrument Rating -Training / Checks (142)</b>               | <input type="checkbox"/>   | _____  |  |
| <b>Type Rating - Training / Checks (135/121/142)</b>            | <input type="checkbox"/>   | _____  |  |
| <b>Proficiency Checks (135/121/142)</b>                         | <input type="checkbox"/>   | _____  |  |
| <b>CAT I: (RVR 2400/1800 ft. DH200 ft)</b>                      | <input type="checkbox"/>   | _____  |  |
| <b>CAT II: (RVR 1200 ft. DH 100 ft)</b>                         | <input type="checkbox"/>   | _____  |  |

**Attachment 4 to Appendix C to Part 60—  
Figure C4E – Sample Statement of Qualification; Configuration List**

**INFORMATION**

|   |                          |       |
|---|--------------------------|-------|
| CAT III * (lowest minimum) _____ RVR _____ ft.<br><i>* State CAT III (<math>\leq 700</math> ft.), CAT IIIb (<math>\leq 150</math> ft.), or CAT IIIc (0 ft.)</i> | <input type="checkbox"/> | _____ |
| <b>Circling Approach</b>  | <input type="checkbox"/> | _____ |
| <b>Windshear Training:</b>  | <input type="checkbox"/> | _____ |
| <b>Windshear Training IAW 121.409(d) (121 Turbojets Only)</b>   | <input type="checkbox"/> | _____ |
| <b>Generic Unusual Attitudes and Recoveries</b> within the Normal Flight Envelope   | <input type="checkbox"/> | _____ |
| <b>Specific Unusual Attitudes Recoveries</b>  | <input type="checkbox"/> | _____ |
| <b>Auto-coupled Approach/Auto Go Around</b>   | <input type="checkbox"/> | _____ |
| <b>Auto-land / Roll Out Guidance</b>  | <input type="checkbox"/> | _____ |
| <b>TCAS/ACAS I / II</b>   | <input type="checkbox"/> | _____ |
| <b>WX-Radar</b>   | <input type="checkbox"/> | _____ |
| <b>HUD</b>  | <input type="checkbox"/> | _____ |
| <b>HGS</b>  | <input type="checkbox"/> | _____ |
| <b>EFVS</b>   | <input type="checkbox"/> | _____ |
| <b>Future Air Navigation Systems</b>  | <input type="checkbox"/> | _____ |
| <b>GPWS / EGPWS</b>   | <input type="checkbox"/> | _____ |
| <b>ETOPS Capability</b>   | <input type="checkbox"/> | _____ |
| <b>GPS</b>  | <input type="checkbox"/> | _____ |
| <b>SMGCS</b>  | <input type="checkbox"/> | _____ |
| <b>Helicopter Slope Landings</b>  | <input type="checkbox"/> | _____ |
| <b>Helicopter External Load Operations</b>  | <input type="checkbox"/> | _____ |
| <b>Helicopter Pinnacle Approach to Landings</b>   | <input type="checkbox"/> | _____ |
| <b>Helicopter Night Vision Maneuvers</b>  | <input type="checkbox"/> | _____ |
| <b>Helicopter Category A Takeoffs</b>   | <input type="checkbox"/> | _____ |

**Attachment 4 to Appendix C to Part 60—  
Figure C4F – Sample Statement of Qualification – List of Qualified Tasks**

**INFORMATION**

**STATEMENT of QUALIFICATION  
List of Qualified Tasks**

**Go Fast Airline Training -- Farnsworth Z-100 -- Level ZFT -- FAA ID# 0999**

**The FSTD is qualified to perform all of the Maneuvers, Procedures, Tasks, and Functions  
Listed in Appendix A, Attachment 1, Table A1B, Minimum FSTD Requirements  
In Effect on [mm/dd/yyyy] except for the following listed Tasks or Functions.**

Qualified for all tasks in Table C1B for which the sponsor has requested qualification, except for the following:

- 6.e. Environmental system.
- 6.f. Fire detection and extinguisher system.
- 7.b. In-flight fire and smoke removal.
- 7.d. Ditching.

Additional tasks for which this FSTD is qualified (i.e., in addition to the list in Table C1B)

Enhanced Visual System

**Attachment 4 to Appendix C to Part 60—  
Figure C4G – Sample Continuing Qualification Evaluation Requirements Page  
INFORMATION**

|  |   |
|--|---|
| <b>Recurrent Evaluation Requirements</b><br><i>Completed at conclusion of Initial Evaluation</i>                 |   |
| Recurrent Evaluations to be conducted each<br><br>_ (fill in) _ months<br><br>Allotting _____ hours of FTD time. | Recurrent evaluations are due as follows:<br><br>_ (month) _ and _ (month) _ and _ (month) _<br>(enter or strike out, as appropriate) |
| Signed: _____<br>NSPM / Evaluation Team Leader   | _____ Date  |

|  |   |
|--|---|
| <b>Revision:</b><br>Based on (enter reasoning):  |   |
|  |   |
| Recurrent Evaluations are to be conducted each<br><br>_ (fill in) _ months. Allotting _____ hours. | Recurrent evaluations are due as follows:<br><br>_ (month) _ and _ (month) _ and _ (month) _<br>(enter or strike out, as appropriate) |
| Signed: _____<br>NSPM Evaluation Team Leader   | _____ Date  |

|  |   |
|--|---|
| <b>Revision:</b><br>Based on (enter reasoning):  |   |
|  |   |
| Recurrent Evaluations are to be conducted each<br><br>_ (fill in) _ months. Allotting _____ hours. | Recurrent evaluations are due as follows:<br><br>_ (month) _ and _ (month) _ and _ (month) _<br>(enter or strike out, as appropriate) |
| Signed: _____<br>NSPM Evaluation Team Leader   | _____ Date  |

(Repeat as Necessary)



- (1) FlightSafety VITAL IV.
  - (2) Redifusion SP3 and SP3T.
  - (3) Link-Miles Image II.
- c. Visual systems not required to have accurate taxiway edge lighting are:
- (1) Redifusion SP1.
  - (2) FlightSafety Vital IV.
  - (3) Link-Miles Image II and Image IIT.
  - (4) XKD displays (even though the XKD image generator is capable of generating blue colored lights, the display cannot accommodate that color).

6. A copy of this Directive must be filed in the Master Qualification Test Guide in the designated FSTD Directive Section, and its inclusion must be annotated on the Index of Effective FSTD Directives chart. See Attachment 4, Appendices A through D for a sample MQTG Index of Effective FSTD Directives chart.

#### Appendix D to Part 60—Qualification Performance Standards for Helicopter Flight Training Devices

##### Begin Information

This appendix establishes the standards for Helicopter Flight Training Device (FTD) evaluation and qualification at Level 4, Level 5, Level 6, or Level 7. The Flight Standards Service, National Simulator Program Manager (NSPM), is responsible for the development, application, and implementation of the standards contained within this appendix. The procedures and criteria specified in this appendix will be used by the NSPM, or a person or persons assigned by the NSPM when conducting helicopter FTD evaluations.

##### Table of Contents

1. Introduction
2. Applicability (§§ 60.1 60.2)
3. Definitions (§ 60.3)
4. Qualification Performance Standards (§ 60.4)
5. Quality Management System (§ 60.5)
6. Sponsor Qualification Requirements (§ 60.7)
7. Additional Responsibilities of the Sponsor (§ 60.9)
8. FSTD Use (§ 60.11)
9. FSTD Objective Data Requirements (§ 60.13)
10. Special Equipment and Personnel Requirements for Qualification of the FTD (§ 60.14)
11. Initial (and Upgrade) Qualification Requirements (§ 60.15)
12. Additional Qualifications for Currently Qualified FSTDs (§ 60.16)
13. Previously Qualified FSTDs (§ 60.17)
14. Inspection, Continuing Qualification Evaluation, and Maintenance Requirements (§ 60.19)
15. Logging FSTD Discrepancies (§ 60.20)
16. Interim Qualification of FSTDs for New Helicopter Types or Models (§ 60.21)
17. Modifications to FSTDs (§ 60.23)
18. Operations with Missing, Malfunctioning, or Inoperative Components (§ 60.25)
19. Automatic Loss of Qualification and Procedures for Restoration of Qualification (§ 60.27)

20. Other Losses of Qualification and Procedures for Restoration of Qualification (§ 60.29)
  21. Record Keeping and Reporting (§ 60.31)
  22. Applications, Logbooks, Reports, and Records: Fraud, Falsification, or Incorrect Statements (§ 60.33)
  23. [Reserved]
  24. Levels of FTD
  25. FSTD Qualification on the Basis of a Bilateral Aviation Safety Agreement (BASA) (§ 60.37)
- Attachment 1 to Appendix D to Part 60—General FTD Requirements
- Attachment 2 to Appendix D to Part 60—Flight Training Device (FTD) Objective Tests
- Attachment 3 to Appendix D to Part 60—Flight Training Device (FTD) Subjective Evaluation
- Attachment 4 to Appendix D to Part 60—Sample Documents
- Attachment 5 to Appendix D to Part 60—FSTD Directives Applicable to Helicopter Flight Training Devices

##### End Information

#### 1. Introduction

##### Begin Information

a. This appendix contains background information as well as regulatory and informative material as described later in this section. To assist the reader in determining what areas are required and what areas are permissive, the text in this appendix is divided into two sections: “QPS Requirements” and “Information.” The QPS Requirements sections contain details regarding compliance with the part 60 rule language. These details are regulatory, but are found only in this appendix. The Information sections contain material that is advisory in nature, and designed to give the user general information about the regulation.

b. Questions regarding the contents of this publication should be sent to the U.S. Department of Transportation, Federal Aviation Administration, Flight Standards Service, National Simulator Program Staff, AFS-205, 100 Hartsfield Centre Parkway, Suite 400, Atlanta, Georgia, 30354. Telephone contact numbers for the NSP are: phone, 404-832-4700; fax, 404-761-8906. The general email address for the NSP office is: [9-aso-avr-sim-team@faa.gov](mailto:9-aso-avr-sim-team@faa.gov). The NSP Internet Web Site address is: [http://www.faa.gov/safety/programs\\_initiatives/aircraft\\_aviation/nsp/](http://www.faa.gov/safety/programs_initiatives/aircraft_aviation/nsp/). On this Web Site you will find an NSP personnel list with telephone and email contact information for each NSP staff member, a list of qualified flight simulation devices, advisory circulars, a description of the qualification process, NSP policy, and an NSP “In-Works” section. Also linked from this site are additional information sources, handbook bulletins, frequently asked questions, a listing and text of the Federal Aviation Regulations, Flight Standards Inspector’s handbooks, and other FAA links.

c. The NSPM encourages the use of electronic media for all communication, including any record, report, request, test, or

statement required by this appendix. The electronic media used must have adequate security provisions and be acceptable to the NSPM. The NSPM recommends inquiries on system compatibility, and minimum system requirements are also included on the NSP Web site.

##### d. Related Reading References.

- (1) 14 CFR part 60.
- (2) 14 CFR part 61.
- (3) 14 CFR part 63.
- (4) 14 CFR part 119.
- (5) 14 CFR part 121.
- (6) 14 CFR part 125.
- (7) 14 CFR part 135.
- (8) 14 CFR part 141.
- (9) 14 CFR part 142.
- (10) Advisory Circular (AC) 120-28C, Criteria for Approval of Category III Landing Weather Minima.
- (11) AC 120-29, Criteria for Approving Category I and Category II Landing Minima for part 121 operators.
- (12) AC 120-35B, Line Operational Simulations: Line-Oriented Flight Training, Special Purpose Operational Training, Line Operational Evaluation.
- (13) AC 120-41, Criteria for Operational Approval of Airborne Wind Shear Alerting and Flight Guidance Systems.
- (14) AC 120-57A, Surface Movement Guidance and Control System (SMGS).
- (15) AC 150/5300-13, Airport Design.
- (16) AC 150/5340-1G, Standards for Airport Markings.
- (17) AC 150/5340-4C, Installation Details for Runway Centerline Touchdown Zone Lighting Systems.
- (18) AC 150/5390-2B, Heliport Design.
- (19) AC 150/5340-19, Taxiway Centerline Lighting System.
- (20) AC 150/5340-24, Runway and Taxiway Edge Lighting System.
- (21) AC 150/5345-28D, Precision Approach Path Indicator (PAPI) Systems.
- (22) International Air Transport Association document, “Flight Simulator Design and Performance Data Requirements,” as amended.
- (23) AC 29-2B, Flight Test Guide for Certification of Transport Category Rotorcraft.
- (24) AC 27-1A, Flight Test Guide for Certification of Normal Category Rotorcraft.
- (25) International Civil Aviation Organization (ICAO) Manual of Criteria for the Qualification of Flight Simulators, as amended.
- (26) Airplane Flight Simulator Evaluation Handbook, Volume I, as amended and Volume II, as amended, The Royal Aeronautical Society, London, UK.
- (27) FAA Publication FAA-S-8081 series (Practical Test Standards for Airline Transport Pilot Certificate, Type Ratings, Commercial Pilot, and Instrument Ratings).
- (28) The FAA Aeronautical Information Manual (AIM). An electronic version of the AIM is on the Internet at <http://www.faa.gov/atpubs>.

##### End Information

#### 2. Applicability (§§ 60.1 and 60.2)

**Begin Information**

No additional regulatory or informational material applies to § 60.1, Applicability, or to § 60.2, Applicability of sponsor rules to person who are not sponsors and who are engaged in certain unauthorized activities.

**End Information****3. Definitions (§ 60.3)****Begin Information**

See Appendix F of this part for a list of definitions and abbreviations from part 1, part 60, and the QPS appendices of part 60.

**End Information****4. Qualification Performance Standards (§ 60.4)****Begin Information**

No additional regulatory or informational material applies to § 60.4, Qualification Performance Standards.

**End Information****5. Quality Management System (§ 60.5)****Begin Information**

Additional regulatory material and informational material regarding Quality Management Systems for FTDs may be found in appendix E of this part.

**End Information****6. Sponsor Qualification Requirements (§ 60.7)****Begin Information**

a. The intent of the language in § 60.7(b) is to have a specific FTD, identified by the sponsor, used at least once in an FAA-approved flight training program for the helicopter simulated during the 12-month period described. The identification of the specific FTD may change from one 12-month period to the next 12-month period as long as that sponsor sponsors and uses at least one FTD at least once during the prescribed period. There is no minimum number of hours or minimum FTD periods required.

b. The following examples describe acceptable operational practices:

## (1) Example One.

(a) A sponsor is sponsoring a single, specific FTD for its own use, in its own facility or elsewhere—this single FTD forms the basis for the sponsorship. The sponsor uses that FTD at least once in each 12-month period in that sponsor's FAA-approved flight training program for the helicopter simulated. This 12-month period is established according to the following schedule:

(i) If the FTD was qualified prior to May 30, 2008, the 12-month period begins on the

date of the first continuing qualification evaluation conducted in accordance with § 60.19 after May 30, 2008, and continues for each subsequent 12-month period;

(ii) A device qualified on or after May 30, 2008, will be required to undergo an initial or upgrade evaluation in accordance with § 60.15. Once the initial or upgrade evaluation is complete, the first continuing qualification evaluation will be conducted within 6 months. The 12 month continuing qualification evaluation cycle begins on that date and continues for each subsequent 12-month period.

(b) There is no minimum number of hours of FTD use required.

(c) The identification of the specific FTD may change from one 12-month period to the next 12-month period as long as that sponsor sponsors and uses at least one FTD at least once during the prescribed period.

## (2) Example Two.

(a) A sponsor sponsors an additional number of FTDs, in its facility or elsewhere. Each additionally sponsored FTD must be—

(i) Used by the sponsor in the sponsor's FAA-approved flight training program for the helicopter simulated (as described in § 60.7(d)(1));

OR

(ii) Used by another FAA certificate holder in that other certificate holder's FAA-approved flight training program for the helicopter simulated (as described in § 60.7(d)(1)). This 12-month period is established in the same manner as in example one.

OR

(iii) Provided a statement each year from a qualified pilot, (after having flown the helicopter not the subject FTD or another FTD, during the preceding 12-month period) stating that the subject FTD's performance and handling qualities represent the helicopter (as described in § 60.7(d)(2)). This statement is provided at least once in each 12-month period established in the same manner as in example one.

(b) There is no minimum number of hours of FTD use required.

## (3) Example Three.

(a) A sponsor in New York (in this example, a Part 142 certificate holder) establishes "satellite" training centers in Chicago and Moscow.

(b) The satellite function means that the Chicago and Moscow centers must operate under the New York center's certificate (in accordance with all of the New York center's practices, procedures, and policies; e.g., instructor and/or technician training/checking requirements, recordkeeping, QMS program).

(c) All of the FTDs in the Chicago and Moscow centers could be dry-leased (i.e., the certificate holder does not have and use FAA-approved flight training programs for the FTDs in the Chicago and Moscow centers) because—

(i) Each FTD in the Chicago center and each FTD in the Moscow center is used at least once each 12-month period by another FAA certificate holder in that other certificate holder's FAA-approved flight training program for the helicopter (as described in § 60.7(d)(1));

OR

(ii) A statement is obtained from a qualified pilot (having flown the helicopter, not the subject FTD or another FTD during the preceding 12-month period) stating that the performance and handling qualities of each FTD in the Chicago and Moscow centers represents the helicopter (as described in § 60.7(d)(2)).

**End Information****7. Additional Responsibilities of the Sponsor (§ 60.9)****Begin Information**

The phrase "as soon as practicable" in § 60.9(a) means without unnecessarily disrupting or delaying beyond a reasonable time the training, evaluation, or experience being conducted in the FSTD.

**End Information****8. FSTD Use (§ 60.11)****Begin Information**

No additional regulatory or informational material applies to § 60.11, FSTD Use.

**End Information****9. FSTD Objective Data Requirements (§ 60.13)****Begin QPS Requirements**

a. Flight test data used to validate FTD performance and handling qualities must have been gathered in accordance with a flight test program containing the following:

## (1) A flight test plan consisting of:

(a) The maneuvers and procedures required for aircraft certification and simulation programming and validation.

(b) For each maneuver or procedure—

(i) The procedures and control input the flight test pilot and/or engineer used.

(ii) The atmospheric and environmental conditions.

## (iii) The initial flight conditions.

(iv) The helicopter configuration, including weight and center of gravity.

## (v) The data to be gathered.

(vi) All other information necessary to recreate the flight test conditions in the FTD.

(2) Appropriately qualified flight test personnel.

(3) Appropriate and sufficient data acquisition equipment or system(s), including appropriate data reduction and analysis methods and techniques, as would be acceptable to the FAA's Aircraft Certification Service.

b. The data, regardless of source, must be presented:

(1) In a format that supports the FTD validation process;

(2) In a manner that is clearly readable and annotated correctly and completely;

(3) With resolution sufficient to determine compliance with the tolerances set forth in Attachment 2, Table D2A appendix.



(4) With any necessary guidance information provided; and

(5) Without alteration, adjustments, or bias; however the data may be re-scaled, digitized, or otherwise manipulated to fit the desired presentation.

c. After completion of any additional flight test, a flight test report must be submitted in support of the validation data. The report must contain sufficient data and rationale to support qualification of the FTD at the level requested.

d. As required by § 60.13(f), the sponsor must notify the NSPM when it becomes aware that an addition to or a revision of the flight related data or helicopter systems related data is available if this data is used to program and operate a qualified FTD. The data referred to in this sub-section are those data that are used to validate the performance, handling qualities, or other characteristics of the aircraft, including data related to any relevant changes occurring after the type certification is issued. The sponsor must—

(1) Within 10 calendar days, notify the NSPM of the existence of this data; and

(a) Within 45 calendar days, notify the NSPM of—

(b) The schedule to incorporate this data into the FTD; or

(c) The reason for not incorporating this data into the FTD.

e. In those cases where the objective test results authorize a “snapshot test” or a “series of snapshot tests” results in lieu of a time-history result, the sponsor or other data provider must ensure that a steady state condition exists at the instant of time captured by the “snapshot.” The steady state condition must exist from 4 seconds prior to, through 1 second following, the instant of time captured by the snapshot.

#### End QPS Requirements

#### Begin Information

f. The FTD sponsor is encouraged to maintain a liaison with the manufacturer of the aircraft being simulated (or with the holder of the aircraft type certificate for the aircraft being simulated if the manufacturer is no longer in business), and if appropriate, with the person having supplied the aircraft data package for the FTD in order to facilitate the notification described in this paragraph.

g. It is the intent of the NSPM that for new aircraft entering service, at a point well in advance of preparation of the Qualification Test Guide (QTG), the sponsor should submit to the NSPM for approval, a descriptive document (a validation data roadmap) containing the plan for acquiring the validation data, including data sources. This document should clearly identify sources of data for all required tests, a description of the validity of these data for a specific engine type and thrust rating configuration, and the revision levels of all avionics affecting the performance or flying qualities of the aircraft. Additionally, this document should provide other information such as the rationale or explanation for cases where data or data parameters are missing, instances where engineering simulation data are used, or

where flight test methods require further explanations. It should also provide a brief narrative describing the cause and effect of any deviation from data requirements. The aircraft manufacturer may provide this document.

h. There is no requirement for any flight test data supplier to submit a flight test plan or program prior to gathering flight test data. However, the NSPM notes that inexperienced data gatherers often provide data that is irrelevant, improperly marked, or lacking adequate justification for selection. Other problems include inadequate information regarding initial conditions or test maneuvers. The NSPM has been forced to refuse these data submissions as validation data for an FTD evaluation. For this reason the NSPM recommends that any data supplier not previously experienced in this area review the data necessary for programming and for validating the performance of the FTD and discuss the flight test plan anticipated for acquiring such data with the NSPM well in advance of commencing the flight tests.

i. The NSPM will consider, on a case-by-case basis, whether to approve supplemental validation data derived from flight data recording systems such as a Quick Access Recorder or Flight Data Recorder.

#### End Information

### 10. Special Equipment and Personnel Requirements for Qualification of the FTD (§ 60.14)

#### Begin Information

a. In the event that the NSPM determines that special equipment or specifically qualified persons will be required to conduct an evaluation, the NSPM will make every attempt to notify the sponsor at least one (1) week, but in no case less than 72 hours, in advance of the evaluation. Examples of special equipment include flight control measurement devices, accelerometers, or oscilloscopes. Examples of specially qualified personnel include individuals specifically qualified to install or use any special equipment when its use is required.

b. Examples of a special evaluation include an evaluation conducted after an FTD is moved; at the request of the TPAA; or as a result of comments received from users of the FTD that raise questions about the continued qualification or use of the FTD.

#### End Information

### 11. Initial (and Upgrade) Qualification Requirements (§ 60.15)

#### Begin QPS Requirement

a. In order to be qualified at a particular qualification level, the FTD must:

(1) Meet the general requirements listed in Attachment 1.

(2) Meet the objective testing requirements listed in Attachment 2 (Level 4 FTDs do not require objective tests).

(3) Satisfactorily accomplish the subjective tests listed in Attachment 3.

b. The request described in § 60.15(a) must include all of the following:

(1) A statement that the FTD meets all of the applicable provisions of this part and all applicable provisions of the QPS.

(2) A confirmation that the sponsor will forward to the NSPM the statement described in § 60.15(b) in such time as to be received no later than 5 business days prior to the scheduled evaluation and may be forwarded to the NSPM via traditional or electronic means.

(3) Except for a Level 4 FTD, a qualification test guide (QTG), acceptable to the NSPM, that includes all of the following:

(a) Objective data obtained from aircraft testing or another approved source.

(b) Correlating objective test results obtained from the performance of the FTD as prescribed in the appropriate QPS.

(c) The result of FTD subjective tests prescribed in the appropriate QPS.

(d) A description of the equipment necessary to perform the evaluation for initial qualification and the continuing qualification evaluations.

c. The QTG described in paragraph a(3) of this section must provide the documented proof of compliance with the FTD objective tests in Attachment 2, Table D2A of this appendix.

d. The QTG is prepared and submitted by the sponsor, or the sponsor's agent on behalf of the sponsor, to the NSPM for review and approval, and must include, for each objective test:

(1) Parameters, tolerances, and flight conditions.

(2) Pertinent and complete instructions for conducting automatic and manual tests.

(3) A means of comparing the FTD test results to the objective data.

(4) Any other information as necessary to assist in the evaluation of the test results.

(5) Other information appropriate to the qualification level of the FTD.

e. The QTG described in paragraphs (a)(3) and (b) of this section, must include the following:

(1) A QTG cover page with sponsor and FAA approval signature blocks (see Attachment 4, Figure D4C, for a sample QTG cover page).

(2) A continuing qualification evaluation requirements page. This page will be used by the NSPM to establish and record the frequency with which continuing qualification evaluations must be conducted and any subsequent changes that may be determined by the NSPM in accordance with § 60.19. See Attachment 4, Figure D4G, for a sample Continuing Qualification Evaluation Requirements page.

(3) An FTD information page that provides the information listed in this paragraph, if applicable (see Attachment 4, Figure D4B, for a sample FTD information page). For convertible FTDs, the sponsor must submit a separate page for each configuration of the FTD.

(a) The sponsor's FTD identification number or code.

(b) The helicopter model and series being simulated.

(c) The aerodynamic data revision number or reference.

(d) The source of the basic aerodynamic model and the aerodynamic coefficient data used to modify the basic model.

(e) The engine model(s) and its data revision number or reference.

(f) The flight control data revision number or reference.

(g) The flight management system identification and revision level.

(h) The FTD model and manufacturer.

(i) The date of FTD manufacture.

(j) The FTD computer identification.

(k) The visual system model and manufacturer, including display type.

(l) The motion system type and manufacturer, including degrees of freedom.

(4) A Table of Contents.

(5) A log of revisions and a list of effective pages.

(6) List of all relevant data references.

(7) A glossary of terms and symbols used (including sign conventions and units).

(8) Statements of compliance and capability (SOCs) with certain requirements. SOC's must provide references to the sources of information that show the capability of the FTD to comply with the requirement, a rationale explaining how the referenced material is used, mathematical equations and parameter values used, and the conclusions reached; i.e., that the FTD complies with the requirement.

(9) Recording procedures or equipment required to accomplish the objective tests.

(10) The following information for each objective test designated in Attachment 2, as applicable to the qualification level sought:

(a) Name of the test.

(b) Objective of the test.

(c) Initial conditions.

(d) Manual test procedures.

(e) Automatic test procedures (if applicable).

(f) Method for evaluating FTD objective test results.

(g) List of all relevant parameters driven or constrained during the automatic test(s).

(h) List of all relevant parameters driven or constrained during the manual test(s).

(i) Tolerances for relevant parameters.

(j) Source of Validation Data (document and page number).

(k) Copy of the Validation Data (if located in a separate binder, a cross reference for the identification and page number for pertinent data location must be provided).

(l) FTD Objective Test Results as obtained by the sponsor. Each test result must reflect the date completed and must be clearly labeled as a product of the device being tested.

f. A convertible FTD is addressed as a separate FTD for each model and series helicopter to which it will be converted and for the FAA qualification level sought. The NSPM will conduct an evaluation for each configuration. If a sponsor seeks qualification for two or more models of a helicopter type using a convertible FTD, the sponsor must provide a QTG for each helicopter model, or a QTG for the first helicopter model and a supplement to that QTG for each additional helicopter model. The NSPM will conduct evaluations for each helicopter model.

g. The form and manner of presentation of objective test results in the QTG must include the following:

(1) The sponsor's FTD test results must be recorded in a manner acceptable to the NSPM, that allows easy comparison of the FTD test results to the validation data (e.g., use of a multi-channel recorder, line printer, cross plotting, overlays, transparencies).

(2) FTD results must be labeled using terminology common to helicopter parameters as opposed to computer software identifications.

(3) Validation data documents included in a QTG may be photographically reduced only if such reduction will not alter the graphic scaling or cause difficulties in scale interpretation or resolution.

(4) Scaling on graphical presentations must provide the resolution necessary to evaluate the parameters shown in Attachment 2, Table D2A of this appendix.

(5) Tests involving time histories, data sheets (or transparencies thereof) and FTD test results must be clearly marked with appropriate reference points to ensure an accurate comparison between FTD and helicopter with respect to time. Time histories recorded via a line printer are to be clearly identified for cross-plotting on the helicopter data. Over-plots may not obscure the reference data.

h. The sponsor may elect to complete the QTG objective and subjective tests at the manufacturer's facility or at the sponsor's training facility. If the tests are conducted at the manufacturer's facility, the sponsor must repeat at least one-third of the tests at the sponsor's training facility in order to substantiate FTD performance. The QTG must be clearly annotated to indicate when and where each test was accomplished. Tests conducted at the manufacturer's facility and at the sponsor's training facility must be conducted after the FTD is assembled with systems and sub-systems functional and operating in an interactive manner. The test results must be submitted to the NSPM.

i. The sponsor must maintain a copy of the MQTG at the FTD location.

j. All FTDs for which the initial qualification is conducted after May 30, 2014, must have an electronic MQTG (eMQTG) including all objective data obtained from helicopter testing, or another approved source (reformatted or digitized), together with correlating objective test results obtained from the performance of the FTD (reformatted or digitized) as prescribed in this appendix. The eMQTG must also contain the general FTD performance or demonstration results (reformatted or digitized) prescribed in this appendix, and a description of the equipment necessary to perform the initial qualification evaluation and the continuing qualification evaluations. The eMQTG must include the original validation data used to validate FTD performance and handling qualities in either the original digitized format from the data supplier or an electronic scan of the original time-history plots that were provided by the data supplier. A copy of the eMQTG must be provided to the NSPM.

k. All other FTDs (not covered in subparagraph "j") must have an electronic

copy of the MQTG by and after May 30, 2014. A copy of the eMQTG must be provided to the NSPM. This may be provided by an electronic scan presented in a Portable Document File (PDF), or similar format acceptable to the NSPM.

l. During the initial (or upgrade) qualification evaluation conducted by the NSPM, the sponsor must also provide a person knowledgeable about the operation of the aircraft and the operation of the FTD.

## End QPS Requirements

### Begin Information

m. Only those FTDs that are sponsored by a certificate holder as defined in Appendix F will be evaluated by the NSPM. However, other FTD evaluations may be conducted on a case-by-case basis as the Administrator deems appropriate, but only in accordance with applicable agreements.

n. The NSPM will conduct an evaluation for each configuration, and each FTD must be evaluated as completely as possible. To ensure a thorough and uniform evaluation, each FTD is subjected to the general FTD requirements in Attachment 1, the objective tests listed in Attachment 2, and the subjective tests listed in Attachment 3 of this appendix. The evaluations described herein will include, but not necessarily be limited to the following:

(1) Helicopter responses, including longitudinal and lateral-directional control responses (see Attachment 2 of this appendix).

(2) Performance in authorized portions of the simulated helicopter's operating envelope, to include tasks evaluated by the NSPM in the areas of surface operations, takeoff, climb, cruise, descent, approach and landing, as well as abnormal and emergency operations (see Attachment 2 of this appendix).

(3) Control checks (see Attachment 1 and Attachment 2 of this appendix).

(4) Flight deck configuration (see Attachment 1 of this appendix).

(5) Pilot, flight engineer, and instructor station functions checks (see Attachment 1 and Attachment 3 of this appendix).

(6) Helicopter systems and sub-systems (as appropriate) as compared to the helicopter simulated (see Attachment 1 and Attachment 3 of this appendix).

(7) FTD systems and sub-systems, including force cueing (motion), visual, and aural (sound) systems, as appropriate (see Attachment 1 and Attachment 2 of this appendix).

(8) Certain additional requirements, depending upon the qualification level sought, including equipment or circumstances that may become hazardous to the occupants. The sponsor may be subject to Occupational Safety and Health Administration requirements.

o. The NSPM administers the objective and subjective tests, which includes an examination of functions. The tests include a qualitative assessment of the FTD by an NSP pilot. The NSP evaluation team leader may assign other qualified personnel to assist in accomplishing the functions examination

and/or the objective and subjective tests performed during an evaluation when required.

(1) Objective tests provide a basis for measuring and evaluating FTD performance and determining compliance with the requirements of this part.

(2) Subjective tests provide a basis for:

(a) Evaluating the capability of the FTD to perform over a typical utilization period;

(b) Determining that the FTD satisfactorily simulates each required task;

(c) Verifying correct operation of the FTD controls, instruments, and systems; and

(d) Demonstrating compliance with the requirements of this part.

p. The tolerances for the test parameters listed in Attachment 2 of this appendix reflect the range of tolerances acceptable to the NSPM for FTD validation and are not to be confused with design tolerances specified for FTD manufacture. In making decisions regarding tests and test results, the NSPM relies on the use of operational and engineering judgment in the application of data (including consideration of the way in which the flight test was flown and way the data was gathered and applied), data presentations, and the applicable tolerances for each test.

q. In addition to the scheduled continuing qualification evaluation, each FTD is subject to evaluations conducted by the NSPM at any time without prior notification to the sponsor. Such evaluations would be accomplished in a normal manner (i.e., requiring exclusive use of the FTD for the conduct of objective and subjective tests and an examination of functions) if the FTD is not being used for flight crewmember training, testing, or checking. However, if the FTD were being used, the evaluation would be conducted in a non-exclusive manner. This non-exclusive evaluation will be conducted by the FTD evaluator accompanying the check airman, instructor, Aircrew Program Designee (APD), or FAA inspector aboard the FTD along with the student(s) and observing the operation of the FTD during the training, testing, or checking activities.

r. Problems with objective test results are handled as follows:

(1) If a problem with an objective test result is detected by the NSP evaluation team during an evaluation, the test may be repeated or the QTG may be amended.

(2) If it is determined that the results of an objective test do not support the qualification level requested but do support a lower level, the NSPM may qualify the FTD at a lower level.

s. After an FTD is successfully evaluated, the NSPM issues a Statement of Qualification (SOQ) to the sponsor. The NSPM recommends the FTD to the TPAA, who will approve the FTD for use in a flight training program. The SOQ will be issued at the satisfactory conclusion of the initial or continuing qualification evaluation and will list the tasks for which the FTD is qualified, referencing the tasks described in Table D1B in attachment 1. However, it is the sponsor's responsibility to obtain TPAA approval prior to using the FTD in an FAA-approved flight training program.

t. Under normal circumstances, the NSPM establishes a date for the initial or upgrade

evaluation within ten (10) working days after determining that a complete QTG is acceptable. Unusual circumstances may warrant establishing an evaluation date before this determination is made. A sponsor may schedule an evaluation date as early as 6 months in advance. However, there may be a delay of 45 days or more in rescheduling and completing the evaluation if the sponsor is unable to meet the scheduled date. See Attachment 4, Figure D4A, Sample Request for Initial, Upgrade, or Reinstatement Evaluation.

u. The numbering system used for objective test results in the QTG should closely follow the numbering system set out in Attachment 2, FTD Objective Tests, Table D2A.

v. Contact the NSPM or visit the NSPM Web site for additional information regarding the preferred qualifications of pilots used to meet the requirements of § 60.15(d).

w. Examples of the exclusions for which the FTD might not have been subjectively tested by the sponsor or the NSPM and for which qualification might not be sought or granted, as described in § 60.15(g)(6), include approaches to and departures from slopes and pinnacles.

#### End Information

### 12. Additional Qualifications for Currently Qualified FSTDs (§ 60.16)

#### Begin Information

No additional regulatory or informational material applies to § 60.16, Additional Qualifications for a Currently Qualified FTD.

#### End Information

### 13. Previously Qualified FSTDs (§ 60.17)

#### Begin QPS Requirements

a. In instances where a sponsor plans to remove an FTD from active status for a period of less than two years, the following procedures apply:

(1) The NSPM must be notified in writing and the notification must include an estimate of the period that the FTD will be inactive.

(2) Continuing Qualification evaluations will not be scheduled during the inactive period.

(3) The NSPM will remove the FTD from the list of qualified FSTDs on a mutually established date not later than the date on which the first missed continuing qualification evaluation would have been scheduled.

(4) Before the FTD is restored to qualified status, it must be evaluated by the NSPM. The evaluation content and the time required to accomplish the evaluation is based on the number of continuing qualification evaluations and sponsor-conducted quarterly inspections missed during the period of inactivity.

(5) The sponsor must notify the NSPM of any changes to the original scheduled time out of service.

b. FTDs and replacement FTD systems qualified prior to May 30, 2008, are not

required to meet the general FTD requirements, the objective test requirements, and the subjective test requirements of Attachments 1, 2, and 3, respectively, of this appendix as long as the FTD continues to meet the test requirements contained in the MQTG developed under the original qualification basis.

c. After (1 year after date of publication of the final rule in the **Federal Register**) each visual scene and airport model installed in and available for use in a qualified FTD must meet the requirements described in Attachment 3 of this appendix.

#### End QPS Requirements

#### Begin Information

d. Other certificate holders or persons desiring to use an FTD may contract with FTD sponsors to use FTDs previously qualified at a particular level for a helicopter type and approved for use within an FAA-approved flight training program. Such FTDs are not required to undergo an additional qualification process, except as described in § 60.16.

e. Each FTD user must obtain approval from the appropriate TPAA to use any FTD in an FAA-approved flight training program.

f. The intent of the requirement listed in § 60.17(b), for each FTD to have a Statement of Qualification within 6 years, is to have the availability of that statement (including the configuration list and the limitations to authorizations) to provide a complete picture of the FTD inventory regulated by the FAA. The issuance of the statement will not require any additional evaluation or require any adjustment to the evaluation basis for the FTD.

g. Downgrading of an FTD is a permanent change in qualification level and will necessitate the issuance of a revised Statement of Qualification to reflect the revised qualification level, as appropriate. If a temporary restriction is placed on an FTD because of a missing, malfunctioning, or inoperative component or on-going repairs, the restriction is not a permanent change in qualification level. Instead, the restriction is temporary and is removed when the reason for the restriction has been resolved.

h. It is not the intent of the NSPM to discourage the improvement of existing simulation (e.g., the "updating" of a control loading system, or the replacement of the IOS with a more capable unit) by requiring the "updated" device to meet the qualification standards current at the time of the update. Depending on the extent of the update, the NSPM may require that the updated device be evaluated and may require that an evaluation include all or a portion of the elements of an initial evaluation. However, the standards against which the device would be evaluated are those that are found in the MQTG for that device.

i. The NSPM will determine the evaluation criteria for an FTD that has been removed from active status for a prolonged period. The criteria will be based on the number of continuing qualification evaluations and quarterly inspections missed during the period of inactivity. For example, if the FTD

were out of service for a 1 year period, it would be necessary to complete the entire QTG, since all of the quarterly evaluations would have been missed. The NSPM will also consider how the FTD was stored, whether parts were removed from the FTD and whether the FTD was disassembled.

j. The FTD will normally be requalified using the FAA-approved MQTG and the criteria that was in effect prior to its removal from qualification. However, inactive periods of 2 years or more will require re-qualification under the standards in effect and current at the time of requalification.

#### End Information

### 14. Inspection, Continuing Qualification, Evaluation, and Maintenance Requirements (§ 60.19)

#### Begin QPS Requirement

a. The sponsor must conduct a minimum of four evenly spaced inspections throughout the year. The objective test sequence and content of each inspection in this sequence must be developed by the sponsor and must be acceptable to the NSPM.

b. The description of the functional preflight inspection must be contained in the sponsor's QMS.

c. Record "functional preflight" in the FTD discrepancy log book or other acceptable location, including any item found to be missing, malfunctioning, or inoperative.

d. During the continuing qualification evaluation conducted by the NSPM, the sponsor must also provide a person knowledgeable about the operation of the aircraft and the operation of the FTD.

#### End QPS Requirements

#### Begin Information

e. The sponsor's test sequence and the content of each quarterly inspection required in § 60.19(a)(1) should include a balance and a mix from the objective test requirement areas listed as follows:

- (1) Performance.
- (2) Handling qualities.
- (3) Motion system (where appropriate).
- (4) Visual system (where appropriate).
- (5) Sound system (where appropriate).
- (6) Other FTD systems.

f. If the NSP evaluator plans to accomplish specific tests during a normal continuing qualification evaluation that requires the use of special equipment or technicians, the sponsor will be notified as far in advance of the evaluation as practical; but not less than 72 hours. Examples of such tests include latencies and control sweeps.

g. The continuing qualification evaluations described in § 60.19(b) will normally require 4 hours of FTD time. However, flexibility is necessary to address abnormal situations or situations involving aircraft with additional levels of complexity (e.g., computer controlled aircraft). The sponsor should anticipate that some tests may require additional time. The continuing qualification evaluations will consist of the following:

(1) Review of the results of the quarterly inspections conducted by the sponsor since the last scheduled continuing qualification evaluation.

(2) A selection of approximately 8 to 15 objective tests from the MQTG that provide an adequate opportunity to evaluate the performance of the FTD. The tests chosen will be performed either automatically or manually and should be able to be conducted within approximately one-third (1/3) of the allotted FTD time.

(3) A subjective evaluation of the FTD to perform a representative sampling of the tasks set out in attachment 3 of this appendix. This portion of the evaluation should take approximately two-thirds (2/3) of the allotted FTD time.

(4) An examination of the functions of the FTD may include the motion system, visual system, sound system as applicable, instructor operating station, and the normal functions and simulated malfunctions of the simulated helicopter systems. This examination is normally accomplished simultaneously with the subjective evaluation requirements.

h. The requirement established in § 60.19(b)(4) regarding the frequency of NSPM-conducted continuing qualification evaluations for each FTD is typically 12 months. However, the establishment and satisfactory implementation of an approved QMS for a sponsor will provide a basis for adjusting the frequency of evaluations to exceed 12-month intervals.

#### End Information

### 15. Logging FSTD Discrepancies (§ 60.20)

#### Begin Information

No additional regulatory or informational material applies to § 60.20. Logging FSTD Discrepancies.

#### End Information

### 16. Interim Qualification of FSTDs for New Helicopter Types or Models (§ 60.21)

#### Begin Information

No additional regulatory or informational material applies to § 60.21, Interim Qualification of FSTDs for New Helicopter Types or Models.

#### End Information

### 17. Modifications to FSTDs (§ 60.23)

#### Begin QPS Requirements

a. The notification described in § 60.23(c)(2) must include a complete description of the planned modification, with a description of the operational and engineering effect the proposed modification will have on the operation of the FTD and the results that are expected with the modification incorporated.

b. Prior to using the modified FTD:

- (1) All the applicable objective tests completed with the modification

incorporated, including any necessary updates to the MQTG (e.g., accomplishment of FSTD Directives) must be acceptable to the NSPM; and

(2) The sponsor must provide the NSPM with a statement signed by the MR that the factors listed in § 60.15(b) are addressed by the appropriate personnel as described in that section.

#### End QPS Requirements

#### Begin Information

c. FSTD Directives are considered modification of an FTD. See Attachment 4, Figure D4H for a sample index of effective FSTD Directives. See Attachment 6 for a list of all effective FSTD Directives applicable to Helicopter FTDs.

#### End Information

### 18. Operation with Missing, Malfunctioning, or Inoperative Components (§ 60.25)

#### Begin Information

a. The sponsor's responsibility with respect to § 60.25(a) is satisfied when the sponsor fairly and accurately advises the user of the current status of an FTD, including any missing, malfunctioning, or inoperative (MMI) component(s).

b. If the 29th or 30th day of the 30-day period described in § 60.25(b) is on a Saturday, a Sunday, or a holiday, the FAA will extend the deadline until the next business day.

c. In accordance with the authorization described in § 60.25(b), the sponsor may develop a discrepancy prioritizing system to accomplish repairs based on the level of impact on the capability of the FTD. Repairs having a larger impact on the FTD's ability to provide the required training, evaluation, or flight experience will have a higher priority for repair or replacement.

#### End Information

### 19. Automatic Loss of Qualification and Procedures for Restoration of Qualification (§ 60.27)

#### Begin Information

If the sponsor provides a plan for how the FTD will be maintained during its out-of-service period (e.g., periodic exercise of mechanical, hydraulic, and electrical systems; routine replacement of hydraulic fluid; control of the environmental factors in which the FTD is to be maintained.) there is a greater likelihood that the NSPM will be able to determine the amount of testing that required for requalification.

#### End Information

### 20. Other Losses of Qualification and Procedures for Restoration of Qualification (§ 60.29)

**Begin Information**

If the sponsor provides a plan for how the FTD will be maintained during its out-of-service period (e.g., periodic exercise of mechanical, hydraulic, and electrical systems; routine replacement of hydraulic fluid; control of the environmental factors in which the FTD is to be maintained.) there is a greater likelihood that the NSPM will be able to determine the amount of testing that required for requalification.

**End Information****21. Recordkeeping and Reporting (§ 60.31)****Begin QPS Requirements**

a. FTD modifications can include hardware or software changes. For FTD modifications involving software programming changes, the record required by § 60.31(a)(2) must consist of the name of the aircraft system software, aerodynamic model, or engine model change, the date of the change, a summary of the change, and the reason for the change.

b. If a coded form for recordkeeping is used, it must provide for the preservation and retrieval of information with appropriate security or controls to prevent the inappropriate alteration of such records after the fact.

**End QPS Requirements****22. Applications, Logbooks, Reports, and Records: Fraud, Falsification, or Incorrect Statements (§ 60.33)****Begin Information**

No additional regulatory or informational material applies to § 60.33, Applications, Logbooks, Reports, and Records: Fraud, Falsification, or Incorrect Statements.

**23. [Reserved]****End Information****24. Levels of FTD****Begin Information**

a. The following is a general description of each level of FTD. Detailed standards and tests for the various levels of FTDs are fully defined in Attachments 1 through 3 of this appendix.

(1) *Level 4.* A Level 4 device is one that may have an open helicopter-specific flight deck area, or an enclosed helicopter-specific flight deck and at least one operating system. Air/ground logic is required (no aerodynamic programming required). All displays may be flat/LCD panel representations or actual representations of displays in the aircraft. All controls, switches, and knobs may be touch

sensitive activation (not capable of manual manipulation of the flight controls) or may physically replicate the aircraft in control operation.

(2) *Level 5.* A Level 5 device is one that may have an open helicopter-specific flight deck area, or an enclosed helicopter-specific flight deck and a generic aerodynamic program with at least one operating system and control loading representative of the simulated helicopter. The control loading need only represent the helicopter at an approach speed and configuration. All displays may be flat/LCD panel representations or actual representations of displays in the aircraft. Primary and secondary flight controls (e.g., rudder, aileron, elevator, flaps, spoilers/speed brakes, engine controls, landing gear, nose wheel steering, trim, brakes) must be physical controls. All other controls, switches, and knobs may be touch sensitive activation.

(3) *Level 6.* A Level 6 device is one that has an enclosed helicopter-specific flight deck and aerodynamic program with all applicable helicopter systems operating and control loading that is representative of the simulated helicopter throughout its ground and flight envelope and significant sound representation. All displays may be flat/LCD panel representations or actual representations of displays in the aircraft, but all controls, switches, and knobs must physically replicate the aircraft in control operation.

(4) *Level 7.* A Level 7 device is one that has an enclosed helicopter-specific flight deck and aerodynamic program with all applicable helicopter systems operating and control loading that is representative of the simulated helicopter throughout its ground and flight envelope and significant sound representation. All displays may be flat/LCD panel representations or actual representations of displays in the aircraft, but all controls, switches, and knobs must physically replicate the aircraft in control operation. It also has a visual system that provides an out-of-the-flight deck view, providing cross-flight deck viewing (for both pilots simultaneously) of a field of view of at least 146° horizontally and 36° vertically as well as a vibration cueing system for characteristic helicopter vibrations noted at the pilot station(s).

**End Information****25. FSTD Qualification on the Basis of a Bilateral Aviation Safety Agreement (BASA) (§ 60.37)****Begin Information**

No additional regulatory or informational material applies to § 60.37, FSTD Qualification on the Basis of a Bilateral Aviation Safety Agreement (BASA).

**End Information****Attachment 1 to Appendix D to Part 60—General FTD Requirements****Begin QPS Requirements****1. Requirements**

a. Certain requirements included in this appendix must be supported with a Statement of Compliance and Capability (SOC), which may include objective and subjective tests. The SOC will confirm that the requirement was satisfied, and describe how the requirement was met. The requirements for SOCs and tests are indicated in the "General FTD Requirements" column in Table D1A of this appendix.

b. Table D1A describes the requirements for the indicated level of FTD. Many devices include operational systems or functions that exceed the requirements outlined in this section. In any event, all systems will be tested and evaluated in accordance with this appendix to ensure proper operation.

**End QPS Requirements****Begin Information****2. Discussion**

a. This attachment describes the general requirements for qualifying Level 4 through Level 7 FTDs. The sponsor should also consult the objective tests in Attachment 2 and the examination of functions and subjective tests listed in Attachment 3 to determine the complete requirements for a specific level FTD.

b. The material contained in this attachment is divided into the following categories:

- (1) General Flight Deck Configuration.
- (2) Programming.
- (3) Equipment Operation.
- (4) Equipment and facilities for instructor/evaluator functions.
- (5) Motion System.
- (6) Visual System.
- (7) Sound System.

c. Table D1A provides the standards for the General FTD Requirements.

d. Table D1B provides the tasks that the sponsor will examine to determine whether the FSTD satisfactorily meets the requirements for flight crew training, testing, and experience.

e. Table D1C provides the functions that an instructor/check airman must be able to control in the simulator.

f. It is not required that all of the tasks that appear on the List of Qualified Tasks (part of the SOQ) be accomplished during the initial or continuing qualification evaluation.

**End Information**

TABLE D1A.—MINIMUM FTD REQUIREMENTS

| <<<QPS requirements>>>                      |  |           |   |   |   | <<Information>><br>notes   |
|---|--|-----------|---|---|---|--|
| Number                                      | General FTD requirements   | FTD level |   |   |   |  |
|   |  | 4         | 5 | 6 | 7 |  |
| <b>1. General Flight Deck Configuration</b> |  |           |   |   |   |  |
| 1.a. ....                                   | The FTD must have a flight deck that is a replica of the helicopter, or set of helicopters simulated with controls, equipment, observable flight deck indicators, circuit breakers, and bulkheads properly located, functionally accurate and replicating the helicopter or set of helicopters. The direction of movement of controls and switches must be identical to that in the helicopter or set of helicopters. Crewmember seats must afford the capability for the occupant to be able to achieve the design "eye position." Equipment for the operation of the flight deck windows must be included, but the actual windows need not be operable. Fire axes, extinguishers, and spare light bulbs must be available in the flight simulator, but may be relocated to a suitable location as near as practical to the original position. Fire axes, landing gear pins, and any similar purpose instruments need only be represented in silhouette.<br>An SOC is required. |           |   | X | X | For FTD purposes, the flight deck consists of all that space forward of a cross section of the flight deck at the most extreme aft setting of the pilots' seats including additional, required crewmember duty stations and those required bulkheads aft of the pilot seats. |
| 1.b. ....                                   | The FTD must have equipment (i.e., instruments, panels, systems, circuit breakers, and controls) simulated sufficiently for the authorized training/checking events to be accomplished. The installed equipment, must be located in a spatially correct configuration, and may be in a flight deck or an open flight deck area. Additional equipment required for the authorized training and checking events must be available in the FTD but may be located in a suitable location as near as practical to the spatially correct position. Actuation of this equipment must replicate the appropriate function in the helicopter. Fire axes, landing gear pins, and any similar purpose instruments need only be represented in silhouette.<br>An SOC is required.   | X         | X |   |   |  |
| <b>2. Programming</b>                       |  |           |   |   |   |  |
| 2.a. ....                                   | The FTD must provide the proper effect of aerodynamic changes for the combinations of drag and thrust normally encountered in flight. This must include the effect of change in helicopter attitude, thrust, drag, altitude, temperature, and configuration.<br>Levels 6 and 7 additionally require the effects of changes in gross weight and center of gravity.<br>Level 5 requires only generic aerodynamic programming.<br>An SOC is required.   |           | X | X | X |  |
| 2.b. ....                                   | The FTD must have the computer (analog or digital) capability (i.e., capacity, accuracy, resolution, and dynamic response) needed to meet the qualification level sought.<br>An SOC is required.   | X         | X | X | X |  |
| 2.c. ....                                   | Relative responses of the flight deck instruments must be measured by latency tests or transport delay tests, and may not exceed 150 milliseconds. The instruments must respond to abrupt input at the pilot's position within the allotted time, but not before the time that the helicopter or set of helicopters would respond under the same conditions.   |           |   |   |   |  |

TABLE D1A.—MINIMUM FTD REQUIREMENTS—Continued

| <<<QPS requirements>>>        |   |           |   |   |   | <<Information>><br>notes  |
|-------------------------------|---|-----------|---|---|---|---|
| Number                        | General FTD requirements  | FTD level |   |   |   |   |
|                               |   | 4         | 5 | 6 | 7 |   |
|                               | <ul style="list-style-type: none"> <li>• Latency: The FTD instrument and, if applicable, the motion system and the visual system response must not be prior to that time when the helicopter responds and may respond up to 150 milliseconds after that time under the same conditions.</li> <li>• Transport Delay: As an alternative to the Latency requirement, a transport delay objective test may be used to demonstrate that the FTD system does not exceed the specified limit. The sponsor must measure all the delay encountered by a step signal migrating from the pilot's control through all the simulation software modules in the correct order, using a handshaking protocol, finally through the normal output interfaces to the instrument display and, if applicable, the motion system, and the visual system.</li> </ul> <p>An objective test is required.</p> |           | X | X | X | The intent is to verify that the FTD provides instrument cues that are, within the stated time delays, like the helicopter responses. For helicopter response, acceleration in the appropriate, corresponding rotational axis is preferred. |
| <b>3. Equipment Operation</b> |   |           |   |   |   |   |
| 3.a. ....                     | All relevant instrument indications involved in the simulation of the helicopter must automatically respond to control movement or external disturbances to the simulated helicopter or set of helicopters; e.g., turbulence or winds.<br>A subjective test is required.  | A         | X | X | X |   |
| 3.b. ....                     | Navigation equipment must be installed and operate within the tolerances applicable for the helicopter or set of helicopters.<br>Levels 6 and 7 must also include communication equipment (inter-phone and air/ground) like that in the helicopter.<br>Level 5 only needs that navigation equipment necessary to fly an instrument approach.<br>A subjective test is required.  | A         | X | X | X |   |
| 3.c. ....                     | Installed systems must simulate the applicable helicopter system operation both on the ground and in flight. At least one helicopter system must be represented. Systems must be operative to the extent that applicable normal, abnormal, and emergency operating procedures included in the sponsor's training programs can be accomplished.<br>Levels 6 and 7 must simulate all applicable helicopter flight, navigation, and systems operation.<br>Level 5 must have functional flight and navigational controls, displays, and instrumentation.<br>A subjective test is required.  | A         | X | X | X |   |
| 3.d. ....                     | The lighting environment for panels and instruments must be sufficient for the operation being conducted.<br>A subjective test is required.   | X         | X | X | X | Back-lighted panels and instruments may be installed but are not required.  |
| 3.e. ....                     | The FTD must provide control forces and control travel that correspond to the replicated helicopter or set of helicopters. Control forces must react in the same manner as in the helicopter or set of helicopters under the same flight conditions.<br>A subjective test is required.  |           |   | X | X |   |
| 3.f. ....                     | The FTD must provide control forces and control travel of sufficient precision to manually fly an instrument approach. The control forces must react in the same manner as in the helicopter or set of helicopters under the same flight conditions.<br>A subjective test is required.  |           | X |   |   |   |

TABLE D1A.—MINIMUM FTD REQUIREMENTS—Continued

| <<<QPS requirements>>>                       |   |           |   |   |   | <<Information>><br>notes   |
|--|---|-----------|---|---|---|--|
| Number                                       | General FTD requirements  | FTD level |   |   |   |  |
|  |   | 4         | 5 | 6 | 7 |  |
| <b>4. Instructor or Evaluator Facilities</b> |   |           |   |   |   |  |
| 4.a. ....                                    | In addition to the flight crewmember stations, suitable seating arrangements for an instructor/check airman and FAA Inspector must be available. These seats must provide adequate view of crewmember's panel(s).<br>A subjective test is required.   | X         | X | X | X | These seats need not be a replica of an aircraft seat and may be as simple as an office chair placed in an appropriate position. |
| 4.b. ....                                    | The FTD must have instructor controls that permit activation of normal, abnormal, and emergency conditions, as may be appropriate. Once activated, proper system operation must result from system management by the crew and not require input from the instructor controls.<br>A subjective test is required.   | X         | X | X | X |  |
| <b>5. Motion System</b>                      |   |           |   |   |   |  |
| 5.a. ....                                    | The FTD may have a motion system; if desired, although it is not required. If installed, the motion system operation may not be distracting.<br>A subjective test is required.  | X         | X | X |   |  |
| 5.b. ....                                    | Although it is not required, if a motion system is installed and additional training, testing, or checking credits are being sought on the basis of having a motion system, the motion system operation may not be distracting and must be coupled closely to provide integrated sensory cues. The motion system must also respond to abrupt input at the pilot's position within the allotted time, but not before the time when the helicopter would respond under the same conditions, it must be measured by latency tests or transport delay tests and may not exceed 150 milliseconds. Instrument response may not occur prior to motion onset.<br>An objective test is required. | X         | X | X |   |  |
| 5.c. ....                                    | The FTD must have at least a vibration cueing system for characteristic helicopter vibrations noted at the pilot station(s).<br>If a motion system is installed, although it is not required, it must be measured by latency tests or transport delay tests and may not exceed 100 milliseconds. Instrument response may not occur prior to motion onset.<br>A subjective test is required.   |           |   |   | X | May be accomplished by a "seat shaker" or a bass speaker sufficient to provide the necessary cueing.                             |
| <b>6. Visual System</b>                      |   |           |   |   |   |  |
| 6.a. ....                                    | The FTD may have a visual system, if desired, although it is not required. If a visual system is installed, it must meet the following criteria:  |           |   |   |   |  |
| 6.a.1. ...                                   | The visual system must respond to abrupt input at the pilot's position.<br>An SOC is required.<br>A Subjective Test is required.  | X         | X | X |   |  |
| 6.a.2. ...                                   | The visual system must be at least a single channel, non-collimated display.<br>An SOC is required.<br>A Subjective Test is required.   | X         | X | X |   |  |
| 6.a.3. ...                                   | The visual system must provide at least a field of view of 18° vertical/24° horizontal for the pilot flying.<br>An SOC is required.   | X         | X | X |   |  |



TABLE D1A.—MINIMUM FTD REQUIREMENTS—Continued

| <<<QPS requirements>>> |  | <<Information>> notes |   |   |   |   |
|------------------------|--|-----------------------|---|---|---|---|
| Number                 | General FTD requirements   | FTD level             |   |   |   |   |
|                        |  | 4                     | 5 | 6 | 7 |   |
| 6.a.4. ...             | The visual system must provide for a maximum parallax of 10° per pilot.<br>An SOC is required.   | X                     | X | X |   |   |
| 6.a.5. ...             | The visual scene content may not be distracting .....<br>An SOC is required.<br>A Subjective Test is required.   | X                     | X | X |   |   |
| 6.a.6. ...             | The minimum distance from the pilot's eye position to the surface of a direct view display may not be less than the distance to any front panel instrument.<br>An SOC is required.   | X                     | X | X |   |   |
| 6.a.7. ...             | The visual system must provide for a minimum resolution of 5 arc-minutes for both computed and displayed pixel size.<br>An SOC is required.  | X                     | X | X |   |   |
| 6.b. ....              | If a visual system is installed and additional training, testing, or checking credits are being sought on the basis of having a visual system, a visual system meeting the standards set out for at least a Level A FFS (see Appendix A of this part) will be required. A "direct-view," non-collimated visual system (with the other requirements for a Level A visual system met) may be considered satisfactory for those installations where the visual system design "eye point" is appropriately adjusted for each pilot's position such that the parallax error is at or less than 10° simultaneously for each pilot.<br>An SOC is required.<br>An objective test is required.  | X                     | X | X |   |   |
| 6.c. ....              | The FTD must provide a continuous visual field of view of at least 146° horizontally and 36° vertically for both pilot seats, simultaneously. The minimum horizontal field of view coverage must be plus and minus one-half (1/2) of the minimum continuous field of view requirement, centered on the zero degree azimuth line relative to the aircraft fuselage. Additional horizontal field of view capability may be added at the sponsor's discretion provided the minimum field of view is retained. Capability for a field of view in excess of these minima is not required for qualification at Level 7. However, where specific tasks require extended fields of view beyond the 146° by 36° (e.g., to accommodate the use of "chin windows" where the accommodation is either integral with or separate from the primary visual system display), then such extended fields of view must be provided.<br>An SOC is required and must explain the geometry of the installation.<br>An objective test is required. |                       |   |   | X | Optimization of the vertical field of view may be considered with respect to the specific helicopter flight deck cut-off angle. When considering the installation/use of augmented fields of view, as described here, it will be the responsibility of the sponsor to meet with the NSPM to determine the training, testing, checking, or experience tasks for which the augmented field of view capability may be critical to that approval. |
| <b>7. Sound System</b> |  |                       |   |   |   |   |
| 7.a. ....              | The FTD must simulate significant flight deck sounds resulting from pilot actions that correspond to those heard in the helicopter.<br>A subjective test is required.  |                       |   | X | X |   |

**Note:** An "A" in the table indicates that the system, task, or procedure may be examined if the appropriate helicopter system or control is simulated in the FTD and is working properly.

TABLE D1B.—MINIMUM FTD REQUIREMENTS

| <<<QPS requirements>>>                |  |           |   |   |   | <<<Information>>> |  |
|---------------------------------------|--|-----------|---|---|---|-------------------|--|
| Number                                | Subjective requirements<br>The FTD must be able to perform the tasks associated<br>with the level of qualification sought. | FTD level |   |   |   | Notes             |  |
|                                       |  | 4         | 5 | 6 | 7 |                   |  |
| <b>1. Preflight Procedures</b>        |  |           |   |   |   |                   |  |
| 1.a. ....                             | Preflight Inspection (Flight Deck Only) switches, indicators, systems, and equipment.                                      | A         | A | X | X |                   |  |
| 1.b. ....                             | APU/Engine start and run-up.   |           |   |   |   |                   |  |
| 1.b.1. ...                            | Normal start procedures .....  | A         | A | X | X |                   |  |
| 1.b.2. ...                            | Alternate start procedures .....   | A         | A | X | X |                   |  |
| 1.b.3. ...                            | Abnormal starts and shutdowns (hot start, hung start) ...  | A         | A | X | X |                   |  |
| 1.c. ....                             | Taxiing—Ground .....   |           |   |   | X |                   |  |
| 1.d. ....                             | Taxiing—Hover .....  |           |   |   | X |                   |  |
| 1.e. ....                             | Pre-takeoff Checks .....   | A         | A | X | X |                   |  |
| <b>2. Takeoff and Departure Phase</b> |  |           |   |   |   |                   |  |
| 2.a. ....                             | Normal takeoff.  |           |   |   |   |                   |  |
| 2.a.1. ...                            | From ground .....  |           |   |   | X |                   |  |
| 2.a.2. ...                            | From hover .....   |           |   |   | X |                   |  |
| 2.a.3. ....                           | Running .....  |           |   |   | X |                   |  |
| 2.b. ....                             | Instrument .....   |           |   | X | X |                   |  |
| 2.c. ....                             | Powerplant Failure During Takeoff .....  |           |   | X | X |                   |  |
| 2.d. ....                             | Rejected Takeoff .....   |           |   |   | X |                   |  |
| 2.e. ....                             | Instrument Departure .....   |           |   | X | X |                   |  |
| <b>3. Climb</b>                       |  |           |   |   |   |                   |  |
| 3.a. ....                             | Normal .....   |           |   | X | X |                   |  |
| 3.b. ....                             | Obstacle clearance .....   |           |   |   | X |                   |  |
| 3.c. ....                             | Vertical .....   |           |   | X | X |                   |  |
| 3.d. ....                             | One engine inoperative .....   |           |   | X | X |                   |  |
| <b>4. In-flight Maneuvers</b>         |  |           |   |   |   |                   |  |
| 4.a. ....                             | Turns (timed, normal, steep) .....   |           | X | X | X |                   |  |
| 4.b. ....                             | Powerplant Failure—Multiengine Helicopters .....   |           |   | X | X |                   |  |
| 4.c. ....                             | Powerplant Failure—Single-Engine Helicopters .....   |           |   | X | X |                   |  |
| 4.d. ....                             | Recovery From Unusual Attitudes .....  |           |   |   | X |                   |  |
| 4.e. ....                             | Settling with Power .....  |           |   |   | X |                   |  |
| <b>5. Instrument Procedures</b>       |  |           |   |   |   |                   |  |
| 5.a. ....                             | Instrument Arrival .....   |           |   | X | X |                   |  |
| 5.b. ....                             | Holding .....  |           |   | X | X |                   |  |
| 5.c. ....                             | Precision Instrument Approach  |           |   |   |   |                   |  |
| 5.c.1. ....                           | Normal—All engines operating .....   |           | X | X | X |                   |  |
| 5.c.2. ....                           | Manually controlled—One or more engines inoperative  |           |   | X | X |                   |  |

TABLE D1B.—MINIMUM FTD REQUIREMENTS—Continued

| <<<QPS requirements>>>                         |  |           |   |   | <<<Information>>> |       |
|--|--|-----------|---|---|-------------------|-------|
| Number   | Subjective requirements<br>The FTD must be able to perform the tasks associated<br>with the level of qualification sought.                                   | FTD level |   |   |                   | Notes |
|  |  | 4         | 5 | 6 | 7                 |       |
| 5.d. ....                                      | Non-precision Instrument Approach .....  |           | X | X | X                 |       |
| 5.e. ....                                      | Missed Approach  |           |   |   |                   |       |
| 5.e.1. ...                                     | All engines operating .....  |           |   | X | X                 |       |
| 5.e.2. ...                                     | One or more engines inoperative .....  |           |   | X | X                 |       |
| 5.e.3. ...                                     | Stability augmentation system failure .....  |           |   | X | X                 |       |
| <b>6. Landings and Approaches to Landings</b>  |  |           |   |   |                   |       |
| 6.a. ....                                      | Visual Approaches (normal, steep, shallow) .....   |           |   |   | X                 |       |
| 6.b. ....                                      | Landings   |           |   |   |                   |       |
| 6.b.1. ...                                     | Normal/crosswind   |           |   |   |                   |       |
| 6.b.1.a.                                       | Running .....  |           |   |   | X                 |       |
| 6.b.1.b.                                       | From Hover .....   |           |   |   | X                 |       |
| 6.b.2. ...                                     | One or more engines inoperative .....  |           |   |   | X                 |       |
| 6.b.3. ...                                     | Rejected Landing .....   |           |   |   | X                 |       |
| <b>7. Normal and Abnormal Procedures</b>       |  |           |   |   |                   |       |
| 7.a. ....                                      | Powerplant .....   | A         | A | X | X                 |       |
| 7.b. ....                                      | Fuel System .....  | A         | A | X | X                 |       |
| 7.c. ....                                      | Electrical System .....  | A         | A | X | X                 |       |
| 7.d. ....                                      | Hydraulic System .....   | A         | A | X | X                 |       |
| 7.e. ....                                      | Environmental System(s) .....  | A         | A | X | X                 |       |
| 7.f. ....                                      | Fire Detection and Extinguisher Systems .....  | A         | A | X | X                 |       |
| 7.g. ....                                      | Navigation and Aviation Systems .....  | A         | A | X | X                 |       |
| 7.h. ....                                      | Automatic Flight Control System, Electronic Flight Instrument System, and Related Subsystems.  | A         | A | X | X                 |       |
| 7.i. ....                                      | Flight Control Systems .....   | A         | A | X | X                 |       |
| 7.j. ....                                      | Anti-ice and Deice Systems .....   | A         | A | X | X                 |       |
| 7.k. ....                                      | Aircraft and Personal Emergency Equipment .....  | A         | A | X | X                 |       |
| 7.l. ....                                      | Special Missions tasks (e.g., Night Vision goggles, Forward Looking Infrared System, External Loads and as may be listed on the Statement of Qualification). |           |   |   | X                 |       |
| <b>8. Emergency procedures (as applicable)</b> |  |           |   |   |                   |       |
| 8.a. ....                                      | Emergency Descent .....  |           |   | X | X                 |       |
| 8.b. ....                                      | Inflight Fire and Smoke Removal .....  |           |   | X | X                 |       |
| 8.c. ....                                      | Emergency Evacuation .....   |           |   | X | X                 |       |
| 8.d. ....                                      | Ditching .....   |           |   |   | X                 |       |
| 8.e. ....                                      | Autorotative Landing .....   |           |   |   | X                 |       |
| 8.f. ....                                      | Retreating blade stall recovery .....  |           |   |   | X                 |       |

TABLE D1B.—MINIMUM FTD REQUIREMENTS—Continued

| <<<QPS requirements>>>          |   |           |   |   | <<<Information>>> |       |
|---------------------------------|---|-----------|---|---|-------------------|-------|
| Number                          | Subjective requirements<br>The FTD must be able to perform the tasks associated with the level of qualification sought. | FTD level |   |   |                   | Notes |
|                                 |   | 4         | 5 | 6 | 7                 |       |
| 8.g. ....                       | Mast bumping .....  |           |   |   | X                 |       |
| 8.h. ....                       | Loss of tail rotor effectiveness .....  |           |   | X | X                 |       |
| <b>9. Postflight Procedures</b> |   |           |   |   |                   |       |
| 9.a. ....                       | After-Landing Procedures .....  | A         | A | X | X                 |       |
| 9.b. ....                       | Parking and Securing  |           |   |   |                   |       |
| 9.b.1. ...                      | Rotor brake operation .....   | A         | A | X | X                 |       |
| 9.b.2. ...                      | Abnormal/emergency procedures .....   | A         | A | X | X                 |       |

**Note:** An “A” in the table indicates that the system, task, or procedure may be examined if the appropriate aircraft system or control is simulated in the FSTD and is working properly.

TABLE D1C.—TABLE OF FTD SYSTEM TASKS

| <<<QPS requirements>>>                       |  |           |   |   | << Information >> |   |
|--|--|-----------|---|---|-------------------|---|
| Number                                       | Subjective requirements<br>In order to be qualified at the FTD qualification level indicated, the FTD must be able to perform at least the tasks associate with that level of qualification. | FTD level |   |   |                   | Notes   |
|  |  | 4         | 5 | 6 | 7                 |   |
| <b>1. Instructor Operating Station (IOS)</b> |  |           |   |   |                   |   |
| 1.a. ....                                    | Power switch(es) .....   | A         | X | X | X                 |   |
| 1.b. ....                                    | Helicopter conditions .....  | A         | A | X | X                 | e.g., GW, CG, Fuel loading, Systems, Ground. Crew.    |
| 1.c. ....                                    | Airports / Heliports / Helicopter Landing Areas .....  | A         | X | X | X                 | e.g., Selection, Surface, Presets, Lighting controls. |
| 1.d. ....                                    | Environmental controls .....   | A         | X | X | X                 | e.g., Temp and Wind.                                  |
| 1.e. ....                                    | Helicopter system malfunctions (Insertion / deletion) ....   | A         | A | X | X                 |   |
| 1.f. ....                                    | Locks, Freezes, and Repositioning (as appropriate) .....   | A         | X | X | X                 |   |
| 1.g. ....                                    | Sound Controls. (On / off / adjustment) .....  |           | X | X | X                 |   |
| 1.fh. ....                                   | Motion / Control Loading System, as appropriate. On / off / emergency stop.  |           | A | X | X                 |   |
| <b>2. Observer Seats / Stations</b>          |  |           |   |   |                   |   |
| 2.a. ....                                    | Position / Adjustment / Positive restraint system .....  | A         | X | X | X                 |   |

**Attachment 2 to Appendix D to Part 60—  
Flight Training Device (FTD) Objective Tests**

**Begin Information**

**1. Discussion**

a. If relevant winds are present in the objective data, the wind vector (magnitude and direction) should be noted as part of the data presentation, expressed in conventional terminology, and related to the runway being used for the test.

b. The format for numbering the objective tests in Appendix C, Attachment 2, Table C2A, and the objective tests in Appendix D, Attachment 2, Table D2A, is identical. However, each test required for FFSs is not necessarily required for FTDs, and each test

required for FTDs is not necessarily required for FFSs. When a test number (or series of numbers) is not required, the term “Reserved” is used in the table at that location. Following this numbering format provides a degree of commonality between the two tables and substantially reduces the potential for confusion when referring to objective test numbers for either FFSs or FTDs.

c. A Level 4 FTD does not require objective tests and is not addressed in the following table.

**End Information**

**Begin QPS Requirements**

**2. Test Requirements**

a. The ground and flight tests required for qualification are listed in Table D2A Objective Evaluation Tests. Computer generated FTD test results must be provided for each test except where an alternate test is specifically authorized by the NSPM. If a flight condition or operating condition is required for the test but does not apply to the helicopter being simulated or to the qualification level sought, it may be disregarded (e.g., engine out climb capability for a single-engine helicopter). Each test result is compared against the validation data described in § 60.13, and in Appendix B. The results must be produced on an appropriate recording device acceptable to the NSPM and

must include FTD number, date, time, conditions, tolerances, and appropriate dependent variables portrayed in comparison to the validation data. Time histories are required unless otherwise indicated in Table D2A. All results must be labeled using the tolerances and units given.

b. Table D2A in this attachment sets out the test results required, including the parameters, tolerances, and flight conditions for FTD validation. Tolerances are provided for the listed tests because mathematical modeling and acquisition and development of reference data are often inexact. All tolerances listed in the following tables are applied to FTD performance. When two tolerance values are given for a parameter, the less restrictive may be used unless otherwise indicated.

c. Certain tests included in this attachment must be supported with a Statement of Compliance and Capability (SOC). In Table D2A, requirements for SOC are indicated in the "Test Details" column.

d. When operational or engineering judgment is used in making assessments for flight test data applications for FTD validity, such judgment must not be limited to a single parameter. For example, data that exhibit rapid variations of the measured parameters may require interpolations or a "best fit" data section. All relevant parameters related to a given maneuver or flight condition must be provided to allow overall interpretation. When it is difficult or impossible to match FTD to helicopter data throughout a time history, differences must be justified by providing a comparison of other related variables for the condition being assessed.

e. The FTD may not be programmed so that the mathematical modeling is correct only at the validation test points. Unless noted otherwise, tests must represent helicopter performance and handling qualities at operating weights and centers of gravity (CG) typical of normal operation. If a test is supported by aircraft data at one extreme weight or CG, another test supported by aircraft data at mid-conditions or as close as possible to the other extreme is necessary. Certain tests that are relevant only at one extreme CG or weight condition need not be repeated at the other extreme. The results of the tests for Level 6 are expected to be indicative of the device's performance and handling qualities throughout all of the following:

- (1) The helicopter weight and CG envelope.
- (2) The operational envelope.
- (3) Varying atmospheric ambient and environmental conditions—including the

extremes authorized for the respective helicopter or set of helicopters.

f. When comparing the parameters listed to those of the helicopter, sufficient data must also be provided to verify the correct flight condition and helicopter configuration changes. For example, to show that control force is within the parameters for a static stability test, data to show the correct airspeed, power, thrust or torque, helicopter configuration, altitude, and other appropriate datum identification parameters must also be given. If comparing short period dynamics, normal acceleration may be used to establish a match to the helicopter, but airspeed, altitude, control input, helicopter configuration, and other appropriate data must also be given. If comparing landing gear change dynamics, pitch, airspeed, and altitude may be used to establish a match to the helicopter, but landing gear position must also be provided. All airspeed values must be properly annotated (e.g., indicated versus calibrated). In addition, the same variables must be used for comparison (e.g., compare inches to inches rather than inches to centimeters).

g. The QTG provided by the sponsor must clearly describe how the FTD will be set up and operated for each test. Each FTD subsystem may be tested independently, but overall integrated testing of the FTD must be accomplished to assure that the total FTD system meets the prescribed standards. A manual test procedure with explicit and detailed steps for completing each test must also be provided.

h. In those cases where the objective test results authorize a "snapshot test" or a "series of snapshot test" results in lieu of a time-history result, the sponsor or other data provider must ensure that a steady state condition exists at the instant of time captured by the "snapshot." The steady state condition must exist from 4 seconds prior to, through 1 second following, the instant of time captured by the snap shot.

i. For previously qualified FTDs, the tests and tolerances of this attachment may be used in subsequent continuing qualification evaluations for any given test if the sponsor has submitted a proposed MQTG revision to the NSPM and has received NSPM approval.

j. Tests of handling qualities must include validation of augmentation devices. FTDs for highly augmented helicopters will be validated both in the unaugmented configuration (or failure state with the maximum permitted degradation in handling qualities) and the augmented configuration. Where various levels of handling qualities

result from failure states, validation of the effect of the failure is necessary. For those performance and static handling qualities tests where the primary concern is control position in the unaugmented configuration, unaugmented data are not required if the design of the system precludes any effect on control position. In those instances where the unaugmented helicopter response is divergent and non-repeatable, it may not be feasible to meet the specified tolerances. Alternative requirements for testing will be mutually agreed upon by the sponsor and the NSPM on a case-by-case basis.

k. Some tests will not be required for helicopters using helicopter hardware in the FTD flight deck (e.g., "helicopter modular controller"). These exceptions are noted in Section 2 "Handling Qualities" in Table D2A of this attachment. However, in these cases, the sponsor must provide a statement that the helicopter hardware meets the appropriate manufacturer's specifications and the sponsor must have supporting information to that fact available for NSPM review.

l. For objective test purposes, "Near maximum" gross weight is a weight chosen by the sponsor or data provider that is not less than the basic operating weight (BOW) of the helicopter being simulated plus 80% of the difference between the maximum certificated gross weight (either takeoff weight or landing weight, as appropriate for the test) and the BOW. "Light" gross weight is a weight chosen by the sponsor or data provider that is not more than 120% of the BOW of the helicopter being simulated or as limited by the minimum practical operating weight of the test helicopter. "Medium" gross weight is a weight chosen by the sponsor or data provider that is within 10 percent of the average of the numerical values of the BOW and the maximum certificated gross weight. BOW is the empty weight of the aircraft plus the weight of the following: Normal oil quantity; lavatory servicing fluid; potable water; required crewmembers and their baggage; and emergency equipment.

**End QPS Requirements**

**Begin Information**

Refer to Advisory Circular 120-27, "Aircraft Weight and Balance;" and FAA-H-8083-1, "Aircraft Weight and Balance Handbook" for more information.

**End Information**

TABLE D2A.—FLIGHT TRAINING DEVICE (FTD) OBJECTIVE TESTS

| <<<QPS requirements>>>        |                   |            |                   |              |           |   | <<Information>> Notes |   |
|-------------------------------|-------------------|------------|-------------------|--------------|-----------|---|-----------------------|---|
| Test                          |                   | Tolerances | Flight conditions | Test details | FTD level |   |                       |   |
| Number                        | Title             |            |                   |              | 5         | 6 |                       | 7 |
| <b>1. Performance</b>         |                   |            |                   |              |           |   |                       |   |
| <b>1.a. Engine Assessment</b> |                   |            |                   |              |           |   |                       |   |
| 1.a.1. ....                   | Start Operations. |            |                   |              |           |   |                       |   |

TABLE D2A.—FLIGHT TRAINING DEVICE (FTD) OBJECTIVE TESTS—Continued

| <<<QPS requirements>>> |   |  |  |   |           |   |   | <<Information>><br>Notes |
|------------------------|---|--|--|---|-----------|---|---|--------------------------|
| Test                   |   | Tolerances   | Flight conditions                              | Test details  | FTD level |   |   |                          |
| Number                 | Title   |  |  |   | 5         | 6 | 7 |                          |
| 1.a.1.a. ....          | Engine start and acceleration (transient).      | Light Off Time—±10% or ±1 sec. Torque—±5% Rotor Speed—±3% Fuel Flow—±10% Gas Generator Speed—±5% Power Turbine Speed—±5% Gas Turbine Temp.—±30 °C.   | Ground with the Rotor Brake Used and Not Used. | Record each engine start from the initiation of the start sequence to steady state idle and from steady state idle to operating RPM.  |           | X | X |                          |
| 1.a.1.b. ....          | Steady State Idle and Operating RPM conditions. | Torque—±3% Rotor Speed—±1.5% Fuel Flow—±5% Gas Generator Speed—±2% Power Turbine Speed—±2% Turbine Gas Temp.—±20 °C.   | Ground .....                                   | Record both steady state idle and operating RPM conditions. May be a series of snapshot tests.  | X         | X | X |                          |
| 1.a.2. ....            | Power Turbine Speed Trim.                       | ±10% of total change of power turbine speed.   | Ground .....                                   | Record engine response to trim system actuation in both directions.   |           | X | X |                          |
| 1.a.2.a. ....          | Engine and Rotor Speed Governing.               | Torque—±5% Rotor Speed—±1.5%.  | Climb Descent ...                              | Record results using a step input to the collective. May be conducted concurrently with climb and descent performance tests.  |           | X | X |                          |
| 1.a.3. ....            | Reserved.                                       |  |  |   |           |   |   |                          |
| 1.b. Reserved          |   |  |  |   |           |   |   |                          |
| 1.c. Takeoff           |   |  |  |   |           |   |   |                          |
| 1.c.1. ....            | All Engines .....                               | Airspeed—±3 kt, Altitude—±20 ft (6.1 m) Torque—±3%, Rotor Speed—±1.5%, Vertical Velocity—±100 fpm (0.50 m/sec) or 10%, Pitch Attitude—±1.5°, Bank Attitude—±2°, Heading—±2°, Longitudinal Control Position—±10%, Lateral Control Position—±10%, Directional Control Position—±10%, Collective Control Position—±10%. | Ground/Takeoff and Initial Segment of Climb.   | Record results of takeoff flight path (running takeoff and takeoff from a hover). The criteria apply only to those segments at airspeeds above effective translational lift. Results must be recorded from the initiation of the takeoff to at least 200 ft (61 m) AGL. |           |   | X |                          |
| 1.c.2. through 1.c.3.  | Reserved.                                       |  |  |   |           |   |   |                          |
| 1.d. Hover             |   |  |  |   |           |   |   |                          |

TABLE D2A.—FLIGHT TRAINING DEVICE (FTD) OBJECTIVE TESTS—Continued

| <<<QPS requirements>>> |   |   |   |   |           |   |   | <<Information>><br>Notes  |
|------------------------|---|---|---|---|-----------|---|---|---|
| Test                   |   | Tolerances  | Flight conditions   | Test details  | FTD level |   |   |   |
| Number                 | Title   |   |   |   | 5         | 6 | 7 |   |
|                        | Performance .....   | Torque—±3%, Pitch Attitude—±1.5°, Bank Attitude—±1.5°, Longitudinal Control Position—±5%, Lateral Control Position—±5%, Directional Control Position—±5%, Collective Control Position—±5%.                            | In Ground Effect (IGE); and Out of Ground Effect (OGE).   | Record results for light and heavy gross weights. May be a series of snapshot tests.  |           |   | X |   |
| 1.e. Vertical Climb    |   |   |   |   |           |   |   |   |
|                        | Performance .....   | Vertical Velocity—±100 fpm (0.50 m/sec) or ±10%, Directional Control Position—±5%, Collective Control Position—±5%.   | From OGE Hover.   | Record results for light and heavy gross weights. May be a series of snapshot tests.  |           |   | X |   |
| 1.f. Level Flight      |   |   |   |   |           |   |   |   |
|                        | Performance and Trimmed Flight Control Positions.         | Torque—±3% Pitch Attitude—±1.5° Sideslip Angle—±2° Longitudinal Control Position—±5% Lateral Control Position—±5% Directional Control Position—±5% Collective Control Position—±5%.                                   | Cruise (Augmentation On and Off).   | Record results for two gross weight and CG combinations with varying trim speeds throughout the airspeed envelope. May be a series of snapshot tests.     | X         | X | X | This test validates performance at speeds above maximum endurance airspeed. |
| 1.g. Climb             |   |   |   |   |           |   |   |   |
|                        | Performance and Trimmed Flight Control Positions.         | Vertical Velocity—±100 fpm (61m/sec) or ±10% Pitch Attitude—±1.5° Sideslip Angle—±2° Longitudinal Control Position—±5% Lateral Control Position—±5% Directional Control Position—±5% Collective Control Position—±5%. | All engines operating. One engine inoperative. Augmentation System(s) On and Off.                                 | Record results for two gross weight and CG combinations. The data presented must be for normal climb power conditions. May be a series of snapshot tests. | X         | X | X |   |
| 1.h. Descent           |   |   |   |   |           |   |   |   |
| 1.h.1. ....            | Descent Performance and Trimmed Flight Control Positions. | Torque—±3% Pitch Attitude—±1.5° Sideslip Angle—±2° Longitudinal Control Position—±5% Lateral Control Position—±5% Directional Control Position—±5% Collective Control Position—±5%.                                   | At or near 1,000 fpm (5 m/sec) rate of descent (RoD) at normal approach speed. Augmentation System(s) On and Off. | Record results for two gross weight and CG combinations. May be a series of snapshot tests.   | X         | X | X |   |

TABLE D2A.—FLIGHT TRAINING DEVICE (FTD) OBJECTIVE TESTS—Continued

| <<<QPS requirements>>> |  |   |   |  |           |   | <<Information>><br>Notes |   |
|------------------------|--|---|---|--|-----------|---|--------------------------|---|
| Test                   |  | Tolerances  | Flight conditions                                   | Test details   | FTD level |   |                          |   |
| Number                 | Title  |   |   |  | 5         | 6 |                          | 7 |
| 1.h.2. ....            | Autorotation Performance and Trimmed Flight Control Positions. | Pitch Attitude—±1.5°<br>Sideslip Angle—±2°<br>Longitudinal Control Position—±5%<br>Lateral Control Position—±5%<br>Directional Control Position—±5%<br>Collective Control Position—±5%. | Steady descents. Augmentation System(s) On and Off. | Record results for two gross weight conditions. Data must be recorded for normal operating RPM. (Rotor speed tolerance applies only if collective control position is full down.) Data must be recorded for speeds from 50 kts., ±5 kts through at least maximum glide distance airspeed. May be a series of snapshot tests. | X         | X | X                        |   |
| 1.i. Autorotation      |  |   |   |  |           |   |                          |   |
|                        | Entry .....  | Rotor Speed—±3%<br>Pitch Attitude ±2°<br>Roll Attitude—±3°<br>Yaw Attitude—±5°<br>Airspeed—±5 kts.<br>Vertical Velocity—±200 fpm (1.00 m/sec) or 10%.                                   | Cruise; or Climb                                    | Record results of a rapid throttle reduction to idle. If accomplished in cruise, results must be for the maximum range airspeed. If accomplished in climb, results must be for the maximum rate of climb airspeed at or near maximum continuous power.   |           | X | X                        |   |
| 1.j. Landing           |  |   |   |  |           |   |                          |   |



TABLE D2A.—FLIGHT TRAINING DEVICE (FTD) OBJECTIVE TESTS—Continued

| <<<QPS requirements>>>       |  |  |  |  |           |   |   | <<Information>><br>Notes |
|------------------------------|--|--|--|--|-----------|---|---|--------------------------|
| Test                         |  | Tolerances   | Flight conditions  | Test details   | FTD level |   |   |                          |
| Number                       | Title                                      |  |  |  | 5         | 6 | 7 |                          |
| 1.j.1. ....                  | All Engines .....                          | Airspeed— $\pm 3$ kts., Altitude— $\pm 20$ ft.(6.1 m) Torque— $\pm 3\%$ , Rotor Speed— $\pm 1.5\%$ , Pitch Attitude— $\pm 1.5^\circ$ , Bank Attitude— $\pm 1.5^\circ$ , Heading— $\pm 2^\circ$ , Longitudinal Control Position— $\pm 10\%$ , Lateral Control Position— $\pm 10\%$ , Directional Control Position— $\pm 10\%$ , Collective Control Position— $\pm 10\%$ . | Approach .....   | Record results of the approach and landing profile (running landing or approach to a hover). The criteria apply only to those segments at airspeeds above effective translational lift. Record the results from 200 ft. AGL (61 m) to the landing or to where the hover is established prior to landing. |           |   | X |                          |
| 1.j.2. through<br>1.j.3.     | Reserved.                                  |  |  |  |           |   |   |                          |
| 1.j.4. ....                  | Autorotational Landing.                    | Torque— $\pm 3\%$ , Rotor Speed— $\pm 3\%$ , Vertical Velocity— $\pm 100$ fpm (0.50 m/sec) or 10%, Pitch Attitude— $\pm 2^\circ$ , Bank Attitude— $\pm 2^\circ$ , Heading— $\pm 5^\circ$ , Longitudinal Control Position— $\pm 10\%$ , Lateral Control Position— $\pm 10\%$ , Directional Control Position— $\pm 10\%$ , Collective Control Position— $\pm 10\%$ .       | Landing .....  | Record the results of an autorotational deceleration and landing from a stabilized autorotational descent, to touch down.  |           |   | X |                          |
| <b>2. Handling Qualities</b> |  |  |  |  |           |   |   |                          |
| 2.a. ....                    | Control System Mechanical Characteristics. | Contact the NSPM for clarification of any issue regarding helicopters with reversible controls.  |  |  |           |   |   |                          |
| 2.a.1. ....                  | Cyclic .....                               | Breakout— $\pm 0.25$ lbs. (0.112 daN) or 25%. Force— $\pm 1.0$ lb. (0.224 daN) or 10%.   | Ground; Static conditions. Trim On and Off. Friction Off. Augmentation On and off. | Record results for an uninterrupted control sweep to the stops. (This test does not apply if aircraft hardware modular controllers are used.)  | X         | X | X |                          |
| 2.a.2. ....                  | Collective and Pedals.                     | Breakout— $\pm 0.5$ lb. (0.224 daN) or 25%. Force— $\pm 1.0$ lb. (0.224 daN) or 10%.   | Ground; Static conditions. Trim On and Off. Friction Off Augmentation On and Off.  | Record results for an uninterrupted control sweep to the stops.  | X         | X | X |                          |

TABLE D2A.—FLIGHT TRAINING DEVICE (FTD) OBJECTIVE TESTS—Continued

| <<<QPS requirements>>>                      |  |   |   |  |           |   |   | <<Information>><br>Notes  |
|---|--|---|---|--|-----------|---|---|---|
| Test  |  | Tolerances  | Flight conditions   | Test details   | FTD level |   |   |   |
| Number                                      | Title                                      |   |   |  | 5         | 6 | 7 |   |
| 2.a.3. ....                                 | Brake Pedal Force vs. Position.            | ±5 lbs. (2.224 daN) or 10%.   | Ground; Static conditions.  |  | X         | X | X |   |
| 2.a.4. ....                                 | Trim System Rate (all applicable systems). | Rate—±10% .....   | Ground; Static conditions. Trim On Friction Off.  | The tolerance applies to the recorded value of the trim rate.  | X         | X | X |   |
| 2.a.5. ....                                 | Control Dynamics (all axes).               | ±10% of time for first zero crossing and ±10 (N+1)% of period thereafter. ±10% of amplitude of first overshoot. ±20% of amplitude of 2nd and subsequent overshoots greater than 5% of initial displacement. ±1 overshoot. | Hover/Cruise Trim On Friction Off.  | Results must be recorded for a normal control displacement in both directions in each axis, using 25% to 50% of full throw.                              |           | X | X | Control Dynamics for irreversible control systems may be evaluated in a ground/static condition. Refer to paragraph 3 of this attachment for additional information. "N" is the sequential period of a full cycle of oscillation. |
| 2.a.6. ....                                 | Freeplay .....                             | ±0.10 in .....  | Ground; Static conditions.  | Record and compare results for all controls.   | X         | X | X |   |
| <b>2.b. Low Airspeed Handling Qualities</b> |  |   |   |  |           |   |   |   |
| 2.b.1. ....                                 | Trimmed Flight Control Positions.          | Torque ±3% Pitch Attitude ±1.5° Bank Attitude ±2° Longitudinal Control Position ±5% Lateral Control Position ±5% Directional Control Position ±5% Collective Control Position ±5%.  | Translational Flight IGE—Sideward, rearward, and forward flight. Augmentation On and Off. | Record results for several airspeed increments to the translational airspeed limits and for 45 kts. forward airspeed. May be a series of snapshot tests. |           |   | X |   |
| 2.b.2. ....                                 | Critical Azimuth                           | Torque ±3% Pitch Attitude ±1.5°, Bank Attitude ±2°, Longitudinal Control Position ±5%, Lateral Control Position ±5%, Directional Control Position ±5%, Collective Control Position ±5%.                                   | Stationary Hover. Augmentation On and Off.  | Record results for three relative wind directions (including the most critical case) in the critical quadrant. May be a series of snapshot tests.        |           |   | X |   |
| 2.b.3. ....                                 | Control Response.                          |   |   |  |           |   |   |   |

TABLE D2A.—FLIGHT TRAINING DEVICE (FTD) OBJECTIVE TESTS—Continued

| <<<QPS requirements>>>               |                    |  |                                 |   |           |   |   | <<Information>><br>Notes     |
|--------------------------------------|--------------------|--|---------------------------------|---|-----------|---|---|------------------------------|
| Test                                 |                    | Tolerances   | Flight conditions               | Test details  | FTD level |   |   |                              |
| Number                               | Title              |  |                                 |   | 5         | 6 | 7 |                              |
| 2.b.3.a. ....                        | Longitudinal ..... | Pitch Rate— $\pm 10\%$ or $\pm 2^\circ$ /sec. Pitch Attitude Change— $\pm 10\%$ or $1.5^\circ$ .     | Hover. Augmentation On and Off. | Record results for a step control input. The Off-axis response must show correct trend for un-augmented cases. This test must be conducted in a hover, in ground effect, without entering translational flight. |           |   | X | This is a "short time" test. |
| 2.b.3.c. ....                        | Directional .....  | Yaw Rate— $\pm 10\%$ or $\pm 2^\circ$ /sec. Heading Change— $\pm 10\%$ or $\pm 2^\circ$ .            | Hover Augmentation On and Off.  | Record results for a step control input. The Off-axis response must show correct trend for un-augmented cases. This test must be conducted in a hover, in ground effect, without entering translational flight. |           |   | X | This is a "short time" test. |
| 2.b.3.d. ....                        | Vertical .....     | Normal Acceleration $\pm 0.1g$ .   | Hover .....                     | Record results for a step control input. The Off-axis response must show correct trend for un-augmented cases.  |           |   | X |                              |
| 2.c. Longitudinal Handling Qualities |                    |  |                                 |   |           |   |   |                              |
| 2.c.1. ....                          | Control Response.  | Pitch Rate— $\pm 10\%$ or $\pm 2^\circ$ /sec. Pitch Attitude Change— $\pm 10\%$ or $\pm 1.5^\circ$ . | Cruise Augmentation On and Off. | Results must be recorded for two cruise airspeeds to include minimum power required speed. Record data for a step control input. The Off-axis response must show correct trend for un-augmented cases.          | X         | X | X |                              |

TABLE D2A.—FLIGHT TRAINING DEVICE (FTD) OBJECTIVE TESTS—Continued

| <<<QPS requirements>>> |                       |  |   |  |           |   |   | <<Information>><br>Notes  |
|------------------------|-----------------------|--|---|--|-----------|---|---|---|
| Test                   |                       | Tolerances   | Flight conditions                                       | Test details   | FTD level |   |   |   |
| Number                 | Title                 |  |   |  | 5         | 6 | 7 |   |
| 2.c.2. ....            | Static Stability .... | Longitudinal Control Position: $\pm 10\%$ of change from trim or $\pm 0.25$ in. (6.3 mm) or Longitudinal Control Force: $\pm 0.5$ lb. (0.223 daN) or $\pm 10\%$ .  | Cruise or Climb. Autorotation. Augmentation On and Off. | Record results for a minimum of two speeds on each side of the trim speed. May be a series of snapshot tests.  | X         | X | X |   |
| 2.c.3. ....            | Dynamic Stability.    |  |   |  |           |   |   |   |
| 2.c.3.a. ....          | Long Term Response.   | $\pm 10\%$ of calculated period. $\pm 10\%$ of time to $\frac{1}{2}$ or double amplitude, or $\pm 0.02$ of damping ratio. For non-periodic responses, the time history must be matched within $\pm 10\%$ pitch; and $\pm 10\%$ air-speed over a 20 sec period following release of the controls. | Cruise Augmentation On and Off.                         | Record results for three full cycles (6 overshoots after input completed) or that sufficient to determine time to $\frac{1}{2}$ or double amplitude, whichever is less. For non-periodic responses, the test may be terminated prior to 20 sec if the test pilot determines that the results are becoming uncontrollably divergent. Displace the cyclic for one second or less to excite the test. The result will be either convergent or divergent and must be recorded. If this method fails to excite the test, displace the cyclic to the predetermined maximum desired pitch attitude and return to the original position. If this method is used, record the results. | X         | X | X | The response for certain helicopters may be unrepeatable throughout the stated time.            |
| 2.c.3.b. ....          | Short Term Response.  | $\pm 1.5^\circ$ Pitch or $\pm 2^\circ/\text{sec}$ . Pitch Rate. $\pm 0.1$ g Normal Acceleration.   | Cruise or Climb. Augmentation On and Off.               | Record results for at least two airspeeds.   |           | X | X | A control doublet inserted at the natural frequency of the aircraft normally excites this test. |

TABLE D2A.—FLIGHT TRAINING DEVICE (FTD) OBJECTIVE TESTS—Continued

| <<<QPS requirements>>>                          |                        |  |   |  |           |   |   | <<Information>><br>Notes |
|---|------------------------|--|---|--|-----------|---|---|--------------------------|
| Test  |                        | Tolerances   | Flight conditions                         | Test details   | FTD level |   |   |                          |
| Number  | Title                  |  |   |  | 5         | 6 | 7 |                          |
| 2.c.4. ....                                     | Maneuvering Stability. | Longitudinal Control Position— $\pm 10\%$ of change from trim or $\pm 0.25$ in. (6.3 mm) or Longitudinal Control Forces— $\pm 0.5$ lb. (0.223 daN) or $\pm 10\%$ . | Cruise or Climb. Augmentation On and Off. | Record results for at least two airspeeds at $30^\circ$ – $45^\circ$ bank angle. The force may be shown as a cross plot for irreversible systems. May be a series of snapshot tests.   |           | X | X |                          |
| 2.d. Lateral and Directional Handling Qualities |                        |  |   |  |           |   |   |                          |
| 2.d.1. ....                                     | Control Response.      |  |   |  |           |   |   |                          |
| 2.d.1.a ....                                    | Lateral .....          | Roll Rate— $\pm 10\%$ or $\pm 3^\circ$ /sec. Roll Attitude Change— $\pm 10\%$ or $\pm 3^\circ$ .   | Cruise Augmentation On and Off.           | Record results for at least two airspeeds, including the speed at or near the minimum power required airspeed. Record results for a step control input. The Off-axis response must show correct trend for unaugmented cases. | X         | X | X |                          |
| 2.d.1.b. ....                                   | Directional .....      | Yaw Rate— $\pm 10\%$ or $\pm 2^\circ$ /sec. Yaw Attitude Change— $\pm 10\%$ or $\pm 2^\circ$ .   | Cruise Augmentation On and Off.           | Record data for at least two Airspeeds, including the speed at or near the minimum power required airspeed. Record results for a step control input. The Off-axis response must show correct trend for unaugmented cases.    | X         | X | X |                          |

TABLE D2A.—FLIGHT TRAINING DEVICE (FTD) OBJECTIVE TESTS—Continued

| <<<QPS requirements>>> |  |   |   |   |           |   |   | <<Information>><br>Notes                |
|------------------------|--|---|---|---|-----------|---|---|---|
| Test                   |  | Tolerances  | Flight conditions   | Test details  | FTD level |   |   |   |
| Number                 | Title                                      |   |   |   | 5         | 6 | 7 |   |
| 2.d.2. ....            | Directional Static Stability.              | Lateral Control Position— $\pm 10\%$ of change from trim or $\pm 0.25$ in. (6.3 mm) or Lateral Control Force— $\pm 0.5$ lb. (0.223 daN) or 10%. Roll Attitude— $\pm 1.5$ Directional Control Position— $\pm 10\%$ of change from trim or $\pm 0.25$ in. (6.3 mm) or Directional Control Force— $\pm 1$ lb. (0.448 daN) or 10%. Longitudinal Control Position— $\pm 10\%$ of change from trim or $\pm 0.25$ in. (6.3 mm). Vertical Velocity— $\pm 100$ fpm (0.50m/sec) or 10%. | Cruise; or Climb (may use Descent instead of Climb if desired) Augmentation On and Off. | Record results for at least two sideslip angles on either side of the trim point. The force may be shown as a cross plot for irreversible systems. May be a series of snapshot tests.   | X         | X | X | This is a steady heading sideslip test. |
| 2.d.3. ....            | Dynamic Lateral and Directional Stability. |   |   |   |           |   |   |   |
| 2.d.3.a. ....          | Lateral-Directional Oscillations.          | $\pm 0.5$ sec. or $\pm 10\%$ of period. $\pm 10\%$ of time to $\frac{1}{2}$ or double amplitude or $\pm 0.02$ of damping ratio. $\pm 20\%$ or $\pm 1$ sec of time difference between peaks of bank and sideslip.  | Cruise or Climb Augmentation On/Off.  | Record results for at least two airspeeds. The test must be initiated with a cyclic or a pedal doublet input. Record results for six full cycles (12 overshoots after input completed) or that sufficient to determine time to $\frac{1}{2}$ or double amplitude, whichever is less. For non-periodic response, the test may be terminated prior to 20 sec if the test pilot determines that the results are becoming uncontrollably divergent. | X         | X | X |   |

TABLE D2A.—FLIGHT TRAINING DEVICE (FTD) OBJECTIVE TESTS—Continued

| <<<QPS requirements>>>   |                           |   |   |  |           |   |   | <<Information>><br>Notes |
|--|---------------------------|---|---|--|-----------|---|---|--------------------------|
| Test   |                           | Tolerances  | Flight conditions                               | Test details   | FTD level |   |   |                          |
| Number   | Title                     |   |   |  | 5         | 6 | 7 |                          |
| 2.d.3.b. ....  | Spiral Stability ...      | ±2° or ±10% roll angle ....                       | Cruise or Climb.<br>Augmentation<br>On and Off. | Record the re-<br>sults of a re-<br>lease from<br>pedal only or<br>cyclic only<br>turns for 20<br>sec. Results<br>must be re-<br>corded from<br>turns in both<br>directions. Ter-<br>minate check<br>at zero roll<br>angle or when<br>the test pilot<br>determines<br>that the atti-<br>tude is becom-<br>ing uncontrol-<br>lably divergent. | X         | X | X |                          |
| 2.d.3.c. ....  | Adverse/<br>Proverse Yaw. | Correct Trend, ±2° tran-<br>sient sideslip angle. | Cruise or Climb.<br>Augmentation<br>On and Off. | Record the time<br>history of initial<br>entry into cyc-<br>lic only turns,<br>using only a<br>moderate rate<br>for cyclic input.<br>Results must<br>be recorded<br>for turns in<br>both directions.   | X         | X | X |                          |
| <b>3. Reserved</b>   |                           |   |   |  |           |   |   |                          |
| <b>4. Visual System</b>  |                           |   |   |  |           |   |   |                          |
| 4.a. Visual System Response Time: (Choose either test 4.a.1. or 4.a.2. to satisfy test 4.a., Visual System Response Time Test. This test is also sufficient for flight deck instrument response timing.) |                           |   |   |  |           |   |   |                          |
| 4.a.1. ....  | Latency.                  |   |   |  |           |   |   |                          |
|  |                           | 150 ms (or less) after heli-<br>copter response.  | Takeoff, climb,<br>and descent.                 | One test is re-<br>quired in each<br>axis (pitch, roll<br>and yaw) for<br>each of the<br>three condi-<br>tions (take-off,<br>cruise, and ap-<br>proach or<br>landing).   |           |   | X |                          |
| 4.a.2. ....  | Transport Delay.          |   |   |  |           |   |   |                          |
|  |                           | 150 ms (or less) after<br>controller movement.    | N/A .....                                       | A separate test<br>is required in<br>each axis<br>(pitch, roll, and<br>yaw).   |           |   | X |                          |
| <b>4.b. Field of View</b>  |                           |   |   |  |           |   |   |                          |
| 4.b.1. ....  | Reserved.                 |   |   |  |           |   |   |                          |

TABLE D2A.—FLIGHT TRAINING DEVICE (FTD) OBJECTIVE TESTS—Continued

| <<<QPS requirements>>> |                                  |  |                   |   |           |   |   | <<Information>><br>Notes  |
|------------------------|----------------------------------|--|-------------------|---|-----------|---|---|---|
| Test                   |                                  | Tolerances   | Flight conditions | Test details  | FTD level |   |   |   |
| Number                 | Title                            |  |                   |   | 5         | 6 | 7 |   |
| 4.b.2. ....            | Continuous visual field of view. | Minimum continuous field of view providing 146° horizontal and 36° vertical field of view for each pilot simultaneously and any geometric error between the Image Generator eye point and the pilot eye point is 8° or less. | N/A .....         | An SOC is required and must explain the geometry of the installation. Horizontal field of view must not be less than a total of 146° (including not less than 73° measured either side of the center of the design eye point). Additional horizontal field of view capability may be added at the sponsor's discretion provided the minimum field of view is retained. Vertical field of view: Not less than a total of 36° measured from the pilot's and co-pilot's eye point. |           |   | X | Horizontal field of view is centered on the zero degree azimuth line relative to the aircraft fuselage.   |
| 4.b.3. ....            | Reserved.                        |  |                   |   |           |   |   |   |
| 4.c. ....              | Surface contrast ratio.          | Not less than 5:1 .....  | N/A .....         | The ratio is calculated by dividing the brightness level of the center, bright square (providing at least 2 foot-lamberts or 7 cd/m <sup>2</sup> ) by the brightness level of any adjacent dark square.   |           |   | X | Measurements may be made using a 1° spot photometer and a raster drawn test pattern filling the entire visual scene (all channels) with a test pattern of black and white squares, 5 per square, with a white square in the center of each channel. During contrast ratio testing, simulator aft-cab and flight deck ambient light levels should be zero. |



TABLE D2A.—FLIGHT TRAINING DEVICE (FTD) OBJECTIVE TESTS—Continued

| <<<QPS requirements>>> |                       |  |                   |  |           |   |   | <<Information>><br>Notes  |
|------------------------|-----------------------|--|-------------------|--|-----------|---|---|---|
| Test                   |                       | Tolerances   | Flight conditions | Test details   | FTD level |   |   |   |
| Number                 | Title                 |  |                   |  | 5         | 6 | 7 |   |
| 4.d. ....              | Highlight brightness. | Not less than three (3) foot-lamberts (10 cd/m <sup>2</sup> ). | N/A .....         | Measure the brightness of the center white square while superimposing a highlight on that white square. The use of calligraphic capabilities to enhance the raster brightness is acceptable, but measuring light points is not acceptable. |           |   | X | Measurements may be made using a 1° spot photometer and a raster drawn test pattern filling the entire visual scene (all channels) with a test pattern of black and white squares, 5 per square, with a white square in the center of each channel.   |
| 4.e. ....              | Surface resolution.   | Not greater than two (2) arc minutes.                          | N/A .....         | An SOC is required and must include the relevant calculations.   |           |   | X | The eye will subtend two (2) arc minutes when positioned on a 3° glide slope, 6,876 ft slant range from the centrally located threshold of a black runway surface painted with white threshold bars that are 16 ft wide with 4-foot gaps between the bars. This requirement is the same as 4 arc minutes per optical line pair. |
| 4.f. ....              | Light point size ..   | Not greater than five (5) arc-minutes.                         | N/A .....         | An SOC is required and must include the relevant calculations.   |           |   | X | Light point size may be measured using a test pattern consisting of a centrally located single row of light points reduced in length until modulation is just discernible in each visual channel. A row of 48 lights will form a 4° angle or less.  |

TABLE D2A.—FLIGHT TRAINING DEVICE (FTD) OBJECTIVE TESTS—Continued

| <<<QPS requirements>>>     |                             |   |   |  |           |   | <<Information>><br>Notes |  |
|----------------------------|-----------------------------|---|---|--|-----------|---|--------------------------|--|
| Test                       |                             | Tolerances  | Flight conditions   | Test details   | FTD level |   |                          |  |
| Number                     | Title                       |   |   |  | 5         | 6 |                          | 7  |
| 4.g. ....                  | Light point contrast ratio. |   |   |  |           |   |                          | A 1° spot photometer may be used to measure a square of at least 1° filled with light points (where light point modulation is just discernible) and compare the results to the measured adjacent background. During contrast ratio testing, simulator aft-cab and flight deck ambient light levels should be zero. |
| 4.g.1. ....                | Reserved.                   |   |   |  |           |   |                          |  |
| 4.g.2. ....                |                             | Not less than 25:1 .....  | N/A .....   | An SOC is required and must include the relevant calculations.   |           |   | X                        |  |
| 4.h. Visual ground segment |                             |   |   |  |           |   |                          |  |
|                            |                             | The visible segment in the simulator must be within 20% of the segment computed to be visible from the helicopter flight deck. The tolerance(s) may be applied at either end or at both ends of the displayed segment. However, lights and ground objects computed to be visible from the helicopter flight deck at the near end of the visible segment must be visible in the simulator. | Landing configuration, trimmed for appropriate airspeed, at 100 ft (30 m) above the touchdown zone, on glide slope with an RVR value set at 1,200 ft (350 m). | The QTG must contain relevant calculations and a drawing showing the data used to establish the helicopter location and the segment of the ground that is visible considering design eyepoint, helicopter attitude, flight deck cut-off angle, and a visibility of 1200 ft (350 m) RVR. Simulator performance must be measured against the QTG calculations. The data submitted must include at least the following: |           |   | X                        | Pre-position for this test is encouraged, but may be achieved via manual or autopilot control to the desired position.   |

TABLE D2A.—FLIGHT TRAINING DEVICE (FTD) OBJECTIVE TESTS—Continued

| <<<QPS requirements>>> |       |            |                   |   |           |   | <<Information>><br>Notes |   |
|------------------------|-------|------------|-------------------|---|-----------|---|--------------------------|---|
| Test                   |       | Tolerances | Flight conditions | Test details  | FTD level |   |                          |   |
| Number                 | Title |            |                   |   | 5         | 6 |                          | 7 |
|                        |       |            |                   | (1) Static helicopter dimensions as follows: (i) Horizontal and vertical distance from main landing gear (MLG) to glideslope reception antenna. (ii) Horizontal and vertical distance from MLG to pilot's eyepoint. (iii) Static flight deck cutoff angle.<br>(2) Approach data as follows: (i) Identification of runway. (ii) Horizontal distance from runway threshold to glideslope intercept with runway. (iii) Glideslope angle. (iv) Helicopter pitch angle on approach.<br>(3) Helicopter data for manual testing: (i) Gross weight. (ii) Helicopter configuration. (iii) Approach airspeed. If non-homogeneous fog is used to obscure visibility, the vertical variation in horizontal visibility must be described and be included in the slant range visibility calculation used in the computations. |           |   |                          |   |

5. Reserved

Begin Information

3. Control Dynamics

a. The characteristics of a helicopter flight control system have a major effect on the handling qualities. A significant consideration in pilot acceptability of a helicopter is the "feel" provided through the flight deck controls. Considerable effort is expended on helicopter feel system design in order to deliver a system with which pilots will be comfortable and consider the helicopter desirable to fly. In order for an FTD to be representative, it too must present the pilot with the proper feel; that of the respective helicopter.

(1) Recordings such as free response to an impulse or step function are classically used to estimate the dynamic properties of electromechanical systems. It is only possible to estimate the dynamic properties as a result of only being able to estimate true inputs and responses. Therefore, it is imperative that the best possible data be collected since close matching of the FTD control loading system to the helicopter systems is essential. Control feel dynamic tests are described in the Table of Objective Tests in this appendix. Where accomplished, the free response is measured after a step or pulse input is used to excite the system.

(2) For initial and upgrade evaluations, it is required that control dynamic characteristics be measured at and recorded directly from the flight deck controls. This procedure is usually accomplished by measuring the free response of the controls using a step or pulse input to excite the system. The procedure must be accomplished in hover, climb, cruise, and autorotation. For helicopters with irreversible control systems, measurements may be obtained on the ground. Proper pitot-static inputs (if appropriate) must be provided to represent airspeeds typical of those encountered in flight.

(3) It may be shown that for some helicopters, climb, cruise, and autorotation have like effects. Thus, some tests for one may suffice for some tests for another. If either or both considerations apply, engineering validation or helicopter manufacturer rationale must be submitted as justification for ground tests or for eliminating a configuration. For FTDs requiring static and dynamic tests at the controls, special test fixtures will not be

required during initial and upgrade evaluations if the sponsor's QTG shows both test fixture results and the results of an alternative approach, such as computer plots which were produced concurrently and show satisfactory agreement. Repeat of the alternative method during the initial evaluation would then satisfy this test requirement.

b. Control Dynamics Evaluations. The dynamic properties of control systems are often stated in terms of frequency, damping, and a number of other classical measurements which can be found in texts on control systems. In order to establish a consistent means of validating test results for FTD control loading, criteria are needed that will clearly define the interpretation of the measurements and the tolerances to be applied. Criteria are needed for both the underdamped system and the overdamped system, including the critically damped case. In the case of an underdamped system with very light damping, the system may be quantified in terms of frequency and damping. In critically damped or overdamped systems, the frequency and damping is not readily measured from a response time history. Therefore, some other measurement must be used.

(1) Tests to verify that control feel dynamics represent the helicopter must show that the dynamic damping cycles (free response of the control) match that of the helicopter within specified tolerances. The method of evaluating the response and the tolerance to be applied are described below for the underdamped and critically damped cases.

(a) Underdamped Response. Two measurements are required for the period, the time to first zero crossing (in case a rate limit is present) and the subsequent frequency of oscillation. It is necessary to measure cycles on an individual basis in case there are nonuniform periods in the response. Each period will be independently compared to the respective period of the helicopter control system and, consequently, will enjoy the full tolerance specified for that period.

(b) The damping tolerance will be applied to overshoots on an individual basis. Care must be taken when applying the tolerance to small overshoots since the significance of such overshoots becomes questionable. Only those overshoots larger than 5 percent of the total initial displacement will be considered significant. The residual band, labeled T(A<sub>d</sub>)

on Figure 1 of this attachment is ±5 percent of the initial displacement amplitude, A<sub>0</sub>, from the steady state value of the oscillation. Oscillations within the residual band are considered insignificant. When comparing simulator data to helicopter data, the process would begin by overlaying or aligning the simulator and helicopter steady state values and then comparing amplitudes of oscillation peaks, the time of the first zero crossing, and individual periods of oscillation. To be satisfactory, the simulator must show the same number of significant overshoots to within one when compared against the helicopter data. The procedure for evaluating the response is illustrated in Figure 1 of this attachment.

(c) Critically Damped and Overdamped Response. Due to the nature of critically damped responses (no overshoots), the time to reach 90 percent of the steady state (neutral point) value must be the same as the helicopter within ±10 percent. The simulator response must be critically damped also. Figure 2 of this attachment illustrates the procedure.

(d) Special considerations. Control systems that exhibit characteristics other than classical overdamped or underdamped responses should meet specified tolerances. In addition, special consideration should be given to ensure that significant trends are maintained.

(2) Tolerances.

(a) The following summarizes the tolerances, "T" for underdamped systems, and "n" is the sequential period of a full cycle of oscillation. See Figure D2A of this attachment for an illustration of the referenced measurements.

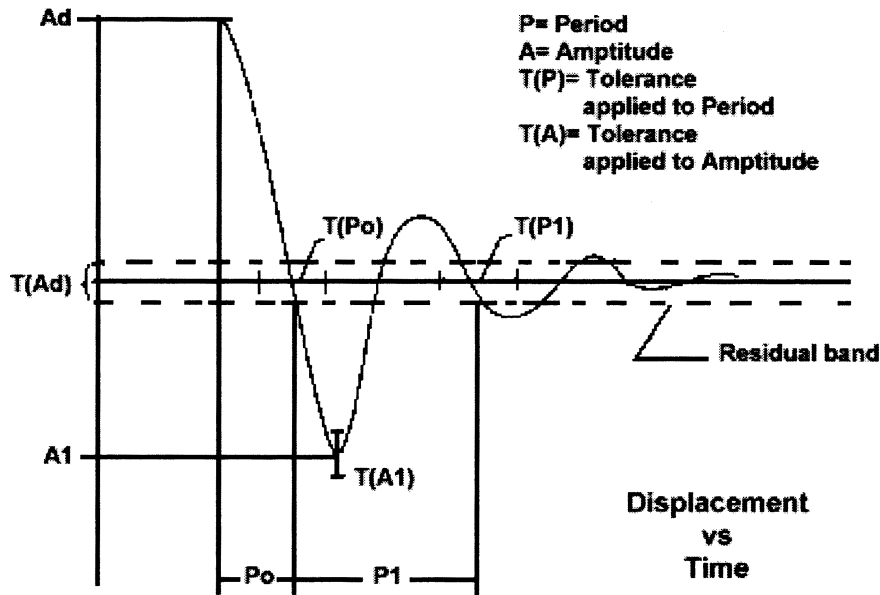
|                    |       |                                       |
|--------------------|-------|---------------------------------------|
| T(P <sub>0</sub> ) | ..... | ±10% of P <sub>0</sub>                |
| T(P <sub>1</sub> ) | ..... | ±20% of P <sub>1</sub>                |
| T(P <sub>2</sub> ) | ..... | ±30% of P <sub>2</sub>                |
| T(P <sub>n</sub> ) | ..... | ±10(n+1)% of P <sub>n</sub>           |
| T(A <sub>n</sub> ) | ..... | ±10% of A <sub>1</sub>                |
| T(A <sub>d</sub> ) | ..... | ±5% of A <sub>d</sub> = residual band |

Significant First overshoot and ±1 overshoots. subsequent overshoots

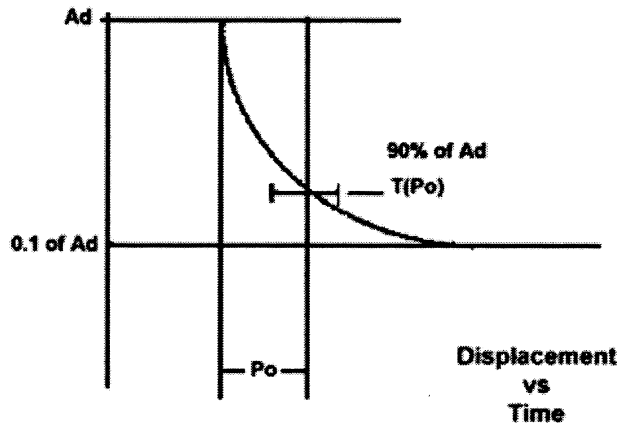
(b) The following tolerance applies to critically damped and overdamped systems only. See Figure D2B for an illustration of the reference measurements:

|                    |       |                        |
|--------------------|-------|------------------------|
| T(P <sub>0</sub> ) | ..... | ±10% of P <sub>0</sub> |
|--------------------|-------|------------------------|

**Attachment 2 to Appendix D to Part 60—  
Figure D2A. Under-Damped Step Response**



**Attachment 2 to Appendix D to Part 60—  
Figure D2B. Critically-Damped Step Response**



**End Information**

**Begin QPS Requirement**

BILLING CODE 4910-13-C

c. Alternative method for control dynamics evaluation.

(1) An alternative means for validating control dynamics for aircraft with hydraulically powered flight controls and artificial feel systems is by the measurement of control force and rate of movement. For each axis of pitch, roll, and yaw, the control must be forced to its maximum extreme position for the following distinct rates.

These tests are conducted at under normal flight and ground conditions.

(a) Static test—Slowly move the control so that a full sweep is achieved within 95–105 seconds. A full sweep is defined as movement of the controller from neutral to the stop, usually aft or right stop, then to the opposite stop, then to the neutral position.

(b) Slow dynamic test—Achieve a full sweep within 8–12 seconds.

(c) Fast dynamic test—Achieve a full sweep within 3–5 seconds.

**Note:** Dynamic sweeps may be limited to forces not exceeding 100 lbs. (44.5 daN).

(d) Tolerances

(i) Static test; see Table D2A, Flight Training Device (FTD) Objective Tests, Items 2.a.1., 2.a.2., and 2.a.3.

(ii) Dynamic test— $\pm 2$  lbs (0.9 daN) or  $\pm 10\%$  on dynamic increment above static test.

**End QPS Requirement**

**Begin Information**

d. The FAA is open to alternative means that are justified and appropriate to the application. For example, the method described here may not apply to all manufacturers' systems and certainly not to aircraft with reversible control systems. Each

case is considered on its own merit on an ad hoc basis. If the FAA finds that alternative methods do not result in satisfactory performance, more conventionally accepted methods will have to be used.

**4. For Additional Information on the Following Topics, Please Refer to Appendix C, Attachment 2, and the Indicated Paragraph Within That Attachment**

- Additional Information About Flight Simulator Qualification for New or Derivative Helicopters, paragraph 8.
- Engineering Simulator Validation Data, paragraph 9.
- Validation Test Tolerances, paragraph 11.
- Validation Data Road Map, paragraph 12.
- Acceptance Guidelines for Alternative Avionics, paragraph 13.
- Transport Delay Testing, paragraph 14.
- Continuing Qualification Evaluation Validation Data Presentation, paragraph 15.

**End Information**

**Attachment 3 to Appendix D to Part 60—Flight Training Device (FTD) Subjective Evaluation**

**Begin QPS Requirements**

**1. Requirements**

a. Except for special use visual scenes and airport models described below, all visual scenes and airport models required by this part must be representations of real-world, operational airports or representations of fictional airports and must meet the requirements set out in Tables D3B and D3C of this attachment, as appropriate.

b. If fictional airports are used, the sponsor must ensure that navigational aids and all appropriate maps, charts, and other navigational reference material for the fictional airports (and surrounding areas as necessary) are compatible, complete, and accurate with respect to the visual presentation and scene content of the visual model of this fictional airport. An SOC must be submitted that addresses navigation aid installation and performance and other criteria (including obstruction clearance protection) for all instrument approaches to the fictional airports that are available in the simulator. The SOC must reference and account for information in the terminal instrument procedures manual and the construction and availability of the required maps, charts, and other navigational material. This material must be clearly marked “for training purposes only.”

c. When the simulator is being used by an instructor or evaluator for purposes of training, checking, or testing under this chapter, only visual scenes and airport models classified as Class I, Class II, or Class III may be available to the instructor or evaluator. The classifications are as follows:

(1) Class I (whether modeling real world airports or fictional airports), for those visual scenes and airport models used for FTD qualification at a specified level. These visual scenes and airport models must meet the minimum requirements in Table D3B of this

attachment, be evaluated by the NSPM, be listed on the Statement of Qualification (SOQ), and be available for use at the FTD IOS.

(2) Class II (whether modeling real world airports or fictional airports), for those visual scenes and airport models that are in excess of those used for FTD qualification at a specified level. These visual scenes and airport models must meet the minimum requirements set out in Table C3C of this attachment. These visual scenes and airport models may be made available on the FTD IOS without further involvement of the NSPM or the TPAA.

(3) For an interim period ending (2 years after date of publication of the final rule in the **Federal Register**), Class III visual scenes and airport models (whether modeling real world airports, generic airports, or fictional airports) may be approved for specific purposes by the TPAA or a foreign regulatory authority for a foreign user of the device. Examples of approved activities include specific airport or runway qualification, very low visibility operations training, including Surface Movement Guidance System (SMGS) operations, or use of a specific airport visual model aligned with an instrument procedure for another airport for instrument training. At the end of the interim period, all Class III visual scenes and airport models must be classified as either a Class I or a Class II visual scene or airport model or be removed from availability at the simulator IOS. However, Class III visual scenes and airport models may continue to be used after the end of the interim period if they are part of a training program specifically approved by the TPAA or other regulatory authority that uses a task and capability analysis as the basis for approval of this specific media element, (i.e., the specific scene or model selected for use in that program).

d. When a person sponsors an FSTD maintained by a person other than a U.S. certificate holder, the sponsor is accountable for that FSTD originally meeting, and continuing to meet, the criteria under which it was originally qualified and the appropriate Part 60 criteria, including the visual scenes and airport models that may be used by instructors or evaluators for purposes of training, checking, or testing under this chapter.

e. Neither Class II nor Class III airport visual models are required to appear on the SOQ. However, the sponsor is accountable that the FSTD originally meets, and continues to meet, the visual scene and airport model requirements for Class II or Class III visual scenes and airport models that may be used by instructors or evaluators for training, checking, or testing under this chapter.

f. When the visual scenes and airport models represent real world airports and a permanent change is made to that real world airport (e.g., a new runway, an extended taxiway, a new lighting system, a runway closure) without a written extension grant from the NSPM (described below), an update to that visual scene or airport model must be made in accordance with the following time limits:

(1) For a new airport runway, a runway extension, a new airport taxiway, a taxiway

extension, or a runway/taxiway closure—within 60 days of the opening for use of the new airport runway, runway extension, new airport taxiway, or taxiway extension; or within 60 days of the closure of the runway or taxiway.

(2) For a new or modified approach light system—within 30 days of the activation of the new or modified approach light system.

(3) For other facility or structural changes on the airport (e.g., new terminal, relocation of Air Traffic Control Tower)—within 6 months of the opening of the new or changed facility or structure.

g. If a sponsor desires an extension to the time limit for an update to a visual scene or airport model, the sponsor must provide a written extension request to the POI/TCPM stating the reason for the update delay and a proposed completion date. A copy of this request must also be sent to the NSPM. The sponsor will forward a copy of the POI/TCPM's response to the NSPM. If the POI/TCPM has granted an extension, the NSPM will issue an extension authorization, not to exceed an additional 12 months.

**End QPS Requirements**

**Begin Information**

**2. Discussion**

a. The subjective tests and the examination of functions provide a basis for evaluating the capability of the FTD to perform over a typical utilization period; determining that the FTD satisfactorily meets the appropriate training/testing/checking objectives and competently simulates each required maneuver, procedure, or task; and verifying correct operation of the FTD controls, instruments, and systems. The items in the list of operations tasks are for FTD evaluation purposes only. They must not be used to limit or exceed the authorizations for use of a given level of FTD as found in the Practical Test Standards or as may be approved by the TPAA. All items in the following paragraphs are subject to an examination of function.

b. The List of Operations Tasks addressing pilot functions and maneuvers is divided by flight phases. All simulated helicopter systems functions will be assessed for normal and, where appropriate, alternate operations. Normal, abnormal, and emergency operations associated with a flight phase will be assessed during the evaluation of maneuvers or events within that flight phase.

c. Systems to be evaluated are listed separately under “Any Flight Phase” to ensure appropriate attention to systems checks. Operational navigation systems (including inertial navigation systems, global positioning systems, or other long-range systems) and the associated electronic display systems will be evaluated if installed. The NSP pilot will include in his report to the TPAA, the effect of the system operation and any system limitation.

d. At the request of the TPAA, the NSP Pilot may assess the FTD for a special aspect of a sponsor's training program during the functions and subjective portion of an evaluation. Such an assessment may include a portion of a specific operation (e.g., a Line Oriented Flight Training (LOFT) scenario) or

special emphasis items in the sponsor's training program. Unless directly related to a requirement for the qualification level, the results of such an evaluation would not necessarily affect the qualification of the FTD.

e. The FAA intends to allow the use of Class III visual scenes and airport models on a limited basis when the sponsor provides the TPAAs (or other regulatory authority) an

appropriate analysis of the skills, knowledge, and abilities (SKAs) necessary for competent performance of the tasks in which this particular media element is used. The analysis should describe the ability of the FSTD/visual media to provide an adequate environment in which the required SKAs may be satisfactorily performed and learned. The analysis should also include the specific media element, such as the visual scene or

airport model. Additional sources of information on the conduct of task and capability analysis may be found on the FAA's Advanced Qualification Program (AQP) Web site at: [http://www.faa.gov/education\\_research/training/aqp/](http://www.faa.gov/education_research/training/aqp/).

**End Information**

TABLE D3A.—TABLE OF FUNCTIONS AND SUBJECTIVE TESTS LEVEL 7 FTD

| <<<QPS requirements>>>  |   |
|---|---|
| Number  | Operations tasks  |
| Tasks in this table are subject to evaluation if appropriate for the helicopter simulated as indicated in the SOQ Configuration List or a Level 7 FTD. Items not installed, not functional on the FTD, and not appearing on the SOQ Configuration List, are not required to be listed as exceptions on the SOQ. |   |
| <b>1. Preflight Procedures</b>  |   |
| 1.a. ....   | Preflight Inspection (Flight Deck Only) switches, indicators, systems, and equipment. |
| 1.b. ....   | APU/Engine start and run-up.  |
| 1.b.1. ....   | Normal start procedures.  |
| 1.b.2. ....   | Alternate start procedures.   |
| 1.b.3. ....   | Abnormal starts and shutdowns (hot start, hung start).                                |
| 1.b.4. ....   | Rotor engagement.   |
| 1.b.5. ....   | System checks.  |
| 1.c. ....   | Taxiing—Ground.   |
| 1.c.1. ....   | Power required to taxi.   |
| 1.c.2. ....   | Brake effectiveness.  |
| 1.c.3. ....   | Ground handling.  |
| 1.c.4. ....   | Abnormal/emergency procedures, for example:   |
| 1.c.4.a. ....   | Brake system failure.   |
| 1.c.4.b. ....   | Ground resonance.   |
| 1.c.4.c. ....   | Other (as may be listed on the Statement of Qualification).                           |
| 1.d. ....   | Taxiing—Hover.  |
| 1.d.1. ....   | Takeoff to a hover.   |
| 1.d.2. ....   | Instrument response.  |
| 1.d.2.a. ....   | Engine instruments.   |
| 1.d.2.a. ....   | Flight instruments.   |
| 1.d.3. ....   | Hovering turns.   |
| 1.d.4. ....   | Hover power checks.   |
| 1.d.4.a. ....   | In ground effect (IGE).   |
| 1.d.4.b. ....   | Out of ground effect (OGE).   |
| 1.d.5. ....   | Crosswind/tailwind hover.   |
| 1.d.6. ....   | Abnormal/emergency procedures:  |
| 1.d.6.a. ....   | Engine failure.   |

TABLE D3A.—TABLE OF FUNCTIONS AND SUBJECTIVE TESTS LEVEL 7 FTD—Continued

| <<<QPS requirements>>>                |  |
|---------------------------------------|--|
| Number                                | Operations tasks   |
| 1.d.6.b. ....                         | Fuel governing system failure.   |
| 1.d.6.c. ....                         | Settling with power (OGE).   |
| 1.d.6.d. ....                         | Stability augmentation system failure.   |
| 1.d.6.e. ....                         | Directional control malfunction (including Loss of Tail Rotor Effectiveness, LTE). |
| 1.d.6.f. ....                         | Other (as may be listed on the Statement of Qualification).                        |
| 1.e. ....                             | Pre-takeoff Checks.  |
| <b>2. Takeoff and Departure Phase</b> |  |
| 2.a. ....                             | Normal and Crosswind Takeoff.  |
| 2.a.1. ....                           | From ground.   |
| 2.a.2. ....                           | From hover.  |
| 2.a.3. ....                           | Running.   |
| 2.a.4. ....                           | Crosswind/tailwind.  |
| 2.a.5. ....                           | Maximum performance.   |
| 2.b. ....                             | Instrument.  |
| 2.c. ....                             | Powerplant Failure During Takeoff.   |
| 2.c.1. ....                           | Takeoff with engine failure after critical decision point (CDP).                   |
| 2.d. ....                             | Rejected Takeoff.  |
| 2.e. ....                             | Instrument Departure.  |
| 2.f. ....                             | Other (as may be listed on the Statement of Qualification).                        |
| <b>3. Climb</b>                       |  |
| 3.a. ....                             | Normal.  |
| 3.b. ....                             | Obstacle clearance.  |
| 3.c. ....                             | Vertical.  |
| 3.d. ....                             | One engine inoperative.  |
| 3.e. ....                             | Other (as may be listed on the Statement of Qualification).                        |
| <b>4. Inflight Maneuvers</b>          |  |
| 4.a. ....                             | Performance.   |
| 4.b. ....                             | Flying qualities.  |
| 4.c. ....                             | Turns.   |
| 4.c.1. ....                           | Timed.   |
| 4.c.2. ....                           | Normal.  |
| 4.c.3. ....                           | Steep.   |
| 4.d. ....                             | Accelerations and decelerations.   |
| 4.e. ....                             | High-speed vibrations.   |
| 4.f. ....                             | Abnormal/emergency procedures, for example:  |
| 4.f.1. ....                           | Engine fire.   |



TABLE D3A.—TABLE OF FUNCTIONS AND SUBJECTIVE TESTS LEVEL 7 FTD—Continued

| <<<QPS requirements>>>          |   |
|---------------------------------|---|
| Number                          | Operations tasks  |
| 4.f.2. ....                     | Engine failure.   |
| 4.f.2.a. ....                   | Powerplant Failure—Multiengine Helicopters.                 |
| 4.f.2.b. ....                   | Powerplant Failure—Single-Engine Helicopters.               |
| 4.f.3. ....                     | In-flight engine shutdown (and restart, if applicable).     |
| 4.f.4. ....                     | Fuel governing system failures (e.g., FADEC malfunction).   |
| 4.f.5. ....                     | Directional control malfunction.                            |
| 4.f.6. ....                     | Hydraulic failure.  |
| 4.f.7. ....                     | Stability augmentation system failure.                      |
| 4.f.8. ....                     | Rotor vibrations.   |
| 4.f.9. ....                     | Recovery From Unusual Attitudes.                            |
| 4.f.10. ....                    | Settling with Power.  |
| 4.g. ....                       | Other (as may be listed on the Statement of Qualification). |
| <b>5. Instrument Procedures</b> |   |
| 5.a. ....                       | Instrument Arrival.   |
| 5.b. ....                       | Holding.  |
| 5.c. ....                       | Precision Instrument Approach.                              |
| 5.c.1. ....                     | Normal—All engines operating.                               |
| 5.c.2. ....                     | Manually controlled—One or more engines inoperative.        |
| 5.c.3. ....                     | Approach procedures:  |
| 5.c.3.a. ....                   | PAR.  |
| 5.c.3.b. ....                   | GPS.  |
| 5.c.3.c. ....                   | ILS.  |
| 5.c.3.c.1. ....                 | Manual (raw data).  |
| 5.c.3.c.2. ....                 | Autopilot* only.  |
| 5.c.3.c.3. ....                 | Flight director only.                                       |
| 5.c.3.c.4. ....                 | Autopilot* and flight director (if appropriate) coupled.    |
| 5.c.3.d. ....                   | Other (as may be listed on the Statement of Qualification). |
| 5.d. ....                       | Non-precision Instrument Approach.                          |
| 5.d.1. ....                     | Normal—All engines operating.                               |
| 5.d.2. ....                     | One or more engines inoperative.                            |
| 5.d.3. ....                     | Approach procedures:  |
| 5.d.3.a. ....                   | NDB.  |
| 5.d.3.b. ....                   | VOR, RNAV, TACAN, GPS.                                      |
| 5.d.3.c. ....                   | ASR.  |
| 5.d.3.d. ....                   | Circling.   |
| 5.d.3.e. ....                   | Helicopter only.  |

TABLE D3A.—TABLE OF FUNCTIONS AND SUBJECTIVE TESTS LEVEL 7 FTD—Continued

| <<<QPS requirements>>>   |  |
|--|--|
| Number   | Operations tasks   |
| 5.d.3.f. ....  | Other (as may be listed on the Statement of Qualification).  |
| 5.e. ....  | Missed Approach.   |
| 5.e.1. ....  | All engines operating.                                       |
| 5.e.2. ....  | One or more engines inoperative.                             |
| 5.e.3. ....  | Stability augmentation system failure.                       |
| 5.e.4. ....  | Other (as may be listed on the Statement of Qualification).  |
| <b>6. Landings and Approaches to Landings</b>                  |  |
| 6.a. ....  | Visual Approaches.   |
| 6.a.1. ....  | Normal.  |
| 6.a.2. ....  | Steep.   |
| 6.a.3. ....  | Shallow.   |
| 6.a.4. ....  | Crosswind.   |
| 6.b. ....  | Landings.  |
| 6.b.1. ....  | Normal.  |
| 6.b.1.a. ....  | Running.   |
| 6.b.1.b. ....  | From Hover.  |
| 6.b.2. ....  | Crosswind.   |
| 6.b.3. ....  | Tailwind.  |
| 6.b.4. ....  | One or more engines inoperative.                             |
| 6.b.5. ....  | Rejected Landing.  |
| 6.b.6. ....  | Other (as may be listed on the Statement of Qualification).  |
| <b>7. Normal and Abnormal Procedures (any phase of flight)</b> |  |
| 7.a. ....  | Helicopter and powerplant systems operation (as applicable). |
| 7.a.1. ....  | Anti-icing/deicing systems.                                  |
| 7.a.2. ....  | Auxiliary power-plant.                                       |
| 7.a.3. ....  | Communications.  |
| 7.a.4. ....  | Electrical system.   |
| 7.a.5. ....  | Environmental system.  |
| 7.a.6. ....  | Fire detection and suppression.                              |
| 7.a.7. ....  | Flight control system.                                       |
| 7.a.8. ....  | Fuel system.   |
| 7.a.9. ....  | Engine oil system.   |
| 7.a.10. ....   | Hydraulic system.  |
| 7.a.11. ....   | Landing gear.  |
| 7.a.12. ....   | Oxygen.  |
| 7.a.13. ....   | Pneumatic.   |

TABLE D3A.—TABLE OF FUNCTIONS AND SUBJECTIVE TESTS LEVEL 7 FTD—Continued

| <<<QPS requirements>>>  |   |
|---|---|
| Number  | Operations tasks  |
| 7.a.14. ....  | Powerplant.   |
| 7.a.15. ....  | Flight control computers.                                   |
| 7.a.16. ....  | Fly-by-wire controls.                                       |
| 7.a.17. ....  | Stabilizer.   |
| 7.a.18. ....  | Stability augmentation and control augmentation system(s).  |
| 7.a.19. ....  | Other (as may be listed on the Statement of Qualification). |
| 7.b. ....   | Flight management and guidance system (as applicable).      |
| 7.b.1. ....   | Airborne radar.   |
| 7.b.2. ....   | Automatic landing aids.                                     |
| 7.b.3. ....   | Autopilot*.   |
| 7.b.4. ....   | Collision avoidance system.                                 |
| 7.b.5. ....   | Flight data displays.                                       |
| 7.b.6. ....   | Flight management computers.                                |
| 7.b.7. ....   | Head-up displays.   |
| 7.b.8. ....   | Navigation systems.   |
| 7.b.9. ....   | Other (as may be listed on the Statement of Qualification). |
| <b>8. Emergency procedures (as applicable)</b>                |   |
| 8.a. ....   | Autorotative Landing.                                       |
| 8.b. ....   | Air hazard avoidance.                                       |
| 8.c. ....   | Ditching.   |
| 8.d. ....   | Emergency evacuation.                                       |
| 8.e. ....   | Inflight fire and smoke removal.                            |
| 8.f. ....   | Retreating blade stall recovery.                            |
| 8.g. ....   | Mast bumping.   |
| 8.h. ....   | Loss of tail rotor effectiveness.                           |
| 8.i. ....   | Other (as may be listed on the Statement of Qualification). |
| <b>9. Postflight Procedures</b>                               |   |
| 9.a. ....   | After-Landing Procedures.                                   |
| 9.b. ....   | Parking and Securing.                                       |
| 9.b.1. ....   | Engine and systems operation.                               |
| 9.b.2. ....   | Parking brake operation.                                    |
| 9.b.3. ....   | Rotor brake operation.                                      |
| 9.b.4. ....   | Abnormal/emergency procedures.                              |
| <b>10. Instructor Operating Station (IOS), as appropriate</b> |   |
| 10.a. ....  | Power Switch(es).   |
| 10.b. ....  | Helicopter conditions.                                      |

TABLE D3A.—TABLE OF FUNCTIONS AND SUBJECTIVE TESTS LEVEL 7 FTD—Continued

| <<<QPS requirements>>> |  |
|------------------------|--|
| Number                 | Operations tasks   |
| 10.b.1. ....           | Gross weight, center of gravity, fuel loading and allocation, etc. |
| 10.b.2. ....           | Helicopter systems status.   |
| 10.b.3. ....           | Ground crew functions (e.g., ext. power).                          |
| 10.c. ....             | Airports.  |
| 10.c.1. ....           | Selection.   |
| 10.c.2. ....           | Runway selection.  |
| 10.c.3. ....           | Preset positions (e.g., ramp, over final approach fix).            |
| 10.d. ....             | Environmental controls.  |
| 10.d.1. ....           | Temperature.   |
| 10.d.2. ....           | Climate conditions (e.g., ice, rain).                              |
| 10.d.3. ....           | Wind speed and direction.  |
| 10.e. ....             | Helicopter system malfunctions.                                    |
| 10.e.1. ....           | Insertion/deletion.  |
| 10.e.2. ....           | Problem clear.   |
| 10.f. ....             | Locks, Freezes, and Repositioning.                                 |
| 10.f.1. ....           | Problem (all) freeze/release.                                      |
| 10.f.2. ....           | Position (geographic) freeze/release.                              |
| 10.f.3. ....           | Repositioning (locations, freezes, and releases).                  |
| 10.f.4. ....           | Ground speed control.  |
| 10.g. ....             | Sound Controls.  |
| 10.g.1. ....           | On/off/adjustment.   |
| 10.h. ....             | Control Loading System (as applicable).                            |
| 10.h.1. ....           | On/off/emergency stop.   |
| 10.i. ....             | Observer Stations.   |
| 10.i.1. ....           | Position.  |
| 10.i.2. ....           | Adjustments.   |

\*“Autopilot” means attitude retention mode of operation.

TABLE D3B.—TABLE OF FUNCTIONS AND SUBJECTIVE TESTS LEVEL 7 FTD

| <<<QPS requirements>>> |  |
|------------------------|--|
| Number                 | Visual scene content requirements for qualification at Level 7 |

This table specifies the minimum airport visual model content and functionality to qualify an FTD at the indicated level. This table applies only to the airport/helicopter landing area scenes required for FTD qualification.

|           |  |
|-----------|--|
| 1. ....   | <b>Functional test content</b> requirements for Level 7 Flight Training Devices.   |
|           | The following is the minimum airport/landing area model content requirement to satisfy visual capability tests, and provides suitable visual cues to allow completion of all functions and subjective tests described in this attachment for FTDs at Levels 7. |
| 1.a. .... | A minimum of one (1) representative airport and one (1) representative helicopter landing area model.  |

TABLE D3B.—TABLE OF FUNCTIONS AND SUBJECTIVE TESTS LEVEL 7 FTD—Continued

| <<<QPS requirements>>> |  |
|------------------------|--|
| Number                 | Visual scene content requirements for qualification at Level 7   |
|                        | The airport and the helicopter landing area may be contained within the same visual model. If this option is selected, the approach path to the airport runway(s) and the approach path to the helicopter landing area must be different. The model(s) used to meet the following requirements may be demonstrated at either a fictional or a real-world airport or helicopter landing area, but each must be acceptable to the sponsor's TPAA, selectable from the IOS, and listed on the Statement of Qualification. |
| 1.b. ....              | <b>Fidelity of the Visual Scene.</b><br>The fidelity of the visual scene must be sufficient for the aircrew to visually identify the airport and/or helicopter landing area; determine the position of the simulated helicopter within the visual scene; successfully accomplish take-offs, approaches, and landings; and maneuver around the airport and/or helicopter landing area on the ground, or hover taxi, as necessary.   |
| 1.b.1. ....            | For each of the airport/helicopter landing areas described in 1.a., the FTD visual system must be able to provide at least the following:  |
| 1.b.1.a. ....          | A night and twilight (dusk) environment.   |
| 1.b.1.b. ....          | A daylight environment.  |
| 1.c. ....              | <b>Runways:</b>  |
| 1.c.1. ....            | Visible runway number.   |
| 1.c.2. ....            | Runway threshold elevations and locations must be modeled to provide sufficient correlation with helicopter systems (e.g., altimeter).   |
| 1.c.3. ....            | Runway surface and markings.   |
| 1.c.4. ....            | Lighting for the runway in use including runway edge and centerline.   |
| 1.c.5. ....            | Lighting, visual approach aid (VASI or PAPI) and approach lighting of appropriate colors.  |
| 1.c.6. ....            | Taxiway lights.  |
| 1.d. ....              | <b>Helicopter landing area.</b>  |
| 1.d.1. ....            | Standard heliport designation ("H") marking, properly sized and oriented.  |
| 1.d.2. ....            | Perimeter markings for the Touchdown and Lift-Off Area (TLOF) or the Final Approach and Takeoff Area (FATO), as appropriate.   |
| 1.d.3. ....            | Perimeter lighting for the TLOF or the FATO areas, as appropriate.   |
| 1.d.4. ....            | Appropriate markings and lighting to allow movement from the runway or helicopter landing area to another part of the landing facility.  |
| 2. ....                | <b>Visual scene management.</b><br>The following is the minimum visual scene management requirements for a Level 7 FTD.  |
| 2.a. ....              | Runway and helicopter landing area approach lighting must fade into view appropriately in accordance with the environmental conditions set in the FTD.   |
| 2.b. ....              | The direction of strobe lights, approach lights, runway edge lights, visual landing aids, runway centerline lights, threshold lights, touchdown zone lights, and TLOF or FATO lights must be replicated.   |
| 3. ....                | <b>Visual feature recognition.</b><br>The following are the minimum distances at which runway features must be visible. Distances are measured from runway threshold or a helicopter landing area to a helicopter aligned with the runway or helicopter landing area on an extended 3° glide-slope in simulated meteorological conditions. For circling approaches, all tests apply to the runway used for the initial approach and to the runway of intended landing.   |
| 3.a. ....              | For runways: runway definition, strobe lights, approach lights, and edge lights from 5 sm (8 km) of the threshold.   |
| 3.b. ....              | For runways: centerline lights and taxiway definition from 3 sm (5 km).  |
| 3.c. ....              | For runways: Visual Approach Aid lights (VASI or PAPI) from 3 sm (5 km) of the threshold.  |
| 3.d. ....              | For runways: Visual Approach Aid lights (VASI or PAPI) from 5 sm (8 km) of the threshold.  |
| 3.e. ....              | For runways: runway threshold lights and touchdown zone from 2 sm (3 km).  |

TABLE D3B.—TABLE OF FUNCTIONS AND SUBJECTIVE TESTS LEVEL 7 FTD—Continued

| <<<QPS requirements>>> |  |
|------------------------|--|
| Number                 | Visual scene content requirements for qualification at Level 7   |
| 3.f. ....              | For runways and helicopter landing areas: markings within range of landing lights for night/twilight scenes and the surface resolution test on daylight scenes, as required.   |
| 3.g. ....              | For circling approaches: the runway of intended landing and associated lighting must fade into view in a non-distracting manner.   |
| 3.h. ....              | For helicopter landing areas: landing direction lights and raised FATO lights from 1 sm (1.5 km).  |
| 3.i. ....              | For helicopter landing areas: Flush mounted FATO lights, TOFL lights, and the lighted windsock from 0.5 sm (750 m).  |
| 4. ....                | <b>Airport or Helicopter Landing Area Model Content.</b><br>The following prescribes the minimum requirements for an airport/helicopter landing area visual model and identifies other aspects of the environment that must correspond with that model for a Level 7 FTD. For circling approaches, all tests apply to the runway used for the initial approach and to the runway of intended landing. If all runways or landing areas in a visual model used to meet the requirements of this attachment are not designated as "in use," then the "in use" runways/landing areas must be listed on the Statement of Qualification (e.g., KORD, Rwy 9R, 14L, 22R). Models of airports or helicopter landing areas with more than one runway or landing area must have all significant runways or landing areas not "in-use" visually depicted for airport/runway/landing area recognition purposes. The use of white or off white light strings that identify the runway or landing area for twilight and night scenes are acceptable for this requirement; and rectangular surface depictions are acceptable for daylight scenes. A visual system's capabilities must be balanced between providing visual models with an accurate representation of the airport and a realistic representation of the surrounding environment. Each runway or helicopter landing area designated as an "in-use" runway or area must include the following detail that is either modeled using airport/heliport pictures, construction drawings and maps, U.S. National Imagery and Mapping Agency data other appropriate data, or modeled in accordance with published regulatory material. |
| 4.a. ....              | The surface and markings for each "in-use" runway or helicopter landing area must include the following:   |
| 4.a.1. ....            | For airports: runway threshold markings, runway numbers, touchdown zone markings, fixed distance markings, runway edge markings, and runway centerline stripes.  |
| 4.a.2. ....            | For helicopter landing areas: markings for standard heliport identification ("H") and TOFL, FATO, and safety areas.  |
| 4.b. ....              | The lighting for each "in-use" runway or helicopter landing area must include the following:   |
| 4.b.1. ....            | For airports: runway approach, threshold, edge, end, centerline (if applicable), touchdown zone (if applicable), leadoff, and visual landing aid lights or light systems for that runway.  |
| 4.b.2. ....            | For helicopter landing areas: landing direction, raised and flush FATO, TOFL, windsock lighting.   |
| 4.c. ....              | The taxiway surface and markings associated with each "in-use" runway or helicopter landing area must include the following:   |
| 4.c.1. ....            | For airports: taxiway edge, centerline (if appropriate), runway hold lines, and ILS critical area(s).  |
| 4.c.2. ....            | For helicopter landing areas: taxiways, taxi routes, and aprons.   |
| 4.d. ....              | The taxiway lighting associated with each "in-use" runway or helicopter landing area must include the following:   |
| 4.d.1. ....            | For airports: taxiway edge, centerline (if appropriate), runway hold lines, ILS critical areas.  |
| 4.d.2. ....            | For helicopter landing areas: taxiways, taxi routes, and aprons.   |
| 4.d.3. ....            | For airports: taxiway lighting of correct color.   |
| 4.e. ....              | Airport signage associated with each "in-use" runway or helicopter landing area must include the following:  |
| 4.e.1. ....            | For airports: signs for runway distance remaining, intersecting runway with taxiway, and intersecting taxiway with taxiway.  |
| 4.e.2. ....            | For helicopter landing areas: as may be appropriate for the model used.  |
| 4.f. ....              | Required visual model correlation with other aspects of the airport or helicopter landing environment simulation:  |
| 4.f.1. ....            | The airport or helicopter landing area model must be properly aligned with the navigational aids that are associated with operations at the "in-use" runway or helicopter landing area.  |
| 4.f.2. ....            | The simulation of runway or helicopter landing area contaminants must be correlated with the displayed runway surface and lighting, if applicable.   |
| 5. ....                | <b>Correlation with helicopter and associated equipment.</b><br>The following are the minimum correlation comparisons that must be made for a Level 7 FTD.   |
| 5.a. ....              | Visual system compatibility with aerodynamic programming.  |

TABLE D3B.—TABLE OF FUNCTIONS AND SUBJECTIVE TESTS LEVEL 7 FTD—Continued

| <<<QPS requirements>>>     |  |
|----------------------------|--|
| Number                     | Visual scene content requirements for qualification at Level 7   |
| 5.b. ....                  | Visual cues to assess sink rate and depth perception during landings.  |
| 5.c. ....                  | Accurate portrayal of environment relating to FTD attitudes.   |
| 5.d. ....                  | The visual scene must correlate with integrated helicopter systems, where fitted (e.g., terrain, traffic and weather avoidance systems and Head-up Guidance System (HGS)).   |
| 5.e. ....                  | Representative visual effects for each visible, own-ship, helicopter external light(s).  |
| 5.f. ....                  | The effect of rain removal devices.  |
| <b>6. ....</b>             | <b>Scene quality.</b><br>The following are the minimum scene quality tests that must be conducted for a Level 7 FTD.   |
| 6.a. ....                  | System light points should be free from distracting jitter, smearing or streaking.   |
| 6.b. ....                  | Demonstration of occulting through each channel of the system in an operational scene.   |
| 6.c. ....                  | Six discrete light step controls (0–5).  |
| <b>7. ....</b>             | Special weather representations, which include visibility and RVR, measured in terms of distance. Visibility/RVR checked at 2,000 ft (600 m) above the airport or helicopter landing area and at two heights below 2,000 ft with at least 500 ft of separation between the measurements. The measurements must be taken within a radius of 10 sm (16 km) from the airport or helicopter landing area.  |
| 7.a. ....                  | Effects of fog on airport lighting such as halos and defocus.  |
| 7.b. ....                  | Effect of own-ship lighting in reduced visibility, such as reflected glare, including landing lights, strobes, and beacons.  |
| <b>8. ....</b>             | <b>Instructor control of the following:</b><br>The following are the minimum instructor controls that must be available in a Level 7 FTD.  |
| 8.a. ....                  | Environmental effects: e.g., cloud base, cloud effects, cloud density, visibility in statute miles/kilometers and RVR in feet/meters.  |
| 8.b. ....                  | Airport or helicopter landing area selection.  |
| 8.c. ....                  | Airport or helicopter landing area lighting, including variable intensity.   |
| 8.d. ....                  | Dynamic effects including ground and flight traffic.   |
| <b>End QPS Requirement</b> |  |
| <b>Begin Information</b>   |  |
| <b>9. ....</b>             | An example of being able to “combine two airport models to achieve two “in-use” runways: One runway designated as the “in-use” runway in the first model of the airport, and the second runway designated as the “in-use” runway in the second model of the same airport. For example, the clearance is for the ILS approach to Runway 27, Circle to Land on Runway 18 right. Two airport visual models might be used: the first with Runway 27 designated as the “in use” runway for the approach to runway 27, and the second with Runway 18 Right designated as the “in use” runway. When the pilot breaks off the ILS approach to runway 27, the instructor may change to the second airport visual model in which runway 18 Right is designated as the “in use” runway, and the pilot would make a visual approach and landing. This process is acceptable to the FAA as long as the temporary interruption due to the visual model change is not distracting to the pilot. |
| <b>10. ....</b>            | Sponsors are not required to provide every detail of a runway, but the detail that is provided should be correct within reasonable limits.   |
| <b>End Information</b>     |  |

TABLE D3C.—TABLE OF FUNCTIONS AND SUBJECTIVE TESTS LEVEL 7 FTD

| <<<QPS requirements>>>  |   |
|---|---|
| Number  | Visual scene content requirements additional visual models beyond minimum required for qualification  |
| This table specifies the minimum airport or helicopter landing area visual model content and functionality necessary to add visual models to an FTD’s visual model library (i.e., beyond those necessary for qualification at the stated level) without the necessity of further involvement of the NSPM or TPAA. |   |
| <b>1. ....</b>  | <b>Visual scene management.</b><br>The following is the minimum visual scene management requirements. |

TABLE D3C.—TABLE OF FUNCTIONS AND SUBJECTIVE TESTS LEVEL 7 FTD—Continued

| <<<QPS requirements>>> |   |
|------------------------|---|
| Number                 | Visual scene content requirements additional visual models beyond minimum required for qualification  |
| 1.a. ....              | The installation and direction of the following lights must be replicated for the “in-use” surface:   |
| 1.a.1. ....            | For “in-use” runways: strobe lights, approach lights, runway edge lights, visual landing aids, runway centerline lights, threshold lights, and touchdown zone lights.   |
| 1.a.2. ....            | For “in-use” helicopter landing areas: ground level TLOF perimeter lights, elevated TLOF perimeter lights (if applicable), Op-tional TLOF lights (if applicable), ground FATO perimeter lights, elevated TLOF lights (if applicable), landing direction lights.   |
| 2. ....                | <b>Visual feature recognition.</b><br>The following are the minimum distances at which runway or landing area features must be visible. Distances are measured from runway threshold or a helicopter landing area to an aircraft aligned with the runway or helicopter landing area on a 3° glide-slope from the aircraft to the touchdown point, in simulated meteorological conditions. For circling approaches, all tests apply to the runway used for the initial approach and to the runway of intended landing.   |
| 2.a. ....              | For Runways.  |
| 2.a.1. ....            | Strobe lights, approach lights, and edge lights from 5 sm (8 km) of the threshold.  |
| 2.a.2. ....            | Centerline lights and taxiway definition from 3 sm (5 km).  |
| 2.a.3. ....            | Visual Approach Aid lights (VASI or PAPI) from 3 sm (5 km) of the threshold.  |
| 2.a.4. ....            | Visual Approach Aid lights (VASI or PAPI) from 5 sm (8 km) of the threshold.  |
| 2.a.5. ....            | Threshold lights and touchdown zone lights from 2 sm (3 km).  |
| 2.a.6. ....            | Markings within range of landing lights for night/twilight (dusk) scenes and as required by the surface resolution test on daylight scenes.   |
| 2.a.7. ....            | For circling approaches, the runway of intended landing and associated lighting must fade into view in a non-distracting manner.  |
| 2.b. ....              | For Helicopter landing areas.   |
| 2.b.1. ....            | Landing direction lights and raised FATO lights from 2 sm (3 km).   |
| 2.b.2. ....            | Flush mounted FATO lights, TOFL lights, and the lighted windsock from 1 sm (1500 m).  |
| 2.b.3. ....            | Hover taxiway lighting (yellow/blue/yellow cylinders) from TOFL area.   |
| 2.b.4. ....            | Markings within range of landing lights for night/twilight (dusk) scenes and as required by the surface resolution test on daylight scenes.   |
| 3. ....                | <b>Airport or Helicopter Landing Area Model Content.</b><br>The following prescribes the minimum requirements for what must be provided in an airport visual model and identifies other as-pects of the airport environment that must correspond with that model. The detail must be modeled using airport pictures, construction drawings and maps, U.S. National Imagery and Mapping Agency data or other data, or modeled in accordance with published regulatory material; however, this does not require that airport or helicopter landing area models contain details that are beyond the designed capability of the currently qualified visual system. For circling approaches, all requirements of this section apply to the runway used for the initial approach and to the runway of intended landing. |
| 3.a. ....              | The surface and markings for each “in-use” runway or helicopter landing area must include the following:  |
| 3.a.1. ....            | For airports: runway threshold markings, runway numbers, touchdown zone markings, fixed distance markings, runway edge markings, and runway centerline stripes.   |
| 3.a.2. ....            | For helicopter landing areas: Standard heliport marking (“H”), TOFL, FATO, and safety areas.  |
| 3.b. ....              | The lighting for each “in-use” runway or helicopter landing area must include the following:  |
| 3.b.1. ....            | For airports: runway approach, threshold, edge, end, centerline (if applicable), touchdown zone (if applicable), leadoff, and vis-ual landing aid lights or light systems for that runway.  |
| 3.b.2. ....            | For helicopter landing areas: landing direction, raised and flush FATO, TOFL, windsock lighting.  |
| 3.c. ....              | The taxiway surface and markings associated with each “in-use” runway or helicopter landing area must include the following:  |
| 3.c.1. ....            | For airports: taxiway edge, centerline (if appropriate), runway hold lines, and ILS critical area(s),   |
| 3.c.2. ....            | For helicopter landing areas: taxiways, taxi routes, and aprons.  |
| 3.d. ....              | The taxiway lighting associated with each “in-use” runway or helicopter landing area must include the following:  |



TABLE D3C.—TABLE OF FUNCTIONS AND SUBJECTIVE TESTS LEVEL 7 FTD—Continued

| <<<QPS requirements>>>      |  |
|-----------------------------|--|
| Number                      | Visual scene content requirements additional visual models beyond minimum required for qualification   |
| 3.d.1. ....                 | For airports: runway edge, centerline (if appropriate), runway hold lines, ILS critical areas.   |
| 3.d.2. ....                 | For helicopter landing areas: taxiways, taxi routes, and aprons.   |
| <b>4. ....</b>              | <b>Required visual model correlation with other aspects of the airport environment simulation.</b><br>The following are the minimum visual model correlation tests that must be conducted for Level 7 FTD. |
| 4.a. ....                   | The airport model must be properly aligned with the navigational aids that are associated with operations at the “in-use” runway.  |
| 4.b. ....                   | Slopes in runways, taxiways, and ramp areas must not cause distracting or unrealistic effects.   |
| <b>5. ....</b>              | <b>Correlation with helicopter and associated equipment.</b><br>The following are the minimum correlation comparisons that must be made.   |
| 5.a. ....                   | Visual system compatibility with aerodynamic programming.  |
| 5.b. ....                   | Accurate portrayal of environment relating to flight simulator attitudes.  |
| 5.c. ....                   | Visual cues to assess sink rate and depth perception during landings.  |
| <b>6. ....</b>              | <b>Scene quality.</b><br>The following are the minimum scene quality tests that must be conducted.   |
| 6.a. ....                   | Light points free from distracting jitter, smearing or streaking.  |
| 6.b. ....                   | Surfaces and textural cues free from apparent quantization (aliasing).   |
| <b>7. ....</b>              | <b>Instructor controls of the following.</b><br>The following are the minimum instructor controls that must be available.  |
| 7.a. ....                   | Environmental effects, e.g., cloud base (if used), cloud effects, cloud density, visibility in statute miles/kilometers and RVR in feet/meters.  |
| 7.b. ....                   | Airport/Heliport selection.  |
| 7.c. ....                   | Airport/Heliport lighting including variable intensity.  |
| 7.d. ....                   | Dynamic effects including ground and flight traffic.   |
| <b>End QPS Requirements</b> |  |
| <b>Begin Information</b>    |  |
| <b>8. ....</b>              | Sponsors are not required to provide every detail of a runway or helicopter landing area, but the detail that is provided must be correct within the capabilities of the system.                           |
| <b>End Information</b>      |  |

TABLE D3D.—TABLE OF FUNCTIONS AND SUBJECTIVE TESTS LEVEL 6 FTD

| <<<QPS requirements>>>   |   |
|--|---|
| Number   | Operations tasks  |
| Tasks in this table are subject to evaluation if appropriate for the helicopter simulated as indicated in the SOQ Configuration List or for a Level 6 FTD. Items not installed or not functional on the FTD and not appearing on the SOQ Configuration List, are not required to be listed as exceptions on the SOQ. |   |
| <b>1. Preflight Procedures</b>   |   |
| 1.a. ....  | Preflight Inspection (Flight Deck Only) switches, indicators, systems, and equipment. |
| 1.b. ....  | APU/Engine start and run-up.  |
| 1.b.1. ....  | Normal start procedures.  |
| 1.b.2. ....  | Alternate start procedures.   |
| 1.b.3. ....  | Abnormal starts and shutdowns.  |

TABLE D3D.—TABLE OF FUNCTIONS AND SUBJECTIVE TESTS LEVEL 6 FTD—Continued

| <<<QPS requirements>>>                |  |
|---------------------------------------|--|
| Number                                | Operations tasks   |
| 1.b.4. ....                           | Rotor engagement.  |
| 1.b.5. ....                           | System checks.   |
| <b>2. Takeoff and Departure Phase</b> |  |
| 2.a. ....                             | Instrument.  |
| 2.b. ....                             | Takeoff with engine failure after critical decision point (CDP).   |
| <b>3. Climb</b>                       |  |
| 3.a. ....                             | Normal.  |
| 3.b. ....                             | One engine inoperative.  |
| <b>4. Inflight Maneuvers</b>          |  |
| 4.a. ....                             | Performance.   |
| 4.b. ....                             | Flying qualities.  |
| 4.c. ....                             | Turns.   |
| 4.c.1. ....                           | Timed.   |
| 4.c.2. ....                           | Normal.  |
| 4.c.3. ....                           | Steep.   |
| 4.d. ....                             | Accelerations and decelerations.   |
| 4.e. ....                             | Abnormal/emergency procedures:   |
| 4.e.1. ....                           | Engine fire.   |
| 4.e.2. ....                           | Engine failure.  |
| 4.e.3. ....                           | In-flight engine shutdown (and restart, if applicable).  |
| 4.e.4. ....                           | Fuel governing system failures (e.g., FADEC malfunction).  |
| 4.e.5. ....                           | Directional control malfunction (restricted to the extent that the maneuver may not terminate in a landing). |
| 4.e.6. ....                           | Hydraulic failure.   |
| 4.e.7. ....                           | Stability augmentation system failure.   |
| <b>5. Instrument Procedures</b>       |  |
| 5.a. ....                             | Holding.   |
| 5.b. ....                             | Precision Instrument Approach.   |
| 5.b.1. ....                           | All engines operating.   |
| 5.b.2. ....                           | One or more engines inoperative.   |
| 5.b.3. ....                           | Approach procedures:   |
| 5.b.4. ....                           | PAR.   |
| 5.b.5. ....                           | ILS.   |
| 5.b.6. ....                           | Manual (raw data).   |
| 5.b.7. ....                           | Flight director only.  |
| 5.b.8. ....                           | Autopilot* and flight director (if appropriate) coupled.   |
| 5.c. ....                             | Non-precision Instrument Approach.   |

TABLE D3D.—TABLE OF FUNCTIONS AND SUBJECTIVE TESTS LEVEL 6 FTD—Continued

| <<<QPS requirements>>>   |  |
|--|--|
| Number   | Operations tasks   |
| 5.c. ....  | Normal—All engines operating.                                |
| 5.c. ....  | One or more engines inoperative.                             |
| 5.c. ....  | Approach procedures:   |
| 5.c.1. ....  | NDB.   |
| 5.c.2. ....  | VOR, RNAV, TACAN, GPS.                                       |
| 5.c.3. ....  | ASR.   |
| 5.c.4. ....  | Helicopter only.   |
| 5.d. ....  | Missed Approach.   |
| 5.d.1. ....  | All engines operating.                                       |
| 5.d.2. ....  | One or more engines inoperative.                             |
| 5.d.3. ....  | Stability augmentation system failure.                       |
| <b>6. Normal and Abnormal Procedures (any phase of flight)</b> |  |
| 6.a. ....  | Helicopter and powerplant systems operation (as applicable). |
| 6.a.1. ....  | Anti-icing/deicing systems.                                  |
| 6.a.2. ....  | Auxiliary power-plant.                                       |
| 6.a.3. ....  | Communications.  |
| 6.a.4. ....  | Electrical system.   |
| 6.a.5. ....  | Environmental system.  |
| 6.a.6. ....  | Fire detection and suppression.                              |
| 6.a.7. ....  | Flight control system.                                       |
| 6.a.8. ....  | Fuel system.   |
| 6.a.9. ....  | Engine oil system.   |
| 6.a.10. ....   | Hydraulic system.  |
| 6.a.11. ....   | Landing gear.  |
| 6.a.12. ....   | Oxygen.  |
| 6.a.13. ....   | Pneumatic.   |
| 6.a.14. ....   | Powerplant.  |
| 6.a.15. ....   | Flight control computers.                                    |
| 6.a.16. ....   | Stability augmentation and control augmentation system(s).   |
| 6.b. ....  | Flight management and guidance system (as applicable).       |
| 6.b.1. ....  | Airborne radar.  |
| 6.b.2. ....  | Automatic landing aids.                                      |
| 6.b.3. ....  | Autopilot.*  |
| 6.b.4. ....  | Collision avoidance system.                                  |
| 6.b.5. ....  | Flight data displays.  |
| 6.b.6. ....  | Flight management computers.                                 |

TABLE D3D.—TABLE OF FUNCTIONS AND SUBJECTIVE TESTS LEVEL 6 FTD—Continued

| <<<QPS requirements>>>                                       |  |
|--|--|
| Number   | Operations tasks   |
| 6.b.7. ....  | Navigation systems.  |
| <b>7. Postflight Procedures</b>                              |  |
| 7.a. ....  | Parking and Securing.  |
| 7.b. ....  | Engine and systems operation.                                      |
| 7.c. ....  | Parking brake operation.   |
| 7.d. ....  | Rotor brake operation.   |
| 7.e. ....  | Abnormal/emergency procedures.                                     |
| <b>8. Instructor Operating Station (IOS), as appropriate</b> |  |
| 8.a. ....  | Power Switch(es).  |
| 8.b.1. ....  | Helicopter conditions.   |
| 8.b.2. ....  | Gross weight, center of gravity, fuel loading and allocation, etc. |
| 8.b.3. ....  | Helicopter systems status.   |
| 8.b.4. ....  | Ground crew functions (e.g., ext. power).                          |
| 8.c. ....  | Airports and landing areas.  |
| 8.c.1. ....  | Number and selection.  |
| 8.c.2. ....  | Runway or landing area selection.                                  |
| 8.c.3. ....  | Preset positions (e.g., ramp, over FAF).                           |
| 8.c.4. ....  | Lighting controls.   |
| 8.d. ....  | Environmental controls.  |
| 8.d.1. ....  | Temperature.   |
| 8.d.2. ....  | Climate conditions (e.g., ice, rain).                              |
| 8.d.3. ....  | Wind speed and direction.  |
| 8.e. ....  | Helicopter system malfunctions.                                    |
| 8.e.1. ....  | Insertion/deletion.  |
| 8.e.2. ....  | Problem clear.   |
| 8.f. ....  | Locks, Freezes, and Repositioning.                                 |
| 8.f.1. ....  | Problem (all) freeze/release.                                      |
| 8.f.2. ....  | Position (geographic) freeze/release.                              |
| 8.f.3. ....  | Repositioning (locations, freezes, and releases).                  |
| 8.f.4. ....  | Ground speed control.  |
| 8.g. ....  | Sound Controls. On/off/adjustment.                                 |
| 8.h. ....  | Control Loading System (as applicable On/off/emergency stop.)      |
| 8.i. ....  | Observer Stations.   |
| 8.i.1. ....  | Position.  |
| 8.i.2. ....  | Adjustments.   |

\*“Autopilot” means attitude retention mode of operation.

TABLE D3E.—TABLE OF FUNCTIONS AND SUBJECTIVE TESTS LEVEL 5 FTD

&lt;&lt;&lt;QPS requirements&gt;&gt;&gt;

| Number | Operations tasks |
|--------|------------------|
|--------|------------------|

Tasks in this table are subject to evaluation if appropriate for the helicopter simulated as indicated in the SOQ Configuration List or for a Level 5 FTD. Items not installed or not functional on the FTD and not appearing on the SOQ Configuration List, are not required to be listed as exceptions on the SOQ.

**1. Preflight Procedures**

|             |   |
|-------------|---|
| 1.a. ....   | Preflight Inspection (Flight Deck Only) switches, indicators, systems, and equipment. |
| 1.b. ....   | APU/Engine start and run-up.  |
| 1.b.1. .... | Normal start procedures.  |
| 1.b.2. .... | Alternate start procedures.   |
| 1.b.3. .... | Abnormal starts and shutdowns.  |

**2. Climb**

|           |         |
|-----------|---------|
| 2.a. .... | Normal. |
|-----------|---------|

**3. Inflight Maneuvers**

|           |                |
|-----------|----------------|
| 3.a. .... | Performance.   |
| 3.b. .... | Turns, Normal. |

**4. Instrument Procedures**

|           |  |
|-----------|--|
| 4.a. .... | Coupled instrument approach maneuvers (as applicable for the systems installed). |
|-----------|--|

**5. Normal and Abnormal Procedures (any phase of flight)**

|           |  |
|-----------|--|
| 5.a. .... | Normal system operation (Installed systems).             |
| 5.b. .... | Abnormal/Emergency system operation (installed systems). |

**6. Postflight Procedures**

|           |                                |
|-----------|--------------------------------|
| 6.a. .... | Parking and Securing.          |
| 6.b. .... | Engine and systems operation.  |
| 6.c. .... | Parking brake operation.       |
| 6.d. .... | Rotor brake operation.         |
| 6.e. .... | Abnormal/emergency procedures. |

**7. Instructor Operating Station (IOS), as appropriate**

|             |   |
|-------------|---|
| 7.a. ....   | Power Switch(es).   |
| 7.b. ....   | Preset positions (ground; air)                                    |
| 7.c. ....   | Helicopter system malfunctions.                                   |
| 7.c.1. .... | Insertion / deletion.   |
| 7.c.2. .... | Problem clear.  |
| 7.d. ....   | Control Loading System (as applicable) On / off / emergency stop. |
| 7.e. ....   | Observer Stations.  |
| 7.e.1. .... | Position.   |
| 7.e.2. .... | Adjustments.  |

TABLE D3F.—TABLE OF FUNCTIONS AND SUBJECTIVE TESTS LEVEL 4 FTD

<<<QPS requirements>>>

| Number   | Operations tasks  |
|--|---|
| Tasks in this table are subject to evaluation if appropriate for the helicopter simulated as indicated in the SOQ Configuration List or for a Level 4 FTD. Items not installed or not functional on the FTD and not appearing on the SOQ Configuration List, are not required to be listed as exceptions on the SOQ. |   |
| <b>1. Preflight Procedures</b>   |   |
| 1.a. ....  | Preflight Inspection (Flight Deck Only) switches, indicators, systems, and equipment. |
| 1.b. ....  | APU/Engine start and run-up.  |
| 1.b.1. ....  | Normal start procedures.  |
| 1.b.2. ....  | Alternate start procedures.   |
| 1.b.3. ....  | Abnormal starts and shutdowns.  |
| <b>2. Normal and Abnormal Procedures (any phase of flight)</b>   |   |
| 2.a. ....  | Normal system operation (Installed systems).  |
| 2.b. ....  | Abnormal/Emergency system operation (installed systems).                              |
| <b>3. Postflight Procedures</b>  |   |
| 3.a. ....  | Parking and Securing.   |
| 3.b. ....  | Engine and systems operation.   |
| 3.c. ....  | Parking brake operation.  |
| <b>4. Instructor Operating Station (IOS), as appropriate</b>   |   |
| 4.a. ....  | Power Switch(es).   |
| 4.b. ....  | Preset positions (ground; air)  |
| 4.c. ....  | Helicopter system malfunctions.   |
| 4.c.1. ....  | Insertion / deletion.   |
| 4.c.2. ....  | Problem clear.  |

**Attachment 4 to Appendix D to Part 60—  
Sample Documents**

**Table of Contents**

Figure D4A Sample Letter, Request for Initial, Upgrade, or Reinstatement Evaluation.

Figure D4B Attachment: FSTD Information Form  
 Figure D4C Sample Qualification Test Guide Cover Page  
 Figure D4D Sample Statement of Qualification—Certificate  
 Figure D4E Sample Statement of Qualification—Configuration List

Figure D4F Sample Statement of Qualification—List of Qualified Tasks  
 Figure D4G Sample Continuing Qualification Evaluation Requirements Page  
 Figure D4H Sample MQTG Index of Effective FSTD Directives  
**BILLING CODE 4910-13-P**

**Attachment 4 to Appendix D to Part 60—  
Figure D4A – Sample Letter, Request for Initial, Upgrade, or Reinstatement Evaluation  
INFORMATION**

Date \_\_\_\_\_

Mr. Charles A. Spillner  
Manager, National Simulator Program  
Federal Aviation Administration  
100 Hartsfield Centre Parkway  
Suite 400  
Atlanta, GA 30354

Dear Mr. Spillner:

**RE: Request for Initial/Upgrade Evaluation Date**

This is to advise you of our intent to request an (initial or upgrade) evaluation of our (FSTD Manufacturer), (Aircraft Type/Level) Flight Simulation Training Device (FSTD), (FAA ID Number, if previously qualified), located in (City, State) at the (Facility) on (Proposed Evaluation Date). (The proposed evaluation date shall not be more than 180 days following the date of this letter.) The FSTD will be sponsored by (Name of Training Center/Air Carrier), FAA Designator (4 Letter Code). The FSTD will be sponsored as follows; (Select One)

- The FSTD will be used within the sponsor's FAA approved training program and placed on the sponsor's Training/Operations Specifications.
- The FSTD will be used for dry lease only.

We agree to provide the formal request for the evaluation to your staff as follows: (check one)

- For QTG tests run at the factory, not later, than 45 days prior to the proposed evaluation date with the additional "1/3 on-site" tests provided not later than 14 days prior to the proposed evaluation date.
- For QTG tests run on-site, not later than 30 days prior to the proposed evaluation date.

We understand that the formal request will contain the following documents:

10. Sponsor's Letter of Request (*Company Compliance Letter*).
11. Principal Operations Inspector (POI) or Training Center Program Manager's (TCPM) endorsement.
12. Complete QTG.

If we are unable to meet the above requirements, we understand this may result in a significant delay, perhaps 45 days or more, in rescheduling and completing the evaluation.

(The sponsor should add additional comments as necessary).

Please contact (Name Telephone and Fax Number of Sponsor's Contact) to confirm the date for this initial evaluation. We understand a member of your National Simulator Program staff will respond to this request within 14 days.

A copy of this letter of intent has been provided to (Name), the Principal Operations Inspector (POI) and/or Training Center Program Manager (TCPM).

Sincerely,

Attachment: FSTD Information Form

cc: POI/TCPM

**Attachment 4 to Appendix D to Part 60—  
Figure D4B – Sample Letter , Request for Initial, Upgrade, or Reinstatement Evaluation  
Attachment: FSTD Information Form  
INFORMATION**

|   |  |  |  |
|---|--|--|--|
| <b>Date:</b> _____  |  |  |  |
| <b>Section 1. FSTD Information and Characteristics</b>              |  |  |  |
| <b>Sponsor Name:</b> _____  |  | <b>FSTD Location:</b> _____  |  |
| <b>Address:</b> _____   |  | <b>Physical Address:</b> _____   |  |
| <b>City:</b> _____  |  | <b>City:</b> _____   |  |
| <b>State:</b> _____   |  | <b>State:</b> _____  |  |
| <b>Country:</b> _____   |  | <b>Country:</b> _____  |  |
| <b>ZIP:</b> _____   |  | <b>ZIP:</b> _____  |  |
| <b>Manager</b> _____  |  |  |  |
| <b>Sponsor ID No:</b><br><i>(Four Letter FAA Designator)</i> _____  |  | <b>Nearest Airport:</b><br><i>(Airport Designator)</i> _____   |  |
| <b>Type of Evaluation Requested:</b>                                |  |  |  |
|   |  | <input type="checkbox"/> Initial <input type="checkbox"/> Upgrade <input type="checkbox"/> Recurrent <input type="checkbox"/> Special <input type="checkbox"/> Reinstatement |  |
| <b>Qualification Basis:</b> _____                                   | <input type="checkbox"/> A                           | <input type="checkbox"/> B   | <input type="checkbox"/> Interim C <input type="checkbox"/> C <input type="checkbox"/> D |
|   | <input type="checkbox"/> 6                           | <input type="checkbox"/> 7   | <input type="checkbox"/> Provisional Status  |
| <b>Initial Qualification:</b><br><i>(If Applicable)</i>             | <b>Date:</b> _____ <b>Level</b> _____                | <b>Manufacturer's Identification/Serial No:</b> _____  |  |
| <b>Upgrade Qualification:</b><br><i>(If Applicable)</i>             | <b>Date:</b> _____ <b>Level</b> _____<br>MM/DD/YYYY  | <input type="checkbox"/> eQTG  |  |
| <b>Other Technical Information:</b>                                 |  |  |  |
| <b>FAA FSTD ID No:</b><br><i>(If Applicable)</i>                    | _____  | <b>FSTD Manufacturer:</b>  | _____  |
| <b>Convertible FSTD:</b>  | <input type="checkbox"/> Yes:                        | <b>Date of Manufacture:</b>  | MM/DD/YYYY   |
| <b>Related FAA ID No.</b><br><i>(If Applicable)</i>                 | _____  | <b>Sponsor FSTD ID No:</b> _____   |  |
| <b>Aircraft model/series:</b> _____                                 | <b>Source of aerodynamic model:</b> _____            |  |  |
| <b>Engine model(s) and data revision:</b> _____                     | <b>Source of aerodynamic doefficient data:</b> _____ |  |  |
| <b>FMS identification and revision level:</b> _____                 | <b>Aerodynamic data revision number:</b> _____       |  |  |
| <b>Visual system manufacturer/model:</b> _____                      | <b>Visual system display:</b> _____                  |  |  |
| <b>Flight control data revision:</b> _____                          | <b>FSTD computer(s) identification:</b> _____        |  |  |
| <b>Motion system manufacturer/type:</b> _____                       |  |  |  |
| <b>National Aviation Authority (NAA):</b><br><i>(If Applicable)</i> | _____  |  | _____  |
| <b>NAA FSTD ID No:</b>  | _____  | <b>Last NAA Evaluation Date:</b>   | _____  |
| <b>NAA Qualification Level:</b>                                     | _____  |  |  |
| <b>NAA Qualification Basis:</b>                                     | _____  |  |  |



**Attachment 4 to Appendix D to Part 60—  
Figure D4B – Sample Letter , Request for Initial, Upgrade, or Reinstatement Evaluation  
Attachment: FSTD Information Form  
INFORMATION**

|   |  |  |  |
|---|--|--|--|
| <b>Visual System<br/>Manufacturer and<br/>Type:</b> | _____                                    | <b>Motion System<br/>Manufacturer and<br/>Type:</b>  | _____  |
| <b>Aircraft<br/>Make/Model/Series:</b>              | _____                                    | <b>FSTD Seats<br/>Available:</b>   | _____  |
| <b>Aircraft<br/>Equipment</b>                       | <b>ENGINE TYPE(S):</b><br>_____          | <b>Flight Instrumentation:</b><br><input type="checkbox"/> EFIS <input type="checkbox"/> HUD <input type="checkbox"/> HGS <input type="checkbox"/> EFVS<br><input type="checkbox"/> TCAS <input type="checkbox"/> GPWS <input type="checkbox"/> Plain View<br><input type="checkbox"/> GPS <input type="checkbox"/> FMS Type: _____<br><input type="checkbox"/> WX Radar <input type="checkbox"/> Other: _____ | <b>Engine<br/>Instrumentation:</b><br><input type="checkbox"/> EICAS <input type="checkbox"/> FADEC<br><input type="checkbox"/> Other: _____ |
|   |  |  |  |
| <b>Airport Models:</b>                              | 3.6.1 _____<br><i>Airport Designator</i> | 3.6.2 _____<br><i>Airport Designator</i>   | 3.6.3 _____<br><i>Airport Designator</i>   |
| <b>Circle to Land:</b>                              | 3.7.1 _____<br><i>Airport Designator</i> | 3.7.2 _____<br><i>Approach</i>   | 3.7.3 _____<br><i>Landing Runway</i>   |
| <b>Visual Ground Segment</b>                        | 3.8.1 _____<br><i>Airport Designator</i> | 3.8.2 _____<br><i>Approach</i>   | 3.8.3 _____<br><i>Landing Runway</i>   |
| <b>Section 2. Supplementary Information</b>         |  |  |  |
| <b>FAA Training Program Approval Authority:</b>     |  | <input type="checkbox"/> POI <input type="checkbox"/> TCPM <input type="checkbox"/> Other: _____   |  |
| <b>Name:</b>  | _____                                    | <b>Office:</b>   | _____  |
| <b>Tel:</b>   | _____                                    | <b>Fax:</b>  | _____  |
| <b>Email:</b>                                       | _____                                    |  |  |
|   |  |  |  |
| <b>FSTD Scheduling Person:</b>                      |  |  |  |
| <b>Name:</b>  | _____                                    |  |  |
| <b>Address 1:</b>                                   | _____                                    | <b>Address 2</b>   | _____  |
| <b>City:</b>  | _____                                    | <b>State:</b>  | _____  |
| <b>ZIP:</b>   | _____                                    | <b>Email:</b>  | _____  |
| <b>Tel:</b>   | _____                                    | <b>Fax:</b>  | _____  |
|   |  |  |  |
| <b>FSTD Technical Contact:</b>                      |  |  |  |
| <b>Name:</b>  | _____                                    |  |  |
| <b>Address 1:</b>                                   | _____                                    | <b>Address 2</b>   | _____  |
| <b>City:</b>  | _____                                    | <b>State:</b>  | _____  |
| <b>ZIP:</b>   | _____                                    | <b>Email:</b>  | _____  |
| <b>Tel:</b>   | _____                                    | <b>Fax:</b>  | _____  |

**Attachment 4 to Appendix D to Part 60—  
Figure D4B – Sample Letter , Request for Initial, Upgrade, or Reinstatement Evaluation  
Attachment: FSTD Information Form  
INFORMATION**

| <b>Section 3. Training, Testing and Checking Considerations</b>  |                          |         |
|--|--------------------------|---------|
| Area/Function/Maneuver   | Requested                | Remarks |
| Private Pilot - Training / Checks: (142)   | <input type="checkbox"/> | _____   |
| Commercial Pilot - Training /Checks:(142)  | <input type="checkbox"/> | _____   |
| Multi-Engine Rating - Training / Checks (142)  | <input type="checkbox"/> | _____   |
| Instrument Rating -Training / Checks (142)   | <input type="checkbox"/> | _____   |
| Type Rating - Training / Checks (135/121/142)  | <input type="checkbox"/> | _____   |
| Proficiency Checks (135/121/142)   | <input type="checkbox"/> | _____   |
| CAT I: (RVR 2400/1800 ft. DH200 ft)  | <input type="checkbox"/> | _____   |
| CAT II: (RVR 1200 ft. DH 100 ft)   | <input type="checkbox"/> | _____   |
| CAT III * (lowest minimum) _____ RVR _____ ft.<br>* State CAT III ( $\leq 700$ ft.), CAT IIIb ( $\leq 150$ ft.), or CAT IIIc (0 ft.) | <input type="checkbox"/> | _____   |
| Circling Approach  | <input type="checkbox"/> | _____   |
| Windshear Training:  | <input type="checkbox"/> | _____   |
| Windshear Training IAW 121.409(d) (121 Turbojets Only)   | <input type="checkbox"/> | _____   |
| Generic Unusual Attitudes and Recoveries within the Normal Flight Envelope   | <input type="checkbox"/> | _____   |
| Specific Unusual Attitudes Recoveries  | <input type="checkbox"/> | _____   |
| Auto-coupled Approach/Auto Go Around   | <input type="checkbox"/> | _____   |
| Auto-land / Roll Out Guidance  | <input type="checkbox"/> | _____   |
| TCAS/ACAS I / II   | <input type="checkbox"/> | _____   |
| WX-Radar   | <input type="checkbox"/> | _____   |
| HUD  | <input type="checkbox"/> | _____   |
| HGS  | <input type="checkbox"/> | _____   |
| EFVS   | <input type="checkbox"/> | _____   |
| Future Air Navigation Systems  | <input type="checkbox"/> | _____   |
| GPWS / EGPWS   | <input type="checkbox"/> | _____   |
| ETOPS Capability   | <input type="checkbox"/> | _____   |
| GPS  | <input type="checkbox"/> | _____   |
| SMGCS  | <input type="checkbox"/> | _____   |
| Helicopter Slope Landings  | <input type="checkbox"/> | _____   |
| Helicopter External Load Operations  | <input type="checkbox"/> | _____   |
| Helicopter Pinnacle Approach to Landings   | <input type="checkbox"/> | _____   |
| Helicopter Night Vision Maneuvers  | <input type="checkbox"/> | _____   |
| Helicopter Category A Takeoffs   | <input type="checkbox"/> | _____   |

**Attachment 4 to Appendix D to Part 60—  
Figure D4C – Sample Qualification Test Guide Cover Page**

**INFORMATION**

SPONSOR NAME

SPONSOR ADDRESS

FAA QUALIFICATION TEST GUIDE

(SPECIFIC HELICOPTER MODEL)

( *for example* )

( Vertiflite AB-320 )

(FTD Identification Including Manufacturer, Serial Number, Visual System Used)

(FTD Level)

(Qualification Performance Standard Used)

(FTD Location)

FAA Initial Evaluation

Date: \_\_\_\_\_

\_\_\_\_\_ Date: \_\_\_\_\_  
(Sponsor)

\_\_\_\_\_ Date: \_\_\_\_\_  
Manager, National Simulator Program, FAA

**Attachment 4 to Appendix D to Part 60—  
Figure D4D – Sample Statement of Qualification - Certificate**

**INFORMATION**

**Federal Aviation Administration  
National Simulator Program**



**Certificate of Qualification**

**This is to certify that representatives of the National Simulator Program  
Completed an evaluation of the**

**Go-Fast Training Center  
Vertiflite AB-320 Flight Training Device  
FAA Identification Number 889**

**And found it to meet the standards set forth in  
14 CFR Part 60, Appendix D  
Qualification Performance Standards**

**The Master Qualification Test Guide and the attached  
Configuration List and List of Qualified Tasks  
Provide the Qualification Basis for this device to operate at**

**Level 6  
Until April 30, 2010**

**Unless sooner rescinded or extended by the National Simulator Program Manager**

**March 15, 2009**

**(date)**

***C. Nordlie***

**(for the NSPM)**

**Attachment 4 to Appendix D to Part 60—  
Figure D4E – Sample Statement of Qualification – Configuration List  
INFORMATION**

|  |  |  |  |
|--|--|--|--|
| Date: _____  |  |  |  |
| <b>Section 1. FSTD Information and Characteristics</b>   |  |  |  |
| Sponsor Name: _____  |  | FSTD Location: _____   |  |
| Address: _____   |  | Physical Address: _____  |  |
| City: _____  |  | City: _____  |  |
| State: _____   |  | State: _____   |  |
| Country: _____   |  | Country: _____   |  |
| ZIP: _____   |  | ZIP: _____   |  |
| Manager _____  |  |  |  |
| Sponsor ID No:<br><i>(Four Letter FAA Designator)</i> _____  |  | Nearest Airport:<br><i>(Airport Designator)</i> _____  |  |
| Type of Evaluation Requested: _____  |  |  |  |
| <input type="checkbox"/> Initial <input type="checkbox"/> Upgrade <input type="checkbox"/> Recurrent <input type="checkbox"/> Special <input type="checkbox"/> Reinstatement |  |  |  |
| Qualification Basis: _____   |  | <input type="checkbox"/> A <input type="checkbox"/> B <input type="checkbox"/> Interim C <input type="checkbox"/> C <input type="checkbox"/> D |  |
| <input type="checkbox"/> 6 <input type="checkbox"/> 7  |  | <input type="checkbox"/> Provisional Status  |  |
| Initial Qualification:<br><i>(If Applicable)</i>   |  | Date: _____ Level _____  |  |
| Upgrade Qualification:<br><i>(If Applicable)</i>   |  | Date: _____ Level _____<br>MM/DD/YYYY  |  |
|  |  | Manufacturer's Identification/Serial No: _____   |  |
|  |  | <input type="checkbox"/> eQTG  |  |
| <b>Other Technical Information:</b>  |  |  |  |
| FAA FSTD ID No:<br><i>(If Applicable)</i>  |  | FSTD Manufacturer: _____   |  |
| Convertible FSTD: <input type="checkbox"/> Yes:  |  | Date of Manufacture: _____<br>MM/DD/YYYY   |  |
| Related FAA ID No.<br><i>(If Applicable)</i>   |  | Sponsor FSTD ID No: _____  |  |
| Aircraft model/series: _____   |  | Source of aerodynamic model: _____   |  |
| Engine model(s) and data revision: _____   |  | Source of aerodynamic doefficient data: _____  |  |
| FMS identification and revision level: _____   |  | Aerodynamic data revision number: _____  |  |
| Visual system manufacturer/model: _____  |  | Visual system display: _____   |  |
| Flight control data revision: _____  |  | FSTD computer(s) identification: _____   |  |
| Motion system manufacturer/type: _____   |  |  |  |
| National Aviation Authority (NAA):<br><i>(If Applicable)</i>   |  |  |  |
| NAA FSTD ID No: _____  |  | Last NAA Evaluation Date: _____  |  |
| NAA Qualification Level: _____   |  |  |  |
| NAA Qualification Basis: _____   |  |  |  |
| Visual System Manufacturer and Type: _____   |  |  |  |
| Motion System Manufacturer and Type: _____   |  |  |  |

**Attachment 4 to Appendix D to Part 60—  
Figure D4E – Sample Statement of Qualification – Configuration List  
INFORMATION**

|  |                          |   |   |
|--|--------------------------|---|---|
| Aircraft Make/Model/Series: _____  |                          | FSTD Seats Available: _____   |   |
| Aircraft Equipment   | ENGINE TYPE(S):<br>_____ | Flight Instrumentation:<br><input type="checkbox"/> EFIS <input type="checkbox"/> HUD <input type="checkbox"/> HGS <input type="checkbox"/> EFVS<br><input type="checkbox"/> TCAS <input type="checkbox"/> GPWS <input type="checkbox"/> Plain View<br><input type="checkbox"/> GPS <input type="checkbox"/> FMS Type: _____<br><input type="checkbox"/> WX Radar <input type="checkbox"/> Other: _____ | Engine Instrumentation:<br><input type="checkbox"/> EICAS <input type="checkbox"/> FADEC<br><input type="checkbox"/> Other: _____ |
| <b>Section 2. Supplementary Information</b>  |                          |   |   |
| FAA Training Program Approval Authority:   |                          | <input type="checkbox"/> POI <input type="checkbox"/> TCPM <input type="checkbox"/> Other: _____  |   |
| Name:  | _____                    | Office:   | _____   |
| Tel:   | _____                    | Fax:  | _____   |
| Email:   | _____                    |   |   |
| <b>FSTD Scheduling Person:</b>   |                          |   |   |
| Name:  | _____                    |   |   |
| Address 1:   | _____                    | Address 2   | _____   |
| City:  | _____                    | State:  | _____   |
| ZIP:   | _____                    | Email:  | _____   |
| Tel:   | _____                    | Fax:  | _____   |
| <b>FSTD Technical Contact:</b>   |                          |   |   |
| Name:  | _____                    |   |   |
| Address 1:   | _____                    | Address 2   | _____   |
| City:  | _____                    | State:  | _____   |
| ZIP:   | _____                    | Email:  | _____   |
| Tel:   | _____                    | Fax:  | _____   |
| <b>Section 3. Training, Testing and Checking Considerations</b>  |                          |   |   |
| Area/Function/Maneuver   | Requested                | Remarks   |   |
| Private Pilot - Training / Checks: (142)   | <input type="checkbox"/> | _____   |   |
| Commercial Pilot - Training /Checks:(142)  | <input type="checkbox"/> | _____   |   |
| Multi-Engine Rating - Training / Checks (142)  | <input type="checkbox"/> | _____   |   |
| Instrument Rating -Training / Checks (142)   | <input type="checkbox"/> | _____   |   |
| Type Rating - Training / Checks (135/121/142)  | <input type="checkbox"/> | _____   |   |
| Proficiency Checks (135/121/142)   | <input type="checkbox"/> | _____   |   |
| CAT I: (RVR 2400/1800 ft. DH200 ft)  | <input type="checkbox"/> | _____   |   |
| CAT II: (RVR 1200 ft. DH 100 ft)   | <input type="checkbox"/> | _____   |   |
| CAT III * (lowest minimum) _____ RVR _____ ft.<br>* State CAT III (≤ 700 ft.), CAT IIIb (≤ 150 ft.), or CAT IIIc (0 ft.) | <input type="checkbox"/> | _____   |   |

**Attachment 4 to Appendix D to Part 60—  
Figure D4E – Sample Statement of Qualification – Configuration List  
INFORMATION**

|   |                          |       |
|---|--------------------------|-------|
| <b>Circling Approach</b>  | <input type="checkbox"/> | _____ |
| <b>Windshear Training:</b>  | <input type="checkbox"/> | _____ |
| <b>Windshear Training IAW 121.409(d) (121 Turbojets Only)</b>                     | <input type="checkbox"/> | _____ |
| <b>Generic Unusual Attitudes and Recoveries within the Normal Flight Envelope</b> | <input type="checkbox"/> | _____ |
| <b>Specific Unusual Attitudes Recoveries</b>                                      | <input type="checkbox"/> | _____ |
| <b>Auto-coupled Approach/Auto Go Around</b>                                       | <input type="checkbox"/> | _____ |
| <b>Auto-land / Roll Out Guidance</b>  | <input type="checkbox"/> | _____ |
| <b>TCAS/ACAS I / II</b>   | <input type="checkbox"/> | _____ |
| <b>WX-Radar</b>   | <input type="checkbox"/> | _____ |
| <b>HUD</b>  | <input type="checkbox"/> | _____ |
| <b>HGS</b>  | <input type="checkbox"/> | _____ |
| <b>EFVS</b>   | <input type="checkbox"/> | _____ |
| <b>Future Air Navigation Systems</b>  | <input type="checkbox"/> | _____ |
| <b>GPWS / EGPWS</b>   | <input type="checkbox"/> | _____ |
| <b>ETOPS Capability</b>   | <input type="checkbox"/> | _____ |
| <b>GPS</b>  | <input type="checkbox"/> | _____ |
| <b>SMGCS</b>  | <input type="checkbox"/> | _____ |
| <b>Helicopter Slope Landings</b>  | <input type="checkbox"/> | _____ |
| <b>Helicopter External Load Operations</b>  | <input type="checkbox"/> | _____ |
| <b>Helicopter Pinnacle Approach to Landings</b>                                   | <input type="checkbox"/> | _____ |
| <b>Helicopter Night Vision Maneuvers</b>  | <input type="checkbox"/> | _____ |
| <b>Helicopter Category A Takeoffs</b>   | <input type="checkbox"/> | _____ |

**Attachment 4 to Appendix D to Part 60—  
Figure D4F – Sample Statement of Qualification – List of Qualified Tasks  
INFORMATION**

**STATEMENT of QUALIFICATION  
LIST of QUALIFIED TASKS**

**Go-Fast Training Center Vertiflite AB-320 -- Level C -- FAA ID# 888**

**The FTD is qualified to perform all of the Maneuvers, Procedures, Tasks, and Functions  
Listed in Appendix D, Attachment 1, Table D1B, Minimum FTD Requirements  
In Effect on [mm/dd/yyyy] except for the following listed Tasks or Functions.**

*(Example)*

**Excepted Tasks:**

- 6.f.** Fire Detection and Extinguisher System.
- 7.d** Ditching.

**Excepted Simulator Systems:**

Remote IOS

**Additional Qualified Tasks or Functions in addition to those listed in Appendix D,  
Attachment 3, Table D1B, Minimum FTD Requirements.**

(None)



|   |   |
|---|---|
| <b>Recurrent Evaluation Requirements</b><br><i>Completed at conclusion of Initial Evaluation</i>  |   |
| Recurrent Evaluations to be conducted each<br>___(fill in)___ months<br><br>Allotting _____ hours of FTD time.<br><br>Signed:<br>_____<br>NSPM / Evaluation Team Leader | Recurrent evaluations are due as follows:<br><br>___(month)___ and ___(month)___ and<br>___(month)___<br>(enter or strike out, as appropriate)<br><br>_____<br>Date |

|   |   |
|---|---|
| <b>Revision:</b><br><br>Based on (enter reasoning):<br>_____<br>_____   |   |
| Recurrent Evaluations are to be conducted each<br>___(fill in)___ months. Allotting _____ hours.<br><br>Signed:<br>_____<br>NSPM Evaluation Team Leader | Recurrent evaluations are due as follows:<br><br>___(month)___ and ___(month)___ and<br>___(month)___<br>(enter or strike out, as appropriate)<br><br>_____<br>Date |

(Repeat as Necessary)



warrant a finding of “non-compliance,” or “non-conformity;” “partial compliance,” or “partial conformity;” and “acceptable compliance,” or “acceptable conformity.”

(6) A sample Continuation Sheet for additional comments that may be added by the sponsor or the NSPM during a QMS evaluation.

(7) A sample Sponsor Checklist to assist the sponsor in verifying the elements that comprise the required QMS program.

(8) A sample Sponsor Checklist to assist the sponsor in verifying the elements that comprise the voluntary portion of QMS program.

(9) A table showing the essential functions, processes, and procedures that relate to the required and voluntary QMS components and a cross-reference to each represented task.

i. Additional Information.

(1) In addition to specifically designated QMS evaluations, the NSPM will evaluate the sponsor’s QMS program as part of regularly scheduled FSTD continuing qualification evaluations and no-notice FSTD evaluations, focusing in part on the effectiveness and viability of the QMS program and its contribution to the overall capability of the FSTD to meet the requirements of this part.

(2) The sponsor or MR may delegate duties associated with maintaining the qualification of the FSTD (e.g., corrective and preventive maintenance, scheduling and conducting tests or inspections, functional preflight checks) but retain the responsibility and authority for the day-to-day qualification of the FSTD. One person may serve as the sponsor or MR for more than one FSTD, but

one FSTD may not have more than one sponsor or MR.

(3) A QMS program may be applicable to more than one certificate holder (e.g., part 119 and part 142 or two part 119 certificate holders) and an MR may work for more than one certificate holder (e.g., part 119 and part 142 or two part 119 certificate holders) as long as the QMS program requirements and the MR requirements are met for each certificate holder.

(4) Standard Measurements for Flight Simulator Quality: A quality system based on FSTD performance will improve and maintain training quality. See [http://www.faa.gov/safety/programs\\_initiatives/aircraft\\_aviation/nsp/sqms/](http://www.faa.gov/safety/programs_initiatives/aircraft_aviation/nsp/sqms/) for more information on measuring FSTD performance.

(5) The NSPM will use the results of the assessment(s) of the voluntary portions of the QMS program (as described in Tables E4 and E5) to determine whether to extend the intervals between NSPM-conducted evaluations.

j. The FAA does not mandate a specific QMS program format, but an acceptable QMS program should contain the following:

(1) A Quality Policy. This is a formal written Quality Policy Statement that is a commitment by the sponsor outlining what the Quality System will achieve.

(2) A MR who has overall authority for monitoring the on-going qualification of assigned FSTDs to ensure that all FSTD qualification issues are resolved as required by this part. The MR should ensure that the QMS program is properly implemented and maintained, and should:

(a) Brief the sponsor’s management on the qualification processes;

(b) Serve as the primary contact point for all matters between the sponsor and the NSPM regarding the qualification of the assigned FSTDs; and

(c) Oversee the day-to-day quality control.

(3) The system and processes outlined in the QMS should enable the sponsor to monitor compliance with all applicable regulations and ensure correct maintenance and performance of the FSTD.

(4) A QMS program and a statement acknowledging completion of a periodic review by the MR should include the following:

(a) A maintenance facility that provides suitable FSTD hardware and software tests and maintenance capability.

(b) A recording system in the form of a technical log in which defects, deferred defects, and development projects are listed, assigned and reviewed within a specified time period.

(c) Routine maintenance of the FSTD and performance of the QTG tests with adequate staffing to cover FSTD operating periods.

(d) A planned internal assessment schedule and a periodic review should be used to verify that corrective action was complete and effective. The assessor should have adequate knowledge of FSTDs and should be acceptable to the NSPM.

(5) The MR should receive appropriate Quality System training and brief other personnel on the procedures.

**End Information**

TABLE E1.—FSTD QUALITY MANAGEMENT SYSTEM

| Number     | <<<QPS requirement>>>  | Information (reference) |
|------------|--|-------------------------|
| E1.1. .... | A QMS manual that prescribes the policies, processes, or procedures outlined in this table ....  | § 60.5(a).              |
| E1.2. .... | A policy, process, or procedure specifying how the sponsor will identify deficiencies in the QMS.  | § 60.5(b).              |
| E1.3. .... | A policy, process, or procedure specifying how the sponsor will document how the QMS program will be changed to address deficiencies.  | § 60.5(b).              |
| E1.4. .... | A policy, process, or procedure specifying how the sponsor will address proposed program changes (for programs that do not meet the minimum requirements as notified by the NSPM) to the NSPM and receive approval prior to their implementation.  | § 60.5(c).              |
| E1.5. .... | A policy, process, or procedure specifying how the sponsor will document that at least one FSTD is used within the sponsor’s FAA-approved flight training program for the aircraft or set of aircraft at least once within the 12-month period following the initial or upgrade evaluation conducted by the NSPM and at least once within each subsequent 12-month period thereafter.            | § 60. 7(b)(5).          |
| E1.6. .... | A policy, process, or procedure specifying how the sponsor will document that at least one FSTD is used within the sponsor’s FAA-approved flight training program for the aircraft or set of aircraft at least once within the 12-month period following the first continuing qualification evaluation conducted by the NSP and at least once within each subsequent 12-month period thereafter. | § 60.7(b)(6).           |

TABLE E1.—FSTD QUALITY MANAGEMENT SYSTEM—Continued

| Number        | <<<QPS requirement>>>   | Information (reference)   |
|---------------|---|---|
| E1.7. ....    | A policy, process, or procedure specifying how the sponsor will obtain an annual written statement from a qualified pilot (who has flown the subject aircraft or set of aircraft during the preceding 12-month period) that the performance and handling qualities of the subject FSTD represents the subject aircraft or set of aircraft (within the normal operating envelope). Required only if the subject FSTD is not used in the sponsor's FAA-approved flight training program for the aircraft or set of aircraft at least once within the preceding 12-month period. | § 60.5(b)(7) and § 60.7(d)(2).  |
| E1.8. ....    | A policy, process, or procedure specifying how independent feedback (from persons recently completing training, evaluation, or obtaining flight experience; instructors and check airmen using the FSTD for training, evaluation or flight experience sessions; and FSTD technicians and maintenance personnel) will be received and addressed by the sponsor regarding the FSTD and its operation.   | § 60.9(b)(1).   |
| E1.9. ....    | A policy, process, or procedure specifying how and where the FSTD Statement of Qualification will be posted, or accessed by an appropriate terminal or display, in or adjacent to the FSTD.   | § 60.9(b)(2).   |
| E1.10. ....   | A policy, process, or procedure specifying how the sponsor's management representative (MR) is selected and identified by name to the NSPM.   | § 60.9(c) and Appendix E, paragraph(d).                                     |
| E1.11. ....   | A policy, process, or procedure specifying the MR authority and responsibility for the following:   | § 60.9(c)(2), (3), and (4).   |
| E1.11.a. .... | Monitoring the on-going qualification of assigned FSTDs to ensure all matters regarding FSTD qualification are completed as required by this part.  |   |
| E1.11.b. .... | Ensuring that the QMS is properly maintained by overseeing the QMS policies, practices, or procedures and modifying as necessary.   |   |
| E1.11.c. .... | Regularly briefing sponsor's management on the status of the on-going FSTD qualification program and the effectiveness and efficiency of the QMS.   |   |
| E1.11.d. .... | Serving as the primary contact point for all matters between the sponsor and the NSPM regarding the qualification of assigned FSTDs.  |   |
| E1.11.e. .... | Delegating the MR assigned duties to an individual at each of the sponsor's locations, as appropriate.  |   |
| E1.12. ....   | A policy, process, or procedure specifying how the sponsor will:  | § 60.13; QPS Appendices A, B, C, and D.                                     |
| E1.12.a. .... | Ensure that the data made available to the NSPM (the validation data package) includes the aircraft manufacturer's flight test data (or other data approved by the NSPM) and all relevant data developed after the type certificate was issued (e.g., data developed in response to an airworthiness directive) if the data results from a change in performance, handling qualities, functions, or other characteristics of the aircraft that must be considered for flight crewmember training, evaluation, or experience requirements.                                     |   |
| E1.12.b. .... | Notify the NSPM within 10 working days of becoming aware that an addition to or a revision of the flight related data or airplane systems related data is available if this data is used to program or operate a qualified FSTD.  |   |
| E1.12.c. .... | Maintain a liaison with the manufacturer of the aircraft being simulated (or with the holder of the aircraft type certificate for the aircraft being simulated if the manufacturer is no longer in business), and if appropriate, with the person who supplied the aircraft data package for the FFS for the purposes of receiving notification of data package changes.  |   |
| E1.13. ....   | A policy, process, or procedure specifying how the sponsor will make available all special equipment and qualified personnel needed to conduct tests during initial, continuing qualification, or special evaluations.  | § 60.14.  |
| E1.14. ....   | A policy, process, or procedure specifying how the sponsor will submit to the NSPM a request to evaluate the FSTD for initial qualification at a specific level and simultaneously request the TPAA forward a concurring letter to the NSPM; including how the MR will use qualified personnel to confirm the following:  | § 60.15(a)–(d); § 60.15(b); § 60.15(b)(i); § 60.15(b)(ii); § 60.15(b)(iii). |
| E1.14.a. .... | That the performance and handling qualities of the FSTD represent those of the aircraft or set of aircraft within the normal operating envelope.  |   |
| E1.14.b. .... | The FSTD systems and sub-systems (including the simulated aircraft systems) functionally represent those in the aircraft or set of aircraft.  |   |

TABLE E1.—FSTD QUALITY MANAGEMENT SYSTEM—Continued

| Number        | <<<QPS requirement>>>   | Information (reference)                              |
|---------------|---|--|
| E1.14.c. .... | The flight deck represents the configuration of the specific type or aircraft make, model, and series aircraft being simulated, as appropriate.   |  |
| E1.15. ....   | A policy, process, or procedure specifying how the subjective and objective tests are completed at the sponsor's training facility for an initial evaluation.   | § 60.15(e).  |
| E1.16. ....   | A policy, process, or procedure specifying how the sponsor will update the QTG with the results of the FAA-witnessed tests and demonstrations together with the results of the objective tests and demonstrations after the NSPM completes the evaluation for initial qualification.  | § 60.15(h).  |
| E1.17. ....   | A policy, process, or procedure specifying how the sponsor will make the MQTG available to the NSPM upon request.   | § 60.15(i).  |
| E1.18. ....   | A policy, process, or procedure specifying how the sponsor will apply to the NSPM for additional qualification(s) to the Statement of Qualification.  | § 60.16(a); § 60.16(a)(1)(i); and § 60.16(a)(1)(ii). |
| E1.19. ....   | A policy, process, or procedure specifying how the sponsor completes all required Attachment 2 objective tests each year in a minimum of four evenly spaced inspections as specified in the appropriate QPS.  | § 60.19(a)(1) QPS Appendices A, B, C, or D.          |
| E1.20. ....   | A policy, process, or procedure specifying how the sponsor completes and records a functional preflight check of the FSTD within the preceding 24 hours of FSTD use, including a description of the functional preflight.   | § 60.19(a)(2) QPS Appendices A, B, C, or D.          |
| E1.21. ....   | A policy, process, or procedure specifying how the sponsor schedules continuing qualification evaluations with the NSPM.  | § 60.19(b)(2).                                       |
| E1.22. ....   | A policy, process, or procedure specifying how the sponsor ensures that the FSTD has received a continuing qualification evaluation at the interval described in the MQTG.  | § 60.19(b)(5)–(6).                                   |
| E1.23. ....   | A policy, process, or procedure describing how discrepancies are recorded in the FSTD discrepancy log, including:   | § 60.19(c); § 60.19(c)(2)(i); § 60.19(c)(2)(ii).     |
| E1.23.a. .... | A description of how the discrepancies are entered and maintained in the log until corrected.   |  |
| E1.23.b. .... | A description of the corrective action taken for each discrepancy, the identity of the individual taking the action, and the date that action is taken.   |  |
| E1.24. ....   | A policy, process, or procedure specifying how the discrepancy log is kept in a form and manner acceptable to the Administrator and kept in or adjacent to the FSTD. (An electronic log that may be accessed by an appropriate terminal or display in or adjacent to the FSTD is satisfactory.)   | § 60.19(c)(2)(iii).                                  |
| E1.25. ....   | A policy, process, or procedure that requires each instructor, check airman, or representative of the Administrator conducting training, evaluation, or flight experience, and each person conducting the preflight inspection, who discovers a discrepancy, including any missing, malfunctioning, or inoperative components in the FSTD, to write or cause to be written a description of that discrepancy into the discrepancy log at the end of the FSTD preflight or FSTD use session. | § 60.20.   |
| E1.26. ....   | A policy, process, or procedure specifying how the sponsor will apply for initial qualification based on the final aircraft data package approved by the aircraft manufacturer if operating an FSTD based on an interim qualification.  | § 60.21(c).  |
| E1.27. ....   | A policy, process, or procedure specifying how the sponsor determines whether an FSTD change qualifies as a modification as defined in § 60.23.   | § 60.23(a)(1)–(2).                                   |
| E1.28. ....   | A policy, process, or procedure specifying how the sponsor will ensure the FSTD is modified in accordance with any FSTD Directive regardless of the original qualification basis.   | § 60.23(b).  |
| E1.29. ....   | A policy, process, or procedure specifying how the sponsor will notify the NSPM and TPAA of their intent to use a modified FSTD and to ensure that the modified FSTD will not be used prior to:   | § 60.23(c)(1)(i),(ii), and (iv).                     |
| E1.29.a. .... | Twenty-one days since the sponsor notified the NSPM and the TPAA of the proposed modification and the sponsor has not received any response from either the NSPM or the TPAA; or  |  |

TABLE E1.—FSTD QUALITY MANAGEMENT SYSTEM—Continued

| Number          | <<<QPS requirement>>>  | Information (reference)                           |
|-----------------|--|---|
| E1.29.b. ....   | Twenty-one days since the sponsor notified the NSPM and the TPAA of the proposed modification and one has approved the proposed modification and the other has not responded; or   |   |
| E1.29.c. ....   | The FSTD successfully completing any evaluation the NSPM may require in accordance with the standards for an evaluation for initial qualification or any part thereof before the modified FSTD is placed in service.   |   |
| E1.30. ....     | A policy, process, or procedure specifying how, after an FSTD modification is approved by the NSPM, the sponsor will:  | § 60.23(d)–(e).                                   |
| E1.30.a. ....   | Post an addendum to the Statement of Qualification until as the NSPM issues a permanent, updated Statement of Qualification.   |   |
| E1.30.b. ....   | Update the MQTG with current objective test results and appropriate objective data for each affected objective test or other MQTG section affected by the modification.  |   |
| E1.30.c. ....   | File in the MQTG the requirement from the NSPM to make the modification and the record of the modification completion.   |   |
| E1.31. ....     | A policy, process, or procedure specifying how the sponsor will track the length of time a component has been missing, malfunctioning, or inoperative (MMI), including:  | § 60.25(b)–(c), and QPS Appendices A, B, C, or D. |
| E1.31.a. ....   | How the sponsor will post a list of MMI components in or adjacent to the FSTD.   |   |
| E1.31.b. ....   | How the sponsor will notify the NSPM if the MMI has not been repaired or replaced within 30 days.*   |   |
| E1.32. ....     | A policy, process, or procedure specifying how the sponsor will notify the NSPM and how the sponsor will seek requalification of the FSTD if the FSTD is moved and reinstalled in a different location.  | § 60.27(a)(3).                                    |
| E1.33. ....     | A policy, process, or procedure specifying how the sponsor will maintain control of the following: (The sponsor must specify how these records are maintained in plain language form or in coded form; but if the coded form is used, the sponsor must specify how the preservation and retrieval of information will be conducted.) | § 60.31.  |
| E1.33.a. ....   | The MQTG and each amendment.   |   |
| E1.33.b. ....   | A record of all FSTD modifications required by this part since the issuance of the original Statement of Qualification.  |   |
| E1.33.c. ....   | Results of the qualification evaluations (initial and each upgrade) since the issuance of the original Statement of Qualification.   |   |
| E1.33.d. ....   | Results of the objective tests conducted in accordance with this part for a period of 2 years.   |   |
| E1.33.e. ....   | Results of the previous three continuing qualification evaluations, or the continuing qualification evaluations from the previous 2 years, whichever covers a longer period.   |   |
| E1.33.f. ....   | Comments obtained in accordance with § 60.9(b).  |   |
| E1.33.g. ....   | A record of all discrepancies entered in the discrepancy log over the previous 2 years, including the following:   |   |
| E1.33.g.1. .... | A list of the components or equipment that were or are missing, malfunctioning, or inoperative.  |   |
| E1.33.g.2. .... | The action taken to correct the discrepancy.   |   |
| E1.33.g.3. .... | The date the corrective action was taken.  |   |
| E1.33.g.4. .... | The identity of the person determining that the discrepancy has been corrected.  |   |

\*Note: If the sponsor has an approved discrepancy prioritization system, this item is satisfied by describing how discrepancies are prioritized, what actions are taken, and how the sponsor will notify the NSPM if the MMI has not been repaired or replaced within the specified timeframe.

**SIMULATION QUALITY MANAGEMENT SYSTEM (SQMS) RESPONSIBILITIES MATRIX—QPS REQUIREMENTS**  
 [Simulation Quality Management System (SQMS) Responsibilities Matrix]

<<< QPS requirements >>>

| Number                 | Function/element   | Designated responsibility for approval or control position, name or title |
|------------------------|--|---|
| Sponsor Site/Location: |  |   |
| 1. ....                | R Responsible Management/Ultimate SQMS Authority.  |   |
| 2. ....                | R Management Representative (Primary Contact Point with NSPM): Overseeing (Monitoring, Measurement, Analysis) and Modifying SQMS Policies, Processes, Practices and Procedures; Monitoring and Ensuring FSTD Qualification; Evaluation Scheduling. |   |
| 3. ....                | V Quality Policy.  |   |
| 4. ....                | V Quality Objectives.  |   |
| 5. ....                | R SQMS Manual/Chart-Maps for Functions—Elements—Processes.   |   |
| 6. ....                | R Responsibilities Matrix.   |   |
| 7. ....                | V SQMS Awareness and Training.   |   |
| 8. ....                | V Management Review/Management Provision of Resources.   |   |
| 9.a. ....              | R SQMS Internal Assessment.  |   |
| 9.b. ....              | V Reporting of Assessment Results.   |   |
| 10.a. ....             | R SQMS Deficiency Identification, Program Change or Modification.  |   |
| 10.b. ....             | V SQMS Corrective Action or Managed Change.  |   |
| 11.a. ....             | R FSTD Routine Maintenance, Preventative Maintenance, and Pre-flight.  |   |
| 11.b. ....             | V Periodic Expanded Pre-flight/Fly-out.  |   |
| 12.a. ....             | R Objective Testing.   |   |
| 12.b. ....             | V QTG Test Completion Schedules.   |   |
| 13. ....               | R FSTD User Comments.  |   |
| 14. ....               | V Tech-Management Liaison with Primary FSTD User(s).   |   |
| 15. ....               | V Scheduling/Tracking—Inspection, Testing, Engineering, Maintenance.   |   |
| 16. ....               | V FSTD Reliability Tracking, Measurement and Analysis.   |   |
| 17. ....               | V Trend Analysis of “Current/Closed” FSTD Discrepancy Records/Action Plan.   |   |
| 18. ....               | V Navigation Aid Data Base and Visual Model Currency.  |   |
| 19. ....               | V FSTD “Training, Evaluation, and Flight Experience” Restrictions.   |   |
| 20. ....               | V FSTD Removal from Service/Active Status, Out-of-Service Maintenance, Return to Service (Other than Loss of Qualification).   |   |
| 21. ....               | R FSTD Discrepancy Corrective Action and MMI Resolution.   |   |
| 22.a. ....             | R Liaison with Aircraft Manufacturer.  |   |
| 22.b. ....             | V Liaison with FSTD Manufacturer.  |   |
| 23. ....               | V Flight deck Configuration Control.   |   |
| 24. ....               | V Engineering Order Control.   |   |
| 25. ....               | V Aircraft Avionics and Simulated Avionics Revision Control.   |   |
| 26. ....               | R FSTD Modification.   |   |
| 27. ....               | R Documented FSTD Usage or Annual “FSTD Performance-Handling Quality” Statement.   |   |

SIMULATION QUALITY MANAGEMENT SYSTEM (SQMS) RESPONSIBILITIES MATRIX—QPS REQUIREMENTS—Continued  
[Simulation Quality Management System (SQMS) Responsibilities Matrix]

<<< QPS requirements >>>

| Number     | Function/element   | Designated responsibility for approval or control position, name or title |
|------------|--|---|
| 28. .... V | Assignment Of Personnel (FSTD).                              |   |
| 29. .... V | Work Environment, Criteria, Standards and Equipment Control. |   |
| 30. .... V | Measuring and Monitoring Device Control.                     |   |
| 31. .... V | Document/Record Control.                                     |   |
| 32. .... R | Organizational Chart.  |   |

**Note:**

“R” indicates the element is Required as part of a Basic SQMS Program.

“V” indicates the element is voluntary and is part of the Advanced (Voluntary) SQMS Program.

### Appendix F to Part 60—Definitions and Abbreviations for Flight Simulation Training Devices

#### Begin Information

1. Some of the definitions presented below are repeated from the definitions found in 14 CFR part 1, as indicated parenthetically.

#### End Information

#### Begin QPS Requirements

##### 2. Definitions

*1st Segment*—the portion of the takeoff profile from liftoff to gear retraction.

*2nd Segment*—the portion of the takeoff profile from after gear retraction to initial flap/slat retraction.

*3rd Segment*—the portion of the takeoff profile after flap/slat retraction is complete.

*Aircraft Data Package*—a combination of the various types of data used to design, program, manufacture, modify, and test the FSTD.

*Airspeed*—calibrated airspeed unless otherwise specified and expressed in terms of nautical miles per hour (knots).

*Altitude*—pressure altitude (meters or feet) unless specified otherwise.

*Angle of Attack*—the angle between the airplane longitudinal axis and the relative wind vector projected onto the airplane plane of symmetry.

*Automatic Testing*—FSTD testing where all stimuli are under computer control.

*Bank*—the airplane attitude with respect to or around the longitudinal axis, or roll angle (degrees).

*Breakout*—the force required at the pilot's primary controls to achieve initial movement of the control position.

*Certificate Holder*—a person issued a certificate under parts 119, 141, or 142 of this chapter or a person holding an approved course of training for flight engineers in accordance with part 63 of this chapter.

*Closed Loop Testing*—a test method where the input stimuli are generated by controllers that drive the FSTD to follow a pre-defined target response.

*Computer Controlled Airplane*—an airplane where all pilot inputs to the control surfaces are transferred and augmented by computers.

*Confined Area (helicopter operations)*—an area where the flight of the helicopter is limited in some direction by terrain or the presence of natural or man-made obstructions (e.g., a clearing in the woods, a city street, or a road bordered by trees or power lines are regarded as confined areas).

*Control Sweep*—movement of the appropriate pilot controller from neutral to an extreme limit in one direction (Forward, Aft, Right, or Left), a continuous movement back through neutral to the opposite extreme position, and then a return to the neutral position.

*Convertible FSTD*—an FSTD in which hardware and software can be changed so that the FSTD becomes a replica of a different model, usually of the same type aircraft. The same FSTD platform, cockpit shell, motion system, visual system, computers, and peripheral equipment can be used in more than one simulation.

*Critical Engine Parameter*—the parameter that is the most accurate measure of propulsive force.

*Deadband*—the amount of movement of the input for a system for which there is no reaction in the output or state of the system observed.

*Distance*—the length of space between two points, expressed in terms of nautical miles unless otherwise specified.

*Discrepancy*—as used in this part, an aspect of the FSTD that is not correct with respect to the aircraft being simulated. This includes missing, malfunctioning, or inoperative components that are required to be present and operate correctly for training, evaluation, and experience functions to be creditable. It also includes errors in the documentation used to support the FSTD (e.g., MQTG errors, information missing from the MQTG, or required statements from appropriately qualified personnel).

*Downgrade*—a permanent change in the qualification level of an FSTD to a lower level.

*Driven*—a test method where the input stimulus or variable is positioned by automatic means, usually a computer input.

*Electronic Copy of the MQTG*—an electronic copy of the MQTG provided by an electronic scan presented in a format, acceptable to the NSPM.

*Electronic Master Qualification Test Guide*—an electronic version of the MQTG (eMQTG), where all objective data obtained from airplane testing, or another approved source, together with correlating objective test results obtained from the performance of the FSTD and a description of the equipment necessary to perform the evaluation for the initial and the continuing qualification evaluations is stored, archived, or presented in either reformatted or digitized electronic format.

*Engine*—as used in this part, the appliance or structure that supplies propulsive force for movement of the aircraft: i.e., the turbine engine for turbine powered aircraft; the turbine engine and propeller assembly for turbo-propeller powered aircraft; and the reciprocating engine and propeller assembly for reciprocating engine powered aircraft. For purposes of this part, engine failure is the failure of either the engine or propeller assembly to provide thrust higher than idle power thrust due to a failure of either the engine or the propeller assembly.

*Evaluation*—with respect to an individual, the checking, testing, or review associated with flight crewmember qualification, training, and certification under parts 61, 63, 121, or 135 of this chapter. With respect to an FSTD, the qualification activities for the device (e.g., the objective and subjective tests, the inspections, or the continuing qualification evaluations) associated with the requirements of this part.

*Fictional Airport*—a visual model of an airport that is a collection of “non-real world” terrain, instrument approach procedures, navigation aids, maps, and visual modeling detail sufficient to enable completion of an Airline Transport Pilot Certificate or Type Rating.

*Flight Experience*—recency of flight experience for landing credit purposes.



**Flight Simulation Training Device (FSTD)**—a full flight simulator (FFS) or a flight training device (FTD). (Part 1)

**Flight Test Data**—(a subset of objective data) aircraft data collected by the aircraft manufacturer or other acceptable data supplier during an aircraft flight test program.

**Flight Training Device (FTD)**—a replica of aircraft instruments, equipment, panels, and controls in an open flight deck area or an enclosed aircraft cockpit replica. It includes the equipment and computer programs necessary to represent aircraft (or set of aircraft) operations in ground and flight conditions having the full range of capabilities of the systems installed in the device as described in part 60 of this chapter and the qualification performance standard (QPS) for a specific FTD qualification level. (Part 1)

**Free Response**—the response of the FSTD after completion of a control input or disturbance.

**Frozen**—a test condition where one or more variables are held constant with time.

**FSTD Approval**—the extent to which an FSTD may be used by a certificate holder as authorized by the FAA.

**FSTD Directive**—a document issued by the FAA to an FSTD sponsor requiring a modification to the FSTD due to a recognized safety-of-flight issue and amending the qualification basis for the FSTD.

**FSTD Latency**—the additional time for the FSTD to respond to input that is beyond the response time of the aircraft.

**FSTD Performance**—the overall performance of the FSTD, including aircraft performance (e.g., thrust/drag relationships, climb, range) and flight and ground handling.

**Full Flight Simulator (FFS)**—a replica of a specific type, make, model, or series aircraft. It includes the equipment and computer programs necessary to represent aircraft operations in ground and flight conditions, a visual system providing an out-of-the-flight deck view, a system that provides cues at least equivalent to those of a three-degree-of-freedom motion system, and has the full range of capabilities of the systems installed in the device as described in part 60 of this chapter and the QPS for a specific FFS qualification level. (Part 1)

**Generic Airport**—a Class III visual model that combines correct navigation aids for a real world airport with a visual model that does not depict that same airport.

**Grandfathering**—as used in this part, the practice of assigning a qualification basis for an FSTD based on the period of time during which a published set of standards governed the requirements for the initial and continuing qualification of FSTDs. Each FSTD manufactured during this specified period of time is “grandfathered” or held to the standards that were in effect during that time period. The grandfathered standards remain applicable to each FSTD manufactured during the stated time period regardless of any subsequent modification to those standards and regardless of the sponsor, as long as the FSTD remains qualified or is maintained in a non-qualified status in accordance with the specific requirements and time periods prescribed in this part.

**Gross Weight**—For objective test purposes: **Basic Operating Weight (BOW)**—the empty weight of the aircraft plus the weight of the following: normal oil quantity; lavatory servicing fluid; potable water; required crewmembers and their baggage; and emergency equipment.

**Near Maximum Gross Weight**—a weight chosen by the sponsor or data provider that is not less than the basic operating weight (BOW) of the airplane being simulated plus 80% of the difference between the maximum certificated gross weight (either takeoff weight or landing weight, as appropriate for the test) and the BOW.

**Light Gross Weight**—a weight chosen by the sponsor or data provider that is not more than 120% of the BOW of the airplane being simulated or the minimum practical operating weight of the test airplane.

**Medium Gross Weight**—a weight chosen by the sponsor or data provider that is within 10 percent of the average of the numerical values of the BOW and the maximum certificated gross weight.

**Ground Effect**—the change in aerodynamic characteristics due to the change in the airflow past the aircraft caused by the proximity of the earth’s surface to the airplane.

**Hands Off**—a test maneuver conducted without pilot control inputs.

**Hands On**—a test maneuver conducted with pilot control inputs as required.

**Heave**—FSTD movement with respect to or along the vertical axis.

**Height**—the height above ground level (or AGL) expressed in meters or feet.

**“In Use” Runway**—as used in this part, the runway that is currently selected, able to be used for takeoffs and landings, and has the surface lighting and markings required by this part. Also known as the “active” runway.

**Integrated Testing**—testing of the FSTD so that all aircraft system models are active and contribute appropriately to the results. With integrated testing, none of the models used are substituted with models or other algorithms intended for testing only.

**Irreversible Control System**—a control system where movement of the control surface will not backdrive the pilot’s control on the flight deck.

**Locked**—a test condition where one or more variables are held constant with time.

**Manual Testing**—FSTD testing conducted without computer inputs except for initial setup, and all modules of the simulation are active.

**Master Qualification Test Guide (MQTG)**—the FAA-approved Qualification Test Guide with the addition of the FAA-witnessed test results, applicable to each individual FSTD.

**Medium**—the normal operational weight for a given flight segment.

**National Simulator Program Manager (NSPM)**—the FAA manager responsible for the overall administration and direction of the National Simulator Program (NSP), or a person approved by that FAA manager.

**Near Limiting Performance**—the performance level the operating engine must be required to achieve to have sufficient power to land a helicopter after experiencing a single engine failure during takeoff of a

multiengine helicopter. The operating engine must be required to operate within at least 5 percent of the maximum RPM or temperature limits of the gas turbine or power turbine, or operate within at least 5 percent of the maximum drive train torque limits. Near limiting performance is based on the existing combination of density altitude, temperature, and helicopter gross weight.

**Nominal**—the normal operating configuration, atmospheric conditions, and flight parameters for the specified flight segment.

**Non-Normal Control**—a term used in reference to Computer Controlled Airplanes. It is the state where one or more of the intended control, augmentation, or protection functions are not fully working.

**Note:** Specific terms such as ALTERNATE, DIRECT, SECONDARY, or BACKUP may be used to define an actual level of degradation.

**Normal Control**—a term used in reference to Computer Controlled Airplanes. It is the state where the intended control, augmentation, and protection functions are fully working.

**Objective Data**—quantitative data, acceptable to the NSPM, used to evaluate the FSTD.

**Objective Test**—a quantitative measurement and evaluation of FSTD performance.

**Pitch**—the airplane attitude with respect to, or around, the lateral axis expressed in degrees.

**Power Lever Angle (PLA)**—the angle of the pilot’s primary engine control lever(s) on the flight deck. This may also be referred to as THROTTLE or POWER LEVER.

**Predicted Data**—estimations or extrapolations of existing flight test data or data from other simulation models using engineering analyses, engineering simulations, design data, or wind tunnel data.

**Protection Functions**—systems functions designed to protect an airplane from exceeding its flight maneuver limitations.

**Pulse Input**—a step input to a control followed by an immediate return to the initial position.

**Qualification Level**—the categorization of an FSTD established by the NSPM based on the FSTDs demonstrated technical and operational capabilities as prescribed in this part.

**Qualification Performance Standard (QPS)**—the collection of procedures and criteria used when conducting objective and subjective tests, to establish FSTD qualification levels. The QPS are published in the appendices to this part, as follows: Appendix A, for Airplane Simulators; Appendix B, for Airplane Flight Training Devices; Appendix C, for Helicopter Simulators; Appendix D, for Helicopter Flight Training Devices; Appendix E, for Quality Management Systems for Flight Simulation Training Devices; and Appendix F, for Definitions and Abbreviations for Flight Simulation Training Devices.

**Qualification Test Guide (QTG)**—the primary reference document used for evaluating an aircraft FSTD. It contains test results, statements of compliance and capability, the configuration of the aircraft

simulated, and other information for the evaluator to assess the FSTD against the applicable regulatory criteria.

**Quality Management System (QMS)**—a flight simulation quality-systems that can be used for external quality-assurance purposes. It is designed to identify the processes needed, determine the sequence and interaction of the processes, determine criteria and methods required to ensure the effective operation and control of the processes, ensure the availability of information necessary to support the operation and monitoring of the processes, measure, monitor and analyze the processes, and implement the actions necessary to achieve planned results.

**Real-World Airport**—as used in this part in reference to airport visual models, a computer generated visual depiction of an existing airport.

**Representative**—when used as an adjective in this part, typical, demonstrative, or characteristic of, the feature being described. For example, “representative sampling of tests” means a sub-set of the complete set of all tests such that the sample includes one or more of the tests in each of the major categories, the results of which would provide the evaluator an overall, understanding of the performance and handling characteristics of the FSTD.

**Reversible Control System**—a control system in which movement of the control surface will backdrive the pilot’s control in the cockpit.

**Roll**—the airplane attitude with respect to, or around, the longitudinal axis expressed in degrees.

**Set of Aircraft**—aircraft that share similar handling and operating characteristics, similar operating envelopes, and have the same number and type of engines or powerplants.

**Sideslip Angle**—the angle between the relative wind vector and the airplane plane of symmetry. (**Note:** this definition replaces the current definition of “sideslip.”)

**Simulation Quality Management System (SQMS)**—the required and voluntary elements of a quality management system for FSTD continuing qualification.

**Snapshot**—a presentation of one or more variables at a given instant of time.

**Special Evaluation**—an evaluation of the FSTD for purposes other than initial, upgrade, or continuing qualification. Circumstances that may require a special evaluation include movement of the FSTD to a different location, or an update to FSTD software or hardware that might affect performance or flying qualities.

**Sponsor**—a certificate holder who seeks or maintains FSTD qualification and is responsible for the prescribed actions as prescribed in this part and the QPS for the appropriate FSTD and qualification level.

**Statement of Compliance and Capability (SOC)**—a declaration that a specific requirement has been met and explaining how the requirement was met (e.g., gear modeling approach, coefficient of friction sources). The SOC must also describe the capability of the FSTD to meet the requirement, including references to sources of information for showing compliance,

rationale to explain how the referenced material is used, mathematical equations and parameter values used, and conclusions reached.

**Step Input**—an abrupt control input held at a constant value.

**Subjective Test**—a qualitative assessment of the performance and operation of the FSTD.

**Surge**—FSTD movement with respect to or along the longitudinal axis.

**Sway**—FSTD movement with respect to or along the lateral axis.

**Time History**—a presentation of the change of a variable with respect to time.

**Training Program Approval Authority (TPAA)**—a person authorized by the Administrator to approve the aircraft flight training program in which the FSTD will be used.

**Training Restriction**—a temporary condition where an FSTD with missing, malfunctioning, or inoperative (MMI) components may continue to be used at the qualification level indicated on its SOQ, but restricted from completing the tasks for which the correct function of the MMI component is required.

**Transport Delay or “Throughput”**—the total FSTD system processing time required for an input signal from a pilot primary flight control until motion system, visual system, or instrument response. It is the overall time delay incurred from signal input to output response. It does not include the characteristic delay of the airplane simulated.

**Upgrade**—the improvement or enhancement of an FSTD for the purpose of achieving a higher qualification level.

**Validation Data**—objective data used to determine if the FSTD performance is within the tolerances prescribed in the QPS.

**Validation Test**—an objective test where FSTD parameters are compared to the relevant validation data to ensure that the FSTD performance is within the tolerances prescribed in the QPS.

**Visual Data Base**—a display that may include one or more visual models.

**Visual Model**—a collection of one or more visual scenes of an airport or portion(s) of an airport.

**Visual System Response Time**—the interval from a control input to the completion of the visual display scan of the first video field containing the resulting different information.

**Yaw**—the airplane attitude with respect to, or around, the vertical axis expressed in degrees.

### 3. Abbreviations

AFM Airplane Flight Manual.  
 AGL Above Ground Level (meters or feet).  
 AOA Angle of Attack (degrees).  
 APD Aircrew Program Designee.  
 CCA Computer Controlled Airplane.  
 cd/m<sup>2</sup> candela/meter<sup>2</sup>, 3.4263 candela/m<sup>2</sup> = 1 ft-Lambert.  
 CFR Code of Federal Regulations.  
 cm(s) centimeter, centimeters.  
 daN decaNewtons, one (1) decaNewton = 2.27 pounds.  
 deg(s) degree, degrees.  
 DOF Degrees-of-freedom.  
 eMQTG Electronic Master Qualification Test Guide.

EPR Engine Pressure Ratio.

FAA Federal Aviation Administration (U.S.).

fpm feet per minute.

ft foot/feet, 1 foot = 0.304801 meters.

ft-Lambert foot-Lambert, 1 ft-Lambert = 3.4263 candela/m<sup>2</sup>.

g Acceleration due to Gravity (meters or feet/sec<sup>2</sup>); 1g = 9.81 m/sec<sup>2</sup> or 32.2 feet/sec<sup>2</sup>.

G/S Glideslope.

IATA International Airline Transport Association.

ICAO International Civil Aviation Organization.

IGE In ground effect.

ILS Instrument Landing System.

IQTG International Qualification Test Guide.

km Kilometers 1 km = 0.62137 Statute Miles.

kPa KiloPascal (Kilo Newton/Meters<sup>2</sup>). 1 psi = 6.89476 kPa.

kts Knots calibrated airspeed unless otherwise specified, 1 knot = 0.5148 m/sec or 1.689 ft/sec.

lb(s) pound(s), one (1) pound = 0.44 decaNewton.

LDP Landing decision point.

M,m Meters, 1 Meter = 3.28083 feet.

Min(s) Minute, minutes.

MLG Main Landing Gear.

Mpa MegaPascals (1 psi = 6894.76 pascals).

ms millisecond(s).

N NORMAL CONTROL Used in reference to Computer Controlled Airplanes.

nm Nautical Mile(s) 1 Nautical Mile = 6,080 feet.

NN NON-NORMAL CONTROL Used in reference to Computer Controlled Airplanes.

N1 Low Pressure Rotor revolutions per minute, expressed in percent of maximum.

N2 High Pressure Rotor revolutions per minute, expressed in percent of maximum.

N3 High Pressure Rotor revolutions per minute, expressed in percent of maximum.

NWA Nosewheel Angle (degrees).

NZFT Non-Zero Flight Time.

OGE Out of ground effect.

PAPI Precision Approach Path Indicator System.

Pf Impact or Feel Pressure, often expressed as “q.”

PLA Power Lever Angle.

PLF Power for Level Flight.

psi pounds per square inch.

QPS Qualification Performance Standard.

RAE Royal Aerospace Establishment.

R/C Rate of Climb (meters/sec or feet/min).

R/D Rate of Descent (meters/sec or feet/min).

REIL Runway End Identifier Lights.

RVR Runway Visual Range (meters or feet).

s second(s).

sec(s) second, seconds.

sm Statute Mile(s) 1 Statute Mile = 5,280 feet.

SOC Statement of Compliance and Capability.

Tf Total time of the flare maneuver duration.

Ti Total time from initial throttle movement until a 10% response of a critical engine parameter.

TIR Type Inspection Report.

T/O Takeoff.

Tt Total time from Ti to a 90% increase or decrease in the power level specified.

VASI Visual Approach Slope Indicator System.

VGS Visual Ground Segment.

V<sub>1</sub> Decision speed.

V<sub>2</sub> Takeoff safety speed.

Vmc Minimum Control Speed.

Vmca Minimum Control Speed in the air.

Vmcg Minimum Control Speed on the ground.

Vmcl Minimum Control Speed—Landing.

Vmu The speed at which the last main landing gear leaves the ground.

V<sub>R</sub> Rotate Speed.

V<sub>S</sub> Stall Speed or minimum speed in the stall.

WAT Weight, Altitude, Temperature.

ZFT Zero Flight Time.

#### End QPS Requirements

---

Issued in Washington, DC, on September 26, 2007.

**John M. Allen,**

*Director, Flight Standards Service.*

[FR Doc. 07-4884 Filed 10-19-07; 8:45 am]

**BILLING CODE 4910-13-P**