



U.S. Department  
of Transportation  
**Federal Railroad  
Administration**

## **Survivability of Railroad Tank Car Top Fittings in Rollover Scenario Derailments**

---

Office of Research and  
Development  
Washington, DC 20590

---

DOT/FRA/ORD-06/11

This document is available to the  
U.S. public through the National  
Technical Information Service  
Springfield, Virginia 22161

**Notice**

This document is disseminated under the sponsorship of the Department of Transportation in the interest of information exchange. The United States Government assumes no liability for its contents or use thereof.

**Notice**

The United States Government does not endorse products or manufacturers. Trade or manufacturers' names appear herein solely because they are considered essential to the objective of this report.

<b>REPORT DOCUMENTATION PAGE</b>		<i>Form approved</i> <b>OMB No. 0704-0188</b>	
Public reporting burden for this collection of information is estimated to average 1 hour per response, including the time for reviewing instructions, searching existing data sources, gathering and maintaining the data needed, and completing and reviewing the collection of information. Send comments regarding this burden estimate or any other aspect of this collection of information, including suggestions for reducing this burden to Washington Headquarters Services, Directorate for Information Operations and Reports, 1215 Jefferson Davis Highway, Suite 1204, Arlington, VA 22202-4302, and to the Office of Management and Budget, Paperwork Reduction Project (0702-0288), Washington, D.C. 20503			
<b>1. AGENCY USE ONLY (Leave blank)</b>		<b>2. REPORT DATE</b> December 14, 2005	<b>3. REPORT TYPE AND DATES COVERED</b> 04/2002 to 12/2004
<b>4. TITLE AND SUBTITLE</b> Survivability of Railroad Tank Car Top Fittings in Rollover Scenario Derailments		<b>5. FUNDING NUMBERS</b>	
<b>6. AUTHOR(S)</b> Robert Trent, Anand Prabhakaran, Vinaya Sharma			
<b>7. PERFORMING ORGANIZATION NAME(S) AND ADDRESS(ES)</b> Sharma & Associates, Inc. 5810 S Grant Street Hinsdale, IL 60521		<b>8. PERFORMING ORGANIZATION REPORT NUMBERS</b>	
<b>9. SPONSORING/MONITORING AGENCY NAME(S) AND ADDRESS(ES)</b> U.S. Department of Transportation Federal Railroad Administration Office of Research and Development 1120 Vermont Avenue, NW, MS-20 Washington, DC 20590		<b>10. SPONSORING/MONITORING AGENCY REPORT NUMBER</b>  DOT/FRA/ORD-06/11	
<b>11. SUPPLEMENTARY NOTES</b>			
<b>12a. DISTRIBUTION/AVAILABILITY STATEMENT</b> This document is available through National Technical Information Service, Springfield, VA 22161		<b>12b. DISTRIBUTION CODE</b>	
<b>13. ABSTRACT</b> <p>This project examined the structural susceptibility of tank car fittings during derailments. The report identified non-pressure cars as being the most susceptible to derailment damage. A DOT111A100W1 fuel service car was selected for analysis. Two derailment scenarios were modeled. The first simulated a severe derailment, where the tank car body is thrown off its trucks with significant momentum. The second simulated a nominal rollover, which is more representative of a low speed yard derailment. Simulation results indicated failure of multiple components in the fittings structure for both scenarios, implying that conventional non-pressure car top fittings are likely to suffer damage and cause lading release under most derailment scenarios.</p> <p>Subsequently, the report developed two concepts of protective structure. The first (Concept 1) is designed to protect the fittings with a bolt-on sleeve structure. The second concept starts with Concept 1 and adds elements to strengthen the fittings-to-tank shell interface. Simulations indicate that both concepts survive the nominal rollover and neither of them survive the severe impact, with Concept 2 faring better than Concept 1 in both scenarios. Concepts similar to the ones developed in this report could improve the structural performance of top fittings in many cases.</p>			
<b>14. SUBJECT TERMS</b>  Tank car, rollover, fittings, protection, tank car safety, dynamic simulation		<b>15. NUMBER OF PAGES</b>	
		<b>16. PRICE CODE</b>	
<b>17. SECURITY CLASSIFICATION</b> UNCLASSIFIED	<b>18. SECURITY CLASSIFICATION OF THIS PAGE</b> UNCLASSIFIED	<b>19. SECURITY CLASSIFICATION OF ABSTRACT</b> UNCLASSIFIED	<b>20. LIMITATION OF ABSTRACT</b>

# METRIC/ENGLISH CONVERSION FACTORS

## ENGLISH TO METRIC

## METRIC TO ENGLISH

<p><b>LENGTH (APPROXIMATE)</b></p> <p>1 inch (in) = 2.5 centimeters (cm)</p> <p>1 foot (ft) = 30 centimeters (cm)</p> <p>1 yard (yd) = 0.9 meter (m)</p> <p>1 mile (mi) = 1.6 kilometers (km)</p>	<p><b>LENGTH (APPROXIMATE)</b></p> <p>1 millimeter (mm) = 0.04 inch (in)</p> <p>1 centimeter (cm) = 0.4 inch (in)</p> <p>1 meter (m) = 3.3 feet (ft)</p> <p>1 meter (m) = 1.1 yards (yd)</p> <p>1 kilometer (km) = 0.6 mile (mi)</p>
<p><b>AREA (APPROXIMATE)</b></p> <p>1 square inch (sq in, in<sup>2</sup>) = 6.5 square centimeters (cm<sup>2</sup>)</p> <p>1 square foot (sq ft, ft<sup>2</sup>) = 0.09 square meter (m<sup>2</sup>)</p> <p>1 square yard (sq yd, yd<sup>2</sup>) = 0.8 square meter (m<sup>2</sup>)</p> <p>1 square mile (sq mi, mi<sup>2</sup>) = 2.6 square kilometers (km<sup>2</sup>)</p> <p>1 acre = 0.4 hectare (he) = 4,000 square meters (m<sup>2</sup>)</p>	<p><b>AREA (APPROXIMATE)</b></p> <p>1 square centimeter (cm<sup>2</sup>) = 0.16 square inch (sq in, in<sup>2</sup>)</p> <p>1 square meter (m<sup>2</sup>) = 1.2 square yards (sq yd, yd<sup>2</sup>)</p> <p>1 square kilometer (km<sup>2</sup>) = 0.4 square mile (sq mi, mi<sup>2</sup>)</p> <p>10,000 square meters (m<sup>2</sup>) = 1 hectare (ha) = 2.5 acres</p>
<p><b>MASS - WEIGHT (APPROXIMATE)</b></p> <p>1 ounce (oz) = 28 grams (gm)</p> <p>1 pound (lb) = 0.45 kilogram (kg)</p> <p>1 short ton = 2,000 pounds (lb) = 0.9 tonne (t)</p>	<p><b>MASS - WEIGHT (APPROXIMATE)</b></p> <p>1 gram (gm) = 0.036 ounce (oz)</p> <p>1 kilogram (kg) = 2.2 pounds (lb)</p> <p>1 tonne (t) = 1,000 kilograms (kg) = 1.1 short tons</p>
<p><b>VOLUME (APPROXIMATE)</b></p> <p>1 teaspoon (tsp) = 5 milliliters (ml)</p> <p>1 tablespoon (tbsp) = 15 milliliters (ml)</p> <p>1 fluid ounce (fl oz) = 30 milliliters (ml)</p> <p>1 cup (c) = 0.24 liter (l)</p> <p>1 pint (pt) = 0.47 liter (l)</p> <p>1 quart (qt) = 0.96 liter (l)</p> <p>1 gallon (gal) = 3.8 liters (l)</p> <p>1 cubic foot (cu ft, ft<sup>3</sup>) = 0.03 cubic meter (m<sup>3</sup>)</p> <p>1 cubic yard (cu yd, yd<sup>3</sup>) = 0.76 cubic meter (m<sup>3</sup>)</p>	<p><b>VOLUME (APPROXIMATE)</b></p> <p>1 milliliter (ml) = 0.03 fluid ounce (fl oz)</p> <p>1 liter (l) = 2.1 pints (pt)</p> <p>1 liter (l) = 1.06 quarts (qt)</p> <p>1 liter (l) = 0.26 gallon (gal)</p> <p>1 cubic meter (m<sup>3</sup>) = 36 cubic feet (cu ft, ft<sup>3</sup>)</p> <p>1 cubic meter (m<sup>3</sup>) = 1.3 cubic yards (cu yd, yd<sup>3</sup>)</p>
<p><b>TEMPERATURE (EXACT)</b></p> <p><math>[(x-32)(5/9)]\text{ }^{\circ}\text{F} = y\text{ }^{\circ}\text{C}</math></p>	<p><b>TEMPERATURE (EXACT)</b></p> <p><math>[(9/5)y + 32]\text{ }^{\circ}\text{C} = x\text{ }^{\circ}\text{F}</math></p>

## QUICK INCH - CENTIMETER LENGTH CONVERSION

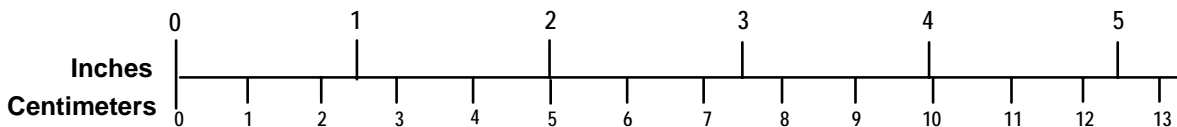

## QUICK FAHRENHEIT - CELSIUS TEMPERATURE CONVERSION

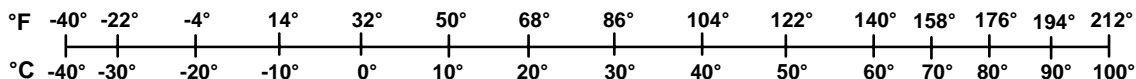

For more exact and or other conversion factors, see NIST Miscellaneous Publication 286, Units of Weights and Measures. Price \$2.50 SD Catalog No. C13 10286

Updated 6/17/98

# Table of Contents

List of Figures.....	v
Executive Summary.....	1
1. Introduction.....	3
1.1 Background.....	3
1.2 Objectives.....	3
2. Identification of Susceptible Fittings.....	5
3. Base Case Analyses.....	7
3.1 Car Description.....	7
3.2 Model Description.....	7
3.3 Scenarios Simulated.....	11
3.4 Simulations and Results.....	11
4. Concepts for Top Fittings Protection.....	25
4.1 Concept 1–Sleeve Type Fittings Protection.....	25
4.2 Concept 2–Cone for Reinforcing Tank Shell.....	33
4.3 Summary–Protective Concepts.....	36
5. Conclusions.....	41
6. Recommendations.....	43
Appendix A. FRA and AAR Document Summaries.....	A-1
Appendix B. Material Data.....	B-1
Appendix C. Discussion of Velocities and Forces.....	C-1



## List of Figures

Figure 1.	Schematic of Specimen Tank Car.....	8
Figure 2.	Ansys Finite Element Analysis Model.....	9
Figure 3.	Base Case Fittings Mesh–LS-Dyna.....	10
Figure 4.	Base Case LS-Dyna Model.....	10
Figure 5.	Simulation Sequence–Base Case–Scenario 1.....	13
Figure 6.	Initial Impact of Fittings–Base Case–Scenario 1.....	14
Figure 7.	Failure of Unloading Valve–Base Case–Scenario 1.....	14
Figure 8.	Failure of Unloading Nozzle Cover–Base Case–Scenario 1.....	15
Figure 9.	Failure of Fittings (t=0.47)–Base Case–Scenario 1.....	16
Figure 10.	Failure of Fittings (t=0.57)–Base Case–Scenario 1.....	16
Figure 11.	Flue Failure (Looking from Within Tank)–Base Case–Scenario 1.....	18
Figure 12.	Flue Failure (Tank Hidden)–Base Case–Scenario 1.....	18
Figure 13.	Base Case–Scenario 2.....	20
Figure 14.	Simulation Sequence–Base Case–Scenario 2.....	21
Figure 15.	Tank Impact–Base Case–Scenario 2.....	22
Figure 16.	Flue Failure–Base Case–Scenario 2.....	22
Figure 17.	Valve Impact–Base Case–Scenario 2.....	23
Figure 18.	Safety Valve Failure–Base Case–Scenario 2.....	23
Figure 19.	Failure of Unloading Valve–Base Case–Scenario 2.....	24
Figure 20.	Basic Dimensions, Protective Sleeve Application.....	26
Figure 21.	Concept 1–Bolt-On Sleeve.....	27
Figure 22.	Concept 1–Protective Sleeve.....	27
Figure 23.	Simulation Sequence–Concept 1–Scenario 1.....	29
Figure 24.	Failure of Fittings Assembly and Components–Concept 1–Scenario 1.....	30
Figure 25.	Failure of Flue at Tank Attachment–Concept 1–Scenario 1.....	30
Figure 26.	Simulation Sequence–Concept 1–Scenario 2.....	31
Figure 27.	Impact of Sleeve–Concept 1–Scenario 2.....	32
Figure 28.	Deformation of Sleeve–Concept 1–Scenario 2.....	32
Figure 29.	Second Configuration of Fittings (Concept 2).....	34
Figure 30.	Concept 2–Sleeve with Disc and Cone Reinforcement.....	34

Figure 31. Simulation Sequence–Concept 2–Scenario 1.....	35
Figure 32. Failure of Fittings–Concept 2–Scenario 1.....	37
Figure 33. Failure of Flue at Tank Attachment and Bearing Failure of Flange and Cover Concept 2–Scenario 1.....	37
Figure 34. Failure of Tank Shell at Fittings–Concept 2–Scenario 1.....	38
Figure 35. Simulation Sequence–Concept 2–Scenario 2.....	39
Figure 36. Impact of Fittings–Concept 2–Scenario 2.....	40
Figure 37. Deformation of Sleeve–Concept 2–Scenario 2.....	40



## Executive Summary

Railroad tank cars are commonly outfitted with an arrangement of fittings used for loading and unloading of car lading and other purposes such as pressure relief. The survival of these devices if they are impacted during a rollover/derailment is doubtful. The subsequent release of car contents and its safety implications to the public are critical, as exemplified by incidences such as the derailment in Minot, North Dakota.

The project team identified tank car fittings that were most susceptible to derailment damage and examined their structural survival in rollover type derailments using finite element techniques. In addition, the project team developed and analyzed two concepts for protective structures to determine their effectiveness.

Identification of susceptible fittings was done through study of the tank car accident databases, discussions with industry experts, reviews of analysis and data presented at tank car committee meetings, and review of recent tank car accidents. This study indicated that top fittings on non-pressure cars were the most susceptible to derailment damage, specifically cars in acid service (especially sulfuric and hydrochloric acids), fuel service (gasoline and fuel oil), methanol service, and benzene service.

Based on the above, this report focuses on top fittings of non-pressure cars. For analysis and modeling efforts, the project team selected a DOT 111A100W1 class, 30,000-gallon fuel service car based on suitability of the car and the availability of car drawings. While all subsequent work on this project was focused on this car type, the findings from these analyses are applicable to many other non-pressure car types, whose fittings are structurally similar.

The finite element model of the complete car body was created using the pre-processing tools in ANSYS® and converted to an input file for LS-DYNA3D, an application for dynamic systems simulation. To facilitate model convergence, two critical fittings, the unloading valve and safety valve, were modeled along with the unloading flue structure.

The project team modeled two derailment scenarios. The first scenario simulated a severe derailment, where the tank body is thrown off its trucks with significant downward and rotational velocities. The second scenario simulated a more nominal (and less severe) case, where the carbody tank rolls off its trucks without significant initial velocities and accelerates under gravity to impact first the tank and then the fittings on the ground surface. The latter case is more representative of a low speed yard derailment.

The simulation results of the base case (no protective structure) indicated failure of multiple components in the fittings structure with a release of car contents for both scenarios. It can be concluded from these simulations that conventional non-pressure car top fittings are likely to suffer damage and cause lading release under most derailment scenarios. Simulations indicated damage of the fittings themselves in addition to damage of the tank car-to-fittings interface.

Based on a review of the base case simulations, the project team developed two concepts of protective structures. The first (concept 1) consisted of a steel sleeve with base that is bolted on to the existing unloading nozzle flue using existing fastener holes. This sleeve functions to protect the devices inside it while providing adequate clearance for operation of the protected devices. Concept 2 adds two components (a disk and cone) to concept 1 to reinforce the fittings to tank shell interface. This interface was identified as being a limiting factor in crash

survivability. Both concepts are designed for easy retrofit on cars similar in design to those used in these analyses.

The two concepts for protection were modeled and simulated under both scenarios described above. Both protective concepts (with and without the cone reinforcement) survived the nominal rollover, and neither of them survived the severe impact. The simpler of the two concepts (a protective sleeve like those used on pressure cars) will improve the probability of survival of top fittings in non-pressure cars under derailment conditions and is easily retrofittable to most designs. Concept 2, which adds additional protection, will further improve the survivability of these fittings, though it will still be insufficient in the case of severe derailments.

Concepts similar to the ones developed in this report could improve the structural performance of top fittings in many cases. If the Federal Railroad Administration (FRA) considers developing specifications for improving the survivability of top fittings on non-pressure cars, these specifications for the structural design could follow the ideas outlined by similar specifications in use for pressure cars.

# 1. Introduction

## 1.1 Background

Tank cars are usually fitted with various appurtenances that allow efficient loading and unloading operations and provide for the safe handling and transportation of the lading. These fittings include manways, liquid/vapor valves, pressure relief devices, vacuum relief devices, unloading valves, sample lines, gauging devices, and bottom outlets. They are generally installed on either the top or bottom of the car based on the intended function of the device and come in various forms depending on the application. The fittings generally project out of the envelope of the tank for easy access and are designed to provide safe operation under normal operating conditions.

In cases of serious derailments, where the tank has been thrown off its trucks, it is possible that one of these devices could impact the ground or another object with the entire weight and momentum of the tank behind it. The survivability of these devices under such conditions is questionable. It is possible that the impact forces under such derailment conditions could cause structural failure of the device or the connection between the device and the tank, resulting in a leak or loss of lading of a hazardous material. The safety and environmental implications of such an event are tremendous. The Minot, North Dakota, incident of January 8, 2002, is a case in point. Several of the less severely damaged derailed cars leaked their entire contents of anhydrous ammonia for many hours after their top fittings were damaged in the derailment. The release (including that from the completely ruptured cars) produced a large toxic plume, resulting in one fatality and the evacuation of thousands of nearby residences.

A need to evaluate the structural survival of the most common fittings on tank cars under derailment and rollover conditions exists. Based on such evaluation, suitable retrofits must be designed for fittings that are susceptible to failure. Identification of susceptible fittings and improving their survivability will significantly enhance the safety of hazmat transportation in the United States. Appendices E-9 and E-10 of the Association of American Railroads (AAR) Manual of Standards and Recommended Practices (Section C, Part III) provide recommended practices for tank car fittings protection. Appendix A provides a summary of these standards. These standards may need to be revisited for applicability in present day transportation.

## 1.2 Objectives

The primary objectives of this project are to:

1. Identify common modes of fitting failure, which resulted in lading release or other damage, to identify most susceptible car types, fitting types, and fitting geometries. This was to be accomplished through study of accident databases, discussions with industry, study of fittings geometries, and study of accidents, such as the Minot incident.
2. Analyze the survivability of critical fittings under derailment conditions, using finite element analysis techniques, including appropriate modeling of derailment scenarios, as well as the modeling of relevant tank car and fittings details.
3. Develop concepts for protective structures that are likely to enhance the survivability of tank car fittings, and analyze these concepts to quantify the resulting benefits. Such concepts will be recommendations only, will be one of many possible designs, and will serve to demonstrate the advantages of incorporating such protection in tank cars.



## 2. Identification of Susceptible Fittings

The first task in the project was to identify susceptible fittings for further structural analysis. This was done through study of the tank car accident databases, discussions with industry experts, reviews of analysis and data presented at tank car committee meetings, and review of recent tank car accidents.

The above review indicated that top mounted fittings are a bigger risk under derailment conditions than bottom mounted fittings. Bottom mounted fittings are generally protected from direct impact through the use of skirts or similar structures; their placement in the lower half of the tank results in less exposure under rollover conditions. Top fittings usually do not have the benefit of protection from other structural members and are likely to take a direct hit under rollover conditions. Consequently, top fittings are significantly more likely to be damaged and result in lading release under derailment conditions. Therefore, it was decided that this project would concentrate only on top mounted fittings.

Another significant observation from the above review was that, in general, pressure cars perform better than non-pressure cars under accident conditions. Lading loss reports show that the effectiveness of pressure car housings over non-pressure car housings exceeds 50 percent. Many contributors to the increased survivability of pressure car fittings exist, including:

1. Some accident damage protection is designed into these fittings by the requirements of 49 CFR 179.100-12. The structural highlights of this specification require a protective housing of approved material bolted to the manway cover with not less than twenty  $\frac{3}{4}$ -inch studs. The shearing value of the bolts that attach the protective housing to the manway cover must not exceed 70 percent of the shearing value of the bolts attaching manway cover to the manway nozzle. The housing must have steel sidewalls not less than  $\frac{3}{4}$ -inch in thickness. Appendix A includes a brief summary of applicable and related FRA and AAR documents.
2. Fittings in pressure cars generally project out of a singular opening in the top of the car and are substantially protected by a heavy-duty housing.
3. The increased thickness of the tank car shell permits a stronger connection to the fitting/housing.

Therefore, Sharma & Associates, Inc. (SA), in consultation with FRA, decided to focus its work on the performance of non-pressure tank car top fittings. A review of non-pressure accident release data indicated that cars in acid (especially sulfuric and hydrochloric acids), fuel (gasoline and fuel oil), methanol, and benzene services had a high number of lading releases.

Of the car types carrying these commodities, fuel service and acid service cars are the most common in the HAZMAT non-pressure car fleet. Therefore, the report's focus was further refined to these types. Based on the availability of drawings, as well as discussion and agreement with FRA, a non-pressure fuel service car was selected for the analyses, with emphasis on the performance of its top fittings. This car type (DOT 111A100W1) shows a relatively high number of lading releases from available statistical data and is absent the more substantial structural protection of a pressure car design. While all subsequent modeling work on this project was focused on this car type, the findings from these analyses are applicable to many other non-pressure car types with similar fittings structures, such as acid service cars.



### **3. Base Case Analyses**

#### **3.1 Car Description**

The base case analyses used a current model fuel service car (DOT111A100W1) with an existing top fitting configuration. The car was designed for 30,000 gal diesel fuel service with a tank length of 56 feet and 3-½ inches, tank diameter of 111 ¾-inches, and tank shell thickness of 7/16 inch. Figure 1 shows a schematic of the specimen tank car.

#### **3.2 Model Description**

The simulation of a rollover derailment event is best accomplished using a finite element solver with an explicit integration mechanism. Excellent contact algorithms, nonlinear material models, and dynamic modeling capabilities are required for these simulations. LS-DYNA3D is an explicit finite element solver that meets these requirements and is used for modeling impact simulations and crash-worthiness analyses. SA used this solver for all the simulations.

SA accomplished finite element model creation using pre-processing tools in ANSYS®. The geometry for the model was built from drawings obtained for the tank car described above and includes the tapered body of the tank. The entire car body along with stub sills and fittings were modeled using the SOLID45 8-node brick element, with tetrahedron elements used only where absolutely required (Figure 2). To keep the model from becoming overly complex and to focus on the components most susceptible to damage, SA identified and modeled only two fittings representing the highest profile elements (Figure 3). These were:

1. A typical unloading nozzle with a typical unloading valve attached
2. A typical safety relief valve

The unloading valve was simplified for modeling by being represented by a cylinder with a height and diameter equivalent to a typical valve and a wall thickness approximately equal to the average wall thickness of the actual valve. SA modeled the safety relief valve in a similar manner. Fasteners were modeled by creating cylindrical volumes in the fittings and merging the nodes in the common circular areas between the fittings components. This is done between the unloading valve and unloading nozzle cover and between the unloading nozzle cover and the unloading nozzle flange. Twelve ¾-inch diameter bolts secure the unloading nozzle cover to the nozzle flange, and eight 5/8-inch diameter bolts secure the unloading valve to the unloading nozzle cover. See appendix B, table B1 and table B2 for fastener materials.

Obtaining accurate results is dependent on how well the mesh is created. SA used proper meshing techniques, such as mapped meshing to produce better shaped elements and meshes with higher densities for higher stress gradients, in the meshing process.

The model created using the ANSYS® preprocessor was converted to an appropriately formatted (.dyn) file for input into the LS-DYNA3D program (Figure 4).

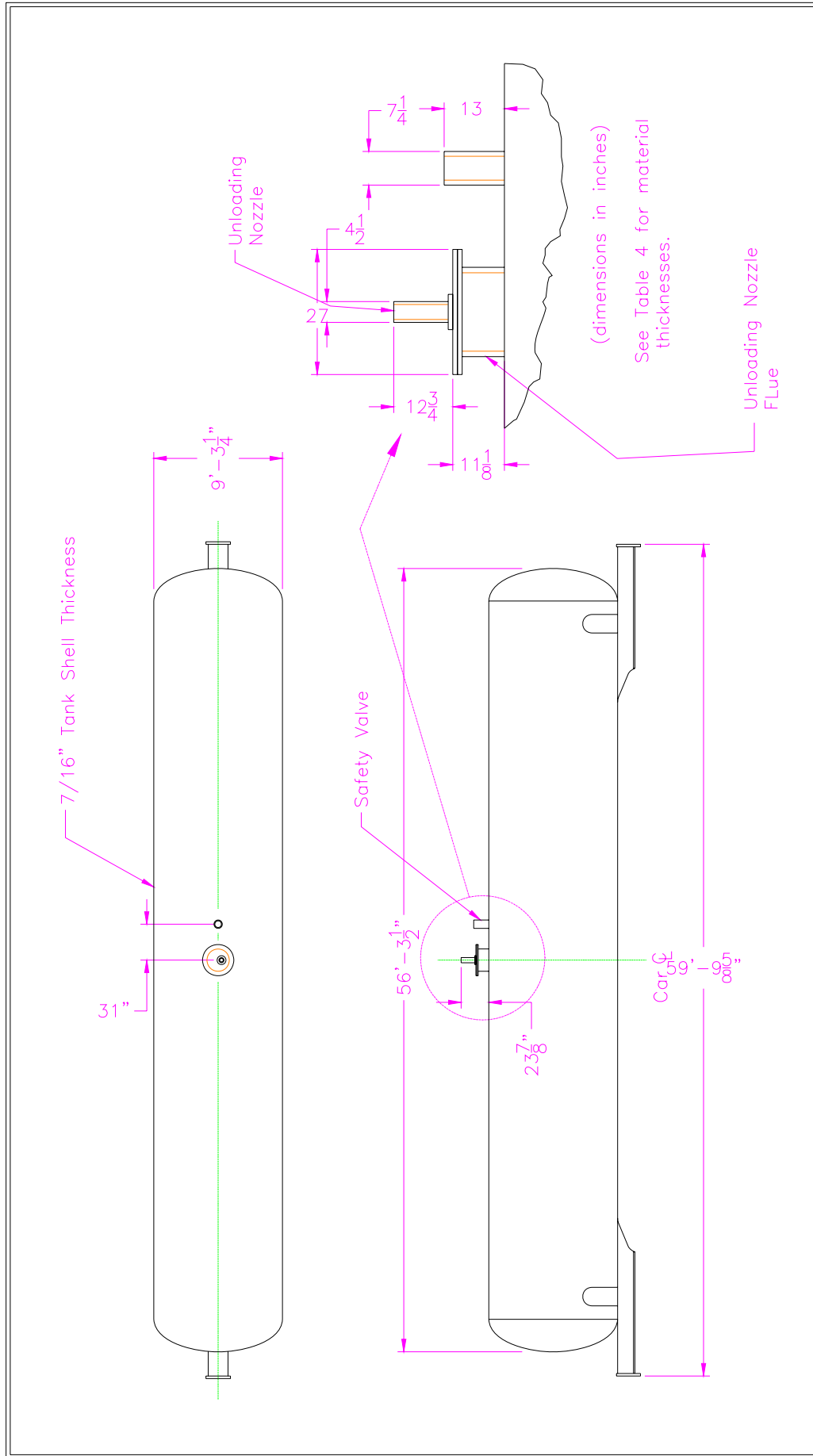

Figure 1. Schematic of Specimen Tank Car



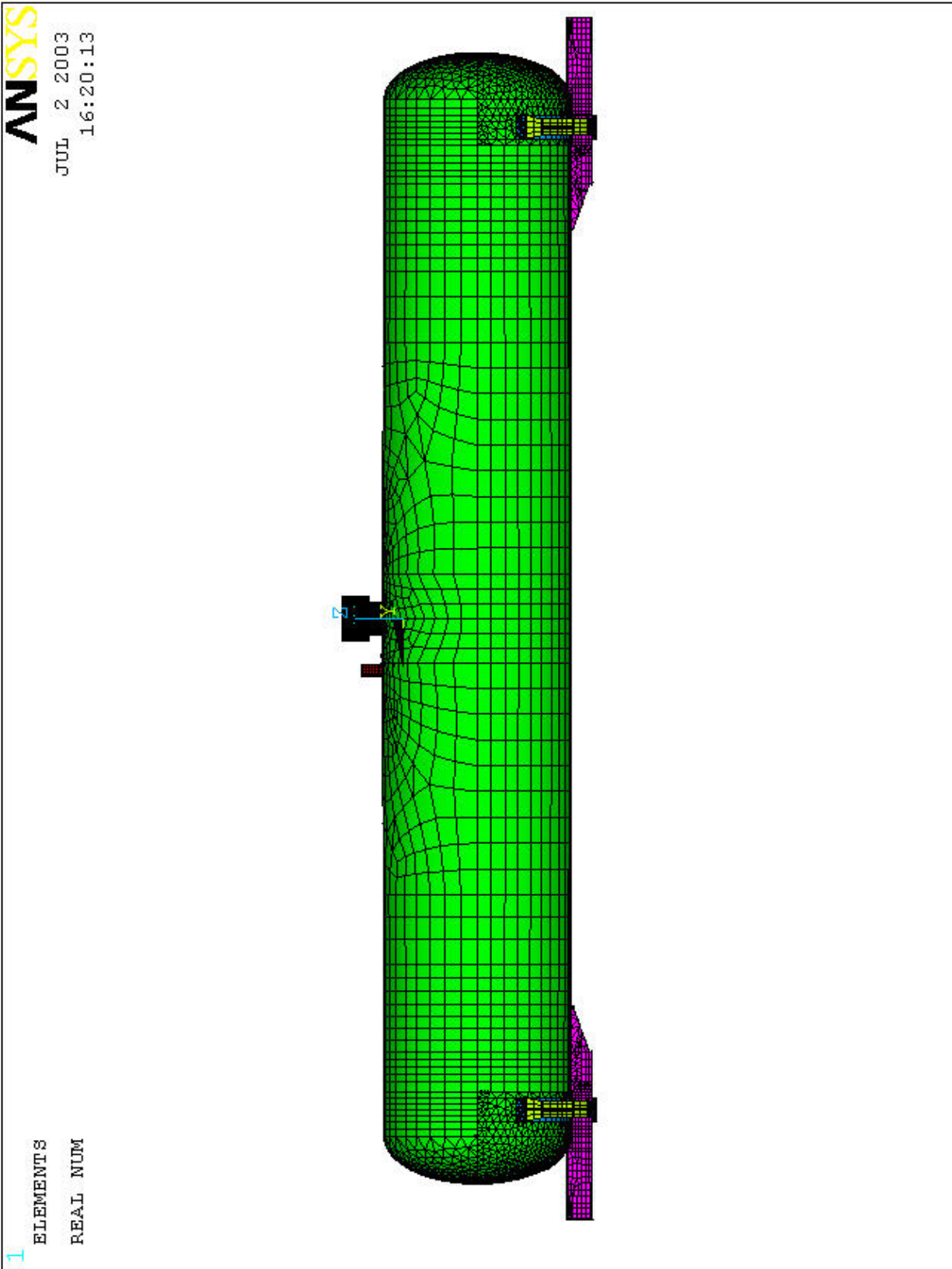
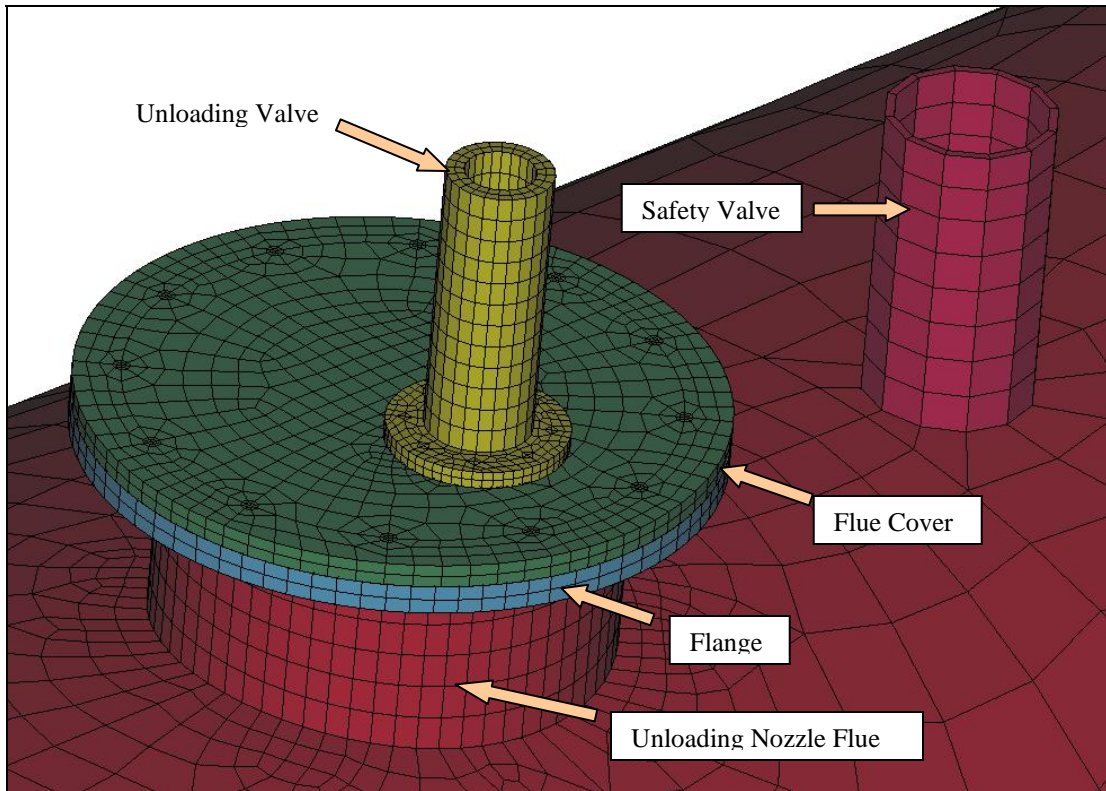
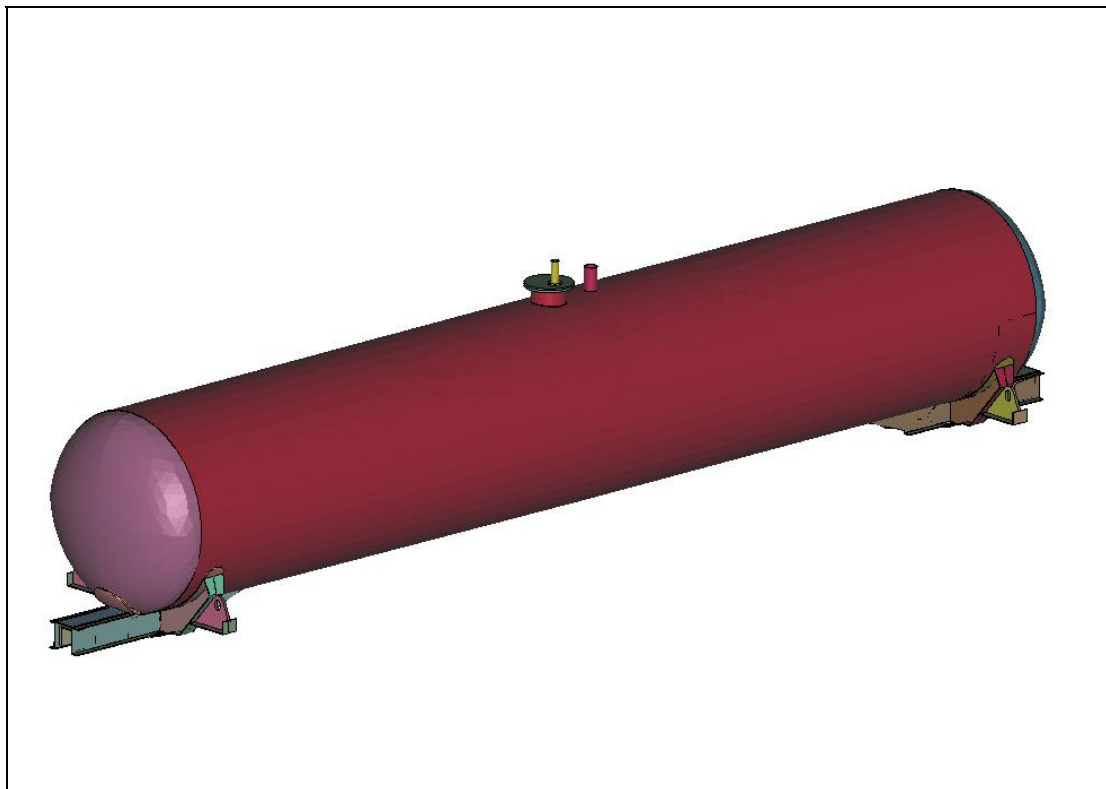

Figure 2. Ansys Finite Element Analysis Model



**Figure 3. Base Case Fittings Mesh-LS-Dyna**



**Figure 4. Base Case LS-Dyna Model**

### 3.3 Scenarios Simulated

SA simulated two primary scenarios. Scenario 1 simulated the case of a severe derailment condition, where a tank car is violently thrown off its trucks with significant initial (downward vertical) velocity, speeds up under the influence of gravity, and hits a rigid ground surface with significant impact velocities (and therefore considerable force). A less severe Scenario 2 simulated a simple rollover wherein the tank car rolls over off its trucks, with initial velocities being zero. It then speeds up under the influence of gravity and hits a rigid ground surface with nominal impact velocities.

These two scenarios represent two extreme conditions; most rollover incidents are likely to fall in between these two extremes (in both scenarios, no longitudinal velocity exists). SA anticipates that low speed derailment events likely to occur in a yard will be closer to Scenario 2 (simple rollover) in intensity and energy levels. The structural adequacy of tanks and fittings under these two scenarios will give an excellent idea of the survivability under some real world conditions. Section 3.4 provides additional details of the methodologies and velocities used for the simulations.

### 3.4 Simulations and Results

#### 3.4.1 Scenario 1

This scenario (severe case) simulates the loaded tank car body falling from a height equivalent to the trucked car body height while rotating to impact the top fittings with the ground. The tank car model is given an initial rotational velocity about its longitudinal axis of 6.82 rad/sec, an initial downward vertical velocity of 178 inches/sec, and is acted upon by the gravitational force. These values were chosen to time the impact of the top fittings with the ground as the car falls from its trucked height. These fairly high translational (vertical) and rotational velocities produce high impact forces that will not likely be seen in low speed yard derailments.

The ground is simulated as a rigid wall. Contact was defined between all deformable components and the ground, as well as between components that could potentially contact each other; for example, the unloading valve could contact the unloading cover, in addition to contacting the ground surface. SA used a static and dynamic coefficient of friction of 0.3 and 0.2, respectively, for the analysis.

A material failure strain of 0.21 was specified for the fittings. Appendix B includes a table of material properties used in these models.

Commands were included to extract the resultant forces as functions of time at each fastener around the unloading valve and unloading cover. Similar commands also extract forces at a perpendicular section through the unloading valve at approximately 1/3 of its height and at the base of the unloading nozzle and the base of the safety valve where it attaches to the tank.

As the resulting simulation is viewed (Figure 5), the tank is seen rotating as it is descending. The following describes a brief chronology of the simulation:

- 0.37 sec: The end of the unloading valve strikes the ground at about a 45-degree angle (Figure 6). The material at the upper extremity of the valve fails immediately followed closely by its attachment to its base as it exceeds its 0.21 failure strain

(Figure 7). The leading edge of the unloading nozzle cover then begins to fail as it impacts the ground, and the entire unloading nozzle recedes into the tank as the tank shell deforms inward (Figures 8-10). Fastener resultant forces, as shown in Table 1, indicate fastener failure at the unloading nozzle cover and the unloading valve.

0.40 sec: The base of the unloading flue begins to fail (Figures 11 and 12). The edge of the tank at this interface does not visually show failure but exceeds its yield strength of 50 ksi, showing values as high as 70 ksi.

0.42 sec: The leading upper edge of the safety valve impacts the ground surface, begins failing, and proceeds until the upper third of the valve is broken off. Its connection to the tank survives being protected by the adjacent unloading fitting assembly.

As discussed above, the simulation of Scenario 1 indicated failure of multiple components in the fitting structure, including the tank itself. It is probable that the above described failures would result in a release of the lading in the tank as the cover unseats from the nozzle and the valves fracture. This was the expected result. Currently, top fittings on non-pressure cars are not designed to withstand impact/derailment loads, and the fittings behaved as anticipated.

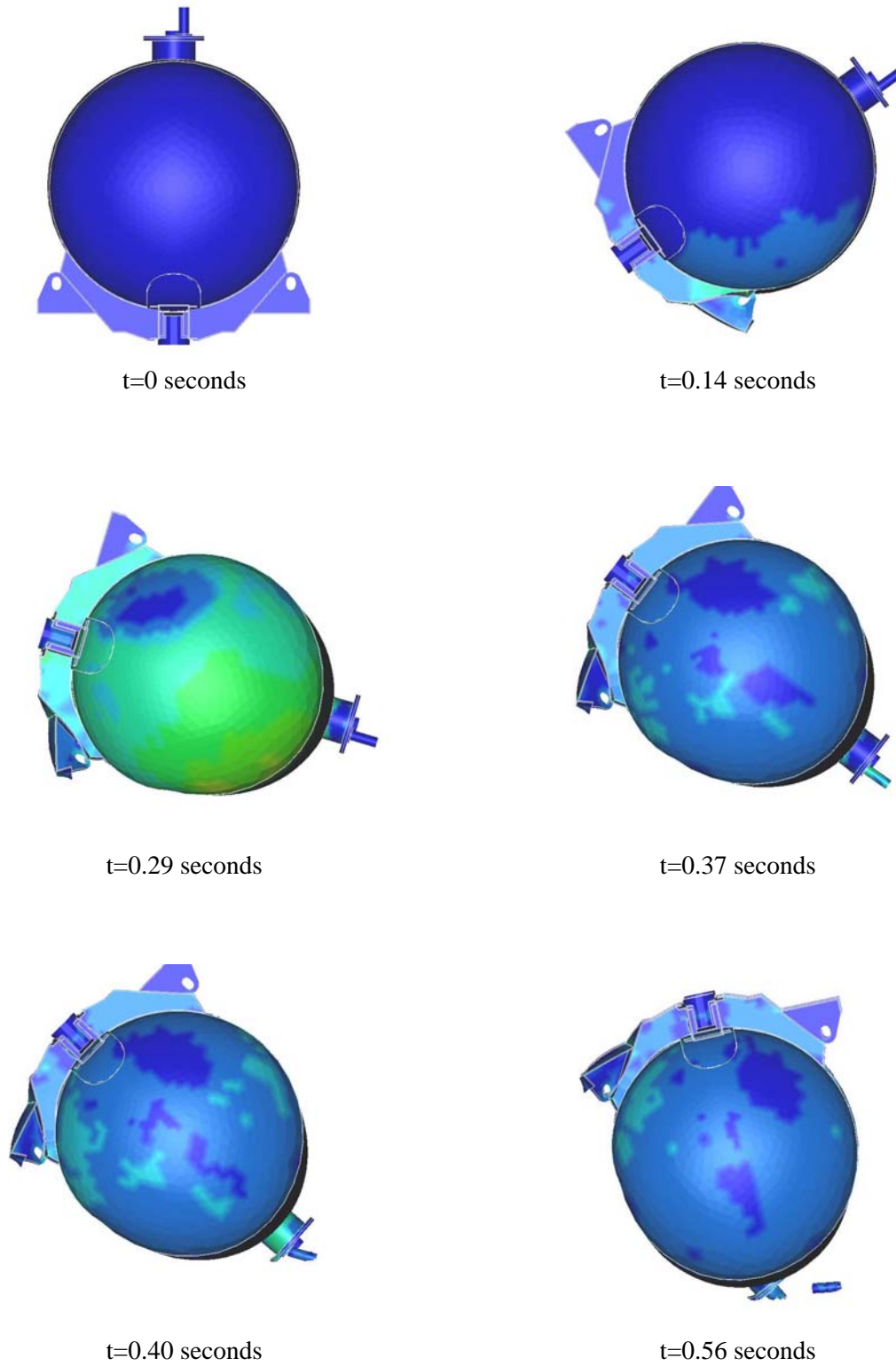

**Figure 5. Simulation Sequence–Base Case–Scenario 1**

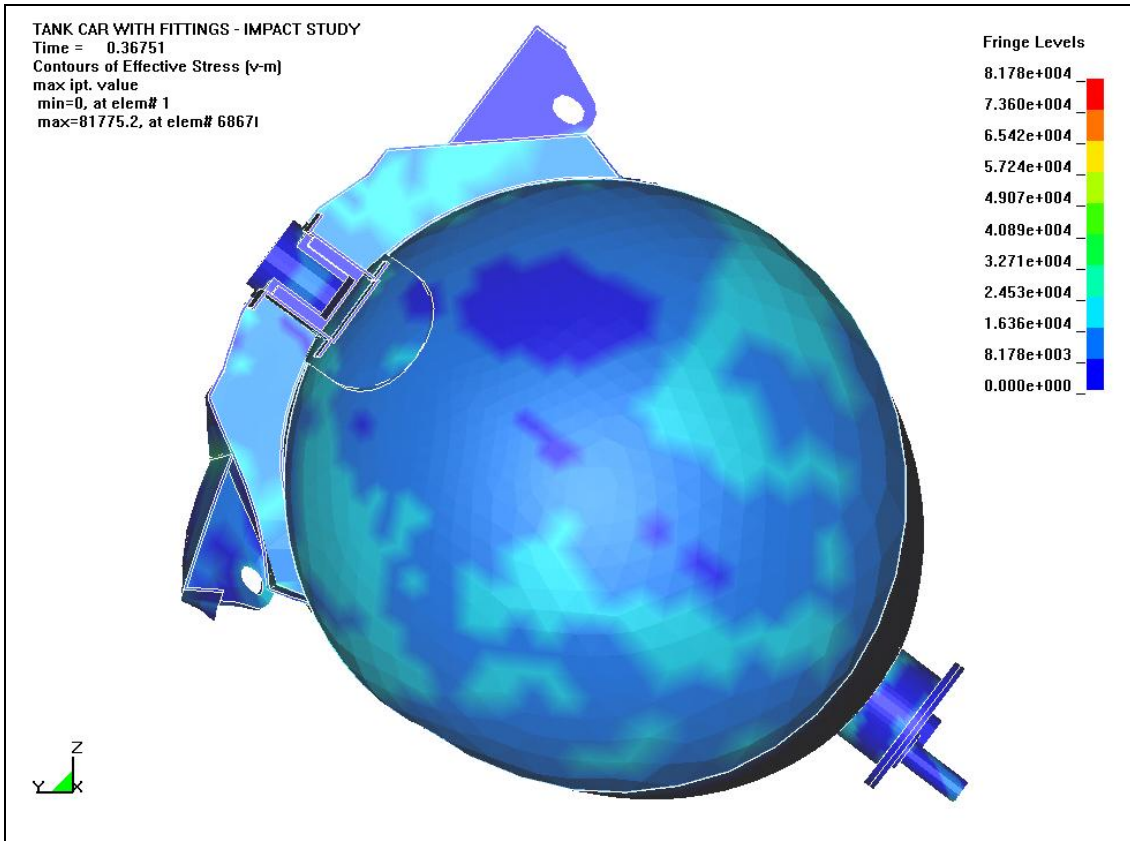

**Figure 6. Initial Impact of Fittings–Base Case–Scenario 1**

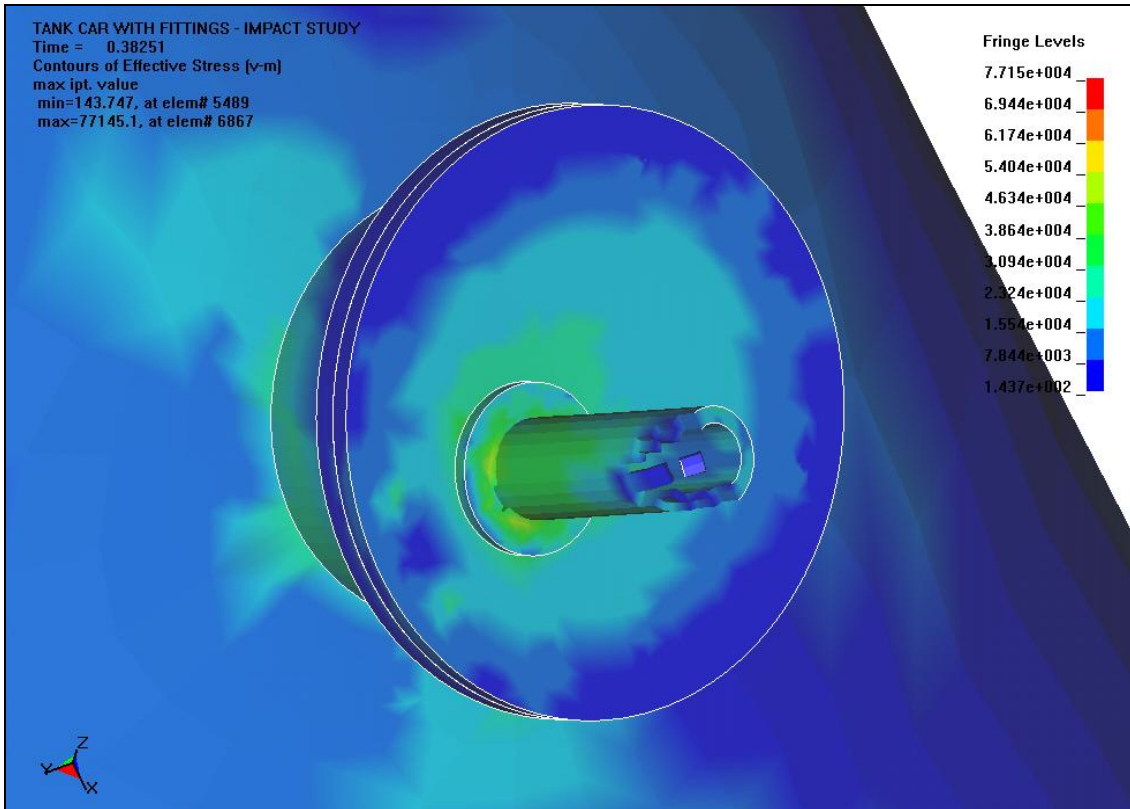

**Figure 7. Failure of Unloading Valve–Base Case–Scenario 1**

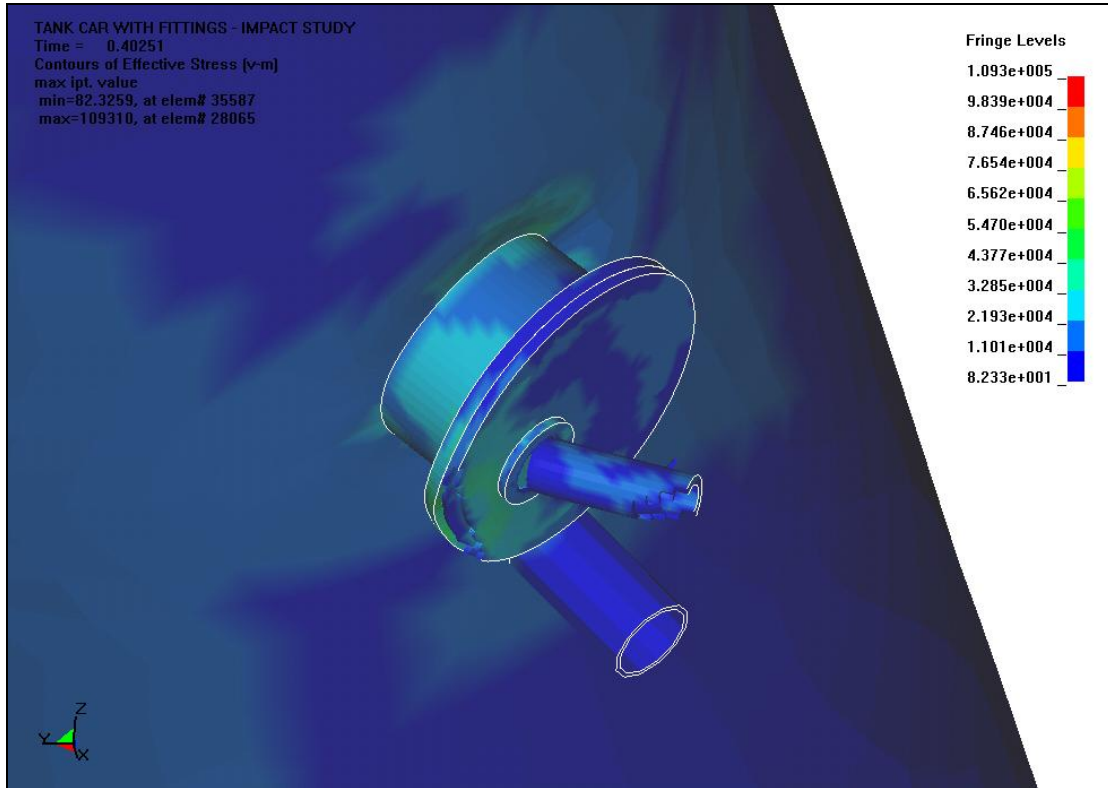

**Figure 8. Failure of Unloading Nozzle Cover–Base Case–Scenario 1**

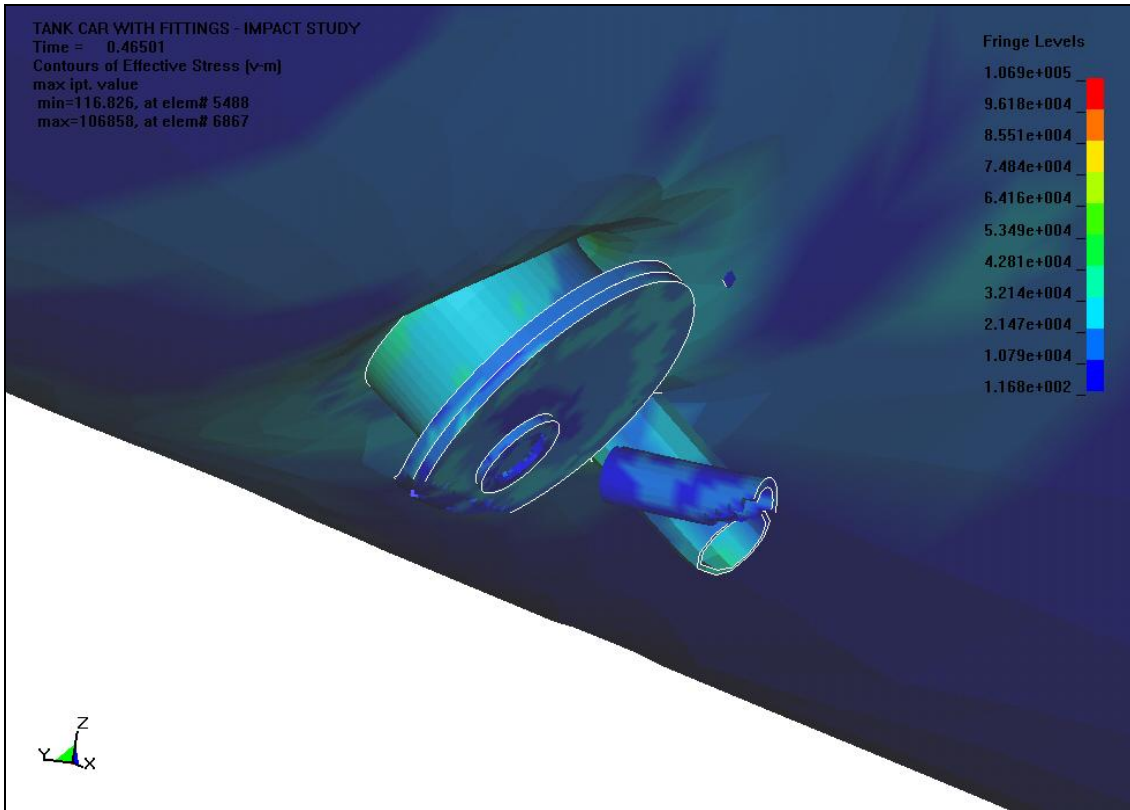

**Figure 9. Failure of Fittings (t=0.47)–Base Case–Scenario 1**

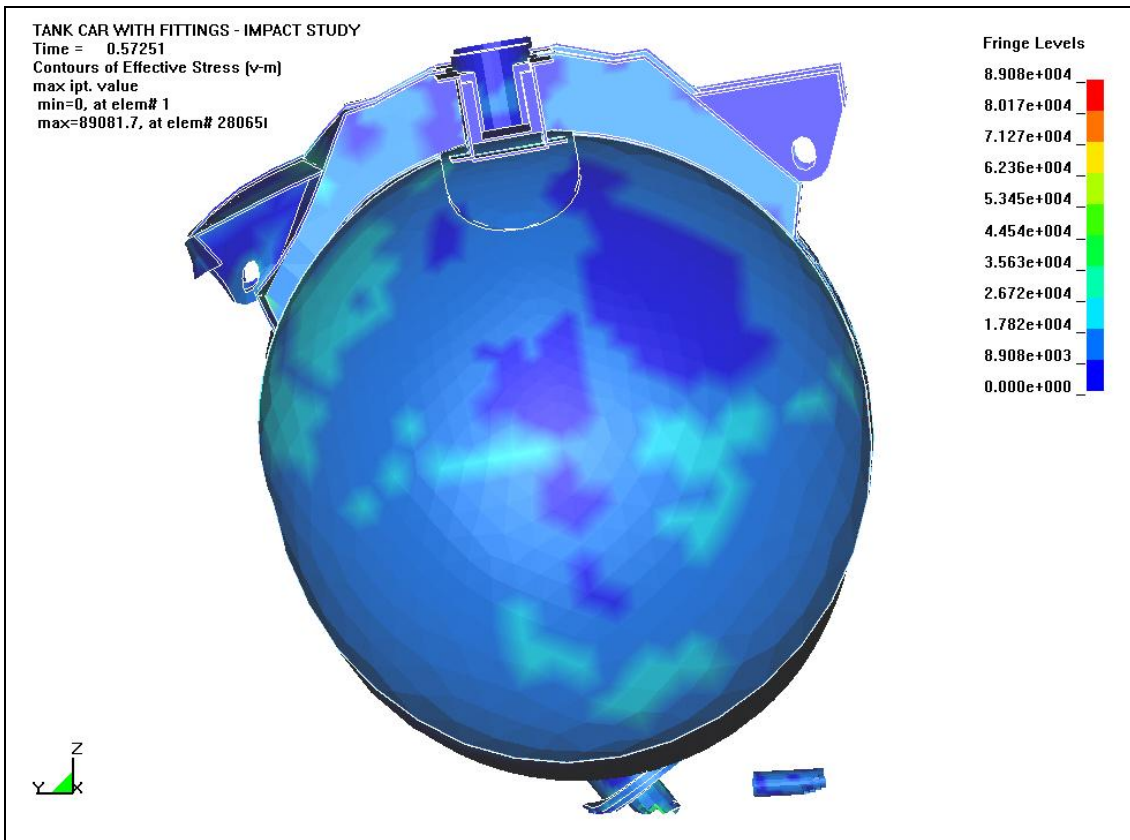
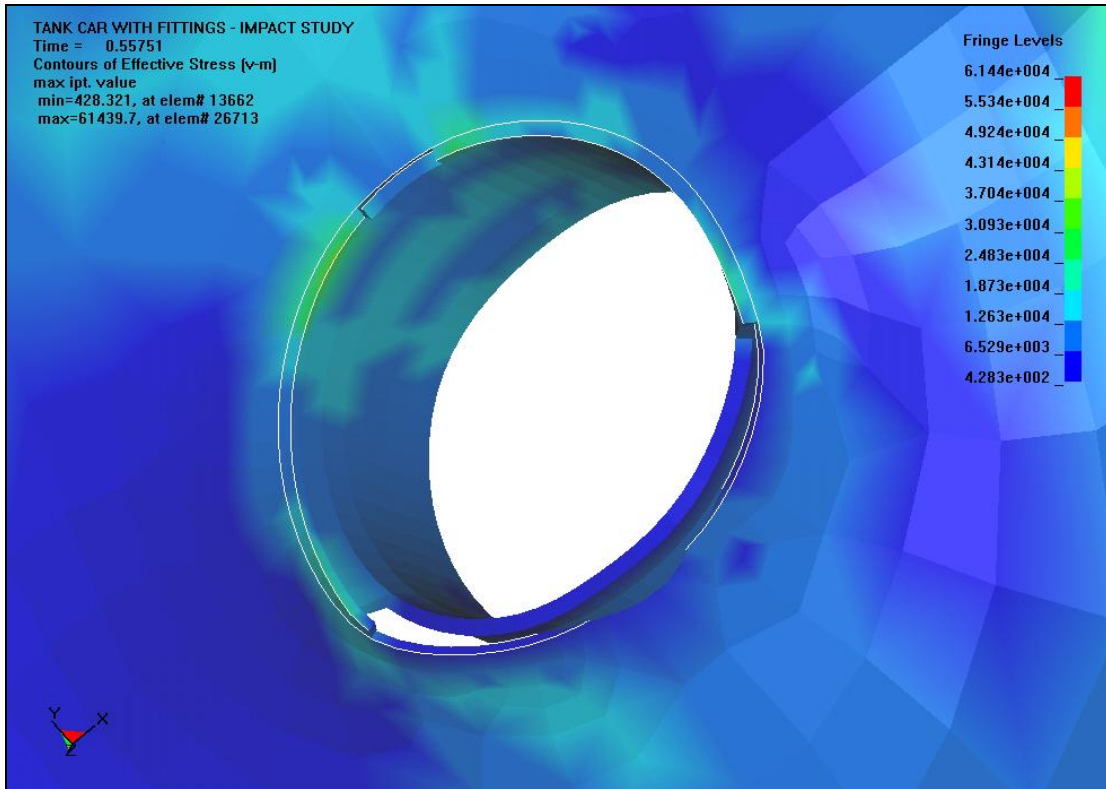

**Figure 10. Failure of Fittings (t=0.57)–Base Case–Scenario 1**

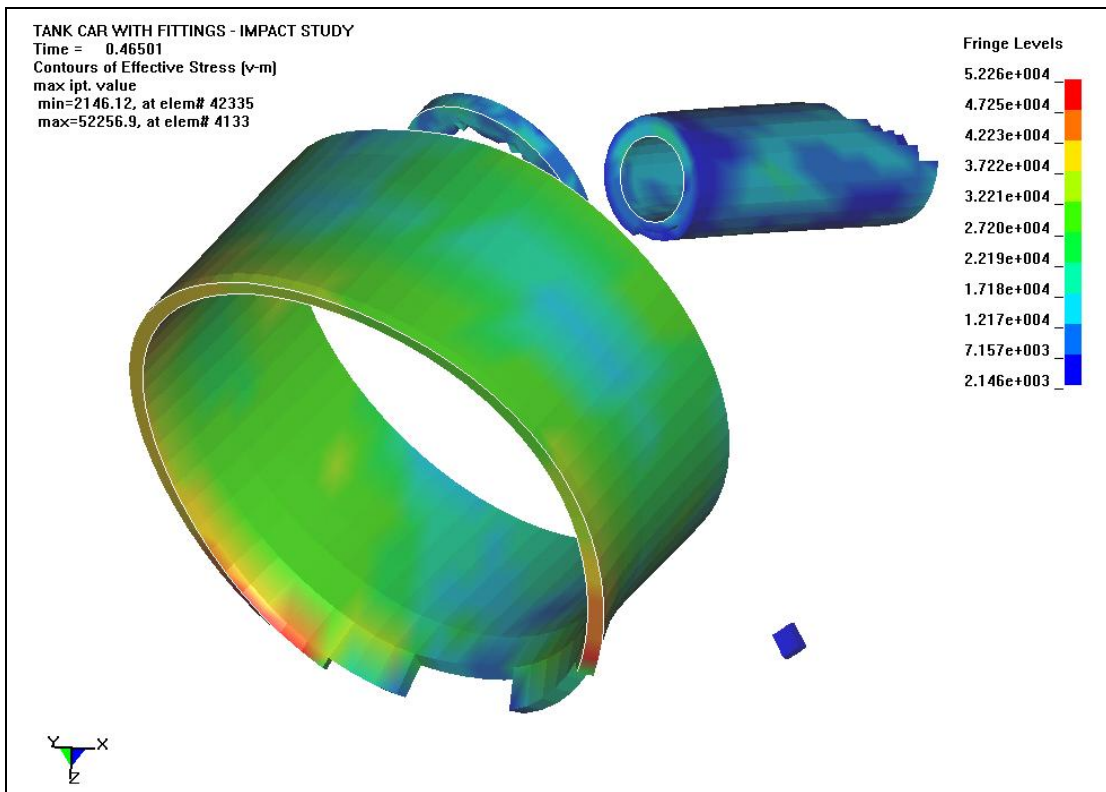

**Table 1. Fastener Results–Base Case–Scenario 1**

<b>BOLT ID</b>	<b>MAX RESULTANT FORCE (lbs)</b>	<b>FASTENER YIELD FORCE (lbs)</b>	<b>FASTENER ULTIMATE FORCE (lbs)</b>
<i>Unloading Nozzle Cover to Nozzle Flange</i>			
<i>1</i>	<i>47160</i>	<i>40654</i>	<i>53000</i>
<i>2</i>	<i>56526</i>	<i>40654</i>	<i>53000</i>
<i>3</i>	<i>55261</i>	<i>40654</i>	<i>53000</i>
<i>4</i>	<i>54250</i>	<i>40654</i>	<i>53000</i>
<i>5</i>	<i>58669</i>	<i>40654</i>	<i>53000</i>
<i>6</i>	<i>47088</i>	<i>40654</i>	<i>53000</i>
<i>7</i>	<i>61488</i>	<i>40654</i>	<i>53000</i>
<i>8</i>	<i>53555</i>	<i>40654</i>	<i>53000</i>
<i>9</i>	<i>62433</i>	<i>40654</i>	<i>53000</i>
<i>10</i>	<i>63385</i>	<i>40654</i>	<i>53000</i>
<i>11</i>	<i>56578</i>	<i>40654</i>	<i>53000</i>
<i>12</i>	<i>63127</i>	<i>40654</i>	<i>53000</i>
<i>Unloading Valve to Cover</i>			
<i>13</i>	<i>36273</i>	<i>32214</i>	<i>38350</i>
<i>14</i>	<i>29742</i>	<i>32214</i>	<i>38350</i>
<i>15</i>	<i>30108</i>	<i>32214</i>	<i>38350</i>
<i>16</i>	<i>30803</i>	<i>32214</i>	<i>38350</i>
<i>17</i>	<i>35023</i>	<i>32214</i>	<i>38350</i>
<i>18</i>	<i>40562</i>	<i>32214</i>	<i>38350</i>
<i>19</i>	<i>38936</i>	<i>32214</i>	<i>38350</i>
<i>20</i>	<i>42915</i>	<i>32214</i>	<i>38350</i>



**Figure 11. Flue Failure (Looking from Within Tank)–Base Case–Scenario 1**



**Figure 12. Flue Failure (Tank Hidden)–Base Case–Scenario 1**

### 3.4.2 Scenario 2

As previously mentioned, Scenario 2 is a less severe incident and more typical of a simple rollover. SA anticipates that a larger percentage of derailments will be closer in intensity to Scenario 2 than to Scenario 1. The simulation for Scenario 2 has the tank car body falling off its truck; specifically, falling off a surface that simulates the side bearings of the truck (Figure 13). The car rolls off two line contacts, one at each truck, and falls accelerating under the force of gravity to the ground surface. This movement is accomplished by setting the initial rotational orientation of the tank car body relative to the trucks (side bearings) such that its center of gravity is just beyond the point of imminent rotation. No initial velocities are imparted to the tank body.

The other parameters for the simulation, such as material properties, force derivations, and contact definitions, were similar to those used for Scenario 1.

The simulation runs as follows (Figure 14):

- 0.0 sec: The tank car body begins to pivot about the side bearing contact at the start of the simulation and continues to rotate and translate downward.
- 1.7 sec: The tank shell strikes the ground surface (rigid wall) with von Mises stresses in the tank body approaching 62 ksi near the impact points of the outer tank heads (Figure 15).
- 2.0 sec: The flue fails at its base just above the reinforcing disc at  $t=2.14$  sec (Figure 16).
- 2.1 sec: The extreme end of the unloading valve impacts the ground at approximately  $t=2.13$  sec and begins failing at its outer end (Figure 17).
- 2.2 sec: The base of the safety valve fails at  $t=2.20$  sec (Figure 18). The unloading nozzle fractures at its base and breaks off at  $t=2.26$  sec (Figure 19). The tank car then begins to slide along the ground surface with no additional damage being imparted to the fittings components.

It can be seen that the maximum force on the fittings is approximately 256,000 lbs as compared to 600,000 lbs for Scenario 1 (see Appendix C for a discussion of force and velocity data). This simulation indicates that though this impact is less severe, it still results in significant damage to fittings. The extent of damage would likely result in release of lading. It can be concluded from these simulations that conventional non-pressure car top fittings are likely to suffer damage and cause lading release under most derailment scenarios. The next logical step is to design concepts for protection and evaluate their effectiveness under the above scenarios. The next section describes these efforts.

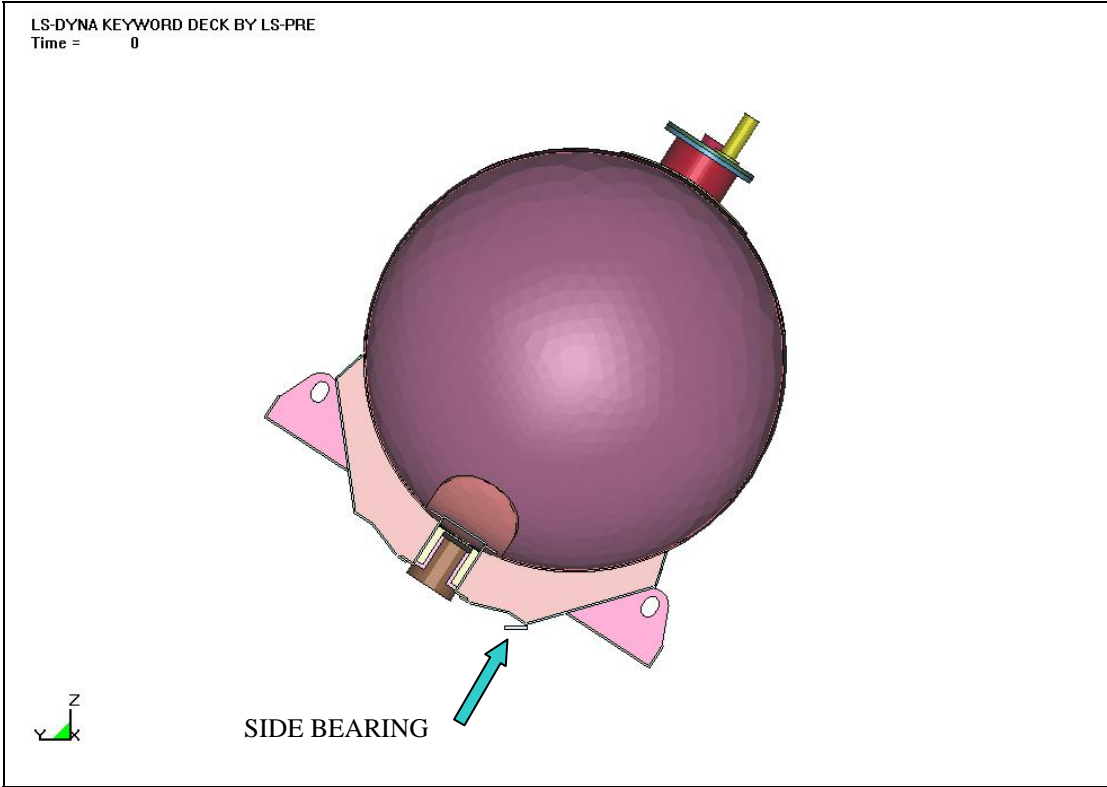

**Figure 13. Base Case–Scenario 2**

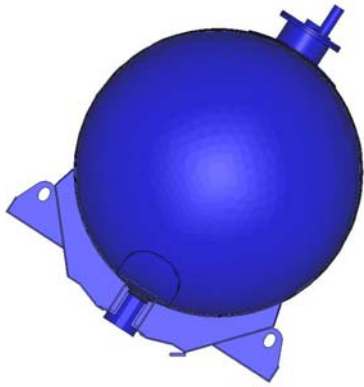

t=0 seconds

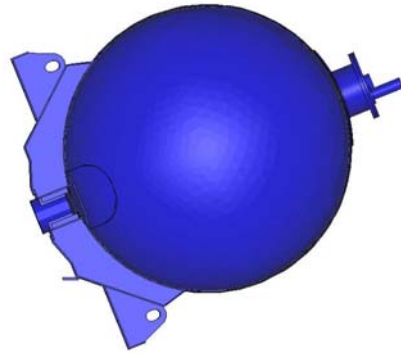

t=1.34 seconds

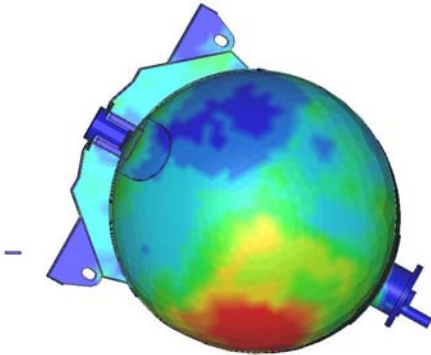

t=1.96 seconds

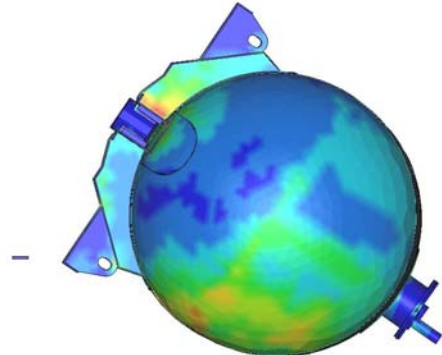

t=2.04 seconds

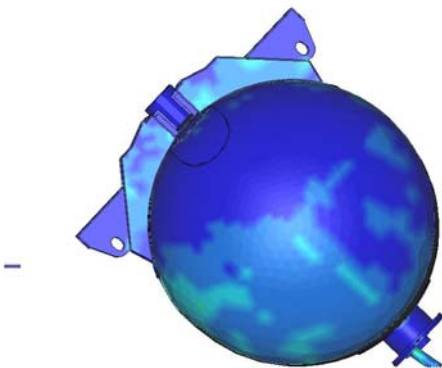

t=2.22 seconds

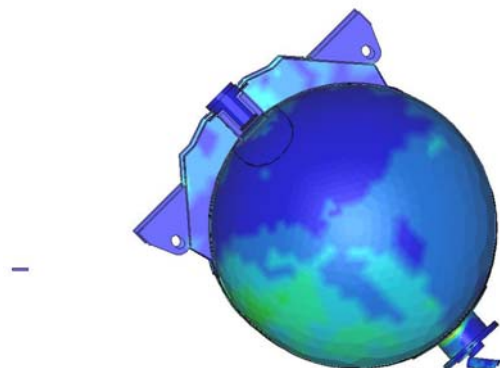

t=2.60 seconds

**Figure 14. Simulation Sequence–Base Case–Scenario 2**

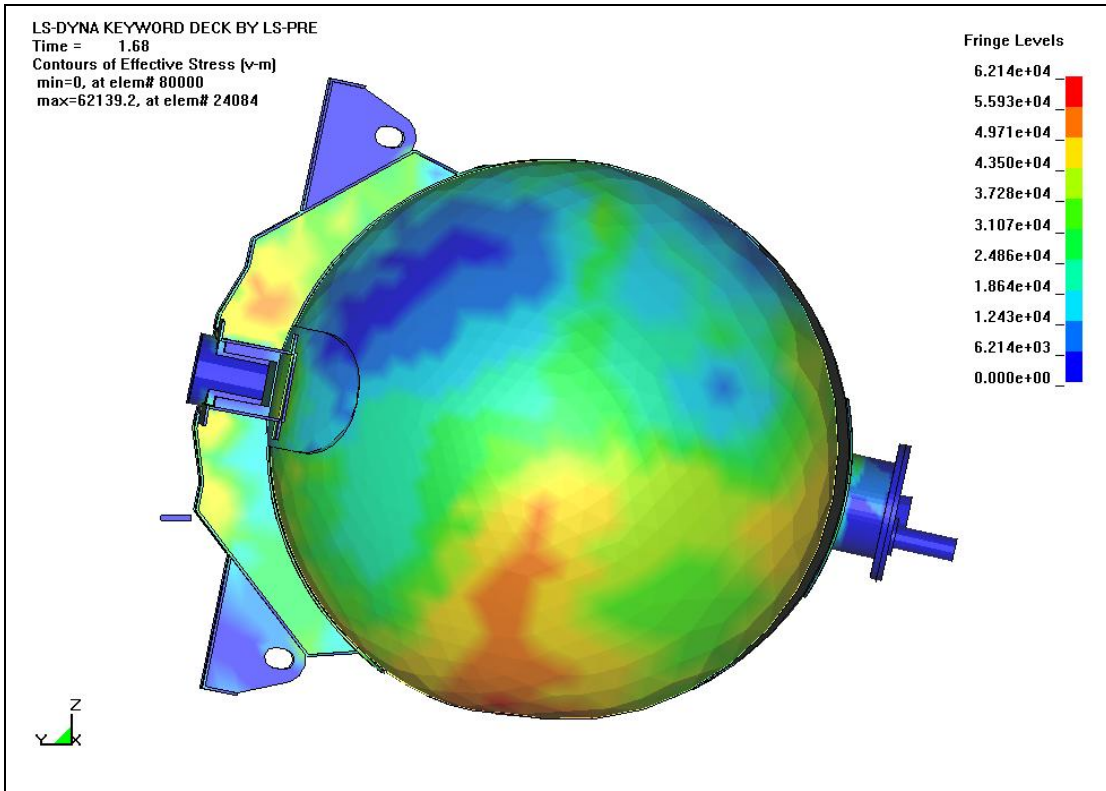

**Figure 15. Tank Impact–Base Case–Scenario 2**

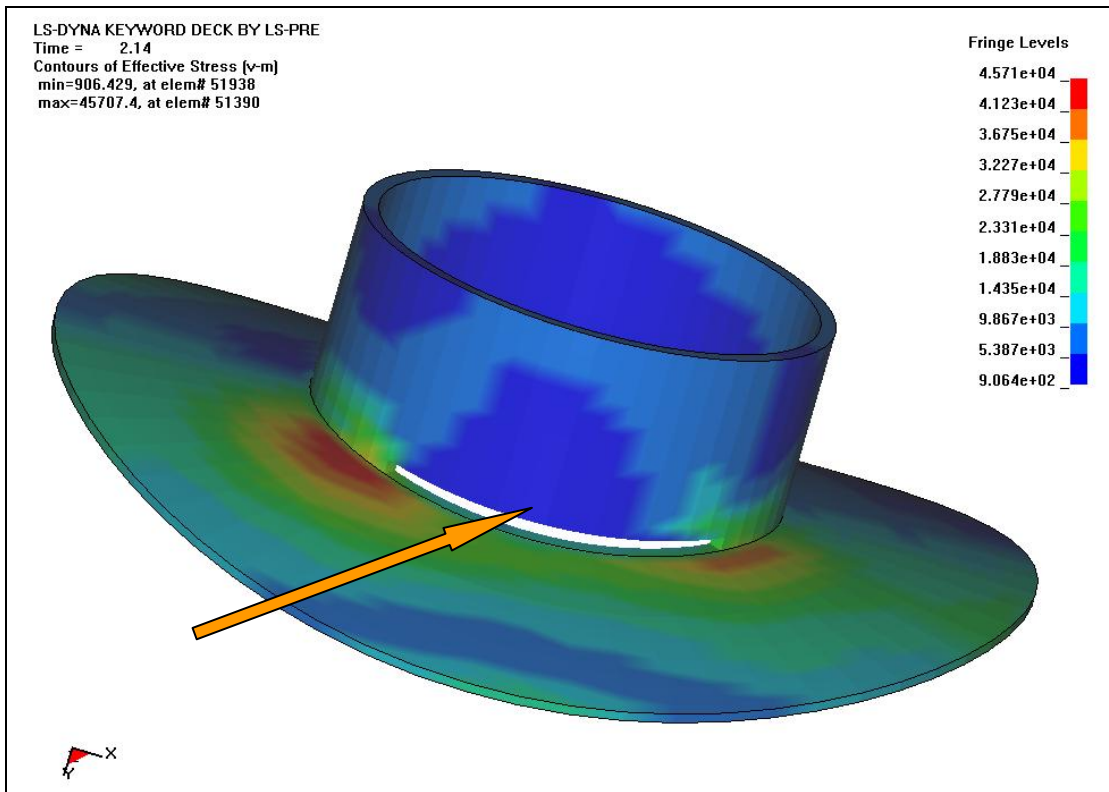

**Figure 16. Flue Failure–Base Case–Scenario 2**

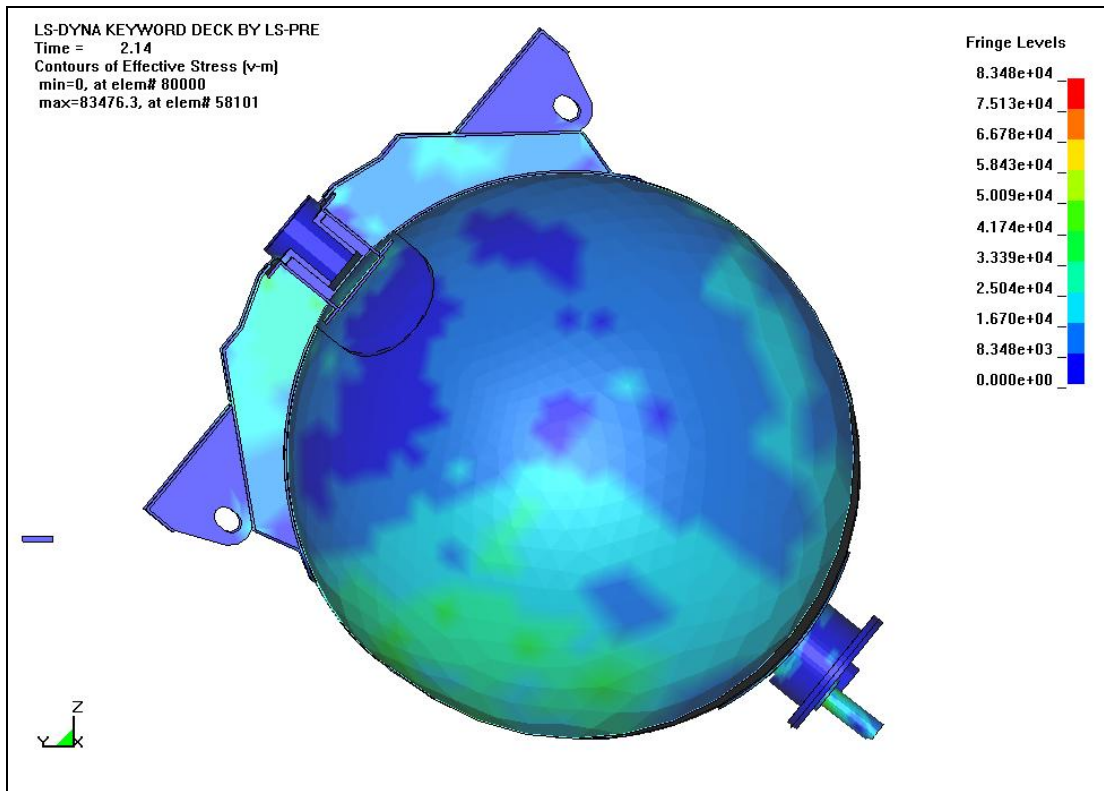

Figure 17. Valve Impact–Base Case–Scenario 2

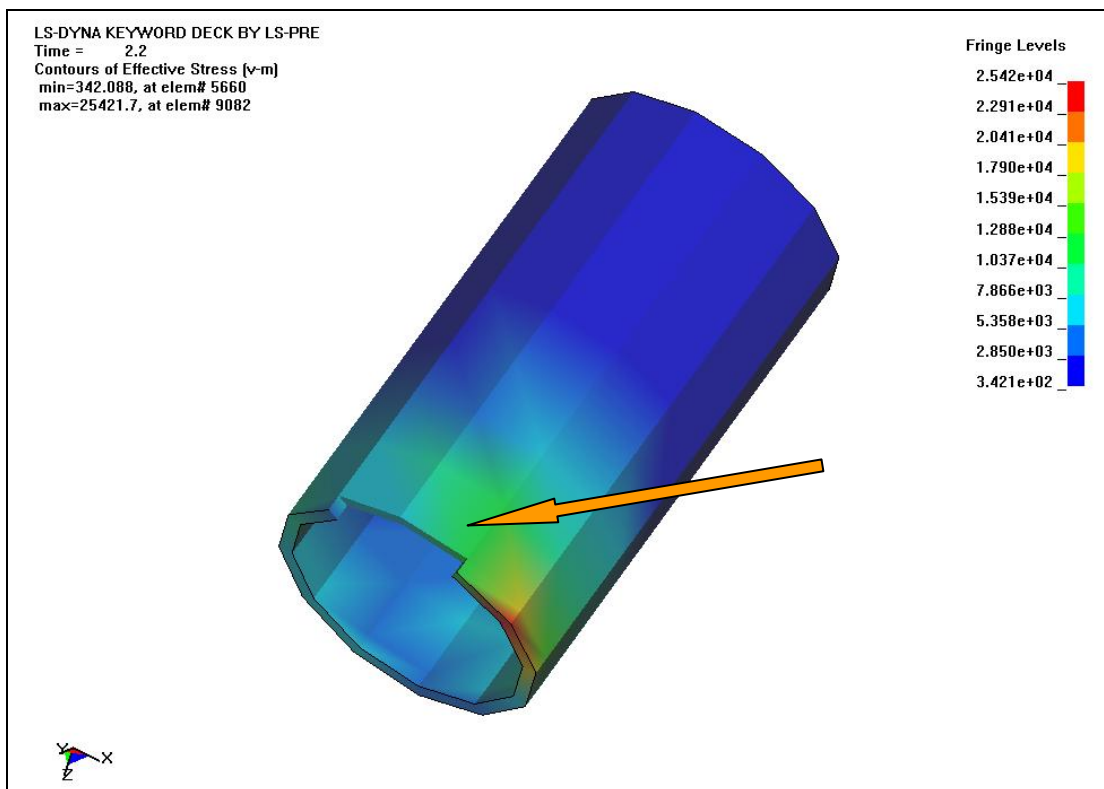
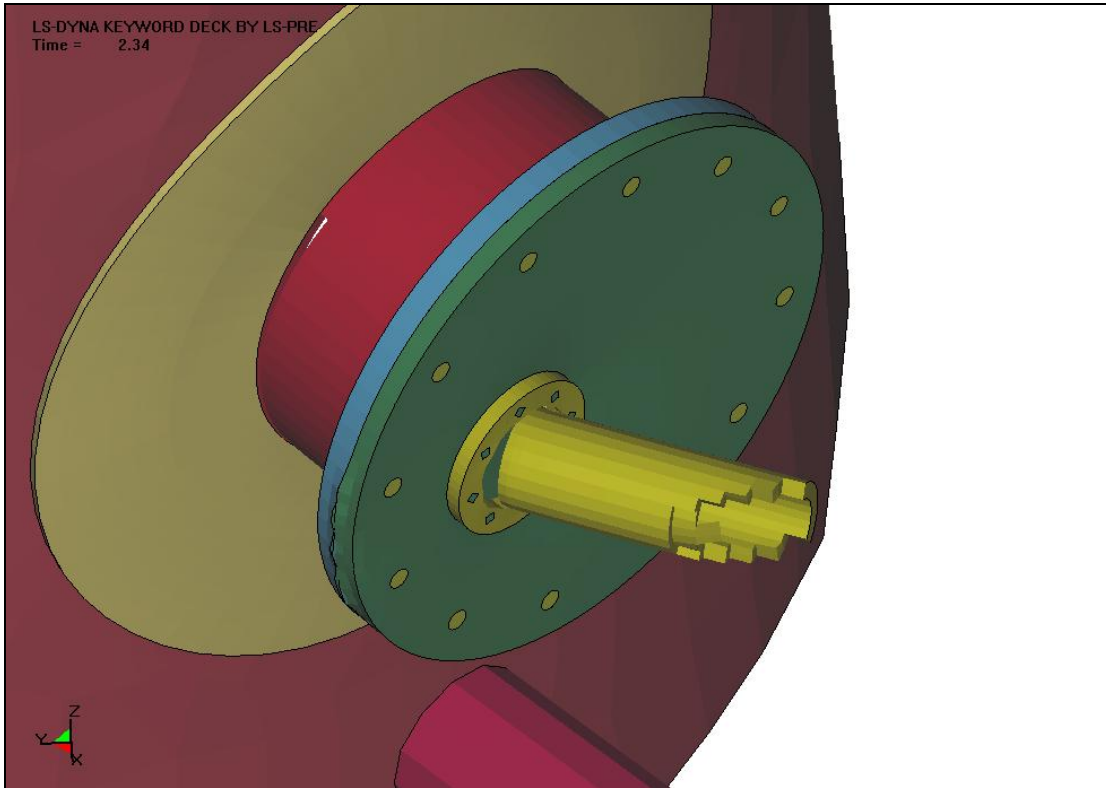

Figure 18. Safety Valve Failure–Base Case–Scenario 2



**Figure 19. Failure of Unloading Valve–Base Case–Scenario 2**



## 4. Concepts for Top Fittings Protection

Simulations of derailments of tank cars with unprotected top fittings indicated that significant fitting damage and consequent lading release would result under most derailment scenarios. Therefore, SA decided to develop conceptual protective structures that would be suitable for retrofit on an existing tank car. The previous analysis had identified two critical areas on the tank car that could benefit from structural improvement, specifically, in regard to top fittings protection. The first (and primary) area that needs protection is the fittings themselves; mechanisms to protect the fittings from direct impact will be of significant help. The second area that needs attention is the connection between the tank and the fittings; the thinner tank shell used on non-pressure cars results in a weaker (compared to pressure cars) connection at this interface. With the above in consideration, SA developed two concepts to improve the performance of top fittings on non-pressure cars. This chapter describes these concepts and their simulation.

### 4.1 Concept 1–Sleeve Type Fittings Protection

The first configuration of protective structure incorporates a sleeve-shaped steel weldment consisting of a 1.0-inch thick rolled sleeve and a 1.0-inch thick base plate of T-1 steel and follows the general concept of the fittings sleeve used on newer pressure cars (Figure 20). The base plate is predrilled to accept  $\frac{3}{4}$ -inch fasteners used through the unloading nozzle cover and nozzle flange for securement to the fittings assembly. The sleeve secures through the top of the unloading nozzle cover and nozzle flange. The external fittings are then fastened through the nozzle cover and base plate of the protective sleeve. The inner diameter of the sleeve is 25.25 inches and is sized to allow access and function of the fittings inside. The height of the sleeve is 16 inches and extends slightly beyond the unloading valve, the highest device in this arrangement (Figures 21 and 22). It is intended that this arrangement will also protect the safety valve since it has a higher profile and is close in proximity to the safety valve. The material for the unloading nozzle flange, flange, and cover, along with the safety valve, were changed to T-1 steel to better withstand the impact forces.

SA modeled the modifications using ANSYS, exporting to LS-Dyna for the two rollover simulations. For this case, the fasteners supporting the fittings were modeled as separate entities using SAE grade 8 fastener steel (Appendix B shows material properties). The following paragraphs describe the results from the simulations. Appendix B shows the materials and part thicknesses used for each configuration.

#### 4.1.1 Concept 1–Scenario 1

Scenario 1 represents a severe derailment condition that induces high forces into the fittings structure. This LS-Dyna run was set up to provide the same environment and conditions as the Scenario 1 base case run (see Section 3.4.1). SA adjusted the initial velocity to provide a closer match of impact velocity with the ground surface to agree with the base case (unmodified case). This was necessary because of small changes in mass distribution with the added components. Appendix C presents charts of impact velocity and impact force.

.75 x 3.25" Grip HEX CAP SCR -  
(For Concept 1)

1.0 x 4.25" Grip HEX CAP SCR -  
(For Concept 2)

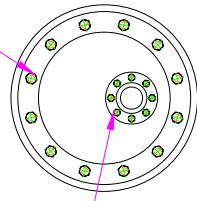

.75 x 3.00 Grip HEX CAP SCR -  
(For Concept 1)

1.0 x 3.50 Grip HEX CAP SCR -  
(For Concept 2)

(Grips shown do not include washers)

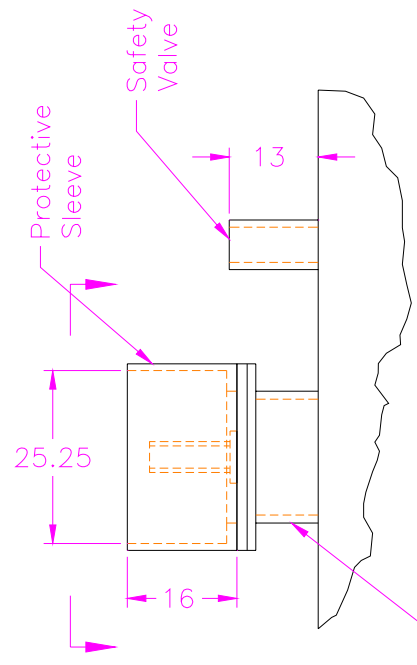

(dimensions in inches)

See Appendix B for material thicknesses.

Figure 20. Basic Dimensions, Protective Sleeve Application

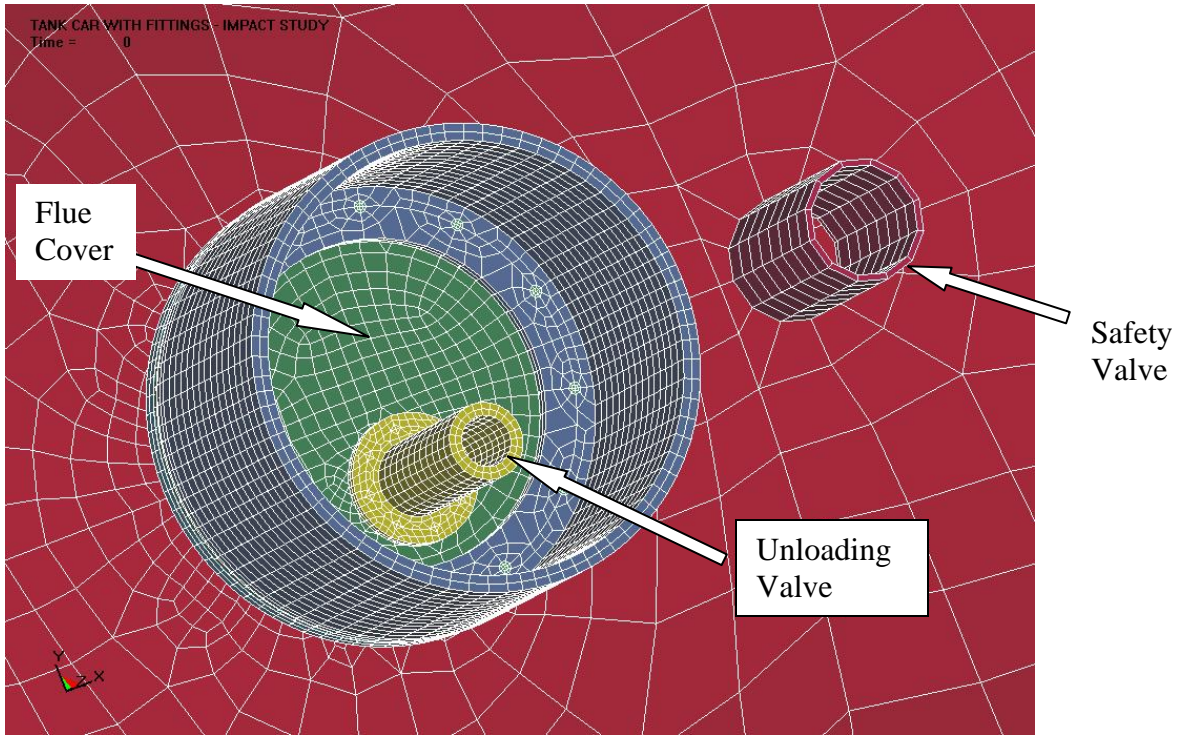

**Figure 21. Concept 1–Bolt-On Sleeve**

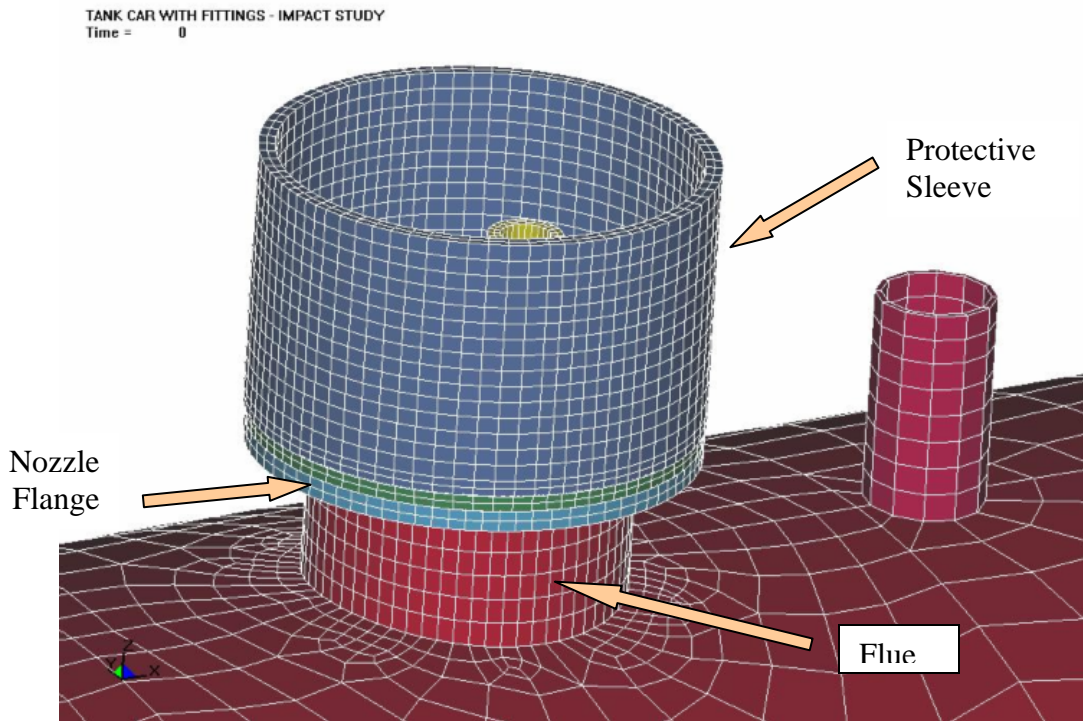

**Figure 22. Concept 1–Protective Sleeve**

As the resulting animation is viewed (Figure 23), the trajectory of the tank and fittings is similar to that of the base case. The chronology is as follows:

- 0.1 sec: The jacking pads strike the ground surface first and continue deforming as the tank rotates.
- 0.24 sec: The tank side impacts the ground. At this point no structural failures have occurred.
- 0.34 sec: The protective sleeve around the fittings impacts the ground surface and begins to deform but does not contact the fittings inside. The unloading valve, however, begins failing at its base due to flexure of the nozzle cover, followed by failure of the base of the unloading nozzle flue at the tank attachment at  $t=0.35$ .
- 0.38 sec: The nozzle cover itself begins to fail. The bolts (3/4-inch diameter) that secure the sleeve start to fracture at  $t=0.378$  along with the material around the bolts on the protective sleeve. The unloading valve separates from the cover. The unloading nozzle flange material initiates failure at  $t=0.39$ .
- 0.45 sec: The protective sleeve separates from the fittings assembly.
- 0.46 sec: The base of the safety valve fails at its attachment to the tank (Figures 24 and 25).

The tank material shows failure at the attachment to the flue by way of von Mises stresses exceeding 70 ksi.

This simulation indicates that, even with a protective sleeve, the top fittings would not survive a severe impact. In addition, they indicate a failure of the tank shell structure. Failures of this magnitude would likely result in a lading release. The next step was to determine if the protective structure would help in the case of a more nominal failure, such as the one simulated by Scenario 2.

#### *4.1.2 Concept 1–Scenario 2*

Scenario 2 represents a more nominal rollover type of derailment (Figure 26). Concept 1, described above, was subjected to a Scenario 2 rollover in this simulation. The motion of this run is similar to that of the base case with the tank shell impacting the ground at  $t=1.66$  sec with maximum von Mises stresses on the tank about 50 ksi and 80 ksi on the base of the safety valve. The upper edge of the protective sleeve impacts the ground surface at  $t=1.98$  sec and deforms slightly (Figure 27). The sleeve protects the unloading valve inside and the adjacent safety valve as the car body continues to slide along the ground surface. Figure 28 shows a view of the sleeve deformation.

This simulation shows that, under a more nominal derailment, a pressure car type protective structure would likely prevent significant damage to the fittings and prevent a lading release. The analysis also indicated that stresses on the tank shell are still quite high. SA, therefore, developed a concept for a tank shell reinforcement (Concept 2) that could be retrofitted to existing non-pressure cars, possibly improving the survivability of top fittings.

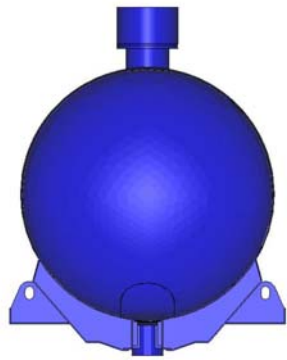

t=0 seconds

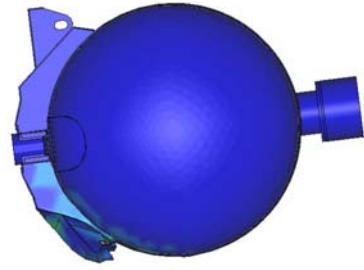

t=0.22 seconds

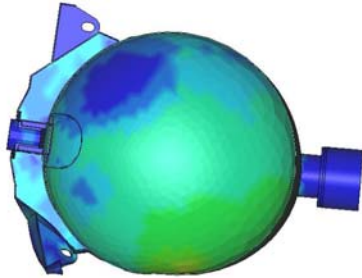

t=0.26 seconds

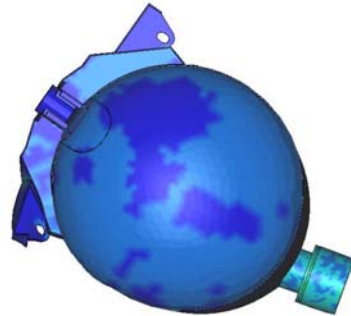

t=0.36 seconds

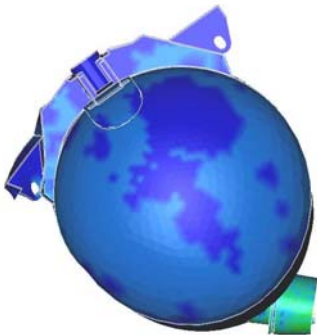

t=0.44 seconds

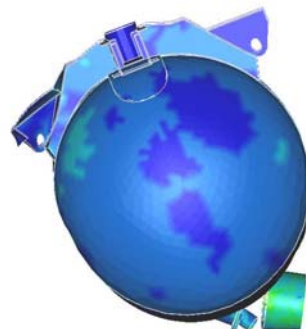

t=0.51 seconds

**Figure 23. Simulation Sequence–Concept 1–Scenario 1**

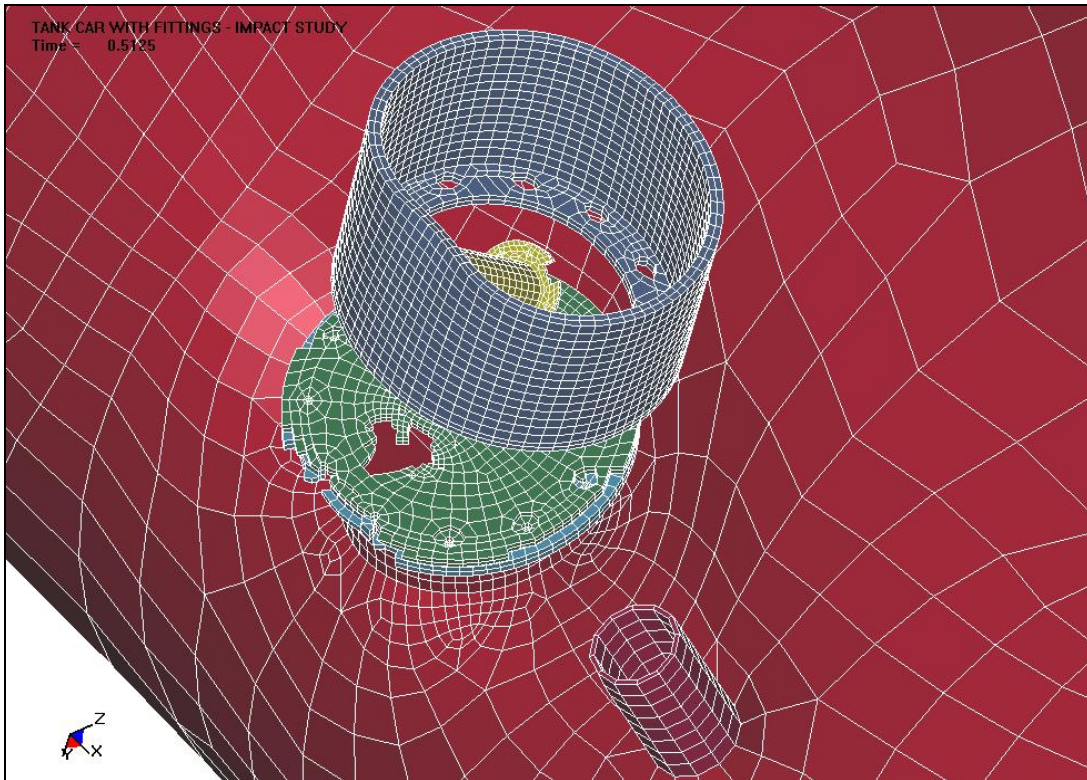

**Figure 24. Failure of Fittings Assembly and Components  
Concept 1–Scenario 1**

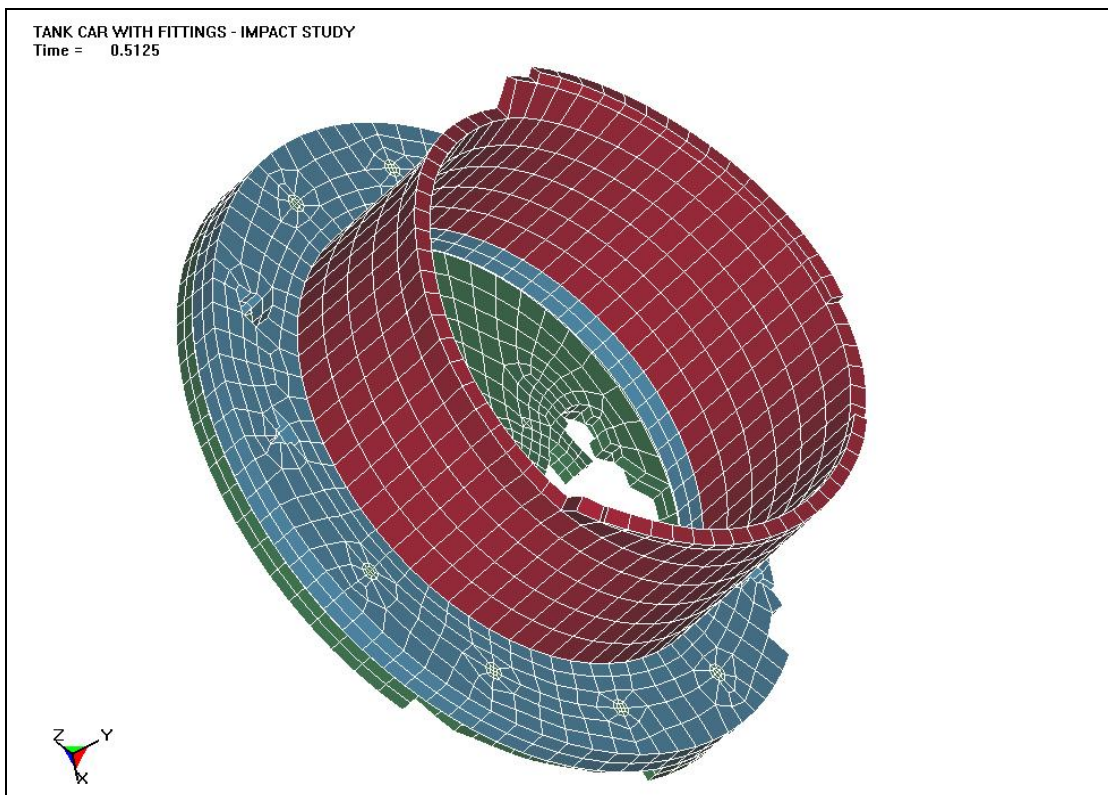

**Figure 25. Failure of Flue at Tank Attachment  
Concept 1–Scenario 1**

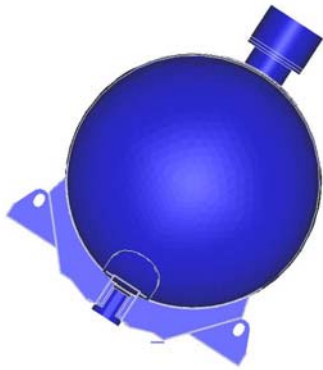

t=0 seconds

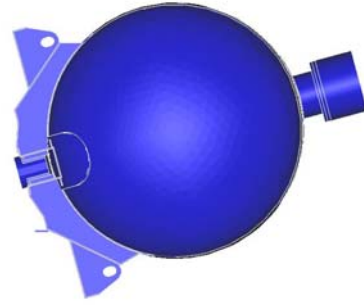

t=1.42 seconds

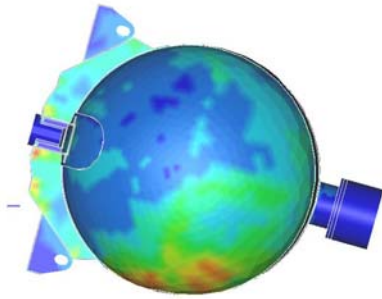

t=1.72 seconds

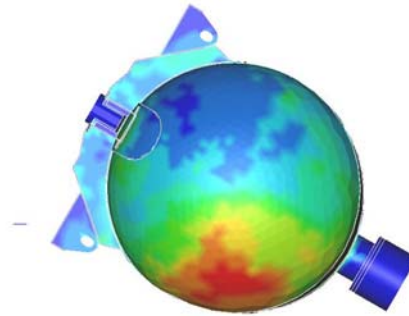

t=1.96 seconds

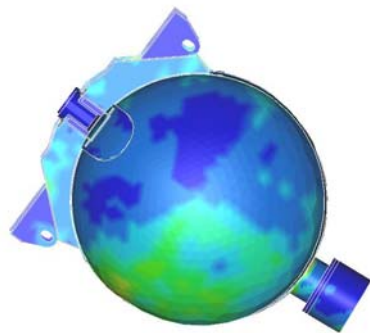

t=2.18 seconds

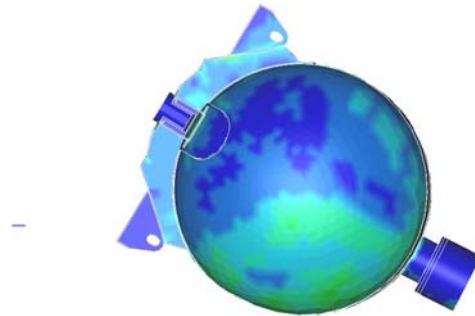

t=2.48 seconds

**Figure 26. Simulation Sequence–Concept 1–Scenario 2**

LS-DYNA KEYWORD DECK BY LS-PRE  
Time = 1.98  
Contours of Effective Stress (v-m)  
min=0, at elem# 80000  
max=81215.5, at elem# 9084

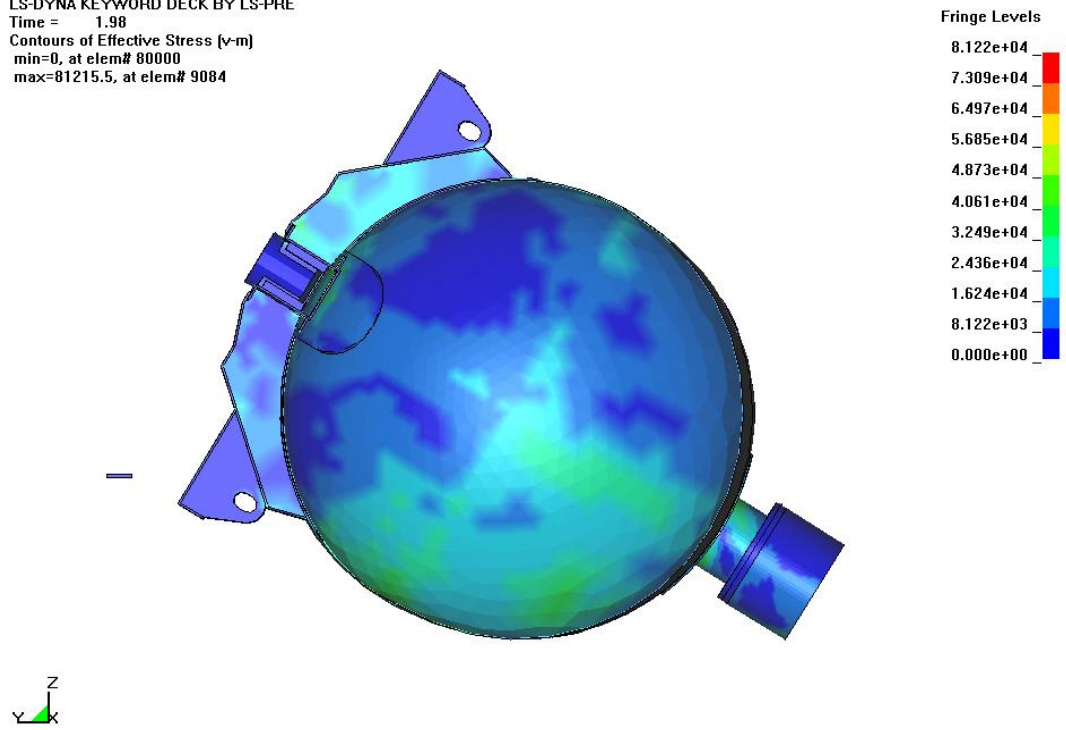

Figure 27. Impact of Sleeve–Concept 1–Scenario 2

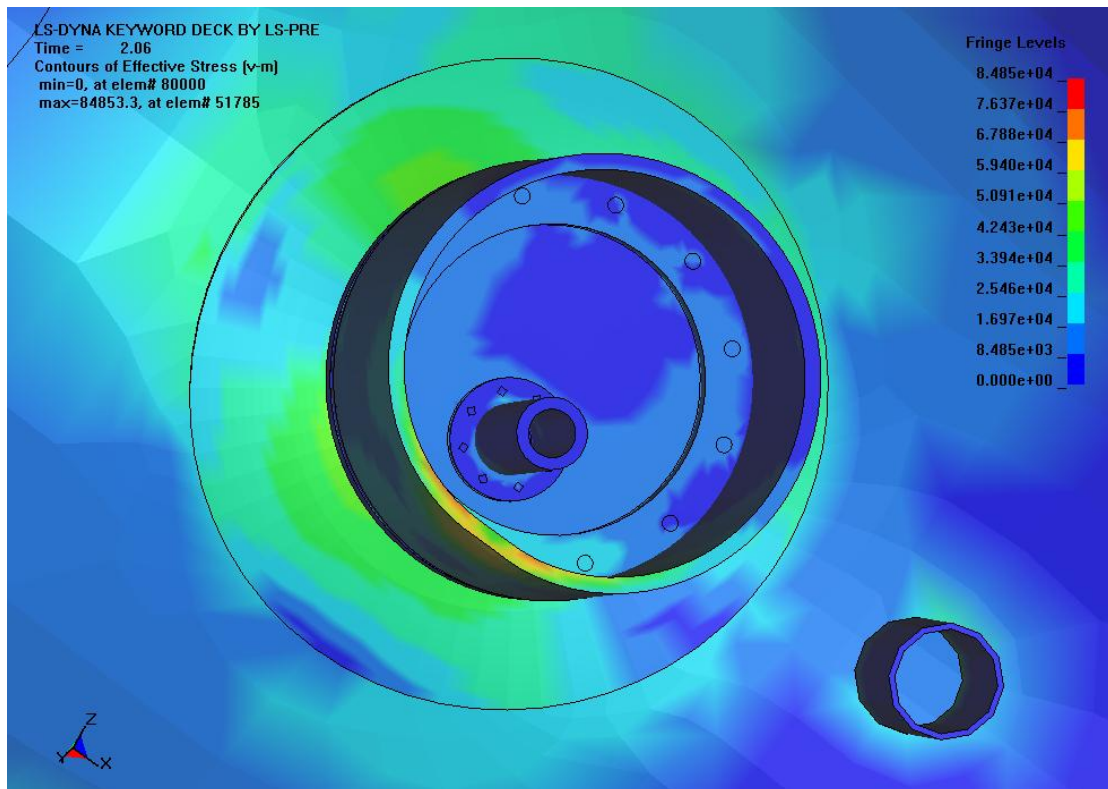

Figure 28. Deformation of Sleeve–Concept 1–Scenario 2



## 4.2 Concept 2–Cone for Reinforcing Tank Shell

Concept 2 adds two components for reinforcement of the tank-to-fittings interface and increases the material thickness of several components. A disc-shaped reinforcing plate (7/16-inch thick) contoured to the tank surface is added around the unloading nozzle flue and is attached at its outer diameter to the tank surface and at its inner diameter to the flue base. This component strengthens the flue to tank connection. A cone-shaped reinforcement (3/8-inch thick) is also added, extending from a level on the flue down to the reinforcing plate on the tank, and functions to move a portion of the load outward away from the flue to tank connection where failure was seen in the first configuration (Figures 29 and 30).

Since the flue cover and base of the protective sleeve failed in Concept 1 (Scenario 1), these T-1 steel components were increased in thickness from 1 inch to 1.5 inches. The grade 8 fasteners through the assembly were also increased from 0.75-inch diameter to 1.0-inch diameter.

### 4.2.1 Concept 2–Scenario 1

Scenario 1 represents a more severe derailment condition that induces high forces into the fittings structure. For this simulation, SA set up the LS-Dyna run to provide the same environment and conditions as the Scenario 1 base case run (see Section 3.4.1). A failure strain of 0.19 was added to elements of the tank shell around the attachment of the unloading nozzle flue to the tank shell. This was done to enable animation of any tank shell element failure in this area. The initial velocity was adjusted slightly to provide a closer match of impact velocity with the ground surface to agree with the base case (unmodified case). This was necessary because of small changes in mass distribution with the added components (this was also done for Scenario 2). Appendix C includes charts of impact velocity and impact force.

As the resulting animation is viewed (Figure 31), the trajectory of the tank and fittings is similar to that of the base case.

- 0.48 sec: The protective sleeve impacts the ground surface and begins its deformation.
- 0.54 sec: The reinforcing cone begins to fail at its top edge, separating from the assembly. The tank begins failing at the trailing edge of the reinforcing disc. The upper leading edge of the reinforcing cone at its attachment to the flue starts failing at  $t=0.545$ .
- 0.58 sec: The flue fails just above the reinforcing disc on the trailing side, followed by the disc itself at 0.66 sec.
- 0.67 sec: The fasteners start breaking out in bearing on the flue flange followed by failure of the fasteners themselves at  $t=0.675$ . At  $t=0.69$ , the fasteners experience bearing failure in the protective sleeve and flue cover, respectively.
- 0.74 sec: The safety valve fails at its base.

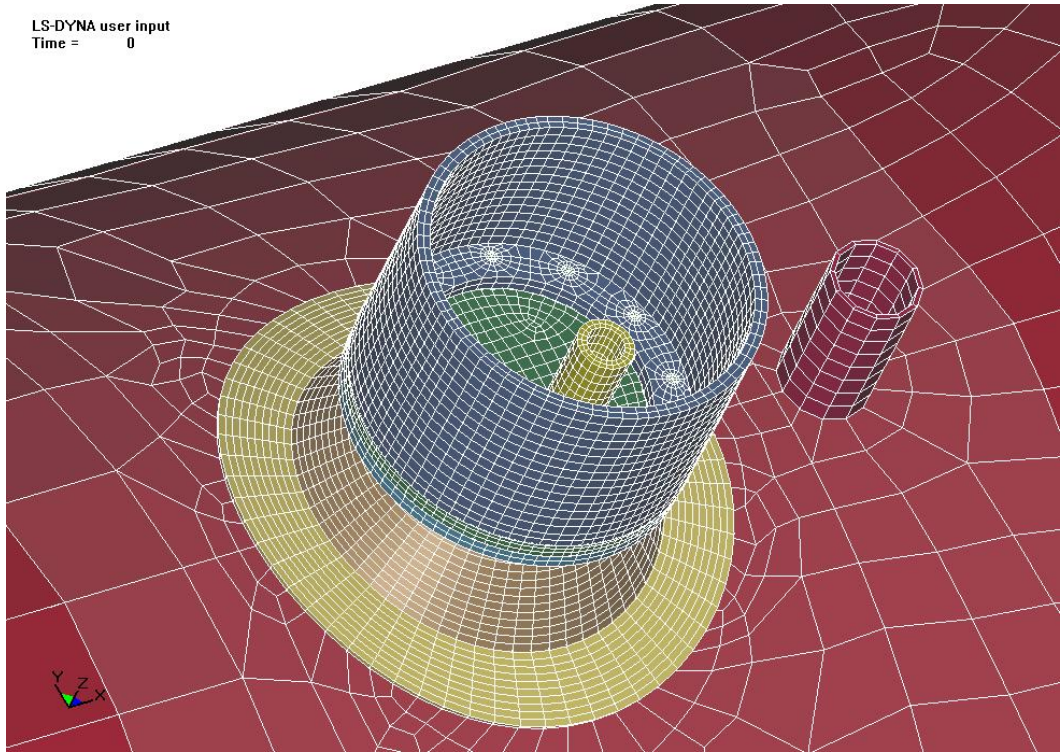

**Figure 29. Second Configuration of Fittings (Concept 2)**

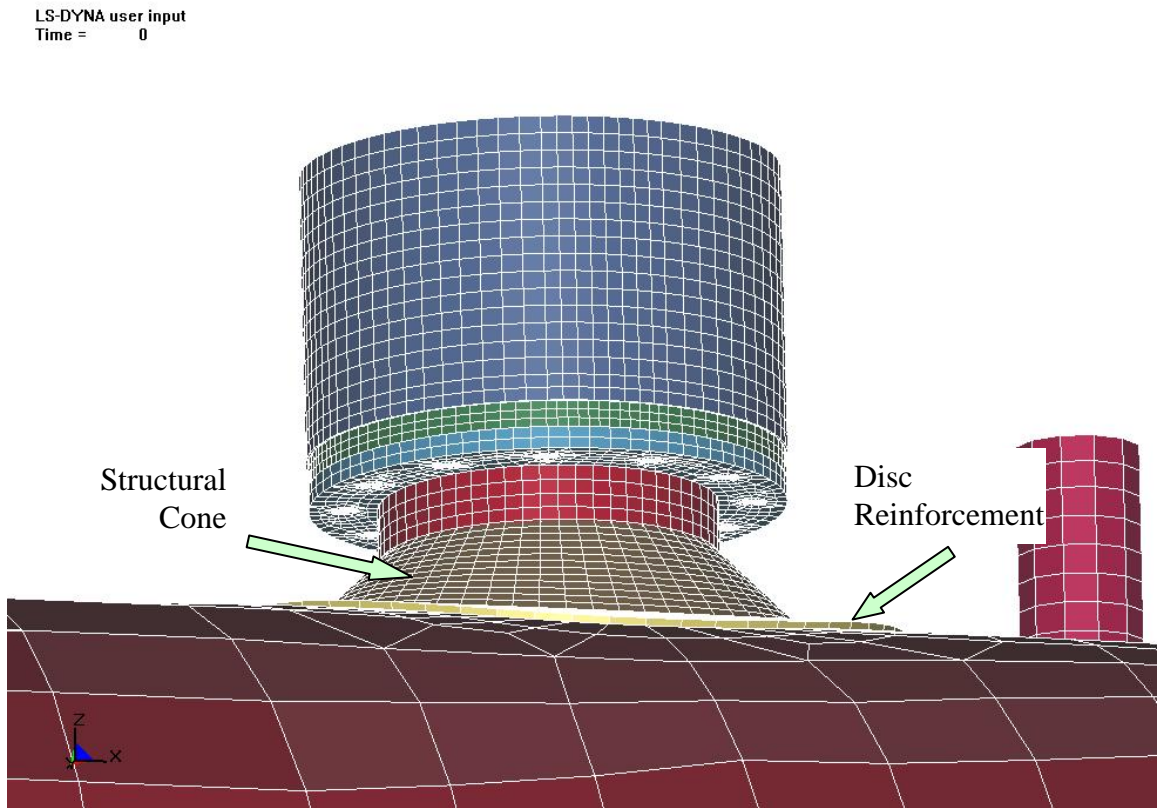

**Figure 30. Concept 2–Sleeve with Disc and Cone Reinforcement**

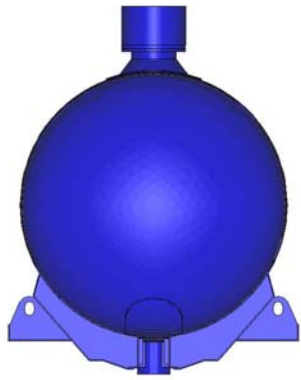

t=0 seconds

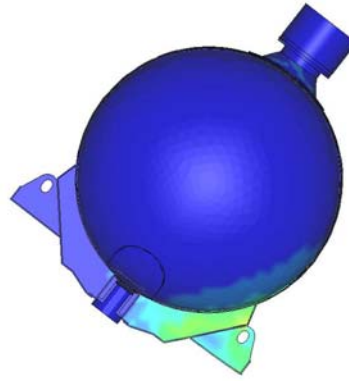

t=0.11 seconds

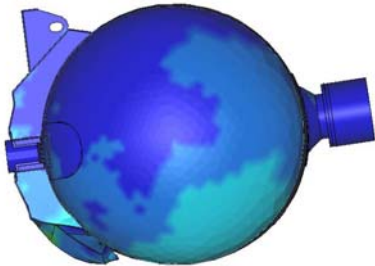

t=0.25 seconds

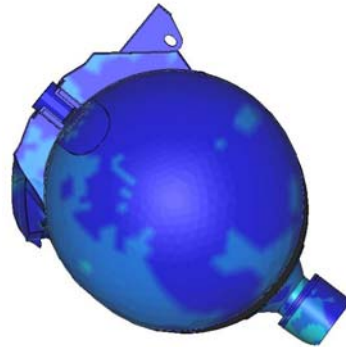

t=0.49 seconds

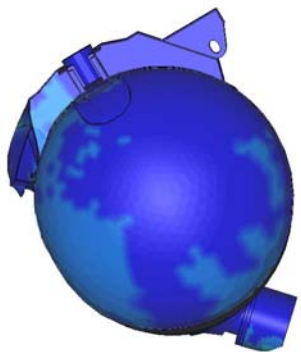

t=0.65 seconds

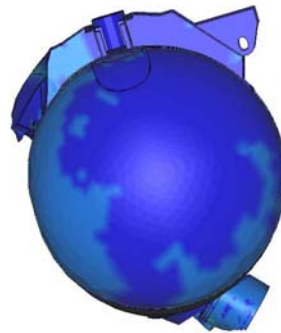

t=0.79 seconds

**Figure 31. Simulation Sequence–Concept 2–Scenario 1**

Figure 32 shows an overall view of the failed fittings. Figure 33 shows the failure of the flue flange, cover, and sleeve, along with the flue failure, at the attachment to the tank. Figure 34 shows the tank shell failure. As viewed from the images, this would have also resulted in the release of lading. This indicates the difficulty in providing an effective mechanism to protect the top fittings of a non-pressure car in the case of severe derailments. In the next simulation (Scenario 2), SA will evaluate the effectiveness of this concept on a more nominal rollover or derailment.

#### *4.2.2 Concept 2–Scenario 2*

As mentioned above, Scenario 2 represents a nominal rollover type of derailment, as would occur in the yard at low speed. The motion of this simulation (Figure 35) is similar to that of the base case with the tank shell impacting the ground at  $t=1.66$  sec with max von Mises stresses on the tank about 50 ksi and 80 ksi on the base of the safety valve (Figure 36). The upper edge of the protective sleeve impacts the ground surface at  $t=1.98$  sec and deforms slightly (Figure 37). The sleeve protects the unloading valve inside it and the adjacent safety valve as the car body continues to slide along the ground surface.

As expected, this concept (which is more robust than Concept 1) performed well in the nominal derailment scenario. Concept 1, without the additional reinforcement, also survived this scenario. Naturally, the question is whether the additional reinforcement is necessary.

Looking at the stresses at the tank-to-fittings interface reveals the following. Stresses (von Mises) at the lower portion of the flue, near the connection with the tank shell, reach around 92 ksi without the cone reinforcement and only around 53 ksi with the cone reinforcement ( $t=2.02$ ). This is a 42 percent decrease in stress. The cone reinforcement, therefore, would help the structure survive a scenario somewhat more severe than Scenario 2 that could not be survived without the cone. Stresses (von Mises) in the fasteners (securing the protective sleeve) see about an 81 percent increase with the use of the cone. They reach a maximum of about 63 ksi without the cone reinforcement and about 114 ksi with the cone ( $t=2.04$ ). This occurs since the structure is more rigid with the cone reinforcement and sends more load through the fasteners. Even so, the stresses in the fasteners with the use of the cone are still well below their ultimate strength value of 150 ksi.

### **4.3 Summary–Protective Concepts**

Both protective concepts (with and without the cone reinforcement) survive the nominal rollover, and neither of them survives the severe impact. The simpler of the two concepts (a protective sleeve like those used on pressure cars) will improve the probability of survival of top fittings in non-pressure cars under derailment conditions and is easily retrofitable to most designs. Concept 2, which adds additional protection, will further improve the survivability of these fittings; it will still be insufficient in the case of severe derailments. SA recommends that, at a minimum, car builders and owners consider retrofitting designs similar to Concept 1 for non-pressure hazmat cars.

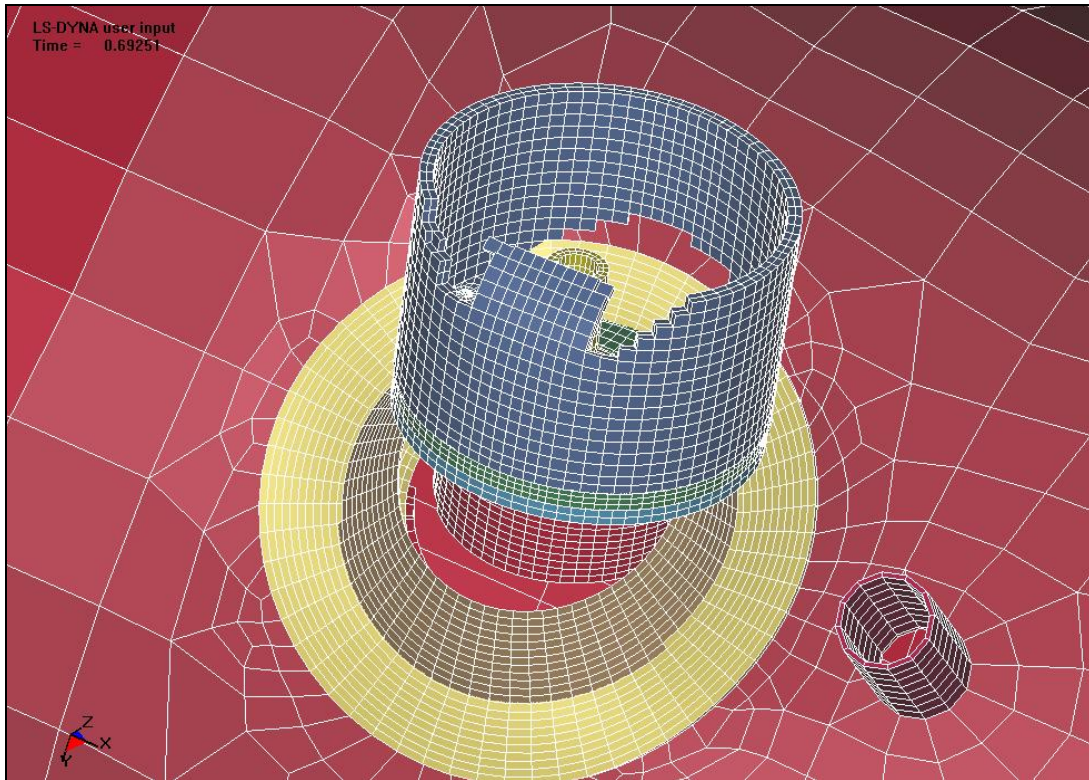

**Figure 32. Failure of Fittings–Concept 2–Scenario 1**

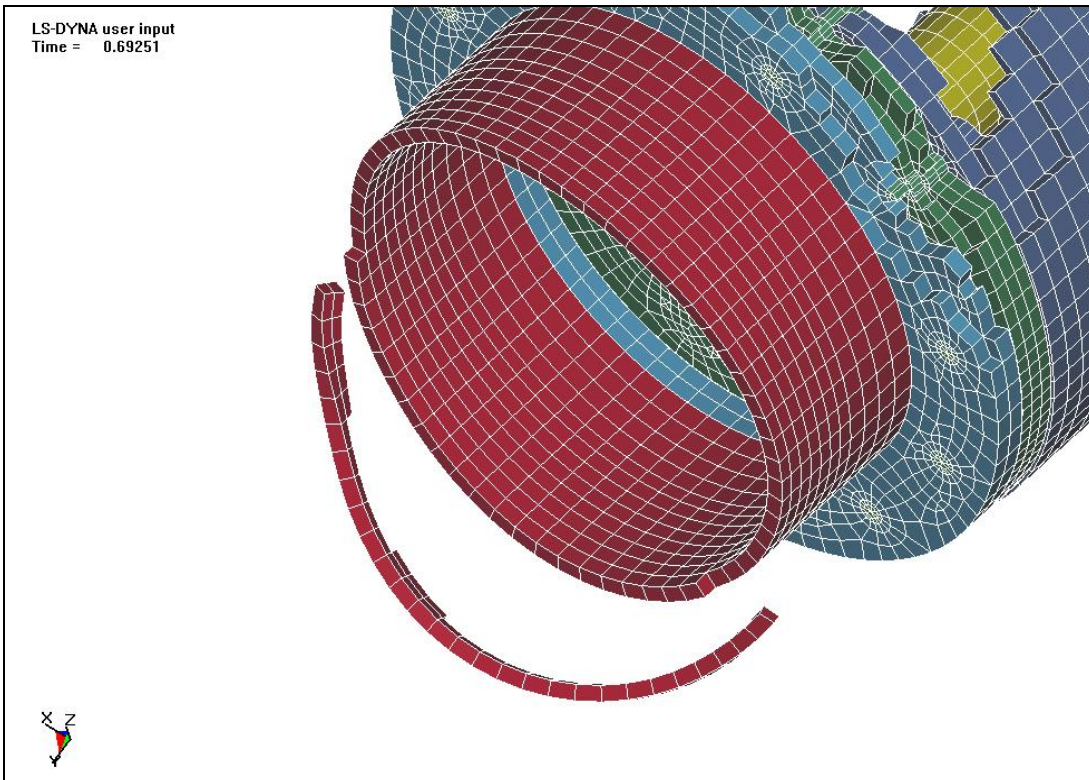

**Figure 33. Failure of Flue at Tank Attachment and Bearing Failure of Flange and Cover  
Concept 2–Scenario 1**

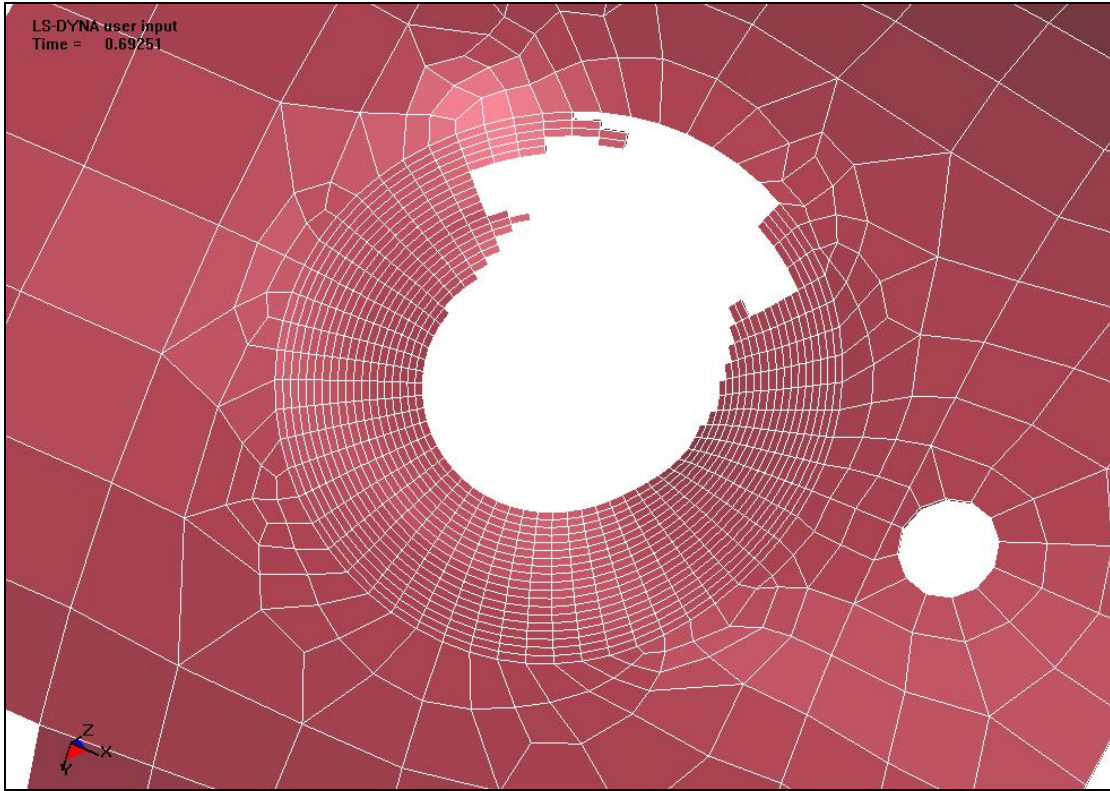

**Figure 34. Failure of Tank Shell at Fittings–Concept 2–Scenario 1**

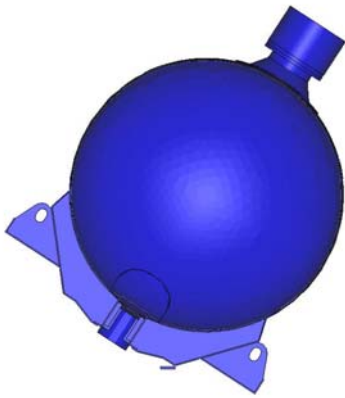

t=0 seconds

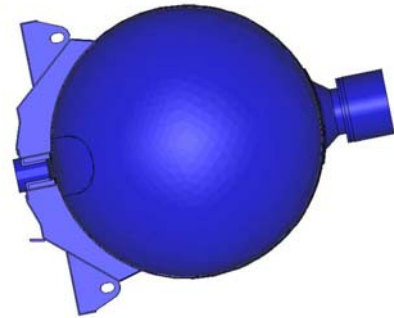

t=1.46 seconds

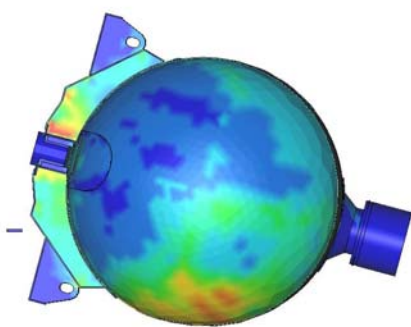

t=1.72 seconds

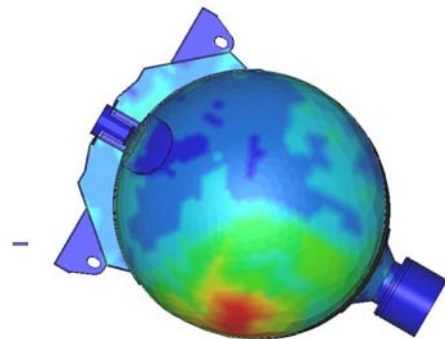

t=1.96 seconds

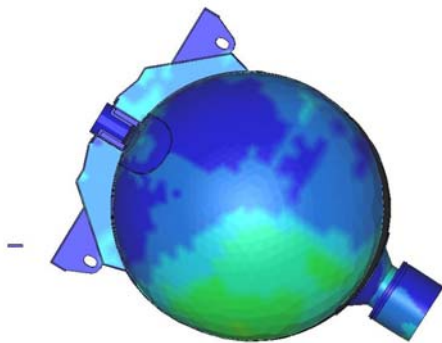

t=1.98 seconds

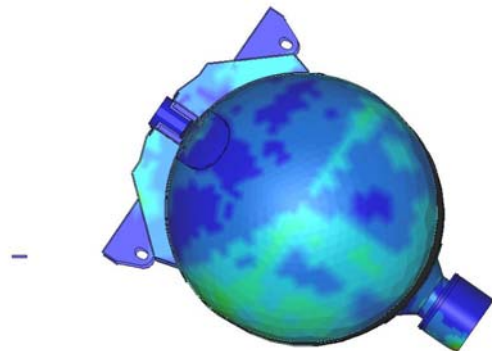

t=2.33 seconds

**Figure 35. Simulation Sequence–Concept 2–Scenario 2**

LS-DYNA KEYWORD DECK BY LS-PRE  
Time = 2.1  
Contours of Effective Stress (v-m)  
min=0, at elem# 80000  
max=82329, at elem# 75914

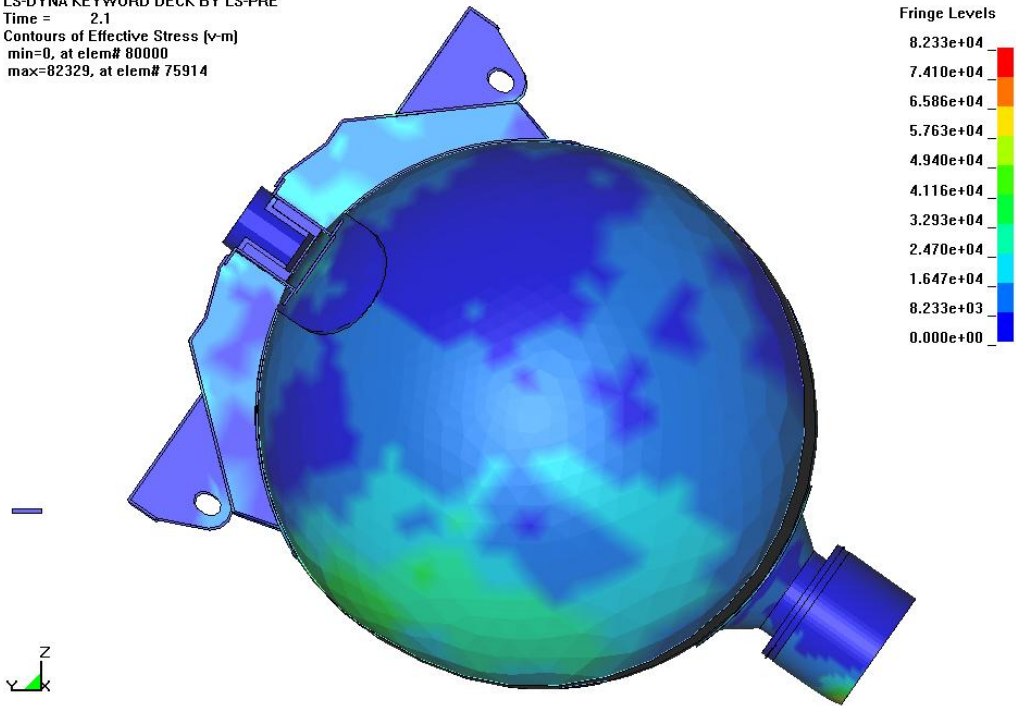

**Figure 36. Impact of Fittings–Concept 2–Scenario 2**

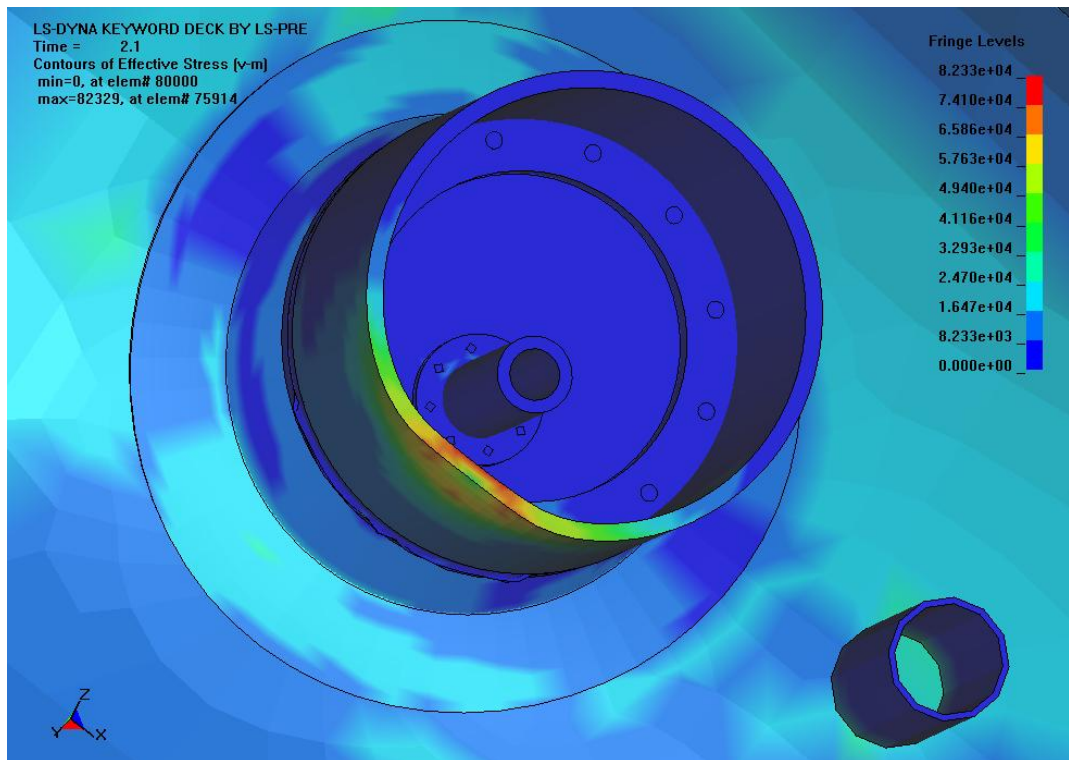

**Figure 37. Deformation of Sleeve–Concept 2–Scenario 2**



## 5. Conclusions

This project studied the survivability of existing design tank car fittings under derailment conditions, as well as mechanisms for improving the structural performance of such fittings under derailment scenarios. The following summarizes the conclusions.

1. Top fittings in non-pressure tank cars are the most likely to result in lading release under accident conditions and are therefore the most critical. The most common hazmat commodities that are transported in these cars are acids (sulfuric and hydrochloric), fuel oil, methanol, and benzene.
2. Existing top fitting designs are unlikely to survive even nominal derailments, such as rollovers. Simulations indicate damage of the fittings themselves in addition to damage of the tank car-to-fittings interface.
3. This report developed two concepts of protective structures that improve the survivability of top fittings. Concept 1 uses a bolt-on sleeve around the crucial fittings. Concept 2 adds reinforcement at the tank to fittings interface to Concept 1.
4. For nominal rollover scenarios, the use of a bolt-on protective sleeve (Concept 1) similar in configuration, material, and attachment to that used in this investigation appears to reduce or eliminate structural damage to the fittings typical on the unloading nozzle. For the particular tank car design used in this analysis, this protective structure also prevented damage to the closely adjacent safety valve. In this scenario, the protective structure would reduce the probability of an accidental release in lading. Concept 2 will further enhance the protection offered in many derailment scenarios.
5. Severe derailments that involve high impact velocities are likely to result in fittings damage (and lading release), even when protective structures are employed. Protection of top fittings with simple add-on structures is probably not practical under such circumstances. These higher velocities could be a result of longitudinal or lateral motion of the tank at impact or a higher rotational velocity of the tank car body at impact. The structural connection of any add-on structure to the tank shell is a major limiting factor in the design of any system of protection.



## 6. Recommendations

The following presents recommendations based from this study:

1. This report recommends that FRA consider developing specifications for improving the survivability of top fittings on non-pressure cars. These specifications for the structural design of top fittings on non-pressure cars could follow the ideas outlined by similar specifications in use for pressure cars. Design forces for such specifications can be evaluated from multiple simulations of various scenarios and fittings configurations.
2. This report also recommends, for further investigation, modeling the systems of protection described in this investigation using the more typical tank car steels in the place of the T-1 steel to verify whether a more cost effective protection is available. In addition, additional concepts/designs for improving the survivability of top fittings on non-pressure cars should be considered for study.



## **Appendix A.**

### **FRA and AAR Document Summary**

#### **AAR M-1002 APPENDIX E9**

This document describes requirements for protection of bottom discontinuities on stub sill equipped pressure tank cars. It includes structural requirements for the protective skid, the skid to tank interface, and material requirements. It also includes design requirements for break-off points in the discontinuities that extend beyond the protective skid and other requirements.

#### **AAR M-1002 APPENDIX E10**

This document describes the requirements for protection of bottom and top discontinuities on stub sill equipped non-pressure tank cars. It includes structural requirements for the protective skid, the skid to tank interface, and material requirements. It also includes design requirements for break-off points in the discontinuities that extend beyond the protective skid and other requirements. Requirements in this specification are somewhat less restricting regarding bottom protection than that of Appendix E9. This specification covers top protection of fittings including design loads (2W vertical and 1W horizontal—in any direction). The protection can be either a pressure car type protective housing or a skid type structure. In either case the device must withstand the design loads without exceeding the allowable stresses. No factor of safety is specified.

#### **49 CFR 179.100-12**

This document outlines the required materials and dimensions of the manway nozzle, cover, and protective housing for pressure tank cars. The protective housing must be cast, forged, or fabricated out of approved material and be bolted to the manway cover with not less than twenty ¾-inch studs. The shearing value of the bolts attaching the protective housing to manway cover must not exceed 70 percent of the shearing value of bolts attaching manway cover to manway nozzle. The protective housing must have steel sidewalls not less than ¾-inch in thickness.

#### **49 CFR 178.337-10**

This specification is for highway motor vehicle tank trailers and describes DOT requirements for collision damage protection. For protective devices of fittings, this specification states that the device and its attachment to the tank must withstand static loading in any direction equal to twice the loaded weight of the tank and attachments. A factor of safety of four based on the tensile strength of the material must be used. Other requirements are included.

#### **49 CFR 178.337-12**

This section specifies that discharge control valves (for highway motor vehicle tank trailers) must be designed with a shear section or breakage groove that would prevent leakage through the valve in the event of a crash or rollover.



## Appendix B. Material Data

**Table B1. Part Materials by Concept–Scenario 1**

ITEM	BASE CASE	CONCEPT 1	CONCEPT 2
Sleeve	N/A	T-1 steel	T-1 steel
Cone & Reinf.	N/A	N/A	TC-128 steel wFS
Fasteners	N/A	Grd 8	Grd 8
Tank (around Flue)	N/A	N/A	TC-128 steel wFS
Tank (Main)	SY=27000	SY=27000	TC-128 steel
Fittings	A516 Gr 70	T-1 steel	T-1 steel

wFS=with Failure Strain

**Table B2. Part Materials by Concept–Scenario 2**

ITEM	BASE CASE	CONCEPT 1	CONCEPT 2
Sleeve	N/A	T-1 steel	T-1 steel
Cone & Reinf.	N/A	N/A	TC-128 steel wFS
Fasteners	Grd 8	Grd 8	Grd 8
Tank (around Flue)	TC-128 steel wFS	TC-128 steel wFS	TC-128 steel wFS
Tank (Main)	TC-128 steel	TC-128 steel	TC-128 steel
Fittings	T-1 steel	T-1 steel	T-1 steel

wFS=with Failure Strain

**Table B3. Material Properties**

<b>MATERIAL</b>	<b>YIELD STRESS (ksi)</b>	<b>TANGENT MODULUS (ksi)</b>	<b>FAILURE STRAIN</b>	<b>ULTIMATE STRESS (ksi)</b>
<b>SY=27000</b>	27,000	389375.0	Not Used	Not Used
<b>A516 Gr 70</b>	38,000	152381.0	0.21	70,000
<b>T-1 steel</b>	100,000	63816.2	0.16	110,000
<b>Grd 8</b>	130,000	166700.0	0.12	150,000
<b>TC-128</b>	50,000	164602.0	0.19	81,000



**Table B4. Material Thickness (in.) by Component–Scenario 1**

<b>COMPONENT</b>	<b>BASE CASE</b>	<b>CONCEPT 1</b>	<b>CONCEPT 2</b>
Tank Sheet	0.4375 (7/16)	0.4375 (7/16)	0.4375 (7/16)
Tank Disc Reinforcement	N/A	N/A	0.4375 (7/16)
Cone Reinforcement	N/A	N/A	0.375 (3/8)
Nozzle Flue	0.625 (5/8)	0.625 (5/8)	0.625 (5/8)
Nozzle Flue Flange	1.25	1.25	1.25
Flue Cover	1.00	1.00	1.50
Cover Fasteners (diameter)	0.75	0.75	1
Protective Sleeve	N/A	1.00	1.00
Protective Sleeve Base	N/A	1.00	1.50
Safety Valve	0.375 (3/8)	0.375 (3/8)	0.375 (3/8)
Unloading Valve	0.7500	0.7500	0.7500
Unloading Valve Base	0.7500	0.7500	0.7500

**Table B5. Material Thickness (in.) by Component-Scenario 2**

<b>COMPONENT</b>	<b>BASE CASE</b>	<b>CONCEPT 1</b>	<b>CONCEPT 2</b>
Tank Sheet	0.4375 (7/16)	0.4375 (7/16)	0.4375 (7/16)
Tank Disc Reinforcement	N/A	N/A	0.4375 (7/16)
Cone Reinforcement	N/A	N/A	0.375 (3/8)
Nozzle Flue	0.625 (5/8)	0.625 (5/8)	0.625 (5/8)
Nozzle Flue Flange	1.25	1.25	1.25
Flue Cover	1.00	1.00	1.50
Cover Fasteners (diameter)	0.75	0.75	1.00
Protective Sleeve	N/A	1.00	1.00
Protective Sleeve Base	N/A	1.00	1.50
Safety Valve	0.375 (3/8)	0.375 (3/8)	0.375 (3/8)
Unloading Valve	0.7500	0.7500	0.7500
Unloading Valve Base	0.7500	0.7500	0.7500

## **Appendix C.**

### **Discussion of Velocities and Forces**

Figures C1 through C3 show the resultant velocities of the impact points on the fittings as functions of time for all the Scenario 1 runs, including the base case and runs of Concepts 1 and 2. In the base case (Figure C1), no protective sleeve existed, so the upper extreme point on the unloading valve was used for reference. The Scenario 1 runs of Concepts 1 and 2 used a point in the upper leading edge of the protective sleeve for reference. It can be seen that, in all three cases, the resultant velocity of the fittings at the moment of impact with the ground is between 250 inches/sec and 260 inches/sec. Points of rapid velocity reduction are clearly apparent at the moment of impact of the fittings with the ground surface. The Z-velocity is also plotted for the base case and Concept 1 for reference in Figures C4 and C5, showing values at initial impact with the ground surface very close to the resultant velocities already discussed.

Figures C6 and C7 plot the resultant (of x, y, z directions) contact forces between the fittings and the rigid ground surface for Concept 1–Scenario 1, and show peak forces reaching 175,000 lbf. Two graphs were necessary due to a restart of the run in LS-Dyna. Figure C8 shows the normal force on the ground surface for the Concept 2–Scenario 1. It can be seen that this force averaged about 300,000 lbf during the time interval of the crushing of the fittings assembly and reached a peak of about 600,000 lbf. The graph clearly shows the instant and force magnitudes of the impact of the jacking pad and tank body. Since the methods of obtaining the forces between Concept 1 and Concept 2 by necessity were different because of changes in the modeling method to facilitate convergence, caution should be used when directly comparing the force values. The higher force values of the Concept 2 run (configuration with added reinforcing components) are expected since the structure has greater rigidity. Force values were not available in the base case.

The Scenario 2 runs represent a less severe impact scenario than those of Scenario 1. This scenario is one of a very slow rollover of the tank car body off of its trucks. Considering the protected cases (Concepts 1 and 2), the resultant and Z-component velocities at impact with the ground surface are about the same for Scenario 1 and Scenario 2 (compare Scenario 2 Figures C9 and C10 with Scenario 1 Figures C1 and C4). In the Scenario 1 case, the entire mass of the tank car body is bearing upon the fittings during the time frame where most of the damage is done to the fittings structure. This is not the case in the Scenario 2 runs where the mass of the tank car body bears on the ground surface at two points during this time, the tank shell and the fittings. The force of impact with the ground surface is about the same at the moment the tank alone strikes the ground for Scenario 1 versus Scenario 2. For the second impact where the fittings impact the ground, the wall force shows higher in the Scenario 2 runs (compare Figures C8 and C11). At first this appears contradictory with the animation and results of structural deformation and failure since the Scenario 1 runs show much greater structural damage. However, in the Scenario 2 runs, the tank and fittings impact the ground at the same time (about  $t=1.95$  sec) at two points as discussed above, producing a greater wall force than that of the fittings alone. To verify that the force on the fittings in the Scenario 2 run was effectively less than that of the Scenario 1 run, a fourth run was made with the ground wall split midway between the point of tank shell impact and the point of impact on the fittings. Figure C12 shows the results with the green curve representing the force on the fittings alone for the Scenario 2 run. It can be seen that the maximum force on the fittings is about 256,000 lbs as compared to 600,000 lbs for Scenario 1 (Figures C8 and C12).

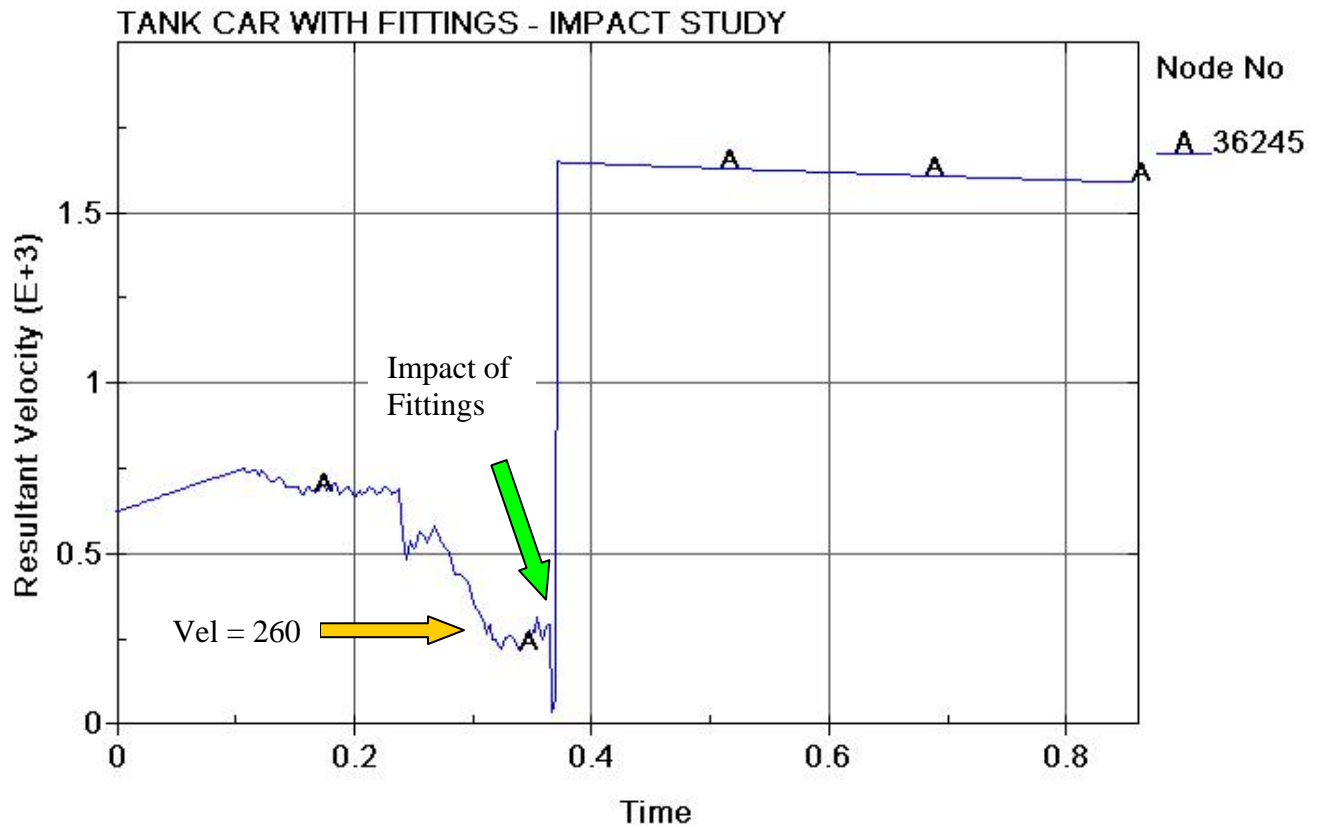

**Figure C1. Resultant Velocity of Unloading Valve–Base Case–Scenario 1**

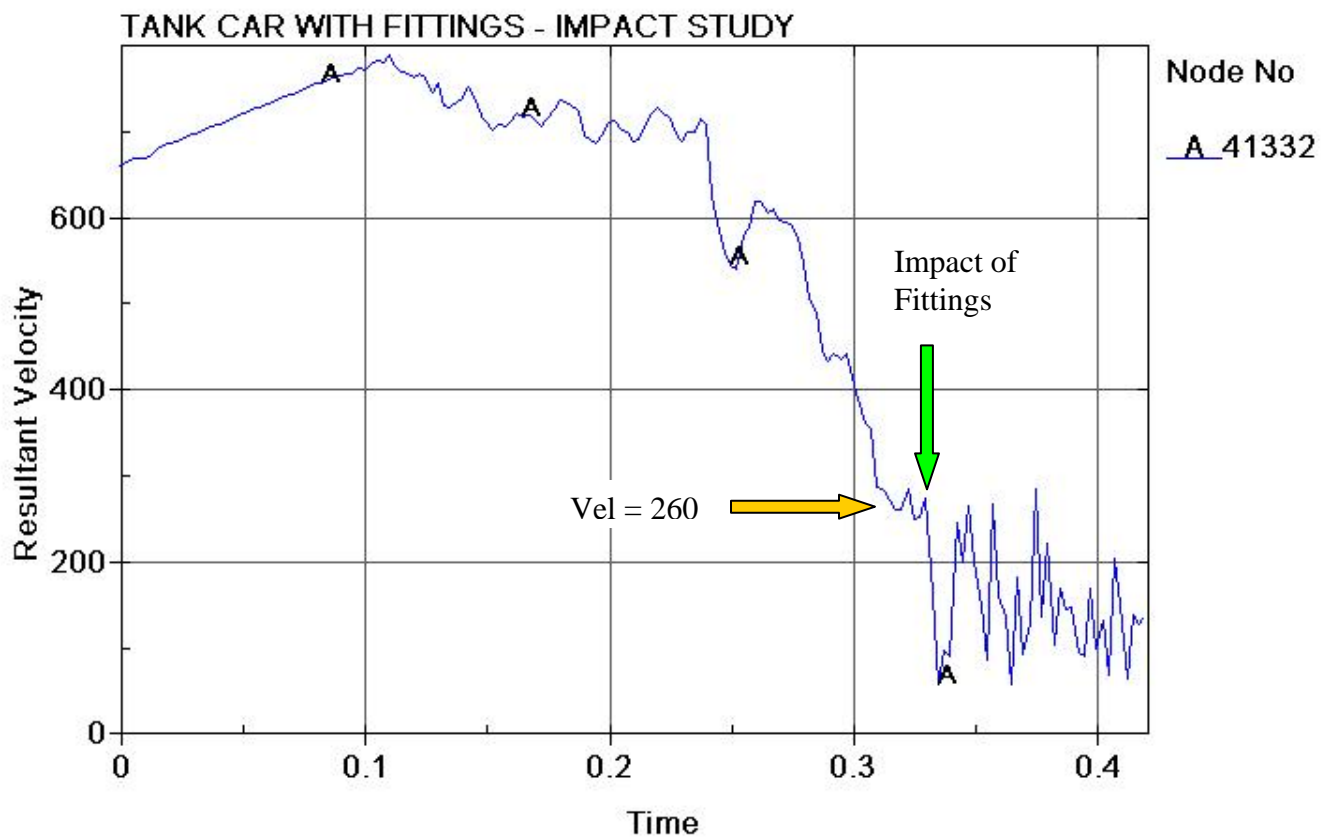

**Figure C2. Resultant Velocity of Sleeve–Concept 1–Scenario 1**

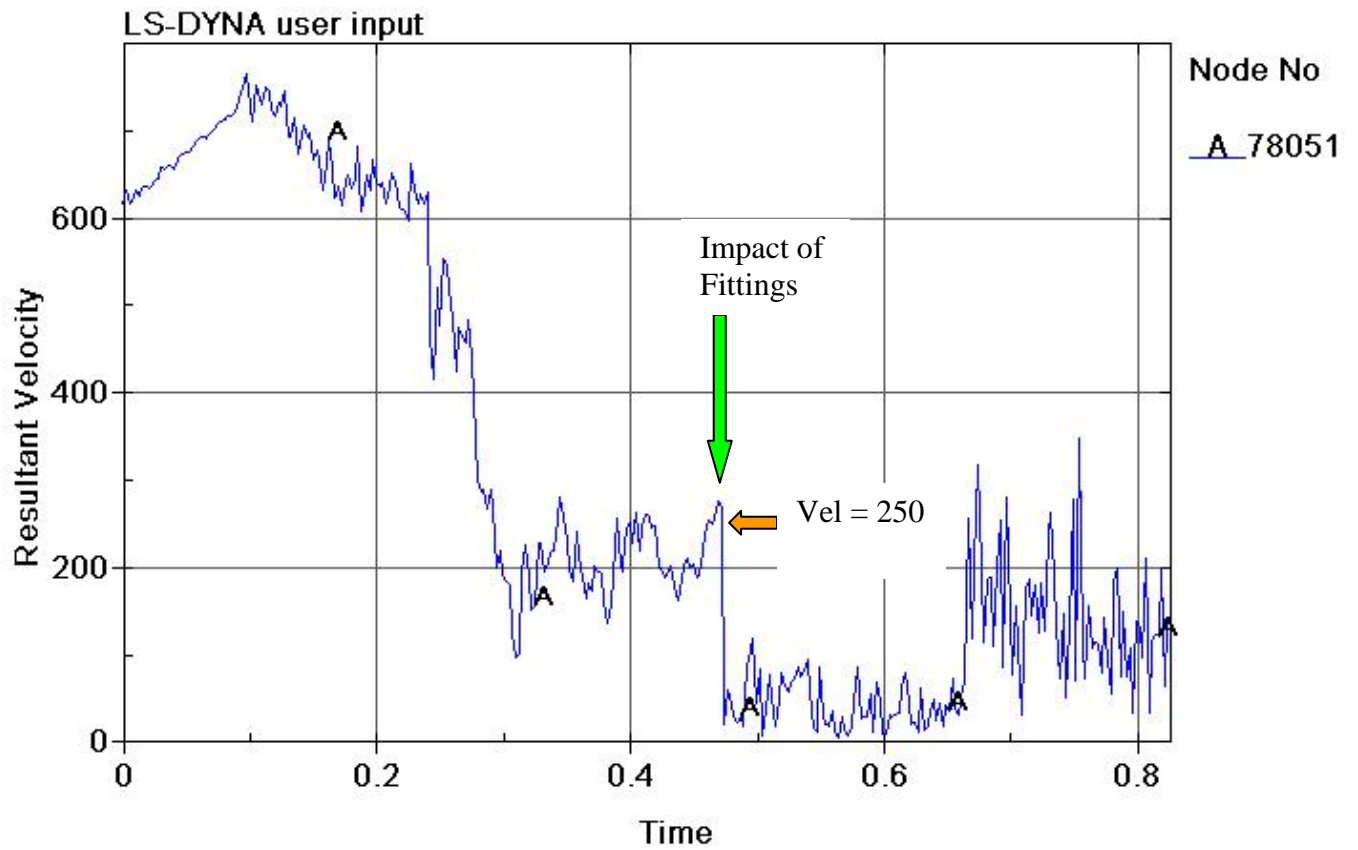

Figure C3. Resultant Velocity of Sleeve-Concept 2-Scenario 1

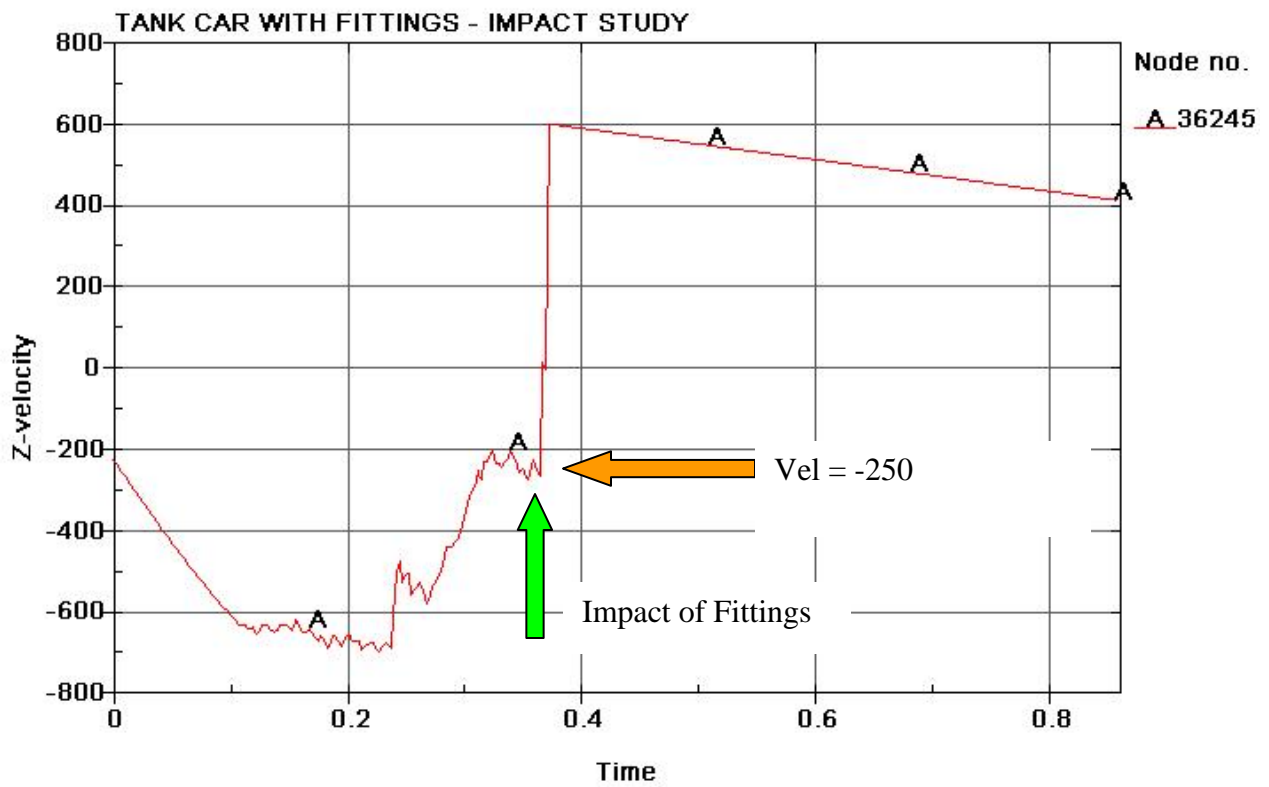

Figure C4. Z-Velocity of Unloading Valve–Base Case–Scenario 1

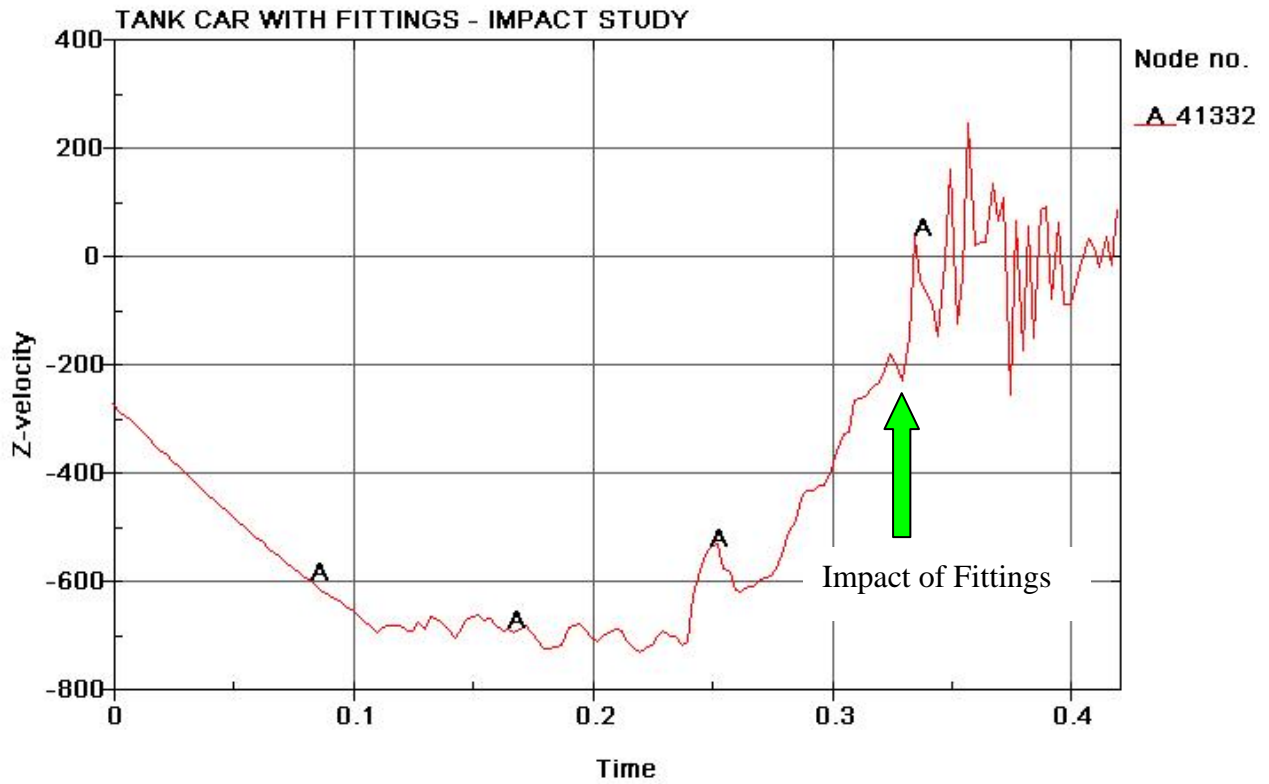

Figure C5. Z-Velocity of Sleeve–Concept 1–Scenario 1

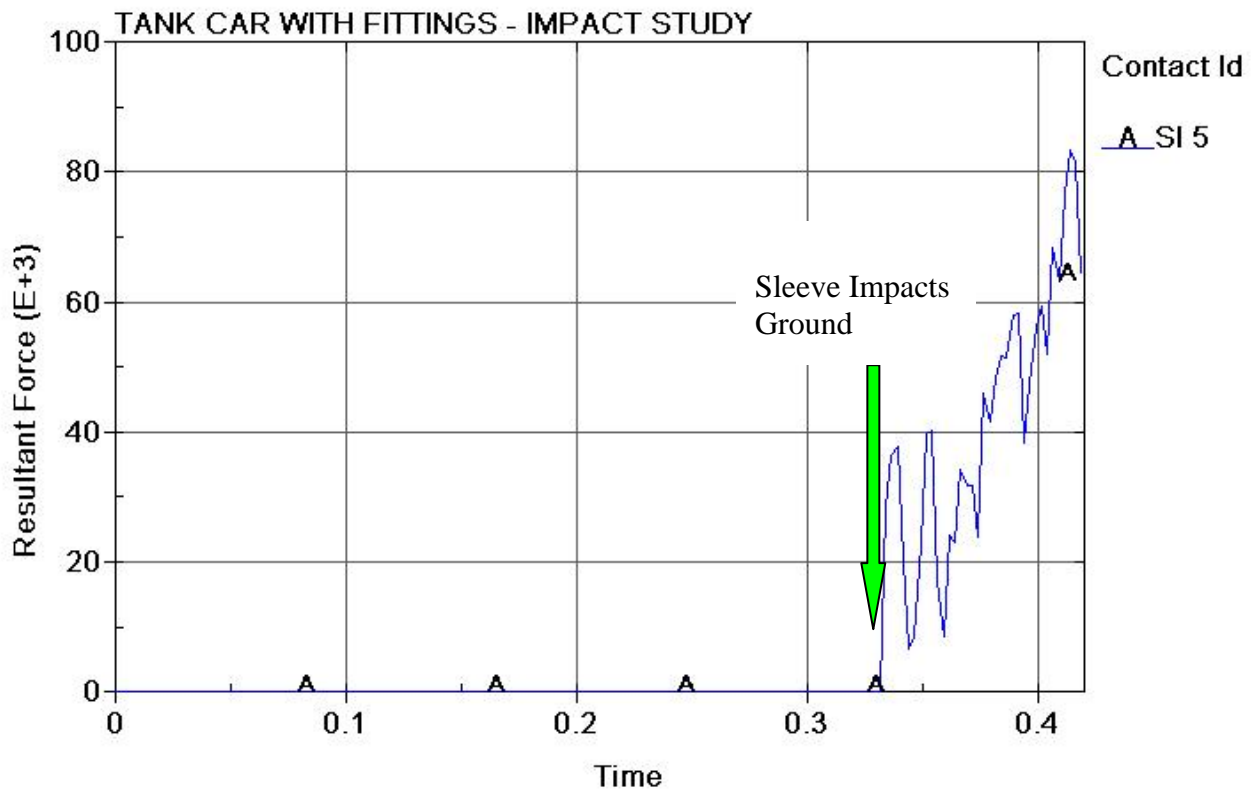

Figure C6. Contact Force-Fittings to Ground-Concept 1-Scenario 1

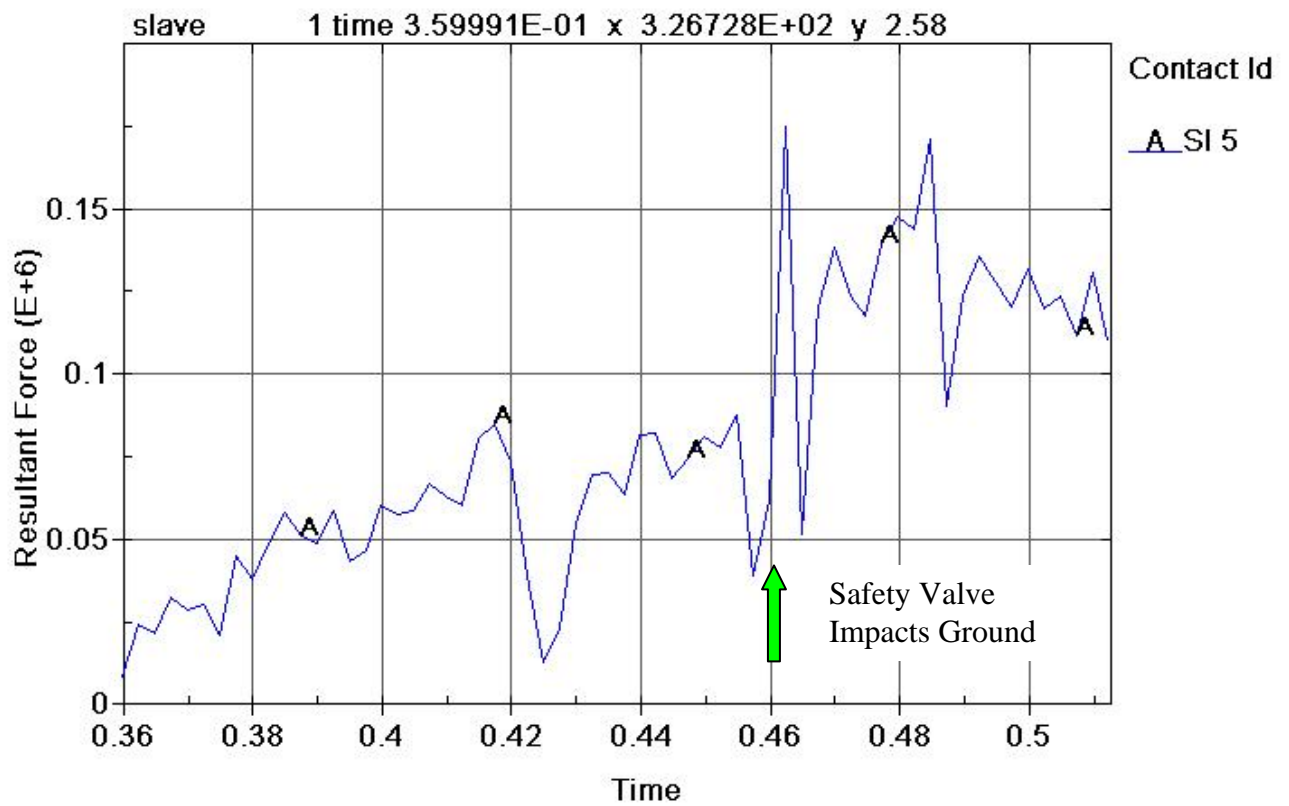
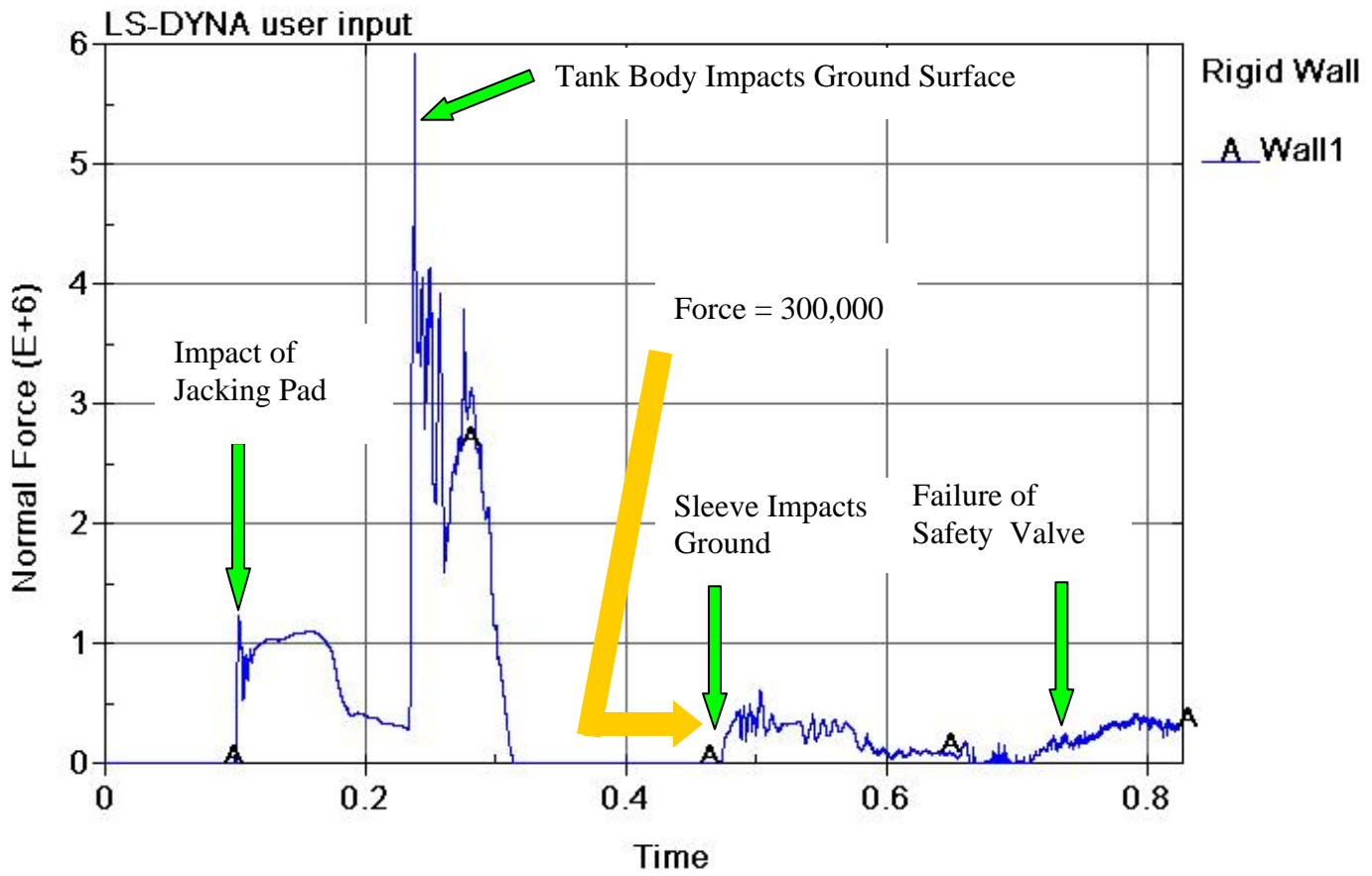

Figure C7. Contact Force-Fittings to Ground-Concept 1-Scenario 1 (Continued)



**Figure C8. Force on Ground Surface–Concept 2–Scenario 1**



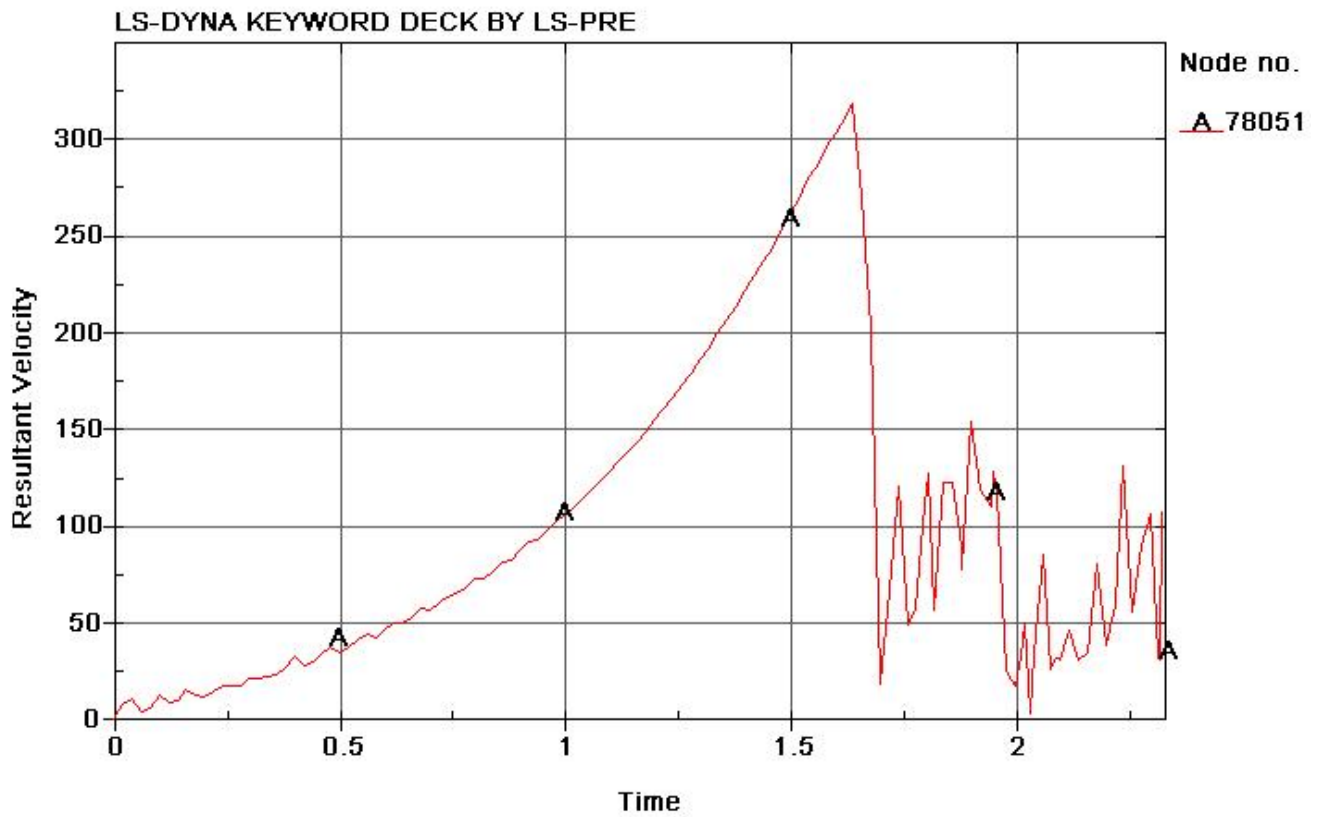

Figure C9. Resultant Velocity of Sleeve-Concept 2-Scenario 2

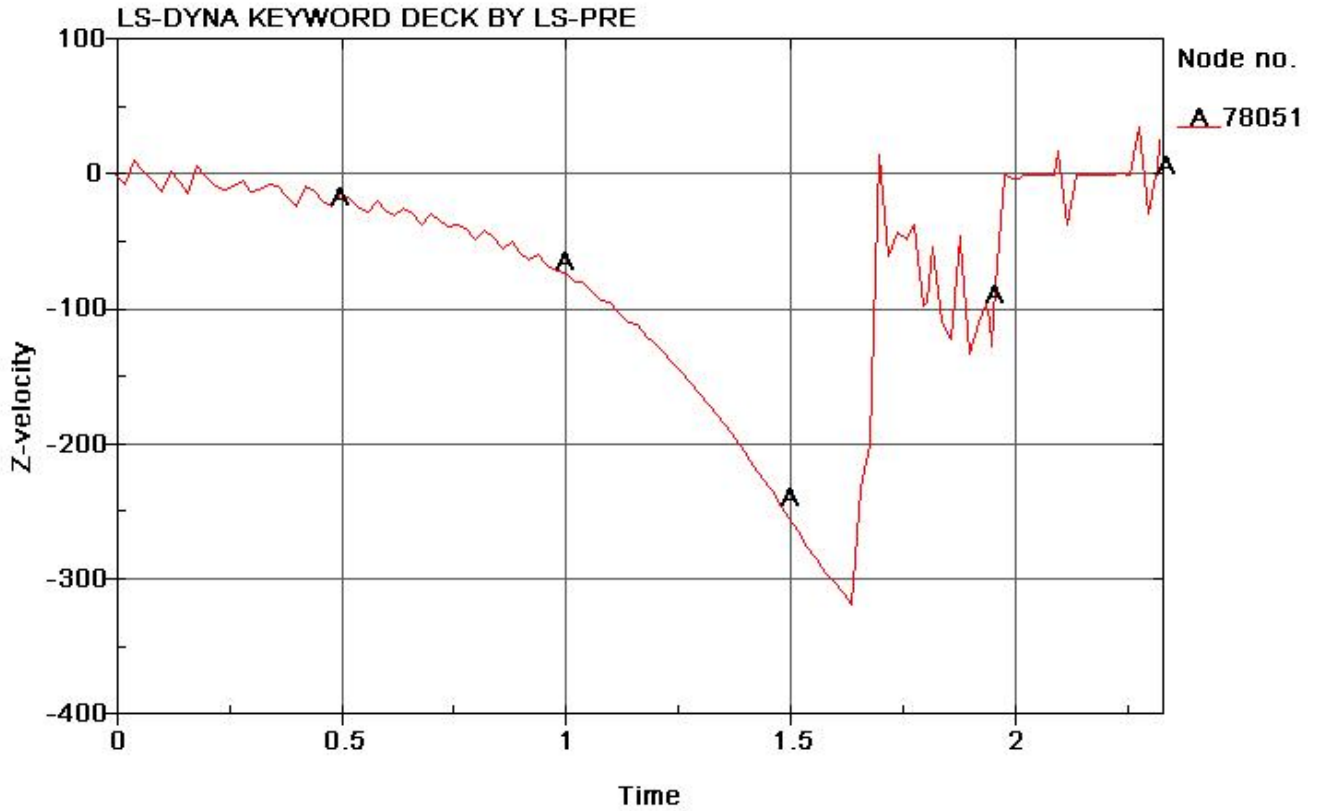

Figure C10. Z-Velocity of Sleeve-Concept 2-Scenario 2

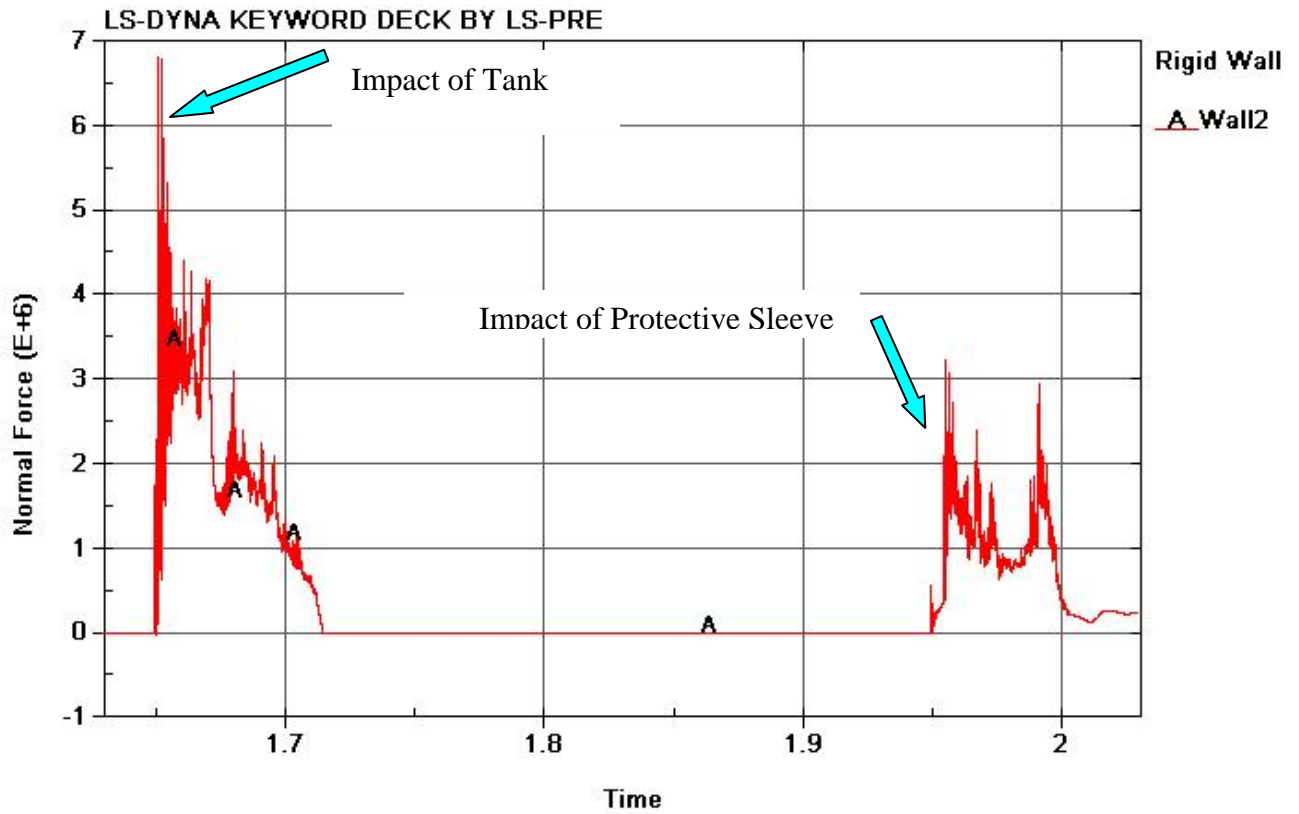

Figure C11. Force on Ground Wall–Concept 2–Scenario 2

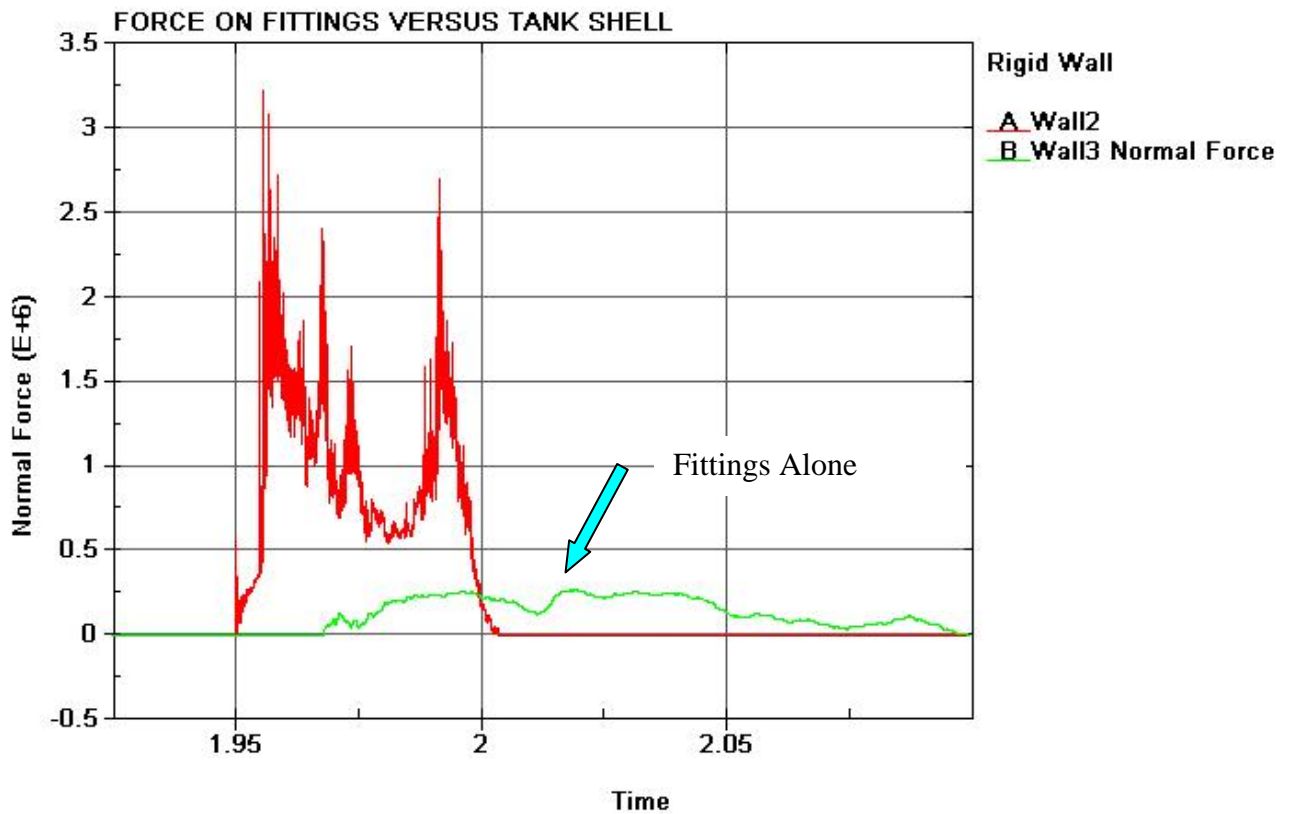

Figure C12. Force on Ground Wall–Concept 2–Scenario 2