

**UNITED STATES DEPARTMENT OF LABOR  
Mine Safety and Health Administration**

**Investigative Report**

**March 1999**

**A Study of the Fire and Explosion Hazards  
Associated with the Electrowinning of Copper  
in Arizona Surface Mine Plants**

By

Derrick M. Tjernlund  
Fire Protection Engineer  
Engineering Support Branch

**-Originating Office-**

**Approval and Certification Center**

Steven J. Luzik, Chief

**Engineering and Testing Division**

David C. Chirdon, Chief

RR #1, Box 251  
Industrial Park Road  
Triadelphia, West Virginia 26059  
(304) 547-0400

<b>PART I. INTRODUCTION</b> .....	<b>1</b>
A. PURPOSE OF STUDY .....	1
B. SCOPE .....	1
C. STUDY METHODOLOGY .....	2
<b>PART II. GENERAL MINE INFORMATION</b> .....	<b>2</b>
A. APPLICABILITY .....	2
B. MINE LIST AND LOCATION MAP .....	3
C. MADSS DATABASE SEARCH RESULTS .....	3
<b>PART III. SXEW PROCESS</b> .....	<b>3</b>
A. OVERVIEW .....	3
1. Description of process .....	3
2. Ore types .....	5
3. Leaching .....	5
B. SX PROCESS .....	6
1. General .....	6
2. Mixing and Separation .....	6
3. Chemical Reactions .....	7
4. multi-stage extraction .....	9
5. multi-stage stripping .....	9
6. wash stage .....	10
C. EW PROCESS .....	10
1. General .....	10
2. Cathodes .....	11
3. Anodes .....	11
4. Tankhouse .....	11
5. Cell operation .....	12
6. Normal electrochemical process .....	12
7. Abnormal electrochemical process .....	13
8. acid misting from electrowinning .....	14
D. RECOVERY OF FUGITIVE ORGANIC SOLUTION .....	17
1. Fugitive organic .....	17
2. Economic benefit .....	17
3. Hazard reduction .....	17
<b>PART IV. FIELD OBSERVATION</b> .....	<b>18</b>
A. FIELD SURVEY PROCEDURES .....	18
B. FIELD SURVEY FORMS .....	18
C. SX .....	18
D. EW .....	20
<b>PART V. HAZARDS ANALYSIS</b> .....	<b>23</b>
A. INTRODUCTION .....	23
B. LABORATORY INVESTIGATION OF HAZARDS OF FUGITIVE ORGANIC .....	23
1. Goal .....	23
2. Methodology .....	24
3. Results .....	25
C. LABORATORY INVESTIGATION OF HAZARDS OF CELL DEPLETION .....	27
1. Goal .....	27
2. Methodology .....	28
3. Results .....	30

<b>PART VI. CONCLUSIONS AND RECOMMENDATIONS</b> .....	<b>32</b>
A. TANKHOUSE HAZARD MITIGATION STRATEGIES.....	32
1. <i>Fugitive Organic Hazards</i> .....	32
2. <i>Cell Depletion Hazards</i> .....	36
B. SOLVENT EXTRACTION HAZARD MITIGATION STRATEGIES.....	39
C. LEACH PAD HAZARD MITIGATION STRATEGIES.....	39
<b>PART VII. ACKNOWLEDGMENTS</b> .....	<b>40</b>
<b>PART VIII. REFERENCES</b> .....	<b>40</b>
<b>PART IX. LIST OF ATTACHMENTS</b> .....	<b>41</b>
A. ATTACHMENT 1: MINES SITES VISIT FOR STUDY.....	41
B. ATTACHMENT 2: MINE SITE LOCATION MAP.....	41
C. ATTACHMENT 3: FIELD SURVEY FORM.....	41
D. ATTACHMENT 4: TABLES.....	41
E. ATTACHMENT 5: FIGURES.....	41

## Part I. Introduction

### A. *Purpose of Study*

This fire/explosion hazard study was initiated by A&CC at the request of The Rocky Mountain District of Metal and Non-Metal Safety and Health (MNMSH) to identify the various hazards at copper mining sites in Arizona.

Specifically, the study focused on those mine sites utilizing electrolytic recovery of copper from leached ores. This electrolytic process is known within the industry as *electrowinning*<sup>1</sup> (EW) and is used at most of Arizona's copper mines. It is conducted with the support of another process known as *solvent extraction*<sup>2</sup> (SX). Both processes are part of a larger scheme often known as *hydrometallurgical* recovery of copper.

Both documented and undocumented fire and explosion incidents historically indicate that the EW process represents a realistic fire and explosion hazard. The conclusions of this study are consistent with these historical experiences. This written report records the study results and presents hazard identification methods and hazard mitigation strategies.

This single report will collectively address all of the mine sites examined in this study. The style and contents of this report are intended to permit its incorporation into any training program presented to mine inspectors as part of on-going continuing education and training.

In particular, Part III provides a primer describing the Solvent Extraction and Electrowinning processes and typical equipment for those readers not familiar with the subject. Part IV provides a description and summary of actual conditions and factors noted in the field during site visits. Part V provides a summary and synopsis of laboratory testing conducted for this study. Part VI summarizes recommendations and mitigation strategies based upon data and information collected from site visits and laboratory analysis.

### B. *Scope*

This study is limited to the fire and explosion hazards of copper-ore electrowinning. However, the electrowinning process does not stand alone and interconnects sequentially with two pre-electrowinning processes identified as *leaching* and solvent extraction. These two processes are therefore examined for their impact on the EW process. Description of these processes are included

---

<sup>1</sup> Words unique to the copper mining industry are shown in Italics the first time they appear in the report.

<sup>2</sup> For brevity, the acronyms "SX", "EW", or "SXEW" will typically be used to refer to the overall process, or specific portions thereof, as necessary.

as part of the report. Any specific fire/explosion hazards involving these two processes identified during this study are included.

This study is being conducted in parallel with a health hazard study by MSHA's Pittsburgh Safety and Health Technology Center (PSHTC) in Bruceton, PA. The PSHTC study is examining the health hazards from worker exposure to SXEW-related chemicals and process conditions.

### **C. Study Methodology**

This study was conducted in four main phases.

Phase 1      **Preliminary Information Gathering.** This phase included a literature search and review for information about the SXEW process.

Phase 2      **Identification of the probable hazards.** This phase involved site visits to make observations, conduct interviews with operations personnel, and collect information and samples of appropriate chemicals.

Phase 3      **Evaluation of the hazards.** In this phase, various laboratory analyses were performed and working scale models of the EW process were constructed and operated in an attempt to recreate conditions capable of yielding a fire and/or explosion.

Phase 4      **Hazard Mitigation strategies.** In this phase, the results of the first three phases were evaluated. Guidelines were then developed for recognizing potential hazards in the field, along with strategies for both preventing and mitigating those hazards. Prevention strategies include proactive efforts, while mitigation strategies include reactive efforts (dealing with a hazardous condition when it occurs). As with any other fire or explosion hazard, a priority should always be given to prevention.

## **Part II. General Mine information**

### **A. Applicability**

The MSHA field office in Mesa, Arizona provided the list of mines visited for this study. The list included 11 mine sites currently utilizing SXEW for copper recovery. Seven of the eleven mine sites had one or more union affiliations. These mines were visited during three separate trips to Arizona. During these visits, observations were limited to examining the solvent extraction processes, the electrowinning processes, and in several cases, the associated ore leaching facilities.

## **B. Mine List and location Map**

[Attachment-1](#) lists basic information on all of the sites visited in tabular form. This list includes the MSHA Mine ID number, the mining company name, the associated mine name, the approximate location, and the number of SX and EW plants at each site. Some of these sites visited had more than one SX or EW facility. Column-8 indicates whether or not active ore mining was in progress at the time of the visit. Column-9 provides the chronological order of the site visits. The first digit indicates the trip number and the second digit the order of visitation during the trip.

The last column is a map locator number associated with [Attachment-2](#). This map provides the general location of each mine site.

## **C. MADSS<sup>3</sup> Database Search Results**

The MADSS database, current through the end of 1997, was searched for all copper ore mines in Arizona for accidents related to the electrowinning process. Five separate incident entries were identified as having occurred at three separate mine sites. These included two incidents in 1987 and one each in 1989, 1993, and 1995.

In addition, interviews with various mine personnel during the site visits suggest that at least three other incidents occurred that were not identified in MADSS.

# **Part III. SXEW Process**

## **A. Overview**

In order to identify and evaluate the hazards associated with the SXEW process, it is necessary to establish a basic understanding of what takes place at a typical SXEW operation.

### **1. Description of process**

The overall SXEW process is shown in [Figure-1](#). This process consists of three major phases: leaching, solvent extraction, and electrowinning. The solvent extraction phase, in turn, consists of two sub-phases: extraction and stripping. For this report, the complete process will be described as four principle steps: *leaching*, *extraction*, *stripping*, and *electrowinning*, keeping in mind that extraction and stripping collectively make up the SX phase.

Figure-1 further indicates that each of the above four steps is successively linked together by three continuously flowing, closed-loop fluid paths: the *leach solution* loop, the *organic solution* loop, and the *electrolyte solution*

---

<sup>3</sup> Mine Accident Decision Support System

loop. The organic loop is an oil-based solution(non water-soluble), while the two remaining solution loops are aqueous (water based).

In both the extraction and stripping stages, one of the water-based solutions is first vigorously mixed with the organic solution and then allowed to separate. Mixing is represented in Figure-1 by a circle containing a “+” sign. Separation is represented by a square box with diverging arrows. These same symbols are also used in subsequent figures as necessary. Mixing and separation are always used together.

Throughout the SXEW process, copper is present in one of three forms: 1) as chemical copper {*i.e.* chemically bonded to other molecular species}, 2) as ionic copper {ions in solution}, or 3) as elemental copper {nearly pure solid copper}. In each of the four basic steps, copper makes a transition from one of these forms to another as follows:

In the leaching step, copper is dissolved from its ore using a weak sulfuric acid solution (transfer from chemical copper to ionic copper). To accomplish this, the ore is often spread in layers on a *leach pad* or in a *dump*. In other cases, it is fractured in place (*in-situ*) using explosives. The ore is soaked with large quantities of the acid solution and/or water. This copper-containing solution is collected for further processing as it exits the ore.

In the extraction step, a special organic chemical with a high attraction for ionic copper extracts the ions from the leach solution by chemically bonding to the ions (transfer from ionic copper back to chemical copper). Nearly all other compounds, including incoming impurities, remain behind in the leaching liquid, rather than being picked up by the organic solution. This chemical form of filtering is important to the economic attractiveness of the process.

In the stripping step, an aqueous solution with a high concentration of sulfuric acid is used to strip the copper from the organic back into solution (transfer from chemical copper back to ionic copper). This is the reverse of the extraction step. Both the extraction and stripping step occur at the SX Plant.

In the final step, electrowinning, low DC voltage and high current are used to plate out the ionic copper from the highly acidic aqueous solution onto cathodes immersed within the solution (transfer from ionic copper to elemental copper). The electrowinning process occurs in a separate building from the SX Plant commonly referred to as a *tankhouse*.

## 2. Ore types

Not all copper ores are readily leachable, and therefore electrowinning is not used to recover all mined copper. Table-1 lists the copper ores typically recovered in mining. These are classified as two broad categories: primary ores and secondary ores.

In the leaching process, copper-bearing ore is soaked with an acid solution to chemically dissolve the bonded copper from the various other ore compounds. It is the secondary ores that lend themselves more readily to leaching because the bonds are more readily attacked and broken by the acidic leach solutions. The primary ores tend to take much longer to leach, often measured in years rather than weeks or months. However, there is a growing interest in long term leaching as a viable alternative to traditional, thermally inefficient methods such as smelting.

## 3. Leaching

There are a variety of leaching methods available to the mining industry. Of these methods, U.S. copper mines, including those visited for this study, use either heap leaching, dump leaching, or in-situ leach almost exclusively. Of these, heap leaching seems to be the method of choice. Nevertheless, use of dump and in-situ leaching is growing.

In heap leaching (see [Figure-2](#)), mined ore is typically broken and then layered in lifts of about 10 to 30 feet deep. The first layer is placed on top of an impermeable membrane laid on a gradual slope. This membrane catches the solution as it percolates down through the pad and directs it to an open channel. This runoff containing the leached ionic copper is known as *pregnant leach solution*, or PLS, and is sent to the SX plant.

The leaching solution discharged over the top of the leach pad is delivered by either a sprinkling system or by perforated pipes laid on the pad surface. The leaching solution may initially be a strong concentration of sulfuric acid delivered for a number of days, followed by longer delivery periods of the weak acid solution returning from the SX operation. Plain water is also typically used.

The aqueous solution returning from SX plant back to the leach pads is sometimes known as barren leach solution, or more commonly, as *raffinate*. Special starter leach solutions called *lixivants*, containing iron sulfate or certain bacteria, are also sometimes used to encourage initiation of the leaching reactions.

The specific make up of starter solutions, raffinate, and delivery cycles varies from mine to mine and depends upon the type and grade of ore, and the make up of interstitial rock and materials.



Dump leaching is similar to heap leaching, except that natural local terrain (hills and valleys) are filled in with the broken ore. This terrain confines the ore and collects the PLS as it exits the ore pile.

In-situ leaching involves the fracturing of an underground ore body in-place, and then leaching the fractured ore without moving it. The PLS is then pumped from underground collection points to the SX processing plant.

## **B. SX Process**

### **1. General**

The details of solvent extraction involve using special oil-based chemicals to extract copper ions from one aqueous solution and then yield the same copper ions over to a second aqueous solution, leaving behind impurities in the process.

The SX process is primarily conducted in a series of outdoor mixing vats and open or enclosed horizontal rectangular tanks. The process also includes piping, valves, pumps, chemical additive systems, instrumentation systems, and other support facilities including a control room and process laboratory.

The location of each SX facility in relationship to adjacent processes varies from site to site. The location is typically based upon the most strategic location contingent upon field conditions including location and number of tankhouses supplied by the SX plant, the size and location of the leach sites, and other physical or economic factors. In some cases, the SX plant is located close to the leach process; in others, it is next to the tankhouse; and in still others, it is somewhere in between, often separated from both leach pads and the tankhouse by one or more miles.

### **2. Mixing and Separation**

In the extraction step at the SX plant, the PLS is vigorously mixed with an organic liquid having a strong attraction for ionic copper. The ionic copper is supplied by the PLS in the form of  $\text{Cu}^{2+}$  ions in solution. The mixing occurs in one or more large cylindrical vats, where a vertical-shaft electric motor above the vat rotates disc-mounted impeller vanes near the bottom of the vat. A series of mixing vats, with three vats per settling tank, are shown in [Figure-3](#).

During mixing, the organic molecules chemically bond to the copper ions, extracting them from the pregnant leach solution. The clean organic, initially light brown in color, turns almost black in the process. This reaction takes

place primarily during mixing. The organic liquid is now rich with copper and is said to be *loaded*.

From the mixer, the water/oil mixture discharges into a large, rectangular settling tank where slow, horizontal travel allows laminar flow to occur. This laminar flow permits the organic (oil) and water components (raffinate) to separate because of nonsolubility, with the organic floating to the top because of its lower specific gravity (~0.9).

[Figures-4A](#) shows a conceptual cross section of a typical settling tank used for separation; [Figure-4B](#) is a view of its real life counterpart at the far end of the settler tank, where the flow encounters the under/overflow baffle system. The height of these baffles is often manually adjustable to compensate for varying flow conditions. The organic solution overflows into a trough, which directs it out of the tank.

The aqueous raffinate, now depleted of much of its copper ions, remains heavier than the organic. It underflows the baffle and then up and over into a second trough, redirecting it back to the leaching process.

In the stripping step of the SX plant, a similar process occurs. However, in this step, the incoming fluids to the mixer are the loaded organic containing chemically bonded copper, and a highly acidic aqueous electrolyte solution returning from the tankhouse. This returning electrolytic has a high concentration of both sulfuric acid and residual copper sulfate (ionic copper). The high acid concentration is necessary if stripping is to occur effectively.

### 3. Chemical Reactions

Since solvent extraction is a chemical process, it is beneficial to review, in simple terms, the chemical reactions taking place.

#### a) *Extraction Stage*

The extractant chemical is the key to this process. This family of chemicals is an example of “designer” molecules and fall into the general class known as hydroxyphenyl oximes<sup>4</sup>, with two subclasses: salicylaldoximes and ketoximes[1]<sup>5</sup>.

In essences, these molecules are based upon benzene ring-type structures attached to a saturated hydrocarbon chain. This ring complex has a strategically located hydrogen atom easily removed as an  $H^+$  ion, shown in bold in [Figure-5](#).

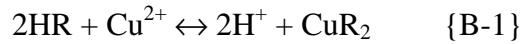
---

<sup>4</sup> Oximes are commonly derived from aldehydes [7]. They can be recognized by an OH group bonded to a nitrogen atom, which in turn, is double bonded to a carbon atom, as shown in figure 5.

<sup>5</sup> A number in square brackets identifies a particular reference source listed in Part VIII.

Upon losing their respective  $H^+$  ions, it is likely that two extraction molecules act together as ligands to capture one  $Cu^{2+}$  ion using four coordination bonds as shown in Figure-5. [1]

Using R to represent all atoms in the extraction molecule except the strategic hydrogen (represented by H), we can write a basic chemical equation for the process as follows:



Where:

- HR = the clean (unloaded) organic extractant molecule including the easily removable hydrogen.
- $Cu^{2+}$  = copper ion in solution.
- $H^+$  = hydrogen ion in solution. The concentration of these are measured by the solution's *pH* value.
- $CuR_2$  = loaded organic molecule pair with captured copper atom.

Note that this simplified version of the overall reaction does not include, among other things, spectator ions. Spectator ions would include the sulfate radical,  $SO_4^{2-}$ . Also note the very important characteristic that this reaction is reversible. *LeChatelier's principle* states that a reversible reaction will go in the direction that establishes equilibrium, *i.e.*, with all other things equal, the reaction will proceed in the direction that reduces any excess concentration of reactants or products[2].

Entering the extraction step, the concentration of reactants (left side of equation B-1) is higher than the products (right side). Coming into the mixing chamber, the PLS is relatively high in ionic copper and low in sulfuric acid, represented by few surplus  $H^+$  ions. Thus, the chemical reaction tends to proceed to the right, where the extractant becomes loaded with chemically bonded copper, and the raffinate gains  $H^+$  ions, thus becoming more acidic.

**b) *Stripping stage***

Chemical reaction B-1 also applies to stripping. However, in this process, the loaded organic,  $CuR_2$ , is mixed with highly acidic electrolyte returning from electrowinning. High acidity means a high excess of  $H^+$  ions. Hence, the products on the right side of equation B-1 are now greater than the reactants on the left side.

The reaction proceeds in the reverse direction (to the left) in an effort to re-establish equilibrium (again, *LeChatelier's principle*). The organic releases  $Cu^{2+}$  ions into the electrolyte in favor of recapturing  $H^+$  ions. The net result: the organic is stripped of its chemical copper (unloaded) while the acidity of

the electrolyte decreases. The electrolyte leaving the SX plant for the tankhouse is labeled as *rich*.

**c) *Extractant chemicals***

Table-2 lists the various manufacturers of extractant chemicals identified during this study. The table also lists examples of the products by trade name. The specific choice of extractant at each mine is based upon a variety of factors including the strength of the PLS, the rate of PLS flow available, the desired minimum acceptable extraction efficiency, and cost.

**d) *Diluents***

The organic solution, as used, is not pure extractant chemical. The extractant is diluted with a nonpolar liquid essentially consisting of refined kerosene. This dilution increases the surface exposure of the extractant to the aqueous solutions by balancing the flow rates of the two solutions entering the mixer. Mixing ratios of extractant to diluent vary depending upon a number of factors including the strength of the extractant, the type of diluent, the strength of the PLS, flow rate balance, and the number of stages of extraction or stripping. The diluent chemicals and their manufacturers are also listed in [Table-2](#), along with some typical volumetric mixing ratios identified during site visits.

**4. Multi-stage extraction**

In practice, a single stage of mixing and separation proves to be inefficient. To resolve this problem, virtually all SX plants observed were set up to conduct multi-stage extraction. A typical flow diagram for a two-stage extraction process can be seen in [Figure-6](#). Note that the flow of PLS and organic are in opposite directions through the system. The strongest extractant (most unloaded) mixes with the weakest PLS and vice versa. This scheme maximizes the chemical driving force needed to sustain reaction B-1.

[Figure-7](#) represents a three-stage extraction process. Note that it follows the same basic opposing-flow scheme as the two-stage process. In practice, three-stage extraction is at least as common, or even more common, than two-stage extraction.

**5. Multi-stage stripping**

As with extraction, the stripping process can be conducted in multiple stages, as shown by the two-stage version in [Figure-8](#). Again, the flow of the two fluids are in oppose directions so that the strongest organic (in this case the most loaded) mixes with the weakest electrolyte in terms of ionic copper, but the strongest in acidity. Based upon field observations, the use of multi-stage stripping is far less common than multi-stage extraction, although several cases of two or three stage stripping were found.

## 6. Wash stage

At several facilities, a wash stage is applied to the loaded organic prior to stripping. In this stage, clean water is used to wash sediment and other trace contaminants from the loaded organic. This process is depicted in [Figure-9](#).

## C. EW Process

### 1. General

In terms of fire or explosion hazards, the electrowinning process has generated the most concern based upon historic experience. As will be discussed, this process has several characteristics that, under abnormal conditions, can create a flammable or explosive atmosphere.

Electrowinning utilizes a DC voltage and current to drive ionic copper onto cathode plates connected to the negative side of the voltage source. The process is conducted in banks of long, horizontal, rectangular tanks open at the top and placed side-by-side. Each tank is referred to as a *cell*. Cells vary in length from about 8 feet to over 25 feet. Cell widths are typically about 4 feet. The number of cells in a bank can vary from less than 20 to more than 120. Two side-by-side banks of cells usually make up one operating train, as shown in [Figure-10](#).

Each cell is equipped with two copper bus bars running the length of the cell, one on top of each of the barriers between cells. One copper bus is at a negative potential with respect to the opposite bus.

Each cell is filled with anode and cathode plates. This is accomplished by attaching each plate to a copper crossbar, or *hangerbar*, as an assembly and then laying the assembly across the cell bus bars. The plate assemblies alternate between anode and cathode until the cell is full from front to back. There is always one more anode than cathode so that each cathode has an anode on both sides. Anode/cathode pairs can vary from less than 20 to more than 60 per cell. (See [Figure-11](#))

Each anode-plate hangerbar is in contact with the positive cell bus and insulated from the negative bus. Alternately, each cathode-plate hangerbar is in contact with the negative cell bus and insulated from the positive bus. Since the cells are electrically connected in series, the negative cell bus for one cell acts as the positive cell bus for the next cell, and so on.

The rich electrolytic solution, laden with ionic copper, moves through the cells lengthwise in a slow, continuous manner. The solution is pumped into each cell through a valved supply pipe usually entering the cell from the outboard end. Each cell supply pipe receives flow from a supply header. At the inboard end of the cell, the solution enters an overflow drain that leads into a drain

header and eventually back to the SX plant. (See [Figure-12](#)) The overflows may or may not be covered; however, where covers are provided, they are lightweight and easily removed for visual inspection to verify cell flow.

## **2. Cathodes**

One of two types of cathode plates are used. If the cathode plate is to be part of the final product, then the plate itself is made of copper and usually referred to as a *starter* plate.

In some cases, stainless steel or titanium cathodes are used. These are usually referred to as *blanks*. The copper ions plate onto these blanks as elemental copper, but are not chemically bonded to the steel or titanium. After the blanks are removed from the cell, the plated copper is peeled off of the steel as a sheet ( one sheet from each side of the blank). The peeling operation is done either by hand using a hammer and chisel, or by a machine with a chisel on a hydraulic piston. The peeled copper sheets are either sold as a final product, or used as starter sheets and attached to hangerbars for final electrowinning. They are also sometimes sold to other SXEW operators as starter plates.

Although EW times vary, in general, it takes 7 to 9 days of continuous plating to yield sufficient copper on the cathode to consider it marketable. The finished cathodes are typically removed from a cell in groups using an overhead traveling crane equipped with a special spreader bar. The hooks on the spreader bar interlock with openings on the top of each cathode.

Not all plates within a cell can be removed at one time, as this would disrupt current flow throughout the entire cell bank. Typically, 1/4 to 1/3 of the cell's cathodes are removed in each lift. (See [Figure-13](#)) The finished plates are rinsed and then prepared for further processing. New cathodes are inserted into the cell in place of the removed plates before removing the next group of cathodes within the cell. As a general rule, only the cathodes are removed from the cells during production.

## **3. Anodes**

Anodes are made from an alloy of lead, tin, and calcium, with lead being the principle component. The tin and calcium improve the strength of the plate and discourage scavenging of lead into the electrolyte, which would contaminate the plated copper. Anodes are often provided with insulating straps or spacers to reduce the likelihood of anode-to-cathode shorting. Straps may be removable (See [Figure-14](#)), or permanent (See [Figure-15](#)).

## **4. Tankhouse**

As previously stated, the electrowinning cells are enclosed within a building commonly referred to as a tankhouse. Support equipment typically includes

offices, control room, laboratory, electrical switchgear and rectifier room, and electrical substation.

Tankhouses are constructed of unprotected steel frames with metal panel sides and roof. Where they are naturally ventilated, it is often accomplished by removing lower wall panels along one or both sides of the building, as shown in [Figure-16](#). Floors are usually of concrete and provided with corrosion resistant coatings or membranes. Each cell is usually made of a concrete shell with a corrosion-resistant membrane or a polymeric insert.

The tankhouses are invariably found at lower elevations than their associated SX plants, unless those plants are adjacent to the tankhouse.

## 5. Cell operation

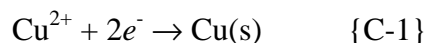
A simplified cross section of an electrowinning cell is shown in [Figure-17](#) and [Figure-18](#). The polarity of the power source is set by the process. Average cell voltages typically varied between 2.0 and 2.2 volts per cell.

Rich electrolyte continuously enters the cell and migrates through it. For any given volume of electrolyte passing through the cell, only a small fraction of the ionic copper is recovered as plated, elemental copper on the cathode plates. Recovery rates can vary from as little as a few grams of copper per liter of solution, to over ten grams per liter. The electrolyte leaving the cell for return to the SX plant is referred to as *lean* because of its lowered ionic copper concentration.

## 6. Normal electrochemical process

Under normal conditions, two separate electrochemical reactions are simultaneously occurring, one each at the anode and the cathode. A reduction half-reaction occurs at the cathode. An oxidation half-reaction occurs at the anode.

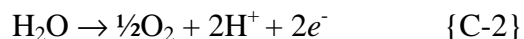
At the cathode, power supply electrons create a negative charge, attracting  $\text{Cu}^{2+}$  ions. As these ions contact the plate, they gain the two electrons needed to make them neutral atoms, thus reducing them to elemental copper. In this form, the copper atoms metallically bond to adjacent copper atoms, thereby building up essentially pure copper on the plate. The reduction half-reaction is:



This reaction requires the application of 0.34 volts across the cell (at standard conditions of 25°C, one atmosphere, and a 1-Molar ion concentration).[3]

While reduction is taking place at the cathode (supplying electrons), oxidation is taking place at the anode (removing electrons). Only three species in the electrolyte are candidates for undergoing oxidation: hydroxyl ions (OH<sup>-</sup>), sulfate ions (SO<sub>4</sub><sup>2-</sup>), and water (H<sub>2</sub>O).

Because the solution is highly acidic (excess H<sup>+</sup>), hydroxyl ions are essentially nonexistent and not directly available as electron contributors. Furthermore, to oxidize sulfate ions, hydroxyl ions are also necessary. Hence, water turns out to be the only practical candidate available for oxidation. The oxidation half reaction for water is listed below [3]:



In this reaction, oxygen is given off as a diatomic gas. The oxygen generated at the anode surface rises to the top of the cell liquid as a continuously flowing sheet of gas bubbles. As the gas is generated, hydrogen ions go into solution. This increases the acidity of the lean electrolyte before returning to SX. The benefit of increased acidity of the electrolyte entering the SX stripping stage was previously identified. Note that the generation of H<sup>+</sup> in electrowinning compensates for the loss of H<sup>+</sup> when the loaded organic is stripped of its copper.

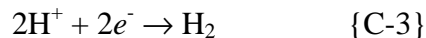
The energy potential needed for this oxidation is 1.23 volts (at standard conditions similar to the reduction reaction). Hence, the total threshold cell voltage needed to initiate the total reaction is 1.23 – 0.34 = 0.89 volts. In practice, 2.0 to 2.2 volts is normally provided for each cell to account for resistance voltage drop losses, deposition overvoltages needed to drive the reaction at a meaningful rate, and conditions varying from standard temperature and concentration.

## 7. Abnormal electrochemical process

Under certain conditions, an electrowinning cell can transition from normal to abnormal operation. When this happens, the electrochemical dynamics of the cell changes. This change takes place at the cathode, where a different reduction half-reaction takes over.

Of particular importance is the adverse condition of ionic copper depletion. If certain conditions occur, such as extended interruption of electrolyte flow to a cell, excessive copper depletion will take place. That is, the level of ionic copper will decrease substantially as copper ions plate out and are not replaced by fresh electrolyte. As the concentration of copper ions decreases, the relative availability of hydrogen ions increases. The cathode half-reaction transitions from C-1 above to reaction C-3 below.





The voltage threshold for this reaction is 0.0 volts (by definition)[3]. The net applied voltage across a cell needed for the overall reaction to occur (equations C-1 and C-3) becomes:  $1.23 - 0 = 1.23$  volts.

The single most important ramification from the C-3 cathode half-reaction is the generation of hydrogen gas. However, any copper that does continue to plate out will be of a very poor quality. The copper in depleted cells tends to fall off the cathodes as a brownish granular powder when removed from the electrolyte and dried.

In a depleted cell, the generation of hydrogen occurs along the cathode surface similar to the generation of oxygen along the anode. In fact, even under abnormal conditions, anode oxygen generation continues.

In its gaseous form, hydrogen is extremely explosive. Table-3 lists the important properties of Hydrogen[4] [5] [6]. For comparison, values for methane are also provided.

Note hydrogen's very wide range of flammability, high burning velocity, and very low minimum ignition energy (MIE). Although the autoignition temperature is relatively high, this is less applicable in assessing hazards in a tankhouse than the MIE since electric sparks created during removal of cathode plates are the most likely source of ignition. As ignition sources, electric sparks are usually evaluated in terms of their energy dissipation, rather than the temperature they create, since energy dissipation is easier and more accurate to measure or estimate.

## **8. Acid misting from electrowinning**

Oxygen bubbles created at the anode rise to the surface of the electrolyte. At the surface, these bubbles expand above the liquid and then break, releasing the entrapped oxygen into the atmosphere. The liquid in the bubble wall just before it breaks is made up of the acidic electrolyte solution. As the liquid wall ruptures, it disintegrates into extremely small droplets that readily become airborne.

The macroscopic effect of this process is to create an acrid, acid mist above the cells. This mist readily migrates throughout the work area and represents a potential health hazard to workers in the tankhouse. It also creates a corrosive atmosphere that can be detrimental to equipment and the tankhouse structure itself.

Field visits revealed a variety of strategies being used in an effort to address this problem. These strategies are used singularly, or in combination.

Evaluation of the effectiveness of these strategies is not part of this fire/explosion study. Examination of these strategies was limited only to their possible impact on the fire/explosion hazard. A description of the various strategies used is presented below. All strategies are included for completeness.

**a) Strategy 1: tankhouse ventilation**

Tankhouses can be ventilated using either natural or mechanical ventilation. When natural ventilation is used, lower-level exterior wall panels are usually removed (See [Figure-16](#)) and the roof is provided with a side-louvered ridge monitor. Mechanical ventilation is usually accomplished using induced-draft exhaust fans along one side of the building. In all but a few cases, ventilation was used in conjunction with other methods for controlling acid misting.

**b) Strategy 2: balls or beads**

Many plants address misting by using a floating media in the cell. The most common media are plastic beads or hollow balls (See [Figures-19](#) and [20](#)). These are usually manufactured of high-density polyethylene, polypropylene, or polyurethane. The beads or balls float on top of the electrolyte, creating a torturous travel path for the rising mist droplets, thereby encouraging droplet attachment onto the media surface rather than escaping into the local atmosphere. Too thin a layer of media will not provide a sufficient path; too thick a layer may impede removal and insertion of cathodes and inspection of the electrolyte for abnormal conditions.

**c) Strategy 4: surfactants**

In most tankhouses, a water soluble surface-tension reducer is used to discourage misting. Two different agents were found in use, all from the same manufacturer, the 3M Corp. Table-4 lists these chemicals by trade name, along with the number of plants using each.

By lowering the electrolyte surface tension, the gas bubble wall becomes thinner when it reaches and protrudes above the electrolyte surface. This causes the bubble to break sooner with less generation of mist droplets.

Based upon observations and interviews, one of the surfactants, FC-100, readily creates and traps the rising gas in soapsuds-like bubbles above the surface, even at very low concentrations (a few hundred ppm<sup>6</sup>). This foamy layer further helps to prevent misting by allowing liquid electrolyte within the bubble wall to drain back into the bath. By the time the bubbles break at the upper exposed surface of the foam layer, they are much dryer, and upon breaking, generate fewer mist droplets (See

---

<sup>6</sup> ppm indicates parts per million by volume.

Figure-21). Unfortunately, as will be discussed shortly, this foamy layer also creates significant potential fire/explosion problems.

The FC-1100 had significantly less tendency to form suds than FC-100. However, at higher concentrations, even this surfactant generated a foaming suds layer.

**d) Strategy 5: sealed cells**

One facility utilizes a semi-sealed cell design that reduces open air misting by creating a zone of local ventilation, or headspace, above the top of the cell. This is accomplished by providing flexible rubber “wipers” on the sides of each of the anodes about 5 to 6 inches above the cell liquid level. These wipers directly contact the cathodes and, with the help of sidewall wipers, provide a partial seal over the cell.

The electrolyte overflow drain is also contained within this headspace. The drain header servicing the cell bank is large enough to flow only partially full. The vapor space in the header pipe is connected to a ventilation fan that keeps the header and cell headspace under slight negative pressure. Fresh air leakage around the wiper system into the cell is intended to provide the airflow needed to sweep the mist into the drain header.

**e) Strategy 6: cell membranes**

One facility was experimenting with sheets of fabric laid over the cells (See Figure-22). The fabric was intended to act as a membrane capable of letting oxygen escape, while trapping and condensing acid mist droplets on the under side of the fabric membrane. The initial material in use was a flame-retardant fabric with an inert, high-temperature resistant coating. This facility was only in the early stages of this study at the time of the visit.

**f) Strategy 7: cell-top elevation**

In some of the older tankhouses, the tops of the cells were elevated approximately 16 to 20 inches above the adjacent walkways (See Figure-23). This has the effect of raising the misting zone higher into the ventilation airflow moving through the tankhouse. The intent is to increase mist dilution with air. However, this approach also has the counter-productive effect of raising the misting zone closer to the worker face level, thus likely increasing acid-mist respiratory exposure.

All of the newer facilities were constructed with the cell tops at the same elevation as the adjacent walkway surfaces (See Figure-10). This provides a limited benefit of additional separation between the misting source and the worker breathing level.

**g) Strategy 8: respirator protection**

At several tankhouses, the operator required workers to wear half-face air-purifying respirators (APR) when working on the cell operating floor.

**D. Recovery of Fugitive Organic Solution**

**1. Fugitive organic**

Unfortunately, the separation process in extraction and stripping is not perfect. A small amount of organic is retained in the aqueous raffinate or rich electrolyte. This fugitive organic will travel with the aqueous solution and eventually collect somewhere in the flow loops. For a number of reasons, this occurrence is not only undesirable, but also detrimental to the overall process. Therefore, steps are normally taken to remove and even recover this liquid.

**2. Economic benefit**

Raffinate leaving the solvent extraction settlers will invariably carry with it some stray organic. Since the raffinate is often recycled back to the leaching pads, failure to remove it from the flow path will eventually allow it to become entrapped in the leach pad ore body. Saturation of the ore bed with this oily liquid can significantly degrade leaching rates. Such an effect is very detrimental to the productivity of the mine.

Rich electrolyte leaving the stripper-settler tank and bound for the tankhouse will also carry with it stray organic. Failure to remove this material will allow it to enter into the tankhouse and into each cell. From an economic standpoint, the stray organic adversely affects the quality of the copper produced by interfering with the electroplating process and by contaminating the final product.

Stray organic lost from both the extraction and stripping processes must also be replaced with new organic. Because of the cost of the organic chemicals, this make-up quantity becomes a measurable economic burden over a period of time. Therefore, recovery of the fugitive organic for reuse becomes as much an economic benefit as removing it for hazard reduction and quality control reasons.

**3. Hazard reduction**

When fugitive organic enters an EW cell, not only will it interfere with the process, it will also create a fire and explosion hazard. The organic and its diluent carrier are both combustible liquids (flashpoint<sup>7</sup> equal or greater than 100°F)[8]. Although combustible liquids themselves are not as significant a fire hazard when compared to flammable liquids (flashpoint less than 100°F),

---

<sup>7</sup> Flashpoint is the lowest bulk temperature of a liquid at which it generates sufficient vapors to create an ignitable vapor-air mixture above the surface of the liquid.

when in the presence of excess oxygen, their fire hazard increases significantly. Since EW continually generates large quantities of oxygen, the presents of fugitive organic in a cell becomes a potentially severe problem.

## **Part IV. Field Observation**

### **A. *Field Survey procedures***

Each of the eleven Arizona mines listed in Attachment-1 were visited during one of three trips to the region. Each visit had the following objectives:

- 1) identify the size, extent, and location of each SXEW operation.
- 2) identify any undocumented or previously unrecognized incidents involving the process.
- 3) identify those conditions or practices generally common to all mine sites.
- 4) identify those conditions or practices unusual to the specific site.
- 5) identify the perceptions or awareness of plant personnel toward the dangers involving the process.
- 6) identify specific mitigation strategies currently in use at the sites.
- 7) obtain samples of chemicals, their material safety data sheets (MSDS), and plant operating procedures used by the various sites.

### **B. *Field Survey forms***

As part of the data collecting strategy, a survey form was used to assist in data collection. This form was developed during the first trip to Arizona, and then formalized prior to the second and third trips. However, during the field visit phase of the investigation the form existed as a living document, evolving with each visit to a mine site as new factors were identified.

The survey form consisted of a standard set of questions about SX and EW operations intended to identify important characteristics of the process. The final version of the survey, used during the last visit, can be found as Attachment-3.

### **C. *SX***

Important information identified for the solvent extraction process included:

1. number of SX plants
2. PLS copper content
3. number of stages of extraction
4. number of stages of stripping
5. number of trains of SX
6. extractant chemical used
7. diluent carrier used
8. extractant/diluent mixing ratio

9. rate of copper extraction
10. PLS flow rate
11. Method of controlling fugitive organic carryover into raffinate
12. extent of ore mining activity

There were two facilities that had two SX plants each; the remaining sites had only one each. Ionic copper in the PLS ranged from a low of 0.4 g/l (grams per liter), to a high of 3.0 g/l. However, for most sites, the copper content was in the range of 0.85 g/l to 1.0 g/l.

All facilities used either two-stage or three-stage extraction. However, most sites used single-stage stripping. A number of sites also had more than one train of SX. Most settlers were semi-enclosed with wood-frame roof enclosures and side panels protecting them from the weather. Several facilities had settlers fully enclosed with flat concrete caps. Several other sites used fully open settler tanks (no roofs or overhead enclosures), thus providing no protection from the weather.

Protection of the settler tanks from the weather is important since direct exposure of the settler surface to heavy rain, hail, and wind may decrease separation efficiency, especially through agitation. This agitation and decreased separation efficiency can increase the rate of fugitive organic underflow into the aqueous solution both during and after inclement weather.

Extractant chemicals, diluent chemicals, and typical mixing ratios were previously presented in Section II.B.3. At all facilities, the rate of copper recovery from the PLS ranged from 85% to almost 94% by weight.

PLS flow rates varied greatly, depending upon the PLS copper content and the overall production rate. Various mines reported values as low as 1800 g.p.m., to as high as 60,000 g.p.m..

In general, raffinate was collected in one or more ponds after discharge from the extractor settlers. These ponds provide the dual function of both holding raffinate until needed for leaching, and for settling out fugitive organic. The raffinate ponds are typically provided with flotation booms capable of retaining surface floating organic. Oil skimmers were often used to recover the separated organic for reuse. Several sites not yet conducting organic recovery, were making preparations to do so in the near future.

All but three facilities were actively mining new ore at the time of these visits. One of these sites was withholding this effort until market conditions made mining more economical; the second was in the process of transferring to new ownership; and the third had depleted its on-site ore reserves and was trying to negotiate access to adjacent ore bodies with the landowners.

#### **D. EW**

Important information identified for the electrowinning process included:

1. number of EW tankhouses
2. number of EW trains.
3. number of cells per train.
4. number of cathode/anode pairs per cell.
5. types and sizes of cathodes and anodes.
6. ionic copper concentration in both the rich and lean electrolyte.
7. flow rate of electrolyte through the tankhouse.
8. acid levels in both the rich and lean electrolyte.
9. typical cell DC current draws.
10. typical cell voltages.
11. acid misting mitigation methods and chemicals used, if any.
12. fugitive organic mitigation efforts.
13. operating procedures to prevent fugitive organic.
14. operating procedures to prevent generation of hydrogen gas.

One mine site had three tankhouses supplied by two SX plants. A second mine site had two tankhouses, each with its own SX plant. The remainder of the sites had only one tankhouse each.

Most tankhouses were equipped with two trains of electrowinning cells. In several of these, the trains were not being used to full capacity because of limited leach pad output.

The number of cells in a train varied from about 40 to over 200 (two banks per train). At several locations, a certain number of cells were either out of service because of reduced production, or were used as retaining and flotation tanks for collecting fugitive organic (See [Figure-24](#)); in these cases, the non-producing cells were without electrode plates.

As previously stated, the number of anode/cathode plate pairs varied between 20 and 60 pairs per cell. The average dimension of the anodes and cathodes were 3 feet wide by 4 feet deep. Immersed surface areas varied from about 10-ft<sup>2</sup> (square feet) to 12-ft<sup>2</sup> per plate, per side.

Ionic copper concentrations in the electrolyte varied from about 45 to 55 g/l on the rich side, and 27 to 42 g/l on the lean side. Electroplating levels varied from a low of 8 g/l to almost 30 g/l of copper from the electrolyte. Electrolyte pass-through flow rates varied from a low of 140 g.p.m. to a high of 10,000 g.p.m. Sulfuric acid levels in the rich electrolyte varied from 150 g/l to 180 g/l, while the lean electrolyte varied from 170 g/l to 200 g/l.

Electric current levels varied from a low of approximately 8 amperes per square foot ( $\text{amp}/\text{ft}^2$ ) of immersed cathode, to as high as  $24 \text{ amp}/\text{ft}^2$ . Cell voltages typically averaged between 1.9 to 2.2 volts per cell.

All facilities use either natural or mechanical ventilation in dealing with acid misting. However, in only two cases, did this represent the sole strategy for dealing with this problem.

The remaining facilities utilized one or more of the surfactants listed in Table-4. In some cases, especially when using FC-100, noticeable sudsing was observed in the cells. In several of these plants, contamination of the surfactant bubbles with fugitive organic was noticeable (See [Figures-25](#) and [26](#)). This was particularly true when a floating medium was used in conjunction with the surfactant. In several other cases, only trace amounts of organic were evident. In the remainder, fugitive organic could not be seen.

Use of a floating media on top of the cells to help suppress misting was common. In all but one case where this media was used, either hollow balls or solid beads were employed. In at least one of these cases, both balls and beads were used at the same time. In the exception case to balls or beads, the media was reject solid plastic pellets normally used as raw material for plastic injection molding. These pellets were cylindrically shaped, versus the spherically shaped balls and beads, but were of approximately the same size as the beads.

For the solid beads and pellets, high-density polypropylene (HDPP) and polyurethane (HDPU) plastic was common. For the hollow balls, HDPU or polyethylene (HDPE) was common. The media layer tended to be limited to about 3 inches or less. However, in some cases, the media did not completely cover the cell surface at all. For these cases, the benefit of the media an acid mist suppressant is questionable.

Contamination and/or discoloration of the floating media with fugitive organic were noted in many cases, as seen in the referenced figures. When a bubbling surfactant was used in conjunction with the floating media, the media seemed to increase the uptake of organic into the bubbles.

In all tankhouses visited, at least some acid misting was discernible both visually and by smell. In most cases, the smell of acid mist was sufficiently strong to induce occasional coughing. Even with multiple strategies, conditions at several plants warranted, and plant policy required, use of respirators (APR) by those working on the cell operating floor.



Strategies for preventing entrance of fugitive organic into the tankhouse ranged from essentially no efforts, to multiple strategies that appeared to be very successful. These strategies included:

1. Use of flotation columns (tanks).
2. Use of special filters.
3. Use of Jameson cells
4. Use of non copper-producing cells (without plates) for organic entrainment, flotation, and skimming.
5. Combinations of the above.

A number of plants utilized flotation tanks to entrap fugitive organic in the electrolyte, prior to entering the tankhouses. In some cases, these tanks were provided with oil skimmers. In one case, the plant used absorbent pads floating at the top of their 1 million-gallon tank to collect floating organic (See [Figure-27](#)). At the time of the visit, the plant was preparing to replace the pads with a skimmer system due to the many problems and expense associated with the pads.

Jameson cells work by mixing the contaminated electrolyte with air as it discharges into a special tank as shown in [Figure-50](#). The air may be injected under pressure, or drawn in using the venturi principle. The air bubbles attach themselves to the organic, creating a buoyant froth. A special chemical additive is sometimes used to increase the adhesion between the organic and the air bubbles. The froth/electrolyte mixture discharges into the inner tank, which is deep enough to allow the froth to float to the top and over into the second tank where it is recovered and removed.

Use of filters were another common and effective approach to removing fugitive organic. These filters usually consisted of a dual medium of garnet<sup>8</sup> and anthracite within a steel vessel (see [Figure-28](#)). In several cases, sand filters supplemented these filters. Most plants had multiple filters in parallel, thereby allowing for at least one filter to be in backwash mode at all times.

Some facilities pass their electrolyte through nonproducing cells in the tankhouse prior to entering working cells (See [Figure-24](#)). Operators often referred to these as “non-commercial” cells. These cells are manually skimmed of organic on a regular basis, typically one or more times per day.

Those plants that used multiple strategies for organic control were most successful at preventing entry of fugitive organic into the trains of working cells.

---

<sup>8</sup> Garnet is a class of dense, hard silicate-based (SiO<sub>4</sub>) minerals similar to sand.

The operating procedures for dealing with an excess organic condition varied from plant to plant. In some cases, small quantities of organic were flushed through the affected cells without special removal efforts. In other cases, the plant skims excess organic from the cell. This is sometimes accomplished with the help of a shorting frame (See [Figure-29](#)), which allows for removal of a both anodes and cathodes without the interruption of current flow through the remainder of the cell bank. The cell can even be drained and scrubbed if necessary. Cleaning of contaminated anti-misting float media is also sometimes conducted.

Cell depletion is another concern, and all plants make efforts to ensure adequate flow by regularly inspecting cell inflow or outflow activity. These visual checks are almost always made at least once per shift and generally more often. Another method at some locations is the use of level detectors that give warning if the level of a cell drops to the top of the overflow drain elevation. Finally, all plants regularly determine cell ionic copper levels using a titration method. Some facilities had written emergency procedures for dealing with a depleted cell.

## **Part V. Hazards Analysis**

### **A. Introduction**

In reviewing historical incident data, information collected during on-site interviews concerning undocumented incidents, and actual field observations, it was concluded that the following potential hazards warranted further investigation.

1. Hazards of fugitive organic entering an electrowinning cell, where the hazard is due primarily to the organic entrapment within surfactant bubbles filled with oxygen gas.
2. Hazards due to generation of hydrogen gas from a depleted electrowinning cell.
3. Other fire hazards associated with the combustible nature of the organic solution.

### **B. Laboratory Investigation of Hazards of Fugitive Organic**

#### **1. Goal**

The following two primary concerns were examined during this phase of the investigation.

1. Are noncontaminated surfactant bubbles (“clean bubbles”) filled with oxygen gas an ignition hazard?

2. Are organic contaminated surfactant bubbles (“dirty bubbles”) filled with oxygen gas an ignition hazard?

## 2. Methodology

In order to determine answers to the above two concerns, it was necessary to create both clean and contaminated oxygen-filled bubbles. This was accomplished by using oxygen from compressed cylinders bubbled through aquarium airstones submersed in various aqueous solutions containing surfactant. The airstones helped distribute the gas bubbles across the surface and also created smaller bubbles closer to that expected from chemical generation of the gas. The gas bubbles rose from the stones to the surface and generated foam bubbles above the surface. Since mine personnel indicated that FC-100 had a greater tendency to create foam bubbles, it was used as the surfactant in all experiments.

- a) Clean bubbles were generated using an aqueous solution in a 15-liter, rectangular glass tank (See [Figure-30](#)). Collected bubbles were then scooped from the tank and placed on a plastic screen mesh to allow excess water to drain from the bubbles. A piloted, small-flame ignition source was then applied to the foam to test for ignition (See [Figure-31](#)). Three different aqueous solutions were included in the clean-bubble tests: clean tap water; an aqueous sulfuric acid solution; and an aqueous copper sulfate and sulfuric acid solution.

A piloted ignition source, rather than an electric spark source, was used in all testing intended to establish ignitability. This provided expediency in testing, and was justified because the concern was not for the ignition source itself, but for the ignitability of the potential fuel any time an adequate ignition source was present. Based upon both actual incidents and the nature of the electrowinning process itself, it is conservatively assumed that an adequate ignition source can be created at any time.

- b) Contaminated bubbles were generated in a one-square-foot, 3-inch deep metal pan lined with a polymeric, impermeable fabric membrane (brattice cloth). The depth of the aqueous solution was approximately 2 inches, with the airstones submersed beneath the liquid surface (See [Figure-32](#)). The aqueous solution consisted of a mixture of copper sulfate (20 g/l), sulfuric acid (150 g/l), and water intended to represent a typical EW electrolytic solution (See [Figure-33](#)). The solution contained varying amounts of organic contamination. The organic used was a mixture of ACORGA M5774 and Phillips 66 Orfom SX-7 at a ratio of 1:11.5.

During initial experiments, the organic floating on the electrolyte surface tended to move away from the gas bubbles as they reached the surface. This discouraged organic uptake into the foam. Two separate methods

were devised to address the problem of encouraging uptake. The first method utilized manual stirring and agitation of the organic at the surface as the gas was generated. This approach yielded at least some success.

The second method was intended to simulate the presence of flotation media, such as beads or balls, which in the field appeared to encourage uptake and generation of dirty bubbles. This most likely occurred because the lower surface of the media would hold the organic captive, retarding any sideways movement of organic away from the gas bubbles. Hence, gas bubbles would be forced up through the captive organic, causing organic to pull up into the bubbles as the layer of foam developed.

To simulate the flotation media, a piece of open-meshed brattice cloth was stretched across the pan at the surface of the liquid (See [Figure-34](#)). The mesh was held in place along the sides of the pan using strong spring clips.

- c) Tests were conducted on the various SXEW chemicals listed in Table-2 in order to determine flashpoint and water content.

### 3. Results

The following results were obtained during the testing described above.

- a) The surfactant demonstrated no tendency to ignite when the oxygen-filled bubbles were uncontaminated, *i.e.*, when the foam was clean. Neither solution chemistry (acidity or copper loading), nor solution temperature influenced the foam's lack of ignitability. Pan solution temperatures as high as 130°F were used. However, the presence of the sulfuric acid did encourage smaller diameter foam bubbles. This last effect likely decreased ignitability further by increasing the total water content in the foam and water vapor within the bubbles.
- b) When contaminated with organic solution sufficient to create "dirty bubbles" (See [Figure-35](#)), the foam proved readily ignitable. Upon ignition, the foam layer was often consumed in a rapid and brilliant flame. If contamination was sparse, the flame would self extinguish before consuming all of the foam. [Figure-36](#) shows the same foam-layer being ignited, and [Figure-37](#) shows it burning<sup>9</sup>. If contamination occurred in different parts of the foam layer, the flame would often tunnel through the foam layer along the path of contaminated portions of the foam. Under heavy contamination, the entire foam layer would be consumed in a rapid blue-white flash.

---

<sup>9</sup> The flame is already dying down in Figure-35. The camera was manually operated and not fast enough to catch the flame during its brilliant peak. The entire ignition and burning sequence typically lasted less than two seconds.

In nearly all cases, the flash was sufficiently brilliant to prevent direct viewing. This may have been due to the combustion of ionic copper in the bubble wall from the electrolytic solution. Metals and metallic compounds tend to produce brilliant flames during combustion.

- c) Results of testing conducted on samples of chemicals collected during site visits are summarized in Table-4. This test data helps explain some of the observed ignitability test results.

The surfactant, without organic contamination, did not create an ignitable foam. It is obvious from Table-4 that the surfactant is water soluble and contains significant water even before dilution in the aqueous electrolyte. The surfactant thus becomes highly diluted when mixed with the electrolyte. In the field, concentration levels for the surfactant were generally in the few hundred parts-per-million range.

Under these low concentration conditions, any vapor space in the foam bubbles would contain significant water vapor because of the water's high partial pressure contribution. This would cut down on available vapor space for any flammable component that might be in the surfactant; thus, reducing its concentration far below its LEL<sup>10</sup>. The high water vapor concentration would also act as a significant heat sink for quenching any ignition source.<sup>11</sup>

- d) An examination of Table-4 shows that both the extractant and diluent have reasonably high flashpoints. Even with heating by the electrolytic solution, which is typically at temperatures as high as 120°F, the organic would remain below its flashpoint. Thus, other factors must compensate for the high flashpoint and contribute to the ignition of the organic solution.

The first factor is the increased oxygen concentration. However, enriched oxygen would have little effect on lowering the flashpoint since flashpoint is driven by LEL, and LEL is not significantly depressed with excess oxygen (See Table-3). Rather, the affect from oxygen enrichment would be to raise the UEL<sup>12</sup> thus expanding the flammable range of any vapors trapped in the foam. It would also lower ignition energy or ignition temperature.

The second factor is that the organic in the foam no longer exists as a liquid pool, as it would in the flashpoint tester. As a pool, the organic is

---

<sup>10</sup> lower explosive limit

<sup>11</sup> Other miscible flammable liquids, such as alcohols, can be rendered unignitable when sufficiently diluted with water for the same reasons.

<sup>12</sup> upper explosive limit

exposed to air, and vapors are generated, only along the upper exposed surface. In the foam, the organic exists as both a film in the bubble walls (two-surface exposure), and as droplets at the intersection of adjacent bubbles. These conditions increase the overall exposed surface-area-to-mass ratio of the organic, much the same as a wick does to wax in a candle. This “wick action” allows for greater flammable vapor generation, and overall, increases the likelihood of organic ignition.

## **C. *Laboratory Investigation of Hazards of Cell Depletion***

### **1. Goal**

This phase of the investigation attempted to verify generation of hydrogen gas in an electrowinning cell, and to also determine what levels of cell depletion or other factors could lead to this generation.

It should first be noted that the fire and explosion hazards of hydrogen gas have long been recognized and are well documented in the literature.[4][5][6] The ignition and combustion properties of hydrogen are also well established.[10][11] Hence, the presence of any hydrogen is assumed to be a hazard by default. However, it must be noted that generation of hydrogen gas is a theoretical possibility that has never been confirmed to have occurred in actual field installations.

When hydrogen begins escaping from a container under high pressure, it tends to immediately self ignite from friction-generated heat. This results in a fire rather than an explosion. The gas is consumed as it escapes from the container. When not burning, hydrogen’s very low vapor density encourages it to rise and disperse in the atmosphere. Both of these properties discourage gas collection, a necessity for developing conditions leading to an explosion.

In electrowinning, hydrogen is generated and released at or near atmospheric pressure, thus decreasing the likelihood of immediate ignition. In addition, presence of surfactant bubbles will entrap the gas, preventing its dispersion and dilution in the atmosphere. Finally, hydrogen demonstrates sometimes-undesirable properties in the presence of copious quantities of gaseous oxygen, such as generated in electrowinning. These properties include an extremely low ignition energy and a high flame velocity. Under these adverse conditions, the only missing ingredient for a severe, and even devastating explosion, is an ignition source.

When cathodes are removed from a cell, they tend to generate electric sparks. These sparks are caused because the electric power supply to the cell bank is highly inductive. Lifting cathodes from a cell will cause a partial interruption of the current flow. Disrupting current flow in an inductive circuit tends to

generate sparks and arcing at the point of disruption, the magnitude of which varies proportionally with the level of inductance and rate-of-change in current.

In electrowinning, the disruption occurs at the connection between the hangerbar and its feed bus (See [Figure-17](#)). There are references in the literature that the energy released in such “break sparks” can be higher than given credit for in some of the research evaluating spark ignition energy.[12]

Sparks or arcing can also occur when the cathodes (or their hangerbars) accidentally contact the anodes (or their hangarbars) during insertion into or removal from the cell. Although there may only be 2 volts across the cell, this short circuit will cause some, or even most of the current flow to shift to the shorted path. Cell bank current draws are typically in the thousands of amperes<sup>13</sup>. Therefore, these short circuits can result in significant sparking and even molten copper splatter<sup>14</sup> from the localized heating of the copper plates, cell busbars, or hangarbars.

Based upon the above mechanisms, it can be assumed that the potential for creating an adequate ignition event is always present during the electrowinning process.

## 2. Methodology

This phase of the laboratory testing was conducted primarily in a 1-liter electrowinning cell, as shown in [Figure-38](#). The electric circuit feeding this cell, and associated circuit instrumentation, are shown schematically in [Figure-39](#). The overall physical arrangement is shown in [Figure-40](#), and the instrumentation equipment in [Figure-41](#).

Cell voltage, V2, was measured directly across the cell plates rather than at the bus or the power supply output. This eliminated any skewed voltage readings due to lead losses or resistance in the plate-to-bus connections. Cell current was established by measuring the voltage drop across a low resistance, calibrated shunt resistor, R1, in series with the cell. This resistor was in the power lead to the anode, and the voltage drop across it is designated as V1.

With R1 having a value of 0.1 ohms, and setting the voltmeter scale of V1 to millivolts, the current draw would be 10 times V1 in milliamperes. Thus, by moving the decimal point in the voltage reading one place to the right, the current draw in milliamperes is read directly. For example, a reading of 62.7 millivolts across the resistor would correspond to a current flow of 627 milliamperes.

---

<sup>13</sup> 4,500 to 50,000 amperes, depending upon the size of the cell bank.

<sup>14</sup> The melting temperature of copper is 1981°F.

Tests were conducted by making incremental changes to the power supply voltage, and recording cell voltage and shunt voltage readings with each change. Typically, at least one minute was allotted between power supply changes to permit the cell to stabilize. Equivalent cell impedance was calculated for each reading period by dividing the cell voltage by its associated current draw. It was noted that when copper was present in the electrolyte in sufficient concentrations to prevent hydrogen generation, actual copper plating began at a cell voltage of 1.7 to 1.8 VDC.

Verification of the gases generated under various conditions was done qualitatively. This was accomplished by using specially bent electrode plates that had a rising seam in the plate just below the liquid level (See [Figure-48](#) and [Figure-49](#)). This seam trapped gas rising along the vertical surface of the plate and directed it to one point of exit to the liquid surface. A 3-ml test tube was filled with electrolyte, inverted with the opening just below the surface, and then held over the point where the accumulated gas bubbles exited from the seam. As the gas collected and filled the test tube, the electrolyte was displaced.

Upon completely filling with gas, the end of the test tube was covered while still in the inverted position, and then lifted out of the cell. A small wood splint was lit, the tube end uncovered, and the splint inserted into the test tube. If the burning splint suddenly flared up with a bright flame, it was considered adequate evidence that the collected gas was oxygen. If the burning splint created a loud “pop” sound, it was considered adequate evidence the collected gas was hydrogen.

This method of verifying oxygen and hydrogen generation is considered adequate for the following reasons:

- During the gas verification phase of testing, no chemicals other than sulfuric acid, copper sulfate, and water were used to create the electrolytic test solution. The only other chemicals in the cell were the copper cathode and lead anode plates. Any electrochemical reactions occurring in the cell could only involve these non-organic compounds. Only related non-organic products could result.
- The normal and abnormal electrochemical reactions that take place in an electrolytic cell of the type used in this work is well documented in the literature. The only gases that can be generated are oxygen and hydrogen.
- The fire-hazard related properties of both oxygen and hydrogen are distinctly different and well documented. Discerning between the two is straight forward.



- The results indicated that oxygen was generated at the anode, and hydrogen at the cathode. This is consistent with the associated electrochemical theory.

One problem resulting during testing dealt with the significant oxygen generated at the anode at higher cell voltages. At voltages associated with possible cathode hydrogen generation, the anode oxygen production was so great that the oxygen bubbles could not escape the liquid fast enough and rapidly moved horizontally through the liquid, engulfing the cathode, and making it difficult or impossible to discern any gas generated at that plate.

This problem was overcome by inserting a nonconducting plastic, inert baffle between the anode and cathode. This baffle extended below the oxygen gas bubble cloud level. This kept the cathode free of oxygen, and any gas bubbles generated at the cathode could be readily identified.

### 3. Results

The first series of tests verified the generation of oxygen from the anode, and hydrogen from the cathode, as previously stated.

The second series compared various factors including temperature and acid concentration as they affected cell impedance. When acid was used, it was always at a concentration of 180 g/l. This concentration level was typical of those found in the field. The results of these first comparisons are shown in [Figure-42](#) and [Figure 43](#).

From [Figure-42](#), it can be seen that cell impedance is not measurably affected by temperature in the range of voltages normally associated with electrowinning (1.8 to 2.2 volts). During subsequent tests, the cell temperature was generally maintained in the 110°F to 120°F range. However, based upon the results above, it is believed that minor temperature variations did not affect the overall outcome of the various subsequent experiments.

[Figure-43](#) shows the comparative results of a cell with acid versus no acid. [Figure-44](#) is the cell impedance for varying copper loadings without acid. It can be seen that the presence of acid can make a significant difference in cell impedance, especially at lower copper loadings. This is consistent with basic electrochemical theory. Hence, most additional testing was conducted with an acid concentration of 180 g/l. This concentration was typical of that seen in the field.

It can also be seen that copper loading can have a measurable affect on cell impedance, especially at greater copper depletion levels. [Figure-45](#) is a summary of the cell impedance versus copper loading at a typical cell voltage of 2.0 volts DC. At copper levels below approximately 15 g/l, the cell

impedance begins to increase; and at copper levels below approximately 10 g/l, the impedance curve steepens noticeably.

Figure-46 summarizes the cell impedance versus copper level when the electrolyte contains the nominal 180 g/l of sulfuric acid. As expected, cell impedances are lower with acid than without, especially within the normal cell voltage operating range. Also expected is that impedance begins to climb steeply, even at voltages below 2.5 volts, for copper levels below 10 g/l.

Figure-47 summarizes the cell voltages at which copper depletion resulted in generation of hydrogen gas from the cathode. All of the cell tests in this series contained 180 g/l of acid, similar to that in an actual tankhouse cell.

It was not ascertained whether the specific results extrapolate to larger, commercial size cells. However, there is no readily identifiable reason that would preclude this extrapolation. Consequently, the results provide generalizations and trends that can be used to suggest potential hazards and mitigation strategies.

These generalized characteristics include the following:

- a) As the cell becomes depleted, the voltage needed to commence hydrogen generation decreases. This threshold voltage level drops to realistically obtainable levels as the cell ionic copper concentration drops below about 15 g/l.
- b) As the cell becomes depleted, its impedance also increases. As all of the cells are in series and collectively represent a voltage divider network, a cell with a growing impedance will have more of the total voltage distributed across it. Hence, even though the average cell voltage may not change, each normal operating cell need only contribute a very small portion of its voltage to the depleted cell in order for that cell to exceed hydrogen generation thresholds.

It must be remembered that the cell voltages quoted by plant operators are average values, and no visited plants have continuous instrumentation to monitor voltage levels from individual cells.

- c) Overall cell conductivity<sup>15</sup> increases with acid level. Since the acid levels in the cells are always high, even a cell fully depleted of copper will continue to conduct significant current. It is this current that provides the reduction energy needed to generate hydrogen at the cathode.

---

<sup>15</sup> conductivity is the mathematical inverse of impedance

## Part VI. Conclusions and Recommendations

### A. *Tankhouse Hazard Mitigation Strategies*

The following sections discuss the strategies developed from the results of this study. Each item includes a hazard statement, a list of factors that can lead to the creation of the hazard, hazard identification guidelines, methods for preventing the hazard from occurring, and efforts capable of mitigating the hazard. For this report, mitigation is defined as those specific actions needed to reduce the danger from the hazard once it has actually developed or is suspected.

#### 1. **Fugitive Organic Hazards**

##### a) **Hazard definition:**

Fugitive organic reaches the EW cells. This creates an increased potential for a flash fire.

##### b) **Site factors:**

A variety of factors can lead to this condition. These include:

- Inadequately designed filtering methods, or the complete lack of filtering methods between the SX plant and the tankhouse.
- Improperly maintained filtering methods, or inadequately supervised filtering procedures.
- Loss of power to the SX plant. This can cause a severe drop in the electrolyte level in any flotation tanks or columns upstream of the tankhouse. If the level drops sufficiently, the organic layer floating on top may flow directly into the supply pipe to the tankhouse, resulting in large quantities of organic reaching the electrowinning cells.
- Operational procedures, or lack thereof, that create conditions conducive to letting organic escape from the stripping separator. For example, conditions such as lack of adequate manual skimming of tanks or removal of sludge layers in the separator can lead to excess fugitive organic.
- Uncovered stripping separator tanks. This can expose these tanks to severe weather that can agitate the tanks and decrease separation efficiency.

c) **Identification:**

Fugitive organic tends to turn brown in the electrolytic solution. Once in the EW cells, it will float to the surface and collect in areas of slow or stagnant flow. It often appears as a brown scum on the cell liquid surface, tank sides, or mixed in with the anti-misting flotation media (balls or beads), if such media is used.

If a surfactant is used, the production cells must be readily examined for the generation of any foam bubbles. If bubbles do occur, they should have a white color with no signs of discoloration. Brown or dirty bubbles, even in limited quantities, denotes an actual fire hazard as the bubbles are likely to be contaminated with organic and filled with oxygen. Contaminated surfactant bubbles are a more severe hazard than trace amounts of organic floating on the surfaces of the tank walls, plates, or flotation media.

d) **Prevention:**

Prevention methods depend upon the potential condition capable of permitting fugitive organic. The following items are presented as methods capable of preventing organic from reaching the production cells.

1. Use of organic capture technology.
2. Adequate maintenance of capture technology.
3. Improved SX plant power reliability.
4. Improved SX plant operation.
5. SX stripping separator tank weather protection.

The most effective capture technology appears to be a combination of upstream flotation tanks or Jameson cells, followed downstream by anthracite/garnet (A/G) filters. The flotation tanks or Jameson cells entrap most of the organic escaping into the electrolyte.

Flotation tanks should have sufficient volume and depth between the normal liquid level and the discharge outlet to provide time to react to a loss of SX power. During a loss of power, output from the SX plant to the tank will cease, and the tank level will begin to drop. If action is not taken to either restore flow to the tank, or stop flow from the tank, the organic top layer will reach the outlet resulting in a large quantity of organic heading toward the tankhouse.

Downstream of the tank, filters can remove the remaining residual organic. There should be a sufficient number and size of A/G filters in parallel to handle the maximum anticipated flow with at least one filter out of service for backwash. Any future SX plants constructed should give serious consideration to using these technologies.

Automatic skimmers, whether they are used in a flotation column, or on incoming cells in the tankhouse, must be kept in working order. Visual inspection for operation should be part of the daily, on-going plant surveillance procedures.

An SX plant power loss alarm, or other operational alarms such as flotation tank level switches, should be provided and either connected to a constantly attended location, or be provided with outdoor visual and audible warning discernible for long distances. Note that for power loss alarms, back up power must be available for the warning devices.

SX plant power reliability can be enhanced by one or more of the following methods.

- Good electrical system design including:
  1. Providing power loss alarms
  2. Providing emergency back up power.
  3. Proper circuit overload protection and coordination.
  4. Protection of equipment and circuits from lightning and physical damage.
  5. Proper labeling and identification of electrical equipment.
  6. Maintaining up-to-date one line diagrams for trouble shooting and work planning.
  7. Proper training of personnel.
  
- Effective outage procedures including:
  1. Careful pre-outage planning.
  2. Close communications with the tankhouse.
  3. Post-job testing, check-out, and start up procedures.
  
- Effective contractor control including:
  1. Close pre-job work planning.
  2. Training and familiarization of contractor personnel with the plant and the work.
  3. On-site supervision by the operator.
  4. Effective outage procedures as listed above.

Improved operation of the SX plant should include adequate training of operations personnel, written operation procedures, and written emergency procedures including use of these procedures for training evolutions.

If fugitive organic is captured using manual skimming in non-production EW cells, the skimming should be done on a regularly scheduled basis. Once per day is likely to be the minimum periodicity, and more frequently if necessary based upon daily surveillance and plant experience. A log should be kept for

tracking this activity and noting the condition of the cells before and after skimming. Excessive organic should trigger an investigation into the cause and an intensified surveillance of the production cells.

If a surfactant is used, its concentration should be minimized as much as practical. Although field observations indicated that FC-1100 is less prone to generating foam than FC-100, use of FC-100 is acceptable if concentrations are kept very low and any foam generated appears clean (white) and is periodically washed down with water to prevent build up. Wash down must also be done with the FC-1100 if used in concentrations sufficient to generate foam. In general, any foam created should not be permitted to raise above the hangerbars.

During the separation process, some of the organic solution will mix with silt or other sediment and remain in the separator tank as a layer of sludge trapped between the underflowing electrolyte and the overflowing organic (*i.e.*, within the emulsion zone in [Figure-4a](#)). Over a period of time, this sludge layer will thicken, resulting in decreasing separation efficiency. If left uncorrected, this condition can increase the level of fugitive organic escaping downstream of the SX plant. Operational procedures should include periodic surveillance of this sludge layer and removal as necessary.

In general, separator tanks are best constructed with covers to protect them from the weather. Severe weather, such as the heavy thunderstorms that periodically strike Arizona, can create large raindrops, hail, and heavy winds that can agitate the separators, resulting in increased fugitive organic.

*e) **Mitigation:***

A written procedure should be in place to deal with conditions of contamination occurring in a production cell(s). This procedure should include the following as a minimum:

- Immediate notification of appropriate management and operational personnel as to the condition.
- Control of those potential ignition sources capable of coming in contact with the contaminated surfactant bubbles. For example, plate pulling or inserting operations should be suspended in the affected cells. Plate moving should not recommence until the condition is either rectified, or power is removed from the train prior to moving plates. Any hot-work type maintenance operations in the vicinity should also cease immediately.
- Small levels of contamination can be addressed by skimming or otherwise directly removing the contamination from the cell.

- Large scale contamination may require cessation of operations until the affected cells can be drained, flushed, and cleaned.
- Response to a loss of power at the SX plant should be included in the procedures. This response should require evaluation and surveillance of flotation cell levels and valve closures for electrolyte supply piping to the tankhouse, if flotation tank levels drop below a certain level.

**WARNING:** A drop or loss in flow of electrolyte to the tankhouse may also impact the hydrogen gas generation hazard by permitting cell depletion, as described below.

## 2. Cell Depletion Hazards

### a) Hazard definition:

Ionic copper concentration levels in one or more tankhouse cells drop sufficiently to permit generation of hydrogen gas, or conditions permit excessive redistribution of voltages across the cells, or both.

### b) Site factors:

A variety of factors can lead to this condition. These include:

- Loss or reduction of electrolyte flow from SX plant to the tankhouse.
- Loss or reduction of electrolyte flow to an individual cell.
- Cathode to anode shorting, especially in multiple cells, thus redistributing voltages across the remaining cells.
- Removal of an excessive number of cells from service using one or more shorting frames without providing compensating measures such as voltage supply readjustment.

### c) Identification:

Direct identification of hydrogen gas generation is difficult. However, conditions having the potential to generate hydrogen can be identified.

A key to hydrogen generation is the cell ionic copper level. Base upon small scale tests, there appears little danger of hydrogen generation at copper levels above 15 g/l unless a very excessive cell voltage occurs. Although visual examination of the cell may reveal depletion, color alone should not be relied upon for making this assessment.. However, if a cell does have a color out of character with normal operations, it should result in an immediate investigation and testing.

If a cell is found without inflow or outflow of electrolyte, cell depletion may be occurring due to the loss of flow.

**d) Prevention:**

Prevention methods include programs for inspecting cells for normal operation, and by use of instrumentation for measuring cell conditions. Inspection of cells for normal operation include visual verification of cell flow and use of titration testing.

Instrumentation on each cell for measuring cell conditions could include ionic copper concentration using ion-specific electrodes, cell voltage, cell flow, or cell liquid level. Another alternative would be to provide a fixed hydrogen gas detection system throughout the tankhouse. Any of these indications, if provided, should be arranged to give an alarm at the EW laboratory or other constantly attended location.

To provide a quantitative basis for an adequate frequency of visual inspections or titration testing, each plant should perform and document calculations that predict the time it would take to deplete a cell from its normal copper content down to 20 g/l. This calculation should assume all electrolyte flow to the cell has stopped and that the electrical current draw is at the maximum value expected or recorded under normal operating conditions. Use of 20 g/l as the lower limit, rather than 15 g/l, will establish a margin of safety.

If operational conditions change that affect the incoming copper loading, these calculations should be revised and surveillance frequencies adjusted accordingly. Also, if the tankhouse has multiple trains with differing characteristics, then separate time-to-depletion values should be determined for each train and used accordingly.

All cells should be checked for the possibility of copper depletion by one of the following methods. The frequency should ensure that each cell is checked at least once within the calculated cell depletion time period, as determined above.

- Visual examination of outflow or inflow to each cell. Outflow can be verified at the overflow drain; inflow can be verified at the inflow pipe, but only if the end is visible above the liquid surface. Either method will be adequate.
- Use of flow or level detectors on each cell. These detectors should transmit alarms to the control room or laboratory. Level or flow indicators should periodically be tested.



- Use of indicating control valves on the electrolyte feed piping and the supply piping to each cell. If indicating valves are used instead of visual flow checks, the valves should be visually verified open at the same frequency as a visual flow check. They should also be physically tested periodically.
- Electrolyte samples taken from each cell for titration testing. Cells should be tested on a rotating basis so that all cells are tested within the time-to-depletion period, unless testing is only a spot check back up for one of the other methods listed above. Testing documentation should identify which cell was tested, the date and time the sample was collected, and results.

Titration testing should also be conducted any time abnormal conditions are noted or suspected.

A procedure should also be in place to track supply valve closures when a cell is taken out of service, even if only for a brief period of time. Out of service in this context means electrolyte flow to one or more cells is intentionally interrupted. Tracking of valves should include tagging and logging.

When an SX plant power loss occurs, tankhouse personnel should be alerted immediately. The EW process power should be shut off if SX power is not promptly restored.

If a surfactant is used, any build up of foam should be prevented by proper concentration management, and by washing down foam as needed.

Records of all surveillances and titration testing results should be maintained for later review by plant management and by MSHA inspectors.

e) **Mitigation:**

If one or more conditions occur that indicate hydrogen is or may likely be present, written emergency procedures should be in place and followed.

These procedures should include as a minimum:

- Notification of appropriate management and operational personnel as to the hazard.
- Plate pulling or inserting operations should immediately be suspended throughout the tankhouse. Plate moving should not recommence until the hazardous conditions are abated. Any hot-work type maintenance operations in the vicinity should also cease immediately. These operations can present an ignition source.

- All non-essential personnel should be removed from the building and relocated to a safe location.
- Electrical power to the cells should be removed from the train immediately. This both removes the power as a source of ignition, and halts any further generation of hydrogen and oxygen gas.
- Ventilation should be maintained, and where possible, increased. If forced ventilation is provided using fans, these should either be explosion proof, or should be located in a fresh air stream, e.g. upwind.
- Portable gas detectors suitable for detecting hydrogen should be used upon entering the area to identify any actual conditions of hydrogen. These detectors should be approved or listed by a nationally recognized testing agency. If hydrogen is detected, further actions should be suspended until ventilation has purged the area.
- Foam bubbles should be washed down as soon as other steps have been accomplished.
- As soon as practical, an investigation into the cause of the hazard should be initiated. Recommencing of operations should not occur until the cause has been identified and rectified.

### ***B. Solvent Extraction Hazard Mitigation Strategies***

Because the organic solvent solution is a combustible liquid, and because it is found in large quantities at the SX plant, general firesafety precautions should be taken and practiced at all times. These practices should include controlling ignition sources as required in 30CFR, Section 56.4500 (such as smoking and hot work operations), immediate cleanup of organic liquid spills when they occur, and the type and inspection of firefighting and fire suppression equipment (fire extinguishers, sprinklers, etc.) as required in 30CFR, Sections 56.4200, 56.4201, and 56.4202.

### ***C. Leach Pad Hazard Mitigation Strategies***

In general, the leach pads represent little hazard to the SXEW operation. One potential exception to this would be a flammable liquid spill, because the liquid would eventually find its way through the leach bed and into the PLS. One scenario for such a spill would be a leak or rupture from the fuel tank of a gasoline powered vehicle, such as a pickup truck. Plant policy should require that all spills be reported to management as part of the facility's environmental protection program.

Response to spills are typically found in a facility's hazardous materials response procedures. These should include spill containment and removal of contaminated soil.

Large spills, especially if immediate clean up is not accomplished, should result in periodic testing of PLS exiting the leach pads. PLS contaminated with gasoline should not be permitted to enter the SX plant until the contaminant is removed.

## **Part VII. Acknowledgments**

The author would like to acknowledge and thank the following persons for their assistance and effort in successfully conducting and completing this study.

First, all of the managers and employees at the various mines who participated in the study effort. All these persons were very helpful and cooperative, offered insights and experiences, and made information and samples available when requested.

Second, Harry Verakis, Chief of the A&CC Materials and Explosions Testing Branch (METB), who accompanied the author on the first of the three Arizona visits and provided guidance and insight into the investigation and the report.

Third, David Creamer, METB chemist, who provided both chemical knowledge and significant hands-on assistance in conducting the laboratory work.

Fourth, Steven Luzik, Approval and Certification Center Chief, and David Chirdon, Chief of the A&CC Engineering and Testing Division (ETD) for their review and input into the final report and the inspector training presentation.

And finally, a special thanks to MSHA mine inspectors David Estrada and Larry Aubuchon, who patiently escorted the author to the various mines, assisted with interviews, and provided insights and experiences about each of the sites.

## **Part VIII. References**

- [1] Biswas, A. K. and W. G. Davenport, Extractive Metallurgy of Copper, 3<sup>rd</sup> Ed., Pergamon - 1994: ISBN 0-08-042124-5
- [2] Masterton, W. L. and E. J. Slowinski, Chemical Principles with Qualitative Analysis, Saunders - 1978: ISBN 0-7216-6175-0
- [3] Lide, D. R., Editor-in-Chief, Handbook of Chemistry and Physics, 79<sup>th</sup> Ed., CRC Press - 1998: ISBN 0-8493-0479-2
- [4] Kutchta, J. M., *Investigation of Fire and Explosion Accidents in the Chemical, Mining, and Fuel-Related Industries - A Manual*, US BuMines Bulletin 680, 1985.

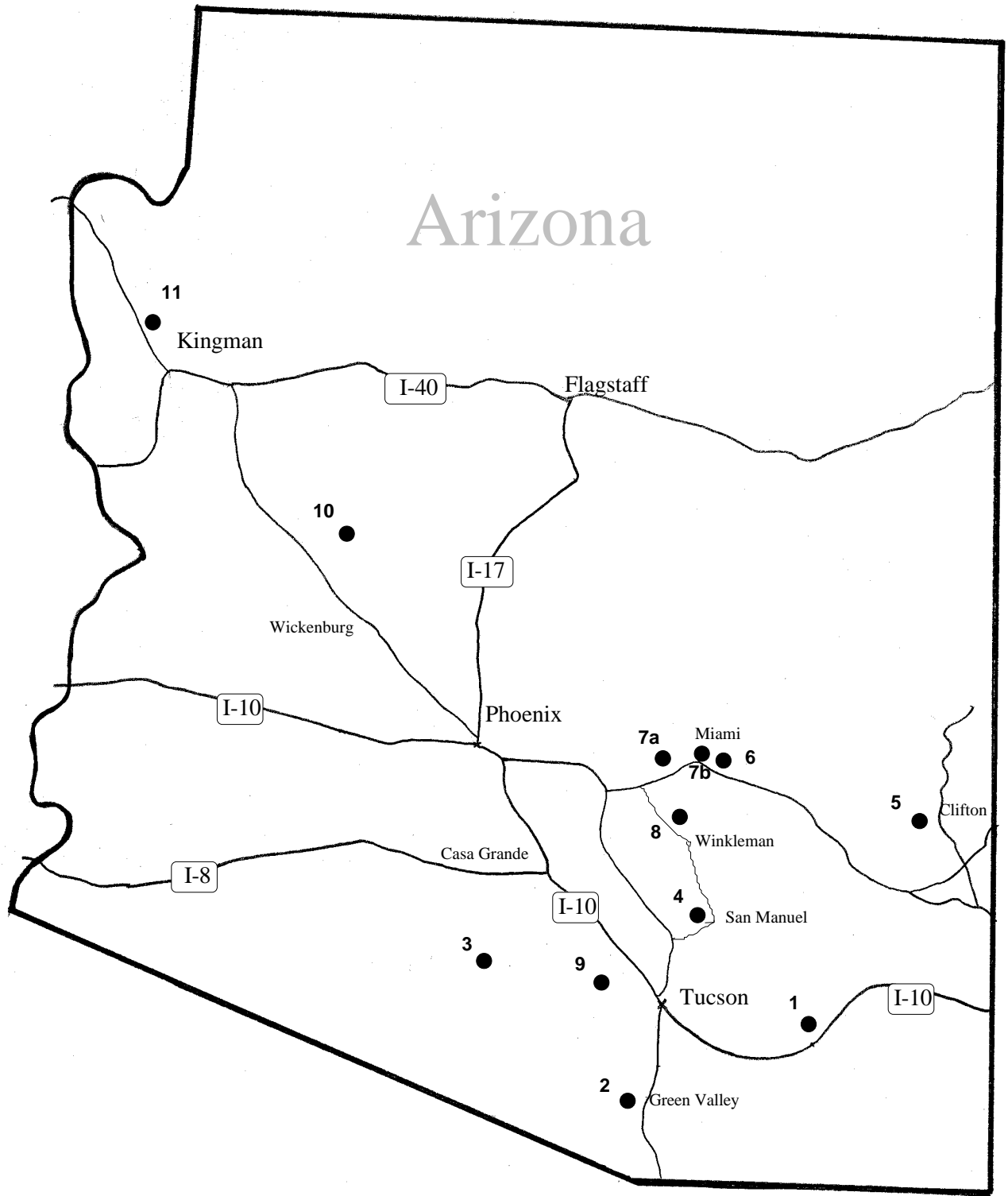
- [5] Lewis, R. J. Sr., Sax's Dangerous Properties of Industrial Materials, 8<sup>th</sup> Ed., Van Nostrand Reinhold - 1992: ISBN 0-442-01132-6
- [6] Cote, A. E., Editor-in-Chief, Fire Protection Handbook, 17<sup>th</sup> Ed., National Fire Protection Association - 1991:ISBN 0-87765-378-X
- [7] Solomons, T. W. Graham, Organic Chemistry, 3<sup>rd</sup> Ed., John Wiley & Sons - 1984:ISBN 0-471-87032-3
- [8] NFPA 30-1996, Flammable and Combustible Liquids Code, National Fire Protection Association, Quincy MA
- [9] ASTM D93, *Standard Test Methods for Flash Point by Pensky-Martens Closed Tester*, American Society for Testing and Materials - 1990, Philadelphia PA.
- [10] Drell, I. I., and F. E. Belles, *Survey of Hydrogen Combustion Properties*, National Advisory Committee for Aeronautics-Report #1383: 1957 Washington, DC.
- [11] Zabetakis, M. G., *Flammability Characteristics of Combustible Gases and Vapors*, US BuMines Bulletin 627, 1965.
- [12] Litchfield, E. L., *Minimum Ignition-Energy Concept and Its Application to Safety Engineering*, US BuMines Report of Investigations 5671, 1960.

## **Part IX. List of Attachments**

- A. Attachment 1: Mines Sites Visit For Study**
- B. Attachment 2: Mine Site Location Map**
- C. Attachment 3: Field Survey Form**
- D. Attachment 4: Tables**
- E. Attachment 5: Figures**

MSHA Mine ID #	Mine Company	Mine Name	Location	SX Plants	EW Tankhouses	Active Mining	Trip #	Map Site #
02-00112	Cyprus	Miami	Miami	1	1	Y	1-1	6
02-02264	BHP	San Manuel	N. of San Manuel	1	1	Y	1-2	4
02-01738	Cyprus	Bagdad	Bagdad	1	1	Y	1-3	10
02-02579	Cyprus	Tohono	SW of Casa Grande	1	1	N	1-4	3
02-00150	ASARCO	Ray Complex	S. of Superior	1	1	Y	2-1	8
02-00024	Phelps Dodge	Morenci	Morenci	2	3	Y	2-2	5
02-00843	Equitorial Mineral Parks	Equitorial Mineral Parks	16 mi. NW of Kingman	1	1	N	2-3	11
02-00144	Cyprus	Sierrita	W. of Green Valley	1	1	Y	3-1	2
02-00411	ARIMCTCO	Johnson Camp	Dragoon	1	1	N	3-2	1
02-00134	ASARCO	Silver Bell	W. of Rillito	1	1	Y	3-3	9
02-01049	BHP	Pinto Valley	7 mi. W. of Miami	1	1	Y	3-4a	7a
			in Miami	1	1	Y	3-4b	7b

ATTACHMENT -1 ARIZONA MINES UTILIZING SXEW



ATTACHMENT-2 SXEW MINE LOCATOR MAP

**MSHA A&CC SURVEY**

**COPPER INDUSTRY**

**SOLVENT EXTRACT (SX)/ELECTROWINNING (EW) PROCESS**

**PART A Mine Information**

Company Name: \_\_\_\_\_; Mine Name: \_\_\_\_\_;

Location (city, state) \_\_\_\_\_;

Mine I.D. \_\_\_\_\_; MSHA Rep.: \_\_\_\_\_; Date: \_\_\_\_\_;

MSHA MNMHS District: \_\_\_\_\_; MSHA F.O.: \_\_\_\_\_;

**PART B SX/EW Applicability**

B.1 Is solvent extract and/or electrowinning used for mineral recovery at this plant? **YES**  
**NO**

*If the answer is NO, then proceed to Part E. Otherwise, complete Parts C and D as appropriate. Attach process flow diagram, if available.*

**PART C Solvent Extract Information**

*If solvent extract is used, complete this part. Then proceed to Part D.*

C.1 Number of stages of extraction used? 1 2 3 4 other \_\_\_\_\_;

C.2 Number of stages of stripping used? 1 2 3 4 other \_\_\_\_\_;

C.3 Number of parallel extraction/stripping production lines? 1 2 other \_\_\_\_\_;

C.4 Reagent used for stripping? Trade Name \_\_\_\_\_; Mfgr \_\_\_\_\_;  
*Attach MSDS sheet.*

C.5 Solvent carrier used? Trade Name \_\_\_\_\_; Mfgr \_\_\_\_\_;  
*Attach MSDS sheet.*

C.6 Typical volumetric mixing ratio of Reagent to reagent/solvent mixture: \_\_\_\_\_ %

C.7 Typical copper content in pregnant leach solution (PLS): \_\_\_\_\_ grams/liter

C.8 Typical copper content in barren leach solution (BLS): \_\_\_\_\_ grams/liter

C.9 Typical copper content in loaded electrolyte to EW: \_\_\_\_\_ grams/liter

C.10 Typical copper content in unloaded electrolyte from EW: \_\_\_\_\_ grams/liter

C.11 Describe methods/equipment/instrumentation used to limit amount of organic reagent/solvent solution entering EW process.

\_\_\_\_\_  
\_\_\_\_\_  
\_\_\_\_\_  
\_\_\_\_\_

C.12 Average daily (24 hour) flow rate of (PLS): \_\_\_\_\_ g.p.m.

C.13 Average daily (24 hour) flow rate of loaded electrolyte: \_\_\_\_\_ g.p.m.

**PART D Electrowinning Information**

- D.1 Loaded electrolyte is supplied from? **SX process** other \_\_\_\_\_
- D.2 EW production rate of copper? \_\_\_\_\_ lbs./month or lbs./year;
- D.3 Number of banks of EW tanks (production lines)? \_\_\_\_\_
- D.4 Number of electrolyte cells in series per bank? \_\_\_\_\_
- D.5 Number of anode/cathode pairs per cell? \_\_\_\_\_
- D.6 DC voltage applied across single cell? \_\_\_\_\_ vdc
- D.7 DC current range through cell? \_\_\_\_\_ amps up to \_\_\_\_\_ amps
- D.8 One-side wetted surface area of anode? \_\_\_\_\_ sq.ft.
- D.9 Anode material? \_\_\_\_\_; Cathode material? \_\_\_\_\_;
- D.10 Is chemical means used to control acid vapors? **YES NO**  
 Surfactant Trade Name \_\_\_\_\_; Surfactant Mfgr \_\_\_\_\_;  
*Attach MSDS sheet.*
- D.11 Is physical means used to control acid vapors? **YES NO**  
 beads? **YES NO** size: \_\_\_\_\_; material: \_\_\_\_\_  
 balls? **YES NO** size: \_\_\_\_\_; material: \_\_\_\_\_
- D.12 Is mechanical means used to control acid vapors? **YES NO**  
 natural ventilation? **YES NO**  
 fan ventilation? **YES NO**; Type: forced draft induced draft  
 number of fans: \_\_\_\_\_; fan rating: \_\_\_\_\_ cfm:
- D.13 Concentration of H<sub>2</sub>SO<sub>4</sub> entering EW process? \_\_\_\_\_ grams/liter.
- D.14 Concentration of H<sub>2</sub>SO<sub>4</sub> exiting EW process? \_\_\_\_\_ grams/liter.
- D.15a Method of assaying ionic copper in electrolyte?  
 \_\_\_\_\_.
- D.15b Frequency of tests \_\_\_\_\_.
- D16 Method of detecting interelectrode shorting?  
 \_\_\_\_\_
- D.17 Methods of preventing and detecting a depleted tank?  
 \_\_\_\_\_
- D.18 Describe methods/equipment/instrumentation used to limit the generation of Hydrogen gas (H<sub>2</sub>) during the EW process.  
 \_\_\_\_\_  
 \_\_\_\_\_  
 \_\_\_\_\_  
 \_\_\_\_\_



**PART E Survey Processing**

Make one copy of completed survey with attachments and file in Field Office or District file for subject mine.

Send original completed survey and attachments to attention of Engineering Support Branch at:

Mine Safety and Health Administration  
Approval & Certification Center  
Industrial Park Road  
RR1 Box 251  
Triadelphia, WV 26059

### SECONDARY MINERALS

ore type	geological name	chemical formula
carbonates	<i>Azurite</i>	$2\text{CuCO}_3 \cdot \text{Cu}(\text{OH})_2$
	<i>Malachite</i>	$\text{CuCO}_3 \cdot \text{Cu}(\text{OH})_2$
oxides	<i>Cuprite</i>	$\text{Cu}_2\text{O}$
	<i>Tenorite</i>	$\text{CuO}$
hydroxy-silicates	<i>Chrysocolla</i>	$\text{CuO} \cdot \text{SiO}_2 \cdot 2\text{H}_2\text{O}$
sulphates	<i>Antlerite</i>	$\text{CuSO}_4 \cdot 2\text{Cu}(\text{OH})_2$
	<i>Brochantite</i>	$\text{CuSO}_4 \cdot 3\text{Cu}(\text{OH})_2$
secondary sulfides (supergene)	<i>Chalcocite</i>	$\text{Cu}_2\text{S}$
	<i>Covellite</i>	$\text{CuS}$

### PRIMARY MINERALS

ore type	geological name	chemical formula
primary sulfides (hypogene)	<i>Chalcopyrite</i>	$\text{CuFeS}_2$
	<i>Bornite</i>	$\text{Cu}_5\text{FeS}_4$

NOTE: Pyrite,  $\text{FeS}_2$ , contains no copper but is a primary ore supplying  $\text{Fe}^{2+}$  and  $\text{Fe}^{3+}$  ions for oxidation and also  $\text{H}_2\text{SO}_4$ .

**Table-1 Copper Containing Ores** <sup>[1]</sup>

### EXTRACTANT CHEMICALS

Manufacturer	Address	Trade Name Products
Henkle Corporation	S. Kensington Rd. P.O. Box 191 Kankakee, IL 60901-0191	LIX <sup>®</sup> -84, -860, -860-IC, -984, -984N, and -985
INSPEC USA	Alternate 69 Hwy Galena, KS 66739	MOC <sup>®</sup> -80TD and -100TD
Zeneca, Inc.	Wilmington, DE 19897	ACORGA <sup>®</sup> M5774, M5397, and P-50M

### DILUENT CHEMICALS

Manufacturer	Address	Trade Name Products
Conoco/Penreco	c/o Penreco P.O. Box 4274 Houston, TX 77210	170 ES (Exempt Solvent)
Phillips 66 Mining Chemicals Division	c/o Phillips Petroleum Co. Bartlesville, OK 74004	Orfom <sup>®</sup> SX-7 and SX-12

### OBSERVED MIXING RATIOS

Extractant(E) / Diluent(D)	E/D volume ratio
LIX 984N / SX-7	1:19
LIX 984N / SX-12	1:11.5
LIX 984 / 170 ES	1:32
M5774 / SX-7	1:5 to 1:7
MOC 80TD / SX-12	1:7

**Table-2 SX Chemical Manufacturers, Products, Mixing Ratios**

property	units	HYDROGEN	METHANE
chemical formula		H <sub>2</sub>	CH <sub>4</sub>
molecular weight [5]	amu	2.02	16.05
vapor density [5]	ratio	0.069	0.6
In air:			
LEL	% v	4	5
UEL	% v	75	15
autoignition temperature (AIT)	°C	520	630
1-cm dia. heated air jet ignition temperature	°C	640	1040
minimum spark ignition energy (MIE)	mJ	0.017	0.30
In 100% Oxygen:			
LEL	% v	4	5
UEL	% v	94	61
autoignition temperature (AIT)	°C	400	555
minimum spark ignition energy (MIE)	mJ	0.0012	0.003
Inerting concentration in air:			
Nitrogen (N <sub>2</sub> )	% v	71	36
Carbon dioxide (CO <sub>2</sub> )	% v	57	23
Net Heat of Combustion [6]	MJ/Kg	130.8	50.03
Characterisitic maximum burning velocity	cm/s	326	45

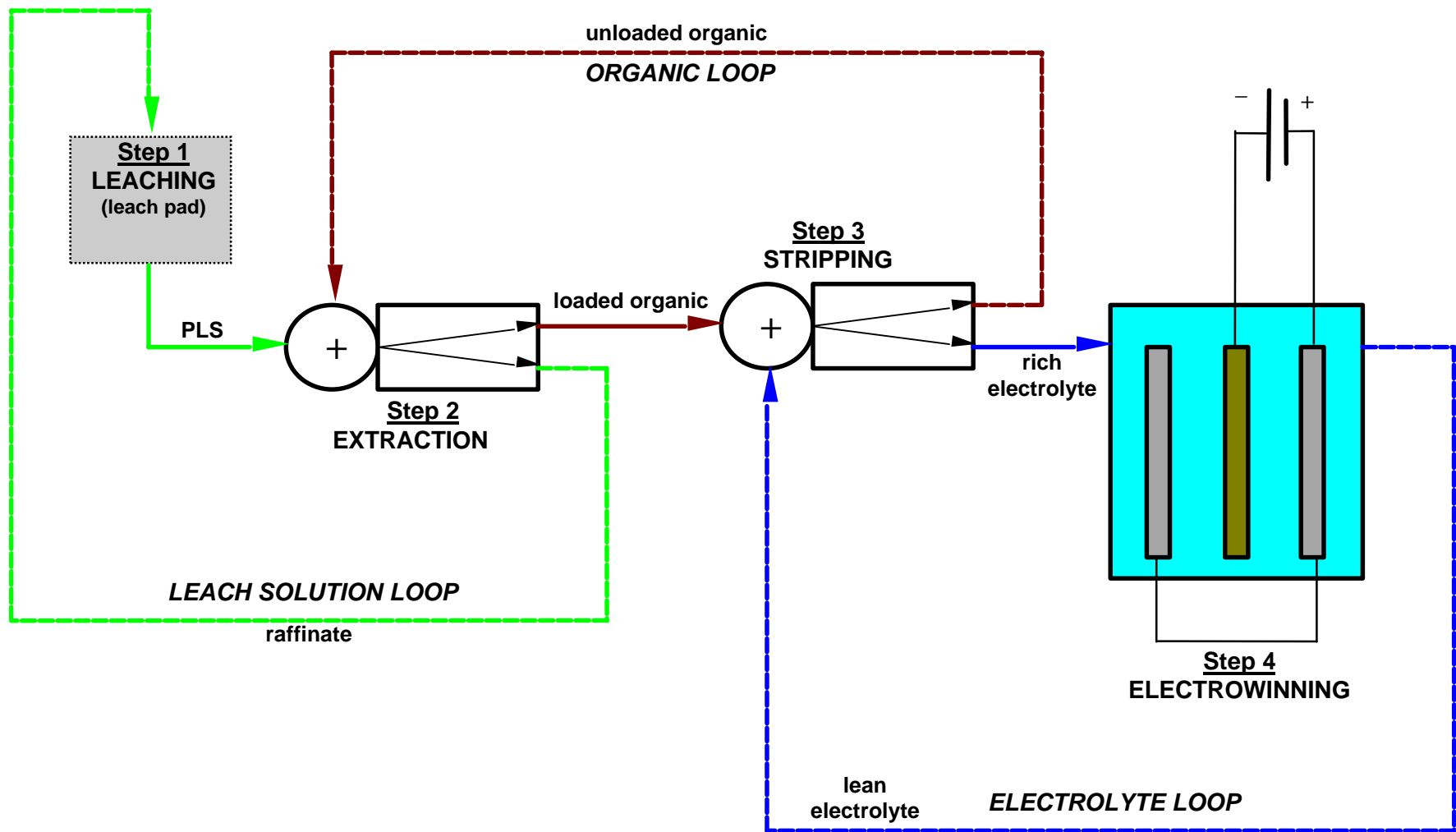
NOTE: All data from [4] unless otherwise noted.

**Table-3 Fire Hazard Properties of Hydrogen**

chemical trade name	type	flashpoint [9] (°F)	% water <sup>†</sup>
FC-100	surfactant	none (boiled over)	38.6
FC-1100	surfactant	none (boiled over)	33.6 to 34.5
LIX 84N	extractant	155	0.26
LIX 984N	extractant	no flash up to 212 continuous burning at 217	0.58
ACORGA M5774	extractant	215	0.21
Orfom SX-7	diluent	165	0.29
Conoco 170 ES	diluent	180	0.03

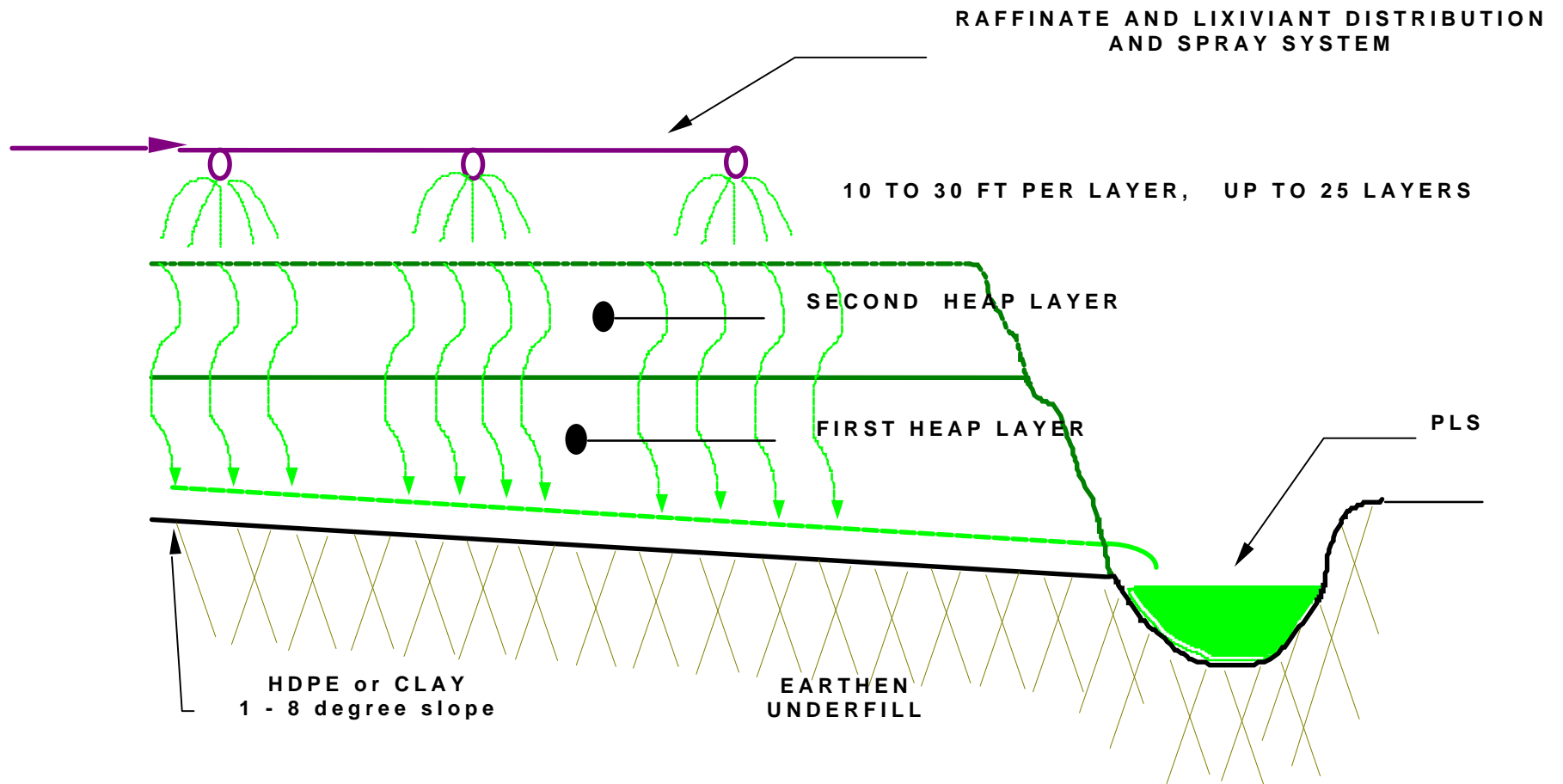
<sup>†</sup> Percent water content was determined using a METTLER DL18, Karl Fischer Titrator. Results are average values of three test samples, except FC-1100, which is the range of average values for samples from three different mines.

**Table-4 Fire Hazard Properties of SXEW Chemicals**

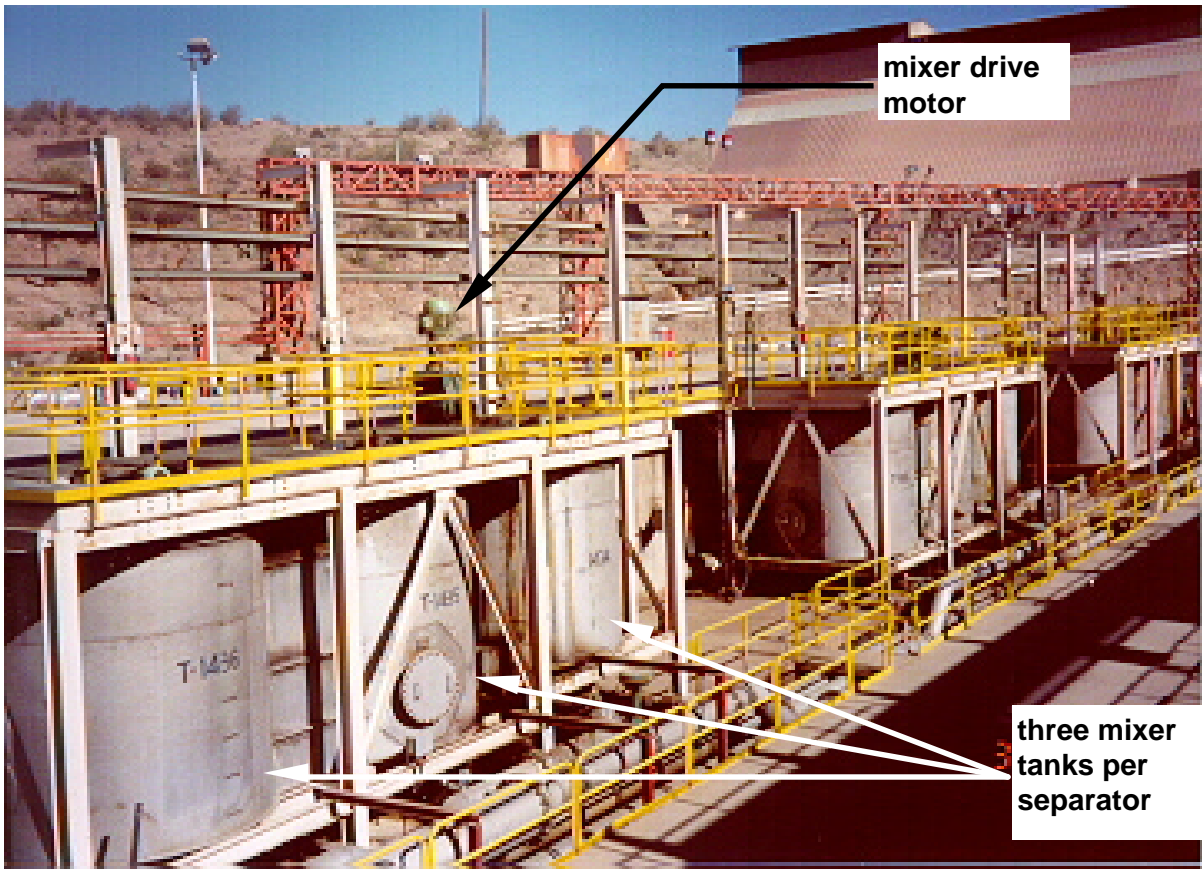


**Figure-1 SXEW Basic Process Flow Diagram**

NO SCALE

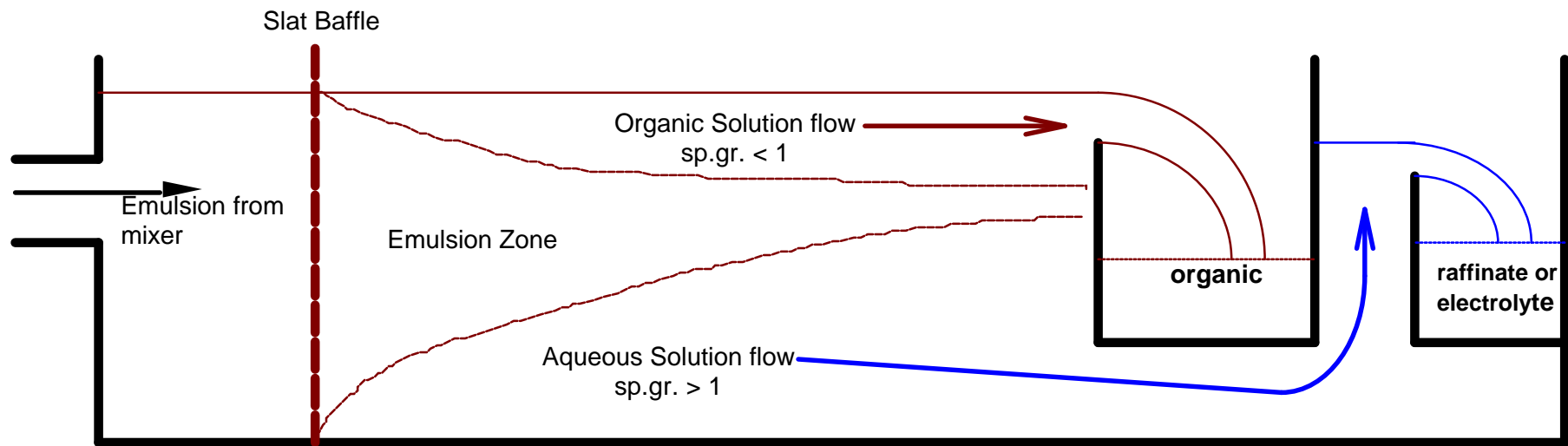


**Figure-2 Cross-Section of Heap Leach Pad**  
NO SCALE



**Figure-3 Banks of Three SX Mixing Vats per Separator**

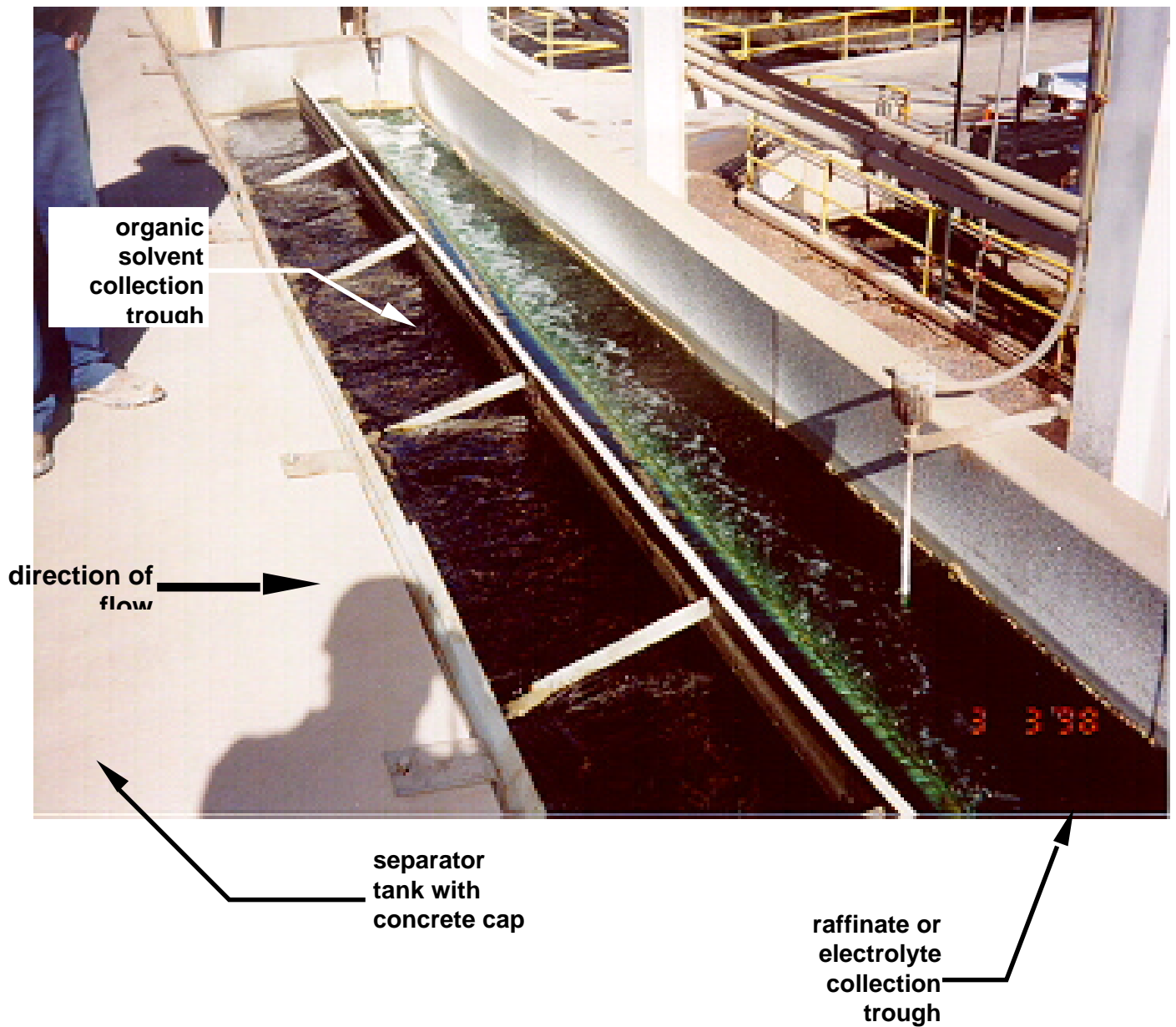




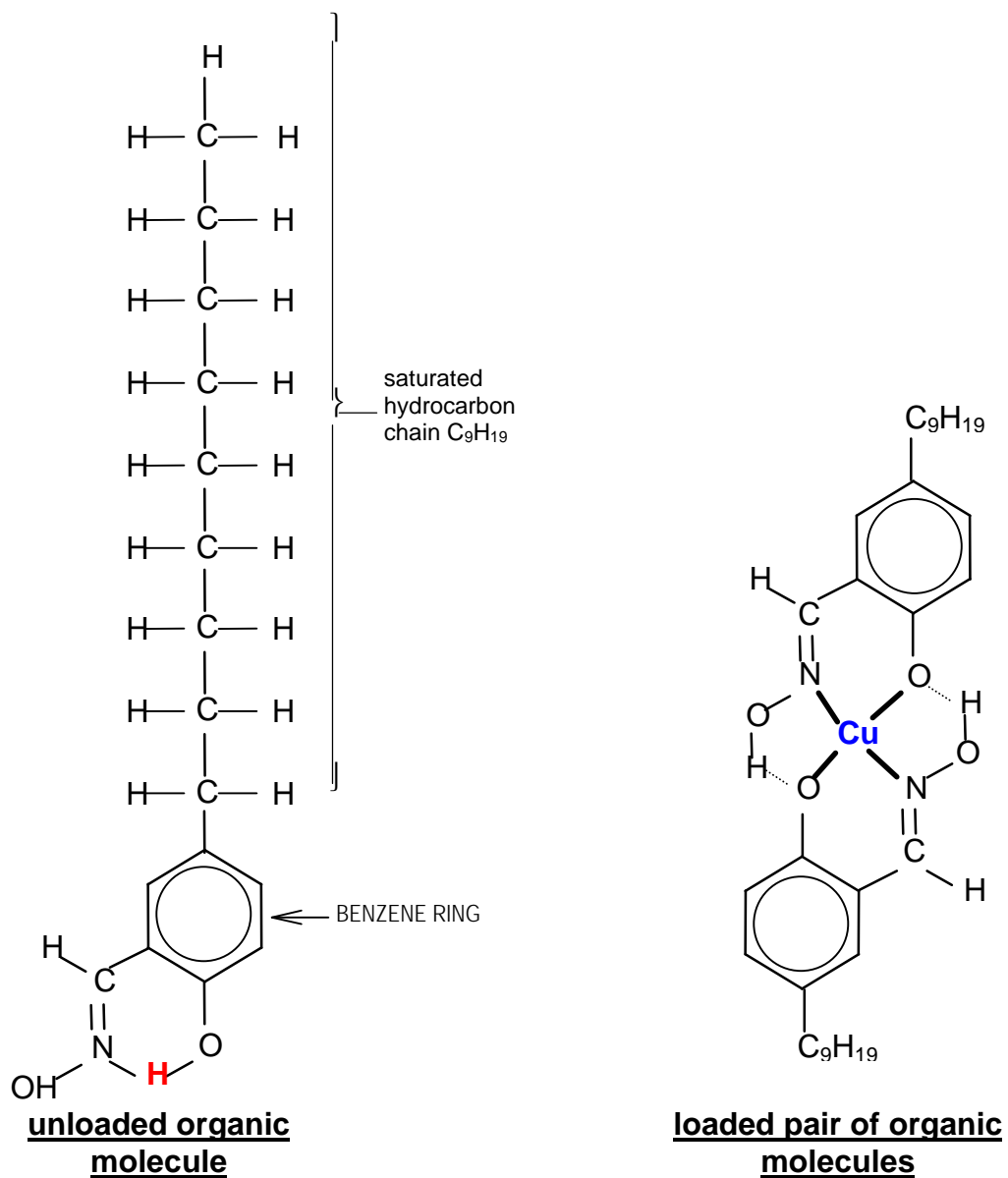
**Figure-4A Side View of Solvent Extraction**  
**Settler Tank**

Typical for both extraction and stripping

NO SCALE

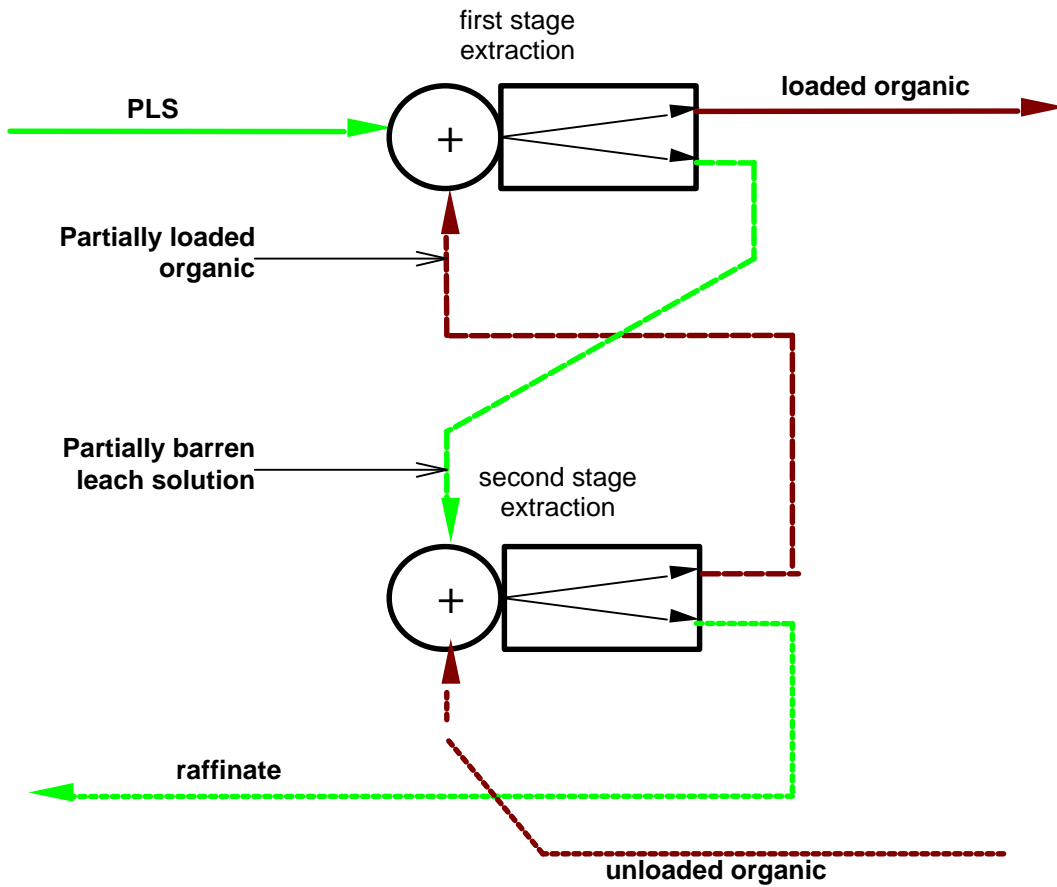


**Figure-4B Field View of Typical SX Settler Tank**  
Typical for both extraction and stripping



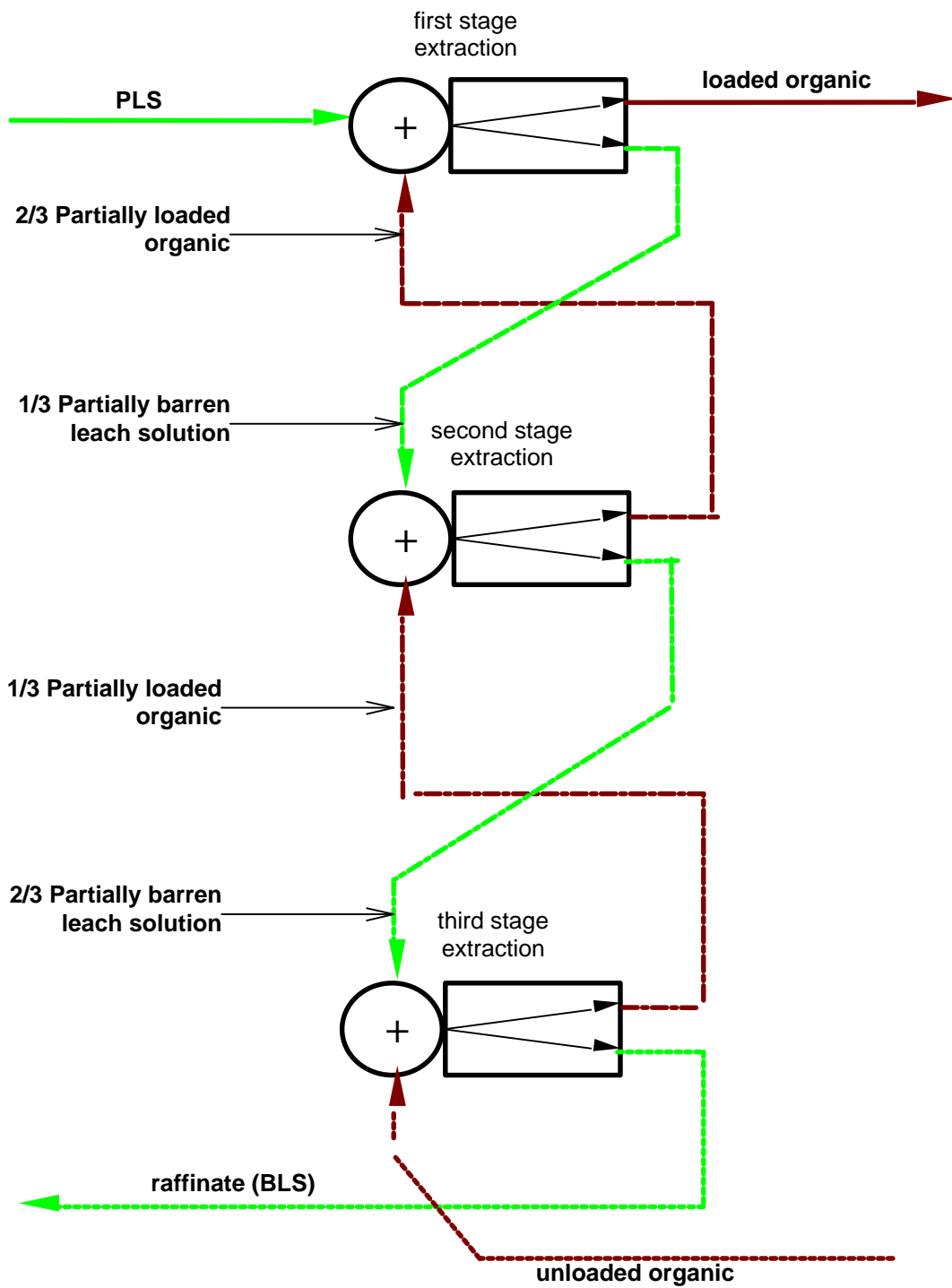
NOTE: Saturated hydrocarbon chain is shown as unbranched for illustrative purposes only. May not depict actual molecular structure.

**Figure-5 Typical Extractant Molecule**



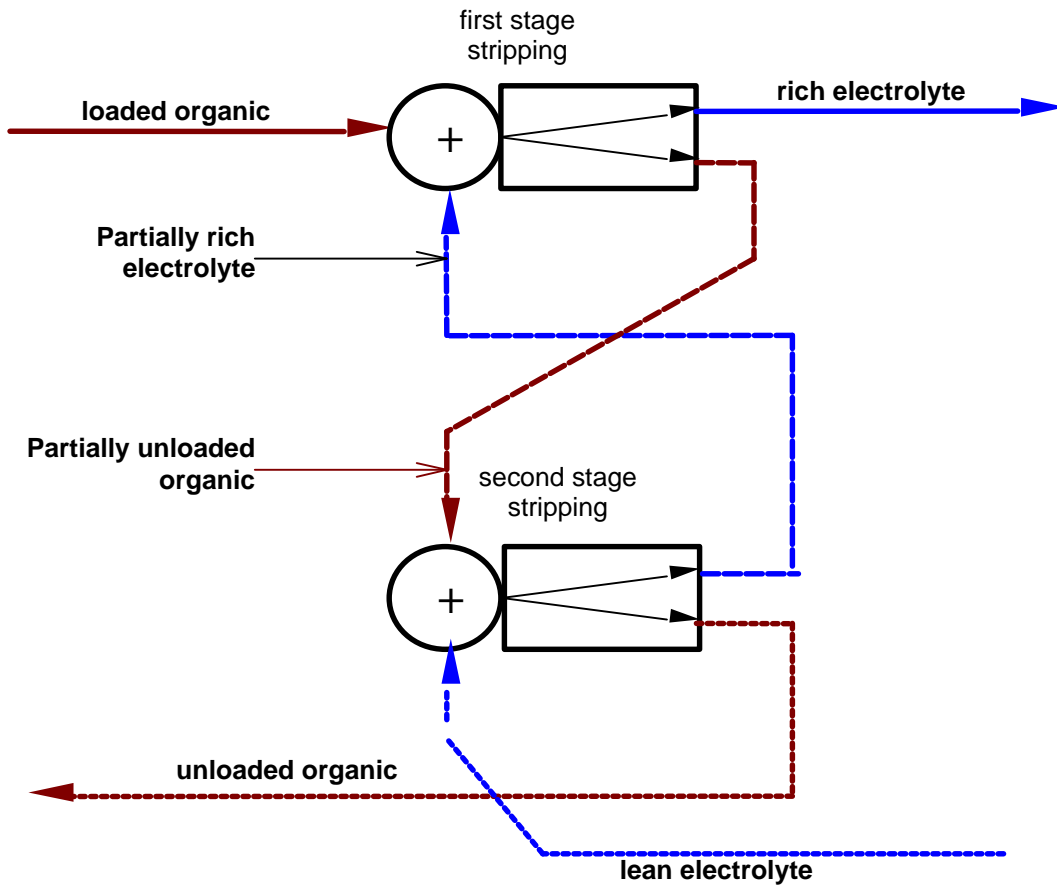
**Figure-6 SXEW Two Stage Extraction**

NO SCALE



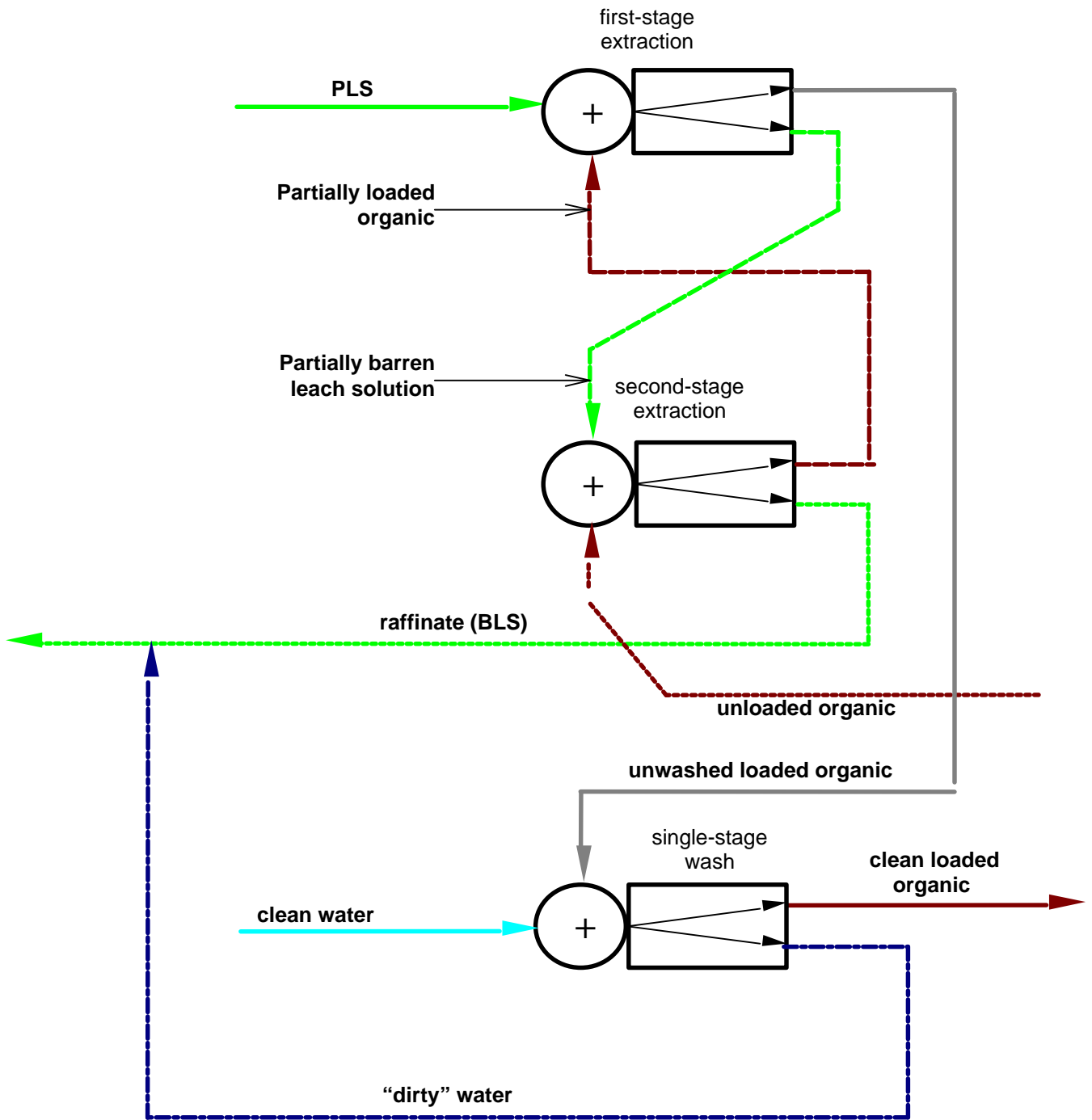
**Figure-7 SXEW Three Stage Extraction**

NO SCALE



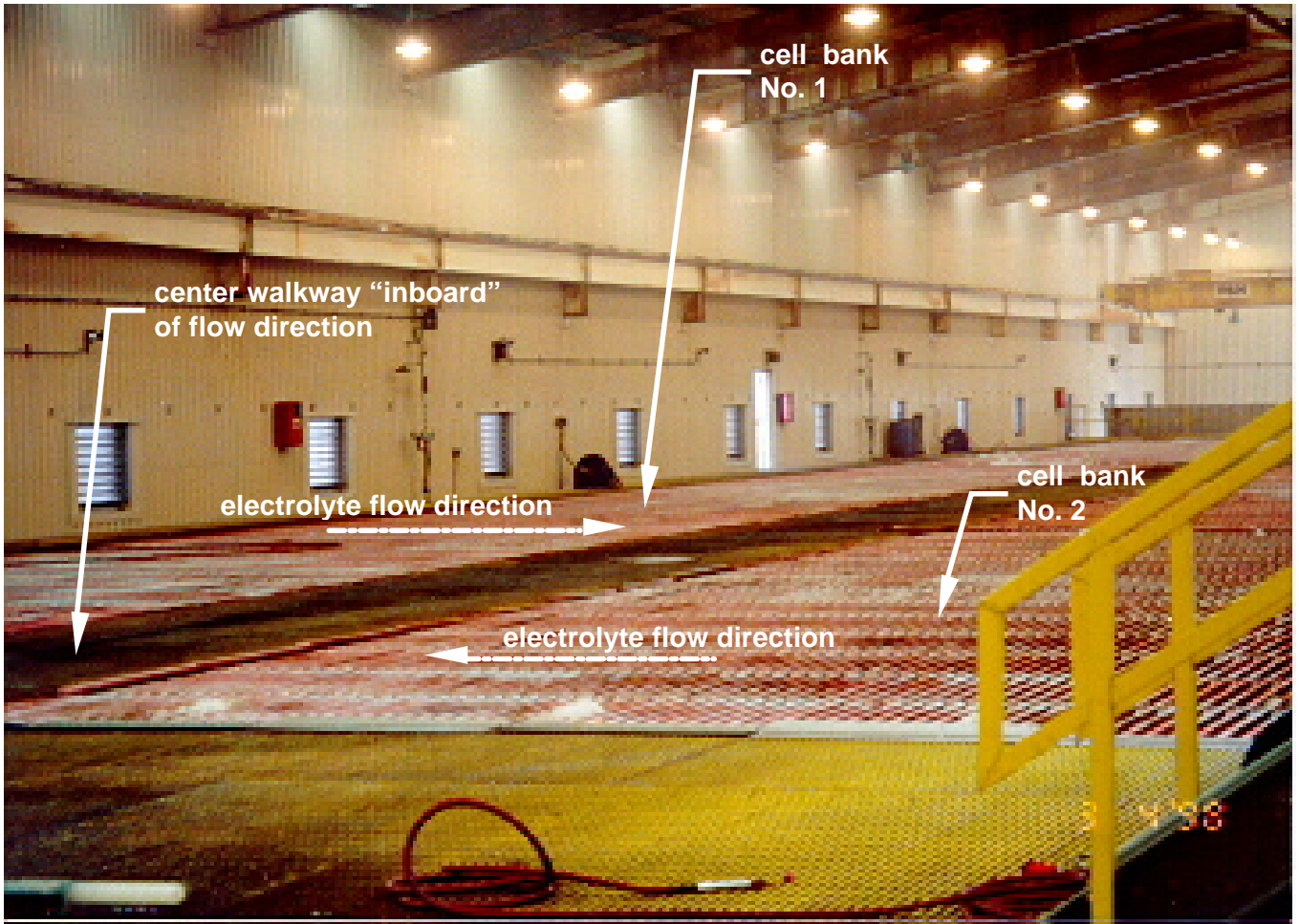
**Figure-8 SXEW Two Stage Stripping**

NO SCALE



**Figure-9 SXEW Two-Stage Extraction with Wash**

NO SCALE

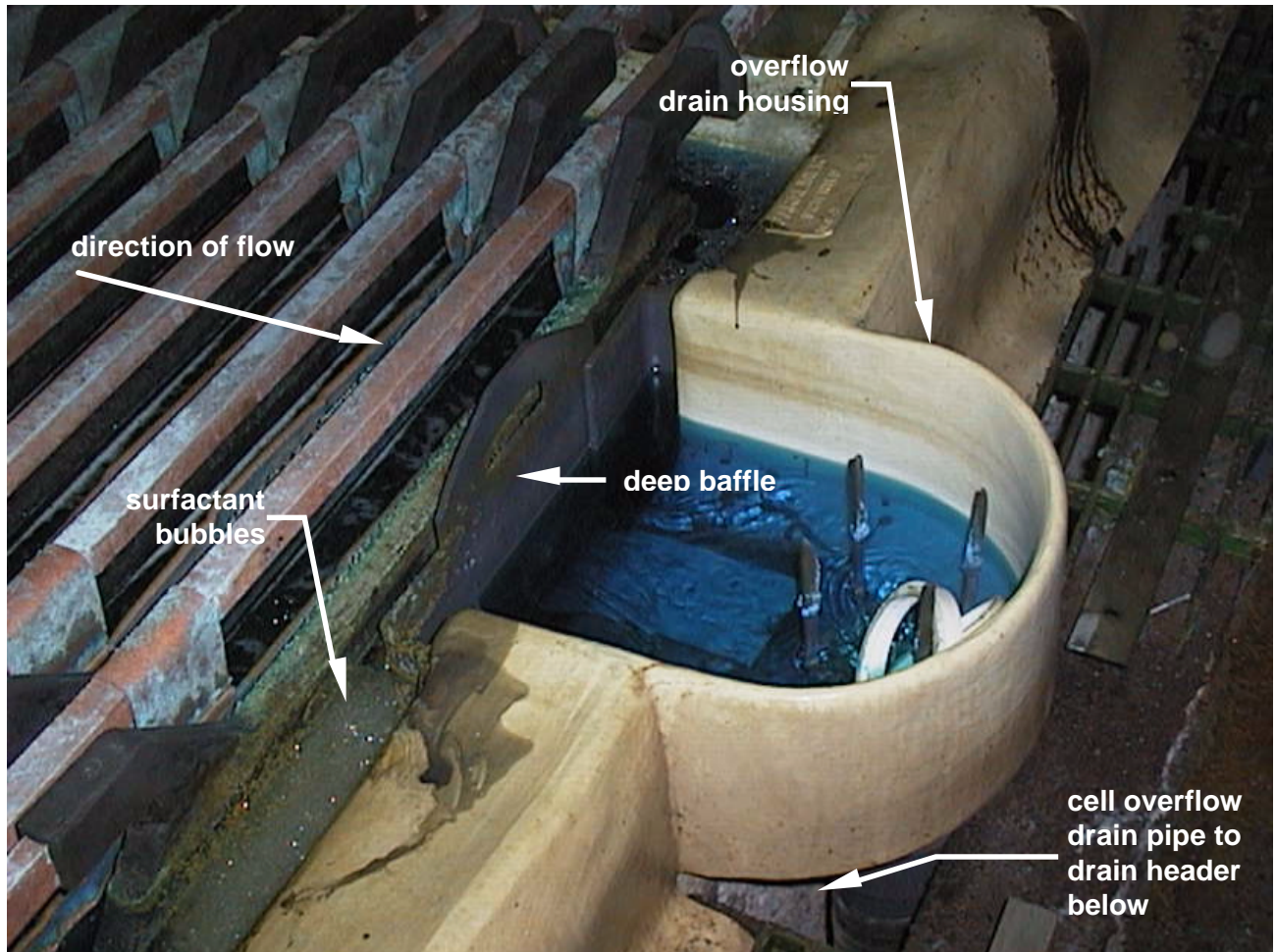


**Figure-10 Operating Train of Electrowinning Cells**





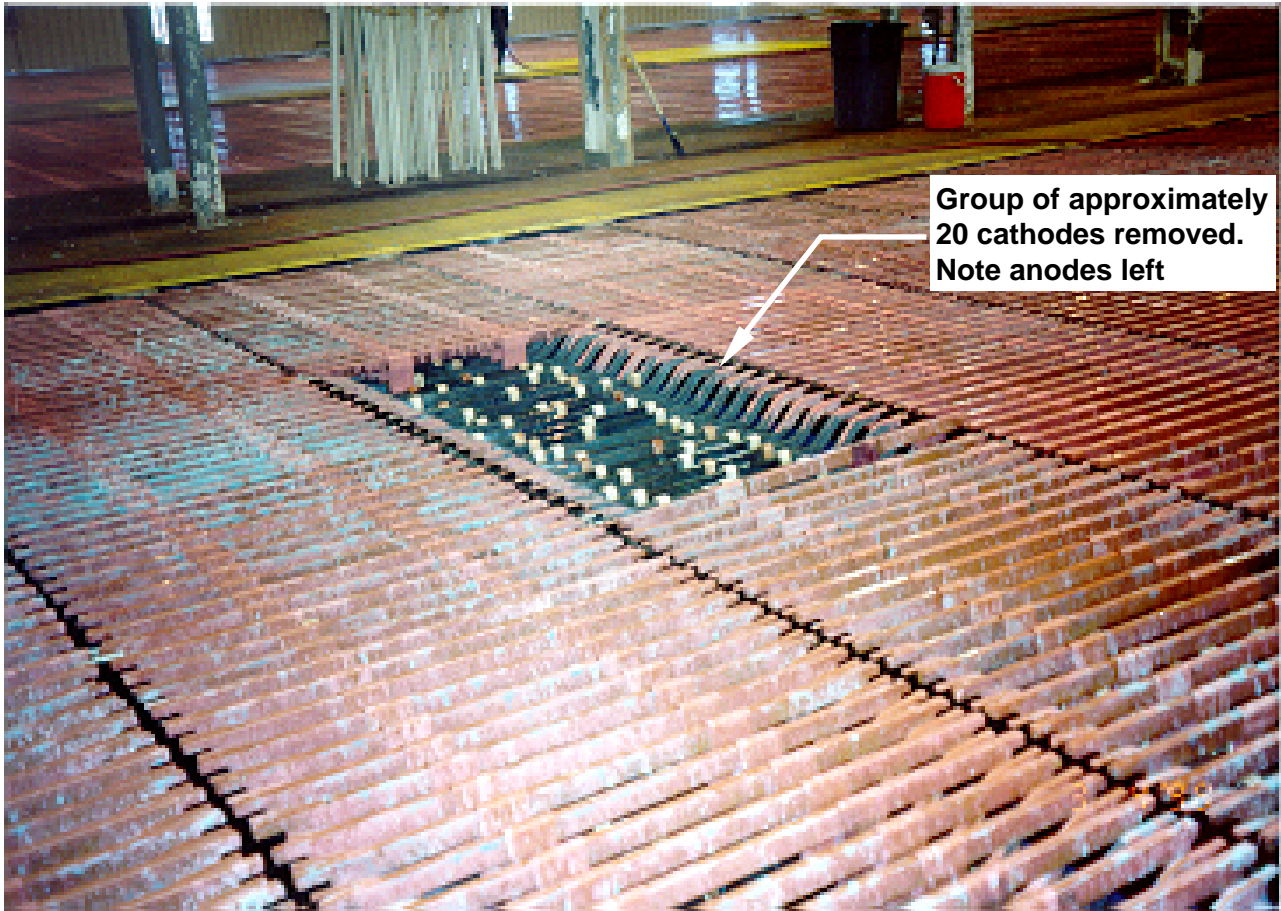
**Figure-11 Basic features of operating cell**



Note 1: The deep baffle extends down 2-1/2 to 3 feet into the electrolyte solution to encourage retainment of surfactant and associated bubbles in the cell.

Note 2: Overflow drain is open at the top for ease of visual verification of cell flow.

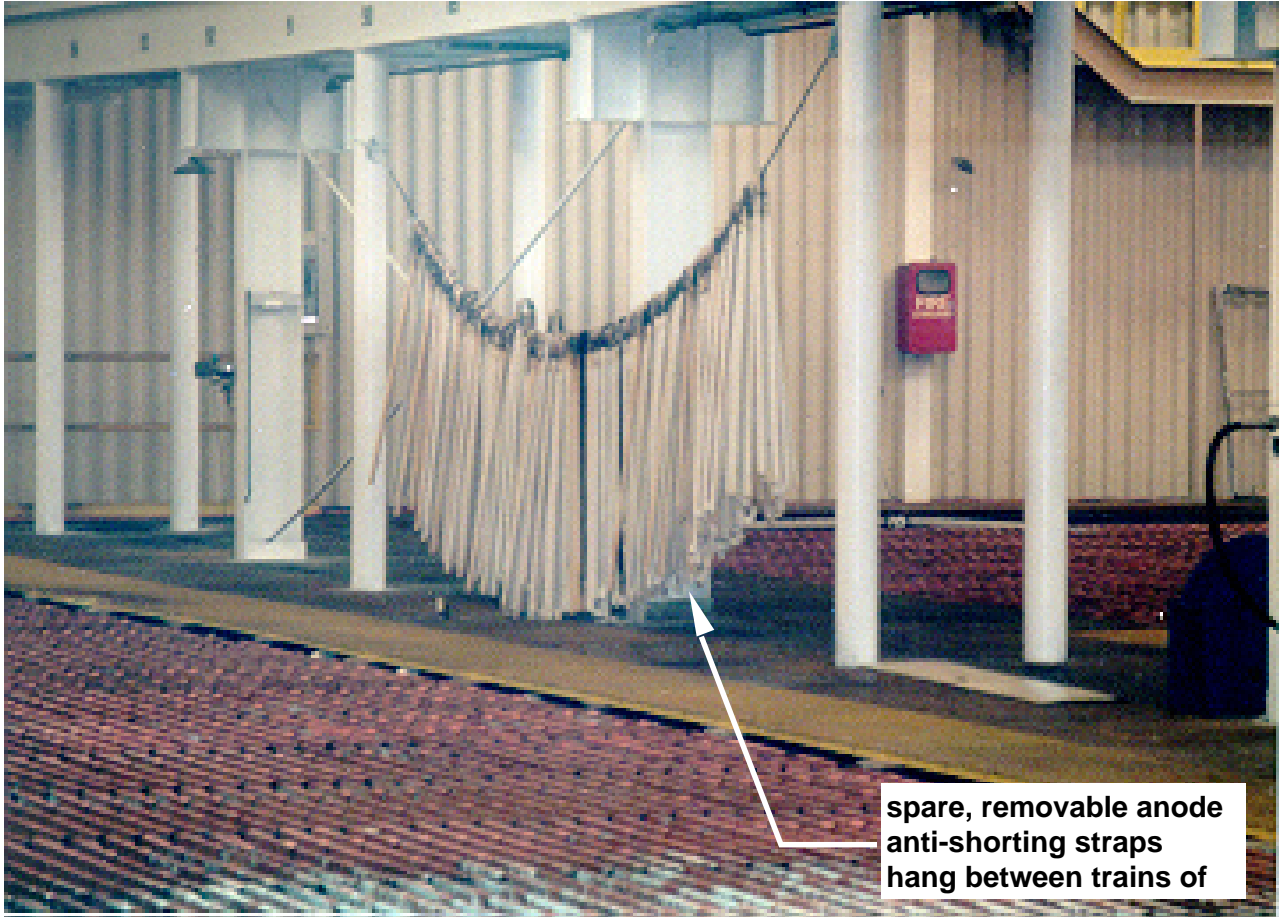
**Figure-12 Cell Overflow Drain**



NOTE 1: Hanger bars drop down toward electrolyte surface to reduce potential interference with lifting hooks as they interlock with cathodes.

NOTE 2: White marks on anodes are part of plastic insulator spacers installed to prevent interplate shorting.

**Figure-13 Cell After Lift Of Finished Cathodes Removed**

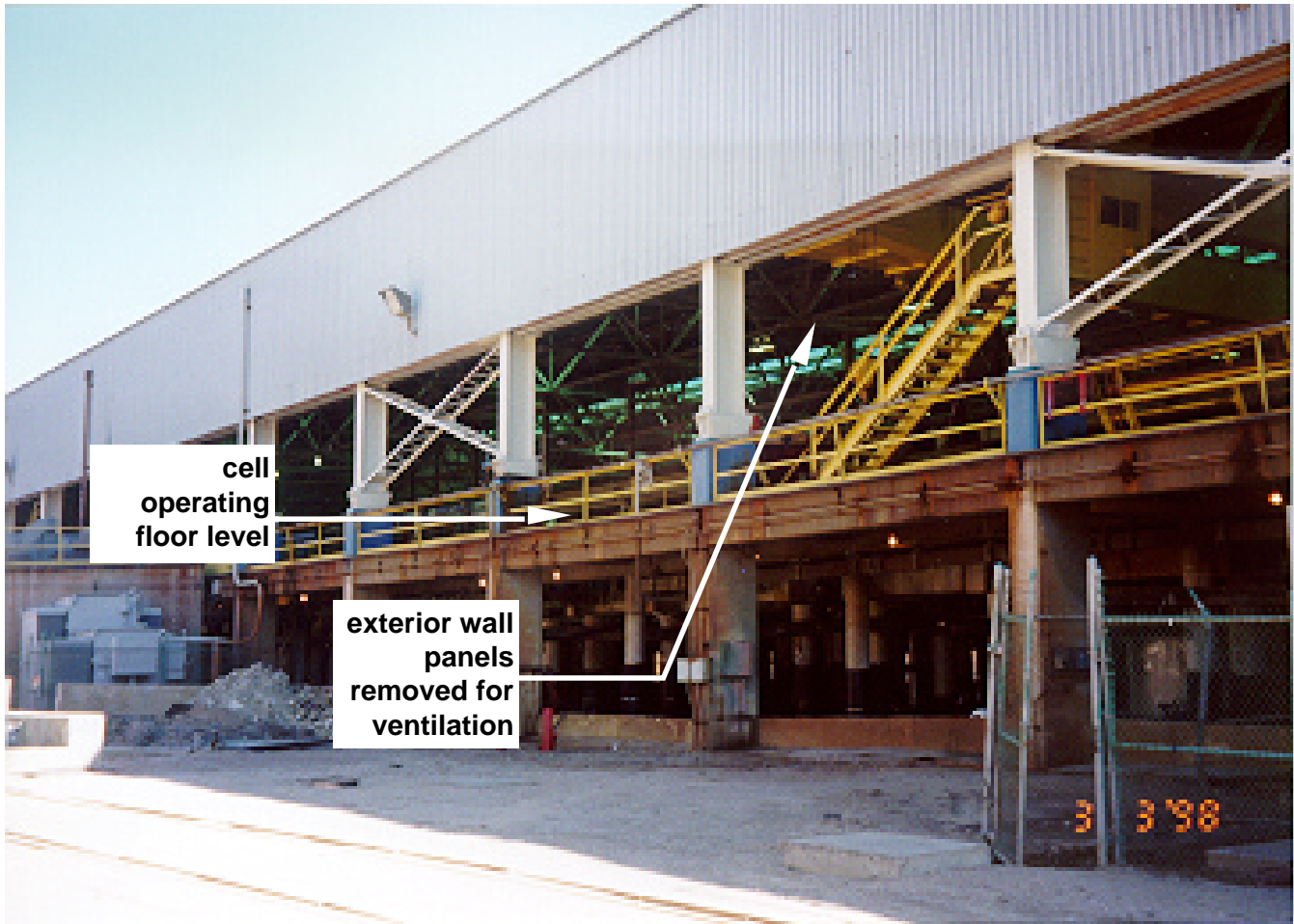


**Figure-14 Removable Anti-shorting Straps**

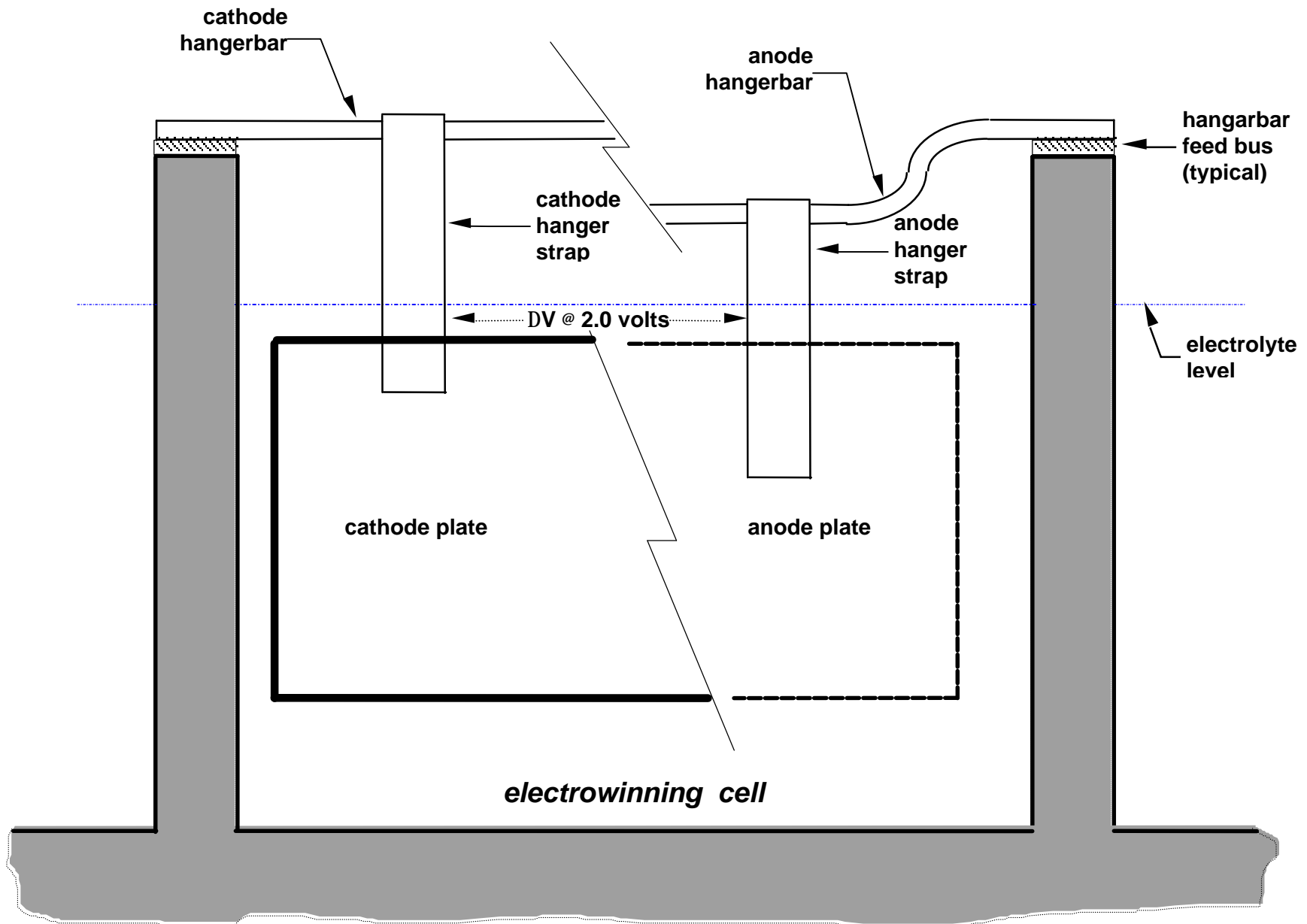


electrical insulator  
straps to prevent  
anode to cathode  
shorting

**Figure-15 Spare Anodes**



**Figure-16 Typical Exterior View Of Tankhouse**

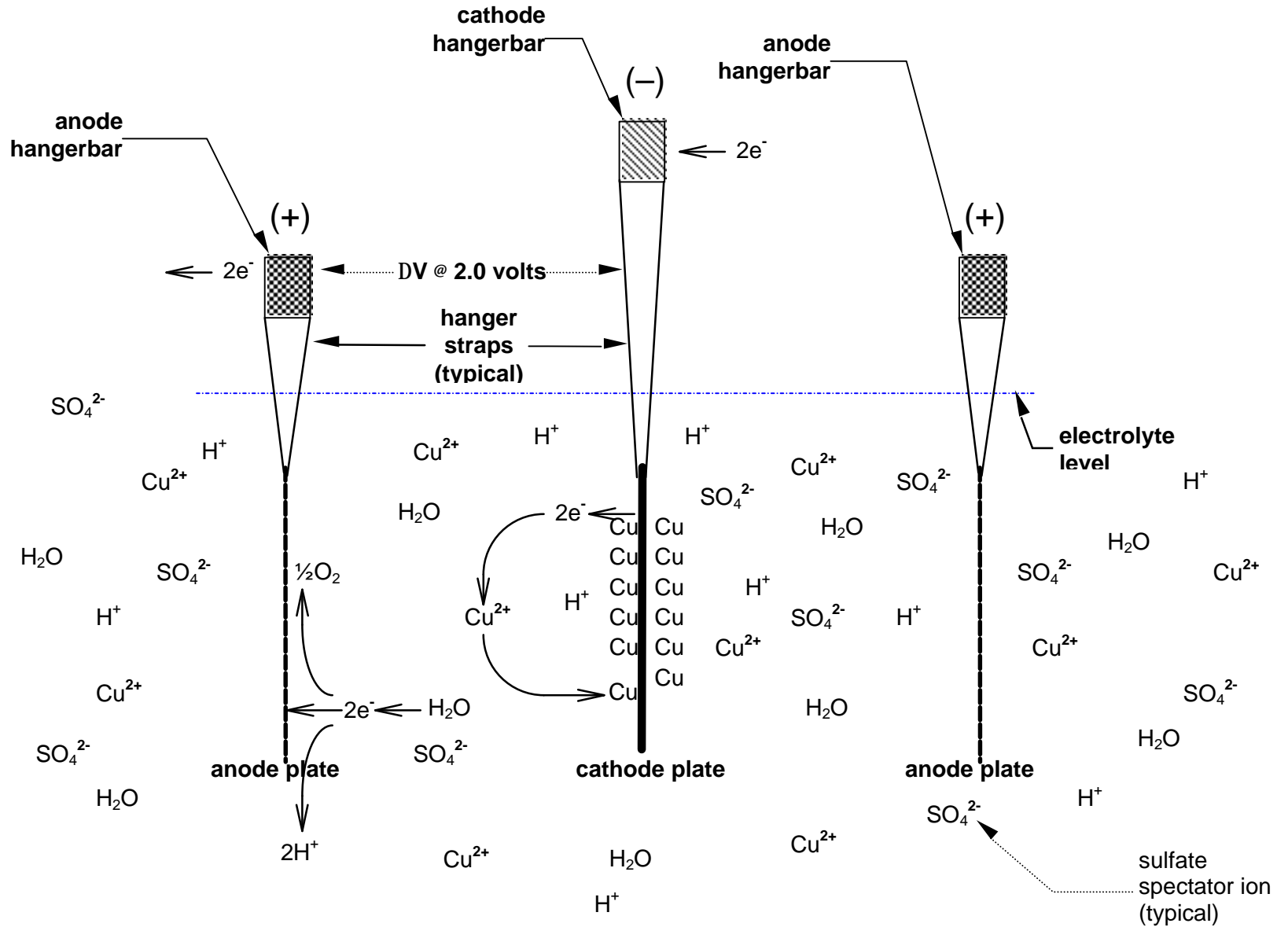


NOTE: Hangarbars are shown at electrical feed ends. Unviewed ends are insulated from feed bus.

**Figure-17 Transverse Cross Section of Electrowinning Cell**

NO SCALE



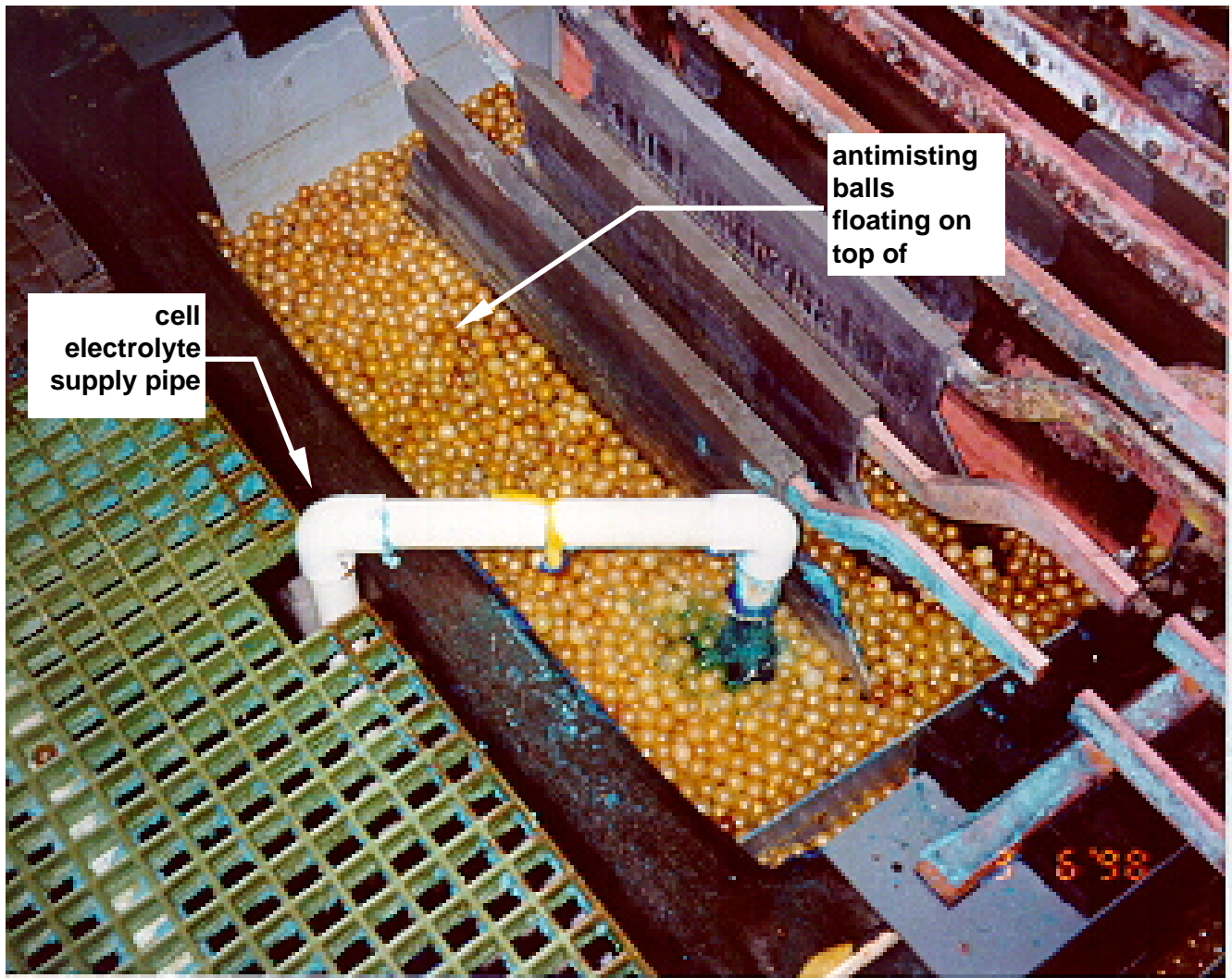


NOTE: Hangerbars straps are made of copper to provide electrical continuity from each hangerbar to its plate.

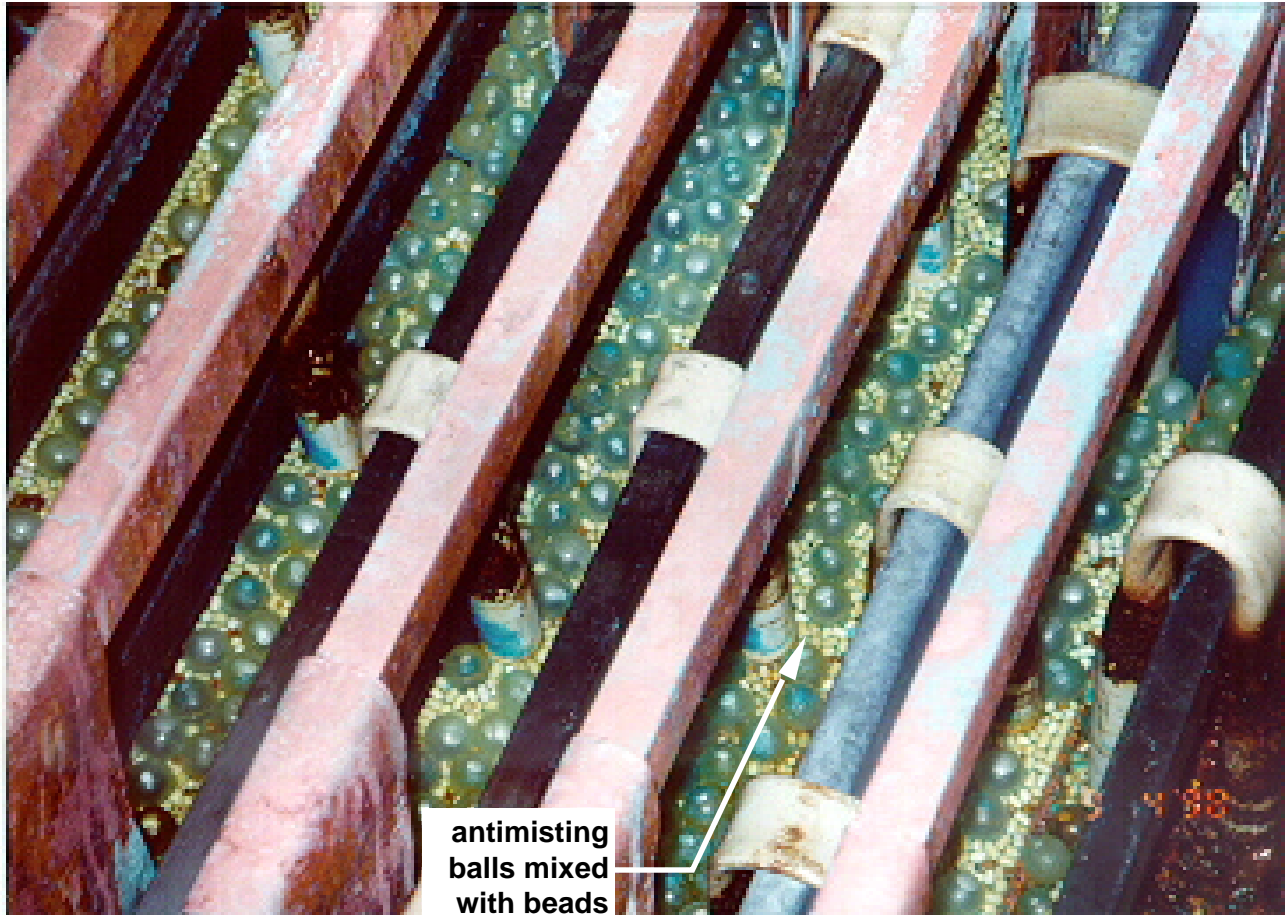
**Figure-18 Longitudinal Cross Section of Electrowinning Cell**

NO SCALE

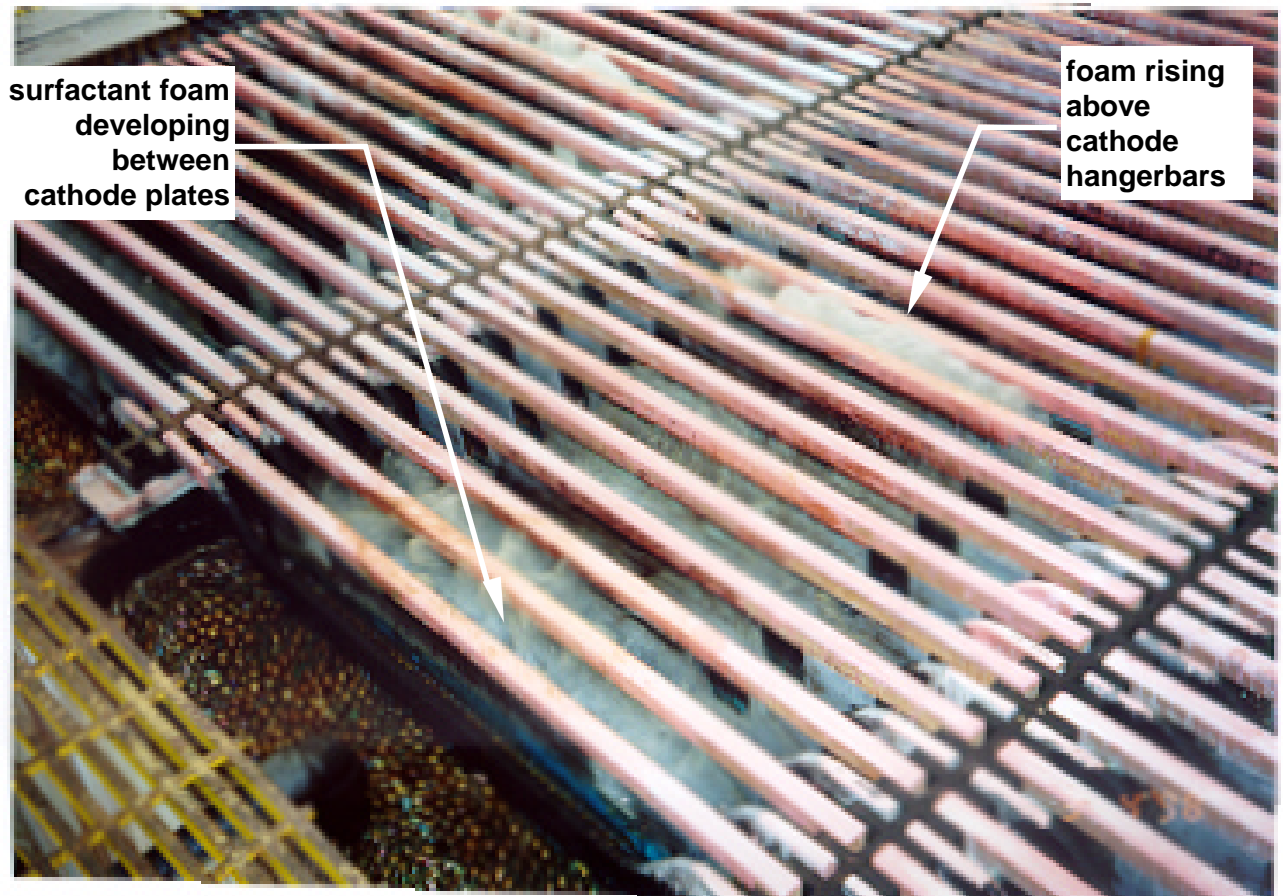




**Figure-19 Antimisting Float Media - 3/4-inch Plastic Balls**



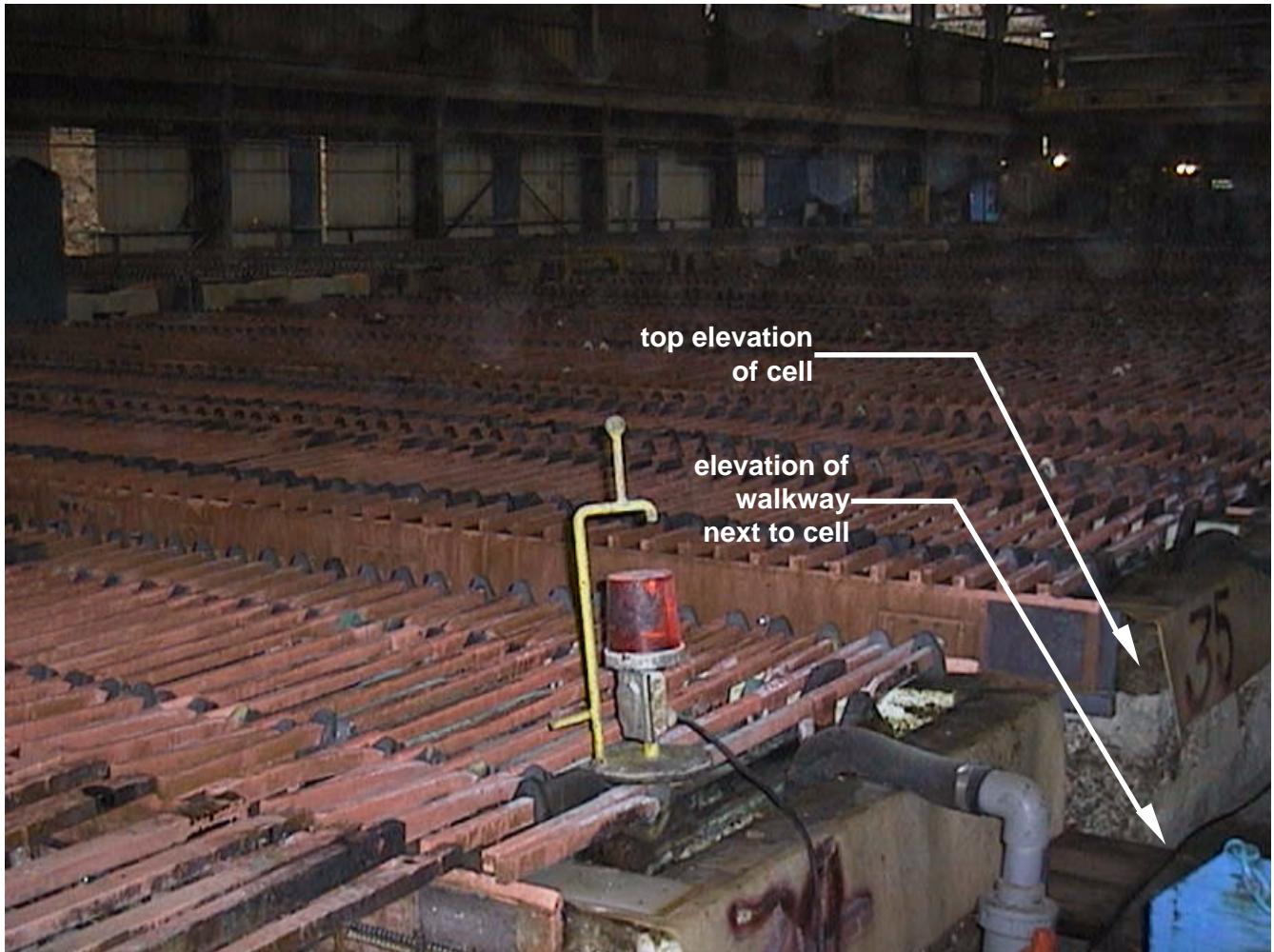
**Figure-20 Antimisting Float Media - Combination of Plastic Balls and Beads**



**Figure-21 Foam Bubble Generation by Surfactant Antimisting Agent**



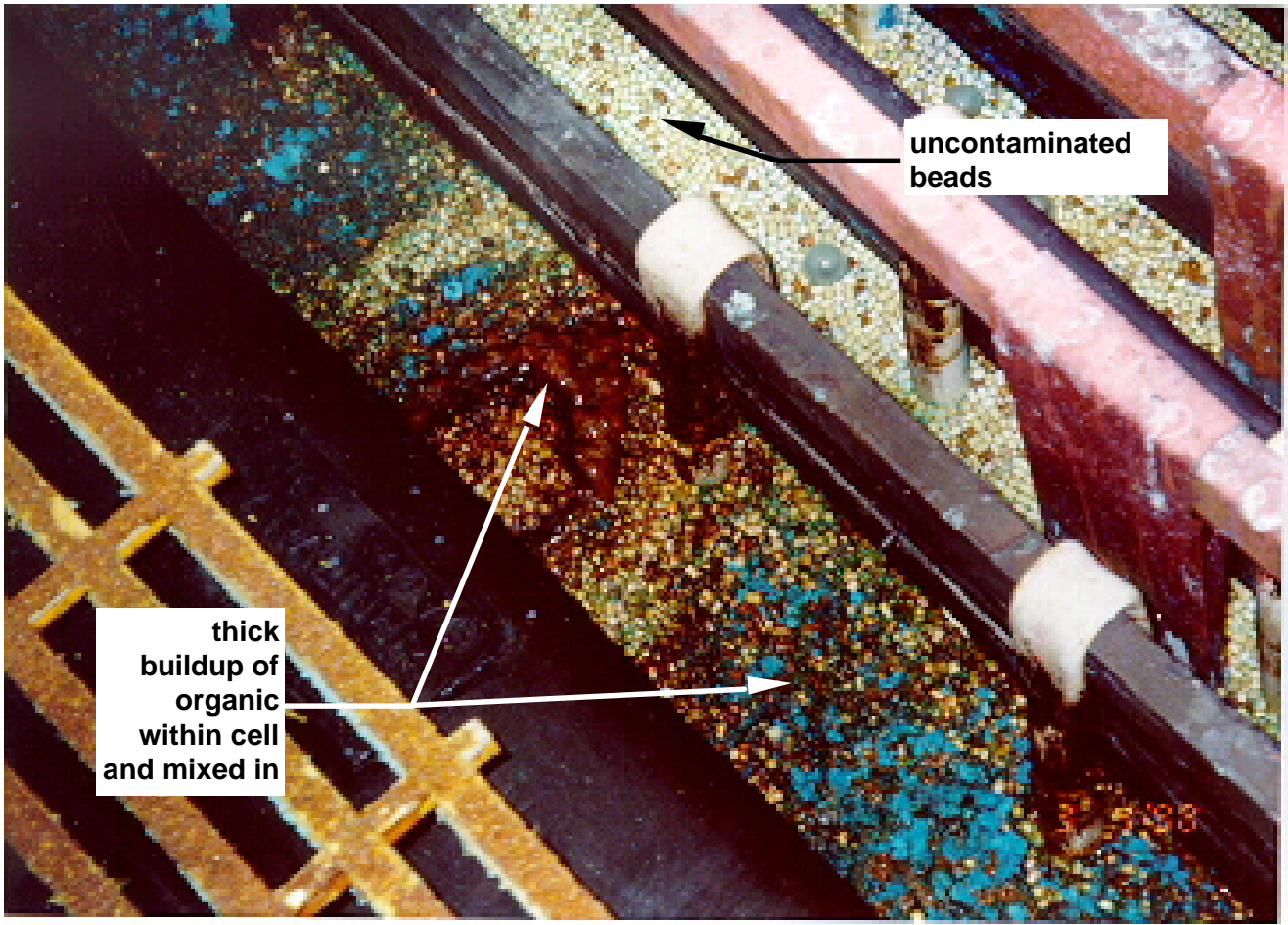
**Figure-22 Antimisting Fabric Membrane**



**Figure-23 Elevated Cell Tops**

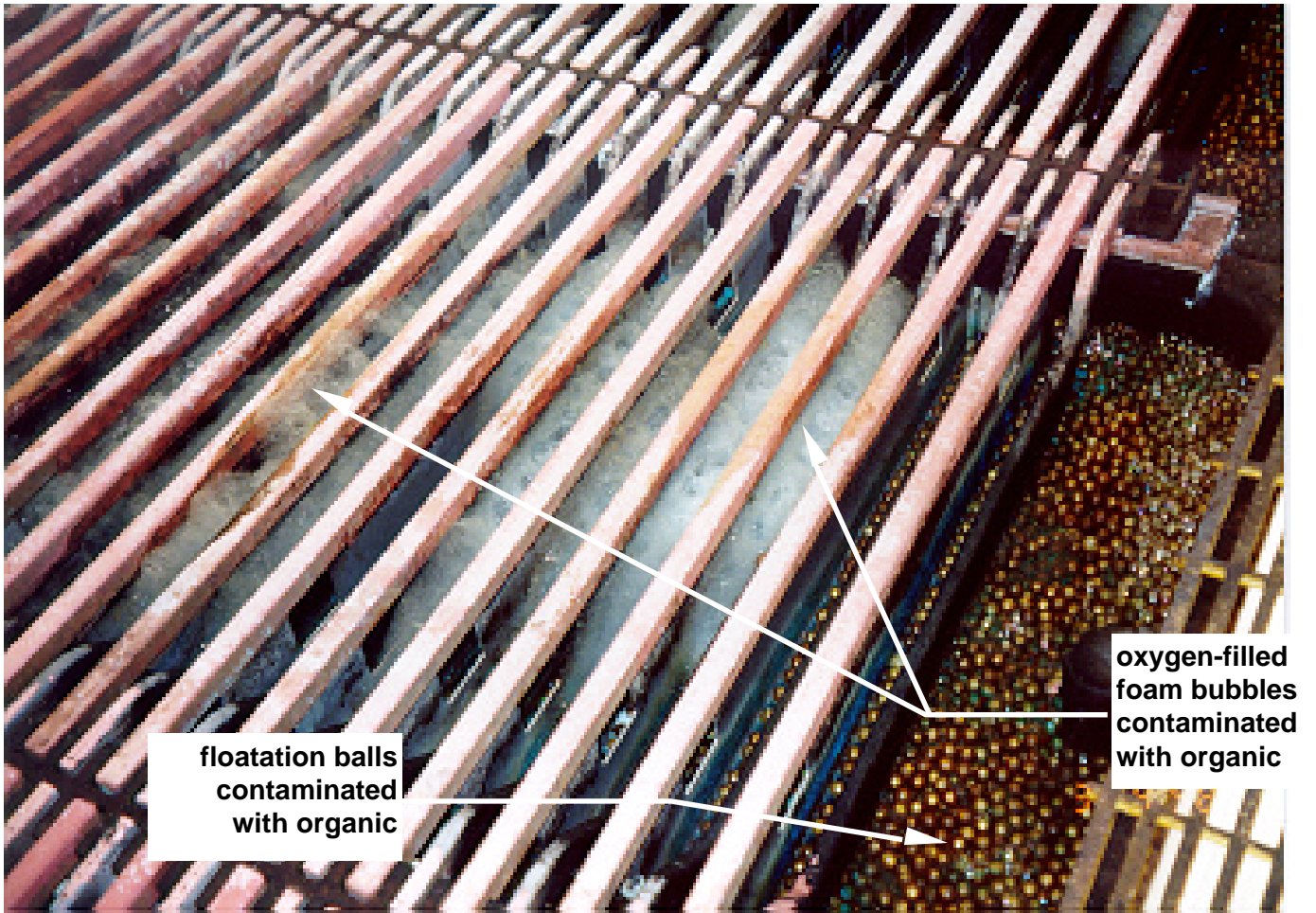


**Figure-24 Non-production Cells for Removing Fugitive Organic**



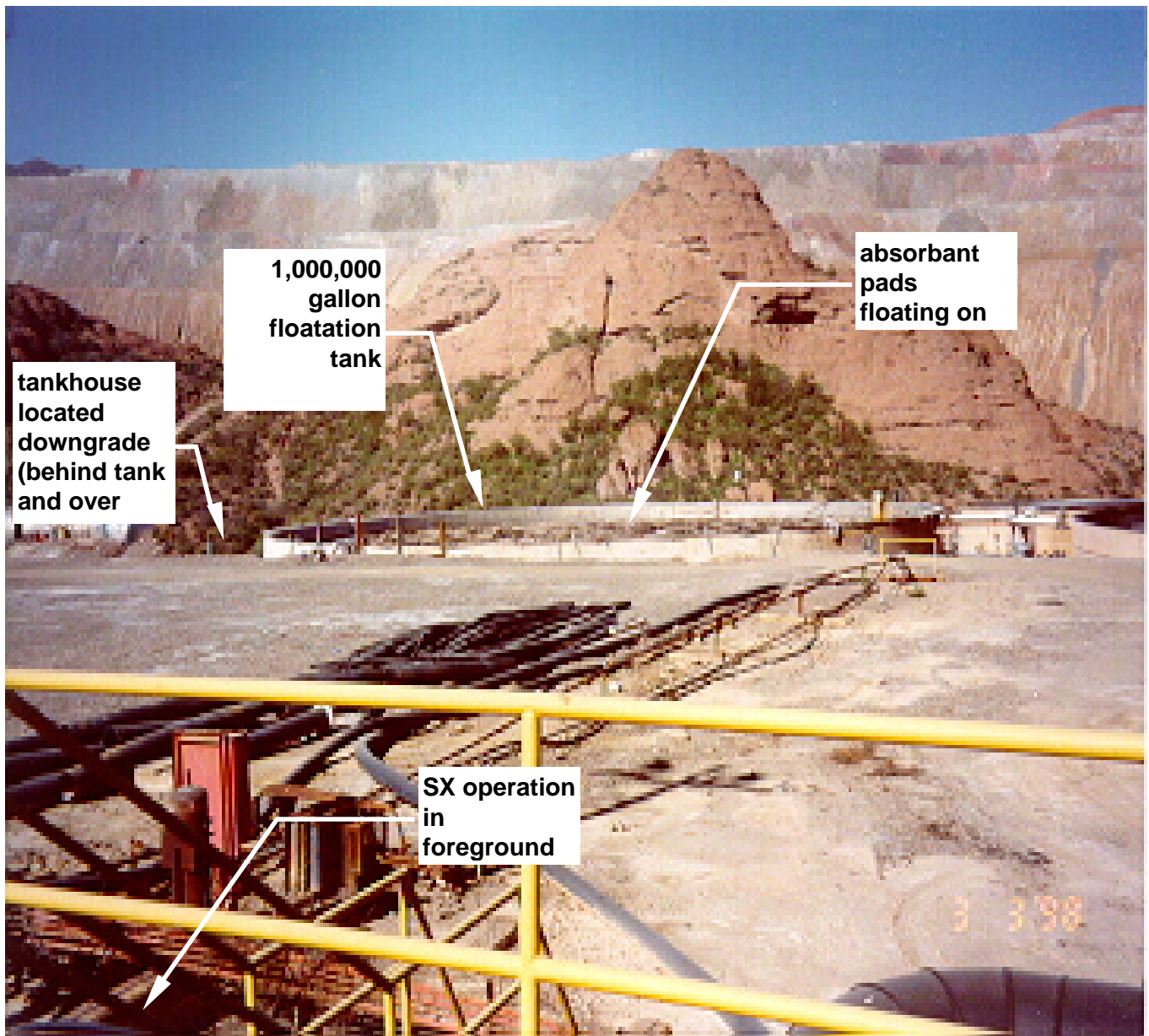
**Figure-25 Cell Contaminated with Fugitive Organic**





**Figure-26 Surfactant Bubbles Contaminated with Fugitive Organic**

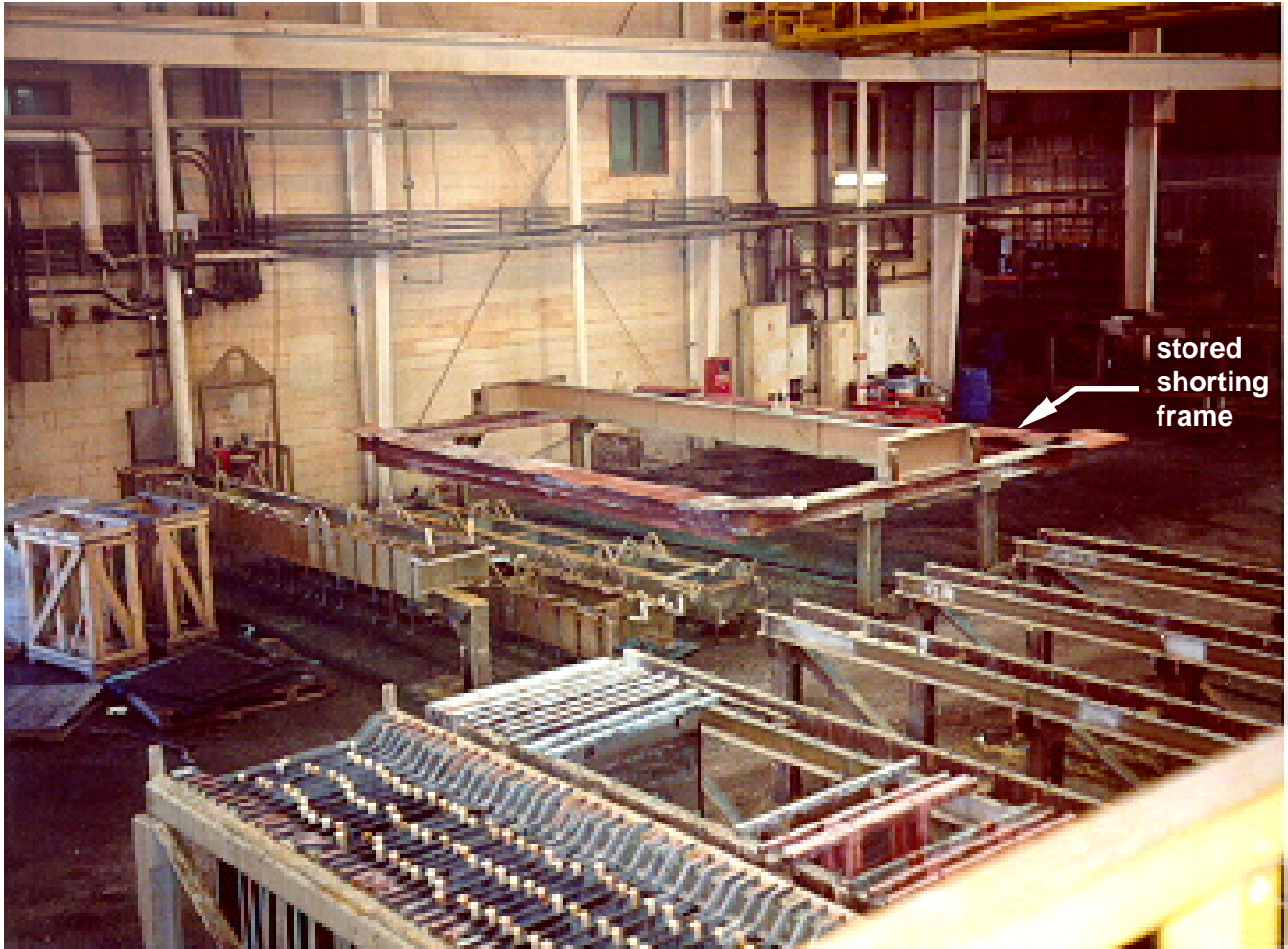




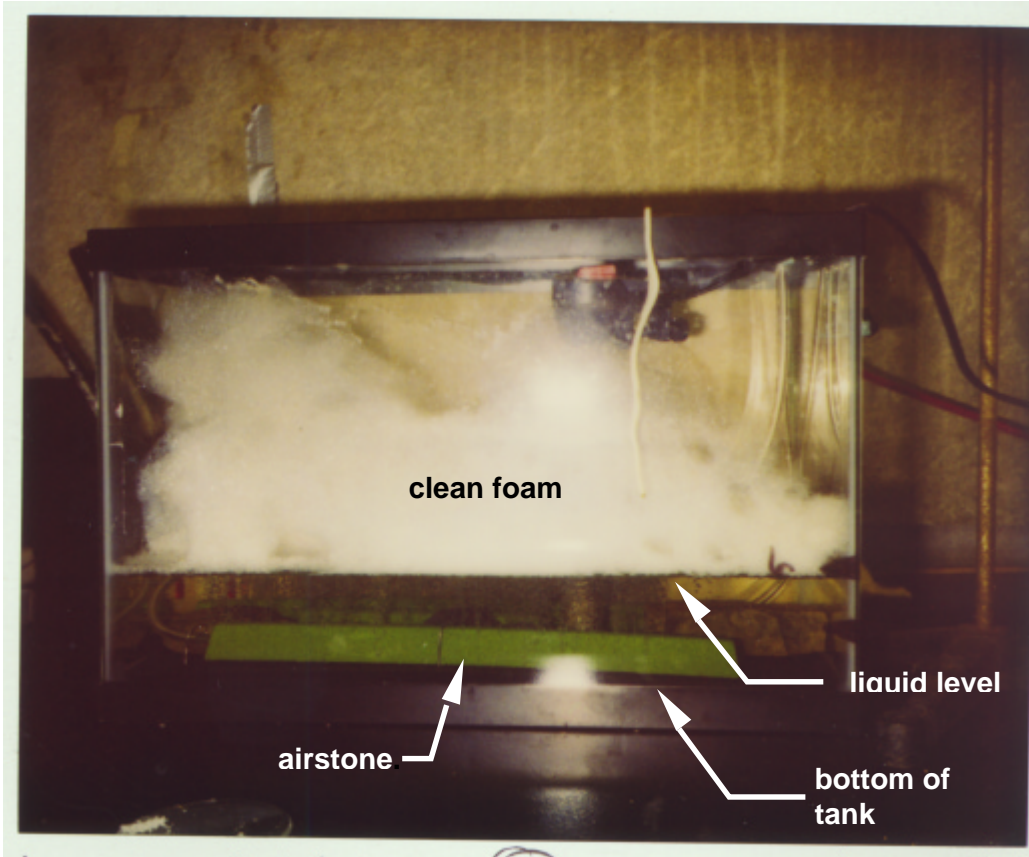
**Figure-27 Electrolyte Flotation Tank for Entrapping Fugitive Organic**



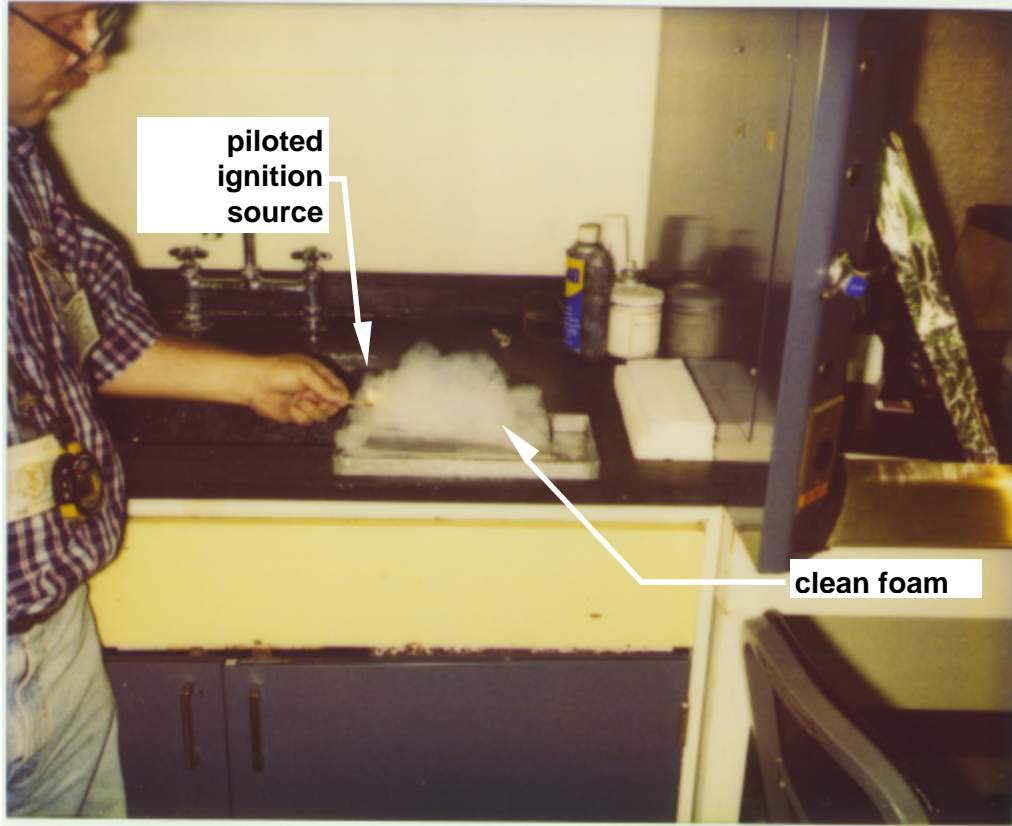
**Figure-28 Bank of Garnet / Anthracite Filters for Removing Organic from Electrolyte Prior to Entering Tankhouse**



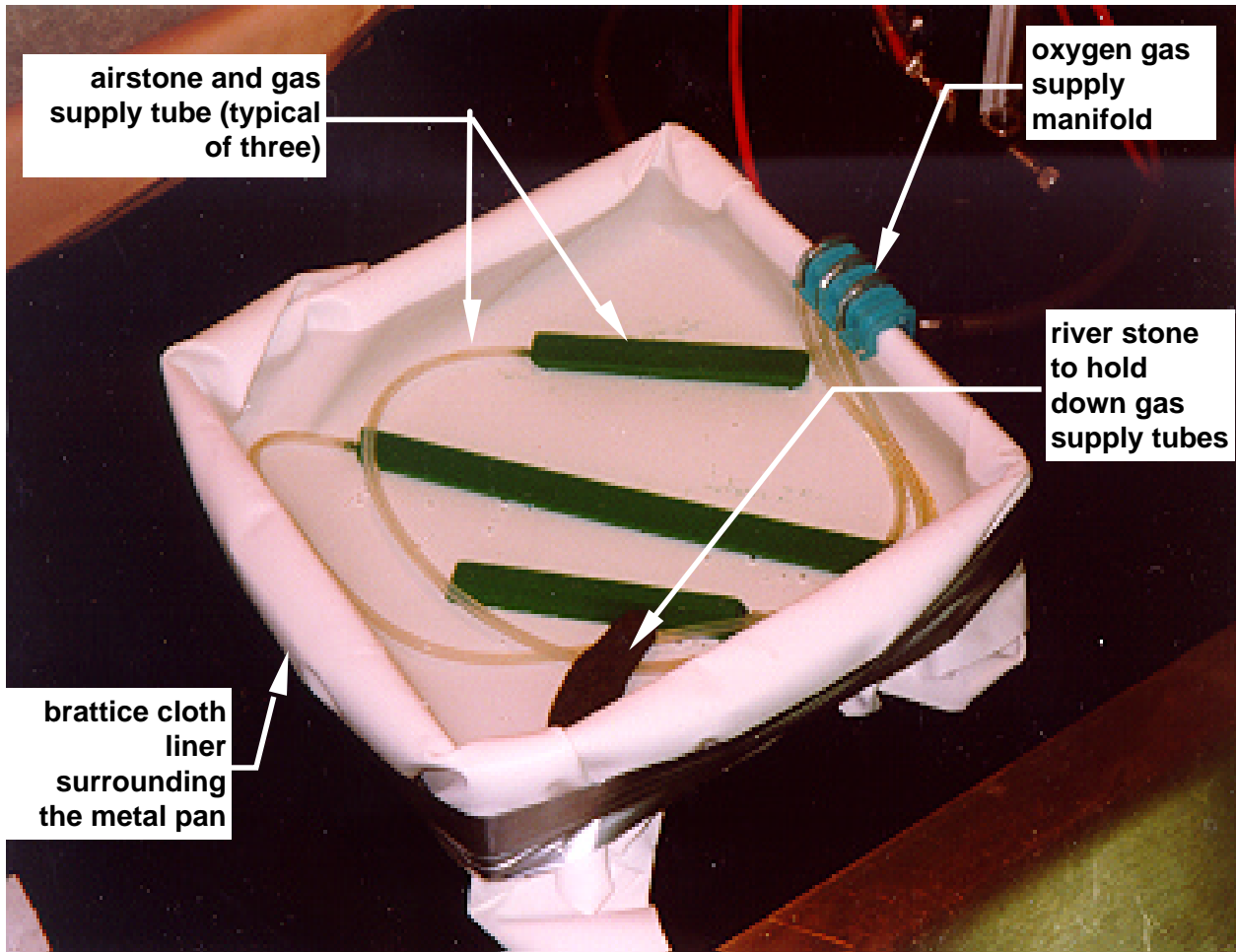
**Figure-29 Cell Shorting Frame in Stored Location**



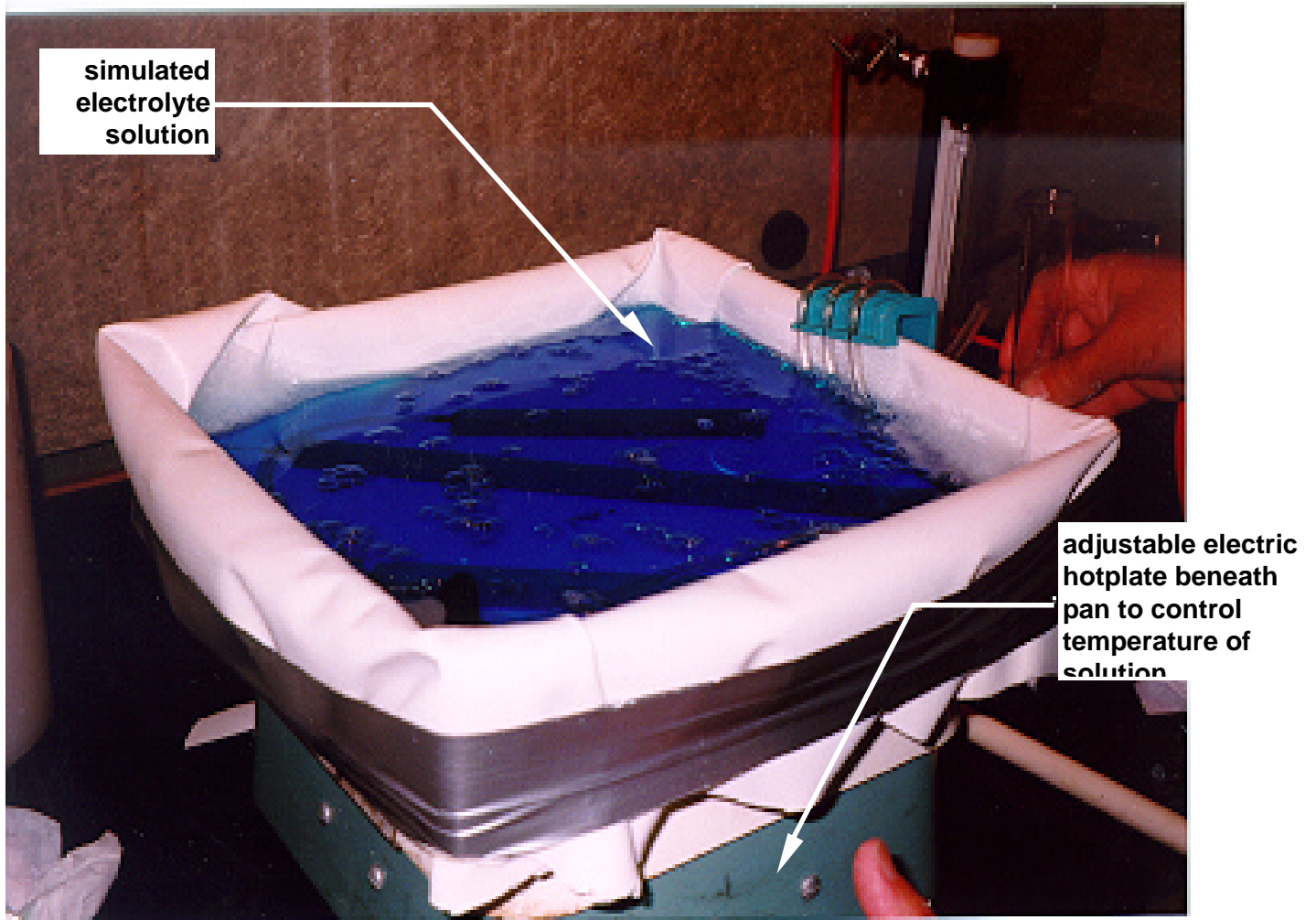
**Figure-30 15- Liter Cell with Surfactant Foam**



**Figure-31 Ignitability Testing of Clean Foam**

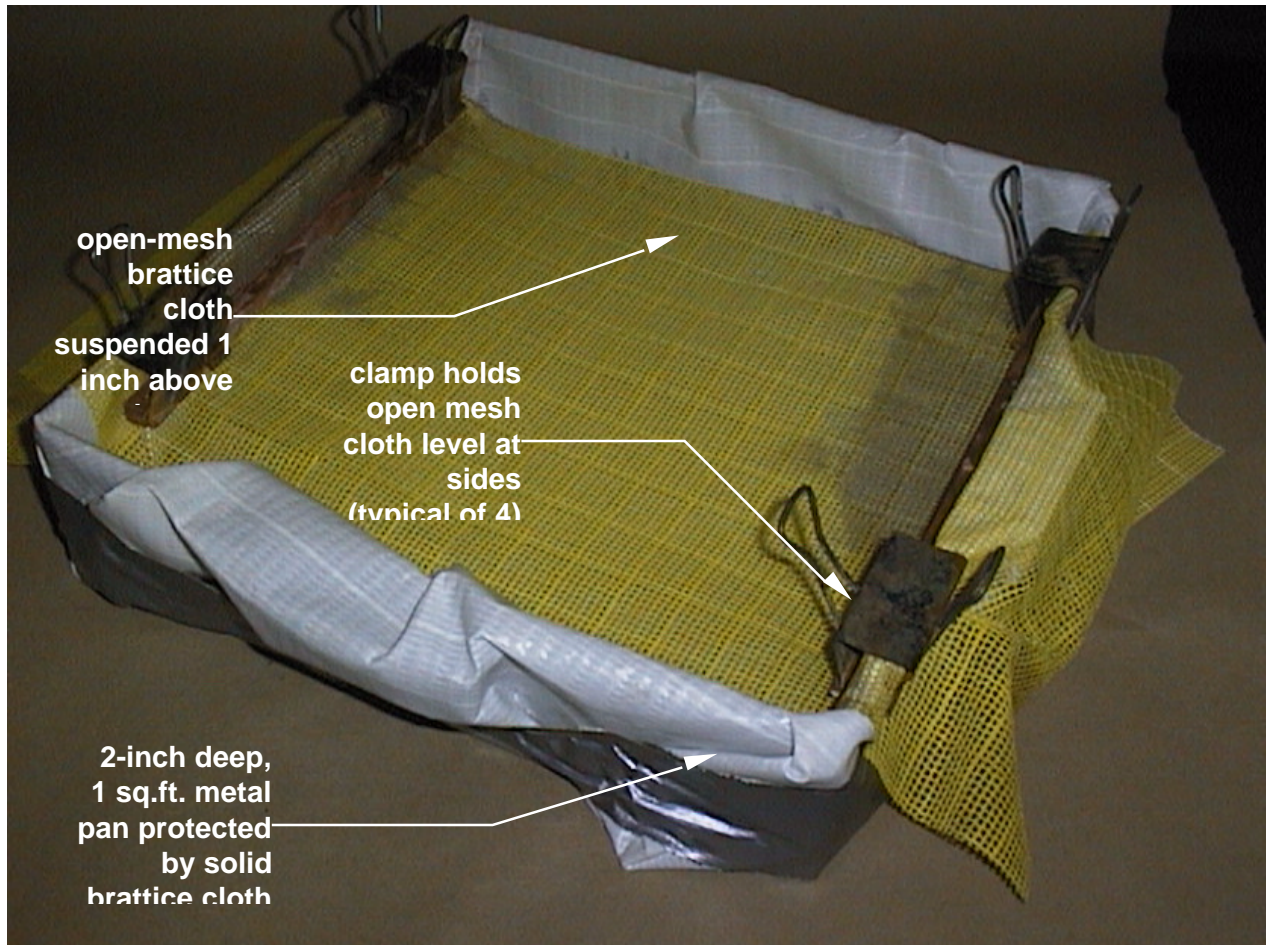


**Figure-32 Lined Test Pan with Water**



**Figure-33 Test Pan with Electrolyte and beginning of Bubble Production**





**NOTES:**

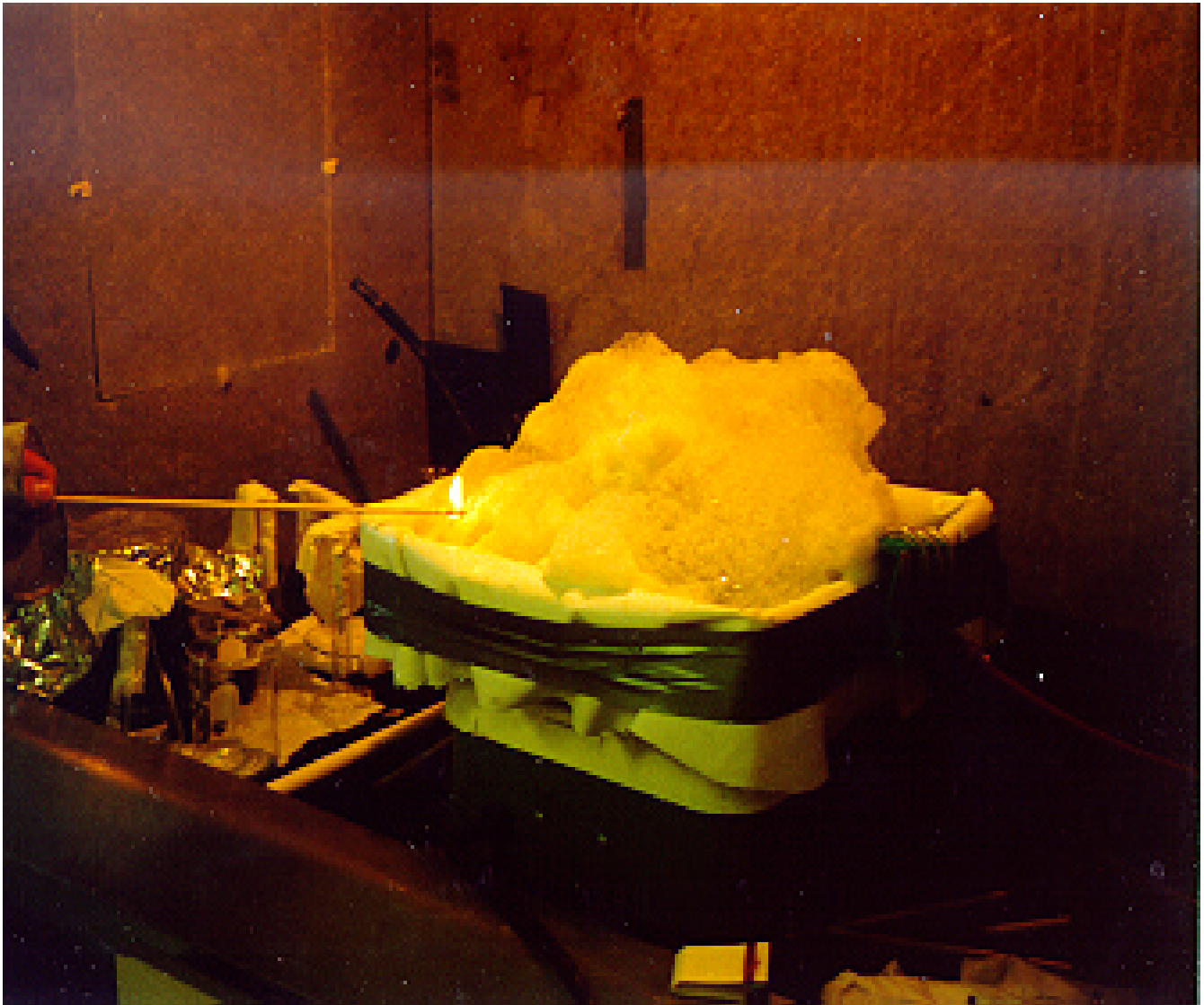
1. Pan is filled with electrolyte to level of open-mesh brattice cloth.
2. Air stones for oxygen are located below open-mesh cloth (stones not shown).
3. Electrolyte is covered with organic solution, which becomes entrapped by open-mesh cloth

**Figure-34 “Dirty Bubbles” Pan Test Apparatus**





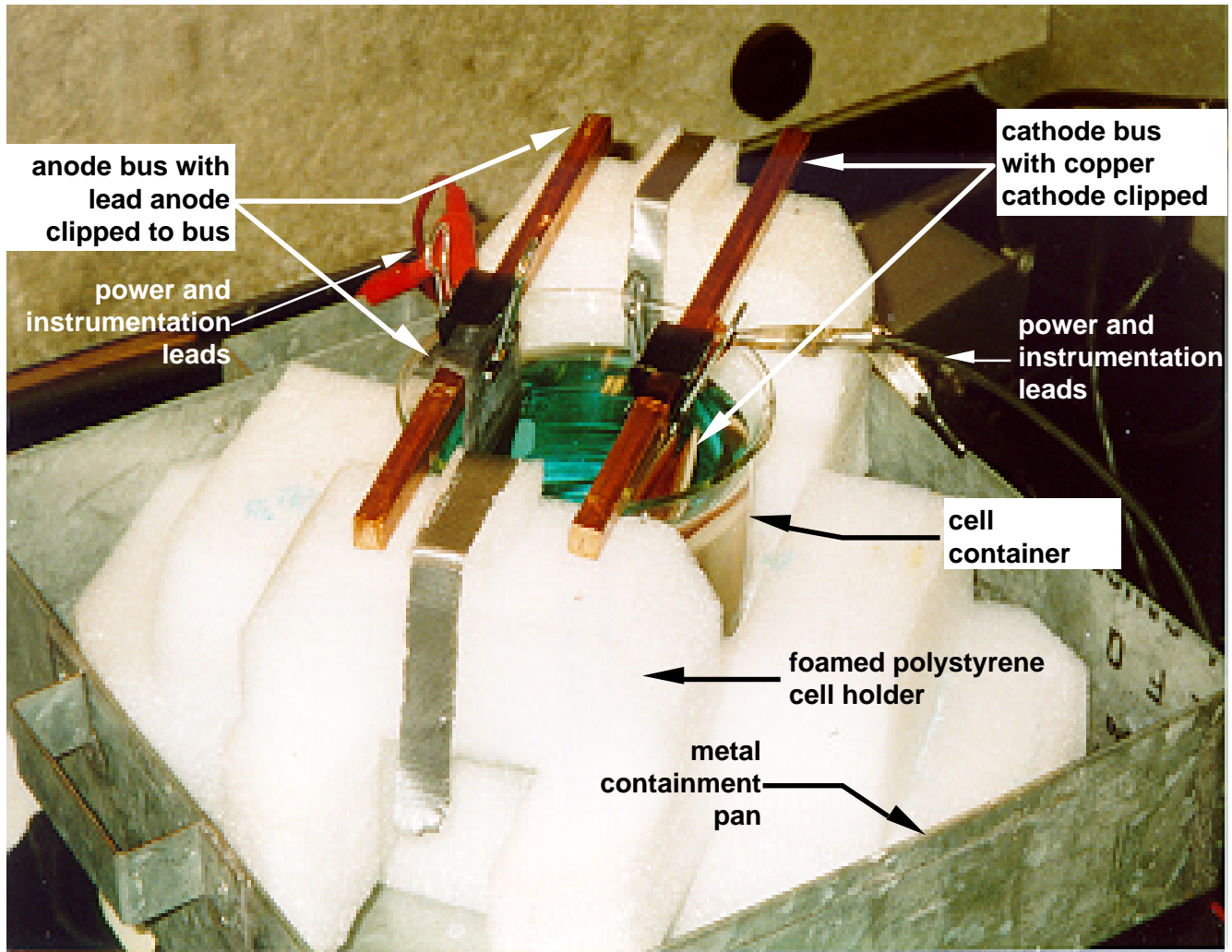
**Figure-35 "Dirty Bubbles" Generated in Pan Test Apparatus**



**Figure-36 Application of Piloted Ignition Source to Contaminated Bubbles**

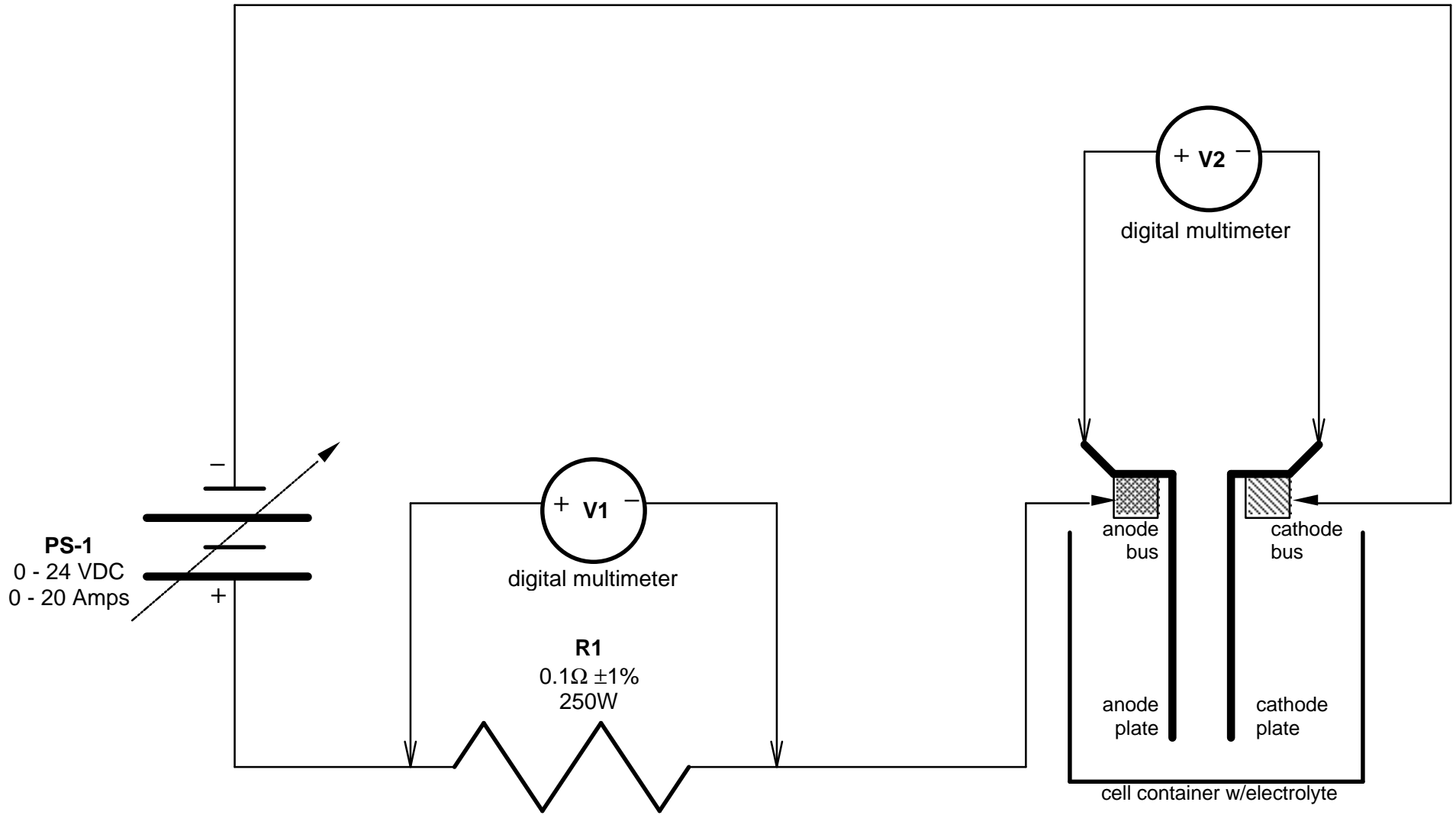


**Figure-37 Contaminated Bubbles Burning in Pan Test Apparatus**



Note: The foamed polystyrene cell holder is used to support the anode and cathode buses above the cell. The metal pan both supports the cell holder and provides a degree of containment should the electrolyte spill from the cell.

**Figure-38 One-Liter Electro-winning Cell**

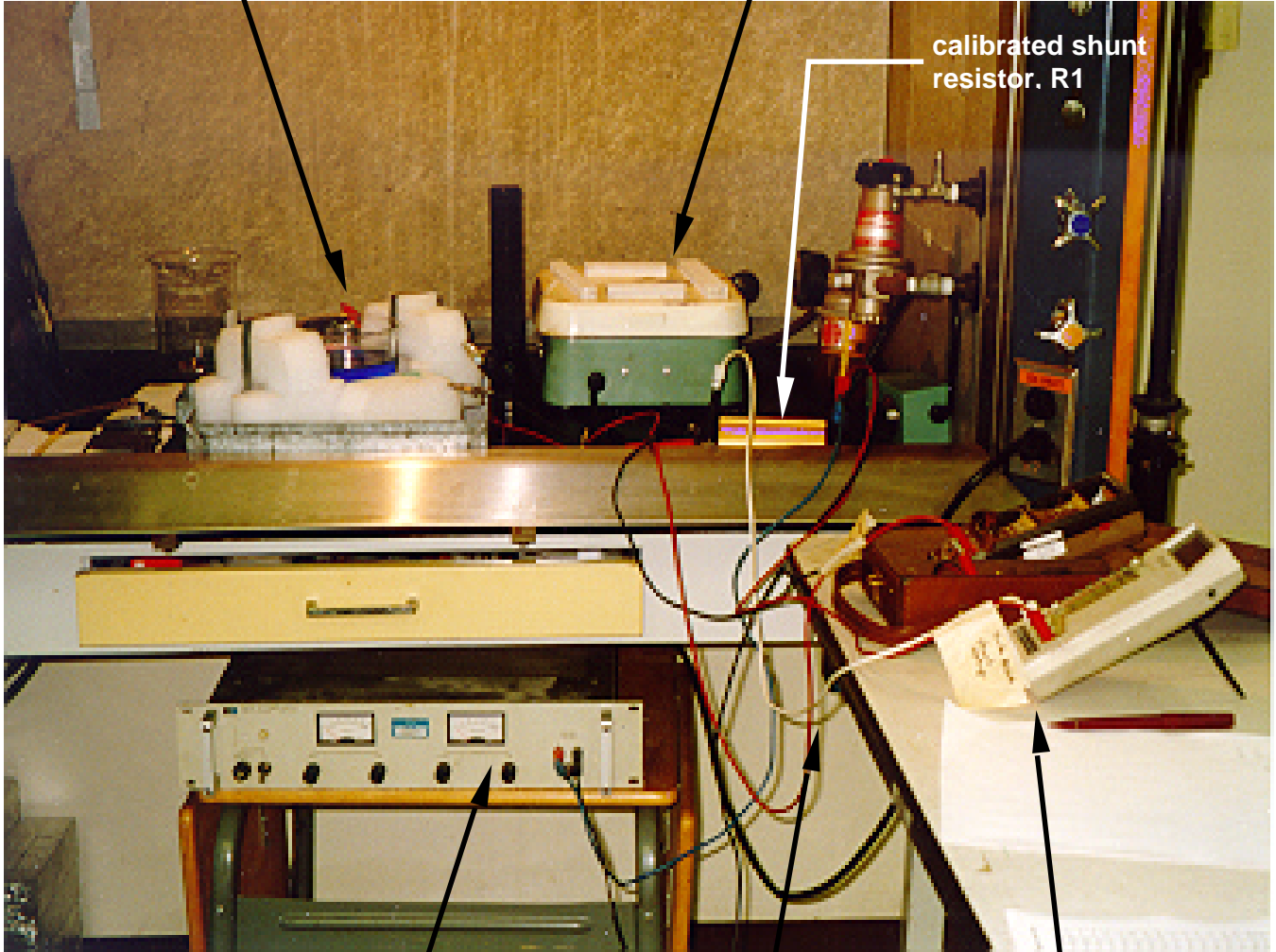


**Figure-39 One-Liter Electrowinning Cell Electrical Schematic**

NO SCALE

1-liter cell with foam holder and containment pan

hotplate with marinite spacers.  
Cell and containment pan rests on this during test



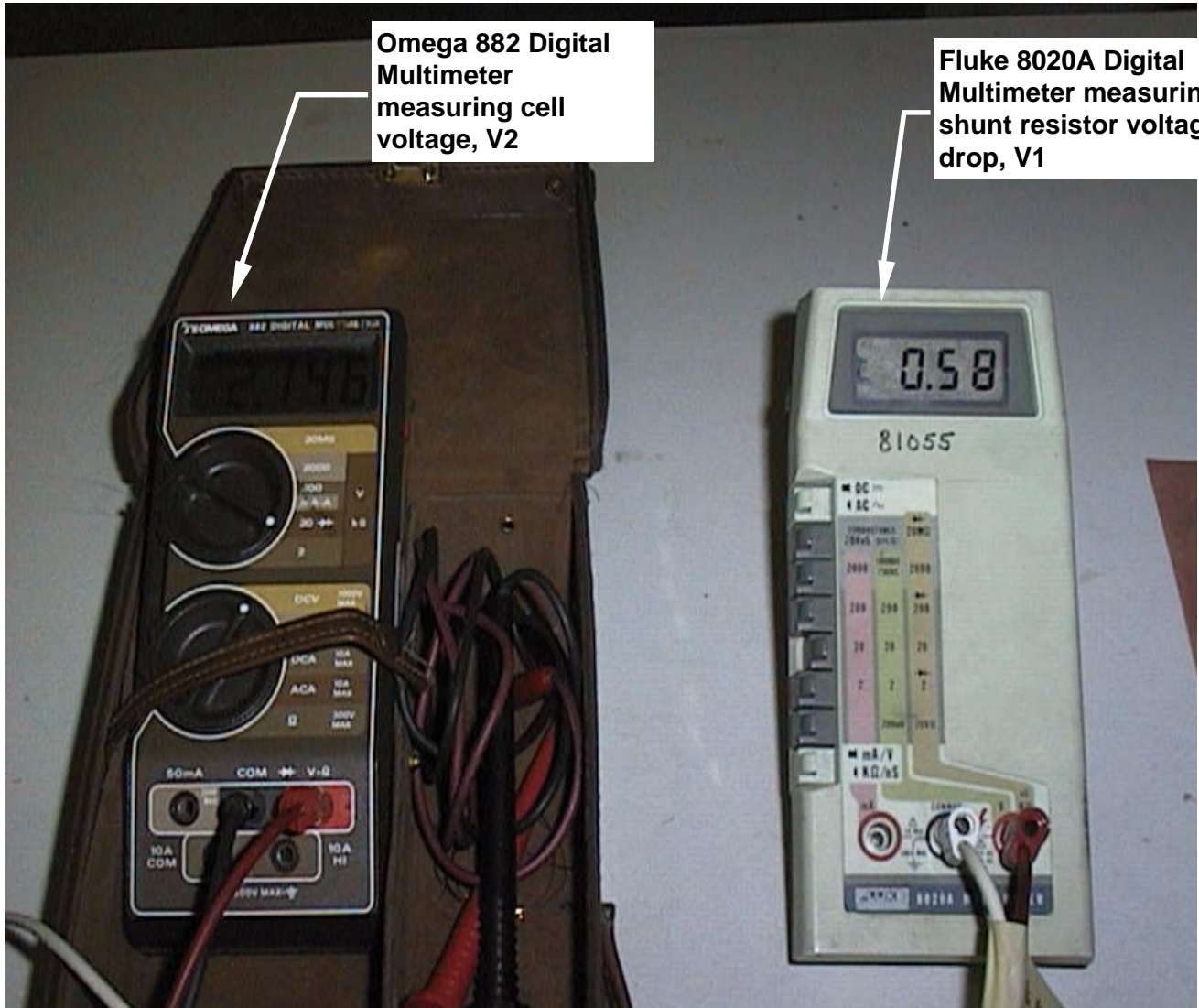
calibrated shunt resistor, R1

power supply (PS-

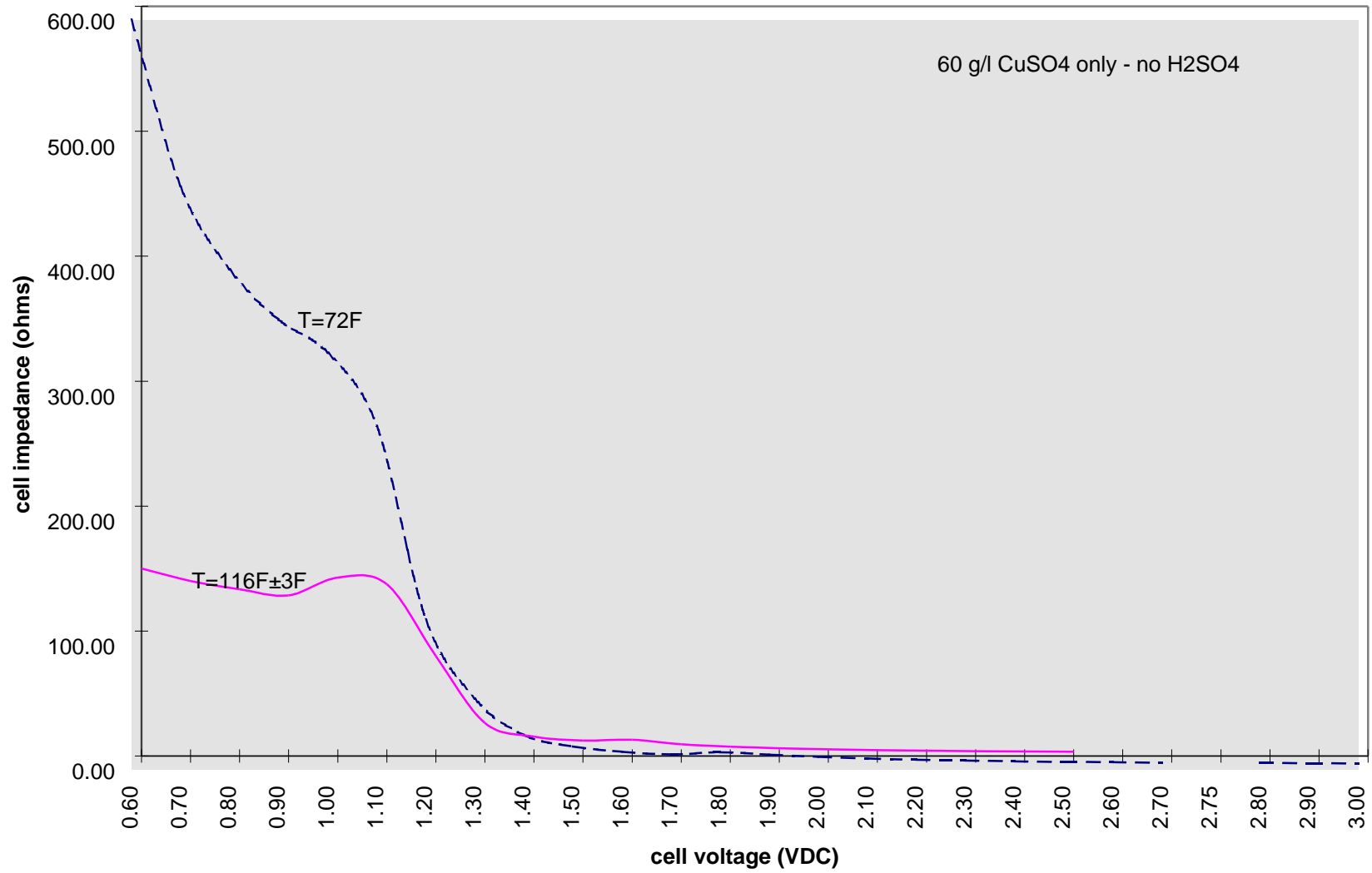
power and instrumentation leads

instrumentation

**Figure-40 Overall Arrangement of One-Liter Electrowinning Cell**

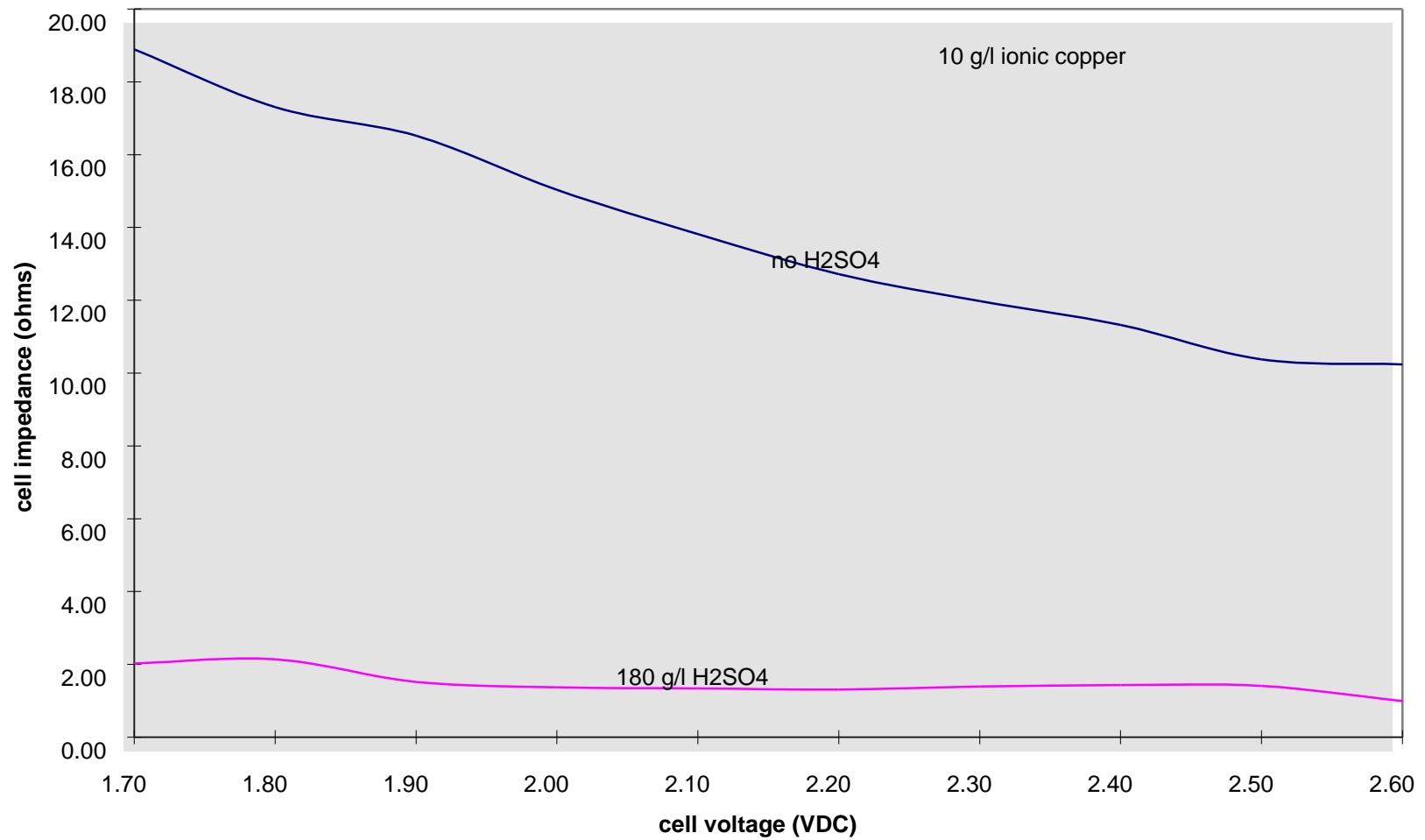


**Figure-41 One-Liter Electrowinning Cell Instrumentation**

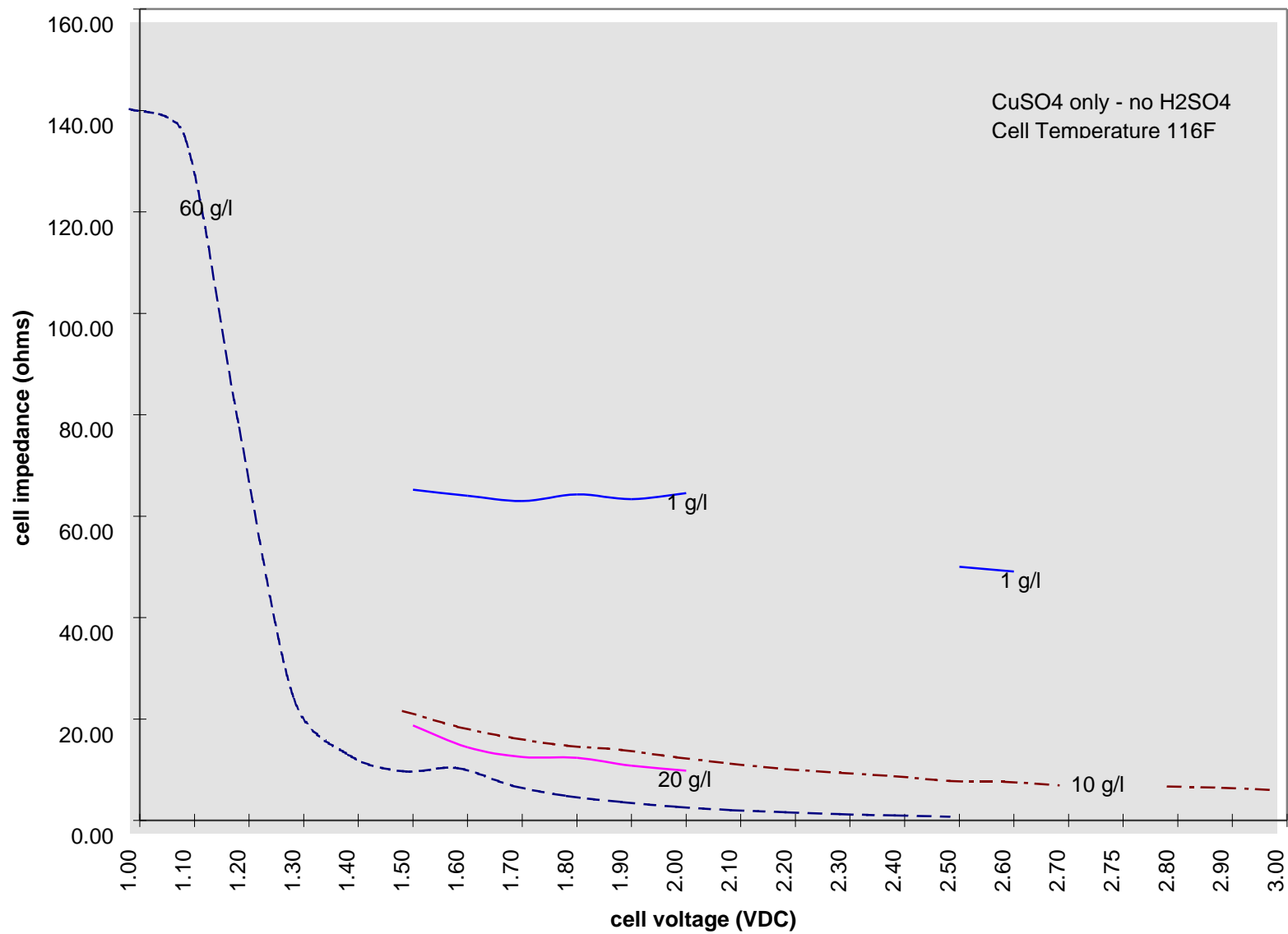


**Figure-42 Cell Impedance vs Cell Temperature**

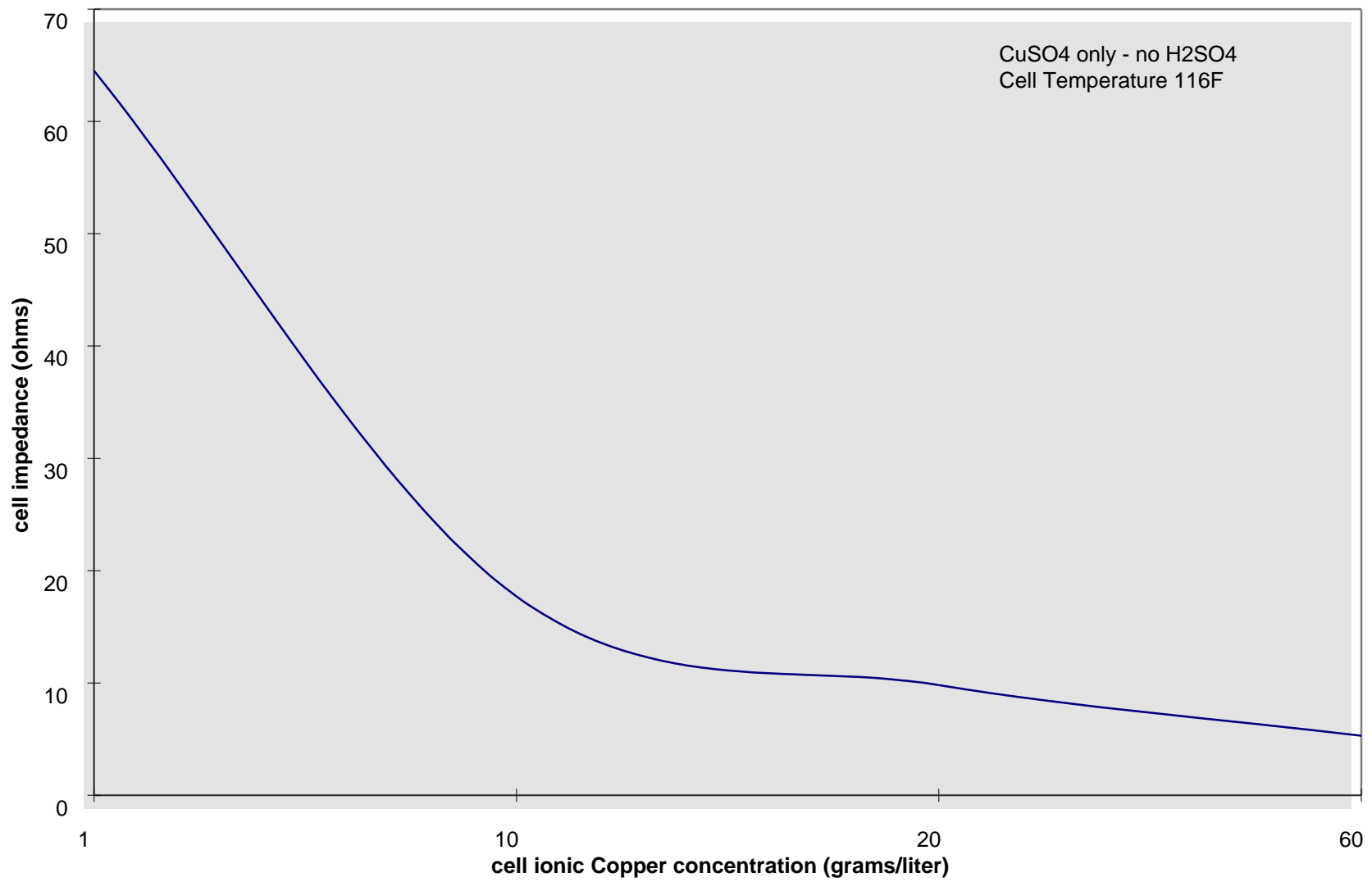




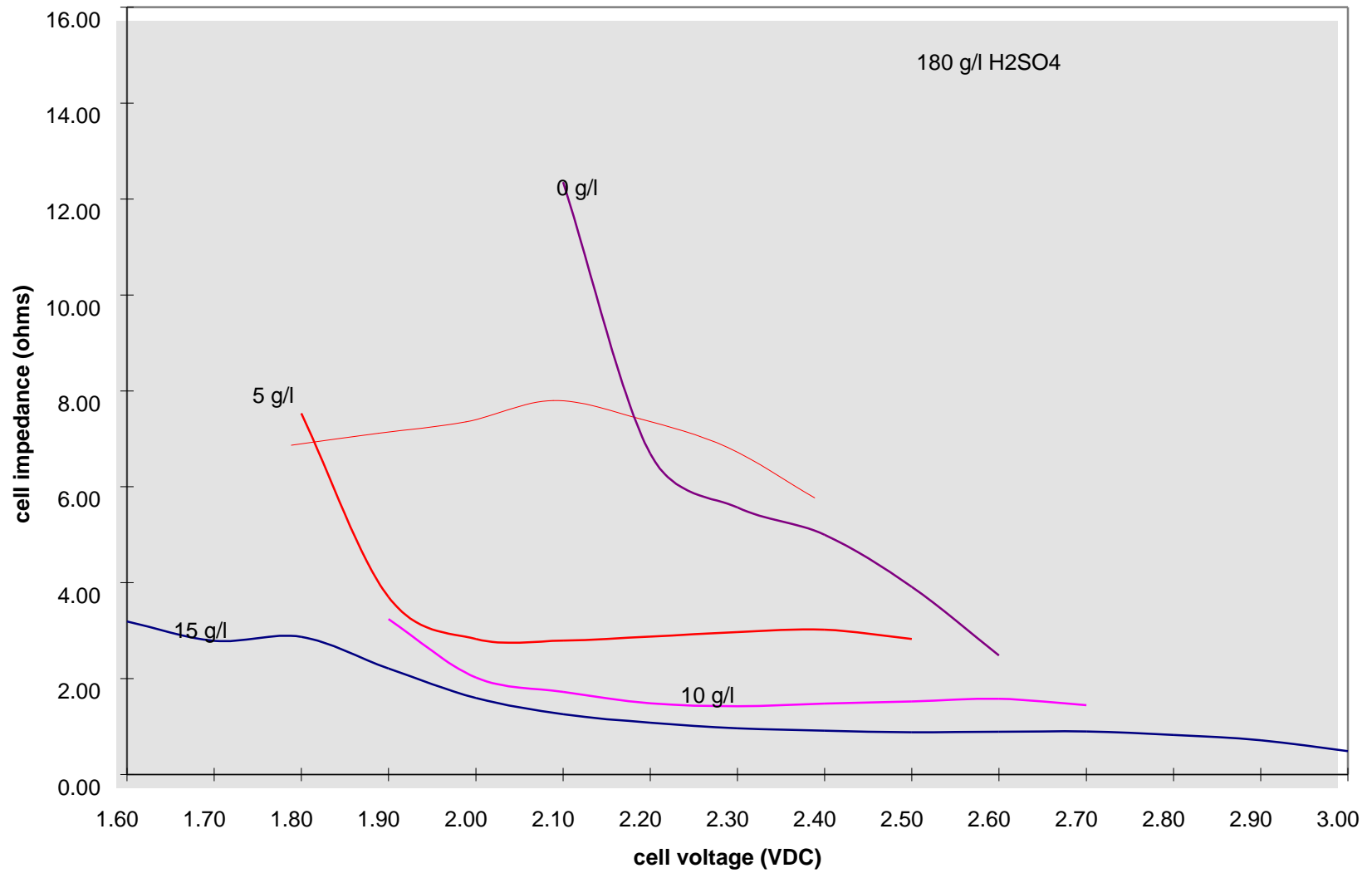
**Figure-43 Cell Impedance vs Sulfuric Acid Concentration**



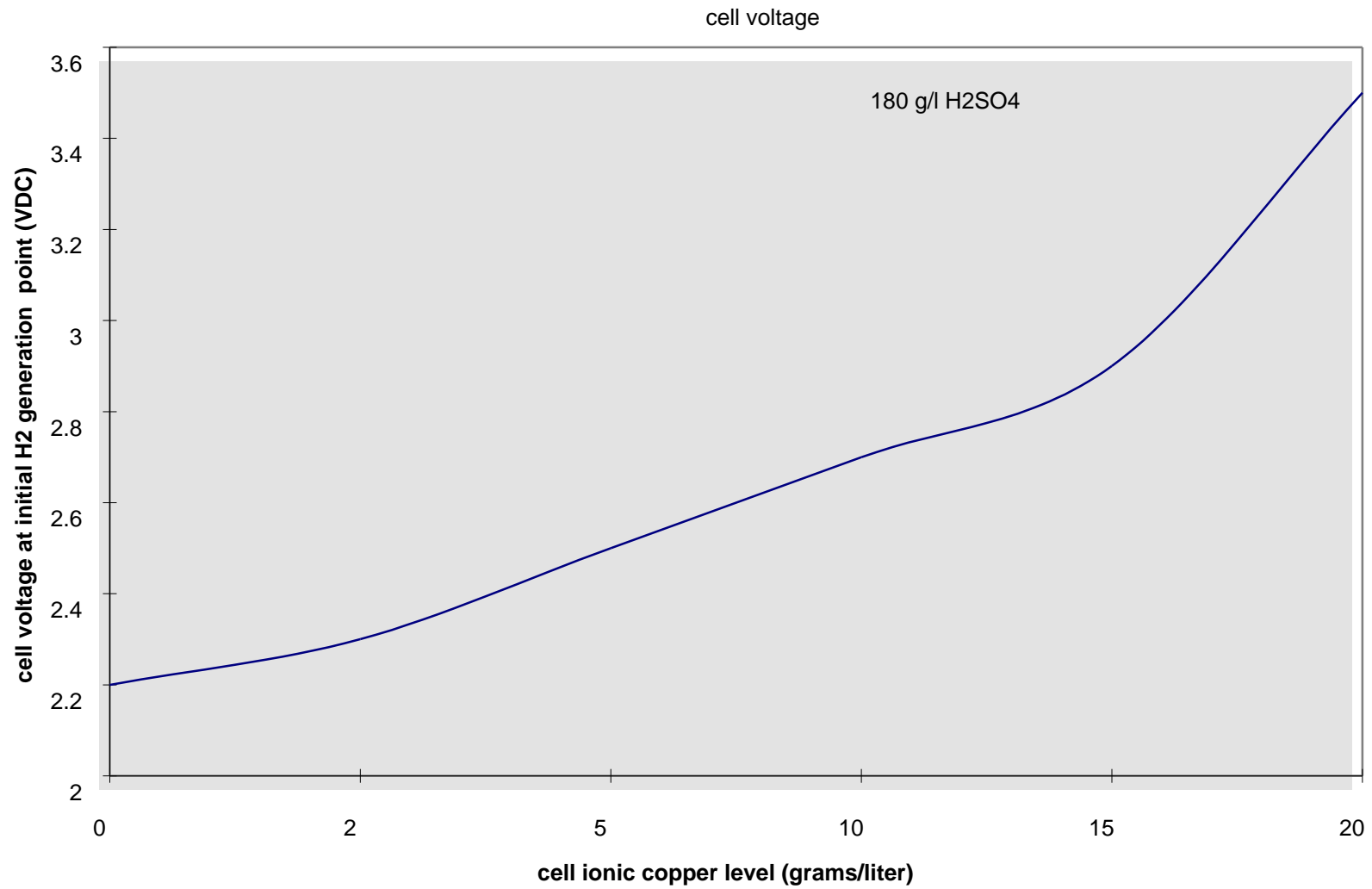
**Figure-44 Cell Impedance vs Cell Depletion**



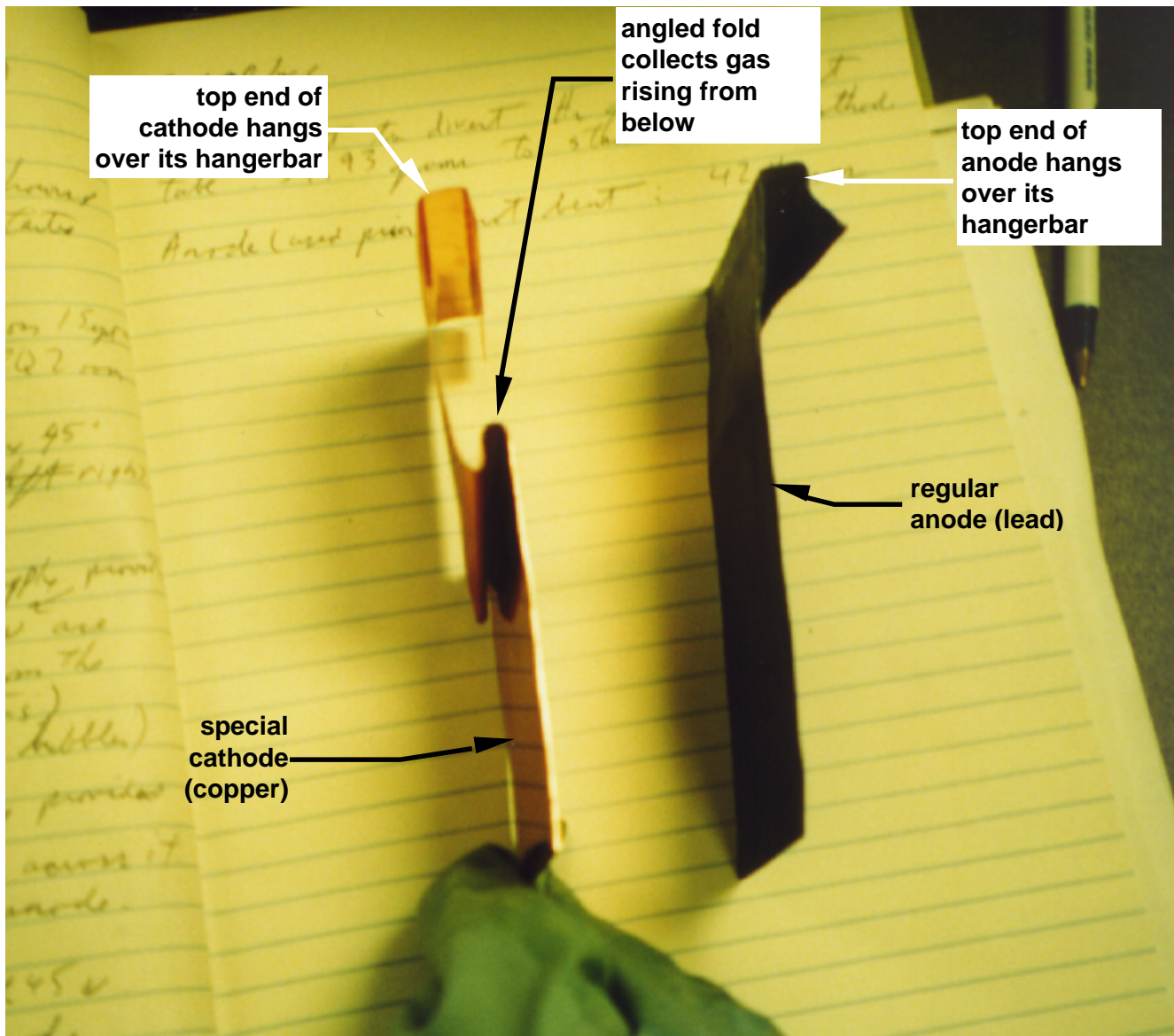
**Figure-45 Cell Impedance vs Depletion at 2.0 VDC**



**Figure - 46 Cell Impedance vs Depletion with Acid**

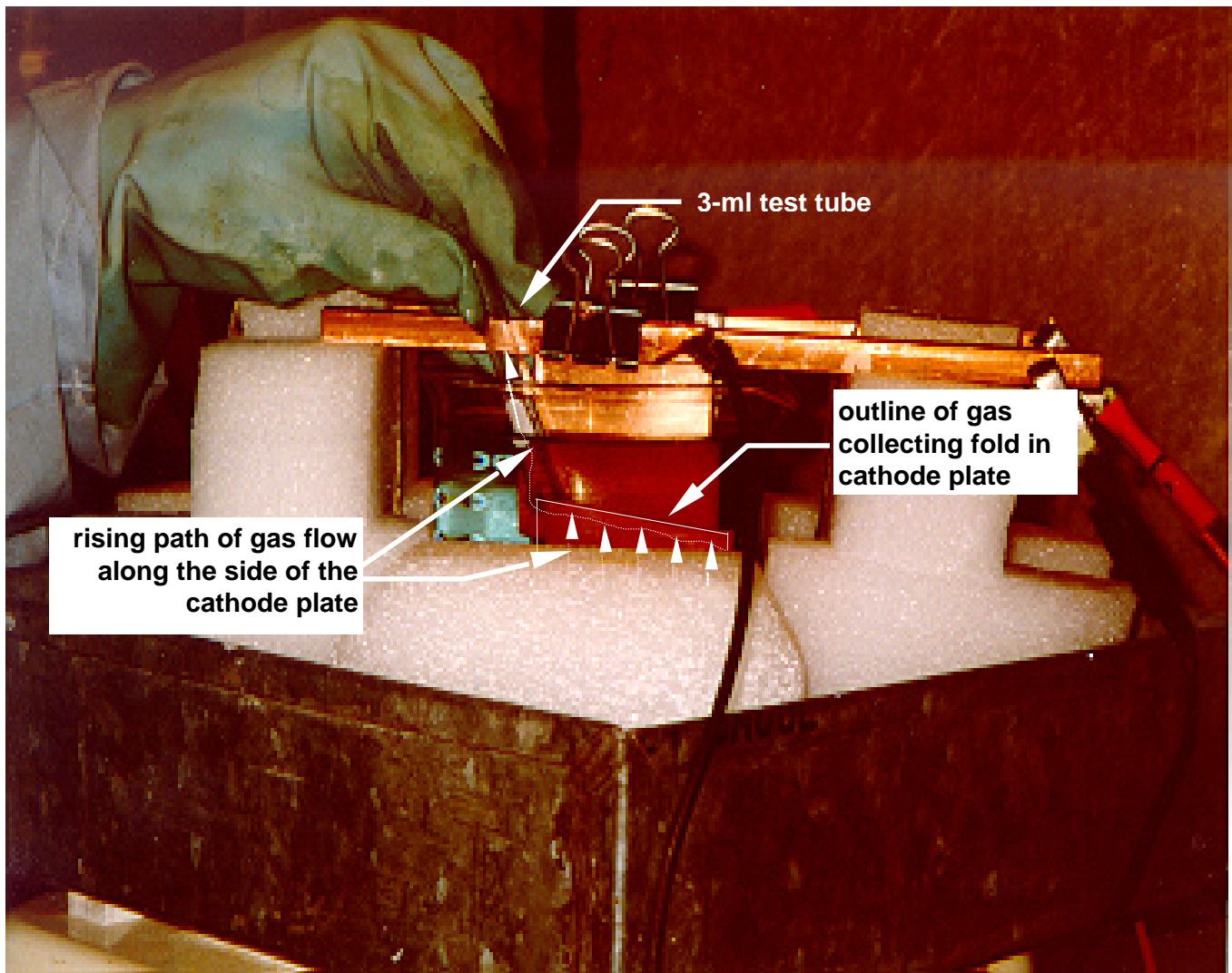


**Figure-47 Hydrogen Generating Cell Voltage vs Copper Depletion**

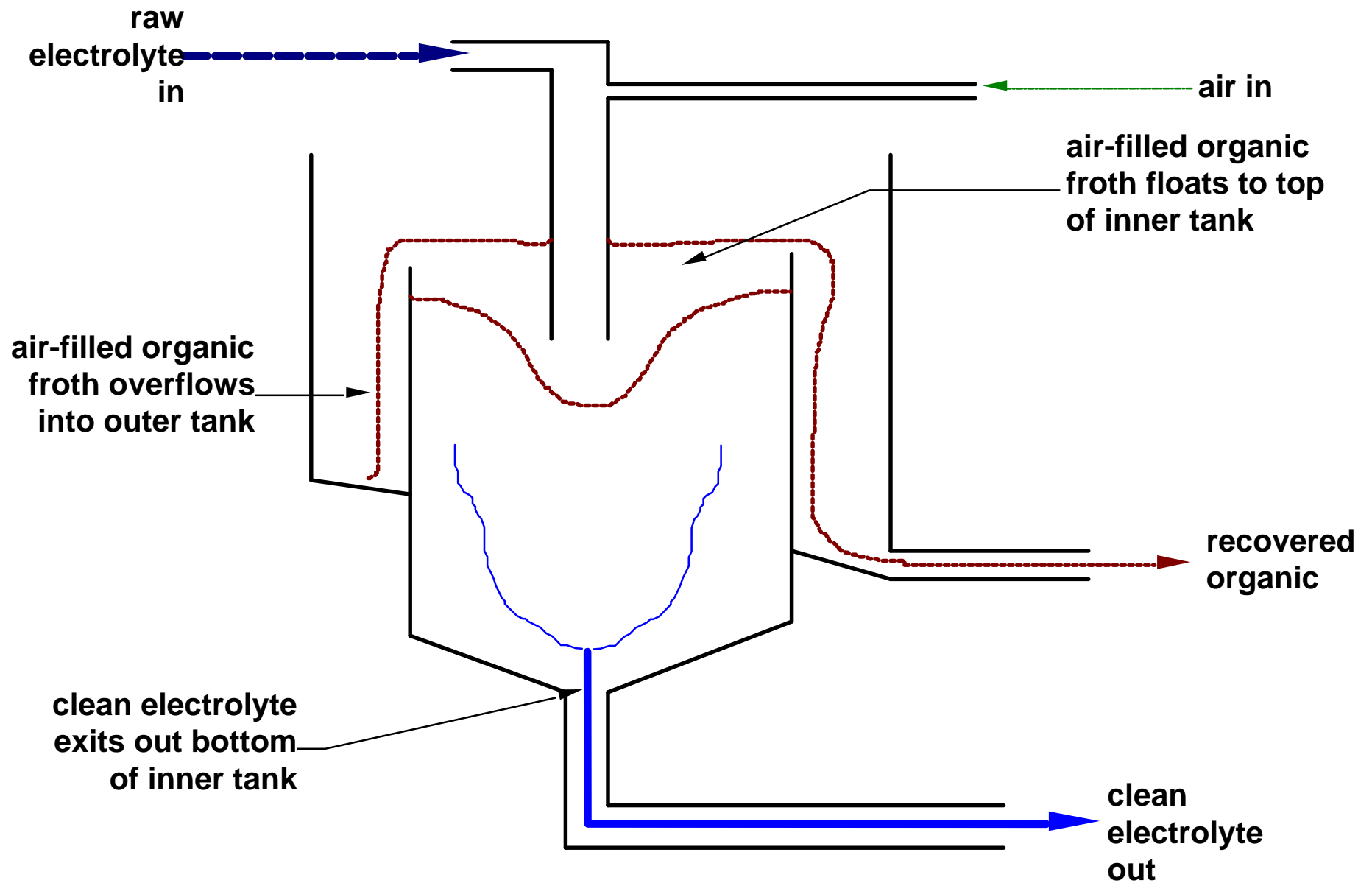


NOTE: The special copper cathode was used to collect suspected hydrogen gas. A similarly folded lead anode was used to collect suspected oxygen gas (not shown).

**Figure-48 Special Gas Collection Cathode for One-Liter Cell**



**Figure-49 Gas Collection Cathode Being Used to Fill Test Tube**



**Figure-50 Typical Jameson Cell**