

PART 6

Temporary Traffic Control

MUTCD 2000

Manual on Uniform Traffic Control Devices

m i l l e n n i u m e d i t i o n

December 2000



U.S. Department
of Transportation

**Federal Highway
Administration**

PART 6. TEMPORARY TRAFFIC CONTROL**TABLE OF CONTENTS**

	<u>Page</u>
CHAPTER 6A. GENERAL	Dec., 2000
Section 6A.01 General	6A-1
CHAPTER 6B. FUNDAMENTAL PRINCIPLES	Dec., 2000
Section 6B.01 Fundamental Principles of Temporary Traffic Control	6B-1
CHAPTER 6C. TEMPORARY TRAFFIC CONTROL ELEMENTS Dec., 2000	
Section 6C.01 Temporary Traffic Control Plans	6C-1
Section 6C.02 Temporary Traffic Control Zones	6C-2
Section 6C.03 Components of Temporary Traffic Control Zones	6C-3
Section 6C.04 Advance Warning Area	6C-3
Section 6C.05 Transition Area	6C-5
Section 6C.06 Activity Area	6C-6
Section 6C.07 Termination Area	6C-7
Section 6C.08 Tapers	6C-9
Section 6C.09 Detours and Diversions	6C-11
Section 6C.10 One-Lane, Two-Way Traffic Control	6C-11
Section 6C.11 Flagger Method of One-Lane, Two-Way Traffic Control	6C-13
Section 6C.12 Flag Transfer Method of One-Lane, Two-Way Traffic Control	6C-13
Section 6C.13 Pilot Car Method of One-Lane, Two-Way Traffic Control	6C-14
Section 6C.14 Temporary Traffic Control Signal Method of One-Lane, Two-Way Traffic Control	6C-14
Section 6C.15 Stop or Yield Control Method of One-Lane, Two-Way Traffic Control	6C-14
CHAPTER 6D. PEDESTRIAN AND WORKER SAFETY	Dec., 2000
Section 6D.01 Pedestrian Considerations	6D-1
Section 6D.02 Worker Considerations	6D-4
CHAPTER 6E. FLAGGER CONTROL	Dec., 2000
Section 6E.01 Qualifications for Flaggers	6E-1
Section 6E.02 High-Visibility Clothing	6E-1
Section 6E.03 Hand-Signaling Devices	6E-2

Section 6E.04 Flagger Procedures6E-3
 Section 6E.05 Flagger Stations6E-5

**CHAPTER 6F. TEMPORARY TRAFFIC CONTROL
 ZONE DEVICESDec., 2000**

Section 6F.01 Types of Devices6F-1
 Section 6F.02 General Characteristics of Signs6F-1
 Section 6F.03 Sign Placement.....6F-3
 Section 6F.04 Sign Maintenance.....6F-7
 Section 6F.05 Regulatory Sign Authority6F-7
 Section 6F.06 Regulatory Sign Design6F-7
 Section 6F.07 Regulatory Sign Applications6F-7
 Section 6F.08 ROAD (STREET) CLOSED Sign (R11-2)6F-11
 Section 6F.09 Local Traffic Only Signs (R11-3a, R11-4)6F-11
 Section 6F.10 Weight Limit Signs (R12-1, R12-2, R12-5)6F-12
 Section 6F.11 STAY IN LANE Sign (R4-9).....6F-12
 Section 6F.12 PEDESTRIAN CROSSWALK Sign (R9-8).....6F-12
 Section 6F.13 SIDEWALK CLOSED Signs (R9-9, R9-10, R9-11, R9-11a)6F-12
 Section 6F.14 Special Regulatory Signs6F-13
 Section 6F.15 Warning Sign Function, Design, and Application6F-13
 Section 6F.16 Position of Advance Warning Signs6F-21
 Section 6F.17 ROAD (STREET) WORK Sign (W20-1)6F-22
 Section 6F.18 DETOUR Sign (W20-2)6F-22
 Section 6F.19 ROAD (STREET) CLOSED Sign (W20-3).....6F-23
 Section 6F.20 ONE LANE ROAD Sign (W20-4).....6F-23
 Section 6F.21 LANE(S) CLOSED Signs (W20-5, W20-5a).....6F-23
 Section 6F.22 CENTER LANE CLOSED AHEAD Signs (W9-3, W9-3a)6F-24
 Section 6F.23 THRU TRAFFIC MERGE RIGHT (LEFT) Sign (W4-1a).....6F-24
 Section 6F.24 Lane Reduction Sign (W4-2).....6F-24
 Section 6F.25 ON RAMP Plaque (W13-4).....6F-24
 Section 6F.26 RAMP NARROWS Sign (W5-4)6F-24
 Section 6F.27 SLOW TRAFFIC AHEAD Sign (W23-1).....6F-25
 Section 6F.28 EXIT OPEN, EXIT CLOSED Signs (E5-2, E5-2a)6F-25
 Section 6F.29 Flagger Sign (W20-7, W20-7a)6F-25
 Section 6F.30 Two-Way Traffic Sign (W6-3).....6F-25
 Section 6F.31 Workers Sign (W21-1, W21-1a).....6F-26
 Section 6F.32 FRESH OIL (TAR) Sign (W21-2).....6F-26
 Section 6F.33 ROAD MACHINERY AHEAD Sign (W21-3)6F-26
 Section 6F.34 SHOULDER WORK Signs (W21-5, W21-5a, W21-5b)6F-26
 Section 6F.35 SURVEY CREW Sign (W21-6)6F-27
 Section 6F.36 UTILITY WORK Sign (W21-7).....6F-27
 Section 6F.37 Signs for Blasting Areas6F-28
 Section 6F.38 BLASTING ZONE AHEAD Sign (W22-1)6F-28
 Section 6F.39 TURN OFF 2-WAY RADIO AND PHONE Sign (W22-2)6F-28
 Section 6F.40 END BLASTING ZONE Sign (W22-3).....6F-29
 Section 6F.41 SHOULDER DROP-OFF Sign (W8-9a).....6F-29
 Section 6F.42 UNEVEN LANES Sign (W8-11)6F-29

Section 6F.43	NO CENTER STRIPE Sign (W8-12).....	6F-29
Section 6F.44	Other Warning Signs	6F-29
Section 6F.45	Advisory Speed Plaque (W13-1)	6F-30
Section 6F.46	Supplementary Distance Plaque (W7-3a).....	6F-30
Section 6F.47	Guide Signs	6F-31
Section 6F.48	ROAD WORK NEXT XX KM (MILES) Sign (G20-1).....	6F-32
Section 6F.49	END ROAD WORK Sign (G20-2a).....	6F-32
Section 6F.50	Detour Signs and Markers (M4-8, M4-8a, M4-8b, M4-9, and M4-10).....	6F-32
Section 6F.51	PILOT CAR FOLLOW ME Sign (G20-4)	6F-33
Section 6F.52	Portable Changeable Message Signs	6F-33
Section 6F.53	Arrow Panels.....	6F-36
Section 6F.54	High-Level Warning Devices (Flag Trees).....	6F-40
Section 6F.55	Channelizing Devices	6F-41
Section 6F.56	Cones.....	6F-44
Section 6F.57	Tubular Markers.....	6F-45
Section 6F.58	Vertical Panels.....	6F-46
Section 6F.59	Drums	6F-47
Section 6F.60	Type I, II, or III Barricades	6F-48
Section 6F.61	Direction Indicator Barricades	6F-50
Section 6F.62	Temporary Traffic Barriers as Channelizing Devices.....	6F-51
Section 6F.63	Temporary Raised Islands	6F-51
Section 6F.64	Opposing Traffic Lane Divider.....	6F-52
Section 6F.65	Pavement Markings.....	6F-52
Section 6F.66	Temporary Pavement Markings	6F-53
Section 6F.67	Raised Pavement Markers.....	6F-54
Section 6F.68	Delineators	6F-55
Section 6F.69	Lighting Devices	6F-55
Section 6F.70	Floodlights.....	6F-56
Section 6F.71	Flashing Warning Beacons.....	6F-56
Section 6F.72	Warning Lights.....	6F-57
Section 6F.73	Steady-Burn Electric Lamps	6F-58
Section 6F.74	Temporary Traffic Control Signals	6F-59
Section 6F.75	Temporary Traffic Barriers	6F-61
Section 6F.76	Crash Cushions	6F-62
Section 6F.77	Vehicle-Arresting Systems.....	6F-63
Section 6F.78	Rumble Strips.....	6F-64
Section 6F.79	Screens	6F-64
Section 6F.80	Future and Experimental Devices.....	6F-65

CHAPTER 6G. TYPE OF TEMPORARY TRAFFIC CONTROL ZONE ACTIVITIESDec., 2000

Section 6G.01	Typical Applications.....	6G-1
Section 6G.02	Work Duration	6G-1
Section 6G.03	Location of Work.....	6G-5
Section 6G.04	Modifications to Fulfill Special Needs	6G-5
Section 6G.05	Work Outside of Shoulder.....	6G-7

Section 6G.06 Work on the Shoulder with No Encroachment6G-8
 Section 6G.07 Work on the Shoulder with Minor Encroachment6G-9
 Section 6G.08 Work Within the Median6G-10
 Section 6G.09 Work Within the Traveled Way of Two-Lane Highways6G-10
 Section 6G.10 Work Within the Traveled Way of Urban Streets.....6G-11
 Section 6G.11 Work Within the Traveled Way of Multi-Lane, Non-Access
 Controlled Highways.....6G-12
 Section 6G.12 Work Within the Traveled Way at an Intersection6G-14
 Section 6G.13 Work Within the Traveled Way of Expressways and Freeways6G-16
 Section 6G.14 Two-Lane, Two-Way Traffic on One Roadway of a Normally
 Divided Highway6G-17
 Section 6G.15 Crossovers6G-18
 Section 6G.16 Interchanges.....6G-18
 Section 6G.17 Movable Barriers6G-19
 Section 6G.18 Work in the Vicinity of Highway-Rail Grade Crossings6G-19
 Section 6G.19 Control of Traffic Through Incident Areas6G-19

CHAPTER 6H. TYPICAL APPLICATIONSDec., 2000

Section 6H.01 Typical Applications6H-1

FIGURES

CHAPTER 6C. TEMPORARY TRAFFIC CONTROL ELEMENTS

Figure 6C-1 Component Parts of a Temporary Traffic Control Zone6C-4
 Figure 6C-2 Types of Tapers and Buffer Spaces6C-8
 Figure 6C-3 Example of a One-Lane Two-Way Traffic Taper6C-12

CHAPTER 6E. FLAGGER CONTROL

Figure 6E-1 Use of Hand-Signaling Devices by Flaggers.....6E-4

CHAPTER 6F. TEMPORARY TRAFFIC CONTROL ZONE DEVICES

Figure 6F-1 Height and Lateral Location of Signs - Typical Installations.....6F-4
 Figure 6F-2 Methods of Mounting Signs Other Than on Posts6F-6
 Figure 6F-3 Advance Warning Arrow Display Specifications6F-38
 Figure 6F-4 Channelizing Devices6F-42

CHAPTER 6H. TYPICAL APPLICATIONS

Figure 6H-1	Work Beyond the Shoulder (TA-1)	6H-7
Figure 6H-2	Blasting Zone (TA-2)	6H-9
Figure 6H-3	Work on Shoulders (TA-3)	6H-11
Figure 6H-4	Short Duration or Mobile Operation on Shoulder (TA-4)	6H-13
Figure 6H-5	Shoulder Closure on Freeway (TA-5)	6H-15
Figure 6H-6	Shoulder Work with Minor Encroachment (TA-6)	6H-17
Figure 6H-7	Road Closure with Diversion (TA-7)	6H-19
Figure 6H-8	Road Closure with Off-Site Detour (TA-8)	6H-21
Figure 6H-9	Overlapping Routes with Detour (TA-9)	6H-23
Figure 6H-10	Lane Closure on Two-Lane Road Using Flaggers (TA-10)	6H-25
Figure 6H-11	Lane Closure on Two-Volume Two-Lane Road (TA-11)	6H-27
Figure 6H-12	Lane Closure on Two-Lane Road Using Traffic Control Signals (TA-12)	6H-29
Figure 6H-13	Temporary Road Closure (TA-13)	6H-31
Figure 6H-14	Haul Road Crossing (TA-14)	6H-33
Figure 6H-15	Work in Center of Low-Volume Road (TA-15)	6H-35
Figure 6H-16	Surveying Along Centerline of Low-Volume Road (TA-16)	6H-37
Figure 6H-17	Mobile Operations on Two-Lane Road (TA-17)	6H-39
Figure 6H-18	Lane Closure on Minor Street (TA-18)	6H-41
Figure 6H-19	Detour for One Travel Direction (TA-19)	6H-43
Figure 6H-20	Detour for Closed Street (TA-20)	6H-45
Figure 6H-21	Lane Closure on Near Side of Intersection (TA-21)	6H-47
Figure 6H-22	Right Lane Closure on Far Side of Intersection (TA-22)	6H-49
Figure 6H-23	Left Lane Closure on Far Side of Intersection (TA-23)	6H-51
Figure 6H-24	Half Road Closure on Far Side of Intersection (TA-24)	6H-53
Figure 6H-25	Multiple Lane Closures at Intersection (TA-25)	6H-55
Figure 6H-26	Closure in Center of Intersection (TA-26)	6H-57
Figure 6H-27	Closure at Side of Intersection (TA-27)	6H-59
Figure 6H-28	Sidewalk Detour or Diversion (TA-28)	6H-61
Figure 6H-29	Crosswalk Closures and Pedestrian Detours (TA-29)	6H-63
Figure 6H-30	Interior Lane Closure on Multi-Lane Street (TA-30)	6H-65
Figure 6H-31	Lane Closures on Street with Uneven Directional Volumes (TA-31)	6H-67
Figure 6H-32	Half Road Closure on Multi-Lane, High-Speed Highway (TA-32)	6H-69
Figure 6H-33	Stationary Lane Closure on Divided Highway (TA-33)	6H-71
Figure 6H-34	Lane Closure with Temporary Traffic Barrier (TA-34)	6H-73
Figure 6H-35	Mobile Operation on Multi-Lane Road (TA-35)	6H-75
Figure 6H-36	Lane Shift on Freeway (TA-36)	6H-77
Figure 6H-37	Double Lane Closure on Freeway (TA-37)	6H-79
Figure 6H-38	Interior Lane Closure on Freeway (TA-38)	6H-81
Figure 6H-39	Median Crossover on Freeway (TA-39)	6H-83
Figure 6H-40	Median Crossover for Entrance Ramp (TA-40)	6H-85
Figure 6H-41	Median Crossover for Exit Ramp (TA-41)	6H-87
Figure 6H-42	Work in Vicinity of Exit Ramp (TA-42)	6H-89
Figure 6H-43	Partial Exit Ramp Closure (TA-43)	6H-91
Figure 6H-44	Work in Vicinity of Entrance Ramp (TA-44)	6H-93
Figure 6H-45	Movable Barriers (TA-45)	6H-95
Figure 6H-46	Work in Vicinity of Highway-Rail Grade-Crossing (TA-46)	6H-97

TABLES

CHAPTER 6C. TRAFFIC CONTROL PLANS

Table 6C-1 Suggested Advance Warning Sign Spacing.....6C-5
Table 6C-2 Taper Length Criteria for Temporary Traffic Control Zones6C-10

CHAPTER 6E. FLAGGER CONTROL

Table 6E-1 Distance of Flagger Station in Advance of the Work Space6E-6

CHAPTER 6H. TYPICAL APPLICATIONS

Table 6H-1 Index to Typical Application Diagrams6H-2
Table 6H-2 Meaning of Symbols on Typical Application Diagrams6H-4
Table 6H-3 Meaning of Letter Codes on Typical Application Diagrams6H-5

CHAPTER 6A. GENERAL

Section 6A.01 General

Support:

When the normal function of the roadway is suspended, temporary traffic control planning provides for continuity of the movement of motor vehicle, bicycle, and pedestrian traffic; transit operations; and access to property and utilities.

The primary function of temporary traffic control is to provide for the safe and efficient movement of vehicles, bicyclists, and pedestrians through or around temporary traffic control zones while reasonably protecting workers and equipment.

Of equal importance to the public traveling through the temporary traffic control zone is the safety of workers performing the many varied tasks within the work space. Temporary traffic control zones present constantly changing conditions that are unexpected by the road user. This creates an even higher degree of vulnerability for the workers on or near the roadway (see Section 6D.02). At the same time, the temporary traffic control zone provides for the efficient completion of whatever activity interrupted the normal use of the roadway.

Consideration for road user safety, worker safety, and the efficiency of road user flow is an integral element of every temporary traffic control zone, from planning through completion. A concurrent objective of the temporary traffic control is the efficient construction and maintenance of the highway.

No one set of temporary traffic control devices can satisfy all conditions for a given project. At the same time, defining details that would be adequate to cover all applications is not practical. Instead, Part 6 displays typical applications that depict common applications of temporary traffic control devices. The temporary traffic control selected for each situation depends on type of highway, road user conditions, duration of operation, physical constraints, and the nearness of the work space to road users.

Improved road user performance might be realized through a well-prepared public relations effort that covers the nature of the work, the time and duration of its execution, the anticipated effects upon road users, and possible alternate routes and modes of travel. Such programs have been found to result in a significant reduction in the number of road users traveling through the temporary traffic zone, which reduces the possible number of conflicts.

Standard:

Temporary traffic control plans and devices shall be the responsibility of the authority of a public body or official having jurisdiction for guiding road users. There shall be adequate statutory authority for the implementation and enforcement of needed road user regulations, parking controls, speed zoning, and

incident management. Such statutes shall provide sufficient flexibility in the application of temporary traffic control to meet the needs of changing conditions in the temporary traffic control zone.

Guidance:

The temporary traffic control plan should start in the planning phase and continue through the design, construction, and restoration phases. The temporary traffic control plans and devices should follow the principles set forth in Part 6.

Option:

Temporary traffic control plans may deviate from the typical applications described in Chapter 6H to allow for conditions and requirements of a particular site or jurisdiction.

Support:

The criteria of Part 6 apply to both rural and urban areas. A rural highway is normally characterized by lower volumes, higher speeds, fewer turning conflicts, and less conflict with pedestrians. An urban street is typically characterized by relatively low speeds, wide ranges of road user volumes, narrower roadway lanes, frequent intersections and driveways, significant pedestrian activity, and more businesses and houses.

CHAPTER 6B. FUNDAMENTAL PRINCIPLES

Section 6B.01 Fundamental Principles of Temporary Traffic Control

Standard:

The control of road users through a temporary traffic control zone shall be an essential part of highway construction, utility work, maintenance operations, and incident management.

Support:

Construction, maintenance, utility, and incident zones can all benefit from temporary traffic control to compensate for the unexpected or unusual situations faced by road users. When planning for temporary traffic control in these zones, it can be assumed that is appropriate for road users to exercise extra caution. Even though road users are assumed to be using extra caution, special care is still needed in applying temporary control techniques.

Special plans preparation and coordination with transit, other highway agencies, police and other emergency units, utilities, schools, and railroad companies might be needed to reduce unexpected and unusual road user operation situations.

During temporary traffic control activities, commercial vehicles might need to follow a different route from passenger vehicles because of bridge, weight, clearance, or geometric restrictions. Also, vehicles carrying hazardous materials might need to follow a different route from other vehicles. The Truck Route National Network and hazardous materials signs are included in Section 2B.45.

Experience has shown that following the fundamental principles of Part 6 will assist road users and help protect workers in the vicinity of temporary traffic control zones. While these principles provide guidance for good temporary traffic control for the practitioner, they do not establish standards and warrants.

Guidance:

Road user and worker safety in temporary traffic control zones should be an integral and high-priority element of every project from planning through design and construction. Similarly, maintenance and utility work should be planned and conducted with the safety of drivers, bicyclists, pedestrians, and workers being considered at all times. If the temporary traffic control zone includes a highway-rail grade crossing, early coordination with the railroad company should take place.

Support:

Formulating specific plans for incident management temporary traffic control is difficult because of the variety of situations that can arise.

Guidance:

General plans or guidelines should be developed to provide safety for drivers, bicyclists, pedestrians, workers, enforcement/emergency officials, and equipment, with the following factors being considered:

- A. The basic safety principles governing the design of permanent roadways and roadsides should also govern the design of temporary traffic control zones. The goal should be to route road users through such zones using roadway geometrics, roadside features, and temporary traffic control devices as nearly as possible comparable to those for normal highway situations.
- B. A temporary traffic control plan, in detail appropriate to the complexity of the work project or incident, should be prepared and understood by all responsible parties before the site is occupied. Any changes in the temporary traffic control plan should be approved by an official knowledgeable (for example, trained and/or certified) in proper temporary traffic control practices.

Road user movement should be inhibited as little as practical, based on the following considerations:

- A. Temporary traffic control at work and incident sites should be designed on the assumption that drivers will only reduce their speeds if they clearly perceive a need to do so (see Section 6C.01).
- B. Frequent and abrupt changes in geometrics such as lane narrowing, dropped lanes, or main roadway transitions that require rapid maneuvers, should be avoided.
- C. Provisions should be made for the reasonably safe operation of work, particularly on high-speed, high-volume roadways.
- D. Road users should be encouraged to use alternative routes that do not include temporary traffic control zones.
- E. Bicyclists and pedestrians should be provided with access and reasonably safe passage through the temporary traffic control zone.
- F. Roadway occupancy should be scheduled during off-peak hours and, if necessary, night work should be considered.
- G. Early coordination with officials having jurisdiction over the affected cross streets and providing emergency services should occur before roadway or ramp closings.

Drivers, bicyclists, and pedestrians should be guided in a clear and positive manner while approaching and traversing temporary traffic control zones and incident sites. The following principles should be applied:

- A. Adequate warning, delineation, and channelization should be provided to assist in guiding road users in advance of and through the temporary traffic control zone or incident site by using proper pavement marking, signing, or other devices that are effective under varying conditions.
- B. Temporary traffic control devices inconsistent with intended travel paths through temporary traffic control zones should be removed or covered. However, in intermediate-term stationary, short-term, and mobile operations, where visible permanent devices are inconsistent with intended travel paths, devices that highlight or emphasize the appropriate path should be used.
- C. Flagging procedures, when used, should provide positive guidance to road users traversing the temporary traffic control zone.

To provide acceptable levels of operations, routine day and night inspections of temporary traffic control elements should be performed as follows:

- A. Individuals who are knowledgeable (for example, trained and/or certified) in the principles of proper temporary traffic control should be assigned responsibility for safety in temporary traffic control zones. The most important duty of these individuals should be to check that all temporary traffic control devices of the project are reasonably consistent with the temporary traffic control plan and are effective in providing safe conditions for drivers, bicyclists, pedestrians, and workers.
- B. As the work progresses, temporary traffic controls and/or working conditions should be modified in order to provide safe and efficient road user movement and to promote worker safety. The individual responsible for temporary traffic control should have the authority to halt work until applicable or remedial safety measures are taken.
- C. Temporary traffic control zones should be carefully monitored under varying conditions of road user volumes, light, and weather to check that applicable temporary traffic control devices are effective, clearly visible, clean, and in compliance with the temporary traffic control plan.
- D. When warranted, an engineering study should be made (in cooperation with law enforcement officials) of reported crashes occurring within the temporary traffic control zone. Crash records in temporary traffic control zones should be monitored to identify the need for changes in the temporary traffic control zone.

Attention should be given to the maintenance of roadside safety during the life of the temporary traffic control zone by applying the following principles:

- A. To accommodate run-off-the-road incidents, disabled vehicles, or emergency situations, unencumbered roadside recovery areas or clear zones should be provided where practical.
- B. Channelization of road users should be accomplished by the use of pavement markings, signing, and crashworthy channelizing devices.
- C. Work equipment, workers' private vehicles, materials, and debris should be stored in such a manner to reduce the probability of being impacted by run-off-the-road vehicles.

Each person whose actions affect temporary traffic control zone safety, from the upper-level management through the field workers, should receive training appropriate to the job decisions each individual is required to make. Only those individuals who are trained in proper temporary traffic control practices and have a basic understanding of the principles (established by applicable standards and guidelines, including those of this Manual) should supervise the selection, placement, and maintenance of temporary traffic control devices used for temporary traffic control zones and for incident management.

Good public relations should be maintained by applying the following principles:

- A. The cooperation of the various news media in publicizing the existence of and reasons for temporary traffic control zones should be sought as news releases can assist in keeping the road users well informed.
- B. The needs of abutting property owners, residents, and businesses should be assessed and appropriate accommodations made.
- C. The needs of emergency service providers (police, fire, and medical) should be assessed and appropriate coordination and accommodations made.
- D. The needs of railroads and transit should be assessed and appropriate coordination and accommodations made.

Standard:

All temporary traffic control devices shall be removed as soon as practical when they are no longer needed. When work is suspended for short periods of time, temporary traffic control devices that are no longer appropriate shall be removed or covered.

CHAPTER 6C. TEMPORARY TRAFFIC CONTROL ELEMENTS

Section 6C.01 Temporary Traffic Control Plans

Support:

A temporary traffic control plan describes temporary traffic control measures to be used for facilitating road users through a work zone. Temporary traffic control plans play a vital role in providing continuity of safe and efficient road user flow when a work zone, incident, or other events temporarily disrupt normal road user flow. Important auxiliary provisions that cannot conveniently be specified on project plans can easily be incorporated into Special Provisions within the temporary traffic control plan.

Temporary traffic control plans range in scope from being very detailed to simply referencing typical drawings contained in this Manual, standard approved highway agency drawings and manuals, or specific drawings contained in the contract documents. The degree of detail in the temporary traffic control plan depends entirely on the complexity of the situation.

Guidance:

Temporary traffic control plans should be prepared by persons knowledgeable (for example, trained and/or certified) about the fundamental principles of temporary traffic control and work activities to be performed. The design, selection and placement of temporary traffic control devices for a temporary traffic control plan should be based on engineering judgment.

Coordination should be made between adjacent or overlapping projects to check that duplicate signing is not used and to check compatibility of traffic control between adjacent or overlapping projects.

Traffic control planning should be completed for all highway construction, utility work, maintenance operations, and incident management including minor maintenance and utility projects prior to occupying the temporary traffic control zone.

Option:

Provisions may be incorporated into the project bid documents that enable contractors to develop an alternate temporary traffic control plan.

Modifications of temporary traffic control plans may be necessary because of changed conditions or a determination of better methods of safely and efficiently handling road users.

Guidance:

This alternate or modified plans should have the approval of the responsible highway agency prior to implementation.

Provisions for effective continuity of transit service should be incorporated into the temporary traffic control planning process. Oftentimes, public transit buses cannot efficiently be detoured in the same manner as other vehicles (particularly for short-term maintenance projects). The temporary traffic control plan should provide for features such as temporary bus stops, pull out, and satisfactory waiting areas for transit patrons, if applicable (see Section 10A.05 for additional light rail transit issues to consider for temporary traffic control).

Provisions for effective continuity of railroad service and acceptable access to abutting property owners and businesses should also be incorporated into the temporary traffic control planning process.

Reduced speed limits should be used only in the specific portion of the temporary traffic control zone where conditions or restrictive features are present. However, frequent changes in the speed limit should be avoided. A temporary traffic control plan should be designed so that vehicles can safely travel through the temporary traffic control zone with a speed limit reduction of no more than 16 km/h (10 mph).

A reduction of more than 16 km/h (10 mph) in the speed limit should be used only when required by restrictive features in the temporary traffic control zone. Where restrictive features justify a speed reduction of more than 16 km/h (10 mph), additional driver notification should be provided. The speed limit should be stepped down in advance of the location requiring the lowest speed, and additional temporary traffic control warning devices should be used.

Reduced speed zoning (lowering the regulatory speed limit) should be avoided as much as practical because drivers will reduce their speeds only if they clearly perceive a need to do so.

Support:

Research has demonstrated that large reductions in the speed limit, such as a 50 km/h (30 mph) reduction, increase speed variance and the potential for crashes. Smaller reductions in the speed limit of up to 16 km/h (10 mph) cause smaller changes in speed variance and lessen the potential for increased crashes. A reduction in the regulatory speed limit of only up to 16 km/h (10 mph) from the normal speed limit has been shown to be more effective.

Section 6C.02 Temporary Traffic Control Zones

Support:

A temporary traffic control zone is an area of a highway where road user conditions are changed because of a work zone or an incident through the use of temporary traffic control devices, police, or other authorized officials.

A work zone is an area of a highway with construction, maintenance, or utility work activities. A work zone is typically marked by signs, channelizing devices, barriers, pavement markings, and/or work vehicles. It extends from the first warning sign or rotating/strobe lights on a vehicle to the END ROAD WORK sign or the last temporary traffic control device.

An incident area is an area of a highway where temporary traffic controls are imposed by authorized officials in response to a road user incident, natural disaster, or special event.

Section 6C.03 Components of Temporary Traffic Control Zones

Support:

Most temporary traffic control zones are divided into four areas: the advance warning area, the transition area, the activity area, and the termination area. Figure 6C-1 illustrates these four areas. These four areas are described in Sections 6C.04 through 6C.07.

Section 6C.04 Advance Warning Area

Support:

The advance warning area is the section of highway where road users are informed about the upcoming work zone or incident area.

Option:

The advance warning area may vary from a single sign or rotating/strobe lights on a vehicle to a series of signs in advance of the temporary traffic control zone activity area.

Guidance:

Typical distances for placement of advance warning signs on expressways and freeways should be longer because drivers are conditioned to uninterrupted flow. Therefore, the advance warning sign placement should extend on these facilities as far as 800 m (0.5 mi) or more.

On urban streets, the effective placement of the first warning sign in meters (feet) should range from 0.75 to 1.5 times the speed limit in km/h (4 to 8 times the speed limit in mph), with the high end of the range being used when speeds are relatively high. When a single advance warning sign is used (in cases such as low-speed residential streets), the advance warning area can be as short as 30 m (100 ft). When two or more advance warning signs are used on higher-speed streets, such as major arterials, the advance warning area should extend a greater distance (see Table 6C-1).

Since rural highways are normally characterized by higher speeds, the effective placement of the first warning sign in meters (feet) should be substantially longer – from

Figure 6C-1. Component Parts of a Temporary Traffic Control Zone

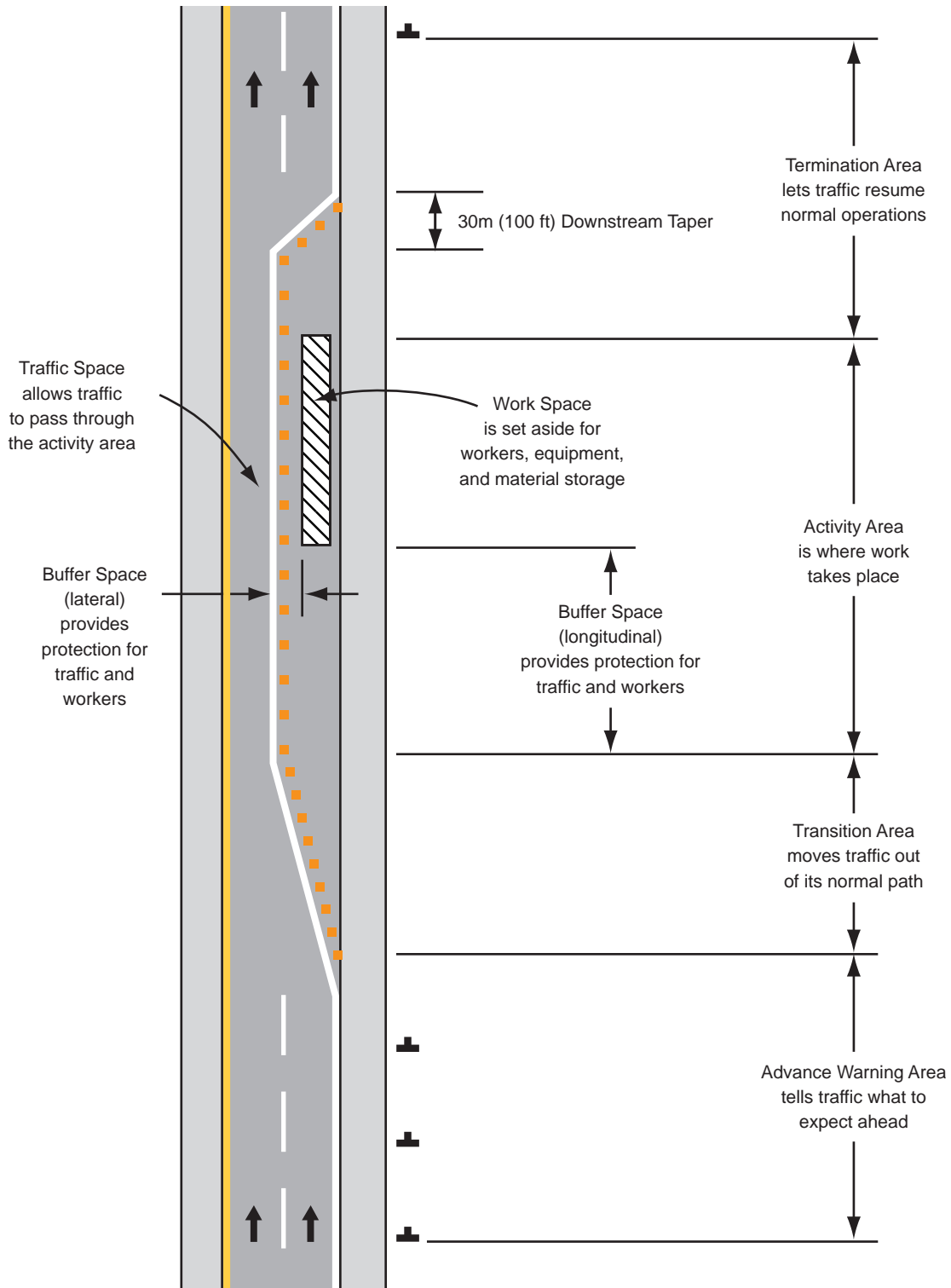

Legend

➔ Direction of travel

Table 6C-1. Suggested Advance Warning Sign Spacing

Road Type	Distance Between Signs**		
	A	B	C
Urban (low speed)*	30 (100)	30 (100)	30 (100)
Urban (high speed)*	100 (350)	100 (350)	100 (350)
Rural	150 (500)	150 (500)	150 (500)
Expressway / Freeway	300 (1,000)	450 (1,500)	800 (2,640)

* Speed category to be determined by highway agency

** Distances are shown in meters (feet). The column headings A, B, and C are the dimensions shown in Figures 6H-1 through 6H-46. The A dimension is the distance from the transition or point of restriction to the first sign. The B dimension is the distance between the first and second signs. The C dimension is the distance between the second and third signs. (The third sign is the first one in a three-sign series encountered by a driver approaching a temporary traffic control zone.)

1.5 to 2.25 times the speed limit in km/h (8 to 12 times the speed limit in mph). Since two or more advance warning signs are normally used for these conditions, the advance warning area should extend 450 m (1,500 ft) or more for open highway conditions (see Table 6C-1).

Option:

Advance warning may be eliminated when the activity area is sufficiently removed from the road users' path so that it does not interfere with the normal flow.

Section 6C.05 Transition Area

Support:

The transition area is that section of highway where road users are redirected out of their normal path.

Standard:

When redirection of the road users' normal path is required, they shall be channelized from the normal path to a new path.

Support:

In mobile operations, the transition area moves with the work space. Transition areas usually involve strategic use of tapers, which because of their importance are discussed separately in detail.

Section 6C.06 Activity Area**Support:**

The activity area is the section of the highway where the work activity takes place. It is comprised of the work space, the traffic space, and the buffer space.

The work space is that portion of the highway closed to road users and set aside for workers, equipment, and material, and a shadow vehicle if one is used upstream. Work spaces are usually delineated for road users by channelizing devices or, to exclude vehicles and pedestrians, by temporary barriers.

Option:

The work space may be stationary or may move as work progresses.

Guidance:

Since there may be several work spaces (some even separated by several kilometers or miles) within the project limits, each work space should be adequately signed to inform road users and reduce confusion.

Support:

The traffic space is the portion of the highway in which road users are routed through the activity area.

The buffer space is a lateral and/or longitudinal area that separates road user flow from the work space or an unsafe area, and might provide some recovery space for an errant vehicle.

Guidance:

Neither work activity nor storage of equipment, vehicles, or material should occur within a buffer space.

Option:

Buffer spaces may be positioned either longitudinally or laterally with respect to the direction of road user flow. The activity area may contain one or more lateral or longitudinal buffer spaces.

A longitudinal buffer space may be placed in advance of a work space.

The longitudinal buffer space may also be used to separate opposing road user flows that use portions of the same traffic lane, as shown in Figure 6C-2.

Support:

Typically, the buffer space is formed as a traffic island and defined by channelizing devices. When a formidable device, such as a shadow vehicle or an arrow panel, is placed in such an island, only the area in front of the device functions as a buffer.

Option:

The lateral buffer space may be used to separate the traffic space from the work space, as shown in Figures 6C-1 and 6C-2, or such areas as excavations or pavement-edge drop-offs. A lateral buffer space also may be used between two travel lanes, especially those carrying opposing flows.

Guidance:

The width of a lateral buffer space should be determined by engineering judgment.

Option:

When work occurs on a high-volume, highly-congested facility, an incident management vehicle storage space may be provided so that emergency vehicles (for example, tow trucks) can respond quickly to road user incidents.

Guidance:

If used, an emergency-vehicle storage area should not extend into any portion of the buffer space.

Section 6C.07 Termination Area

Support:

The termination area is used to return road users to their normal path. The termination area extends from the downstream end of the work area to the END ROAD WORK signs, if posted.

Option:

An END ROAD WORK sign, a Speed Limit sign, or other signs may be used to inform road users that they can resume normal operations.

Figure 6C-2. Types of Tapers and Buffer Spaces

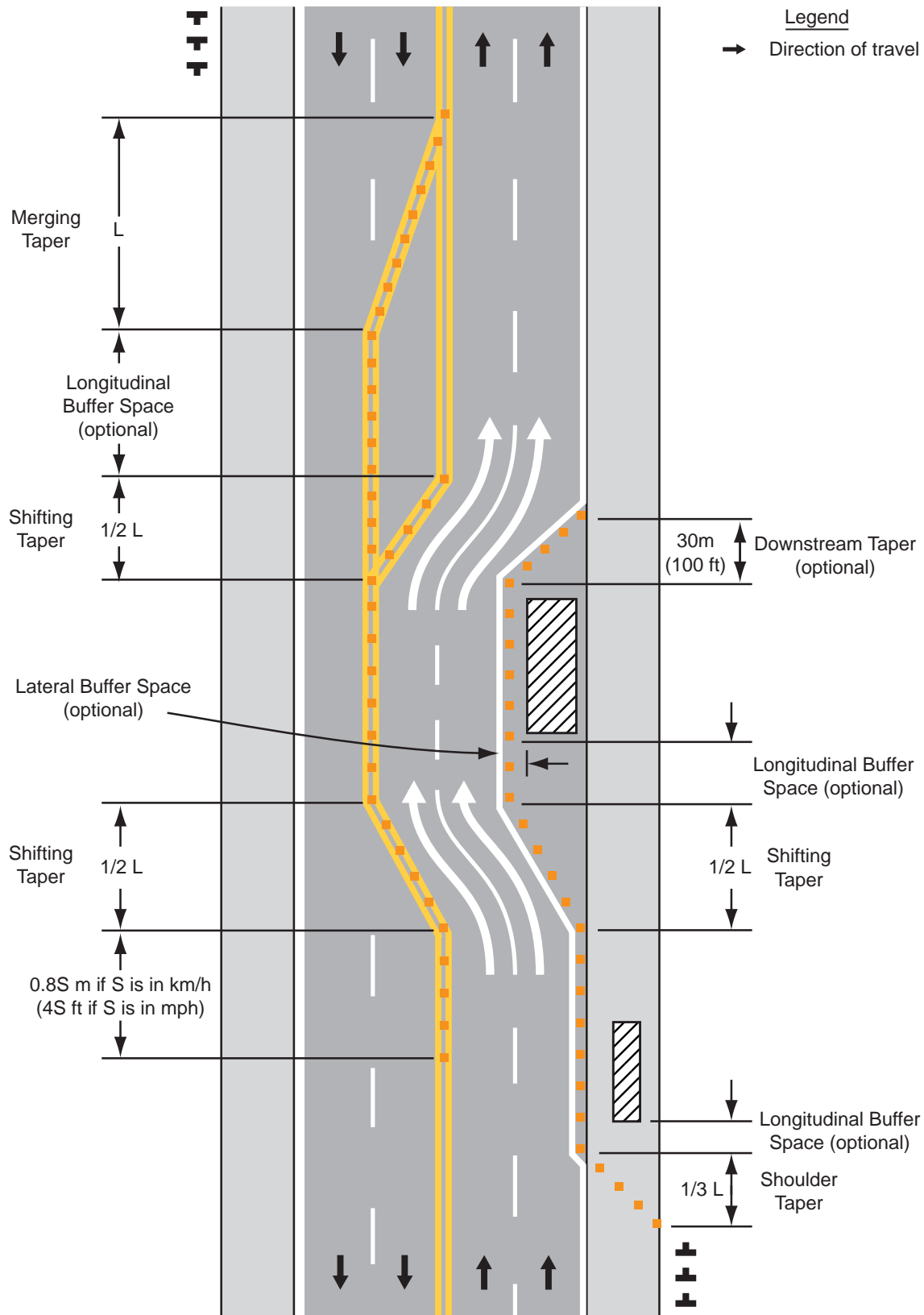

Section 6C.08 Tapers**Option:**

Tapers may be used in both the transition and termination areas. Whenever tapers are to be used in close proximity to an interchange ramp, crossroads, curves, or other influencing factors, the length of the tapers may be adjusted.

Support:

Tapers are created by using a series of channelizing devices and/or pavement markings to move traffic out of or into the normal path. Types of tapers are shown in Figure 6C-2.

Longer tapers are not necessarily better than shorter tapers (particularly in urban areas characterized by short block lengths, driveways, etc.) because extended tapers tend to encourage sluggish operation and to encourage drivers to delay lane changes unnecessarily. The test concerning adequate lengths of tapers involves observation of driver performance after temporary traffic control plans are put into effect.

Guidance:

The criteria for determining the taper length (L) is shown in Table 6C-2 and should be the minimum used.

The maximum distance in meters (feet) between devices in a taper should not exceed 0.2 times the speed limit in km/h (1.0 times the speed limit in mph).

Support:

A merging taper requires the longest distance because drivers are required to merge into common road space.

Guidance:

A merging taper should be long enough to enable merging drivers to have adequate advance warning and sufficient length to adjust their speeds and merge into a single lane before the end of the transition.

Support:

A shifting taper is used when a lateral shift is needed. When more space is available, a longer than minimum taper distance can be beneficial. Changes in alignment can also be accomplished by using horizontal curves designed for normal highway speeds.

Guidance:

A shifting taper should have a length of approximately 0.5 L (see Table 6C-2).

**Table 6C-2. Taper Length Criteria for
Temporary Traffic Control Zones**

Type of Taper	Taper Length (L)*
Merging Taper	at least L
Shifting Taper	at least 0.5L
Shoulder Taper	at least 0.33L
One-Lane, Two-Way Traffic Taper	30 m (100 ft) maximum
Downstream Taper	30 m (100 ft) per lane

* Formulas for L are as follows:

For speed limits of 60 km/h (40 mph) or less:

$$L = \frac{WS^2}{150} \quad (L = \frac{WS^2}{60})$$

For speed limits of 70 km/h (45 mph) or greater:

$$L = \frac{WS}{1.6} \quad (L = WS)$$

Where: L = taper length in meters (feet)

W = width of offset in meters (feet)

S = posted speed limit, or off-peak

85th-percentile speed prior to work starting,
or the anticipated operating speed in km/h (mph)

Support:

A shoulder taper may be beneficial on a high-speed roadway where shoulders are part of the activity area and are closed, or when improved shoulders might be mistaken as a driving lane. In these instances, the same type, but abbreviated, closure procedures used on a normal portion in the roadway can be used.

Guidance:

If used, shoulder tapers should have a length of approximately 0.33 L (see Table 6C-2). If a shoulder is used as a travel lane, either through practice or during a temporary traffic control activity, a normal merging or shifting taper should be used.

Option:

A downstream taper may be useful in termination areas to provide a visual cue to the driver that access is available back into the original lane or path that was closed.

Guidance:

When used, a downstream taper should have a minimum length of approximately 30 m (100 ft) per lane with devices placed at a spacing of approximately 6.1 m (20 ft).

Support:

The one-lane, two-way taper is used in advance of an activity area that occupies part of a two-way roadway in such a way that a portion of the road is used alternately by traffic in each direction.

Guidance:

Traffic should be controlled by a flagger or temporary traffic signal (if sight distance is limited), or a STOP or YIELD sign. A short taper having a maximum length of 30 m (100 ft) with channelizing devices at approximately 6.1 m (20 ft) spacings should be used to guide traffic into the one-way section.

Support:

An example of a one-lane, two-way traffic taper is shown in Figure 6C-3.

Section 6C.09 Detours and Diversions**Support:**

A detour is a temporary rerouting of road users onto an existing highway in order to avoid a temporary traffic control zone.

Guidance:

Detours should be clearly signed over their entire length so that road users can easily use existing highways to return to the original highway.

Support:

A diversion is a temporary rerouting of road users onto a temporary highway or alignment placed around the work area.

Section 6C.10 One-Lane, Two-Way Traffic Control**Standard:**

When traffic in both directions must use a single lane for a limited distance, movements from each end shall be coordinated.

Figure 6C-3. Example of a One-Lane Two-Way Traffic Taper

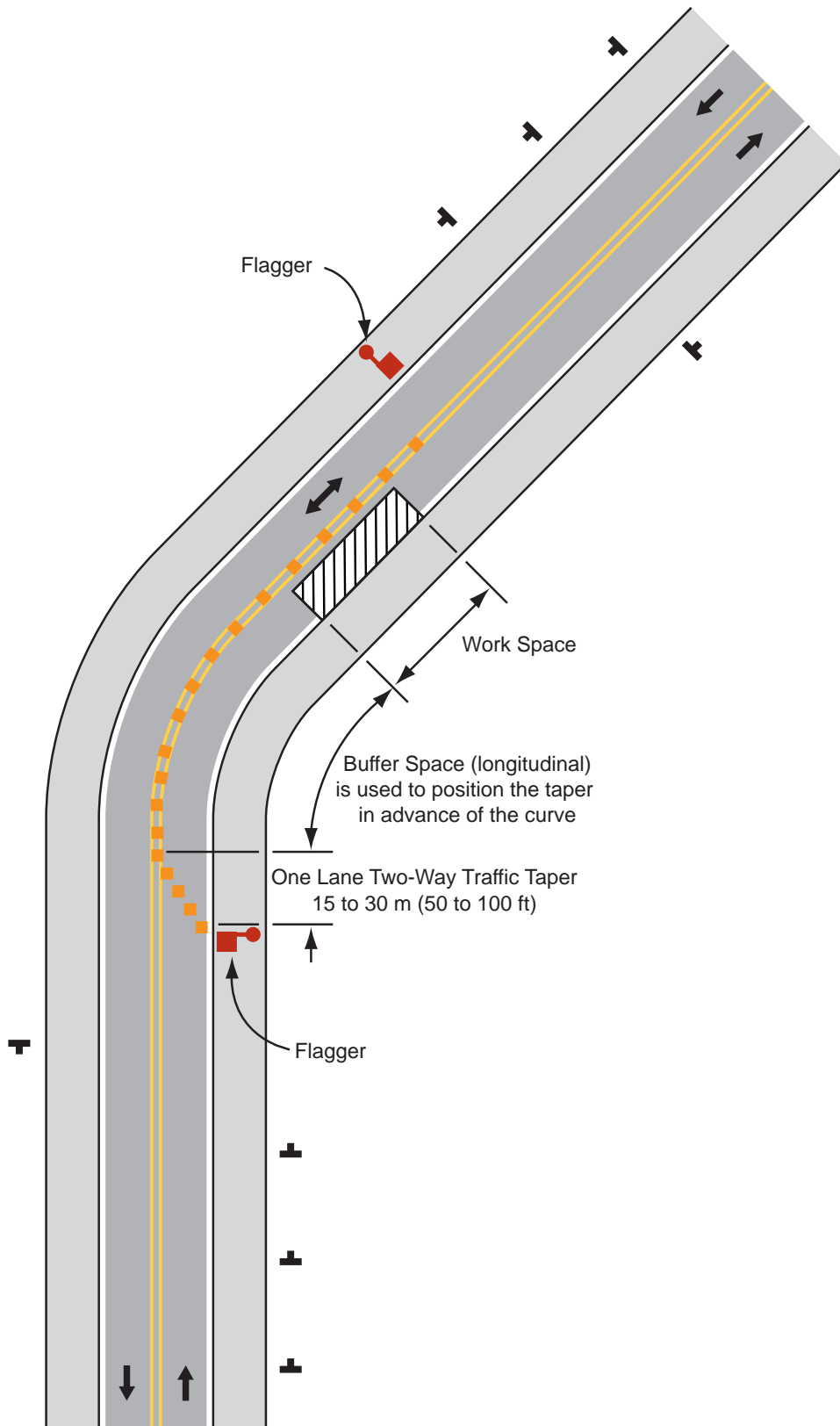

Guidance:

Provisions should be made for alternate one-way movement through the constricted section via methods such as flagger control, a flag transfer, a pilot car, traffic control signals, or stop or yield control.

Control points at each end should be chosen to permit easy passing of opposing lanes of vehicles.

If traffic on the affected one-lane roadway is not visible from one end to the other, then flagging procedures, a pilot car, or traffic signal control should be used to control opposing traffic flows.

Support:

At a spot constriction, such as an isolated pavement patch on highways with lower speeds and adequate sight distance, the movement of traffic through one-lane, two-way constrictions tends to be self-regulating.

Section 6C.11 Flagger Method of One-Lane, Two-Way Traffic Control**Option:**

When a one-lane, two-way temporary traffic control zone is short enough to allow a flagger to see from one end of the zone to the other, traffic may be controlled by either a single flagger or by a flagger at each end of the section.

Guidance:

When a single flagger is used, the flagger should be stationed on the shoulder opposite the constriction or work space, or in a position where good visibility and traffic control can be maintained at all times. When good visibility and traffic control cannot be maintained by one flagger station, traffic should be controlled by a flagger at each end of the section. One of the flaggers should be designated as the coordinator. Flaggers should be able to communicate with each other orally, electronically, or with manual signals. These manual signals should not be mistaken for flagging signals.

Section 6C.12 Flag Transfer Method of One-Lane, Two-Way Traffic Control**Support:**

The driver of the last vehicle proceeding into the one-lane section is given a red flag (or other token) and instructed to deliver it to the flagger at the other end. The opposite flagger, upon receipt of the flag, then knows that it is safe to allow traffic to move in the other direction.

A variation of this method is to replace the use of a flag with an official pilot car that always follows the last road user vehicle proceeding through the section.

Guidance:

The flag transfer method should be employed only where the one-way traffic is confined to a relatively short length of a road, usually not more than 1.6 km (1 mi) in length.

Section 6C.13 Pilot Car Method of One-Lane, Two-Way Traffic Control

Option:

A pilot car may be used to guide a queue of vehicles through the temporary traffic control zone or detour.

Guidance:

The operation of the pilot vehicle should be coordinated with flagging operations or other controls at each end of the one-lane section. The pilot car should have the name of the contractor or contracting authority prominently displayed.

Standard:

The PILOT CAR FOLLOW ME (G20-4) sign shall be mounted at a conspicuous location on the rear of the vehicle.

Section 6C.14 Temporary Traffic Control Signal Method of One-Lane, Two-Way Traffic Control

Option:

Traffic control signals may be used to control motor vehicle traffic movements in one-lane, two-way temporary traffic control zones (see Figure 6H-12 and Chapter 4G).

Section 6C.15 Stop or Yield Control Method of One-Lane, Two-Way Traffic Control

Option:

STOP or YIELD signs may be used to control traffic on low-volume roads at a one-lane, two-way work zone when drivers are able to see the other end of the one-lane, two-way operation and have sufficient visibility of approaching vehicles.

Guidance:

If the STOP or YIELD sign is installed for only one direction, then the STOP or YIELD sign should face road users who are driving on the side of the roadway that is closed for the work activity area.

CHAPTER 6D. PEDESTRIAN AND WORKER SAFETY

Section 6D.01 Pedestrian Considerations

Support:

A wide range of pedestrians can be expected at work sites, including the young, old, and disabled (for example, hearing, visual, and mobility). All of these pedestrians need a clearly delineated and usable travel path.

Standard:

The various temporary traffic control provisions for pedestrian and worker safety set forth in Part 6 shall be applied by knowledgeable (for example, trained and/or certified) persons after appropriate evaluation and engineering judgment.

Advance notification of sidewalk closures shall be provided.

Support:

It must be recognized that pedestrians are reluctant to retrace their steps to a prior intersection for a crossing.

Guidance:

Adequate provisions should be made for persons with disabilities as determined by an engineering study.

There are three considerations in planning for pedestrians in temporary traffic control zones:

- A. Pedestrians should not be led into conflicts with work site vehicles, equipment, and operations.
- B. Pedestrians should not be led into conflicts with vehicles moving through or around the work site.
- C. Pedestrians should be provided with a safe, convenient path that replicates as nearly as practical the most desirable characteristics of the existing sidewalk(s) or a footpath(s).

Consideration should be made to separate pedestrian movements from both work site activity and motor vehicle traffic. Pedestrians should be appropriately directed with advance signing that encourages them to cross to the opposite side of the roadway. In urban and suburban areas with high motor vehicle traffic volumes, these signs should be placed at intersections so that pedestrians are not confronted with mid-block work sites that will induce them to attempt skirting the work site or making a mid-block crossing.

Support:

Figures 6H-28 and 6H-29 show typical temporary traffic control device usage and techniques for pedestrian movement through work zones.

Guidance:

When pedestrian movement through or around a work site is necessary, a separate usable footpath without abrupt changes in grade or terrain should be provided.

Option:

Whenever it is feasible, closing off the work site from pedestrian intrusion may be preferable to channelizing pedestrian traffic along the site with temporary traffic control devices such as cones, tubular markers, barricades and drums, or other suitable fencing.

Guidance:

Fencing should not create sight distance restrictions for road users. Fences should not be constructed of materials that would be hazardous if impacted by vehicles.

Wooden railing, fencing, and similar systems placed immediately adjacent to motor vehicle traffic should not be used as substitutes for crashworthy temporary traffic barriers.

Standard:

Temporary traffic control devices used to delineate a temporary traffic control zone pedestrian walkway shall be crashworthy and, when struck by vehicles, present a minimum threat to pedestrians, workers, and occupants of impacting vehicles.

Guidance:

Ballast for temporary traffic control devices should be kept to the minimum amount needed and should be mounted low to prevent penetration of the vehicle windshield.

Movement by work vehicles and equipment across designated pedestrian paths should be minimized and, when necessary, should be controlled by flaggers or temporary traffic control. Staging or stopping of work vehicles or equipment along the side of pedestrian paths should be avoided, since it encourages movement of workers, equipment and materials across the pedestrian path.

Access to work space across pedestrian walkways should be minimized because the access often creates unacceptable changes in grade, and rough or muddy terrain and pedestrians will tend to avoid these areas by attempting non-intersection crossings.

Option:

A canopied walkway may be used to protect pedestrians from falling debris.

Guidance:

Covered walkways should be sturdily constructed and adequately lighted for nighttime use.

When pedestrian and vehicle paths are rerouted to a closer proximity to each other, consideration should be given to separating them by a temporary traffic barrier.

If a temporary traffic barrier is used to shield pedestrians, it should be designed to suit site conditions.

Support:

Depending on the possible motor vehicle speed and angle of impact, temporary traffic barriers might deflect upon impact by an errant vehicle. Guidance for locating and designing temporary traffic barriers can be found in Chapter 9 of AASHTO's "Roadside Design Guide" (see Section 1A.11).

Standard:

Short intermittent segments of temporary traffic barrier shall not be used because they nullify the containment and re-directive capabilities of the temporary traffic barrier, increase the potential for serious injury both to vehicle occupants and pedestrians, and encourage the presence of blunt, leading ends. All upstream leading ends that are present shall be appropriately flared or protected with properly installed and maintained crashworthy cushions. Adjacent temporary traffic barrier segments shall be properly connected in order to provide the overall strength required for the temporary traffic barrier to perform properly.

Normal vertical curbing shall not be used as a substitute for temporary traffic barriers when temporary traffic barriers are clearly needed.

Option:

Temporary traffic barriers or longitudinal channelizing devices may be used to discourage pedestrians from unauthorized movements into the work space. They may also be used to inhibit conflicts with motor vehicle traffic by minimizing the possibility of mid-block crossings.

Support:

One example of a major pedestrian concern is urban and suburban building construction encroaching onto the contiguous sidewalks, which forces pedestrians off the curb into direct conflict with moving vehicles.

Guidance:

If a high potential exists for vehicle incursions into the pedestrian path, pedestrians should be rerouted or temporary traffic barriers should be installed.

Support:

Standard temporary traffic control devices can satisfactorily delineate a pedestrian path. Although tape, rope, fencing, or plastic chain strung between devices can help discourage pedestrian movements off the designated pathway, they cannot eliminate them entirely.

Guidance:

The extent of pedestrian needs should be determined through engineering judgment for each work zone situation.

The highway agency in charge of the temporary traffic control should regularly inspect the activity area so that effective pedestrian temporary traffic control is maintained.

Section 6D.02 Worker Considerations**Support:**

Of equal importance to the safety of road users traveling through the work zone is the safety of workers. Temporary traffic control zones present temporary and constantly changing conditions that are unexpected by the road user. This creates an even higher degree of vulnerability for workers on or near the roadway.

Maintaining work zones with road user flow inhibited as little as possible, and using temporary traffic control devices that get the road user's attention and provide positive direction are of particular importance.

Guidance:

The following are the key elements of temporary traffic control management that should be considered to improve worker safety:

- A. Training - all workers should be trained on how to work next to motor vehicle traffic in a way that minimizes their vulnerability. Workers having specific temporary traffic control responsibilities should be trained in temporary traffic control techniques, device usage, and placement.
- B. Worker Clothing - workers close to the motor vehicle traveled way should wear bright, highly-visible clothing (see Section 6E.02).

- C. Temporary Traffic Barriers - temporary traffic barriers should be placed along the work space depending on factors such as lateral clearance of workers from adjacent traffic, speed of traffic, duration and type of operations, time of day, and volume of traffic.
- D. Speed Reduction - reducing the speed of motor vehicle traffic, mainly through regulatory speed zoning, funneling, use of law enforcement officials, lane reduction, or flaggers, should be considered.

Option:

The following are additional elements of temporary traffic control management that may be considered to improve worker safety:

- A. Shadow Vehicle - in the case of mobile and constantly moving operations, such as pothole patching and striping operations, a shadow vehicle, equipped with appropriate lights, warning signs, and/or a rear-mounted impact attenuator may be used to protect the workers from impacts by errant vehicles.
- B. Road Closure - if alternate routes are available to handle road users, the road may be closed temporarily. This may also facilitate project completion and thus further reduce worker vulnerability.
- C. Police Use - in highly vulnerable work situations, particularly those of relatively short duration, police units may be stationed to heighten the awareness of passing motor vehicle traffic and to improve safety through the temporary traffic control zone.
- D. Lighting - for nighttime work, the work zone and approaches may be lighted.
- E. Special Devices - judicious use of special warning and control devices may be helpful for certain difficult work zone situations. These include rumble strips, changeable message signs, hazard identification beacons, flags, and warning lights. Intrusion warning devices may be used to alert workers to the approach of errant vehicles. However, misuse or overuse of special devices or techniques may lessen their effectiveness.

CHAPTER 6E. FLAGGER CONTROL

Section 6E.01 Qualifications for Flaggers

Support:

A flagger is a person who provides temporary traffic control.

Guidance:

Because they are responsible for road user safety, and because they make frequent contact with the public, flaggers should have the following minimum qualifications:

- A. Sense of responsibility for the safety of the public and the workers
- B. Adequate training in safe temporary traffic control practices
- C. Average intelligence
- D. Good physical condition, including sight, mobility, and hearing
- E. Mental alertness and the ability to react in an emergency
- F. Courteous, but with a firm manner
- G. Neat appearance

Section 6E.02 High-Visibility Clothing

Standard:

For daytime work, the flagger's vest, shirt, or jacket shall be either orange, yellow, yellow-green, or a fluorescent version of these colors. For nighttime work, similar outside garments shall be retroreflective. The retroreflective material shall be either orange, yellow, white, silver, yellow-green, or a fluorescent version of these colors, and shall be visible at a minimum distance of 300 m (1,000 ft). The retroreflective clothing shall be designed to clearly identify the wearer as a person.

Guidance:

When uniformed law enforcement officers are used, high-visibility clothing as described above should be worn by the law enforcement officer.

Section 6E.03 Hand-Signaling Devices**Support:**

Hand-signaling devices, such as STOP/SLOW paddles, lights, and red flags, are used to control road users through temporary traffic control zones.

Guidance:

The STOP/SLOW paddle should be the primary and preferred hand-signaling device because the STOP/SLOW paddle gives road users more positive guidance than red flags. Use of flags should be limited to emergency situations.

Standard:

The STOP/SLOW paddle shall have an octagonal shape on a rigid handle. STOP/SLOW paddles shall be at least 450 mm (18 in) wide with letters at least 150 mm (6 in) high and should be fabricated from light semi-rigid material. The background of the STOP face shall be red with white letters and border. The background of the SLOW face shall be orange with black letters and border. When used at night, the STOP/SLOW paddle shall be retroreflectorized

Option:

The STOP/SLOW paddle may be modified to improve conspicuity by incorporating white flashing lights. Two lights may be installed and centered vertically above and below the STOP legend, or centered horizontally on either side of the STOP legend. Instead of the above two-light arrangement, one light may be centered below the STOP legend.

Standard:

Flags, when used, shall be a minimum of 600 mm (24 in) square, made of a good grade of red material, and securely fastened to a staff that is approximately 900 mm (36 in) in length.

Guidance:

The free edge of a flag should be weighted so the flag will hang vertically, even in heavy winds.

Standard:

When used at nighttime, flags shall be retroreflectorized red.

Section 6E.04 Flagger Procedures**Support:**

The use of paddles and flags by flaggers are illustrated in Figure 6E-1.

Standard:

The following methods of signaling with paddles shall be used:

- A. To stop road users, the flagger shall face road users and aim the STOP paddle face toward road users in a stationary position with the arm extended horizontally away from the body. The free arm shall be held with the palm of the hand above shoulder level toward approaching traffic.**
- B. To direct stopped road users to proceed, the flagger shall face road users with the SLOW paddle face aimed toward road users in a stationary position with the arm extended horizontally away from the body. The flagger shall motion with the free hand for road users to proceed.**
- C. To alert or slow traffic, the flagger shall face road users with the SLOW paddle face aimed toward road users in a stationary position with the arm extended horizontally away from the body.**

Option:

To further alert or slow traffic, the flagger holding the SLOW paddle face toward road users may motion up and down with the free hand, palm down.

Standard:

The following methods of signaling with a flag shall be used:

- A. To stop road users, the flagger shall face road users and extend the flag staff horizontally across the road users lane in a stationary position so that the full area of the flag is visibly hanging below the staff. The free arm shall be held with the palm of the hand above the shoulder level toward approaching traffic.**
- B. To direct stopped road users to proceed, the flagger shall stand parallel to the road user movement and with flag and arm lowered from the view of the road users, and shall motion with the free hand for road users to proceed. Flags shall not be used to signal road users to proceed.**

Figure 6E-1. Use of Hand-Signaling Devices by Flaggers

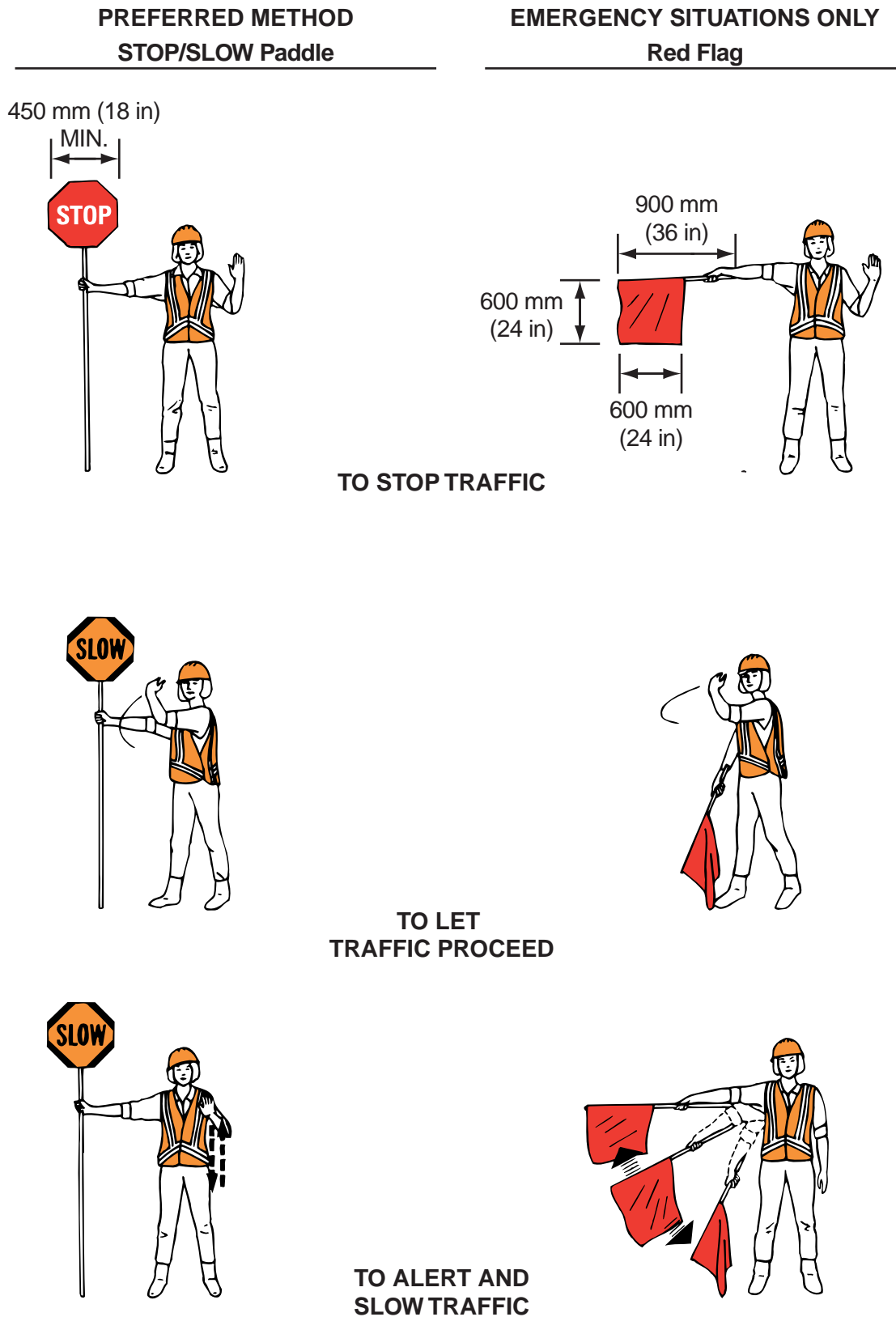

- C. To alert or slow traffic, the flagger shall face road users and slowly wave the flag in a sweeping motion of the extended arm from shoulder level to straight down without raising the arm above a horizontal position. The flagger shall keep the free hand down.**

Section 6E.05 Flagger Stations

Standard:

Flagger stations shall be located far enough in advance of the work space so that approaching road users will have sufficient distance to stop before entering the work space.

Support:

Guidelines for determining the distance of the flagger station in advance of the work space are shown in Table 6E-1.

Option:

The distances shown in Table 6E-1 may be increased for downgrades and other conditions that affect stopping distance.

Guidance:

Flagger stations should be preceded by proper advance warning signs. At night, flagger stations should be illuminated.

The flagger should stand either on the shoulder adjacent to the road user being controlled or in the closed lane prior to stopping road users. A flagger should only stand in the lane being used by moving road users after road users have stopped. The flagger should be clearly visible to first approaching road user at all times. The flagger also should be visible to other road users. The flagger should be stationed sufficiently in advance of the workers to warn them (for example, with audible warning devices such as horns, whistles, etc.) of approaching danger by out-of-control vehicles. The flagger should stand alone, never permitting a group of workers to congregate around the flagger station.

Option:

At a spot constriction, the flagger may have to take a position on the shoulder opposite the closed section in order to operate effectively.

Table 6E-1 may be used to determine the visibility distance for road users approaching the flagger.

At spot lane closures where adequate sight distance is available for the safe handling of traffic, the use of one flagger may be sufficient.

Table 6E-1. Distance of Flagger Station in Advance of the Work Space

Speed* (km/h)	Distance (m)	Speed* (mph)	Distance (ft)
30	10	20	35
40	15	25	55
50	30	30	85
60	45	35	120
70	65	40	170
80	85	45	220
90	110	50	280
100	135	55	335
110	170	60	415
120	205	65	485

* Posted speed, off-peak 85th-percentile speed prior to work starting, or the anticipated operating speed

CHAPTER 6F. TEMPORARY TRAFFIC CONTROL ZONE DEVICES

Section 6F.01 Types of Devices

Guidance:

The design and application of temporary traffic control devices used in temporary traffic control zones should consider the needs of all road users.

Support:

Crashworthiness and crash testing information on devices described in Part 6 are found in AASHTO's "Roadside Design Guide" (see Section 1A.11).

Standard:

Traffic control devices shall be defined as all signs, signals, markings, and other devices used to regulate, warn, or guide traffic, placed on, over, or adjacent to a street, highway, pedestrian facility, or bikeway by authority of a public body or official having jurisdiction.

All traffic control devices used on street and highway construction, maintenance, utility, or incident management operations shall conform to the applicable provisions of this Manual.

Option:

Where the color orange is required, fluorescent red-orange or fluorescent yellow-orange colors may also be used.

Support:

The fluorescent versions of orange provide higher conspicuity than standard orange, especially during twilight.

Section 6F.02 General Characteristics of Signs

Support:

Temporary traffic control zone signs convey both general and specific messages by means of words or symbols and have the same three categories as all road user signs: regulatory, warning, and guide.

Standard:

The colors for regulatory signs shall follow the Standards for regulatory signs in Table 2A-4 and Chapter 2B. Warning signs in temporary traffic control zones shall have a black legend on an orange background, except for the Railroad Advance Warning (W10-1) sign which shall have a black message and border on a yellow background, and except for signs that are permitted in Part 2 to have yellow or fluorescent yellow-green backgrounds. Colors for guide signs shall follow the Standards in Table 2A-4 and Chapter 2D, except for guide signs as noted in Section 6F.47.

Option:

Existing warning signs that are still applicable may remain in place.

In order to maintain the systematic use of yellow or fluorescent yellow-green background for pedestrian, bicycle, and school warning signs in a jurisdiction, the yellow or fluorescent yellow-green background for pedestrian, bicycle, and school warning signs may be used in temporary traffic control zones.

Standard orange flags or flashing warning lights may be used in conjunction with signs.

Standard:

When standard orange flags or flashing warning lights are used in conjunction with signs, they shall not block the sign face.

Option:

The dimensions of signs shown in Part 6 are for standard sizes, which may be increased wherever necessary for greater legibility or emphasis.

Standard:

Deviations from standard sizes as prescribed herein shall be in 150 mm (6 in) increments.

Support:

Sign design details are contained in the "Standard Highway Signs" book (see Section 1A.11).

Standard:

All signs used at night shall be either retroreflective with a material that has a smooth, sealed outer surface or illuminated to show the same shape and similar color both day and night.

Option:

Sign illumination may be either internal or external.

Support:

Street, highway, or strobe lighting does not constitute external sign illumination.

Option:

Signs may be made of rigid or flexible material.

Section 6F.03 Sign Placement

Guidance:

Signs should be located on the right side of the roadway unless otherwise specified in this Manual.

Option:

Where special emphasis is needed, signs may be placed on both the left and right sides of the roadway. Signs mounted on portable supports may be placed within the roadway itself. Signs may also be mounted on or above barricades.

Support:

Guidelines for height and lateral clearance of temporary post-mounted signs are shown in Figure 6F-1.

Standard:

Post-mounted signs installed at the side of the road in rural areas shall be mounted at a height at least 1.5 m (5 ft), measured from the bottom of the sign to the near edge of the pavement. In business, commercial, and residential districts where parking and/or pedestrian movement is likely to occur, or where there are other obstructions to view, the distance between the bottom of the sign and the top of the near edge of the traveled way shall be at least 2.1 m (7 ft).

Signs mounted on barricades and barricade/sign combination shall be crashworthy.

Guidance:

Neither portable nor permanent sign supports should be located on sidewalks, bicycle lanes, or areas designated for pedestrian or bicycle traffic.

Figure 6F-1. Height and Lateral Location of Signs – Typical Installations

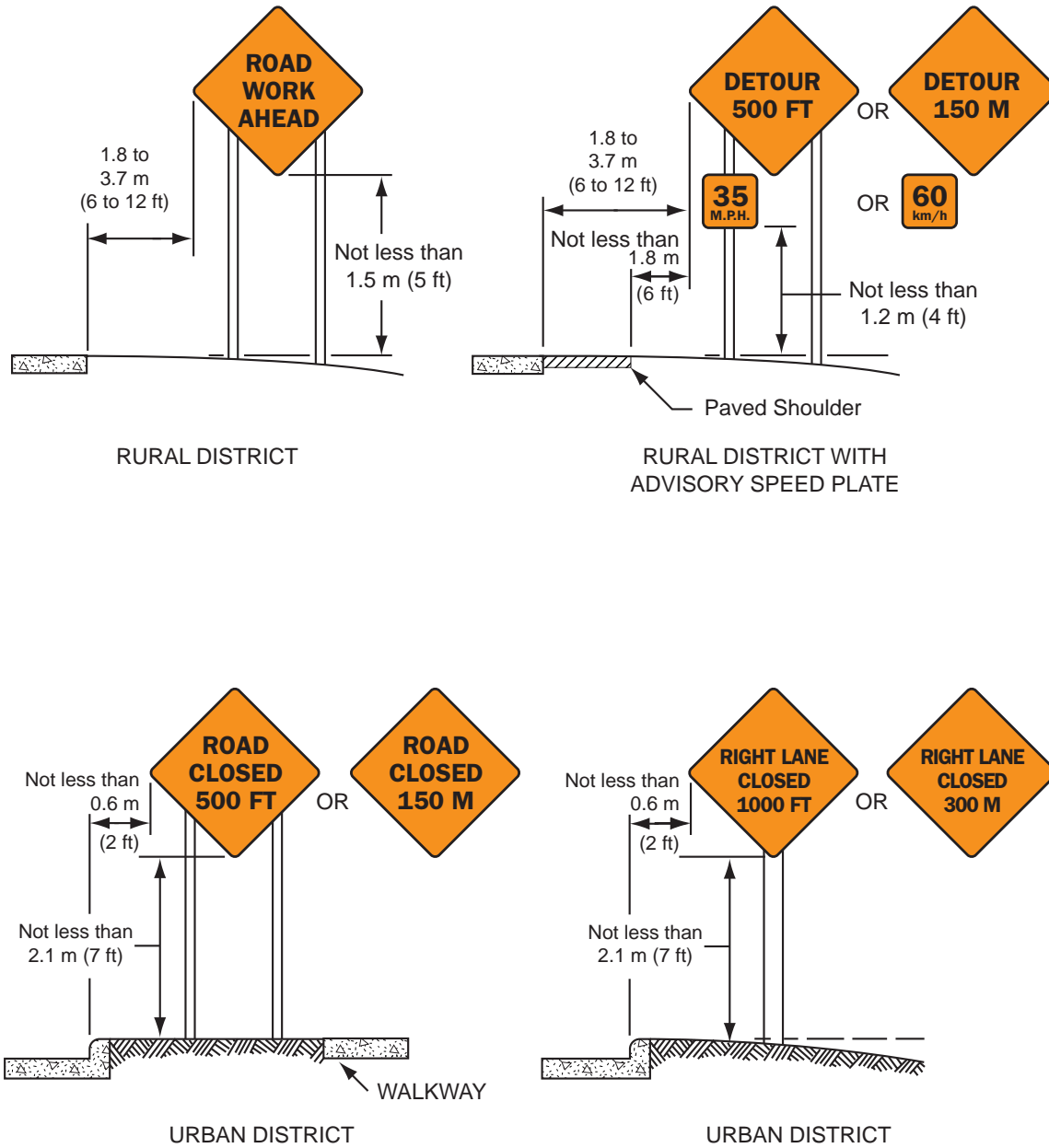

Option:

A 2.1 m (7 ft) mounting height may be used in rural areas for increased visibility.

The height to the bottom of a secondary sign mounted below another sign may be 0.3 m (1 ft) less than the appropriate height specified above.

Guidance:

Except as noted in the Option, signs mounted on portable supports should not be used for a duration of more than 3 days.

Option:

The R9-8 through R9-11a series, R11 series, W1-6 through W1-8 series, M4-10, E5-1, or other similar type signs may be used on portable supports for longer than 3 days.

Support:

Methods of mounting signs other than on posts are illustrated in Figure 6F-2.

Guidance:

Signs mounted on Type III barricades should not cover more than 50 percent of the top two rails or 33 percent of the total area of the three rails.

Standard:

Sign supports shall be crashworthy. Large signs having an area exceeding 5 square meters (50 square feet) that are installed on multiple breakaway posts shall be mounted a minimum of 2.1 m (7 ft) above the ground.

Signs mounted on barricades, or other (added by subteam to include barricade as a temporary support) portable supports, shall be no less than 0.3 m (1 ft) above the traveled way.

Option:

For mobile operations, a sign may be mounted on a work vehicle, a shadow vehicle, or a trailer stationed in advance of the temporary traffic control zone or moving along with it. The work vehicle, the shadow vehicle, or the trailer may or may not have an impact attenuator.

Figure 6F-2. Methods of Mounting Signs Other Than on Posts

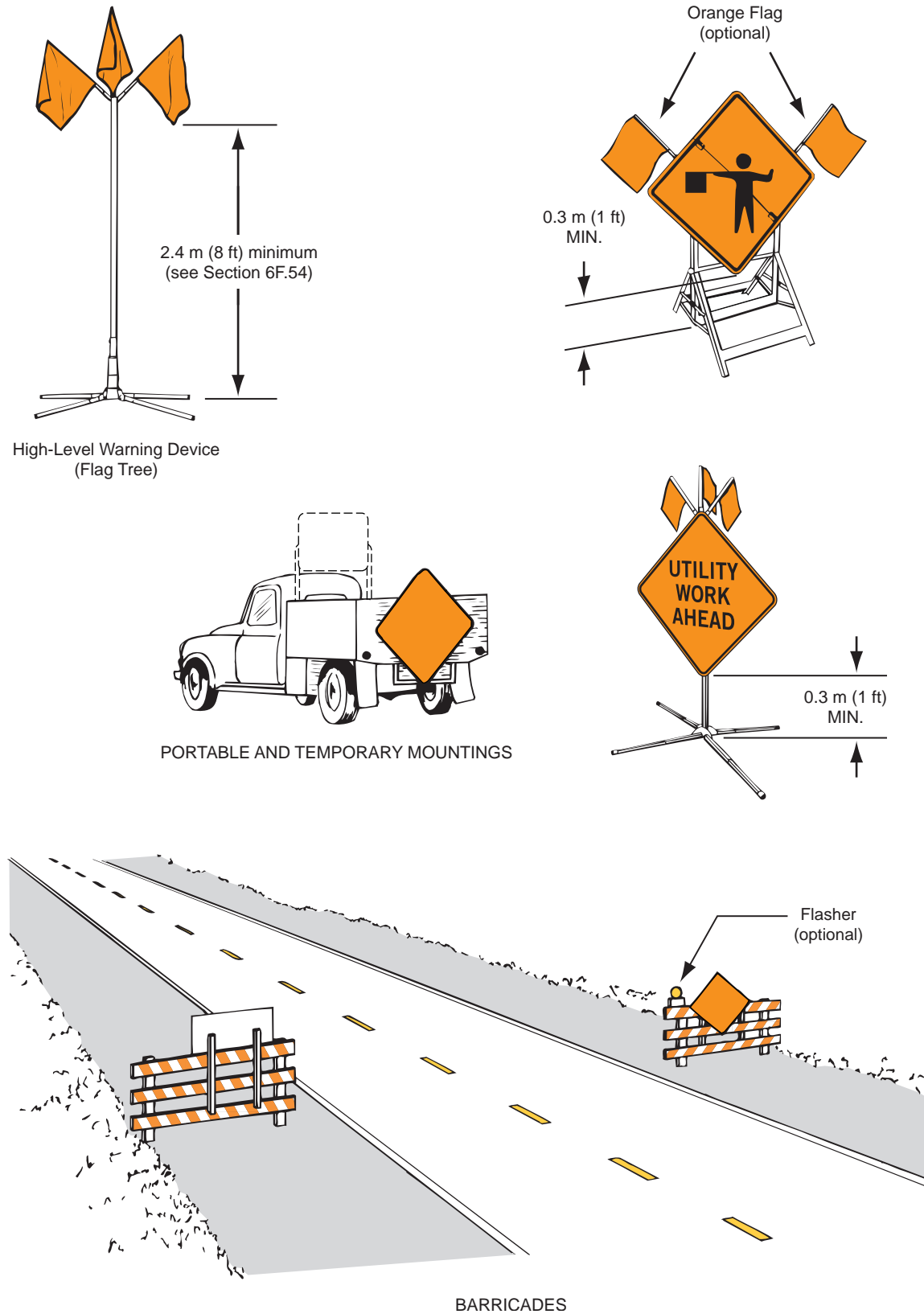

Section 6F.04 Sign Maintenance

Standard:

Signs shall be properly maintained for cleanliness, visibility, and correct positioning.

Signs that have lost significant legibility shall be promptly replaced.

Section 6F.05 Regulatory Sign Authority

Support:

Regulatory signs inform road users of traffic laws or regulations and indicate the applicability of legal requirements that would not otherwise be apparent.

Standard:

Regulatory signs shall be authorized by the public agency or official having jurisdiction and shall conform with Chapter 2B.

Section 6F.06 Regulatory Sign Design

Support:

Temporary traffic control regulatory signs shall conform to the Standards for regulatory signs presented in Part 2 and in FHWA's "Standard Highway Signs" book. Regulatory signs are generally rectangular with a black legend and border on a white background. Exceptions include the STOP, YIELD, DO NOT ENTER, WRONG WAY, and ONE WAY signs.

Option:

The ONE WAY sign may be either a horizontal or vertical rectangular sign.

Section 6F.07 Regulatory Sign Applications

Standard:

If a temporary traffic control zone requires regulatory measures different from those existing, the existing permanent regulatory devices shall be removed or covered and superseded by the appropriate temporary regulatory signs. This change shall be made in conformance with applicable ordinances or statutes of the jurisdiction.



R1-1
750 x 750 mm
(30 x 30 in)



R1-2
900 x 900 x 900 mm
(36 x 36 x 36 in)



R1-2a
1200 x 600 mm
(48 x 24 in)

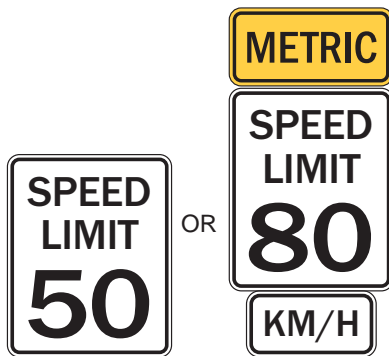

R2-1
600 x 750 mm
(24 x 30 in)

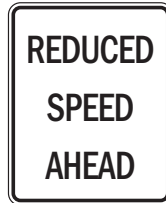

R2-5a
600 x 750 mm
(24 x 30 in)

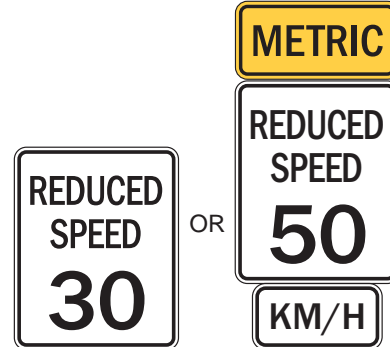

R2-5b
600 x 750 mm
(24 x 30 in)



R2-5c
600 x 750 mm
(24 x 30 in)



R3-1
600 x 600 mm
(24 x 24 in)



R3-2
600 x 600 mm
(24 x 24 in)



R3-3
600 x 600 mm
(24 x 24 in)



R3-4
600 x 600 mm
(24 x 24 in)



R3-5
750 x 900 mm
(30 x 36 in)

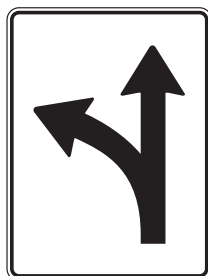

R3-6
750 x 900 mm
(30 x 36 in)



R3-7
750 x 750 mm
(30 x 30 in)



R3-8
750 x 750 mm
(30 x 30 in)



R4-1
600 x 750 mm
(24 x 30 in)



R4-2
600 x 750 mm
(24 x 30 in)



R4-7
600 x 750 mm
(24 x 30 in)



R4-9
600 x 750 mm
(24 x 30 in)



R5-1
750 x 750 mm
(30 x 30 in)



R5-1A
900 x 600 mm
(36 x 24 in)



R6-1
900 x 300 mm
(36 x 12 in)



R6-2
450 x 600 mm
(18 x 24 in)



R8-3
600 x 600 mm
(24 x 24 in)



R9-8
600 x 300 mm
(24 x 12 in)



R9-9
600 x 300 mm
(24 x 12 in)



R9-10
600 x 300 mm
(24 x 12 in)



R9-11
600 x 300 mm
(24 x 12 in)



R9-11a
600 x 300 mm
(24 x 12 in)



R11-2
1200 x 750 mm
(48 x 30 in)

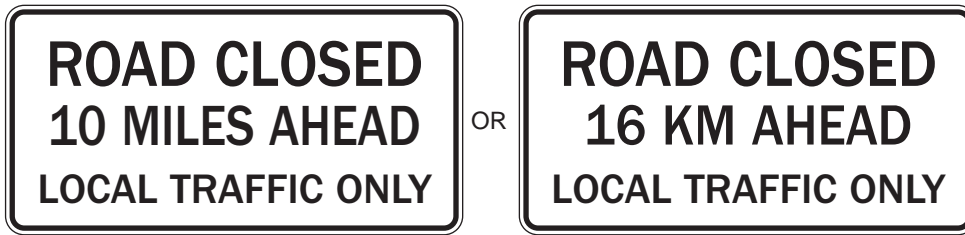

R11-3a
1500 x 750 mm
(60 x 30 in)



R11-4
1500 x 750 mm
(60 x 30 in)

R12-1
600 x 750 mm
(24 x 30 in)

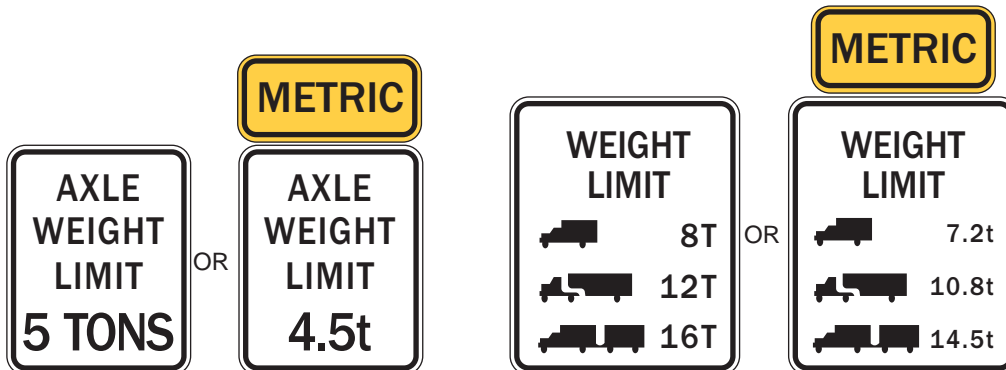

R12-2
600 x 750 mm
(24 x 30 in)

R12-5
750 x 900 mm
(30 x 36 in)

Section 6F.08 ROAD (STREET) CLOSED Sign (R11-2)**Guidance:**

The ROAD (STREET) CLOSED (R11-2) sign should be used when the roadway is closed to all road users except contractors' equipment or officially authorized vehicles. The R11-2 sign should be accompanied by appropriate warning and detour signing.

Option:

The words BRIDGE OUT (or BRIDGE CLOSED) may be substituted for ROAD (STREET) CLOSED where applicable.

Guidance:

The ROAD (STREET) CLOSED sign should be installed at or near the center of the roadway on or above a Type III barricade that closes the roadway (see Section 6F.60).

Standard:

The ROAD (STREET) CLOSED sign shall not be used where road user flow is maintained or where the actual closure is some distance beyond the sign.

Section 6F.09 Local Traffic Only Signs (R11-3a, R11-4)**Guidance:**

The Local Traffic Only signs should be used where road user flow detours to avoid a closure some distance beyond the sign, but where local road users can use the roadway to the point of closure. These signs should be accompanied by appropriate warning and detour signing.

In rural applications, the Local Traffic Only sign should have the legend ROAD CLOSED XX KM (MILES) AHEAD, LOCAL TRAFFIC ONLY (R11-3a).

Option:

In urban areas, the legend ROAD (STREET) CLOSED TO THRU TRAFFIC (R11-4) or ROAD CLOSED, LOCAL TRAFFIC ONLY may be used.

The words BRIDGE OUT (or BRIDGE CLOSED) may be substituted for the words ROAD (STREET) CLOSED on the R11-3a or R11-4 sign where applicable.

Section 6F.10 Weight Limit Signs (R12-1, R12-2, R12-5)**Standard:**

A Weight Limit sign, which shows the gross weight or axle weight that is permitted on the roadway or bridge, shall be consistent with State or local regulations and shall not be installed without the approval of the authority having jurisdiction over the highway.

When weight restrictions are imposed, a marked detour shall be provided for vehicles weighing more than the posted limit.

Section 6F.11 STAY IN LANE Sign (R4-9)**Option:**

A STAY IN LANE (R4-9) sign may be used where a multi-lane shift has been incorporated as part of the temporary traffic control on a highway to direct road users around road work that occupies part of the roadway on a multi-lane highway.

Section 6F.12 PEDESTRIAN CROSSWALK Sign (R9-8)**Option:**

The PEDESTRIAN CROSSWALK (R9-8) sign may be used to indicate where a temporary crosswalk has been established.

Section 6F.13 SIDEWALK CLOSED Signs (R9-9, R9-10, R9-11, R9-11a)**Guidance:**

SIDEWALK CLOSED signs should be used where pedestrian flow is restricted or rerouted by work activities.

The SIDEWALK CLOSED (R9-9) sign should be installed at the beginning of the closed sidewalk, at the intersections preceding the closed sidewalk, and elsewhere along the closed sidewalk as needed.

The SIDEWALK CLOSED, (ARROW) USE OTHER SIDE (R9-10) sign should be installed at the beginning of the restricted sidewalk when a parallel sidewalk exists on the other side of the roadway.

The SIDEWALK CLOSED AHEAD, (ARROW) CROSS HERE (R9-11) sign should be used to indicate to pedestrians that sidewalks beyond the sign are closed and to direct them to open crosswalks, sidewalks, or other travel paths.

The SIDEWALK CLOSED, (ARROW) CROSS HERE (R9-11a) sign should be installed just beyond the point to which pedestrians are being redirected.

Support:

These signs are typically mounted on a barricade to encourage compliance.

Section 6F.14 Special Regulatory Signs

Option:

Special regulatory signs may be used based on engineering judgment consistent with regulatory requirements.

Guidance:

Special regulatory signs should conform to the general requirements of color, shape, and alphabet size and series. The sign message should be brief, legible, and clear.

Section 6F.15 Warning Sign Function, Design, and Application

Support:

Temporary traffic control zone warning signs notify road users of specific situations or conditions on or adjacent to a roadway that might not otherwise be apparent.

Standard:

Temporary traffic control warning signs shall conform to the Standards for warning signs presented in Part 2 and in FHWA's "Standard Highway Signs" book. Except as noted in the Option below, temporary traffic control warning signs shall be diamond-shaped with a black symbol or message and border on an orange background, except for the W10-1 sign which shall have a black message and border on a yellow background, and except for signs that are permitted in Part 2 to have yellow or fluorescent yellow-green backgrounds.

Option:

Mounting or space considerations may justify a change from the standard diamond shape.

In emergencies, available warning signs having yellow backgrounds may be used if orange signs are not at hand.



W1-1
750 x 750 mm
(30 x 30 in)



W1-2
750 x 750 mm
(30 x 30 in)



W1-3
750 x 750 mm
(30 x 30 in)



W1-4
750 x 750 mm
(30 x 30 in)



W1-4b
900 x 900 mm
(36 x 36 in)



W1-4c
900 x 900 mm
(36 x 36 in)



W1-6
1200 x 600 mm
(48 x 24 in)



W1-8
450 x 600 mm
(18 x 24 in)



W3-1a
900 x 900 mm
(36 x 36 in)



W3-2a
900 x 900 mm
(36 x 36 in)



W3-3
900 x 900 mm
(36 x 36 in)



W4-1
750 x 750 mm
(30 x 30 in)



W4-1a
900 x 900 mm
(36 x 36 in)



W4-2
900 x 900 mm
(36 x 36 in)



W4-3
1200 x 1200 mm
(48 x 48 in)



W5-1
900 x 900 mm
(36 x 36 in)



W5-2
900 x 900 mm
(36 x 36 in)



W5-2a
900 x 900 mm
(36 x 36 in)



W5-3
900 x 900 mm
(36 x 36 in)



W5-4
900 x 900 mm
(36 x 36 in)



W6-1
900 x 900 mm
(36 x 36 in)



W6-2
900 x 900 mm
(36 x 36 in)



W6-3
750 x 750 mm
(30 x 30 in)



W6-4
300 x 450 mm
(12 x 18 in)



W7-1
750 x 750 mm
(30 x 30 in)



W8-1
750 x 750 mm
(30 x 30 in)



W8-2
750 x 750 mm
(30 x 30 in)



W8-3
750 x 750 mm
(30 x 30 in)



W8-4
750 x 750 mm
(30 x 30 in)



W8-5
750 x 750 mm
(30 x 30 in)



W8-6
750 x 750 mm
(30 x 30 in)



W8-7
750 x 750 mm
(30 x 30 in)



W8-8
750 x 750 mm
(30 x 30 in)



W8-9
750 x 750 mm
(30 x 30 in)



W8-9a
750 x 750 mm
(30 x 30 in)



W8-11
900 x 900 mm
(36 x 36 in)



W8-12
900 x 900 mm
(36 x 36 in)



W9-1
900 x 900 mm
(36 x 36 in)



W9-2
900 x 900 mm
(36 x 36 in)



W9-3
900 x 900 mm
(36 x 36 in)



W10-1
900 mm Diameter
(36 in)



W12-1
600 x 600 mm
(24 x 24 in)



W12-2
900 x 900 mm
(36 x 36 in)

OR



OR



W13-1
450 x 450 mm (18 x 18 in)
600 x 600 mm (24 x 24 in)



W13-4
600 x 750 mm
(24 x 30 in)



W14-3
900 x 1200 x 1200 mm
(36 x 48 x 48 in)

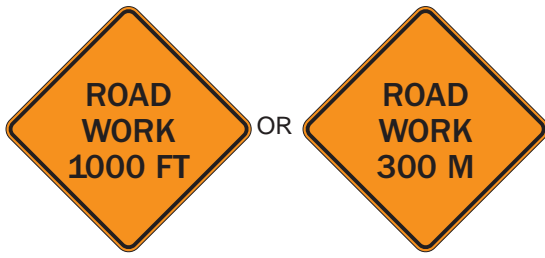

W20-1
1200 x 1200 mm
(48 x 48 in)

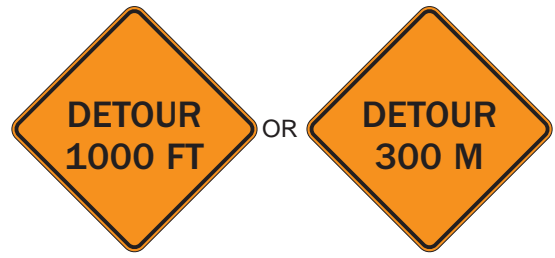

W20-2
1200 x 1200 mm
(48 x 48 in)

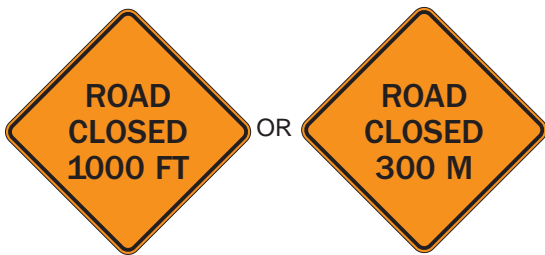

W20-3
1200 x 1200 mm
(48 x 48 in)

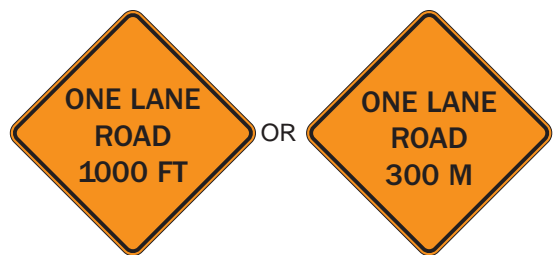

W20-4
1200 x 1200 mm
(48 x 48 in)

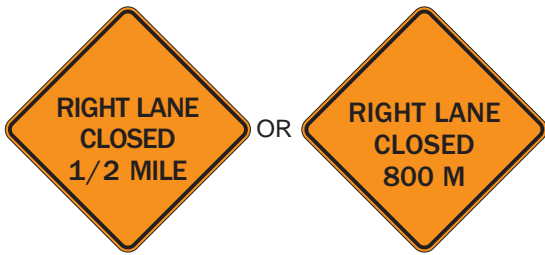

W20-5
1200 x 1200 mm
(48 x 48 in)

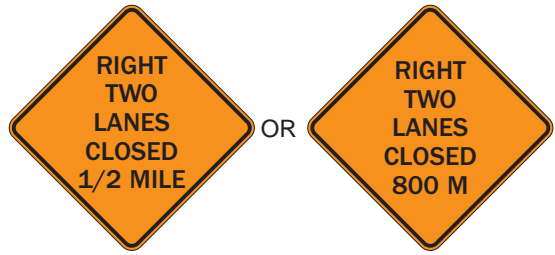

W20-5a
1200 x 1200 mm
(48 x 48 in)

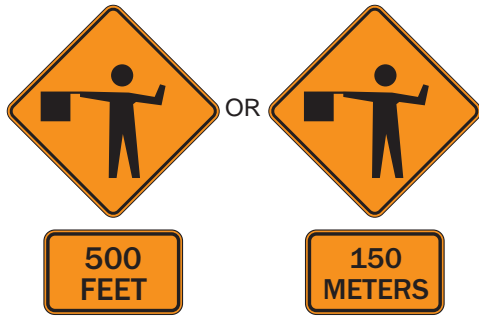

W20-7a
1200 x 1200 mm
(48 x 48 in)
SUPPLEMENTAL PLAQUE
600 x 450 mm
(24 x 18 in)



W20-7b
900 x 900 mm
(36 x 36 in)



W21-1a
900 x 900 mm
(36 x 36 in)



W21-2
750 x 750 mm
(30 x 30 in)



W21-3
900 x 900 mm
(36 x 36 in)



W21-5
750 x 750 mm
(30 x 30 in)



W21-5a
750 x 750 mm
(30 x 30 in)



W21-5b
1200 x 1200 mm
(48 x 48 in)

OR



W21-6
750 x 750 mm
(30 x 30 in)



W21-7
900 x 900 mm
(36 x 36 in)



W22-1
1200 x 1200 mm
(48 x 48 in)



W22-2
1050 x 900 mm
(42 x 36 in)



W22-3
1050 x 900 mm
(42 x 36 in)



W23-1
1200 x 600 mm
(48 x 24 in)



G20-1
900 x 450 mm
(36 x 18 in)

OR



G20-2a
900 x 450 mm
(36 x 18 in)



G20-4
900 x 450 mm
(36 x 18 in)



E5-2
1200 x 900 mm
(48 x 36 in)



E5-2a
1200 x 900 mm
(48 x 36 in)



M4-8
600 x 300 mm
(24 x 12 in)



M4-8a
600 x 450 mm
(24 x 18 in)



M4-8b
600 x 300 mm
(24 x 12 in)



M4-9
750 x 600 mm
(30 x 24 in)



M4-10
1200 x 450 mm
(48 x 18 in)

Guidance:

Where roadway or road user conditions require greater emphasis, larger than standard size warning signs should be used, with the symbol or legend enlarged approximately in proportion to the outside dimensions.

Where any part of the roadway is obstructed or closed by work activities or incidents, advance warning signs should be installed to alert road users well in advance of these obstructions or restrictions.

Option:

Advance warning signs may be used singly or in combination.

Standard:

Because of their importance, advance warning signs for higher-speed locations shall have a size of 1200 x 1200 mm (48 x 48 in) (see Part 2).

Option:

Where speeds and volumes are moderately low, a minimum size of 900 x 900 mm (36 x 36 in) may be used for advance warning signs.

On secondary roads or city streets where speeds are very low, signs smaller than the standard size, but not less than 600 x 600 mm (24 x 24 in), may be used for warning signs having short word messages or clear symbols.

Advance warning signs larger than the minimum standards may be used for additional emphasis of the temporary traffic control zone (see Part 2).

Where distances are not shown on warning signs as part of the message, a supplemental plaque with the distance legend may be mounted immediately below the sign on the same support.

Section 6F.16 Position of Advance Warning Signs**Guidance:**

Where highway conditions permit, warning signs should be placed in advance of the temporary traffic control zone at varying distances depending on roadway type, condition, and posted speed. Table 6C-1 contains information regarding the spacing of advance warning signs. Where a series of two or more advance warning signs is used, the closest sign to the temporary traffic control zone should be placed approximately 30 m (100 ft) for low-speed urban streets to 300 m (1,000 ft) or more for expressways and freeways.

Support:

Various conditions, such as limited sight distance or obstructions that might require a driver to reduce speed or stop, might require additional advance warning signs.

Option:

As an alternative to a specific distance on advance warning signs, the word AHEAD may be used.

Support:

At temporary traffic control zones on lightly-traveled roads, all of the advance warning signs prescribed for major construction might not be needed.

Option:

Utility work, maintenance, or minor construction can occur within the temporary traffic control zone limits of a major construction project, and additional warning signs may be needed.

Guidance:

Utility, maintenance, and minor construction signing and temporary traffic control should be coordinated with appropriate authorities so that road users are not confused or misled by the additional temporary traffic control devices.

Section 6F.17 ROAD (STREET) WORK Sign (W20-1)**Guidance:**

The ROAD (STREET) WORK (W20-1) sign, which serves as a general warning of obstructions or restrictions, should be located in advance of the work space or any detour, on the road where the work is taking place, and on all intersecting roadways.

Standard:

The ROAD (STREET) WORK (W20-1) sign shall have the legend ROAD (STREET) WORK, XX M (FT), XX KM (MILES), or AHEAD.

Section 6F.18 DETOUR Sign (W20-2)**Guidance:**

The DETOUR (W20-2) sign should be used in advance of a road user detour over a different roadway or route.

Standard:

The DETOUR sign shall have the legend DETOUR, XX M (FT), XX KM (MILES), or AHEAD.

Section 6F.19 ROAD (STREET) CLOSED Sign (W20-3)

Guidance:

The ROAD (STREET) CLOSED (W20-3) sign should be used in advance of the point where a highway is closed to all road users, or to all but local road users.

Standard:

The ROAD (STREET) CLOSED sign shall have the legend ROAD (STREET) CLOSED, XX M (FT), XX KM (MILES), or AHEAD.

Section 6F.20 ONE LANE ROAD Sign (W20-4)

Standard:

The ONE LANE ROAD (W20-4) sign shall be used only in advance of that point where motor vehicle traffic in both directions must use a common single lane (see Section 6C.10). It shall have the legend ONE LANE ROAD, XX M (FT), XX KM (MILES), or AHEAD.

Section 6F.21 LANE(S) CLOSED Signs (W20-5, W20-5a)

Standard:

The LANE(S) CLOSED sign shall be used in advance of that point where one or more through lanes of a multiple-lane roadway are closed.

For a single lane closure, the LANE CLOSED (W20-5) sign shall have the legend RIGHT (LEFT) LANE CLOSED, XX M (FT), XX KM (MILES), or AHEAD. Where two adjacent lanes are closed, the sign shall have the legend RIGHT (LEFT) TWO LANES CLOSED, XX M (FT), XX KM (MILES), or AHEAD.

Section 6F.22 CENTER LANE CLOSED AHEAD Signs (W9-3, W9-3a)

Guidance:

The CENTER LANE CLOSED AHEAD (W9-3) sign should be used in advance of that point where work occupies the center lane(s) and approaching motor vehicle traffic is directed to the right or left of the work zone in the center lane.

Option:

The Center Lane Closed Ahead (W9-3a) symbol sign may be substituted for the CENTER LANE CLOSED AHEAD (W9-3) word message sign.

Section 6F.23 THRU TRAFFIC MERGE RIGHT (LEFT) Sign (W4-1a)

Guidance:

The THRU TRAFFIC MERGE RIGHT (LEFT) (W4-1a) sign should be used in advance of an intersection where one or more lane closures on the far side of a multi-lane intersection require through motor vehicle traffic on the approach to the intersection to use the right (left) lane to proceed through the intersection.

Section 6F.24 Lane Reduction Sign (W4-2)

Option:

The Lane Reduction (W4-2) symbol sign may be used to warn drivers of the reduction in the number of motor vehicle traffic lanes in the direction of travel on a multi-lane roadway.

Section 6F.25 ON RAMP Plaque (W13-4)

Guidance:

When work is being done on a ramp, but the ramp remains open, the ON RAMP (W13-4) plaque should be used to supplement the advance ROAD WORK sign.

Section 6F.26 RAMP NARROWS Sign (W5-4)

Guidance:

The RAMP NARROWS (W5-4) sign should be used in advance of the point where work on a ramp reduces the normal width of the ramp along a part or all of the ramp.

Section 6F.27 SLOW TRAFFIC AHEAD Sign (W23-1)

Option:

The SLOW TRAFFIC AHEAD (W23-1) sign may be used on a shadow vehicle, usually mounted on the rear of the most upstream shadow vehicle, along with other appropriate signs for mobile operations to warn of slow moving work vehicles. A ROAD WORK (W20-1) sign may also be used with the SLOW TRAFFIC AHEAD sign.

Section 6F.28 EXIT OPEN, EXIT CLOSED Signs (E5-2, E5-2a)

Option:

An EXIT OPEN (E5-2) or EXIT CLOSED (E5-2a) sign may be used to supplement other warning signs where work is being conducted in the vicinity of an exit ramp and where the exit maneuver for motor vehicle traffic using the ramp is different from the normal condition.

Section 6F.29 Flagger Sign (W20-7, W20-7a)

Guidance:

The Flagger (W20-7a) symbol sign should be used in advance of any point where a flagger is stationed to control road users.

Option:

A distance legend may be displayed on a supplemental plaque below the Flagger sign. The sign may be used with appropriate legends or in conjunction with other warning signs, such as the BE PREPARED TO STOP (W20-7b) sign.

The FLAGGER (W20-7) word message sign with distance legends may be substituted for the Flagger (W20-7a) symbol sign.

Standard:

The Flagger sign shall be removed, covered, or turned away from road users when the flagging operations are not occurring.

Section 6F.30 Two-Way Traffic Sign (W6-3)

Guidance:

When one roadway of a normally divided highway is closed, with two-way motor vehicle traffic maintained on the other roadway, the Two-Way Traffic (W6-3) sign

should be used at the beginning of the two-way motor vehicle traffic section and at intervals to remind road users of opposing motor vehicle traffic.

Section 6F.31 Workers Sign (W21-1, W21-1a)

Option:

A Workers (W21-1a) symbol sign may be used to alert road users of workers in or near the roadway.

Guidance:

In the absence of other warning devices, a Workers symbol sign should be used when workers are in the roadway.

Option:

The WORKERS (W21-1) word message sign may be used as an alternate to the Workers (W21-1a) symbol sign.

Section 6F.32 FRESH OIL (TAR) Sign (W21-2)

Guidance:

The FRESH OIL (TAR) (W21-2) sign should be used to warn road users of the surface treatment.

Section 6F.33 ROAD MACHINERY AHEAD Sign (W21-3)

Option:

The ROAD MACHINERY AHEAD (W21-3) sign may be used to warn of machinery operating in or adjacent to the roadway.

Section 6F.34 SHOULDER WORK Signs (W21-5, W21-5a, W21-5b)

Support:

Shoulder Work signs warn of maintenance, reconstruction, or utility operations on the highway shoulder where the roadway is unobstructed.

Standard:

The Shoulder Work sign shall have the legend SHOULDER WORK (W21-5), RIGHT (LEFT) SHOULDER CLOSED (W21-5a), or RIGHT (LEFT) SHOULDER CLOSED XXX M (FT) (W21-5b).

Option:

The Shoulder Work sign may be used in advance of the point on a non-limited access highway where there is shoulder work. It may be used singly or in combination with a ROAD WORK NEXT X KM (MILES) or ROAD WORK AHEAD sign.

Guidance:

On expressways and freeways, the RIGHT (LEFT) SHOULDER CLOSED XXX M (FT) sign followed by RIGHT (LEFT) SHOULDER CLOSED sign should be used in advance of the point where the shoulder work occurs and should be preceded by a ROAD WORK AHEAD sign.

Section 6F.35 SURVEY CREW Sign (W21-6)**Guidance:**

The SURVEY CREW (W21-6) sign should be used to warn of surveying crews working in or adjacent to the roadway.

Section 6F.36 UTILITY WORK Sign (W21-7)**Option:**

The UTILITY WORK (W21-7) sign may be used as an alternate to the ROAD (STREET) WORK (W20-1) sign for utility operations on or adjacent to a highway.

Support:

Typical examples of where the UTILITY WORK sign is used appear in Figures 6H-4, 6H-6, 6H-10, 6H-15, 6H-18, 6H-21, 6H-22, 6H-26, and 6H-33.

Standard:

The UTILITY WORK sign shall carry the legend UTILITY WORK, XX M (FT), XX KM (MILES), or AHEAD.

Section 6F.37 Signs for Blasting Areas**Support:**

Radio-Frequency (RF) energy can cause the premature firing of electric detonators (blasting caps) used in work zones.

Standard:

Road users shall be warned to turn off mobile radio transmitters and cellular telephones where blasting operations occur. A sequence of signs shall be prominently displayed to direct operators of mobile radio equipment, including cellular telephones, to turn off transmitters in a blasting area. These signs shall be covered or removed when there are no explosives in the area or the area is otherwise secured.

Guidance:

A minimum safe distance of 300 m (1,000 ft) should be used for warning sign placement.

Section 6F.38 BLASTING ZONE AHEAD Sign (W22-1)**Standard:**

The BLASTING ZONE AHEAD (W22-1) sign shall be used in advance of any temporary traffic control zone where explosives are being used. The TURN OFF 2-WAY RADIO AND PHONE and END BLASTING ZONE signs shall be used in sequence with this sign.

Section 6F.39 TURN OFF 2-WAY RADIO AND PHONE Sign (W22-2)**Standard:**

The TURN OFF 2-WAY RADIO AND PHONE (W22-2) sign shall follow the BLASTING ZONE AHEAD sign and shall be placed at least 300 m (1,000 ft) before the beginning of the blasting zone.

Section 6F.40 END BLASTING ZONE Sign (W22-3)

Standard:

The **END BLASTING ZONE (W22-3)** sign shall be placed a minimum of **300 m (1,000 ft)** past the blasting zone.

Option:

The **END BLASTING ZONE** sign may be placed either with or preceding the **END ROAD WORK** sign.

Section 6F.41 SHOULDER DROP-OFF Sign (W8-9a)

Standard:

The **SHOULDER DROP-OFF (W8-9a)** sign shall be used when a shoulder drop-off, adjacent to the travel lane, exceeds **75 mm (3 in)** in depth and is not protected by portable barriers.

Section 6F.42 UNEVEN LANES Sign (W8-11)

Guidance:

The **UNEVEN LANES (W8-11)** sign should be used during operations that create a difference in elevation between adjacent lanes.

Section 6F.43 NO CENTER STRIPE Sign (W8-12)

Guidance:

The **NO CENTER STRIPE (W8-12)** sign should be used when the work obliterates the centerline pavement markings. This sign should be placed at the beginning of the temporary traffic control zone and repeated at **3.2 km (2 mi)** intervals in long temporary traffic control zones.

Section 6F.44 Other Warning Signs

Option:

Advance warning signs may be used by themselves or with other advance warning signs.

Besides the warning signs specifically related to temporary traffic control zones, several other warning signs in Part 2 may apply in temporary traffic control zones.

Standard:

When used in temporary traffic control zones, these other warning signs shall have black legends and borders on an orange background, except for the Railroad Advance Warning (W10-1) sign, and school, pedestrian, and bicycle signs (see Section 6F.02).

Section 6F.45 Advisory Speed Plaque (W13-1)

Option:

In combination with a warning sign, an Advisory Speed (W13-1) plaque may be used to indicate a recommended safe speed through the temporary traffic control zone.

Standard:

The Advisory Speed plaque shall not be used in conjunction with any sign other than a warning sign, nor shall it be used alone. When used with orange temporary traffic control zone signs, this plaque shall have a black legend and border on an orange background. The sign shall be at least 600 x 600 mm (24 x 24 in) in size when used with a sign that is 900 x 900 mm (36 x 36 in) or larger. Except in emergencies, an Advisory Speed plaque shall not be mounted until the recommended speed is determined by the highway agency.

Section 6F.46 Supplementary Distance Plaque (W7-3a)

Option:

In combination with a warning sign, a Supplementary Distance (W7-3a) plaque with the legend NEXT XX KM (MILE) may be used to indicate the length of highway over which a work activity is being conducted, or over which a condition exists in the temporary traffic control zone.

In long temporary traffic control zones, Supplementary Distance plaques with the legend NEXT XX KM (MILES) may be placed in combination with warning signs at regular intervals within the zone to indicate the remaining length of highway over which the temporary traffic control work activity or condition exists.

Standard:

The Supplementary Distance plaque with the legend NEXT XX KM (MILES) shall not be used in conjunction with any sign other than a warning sign, nor shall it be used alone. When used with orange temporary traffic control zone signs, this plaque shall have a black legend and border on an orange background. The sign shall be at least 750 x 600 mm (30 x 24 in) in size when used with a sign that is 900 x 900 mm (36 x 36 in) or larger.

Guidance:

When used in temporary traffic control zones, the Supplementary Distance plaque with the legend NEXT XX KM (MILES) should be placed below the initial warning sign designating that, within the approaching zone, a temporary work activity or condition exists.

Section 6F.47 Guide Signs

Support:

Guide signs along highways provide road users with information to help them along their way through the temporary traffic control zone. The design of guide signs is presented in Part 2.

Guidance:

The following guide signs should be used in temporary traffic control zones as needed:

- A. Standard route markings, where temporary route changes are necessary.
- B. Directional signs and street name signs.
- C. Special guide signs relating to the condition or work being done.

Standard:

If additional guide signs are used in temporary traffic control zones, they shall have a black legend on an orange background.

Option:

When directional signs and street name signs are used in conjunction with detour routing, these signs may have a black legend on an orange background.

Section 6F.48 ROAD WORK NEXT XX KM (MILES) Sign (G20-1)**Guidance:**

The ROAD WORK NEXT XX KM (MILES) (G20-1) sign should be installed in advance of temporary traffic control zones that are more than 3.2 km (2 mi) in length.

Option:

The ROAD WORK NEXT XX KM (MILES) sign may be mounted on a Type III barricade. The sign may also be used for work zones of shorter length.

Standard:

The distance shown on the ROAD WORK NEXT XX KM (MILES) sign shall be stated to the nearest whole kilometer (or mile).

Section 6F.49 END ROAD WORK Sign (G20-2a)**Guidance:**

The END ROAD WORK (G20-2a) sign should be placed about 150 m (500 ft) beyond the temporary traffic control zone.

Option:

The END ROAD WORK sign may be installed on the back of a warning sign facing the opposite direction of road users or on the back of a Type III barricade.

Section 6F.50 Detour Signs and Markers (M4-8, M4-8a, M4-8b, M4-9, and M4-10)**Standard:**

Each detour shall be adequately marked with standard temporary route markers and destination signs.

Option:

The Detour Arrow (M4-10) sign may be used where a detour route has been established.

The DETOUR (M4-8) marker may be mounted at the top of a route marker assembly to mark a temporary route that detours from a highway, bypasses a section closed by a temporary traffic control zone, and rejoins the highway beyond the temporary traffic control zone.

Guidance:

The Detour Arrow (M4-10) sign should normally be mounted just below the ROAD CLOSED (R11-2, R11-3a, or R11-4) sign. The Detour Arrow sign should include a horizontal arrow pointed to the right or left as required.

The DETOUR (M4-9) sign should be used for unnumbered highways, for emergency situations, for periods of short durations, or where, over relatively short distances, road users are guided along the detour and back to the desired highway without route markers.

A Street Name sign should be placed above, or the street name should be incorporated into, a DETOUR (M4-9) sign to indicate the name of the street being detoured.

Option:

The END DETOUR (M4-8a or M4-8b) sign may be used to indicate that the detour has ended.

Guidance:

When the END DETOUR sign is used on a numbered highway, the sign should be mounted above a marker after the end of the detour.

Section 6F.51 PILOT CAR FOLLOW ME Sign (G20-4)**Standard:**

The PILOT CAR FOLLOW ME (G20-4) sign shall be mounted in a conspicuous position on the rear of a vehicle used for guiding one-way motor vehicle traffic through or around a temporary traffic control zone. A flagger shall be stationed on the approach to the activity area to stop motor vehicle traffic until the pilot vehicle is available.

Section 6F.52 Portable Changeable Message Signs**Support:**

Portable Changeable Message signs are temporary traffic control devices with the flexibility to display a variety of messages. Each message consists of either one or two phases. Typically, a phase consists of up to three lines of eight characters per line.

Portable Changeable Message signs are used most frequently on high-density urban freeways, but have applications on all types of highways where highway alignment, road user routing problems, or other pertinent conditions require advance warning and information.

Guidance:

The components of a Portable Changeable Message sign should include: a message sign panel, control systems, a power source, and mounting and transporting equipment.

Portable Changeable Message signs should subscribe to the principles established in this Manual and, to the extent practical, with the design (that is, color, letter size and shape, and borders) and applications prescribed in this Manual, except that the reverse colors for the letters and the background are considered acceptable.

The front face of the sign should be covered with a protective material. The color of the elements should be yellow or orange on a black background.

Portable Changeable Message signs should be visible from 0.8 km (0.5 mi) under both day and night conditions. The message should be legible from a minimum distance of 200 m (650 ft). The message panel should have adjustable display rates, so that the entire message can be read at least twice at the posted speed, the off-peak 85th-percentile speed prior to work starting, or the anticipated operating speed.

Option:

The message sign panel may vary in size.

Standard:

Portable Changeable Message signs shall automatically adjust their brightness under varying light conditions, to maintain legibility.

The control system shall include a display screen upon which messages can be reviewed before being displayed on the message sign. The control system shall be capable of maintaining memory when power is unavailable.

Portable Changeable Message signs shall be equipped with a power source and a battery back-up to provide continuous operation when failure of the primary power source occurs.

The mounting of Portable Changeable Message signs shall be such that the bottom of the message sign panel shall be a minimum of 2.1 m (7 ft) above the roadway when it is in the operating mode.

The text of the messages shall not scroll or travel horizontally or vertically across the face of the sign.

Support:

Portable Changeable Message signs have a wide variety of applications in temporary traffic control zones including: roadway, lane, or ramp closures, crash or emergency incident management, width restriction information, speed reductions, advisories on work scheduling, road user management and diversion, warning of adverse conditions, and operation control.

Guidance:

Portable Changeable Message signs should be used as a supplement to and not as a substitute for conventional signs and pavement markings.

Support:

The primary purpose of Portable Changeable Message signs in temporary traffic control zones is to advise the road user of unexpected situations. Some typical applications include the following:

- A. Where the speed of motor vehicle traffic is expected to drop substantially
- B. Where significant queuing and delays are expected
- C. Where adverse environmental conditions are present
- D. Where there are changes in alignment or surface conditions
- E. To provide advance notice of ramp, lane, or roadway closures
- F. For crash or incident management
- G. Changes in the road user pattern

Guidance:

When Portable Changeable Message signs are used for route diversion, they should be placed far enough in advance of the diversion to allow road users ample opportunity to exit the affected highway. The Portable Changeable Message signs should be sited and aligned to ensure legibility. Multiple Portable Changeable Message signs should be placed on the same side of the roadway, separated from each other at distances based on Table 6C-1.

Portable Changeable Message signs should be placed on the shoulder of the roadway or, if practical, further from the traveled lane. They should be delineated with retroreflective temporary traffic control devices or when within the clear zone, shielded with a barrier or crash cushion. When Portable Changeable Message signs are not being used, they should be removed; if not removed, they should be shielded; or if the

previous two options are not feasible, they should be delineated with retroreflective temporary traffic control devices.

Portable Changeable Message sign trailers should be delineated on a permanent basis by affixing retroreflective material, known as conspicuity material, in a continuous line on the face of the trailer as seen by oncoming road users.

Messages should be designed taking into account the following factors:

- A. Each phase should convey a single thought.
- B. If the message can be displayed in one phase, the top line should present the problem, the center line should present the location or distance ahead, and the bottom line should present the recommended driver action.
- C. The message should be as brief as possible.
- D. When a message is longer than two phases, additional Portable Changeable Message signs should be used.
- E. When abbreviations are used, they should be easily understood (see Section 1A.14).

Section 6F.53 Arrow Panels

Support:

An arrow panel is a sign with a matrix of elements capable of either flashing or sequential displays. This sign is intended to provide additional warning and directional information to assist in merging and controlling road users through or around a temporary traffic control zone.

Guidance:

An arrow panel should be used in combination with appropriate signs, channelizing devices, or other temporary traffic control devices.

An arrow panel should be placed on the shoulder of the roadway or, if practical, further from the traveled lane. It should be delineated with retroreflective temporary traffic control devices, or when within the clear zone, shielded with a barrier or crash cushion. When an arrow panel is not being used, it should be removed; if not removed, it should be shielded; or if the previous two options are not feasible, it should be delineated with retroreflective temporary traffic control devices.

Standard:

Arrow panels shall meet the minimum size, legibility distance, number of elements, and other specifications shown on Figure 6F-3.

Support:

Type A arrow panels are appropriate for use on low-speed urban streets. Type B arrow panels are appropriate for intermediate-speed facilities and for maintenance or mobile operations on high-speed roadways. Type C arrow panels are intended to be used on high-speed, high-volume motor vehicle traffic control projects. Type D arrow panels are intended for use on authorized vehicles.

Standard:

Type A, B, and C arrow panels shall have solid rectangular appearances. A Type D arrow panel shall conform to the shape of the arrow.

All arrow panels shall be finished in non-reflective black. The arrow panel shall be mounted on a vehicle, a trailer, or other suitable support.

Guidance:

The minimum mounting height of an arrow panel should be 2.1 m (7 ft) from the roadway to the bottom of the panel, except on vehicle-mounted panels, which should be as high as practical.

A vehicle-mounted arrow panel should be provided with remote controls.

Standard:

Arrow panel elements shall be capable of at least a 50 percent dimming from full brilliance. The dimmed mode shall be used for nighttime operation of arrow panels.

Guidance:

Full brilliance should be used for daytime operation of arrow panels.

Standard:

The arrow panel shall have suitable elements capable of the various operating modes. The color presented by the elements shall be yellow.

Figure 6F-3. Advance Warning Arrow Display Specifications

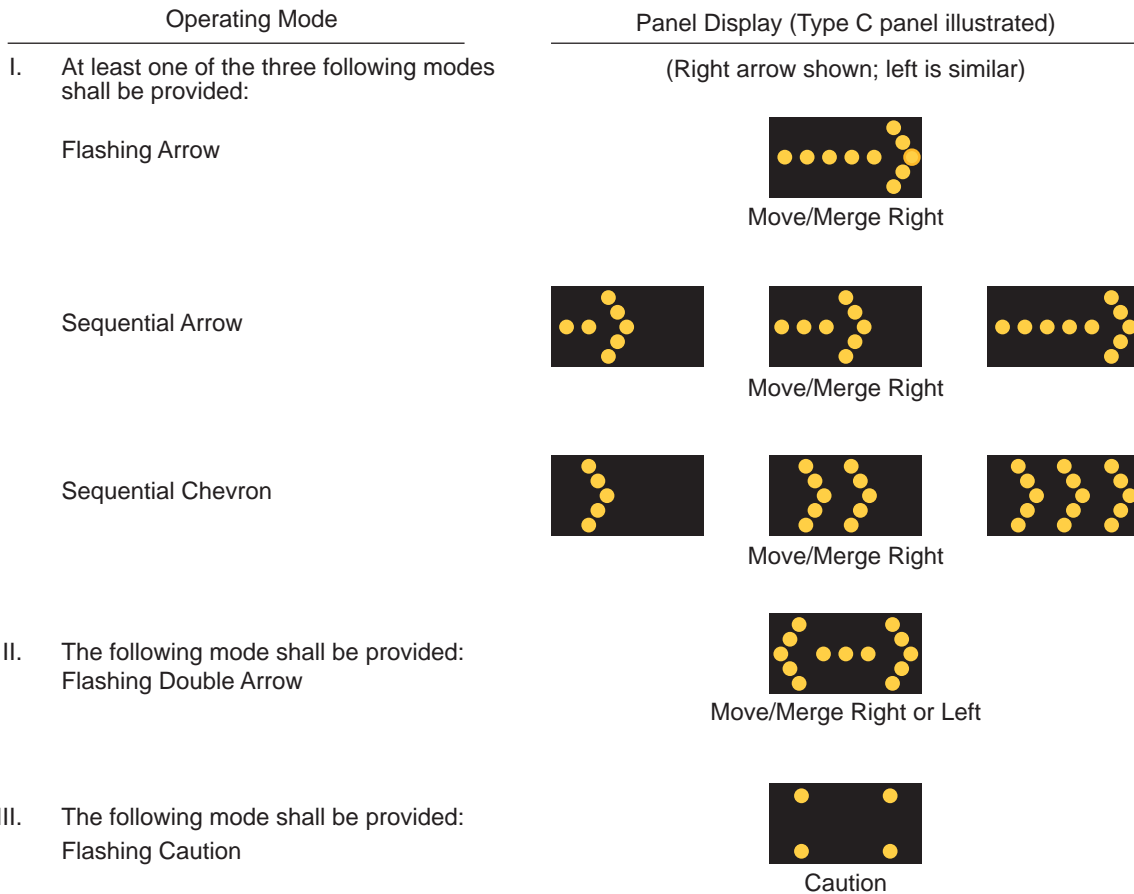

Panel Type	Minimum Size	Minimum Legibility Distance	Minimum Number of Elements
A	1,200 x 600 mm (48 x 24 in)	0.8 km (1/2 mi)	12
B	1,500 x 750 mm (60 x 30 in)	1.2 km (3/4 mi)	13
C	2,400 x 1,200 mm (96 x 48 in)	1.6 km (1 mi)	15
D	None*	0.8 km (1/2 mi)	12

*Length of arrow equals 1,200 mm (48 in), width of arrowhead equals 600 mm (24 in)

Guidance:

If an arrow panel consisting of a bulb matrix is used, the elements should be recess-mounted or equipped with an upper hood of not less than 180 degrees.

Standard:

The minimum element on-time shall be 50 percent for the flashing mode, with equal intervals of 25 percent for each sequential phase. The flashing rate shall be not less than 25 nor more than 40 flashes per minute.

An arrow panel shall have the following three mode selections:

- A. Either a Flashing Arrow, Sequential Arrow, or Sequential Chevron mode, and**
- B. A flashing Double Arrow mode, and**
- C. A flashing Caution mode.**

An arrow panel in the arrow or chevron mode shall be used only for stationary or moving lane closures on multi-lane roadways.

An arrow panel shall be used only in the caution mode for shoulder work, blocking the shoulder, for roadside work near the shoulder, or for temporarily closing one lane on a two-lane, two-way roadway.

Guidance:

For a stationary lane closure, the arrow panel should be located on the shoulder at the beginning of the shifting or merging taper.

Where the shoulder is narrow, the arrow panel should be located in the closed lane.

Standard:

When arrow panels are used to close multiple lanes, a separate arrow panel shall be used for each closed lane.

Guidance:

When arrow panels are used to close multiple lanes, if the first arrow panel is placed on the shoulder, the second arrow panel should be placed in the first closed lane at the beginning of the second merging taper (see Figure 6H-37). When the first arrow panel is

placed in the first closed lane, the second arrow panel should be placed in the second closed lane at the downstream end of the second merging taper.

For mobile operations where a lane is closed, the arrow panel should be located to provide adequate separation from the work operation to allow for appropriate reaction by approaching drivers.

Standard:

A vehicle displaying an arrow panel shall be equipped with rotating lights or strobe lights.

A single arrow panel shall not be used to shift traffic laterally more than one lane.

Section 6F.54 High-Level Warning Devices (Flag Trees)

Option:

A high-level warning device (flag tree) may supplement other temporary traffic control devices in temporary traffic control zones.

Support:

A high-level warning device is designed to be seen over the top of typical passenger cars. A typical high-level warning device is shown in Figure 6F-2.

Standard:

A high-level warning device shall consist of a minimum of two flags with or without a Type B high-intensity flashing warning light. The distance from the roadway to the bottom of the lens of the light and to the lowest point of the flag material shall be not less than 2.4 m (8 ft). The flag shall be 400 mm (16 in) square or larger and shall be orange or fluorescent red-orange in color.

Option:

An appropriate warning sign may be mounted below the flags.

Support:

High-level warning devices are most commonly used in high-density road user situations to warn road users of short-term operations.

Section 6F.55 Channelizing Devices

Support:

Designs of various channelizing devices are shown in Figure 6F-4.

The function of channelizing devices is to warn road users of conditions created by work activities in or near the roadway and to guide road users. Channelizing devices include cones, tubular markers, vertical panels, drums, barricades, and temporary raised islands.

Channelizing devices provide for smooth and gradual motor vehicle traffic flow from one lane to another, onto a bypass or detour, or into a narrower traveled way. They are also used to separate motor vehicle traffic from the work space, pavement drop-offs, pedestrian or bicycle paths, or opposing directions of motor vehicle traffic.

Guidance:

Channelizing devices should be constructed and ballasted to perform in a predictable manner when inadvertently struck by a vehicle. Channelizing devices should be crashworthy. Fragments or other debris from the device or the ballast should not pose a significant hazard to road users or workers in the immediate area.

The spacing of channelizing devices should not exceed a distance in meters (feet) equal to 0.2 times the speed limit in km/h (1.0 times the speed limit in mph) when used for taper channelization, and a distance in meters (feet) equal to 0.4 times the speed limit in km/h (2.0 times the speed limit in mph) when used for tangent channelization.

When channelizing devices have the potential of leading motor vehicle traffic out of the intended motor vehicle traffic space as shown in Figure 6H-39, the channelizing devices should be extended a distance in meters (feet) of 0.4 times the speed limit in km/h (2.0 times the speed limit in mph) beyond the end of the transition area.

Option:

Warning lights may be added to channelizing devices in areas with frequent fog, snow, or severe roadway curvature, or where visual distractions are present.

Standard:

Warning lights shall flash when placed on channelizing devices used alone or in a cluster to warn of a condition. Warning lights placed on channelizing devices used in a series to channelize road users shall be steady-burn.

The retroreflective material used on channelizing devices shall have a smooth, sealed outer surface that will display approximately the same color day or night.

Figure 6F-4. Channelizing Devices (Sheet 1 of 2)

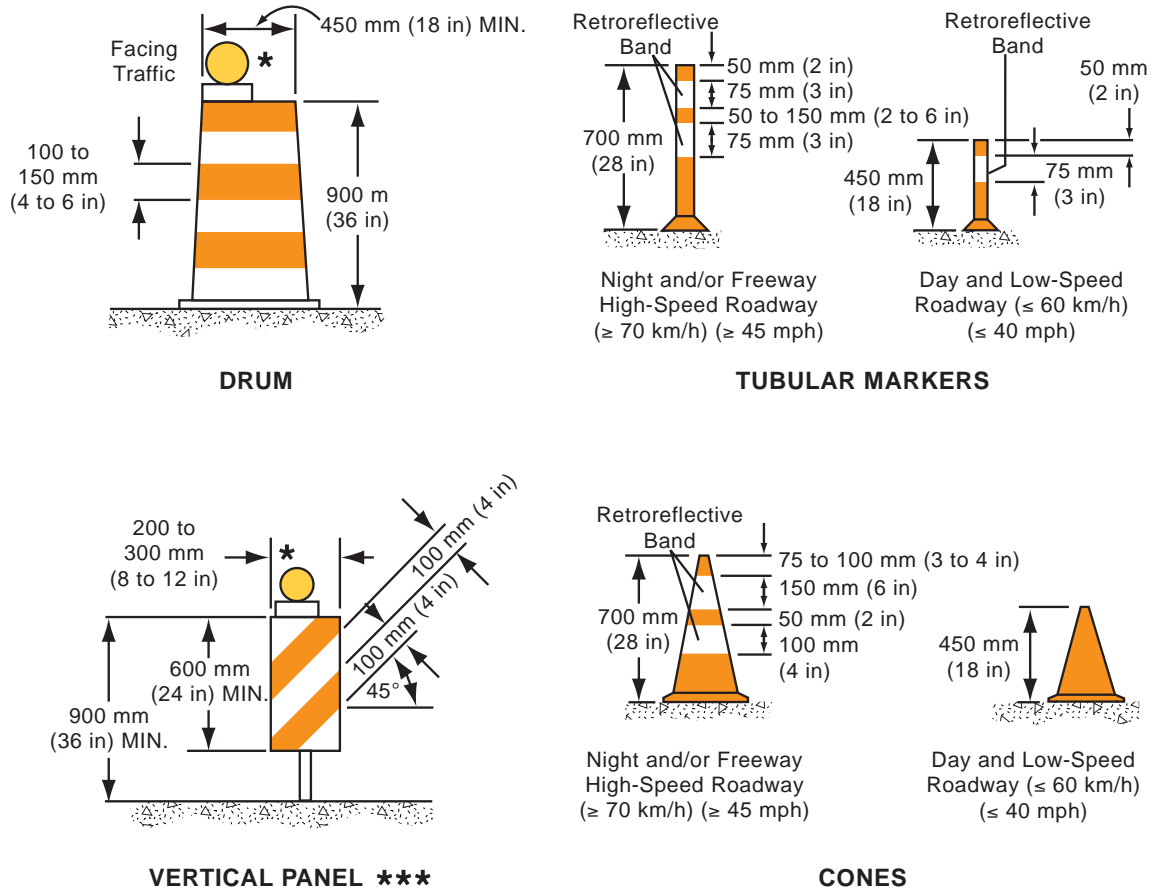

- * Warning lights (optional)
- ** Nominal lumber dimensions are satisfactory for barricade rail width dimensions.
- *** Rail stripe widths shall be 150 mm (6 in), except that 100 mm (4 in) wide stripes may be used if rail lengths are less than 900 mm (36 in).
The sides of barricades facing traffic shall have retroreflective rail faces.

Figure 6F-4. Channelizing Devices (Sheet 2 of 2)

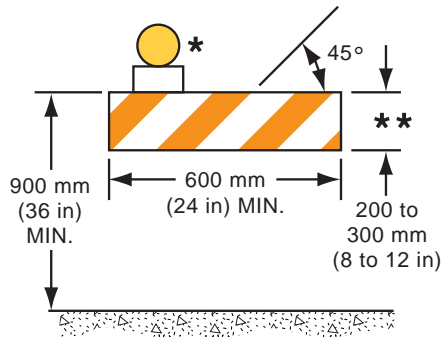

TYPE I BARRICADE ***

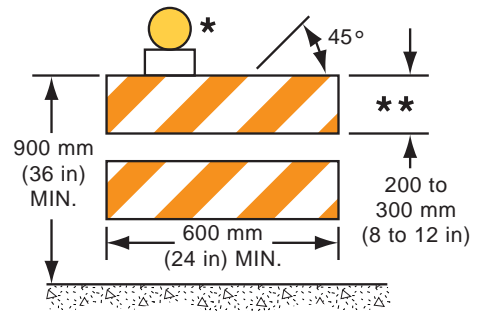

TYPE II BARRICADE ***

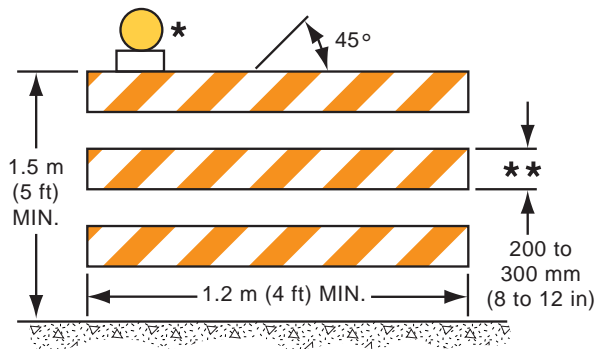

TYPE III BARRICADE ***

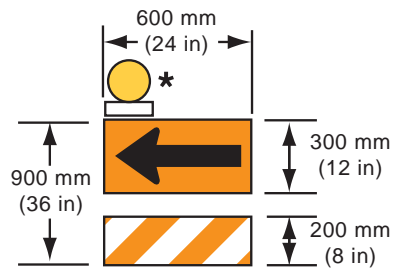

DIRECTION INDICATOR BARRICADE

- * Warning lights (optional)
- ** Nominal lumber dimensions are satisfactory for barricade rail width dimensions.
- *** Rail stripe widths shall be 150 mm (6 in), except that 100 mm (4 in) wide stripes may be used if rail lengths are less than 900 mm (36 in).
The sides of barricades facing traffic shall have retroreflective rail faces.

Option:

The name and telephone number of the highway agency, contractor, or supplier may be shown on the non-retroreflective surface of all types of channelizing devices.

Standard:

The letters and numbers of the name and telephone number shall be non-retroreflective and not over 50 mm (2 in) in height.

Guidance:

Particular attention should be given to maintaining the channelizing devices to keep them clean, visible, and properly positioned at all times.

Standard:

Devices that are damaged or have lost a significant amount of their retroreflectivity and effectiveness shall be replaced.

Section 6F.56 Cones**Standard:**

Cones (see Figure 6F-4) shall be predominantly orange and shall be made of a material that can be struck without causing damage to the impacting vehicle. For daytime and low-speed roadways, cones shall be not less than 450 mm (18 in) in height. When cones are used on freeways and other high-speed highways or at night on all highways, or when more conspicuous guidance is needed, cones shall be a minimum of 700 mm (28 in) in height.

For nighttime use, cones shall be retroreflectorized or equipped with lighting devices for maximum visibility. Retroreflectorization of 700 mm (28 in) or larger cones shall be provided by a white band 150 mm (6 in) wide located 75 to 100 mm (3 to 4 in) from the top of the cone and an additional 100 mm (4 in) wide white band approximately 50 mm (2 in) below the 150 mm (6 in) band.

Option:

Traffic cones may be used to channelize road users, divide opposing motor vehicle traffic lanes, divide lanes when two or more lanes are kept open in the same direction, and delineate short duration maintenance and utility work.

Guidance:

Steps should be taken to ensure that cones will not be blown over or displaced by wind or moving motor vehicle traffic.

Option:

Cones may be doubled up to increase their weight.

Support:

Some cones are constructed with bases that can be filled with ballast. Others have specially weighted bases, or weight such as sandbag rings that can be dropped over the cones and onto the base to provide added stability.

Guidance:

Ballast should be kept to the minimum amount needed.

Section 6F.57 Tubular Markers**Standard:**

Tubular markers (see Figure 6F-4) shall be predominantly orange, and shall be not less than 450 mm (18 in) high and 50 mm (2 in) wide facing road users. They shall be made of a material that can be struck without causing damage to the impacting vehicle.

Tubular markers shall be a minimum of 700 mm (28 in) in height when they are used on freeways and other high-speed highways, on all highways during nighttime, or whenever more conspicuous guidance is needed.

For nighttime use, tubular markers shall be retroreflectorized. Retroreflectorization of 700 mm (28 in) or larger tubular markers shall be provided by two 75 mm (3 in) wide white bands placed a maximum of 50 mm (2 in) from the top with a maximum of 150 mm (6 in) between the bands.

Guidance:

Tubular markers have less visible area than other devices and should be used only where space restrictions do not allow for the use of other more visible devices.

Tubular markers should be stabilized by affixing them to the pavement, by using weighted bases, or weights such as sandbag rings that can be dropped over the tubular

markers and onto the base to provide added stability. Ballast should be kept to the minimum amount needed.

Option:

Tubular markers may be used effectively to divide opposing lanes of road users, divide motor vehicle traffic lanes when two or more lanes are kept open in the same direction, and to delineate the edge of a pavement drop off where space limitations do not allow the use of larger devices.

Standard:

When a non-cylindrical tubular marker is used, it shall be attached to the pavement to ensure that the width facing road users meets the minimum requirements.

A tubular marker shall be attached to the pavement to display the minimum 50 mm (2 in) width to the approaching road users.

Section 6F.58 Vertical Panels

Standard:

Vertical panels (see Figure 6F-4) shall be 200 to 300 mm (8 to 12 in) in width and at least 600 mm (24 in) in height. They shall have orange and white diagonal stripes and be retroreflectorized.

Vertical panels shall be mounted with the top a minimum of 900 mm (36 in) above the roadway.

Where the height of the vertical panel itself is 900 mm (36 in) or greater, a panel stripe width of 150 (6 in) shall be used.

Option:

Where the height of the vertical panel itself is less than 900 mm (36 in), a panel stripe width of 100 mm (4 in) may be used.

Standard:

Markings for vertical panels shall be alternating orange and white retroreflective stripes, sloping downward at an angle of 45 degrees in the direction motor vehicle traffic is to pass. Vertical panels used on expressways, freeways, and other high-speed roadways shall have a minimum of 174,000 mm² (270 in²) retroreflective area facing motor vehicle traffic.

Option:

Where space is limited, vertical panels may be used to channelize motor vehicle traffic, divide opposing lanes, or replace barricades.

Section 6F.59 Drums**Standard:**

Drums (see Figure 6F-4) used for road user warning or channelization shall be constructed of lightweight, deformable materials. They shall be a minimum of 900 mm (36 in) in height and have at least a 450 mm (18 in) minimum width regardless of orientation. Metal drums shall not be used. The markings on drums shall be horizontal, circumferential, alternating orange and white retroreflective stripes 100 to 150 mm (4 to 6 in) wide. Each drum shall have a minimum of two orange and two white stripes with the top stripe being orange. Any non-retroreflectorized spaces between the horizontal orange and white stripes, shall not exceed 75 mm (3 in) wide. Drums shall have closed tops that will not allow collection of construction debris or other debris.

Support:

Drums are highly visible, have good target value, give the appearance of being formidable obstacles and, therefore, command the respect of road users. They are portable enough to be shifted from place to place within a temporary traffic control zone in order to accommodate changing conditions, but are generally used in situations where they will remain in place for a prolonged period of time.

Option:

Although drums are most commonly used to channelize or delineate road user flow, they may also be used alone or in groups to mark specific locations.

Guidance:

Drums should not be weighted with sand, water, or any material to the extent that would make them hazardous to road users or workers when struck. Drums used in regions susceptible to freezing should have drain holes in the bottom so that water will not accumulate and freeze causing a hazard if struck by a road user.

Standard:

Ballast shall not be placed on the top of a drum.

Section 6F.60 Type I, II, or III Barricades**Support:**

A barricade is a portable or fixed device having from one to three rails with appropriate markings and is used to control road users by closing, restricting, or delineating all or a portion of the right-of-way.

As shown in Figure 6F-4, barricades are classified as either Type I, Type II, or Type III.

Standard:

Stripes on barricade rails shall be alternating orange and white retroreflective stripes sloping downward at an angle of 45 degrees in the direction road users are to pass. Except as noted in the Option, the stripes shall be 150 mm (6 in) wide.

Option:

When rail lengths are less than 900 mm (36 in), 100 mm (4 in) wide stripes may be used.

Standard:

The minimum length for Type I and Type II Barricades shall be 600 mm (24 in), and the minimum length for Type III Barricades shall be 1,200 mm (48 in). Each barricade rail shall be 200 to 300 mm (8 to 12 in) wide. Barricades used on expressways, freeways and other high-speed roadways shall have a minimum of 174,000 mm² (270 in²) of retroreflective area facing road users.

Guidance:

Where barricades extend entirely across a roadway, the stripes should slope downward in the direction toward which road users must turn.

Where both right and left turns are provided, the barricade stripes should slope downward in both directions from the center of the barricade or barricades.

Where no turns are intended, the stripes should be positioned to slope downward toward the center of the barricade or barricades.

Barricade rails should be supported in a manner that will allow them to be seen by the road user, and in a manner that provides a stable support that is not easily blown over or displaced.

Option:

For Type I Barricades, the support may include other unstriped horizontal panels necessary to provide stability.

Guidance:

Barricades should be crashworthy as they are located adjacent to motor vehicle traffic flow and are subject to impact by errant vehicles.

On high-speed expressways or in other situations where barricades may be susceptible to overturning in the wind, ballasting should be used.

Option:

Sandbags may be placed on the lower parts of the frame or the stays of barricades to provide the required ballast.

Standard:

Ballast shall not be placed on top of any striped rail. Barricades shall not be ballasted by non-deformable objects such as rocks or chunks of concrete.

Support:

Type I or Type II Barricades are intended for use in situations where road user flow is maintained through the temporary traffic control zone.

Option:

Barricades may be used alone or in groups to mark a specific condition or they may be used in a series for channelizing road users.

Type I Barricades may be used on conventional roads or urban streets.

Guidance:

Type II or Type III Barricades should be used on expressways and freeways or other high-speed roadways. Type III Barricades should be used to close or partially close a road.

Option:

Type III Barricades used at a road closure may be placed completely across a roadway or from curb to curb.

Guidance:

Where provision is made for access of authorized equipment and vehicles, the responsibility for Type III Barricades should be assigned to a person to ensure proper closure at the end of each work day.

Support:

When a highway is legally closed but access must still be allowed for local road users, barricades usually are not extended completely across the roadway.

Standard:

A sign (see Section 6F.09) shall be installed with the appropriate legend concerning permissible use by local road users. Adequate visibility of the barricades from both directions shall be provided.

Option:

Signs may be installed on barricades (see Section 6F.03).

Section 6F.61 Direction Indicator Barricades**Standard:**

The Direction Indicator Barricade (see Figure 6F-4) shall consist of a retroreflective horizontal arrow top panel and a striped retroreflective bottom panel, both mounted horizontally to the ground.

The arrow panel shall be black on an orange background. The stripes on the bottom panel shall be alternating orange and white retroreflective stripes sloping downward at an angle of 45 degrees in the direction road users are to pass. The stripes shall 100 mm (4 in) wide. The arrow panel shall be 600 x 300 mm (24 x 12 in). The bottom panel shall have a length of 600 mm (24 in) and a height of 200 mm (8 in).

Guidance:

The Direction Indicator Barricade should be crashworthy.

Option:

The Direction Indicator Barricade may be used in tapers, transitions, and other areas where specific directional guidance to drivers is necessary.

Guidance:

If used, Direction Indicator Barricades should be used in series to direct the driver through the transition and into the intended travel lane.

Section 6F.62 Temporary Traffic Barriers as Channelizing Devices**Standard:**

Temporary traffic barriers shall not be used solely to channelize road users, but also to protect the work space. For nighttime use, the temporary traffic barrier shall be supplemented with delineation.

Guidance:

Temporary traffic barriers should not be used for a merging taper except in low-speed urban areas. Temporary traffic barriers should not be used for a constricted/restricted temporary traffic control zone.

When it is necessary to use a temporary traffic barrier for a merging taper in low-speed urban areas or for a constricted/restricted temporary traffic control zone, the taper shall be delineated and the taper length should be designed to optimize road user operations considering the available geometric conditions.

When used for channelization, temporary traffic barriers should be of a light color for increased visibility.

Section 6F.63 Temporary Raised Islands**Standard:**

Temporary raised islands shall be used only in combination with pavement striping and other suitable channelizing devices.

Option:

A temporary raised island may be used to separate motor vehicle traffic flows in two-lane, two-way operations on roadways having a motor vehicle traffic volume range of 4,000 to 15,000 average daily traffic (ADT) and on freeways having a motor vehicle traffic volume range of 22,000 ADT to 60,000 ADT.

Temporary raised islands also may be used in other than two-lane, two-way operations where physical separation of motor vehicle traffic from the temporary traffic control zone is not required.

Guidance:

Temporary raised islands should have the basic dimensions of 100 mm (4 in) high by 450 mm (18 in) wide and have rounded or chamfered corners.

The temporary raised islands should not be designed in such a manner that they would cause a driver to lose control of the vehicle if the vehicle inadvertently strikes the temporary raised island. If struck, pieces of the island should not be dislodged to the extent that they could penetrate the occupant compartment or involve other vehicles.

Section 6F.64 Opposing Traffic Lane Divider**Support:**

Opposing traffic lane dividers are delineation devices used as center lane dividers to separate opposing motor vehicle traffic on a two-lane, two-way operation.

Standard:

The Opposing Traffic Lane Divider (W6-4) sign is an upright, retroreflective orange-colored sign placed on a flexible support and sized at least 300 mm (12 in) wide by 450 mm (18 in) high.

Section 6F.65 Pavement Markings**Standard:**

The provisions of this Section shall not be considered applicable for short-term, mobile, or incident management temporary traffic control zones.

Pavement markings shall be maintained along paved streets and highways in all long- and intermediate-term stationary (see Section 6G.02) temporary traffic control zones. All pavement markings shall be in accordance with Chapters 3A and 3B, except as indicated in Section 6F.66. Pavement markings shall match the markings in place at both ends of the temporary traffic control zone. Pavement markings shall be placed along the entire length of any surfaced detour or temporary roadway prior to the detour or roadway being opened to road users.

Warning signs, channelizing devices, and delineation shall be used to indicate required road user paths in temporary traffic control zones where it is not possible to provide a clear path by pavement markings. All pavement markings and devices used to delineate road user paths shall be carefully reviewed during daytime and nighttime periods.

For long-term stationary operations, pavement markings in the temporary traveled way that are no longer applicable shall be removed or obliterated as soon as practical. Pavement marking obliteration shall leave a minimum of pavement scars and shall remove old marking material. Painting over existing pavement markings with black paint or spraying with asphalt shall not be accepted as a substitute for removal or obliteration.

Guidance:

Road users should be provided pavement markings within a temporary traffic control zone comparable to the pavement markings normally maintained along such roadways, particularly at either end of the temporary traffic control zone.

The intended vehicle path should be defined in day, night, and twilight periods under both wet and dry pavement conditions.

The work should be planned and staged to provide for the placement and removal of the pavement markings.

Markings should be provided in intermediate-term, stationary work zones.

Option:

Removable, nonreflective, preformed tape may be used where markings need to be covered temporarily.

Section 6F.66 Temporary Pavement Markings

Support:

Temporary pavement markings are those that are allowed to remain in place until the earliest date when it is practical and possible to install pavement markings that meet the Part 3 standards for pavement markings.

Guidance:

Temporary pavement markings should not be in place for more than 2 weeks unless justified by an engineering study.

Standard:

All temporary pavement markings, including pavement markings for no-passing zones, shall conform to the requirements of Chapters 3A and 3B. All temporary broken-line pavement markings shall use the same cycle length as permanent markings and be at least 0.6 m (2 ft) long.

Option:

Half-cycle lengths with a minimum of 0.6 m (2 ft) stripes may be used for on roadways with severe curvature (see Section 3A.06). This applies to centerlines in passing zones and lane lines.

For temporary situations of 3 calendar days or less, for a two- or three-lane road, no-passing zones may be identified by using NO PASSING ZONE (W14-3) signs (see Section 2C.32) rather than pavement markings. Also, NO PASSING ZONE signs may be used instead of pavement markings on low-volume roads (as defined in Section 5A.01) for longer periods in accordance with the State's or highway agency's policy.

Guidance:

The NO PASSING ZONE signs should be placed in accordance with Sections 2B.24, 2B.25, and 2C.32.

The temporary use of edge lines, channelizing lines, lane reduction transitions, gore markings, and other longitudinal markings, and the various non-longitudinal markings (such as stop lines, railroad crossings, crosswalks, words or symbols) should be in accordance with the State's or highway agency's policy.

Section 6F.67 Raised Pavement Markers**Standard:**

If raised pavement markers are used to substitute for broken line segments, at least two retroreflective markers shall be placed, one at each end of a segment of 0.6 m (2 ft) to 1.5 m (5 ft). For segments over 1.5 m (5 ft), a group of at least three retroreflective markers shall be equally spaced at no greater than $N/8$. The value of N for a broken or dotted line shall equal the length of one line segment plus one gap. The value of N referenced for solid lines shall equal the N for the broken or dotted lines that may be adjacent to or may extend the solid lines (see Chapter 3B).

Guidance:

Raised pavement markers should be considered for use along surfaced detours or temporary roadways, and other changed or new travel-lane alignments.

Option:

Retroreflective or internally-illuminated raised pavement markers, or non-retroreflective raised pavement markers supplemented by retroreflective or internally-illuminated markers, may replace or supplement markings prescribed in Chapters 3A and 3B.

Section 6F.68 Delineators**Standard:**

When used, delineators shall combine with or supplement other temporary traffic control devices. They shall be mounted on crashworthy supports so that the reflecting unit is approximately 1.2 m (4 ft) above the near roadway edge. The standard color for delineators used along both sides of two-way streets and highways and the right side of one-way roadways shall be white. Delineators used along the left side of one-way roadways shall be yellow.

Guidance:

Spacing along roadway curves should be as set forth in Section 3D.04 and should be such that several delineators are always visible to the driver.

Option:

Delineators may be used in temporary traffic control zones to indicate the alignment of the roadway and to outline the required vehicle path through the temporary traffic control zone.

Section 6F.69 Lighting Devices**Guidance:**

Lighting devices should be provided in temporary traffic control zones based on engineering judgment.

Support:

Four types of lighting devices are commonly used in temporary traffic control zones. They are floodlights, flashing warning beacons, warning lights, and steady-burn electric lamps.

Option:

Lighting devices may be used to supplement retroreflectorized signs, barriers, and channelizing devices.

Support:

During normal daytime maintenance operations, the functions of flashing warning beacons are adequately provided by rotating lights or strobe lights on a maintenance vehicle.

Standard:

Although vehicle hazard warning lights are permitted to be used to supplement rotating or strobe lights, they shall not be used instead of rotating or strobe lights.

Section 6F.70 Floodlights

Support:

Utility, maintenance, or construction activities on highways are frequently conducted during nighttime periods when motor vehicle traffic volumes are lower. Large construction projects are sometimes operated on a double-shift basis requiring night work.

Guidance:

When nighttime work is being performed, floodlights should be used to illuminate the work area, flagger stations, equipment crossings, and other areas.

Standard:

Floodlighting shall not produce a disabling glare condition for approaching road users.

Guidance:

The adequacy of the floodlight placement and elimination of potential glare should be determined by driving through and observing the floodlighted area from each direction on all approaching roadways after the initial floodlight setup, at night, and periodically.

Section 6F.71 Flashing Warning Beacons

Support:

Flashing warning beacons are often used to supplement a temporary control device.

Standard:

Flashing warning beacons shall comply with the provisions of Chapter 4K. A flashing warning beacon shall be a flashing yellow light with a minimum nominal diameter of 200 mm (8 in).

Guidance:

Flashing warning beacons should be operated 24 hours per day.

Support:

The temporary terminus of a freeway is an example of a location where flashing warning beacons alert drivers to the changing roadway conditions and the need to reduce speed in transitioning from the freeway to another roadway type.

Section 6F.72 Warning Lights

Standard:

Type A, Type B, and Type C warning lights are portable, powered, yellow, lens-directed, enclosed lights.

Warning lights shall be in accordance with the current ITE "Purchase Specification for Flashing and Steady-Burn Warning Lights" (see Section 1A.11).

When warning lights are used, they shall be mounted on signs or channelizing devices in a manner that, if hit by an errant vehicle, they will not be likely to penetrate the windshield.

Guidance:

The maximum spacing for warning lights should be identical to the channelizing device spacing requirements.

Support:

The light weight and portability of warning lights are advantages that make these devices useful as supplements to the retroreflectorization on signs and channelizing devices. The flashing lights are effective in attracting road users' attention.

Option:

Warning lights may be used in either a steady-burn or flashing mode.

Standard:

Flashing warning lights shall not be used for delineation, as a series of flashers fails to identify the desired vehicle path.

Type A Low-Intensity Flashing warning lights and Type C Steady-Burn warning lights shall be maintained so as to be capable of being visible on a clear night from a distance of 900 m (3,000 ft). Type B High-Intensity Flashing warning lights shall be maintained so as to be capable of being visible on a sunny day when viewed without the sun directly on or behind the device from a distance of 300 m (1,000 ft).

Warning lights shall have a minimum mounting height of 750 mm (30 in) to the bottom of the lens.

Support:

Type A Low-Intensity Flashing warning lights are used to warn road users during nighttime hours that they are approaching or proceeding in a potentially hazardous area.

Option:

Type A warning lights may be mounted on channelizing devices.

Support:

Type B High-Intensity Flashing warning lights are used to warn road users during both daylight and nighttime hours that they are approaching a potentially hazardous area.

Option:

Type B warning lights are designed to operate 24 hours per day and may be mounted on advance warning signs or on independent supports.

Type C Steady-Burn warning lights may be used during nighttime hours to delineate the edge of the traveled way.

Guidance:

When used to delineate a curve, Type C warning lights should only be used on devices on the outside of the curve, and not on the inside of the curve.

Section 6F.73 Steady-Burn Electric Lamps

Support:

Steady-Burn electric lamps are a series of low-wattage, yellow, electric lamps, generally hard-wired to a 110-volt external power source.

Option:

Steady-Burn electric lamps may be used in place of Type C Steady-Burn warning lights (see Section 6F.72).

Section 6F.74 Temporary Traffic Control Signals**Standard:**

Temporary traffic control signals (see Section 4D.20) used to control road user movements through temporary traffic control zones and in other temporary traffic control situations shall meet the applicable provisions of Part 4.

Support:

Temporary traffic control signals are typically used in work zones such as temporary haul road crossings; temporary one-way operations along a one-lane, two-way highway; temporary one-way operations on bridges, reversible lanes, and intersections.

Standard:

One-lane, two-way motor vehicle traffic flow (see Chapter 4G) requires an all-red interval of sufficient duration for road users to clear the portion of the temporary traffic control zone controlled by the traffic control signals. Safeguards shall be incorporated to avoid the possibility of conflicting signal indications at each end of the temporary traffic control zone.

Guidance:

When temporary traffic control signals are used, conflict monitors typical of traditional traffic control signal operations should be used.

Option:

Temporary traffic control signals may be portable or temporarily mounted on fixed supports.

Guidance:

Temporary traffic control signals should only be used in situations where temporary traffic control signals are preferable to other means of traffic control, such as changing the work staging or work zone size to eliminate one-way motor vehicle traffic movements, using flaggers to control one-way or crossing movements, using STOP or YIELD signs, and using warning devices alone.

Support:

Factors related to the design and application of temporary traffic control signals include the following:

- A. Safety and road user needs

- B. Work staging and operations
- C. The feasibility of using other temporary traffic control strategies (for example, flaggers, providing space for two lanes, or detouring road users)
- D. Sight distance restrictions
- E. Human factors considerations (for example, lack of driver familiarity with temporary traffic control signals)
- F. Road user volumes including roadway and intersection capacity
- G. Affected side streets and driveways
- H. Vehicle speeds
- I. The placement of other temporary traffic control devices
- J. Parking
- K. Turning restrictions
- L. Pedestrians
- M. Legal authority
- N. Signal phasing and timing requirements
- O. Full-time or part-time operation
- P. Actuated, fixed-time, or manual operation
- Q. Power failures or other emergencies
- R. Inspection and maintenance needs
- S. Need for detailed placement, timing, and operation records
- T. Operation by contractors or by others

Although temporary traffic control signals can be mounted on trailers or lightweight portable supports, fixed supports offer superior resistance to displacement or damage by severe weather, vehicle impact, and vandalism.

Guidance:

Other temporary traffic control devices should be used to supplement temporary traffic control signals, including warning and regulatory signs, pavement markings, and channelizing devices.

The design and placement of temporary traffic control signals should include interconnection to other traffic control signals along the subject roadway.

Temporary traffic control signals not in use should be covered or removed.

Section 6F.75 Temporary Traffic Barriers

Support:

Temporary traffic barriers are devices designed to help prevent penetration by vehicles while minimizing injuries to vehicle occupants, and designed to protect workers, bicyclists, and pedestrians. A typical use is where one side of a bridge is closed for deck repair. They are also used for certain special events or in other temporary traffic control contexts where separation and channelization of vehicle and pedestrian movements are needed.

Option:

Temporary traffic barriers, including shifting portable or movable barrier installations to accommodate varying directional motor vehicle traffic demands, may be used to separate two-way motor vehicle traffic.

Guidance:

Because the protective requirements of a temporary traffic control situation have priority in determining the need for temporary traffic barriers, their use should be based on an engineering study. When serving the additional function of channelizing motor vehicle traffic, temporary traffic barriers should be a light color for increased visibility.

Standard:

Temporary traffic barriers shall be supplemented with standard delineation, pavement markings, or channelizing devices for improved daytime and nighttime visibility if they are used to channelize motor vehicle traffic. The delineation or pavement marking color shall match the applicable pavement marking color.

In order to mitigate the effect of striking the end of a temporary traffic barrier, the end shall be installed in accordance with AASHTO's "Roadside Design Guide" (see Section 1A.11) by flaring until the end is outside the acceptable clear zone or by providing crashworthy end treatments.

Option:

Warning lights or steady-burn electric lamps may be mounted on temporary traffic barrier installations.

Support:

A movable barrier is a linear system of connected barrier segments that can rapidly be shifted laterally by using a specially designed transfer vehicle. The transfer is accomplished in a manner that does not interfere with motor vehicle traffic in adjacent lanes. Applications of movable barriers include the following:

- A. Closing an additional lane during work periods while maintaining the advantage of having the travel way separated from the work space by a barrier.
- B. Closing an additional lane during off-peak periods to provide extra space for work activities without adversely impacting motor vehicle traffic flow.
- C. Creating a temporary reversible lane, thus providing unbalanced capacity favoring the major direction of motor vehicle traffic flow.

More specific information on the use of temporary traffic barriers is contained in Chapters 8 and 9 of AASHTO's "Roadside Design Guide" (see Section 1A.11).

Section 6F.76 Crash Cushions**Support:**

Crash cushions are systems that mitigate the effects of errant vehicles that strike obstacles, either by smoothly decelerating the vehicle to a stop when hit head-on, or by redirecting the errant vehicle. The two types of crash cushions that are used in temporary traffic control zones are stationary crash cushions and truck-mounted attenuators. Crash cushions in temporary traffic control zones help protect the drivers from the exposed ends of barriers, fixed objects, shadow vehicles, and other obstacles. Specific information on the use of crash cushions can be found in AASHTO's "Roadside Design Guide" (see Section 1A.11).

Standard:

Crash cushions shall be crashworthy. They shall also be designed for each application to stop or redirect errant vehicles under prescribed conditions. Crash cushions shall be periodically inspected to verify that they have not been hit or damaged. Damaged crash cushions shall be promptly repaired or replaced.

Support:

Stationary crash cushions are used in the same manner as permanent highway installations to protect drivers from the exposed ends of barriers, fixed objects, and other obstacles.

Standard:

Stationary crash cushions shall be designed for the specific application intended.

Support:

Truck-mounted attenuators are energy-absorbing devices attached to the rear of shadow trailers or trucks. They are located in advance of the work area, workers, or equipment to reduce the severity of rear-end crashes from errant vehicles.

Trucks or trailers are often used as shadow vehicles to protect workers or work equipment from errant vehicles. These shadow vehicles are normally equipped with flashing arrows, changeable message signs, and/or rotating/strobe lights located properly in advance of the workers and/or equipment that they are protecting. However, these shadow vehicles might themselves cause injuries to occupants of the errant vehicles if they are not equipped with truck-mounted attenuators.

Standard:

The shadow truck shall be positioned a sufficient distance in advance of the workers or equipment being protected so that there will be sufficient distance, but not so much so that errant vehicles will travel around the shadow truck and strike the protected workers and/or equipment.

Support:

Chapter 9 of AASHTO's "Roadside Design Guide" (see Section 1A.11) contains additional information regarding the use of shadow vehicles.

Guidance:

The truck-mounted attenuator should be used in accordance with the manufacturer's specifications.

Section 6F.77 Vehicle-Arresting Systems

Support:

Vehicle-arresting systems are designed to prevent penetration into activity areas while providing for smooth, safe deceleration for the errant vehicles. They can consist of portable netting, cables, and energy-absorbing anchors.

Guidance:

When used, a vehicle-arresting system should be used in accordance with the manufacturer's specifications, and should be located so that vehicles are not likely to penetrate the location that the system is designed to protect.

Section 6F.78 Rumble Strips**Support:**

Rumble strips consist of intermittent narrow, transverse areas of rough-textured or slightly raised or depressed road surface that alert drivers to unusual motor vehicle traffic conditions. Through noise and vibration they attract the driver's attention to such features as unexpected changes in alignment and to conditions requiring a stop.

Option:

Intervals between rumble strips may be reduced as the distance to the approached conditions is diminished in order to convey an impression that a closure speed is too fast and/or that an action is imminent. A sign warning drivers of the onset of rumble strips may be placed in advance of any rumble strip installation.

Guidance:

Rumble strips should be placed transverse to motor vehicle traffic movement. They should not adversely affect overall pavement skid resistance under wet or dry conditions.

In urban areas, even though a closer spacing might be warranted, care should be taken not to promote panic braking or erratic steering maneuvers by drivers.

Rumble strips should not be placed on sharp horizontal or vertical curves.

Sections 6F.79 Screens**Support:**

Screens are used to block the road users' view of activities that can be distracting. Screens might improve safety and motor vehicle traffic flow where volumes approach the roadway capacity because they discourage gawking and reduce headlight glare from oncoming motor vehicle traffic.

Guidance:

Screens should not be mounted where they could adversely restrict motorist visibility and sight distance and adversely affect the safe operation of vehicles.

Option:

Screens may be mounted on the top of temporary traffic barriers that separate two-way motor vehicle traffic.

Guidance:

Design of screens should be in accordance with Chapter 9 of AASHTO's "Roadside Design Guide" (see Section 1A.11).

Section 6F.80 Future and Experimental Devices**Support:**

The States, FHWA, AASHTO, the Transportation Research Board, and other organizations conduct research and experimentation on new traffic control and safety devices. Users of this Manual are encouraged to stay abreast of these current efforts and to use such devices with care so as to avoid presenting road users with unusual or confusing situations that might be abnormal or unexpected.

Standard:

New traffic control devices shall conform to the provisions for design, use, and application set forth in this Manual. New traffic control devices that do not conform with the provisions in this Manual shall be subject to experimentation, documentation, and adoption following the provisions of Section 1A.10.

CHAPTER 6G. TYPE OF TEMPORARY TRAFFIC CONTROL ZONE ACTIVITIES

Section 6G.01 Typical Applications

Support:

Each temporary traffic control zone is different. Many variables, such as location of work, road type, geometrics, vertical and horizontal alignment, intersections, interchanges, road user volumes, road vehicle mix (buses, trucks, and cars), and road user speeds affect the needs of each zone. The goal of temporary traffic control in work zones is safety with minimum disruption to road users. The key factor in promoting temporary traffic control zone safety is proper judgment.

Typical applications (TAs) of temporary traffic control zones are organized according to duration, location, type of work, and highway type. Table 6H-1 is an index of these typical applications. These typical applications include the use of various temporary traffic control methods, but do not include a layout for every conceivable work situation.

Guidance:

Typical applications should be altered, when necessary, to fit the conditions of a particular temporary traffic control zone.

Option:

Other devices may be added to supplement the devices shown in the typical applications, while others may be deleted. The sign spacings and taper lengths may be increased to provide additional time or space for driver response.

Support:

Decisions regarding the selection of the most appropriate typical application to use as a guide for a specific temporary traffic control zone require an understanding of each situation. Although there are many ways of categorizing work zone applications, the four factors mentioned earlier (work duration, work location, work type, and highway type) are used to characterize the typical applications illustrated in Chapter 6H.

Section 6G.02 Work Duration

Support:

Work duration is a major factor in determining the number and types of devices used in temporary traffic control zones. The duration of a temporary traffic control zone is defined relative to the length of time a work operation occupies a spot location.

Standard:

The five categories of work duration and their time at a location shall be:

- A. Long-term stationary is work that occupies a location more than 3 days.**
- B. Intermediate-term stationary is work that occupies a location more than one daylight period up to 3 days, or nighttime work lasting more than 1 hour.**
- C. Short-term stationary is daytime work that occupies a location for more than 1 hour, but less than 12 hours.**
- D. Short duration is work that occupies a location up to 1 hour.**
- E. Mobile is work that moves intermittently or continuously.**

Support:

At long-term stationary temporary traffic control zones, there is ample time to install and realize benefits from the full range of temporary traffic control procedures and devices that are available for use. Generally, larger channelizing devices, temporary roadways, and temporary traffic barriers are used.

Standard:

Since long-term operations extend into nighttime, retroreflective and/or illuminated devices shall be used in long-term stationary temporary traffic control zones.

Guidance:

Inappropriate markings in long-term stationary temporary traffic control zones should be removed and replaced with temporary markings.

Support:

In intermediate-term stationary temporary traffic control zones, it may not be feasible or practical to use procedures or devices that would be desirable for long-term stationary temporary traffic control zones, such as altered pavement markings, temporary traffic barriers, and temporary roadways. The increased time to place and remove these devices in some cases could significantly lengthen the project, thus increasing exposure time. In other instances, there might be insufficient pay-back time to economically justify more elaborate temporary traffic control measures.

Standard:

Since intermediate-term operations extend into nighttime, retroreflective and/or illuminated devices shall be used in intermediate-term stationary temporary traffic control zones.

Support:

Most maintenance and utility operations are short-term stationary work.

As compared to stationary operations, mobile and short-duration operations are activities that might involve different treatments. Devices having greater mobility might be necessary such as signs mounted on trucks. Devices that are larger, more imposing, or more visible can be used effectively and economically. The mobility of the temporary traffic control zone is important.

Maintaining safe work and road user conditions is a paramount goal in carrying out mobile operations.

Guidance:

Safety in short-duration or mobile operations should not be compromised by using fewer devices simply because the operation will frequently change its location.

Option:

Appropriately colored or marked vehicles with rotating/strobe lights, perhaps augmented with signs or arrow panels, may be used in place of signs and channelizing devices for short-duration or mobile operations.

Support:

During short-duration work, it often takes longer to set up and remove the traffic control it often takes longer to set up and remove the temporary traffic control zone than to perform the work. Workers face hazards in setting up and taking down the temporary traffic control zone. Also, since the work time is short, delays affecting road users are significantly increased when additional devices are installed and removed.

Option:

Considering these factors, simplified control procedures may be warranted for short-duration work. A reduction in the number of devices may be offset by the use of other more dominant devices such as rotating lights or strobe lights on work vehicles.

Support:

Mobile operations often involve frequent short stops for activities such as litter cleanup, pothole patching, or utility operations, and are similar to short-duration operations.

Guidance:

Warning signs, rotating/strobe lights on a vehicle, flags, and/or channelizing devices should be used and moved periodically to keep them near the mobile work area.

Option:

Flaggers may be used for mobile operations.

Support:

Mobile operations also include work activities where workers and equipment move along the road without stopping, usually at slow speeds. The advance warning area moves with the work area.

Guidance:

When mobile operations are being performed, a shadow vehicle equipped with an arrow panel or a sign should follow the work vehicle, especially when motor vehicle traffic speeds or volumes are high. Where feasible, warning signs should be placed along the roadway and moved periodically as work progresses.

Under high-volume conditions, consideration should be given to scheduling mobile operations work during off-peak hours.

If there are mobile operations on a high-speed travel lane of a multi-lane divided highway, arrow panels should be used.

Option:

For mobile operations that move at speeds less than 4 km/h (3 mph), mobile signs or stationary signing that is periodically retrieved and repositioned in the advance warning area may be used.

At higher speeds, vehicles may be used as components of the temporary traffic control zones for mobile operations. Appropriately colored and marked vehicles with signs, flags, rotating/strobe lights, truck-mounted attenuators, and arrow panels or portable changeable message signs may follow a train of moving work vehicles.

For some continuously moving operations, such as street sweeping and snow removal, a single work vehicle with appropriate warning devices on the vehicle may be used to provide warning to approaching road users.

Standard:

Mobile operations that move at speeds greater than 30 km/h (20 mph), such as pavement marking operations, shall have appropriate devices on the equipment (that is, rotating lights, signs, or special lighting), or shall use a separate vehicle with appropriate warning devices.

Section 6G.03 Location of Work

Support:

The choice of temporary traffic control needed for a temporary traffic control zone depends upon where the work is located. As a general rule, the closer the work is to road users, the greater the number of temporary traffic control devices that are needed. Procedures are described later in this Chapter for establishing temporary traffic control zones in the following locations:

- A. Outside the shoulder
- B. On the shoulder with no encroachment
- C. On the shoulder with minor encroachment
- D. Within the median
- E. Within the traveled way

Standard:

When the work space is within the traveled way, except for short-duration and mobile operations, advance warning shall provide a general message that work is taking place, shall supply information about highway conditions, and shall indicate how motor vehicle traffic can move through the temporary traffic control zone.

Section 6G.04 Modifications to Fulfill Special Needs

Support:

The typical applications in Chapter 6H illustrate commonly encountered situations in which temporary traffic control devices are employed.

Option:

Other devices may be added to supplement the devices indicated in the typical applications, and device spacing may be adjusted to provide additional reaction time. When conditions are less complex than those depicted in the typical applications, fewer devices may be needed.

Guidance:

When conditions are more complex, typical applications should be modified by incorporating appropriate devices and practices from the following list:

A. Additional devices:

1. Signs
2. Arrow panels
3. More channelizing devices at closer spacing
4. Temporary raised pavement markers
5. High-level warning devices
6. Portable changeable message signs
7. Temporary traffic signals
8. Temporary traffic barriers
9. Crash cushions
10. Screens
11. Rumble strips
12. More delineation

B. Upgrading of devices:

1. A full complement of standard pavement markings
2. Brighter and/or wider pavement markings
3. Larger and/or brighter signs
4. Channelizing devices with greater conspicuity
5. Temporary traffic barriers in place of channelizing devices

C. Improved geometrics at detours or crossovers, giving particular attention to the provisions set forth in Chapter 6B.**D. Increased distances:**

1. Longer advance warning area
2. Longer tapers

E. Lighting:

1. Temporary roadway lighting
2. Steady-burn lights used with channelizing devices
3. Flashing lights for isolated hazards
4. Illuminated signs
5. Floodlights

Support:

Uniformity of devices and their application is always of paramount importance.

As noted earlier, temporary traffic barriers are not temporary traffic control devices in themselves; however, when placed in a position identical to a line of channelizing devices and marked and/or equipped with appropriate channelization features to provide guidance and warning both day and night, they serve as temporary traffic control devices.

Standard:

Temporary traffic barriers serving as temporary traffic control devices shall conform to requirements for such devices as set forth throughout Part 6.

Section 6G.05 Work Outside of Shoulder**Support:**

When work is being performed off the roadway (beyond the shoulders, but within the right-of-way), little or no temporary traffic control may be needed. Temporary traffic control generally is not needed where work is confined to an area 4.5 m (15 ft) or more from the edge of the traveled way. However, temporary traffic control is appropriate where distracting situations exist, such as vehicles parked on the shoulder, vehicles accessing the work site via the highway, and equipment traveling on or crossing the roadway to perform the work operations (for example, mowing). For work beyond the shoulder, see Figure 6H-1.

Guidance:

Where the above situations exist, a single warning sign, such as ROAD WORK AHEAD, should be used. If the equipment travels on the roadway, the equipment should be equipped with appropriate flags, rotating/strobe lights, and/or a SLOW MOVING VEHICLE symbol.

Option:

If work vehicles are on the shoulder, a SHOULDER WORK sign may be used. For mowing operations, the sign MOWING AHEAD may be used.

Guidance:

Where the activity is spread out over a distance of more than 3.2 km (2 mi), the SHOULDER WORK sign should be repeated every 1.6 km (1 mi).

Option:

A supplementary plaque with the message NEXT X KM (MILES) may be used.

Guidance:

A general warning sign like ROAD MACHINERY AHEAD should be used if workers and equipment must occasionally move closer to the traveled way.

Section 6G.06 Work on the Shoulder with No Encroachment**Support:**

The provisions of this Section apply to short-term through long-term stationary operations.

Standard:

When paved shoulders having a width of 2.4 m (8 ft) or more are closed, at least one advance warning sign shall be used. In addition, channelizing devices shall be used to close the shoulder in advance to delineate the beginning of the work space and direct motor vehicle traffic to remain within the traveled way.

Guidance:

When a highway shoulder is occupied, a SHOULDER WORK sign, except for short duration and mobile operations, should be placed in advance of the activity area. When work is performed on a paved shoulder 2.4 m (8 ft) or more in width, channelizing devices should be placed on a taper having a length that conforms to the requirements of a shoulder taper.

When paved shoulders having a width of 2.4 m (8 ft) or more are closed on expressways and freeways, road users should be warned about potential disabled vehicles that cannot get off the traveled way. An initial general warning sign (such as ROAD WORK AHEAD) should be used, followed by a RIGHT or LEFT SHOULDER CLOSED sign. Where the end of the shoulder closure extends beyond the distance which can be perceived by road users, a supplementary plaque bearing the message NEXT X METERS (FEET) or KM (MILES) should be placed below the SHOULDER CLOSED sign. On multi-lane, divided highways, signs advising of shoulder work or the condition of the shoulder should be placed only on the side of the affected shoulder.

When an improved shoulder is closed on a high-speed roadway, it should be treated as a closure of a portion of the road system because road users expect to be able to use it in emergencies. Road users should be given ample advance warning that shoulders are closed for use as refuge areas throughout a specified length of the approaching temporary traffic control zone. The sign(s) should read SHOULDER CLOSED with distances indicated. The work space on the shoulder should be closed off by a taper or channelizing devices with a length of $0.33 L$ using the formulas in Table 6C-2.

When the shoulder is not occupied but work has adversely affected its condition, the LOW SHOULDER or SOFT SHOULDER sign should be used, as appropriate.

Where the condition extends over a distance in excess of 1.6 km (1 mi), the sign should be repeated at 1.6 km (1 mi) intervals.

Option:

In addition, a supplementary plaque bearing the message NEXT X KM (MILES) may be used. Temporary traffic barriers may be needed to inhibit encroachment of errant vehicles into the work space and to protect workers.

Standard:

When used for shoulder work, arrow panels shall operate only in the caution mode.

Support:

A typical application for stationary work operations on shoulders is shown in Figure 6H-3. Short duration or mobile work on shoulders is shown in Figure 6H-4. Work on freeway shoulders is shown in Figure 6H-5.

Section 6G.07 Work on the Shoulder with Minor Encroachment

Guidance:

When work takes up part of a lane, motor vehicle traffic volumes, vehicle mix (buses, trucks, and cars), speed, and capacity, should be analyzed to determine whether the affected lane should be closed. Unless the lane encroachment permits a remaining lane width of 3 m (10 ft), the lane should be closed.

Truck off-tracking should be considered when determining whether the minimum lane width of 3 m (10 ft) is adequate.

Option:

A lane width of 2.7 m (9 ft) may be used for short-term stationary work on low-volume, low-speed roadways when motor vehicle traffic does not include longer and wider heavy commercial vehicles.

Support:

Figure 6H-6 illustrates a method for handling motor vehicle traffic where the stationary or short duration work space encroaches slightly into the traveled way.

Section 6G.08 Work Within the Median**Guidance:**

If work in the median of a divided highway is within 4.5 m (15 ft) from the edge of the traveled way for either direction of travel, temporary traffic control should be used through the use of advance warning signs and channelizing devices.

Section 6G.09 Work Within the Traveled Way of Two-Lane Highways**Support:**

Detour signs are used to direct road users onto another roadway. At diversions, road users are directed onto a temporary roadway or alignment placed within or adjacent to the right-of-way. Typical applications for detouring or diverting road users on two-lane highways are shown in Figures 6H-7, 6H-8, and 6H-9. Figure 6H-7 illustrates the controls around an area where a section of roadway has been closed and a diversion has been constructed. Channelizing devices and pavement markings are used to indicate the transition to the temporary roadway.

Guidance:

When a detour is long, Detour Marker (M4-8) or Detour (M4-9) signs should be installed to remind and reassure road users periodically that they are still successfully following the detour.

When an entire roadway is closed, as illustrated in Figure 6H-8, a detour should be provided and road users should be warned in advance of the closure, which in this example is a closure 16 km (10 mi) from the intersection. If local road users are allowed to use the roadway up to the closure, the ROAD CLOSED TO THRU TRAFFIC sign should be used. The portion of the road open to local road users should have adequate signing, marking, and delineation.

Detours should be signed so that road users will be able to traverse the entire detour route and back to the original roadway as shown in Figure 6H-9.

Support:

Techniques for controlling motor vehicle traffic under one-lane, two-way conditions are described in Section 6C.10.

Option:

Flaggers may be used as shown in Figure 6H-10.

STOP/YIELD sign control may be used on low-volume roads as shown in Figure 6H-11.

A temporary traffic control signal may be used as shown in Figure 6H-12.

Section 6G.10 Work Within the Traveled Way of Urban Streets

Support:

In urban temporary traffic control zones, decisions are needed on how to control motor vehicle traffic, such as how many lanes are required, whether any turns should be prohibited at intersections, and how to maintain access to business, industrial, and residential areas.

Pedestrian traffic needs separate attention. Chapter 6D contains information regarding controlling pedestrian movements near work zones.

Standard:

If the temporary traffic control zone affects the movement of pedestrians, adequate pedestrian access and walkways shall be provided.

If the temporary traffic control zone affects the movement of bicyclists, adequate access to the roadway, bicycle paths, or shared-use paths shall be provided (see Part 9).

Guidance:

If a designated bicycle route is closed because of the work being done, a signed alternate route should be provided. Bicyclists should not be directed onto the path used by pedestrians.

Support:

Utility work takes place both within and outside the roadway to construct and maintain services such as power, gas, light, water, or telecommunications. Operations often involve intersections, since that is where many of the network junctions occur. The work force is usually small, only a few vehicles are involved, and the number and types of temporary traffic control devices placed in the temporary traffic control zone is usually minimal.

Standard:

All temporary traffic control devices shall be retroreflective or illuminated if utility work is performed during nighttime hours.

Guidance:

As discussed under short-duration projects, however, the reduced number of devices in utility work zones should be offset by the use of high-visibility devices, such as rotating lights or strobe lights on work vehicles.

Support:

Figures 6H-6, 6H-10, 6H-15, 6H-18, 6H-21, 6H-22, 6H-23, 6H-26, and 6H-33 are examples of typical applications for utility operations. Other typical applications might apply as well.

Section 6G.11 Work Within the Traveled Way of Multi-Lane, Non-Access Controlled Highways**Support:**

Work on multi-lane (two or more lanes in one direction) highways is divided into right-lane closures, left-lane closures, interior-lane closures, multiple-lane closures, and closures on five-lane roadways.

Standard:

When a lane is closed on a multi-lane road, a transition area containing a merging taper shall be used.

Guidance:

When justified by an engineering study, temporary traffic barriers should be used to prevent incursions of errant vehicles into hazardous areas or work space.

Standard:

When temporary traffic barriers are placed immediately adjacent to the traveled way, they shall be equipped with appropriate channelizing devices, delineation, and/or other temporary traffic control devices. For lane closures, the merging taper shall use channelizing devices and the temporary traffic barrier shall be placed beyond the transition area.

Support:

It must be recognized that although temporary traffic barriers are shown in several of the typical applications of Chapter 6H, they are not considered to be temporary traffic control devices in themselves.

Figure 6H-34 illustrates a lane closure in which temporary traffic barriers are used.

There are four primary functions of temporary traffic barriers:

- A. To keep motor vehicle traffic from entering work areas, such as excavations or material storage sites;
- B. To separate workers, bicyclists, and pedestrians from motor vehicle traffic;
- C. To separate opposing directions of motor vehicle traffic; and,
- D. To separate motor vehicle traffic, bicyclists, and pedestrians from the work area such as false work for bridges and other exposed objects.

Option:

When the right lane is closed, temporary traffic control similar to that shown in Figure 6H-33 may be used for undivided or divided four-lane roads.

Guidance:

If morning and evening peak hourly motor vehicle traffic volumes in the two directions are uneven and the greater volume is on the side where the work is being done in the right lane, consideration should be given to closing the inside lane for opposing motor vehicle traffic and making the lane available to the side with heavier motor vehicle traffic, as shown in Figure 6H-31.

If the larger motor vehicle traffic volume changes to the opposite direction at a different time of the day, the temporary traffic control should be changed to allow two lanes for opposing motor vehicle traffic by moving the devices from the opposing lane back to the centerline. When it is necessary to create a temporary centerline that is not consistent with the pavement markings, channelizing devices should be used and closely spaced.

Option:

When closing a left lane on a multi-lane undivided road, as motor vehicle traffic flow permits, the two interior lanes may be closed, as shown in Figure 6H-30, to provide drivers and workers additional lateral clearance and to provide access to the work space.

Standard:

When only the left lane is closed on undivided roads, channelizing devices shall be placed along the centerline as well as along the adjacent lane.

Guidance:

When an interior lane is closed, an adjacent lane should also be considered for

closure to provide additional space for vehicles and materials and to facilitate the movement of equipment within the work space.

When multiple lanes in one direction are closed, a capacity analysis should be made to determine the number of lanes needed to accommodate motor vehicle traffic needs. Motor vehicle traffic should be moved over one lane at a time. As shown in Figure 6H-37, the tapers should be separated by a distance of $2L$, with L being determined by the formulas in Table 6C-2.

Standard:

When a directional roadway is closed, inapplicable WRONG WAY signs and markings, and other existing traffic control devices at intersections within the temporary two-lane, two-way operations section shall be covered, removed, or obliterated.

Option:

When half the road is closed on an undivided highway, both directions of motor vehicle traffic may be accommodated as shown in Figure 6H-32. When both interior lanes are closed, temporary traffic controls may be used as indicated in Figure 6H-30. When a roadway must be closed on a divided highway, a median crossover may be used (see Section 6G.15).

Support:

Temporary traffic control for lane closures on five-lane roads is similar to other multi-lane undivided roads. Figure 6H-32 can be adapted for use on five-lane roads. Figure 6H-35 can be used on a five-lane road for short duration and mobile operations.

Section 6G.12 Work Within the Traveled Way at an Intersection

Support:

The typical applications for intersections are classified according to the location of the work space with respect to the intersection area (as defined by the extension of the curb or edge lines). The three classifications are near side, far side, and in-the-intersection. Work spaces often extend into more than one portion of the intersection. For example, work in one quadrant often creates a near-side work space on one street and a far-side work space on the cross street. In such instances, an appropriate temporary traffic control plan is obtained by combining features shown in two or more of the intersection and pedestrian typical applications.

Temporary traffic control zones in the vicinity of intersections might block movements and interfere with normal road user flows. Such conflicts frequently occur at more complex signalized intersections having such features as traffic signal heads over particular lanes, lanes allocated to specific movements, multiple signal phases, and signal detectors for actuated control.

Guidance:

The effect of the work upon signal operation should be considered, such as signal phasing for ensuring adequate capacity, maintaining or adjusting signal detectors, and ensuring the appropriate visibility of signal heads.

Standard:

When work will occur near signalized intersections where operational and capacity problems are anticipated, the highway agency having jurisdiction shall be contacted.

Guidance:

When work will occur near non-signalized intersections where operational and capacity problems are anticipated, the highway agency having jurisdiction should be contacted.

For work at an intersection, advance warning signs, devices, and markings should be used on all cross streets, as appropriate. The typical applications depict urban intersections on arterial streets. Where the posted speed limit, the off-peak 85th-percentile speed prior to the work starting, or the anticipated speed exceeds 60 km/h (40 mph), additional warning signs should be used in the advance warning area.

Support:

Near-side work spaces, as depicted in Figure 6H-21, are simply handled as a midblock lane closure. A problem that might occur with near-side lane closure is a reduction in capacity, which during certain hours of operation could result in congestion and backups.

Option:

When near-side work spaces are used, an exclusive turn lane may be used for through motor vehicle traffic.

Where space is restricted in advance of near-side work spaces, as with short block spacings, two warning signs may be used in the advance warning area, and a third action-type warning or a regulatory sign (such as Keep Left) may be placed within the transition area.

Support:

Far-side work spaces, as depicted in Figures 6H-22 through 6H-25, involve additional treatment because road users typically enter the activity area by straight-through and left- or right-turning movements.

Guidance:

When a lane through an intersection must be closed on the far side, it should also be closed on the near-side approach to preclude merging movements within the intersection.

Option:

If, however, there are a significant number of vehicles turning from a near-side lane that is closed on the far side, the near-side lane may be converted to an exclusive turn lane.

Support:

Figures 6H-26 and 6H-27 provide guidance on applicable procedures for work performed within the intersection.

Option:

If the work is within the intersection, any of the following strategies may be used:

- A. A small work space so that road users can move around it, as shown in Figure 6H-26.
- B. Flaggers to assign the right-of-way, as shown in Figure 6H-27.
- C. Work in stages so the work space is kept small.
- D. Reduce road user volumes by road closing or upstream diversions.

Guidance:

Depending on road user conditions, a flagger(s) and/or a uniformed law enforcement officer(s) should be used to control road users.

Section 6G.13 Work Within the Traveled Way of Expressways and Freeways**Support:**

Problems of temporary traffic control might occur under the special conditions encountered where motor vehicle traffic must be moved through or around temporary traffic control zones on high-speed, high-volume roadways. Although the general principles outlined in the previous Sections of this Manual are applicable to all types of highways, high-speed, access-controlled highways need special attention in order to safely and efficiently accommodate motor vehicle traffic while also protecting work forces. The road user volumes, road vehicle mix (buses, trucks, and cars), and speed of vehicles on these facilities require that careful temporary traffic control procedures be implemented, for example, to induce critical merging maneuvers well in advance of work spaces and in a manner that creates minimum turbulence and delay in the motor vehicle traffic stream. These situations often require more conspicuous devices than specified for normal rural highway or urban street use. However, the same important basic considerations of uniformity and standardization of general principles apply for all roadways.

Work under high-speed, high-volume motor vehicle traffic on a controlled access highway is complicated by the roadway design and operational features. The presence of a median that establishes separate roadways for directional motor vehicle traffic flow might prohibit the closing of one of the roadways or the diverting of motor vehicle traffic to the other roadway. Lack of access to and from adjacent roadways prohibits rerouting of motor vehicle traffic away from the work space in many cases. Other conditions exist where work must be limited to night hours, thereby necessitating increased use of warning lights, illumination of work spaces, and advance warning systems.

Temporary traffic control for a typical lane closure on a divided highway is shown in Figure 6H-33. Temporary traffic controls for short duration and mobile operations on freeways are shown in Figure 6H-35. A typical application for shifting motor vehicle traffic lanes around a work space is shown in Figure 6H-36. Temporary traffic control for multiple and interior lane closures on a freeway is shown in Figures 6H-37 and 6H-38.

Guidance:

The method for closing an interior lane when the open lanes have the capacity to carry motor vehicle traffic should be as shown in Figure 6H-37. When the capacity of the other lanes is needed, the method shown in Figure 6H-38 should be used.

Section 6G.14 Two-Lane, Two-Way Traffic on One Roadway of a Normally Divided Highway

Support:

Two-lane two-way operation on one roadway of a normally divided highway is a typical procedure that requires special consideration in the planning, design, and work phases, because unique operational problems (for example, increasing the risk of head-on crashes) can arise with the two-lane, two-way operation.

Standard:

When two-lane, two-way traffic control must be maintained on one roadway of a normally divided highway, opposing motor vehicle traffic shall be separated with either temporary traffic barriers (concrete safety-shape or approved alternate) or with channelizing devices throughout the length of the two-way operation. The use of markings and complementary signing, by themselves, shall not be used.

Support:

Figure 6H-39 shows the procedure for two-lane, two-way operation. Treatments for entrance and exit ramps within the two-way roadway segment of this type of work are shown in Figures 6H-40 and 6H-41.

Section 6G.15 Crossovers**Guidance:**

The following are considered good guiding principles for the design of crossovers:

- A. Tapers for lane drops should be separated from the crossovers, as shown in Figure 6H-39.
- B. Crossovers should be designed for speeds no lower than 15 km/h (10 mph) below the posted speed, the off-peak 85th-percentile speed prior to the work starting, or the anticipated operating speed of the roadway, unless unusual site conditions require that a lower design speed be used.
- C. A good array of channelizing devices, delineators, and full-length, properly-placed pavement markings should be used to provide drivers with a clearly-defined travel path.
- D. The design of the crossover should accommodate all motor vehicle traffic, including trucks and buses.

Support:

Temporary traffic barriers and the excessive use of temporary traffic control devices cannot compensate for poor geometric and roadway cross-section design of crossovers.

Section 6G.16 Interchanges**Guidance:**

Access to interchange ramps on limited-access highways should be maintained even if the work space is in the lane adjacent to the ramps. Access to exit ramps should be clearly marked and delineated with channelizing devices. For long-term projects, conflicting pavement markings should be removed and new ones placed. Early coordination with officials having jurisdiction over the affected cross streets and providing emergency services should occur before ramp closings.

Option:

If access is not possible, ramps may be closed by using signs and Type III barricades. As the work space changes, the access area may be changed, as shown in Figure 6H-42. A temporary traffic control zone in the exit ramp may be handled as shown in Figure 6H-43.

When a work space interferes with an entrance ramp, a lane may need to be closed on the freeway. A temporary traffic control zone in the entrance ramp may require shifting ramp motor vehicle traffic. Temporary traffic control for both operations is shown in Figure 6H-44.

Section 6G.17 Movable Barriers

Support:

Figure 6H-45 shows a temporary reversible lane using movable barriers.

Option:

If the work activity in Figure 6H-34 permits, a movable barrier may be used and relocated to the shoulder during non-work periods or peak-period motor vehicle traffic conditions.

Section 6G.18 Work in the Vicinity of Highway-Rail Grade Crossings

Standard:

When highway-rail grade crossings exist either within or in the vicinity of a temporary traffic control zone, lane restrictions, flagging, or other operations shall not create conditions where vehicles can be stopped on the railroad tracks with no means of escape.

If the queuing of vehicles across the tracks cannot be avoided, a law enforcement officer or flagger shall be provided at the crossing to prevent vehicles from stopping on the tracks, even if automatic warning devices are in place.

Support:

Figure 6H-46 shows work in the vicinity of a highway-rail grade crossing.

Guidance:

Early coordination with the railroad company should occur before work starts.

Section 6G.19 Control of Traffic Through Incident Areas

Support:

An incident is an emergency road user occurrence, a natural disaster, or a special event.

The primary functions of temporary traffic control at an incident area are to move road users safely and expeditiously through or around the incident, and to reduce the likelihood of secondary crashes. Examples include a stalled vehicle blocking a lane, a road user crash blocking the traveled way, a chemical spill along a highway, floods and severe storm damage, a planned visit by a dignitary, or a major sporting event.

Guidance:

In order to reduce response time for incident management, highway agencies should pre-plan for occurrences of incidents along the major and heavily traveled highway and street system. Special events should be planned for and coordinated in advance.

Support:

While some incidents might be anticipated and planned for, emergencies and disasters might pose more severe and unpredictable problems. The ability to install proper temporary traffic control might greatly reduce the effects of an emergency. An essential part of fire, rescue, spill clean-up, and enforcement activities is the proper control of road users through the incident area. These operations need corroborating legislative authority for the implementation and enforcement of appropriate road user regulations, parking controls, and speed zoning. It is desirable for these statutes to provide sufficient flexibility in the authority for and implementation of temporary traffic control to respond to the needs of changing conditions found in incident areas.

Option:

For unexpected incidents, particularly those of an emergency nature, temporary traffic control devices on hand may be used for the initial response as long as they do not themselves create unnecessary additional hazards.

Standard:

If the incident is anticipated to last more than 3 days, applicable procedures and devices set forth in Part 6 shall be used.

Support:

A short-term road closure can be caused by an incident such as a road user crash that blocks the traveled way. Road users are usually detoured around the incident and back to the original roadway. A combination of traffic engineering and enforcement preparations is needed to determine the detour route and install the necessary devices. Large trucks are a significant concern in such a detour.

During incidents, large trucks might need to follow a route separate from that of automobiles because of bridge, weight, clearance, or geometric restrictions. Also, vehicles carrying hazardous cargo might need to follow a different route from other vehicles.

Some incidents such as hazardous spills might require closure of an entire highway. Through road users must have adequate guidance around the incident.

Maintaining good public relations is desirable. The cooperation of the news media in publicizing the existence of and reasons for incident areas and their temporary traffic control can be of great assistance in keeping road users and the general public well informed.

Guidance:

The channelizing devices discussed in Section 6F.55 should be used whenever possible.

When flares are used to initiate temporary traffic control at incidents or for short-term temporary traffic control, they should be replaced by more permanent devices as soon as practical.