

## CHAPTER 6F. TEMPORARY TRAFFIC CONTROL ZONE DEVICES

### Section 6F.01 Types of Devices

#### Guidance:

The design and application of temporary traffic control devices used in temporary traffic control zones should consider the needs of all road users.

#### Support:

Crashworthiness and crash testing information on devices described in Part 6 are found in AASHTO's "Roadside Design Guide" (see Section 1A.11).

#### Standard:

**Traffic control devices shall be defined as all signs, signals, markings, and other devices used to regulate, warn, or guide traffic, placed on, over, or adjacent to a street, highway, pedestrian facility, or bikeway by authority of a public body or official having jurisdiction.**

**All traffic control devices used on street and highway construction, maintenance, utility, or incident management operations shall conform to the applicable provisions of this Manual.**

#### Option:

Where the color orange is required, fluorescent red-orange or fluorescent yellow-orange colors may also be used.

#### Support:

The fluorescent versions of orange provide higher conspicuity than standard orange, especially during twilight.

### Section 6F.02 General Characteristics of Signs

#### Support:

Temporary traffic control zone signs convey both general and specific messages by means of words or symbols and have the same three categories as all road user signs: regulatory, warning, and guide.

**Standard:**

**The colors for regulatory signs shall follow the Standards for regulatory signs in Table 2A-4 and Chapter 2B. Warning signs in temporary traffic control zones shall have a black legend on an orange background, except for the Railroad Advance Warning (W10-1) sign which shall have a black message and border on a yellow background, and except for signs that are permitted in Part 2 to have yellow or fluorescent yellow-green backgrounds. Colors for guide signs shall follow the Standards in Table 2A-4 and Chapter 2D, except for guide signs as noted in Section 6F.47.**

**Option:**

Existing warning signs that are still applicable may remain in place.

In order to maintain the systematic use of yellow or fluorescent yellow-green background for pedestrian, bicycle, and school warning signs in a jurisdiction, the yellow or fluorescent yellow-green background for pedestrian, bicycle, and school warning signs may be used in temporary traffic control zones.

Standard orange flags or flashing warning lights may be used in conjunction with signs.

**Standard:**

**When standard orange flags or flashing warning lights are used in conjunction with signs, they shall not block the sign face.**

**Option:**

The dimensions of signs shown in Part 6 are for standard sizes, which may be increased wherever necessary for greater legibility or emphasis.

**Standard:**

**Deviations from standard sizes as prescribed herein shall be in 150 mm (6 in) increments.**

**Support:**

Sign design details are contained in the "Standard Highway Signs" book (see Section 1A.11).

**Standard:**

**All signs used at night shall be either retroreflective with a material that has a smooth, sealed outer surface or illuminated to show the same shape and similar color both day and night.**

**Option:**

Sign illumination may be either internal or external.

**Support:**

Street, highway, or strobe lighting does not constitute external sign illumination.

**Option:**

Signs may be made of rigid or flexible material.

**Section 6F.03 Sign Placement****Guidance:**

Signs should be located on the right side of the roadway unless otherwise specified in this Manual.

**Option:**

Where special emphasis is needed, signs may be placed on both the left and right sides of the roadway. Signs mounted on portable supports may be placed within the roadway itself. Signs may also be mounted on or above barricades.

**Support:**

Guidelines for height and lateral clearance of temporary post-mounted signs are shown in Figure 6F-1.

**Standard:**

**Post-mounted signs installed at the side of the road in rural areas shall be mounted at a height at least 1.5 m (5 ft), measured from the bottom of the sign to the near edge of the pavement. In business, commercial, and residential districts where parking and/or pedestrian movement is likely to occur, or where there are other obstructions to view, the distance between the bottom of the sign and the top of the near edge of the traveled way shall be at least 2.1 m (7 ft).**

**Signs mounted on barricades and barricade/sign combinations shall be crashworthy.**

**Guidance:**

Neither portable nor permanent sign supports should be located on sidewalks, bicycle lanes, or areas designated for pedestrian or bicycle traffic.

**Figure 6F-1. Height and Lateral Location of Signs—Typical Installations**

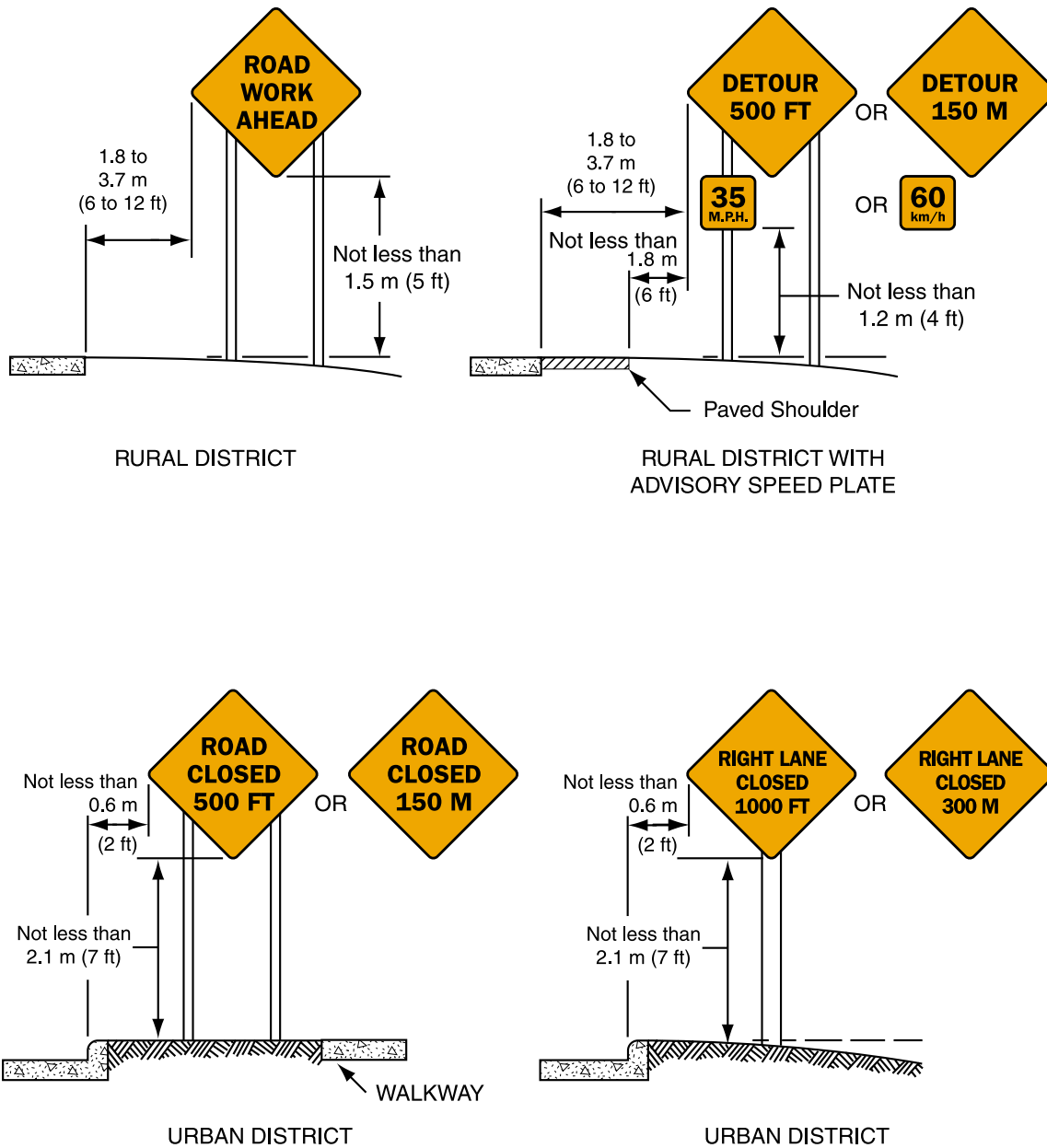

**Option:**

A 2.1 m (7 ft) mounting height may be used in rural areas for increased visibility.

The height to the bottom of a secondary sign mounted below another sign may be 0.3 m (1 ft) less than the appropriate height specified above.

**Guidance:**

Except as noted in the Option, signs mounted on portable supports should not be used for a duration of more than 3 days.

**Option:**

The R9-8 through R9-11a series, R11 series, W1-6 through W1-8 series, M4-10, E5-1, or other similar type signs may be used on portable supports for longer than 3 days.

**Support:**

Methods of mounting signs other than on posts are illustrated in Figure 6F-2.

**Guidance:**

Signs mounted on Type III barricades should not cover more than 50 percent of the top two rails or 33 percent of the total area of the three rails.

**Standard:**

**Sign supports shall be crashworthy. Large signs having an area exceeding 5 square meters (50 square feet) that are installed on multiple breakaway posts shall be mounted a minimum of 2.1 m (7 ft) above the ground.**

**Signs mounted on barricades, or other portable supports, shall be no less than 0.3 m (1 ft) above the traveled way.**

**Option:**

For mobile operations, a sign may be mounted on a work vehicle, a shadow vehicle, or a trailer stationed in advance of the temporary traffic control zone or moving along with it. The work vehicle, the shadow vehicle, or the trailer may or may not have an impact attenuator.

**Figure 6F-2. Methods of Mounting Signs Other Than on Posts**

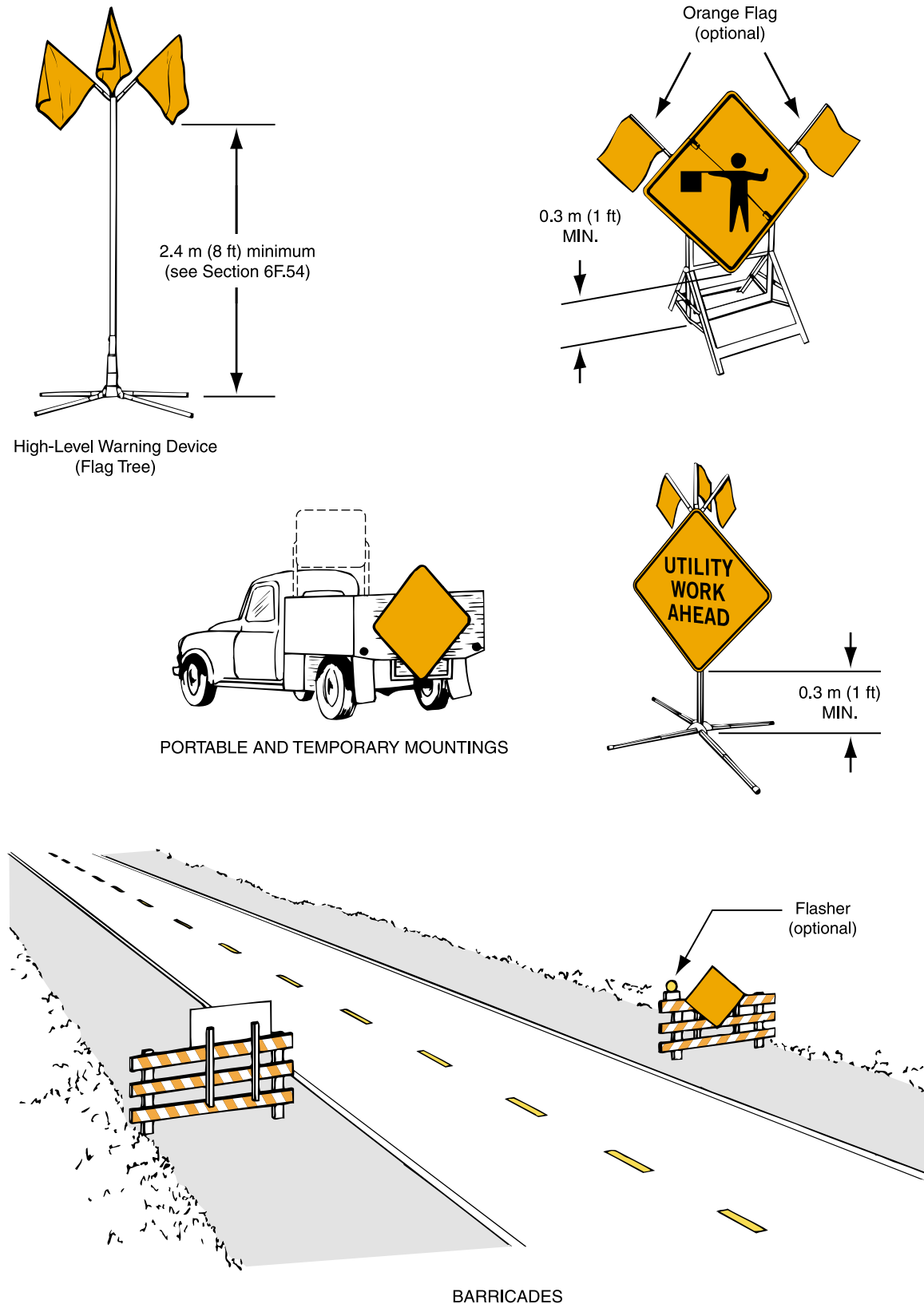

#### **Section 6F.04 Sign Maintenance**

##### **Standard:**

**Signs shall be properly maintained for cleanliness, visibility, and correct positioning.**

**Signs that have lost significant legibility shall be promptly replaced.**

#### **Section 6F.05 Regulatory Sign Authority**

##### Support:

Regulatory signs inform road users of traffic laws or regulations and indicate the applicability of legal requirements that would not otherwise be apparent.

##### **Standard:**

**Regulatory signs shall be authorized by the public agency or official having jurisdiction and shall conform with Chapter 2B.**

#### **Section 6F.06 Regulatory Sign Design**

##### Support:

Temporary traffic control regulatory signs shall conform to the Standards for regulatory signs presented in Part 2 and in FHWA's "Standard Highway Signs" book. Regulatory signs are generally rectangular with a black legend and border on a white background. Exceptions include the STOP, YIELD, DO NOT ENTER, WRONG WAY, and ONE WAY signs.

##### Option:

The ONE WAY sign may be either a horizontal or vertical rectangular sign.

#### **Section 6F.07 Regulatory Sign Applications**

##### **Standard:**

**If a temporary traffic control zone requires regulatory measures different from those existing, the existing permanent regulatory devices shall be removed or covered and superseded by the appropriate temporary regulatory signs. This change shall be made in conformance with applicable ordinances or statutes of the jurisdiction.**



R1-1  
750 x 750 mm  
(30 x 30 in)



R1-2  
900 x 900 x 900 mm  
(36 x 36 x 36 in)



R1-2a  
1200 x 600 mm  
(48 x 24 in)

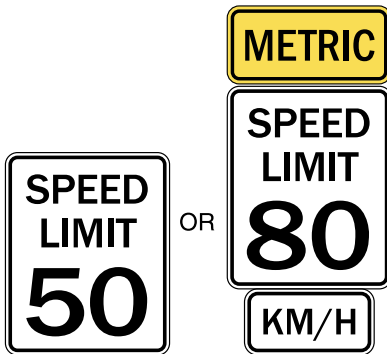

R2-1  
600 x 750 mm  
(24 x 30 in)

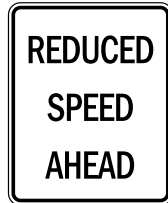

R2-5a  
600 x 750 mm  
(24 x 30 in)

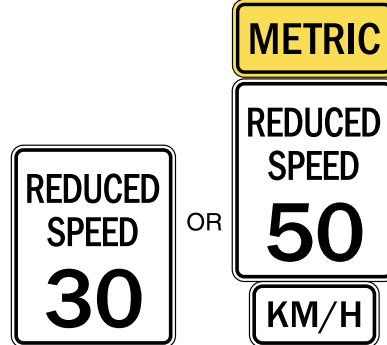

R2-5b  
600 x 750 mm  
(24 x 30 in)



R2-5c  
600 x 750 mm  
(24 x 30 in)



R3-1  
600 x 600 mm  
(24 x 24 in)



R3-2  
600 x 600 mm  
(24 x 24 in)



R3-3  
600 x 600 mm  
(24 x 24 in)



R3-4  
600 x 600 mm  
(24 x 24 in)



R3-5  
750 x 900 mm  
(30 x 36 in)

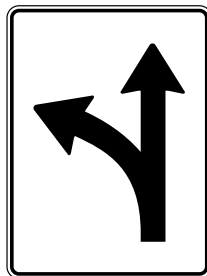

R3-6  
750 x 900 mm  
(30 x 36 in)



R3-7  
750 x 750 mm  
(30 x 30 in)

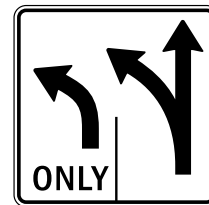

R3-8  
750 x 750 mm  
(30 x 30 in)





R4-1  
600 x 750 mm  
(24 x 30 in)



R4-2  
600 x 750 mm  
(24 x 30 in)

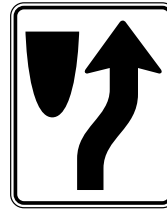

R4-7  
600 x 750 mm  
(24 x 30 in)



R4-9  
600 x 750 mm  
(24 x 30 in)



R5-1  
750 x 750 mm  
(30 x 30 in)



R5-1A  
900 x 600 mm  
(36 x 24 in)



R6-1  
900 x 300 mm  
(36 x 12 in)



R6-2  
450 x 600 mm  
(18 x 24 in)



R8-3  
600 x 600 mm  
(24 x 24 in)



R9-8  
600 x 300 mm  
(24 x 12 in)



R9-9  
600 x 300 mm  
(24 x 12 in)



R9-10  
600 x 300 mm  
(24 x 12 in)



R9-11  
600 x 300 mm  
(24 x 12 in)



R9-11a  
600 x 300 mm  
(24 x 12 in)



R11-2  
1200 x 750 mm  
(48 x 30 in)



OR



R11-3a  
1500 x 750 mm  
(60 x 30 in)



R11-4  
1500 x 750 mm  
(60 x 30 in)



OR



R12-1  
600 x 750 mm  
(24 x 30 in)

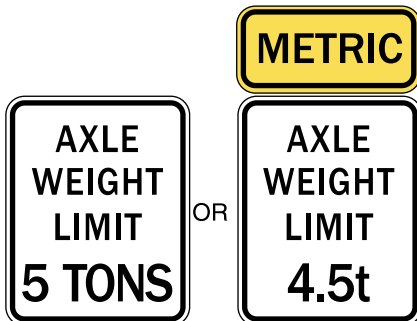

R12-2  
600 x 750 mm  
(24 x 30 in)

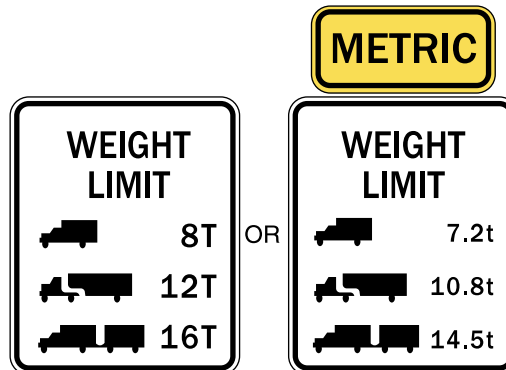

R12-5  
750 x 900 mm  
(30 x 36 in)

**Section 6F.08 ROAD (STREET) CLOSED Sign (R11-2)****Guidance:**

The ROAD (STREET) CLOSED (R11-2) sign should be used when the roadway is closed to all road users except contractors' equipment or officially authorized vehicles. The R11-2 sign should be accompanied by appropriate warning and detour signing.

**Option:**

The words BRIDGE OUT (or BRIDGE CLOSED) may be substituted for ROAD (STREET) CLOSED where applicable.

**Guidance:**

The ROAD (STREET) CLOSED sign should be installed at or near the center of the roadway on or above a Type III barricade that closes the roadway (see Section 6F.60).

**Standard:**

**The ROAD (STREET) CLOSED sign shall not be used where road user flow is maintained or where the actual closure is some distance beyond the sign.**

**Section 6F.09 Local Traffic Only Signs (R11-3a, R11-4)****Guidance:**

The Local Traffic Only signs should be used where road user flow detours to avoid a closure some distance beyond the sign, but where local road users can use the roadway to the point of closure. These signs should be accompanied by appropriate warning and detour signing.

In rural applications, the Local Traffic Only sign should have the legend ROAD CLOSED XX KM (MILES) AHEAD, LOCAL TRAFFIC ONLY (R11-3a).

**Option:**

In urban areas, the legend ROAD (STREET) CLOSED TO THRU TRAFFIC (R11-4) or ROAD CLOSED, LOCAL TRAFFIC ONLY may be used.

The words BRIDGE OUT (or BRIDGE CLOSED) may be substituted for the words ROAD (STREET) CLOSED on the R11-3a or R11-4 sign where applicable.

**Section 6F.10 Weight Limit Signs (R12-1, R12-2, R12-5)****Standard:**

A Weight Limit sign, which shows the gross weight or axle weight that is permitted on the roadway or bridge, shall be consistent with State or local regulations and shall not be installed without the approval of the authority having jurisdiction over the highway.

When weight restrictions are imposed, a marked detour shall be provided for vehicles weighing more than the posted limit.

**Section 6F.11 STAY IN LANE Sign (R4-9)**

## Option:

A STAY IN LANE (R4-9) sign may be used where a multilane shift has been incorporated as part of the temporary traffic control on a highway to direct road users around road work that occupies part of the roadway on a multilane highway.

**Section 6F.12 PEDESTRIAN CROSSWALK Sign (R9-8)**

## Option:

The PEDESTRIAN CROSSWALK (R9-8) sign may be used to indicate where a temporary crosswalk has been established.

**Section 6F.13 SIDEWALK CLOSED Signs (R9-9, R9-10, R9-11, R9-11a)**

## Guidance:

SIDEWALK CLOSED signs should be used where pedestrian flow is restricted or rerouted by work activities.

The SIDEWALK CLOSED (R9-9) sign should be installed at the beginning of the closed sidewalk, at the intersections preceding the closed sidewalk, and elsewhere along the closed sidewalk as needed.

The SIDEWALK CLOSED, (ARROW) USE OTHER SIDE (R9-10) sign should be installed at the beginning of the restricted sidewalk when a parallel sidewalk exists on the other side of the roadway.

The SIDEWALK CLOSED AHEAD, (ARROW) CROSS HERE (R9-11) sign should be used to indicate to pedestrians that sidewalks beyond the sign are closed and to direct them to open crosswalks, sidewalks, or other travel paths.

The SIDEWALK CLOSED, (ARROW) CROSS HERE (R9-11a) sign should be installed just beyond the point to which pedestrians are being redirected.

Support:

These signs are typically mounted on a barricade to encourage compliance.

### **Section 6F.14 Special Regulatory Signs**

Option:

Special regulatory signs may be used based on engineering judgment consistent with regulatory requirements.

Guidance:

Special regulatory signs should conform to the general requirements of color, shape, and alphabet size and series. The sign message should be brief, legible, and clear.

### **Section 6F.15 Warning Sign Function, Design, and Application**

Support:

Temporary traffic control zone warning signs notify road users of specific situations or conditions on or adjacent to a roadway that might not otherwise be apparent.

**Standard:**

**Temporary traffic control warning signs shall conform to the Standards for warning signs presented in Part 2 and in FHWA's "Standard Highway Signs" book. Except as noted in the Option below, temporary traffic control warning signs shall be diamond-shaped with a black symbol or message and border on an orange background, except for the W10-1 sign which shall have a black message and border on a yellow background, and except for signs that are permitted in Part 2 to have yellow or fluorescent yellow-green backgrounds.**

Option:

Mounting or space considerations may justify a change from the standard diamond shape.

In emergencies, available warning signs having yellow backgrounds may be used if orange signs are not at hand.



W1-1  
750 x 750 mm  
(30 x 30 in)



W1-2  
750 x 750 mm  
(30 x 30 in)



W1-3  
750 x 750 mm  
(30 x 30 in)



W1-4  
750 x 750 mm  
(30 x 30 in)



W1-4b  
900 x 900 mm  
(36 x 36 in)



W1-4c  
900 x 900 mm  
(36 x 36 in)

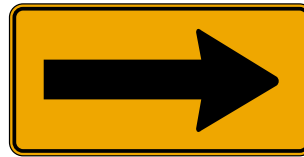

W1-6  
1200 x 600 mm  
(48 x 24 in)



W1-8  
450 x 600 mm  
(18 x 24 in)



W3-1a  
900 x 900 mm  
(36 x 36 in)



W3-2a  
900 x 900 mm  
(36 x 36 in)

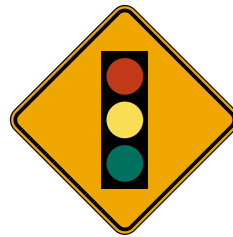

W3-3  
900 x 900 mm  
(36 x 36 in)



W4-1  
750 x 750 mm  
(30 x 30 in)



W4-1a  
900 x 900 mm  
(36 x 36 in)



W4-2  
900 x 900 mm  
(36 x 36 in)



W4-3  
1200 x 1200 mm  
(48 x 48 in)



W5-1  
900 x 900 mm  
(36 x 36 in)



W5-2  
900 x 900 mm  
(36 x 36 in)



W5-2a  
900 x 900 mm  
(36 x 36 in)



W5-3  
900 x 900 mm  
(36 x 36 in)



W5-4  
900 x 900 mm  
(36 x 36 in)



W6-1  
900 x 900 mm  
(36 x 36 in)



W6-2  
900 x 900 mm  
(36 x 36 in)



W6-3  
750 x 750 mm  
(30 x 30 in)



W6-4  
300 x 450 mm  
(12 x 18 in)



W7-1  
750 x 750 mm  
(30 x 30 in)



W8-1  
750 x 750 mm  
(30 x 30 in)



W8-2  
750 x 750 mm  
(30 x 30 in)



W8-3  
750 x 750 mm  
(30 x 30 in)



W8-4  
750 x 750 mm  
(30 x 30 in)



W8-5  
750 x 750 mm  
(30 x 30 in)



W8-6  
750 x 750 mm  
(30 x 30 in)



W8-7  
750 x 750 mm  
(30 x 30 in)



W8-8  
750 x 750 mm  
(30 x 30 in)



W8-9  
750 x 750 mm  
(30 x 30 in)



W8-9a  
750 x 750 mm  
(30 x 30 in)



W8-11  
900 x 900 mm  
(36 x 36 in)



W8-12  
900 x 900 mm  
(36 x 36 in)



W9-1  
900 x 900 mm  
(36 x 36 in)



W9-2  
900 x 900 mm  
(36 x 36 in)



W9-3  
900 x 900 mm  
(36 x 36 in)



W10-1  
900 mm Diameter  
(36 in)



W12-1  
600 x 600 mm  
(24 x 24 in)



W12-2  
900 x 900 mm  
(36 x 36 in)

OR



OR



W13-1  
450 x 450 mm (18 x 18 in)  
600 x 600 mm (24 x 24 in)



W13-4  
600 x 750 mm  
(24 x 30 in)



W14-3  
900 x 1200 x 1200 mm  
(36 x 48 x 48 in)



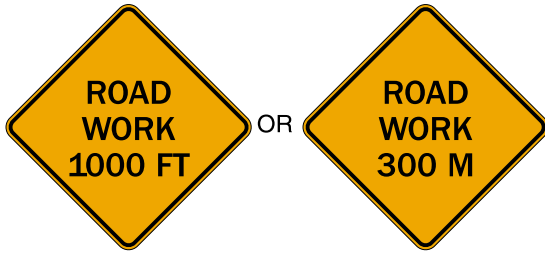

W20-1  
1200 x 1200 mm  
(48 x 48 in)

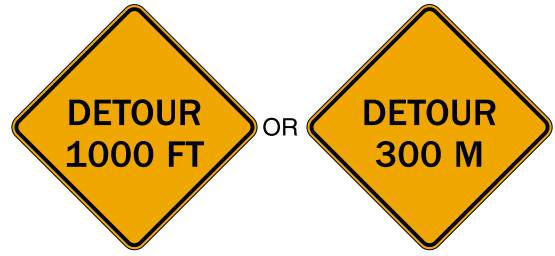

W20-2  
1200 x 1200 mm  
(48 x 48 in)

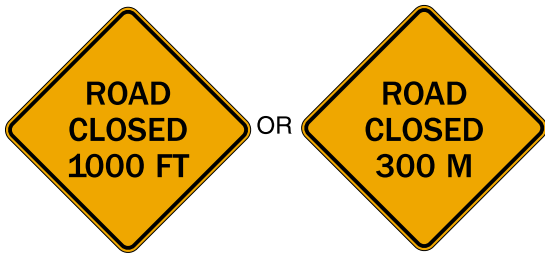

W20-3  
1200 x 1200 mm  
(48 x 48 in)

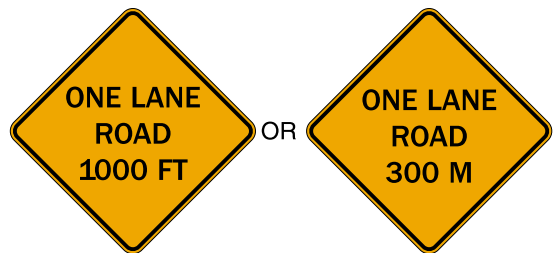

W20-4  
1200 x 1200 mm  
(48 x 48 in)

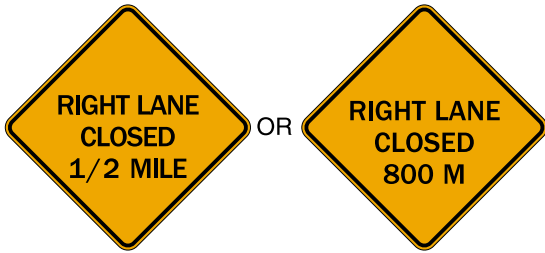

W20-5  
1200 x 1200 mm  
(48 x 48 in)

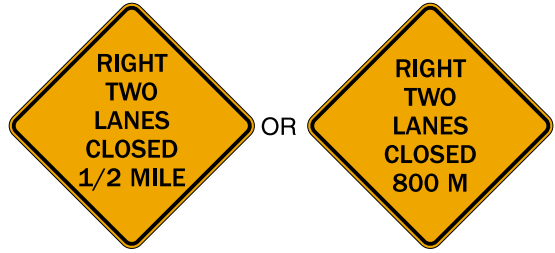

W20-5a  
1200 x 1200 mm  
(48 x 48 in)

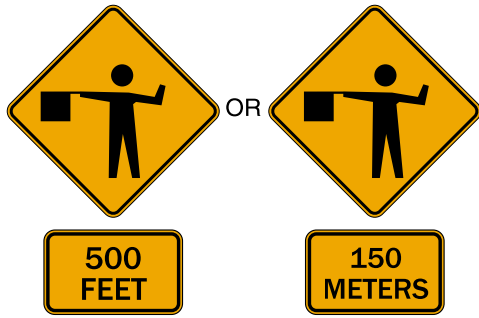

W20-7a  
1200 x 1200 mm  
(48 x 48 in)  
SUPPLEMENTAL PLAQUE  
600 x 450 mm  
(24 x 18 in)



W20-7b  
900 x 900 mm  
(36 x 36 in)



W21-1a  
900 x 900 mm  
(36 x 36 in)



W21-2  
750 x 750 mm  
(30 x 30 in)



W21-3  
900 x 900 mm  
(36 x 36 in)



W21-5  
750 x 750 mm  
(30 x 30 in)



W21-5a  
750 x 750 mm  
(30 x 30 in)



W21-5b  
1200 x 1200 mm  
(48 x 48 in)

OR



W21-6  
750 x 750 mm  
(30 x 30 in)



W21-7  
900 x 900 mm  
(36 x 36 in)



W22-1  
1200 x 1200 mm  
(48 x 48 in)



W22-2  
1050 x 900 mm  
(42 x 36 in)



W22-3  
1050 x 900 mm  
(42 x 36 in)



W23-1  
1200 x 600 mm  
(48 x 24 in)



G20-1  
900 x 450 mm  
(36 x 18 in)

OR



G20-2a  
900 x 450 mm  
(36 x 18 in)



G20-4  
900 x 450 mm  
(36 x 18 in)



E5-2  
1200 x 900 mm  
(48 x 36 in)



E5-2a  
1200 x 900 mm  
(48 x 36 in)



M4-8  
600 x 300 mm  
(24 x 12 in)



M4-8a  
600 x 450 mm  
(24 x 18 in)



M4-8b  
600 x 300 mm  
(24 x 12 in)



M4-9  
750 x 600 mm  
(30 x 24 in)



M4-10  
1200 x 450 mm  
(48 x 18 in)

**Guidance:**

Where roadway or road user conditions require greater emphasis, larger than standard size warning signs should be used, with the symbol or legend enlarged approximately in proportion to the outside dimensions.

Where any part of the roadway is obstructed or closed by work activities or incidents, advance warning signs should be installed to alert road users well in advance of these obstructions or restrictions.

**Option:**

Advance warning signs may be used singly or in combination.

**Standard:**

**Because of their importance, advance warning signs for higher-speed locations shall have a size of 1200 x 1200 mm (48 x 48 in) (see Part 2).**

**Option:**

Where speeds and volumes are moderately low, a minimum size of 900 x 900 mm (36 x 36 in) may be used for advance warning signs.

On secondary roads or city streets where speeds are very low, signs smaller than the standard size, but not less than 600 x 600 mm (24 x 24 in), may be used for warning signs having short word messages or clear symbols.

Advance warning signs larger than the minimum standards may be used for additional emphasis of the temporary traffic control zone (see Part 2).

Where distances are not shown on warning signs as part of the message, a supplemental plaque with the distance legend may be mounted immediately below the sign on the same support.

**Section 6F.16 Position of Advance Warning Signs****Guidance:**

Where highway conditions permit, warning signs should be placed in advance of the temporary traffic control zone at varying distances depending on roadway type, condition, and posted speed. Table 6C-1 contains information regarding the spacing of advance warning signs. Where a series of two or more advance warning signs is used, the closest sign to the temporary traffic control zone should be placed approximately 30 m (100 ft) for low-speed urban streets to 300 m (1,000 ft) or more for expressways and freeways.

**Support:**

Various conditions, such as limited sight distance or obstructions that might require a driver to reduce speed or stop, might require additional advance warning signs.

**Option:**

As an alternative to a specific distance on advance warning signs, the word AHEAD may be used.

**Support:**

At temporary traffic control zones on lightly-traveled roads, all of the advance warning signs prescribed for major construction might not be needed.

**Option:**

Utility work, maintenance, or minor construction can occur within the temporary traffic control zone limits of a major construction project, and additional warning signs may be needed.

**Guidance:**

Utility, maintenance, and minor construction signing and temporary traffic control should be coordinated with appropriate authorities so that road users are not confused or misled by the additional temporary traffic control devices.

**Section 6F.17 ROAD (STREET) WORK Sign (W20-1)****Guidance:**

The ROAD (STREET) WORK (W20-1) sign, which serves as a general warning of obstructions or restrictions, should be located in advance of the work space or any detour, on the road where the work is taking place, and on all intersecting roadways.

**Standard:**

**The ROAD (STREET) WORK (W20-1) sign shall have the legend ROAD (STREET) WORK, XX M (FT), XX KM (MILES), or AHEAD.**

**Section 6F.18 DETOUR Sign (W20-2)****Guidance:**

The DETOUR (W20-2) sign should be used in advance of a road user detour over a different roadway or route.

**Standard:**

The DETOUR sign shall have the legend DETOUR, XX M (FT), XX KM (MILES), or AHEAD.

**Section 6F.19 ROAD (STREET) CLOSED Sign (W20-3)****Guidance:**

The ROAD (STREET) CLOSED (W20-3) sign should be used in advance of the point where a highway is closed to all road users, or to all but local road users.

**Standard:**

The ROAD (STREET) CLOSED sign shall have the legend ROAD (STREET) CLOSED, XX M (FT), XX KM (MILES), or AHEAD.

**Section 6F.20 ONE LANE ROAD Sign (W20-4)****Standard:**

The ONE LANE ROAD (W20-4) sign shall be used only in advance of that point where motor vehicle traffic in both directions must use a common single lane (see Section 6C.10). It shall have the legend ONE LANE ROAD, XX M (FT), XX KM (MILES), or AHEAD.

**Section 6F.21 LANE(S) CLOSED Signs (W20-5, W20-5a)****Standard:**

The LANE(S) CLOSED sign shall be used in advance of that point where one or more through lanes of a multiple-lane roadway are closed.

For a single lane closure, the LANE CLOSED (W20-5) sign shall have the legend RIGHT (LEFT) LANE CLOSED, XX M (FT), XX KM (MILES), or AHEAD. Where two adjacent lanes are closed, the sign shall have the legend RIGHT (LEFT) TWO LANES CLOSED, XX M (FT), XX KM (MILES), or AHEAD.

**Section 6F.22 CENTER LANE CLOSED AHEAD Signs (W9-3, W9-3a)**

Guidance:

The CENTER LANE CLOSED AHEAD (W9-3) sign should be used in advance of that point where work occupies the center lane(s) and approaching motor vehicle traffic is directed to the right or left of the work zone in the center lane.

Option:

The Center Lane Closed Ahead (W9-3a) symbol sign may be substituted for the CENTER LANE CLOSED AHEAD (W9-3) word message sign.

**Section 6F.23 THRU TRAFFIC MERGE RIGHT (LEFT) Sign (W4-1a)**

Guidance:

The THRU TRAFFIC MERGE RIGHT (LEFT) (W4-1a) sign should be used in advance of an intersection where one or more lane closures on the far side of a multilane intersection require through motor vehicle traffic on the approach to the intersection to use the right (left) lane to proceed through the intersection.

**Section 6F.24 Lane Reduction Sign (W4-2)**

Option:

The Lane Reduction (W4-2) symbol sign may be used to warn drivers of the reduction in the number of motor vehicle traffic lanes in the direction of travel on a multilane roadway.

**Section 6F.25 ON RAMP Plaque (W13-4)**

Guidance:

When work is being done on a ramp, but the ramp remains open, the ON RAMP (W13-4) plaque should be used to supplement the advance ROAD WORK sign.

**Section 6F.26 RAMP NARROWS Sign (W5-4)**

Guidance:

The RAMP NARROWS (W5-4) sign should be used in advance of the point where work on a ramp reduces the normal width of the ramp along a part or all of the ramp.



**Section 6F.27 SLOW TRAFFIC AHEAD Sign (W23-1)**

Option:

The SLOW TRAFFIC AHEAD (W23-1) sign may be used on a shadow vehicle, usually mounted on the rear of the most upstream shadow vehicle, along with other appropriate signs for mobile operations to warn of slow moving work vehicles. A ROAD WORK (W20-1) sign may also be used with the SLOW TRAFFIC AHEAD sign.

**Section 6F.28 EXIT OPEN, EXIT CLOSED Signs (E5-2, E5-2a)**

Option:

An EXIT OPEN (E5-2) or EXIT CLOSED (E5-2a) sign may be used to supplement other warning signs where work is being conducted in the vicinity of an exit ramp and where the exit maneuver for motor vehicle traffic using the ramp is different from the normal condition.

**Section 6F.29 Flagger Sign (W20-7, W20-7a)**

Guidance:

The Flagger (W20-7a) symbol sign should be used in advance of any point where a flagger is stationed to control road users.

Option:

A distance legend may be displayed on a supplemental plaque below the Flagger sign. The sign may be used with appropriate legends or in conjunction with other warning signs, such as the BE PREPARED TO STOP (W20-7b) sign.

The FLAGGER (W20-7) word message sign with distance legends may be substituted for the Flagger (W20-7a) symbol sign.

**Standard:**

**The Flagger sign shall be removed, covered, or turned away from road users when the flagging operations are not occurring.**

**Section 6F.30 Two-Way Traffic Sign (W6-3)**

Guidance:

When one roadway of a normally divided highway is closed, with two-way motor vehicle traffic maintained on the other roadway, the Two-Way Traffic (W6-3) sign

should be used at the beginning of the two-way motor vehicle traffic section and at intervals to remind road users of opposing motor vehicle traffic.

### **Section 6F.31 Workers Sign (W21-1, W21-1a)**

Option:

A Workers (W21-1a) symbol sign may be used to alert road users of workers in or near the roadway.

Guidance:

In the absence of other warning devices, a Workers symbol sign should be used when workers are in the roadway.

Option:

The WORKERS (W21-1) word message sign may be used as an alternate to the Workers (W21-1a) symbol sign.

### **Section 6F.32 FRESH OIL (TAR) Sign (W21-2)**

Guidance:

The FRESH OIL (TAR) (W21-2) sign should be used to warn road users of the surface treatment.

### **Section 6F.33 ROAD MACHINERY AHEAD Sign (W21-3)**

Option:

The ROAD MACHINERY AHEAD (W21-3) sign may be used to warn of machinery operating in or adjacent to the roadway.

### **Section 6F.34 SHOULDER WORK Signs (W21-5, W21-5a, W21-5b)**

Support:

Shoulder Work signs warn of maintenance, reconstruction, or utility operations on the highway shoulder where the roadway is unobstructed.

**Standard:**

**The Shoulder Work sign shall have the legend SHOULDER WORK (W21-5), RIGHT (LEFT) SHOULDER CLOSED (W21-5a), or RIGHT (LEFT) SHOULDER CLOSED XXX M (FT) (W21-5b).**

## Option:

The Shoulder Work sign may be used in advance of the point on a nonlimited access highway where there is shoulder work. It may be used singly or in combination with a ROAD WORK NEXT X KM (MILES) or ROAD WORK AHEAD sign.

## Guidance:

On expressways and freeways, the RIGHT (LEFT) SHOULDER CLOSED XXX M (FT) sign followed by RIGHT (LEFT) SHOULDER CLOSED sign should be used in advance of the point where the shoulder work occurs and should be preceded by a ROAD WORK AHEAD sign.

**Section 6F.35 SURVEY CREW Sign (W21-6)**

## Guidance:

The SURVEY CREW (W21-6) sign should be used to warn of surveying crews working in or adjacent to the roadway.

**Section 6F.36 UTILITY WORK Sign (W21-7)**

## Option:

The UTILITY WORK (W21-7) sign may be used as an alternate to the ROAD (STREET) WORK (W20-1) sign for utility operations on or adjacent to a highway.

## Support:

Typical examples of where the UTILITY WORK sign is used appear in Figures 6H-4, 6H-6, 6H-10, 6H-15, 6H-18, 6H-21, 6H-22, 6H-26, and 6H-33.

**Standard:**

**The UTILITY WORK sign shall carry the legend UTILITY WORK, XX M (FT), XX KM (MILES), or AHEAD.**

**Section 6F.37 Signs for Blasting Areas****Support:**

Radio-Frequency (RF) energy can cause the premature firing of electric detonators (blasting caps) used in work zones.

**Standard:**

**Road users shall be warned to turn off mobile radio transmitters and cellular telephones where blasting operations occur. A sequence of signs shall be prominently displayed to direct operators of mobile radio equipment, including cellular telephones, to turn off transmitters in a blasting area. These signs shall be covered or removed when there are no explosives in the area or the area is otherwise secured.**

**Guidance:**

A minimum safe distance of 300 m (1,000 ft) should be used for warning sign placement.

**Section 6F.38 BLASTING ZONE AHEAD Sign (W22-1)****Standard:**

**The BLASTING ZONE AHEAD (W22-1) sign shall be used in advance of any temporary traffic control zone where explosives are being used. The TURN OFF 2-WAY RADIO AND PHONE and END BLASTING ZONE signs shall be used in sequence with this sign.**

**Section 6F.39 TURN OFF 2-WAY RADIO AND PHONE Sign (W22-2)****Standard:**

**The TURN OFF 2-WAY RADIO AND PHONE (W22-2) sign shall follow the BLASTING ZONE AHEAD sign and shall be placed at least 300 m (1,000 ft) before the beginning of the blasting zone.**

**Section 6F.40 END BLASTING ZONE Sign (W22-3)****Standard:**

The END BLASTING ZONE (W22-3) sign shall be placed a minimum of 300 m (1,000 ft) past the blasting zone.

**Option:**

The END BLASTING ZONE sign may be placed either with or preceding the END ROAD WORK sign.

**Section 6F.41 SHOULDER DROP-OFF Sign (W8-9a)****Standard:**

The SHOULDER DROP-OFF (W8-9a) sign shall be used when a shoulder drop-off, adjacent to the travel lane, exceeds 75 mm (3 in) in depth and is not protected by portable barriers.

**Section 6F.42 UNEVEN LANES Sign (W8-11)****Guidance:**

The UNEVEN LANES (W8-11) sign should be used during operations that create a difference in elevation between adjacent lanes.

**Section 6F.43 NO CENTER STRIPE Sign (W8-12)****Guidance:**

The NO CENTER STRIPE (W8-12) sign should be used when the work obliterates the centerline pavement markings. This sign should be placed at the beginning of the temporary traffic control zone and repeated at 3.2 km (2 mi) intervals in long temporary traffic control zones.

**Section 6F.44 Other Warning Signs****Option:**

Advance warning signs may be used by themselves or with other advance warning signs.

Besides the warning signs specifically related to temporary traffic control zones, several other warning signs in Part 2 may apply in temporary traffic control zones.

**Standard:**

**When used in temporary traffic control zones, these other warning signs shall have black legends and borders on an orange background, except for the Railroad Advance Warning (W10-1) sign, and school, pedestrian, and bicycle signs (see Section 6F.02).**

**Section 6F.45 Advisory Speed Plaque (W13-1)**

Option:

In combination with a warning sign, an Advisory Speed (W13-1) plaque may be used to indicate a recommended safe speed through the temporary traffic control zone.

**Standard:**

**The Advisory Speed plaque shall not be used in conjunction with any sign other than a warning sign, nor shall it be used alone. When used with orange temporary traffic control zone signs, this plaque shall have a black legend and border on an orange background. The sign shall be at least 600 x 600 mm (24 x 24 in) in size when used with a sign that is 900 x 900 mm (36 x 36 in) or larger. Except in emergencies, an Advisory Speed plaque shall not be mounted until the recommended speed is determined by the highway agency.**

**Section 6F.46 Supplementary Distance Plaque (W7-3a)**

Option:

In combination with a warning sign, a Supplementary Distance (W7-3a) plaque with the legend NEXT XX KM (MILE) may be used to indicate the length of highway over which a work activity is being conducted, or over which a condition exists in the temporary traffic control zone.

In long temporary traffic control zones, Supplementary Distance plaques with the legend NEXT XX KM (MILES) may be placed in combination with warning signs at regular intervals within the zone to indicate the remaining length of highway over which the temporary traffic control work activity or condition exists.

**Standard:**

**The Supplementary Distance plaque with the legend NEXT XX KM (MILES) shall not be used in conjunction with any sign other than a warning sign, nor shall it be used alone. When used with orange temporary traffic control zone signs, this plaque shall have a black legend and border on an orange background. The sign shall be at least 750 x 600 mm (30 x 24 in) in size when used with a sign that is 900 x 900 mm (36 x 36 in) or larger.**

## Guidance:

When used in temporary traffic control zones, the Supplementary Distance plaque with the legend NEXT XX KM (MILES) should be placed below the initial warning sign designating that, within the approaching zone, a temporary work activity or condition exists.

**Section 6F.47 Guide Signs**

## Support:

Guide signs along highways provide road users with information to help them along their way through the temporary traffic control zone. The design of guide signs is presented in Part 2.

## Guidance:

The following guide signs should be used in temporary traffic control zones as needed:

- A. Standard route markings, where temporary route changes are necessary;
- B. Directional signs and street name signs; and
- C. Special guide signs relating to the condition or work being done.

**Standard:**

**If additional guide signs are used in temporary traffic control zones, they shall have a black legend on an orange background.**

## Option:

When directional signs and street name signs are used in conjunction with detour routing, these signs may have a black legend on an orange background.

**Section 6F.48 ROAD WORK NEXT XX KM (MILES) Sign (G20-1)****Guidance:**

The ROAD WORK NEXT XX KM (MILES) (G20-1) sign should be installed in advance of temporary traffic control zones that are more than 3.2 km (2 mi) in length.

**Option:**

The ROAD WORK NEXT XX KM (MILES) sign may be mounted on a Type III barricade. The sign may also be used for work zones of shorter length.

**Standard:**

**The distance shown on the ROAD WORK NEXT XX KM (MILES) sign shall be stated to the nearest whole kilometer (or mile).**

**Section 6F.49 END ROAD WORK Sign (G20-2a)****Guidance:**

The END ROAD WORK (G20-2a) sign should be placed about 150 m (500 ft) beyond the temporary traffic control zone.

**Option:**

The END ROAD WORK sign may be installed on the back of a warning sign facing the opposite direction of road users or on the back of a Type III barricade.

**Section 6F.50 Detour Signs and Markers (M4-8, M4-8a, M4-8b, M4-9, and M4-10)****Standard:**

**Each detour shall be adequately marked with standard temporary route markers and destination signs.**

**Option:**

The Detour Arrow (M4-10) sign may be used where a detour route has been established.

The DETOUR (M4-8) marker may be mounted at the top of a route marker assembly to mark a temporary route that detours from a highway, bypasses a section closed by a temporary traffic control zone, and rejoins the highway beyond the temporary traffic control zone.



**Guidance:**

The Detour Arrow (M4-10) sign should normally be mounted just below the ROAD CLOSED (R11-2, R11-3a, or R11-4) sign. The Detour Arrow sign should include a horizontal arrow pointed to the right or left as required.

The DETOUR (M4-9) sign should be used for unnumbered highways, for emergency situations, for periods of short durations, or where, over relatively short distances, road users are guided along the detour and back to the desired highway without route markers.

A Street Name sign should be placed above, or the street name should be incorporated into, a DETOUR (M4-9) sign to indicate the name of the street being detoured.

**Option:**

The END DETOUR (M4-8a or M4-8b) sign may be used to indicate that the detour has ended.

**Guidance:**

When the END DETOUR sign is used on a numbered highway, the sign should be mounted above a marker after the end of the detour.

**Section 6F.51 PILOT CAR FOLLOW ME Sign (G20-4)****Standard:**

**The PILOT CAR FOLLOW ME (G20-4) sign shall be mounted in a conspicuous position on the rear of a vehicle used for guiding one-way motor vehicle traffic through or around a temporary traffic control zone. A flagger shall be stationed on the approach to the activity area to stop motor vehicle traffic until the pilot vehicle is available.**

**Section 6F.52 Portable Changeable Message Signs****Standard:**

**Portable Changeable Message signs shall be temporary traffic control devices with the flexibility to display a variety of messages. Each message shall consist of either one or two phases. Typically, a phase shall consist of up to three lines of eight characters per line.**

**Support:**

Portable Changeable Message signs are used most frequently on high-density urban freeways, but have applications on all types of highways where highway alignment, road user routing problems, or other pertinent conditions require advance warning and information.

**Guidance:**

The components of a Portable Changeable Message sign should include: a message sign panel, control systems, a power source, and mounting and transporting equipment.

Portable Changeable Message signs should subscribe to the principles established in this Manual and, to the extent practical, with the design (that is, color, letter size and shape, and borders) and applications prescribed in this Manual, except that the reverse colors for the letters and the background are considered acceptable.

The front face of the sign should be covered with a protective material. The color of the elements should be yellow or orange on a black background.

Portable Changeable Message signs should be visible from 0.8 km (0.5 mi) under both day and night conditions. The message should be legible from a minimum distance of 200 m (650 ft). The message panel should have adjustable display rates, so that the entire message can be read at least twice at the posted speed, the off-peak 85th-percentile speed prior to work starting, or the anticipated operating speed.

**Option:**

The message sign panel may vary in size.

**Standard:**

**Portable Changeable Message signs shall automatically adjust their brightness under varying light conditions, to maintain legibility.**

**The control system shall include a display screen upon which messages can be reviewed before being displayed on the message sign. The control system shall be capable of maintaining memory when power is unavailable.**

**Portable Changeable Message signs shall be equipped with a power source and a battery back-up to provide continuous operation when failure of the primary power source occurs.**

**The mounting of Portable Changeable Message signs shall be such that the bottom of the message sign panel shall be a minimum of 2.1 m (7 ft) above the roadway when it is in the operating mode.**

**The text of the messages shall not scroll or travel horizontally or vertically across the face of the sign.**

Support:

Portable Changeable Message signs have a wide variety of applications in temporary traffic control zones including: roadway, lane, or ramp closures, crash or emergency incident management, width restriction information, speed reductions, advisories on work scheduling, road user management and diversion, warning of adverse conditions, and operation control.

Guidance:

Portable Changeable Message signs should be used as a supplement to and not as a substitute for conventional signs and pavement markings.

Support:

The primary purpose of Portable Changeable Message signs in temporary traffic control zones is to advise the road user of unexpected situations. Some typical applications include the following:

- A. Where the speed of motor vehicle traffic is expected to drop substantially;
- B. Where significant queuing and delays are expected;
- C. Where adverse environmental conditions are present;
- D. Where there are changes in alignment or surface conditions;
- E. Where advance notice of ramp, lane, or roadway closures is needed;
- F. Where crash or incident management is needed; and/or
- G. Where changes in the road user pattern occur.

Guidance:

When Portable Changeable Message signs are used for route diversion, they should be placed far enough in advance of the diversion to allow road users ample opportunity to exit the affected highway. The Portable Changeable Message signs should be sited and aligned to ensure legibility. Multiple Portable Changeable Message signs should be placed on the same side of the roadway, separated from each other at distances based on Table 6C-1.

Portable Changeable Message signs should be placed on the shoulder of the roadway or, if practical, further from the traveled lane. They should be delineated with retroreflective temporary traffic control devices or when within the clear zone, shielded with a barrier or crash cushion. When Portable Changeable Message signs are not being used, they should be removed; if not removed, they should be shielded; or if the

previous two options are not feasible, they should be delineated with retroreflective temporary traffic control devices.

Portable Changeable Message sign trailers should be delineated on a permanent basis by affixing retroreflective material, known as conspicuity material, in a continuous line on the face of the trailer as seen by oncoming road users.

Messages should be designed taking into account the following factors:

- A. Each phase should convey a single thought.
- B. If the message can be displayed in one phase, the top line should present the problem, the center line should present the location or distance ahead, and the bottom line should present the recommended driver action.
- C. The message should be as brief as possible.
- D. When a message is longer than two phases, additional Portable Changeable Message signs should be used.
- E. When abbreviations are used, they should be easily understood (see Section 1A.14).

### **Section 6F.53 Arrow Panels**

#### **Standard:**

**An arrow panel shall be a sign with a matrix of elements capable of either flashing or sequential displays. This sign shall provide additional warning and directional information to assist in merging and controlling road users through or around a temporary traffic control zone.**

#### **Guidance:**

An arrow panel should be used in combination with appropriate signs, channelizing devices, or other temporary traffic control devices.

An arrow panel should be placed on the shoulder of the roadway or, if practical, further from the traveled lane. It should be delineated with retroreflective temporary traffic control devices, or when within the clear zone, shielded with a barrier or crash cushion. When an arrow panel is not being used, it should be removed; if not removed, it should be shielded; or if the previous two options are not feasible, it should be delineated with retroreflective temporary traffic control devices.

**Standard:**

**Arrow panels shall meet the minimum size, legibility distance, number of elements, and other specifications shown on Figure 6F-3.**

## Support:

Type A arrow panels are appropriate for use on low-speed urban streets. Type B arrow panels are appropriate for intermediate-speed facilities and for maintenance or mobile operations on high-speed roadways. Type C arrow panels are intended to be used on high-speed, high-volume motor vehicle traffic control projects. Type D arrow panels are intended for use on authorized vehicles.

**Standard:**

**Type A, B, and C arrow panels shall have solid rectangular appearances. A Type D arrow panel shall conform to the shape of the arrow.**

**All arrow panels shall be finished in nonreflective black. The arrow panel shall be mounted on a vehicle, a trailer, or other suitable support.**

## Guidance:

The minimum mounting height of an arrow panel should be 2.1 m (7 ft) from the roadway to the bottom of the panel, except on vehicle-mounted panels, which should be as high as practical.

A vehicle-mounted arrow panel should be provided with remote controls.

**Standard:**

**Arrow panel elements shall be capable of at least a 50 percent dimming from full brilliance. The dimmed mode shall be used for nighttime operation of arrow panels.**











## Guidance:

Full brilliance should be used for daytime operation of arrow panels.

**Standard:**

**The arrow panel shall have suitable elements capable of the various operating modes. The color presented by the elements shall be yellow.**

**Figure 6F-3. Advance Warning Arrow Display Specifications**

Operating Mode	Panel Display (Type C panel illustrated)		
I. At least one of the three following modes shall be provided:	(Right arrow shown; left is similar)		
Flashing Arrow	 Move/Merge Right		
Sequential Arrow			
	Move/Merge Right		
Sequential Chevron			
	Move/Merge Right		
II. The following mode shall be provided: Flashing Double Arrow	 Move/Merge Right or Left		
III. The following mode shall be provided: Flashing Caution	 Caution	or	 Caution

Panel Type	Minimum Size	Minimum Legibility Distance	Minimum Number of Elements
A	1,200 x 600 mm (48 x 24 in)	0.8 km (1/2 mi)	12
B	1,500 x 750 mm (60 x 30 in)	1.2 km (3/4 mi)	13
C	2,400 x 1,200 mm (96 x 48 in)	1.6 km (1 mi)	15
D	None*	0.8 km (1/2 mi)	12

\*Length of arrow equals 1,200 mm (48 in), width of arrowhead equals 600 mm (24 in)

**Guidance:**

If an arrow panel consisting of a bulb matrix is used, the elements should be recess-mounted or equipped with an upper hood of not less than 180 degrees.

**Standard:**

**The minimum element on-time shall be 50 percent for the flashing mode, with equal intervals of 25 percent for each sequential phase. The flashing rate shall be not less than 25 nor more than 40 flashes per minute.**

**An arrow panel shall have the following three mode selections:**

- A. A Flashing Arrow, Sequential Arrow, or Sequential Chevron mode; and**
- B. A flashing Double Arrow mode; and**
- C. A flashing Caution mode.**

**An arrow panel in the arrow or chevron mode shall be used only for stationary or moving lane closures on multilane roadways.**

**An arrow panel shall be used only in the caution mode for shoulder work, blocking the shoulder, for roadside work near the shoulder, or for temporarily closing one lane on a two-lane, two-way roadway.**

**Guidance:**

For a stationary lane closure, the arrow panel should be located on the shoulder at the beginning of the shifting or merging taper.

Where the shoulder is narrow, the arrow panel should be located in the closed lane.

**Standard:**

**When arrow panels are used to close multiple lanes, a separate arrow panel shall be used for each closed lane.**

**Guidance:**

When arrow panels are used to close multiple lanes, if the first arrow panel is placed on the shoulder, the second arrow panel should be placed in the first closed lane at the beginning of the second merging taper (see Figure 6H-37). When the first arrow panel is placed in the first closed lane, the second arrow panel should be placed in the second closed lane at the downstream end of the second merging taper.

For mobile operations where a lane is closed, the arrow panel should be located to provide adequate separation from the work operation to allow for appropriate reaction by approaching drivers.

**Standard:**

**A vehicle displaying an arrow panel shall be equipped with rotating lights or strobe lights.**

**A single arrow panel shall not be used to shift traffic laterally more than one lane.**

**Section 6F.54 High-Level Warning Devices (Flag Trees)**

Option:

A high-level warning device (flag tree) may supplement other temporary traffic control devices in temporary traffic control zones.

Support:

A high-level warning device is designed to be seen over the top of typical passenger cars. A typical high-level warning device is shown in Figure 6F-2.

**Standard:**

**A high-level warning device shall consist of a minimum of two flags with or without a Type B high-intensity flashing warning light. The distance from the roadway to the bottom of the lens of the light and to the lowest point of the flag material shall be not less than 2.4 m (8 ft). The flag shall be 400 mm (16 in) square or larger and shall be orange or fluorescent red-orange in color.**

Option:

An appropriate warning sign may be mounted below the flags.

Support:

High-level warning devices are most commonly used in high-density road user situations to warn road users of short-term operations.



**Section 6F.55 Channelizing Devices****Standard:**

**Designs of various channelizing devices shall be as shown in Figure 6F-4.**

**Support:**

The function of channelizing devices is to warn road users of conditions created by work activities in or near the roadway and to guide road users. Channelizing devices include cones, tubular markers, vertical panels, drums, barricades, and temporary raised islands.

Channelizing devices provide for smooth and gradual motor vehicle traffic flow from one lane to another, onto a bypass or detour, or into a narrower traveled way. They are also used to separate motor vehicle traffic from the work space, pavement drop-offs, pedestrian or bicycle paths, or opposing directions of motor vehicle traffic.

**Guidance:**

Channelizing devices should be constructed and ballasted to perform in a predictable manner when inadvertently struck by a vehicle. Channelizing devices should be crashworthy. Fragments or other debris from the device or the ballast should not pose a significant hazard to road users or workers in the immediate area.

The spacing of channelizing devices should not exceed a distance in meters (feet) equal to 0.2 times the speed limit in km/h (1.0 times the speed limit in mph) when used for taper channelization, and a distance in meters (feet) equal to 0.4 times the speed limit in km/h (2.0 times the speed limit in mph) when used for tangent channelization.

When channelizing devices have the potential of leading motor vehicle traffic out of the intended motor vehicle traffic space as shown in Figure 6H-39, the channelizing devices should be extended a distance in meters (feet) of 0.4 times the speed limit in km/h (2.0 times the speed limit in mph) beyond the end of the transition area.

**Option:**

Warning lights may be added to channelizing devices in areas with frequent fog, snow, or severe roadway curvature, or where visual distractions are present.

**Standard:**

**Warning lights shall flash when placed on channelizing devices used alone or in a cluster to warn of a condition. Warning lights placed on channelizing devices used in a series to channelize road users shall be steady-burn.**

**The retroreflective material used on channelizing devices shall have a smooth, sealed outer surface that will display approximately the same color day or night.**

**Figure 6F-4. Channelizing Devices (Sheet 1 of 2)**

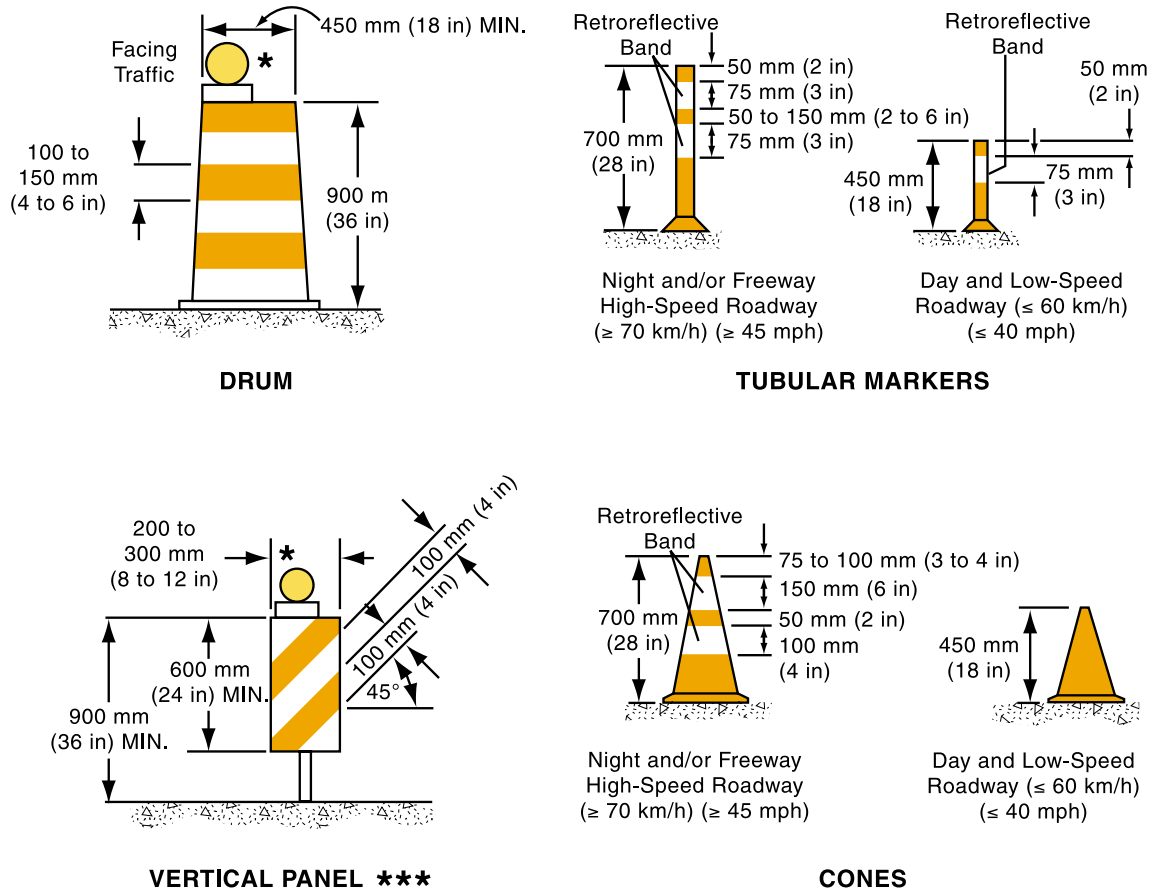

- \* Warning lights (optional)
- \*\* Nominal lumber dimensions are satisfactory for barricade rail width dimensions.
- \*\*\* Rail stripe widths shall be 150 mm (6 in), except that 100 mm (4 in) wide stripes may be used if rail lengths are less than 900 mm (36 in).  
The sides of barricades facing traffic shall have retroreflective rail faces.

**Figure 6F-4. Channelizing Devices (Sheet 2 of 2)**

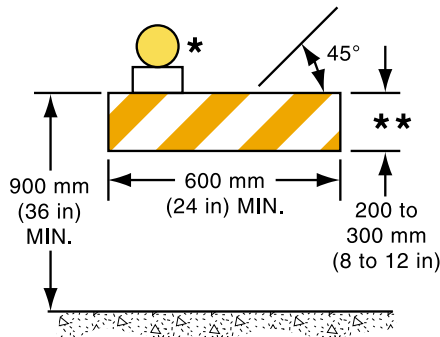

**TYPE I BARRICADE \*\*\***

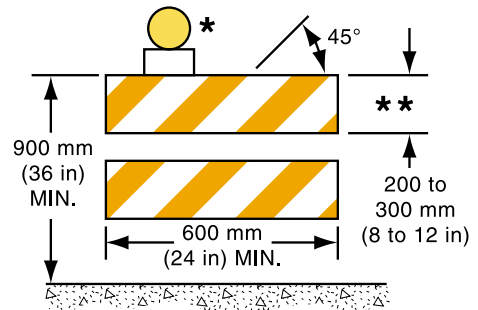

**TYPE II BARRICADE \*\*\***

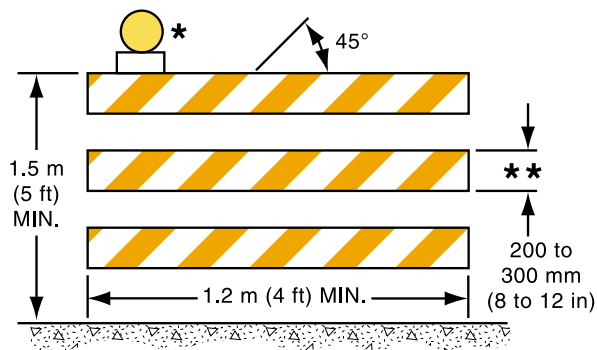

**TYPE III BARRICADE \*\*\***

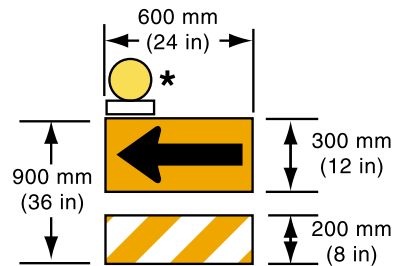

**DIRECTION INDICATOR BARRICADE**

- \* Warning lights (optional)
- \*\* Nominal lumber dimensions are satisfactory for barricade rail width dimensions.
- \*\*\* Rail stripe widths shall be 150 mm (6 in), except that 100 mm (4 in) wide stripes may be used if rail lengths are less than 900 mm (36 in).  
The sides of barricades facing traffic shall have retroreflective rail faces.

Option:

The name and telephone number of the highway agency, contractor, or supplier may be shown on the nonretroreflective surface of all types of channelizing devices.

**Standard:**

**The letters and numbers of the name and telephone number shall be nonretroreflective and not over 50 mm (2 in) in height.**

Guidance:

Particular attention should be given to maintaining the channelizing devices to keep them clean, visible, and properly positioned at all times.

**Standard:**

**Devices that are damaged or have lost a significant amount of their retroreflectivity and effectiveness shall be replaced.**

### **Section 6F.56 Cones**

**Standard:**

**Cones (see Figure 6F-4) shall be predominantly orange and shall be made of a material that can be struck without causing damage to the impacting vehicle. For daytime and low-speed roadways, cones shall be not less than 450 mm (18 in) in height. When cones are used on freeways and other high-speed highways or at night on all highways, or when more conspicuous guidance is needed, cones shall be a minimum of 700 mm (28 in) in height.**

**For nighttime use, cones shall be retroreflectorized or equipped with lighting devices for maximum visibility. Retroreflectorization of 700 mm (28 in) or larger cones shall be provided by a white band 150 mm (6 in) wide located 75 to 100 mm (3 to 4 in) from the top of the cone and an additional 100 mm (4 in) wide white band approximately 50 mm (2 in) below the 150 mm (6 in) band.**

Option:

Traffic cones may be used to channelize road users, divide opposing motor vehicle traffic lanes, divide lanes when two or more lanes are kept open in the same direction, and delineate short duration maintenance and utility work.

**Guidance:**

Steps should be taken to ensure that cones will not be blown over or displaced by wind or moving motor vehicle traffic.

**Option:**

Cones may be doubled up to increase their weight.

**Support:**

Some cones are constructed with bases that can be filled with ballast. Others have specially weighted bases, or weight such as sandbag rings that can be dropped over the cones and onto the base to provide added stability.

**Guidance:**

Ballast should be kept to the minimum amount needed.

**Section 6F.57 Tubular Markers****Standard:**

**Tubular markers (see Figure 6F-4) shall be predominantly orange and shall be not less than 450 mm (18 in) high and 50 mm (2 in) wide facing road users. They shall be made of a material that can be struck without causing damage to the impacting vehicle.**

**Tubular markers shall be a minimum of 700 mm (28 in) in height when they are used on freeways and other high-speed highways, on all highways during nighttime, or whenever more conspicuous guidance is needed.**

**For nighttime use, tubular markers shall be retroreflectorized. Retroreflectorization of 700 mm (28 in) or larger tubular markers shall be provided by two 75 mm (3 in) wide white bands placed a maximum of 50 mm (2 in) from the top with a maximum of 150 mm (6 in) between the bands.**

**Guidance:**

Tubular markers have less visible area than other devices and should be used only where space restrictions do not allow for the use of other more visible devices.

Tubular markers should be stabilized by affixing them to the pavement, by using weighted bases, or weights such as sandbag rings that can be dropped over the tubular

markers and onto the base to provide added stability. Ballast should be kept to the minimum amount needed.

Option:

Tubular markers may be used effectively to divide opposing lanes of road users, divide motor vehicle traffic lanes when two or more lanes are kept open in the same direction, and to delineate the edge of a pavement drop off where space limitations do not allow the use of larger devices.

**Standard:**

**When a noncylindrical tubular marker is used, it shall be attached to the pavement to ensure that the width facing road users meets the minimum requirements.**

**A tubular marker shall be attached to the pavement to display the minimum 50 mm (2 in) width to the approaching road users.**

### **Section 6F.58 Vertical Panels**

**Standard:**

**Vertical panels (see Figure 6F-4) shall be 200 to 300 mm (8 to 12 in) in width and at least 600 mm (24 in) in height. They shall have orange and white diagonal stripes and be retroreflectorized.**

**Vertical panels shall be mounted with the top a minimum of 900 mm (36 in) above the roadway.**

**Where the height of the vertical panel itself is 900 mm (36 in) or greater, a panel stripe width of 150 (6 in) shall be used.**

Option:

Where the height of the vertical panel itself is less than 900 mm (36 in), a panel stripe width of 100 mm (4 in) may be used.

**Standard:**

**Markings for vertical panels shall be alternating orange and white retroreflective stripes, sloping downward at an angle of 45 degrees in the direction motor vehicle traffic is to pass. Vertical panels used on expressways, freeways, and other high-speed roadways shall have a minimum of 174,000 mm<sup>2</sup> (270 in<sup>2</sup>) retroreflective area facing motor vehicle traffic.**

**Option:**

Where space is limited, vertical panels may be used to channelize motor vehicle traffic, divide opposing lanes, or replace barricades.

**Section 6F.59 Drums****Standard:**

**Drums (see Figure 6F-4) used for road user warning or channelization shall be constructed of lightweight, deformable materials. They shall be a minimum of 900 mm (36 in) in height and have at least a 450 mm (18 in) minimum width regardless of orientation. Metal drums shall not be used. The markings on drums shall be horizontal, circumferential, alternating orange and white retroreflective stripes 100 to 150 mm (4 to 6 in) wide. Each drum shall have a minimum of two orange and two white stripes with the top stripe being orange. Any nonretroreflectORIZED spaces between the horizontal orange and white stripes, shall not exceed 75 mm (3 in) wide. Drums shall have closed tops that will not allow collection of construction debris or other debris.**

**Support:**

Drums are highly visible, have good target value, give the appearance of being formidable obstacles and, therefore, command the respect of road users. They are portable enough to be shifted from place to place within a temporary traffic control zone in order to accommodate changing conditions, but are generally used in situations where they will remain in place for a prolonged period of time.

**Option:**

Although drums are most commonly used to channelize or delineate road user flow, they may also be used alone or in groups to mark specific locations.

**Guidance:**

Drums should not be weighted with sand, water, or any material to the extent that would make them hazardous to road users or workers when struck. Drums used in regions susceptible to freezing should have drain holes in the bottom so that water will not accumulate and freeze causing a hazard if struck by a road user.

**Standard:**

**Ballast shall not be placed on the top of a drum.**

**Section 6F.60 Type I, II, or III Barricades****Support:**

A barricade is a portable or fixed device having from one to three rails with appropriate markings and is used to control road users by closing, restricting, or delineating all or a portion of the right-of-way.

As shown in Figure 6F-4, barricades are classified as either Type I, Type II, or Type III.

**Standard:**

**Stripes on barricade rails shall be alternating orange and white retroreflective stripes sloping downward at an angle of 45 degrees in the direction road users are to pass. Except as noted in the Option, the stripes shall be 150 mm (6 in) wide.**

**Option:**

When rail lengths are less than 900 mm (36 in), 100 mm (4 in) wide stripes may be used.

**Standard:**

**The minimum length for Type I and Type II Barricades shall be 600 mm (24 in), and the minimum length for Type III Barricades shall be 1,200 mm (48 in). Each barricade rail shall be 200 to 300 mm (8 to 12 in) wide. Barricades used on expressways, freeways and other high-speed roadways shall have a minimum of 174,000 mm<sup>2</sup> (270 in<sup>2</sup>) of retroreflective area facing road users.**

**Guidance:**

Where barricades extend entirely across a roadway, the stripes should slope downward in the direction toward which road users must turn.

Where both right and left turns are provided, the barricade stripes should slope downward in both directions from the center of the barricade or barricades.

Where no turns are intended, the stripes should be positioned to slope downward toward the center of the barricade or barricades.

Barricade rails should be supported in a manner that will allow them to be seen by the road user, and in a manner that provides a stable support that is not easily blown over or displaced.



**Option:**

For Type I Barricades, the support may include other unstriped horizontal panels necessary to provide stability.

**Guidance:**

Barricades should be crashworthy as they are located adjacent to motor vehicle traffic flow and are subject to impact by errant vehicles.

On high-speed expressways or in other situations where barricades may be susceptible to overturning in the wind, ballasting should be used.

**Option:**

Sandbags may be placed on the lower parts of the frame or the stays of barricades to provide the required ballast.

**Standard:**

**Ballast shall not be placed on top of any striped rail. Barricades shall not be ballasted by nondeformable objects such as rocks or chunks of concrete.**

**Support:**

Type I or Type II Barricades are intended for use in situations where road user flow is maintained through the temporary traffic control zone.

**Option:**

Barricades may be used alone or in groups to mark a specific condition or they may be used in a series for channelizing road users.

Type I Barricades may be used on conventional roads or urban streets.

**Guidance:**

Type II or Type III Barricades should be used on expressways and freeways or other high-speed roadways. Type III Barricades should be used to close or partially close a road.

**Option:**

Type III Barricades used at a road closure may be placed completely across a roadway or from curb to curb.

**Guidance:**

Where provision is made for access of authorized equipment and vehicles, the responsibility for Type III Barricades should be assigned to a person to ensure proper closure at the end of each work day.

**Support:**

When a highway is legally closed but access must still be allowed for local road users, barricades usually are not extended completely across the roadway.

**Standard:**

**A sign (see Section 6F.09) shall be installed with the appropriate legend concerning permissible use by local road users. Adequate visibility of the barricades from both directions shall be provided.**

**Option:**

Signs may be installed on barricades (see Section 6F.03).

**Section 6F.61 Direction Indicator Barricades****Standard:**

**The Direction Indicator Barricade (see Figure 6F-4) shall consist of a retroreflective horizontal arrow top panel and a striped retroreflective bottom panel, both mounted horizontally to the ground.**

**The arrow panel shall be black on an orange background. The stripes on the bottom panel shall be alternating orange and white retroreflective stripes sloping downward at an angle of 45 degrees in the direction road users are to pass. The stripes shall 100 mm (4 in) wide. The arrow panel shall be 600 x 300 mm (24 x 12 in). The bottom panel shall have a length of 600 mm (24 in) and a height of 200 mm (8 in).**

**Guidance:**

The Direction Indicator Barricade should be crashworthy.

**Option:**

The Direction Indicator Barricade may be used in tapers, transitions, and other areas where specific directional guidance to drivers is necessary.

**Guidance:**

If used, Direction Indicator Barricades should be used in series to direct the driver through the transition and into the intended travel lane.

**Section 6F.62 Temporary Traffic Barriers as Channelizing Devices****Standard:**

**Temporary traffic barriers shall not be used solely to channelize road users, but also to protect the work space. For nighttime use, the temporary traffic barrier shall be supplemented with delineation.**

**Guidance:**

Temporary traffic barriers should not be used for a merging taper except in low-speed urban areas. Temporary traffic barriers should not be used for a constricted/restricted temporary traffic control zone.

When it is necessary to use a temporary traffic barrier for a merging taper in low-speed urban areas or for a constricted/restricted temporary traffic control zone, the taper shall be delineated and the taper length should be designed to optimize road user operations considering the available geometric conditions.

When used for channelization, temporary traffic barriers should be of a light color for increased visibility.

**Section 6F.63 Temporary Raised Islands****Standard:**

**Temporary raised islands shall be used only in combination with pavement striping and other suitable channelizing devices.**

**Option:**

A temporary raised island may be used to separate motor vehicle traffic flows in two-lane, two-way operations on roadways having a motor vehicle traffic volume range of 4,000 to 15,000 average daily traffic (ADT) and on freeways having a motor vehicle traffic volume range of 22,000 ADT to 60,000 ADT.

Temporary raised islands also may be used in other than two-lane, two-way operations where physical separation of motor vehicle traffic from the temporary traffic control zone is not required.

## Guidance:

Temporary raised islands should have the basic dimensions of 100 mm (4 in) high by 450 mm (18 in) wide and have rounded or chamfered corners.

The temporary raised islands should not be designed in such a manner that they would cause a driver to lose control of the vehicle if the vehicle inadvertently strikes the temporary raised island. If struck, pieces of the island should not be dislodged to the extent that they could penetrate the occupant compartment or involve other vehicles.

**Section 6F.64 Opposing Traffic Lane Divider**

## Support:

Opposing traffic lane dividers are delineation devices used as center lane dividers to separate opposing motor vehicle traffic on a two-lane, two-way operation.

**Standard:**

**The Opposing Traffic Lane Divider (W6-4) sign is an upright, retroreflective orange-colored sign placed on a flexible support and sized at least 300 mm (12 in) wide by 450 mm (18 in) high.**

**Section 6F.65 Pavement Markings****Standard:**

**The provisions of this Section shall not be considered applicable for short-term, mobile, or incident management temporary traffic control zones.**

**Pavement markings shall be maintained along paved streets and highways in all long- and intermediate-term stationary (see Section 6G.02) temporary traffic control zones. All pavement markings shall be in accordance with Chapters 3A and 3B, except as indicated in Section 6F.66. Pavement markings shall match the markings in place at both ends of the temporary traffic control zone. Pavement markings shall be placed along the entire length of any surfaced detour or temporary roadway prior to the detour or roadway being opened to road users.**

**Warning signs, channelizing devices, and delineation shall be used to indicate required road user paths in temporary traffic control zones where it is not possible to provide a clear path by pavement markings. All pavement markings and devices used to delineate road user paths shall be carefully reviewed during daytime and nighttime periods.**

**For long-term stationary operations, pavement markings in the temporary traveled way that are no longer applicable shall be removed or obliterated as soon as practical. Pavement marking obliteration shall leave a minimum of pavement scars and shall remove old marking material. Painting over existing pavement markings with black paint or spraying with asphalt shall not be accepted as a substitute for removal or obliteration.**

Guidance:

Road users should be provided pavement markings within a temporary traffic control zone comparable to the pavement markings normally maintained along such roadways, particularly at either end of the temporary traffic control zone.

The intended vehicle path should be defined in day, night, and twilight periods under both wet and dry pavement conditions.

The work should be planned and staged to provide for the placement and removal of the pavement markings.

Markings should be provided in intermediate-term, stationary work zones.

Option:

Removable, nonreflective, preformed tape may be used where markings need to be covered temporarily.

### **Section 6F.66 Temporary Pavement Markings**

Support:

Temporary pavement markings are those that are allowed to remain in place until the earliest date when it is practical and possible to install pavement markings that meet the Part 3 standards for pavement markings.

Guidance:

Temporary pavement markings should not be in place for more than 2 weeks unless justified by an engineering study.

**Standard:**

**All temporary pavement markings, including pavement markings for no-passing zones, shall conform to the requirements of Chapters 3A and 3B. All temporary broken-line pavement markings shall use the same cycle length as permanent markings and be at least 0.6 m (2 ft) long.**

**Option:**

Half-cycle lengths with a minimum of 0.6 m (2 ft) stripes may be used on roadways with severe curvature (see Section 3A.06). This applies to centerlines in passing zones and lane lines.

For temporary situations of 3 calendar days or less, for a two- or three-lane road, no-passing zones may be identified by using NO PASSING ZONE (W14-3) signs (see Section 2C.32) rather than pavement markings. Also, NO PASSING ZONE signs may be used instead of pavement markings on low-volume roads (as defined in Section 5A.01) for longer periods in accordance with the State's or highway agency's policy.

**Guidance:**

The NO PASSING ZONE signs should be placed in accordance with Sections 2B.24, 2B.25, and 2C.32.

The temporary use of edge lines, channelizing lines, lane reduction transitions, gore markings, and other longitudinal markings, and the various nonlongitudinal markings (such as stop lines, railroad crossings, crosswalks, words or symbols) should be in accordance with the State's or highway agency's policy.

**Section 6F.67 Raised Pavement Markers****Standard:**

**If raised pavement markers are used to substitute for broken line segments, at least two retroreflective markers shall be placed, one at each end of a segment of 0.6 m (2 ft) to 1.5 m (5 ft). For segments over 1.5 m (5 ft), a group of at least three retroreflective markers shall be equally spaced at no greater than  $N/8$ . The value of  $N$  for a broken or dotted line shall equal the length of one line segment plus one gap. The value of  $N$  referenced for solid lines shall equal the  $N$  for the broken or dotted lines that may be adjacent to or may extend the solid lines (see Chapter 3B).**

**Guidance:**

Raised pavement markers should be considered for use along surfaced detours or temporary roadways, and other changed or new travel-lane alignments.

**Option:**

Retroreflective or internally illuminated raised pavement markers, or nonretroreflective raised pavement markers supplemented by retroreflective or internally illuminated markers, may replace or supplement markings prescribed in Chapters 3A and 3B.

**Section 6F.68 Delineators****Standard:**

**When used, delineators shall combine with or supplement other temporary traffic control devices. They shall be mounted on crashworthy supports so that the reflecting unit is approximately 1.2 m (4 ft) above the near roadway edge. The standard color for delineators used along both sides of two-way streets and highways and the right side of one-way roadways shall be white. Delineators used along the left side of one-way roadways shall be yellow.**

**Guidance:**

Spacing along roadway curves should be as set forth in Section 3D.04 and should be such that several delineators are always visible to the driver.

**Option:**

Delineators may be used in temporary traffic control zones to indicate the alignment of the roadway and to outline the required vehicle path through the temporary traffic control zone.

**Section 6F.69 Lighting Devices****Guidance:**

Lighting devices should be provided in temporary traffic control zones based on engineering judgment.

**Support:**

Four types of lighting devices are commonly used in temporary traffic control zones. They are floodlights, flashing warning beacons, warning lights, and steady-burn electric lamps.

**Option:**

Lighting devices may be used to supplement retroreflectorized signs, barriers, and channelizing devices.

**Support:**

During normal daytime maintenance operations, the functions of flashing warning beacons are adequately provided by rotating lights or strobe lights on a maintenance vehicle.

**Standard:**

**Although vehicle hazard warning lights are permitted to be used to supplement rotating or strobe lights, they shall not be used instead of rotating or strobe lights.**

**Section 6F.70 Floodlights**

## Support:

Utility, maintenance, or construction activities on highways are frequently conducted during nighttime periods when motor vehicle traffic volumes are lower. Large construction projects are sometimes operated on a double-shift basis requiring night work.

## Guidance:

When nighttime work is being performed, floodlights should be used to illuminate the work area, flagger stations, equipment crossings, and other areas.

**Standard:**

**Floodlighting shall not produce a disabling glare condition for approaching road users.**

## Guidance:

The adequacy of the floodlight placement and elimination of potential glare should be determined by driving through and observing the floodlighted area from each direction on all approaching roadways after the initial floodlight setup, at night, and periodically.

**Section 6F.71 Flashing Warning Beacons**

## Support:

Flashing warning beacons are often used to supplement a temporary control device.

**Standard:**

**Flashing warning beacons shall comply with the provisions of Chapter 4K. A flashing warning beacon shall be a flashing yellow light with a minimum nominal diameter of 200 mm (8 in).**

## Guidance:

Flashing warning beacons should be operated 24 hours per day.



Support:

The temporary terminus of a freeway is an example of a location where flashing warning beacons alert drivers to the changing roadway conditions and the need to reduce speed in transitioning from the freeway to another roadway type.

### **Section 6F.72 Warning Lights**

**Standard:**

**Type A, Type B, and Type C warning lights are portable, powered, yellow, lens-directed, enclosed lights.**

**Warning lights shall be in accordance with the current ITE "Purchase Specification for Flashing and Steady-Burn Warning Lights" (see Section 1A.11).**

**When warning lights are used, they shall be mounted on signs or channelizing devices in a manner that, if hit by an errant vehicle, they will not be likely to penetrate the windshield.**

Guidance:

The maximum spacing for warning lights should be identical to the channelizing device spacing requirements.

Support:

The light weight and portability of warning lights are advantages that make these devices useful as supplements to the retroreflectorization on signs and channelizing devices. The flashing lights are effective in attracting road users' attention.

Option:

Warning lights may be used in either a steady-burn or flashing mode.

**Standard:**

**Flashing warning lights shall not be used for delineation, as a series of flashers fails to identify the desired vehicle path.**

**Type A Low-Intensity Flashing warning lights and Type C Steady-Burn warning lights shall be maintained so as to be capable of being visible on a clear night from a distance of 900 m (3,000 ft). Type B High-Intensity Flashing warning lights shall be maintained so as to be capable of being visible on a sunny day when viewed without the sun directly on or behind the device from a distance of 300 m (1,000 ft).**

**Warning lights shall have a minimum mounting height of 750 mm (30 in) to the bottom of the lens.**

Support:

Type A Low-Intensity Flashing warning lights are used to warn road users during nighttime hours that they are approaching or proceeding in a potentially hazardous area.

Option:

Type A warning lights may be mounted on channelizing devices.

Support:

Type B High-Intensity Flashing warning lights are used to warn road users during both daylight and nighttime hours that they are approaching a potentially hazardous area.

Option:

Type B warning lights are designed to operate 24 hours per day and may be mounted on advance warning signs or on independent supports.

Type C Steady-Burn warning lights may be used during nighttime hours to delineate the edge of the traveled way.

Guidance:

When used to delineate a curve, Type C warning lights should only be used on devices on the outside of the curve, and not on the inside of the curve.

### **Section 6F.73 Steady-Burn Electric Lamps**

Support:

Steady-Burn electric lamps are a series of low-wattage, yellow, electric lamps, generally hard-wired to a 110-volt external power source.

Option:

Steady-Burn electric lamps may be used in place of Type C Steady-Burn warning lights (see Section 6F.72).

**Section 6F.74 Temporary Traffic Control Signals****Standard:**

**Temporary traffic control signals (see Section 4D.20) used to control road user movements through temporary traffic control zones and in other temporary traffic control situations shall meet the applicable provisions of Part 4.**

**Support:**

Temporary traffic control signals are typically used in work zones such as temporary haul road crossings; temporary one-way operations along a one-lane, two-way highway; temporary one-way operations on bridges, reversible lanes, and intersections.

**Standard:**

**One-lane, two-way motor vehicle traffic flow (see Chapter 4G) requires an all-red interval of sufficient duration for road users to clear the portion of the temporary traffic control zone controlled by the traffic control signals. Safeguards shall be incorporated to avoid the possibility of conflicting signal indications at each end of the temporary traffic control zone.**

**Guidance:**

When temporary traffic control signals are used, conflict monitors typical of traditional traffic control signal operations should be used.

**Option:**

Temporary traffic control signals may be portable or temporarily mounted on fixed supports.

**Guidance:**

Temporary traffic control signals should only be used in situations where temporary traffic control signals are preferable to other means of traffic control, such as changing the work staging or work zone size to eliminate one-way motor vehicle traffic movements, using flaggers to control one-way or crossing movements, using STOP or YIELD signs, and using warning devices alone.

**Support:**

Factors related to the design and application of temporary traffic control signals include the following:

- A. Safety and road user needs;

- B. Work staging and operations;
- C. The feasibility of using other temporary traffic control strategies (for example, flaggers, providing space for two lanes, or detouring road users);
- D. Sight distance restrictions;
- E. Human factors considerations (for example, lack of driver familiarity with temporary traffic control signals);
- F. Road-user volumes including roadway and intersection capacity;
- G. Affected side streets and driveways;
- H. Vehicle speeds;
- I. The placement of other temporary traffic control devices;
- J. Parking;
- K. Turning restrictions;
- L. Pedestrians;
- M. Legal authority;
- N. Signal phasing and timing requirements;
- O. Full-time or part-time operation;
- P. Actuated, fixed-time, or manual operation;
- Q. Power failures or other emergencies;
- R. Inspection and maintenance needs;
- S. Need for detailed placement, timing, and operation records; and
- T. Operation by contractors or by others.

Although temporary traffic control signals can be mounted on trailers or lightweight portable supports, fixed supports offer superior resistance to displacement or damage by severe weather, vehicle impact, and vandalism.

#### Guidance:

Other temporary traffic control devices should be used to supplement temporary traffic control signals, including warning and regulatory signs, pavement markings, and channelizing devices.

The design and placement of temporary traffic control signals should include interconnection to other traffic control signals along the subject roadway.

Temporary traffic control signals not in use should be covered or removed.

### **Section 6F.75 Temporary Traffic Barriers**

#### **Support:**

Temporary traffic barriers are devices designed to help prevent penetration by vehicles while minimizing injuries to vehicle occupants, and designed to protect workers, bicyclists, and pedestrians. A typical use is where one side of a bridge is closed for deck repair. They are also used for certain special events or in other temporary traffic control contexts where separation and channelization of vehicle and pedestrian movements are needed.

#### **Option:**

Temporary traffic barriers, including shifting portable or movable barrier installations to accommodate varying directional motor vehicle traffic demands, may be used to separate two-way motor vehicle traffic.

#### **Guidance:**

Because the protective requirements of a temporary traffic control situation have priority in determining the need for temporary traffic barriers, their use should be based on an engineering study. When serving the additional function of channelizing motor vehicle traffic, temporary traffic barriers should be a light color for increased visibility.

#### **Standard:**

**Temporary traffic barriers shall be supplemented with standard delineation, pavement markings, or channelizing devices for improved daytime and nighttime visibility if they are used to channelize motor vehicle traffic. The delineation or pavement marking color shall match the applicable pavement marking color.**

**In order to mitigate the effect of striking the end of a temporary traffic barrier, the end shall be installed in accordance with AASHTO's "Roadside Design Guide" (see Section 1A.11) by flaring until the end is outside the acceptable clear zone or by providing crashworthy end treatments.**

#### **Option:**

Warning lights or steady-burn electric lamps may be mounted on temporary traffic barrier installations.

Support:

A movable barrier is a linear system of connected barrier segments that can rapidly be shifted laterally by using a specially designed transfer vehicle. The transfer is accomplished in a manner that does not interfere with motor vehicle traffic in adjacent lanes. Applications of movable barriers include the following:

- A. Closing an additional lane during work periods while maintaining the advantage of having the travel way separated from the work space by a barrier;
- B. Closing an additional lane during off-peak periods to provide extra space for work activities without adversely impacting motor vehicle traffic flow; and
- C. Creating a temporary reversible lane, thus providing unbalanced capacity favoring the major direction of motor vehicle traffic flow.

More specific information on the use of temporary traffic barriers is contained in Chapters 8 and 9 of AASHTO's "Roadside Design Guide" (see Section 1A.11).

### **Section 6F.76 Crash Cushions**

Support:

Crash cushions are systems that mitigate the effects of errant vehicles that strike obstacles, either by smoothly decelerating the vehicle to a stop when hit head-on, or by redirecting the errant vehicle. The two types of crash cushions that are used in temporary traffic control zones are stationary crash cushions and truck-mounted attenuators. Crash cushions in temporary traffic control zones help protect the drivers from the exposed ends of barriers, fixed objects, shadow vehicles, and other obstacles. Specific information on the use of crash cushions can be found in AASHTO's "Roadside Design Guide" (see Section 1A.11).

**Standard:**

**Crash cushions shall be crashworthy. They shall also be designed for each application to stop or redirect errant vehicles under prescribed conditions. Crash cushions shall be periodically inspected to verify that they have not been hit or damaged. Damaged crash cushions shall be promptly repaired or replaced.**

Support:

Stationary crash cushions are used in the same manner as permanent highway installations to protect drivers from the exposed ends of barriers, fixed objects, and other obstacles.

**Standard:**

**Stationary crash cushions shall be designed for the specific application intended.**

**Truck-mounted attenuators shall be energy-absorbing devices attached to the rear of shadow trailers or trucks. They shall be located in advance of the work area, workers, or equipment to reduce the severity of rear-end crashes from errant vehicles.**

## Support:

Trucks or trailers are often used as shadow vehicles to protect workers or work equipment from errant vehicles. These shadow vehicles are normally equipped with flashing arrows, changeable message signs, and/or rotating/strobe lights located properly in advance of the workers and/or equipment that they are protecting. However, these shadow vehicles might themselves cause injuries to occupants of the errant vehicles if they are not equipped with truck-mounted attenuators.

## Guidance:

The shadow truck should be positioned a sufficient distance in advance of the workers or equipment being protected so that there will be sufficient distance, but not so much so that errant vehicles will travel around the shadow truck and strike the protected workers and/or equipment.

## Support:

Chapter 9 of AASHTO's "Roadside Design Guide" (see Section 1A.11) contains additional information regarding the use of shadow vehicles.

## Guidance:

The truck-mounted attenuator should be used in accordance with the manufacturer's specifications.

**Section 6F.77 Vehicle-Arresting Systems**

## Support:

Vehicle-arresting systems are designed to prevent penetration into activity areas while providing for smooth, safe deceleration for the errant vehicles. They can consist of portable netting, cables, and energy-absorbing anchors.

**Guidance:**

When used, a vehicle-arresting system should be used in accordance with the manufacturer's specifications, and should be located so that vehicles are not likely to penetrate the location that the system is designed to protect.

**Section 6F.78 Rumble Strips****Support:**

Rumble strips consist of intermittent narrow, transverse areas of rough-textured or slightly raised or depressed road surface that alert drivers to unusual motor vehicle traffic conditions. Through noise and vibration they attract the driver's attention to such features as unexpected changes in alignment and to conditions requiring a stop.

**Option:**

Intervals between rumble strips may be reduced as the distance to the approached conditions is diminished in order to convey an impression that a closure speed is too fast and/or that an action is imminent. A sign warning drivers of the onset of rumble strips may be placed in advance of any rumble strip installation.

**Guidance:**

Rumble strips should be placed transverse to motor vehicle traffic movement. They should not adversely affect overall pavement skid resistance under wet or dry conditions.

In urban areas, even though a closer spacing might be warranted, care should be taken not to promote panic braking or erratic steering maneuvers by drivers.

Rumble strips should not be placed on sharp horizontal or vertical curves.

**Sections 6F.79 Screens****Support:**

Screens are used to block the road users' view of activities that can be distracting. Screens might improve safety and motor vehicle traffic flow where volumes approach the roadway capacity because they discourage gawking and reduce headlight glare from oncoming motor vehicle traffic.

**Guidance:**

Screens should not be mounted where they could adversely restrict motorist visibility and sight distance and adversely affect the safe operation of vehicles.



**Option:**

Screens may be mounted on the top of temporary traffic barriers that separate two-way motor vehicle traffic.

**Guidance:**

Design of screens should be in accordance with Chapter 9 of AASHTO's "Roadside Design Guide" (see Section 1A.11).

**Section 6F.80 Future and Experimental Devices****Support:**

The States, FHWA, AASHTO, the Transportation Research Board, and other organizations conduct research and experimentation on new traffic control and safety devices. Users of this Manual are encouraged to stay abreast of these current efforts and to use such devices with care so as to avoid presenting road users with unusual or confusing situations that might be abnormal or unexpected.

**Standard:**

**New traffic control devices shall conform to the provisions for design, use, and application set forth in this Manual. New traffic control devices that do not conform with the provisions in this Manual shall be subject to experimentation, documentation, and adoption following the provisions of Section 1A.10.**

