

MarketTips

Volume 11 Number 3
July/August 1998

WHAT'S INSIDE THIS ISSUE?

17

Outreach Europe '98
GSA's Overseas
Products and
Services Expo

35

New: Cross Solo Pen

67

GSA SMARTPAY:
A New and Improved Way to
Manage Your Purchases

87

Highway Safety
Tool Kit

BE FIT!

WE'LL GET YOU UP TO SPEED IN NO TIME!



GSA's General Products Center carries brand name fitness equipment at best value prices. What are you waiting for?

Give us a call at (817) 978-2051.



SEE PAGE 3 FOR HIGHLIGHTS ON OUR CENTER.

Editor

Marguerite Prohaska

A GSA Supply Catalog supplement published by the Office of Business Management and Marketing Federal Supply Service General Services Administration Washington, DC 20406-0001 (703) 308-4195 FAX: (703) 308-0190 Internet: <http://pub.fss.gsa.gov> Published in the months of January, March, May, July, September and November Publication Code: OSSC-0002

****The prices shown reflect the most current list prices at the time we went to press.**

PUBLICATIONS

To request copies of FSS publications, including the GSA Supply Catalog, MarkeTips, Customer Assistance Guide and all Federal Supply Schedules or to request information concerning placement of your activity on our publications mailing list, contact:

Centralized Mailing List Service (CMLS) (817) 334-5215 FAX: (817) 334-5227 Internet: cmls.gsa@gsa.gov

INSIDE THIS ISSUE

Customer Supply Center.....58
CSD Seminars102
Defense Logistics Agency99
GSA Advantage!TM.....53
General Products3
National Furniture Center.....76
News and Information53
Office & Scientific Equipment56
Office Supplies & Paper Products20
Paints and Chemicals.....48
Professional Services.....65
Tools & Appliances79
Transportation & Property Mgmt.72
Vehicle Acquisition & Leasing46

Coming Soon.....



The General Services Administration is proud to announce a new and improved way to manage your purchases, travel and fleet requirements!

More details are available on page 67 of this issue of MarkeTips and visit our website: <http://pub.fss.gsa.gov/services/gsa-smartpay>



The General Products Center . . .

Providing You With a Wide Variety of Diverse Products is Our Business!

Looking to BE FIT?

You've come to the right place. The General Products Center carries the latest and greatest in fitness equipment at best value prices. Give us a call. You'll be glad you did.



There are many other common, as well as unusual products purchased by the Center in support of all Federal agencies and their missions.

The Variety is Limitless!

Not only do we carry the latest in fitness equipment but the General Products Center also carries a broad range of brand-name products and services not carried by other GSA Acquisition Centers — and the variety is limitless! If you can't find it anywhere else, you will most likely find it at the General Products Center. We have a staff of energetic knowledgeable people ready to assist you in finding solutions to your product needs. We carry a wide variety of items from a simple coffee cup to an inflatable boat. We are the world wide supplier of the products and services you need.

Products offered by the General Products Center can be essentially divided into two categories:

- Industrial products
- Morale, welfare and recreational (MWR)

Industrial Products

Industrial products include: material handling equipment, forklifts, fire fighting equipment and supplies, auto repair shop equipment, above ground storage tanks, generators, alarm and signal systems, pre-fab structures, warehouse storage units, batteries, energy efficient products, chillers, recycling collection containers, waste receptacles, janitorial and cleaning supplies, signs, etc.

Morale, Welfare and Recreational

In support of the morale, welfare and recreational needs of personnel in the Department of Defense and civilian agencies, products offered include: boats, mountain bikes, water filtration systems, food service equipment and supplies, musical instruments, televisions, athletic equipment and supplies, playground equipment, law enforcement equipment and supplies, trophies, recruiting aids and promotional materials, flags, household furnishings, etc.



*We can find it, order it,
expedite it, and ship it.*

It's that easy!



These products are available to you under several methods of supply — Stock, Federal Supply Schedules or through our Special Order Program. However, there is no need for you to try to guess which program carries an item you need—just call us and we'll let you know. (817) 978-4545

Our Staff is Waiting to Hear From You

The General Products Center's experienced staff of customer service representatives is committed to providing you with the exceptional service you deserve. Our professional staff can handle just about any situation or problem and find a solution fast. We can find it, order it, expedite it, and ship it. It's that easy! Take a look at our services:

- Provide status of requisitions
- Provide product availability
- Take emergency orders
- Accept orders and provide status of orders over the Internet
- Accept GSA *Advantage!*TM credit card orders
- Provide information on national stock numbers or products
- Expedite orders

For more information about any of our services, give us a call:

(817) 978-2051
DSN: 874-3697
DSN: 874-3698
FAX: (817) 978-2605
Internet: rp&c.gpc@gsa.gov

Or, visit our website at:
www.gsa.gov/regions/7fss/7fx/index.htm

And don't forget, you can shop on-line through GSA *Advantage!*TM on
<http://www.fss.gsa.gov>.

Finally, general questions can be addressed to Genni Brown, Director, Customer/Vendor Relations,
(817) 978-4543, Fax (817) 978-3761,
Internet: genni.brown@gsa.gov

Be Fit! Use Federal Supply Schedule 78, Part I, Section A

Everything needed to support morale, welfare and recreational initiatives is included under Federal Supply Schedule 78, Part I, Section A (Athletic and Recreational Equipment; Crafts and Hobbies; Toys and Preschool Aids; and Theatrical Equipment and Supplies). With annual sales at \$50 million, we know that the brand name products offered are in demand. Brands available include: Life Fitness, Nautilus, Quinton, National, BSN, Wilson, Riddell, Rawlings, American, Nordic Track, Universal, USA, Pro Star Sports, Champion, Western Golf, Everlast, Childcraft, All American ABC, and Discovery Toys, to name a few.

If it's time for new equipment for that gym, to replace those worn out golf clubs at the golf course, or to update equipment at the youth recreational center, you'll find the latest technology in equipment - at the best prices around - on Schedule 78 I A.

Products available include:

-- Exercise, fitness and weight training equipment and supplies,



-- Golf equipment and supplies,
-- Table tennis equipment and supplies,
-- Amusement devices and games,
-- Billiard equipment and supplies,
-- Swimming pool equipment and supplies,

-- Mats:
Floor, Wall
and Post

-- Baseball, basketball, football, boxing, wrestling, judo, gymnastics, soccer, handball, racquetball, track and field, volleyball, and tennis equipment and supplies,



-- Toys and preschool aids,
-- Craft and hobby supplies and more!



Give us a call, we'll do all we can to make your search as easy as possible.

**Contact: kelly.stoker@gsa.gov
(Contracting Officer)
Phone: (817) 978-8655
Fax: (817) 978-8672**

Looking for Recreational Equipment?

Federal Supply Schedule 78, Part I, Section C, has the products you need for outdoor recreation. It includes camping, hiking equipment, tents, sleeping bags, lanterns, heaters, jugs, coolers, tarps, grills, tables, benches, bike racks, bike lockers,



bleachers, playground equipment, and playground safety surfaces.

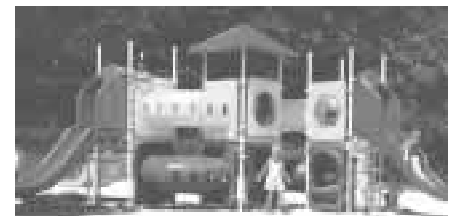

**Contact: margaret.evans@gsa.gov
(Contracting Officer)
Phone: (817) 978-8646
Fax: (817) 978-8672**



Athletic and Recreational Clothing/Footwear

Look what's new under Federal Supply Schedule 84, Part V, Section A: name brand recreational clothing and footwear for baseball, softball, basketball, football, soccer, tennis, gym, hockey, skiing, swimming, and track and field. This Schedule includes sweat suits, T-shirts, and athletic footwear.



KOOL OFF Products Now on Schedule

Look what's new and cool on Federal Supply Schedule 84, Part V, Section A - Clothing and Footwear: Athletic and Recreational.

KOOL OFF Products are designed to act as personal cooling systems and reduce core body temperatures fast, thus helping prevent heat stress at work and play. KOOL OFF products include Arctic Bandanas and KOOL OFF ties, desert caps, skull caps, visors, headbands, sport caps, vests, and more! Each product contains safe, water-absorbing polymer crystals to give hours of cooling relief from hot temperatures. Great products for golf, tennis, running, biking, hiking, boating, etc.

Skullcaps are great for construction workers, maintenance workers, warehouse workers, and under helmets for cyclists or at the gym. One size fits all. They are lined with fleece for cold

weather use, and available in over 28 designs (including: U.S. Flag, Desert Camo, Woodland Camo) and can also be custom designed and screen printed with logos.



Order directly from the contractor:

Premier Equity, Inc.
(dba Sparkling Earth Products)
20817 North 21st Avenue, No. 14
Phoenix, AZ 85027
Contact: William A. Wiles
Phone: (602) 780-9674
Fax: (602) 780-9757
Contract Number: GS-07F-9961H
Schedule 84, Part V, Section A

Contact: larae.hooper@gsa.gov
(Contracting Officer)
Phone: (817) 978-8663
Fax: (817) 978-8672

Reflective Tape for Nighttime Running and Safety

Reflective fabric tape, available from GSA's Stock Program, is for sew-on application. Non-adhesive tape provides nighttime visibility.

NSN: 9390-00-481-3424
Color: Silver
Width: 2"
Price: \$100.34
U/I: RO (50 yards)

Contact: evelyn.furlow@gsa.gov
(Inventory Manager)
Phone: (817) 978-3485
Fax: (817) 978-8600

Sweatpants and Shirts are Available through GSA's Stock Program

For a comfortable feel, you'll enjoy this knitted sweatshirt lined in fleece. The cotton blend shirt has a ribbed knit waistband, cuffs and crew neck collar. Meets Flammable Fabrics Act requirements and is colorfast. Color: Silver Gray. Two sizes only.

Size: Large
NSN: 8415-00-262-1535
Price: \$7.90
U/I: EA

Size: Medium
NSN: 8415-00-262-1536
Price: \$8.22
U/I: EA

Knitted sweatpants have a fleece lining, a closed front and a waist tie cord. The cotton blend pants are ankle length, with elastic leg bottoms. Color: Silver Gray. Two sizes only.

Size: Large
NSN: 8415-00-268-8178
Price: \$8.88
U/I: PR

Size: Medium
NSN: 8415-00-268-8179
Price: \$8.22
U/I: PR

Contact: evelyn.furlow@gsa.gov
(Inventory Manager)
Phone: (817) 978-3485
Fax: (817) 978-8600



Liquid Hydration Drinking Systems

Brand New under Federal Supply Schedule 78, Part I, Section C - Park and Outdoor Recreational Equipment.

The Peak H2O Pack offers the enthusiast one of the most convenient methods of remaining well hydrated while utilizing a back-carried drinking system. When used with the bite valve, the system is designed to offer the optimum in hands-free hydration.

Running, riding, skiing, hiking, back-packing, whatever - the uses are endless. Keeping well hydrated is one of the most performance enhancing measures you can take.

The Peak H2O Pack is designed to help the user maintain the highest level of performance through proper hydration.



H2O Thermal-Bak
with 76 oz. reservoir

Price: \$19.95
Model No: 11100
Color: Black



H2O Thermal-Bak Plus
with 76 oz. reservoir
with large mesh cargo pocket

Price: \$20.95
Model No: 11150
Color: Black

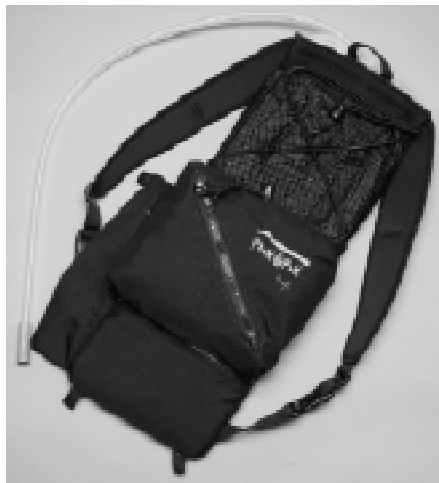

H2O Thermal-Bak Plus 4
with 76 oz. reservoir
with top, middle and bottom
cargo pockets

Price: \$29.90
Model No: 11200
Color: Black

Order directly from the contractor:

PEK Products
8139 Center Street
La Mesa, CA 91942
Contact: Phil Kirk
Phone: (800) 235-2252
FAX: (800) 469-5116
Internet: pekprod@ix.netcom.com
Contract Number: GS-07F-9869H

Contact: margaret.evans@gsa.gov
(Contracting Officer)
Phone: (817) 978-8646
Fax: (817) 978-8672

Before an Injury Occurs

Get your first aid kits from GSA's
General Products Center:

NSN: 6545-00-656-1092
Description: First Aid Kit, one person,
pocket type

Price: \$9.31
U/I: EA

NSN: 6545-00-656-1093
Description: First Aid Kit, up to
10 persons

Price: \$71.13
U/I: EA

NSN: 6545-00-656-1094
Description: First Aid Kit, up to
25 persons

Price: \$78.41
U/I: EA

NSN: 6545-01-010-7754
Description: First Aid Kit, up to
25 persons, belt kit

Price: \$125.66
U/I: EA

Contact: linda.schurg@gsa.gov
(Inventory Manager)
Phone: (817) 978-3163
Fax: (817) 978-8600



Insulated Jugs

For cold liquids, with self-closing faucet.

U/I: EA

NSN: 7330-00-893-8549

Capacity: 2-gallon

Price: \$12.12

NSN: 7330-00-894-1269

Capacity: 3-gallon

Price: \$14.78

NSN: 7330-00-893-8550

Capacity: 5-gallon

Price: \$17.24

Available from GSA's Stock Program.

Contact: virginia.skipwith@gsa.gov

(Inventory Manager)

Phone: (817) 978-8676

Fax: (817) 978-8600

Lock It Up!

The following padlocks are available through GSA's Stock Program.

Tamper-resistant combination lock provides security protection for classified materials. Case measures 2-3/4" wide and 4-1/8" long; shackle is 5/16" in diameter with 3/4" clearance.

NSN: 5340-00-285-6523

Price: \$69.14

U/I: EA

Keyless combination lock. Case is 1-3/4" wide, with a 1/4" hardened steel shackle with 2-1/4" clearance.

NSN: 5340-00-292-0896

Price: \$9.20

U/I: EA

Keyless combination lock. Case is 2" wide, with a 1/4" diameter hardened steel shackle with 7/8" clearance.

NSN: 5340-00-514-2782

Price: \$3.78

U/I: EA

Key-operated padlock. Shackle diameter: 1/4" to 3/8", shackle clearance from 3/4" to 1-1/2". Case may be either solid or laminated

NSN: 5340-01-346-4611

Price: \$3.95

U/I: EA



Key-operated padlock. Includes a 9" sash chain.

NSN: 5340-01-346-4612

Price: \$5.29

U/I: EA

Key-operated padlock. Shackle and case are made of brass or bronze.

NSN: 5340-01-346-7462

Price: \$4.92

U/I: EA

Padlock set with six locks. All keyed alike.

NSN: 5340-01-412-7004

Price: \$26.47

U/I: SE

Contact: virginia.skipwith@gsa.gov

(Inventory Manager)

Phone: (817) 978-8676

Fax: (817) 978-8600

Need to "Chill" Out? We have Water-Chillers

Let GSA's new Federal Supply Schedule for Commercial Water-Chilling Packages help you!

July 1, 1998, is the target date for converting GSA's popular Basic Ordering Agreement for 100 to 2,000 ton commercial centrifugal and rotary screw water-chilling packages to a Federal Supply Schedule. Through partnership with GSA, the Department of Energy, and manufacturers such as Trane, York, and Carrier, a better solution is now available for cooling system replacements.

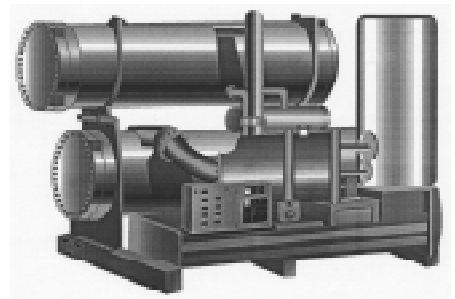

Check out these advantages!

- Design/build options
- Extended service and maintenance options
- Commercial systems meeting facility requirements
- Pre-qualified manufacturers
- Total life-cycle cost analysis (Ref: Executive Order 12902)
- 2-year factory warranty
- Up-front contracts with manufacturers
- Standardized specification
- Streamlined procurement
- Mitigates ozone depletion
- Reduces global warming
- High efficiency - low operating cost
- Computerized control
- Engineered for the new millennium

Contact: jane.parman@gsa.gov

(Contracting Officer)

Phone: (817) 978-2929

Fax: (817) 978-4366



Need a LIFT? (Locating Industrial Forklifts Today)

The LIFT Program was created to greatly simplify and speed the process of purchasing industrial equipment. Under LIFT, agencies no longer need to acquire contractor publications to find the lowest priced item that meets their requirements. Instead, you just select a forklift from the pricing and specification data that's listed in the LIFT catalog. Then complete the order entry form attached to the catalog and fax or mail it in. We take care of everything else.



LIFT covers the most popular forklift configurations and options. If you need something that's not shown, you can still get technical brochures from contractors to enable you to determine your needs.

The BIG benefits of using LIFT include:

- You have a choice of many popular commercial brand names
- Your "best value" selection process is simplified
- We place your order and take care of the administration
- Prices are competitive and reasonable

For assistance in using the LIFT catalog or in placing orders; write, call or fax:

GSA
General Products Center (7FXG)
819 Taylor Street
Fort Worth, TX 76102-6114

Contact for orders:
susan.clark@gsa.gov
(Purchasing Agent)
Phone: (817) 978-8650
Fax: (817) 978-8661

For contract information:
bonnie.bryson@gsa.gov
(Contracting Officer)
Phone: (817) 978-2077
Fax: (817) 978-8634

Flags, Flags and More Flags!

Don't let "Old Glory" get too old and faded! Replace those old worn out flags with new ones from the General Products Center and restore the pride!

Flag Facts:

In general, the American flag should be disposed of by burning in a dignified manner. Call your local chapter of the American Legion for further instructions.

The General Products Center can supply all types of flags - outdoor, indoor, cotton,

nylon, nylon/wool, silk-screened, storm, POW/MIA - in a variety of sizes, with accessories (flag poles, ornaments, snap hooks, etc.) at the best prices and delivery around!

All flags meet specifications set by the Institute of Heraldry.

The U.S. flag should be displayed daily on or near the main building of every governmental institution, schoolhouse, and in or near every polling place on election days.

Our most popular flags:

Outdoor / Nylon Flag

NSN: 8345-00-753-3235
Size: 5' x 9'6"
Price: \$36.47
U/I: EA

NSN: 8345-00-753-3234
Size: 3'6" x 6' 7-3/4"
Price: \$19.36
U/I: EA

NSN: 8345-00-753-3230
Size: 2'4-7/16" x 4'6"
Price: \$11.38
U/I: EA

Indoor with gold fringe

NSN: 8345-00-130-3124
Size: 4'4" x 5'6"
Price: \$67.32
U/I: EA

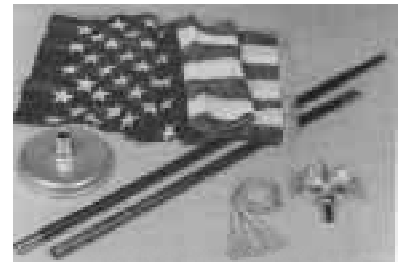

(Available from GSA's Stock Program)

Contact: evelyn.furlow@gsa.gov
(Inventory Manager)
Phone: (817) 978-3484
Fax: (817) 978-8600
To order, call: (817) 978-2051



Want Choices???

GSA now offers Two Types of Upholstery Fabrics

New and Improved! Not the old Naugahyde!

Refurbishing the old office or ship furniture? Bring it into the millennium with GSA's vinyl or new nylon upholstery fabric! Variety does not just stop at the fabric type, just look at the selections of colors offered below.

Vinyl Upholstery Fabric:

Upholstery vinyl has an exterior vinyl wear layer, a secondary expanded layer of vinyl foam, and a plain knit backing cloth. Vinyl surface simulates finely grained leather with a matte (low gloss) finish and a soft, supple hand. The fabric is a uniform, solid color and is fire, mildew, and oil resistant. Minimum weight: 20.3 oz/square yard. Minimum width: 53.5 inches. Roll length: 40 yards, U/I -RO, Price: \$298.34.

Color: Red
NSN: 8305-00-286-5565

Color: Rose
NSN: 8305-00-286-5566

Color: Rust
NSN: 8305-00-242-1032

Color: Light Blue
NSN: 8305-00-286-5564

Color: Dark Blue
NSN: 8305-00-702-2863

Color: Gray
NSN: 8305-00-262-3290

Color: Green
NSN: 8305-00-286-5567

Color: Beige
NSN: 8305-00-722-9411

Color: Brown
NSN: 8305-00-262-2764
Price: \$298.34

Color: Black
NSN: 8305-00-965-4693
Price: \$298.34

Color: Off-White
NSN: 8305-00-710-8535
Price: \$298.34

Nylon Upholstery Fabric:

Plain weave, flat, 100% nylon upholstery fabric is woven from two tones of one color and is stain, mildew, and fire resistant. The fabric has a firm, supple hand. Minimum weight: 13.5 oz/square yard, exclusive of back coating. Minimum width: 53.5 inches. Roll length: 50 yards, U/I RO, Price: \$454.73.

Color: Red
NSN: 8305-01-399-1456

Color: Rose
NSN: 8305-01-399-1458

Color: Rust
NSN: 8305-01-399-14590

Color: Light Blue
NSN: 8305-00-234-9302

Color: Dark Blue
NSN: 8305-01-399-1453

Color: Gray
NSN: 8305-00-702-2868

Color: Green
NSN: 8305-00-710-8547

Color: Beige
NSN: 8305-00-710-8538

Color: Brown
NSN: 8305-00-285-9197

Color: Black
NSN: 8305-01-399-1451

Color: Off-white
NSN: 8305-01-399-1455

With a minimum order of one roll and FOB destination pricing, order today through FEDSTRIP / MILSTRIP, GSA's MUFFIN system, or hard copy via SF344 or DD Form 1348. Direct delivery is to destinations within the 48 contiguous states and the District of Columbia.

Contact: frank.lioce@gsa.gov
(Contracting Officer)
Phone: (817) 978-4544
Fax: (817) 978-8634

**Visit our Home
Page:**

**We now have our
individual Federal
Supply Schedule
Program Guides
on-line.**

**Just Click on
Multiple Award
Schedule at this
site:**

**[http://www.gsa/
gov/regions/7fss/
7fx/index.htm](http://www.gsa.gov/regions/7fss/7fx/index.htm)**



New Power Distribution Equipment added under Schedule 61, Part V, Section B

**Attention...
Power Supply Design
Managers/Engineers and
Buildings/Facility
Managers!**



The word is getting out! In response to customer feedback, GSA has added new products and services to Schedule 61V B to provide a total power equipment package. New categories of products include:

- Switchgear
- Transformers
- Panel-Boards/Switchboards/Load Centers/Metering

Services have been added to support the equipment purchase, including:

- Maintenance
- Training
- Logistical Support
- Site Surveys

Some of the name-brands for these new products are:

- Cutler-Hammer/Westinghouse
- Square D
- Toloc Systems
- Pyramid Power Systems
- Energy Technology, Inc.

GSA has already complied with all procurement regulations by synopsisizing this power equipment procurement, negotiating the contracts, and determining the pricing to be fair and reasonable. All of your power requirements can be met by ordering from Schedule 61, Part V, Section B.

**Contact: sheila.brannan@gsa.gov
(Contracting Officer)
Phone: (817) 978-8421
Fax: (817) 978-8634**

Everyday Low Prices on the Latest and Greatest in Food Service Equipment

Multiple Award Schedule 73 III - Food Service Equipment - has been further expanded to add the following new categories to the existing program:

Special Item Number 302-70
Food Packaging Supplies (includes concession supplies)

Special Item Number 302-71
Pest Control Systems (for kitchen / food service areas)

Special Item Number 302-72
Kiosk Food Center Concepts, A La Carte Services, and Food Court Concepts

In addition to the above items, the program offers a wide range and variety of food service equipment and supplies at fair and reasonable pricing. We cover all of the leading name-brand equipment, allowing you the customer, to select the "best value" for your requirements.

You can download a hard-copy of this schedule at www.gsa.gov/regions/7fss/7fx/schedules/.

**Contact: joann.stanley@gsa.gov
(Contracting Officer)
Phone: (817) 978-2505 or
donna.curphey@gsa.gov
(Contracting Officer)
Phone: (817) 978-8662
Fax: (817) 978-8672**

Spill Containment Products Available Now from GSA

GSA's Federal Supply Schedule 39, Part II, Section A - Material Handling Equipment, Scaffolding, and Work and Service Platforms, has been expanded to include Spill Containment Units under SIN 357-10c.

Spill containment units may be used to control or contain spills of potentially harmful or hazardous chemicals and pollutants. Spill containment units currently available from schedule contractors include vehicle/cargo area hazardous spill remediation trays for transport of hazardous liquids or materials; drive-on units in multiple sizes for use under even the largest military fuel tankers; individual and multi-drum overpacks; or containment flooring for work areas. Schedule contractors can provide containment units for almost any application.

To receive your copy of Schedule 39 II A, contact the Centralized Mailing List Service by phone at (817) 334-5215, by Fax at (817) 334-5227, or have immediate access to all General Products Schedules by visiting our home page at: <http://www.gsa.gov/regions/7fss/7fx/schedules/html> - look for Schedule 39 II A, featuring products for all your material handling needs.

**Contact: cheryl.goff@gsa.gov
(Contracting Officer)
Phone: (817) 978-8386
Fax: (817) 978-8634**



New Item Introductory Program

Damming Devices from Aqua-Barriers™

Aqua-Barriers™ are cost effective water-filled damming devices used for flood protection, construction and reme-



diation site dewatering, and sediment control. Constructed from industrial-grade reinforced plastic products, Aqua-



Barriers™ is lightweight, reusable, and compact in storage. Standard heights range from 2 feet to 7 feet, and lengths up to 200 feet are available. Connection methods are available to join the barriers

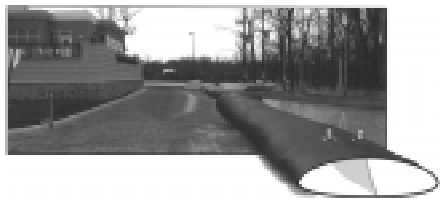

for extended lengths. To install, simply deploy and begin inflating through easily-accessible fill ports. Aqua-Barriers™ conform to uneven terrain and surfaces to restrict liquid transmission. To remove, discharge the water and conveniently store for future needs.

Send orders directly to the contractor:

Aqua-Barrier, Inc.
9597 Jones Road, #365
Houston, TX 77065
Phone: (800) 245-0199
Fax: (281) 807-1218

Internet: barrier1@ix.netcom.com
Website at www.aquabarrier.com
Contract Number: GS-07F-9973H

**Contact: maryann.swearingen
@gsa.gov
(Contract Specialist)
Phone: (817) 978-8377
Fax: (817) 978-8634**

New Item Introductory Program

Sandbag Filling Systems

The Sandbagger™ Gravity Feed (GF) is an automated sandbag filling system used to fill four sandbags simultaneously. Operators simply press a foot pedal to stop the flow. A ladder is provided to manually probe the material in the hopper when necessary. The GF is self-contained, lightweight, and transportable in the bed of a pickup truck. The machine is user-friendly and can fill between 700-900 bags per hour, depending on the material and manpower.



The Sandbagger™ Motorized Auger (MA) is designed to fill four sandbags simultaneously. This machine is capable of filling at least 1,600 bags per hour



using unskilled labor. The MA is equipped with a hydraulic driven hi-directional auger and agitator to keep wet materials flowing. Each machine also includes a safety grid, safety shield, gas engine, hydraulic motor, auger and agitator.

Order directly from the contractor:

The Sandbagger Corp.
P.O. Box 626
Wauconda, IL 60084
Phone: (800) 770-7263
Fax: (815) 363-9909
Internet: sandbagger@aol.com
Contract Number: GS-O7F-9920H

**Contact: maryann.swearingen
@gsa.gov
(Contract Specialist)
Phone: (817) 978-8377
Fax: (817) 978-8634**





Fiberglass Ladders

Whether you need a 3-foot stepladder or a 40-foot extension ladder, look no farther than the JWOD Program. We offer different types of ladders in various lengths, all manufactured by the Oklahoma League for the Blind.

Available using FEDSTRIP/MILSTRIP, or MUFFIN procedures. Please use the following NSN's when placing your order. These items are also available on **GSA Advantage!**TM. U/I: EA

Extension Ladder, Wood, 20'
NSN: 5440-00-223-6025
Price: \$195.91

Extension Ladder, Wood 24'
NSN: 5440-00-242-1000
Price: \$222.74

Stepladder, Aluminum, 4'
NSN: 5440-00-514-4483
Price: \$57.13

Stepladder, Aluminum, 6'
NSN: 5440-00-514-4485
Price: \$77.84

Stepladder, Aluminum, 8'
NSN: 5440-00-514-4487
Price: \$115.44

Stepladder, Fiberglass, 4'
NSN: 5440-01-415-1241
Price: \$48.29

Stepladder, Fiberglass, 6'
NSN: 5440-01-415-1238
Price: \$65.29

Stepladder, Fiberglass, 8'
NSN: 5440-01-415-1240
Price: \$83.87

Stepladder, Wood, 4'
NSN: 5440-00-227-1592
Price: \$41.26

Stepladder, Wood, 6'
NSN: 5440-00-227-1593
Price: \$62.06

Stepladder, Wood, 8'
NSN: 5440-00-227-1594
Price: \$75.66

Stepladder, Wood, 10'
NSN: 5440-00-227-1595
Price: \$105.75

Stepladder, Wood, 12'
NSN: 5440-00-227-1596
Price: \$131.37

Stepladder, Wood, 14'
NSN: 5440-00-531-2589
Price: \$223.73

Stepladder, Wood, 3' (no shelf)
NSN: 5440-00-171-9836
Price: \$33.42

Straight Ladder, Wood, 8'
NSN: 5440-00-242-7151
Price: \$65.72

Straight Ladder, Wood, 12'
NSN: 5440-00-814-5084
Price: \$123.38

The following items are available from GSA's Special Order Program (SOP). Please call (817) 978-2051 for ordering information, pricing and other supply assistance. U/I: EA.

Extension Ladder, Wood, 32'
NSN: 5440-00-223-6026

Extension ladder, Wood, 26'
NSN: 5440-00-242-0998

Extension Ladder, Wood, 40'
NSN: 6440-00-223-6027

Extension Ladder, Wood, 10'
NSN: 5440-00-816-2585

Extension Ladder, Wood, 14'
NSN: 5440-00-242-0995

Straight Ladder, Wood, 16'
NSN: 5440-00-816-2575

Straight Ladder, Wood, 20'
NSN: 5440-00-223-6030

Contact: jeff.fossmeyer@gsa.gov
(Inventory Manager)
Phone: (817) 978-8674
Fax: (817) 978-8600

New Item Introductory Program

Space Bag[®] is the Answer to Storage Problems and More!

Need to:

- Store more in less space?
- Increase shipping capacities?
- Protect valuable equipment, instruments, documents?

Space Bag[®] is the answer to these problems and a lot more. Airtight, watertight, tough, and reusable. Shrinks soft, bulky bedding, linens, foul weather gear up to 75%. Features a "zipper" that seals like a sandwich bag and enables the user to seal the pack airtight. Space Bag[®] storage pack works with any vacuum cleaner with a hose.



Send orders directly to contractor:

The Argosy Group
802 Denier Place
Cincinnati, OH 45224
Phone: (513) 931-2727
Fax: (513) 931-6627
Contract Number: GS-07F-9976H

Contact: maryann.swearingen@gsa.gov
(Contract Specialist)
Phone: (817) 978-8377
Fax: (817) 978-8634



New Item Introductory Program

On-Demand Heavy Duty Door Operator Door Aid®

DOOR AID® is quickly becoming known as an excellent product that is a simple and cost-effective way to make doors easily accessible for those in need of assistance. The unit is easy to install, with no special wiring required, and should only take 90 minutes using standard tools. A unique feature of DOOR AID® is that the actuator arm does not attach to the door itself. This means that the gearbox and motor only cycle when the unit is activated, saving a considerable amount of wear on the mechanism.



As you already know, Title I of the Americans with Disabilities Act is in effect. A principle issue of ADA is access to employment and/or goods or services available inside buildings. Although ADA does not mandate the use of automatic or power door operators, it does mandate accessibility through the use of appropriate hardware. This retrofit automatic door operator is specifically engi

neered to solve entrance accessibility problems, with only moderate cost to clients.



Order directly from:

Door-Aid Corporation
7700 Sprinkle Road
Portage, MI 49002
Phone: (616) 324-5978
Fax: (616) 324-5983
Contract Number: GS-07F-9764H
<http://www.door.aid.com>



New Item Introductory Program

Protect Your Back and Knees

BackMate™! and KneeMate™! Safety Cushions protect workers while they kneel or lie on hazardous surfaces. The materials used in the Safety Cushions were selected with industrial strength in



mind. The BackMate™! and KneeMate™! safety cushions are safe for indoor and outdoor use, on all types of surfaces, and in all types of weather. Easy to clean and store, the cushions are available in four sizes and one color - the highly visible safety orange.

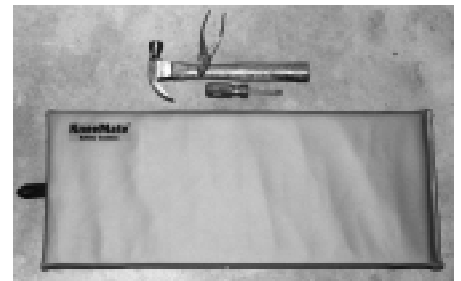

Send orders directly to the contractor:

Coldgon Products International, Inc.
P.O. Box 873
Superior, WI 54880
Phone: 888-550-3317
Contract Number: GS-07F-9865H

**MarkeTips is
Recyclable.**

**We use
Recycled
Paper and
Soy-based
Inks!**



Surface Conditioning Disks Class 5345 Available from GSA's Stock Program

Surface conditioning disks can be used for many different types of applications. These disks are comprised of synthetic fibers and abrasive particles bonded together. You may recognize the commercial term as "scotch-brite" products. These disks work well for cleaning and restoring surfaces without removing or damaging the base material, and conform to flat or irregular surfaces as well as hard-to-reach areas.

GSA now stocks several additional surface conditioning abrasive disks, with the 3M Roloc "TR", quick-change mechanical feature. Customers will find that the TR product will complete the wide selection of quick-change disks available for all types of abrasive disks in the commercial marketplace today.

NSN: 5345-01-367-7680
U/I: BX
Diameter: 2 inch
Abrasive: Aluminum Oxide
Grade: VFN
Qty Per Box: 200
Price: \$114.74

NSN: 5345-01-282-0634
U/I: BX
Diameter: 2 inch
Abrasive: Aluminum Oxide
Grade: MED
Qty Per Box: 200
Price: \$114.74

NSN: 5345-01-252-8565
U/I: BX
Diameter: 2 inch
Abrasive: Aluminum Oxide
Grade: CRS
Qty Per Box: 200
Price: \$114.74

NSN: 5345-01-424-2260
U/I: BX
Diameter: 2 inch
Abrasive: Silicon Carbide
Grade: SFN
Qty Per Box: 200
Price: \$143.45

NSN: 5345-01-397-5253
U/I: BX
Diameter: 3 inch
Abrasive: Aluminum Oxide
Grade: VFN
Qty Per Box: 100
Price: \$105.90

NSN: 5345-01-397-5256
U/I: BX
Diameter: 3 inch
Abrasive: Aluminum Oxide
Grade: MED
Qty Per Box: 100
Price: \$105.90

NSN: 5345-01-249-8361
U/I: BX
Diameter: 3 inch
Abrasive: Aluminum Oxide
Grade: CRS
Qty Per Box: 100
Price: \$106.25

NSN: 5345-01-444-8433
U/I: BX
Diameter: 3 inch
Abrasive: Silicon Carbide
Grade: SFN
Qty Per Box: 100
Price: \$137.57

Available from GSA's Stock Program.

For stock availability contact:
charles.hatch@gsa.gov
(Inventory Manager)
Phone: (817) 978-2469
Fax: (817) 978-8600

For technical assistance contact
steve.hooper@gsa.gov
(Specification Manager)
Phone: (817) 978-4429
Fax: (817) 978-8614

New Item Introductory Program

Security Doors

Available in five models, with numerous options available. All models are supplied with/without metal detectors and bullet-resistant glass. Units constructed with steel sheet supporting structure, come with a self-activating system and provides automatic control of access into a facility. Designed to make the workplace safe and free from robbery and hostage situations. Models and pricing include metal detectors and bullet-resistant glass - which are optional. Quantity discounts are available for 10-50 units and 50+ units. Model and price information available from contractor.

Order directly from:

Dual, Incorporated
30 Skyline Drive
Lake Mary, FL 32746
Phone: (407) 333-888
Fax: (407) 333-8850
Contract Number: GS-07F-8937H

Contact: maryann.swearingen
@gsa.gov
(Contract Specialist)
Phone: (817) 978-8377
Fax: (817) 978-8634

Correction

May/June issue of
MarkeTips, page 14,

Save Water with
Mr. Flush-less

Please add the following
phone numbers:

R&R Precision
Machining, Inc.
Phone: (970) 641-1851
Fax: (970) 641-0967





A Temporary Solution to Your Staffing Problems

Has Federal Government downsizing, decreased budgets, and hiring freezes left you short staffed?

To fill this need, the General Products Center created the first Basic Ordering Agreement for Temporary Nonpersonal Administrative and General Support Services. The national scope program, known as "The Road Ahead", is designed to facilitate mainstream career opportunities for the blind and disabled while providing support to Federal agencies across the country.

This ordering agreement is unique because it meets the requirements of the Javits-Wagner-O'Day Act and the rules of the Committee for Purchase From People Who Are Blind or Severely Disabled. The services are temporary and not permanent on the Procurement List.

Some of the many benefits of this Program include:

- Ordering the temporary service takes only days,
- Substitutions are permitted,
- GSA hourly rates average 17-27% below commercial market for temporary service organizations,
- 30-day cancellation clause available.

Contact: jane.parman@gsa.gov
(Contracting Officer)
Phone: (817) 978-2929
Fax: (817) 978-4366

Federal Supply Schedules Program: It Doesn't Get Much Better!

General Products Center Schedules are now available on the Internet!!!!

For the latest ON-LINE information for the Schedules listed below including: contract specialist name, phone number, and internet address; detailed listing of the items available; Schedule effective dates; and a link to download the current Schedule in a PDF file format, check out <http://www.gsa.gov/regions/7fss/7fx/schedules/>

- 19 I** Small Craft, Marine Equipment and Floating Marine Barriers
- 23 I 32/34** Wheel and Track Vehicles Woodworking and Metalworking Machinery and Equipment
- 37 II A** Lawn and Garden Equipment and Cattle Guards
- 39 II A** Material Handling Equipment
- 42 I B** Fire Fighting & Rescue Equipment, Urban and Wildland
- 49 I B** Automotive/Truck Maintenance and Repair Shop Equipment
- 49 II** Maintenance and Repair Shop Equipment/Cleaning Equipment
- 54 II B** Prefab Structures, Warehouses
- 54 III** Above Ground Storage Tanks
- 56 IVA** Construction and Building Materials
- 61VA** Generators, Portable, Standby and Prime; Load Banks, Transfer Switches, Primary and Secondary Batteries
- 61VB** Power Distribution Equipment

- 62 II** Solar Energy Systems, Energy-Efficient Lighting Products, and Specialty Lighting
- 63 I** Alarm and Signal Systems
- 72 VIII B** Recycling Collection Containers and Specialty Waste Receptacles
- 73 III** Food Service, Handling, Refrigeration and Storage Equipment
- 77 II** Musical Instruments
- 77 III** Audio & Video Equipment
- 78 I A** Athletic and Recreational Equipment
- 78 I C** Park and Outdoor Recreational Equipment
- 79 I B** Cleaning Equipment and Supplies
- 84 II B** Special Purpose Clothing
- 84 VA** Recreational Clothing and Footwear
- 84 VIA** Law Enforcement Equipment
- 99 IVA** Signs
- 99 VIA** Trophies, Awards, Presentations, and Promotional Materials

To get these Schedules or other GSA publications in hard-copy format, contact the following office:

GSA Centralized Mailing List Service
 P.O. Box 6477
 Fort Worth, TX 76115
 Telephone: (817) 334-5215
 Fax: (817) 334-5227

Internet address:
<http://pub.fss.gsa.gov>

For help in locating where an item might be in the GSA Supply System, call our Research Desk at (817) 978-2051. Also, don't forget to visit the General Products Centers home page at: www.gsa.gov/regions/7fss/7fx/index/htm





SKILCRAFT

Javits-Wagner-O'Day
JWOD

Life just got a whole lot brighter!

Self Stick Removable Note Pads



6 Assorted Neon Pads
100 Sheet Pads

SKILCRAFT

NEON Postable Notes

Available through all GSA Distribution Centers.

<u>Product</u>	<u>NSN</u>	<u>Price</u>
Neon Pack, 2 pads each Neon Lemon, Neon Pink, Neon Lime, 4" x 6".....	7530-01-418-1212	\$8.47
Neon Pack, 2 pads each Neon Lemon, Neon Pink, 1 pad each Neon Lime, Neon Melon, 3" x 3".....	7530-01-418-1281	\$4.30
Neon Pack, 2 pads each Neon Lemon, Pink, 1 pad each Neon Lime, Melon, 3" x 5".....	7530-01-418-1420	\$6.14

Standard pastel postable notes also available! Check out GSA *Advantage!*

To order these Postable Notes, See Page 64 for a CSC near you.



Outreach Europe '98

**GSA's Overseas
Products and Services Expo**

More than 200 displays
from America's leading suppliers
and manufacturers showcasing:

- ★ Dormitory & Quarters Furnishings
- ★ New Office & Packaged Room Solutions
- ★ Computers & IT Solutions
- ★ Appliances
- ★ Athletic & Recreational Equipment
- ★ Food Service Products & Equipment
- ★ Child Care Furnishings
- ★ Tools
- ★ Productivity & Office Supplies
- ★ Travel & Transportation Services

Take advantage of Outreach Europe's educational opportunities. Dynamic training and interactive seminars will focus on key issues and important changes in the Federal Government. Discover new tools and techniques designed to help you meet the needs of today and face the challenges of tomorrow with confidence.

Call the Outreach Europe Information Line
1.888.317.5901 or DSN 991.2694.

For additional information including a complete listing of exhibiting companies to date, information on training classes and seminars, hotels and lodging information, or to register on-line, check out our web site at tsd.r3.gsa.gov/oe98.htm

PATRICK HENRY VILLAGE
HEIDELBERG, GERMANY

GSA

Outreach Europe '98

20-22 October 1998



Who Should Attend

- ★ Contracting & Purchasing Officers
- ★ Facilities & Housing Managers
- ★ Supply & Logistics Officers
- ★ Specifiers
- ★ Communication & Information Service Managers
- ★ Telecommunication Managers
- ★ Civil Engineers
- ★ Designers
- ★ Space Planners
- ★ Restaurant & Club Managers
- ★ Decision Makers... and End Users!

Appropriated and non-appropriated fund activities can take advantage of GSA's program and support services.

REGISTRATION

Name First Last

Title

Company/Agency

Division/Department

Mailing Address

City State Country Zip Code

Phone Fax

E-Mail Address

Please send me information on exhibiting at Outreach '98

Fax your registration form to 215.656.3870
or you can register on-line at
td.r3.gsa.gov/oe98.htm

Seminars & Training

Topics will include:

- ★ Value-Added Procurements
- ★ New Travel Regulations & How To Use Them
- ★ Facilities Management
- ★ Government Purchase Card Program
- ★ Getting Quality Supplies Quickly!
- ★ Office & Health Care Solutions
- ★ Work Environments of the Future... and More!

GSA's customer service experts will be on site conducting training sessions on how to order from GSA and demonstrating the on-line ordering system, *GSA Advantage™*. . . you can even place orders during the Expo!



OUTREACH EUROPE '98

IS PRESENTED IN
COOPERATION WITH
THE UNITED STATES ARMED
FORCES AND THE
DEPARTMENT OF STATE.
REGISTRATION IS FREE
FOR MILITARY
AND U.S. FEDERAL
GOVERNMENT EMPLOYEES.



Office Supplies and Paper Products Center

New York, NY

Time To Order Your 1999 Calendars

It's never too early to order your 1999 Calendars.

Calendar Pads, Type II

1999 NSN: 7510-01-363-4999
U/I: EA
Price: \$1.52
1998 NSN: 7510-01-363-4998
Description: Flipover Pads
 3-5/8" x 5-7/8"
 Executive

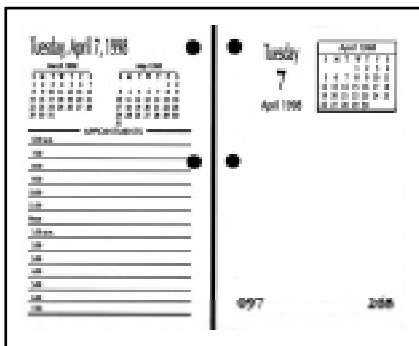

Desk Calendar

Calendar Pads, Type I

1999 NSN: 7510-01-363-3707
U/I: EA
Price: \$1.27
1998 NSN: 7510-01-363-3706
Description: Flipover Pads
 3" x 3-5/8"

Pocket Planner Set and Refill

1999 NSN: 7510-01-363-5003
U/I: SE
Price: \$3.00
1998 NSN: 7510-01-363-5002
Description: Pocket Size Loose Leaf
 Memorandum Book and
 Diaries

Made of 50% recovered material, which includes 20% PCM.
 Manufactured under JWOD by non-profit agencies affiliated with NIB.

Loose Leaf Pocket Appointment Book Refill

1999 NSN: 7530-01-363-6709
U/I: EA
Price: \$2.37
1998 NSN: 7530-01-363-6708
Description: Refill, Appointment Book
 for use with Binder
 NSN 7510-00-285-1765
 Contains 50% recovered material, which includes 20% PCM.
 Manufactured under JWOD by non-profit agencies affiliated with NIB.

Activity Schedule

1999 NSN: 7540-01-337-4704
U/I: PG (10)
Price: \$3.28
1998 NSN: 7540-01-337-8712
Description: Optional Form (OF) 67,
 Monthly Sheets,
 Size 8-1/2" x 11"
 Made of 50% Recovered Material, which includes 10% PCM.
 UNICOR Mandatory Source

Weekly Appointment Book

1999 NSN: 7530-01-337-4700
U/I: EA
Price: \$1.90
1998 NSN: 7530-01-337-4699
Description: Compact Appointment
 Guide, Pages Display an
 Entire Week, 8-1/2" x 11"
 Contains 50% recovered material, which includes 20% PCM.
 UNICOR Mandatory Source

Wall Calendar

1999 NSN: 7510-01-337-4709
U/I: PG (10)
Price: \$2.88
1998 NSN: 7510-01-337-4708
Description: Displays 3 months at time
 11-5/8 x 8-7/8"
 Contains 50% recovered material, which includes 20% PCM.
 UNICOR Mandatory Source



Wall Calendar

Continued next page



Calendar Pad ("Blotter"), Type III

1999 NSN: 7510-01-337-4714
U/I: EA
Price: \$1.61
1998 NSN: 7510-01-337-4713
Description: Calendar Pad, Blotter,
18" x 22"
Monthly Sheets Ruled
and Squared for each day

Blotter: 19" x 24"
NSN: 7520-00-224-7238
Price: \$2.45

UNICOR Mandatory Source

Contact: glenn.vanboven@gsa.gov
Phone: (212) 264-8207

Protect Valuable Documents

Safeguarding and maintaining the integrity of valuable documents, photos, diagrams in files or in transit, requires protection of the highest order. GSA offers a wide variety of quality document protectors.

Top Loading Document Protectors

Top-loading StayzNeat Document Protectors from Eberhard Faber lend a professional appearance, are made of durable polypropylene and are superior to ordinary polyvinyl chloride protectors. Popular size (8-1/2" x 11") and easy access make these protectors most convenient and easiest-to use when inserting or even changing documents.

Multi-punched to fit a wide variety of binders, they are available in standard or heavyweight thickness. Best of all, they will not absorb ink from copier paper, turn yellow or become brittle. Holds

8-1/2" x 11 sheet without hole punching of document.

NSN: 7510-01-347-9580
Size: 9" x 11"
Thickness: Standard weight, 0.0026"
Finish: Clear
U/I: BX (50)
Price: \$4.34

NSN: 7510-01-381-5300
Size: 9" x 11"
Thickness: Standard weight, 0.0026"
Finish: Non-glare
U/I: BX (50)
Price: \$3.45

NSN: 7510-01-381-2219
Size: 9" x 11"
Thickness: Heavy weight, 0.0039"
Finish: Non-glare
U/I: BX (50)
Price: \$4.63

Top loading Document Protectors from Sabina Office Products are highly durable with reinforced binding edges, are static-free, and specially-punched for three and six ring binders. They feature notched corners and oval holes for easy page turning.

NSN: 7510-01-347-9579
Size: 9" x 11"
Thickness: Heavy weight, 0.0039"
Finish: Shiny
U/I: BX (50)
Price: \$4.84

Contact: karen.williams@gsa.gov
Phone: (212) 264-4887

Color-Coded Document Protectors

Separate documents by category to index material or organize presentations with Color Coded Document Protectors. Five colored outside edges (Red, yellow, green, blue and white) are in staggered positions for easy identity. Multi hole-punched to fit a wide variety of binders. Twenty sheets of each color per box.

NSN: 7510-01-318-6591
Thickness: Standard weight, 0.0026"
Finish: Non-glare
U/I: BX (100)
Size: 9" x 11"
Price: \$15.21

Contact: karen.williams@gsa.gov
Phone: (212) 264-4887

Correspondence Protector

Polished, translucent Document Protector specially identified for important documents. Stamped with legend on the top edge: "Executive Correspondence." Stamped on bottom edge: "Do not write on this cover as it is intended for re-use" and "Return with the file copies to the originating office." Not hole punched for binder insertion.

NSN: 7510-01-084-1021
Size: 8-1/2" x 11"
U/I: BX (50)
Price: \$4.84



Contact: charlie.joiner @gsa.gov
(Inventory)
Phone: (212) 264-3539



Three Hole Punched Page Protector

For use in binders, these Document Protectors consist of clear plastic sheets with black album paper inserts included. Hole punched on 11" side for three ring binder insertion. Opens on binder edge.

NSN: 7510-00-233-7686
Size: 11" x 8-1/2"
Thickness: Standard weight
Finish: Matte
U/I: BX (50)
Price: \$4.89

NSN: 7510-00-233-7685
Size: 11" x 9"
Thickness: Standard weight
Finish: Matte
U/I: BX (50)
Price: \$4.81

NSN: 7510-00-634-0209
Size: 11" x 8-1/2"
Thickness: Standard weight
Finish: Shiny
U/I: BX (50)
Price: \$3.22

NSN: 7510-00-286-1407
Size: 11" x 9"
Thickness: Standard weight
Finish: Shiny
U/I: BX (50)
Price: \$3.45

Contact: karen.williams@gsa.gov
(Inventory)
Phone: (212) 264-4887

Transparent Envelope for Multi-Sized Documents

Durable protection for smaller documents. Sealed on three sides plus double safety fold and reinforced plastic edges on the open end. Three hole punched for binder insertion.

NSN: 7510-00-687-2664
Size: 5-1/2" x 9-1/4"
Thickness: Heavy weight
Finish: Shiny
U/I: HD
Price: \$10.08

Grommeted single hole for hanging only.

NSN: 7510-00-272-9804
Size: 6-1/2" x 10-1/2"
Thickness: Heavy weight
Finish: Shiny
U/I: HD
Price: \$57.31

NSN: 7510-00-272-9805
Size: 10" x 13"
Thickness: Heavy weight
Finish: Shiny
U/I: HD
Price: \$76.50

Contact: karen.williams@gsa.gov
(Inventory)
Phone: (212) 264-4887

Plastic Wrap for Protection in Shipping

Normal impact-strength polyethylene plastic is ideal for general purpose packaging. It protects items from dust and is highly water resistant and moderately vapor-resistant, low-slip type.

Approved for wrapping food:

NSN: 8135-00-855-3387
Size: 10' wide, 0.004" thick nominally
U/I: RO (Contains 100 FT)
Price: \$16.30

Not approved for wrapping food:

NSN: 8135-00-584-0610
Size: 8' wide, 0.004" thick nominally
U/I: RO (Contains 100 FT)
Price: \$14.79

NSN: 8135-00-584-0619
Size: 8' 4" wide, 0.002" thick nominally
U/I: RO (Contains 100 FT)
Price: \$16.32

NSN: 8135-00-579-6491
Size: 10' wide, 0.006" thick nominally
U/I: RO (Contains 100 FT)
Price: \$23.53

NSN: 8135-00-579-6489
Size: 12' wide, 0.006" thick nominally
U/I: RO (Contains 100 FT)
Price: \$32.60

NSN: 8135-00-618-1783
Size: 16' wide, 0.006" thick nominally
U/I: RO (Contains 100 FT)
Price: \$38.65

NSN: 8135-00-579-6487
Size: 20' wide, 0.006" thick nominally
U/I: RO (Contains 100 FT)
Price: \$52.67

NSN: 8135-00-282-5635
Size: 48" wide, 0.004" thick nominally
U/I: RO (Contains 50 YD)
Price: \$79.47

NSN: 8135-00-050-7698
Size: 54" wide, 0.20" thick nominally
U/I: RO (Contains 50 YD)
Price: \$258.81

Contact: kevin.enright@gsa.gov
(Inventory)
Phone: (212) 264-8230



Plastic Wrap for Protection of Packaged Food

Clear Plastic film that's soft and self-clinging, making it ideal for packaging food and other products. Comes in dispenser cartons with a cutting edge for ease of use.

NSN: 8135-00-754-2692
Size: 12" wide
U/I: RO (Contains 1,000 FT)
Price: \$5.19

Perforated Film for tearing into individual sheets.

NSN: 8135-00-021-5865
Size: 24" wide, 28" long sheets
U/I: RO (contains 400 SH)
Price: \$10.51

This soft, shrink wrap film is suitable for use in automated machines or for hand wrapping meats and produce. Comes on a 3" core.

NSN: 8135-01-015-4139
Size: 17" wide
U/I: RO (Contains 5,000 FT)
Price: \$42.25

Non Perforated Wrap

NSN: 8135-00-476-5268
Size: 18" wide
U/I: RO (Contains 6800 FT)
Price: \$64.37

Contact: kevin.enright@gsa.gov
(Inventory)
Phone: (212) 264-8230

Reference Books... Information You need...Now

Don't trust your "SpellCheck", need to look up a reference...wouldn't it be nice to have that information at your fingertips? Establish your own library of reference books through FSS.

Dictionaries

Clear, concise definitions, phonetic pronunciations with markings for inflections, parts of speech, and derivations. Includes illustrations or synonyms where applicable. With handy thumb index.

Desk version contains 150,000 entries with sections on punctuation and capitalization, geographical locations, table of weights and measures, metric conversions, and names of famous people.

NSN: 7610-00-142-9051
U/I: EA
Price: \$14.35

Unabridged version is one of the most comprehensive dictionaries anywhere, with over 40,000 entries.

NSN: 7610-00-262-4021
U/I: EA
Price: \$63.96

Thesaurus

The right word at the right time! Indispensable for anyone who writes! Enhances your style and vocabulary. A 100,000-word compilation of synonyms, antonyms, idiomatic phrases, and related and contrasting words.

NSN: 7610-00-514-2927
U/I: EA
Price: \$10.91

Contact: vince.cositore@gsa.gov
(Inventory)
Phone: (212) 264-8214

Shipping Handbook

Shipping Your Household Goods is a guide for government employees who have been authorized to move household goods and personal effects at government expense. Assists you in knowing how to make sure your shipment reached its destination, expediently, at the least expense to both government and employee; 1985 edition.

NSN: 7610-00-058-7938
U/I: EA
Price: \$1.78

Contact: charlie.joiner@gsa.gov
Phone: (212) 264-3539

There's Even More In Schedule 76 I

Federal Supply Schedule 76 I contains several major reference sources, in the following categories: Almanacs, Scientific Training Pamphlets, Technical Books, Dictionaries, Encyclopedias, Geography Books, Atlases, Globes and Maps.

Order Federal Supply Schedule 76 I from the GSA Centralized Mailing List Service (CMLS), (7CPNL), P.O.Box 6477, Fort Worth, TX 76115, FAX (817)334-5227. Internet address: <http://pub.fss.gsa.gov>

Contact: edwin.moldonado@gsa.gov
Phone: (212) 264-3520



New Item Program

Heavy Duty Mailing Envelopes and Shippers

Muscle-Pak Envelopes and Heavy Duty Shippers are designed to take anything that handling and shipping in transit can dish out and arrive at its destination safe and secure. They are waterproof, recyclable, puncture and tear resistant, accept adhesive labels, postage stamps and postage meter tapes. The tape closure lip provides a permanently-sealed tamper evident envelope made by Regal Envelope and brought to you by GSA under the New item program (NIP) they will meet all your specs and then some. Certain styles are reusable, as well.

The **Mailers** are multi-layer .00275 mil polyethylene, high strength, light weight, opaque envelopes, available with First Class markings or plain, with white outside and gray inside. Use them for direct mail, payroll and data processing information and the transfer of sensitive and security documents.

NSN: 7530-01-453-8925
Size: 6" x 9"

NSN: 7530-01-453-8928
Size: 9" x 12"

NSN: 7530-01-453-8931
Size: 12" x 9"

NSN: 7530-01-453-8930
Size: 10" x 13"

NSN: 7530-01-453-8922
Size: 13" x 10"

NSN: 7530-01-453-8933
Size: 10" x 15"

NSN: 7530-01-453-8921
Size: 12" x 15"

NSN: 7530-01-453-8925
Size: 14" x 17"

The **Heavy Duty Shippers** are light weight, opaque High-Density .003 mil polyethylene, gray envelopes. Use them to mail catalogues and books, storage, shipping soft goods, etc.

NSN: 7530-01-453-8923
Size: 6" x 9"

NSN: 7530-01-453-8926
Size: 9" x 12"

NSN: 7530-01-453-8929
Size: 12" x 15-1/2"

NSN: 7530-01-453-8932
Size: 14" x 19"

NSN: 7530-01-453-8934
Size: 20" x 24"

NSN: 7530-01-453-8927
Size: 30" x 30"

You may order Muscle-Pak envelopes and shippers direct from the contractor, Regal Envelope, a Division of Poly-Pak Industries, Inc. Minimum order, 200 Lbs. Attractive discounts available for larger shipments. Overnight and 2 day service available at additional charges. Custom sizes and colors available by special order. Contact them for prices and other information.

Contract # GS-15F-64534

Kathy Haynes
Regal Envelope
125 Spagnoli Road
Melville, NY 11747
Phone: 1-800-969-1995
Fax: 516-454-6366

Contact: valerie.thomas@gsa.gov
(Procurement)
Phone: (212) 264-2496

New Item Program

Advantage 7" Rubber Bands

Alliance Rubber Bands, the country's largest rubber band supplier and a New Item Program (NIP) contractor, presents their Advantage 7-inch Rubber Band for heavy duty banding. Size: 7" long x 1/4" wide. U/I - PG (1 LB), 25 PG per Case.

Made of lightweight crepe rubber, with a minimum of filler, ensuring a high count per pound, maximum tensile strength, and greater biodegradability. The bands owe their high tensile strength and stretch to the extremely high rubber content exceeding Federal Specification AA-151.

NSN: 7510-01-452-0526
Contractor Part # NNP0214.

Quantity discounts	Price/EA
100	\$2.39
100-299	\$1.67
300-999	\$1.46
1,000 +	\$1.31

The rubber bands may be ordered direct from the manufacturer, under Contract No.GS-14F-64717.

Alliance Rubber Company
1720 Kummer Road
P.O.Box 599
Franklin, KY 42134
Phone (502) 506-3218
Fax: (502) 506-5738
Customer Service: 1-800-626-5940

Contact: antonietta.rosenblatt@gsa.gov
(Procurement)
Phone: (212) 264-0392





REPLACEMENT *WALNUT* PICTURE FRAMES



SIZE	NATIONAL STOCK NUMBER	PRICE
8x10	7105-01-419-5293	\$62.58 Box of 12
8.5x11	7105-01-419-5322	\$69.30 Box of 12
11x14	7105-01-419-5332	\$99.08 Box of 12
16x20	7105-01-419-5344	\$72.45 Box of 6
18x24	7105-01-419-5355	\$89.20 Box of 6

OUR HIGH QUALITY PACKAGE INCLUDES:

- *Clear Glass
- *Beveled Cut Matboard
- *Backer & Saw Tooth Hanger
- *Gold Trim Along Inner Edge of Frame
- *Easel Back & Velcro for Desktop or Office Panel Hanging on First 4 Sizes Listed



New Item Program

Theft Resistant Pen... Always Ready to Write

Rolamech Security Pen is Theft-Proof, Frustrating Thieves and Foiling Vandals.

The Rolamech #722 Classic Security Pen for counter use is always ready to write because it cannot be stolen. Smooth-writing 6" long ballpoint pen is attached by a 20" vinyl-covered steel cable -- that cannot be ripped or broken without special tools -- to a permanently-mounted base (2-1/4" x 2-3/4"). Black pen and base. Aluminum pens are tapered for users' writing comfort. Bases feature an attractive textured finish.

Long-term service is assured. Spring-mounted ink fillers retract on impact to resist pen-point damage and assure smooth, continuous writing. The bases are mounted with powerful self-adhesive tape or hidden screws. In addition, the Jumbo Mile-Rite™ Refill will write approximately 13,000 feet, minimizing refilling. Black ink, medium point.

Rolamech security products are available under the New Item program (NIP) which allows buyers to order directly from the manufacturer, under Contract No. GS-14F-64105.

#722 Classic Pen

NSN: 7520-01-448-4362
U/I: EA (No minimums)
Price: \$10.52

#746 Jumbo Mile Rite Refill

NSN: 7510-01-448-4270
U/I: PG (3) Minimum Order: \$10.00
Price: \$1.92

Rolamech Inc.
P.O.Box 2065
Scottsdale, AZ 85252
Phone: (800) 243-7367
Fax: (602) 941-0717

Contact: antonietta.rosenblatt@gsa.gov
(Procurement)
Phone: (212) 264-0392

Pressure-Sensitive Adhesive Tape

FSS offers a vast assortment of pressure-sensitive adhesive tapes for all purposes, including medium and high strength plastic film and woven cloth water resistant tapes polyester, polypropylene and strapping tape.

Transparent film tape. Unaffected by moisture, dryness, and changing atmospheric conditions. It has good edge tear and breakage resistance, and unwinds easily. Is resistant to many acids, alkalis, and solvents. Excellent for a variety of packaging applications. Intended for sealing interior and exterior domestic containers and attaching labels. 3" core. U/I: RO.

NSN: 7510-00-995-0455
Color: Transparent
Width: 1"
Length: 72 YD
Price: \$0.47

NSN: 7510-01-425-6768
Color: Transparent
Width: 2"
Length: 330 FT
Price: \$1.61

NSN: 7510-00-073-6094
Color: Transparent
Width: 4"
Length: 72 YD
Price: \$4.09

NSN: 7510-00-073-6096
Color: Transparent
Width: 6"
Length: 72 YD
Price: \$2.32

Medium-strength plastic film tape for sealing fiberboard boxes and applying exterior labels. Film is abrasion and tear resistance and has good thermal properties. Excellent moisture and chemical resistance. Waterproof and weather resistant. 3" core. U/I: RO.

NSN: 7510-00-266-6715
Color: Transparent
Width: 2"
Length: 60 YD
Price: \$1.76

NSN: 7510-00-281-2700
Color: Transparent
Width: 3"
Length: 60 YD
Price: \$2.84

High-strength plastic film tape has excellent adhesive for a wide variety of surfaces. Waterproof and weather resistant. 3" core. U/I: RO

NSN: 7510-00-079-7906
Color: Tan
Width: 2"
Length: 60 YD
Price: \$1.59

NSN: 7510-00-079-7905
Color: Tan
Width: 3"
Length: 60 YD
Price: \$2.31

NSN: 7510-00-079-7907
Color: Tan
Width: 4"
Length: 60 YD
Price: \$3.05

Contact: jarmina.to@gsa.gov
(Inventory)
Phone: (212) 264-2039

Continued next page



High-strength, woven cloth water-resistant tape. Available in a variety of colors and widths. Used for various bundling and protective purposes as well as non-critical packaging applications. 3" core. Manufactured under JWOD by agencies affiliated with NIB. U/I: RO.

NSN: 7510-00-074-5122
Color: Dark Green
Width: 1"
Length: 60 YD
Price: \$3.35

NSN: 7510-00-890-9872
Color: Olive Drab
Width: 1"
Length: 60 YD
Price: \$3.35

NSN: 7510-00-074-4961
Color: Black
Width: 2"
Length: 60 YD
Price: \$6.72

NSN: 7510-00-074-5124
Color: Dark Green
Width: 2"
Length: 60 YD
Price: \$6.72

NSN: 7510-00-266-5016
Color: Olive Drab
Width: 2"
Length: 60 YD
Price: \$6.72

NSN: 7510-00-074-4969
Color: Red
Width: 2"
Length: 60 YD
Price: \$6.72

NSN: 7510-00-074-4952
Color: White
Width: 2"
Length: 60 YD
Price: \$6.72

NSN: 7510-00-074-4962
Color: Black
Width: 2-1/2"
Length: 60 YD
Price: \$8.47

NSN: 7510-00-074-5157
Color: Dark Green
Width: 2-1/2"
Length: 60 YD
Price: \$8.47

NSN: 7510-00-074-5100
Color: Olive Drab
Width: 2-1/2"
Length: 60 YD
Price: \$8.47

NSN: 7510-00-074-4978
Color: Red
Width: 2-1/2"
Length: 60 YD
Price: \$8.47

NSN: 7510-00-074-4963
Color: Black
Width: 3"
Length: 60 YD
Price: \$10.08

NSN: 7510-00-074-5160
Color: Dark Green
Width: 3"
Length: 60 YD
Price: \$10.08

NSN: 7510-00-890-9874
Color: Olive Drab
Width: 3"
Length: 60 YD
Price: \$10.08

NSN: 7510-00-074-4996
Color: Red
Width: 3"
Length: 60 YD
Price: \$10.08

NSN: 7510-00-074-4954
Color: White
Width: 3"
Length: 60 YD
Price: \$10.08

NSN: 7510-00-074-4964
Color: Black
Width: 4"
Length: 60 YD
Price: \$13.60

NSN: 7510-00-074-5174
Color: Dark Green
Width: 4"
Length: 60 YD
Price: \$13.60

NSN: 7510-00-890-9875
Color: Olive Drab
Width: 4"
Length: 60 YD
Price: \$13.60

NSN: 7510-00-074-5029
Color: Red
Width: 4"
Length: 60 YD
Price: \$13.60

NSN: 7510-00-074-5178
Color: Dark Green
Width: 6"
Length: 60 YD
Price: \$19.70

Contact: carmen.nieves@gsa.gov
(Inventory)
Phone: (212) 264-8200

Water-resistant, weather-resistant flat, paper tape for closing and sealing fiberboard containers. Can be used on weather-resistant or domestic fiberboard. 3" core. U/I: RO.

NSN: 7510-00-297-6655
Color: Opaque
Width: 2"
Length: 120 YD
Price: \$5.06

NSN: 7510-00-297-6656
Color: Opaque
Width: 3"
Length: 120 YD
Price: \$7.63

Continued next page



Polyester Film tape has good stability. Provides excellent water, abrasion, and chemical resistance. Recommended for address label attachment and protection. Excellent bar code protection for consistent scannability. 3" core. U/I: RO.

NSN: 7510-00-801-0482
Color: Clear
Width: 4"
Length: 72 YD
Price: \$10.87

Contact: jarmina.to@gsa.gov
(Inventory)
Phone: (212) 264-2039

Polypropylene Tape. Premium commercial-grade, clear box-sealing tape comes with dispenser, serrated metal blade and paperboard flap. 1.5" core. U/I: PG (6)

NSN: 7510-01-383-7967
Color: Clear
Width: 2"
Length: 22.2 YD
Price: \$6.51

Contact: glen.vanboven@gsa.gov
Phone: (212) 264-8207

Strapping Tape is filament-reinforced and intended for use in closing and reinforcing fiberboard boxes and for bundling items for shipment. Low-tensile tape is impact and cut resistant with polyester fiber reinforcement. Improved impact resistance over glass filament reinforcement. 3" core. U/I: RO.

NSN: 7510-00-290-8035
Color: Opaque
Width: 3/4"
Length: 60 YD
Price: \$1.29

NSN: 7510-00-290-8036
Color: Opaque
Width: 1"
Length: 60 YD
Price: \$1.41

Contact: carmen.nieves@gsa.gov
(Inventory)
Phone: (212) 264-8200

Fiberglass filament-reinforced tape is for closing full overlap or full telescope boxes and other bundling and packaging, such as reinforcement of fiberboard boxes and for bundling maintenance and similar applications. Manufactured under JWOD by agencies affiliated with NIB. 3" core. U/I: RO.

Medium-tensile-strength

NSN: 7510-00-802-8311
Color: Clear
Width: 3/4"
Length: 60 YD
Price: \$1.33

Contact: glen.vanboven@gsa.gov
(Inventory)
Phone: (212) 264-8207

Medium-tensile-strength

NSN: 7510-00-582-4771
Color: Clear
Width: 1/2"
Length: 60 YD
Price: \$0.98

NSN: 7510-00-582-4772
Color: Clear
Width: 1"
Length: 60 YD
Price: \$1.64

NSN: 7510-00-159-4450
Color: Clear
Width: 2"
Length: 60 YD
Price: \$3.29

Contact: carmen.nieves@gsa.gov
(Inventory)
Phone: (212) 264-8200

Gummed Reinforced Paper Tape (Water Moistened)

Strippable* fiberglass reinforced, laminated with water-resistant asphalt material, for closure of fiberboard boxes for domestic shipment and storage and for securing wrapping. No core, 1-1/4" opening. U/I: RO.

NSN: 8135-00-598-6097
Width: 3"
Length: 450 FT
Price: \$3.84

Strippable* fiberglass reinforced, laminated with non-asphalt water resistant material suitable for use on food packages. No core, 1-1/4" opening. U/I: RO.

NSN: 8135-00-155-5473
Width: 3"
Length: 375 FT
Price: \$3.30

*Strippable, tape has a breakaway layer when the tape is pulled off packing, to indicate tampering.

Contact: carmen.cortes@gsa.gov
(Inventory)
Phone: (212) 264-3547



Gummed Non-Reinforced Paper Tape (Water-moistened)

Single-ply, nonlaminated paper tape for sealing cartons and fiberboard boxes, wrapping packages, and banding together paper and paper products. U/I: RO.

Light duty tape has a 35 lb. basis weight. 1-3/8" diameter core.

NSN: 8135-00-270-8726
Color: Natural
Width: 1-1/2"
Length: 800 FT
Price: \$1.92

Medium-duty tape has a 60-lb basis weight. No core, minimum 1/2" opening.

NSN: 8135-00-271-1446
Color: Natural
Width: 2-1/2"
Length: 600 FT
Price: \$2.31

NSN: 8135-00-270-8717
Color: Natural
Width: 3"
Length: 600 FT
Price: \$2.65

Contact: carmen.cortes@gsa.gov
(Inventory)
Phone: (212) 264-3547

Olive Drab High Strength, Water Resistant Tape

High-strength, woven cloth water-resistant olive drab tape is used for various bundling and protective purposes as well as non-critical packaging applications.

It also makes great repair tape. Since rips and tears are not planned or premeasured,

this tape comes in a variety of widths. It's also water resistant, so it can be used in a variety of climatic conditions. 3" core.



Length: 60 YD. Manufactured under JWOD by non-profit agencies affiliated with NIB.

For a complete line of packaging and packing tapes, including this type in a variety of other colors, check the GSA Supply Catalog, Spring, 1987, Pg. 279.

NSN: 7510-00-890-9872
Width: 1"
Price: \$3.35

NSN: 7510-00-266-5016
Width: 2"
Price: \$6.72

NSN: 7510-00-074-5100
Width: 2-1/2"
Price: \$8.47

NSN: 7510-00-890-9874
Width: 3"
Price: \$10.08

NSN: 7510-00-890-9875
Width: 4"
Price: \$13.60

Contact: carmen.nieves@gsa.gov
(Inventory)
Phone: (212) 264-8200

GSA Computer Accessories Make Work Easier Diskettes

The high quality GSA brand name diskette family, both formatted and unformatted, have the quality and render the performance that GSA is famous for. The source to which millions of Federal offices worldwide confidently entrust their important databases, files and records. All are IBM-compatible; all Double Sided. U/I - BX (10).

3-1/2" Diskettes
Mfr: 3M, High Density, Unformatted
NSN: 7045-01-347-5290
Price: \$5.00

Mfr: 3M, Double Density, Formatted
NSN: 7045-01-406-4047
Price: \$4.60

Mfr: 3M, High Density, Formatted
NSN: 7045-01-406-4045
Price: \$4.91

Mfr: IBS, High Density, Unformatted
NSN: 7045-01-364-4073
Price: \$4.00

Mfr: ABM, High Density, Unformatted
NSN: 7045-01-368-4805
Price: \$4.00

Mfr: Maxell, High Density Unformatted
NSN: 7045-01-368-4812
Price: \$3.58

Continued next page



Mfr: Maxell, High Density, Formatted
NSN: 7045-01-375-8543
Price: \$3.58

Mfr: Office Solutions, High Density, Formatted
NSN: 7045-01-375-8544
Price: \$3.19

Mfr: Federal Sales, High Density, Formatted
NSN: 7045-01-392-6514*
Price: \$4.82

Mfr: Velocity, High Density, Formatted
NSN: 7045-01-406-4662
Price: \$4.50

Mfr: Verbatim, High Density, Formatted
NSN: 7045-01-375-8546
Price: \$4.53

Mfr: Verbatim, Double Density, Unformatted
NSN: 7045-01-406-4048
Price: \$4.16

Mfr: Verbatim, High Density, Formatted
NSN: 7045-01-406-4049
Price: \$4.33

* Recycled: Previously-used and carefully erased and cleaned. Guaranteed.



5-1/4" Diskettes

Mfr: 3M, Double Density, Unformatted
NSN: 7045-01-367-4610
Price: \$2.71

Mfr: 3M, High Density, Unformatted
NSN: 7045-01-367-4611
Price: \$4.33

Mfr: ABM, High Density, Unformatted
NSN: 7045-01-368-4806
Price: \$2.40

Mfr: Verbatim, High Density, Formatted
NSN: 7045-01-406-4046
Price: \$3.72



Contact: delores.turner@gsa.gov
(Inventory)
Phone: (212) 264-3547

Diskette Mailer

The safe way to mail diskettes, thanks to the static protective liner on all surfaces which may have contact with the diskette and the stiff, padded board that resists bending. Size: 7-1/2" x 6." The front features space for address and a warning statement against bending and avoiding moisture and magnetic fields. Flap closure by pressure sensitive adhesive. Recycled paperboard contains 80% PCM.

NSN: 8105-01-386-2202
U/I: PG (25)
Price: \$6.42



Mouse Pads

Attractive mouse pads improve traction and mouse control. Decor-complementary colors without product advertising. Mar-resistant base made of open-cell sponge rubber. Polyester fabric surface.

Manufactured under JWOD by non-profit organizations affiliated with NIB. Measures 9-3/8 x 7-7/8 x 1/4".



NSN: 7045-01-368-4809
Color: Blue
U/I: EA
Price: \$1.29

NSN: 7045-01-368-4810
Color: Gray
U/I: EA
Price: \$1.29

NSN: 7045-01-368-4808
Color: Red
U/I: EA
Price: \$1.30

NSN: 7045-01-368-4811
Color: Above 3
U/I: Pack 3
Price: \$3.76

Contact: delores.turner@gsa.gov
(Inventory)
Phone: (212) 264-3547



Hand Held and Desktop Calculators

Multiply, subtract, divide and so much more. Handy, Accurate, Lowest in Price.

Hand held calculators fit pockets attache cases and pocketbooks. Desktop calculators are portable, but are very much at home on desktops.

Other electronics calculators are available through Federal Supply Schedule 74 II and III, which can be ordered from:

GSA/CMLS
P.O. Box 6477
Ft. Worth, TX 76115
Telephone: (817) 334-5215
Fax: (817) 334-5227

Internet address:

<http://pub.fss.gsa.gov>

Hand-Held Calculators (Display Only)

Eight-digit calculator displays only. Include four arithmetic functions (+, -, /, x) one memory, floating decimal, square root, percent functions and automatic constant and chain calculations.

NSN: 7420-01-182-8532
Power Source: Solar
Price: \$2.88

NSN: 7420-01-182-8531
Power Source: Batteries
Price: \$2.11

Scientific models are solar-powered or battery-powered. They have eight-digit capability and one memory and display answer only. Includes four arithmetic functions (+, -, /, x) plus roots, trigonometry (sin, cos, tan and inverses) in degrees and radians, logs and their inverses, scientific notation, standard deviation and floating decimal.

NSN: 7420-01-182-8535
Power Source: Solar
Price: \$12.80

NSN: 7420-01-182-8534
Power Source: Batteries
Price: \$5.47

Desktop Calculators (Display and Print)

Handy multi-use, portable calculators, have four arithmetic functions (+, 1, /, x), a percent key for add-on and discount, a minimum of one independent addressable memory with M+, M-, MR and MC capabilities, a minimum of three fixed decimal positions, total and subtotal functions, negative sign for negative entries and answers; and item count. Print and display or display only capability; the sub-total automatically repints after switching to print from display-only functions.



NSN: 7420-01-174-5221
Power Source: AC Adapter or Batteries (both included)
Price: \$25.22

NSN: 7420-01-174-5218
Power Source: AC (prints in black or red)
Price: \$36.10

Contact: phyllis.rossi@gsa.gov
(Inventory)
Phone: (202) 264-4320

Ergonomic PC Accessories

There is a wide variety of PC ergonomic accessories available to Federal buyers in Federal Supply Schedule Group 58, Part V, Section A, including Wrist Rests, Foot Rests, Lap Rests, Anti-Glare Screens, CRT Screen Cleaners, Keyboard Tray Systems, Lumbar Supports. Order a copy of the schedule from the Centralized Mailing List Service (817) 334-5215 or see MarkeTips, November 1997, page 33 for more information.

Contact: maria.passerman@gsa.gov
(Procurement)
Phone: (212) 264-4287

**GSA
Advantage!™
On-Line
Shopping Service**

**Internet:
www.fss.gsa.gov**

**E-mail:
gsa.advantage@gsa.gov**

**Helpline:
(703) 305-7359**



Binders... Binders...Binders

We have what you need...Two Ring or Three Ring...Clothbound or Plastic...Stiff Cover or Flexible.

Clear Cover Binders make customizing easy. Just slip inserts into front cover and spine and voila! you have your own specially-identified binder for meetings, presentations and a host of other uses.

Heavy Duty Binders with metal hinges for rugged field use or for holding especially heavy contents.

Also available from WDC and CSC are two ring and short side opening binders. See the GSA Supply Catalog, Spring, 1997. In addition, a large variety of vinyl and polyethylene binders can be found in Federal Supply Schedule 75 II A.

Plastic covered binders are made from postconsumer materials in accordance with the President's Executive Order.

Binders designated with an asterisk (*) are made under JWOD by non-profit organizations associated with NIB.

U/I- EA

Stiff Clothbound Cover

NSN: 7510-00-281-6180
Capacity: 1"
Color: Black
Price: \$1.75

NSN: 7510-00-530-8881
Capacity: 2"
Color: Black
Price: \$2.55

Flexible Clothbound Cover

Holds 8-1/2 x 5-1/2" sheets
NSN: 7510-00-187-6486
Capacity: 1"
Color: Black
Price: \$3.31

Holds 9-1/2 x 6" sheets
NSN: 7510-00-187-6488
Capacity: 1"
Color: Black
Price: \$2.54

NSN: 7510-00-187-6496
Capacity: 2"
Color: Black
Price: \$3.22

Holds 11 x 8-1/2" sheets
NSN: 7510-00-187-6489
Capacity: 1"
Color: Black
Price: \$2.00

Stiff Plastic Cover

NSN: 7510-01-278-4131*
Capacity: 1"
Color: Black
Price: \$1.65

NSN: 7510-01-278-4130
Capacity: 2
Color: Black
Price: \$2.37

NSN: 7510-01-278-4129*
Capacity: 3"
Color: Black
Price: \$3.11

NSN: 7510-00-782-2663*
Capacity: 1"
Color: Gray
Price: \$2.80

NSN: 7510-00-782-2664*
Capacity: 2"
Color: Gray
Price: \$2.82

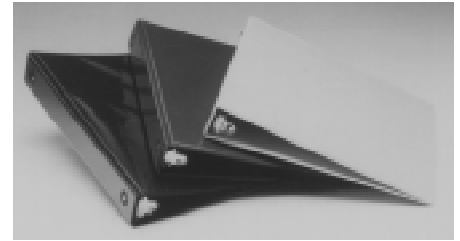

NSN: 7510-00-409-8646*
Capacity: 1"
Color: Blue
Price: \$2.77

NSN: 7510-00-409-8647*
Capacity: 1"
Color: Red
Price: \$2.77

Flexible Plastic Cover

NSN: 7510-00-984-5787*
Capacity: 1/2"
Color: Black
Price: \$2.13

NSN: 7510-01-278-4132
Capacity: 1"
Color: Black
Price: \$1.77

Vinyl Cover with Clear Front Panel and Spine

NSN: 7510-01-203-4708*
Capacity: 1"
Color: White
Price: \$2.26

NSN: 7510-01-203-8814
Capacity: 2"
Color: White
Price: \$2.47

Contact: dennis.steele@gsa.gov
Phone: (212) 264-4864



New National Source For Custom Stamps !

Need to get your message across? Try a **BOLD MESSAGE STAMP**. Tired of signing your name a hundred times a day? How about a stamp with your *signature*?



Whether you need a simple return address stamp, a date stamp, or something totally creative, **SKILCRAFT®** can fill the bill. **SKILCRAFT®** offers an extensive line of Custom and Generic Title (pre-made) stamps. Get their beautiful new catalog now by calling **1-800-799-0402**.

Order direct from them via fax or mail; your stamps are made and shipped **within 7 working days!** (Next day for generic stamps.) Plus, their prices and quality can't be beat.

SKILCRAFT® has custom-made stamps for all uses: office, warehouse, hospital, shipping, mail room, desktop — you name it. **SKILCRAFT®** has the modern, long-lasting, pre-inked and self-inking varieties which require no stamp pad. Their catalog has over 20 different sizes and shapes (mini to monster; rectangular, square, round) in many attractive styles.



SKILCRAFT® also offers a selection of popular, generic title stamps. So if you need a stamp that says something simple, such as, "DRAFT", "FILE COPY", or

"CONFIDENTIAL", **SKILCRAFT®** has what you need at the best price.

SKILCRAFT® stamps are made at The Lighthouse For The Blind, Inc in Seattle, Washington.

Schedule No: FSC Group 7511A
Contract No: GS-14F-1203H



Hot Off The Presses:

Business Cards

Handsome yet inexpensive custom-printed business cards are now available to all Federal employees. Here's a better image for you and your agency, courtesy of GSA and a new ruling from the Department of Justice. (Of course, each agency has discretion regarding whether they will purchase business cards, and who, within the agency, is authorized to do so.)

Under a new Federal Supply Schedule, custom-printed cards are available at excellent prices from **Skilcraft®**. Both plain and foil-embossed cards can be purchased in quantities of 250, 500 or 1,000.

You can order cards direct from **Skilcraft®** via fax or mail, for delivery in just 10 working days. They accept payment via government credit card,



check, money order, or on approved accounts. They will also accept orders from government employees who need to purchase cards with personal funds.

Skilcraft®'s brochure shows 4 classic styles, designed to incorporate different agency seals or logos. **Skilcraft®** will also set up unique designs for agencies wishing to establish their own look. Cards are printed with **soy inks** on bright white **recycled paper**.

For all the details regarding features, pricing, and ordering, call: **1-800-799-0402** to request **Skilcraft®**'s Business Card brochure.

Schedule No. FSC 751B
Contract No. GS-14F-0721G (11/97-9/02)

GSA Contact: cassandra.spann@gsa.gov (Procurement)
Phone: (212) 264-0371



Indicator Tabs Mark Your Place

Chekit Indicator Tabs are an idea whose time has come. They are 2-color, 3-position signaling tabs that indicate actions required and/or actions taken.

For example: Set tab to red for "action required;" set tab to neutral for "action taken;" set tab to green for OK status, or design your own system.

Use Chekit Tabs on file folders, inventory bins, etc., to maintain Inventory Control (i.e., reorder point, out of stock, etc.), Medical Records (patient status, room status, etc.), Filing Systems (file removed, security status, etc.), Data Processing (in use status, job loading, etc.).

Chekit Tabs have adhesive backs and are packaged in lots of 25 and 100 prices at \$19.75 and \$79.00 respectively, including shipment, with red and green colors. They come in bulk at lower discounts (see below) and other color combinations.

Chekit Tabs are available under the Special Order Program, (SOP), which permits ordering through normal FEDSTRIP/MILSTRIP procedures. FSS administers the order, while delivery is made directly by the manufacturer, Bechris Company.

NSN: 7690-01-417-1782
U/I: PG
Price: \$0.73 (1-300)
\$0.69 (301-500)
\$0.65 (501-2,500)
\$0.63 (2,501-5,000)
\$0.61 (5,001-15,000)
\$0.59 (15,000-25,000)
25,001 and above is subject to further negotiation

Std. Colors: Red/Green
Spec'l Colors: Yellow/Black,
Purple/Gold,
Yellow/Green,
Green/Silver or
Orange/Black

Manufacturer's Part: #717A
Shipping Costs: Quantities 1-300,
FOB Seattle, via
UPS, \$4.00
Quantities 301 and
above (Domestic
only)
FOB Destination.
All APO orders, FOB
Seattle

The I.M.P.A.C.[®] card is accepted.

Contact Contractor:
Marvin Christman
Bechris Company
4350 53rd Avenue, NE
Seattle, WA 98105-4939
Phone (206) 527-2156
Fax (206) 527-1704

Contact: marie.beverley@gsa.gov
Phone: (212) 264-3252

Self-directed Computer Training Now on Schedule

Federal agency training personnel now have alternative training solutions when divergent and overlapping group needs or mass classroom sessions are a problem. Federal Supply Schedule 69 now includes several well-known, highly qualified training services that offer a myriad of state-of-the-art training programs that utilize multi-media hardware and software. Programs include training on an individual basis in computer software, operation techniques and other industrial technical subjects.

It's a win-win situation. In addition to the resultant excellent learning experience, this individual training is highly-cost effective, as well:

-- Because it is self-disciplined in format, individual training allows participants to skip sections they know, allowing specific concentration where needed and often saving time.

-- Training costs are reduced with less involvement by agency instructors.
-- Privacy makes participants more comfortable.
-- Learning is self-paced.
-- The multimedia format aids retention.
-- Employee morale and self-esteem is enhanced, because training is self-managed.

Three of the leading contractors are:

ITC
13515 Dulles Technology Drive
Herndon, VA 10271
Phone: (703) 713-3335
Fax: (703) 713-0065

Contract: GS-20F-9415C

ITC offers the broadest spectrum of courses ranging from subjects as simple as Basic Reading, Writing and Math to popular software like Windows 95 and LAN management to advanced courses in other technical non-computer subjects. Space constraints do not allow room for their lengthy list of titles.

Willard Scott
CBT Systems Ltd.
2503 Red Glover Court
Reston, VA 2091-3709
Phone: (703) 758-8166
Fax: (703) 758-9891

Contract: GS-20F-9379C

CBT Systems, Ltd., publishes a growing library of more than 350 interactive educational software titles. These cover a comprehensive range of client/server and internet technologies and desktop systems work with the industry's leading software producers. They are used by more than 1250 of the world's leading corporations.

Continued next page



Robert Jacobs
MicroVideo Learning Systems
250 Park Avenue South
New York, NY 10003
Phone: 212-777-9595
Fax: (212) 777-9597

Contract: GS-20F-9318C

MicroVideo Learning Systems emphasizes "Learning at the Desktop," pioneered the integration of video and training over networks for every user, creating an inexpensive and effective method of software training and support. Many private sector corporations and Federal agency and military units have profited from participation in MicroVideo Systems training.

Other contractors that should be contacted for a look at the full spectrum of training programs available in the Schedule are:

Anderson Soft Teach
Attn: Lonnie Brodkins
983 University Avenue
Los Gatos, CA 95030
Phone: (408) 399-0100

Contract: GS-O2F-9305C

The contractors listed below specialize in computer training:

ICS Learning Systems
Attn: Steve Schein
925 Oak Street
Scranton, PA 18515
(717) 342-7701, Ext 264

Contract GS - 20F-9406C

J3 Learning Corporation
Attn: Steve McCumber
900 Chelmsford Street
Tower 1, Fl.9
Lowell, MA 01851
(800) 427-0714

The contractors listed below specialize in computer training:

ICS Learning Systems
Attn: Steve Schein
925 Oak Street
Scranton, PA 18515
(717) 342-7701, Ext 264

Contract GS - 20F-9406C

J3 Learning Corporation
Attn: Steve McCumber
900 Chelmsford Street
Tower 1, Fl.9
Lowell, MA 01851
(800) 427-0714

Contract: GS - 20F-9420C

The Joy of Education
Attn: Edward Sykes
P.O.Box 66286
Virginia Beach, VA 23456
(757) 427-9726, Ext. 221

Contract: GS - 20F-9317C

Moonbeam Publications, Inc.
Attn: Judith Persing
836 Hastings Street
Traverse City, MI 49696
(616) 922-0553

Contract: GS - 20F-9402C

Order these courses directly from the contractors, being sure to remind them that you represent a government agency and are ordering through a Federal Supply Schedule. Check the invoice for government pricing, as well.

Contact: spring.wells@gsa.gov
(Procurement)
Phone: (212) 264-3553

A Surveillance Camera Is Only As Good As Its Tape

Under normal taping circumstances, videotape takes a terrible beating from recording heads and other elements in the camera. This is particularly so in the time lapse camera, due to the stop-and-start nature of the recording.

Government security personnel, however, can rely on blank Time Lapse Video Cassettes from Fleetwood Video Corporation, a Federal Supply Schedule contractor. The tape is manufactured by Maxell Corporation and possesses the necessary density to accept extra-high output, extra-low noise, and low static electricity to prevent most picture "dropout." It also promises longer life expectancy.

Fleetwood offers customized packaging (including agency name and logo) for the following: Professional/Industrial Quality, Master Grade Quality, and Broadcast Quality VHS 1/2" Recording Tape, and Standard, High Grade and High 8mm Recording Tape.

Bulk order discounts and BPAs are also available. Fleetwood is woman-owned small business.

Contract No: GS - 20F-8011A

Contractor:

Raymond G. Somora
Fleetwood Video Corporation
69 Exchange St.
P.O. Box 150
Lynn, MA 01901-1027
Phone: (617) 596-2144
Fax: (617) 596-2145

Contact: maria.passerman@gsa.gov
(Procurement)
Phone: (212) 264-9576



Pilot Explorer Retractable Rolling Ball Pen

The Pilot Explorer is easy to access, extremely comfortable to hold, and a pleasure to write with.

The Pilot Explorer's secret is in its ergonomically-designed, contour-shaped grip that reduces gripping power and lessens writing fatigue. What's more, it features a unique pocket clip that opens the retractable point automatically when removing pen from the pocket. Black barrel, three ink colors, two point sizes: Fine - 0.7mm; Extra Fine - 0.5 mm. Not refillable. U/I - DZ.

NSN: 7520-01-377-9521
Point: Fine
Color: Black
Price: \$13.56

NSN: 7520-01-377-9527
Point: Fine
Color: Blue
Price: \$13.56

NSN: 7520-01-383-8027
Point: Fine
Color: Red
Price: \$13.56

NSN: 7520-01-383-8028
Point: Extra Fine
Color: Red
Price: \$13.56

NSN: 7520-01-385-3324
Point: Extra Fine
Color: Black
Price: \$13.56

NSN: 7520-01-385-3325
Point: Extra Fine
Color: Blue
Price: \$13.56

Contact: dennis.steele@gsa.gov
(Inventory)
Phone: (212) 264-4869

Pilot Precise V5 Rolling Ball Pen Writes Twice as Long

The Pilot Precise V5 Rolling Ball Pen provides ultra-smooth writing that goes on and on -- twice as far, in fact -- than ordinary rolling ball pens. Advanced ink feed system ensures smooth, consistent feed. See through window lets you know when you're running low. Extra fine 0.5 mm needle point. U/I - DZ.

NSN: 7520-01-386-1625
Point: Extra Fine
Color: Black
Price: \$12.30

NSN: 7520-01-386-1627
Point: Extra Fine
Color: Blue
Price: \$12.30

NSN: 7520-01-386-1657
Point: Extra Fine
Color: Red
Price: \$12.30

NSN: 7520-01-386-1666
Point: Extra Fine
Color: Green
Price: \$12.30

Contact: dennis.steele@gsa.gov
(Inventory)
Phone: (212) 264-4869

The New Cross Solo Pen

Imagine! A genuine A.T. Cross pen at a believably low price, brought to you by FSS and NIB. It contains all the inherent experience and know-how in manufacturing that goes into an A.T. Cross product. There's a lifetime mechanical guarantee, too. Writes beautifully, just a twist is all it takes, refills are available. Comes in five attractive barrel colors, with medium point and black ink.

Assembled and packaged under JWOD at In-Sight, Providence, RI, a non-profit agency affiliated with NIB.

Pens: U/I - EA

NSN: 7520-01-424-4846

Barrel Color: Blue

Price: \$6.72

NSN: 7520-01-424-4881

Barrel Color: Black

Price: \$6.72

NSN: 7520-01-424-4860

Barrel Color: Green

Price: \$6.72

NSN: 7520-01-424-4848

Barrel Color: White

Price: \$6.72

NSN: 7520-01-424-4871

Barrel Color: Red

Price: \$6.72

Refill: U/I - BX (6 cartridges)

NSN: 7510-01-425-6802

Price: \$2.30

Contact: dennis.steele@gsa.gov
(Inventory)
Phone: (212) 264-4869





SKILCRAFT® VuRyte and VuRiser Workstation Puts Work in Focus

The new SKILCRAFT®, VuRyte Workstation, developed to ease work at computers for Federal employees, is now available from stock. The PC accessory was designed to eliminate many of the aches and pains associated with computer work, both orthopedically (improving comfort for neck and back) and visually (placing the monitor at the optimum level to prevent eyestrain.), while boosting productivity. It is composed of three parts that work in conjunction to accomplish its ergonomic goals. The VuRyte Easel is a copy holder that allows data to be placed directly in front of the computer operator and at the same focal point as the monitor screen. It can be adjusted for access to monitor, depth distance, angle preference and split surfaces, minimizing awkward and tiring head and neck movements, as well as eyestrain. Includes a Line Guide Slide and Tracer. Two sizes: 18" Screen Length (SL) and 14" Screen Length (SL).

VuRysers I and II are pedestals upon which the monitor is placed so that it is positioned at a viewing level that is ergonomically correct for the operator and minimizing awkward and tiring head and neck movements. They may be used separately or in tandem, anchored by an interlocking device.

Made under JWOD by the Tarrant County Association for the Blind and the Lighthouse for the Blind of Fort Worth, TX, a non-profit agency affiliated with NIB.

The workstation consists of: (1) VuRyte 18" or 14", (1) VuRyser 1" and (1) VuRyser 2".

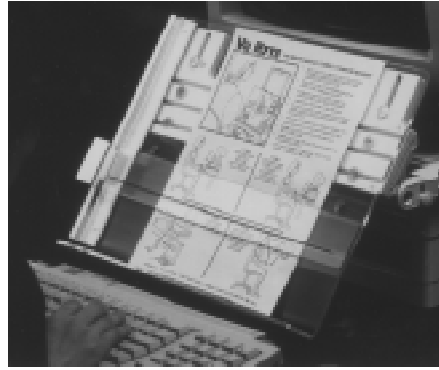

NSN: 7520-01-443-4902
U/I: EA
Price: \$94.14

Contact: dennis.steele@gsa.gov
(Procurement)
Phone: (212) 264-4896



Our Wall Clocks are Styled to Fit in Anywhere

In a range of styles from formal to functional, these clocks add a look of understated distinction to your workplace. All clocks (unless specified) have a quartz movement accurate to 0.33 seconds per day and are powered by an AA battery (not included). So even in a power outage, you'll never lose the time. Easy-to-read Arabic numeral and minute marks; hanger hardware included.

Slimline Clocks

- High impact case and crystal.
- Black numbers and markings on white background.
- Red sweep second hand.

NSN: 6645-01-046-8848
Dial Diam: 8"
Dial Color: White
Case Color: Bronze
Price: \$14.10

NSN: 6645-01-389-7958
Dial Diam: 8"
Dial Color: White
Case Color: Black
Price: \$14.10

NSN: 6645-01-389-7961
Dial Diam: 8"
Dial Color: White
Case Color: White
Price: \$14.10

NSN: 6645-01-046-8849
Dial Diam: 12"
Dial Color: White
Case Color: Bronze
Price: \$18.40

NSN: 6645-01-389-7944
Dial Diam: 12"
Dial Color: White
Case Color: Black
Price: \$18.40

NSN: 6645-01-389-7951
Dial Diam: 12"
Dial Color: White
Case Color: White
Price: \$18.40



NSN: 6645-01-421-6901
Dial Diam: 12"
Dial Color: White
Case Color: Stone Gray
Price: \$17.51



NSN: 6645-01-421-6898
Dial Diam: 12"
Dial Color: White
Case Color: Taupe
Price: \$18.40

NSN: 6645-01-342-8199*
Dial Diam: 12"
Dial Color: White
Case Color: Bronze
Price: \$17.92

Has 1.5 inch power cord, runs on 120v, 60-cycle power. Motor enclosed in dust proof case.

NSN: 6645-00-514-3523
Dial Diam: 8"
Dial Color: White
Case Color: Dark Brown
Price: \$11.63

NSN: 6645-00-530-3342
Dial Diam: 12"
Dial Color: White
Case Color: Dark Brown
Price: \$12.81

*With 12-24 hour dial.



“Designer Series” Slimline Clocks

- High impact case and crystal. • Black numbers and markings on white background. • Red sweep second hand. • White numbers and markings on dark background. • 6” Designer Clocks also have Velcro strips as in addition to standard mount for attaching to fabric work station.

NSN: 6645-01-421-6899
Dial Diam: 6”
Dial Color: Stone Gray
Case Color: Stone Gray
Price: \$13.30

NSN: 6645-01-421-6905
Dial Diam: 8”
Dial Color: Stone Gray
Case Color: Stone Gray
Price: \$13.35

NSN: 6645-01-421-6909
Dial Diam: 8”
Dial Color: Taupe
Case Color: Taupe
Price: \$13.35

24-Hour Slimline Clocks

- Modern, easy-to-read 24-hour dial • Shaded between 6:00 PM and 6:00 AM. • Hour hand makes one revolution each 24-hour period. • Separate numbering for minutes. • Red sweep second hand. • Ideal for military.

NSN: 6645-01-342-5313
Dial Diam: 8”
Dial Color: White
Case Color: Dark Brown
Price: \$16.82

NSN: 6645-01-342-5314
Dial Diam: 12”
Dial Color: Gray
Case Color: Dark Brown
Price: \$20.76



Hardwood Clocks

- Traditional Style hands. • Elegant mahogany or walnut casing.

NSN: 6645-01-421-6904
Dial Diam: 12”
Dial Color: Off White
Case Color: Mahogany
Price: \$66.78

NSN: 6645-01-421-6906
Dial Diam: 12”
Dial Color: White
Case Color: Walnut
Price: \$62.01

Manufactured under JWOD by non-profit agencies affiliated with NIB.

Contact: charlie.joiner@gsa.gov
(Inventory)
Phone: (212) 264-3539



PREMIER SERIES Filing & Storage System™
 A NEW PATENTED SYSTEM TO END OFFICE CLUTTER

- Saves space
- Files can't fall
- Ready-to-use on partitions, walls, doors
- Height adjusts
- Heavy-duty
- Taupe color
- **Holds:** computer disks, CDs & tapes, office supplies, books, stacked paper, files, mags.
- **Displays:** photos, 8.5"x11" sheets, notes, lists, memos



(Above: one #HFPS01 system - *excludes stored items*)

- Shelf/baskets just slide into any slot



CALL CSC

(A) PREMIER SERIES Filing & Storage System™

Mfr. #HFPS01 NSN7510-01-392-5291

Includes 1 molded plastic 3-tier file, 2 steel hangers, 2 "slide-in" reversible shelf/baskets, 1 clear plastic 8.5"x11" sheet & photo display pocket (no assembly required)

(B) ACCESSORIES Package for Plastic PREMIER SERIES Filing & Storage System™ (optional)

Mfr. #HFPS02 NSN7510-01-377-9526

Optional additional accessories for PREMIER SERIES

Includes 2 "slide-in" reversible shelf/baskets, and 1 clear plastic 8.5"x11" sheet & photo display pocket.

	<u>price each - per quantity shipped</u>					
<u>item</u>	<u>2-5</u>	<u>6-19</u>	<u>20-99</u>	<u>100-499</u>	<u>500-999</u>	<u>1000+</u>
(A)	\$ 65.61	59.05	56.42	53.80	51.83	49.21
(B)	\$ 28.72	25.85	24.70	23.55	22.69	21.54

GSA Contract #GS-14F-63177 Contr. Officer (212)-264-6123

U.S. Patent #5158186 (other patents pending)

Vendor: S.W. Heritage, Inc., Box 88428, Dunwoody, GA 30356
 phone 770-393-2016 -- E-mail swher@mindspring.com --
www.mindspring.com/~swher/hangfile.htm 1/1/98

See Page 64 for a CSC near you.



No One Sells Better Plastic Bags

Our plastic bags go through the same rigorous testing that commercial bags do. Puncture tests. Drop tests. Tensile strength tests. Elongation tests. Gas and water vapor permeability tests. Chemical tests that measure how well a bag can withstand accelerated weathering. All carefully designed by the American Standards for Testing Materials Committee.

Whatever your disposal needs are, you can get the right bag for the right purpose, with exactly the strength requirements you need. So when you use bags from FSS, you know that what goes into the bag stays in the bag. And that means quality you can rely on....at a price your budget can afford.

Medium-Duty Trash Bag

Designed for everyday use in cafeterias or mess halls. Comes without closure ties but is suitable for knotting at the top.

For most office and outdoor trash

NSN: 8105-01-184-7159
Size: 21"x20", 5 gal.
Color: Clear
U/I: BX
Quantity: 500
Duty Rating: Medium
Puncture Resist: Moderate
Spec'l. Features: Premium
Load Capacity: 15 lbs.
Price: \$11.89

NSN: 8105-01-195-8730
Size: 23"x24", 10 gal.
Color: Clear
U/I: BX
Quantity: 500
Duty Rating: Medium
Puncture Resist: Moderate
Spec'l. Features: Premium
Load Capacity: 15 lbs.
Price: \$9.44

NSN: 8105-00-200-0195
Size: 24"x24", 10 gal.
Color: Clear
U/I: BX
Quantity: 100
Duty Rating: Medium
Puncture Resist: Moderate
Spec'l. Features: Premium
Load Capacity: 25 lbs.
Price: \$6.23

NSN: 8105-00-299-8532
Size: 40"x20", 12 gal.
Color: Clear
U/I: BX
Quantity: 100
Duty Rating: Medium
Puncture Resist: Moderate
Spec'l. Features: Premium
Load Capacity: 50 lbs.
Price: \$7.06

NSN: 8105-01-183-9768
Size: 39"x33", 33 gal.
Color: Clear
U/I: BX
Quantity: 125
Duty Rating: Medium
Puncture Resist: Moderate
Spec'l. Features: Premium
Load Capacity: 50 lbs.
Price: \$15.24

NSN: 8105-00-726-5607
Size: 48"x40", 58 gal.
Color: Clear
U/I: BX
Quantity: 125
Duty Rating: Medium
Puncture Resist: Moderate
Spec'l. Features: Premium
Load Capacity: 50 lbs.
Price: \$17.69

Heavy-Duty Trash Bag

Comes without closure ties but is suitable for knotting at the top.

With good puncture resistance for dry or dry/wet trash

NSN: 8105-01-183-9767
Size: 36"x30", 25 gal.
Color: Clear

U/I: BX
Quantity: 250
Duty Rating: Medium
Puncture Resist: Moderate
Spec'l. Features: Premium
Load Capacity: 75 lbs.
Price: \$26.75

NSN: 8105-01-183-9769
Size: 39"x33", 33 gal.
Color: Dark Brown or Green
U/I: BX
Quantity: 125
Duty Rating: Heavy
Puncture Resist: Good
Spec'l. Features: Premium
Load Capacity: 75 lbs.
Price: \$21.77

NSN: 8105-01-150-6256
Size: 44"x32", 34 gal.
Color: Clear
U/I: BX
Quantity: 125
Duty Rating: Heavy
Puncture Resist: Good
Spec'l. Capacity: Premium
Load Capacity: 75 lbs.
Price: \$18.54

NSN: 8105-01-183-9764
Size: 58"x36", 57 gal.
Color: Dark Brown or Green
U/I: BX
Quantity: 100
Duty Rating: Heavy
Puncture Resist: Good
Spec'l. Features: Premium
Load Capacity: 75 lbs.
Price: \$20.87

NSN: 8105-00-759-0794
Size: 65"x38", 71 gal.
Color: Clear
U/I: BX
Quantity: 50
Duty Rating: Heavy
Puncture Resist: Good
Spec'l. Features: Premium
Load Capacity: 75 lbs.
Price: \$11.41

Continued next page



NSN: 8105-00-145-0163
Size: 57"x69", 125 gal.
Color: Clear
U/I: BX
Quantity: 100
Duty Rating: Heavy
Puncture Resist: Good
Spec'l. Features: Premium
Load Capacity: 75 lbs.
Price: \$43.99

Light-Duty Trash Bag

Economy-quality bag is suitable for office trash and comes with closure ties.

For office trash

NSN: 8105-00-330-7264
Size: 22"x20", 7 gal.
Color: Clear
U/I: BX
Quantity: 500
Duty Rating: Light
Puncture Resist: Minimal
Spec'l. Features: Economy
Load Capacity: 15 lbs.
Price: \$4.73

Contains 10% PCM

NSN: 8105-01-221-3233
Size: 24"x20", 7 gal.
Color: Clear
U/I: BX
Quantity: 2,000
Duty Rating: Light
Puncture Resist: Minimal
Spec'l. Features: Economy
Load Capacity: 15 lbs.
Price: \$40.92

NSN: 8105-01-175-5533
Size: 24"x24", 10 gal.
Color: Clear
U/I: BX
Quantity: 1,000
Duty Rating: Light
Puncture Resist: Minimal
Spec'l. Features: Economy
Load Capacity: 15 lbs.
Price: \$14.29

NSN: 8105-01-221-3234
Size: 33"x24", 14 gal.
Color: Clear
U/I: BX
Quantity: 1,000
Duty Rating: Light
Puncture Resist: Minimal
Spec'l. Features: Economy
Load Capacity: 15 lbs.
Price: \$19.31

NSN: 8105-01-174-0943
Size: 39"x33", 33 gal.
Color: Clear
U/I: BX
Quantity: 500
Duty Rating: Light
Puncture Resist: Minimal
Spec'l. Features: Economy
Load Capacity: 25 lbs.
Price: \$20.12

NSN: 8105-00-579-8451
Size: 38"x36", 37 gal.
Color: Clear
U/I: BX
Quantity: 100
Duty Rating: Light
Puncture Resist: Minimal
Spec'l. Features: Economy
Load Capacity: 25 lbs.
Price: \$8.70

NSN: 8105-01-174-0944
Size: 25"x24", 11 gal.
Color: Clear
U/I: BX
Quantity: 500
Duty Rating: Light
Puncture Resist: Minimal
Spec'l. Features: Economy
Load Capacity: 20 lbs.
Price: \$7.43

NSN: 8105-01-174-0945
Size: 25"x24", 11 gal.
Color: Clear
U/I: BX
Quantity: 500
Duty Rating: Light
Puncture Resist: Minimal
Spec'l. Features: Economy
Load Capacity: 25 lbs.
Price: \$7.30

Medium duty for cafeteria or mess hall. Contains 10% PCM

NSN: 8105-01-174-0942
Size: 39"x33", 33 gal.
Color: Clear
U/I: BX
Quantity: 500
Duty Rating: Medium
Puncture Resist: Minimal
Spec'l. Features: Economy
Load Capacity: 50 lbs.
Price: \$28.61

Heavy duty for cafeteria or mess hall. Contains 10% PCM

NSN: 8105-01-174-0941
Size: 39"x33", 33 gal.
Color: Clear
U/I: BX
Quantity: 250
Duty Rating: Heavy
Puncture Resist: Minimal
Spec'l. Features: Economy
Load Capacity: 75 lbs.
Price: \$16.50

NSN: 8105-01-175-5532
Size: 40"x33", 33 gal.
Color: Clear
U/I: BX
Quantity: 250
Duty Rating: Heavy
Puncture Resist: Minimal
Spec'l. Features: Economy
Load Capacity: 75 lbs.
Price: \$22.42

NSN: 8105-01-221-3236
Size: 44"x33", 36 gal.
Color: Clear
U/I: BX
Quantity: 250
Duty Rating: Heavy
Puncture Resist: Minimal
Spec'l. Features: Economy
Load Capacity: 75 lbs.
Price: \$18.07

Continued next page



**Heavy duty for cafeteria or mess hall.
Contains 10% PCM (con't.)**

NSN: 8105-01-221-3238
Size: 45"x37", 47 gal.
Color: Clear
U/I: BX
Quantity: 200
Duty Rating: Heavy
Puncture Resist: Minimal
Spec'l. Features: Economy
Load Capacity: 75 lbs.
Price: \$26.56

NSN: 8105-01-221-3237
Size: 48"x40", 58 gal.
Color: Clear
U/I: BX
Quantity: 250
Duty Rating: Heavy
Puncture Resist: Minimal
Spec'l. Features: Economy
Load Capacity: 75 lbs.
Price: \$23.93

NSN: 8105-01-221-3239
Size: 6"x36", 59 gal.
Color: Clear
U/I: BX
Quantity: 200
Duty Rating: Heavy
Puncture Resist: Minimal
Spec'l. Features: Economy
Load Capacity: 75 lbs.
Price: \$21.48

**Multi-Purpose. 100% recycled
material with 30% PCM**

NSN: 8105-01-386-2289
Size: 24"x24", 10gal.
Color: Opaque
U/I: BX
Quantity: 250
Duty Rating: Medium
Puncture Resist: Minimal
Spec'l. Features: Economy
Load Capacity: 15 lbs.
Price: SOP**

NSN: 8105-01-386-2312
Size: 33"x40", 33 gal.
Color: Opaque
U/I: BX
Quantity: 100
Duty Rating: Medium
Puncture Resist: Minimal
Spec'l. Features: Economy
Load Capacity: 51 lbs.
Price: SOP**

NSN: 8105-01-386-2290
Size: 33"x39", 30 gal.
Color: Opaque
U/I: BX
Quantity: 100
Duty Rating: Heavy
Puncture Resist: Minimal
Spec'l. Features: Economy
Load Capacity: 75 lbs.
Price: SOP**

NSN: 8105-01-386-2323
Size: 33"x40", 33 gal.
Color: Opaque
U/I: BX
Quantity: 100
Duty Rating: Heavy
Puncture Resist: Minimal
Spec'l. Features: Economy
Load Capacity: 75 lbs.
Prices: SOP**

NSN: 8105-01-386-2329
Size: 40"x48", 40-45 gal.
Color: Opaque
U/I: BX
Quantity: 100
Duty Rating: Heavy
Puncture Resist: Minimal
Spec'l. Features: Economy
Load Capacity: 75 lbs.
Price: SOP**

NSN: 8105-01-386-2362
Size: 43"x49", 56 gal.
Color: Opaque
U/I: BX
Quantity: 100
Duty Rating: Heavy
Puncture Resist: Minimal
Spec'l. Features: Economy
Load Capacity: 75 lbs.
Price: SOP**

NSN: 8105-01-386-2399
Size: 38"x60", 60 gal.
Color: Opaque
U/I: BX
Quantity: 100
Duty Rating: Heavy
Puncture Resist: Minimal
Spec'l. Features: Economy
Load Capacity: 75 lbs.
Price: SOP**

NSN: 8105-01-386-2410
Size: 36"x58", 60 gal.
Color: Opaque
U/I: BX
Quantity: 100
Duty Rating: Heavy
Puncture Resist: Minimal
Spec'l. Features: Economy
Load Capacity: 75 lbs.
Price: SOP**

NSN: 8105-01-386-2428
Size: 50"x51", 65 gal.
Color: Opaque
U/I: BX
Quantity: 100
Duty Rating: Heavy
Puncture Resist: Minimal
Spec'l. Features: Economy
Load Capacity: 75 lbs.
Price: SOP**

**Special Order Program (SOP), items not in stock. Send requisitions via FEDSTRIP/MILSTRIP.

Continued next page



Shrink Tunnel Pallet Bag

Heat-shrinkable polyethylene bag is for use in shrinking tunnels, makes securing loads on pallets easy. Conveniently furnished on a perforated, tear-off roll for 40" x 48" pallets.

Normal duty use

NSN: 8105-00-191-3776
Size: 50"x42"x65"
Color: Clear
U/I: RO
Quantity: 42
Duty Rating: Normal
Spec'l. Features: Secure pallets
Price: \$72.17

NSN: 8105-00-191-3701
Size: 50"x42"x76"
Color: Clear
U/I: RO
Quantity: 42
Duty Rating: Normal
Spec'l. Features: Secure pallets
Price: \$89.43

Heavy duty use.

NSN: 8105-00-191-3902
Size: 50"x42"x65"
Color: Clear
U/I: RO
Quantity: 32
Duty Rating: Heavy
Spec'l. Rating: Secure pallets
Price: \$75.77

NSN: 8105-00-025-1263
Size: 50"x42"x76"
Color: Clear
U/I: RO
Quantity: 32
Duty Rating: Heavy
Spec'l. Rating: Secure pallets
Price: \$89.96

Interior Packaging Bag

Flexible, opaque envelope is perfect for use as barrier material to wrap items packaged inside another container. It provides protection of contents during transport and storage in all climates.

Open end of envelope is marked with an arrow.

NSN: 8105-00-256-7236
Size: 16"x19-1/4"
Color: Opaque
U/I: HD
Duty Rating: Heavy
Spec'l. Features: Grease/water-vapor proof
Price: SOP**

NSN: 8105-00-190-9816
Size: 4"x6"
Color: Opaque
U/I: BX
Quantity: 500
Duty Rating: Medium
Spec'l. Features: Grease/waterproof
Price: SOP**

NSN: 8105-00-281-3907
Size: 3"x5"
Color: Opaque
U/I: MX
Duty Rating: Heavy
Spec'l. Features: Grease/waterproof
Price: SOP**

NSN: 8105-00-281-3908
Size: 4"x8"
Color: Opaque
U/I: MX
Spec'l. Features: HeavyGrease/waterproof
Price: SOP**

Plastic Food Bag

Either perforated and suitable for fresh fruits or non-perforated for poultry, both with tie closures and meeting FDA requirements.

NSN: 8105-00-579-9163
Size: 6"x15"x3"
Color: Clear
U/I: MX
Puncture Resist: Perforated
Spec'l. Features: Produce
Load Capacity: 2 lbs.
Price: \$25.46

NSN: 8105-00-721-9912
Size: 8"x15"
Color: Clear
U/I: MX
Spec'l. Features: Produce/poultry
Load Capacity: 2 lbs.
Price: SOP**

Flat, Polyethylene Bag

For general-purpose uses. Bag has a reusable interlocking seal closure.

General purpose.

NSN: 8105-00-837-7753
Size: 4"x4"*
Color: Clear
U/I: MX
Spec'l. Feature: Gen. purpose
Price: \$10.46

NSN: 8105-00-837-7754
Size: 6"x6"*
Color: Clear
U/I: MX
Spec'l. Features: Gen. purpose
Price: \$18.64

NSN: 8105-00-837-7755
Size: 8"x8"*
Color: Clear
U/I: MX
Spec'l. Features: Gen. purpose
Price: \$29.74

NSN: 8105-00-837-7756
Size: 10"x10"*
Color: Clear
U/I: BX
Quantity: 500
Spec'l. Features: Gen. purpose
Price: \$23.74

NSN: 8105-00-837-7757
Size: 12"x12"*
Color: Clear
U/I: BX
Quantity: 500
Spec'l. Features: Gen. purpose
Price: \$28.52

**Special Order Program (SOP), items not in stock. Send requisitions via FEDSTRIP/MILSTRIP.

Continued next page



Hospital Bag

Hospital "red bag" for disposing of infectious waste; may be used for liquid or mixed solid/liquid materials. Reads: "DANGER INFECTIOUS WASTE, PELIGRO DESECHO INFECTANTE" in 2" high characters. Closure ties included.

NSN: 8105-01-151-1097
Size: 24"x23", 10 gal.
Color: Red
U/I: BX
Quantity: 250
Spec'l. Features: Infectious waste
Load Capacity: 25 lbs.
Price: \$18.20

NSN: 8105-01-148-0280
Size: 41"x30-1/2", 30 gal.
Color: Red
U/I: BX
Quantity: 250
Spec'l. Feature: Infectious waste
Load Capacity: 75 lbs.
Price: \$41.96

Motion Sickness Bag

One-piece bag made of leakproof plastic comes with a closure tie. Comes folded in an envelope that reads: "MOTION SICKNESS BAG."

NSN: 8105-00-835-7212
Size: 6-1/8"x12x3"
Color: Opaque
U/I: MX
Spec'l. Feature: Motion sickness
Price: \$102.48

Relief Bag

Disposable, flask-shaped bag is designed for male pilots and other airborne personnel. Airtight, leakproof closure seals bag to trap urine and odor. Easily stored, this compact bag has a capacity of 500cc.

NSN: 8105-00-922-9469
U/I: EA
Spec'l. Feature: Pilot relief
Load Capacity: 500 cc
Price: \$8.63

Contact: vitaly.shik@gsa.gov
(Technical)
Phone: (212) 264-9605
glen.vanboven@gsa.gov
(Inventory)
Phone: (212) 264-5198

CORRECTION

GSA Catalog Correction

Readers of the GSA Supply Catalog, (Spring, 1997) should note the following change on Page 260:

NSN 7530-01-372-3098 and NSN 7530-01-372-3104 White Envelopes are now both sized 6-1/2" x 9-1/2".

These are regular white mailing envelopes with one side closure and are made from 50% recovered material, including 10% post consumer material (PCM).

NSN: 7530-01-372-3098
U/I: BX (50)
WDC: \$5.31
CSC: \$6.37

NSN: 7530-01-372-3104
U/I: BX (250)
WDC: \$16.30
CSC: \$19.54

Contact: glen.vanboven@gsa.gov
(Inventory)
Phone: (212) 264-8207

.....
Laser Printer Labels Schedule, Page 7,
January Issue of MarkeTips:

The correct address for Federal Marketing Co:

10400 Eaton Place;
Suite 305,
Fairfax City, VA 22030
Phone: 1-800-706-9249
Fax: (703) 293-6490
Contact: Ed Hurley
Contract No. GS-15F-9505C

Page 17, January issue incorrectly lists the NSN Award Certificate Binder for the U.S. Army.

It should read: 7510-00-755-7077

**Problems with
MUFFIN?**

**Call the
MUFFIN Help
Desk at
(703) 305-7200**



Special Price!

America's Most Popular Organizer

The Everything In One Place™ System features sections and pages which work together for managing time, people, projects and money. Flexible and easy to use, Day Runner offers the power to balance your personal and professional lives.

*Special pricing available July 1–October 31, 1998.

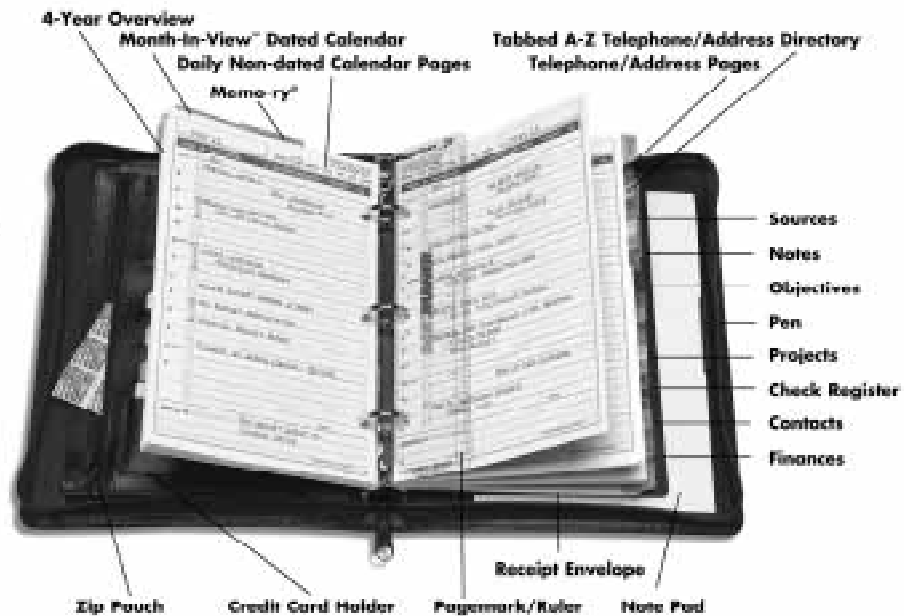

Classic™ Edition
Page size: 5 1/2" x 8 1/2" /
139.7mm x 215.9mm
Loose-leaf, 3-ring,
1 1/2" ring capacity



NSN 7530-01-371-5247 (black)
(Day Runner #114-60991) \$36.00*
NSN 7530-01-371-5248 (burgundy)
(Day Runner #114-6078) \$36.00*



NSN 7530-01-371-5249
camouflage, zip closure
(Day Runner #114-6042) \$36.00*

DAY RUNNER

©1998 Day Runner, Inc., Fullerton, CA 92631 220-8798 or (714) 880-2800 www.dayrunner.com

Available at all GSA Depots.

GSA prices subject to change. Check GSA Systems for current prices.



Vehicle Acquisition and Leasing Services

Washington, DC

Greater Southwest Customer and Vendor Focus Meetings

The Greater Southwest Fleet Management Division invites you to attend one of our Customer and Vendor Focus Meetings. These meetings provide customers and vendors an opportunity to share and exchange ideas and information relative to government vehicles. We'll cover topics such as maintenance, customer service, products, etc., and we'll also explain GSA's Fleet Management Program - - what we offer and the services available to our customers. These meetings will be held throughout the year at various locations in Texas, Louisiana, Oklahoma, New Mexico, and Arkansas. The following identifies meetings scheduled for July through October 1998. For details, please contact **Mr. Fred Cox** at **817-978-4351**.

July 21, 1998

Location: Airport Hilton
El Paso, TX
Customer Sessions: 9:00 am and
1:00 pm

July 23, 1998

Location: DOE Conference
Room
Carlsbad, NM
Customer Sessions: 9:00 am and
1:00 pm

August 5, 1998

Location: Riverfront Hilton
Little Rock, AR
Customer Sessions: 9:00 am and
1:00 pm

September 9, 1998

Location: Airport Radisson
Houston, TX
Customer Sessions: 9:00 am and
1:00 pm

September 22, 1998

Location: Holiday Inn
Gallup, NM
Customer Sessions: 9:00 am and
1:00 pm

What's Hot with Alternative Fuel Vehicles

The GSA fleet program purchased over 3,400 alternative fueled vehicles (AFV) for its customers this year! This brings the total number of AFVs purchased by GSA to over 18,000 vehicles nationwide. For model year 1998, the ethanol flexible fuel Dodge minivan and the ethanol flexible fuel Ford Taurus were offered to the Federal government at NO INCREMENTAL COST. This is great news for our customers! The monthly lease rate for these AFVs is the same as conventionally fueled vehicles. GSA fleet customers get an AFV at no additional cost, which helps them meet President Clinton's AFV goals.

For more information on leasing AFVs contact: **Denise Lenar (703) 305-6278**.

You II Can Have A Better Body, and Accessorize It!!!

Need something special for your vehicle? Want that just right look? Has safety been an issue in the past? Well it's possible to have all those things and more.

Yes, the Automotive Division now has Worldwide Multiple Award Federal Supply Schedule 25 I A, Vehicular Parts and Accessories, for the contract period May 29, 1997 through September 30, 2002 and Schedule 25 II B, Vehicular Bodies, for the contract period October 1, 1997 through September 30, 2002. Both schedules have an option to extend the contracts for one (1) additional five year period.

Both schedules will include the use of the Government Credit Card and expedited delivery will be available. Customers are strongly encouraged to utilize Blanket Purchase Agreements (BPAs) with the new suggested format printed in the schedules.

The following is a list of Special Item Numbers (SINs) under Schedule 25 I A:

Special Item Numbers Currently Awarded

Item Number 025-103
Tarps and Cargo Covers

Contractor:
Wholesale Trailer Supply
GS-03F-1007H

Continued next page



Item Number 025-104:

Truck Mounted Hoist, Tow Hooks and Trailer Towing Packages

Contractor:

Wholesale Trailer Supply
GS-30F-1007H

Item Number 025-105:

Tool Boxes for Trucks and Vans

Contractor:

Delta Consolidated Industries, Inc.
GS-30F-1008H



Contractor:

Wholesale Trailer Supply
Contract: GS-30F-1007H

Item Number 025-106:

Mud Flaps

Contractor:

Wholesale Trailer Supply
GS-30F-1007H

Item Number 025-107:

Remote Control Deadbolt Locks

Contractor:

Cargolock, Inc.
GS-30F-1004H

Item Number 025-109:

Law Enforcement Emergency Signal Systems including PA Speakers

Contractor:

Wholesale Trailer Supply
GS-30F-1007H

Item Number 025-111:

Light Fixtures for all Vehicles

Contractor:

Middle Atlantic Warehouse Dist., Inc.
GS-30F-1005H

Contractor:

Wholesale Trailer Supply
GS-30F-1007H

Special Item Numbers Coming Soon

Item Number:

025-101 Mirrors and Assemblies for all vehicles

025-102 Bed Liners

025-108 Security Systems for all vehicles

25-110 Law Enforcement Vehicle Barriers

025-112 Equipment for Service Vehicles for interior and exterior use

025-113 New Technologies in the Automotive Accessories Department

The following is a list of SINs under Schedule 25 II B:

Special Item Numbers Currently Awarded

Item Number:

125-103 Boring Machines Truck Mounting Bodies

Contractor:

Concord Environmental Equipment
GS-30F-1011H

Item Number:

125-101 Vehicular Insert Dump Bodies (for pickup trucks and trailers)

Contractor:

Highway Equipment Company, Inc.
GS-30F-1014H

Contractor:

Maxi Products Company, Inc.
GS-30F-1015H

Special Item Numbers Coming Soon

125-102 Service and Line Bodies (including Utility, Goose, Snow and Crane Bodies)

125-104 Stake Bodies (for Light Duty, Medium and Heavy Trucks)

125-105 Electric ARC Welding Equipment (Truck Mounted)

125-106 Wrecker Bodies (Light, Medium and Heavy Trucks)

If you would like more information on either of these schedules and their availability, please contact Christy Morrison on (703) 305-3097 for Schedule 25 I A, or Mike Balzer on (703) 308-6011 for Schedule 25 II B, or call our Customer Service Line on (703) 308-CARS.

Phone Number Corrections

GSA's Customer Assistance Guide (CAG), dated Winter 1998 listed an incorrect phone number for the Customer/Vendor Relations Director and Marketing Manager for the Automotive Division. Please make note of the following phone numbers:

Customer Service and Marketing Hotline (703) 308-CARS

Nancy Tyrrell
Customer Service Team Leader
(703) 305-3091

Mike Harris
Marketing Team Leader
(703) 305-6651

Theresa Ashton
Marketing Team
(703) 305-5917



Paints and Chemicals Center Auburn, WA

Sempens Touch-Up Pens Have New NSNs and Unit of Issue

Sempen touch-up pens are now available through GSA. Each pen contains 10cc of product, and is actually MIL-PRF-85285 Type 1 polyurethane coating kits and epoxy primers MIL-P-23377 and MIL-PRF-85582. With Sempens, you have the power to fix small flaws in the paint job!! No more wasting a large kit of material just to touch up a few dings. We've recently added several new colors and changed the unit of issue to each. Since these pens were introduced, demand has been sky-rocketing. They are available at a minimum order of 24 for \$10.45 each. Order now by FEDSTRIP/MILSTRIP to have plenty on hand for those last minute touch up jobs!

MIL-PRF-85285, Type 1 Polyurethane Coating Sempens, U/I: EA.

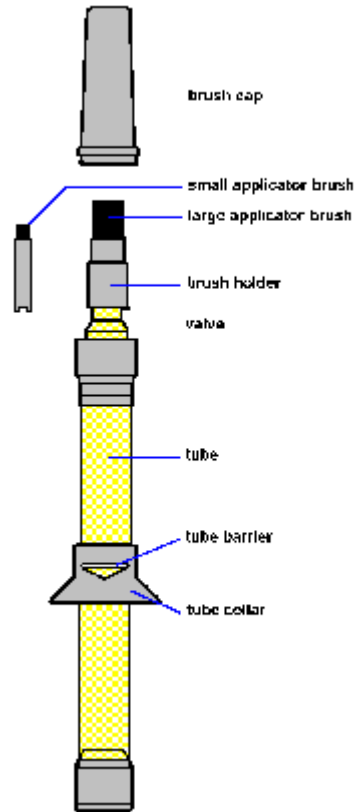

MIL-P-23377 Primer Coating Sempens:

<u>NSN</u>	<u>Color</u>
8010-01-441-6030	Yellow
8010-01-441-6031	Green

MIL-PRF-85582 Primer Coating Sempens:

<u>NSN</u>	<u>Color</u>
8010-01-441-6032	Yellow
8010-01-441-6033	Green

Contact: yvonne.salas@gsa.gov
Phone: (253) 931-7082

Gloss

<u>NSN</u>	<u>Color</u>
8010-01-441-6017	Clear
8010-01-441-6018	11136 Red
8010-01-441-6019	12197 Int'l. Orange
8010-01-441-6003	13538 Yellow
8010-01-441-6004	15044 Blue
8010-01-441-6005	15050 Blue
8010-01-441-6020	16473 Lt. Gray
8010-01-441-6026	17038 Black
8010-01-441-6029	17925 White

Semigloss

<u>NSN</u>	<u>Color</u>
8010-01-441-6006	24052 Green
8010-01-441-6007	26231 Gray
8010-01-441-6035	26250 Gray
8010-01-441-6034	26251 Gray

Flat

<u>NSN</u>	<u>Color</u>
8010-01-441-6008	31136 Red
8010-01-441-6009	33538 Yellow
8010-01-441-6010	35044 Blue
8010-01-441-6011	35237 Blue
8010-01-441-6021	36118 Gray
8010-01-441-6022	36173 Gray
8010-01-441-6012	36176 Blue
8010-01-441-6027	36231 Gray
8010-01-441-6013	36251 Gray
8010-01-441-6023	36270 Gray
8010-01-441-6024	36320 Gray
8010-01-441-6025	36375 Gray
8010-01-441-6014	36293 Gray
8010-01-441-6015	36495 Gray
8010-01-441-6028	37038 Black
8010-01-441-6016	37875 White

Let us take the
hassle out of your
day.

We've done all
the work for you
and we're just a
phone call away!

1-800-241-RAIN
(7246)

or e-Mail:
paintschemctr.
auburn@gsa.gov



Products To Reduce Your Painting Costs

Don't throw out those used paint rollers. They can be clean and dry in seconds with this roller washer!



Roller Saver

NSN: 8020-01-433-6636
U/I: EA
Price: \$31.50

Spatch-It™ - Get every last drop out of the paint can with this unique tool:

NSN: 8020-01-420-3129
U/I: BX (24 per box)
Price: \$47.93

Store-It™ - Paint Saving Disc - Prevent skinning or drying out of partial cans of paint with this floating disk:

NSN: 8020-01-387-2847
U/I: BX (24 per box for gallon cans)
Price: \$46.56

NSN: 8020-01-387-6271
U/I: BX (24 per box for 5 gallon cans)
Price: \$71.94

Pour-It™ and Jr. Pour-It™ - Can Cover - Pour without dripping and reseal cans with reusable paint can covers with these pouring spouts:

NSN: 8020-01-385-7373
U/I: BX (24 lids for gallon cans)
Price: \$47.21

NSN: 8020-01-385-7389
U/I: BX (24 lids for quart cans)
Price: \$39.24

These environmentally innovative products can be ordered through normal FEDSTRIP/MILSTRIP procedures.

Contact: pat.finch@gsa.gov
Phone: (253) 931-7073 or
melissa.scarlett@gsa.gov
Phone: (253) 931-7487

EPA-17 Free, Low VOC Sealants And Adhesives

We have identified many products that contain no chemicals on the EPA-17 list, no carcinogens, no chemicals reportable under SARA 313 and no shipping hazards. Here is a sampling of these products that can help meet your environmental goals.

Architectural Products

Linoleum adhesive, MMM-A-137:

NSN: 8040-00-273-8713
U/I: GL (1 Gallon)
Price: \$13.27

Caulking, A-A-272 Type 4:

NSN: 8030-00-180-6339
U/I: CA (10 oz)
Price: \$2.35

General or Multi-purpose Products

Two part Epoxy adhesives, A-A-3053 Type 1, low strength epoxy adhesive:

NSN: 8040-00-753-4800
U/I: KT (1.5 oz)
Price: \$2.30

A-A-3053 Type II, intermediate strength epoxy adhesive for nonporous substrates:

NSN: 8040-00-846-3351
U/I: KT (1 pint)
Price: \$31.37



EPK 608, optically clear, high strength epoxy bonds metal to fiberglass:

NSN: 8040-00-092-2816
U/I: BX (100 4g double bubble packets)
Price: \$19.83

Office adhesives, A-A-342 (gluestick), for paper:

NSN: 8040-01-039-8132
U/I: BX (12 small white sticks)
Price: \$3.21

These products are available through normal FEDSTRIP/MILSTRIP procedures.

Check our internet homepage at www.northwest.gsa.gov/fss/pnt_chem for additional information on our environmental products.

Contact: pat.finch@gsa.gov
Phone: (253) 931-7073 or
john.mcbrien@gsa.gov
Phone: (253) 931-7526



Scouring Pads

3M Scotch-Brite, a fiber scouring pad made from 100% recycled beverage bottles. This product contains effective grease-cutting detergents. The pads outlast steel wool without painful steel splinters. All detergents used are biodegradable and phosphorous free and will not leave a rusty residue. Order through **GSA Advantage!**TM or normal FEDSTRIP/MILSTRIP procedures.



NSN: 7930-01-393-6753
U/I: BX (168 pads)
Price: \$23.51

Contact: lee.heydlauff@gsa.gov
Phone: (253) 931-7113

Are You Into Space And Waste Minimization?

The Paints and Chemicals Center has a unique Multiple Award Schedule, FSC 79, Part VII, Chemical Dispensing Systems/Products. These systems allow for accurate and safe dilutions into containers so that you use only what you need. GSA has numerous vendors under this schedule. We do not recommend one vendor or product over another. Check them all out and then order the product

that best meets your needs. To ensure you have a choice in ordering, the products have National Stock Numbers and can be ordered by FEDSTRIP/MILSTRIP procedures or you may order direct from the company using a purchase order or your IMPAC Card. Call the Paints and Chemicals Center at 1-800-241-RAIN (7246) for more information, or if you would like to receive a copy of this schedule (mail list code 00SC 7907) contact the GSA Centralized Mailing List Service (7CPNL), PO Box 6477, Fort Worth, TX 76115 on the INTERNET: CMLS.gsa@gsa.gov or on-line ordering at <http://pub.fss.gsa.gov> or FAX your request to (817) 334-5227.

Contact: barbra.weitzel@gsa.gov
Phone: (253) 931-7932

Make Your Vehicles Look Like NEW!

Looking for commercial auto care products to keep your vehicles looking new? You can go to an auto supply store for your automotive care needs without leaving your office. Check out the new Multiple Award Federal Supply Schedule FSC 79 IX A for auto care products. These negotiated contracts are easy to use, provides one stop shopping, products are shipped direct to your location, AND you can use your I.M.P.A.C.[®] Card! What can be easier!



This schedule covers a variety of commercial auto care products including: auto cleaners, car wash soaps, auto polishes, waxes, polish/gloss enhancers,

glazes, chrome/metal polishes, auto polishing kits, plastic and fiberglass cleaners, vinyl and leather cleaners, tire care cleaners/dressings/protectants, tire sealants, windshield care products, ice scrapers, car air fresheners/deodorizers, upholstery/carpet cleaners, road hazards car kits, battery mats and more.

If you would like to receive a copy of this schedule (mail list code 00SC 7911) contact the GSA Centralized Mailing List Service (7CPNL), PO Box 6477, Fort Worth, TX 76115 on the INTERNET: CMLS.gsa@gsa.gov or on-line ordering at <http://pub.fss.gsa.gov> or FAX your request to (817) 334-5227.

Contact: will.kamstra@gsa.gov
Phone: (253) 931-7085

Unit of Issue Change for Sodium Bicarbonate

Effective September 1, 1998, Sodium bicarbonate, NSN 6810-00-297-0092, will be sold in 50 pound bags in lieu of the current 100 pound bags.

The selling price for the smaller size will be \$33.00 per bag as opposed to the current selling price of \$62.29 per 100 pound bag.

The NSN will remain the same.

Contact: warren.hayashi@gsa.gov
Phone: (253) 931-7050



New Schedule for Water Purification Treatment Chemicals and Services

The New Multiple Award Schedule for water purification chemicals, 68 V A is now available, offering you a choice of products from ten (10) contractors. This schedule contains chemicals suitable for:

- purifying water for human consumption;
- purifying and treating water in spas and swimming pools;
- aid in the treatment of waste water/ sewage by affecting the biodegradability, pH, odor control or pathogen control; and
- bio-remediation products - USDA or EPA approved organisms that degrade hydrocarbon spills, grease traps and sewage.

These contracts contain either product only, product with some basic services, or service only for customers that need more extensive testing of water and/or operation of equipment.

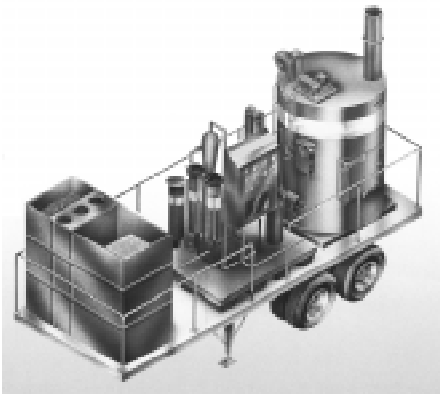

Also Available:

Schedule 68 V B&C: Chemical Products for treatment of Heating and Cooling Systems and Boiler Fuel Oil Additives. The current available issue of this schedule has been extended to January 31, 2002.

Available services include consultation, site evaluation, equipment setup, training of operation/maintenance of water treatment systems; heating, cooling systems, etc. Price includes travel and expenses. Contractors are available nationwide.

If you would like to receive a copy of these schedules, (mail list codes 07SC 6821 and 00SC 6821) contact the:

GSA
Centralized Mailing List Service
(7CPNL)
P.O. Box 6477
Fort Worth, TX 76115

on the Internet: cmls.gsa@gsa.gov or on-line ordering: <http://pub.fss.gsa.gov> or Fax your request to (817) 334-5227.

Contact: sharon.flannery@gsa.gov
Phone: (253) 931-7898

Sorbents - Marine and Nonmarine

For your Hazardous and Toxic Organic Spills, Marine Spills, Non-Water Soluble and Nonhazardous and Nontoxic Organic Spills check out GSA Federal Supply Service's Multiple Award Schedule, FSC 79, Part V.

You have a choice of mats, rolls, pads, pillows and "kitty litter". Also, check out some new areas:

- Reusable Sorbents (may be reused over 500 times)
- Waste Disposal Service
- Pre-moistened hand cleaner towels

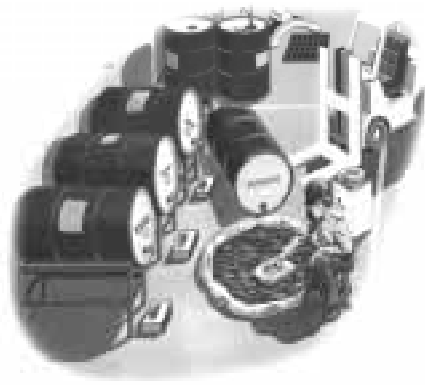

-- 100% Recycled Sorbent Material*
(Some of these items now available through the GSA depot program)



NSN: 7930-01-418-1514
U/I: BX (100 EA)
Size: 14" x 24" pads
Price: \$30.46

NSN: 7930-01-436-7896
U/I: BX (4 EA)
Size: 8" x 120" booms
Price: \$95.85

NSN: 7930-01-436-7998
U/I: BX (25 LBS)
Product: Absorbent Sweep
Price: \$27.69

For your convenience you may use the government I.M.P.A.C.® card. To request a copy of this schedule, (mail list codes 10SC 7905) contact the:

GSA
Centralized Mailing List Service
(7CPNL)
P.O. Box 6477
Fort Worth, TX 76115

on the Internet: cmls.gsa@gsa.gov or on-line ordering: <http://pub.fss.gsa.gov> or Fax your request to (817) 334-5227.

Contact: carol.mckenzie@gsa.gov
Phone: (253) 931-7887

Solvent Recycling Service Continues...

with a NEW service added. The contract now includes Aqueous Recycling Parts Washer Service to help with your hazardous material handling. This will provide a more environmentally acceptable alternative to your solvent usage. All the original service choices are still available.

This contract is still a closed loop system. Safety Kleen services the parts washer, provides clean solvent and takes away the old solvent for recycling. Safety Kleen does the following work for your activity:

- Obtains all necessary licenses
- Obtains all necessary permits
- Compliance with Federal, state, local and municipal laws, codes and regulations.



If you would like to receive a copy of Federal Supply Single Award Schedule 495 I A (mail list code 10SS 4902) contact the:

GSA
Centralized Mailing List Service
(7CPNL)
P.O. Box 6477
Fort Worth, TX 76115

on the Internet: cmls.gsa@gsa.gov or
on-line ordering: <http://pub.fss.gsa.gov>
or Fax your request to (817) 334-5227.

You can contact Safety Kleen directly on
(800) 669-5740.

Contact: carol.mckenzie@gsa.gov
Phone: (253) 931-7887

Toiletry Items Are On Multiple Award Schedules

We have developed a Multiple Award Schedule specifically to provide you, our customer, with the option to purchase commercial toiletry items through GSA. Schedule FSC 85 II A consists of negotiated contracts that are easy to use, provide one stop shopping, products are shipped direct to your location AND you can use your I.M.P.A.C.® Card! What can be easier?

This schedule covers a variety of commercial toiletry products including hand cleaners, shampoo, cream rinse, soap, hand protectant, hand lotions, shaving cream, razors, mouth wash, toothpaste, deodorants, and much more.

If you would like to receive a copy of this schedule (mail list code 00SC 8510) contact the:

GSA
Centralized Mailing List Service
(7CPNL)
P.O. Box 6477
Fort Worth, TX 76115

on the Internet: cmls.gsa@gsa.gov or
on-line ordering: <http://pub.fss.gsa.gov>
or Fax your request to (817) 334-5227.

Contact: yolanda.trevino
Phone: (253) 931-7090

U.S. Postal Service Customers: We have EPA 17 Free Paint!

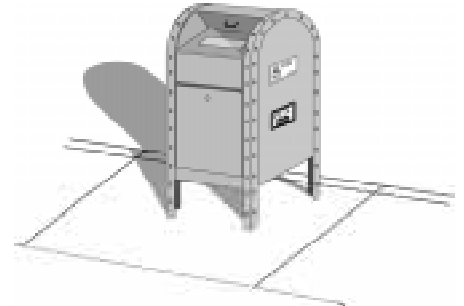

Federal Specification TT-E-2784 is an acrylic enamel that is free of all EPA 17 chemicals. It is intended for use on exterior primed metal, concrete, masonry and wood, but may also be used for interior application. This paint provides a durable, long lasting coating when applied over properly prepared surfaces and is characterized by excellent gloss retention.

So it's the perfect product for indoor and outdoor collection boxes, and also for urks! It has a maximum VOC of 200 grams per liter and is available in over 150 colors. The NSN for Post Office Blkue is 8010-01-333-9819 and comes in a 1-gallon can. For a complete listing of colors and sizes, please check the GSA Supply Catalog or visit us on-line at **GSA Advantage!**™ at: www.fss.gsa.gov for browsing and ordering.

Contact: pat.finch@gsa.gov
Phone: (253) 931-7073



News and Information

Rota Welcomes GSA's Uncle Sam's Club

On Tuesday, May 19, 1998, GSA and Navy officials joined forces at Naval Station Rota, Spain to celebrate the dedication and Grand Opening of the Uncle Sam's Club, Rota. A ribbon cutting ceremony took place with FSS Commissioner Frank Pugliese, Mid-Atlantic Regional Administrator Rafael Borrás, FSS Assistant Regional Administrator Jack Williams, and Captain Gerald Stair, Commander U.S. Naval Activities Spain and Commanding Officer Naval Station Rota, cutting the ribbon.

The Uncle Sam's Club is the result of an initial request for assistance by the Naval Station in 1996. They asked for GSA's help in reducing inventory while continuing to maintain a wide range of products for their customers. GSA's Northeast Distribution Center at Burlington initially partnered with the Navy by providing

display boards in their Servmart allowing the Navy to order directly from GSA and to stock fewer items, while having a greater selection for the customers. The success of this endeavor prompted the Navy to enlist GSA's help once again in enhancing the Navy Servmart. The result was the establishment of the second Uncle Sam's Club! Modeled after the successful Uncle Sam's Club in Norfolk, VA, the store actually opened for business on October 29, 1997. Since then, sales have exceeded \$500,000.

Along with Uncle Sam's Club, two packaged room projects were dedicated on May 19, 1998 at the Naval Station. A total of 255 packaged rooms, valued at over \$1.6 million, were installed. American of Martinsville and Thomasville furnished these. The completion of these projects demonstrated the shared commitment not only between GSA and the U.S. Navy, but with our industry partners as well.

Rota Naval Base in southwestern Spain is one of strategic importance to the Navy.

Its core mission is to keep fuel, oil, ammunition and spare parts flowing to the US SIXTH Fleet operating in the Mediterranean. While remaining under the Spanish flag, the base is used jointly by Spain and the United States. Commander U.S. Naval Activities Spain, Captain Gerald Stair, is headquartered at Rota and is the area coordinator for all US Naval shore activities in Spain. Since he is also the Commanding Officer of Naval Station Rota, Captain Stair maintains and coordinates the overall security, upkeep and support features, which ensure smooth operation of the installation. GSA assists in this capacity by providing services and continued support with supplies and furniture. Both GSA and the Navy are thrilled at the flourishing partnership and look forward to more success stories. GSA is proud to support the U.S. Navy by adding value and excellence to their day to day needs. We thank them for issuing us such a challenge and giving GSA the opportunity to demonstrate our promise to deliver! For more information, please contact Morris Boiman on (609) 499-7000.

GSA Advantage!TM

GSA Advantage!TM Online Shopping "Cool Stuff I Didn't Know"

Attention Savvy Negotiators: Did you know that you can actually reduce the price of a Federal Supply Schedule item on-line?

Let's say you have negotiated a lower price with a schedule contractor for a large quantity order or maybe you have a

Blanket Purchase Agreement (BPA) with the contractor for specific items. **GSA Advantage!TM** allows you to reduce the posted price directly on-line. The price reduction entered will appear on the purchase order generated by **GSA Advantage!TM** (be advised that you will be asked to provide a BPA number or the contractors point of contract authorizing the price reduction. This will be passed to the contractor).

Have questions, need more information call: (703) 305-7359

**GSA Advantage!TM
is constantly adding
items to its data
base. Not all items
listed in MarkeTips
are available at this
time, but we are
catching up... please
keep checking
regularly.**



The I.M.P.A.C.® Card Is Accepted At

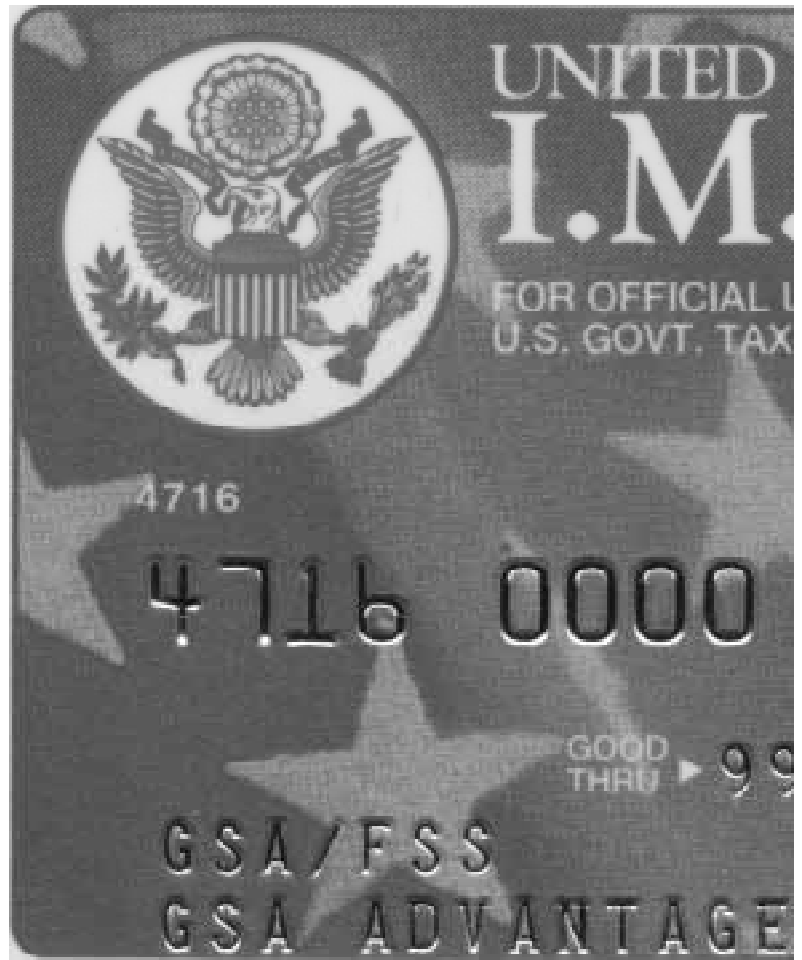

All GSA Customer Supply Centers

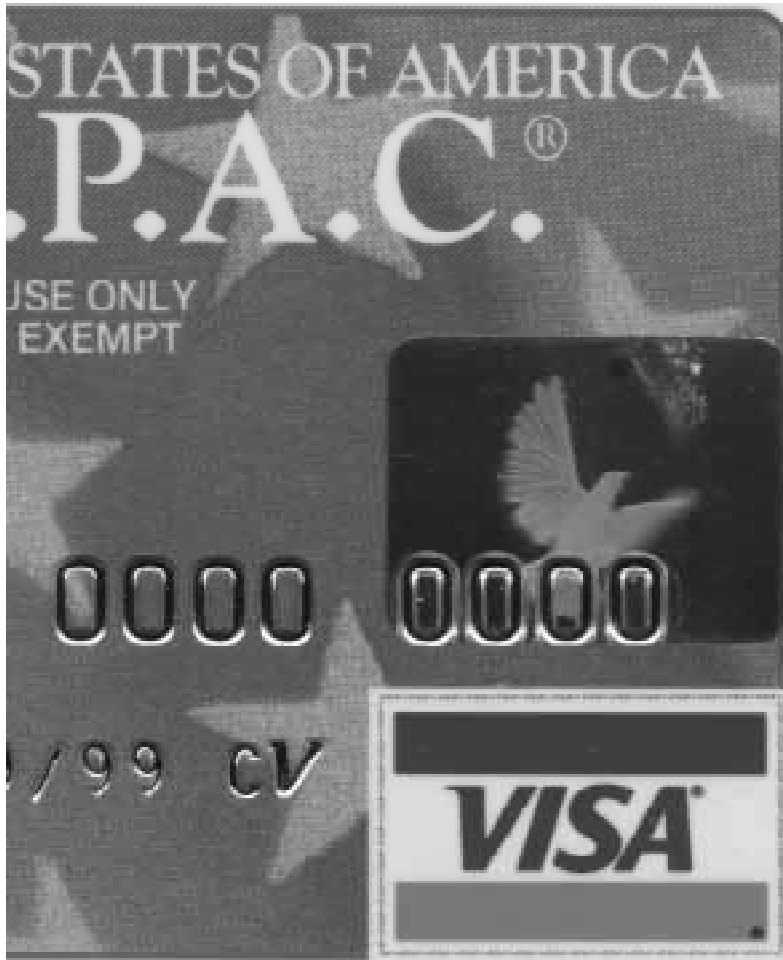

To Place an Order, Contact Your Regional Customer Supply Center*

Franconia Virginia	Palmetto Georgia	Burlington New Jersey	Worth Illinois	Denver** Colorado
Phone: 1-800-848-8952	Phone: 1-800-473-4484	Phone: 1-800-788-7155	Phone: 1-800-262-0570	Phone: 303-236-1917
Fax: 1-800-848-9085	Fax: 1-800-416-7065	Fax: 1-800-814-2571	Fax: 1-800-734-9575	Fax: 303-236-5329
Stockton California	Anchorage Alaska	Auburn Washington	Ft. Worth Texas	
Phone: 1-800-786-0258	Phone: 1-800-472-5843	Phone: 1-800-859-4377	Phone: 1-800-525-8027	
Fax: 1-800-435-9475	Fax: 1-800-660-3833	Fax: 1-800-603-8357	Fax: 1-800-856-7057	

Government I.M.P.A.C.® VISA Accepted

For more information about the Customer Supply Centers and the location nearest you, please visit our Home Page at www.fss.gsa.gov (click "Customer Assistance" and then "GSA Customer Supply Centers").

*Availability and prices of some items may vary outside of the continental United States. Availability may also be limited for customers using *GSA Advantage!*™ or the ROCS system.

**Serving the Denver area only



Office and Scientific Equipment Center

Washington, DC

Digital and One-Time Use Cameras on Schedule

No film required! Now when you take the picture you can transfer the image to your PC. A PC card adapter for your digital disk enables you to transfer images from your camera to your computer. The images are editable and reproducible. GSA's digital cameras perform desktop publishing, graphics, print production, image archives, security and identification, multimedia programs and web page development. The images can even be attached to electronic mail. Let GSA provide you with imaging power!



Great photos are now easier than ever! We've got 35mm One-Time Use Cameras. Indoor and Outdoor color prints and Flash are available on most models. There's even a waterproof model for your convenience. Why look any further?

One-Time Use Cameras and Digital Cameras and Accessories can be found on Multiple Award Schedule 67 II and III, Photographic Equipment and Supplies.

Contact: mary.richards@gsa.gov
Phone: (703) 305-5969

Doppler Acoustic Sounder

Doppler Acoustic Sounders are available that produce real-time wind and turbulence profiles within the atmosphere's lowest kilometer. In uniform terrain conditions, the basic system, comprised of two antennae's, measures north-south and east-west components from which the resultant horizontal wind vector is computed. In complex terrain situations, a third antenna is incorporated for direct measurement of the local vertical wind motions producing a complete measurement of the three-dimensional wind field in 30-meter increments. The result is a time sequence of high-resolution spatial wind and turbulence observations for characterizing the diurnal, dynamic structure of the local boundary layer.

Other Doppler models available are designed as high resolution temporal and spatial monitors of the lower atmospheric boundary layer. They operate on an acoustic frequency of 2800 Hz and samples from 30 meters to 600 meters in five meter increments. Smaller units operate on 4500 Hz and samples from 10 meters to 200 meters. Steered-beam phased array antennae coupled with reflector-type antenna enclosures help to create the high resolution displays. Doppler sonar systems operate in all types of weather as well as both noisy and quiet environments.

Now available on Federal Supply Schedule Group 66, Part II, Section Q, Special Item Number 66-410g.

Contact: rhonda.davis@gsa.gov
Phone: (703)305-6299

Photo Identification Systems

Photo Identification Systems are available under Federal Supply Schedule Group 67, Parts II & III. These Photo Identification Systems can provide a wide array of functions which include Employee Badges, Passport Photos, Magnetic Striped Cards and Membership Cards. Accessories include ID Badge Holders and Laminating Film. An assortment of Fingerprinting Systems and Accessories are also available, including Finger Cards and Cardholders, Fingerprint Pads and Cleansing Towelettes.



Contact: mary.richards@gsa.gov
Phone: (703) 305-5969

**Come visit us at
our new website:**

**[http://pub.fss.
gsa.gov/scientific](http://pub.fss.gsa.gov/scientific)**



Leak Detection Devices Recently Awarded Under New Technology Program

In keeping with our customers demands for the latest technologies, and to stay up-to-date with all the latest products, the Office and Scientific Equipment Center is able to make these products available to you when they become available to commercial customers. Through this new technology program, we now offer devices which can detect environmentally hazardous leaks.

The first is LeakNet, a high performance, easy-to-use, cost-effective leak detection and location system. It can be used for gas, liquid, multi-phase pipelines, and storage tanks. The system offers rapid, completely automatic service under both flowing and static conditions. It has a remote Valve Operator that provides console control of block, delivery, and injection valves and provides the following detection methods: Leak Location, Pressure Point Analysis, Masspack and Smartpoint.

The Federal Supply Schedule contractor for this product is:

EFA Technologies, Inc.
1611 Twentieth Street
Sacramento, CA 95814
(916) 443-8842
FAX: (916) 443-3759



Contract Number: GS-24F-9001H

The second leak detection product is the D-Tek Refrigerant Halogen Leak Detector (Handheld Automotive Model). This monitor is used to detect a wide variety of refrigerant leaks in commercial automotive and truck maintenance repair facilities.

The Federal Supply Schedule contractor for this product is:

Nestor Sales Inc.
d/b/a Ace Tool Company
7337 Bryan Dairy Road
Largo, FL 34647
(813) 544-6114
FAX: (813) 544-6211



Contract Number: GS-24F-3039G

The third item is a Refrigerant Monitor, used to detect refrigerant leaks down to one part per million. This product offers different cost-effective alternatives for continuous monitoring of refrigerants with any chiller configuration. With this product you can be alerted early on to those allusive and insidious low level, costly leaks.

The Federal Supply Schedule contractors are:

North East Technical Sales Inc.
402 Gordon Road
Eton, PA 19341
(610)524-1212
FAX: (610)524-8425

Contract Number: GS-24F-3052G

SenTech Corporation
5745 Progress Road
Indianapolis, IN 46241
(317) 248-1988
FAX: (317) 248-2014

Contract Number: GS-24F-2049D

All of these items are available under Federal Supply Schedule 66 II R.

Contact: rhonda.davis@gsa.gov
Phone: (703)305-6299

Drop Us A Line...

The Office and Scientific Equipment Center would like to reach our customers on the WorldWide Web. Please provide your E-mail address to receive information regarding new products, upcoming seminars, customer focus groups, and various other items of interest.



Send your E-mail address and Customer ID Number to **dee.faulkner@gsa.gov**



Customer Supply Center

Ergonomic Gel Wrist Rests

The Gel Wrist Rest
Forms to standard
and ergonomic
keyboards!



The Gel Wrist Rest with Mouse Pad



- New soothing Memoflex® gel conforms to your wrist, reducing pressure for exceptional comfort.
- Memoflex® is the only gel that is guaranteed never to lose its shape or leak!

Gel Wrist Rest
7510-01-444-2533 **\$10.19**

Mouse Pad with Gel Wrist Rest
7510-01-444-2534 **\$11.20**

Call your local GSA Customer Supply Center and order today!

Now Available at Your Local Customer Supply Center

INFINITY *toner cartridges*

American-Made ★ High-Yield Money-Saving Alternatives To Hewlett-Packard and Remanufactured Cartridges

Infinity 3 Toner



High Yield Alternative to HP 92295A

For HP LaserJet 3, 3L, 3S, 3D and all Laser Printers with 33 type machine
This ultra-high yield toner cartridge fits over 200 printers and will print up to 4 times as many pages as the HP 92295A cartridge.

MSRP 7510-01-417-1222
Part Number 3229560
GSA GSC Price \$123.11

Infinity 4 Toner



High Yield Alternative to HP 92298A

For HP LaserJet 4, 4+, 4M & 4M+ Printers

NOT FOR USE WITH HP 4 SERIES PRINTERS:
Specially designed for HP 4 series LaserJet printers (4, 4+, 4M & 4M+), the Infinity 4 will print 2.5 times as many pages as the HP 92298A.

MSRP 7510-01-417-1229
Part Number 3229865
GSA GSC Price \$165.16

Infinity 5 Toner



High Yield Alternative to HP 92298A

For HP LaserJet 5, 5M, 5N, 4, 4+, 4M & 4M+ Printers

Similar to the Infinity 4 Laser Cartridge but specially designed to fit both the HP 4 & 5 series LaserJet printers (4, 4+, 4M, 4M+, 5, 5M & 5N). Will print twice as many pages as the HP 92298A.

MSRP 7510-01-440-2121
Part Number 3229511
GSA GSC Price \$190.50

Guaranteed Quality • Guaranteed Savings

Made In U.S.A.



ANNOUNCING

NEW JWOD APPROVED PENS



ERGONOMIC RETRACTABLE PEN

\$18.18 ea.

Wide body for extra comfort.

- Thick cushion grip
- Smooth writing, no skip, refillable
- Ergonomically engineered

Black ink, medium point7520-01-424-4876
 Black ink, fine point7520-01-424-4896
 Blue ink, medium point7520-01-424-4854
 Blue ink, fine point7520-01-424-4873

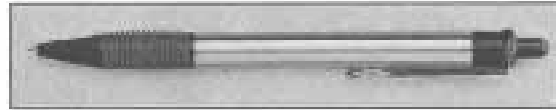

METAL GRIP RETRACTABLE PEN

\$11.00 ea.

Ergonomic design for extra comfort.

- Rubber grip for less writing fatigue
- All metal lightweight construction
- Superior writing characteristics

Black ink, medium point7520-01-445-7226
 Black ink, fine point7520-01-445-7237
 Blue ink, medium point7520-01-445-7230
 Blue ink, fine point7520-01-445-7221

Available at Customer Service Centers



Milwaukee Industries for the Blind
www.thomasregister.com/IB

Attention GSA Customers

3M Privacy Computer Filters, now available at your Regional Customer Supply Center!

3M Privacy Filters allow only the person seated directly in front of the monitor to read the displayed information. From the side, passersby see only a dark, blank screen. The combination of optically-coated glass and contrast enhancement virtually eliminates glare.



3M Privacy Filters

3M offers the only non-blur privacy!

- Patented 3M micro-louver technology makes on-screen data visible only to the person directly in front of the monitor
- Will not blur or distort images on the computer screen
- Help prevent eyestrain
- Anti-radiation models block up to 99.9% of ELEVATED E-field radiation
- Available in flat or contour, assembly-free frame design
- Contour Frame Filter (P1420) provides lighter fit
- Anti-static



NSN No.	Order No.	3M Part No.	Description	Fits Monitor Size	GSA Price
7045-01-437-2440	46184	P1500S	Flat frame filter/privacy	10-13"	\$ 86.75
7045-01-437-2441	46185	P1500L	Flat frame filter/privacy	13-15"	88.30
7045-01-437-2454	46186	P1500XL	Flat frame filter/privacy	16-19"	173.41

3M Computer Filters are

Assembly-Free!

All models shown include a Lifetime Warranty!

Free!

3M™ Precise Mousing Surface

Purchase any computer filter from this flyer and receive absolutely FREE by mail... a 3M™ Precise Mousing Surface. An \$11.00 value.



New Easy Clean Surface!

3M Computer Filters are now available with 3M's exclusive Easy Clean technology. No expensive cleaners are needed. Cleans easily with just water and a soft cloth.



New at GSA's Customer Supply Centers!

Remanufactured Inkjet Cartridges for Plotters and Ink Jet printers!

- Save \$\$\$
- Help the Environment
- 100% Reliable
- 0% Failure in 1997 thru GSA/FSS

Remanufactured Ink Jet Cartridges:

NSN No.	Product	Price Ea.
7510-01-443-2122-A	Reman. HP 51629A Cartridge	\$ 18.13
7510-01-443-2123-A	Reman. HP 51626A Cartridge	\$ 17.20
7510-01-452-6033-A	Reman. HP 51633M Cartridge	\$ 19.13
7510-01-452-6034-A	Reman. HP 51645A Cartridge	\$ 19.19
7510-01-452-6035-A	Reman. Canon BC-01/02 Cart.	\$ 15.44
7510-01-452-6037-A	Reman. HP 51641A Cartridge(tri-color)	\$ 20.00
7510-01-452-6038-A	Reman. HP 51640M Cart. (Magenta)	\$ 20.25
7510-01-452-6039-A	Reman. HP 51640C Cartridge(Cyan)	\$ 20.25
7510-01-452-6040-A	Reman. HP 51640Y Cartridge(Yellow)	\$ 20.25
7510-01-452-6041-A	Reman. HP 51540A Cartridge	\$ 17.38

Save 35-45% off the cost of new cartridges, without sacrificing quality!

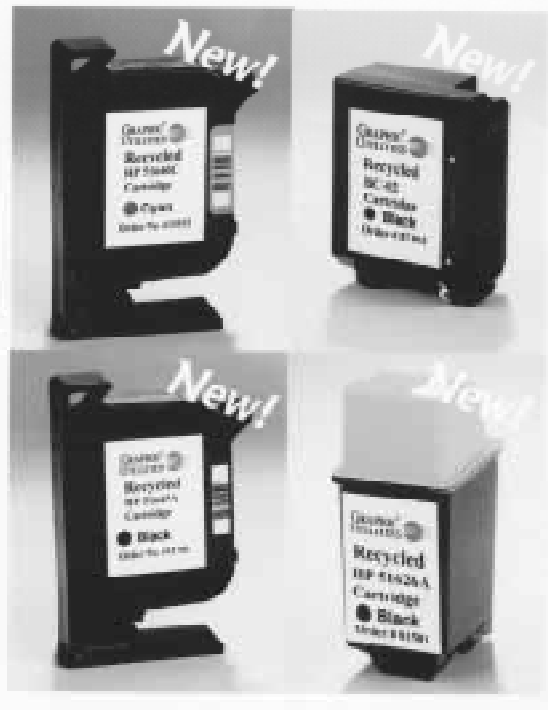

New—Now Available!
SAVE MONEY!
 (without sacrificing quality!)

100% NEW compatible toner cartridges for HP LaserJet printers from Lexmark.

Lexmark is a former division of IBM. Their compatible cartridges are made from **100% new parts**. An independent testing lab, NSTL, reported the Lexmark cartridges meet and in some cases **exceed the performance standard set by HP** for print quality, pages per cartridge, and over all reliability!



NSN	Description	Lexmark's Part #	Price
7510-01-449-6942	Toner cartridge for HP LaserJet 4/5 printer	140198A	\$89.74
7510-01-449-3053	Toner cartridge for HP III/4/4Si printer	140191A	\$110.13

Call your local GSA Customer Supply Center and order today!



Clear the Air with Zep Meter Mist Air Fresheners



Available through GSA
Customer Supply Centers

- *Automatic deodorizing*
- *Long-lasting fragrances*
- *Low VOC formulations*



The Zep Meter Mist 3000 Plus Automatic Aerosol System protects your environment against unpleasant odors. The state-of-the-art dispenser features:

- Automatic metered spray to provide the amount of control you need
- Automatic light sensor to control the operation of the dispenser in the daytime, nighttime, or both.
- Spray interval dial to set the unit to spray as often as required.
- Flashing yellow light to indicate the unit is operating; stops when the batteries are depleted.
- Flashing red light to signal the 3000 spray aerosol needs to be changed.
- Audio signal to alert when the aerosol is empty or when the batteries are low.

Dispenser comes complete with batteries and hardware.

Use the Zep Meter Mist 3000 Plus Dispenser with any of Zep's specially-formulated low VOC fragrances for the most effective air freshening:

Product	NSN	Price
Dispenser	4510-01-426-4187	39.85
No Odor	6840-01-368-4788	5.50
Green Apple	6840-01-368-4787	5.50
Peach	6840-01-368-4785	5.50
Country Garden	6840-01-368-4789	5.50
Cinnamon	6840-01-425-8229	5.50
Smoke Screen	6840-01-425-8232	5.50
Air Sanitizer II	6840-01-368-4786	5.50

ZEP MANUFACTURING COMPANY

Clean Across America and Throughout the World™

Visit www.zepmfg.com

**Order Zep Meter Mist
by calling your local CSC.**

When It Comes To Back Up Tapes GSA Has You Covered!



Verbatim

Covered!

Order Yours Today From Your Local CSC!

NSN	Description	Price
7045-01-406-4060	DC2120, Q1C80, Mini Cartridge	\$9.28 each
7045-01-406-4061	8mm 12mm, Data Cartridge	\$4.59 each
7045-01-406-4062	DC6150, Data Cartridge	\$11.23 each
7045-01-357-9939	4mm, 90mt, 2.0gb, Data Cartridge	\$6.06 each

Don't take chances! Back up your valuable work on top quality Verbatim tapes!

REMEMBER...

**Don't throw those Inkjet cartridges away!
GSA makes it easy for you to recycle.**

Please recycle these and other inkjet cartridges by HP, Canon, Epson, etc.:

HP 51626A	HP 51640C	HP 51641A	Canon BC-02
HP 51629A	HP 51640M	HP 51625A	Canon BC-20
HP 51633A	HP 51640Y	HP 51649A	and more....
HP 51640A	HP 51645A		



FREE postage paid recycle collection boxes. Holds 6 empty HP 51626 / 51629 Ink Jet cartridges. Other Ink Jet cartridge recycle materials available free from the GTS web site.

NSN No.	Product	Price
8115-01-386-2293-A	6-Pack Ink Jet Recycle Collection Box	FREE



Unlike toner cartridges, Ink Jet cartridges have no moving parts. This allows them to be remanufactured to the same standards as new cartridges, or even higher with new formulation inks in some cases. When thrown away, however, this resource never breaks down in the landfill, and requires new virgin materials to produce new cartridges - needlessly!

GSA Customer Supply Centers

To order, contact your regional Customer Supply Center or obtain fax order sheet at: GTS web site: WWW.GTSisGSA.com/recycle/gaorder.htm





InkLink Continuous Ink Supply System

Never run out of ink again! Feeds your HP 51626A or HP 51629A black cartridge 2 cartridges worth of ink. Then replace external ink tank without handling cartridge!



Save Over 50%!(and reduce waste too!)

InkLink Continuous cartridge fill kits:

NSN No.	Product	Price Ea.
7510-01-425-6797-A	InkLink kit for HP 500 Series Printers	\$21.19
7510-01-425-6805-A	InkLink Replace. Tank for 500 Series	\$17.69
7510-01-425-6789-A	InkLink kit for HP 600 Series Printers	\$21.81
7510-01-425-6755-A	InkLink Replace. Tank for 600 Series	\$18.28



Conserving the Environment and Still Write Volumes!

Gray Linen Top Writing Pads Made from 100% Recycled Paper!

Available in 5" x 8", letter, and legal size. 50 sheets of wide-ruled paper per pad. 50/20 recycled paper pads and virgin paper pads also available.

Available through your local
GSA Customer Supply Center!

Product	NSN	Price
5" x 8" Pad	7510-01-421-1585	\$ 3.16/DZ
Letter Pad	7510-01-421-1586	\$ 6.46/DZ
Legal Pad	7510-01-421-1587	\$ 7.94/DZ

JWGD

To Place an Order, Contact Your Regional Customer Supply Center*

Franconia Virginia

Phone: 1-800-848-8952
Fax: 1-800-848-9085

Palmetto Georgia

Phone: 1-800-473-4484
Fax: 1-800-416-7065

Burlington New Jersey

Phone: 1-800-788-7155
Fax: 1-800-814-2571

Worth Illinois

Phone: 1-800-262-0570
Fax: 1-800-734-9575

Denver Colorado

Phone: 303-236-1917
Fax: 303-236-5329

Stockton California

Phone: 1-800-786-0258
Fax: 1-800-435-9475

Anchorage Alaska

Phone: 1-800-472-5843
Fax: 1-800-660-3833

Auburn Washington

Phone: 1-800-859-4377
Fax: 1-800-603-8357

Ft. Worth Texas

Phone: 1-800-525-8027
Fax: 1-800-856-7057

Government I.M.P.A.C.® VISA Accepted

For more information about the Customer Supply Centers and the location nearest you, please visit our Home Page at www.fss.gsa.gov (click "Customer Assistance" and then "GSA Customer Supply Centers").

*Availability and prices of some items may vary outside of the continental United States. Availability may also be limited for customers using *GSA Advantage!*TM or the ROCS system.



Services Acquisition Center Washington, DC

Wouldn't it be great if you could delegate all your difficult tasks?

At GSA's Services Acquisition Center, we take the stress of acquisition off your mind—and deliver fast, direct-access to the quality industry leaders you need in Professional Support Services.

By using our schedules, you're assured every professional is pre-qualified. The price is pre-negotiated. We make compliance with procurement regulations easy. The result? You can now clearly focus on selecting the specialists who can do the best work for you.

In each edition of MarkeTips, we focus on a selection of programs that not only save the taxpayers money, but also assist agencies with specialized tools to meet their requirements. This edition concentrates on our:

- Equal Employment Opportunity (EEO) Services,
- Auditing and Financial Management Services,
- Temporary Clerical Support Services,
- Temporary Professional Support Services,
- Financial Asset Services, and
- The Next Generation of Travel, Purchase, and Fleet Payment Systems, Otherwise Known as GSA SmartPay.

In addition, we are also featuring a "How to..." section on the basics of placing a task order against one of our schedules.

Please share this article with those in your agency who may benefit from these

services. For further information or a listing of the many additional professional services that we provide, please contact one of our customer service representatives on (703) 305-6658 or visit our website at www.fss.gsa.gov and click on the SERVICES listing.

One Stop Shopping with GSA's EEO Program

GSA's newest Equal Employment Opportunity (EEO) Multiple Award Schedule (MAS) is now in full swing. Twenty-four EEO vendors have contracts awarded under the new MAS schedule.

The new MAS schedule contains no zonal restrictions and provides for a complete spectrum of services supplied by qualified EEO vendors at competitive prices.

Agencies can now meet all of the Federal Government EEO regulation requirements with this new and inventive "one stop shop" schedule.



The features of this program can be used to address existing EEO issues within your organization, or more importantly, this service can be used to create a healthier organizational culture and working environment. The new schedule features the following services:

- EEO Counseling,
- Alternative Dispute Resolutions,
- EEO Training and Consulting (off the Shelf Training and Customized Training)
- Investigations (at the Government Facility or at the Contractor's Facility),
- Final Agency Decisions,
- Inquiries Regarding Notices of Intent to Sue under the Age Discrimination in Employment Act,
- EEO Reference Materials,
- Analysis of Allegations of Noncompliance with Settlement Agreements and their findings.

We invite you to view our EEO Services in more detail. Please visit our website at:

<http://pub.fss.gsa.gov/services/eo>

For more information on eliminating the "Red-Tape" commonly associated with the EEO process, please contact Ms. Cindy Jones at the following e:Mail address: cindy.jones@gsa.gov or phone: (703) 308-0803.

Auditing Services and Financial Management Services

GSA's Services Acquisition Center is proud to announce the availability of a new Multiple Award Schedule for Auditing and Financial Management Support Services. This multiple award schedule provides the Federal Community direct access to industry leaders who provide auditing and financial management services to assist agencies in meeting their missions. Government officials, policy makers, and managers need reliable financial and performance information in order to achieve the goal of developing a more responsive and effective government. This schedule provides agencies with a wide choice of vendors, services and prices to meet all of your auditing and financial management needs.

Benefits of this program include direct access to specialized expertise agencies need but do not have on staff and assistance in meeting the requirements of the Chief Financial Officers (CFO) Act, Government Performance and Results Act (GPRA), and various Office of Management and Budget mandates, circulars, and bulletins. Available services include but are not limited to: Financial Audits, Performance Audits, Accounting, Budgeting, Financial Consulting, and other financial management services. The general types of contractual support covered by this program include:

Financial Audits

Provides CFO Act Financial Statement Audits, Forensic Audits, Cost Incurred Audits and Indirect Cost Audits.

Performance Audits

Provides IG Act Audits such as Economy and Efficiency Audits, Program Results, and Program Fraud Audits.



Accounting Services

Provides Accounting and Bookkeeping Support, Accounting Reconciliation, Data Manipulation, Financial Management Accounting Services, Preparing Pro Forma Statements, and Cost Benefit Analyses.

Financial Consulting

Provides Accounting and Audit Consulting, such as Policies and Procedures, Financial Procedures, Internal Control Structure, Financial Systems Improvement, Financial Systems Implementation, Actuarial Services, and Activity Based Costing.

We invite you to view this financial service in more detail. Please visit our website at:

<http://pub.fss.gsa.gov/services/audit-mgmt-svcs>

For more information on GSA's Auditing and Financial Management Services, please contact Ms. Alexandra Walter at the following email address or phone number: alexandra.walter@gsa.gov or (703) 305-6747.

Financial Asset Services

This exciting new GSA program provides a vehicle for all Government agencies to obtain the services of industry leaders with the qualifications, commitment, expertise, and experience required to assist the Government in the evaluation, management, maintenance, and disposal of various assets. The general types of support for Government financial asset services available through contracts under this program include, but are not limited to:

Transaction Financial Advisor Services

Provides asset sales services such as the valuation, management, maintenance, restructuring, and/or disposition of various assets (secured and unsecured notes, premiums, revenue streams, and other receivables).

Program Financial Advisor Services

Provides program financial advisor services which can include overall program management and staff development of marketing plans for an asset sale, review of sales reports, post sale analyses, and credit reform analyses.

Due Diligence and Support Services

Provides Federal Agencies with information to confirm and validate an agency's representations concerning the financial status and/or history of assets offered for sale to the public.

Loan Servicing

Provides services to monitor, service, maintain, and occasionally re-finance Government-held loans and assets such as bank loans, single family and multi-family project mortgage loans, education loans, small business loans, agricultural loans, etc.

Continued next page



Equity Oversight and Monitoring

Provides Federal Agencies with contractors who oversee limited partnership-type arrangements to ensure the Government interests are maximized.

We invite you to view this financial service in more detail. Please visit our website at:

<http://pub.fss.gsa.gov/services/asset-svcs>

Comments or suggestions are welcomed and can be submitted by contacting either Mr. Bill Toth or Ms. Catherine Maloney at the following email addresses or phone numbers:

william.toth@gsa.gov or (703) 305-6670
catherine.maloney@gsa.gov or (703) 305-7014.

Temporary Clerical and Temporary Professional Support Services

Have members of your administrative and professional staff been out sick when a critical project was due?

Are events like jury duty always happening at the worst time?

If so, let GSA come to the rescue with our two new Temporary Support Services Programs. Temporary Clerical and Temporary Professional Support Services both provide access to contractors, who are qualified to supply expert administrative, clerical, and professional support services to the Federal Government. The two contracting programs are 100% small business set-asides. Recent changes in the Procurement Preference Goal Program allow agencies to count the amount of any orders placed for these services towards meeting their small business goals.

Our Temporary Clerical Support Schedule provides clerical, legal, and medical secretaries; receptionists; general and administrative clerks; audit and accounting clerks; data entry operators; court reporters; stenotype operators; and transcribing machine operators.

Our Temporary Professional Support Schedule provides agencies with a wide range of professional services such as accountants, auditors, contract specialists, desktop publishers, environmental analysts, environmental technicians, graphic designers, lawyers, librarians, and market research analysts to name a few.

Both schedules allow agencies to solve temporary staffing problems by providing for the short term assistance of superior clerical and professional services.



These schedules offer many benefits such as:

- Orders for assistance can be filled within 24 hours,
- Quick response to changing staffing requirements,

- Temps can be used for up to 240 consecutive days,
- Choice of vendors, and
- Customers will be able to place orders on **GSA Advantage!**TM.

We invite you to view our Temporary Support Services in more detail. Please visit our website at:

<http://pub.fss.gsa.gov/services/temp-svcs>

For more information on GSA's Temporary Clerical or Temporary Professional Support Services, please contact Mr. Guy Galloway at the following email address or phone number:
guy.galloway@gsa.gov or (703) 305-6000.

GSA SMARTPAY The Next Generation of Travel, Purchase, and Fleet Payment Systems

This special program is a master contract, not a multiple award schedule. GSA has special ordering instructions and assistance available on our website listed at the end of this article.

GSA SMARTPAY, the next generation of Travel, Purchase, and Fleet Card Programs, replaces the Travel and Transportation Payment and Expense Control System (AMERICAN EXPRESS); Government-wide Commercial Purchase Card Program (US BANK's I.M.P.A.C.TM); and the U.S. Government Fleet Services Card (Wright Express). The contracts effective November 30, 1998, have a base period for five years with five one-year options. Agencies will place task orders against this contract, and select a system that best meets their requirements and the Federal Supply Service (FSS) will provide assistance as needed.

Continued next page



This unique program was awarded under a master contract approach for the first time. GSA has historically awarded these contracts separately with each program area being awarded to only one vendor. The master contract concept offers enormous benefits over the previous procurement method. This new approach recognizes that one size does not fit all. Agencies have varying financial requirements and it is impossible to design one system that meets everyone's needs. Under this new approach, agencies will have a selection of vendors and services to choose from and the flexibility to tailor a program to meet their unique needs. Agencies will also have the ability to change vendors if they wish during the contract period. In addition, for the first time ever, agencies will be able to integrate two or more of the travel, purchase, or fleet functions on one card. The structure of the master contract concept allows for continual access to advances in technology, which encourages competition within industry to develop program improvements and share these best practices with the Government.

On February 10, 1998, GSA announced the award of six contracts for the next generation of Federal government charge cards, bringing Federal agencies closer to a single payment system for multiple services. With a potential contract length of 10 years, charges under these contracts could total \$100 Billion.

Purchase card contracts were awarded to American Express, Citibank, First National Bank of Chicago, Mellon Bank, NationsBank, and US Bank (formerly Rocky Mountain BankCard Systems).

Contracts for travel-related payment services were awarded to American Express, Citibank, NationsBank, US Bank, and First Chicago (integrated only).

Fleet card services will be available from American Express, Citibank, Nationsbank, US Bank, and First Chicago (integrated only). As mentioned previously, these services—Purchase, Travel and

Fleet—are currently provided by three separate contractors. Under the new contracts, an agency could choose to receive more than one service (Purchase and Fleet for example)—plus innovative add-ons—from a single contractor.

American Express, Citibank, First National Bank of Chicago, NationsBank, and US Bank (formerly Rocky Mountain BankCard Systems) were awarded contracts that integrate two or more services (Travel and Fleet for example). Such integration might include administrative functions like account set-up and maintenance and financial processes such as reconciliation, reporting and invoicing. Agencies, therefore, could process account set-up through a single system and receive combined reports.

“These contracts represent another step in simplifying government financial transactions and saving on administrative costs while offering agencies broad choices in card-based services,” said GSA Administrator David J. Barram. “They also offer new and innovative methods to increase electronic commerce activity and capture financial data for accounting and performance measurement. This is another major step in our efforts to reinvent how the Federal Government does business.”

Frank P. Pugliese, Jr., Commissioner of GSA's Federal Supply Service—the GSA component that handled the procurement—added, “This is the largest single procurement of card-based services. Agencies will have access to a variety of commercial services, increasing the potential for streamlining transactions, saving money, and improving accountability.”

What services are available?

Traditional card based services as well as ATM services, travelers checks and convenience checks are available. Additionally, contractors may offer new services

such as smart cards, stored value cards, and other emerging technology.

Some of the Advantages of GSA SMARTPAY are:

- Streamlines Agency's procurement process
- Reduces administrative costs
- Improves Agency cash management
- Provides Agencies with the ability to designate cardholders and their spending limits
- Limits the need for imprest funds, third party drafts, and "cash on hand"
- Provides extensive management reports for tracking expenditures and payments
- Improves control and payment process options
- Works like any commercial credit card
- Provides detailed monthly statements that are available electronically
- Provides rebates to agencies

For additional information on this program, we invite you to visit our website at:

<http://pub.fss.gsa.gov/services/gsa-smartpay>

-OR-

contact one of our GSA representatives listed below:

rebecca.koses@gsa.gov
Phone: (703) 305-6681

anniebell.parker@gsa.gov
Phone: (703) 305-7564

marion.williams@gsa.gov
Phone: (703) 305-6906



Want to Place An Order for a “Service” But Your Not Quite Sure How? Read on!

In this edition of MarkeTips, we are presenting a section devoted to the Task Order Request Process. This material supplements information provided on the Federal Supply Service Schedules website at www.fss.gsa.gov.

Multiple Award Schedule Task Order Request Process:

For orders **under \$2,500:**

Agencies can obtain services simply by placing an order with the schedule contractor of the agency's choice.

For orders **over \$2,500:**

a) The agency should prepare a performance-based Statement of Work (SOW) which includes the following information:

- Detailed Description of all Tasks to be Performed.
- Deliverable Schedule .
- Applicable Standards.
- Acceptance Criteria.
- Period of Performance (including any options).
- Location of Work.
- Any Special Requirements (i.e., security clearances, travel, special knowledge, etc.).

After developing the SOW, the agencies should review the Federal Supply Schedule contractor catalogs and pricelists to identify at least three contractors who are able to meet their requirements. For requirements in excess of the schedule's maximum order threshold, the request for quotes should be provided to additional contractors who can meet the agency's needs. The agency may contact the contractors for additional information, if



desired, to assist in determining which contractor can best meet their need.

b) The agency should develop a written task order request. The task order request is not an actual task order, but rather, a request for proposals from the Federal Supply Schedule Contractors. The task order request should include:

- 1) The performance-based SOW.
- 2) A request for technical proposals (a detailed proposal explaining how a schedule contractor plans to meet the requirements of the SOW). The technical proposals may be either oral, written, or a combination of both as determined by the ordering agency. When appropriate, agencies are encouraged to request oral proposals from the contractors.
- 3) A request for the contractor to submit either a firm-fixed price or a ceiling price to provide the services outlined in the SOW.
- 4) A draft format to standardize the contractors' price proposal submissions.
- 5) Evaluation Criteria and their relative importance.

The task order proposal generally is split into two parts: Technical and Price. All

criteria used to evaluate either portion of the potential contractors' proposals must be identified in the agency task order request as evaluation criteria. The agency task order request must also direct the contractors to include such information in their technical and price proposals.

Technical Proposals:

The following checklist represents some commonly used evaluation criteria for service contracts.

- The contractor's understanding of the requirements.
- A description of the contractor's technical and management . approach to accomplish the requirements within the specified timeframe.
- A listing of milestones or a break down of when certain facets of the required task will be completed.
- A description of the skill categories to be utilized.
- A description and/or listing of which portions of the effort will be sub contracted, if any.
- A description of the number of hours required to accomplish the work effort for each requirement, mile stone, or breakdown of the work structure.
- Corporate experience.
- Past performance.

Price Proposals:

Unless otherwise specified, pricing shall be firm-fixed price. The firm-fixed price shall be based on the hourly rates in the schedule contract or the hourly rates negotiated by the ordering agency. (Agencies may negotiate price reductions and the schedule contractors are no longer required to extend the reduced prices to other Federal customers.) Pricing shall consider the mix of labor categories and level of effort required to perform the services described in the SOW. The firm-fixed price of the order should also include any travel costs or other incidental costs related to the performance of the services ordered, unless

Continued next page



the order provides for reimbursement of travel costs at the rates provided in the Federal Travel or Joint Federal Travel Regulations.

The following checklist represents information agencies commonly request contractors to provide in their price proposals.

- List all tasks to be performed and the number of hours required for completion.
- Identify the skill levels required to perform each task, the number of hours needed for each skill level, and the associated labor rate for each skill level.
- Summarize the total number of hours and the extended price required to complete each task.
- Summarize the extended price by labor hour category.
- Provide a total price for all tasks.

If the ordering office makes a determination that it is not possible to accurately estimate the extent or duration of the work or to anticipate costs with any reasonable degree of accuracy at the time of placing the order, a labor hour or time-and-materials proposal may be requested. A ceiling price must be established for labor-hour and time-and-materials orders.

6) Method of Award

The task order request must notify the contractors what basis will be used for selecting the contractor to receive the order and the basis for determining whether the contractors are technically qualified.

7) A due date for receipt of written and/or oral proposals

Agencies are not required to develop formal evaluation plans or scoring schemes for task orders in accordance with FAR 8.4 and agencies are free to make award on a low price, technically acceptable or a best value basis.

c) **The agency should submit the task order request to the identified FSS schedule contractors.** For orders estimated to exceed the micro-purchase threshold, the task order request should be sent to three schedule contractors. If the task order is estimated to exceed the schedule maximum order threshold, the request for proposal should be provided to additional contractors that offer services that will meet the agency's needs. The contract maximum order level is not a ceiling. Rather, it is a suggested target for the agency to seek further price

reductions. If the order exceeds the maximum order threshold and/or the contractor agrees to offer further price reductions, the order should still be placed against the schedule contract. Contractors are no longer required to pass price reductions given to one Federal customer to other Federal clients. Agencies may seek price reductions on task orders of any dollar value.

d) **The contractor(s) shall submit a task order proposal, or notify the ordering agency if they wish to decline the request,** within the timeframe specified by the ordering agency in the task order request.

e) **The Agency will review and evaluate each task order proposal submitted by the contractors.** The technical proposal should be evaluated in accordance with the evaluation criteria and the method of award specified in the task order request.

f) **The Agency selects the contractor that best meets its needs.** After the proposals have been evaluated against the criteria included in the task order request, the agency may:

- select the contractor that represents the best value (considering price, special qualifications, administrative costs, etc.) without further negotiations; or
- conduct negotiations.

If negotiations are conducted, they will occur at the time and place designated by the ordering Contracting Officer and/or his/her designated representative. Following the completion of negotiations, the Contractor shall submit a finalized task order proposal, as directed by the ordering Contracting Officer. The agency will then select the contractor that represents the best value based on the revised proposals.

g) **A task order is issued by the ordering Contracting Officer.** The task order will reflect the final revision of the technical and price proposal and include a firm milestone schedule.

Any changes to a task order will be issued in writing by the ordering Contracting Officer. Only the ordering Contracting Officer may modify the terms and conditions of the task order. A task order may not increase the scope of the contract. The ordering Contracting Officer does not have the authority to modify the terms and conditions of the contract.

h) **Agencies may establish Blanket Purchase Agreements (BPAs) for recurring services** under the Federal Supply Schedule program if the following procedures are used:

The BPA must:

- Define the services that may be ordered under the agreement.
- Specify the delivery or performance time frames.
- Establish billing procedures.
- Estimate, but not guarantee, the volume of purchases that will be made through the agreement. (Contractors may be open to progressive discounts as the volume of orders placed under the BPA increases.)
- Identify the offices able to place orders against the BPA.

Continued next page



Agencies establishing BPAs for ordering services off schedule shall identify their intention to use a single or multiple BPAs to meet the requirements of their SOW in the task order request that is forwarded to contractors for consideration. The task order request must also indicate the basis that will be used for selecting the contractors to be awarded BPAs.

Established BPAs must be reviewed annually to ensure that the agreement still represents the best value (considering price, special qualifications, etc.) and results in the lowest overall cost alternative to meet the agency's needs.

General Guidelines:

- Ordering offices should give preference to small business concerns when two or more contractors can provide the services at the same firm-fixed price or ceiling price.
- When the ordering office's requirement includes both products and professional services, the ordering office should total the prices for the products and the services and select the contractor that represents the greatest value in terms of meeting the agency's total needs.
- The ordering office, at a minimum, should document orders by identifying the contractor from whom the services were purchased, the services purchased, and the amount paid. If other than a firm-fixed price order is placed, the documentation should include the basis for the determination to use a labor-hour or time-and-materials order. For agency requirements in excess of the micro-purchase threshold, the order file should document the evaluation of schedule contractors' proposals that formed the basis for the selection of the contractor that received the order and the rationale for any trade-offs made in making the selection.



Frustrated?

Questions about the Federal Supply Service keep popping up?



NATIONAL CUSTOMER SERVICE CENTER

**1-800-488-3111
(DSN 465-1416)**

Our job is to help you with questions or problems about any of the products or services available from the Federal Supply Service.

Contact our Commodity Center and speak to experts about items you want to purchase, including product information, pricing, placing an order, and status.

Call: 1-800-488-3111 and select option (2) on the menu.



Office of Transportation and Property Management

Transportation Management Programs

Federal civilian agencies can reap significant benefits by using the General Services Administration's (GSA's) Centralized Household Goods Traffic Management Program (CHAMP) and Freight Management Program (FMP). For example, GSA negotiates deeply discounted rates on behalf of Federal agencies for the movement of household goods and freight shipments. In addition, GSA has instituted a strict carrier approval process to carefully screen carriers that wish to participate in the household goods program. GSA's extensive experience in negotiating discounted rates and approving carriers can benefit all agencies and be an especial boon to those of you affected by downsizing, freeing you from the burdensome task of having to conduct rate negotiations and carrier approvals in-house. You can instead use your valuable resources elsewhere. GSA's ability to solicit rate offers on a worldwide basis provides for a more competitive environment, and results in an average CHAMP discount of 49%.

Additionally, GSA provides for the Federal civilian agencies separate Household Goods Tender of Services's (HTOS)

-- Domestic Tender of Service (DTOS) effective January 2, 1996,

-- International Tender of Service (ITOS) effective October 1, 1995, supplements thereto and reissues thereof for domestic and international household goods shipments.

GSA also provides Standard Tender of Service (STOS) for FMP. The HTOS and STOS establish carrier service and performance standards with which partici-

pating carriers agree to comply. GSA's expertise in establishing specific performance standards has in many cases resulted in standards that exceed those in the commercial sector. Regarding the domestic and international HTOS identified above, efforts are underway to develop one HTOS that will incorporate both the tenders' into one publication. A draft of the HTOS along with the official STOS can be found on the GSA web site at:

<http://www.kc.gsa.gov/fsstt>. The STOS is also available on the GSA CD-ROM.

As a Federal civilian agency involved with household goods movements and/or freight shipments, it is important for you to review provisions of the HTOS and STOS to ensure that you are receiving the best transportation services available. CHAMP has many provisions to benefit you, among them: level of service, released value, long carries, weight variance, late delivery reduction, and claims settlement penalties. Under the FMP, Federal civilian agencies also benefit from specific provisions in the STOS such as: all shipments move at full value, specific transit times, ability to aggregate freight claims, and a wide variety of accessorial services to be provided by the carrier. Both CHAMP and FMP provide benefits and performance standards that will help you manage your transportation programs.

If you would like additional information about CHAMP and/or the FMP, please call us at (816) 823-3646 or FAX us at (816) 823-3656. You also may e:mail (for CHAMP) carla.young@gsa.gov or richardj.johnson@gsa.gov; and (for FMP) robyn.bennett@gsa.gov or cindy.schardt@gsa.gov, phone them at (816) 823-3546.

GSA Transportation Management Web Site Update

For those of you who may not recently have visited GSA's web site at www.kc.gsa.gov/fsstt, here are some items of interest you may have missed:

1. August 4, 1997:
Publication of 1997 Carrier Satisfaction Indices(CSI). This index represents a household carrier's average performance level compared with all carriers in the GSA program. For more information, contact Carla Young or Brian Kellhofer at (816) 823-3646.
 2. January 12, 1998:
1995 GSA CHAMP Annual Report published on the web site for the first time. This report provides CHAMP statistical data including: major CHAMP program activities, GBL versus Commuted Rate Schedule analyses, CHAMP data compared with other household goods industry data, and detailed carrier performance information. This information also is available on the ITMS CD-ROM. You may direct questions to Cindy Schardt at (816) 823-3646.
 3. February 24, 1998:
Minutes from the February 12, 1998, CHAMP Federal Household Goods Transportation Council Meeting. For further details, contact Kim Anderson at (816) 823-3646.
 4. Continuing updates on distribution of the Interagency Transportation Management System (ITMS) CD-ROM.
- We regularly post these and many other timely and interesting topics at our web site. Stop by and visit! Also, we welcome your comments and suggestions about the format and content of information posted on our web site.



GSA Federal Household Goods Transportation Council Meeting

On February 12, 1998, the Program Management Office (PMO) for the Centralized Household Goods Traffic Management Program (CHAMP) held a Federal Household Goods Transportation Council Meeting in Washington, DC. We congratulate Noreen Toy-Sneddon, Department of State, on her election as Executive Director of the Federal Council and Charlie Hill, Department of Commerce, NOAA, on his election as the Assistant Executive Director. The Council discussed the following topics:

-- Summary of agency comments GSA received during Household Goods Focus Group meetings held February 10-11, 1998

-- Update on Move Management Services

-- Update on proposed changes to CFR 101-40 & 101-41

-- Update on combining the GSA Domestic and International Household Goods Tenders of Service

-- Brief discussion on the previous distribution of the draft international household good shipment evaluation form

-- Informed council members of the PMS's efforts to determine another method for the calculation of Customer Satisfaction Indices (CSI).

-- Discussion on using a third party to collect GSA Forms 3080, "Household Goods Carrier Evaluation Reports"

-- Distribution of a draft international household goods shipment evaluation form

-- Review of the PMO's calculation of Customer Satisfaction Indices

-- Discussion on whether to raise the maximum liability for full value protection on domestic household goods shipments from \$3.50 to a value not exceeding \$4.00 per hundred weight.

Minutes of the February 12th Council meeting have been posted on the web site at www.kc.gsa.gov/fsstt/hhg. You may direct any questions or comments to Carla Young at (816) 823-3646 or FAX (816) 823-3656, or e:mail to carla.young@gsa.gov.

Training Classes Learn from the Pros!

The Mid-Atlantic Region's FSS Transportation Training Branch is the government trainer for Travel and Transportation courses worldwide.

Sign up today and learn the new "Plain Language" FTR!

GSA's Office of Governmentwide Policy has issued the Federal Travel Regulation (FTR) Chapter 300 and 301 in a new "Plain Language" format that is easier to use and understand. This will be effective July 1, 1998. In conjunction with this, the Transportation Training Branch is offering a Temporary Duty Travel course which will educate you on the new FTR.

This course is one of several courses which can be tailored and offered as an on-site special at your location. You provide us the dates and location, and we will bring a quality course to you at a COST SAVINGS!!!!

Three easy ways to register:

By phone: (202) 619-8907
(credit cards welcomed)

FAX: (202) 619-8999
or MAIL your forms to:

GSA

Transportation Training Branch
490 L'Enfant Plaza, S.W.
Suite 8214

Washington, DC 20407

Attn: Registration

Any questions, please call Nancy Murphy @ 202-619-8907 or Email: nancy.murphy@gsa.gov.

For a listing of courses and schedules, check our website:

<http://tsd.r3.gsa.gov/fss.htm>

Schedule of Travel Courses

Relocation Allowances

Course Number: 1745
Cost: \$515
Length: 4 days
Hours: 8:30-3:30 each day

Atlanta, GA

Session No: 1745-03
Dates: Aug 4-Aug 7, 1998

Denver, CO

Session No: 1745-05
Dates: Jul 21-Jul 24, 1998

Session No: 1745-06
Dates: Sep 15-Sep 18, 1998

Ft. Worth, TX

Session No: 1745-07
Dates: Aug 25-Aug 28, 1998

Kansas City, MO

Session No: 1745-09
Dates: Aug 11-Aug 14, 1998

San Francisco, CA

Session No: 1745-12
Dates: Jul 28-Jul 31, 1998

Continued next page



Seattle, WA
Session No: 1745-14
Dates: Jul 21-Jul 24,1998

Session No: 1745-15
Dates: Sep 1-Sep 4, 1998

Washington, DC
Session No: 1745-23
Dates: Jul 7-Jul 10,1998

Session No: 1745-24
Dates: Aug 18-Aug 21,1998

Session No: 1745-25
Dates: Sep 15-Sep 18,1998

Relocation Income Tax Allowance

Course Number: 1750
Cost: \$420
Length: 2-1/2 days
Hours: 8:30-3:30
Last day: 8:30-12:00 Noon

Washington, DC
Session No: 1750-06
Dates: Jul 21-Jul 23,1998

Session No: 1750-07
Dates: Aug 18-Aug 20,1998

Session No: 1750-08
Dates: Sep 9-Sep 11, 1998

Temporary Duty Travel - FTR

Course Number: 1760
Cost: \$445
Length: 4 days
Hours: 8:30-3:30

Atlanta, GA
Session No: 1760-01
Dates: Jul 21-Jul 24,1998

Denver, CO
Session No: 1760-04
Dates: Jul 28-Jul 31,1998

Session No: 1760-05
Dates: Aug 25-Aug 28,1998

Honolulu, HI
Session No: 1760-06
Dates: Jul 21-Jul 24,1998

Kansas City, MO
Session No: 1760-08
Dates: Aug 25-Aug 28,1998

Portland, OR
Session No: 1760-10
Dates: Aug 11-Aug 14,1998

San Diego,CA
Session No: 1760-12
Dates: Sep 15-Sep 18,1998

San Francisco, CA
Session No: 1760-13
Dates: Jul 21-Jul 24,1998

Seattle, WA
Session No: 1760-15
Dates: Aug 4-Aug 7, 1998

Washington, DC
Session No: 1760-26
Dates: Jul 14-Jul 17,1998

Session No: 1760-27
Dates: Jul 21-Jul 24,1998

Session No: 1760-28
Dates: Aug 4-Aug 7,1998

Session No: 1760-29
Dates: Sep 15-Sep 18,1998

Preparation of Travel Vouchers - FTR

Course Number: 1740
Cost: \$400
Length: 2 days
Hours: 8:30-3:30

San Francisco, CA
Session No: 1740-03
Dates: Aug 11-Aug 12, 1998

Washington, DC
Session No: 1740-06
Dates: Jul 14-Jul 15,1998

Session No: 1740-07
Dates: Sep 15-Sep 16,1998

Imprest Fund Cashiers
Course Number: 1715
Cost: \$400
Length: 2 days
Hours: 8:30-3:30

Washington, DC
Session No: 1715-06
Dates: Jul 7-Jul 8, 1998

Session No: 1715-07
Dates: Aug 26-Aug 27, 1998

TRANSPORTATION:

DOT/Hazardous Materials And Waste Management Regulations

Course Number: 1710
Specials Only

Preparation of Government Bills of Lading

Course Number: 1775
Specials Only

Shipping Household Goods

Course Number: 1755
Cost: \$380
Length: 3 days
Hours: 8:30-3:30

Kansas City, MO
Session No: 1755-01
Dates: Aug 11-Apr 13,1998

Continued next page



Travel Manager Windows
(Computer class)

Course Number: 1769
Cost: \$400
Length: 2 days
Hours: 8:00-3:30 each day

Washington, DC

Session No: 1769-09
Dates: Jul 14-Jul 15, 1998

Session No: 1769-10
Dates: Aug 11-Aug 12, 1998

Session No: 1769-11
Dates: Sep 15-Sep 16, 1998

Session No: 1769-12
Dates: Sep 29-Sep 30, 1998

Travel Manager (DOS)
(Computer Class)

Course Number: 1766
Specials Only

DEPARTMENT OF DEFENSE

Temporary Duty Travel

Course Number: 1770
Cost: \$445
Length: 4 days
Hours: 8:30-3:30 each day

San Diego, CA

Session No: 1770-03
Dates: Jul 21-Jul 24, 1998

Washington, DC

Session No: 1770-10
Dates: Aug 18-Aug 21, 1998

Temporary Duty Travel - JFTR Vol.-I
(uniform members)

Course Number: 1765
Cost: \$445
Length: 4 days
Hours: 8:30-3:30 each day

San Antonio, TX

Session No: 1765-03
Dates: Aug 4-Aug 7, 1998

San Diego, CA

Session No: 1765-04
Dates: Aug 25-Aug 28, 1998

Washington, DC

Session No: 1765-08
Dates: Jul 21-Jul 24, 1998

WE EVEN MAKE HOUSE CALLS:

We'll come directly to your office or site of your choice and conduct courses tailored to your agency policy.

To learn more about our training programs or to obtain a free catalog, please call Nancy Murphy at 202-619-8907 or Email her at nancy.murphy@gsa.gov.

REMINDER...



**See page 18 for
Registration Form**



National Furniture Center Washington, DC



In September of 1996, GSA's National Furniture Center (NFC) opened its Customer Resource Center (CRC) and showroom at the Washington Design Center in Washington, D.C. The Resource Center is located at 300 D Street SW, Suite 632, Washington, D.C. 20024 (Federal Center SW Metro stop).

The Center's reference library provides hands on access to current furniture, furnishings, fabric and carpeting schedules. You can also look at numerous vendor catalogs, as well as fabric and carpet samples and swatches. The showroom itself displays samples of the quality products available through GSA – giving customers a chance to see and touch furnishings. Displays rotate quarterly – highlighting different styles and program areas.



The CRC is open weekdays from 9:00am until 5:00pm and is staffed by NFC procurement and design professionals. While walk-in visitors are welcome, you may also make an appointment to meet personally with the design staff. To make an appointment or to simply ask a question, contact Michael Rudderforth on (202)-245-0045, FAX (202)-245-0038.

Do you need Wood Certificates or Photo Frames? Do you want them delivered directly from the manufacturer to your office? The frames listed below come with velcro adhesive for easy attachment and removal from systems furniture and can be used on any surface. Clear glass and white mats are included in these precision crafted frames that can be displayed either in a vertical or horizontal position.

NSN	Display Area Unmatted	Display Area Matted	Price
Oakwood Frames			
7105-01-440-6068	8 x10	5 x7	\$42.88
7105-01-440-6079	8 1/2 x11	7 x9	\$46.32
7105-01-440-6069	9 x12	7 x9	\$47.40
7105-01-440-6066	11 x14	8 x10	\$52.38
Cherry Finish			
7105-01-357-9978	8 x10	5 x7	\$42.90
7105-01-357-9979	8-1/2 x11	7 x9	\$46.34
7105-01-357-9980	9 x12	7 x9	\$47.43
7105-01-357-9981	11 x14	8 x10	\$52.40
Antique Gold			
7105-01-440-6067	8 x10	5 x7	\$42.90
7105-01-440-6065	8-1/2 x11	7 x9	\$46.34
7105-01-440-6072	9 x12	7 x9	\$47.43
7105-01-440-6082	11 x14	8 x10	\$52.40

All frames are made in the USA at Eastern Carolina Vocational Center (ECVC) by persons with disabilities and are shipped in sturdy corrugated boxes of 12 frames per box. Your order is processed electronically for rapid delivery. For additional information about these and other available frames, check **GSA Advantage!**TM, visit the website at www.ecvinc.com or call GSA Customer Service at (703) 305-7003.

ECVC is an affirmative industry affiliated with JWOD and NISH.



Did You Know...

GSA's National Furniture Center, based in Arlington, VA, is part of the Mid-Atlantic Region's Federal Supply Service. The Center supports the furniture and furnishings requirements of federal activities worldwide, with annual sales of approximately \$1 billion.

Our procurement operations teams provide supply support expressly tailored to our customers' needs. Product options available through the Center include general office furniture (e.g., ergonomic seating, filing systems, daycare and classroom furniture), systems and automated data processing furniture, dormitory and quarters furnishings, hospital furniture, carpeting and more!

At the National Furniture Center, our customers are our greatest asset. With this in mind, we strive each day to maximize customer satisfaction. We are proactively committed to improving the quality of services we provide and to listening to our customers. To this end we have established, in recent years, three exciting initiatives:

-- **Customer Service:** Our Account Management and Customer Service Division is comprised of several core action teams. Each team includes purchasing specialists, customer service specialists, and technicians. These cross functional teams are able to respond quickly to status requests, discrepancies and expediting orders.

-- **Quality Partnerships:** Communication with our customers and suppliers is key to our mutual success. Striving to maximize communication, GSA founded a Quality Partnership Council. The all volunteer partnership is comprised of equal representation from industry, our customer community and GSA. Its collective mission is to foster communication and education and to work

continuously to improve processes involved in servicing one another.

-- **Express Desk - Code 90:** To demonstrate our commitment to providing quality service to our customers, we are offering a convenient new "Express" ordering option.

In utilizing this process, customers simply fax their orders directly to the Center. Customers should include their Item Description, Part Number, Model, NSN, Manufacturer/Supplier, Price, Quantity, Appropriation Code and Contract Number. In addition to product information please provide an ordering point of contact, phone and fax number.

Information on all of these programs may be obtained by calling the Center on (703) 305-6636

Our direct customer service line is: (703) 305-7003

Express Desk - Code 90 orders can be faxed to: (703) 305-7934

New Item

English/Spanish Translation Kits Are Lightweight, Portable and Re-usable

Expert Translations Pase Inc., in conjunction with the Red Cross, as well as medical, military, and law enforcement experts fluent in technical Spanish, has produced the first comprehensive kit of English - Spanish status boards available anywhere. (GSA New Item Introductory Schedule Contract Number: GS-28F-7058G).

Actually Two Complete Kits in One

Each of the 17 status boards in this kit are printed in English on one side and Spanish on the other. These boards are ideal for cities along the United States Southwest border, for international response and relief agencies, for Customs, Immigration and other law enforcement agencies. These kits are also excellent tools for incident command and control, emergency management and emergency public information.

Above All, They're Practical

Each kit is lightweight, portable, low-tech, reusable and affordable. They can be set up anywhere. They permit people to train with the same tools they will use in an actual event.

Every kit contains 17 24"x36" erasable, updatable and reusable mylar laminated bilingual status boards. The kits also have wet erase marker pens and one (1) each English and Spanish set of master boards in form size (8-1/2"x 11"), plus a portfolio carrying case.

Orders may be placed directly with the manufacturer by calling (502) 394-0845; fax: (502) 394-0822 or at Pasa's Website: <http://www.pascinc.com>. The Government I.M.P.A.C.® card is accepted!

**Contact: linda.mcgrail@gsa.gov
Phone: (703) 305-6976**





**High Quality
Hardwood
Picture Frames
GOLD Finish**



SIZE	NATIONAL STOCK NUMBER	PRICE
5X7	7105-01-419-5302	\$43.69 Box of 12
8x10	7105-01-419-5318	\$53.28 Box of 12
8.5x11	7105-01-419-5329	\$58.13 Box of 12
9x12	7105-01-419-5339	\$81.84 Box of 12
10x12	7105-01-419-5350	\$83.00 Box of 12
10x14	7105-01-419-5358	\$39.09 Box of 6
11x14	7105-01-419-5298	\$79.05 Box of 12
14x18	7105-01-419-5347	\$67.50 Box of 6
16x20	7105-01-419-5289	\$57.80 Box of 6
18x24	7105-01-419-5309	\$71.17 Box of 6
20x24	7105-01-419-5360	\$117.90 Box of 6

OUR HIGH QUALITY PACKAGE INCLUDES:

- *Clear Glass
- *Beveled Cut Matboard
- *Backer & Saw Tooth Hanger
- *Gold Trim Along Inner Edge of Frame
- *Easel Back & Velcro for Desktop or Office Panel Hanging on First 4 Sizes Listed

Available Through GSA ADVANTAGE, FEDSTRIP/MILSTRIP, & MUFFIN
For Additional information on these or other frames contact the
GSA Service Representative at (703) 305-7003.

For additional information about these and other picture frames, contact a GSA Customer Service Representative at (703) 305-7003.



Tools and Appliances Center

Kansas City, MO

Bend-A-Light® Flexible Light Inspection and Parts Retrieval Tool Kit

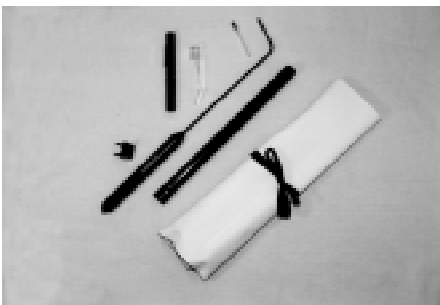

-- 10 inch flexible light shaft with mini size halogen bulb illuminates hard-to-reach areas for inspection and servicing. Light passes through openings as small as 1/4 inch.

-- Plastic extension wand extends reach to 24" and doubles as protective cover for bulb and shaft.

-- Attachable tip magnet permits small parts retrieval.

-- Clip-on magnetic mounting device allows hands-free use.

-- Penlight and attachable reflector add to lighting and inspection capabilities.

Order Quantity: 2 – 71 KT
Unit Price: \$18.94

Order Quantity: 72+ KT
Unit Price: \$14.57

Ordering Period: 1/15/98 to 1/14/2003

Order using FEDSTRIP/MILSTRIP or MUFFIN procedures.

Contact: arlene.tittle@gsa.gov
Phone: (816) 926-7588

Aaron Corporation

NSN: 5180-01-452-6076
Contract: GS-06F-78623
Model No: AR10355A

The New Gerber® Multi-Lock™ Scout

The Ultimate Gerber® Multi-Tool with Fiskars® Scissors features:

- World Class Fiskars® Scissors
- SAF.T.PLUS Lock Release Button
- Large & Medium Flat Tip Screw drivers
- Cross Tip Screwdriver
- Patented "Flick of the Wrist" Opening Plier Head
- Serrated Drop Point Blade
- Bottle Opener
- Can Opener
- File/Carbide Sharpener
- Lanyard Ring
- Awl

Order using FEDSTRIP/MILSTRIP or MUFFIN procedures.



Gerber Multi-Lock™ Scout

NSN: 5110-01-451-4945
Price: \$40.29 EA
Model No: 07542

Contact: arlene.tittle@gsa.gov
Phone: (816) 926-7588



New! Gerber® Multi-Lite™ Multi-Purpose Tool



The Newest tool from Gerber® with a light and Fiskars® Scissors. Compact Multi-Purpose Tool that includes these features:

- Emergency Bright Amber Light
- Detachable Lid
- Drop Point Blade
- Serrated Sheepsfoot Blade
- Fiskars® Scissors
- Flat Tip Screwdriver
- Cross Tip Screwdriver
- Bottle Opener
- Awl
- Storage Compartment
- All Metal Components Are
- Stainless Steel Construction
- Weight: Less than 5 oz.
- Dimensions: 1.0" x 3.5" x 0.75"
(when closed)

Order using FEDSTRIP/MILSTRIP or MUFFIN procedures.



NSN: 5110-01-451-4942
Price: \$24.62 EA
Model No: 07200

Contact: arlene.tittle@gsa.gov
Phone: (816) 926-7588

The World's Most Advanced Ratchet System

-- Eliminates The Weak Link –
Sockets click directly into the ratchet head for up to a 40% stronger, more direct transfer of power.

-- Eliminates Tight Spot Hassles –
Integrated ratchet/socket design is up to 50% slimmer than ordinary ratchets. You can work in places ordinary ratchets can't reach.

-- Eliminates Trips To The Tool Box –
Bolts pass through the ratchet head, eliminating the need for deep sockets or open end wrenches.

-- Eliminates Confusion - Sockets are color coded: Red for Fractional - Blue for Metric. Changing sockets is easy - Just a push of the thumb! - Comes with adapter so you can still use your old sockets.

Armstrong® Eliminator™ Sets

NSN: 5120-01-453-7919
Part No: 16-090

Description: 19-Pc. Combination Fractional/Metric Ratchet System. Contains 3/8" Eliminator™ ratchet, 7 fractional sockets sizes 3/8" – 3/4", 10 metric sockets sizes 10-19mm, Eliminator™ ratchet adapter and metal case.

Price: \$83.98



NSN: 5120-01-453-7920
Part No: 16-100
Description: 9-Pc. Fractional Ratchet System. Contains 3/8" Eliminator™ ratchet, 7 fractional sockets sizes 3/8" – 3/4", Eliminator™ ratchet adapter and metal case.
Price: \$48.37



NSN: 5120-01-453-7927
Part No: 43-100
Description: 12-Pc. Metric Ratchet System. Contains 3/8" Eliminator™ ratchet, 10 metric sockets sizes 10–19mm, Eliminator™ ratchet adapter and metal case.
Price: \$59.01



Continued next page



Individual Eliminator™ Pieces

NSN: 5120-01-453-7931
Part No: 11-902
Description: 3/8" Drive Eliminator™ Ratchet
Price: \$19.25

NSN: 5120-01-453-7934
Part No: 11-930
Description: 3/8" Drive Eliminator™ Adapter
Price: \$4.16

NSN: 5180-01-453-7936
Part No: 11-966
Description: 3/8" Drive Eliminator™ Ratchet Repair Kit
Price: \$4.75



NSN: 5120-01-453-7987
Part No: 11-612
Description: 3/8" Drive 3/8" Socket
Price: \$3.38

NSN: 5120-01-453-7988
Part No: 11-614
Description: 3/8" Drive 7/16" Socket
Price: \$3.49

NSN: 5120-01-453-7941
Part No: 11-616
Description: 3/8" Drive 1/2" Socket
Price: \$3.49

NSN: 5120-01-453-7943
Part No: 11-618
Description: 3/8" Drive 9/16" Socket
Price: \$3.62

NSN: 5120-01-453-7945
Part No: 11-620
Description: 3/8" Drive 5/8" Socket
Price: \$3.62

NSN: 5120-01-453-7946
Part No: 11-622
Description: 3/8" Drive 11/16" Socket
Price: \$3.62

NSN: 5120-01-453-7948
Part No: 11-624
Description: 3/8" Drive 3/4" Socket
Price: \$3.74

NSN: 5120-01-453-7950
Part No: 16-105
Description: 7-Piece Fractional Socket Set (Sockets only, sizes 3/8"-3/4")
Price: \$24.96

NSN: 5120-01-453-7991
Part No: 38-609
Description: 3/8" Drive 9mm Socket
Price: \$3.37

NSN: 5120-01-453-7952
Part No: 38-610
Description: 3/8" Drive 10mm Socket
Price: \$3.37

NSN: 5120-01-453-7954
Part No: 38-611
Description: 3/8" Drive 11mm Socket
Price: \$3.46

NSN: 5120-01-453-7958
Part No: 38-612
Description: 3/8" Drive 12mm Socket
Price: \$3.46

NSN: 5120-01-453-7961
Part No: 38-613
Description: 3/8" Drive 13mm Socket
Part: \$3.46

NSN: 5120-01-453-7966
Part No: 38-614
Description: 3/8" Drive 14mm Socket
Price: \$3.62

NSN: 5120-01-453-7967
Part No: 38-615
Description: 3/8" Drive 15mm Socket
Price: \$3.62

NSN: 5120-01-453-7968
Part No: 38-616
Description: 3/8" Drive 16mm Socket
Price: \$3.62

NSN: 5120-01-453-7969
Part No: 38-617
Description: 3/8" Drive 17mm Socket
Price: \$3.62

NSN: 5120-01-453-7970
Part No: 38-618
Description: 3/8" Drive 18mm Socket
Price: \$3.62

NSN: 5120-01-453-7971
Part No: 38-619
Description: 3/8" Drive 19mm Socket
Price: \$3.74

NSN: 5120-01-453-7973
Part No: 43-105
Description: 10-Pc. Metric Socket Set (Sockets only, sizes 10-19mm)
Price: \$35.61

Order using FEDSTRIP/MILSTRIP or MUFFIN procedures.

Contact: arlene.tittle@gsa.gov
Phone: (816) 926-7588



Listing Of Vendors Who Converted Their Contracts Under The SCIT Industrial Quality Tools Program To Multiple Award Schedule Contracts Under FSS 51 I B

Note: GSA Customers May Now Order Directly From These Vendors And Also Have The Option Of Utilizing The Government's I.M.P.A.C.® Card.

<u>Vendor</u>	<u>POC</u>	<u>Phone/Fax Numbers</u>	<u>Contract No.</u>	<u>Minimum Order</u>
American Tool and Supply, Inc. 937 Sayre Drive Greenwood, IN 46143	Richard Eskew	Phone: (317) 881-394 Fax: (317) 881-0593	GS-2020FF-6011G	\$50.00
A.T.I. Tools, Inc. 2425 W. Vineyard Ave Escondido, CA 92029-1222	Joe Wolosky Sales Manager	Phone: (800) 284-4460 Fax: (760) 746-4295	GS-20F-5055G	\$25.00
Black And Company 5351 W. Minnesota Box 42270 Indianapolis, IN 46242	Marcella Johnson	Phone: (800)892-5225 Fax: (317) 243-8773	GS-20F-6015H	\$50.00
Chicago Dial Indicator 1372 Redeker Road Des Plains, IL 60016	Randal Smith	Phone: (847) 827-7186 Fax: (847) 827-0478	GS-20F-6010G	\$50.00
Columbia Surgical Instrument Company 369 Silver Court Woodmere, NY 11598	Ivan Miller Plant Manager	Phone: (516) 734-6281 Fax: (516) 374-6351	GS-20F-1461G	\$50.00
Consolidated Devices, Inc. 19220 San Jose Avenue City Of Industry, CA 91748	Maureen B. Wilcut Gov't Sales Mgr	Phone: (626) 965-0668 800-525-6319 Fax: (626) 965-2410	GS-20F-1462G	\$00.00
Danaher Tool Group/K-D/ Allen Tools 805 Estelle Drive Box 3767 Lancaster, PA 17604-3767	Bill Spotswood Gov't Sales Rep For Contract Questions/Problems Gina Sprinkle For Questions/ Problems Concerning Product Orders	Phone: (703) 256-1500 Fax: (703) 256-1444 800-234-0569 Fax: 800-234-0472	GS-20F-1459G	\$25.00
Daniels Mfg Corp 526 Thorpe Road Orlando, FL 32824-8133	Jim Vargo Holly Porter-Fair	Phone: (407) 855-6161 Extension: 127 Fax: (407) 855-6884	GS-20F-6016H	\$100.00
Grobet File Co Of America 750 Washington Ave Carlstadt, NJ 07072-3008	Carol Roeland	Phone: (201) 935-0100 Fax: (201) 842-0331	GS-20F-1416G	\$25.00

Continued next page



<u>Vendor</u>	<u>POC</u>	<u>Phone/Fax Numbers</u>	<u>Contract No.</u>	<u>Minimum Order</u>
Haggard & Stocking Assoc, Inc 5318 Victory Drive Indianapolis, IN 46203	Joy Bennett Gov't Sales Rep	Phone: (317) 788-4661 Fax: (317) 786-8147	GS-20F-1463G	\$15.00
J.H. Williams 6969 Jamesson Road Columbus, GA 31909	Pete Kosciolk Karen Davis For Questions Re: The Contract No., Order Processing/I.M.P.A.C.® Card	Phone: 800-865-8445 Fax: 800-367-8318	GS-20F-5054G	\$0.00
Kipper Tool Company PO Box 1750 Gainesville, GA 30503	Dick Cronic James Scott Danny Sears Jerry Kipper	Phone: (770) 532-3232 Fax: (770) 532-3504	GS-20F-1466H	\$10.00
Mac Tools, Inc. C/O Stanley Gov't Sales 11 Grammes Road Allentown, PA 18103	Eileen Spohn Stanley Gov't Customer Support	Phone: 800-523-9462 Fax: 800-843-6274	GS-20F-5051G	\$0.00
Matco Tools Nmtc Inc. 4403 Allen Road Stow, OH 44244-1096	Bill Spotswood Gov't Sales Rep For Contract Questions/ Problems Michelle Tesmer For Questions/ Problems RE: Order Processing	Phone: (703) 256-1500 Fax: (703) 256-1444 Phone: 800-331-2427 Extension: 5 Fax: (330) 929-3827	GS-20F-5050G	\$0.00
Moody Tools, Inc. 42-60 Crompton Ave East Greenwich, RI 02818	Elizabeth Moody	Phone: (800) 866-5462 Fax: (401) 885-4565	GS-20F-1455H	\$0.00
Midland Supply, Inc. 98 County Street Attleboro, MA 02703	Thomas Decker, Jr. President	Phone: (508) 226-5654 Fax: (508) 222-5657	GS-20F-6014G	\$50.00
Sears Ind. Sales Gov't Sales Office PO Box 42538 Cincinnati, OH 35242	Valencia Player Erica Howell Sheri Jesse Melody Mason	Phone: 1-800-776-8666 Extension: 3161 Extension: 3141 Extension: 3118 Extension: 3185 Fax: 1-800-233-4557 Please send Faxes to Attn: Gov't Sales Dept.	GS-20F-5026H	\$0.00
Snap-On Industrial Tools Attn: Contract Sales 2801 80th Street Kenosha, WI 53140	Robert Redlin Contract Admin Mgr. Questions Concerning Contract Sheila Durbin Order Processing Laurie Ashby Order Processing Michelle Ward Order Processing Pat Juga Order Processing	Phone: (414) 656-4794 Fax: (414) 656-5500 Phone: (414) 656-5543 Fax Same As Above Phone: (414) 656-5016 Fax Same As Above Phone: (414) 656-5307 Fax Same As Above Phone: (414) 656-7905 Fax Same As Above	GS-20F-1458G	\$0.00

Continued next page



<u>Vendor</u>	<u>POC</u>	<u>Phone/Fax Numbers</u>	<u>Contract No.</u>	<u>Minimum Order</u>
Stanley-Proto Ind. Tools C/O Stanley Gov't Sales 11 Grammes Road Allentown, PA 18103	Eileen Spohn Stanley Gov't Customer Support	Phone: 800-523-9462 Fax: 800-843-6274	GS-20F-5102G	\$0.00
Sturtevant-Richmont/Div. Ryeson Corp 3203 North Wolf Road Franklin Park, IL 60131	John Raynertson, Jr.	Phone: (847) 455-8677 Fax: (847) 455-0347	GS-20F-4030G	\$25.00
Textron Aerospace Fasteners (Cherry) Box 2157 1224 E. Warner Avenue Santa Ana, CA 92707	Elita Ferreras	Phone: (714) 850-6014 Fax: (714) 850-6095	GS-20F-4052G	\$25.00
U.S.Industrial Tool & Supply Company 15101 Cleat Street Plymouth, MI 48170	Craig Peterson Brett Young	Phone: (800) 521-7394 Fax: (734) 455-3256	GS-20F-1460H	\$1.00
Vaughan & Bushnell Mfg, Inc. 11414 Maple Avenue Hebron, IL 60034-9668	Larry Merhaut Contract Rep For Questions RE: Contract Or Product Information Dan Herman For Questions Concerning Order Processing	Phone: (540) 338-9060 Fax: (540) 338-9073 Phone: (815) 648-2446 X43 Fax: (815) 648-4300	GS-20F-1468H	\$100.00
Waterloo Industries, Inc. 300 Ansbrough Avenue Waterloo, IA 50704	Larry Merhaut Contract Rep For Questions RE: Contract Or Product Information Karen Boelman For Questions Concerning OrderProcessing	Phone: (540) 338-9060 Fax: (540) 338-9073 Phone: 800-833-8851 Fax: (319) 235-6408	GS-20F-5059G	\$200.00

The following vendor does not accept the I.M.P.A.C.® card:

Cooper Power Tools/ Apex Division 762 West Stewart Street Dayton, Oh 45401	Larry Merhaut Contract Rep For Questions RE Contract Or Product Information Steven Pesek For Questions Concerning Order Processing	Phone: (540) 338-9060 Fax: (540) 338-9073 Phone: (937) 285-3204 Fax: (937) 228-0422	GS-20F-5002G	\$100.00
---	--	--	--------------	----------



Various Torque Wrenches Available for IMMEDIATE Delivery through GSA's Stock Program!!!

<u>NSN</u>	<u>TYPE & SIZE</u>	<u>RANGE</u>	<u>GRAD.</u>	<u>U/I</u>	<u>PRICE</u>
5120-00-117-4832	Dial, 1/4" square male drive	6 to 30 in-lb	1 in-lb	EA	\$59.51
5120-00-247-2540	Deflecting Beam, 1/2" square male drive	30 to 150 ft-lb	5 ft-lb	EA	\$48.41
5120-00-618-4433	Deflecting Beam, 1/4" square male drive	2 to 10 in-lb	0.5 in-lb	EA	\$108.06
5120-00-542-5681	Deflecting Beam, 3/8" square male drive	120 to 600 in-lb	25 in-lb	EA	\$57.14
5120-00-853-4538	Deflecting Beam, 3/8" square male drive	40 to 200 in-lb	10 in-lb	EA	\$47.14
5120-00-720-1975	Deflecting Beam, Preset Torque 3/8" square male drive	25 to 100 in-lb	5 in-lb	EA	\$194.52
5120-00-958-6906	Deflecting Beam, Preset Torque 3/8" square male drive	60 to 300 in-lb	10 in-lb	EA	\$391.60
5120-00-585-8434	Dial*, 1/4" square male drive	15 to 75 in-lb	1 in-lb	EA	\$50.04
5120-00-839-8139	Dial*, 1/4" square male drive	6 to 30 in-lb	1 in-lb	EA	\$49.88
5120-00-555-1521	Dial, 1" square male drive	200 to 1000 ft-lb	25 ft-lb	EA	\$399.55
5120-00-640-6364	Dial, 1/2" square male drive	35 to 175 ft-lb	5 ft-lb	EA	\$60.45
5120-00-640-6365	Dial, 1/2" square male drive	50 to 250 ft-lb	10 ft-lb	EA	\$60.23
5120-00-221-7983	Dial, 3/4" square male drive	120 to 600 ft-lb	10 ft-lb	EA	\$142.52
5120-00-230-6380	Dial, 3/8" square male drive	30 to 150 in-lb	5 in-lb	EA	\$45.47
5120-00-288-8865	Dial, 3/8" square male drive	120 to 600 in-lb	20 in-lb	EA	\$50.69
5120-00-776-1841	Dial, 3/8" square male drive	60 to 300 in-lb	5 in-lb	EA	\$46.65
5120-00-242-3263	Dial, 3/4" square male drive with ratcheting head	85 to 420 ft-lb	10 ft-lb	EA	\$285.88
5120-00-931-8361	Limiting Screwdriver, 1/4" hexagonal female drive	5 to 30 in-lb	1 in-lb	EA	\$111.88
5120-00-943-0941	Limiting Screwdriver, 1/4" hexagonal female drive	20 to 100 in-oz	2 in-oz	EA	\$109.77
5120-00-923-9620	Limiting Screwdriver, 1/4" square male drive	5 to 30 in-lb	1 in-lb	EA	\$111.88
5120-00-568-4742	Screwdriver Adjustable	5 to 25 in-lb	1 in-lb	EA	\$76.40
5120-00-900-1283	Deflecting Beam, 1/4" square male drive	25 to 120 in-lb	5 in-lb	EA	\$42.78

*Without signal or memory indicator

These items are available for purchase using I.M.P.A.C.® through **GSA Advantage!**™ or order using FEDSTRIP/MILSTRIP or MUFFIN procedures.

Contact: joann.mahaney@gsa.gov

Phone: (816) 926-3495, **DSN:** 465-3495, **Fax:** (816)926-3495



Facilities and Quarters Tool Kit

Kits consists of 42 light maintenance tool items assembled in a Portable Step Stool type Tool Box.

NSN: 5180-01-423-6468

Price: \$201.33

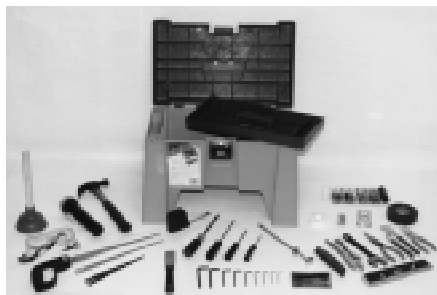

Order using **GSA Advantage!**™ or order using FEDSTRIP/MILSTRIP or MUFFIN procedures.

Contact: pam.booth@gsa.gov

Phone: (816) 926-7880

DSN: 465-7880



STACK-ON Portable Plastic Tool Boxes and Tool Chests



Part No. RB-19N

19" Portable Plastic "Road Box" Trunk Storage Tool Box

- Large bulk storage area
- Built-in recessed full grip handle
- Fits behind the seat of most trucks
- Color: **Black**
- 19" W x 11" D x 4-1/2" H

NSN: 5140-01-439-6912

U/I: PG (4 EA)

Price: \$29.13



Part No. PTB-19

19" Portable Plastic Power Tool Storage Box

- Same features as "Road Box"
- Also features a custom pad to help protect the contents.
- Color: **Blue**
- 19" W x 11" D x 4-1/2" H

NSN: 5140-01-438-1032

U/I: PG (4 EA)

Price: \$29.84



Part No. GM-16

16" Multi-Purpose Portable Plastic Tool Box With Removable Tote Tray

- Partitioned tote tray.
- Deep bottom storage area for larger items.
- Lockable
- Color: **Gray, with Black Tray**
- 16" W x 8" H x 8-3/4" D

NSN: 5140-01-439-7828

U/I: PG (4 EA)

Price: \$24.95





Part No. MP-222

22" Portable Plastic Tool Chest With 2 Steel Drawers

- Smooth action steel drawers and glides.
- Steel inner walls hold heavy loads.
- Extra deep top compartment for power tools and accessories.
- Color: **Gray, with Red Metal Trays**
- 22" W x 11-1/4" H x 10-7/8" D

NSN: 5140-01-439-6907
U/I: PG (2 EA)
Price: \$55.20



Part No. GM-19

19" Hip Roof Portable Plastic Tool Box With Removable Tote Tray

- Deep bottom storage area for power tools.
- Large, partitioned tote tray
- Lockable
- Color: **Gray, with Black Tray**
- 19" W x 10" D x 9-1/4"

NSN: 5140-01-439-6908
U/I: PG (4 EA)
Price: \$33.65



Part No. CL-19

19" Cantilever Tray Portable Plastic Tool Box

- Dual 12-compartment cantilever trays
- Top tray includes 4 "easy scoop" small parts compartments
- Deep bottom storage area
- Convenient lift handle easily lifts trays
- Color: **Gray, with Red Cantilever Trays**
- 19"W x 10" D x 9-1/4" H

NSN: 5140-01-439-6910
U/I: PG (4 EA)
Price: \$54.13

Continued next page





Part No. GM-22

22" Mechanics/Contractor Portable Plastic Tool Box With Removable Tote Tray

- Heavy duty to support heavy loads.
- Large sure-grip handle
- Partitioned tote tray.
- Color: **Gray, with Black Tray**
- 22" W x 10" D x 10-1/4" H

NSN: 5140-01-439-6913

U/I: PG (4 EA)

Price: \$49.37

Order through FEDSTRIP/MILSTRIP or MUFFIN procedures.

Contact: arlene.tittle@gsa.gov

Phone: (816) 926-7588

DSN: 465-7588

Highway Safety Tool Kit

This Highway Safety Tool Kit contains essential highway safety items in a slim plastic trunk storage box. The tool kit is designed to fit in car trunks, under van and utility vehicle seats, and behind the seats of most pickup trucks. The kit contains the following: 1 Reflective Thermal Blanket; 1 set of Battery Booster Cables 12 feet long; 1 Utility Cutter, for cutting seat belts and small gage wire; 1 Flashlight; 1 pair of Gloves; 2 30-minute yellow glow Chemical Light Sticks; 1 Inflatable Pillow; 1 Split Joint 8 inch Pliers; 2 Highway Warning Reflectors; 1 Cross tip Screwdriver; and 1 Flat tip

Screwdriver. Discounts available for larger quantities!

Order through FEDSTRIP/MILSTRIP or MUFFIN procedures.



NSN: 5180-01-441-6698

Price: \$59.97

Part No: HSTK-112

Contact: arlene.tittle@gsa.gov

Phone: (816) 926-7588

DSN: 465-7588

WISE-GRIP® Locking Wrenches

Finally, a VISE-GRIP® designed to be used as a wrench. The new patented VISE-GRIP® Locking Wrenches from American Tool Companies, Inc., are designed to lock on three sides of a hex fastener. Tremendous force can be applied without damaging or slipping off the fastener. Jaws lock on to three sides of the nut or bolt without marring it. Each VISE-GRIP® Locking Wrench adjusts to a range of standard and metric wrench sizes.

NSN: 5120-01-438-0389

Part No: 4LW

Description: 4" Locking Wrench with wire cutter

Wrench size range: 1/4" to 9/16"; 7mm to 14mm

Price: \$6.85

U/I: EA

NSN: 5120-01-438-0386

Part No: 7LW

Description: 7" Locking Wrench with wire cutter

Wrench size range: 7/16" to 3/4"; 11mm to 19mm.

Price: \$7.79

U/I: EA

NSN: 5120-01-438-0387

Part No: 10LW

Description: 10" Locking Wrench with wire cutter

Wrench size range: 5/8" to 1-1/8"; 16mm to 28mm

Price: \$9.55

U/I: EA

NSN: 5120-01-438-0702

Part No: 248

Description: 3-piece VISE-GRIP® Locking Wrench Set

Part numbers: 4LW™, 7LW and 10LW™ in a kit bag

Price: \$24.19

U/I: SE

Order through FEDSTRIP/MILSTRIP or MUFFIN procedures.



Contact: arlene.tittle@gsa.gov

Phone: (816) 926-7588

DSN: 465-7588



Makita Cordless Driver-Drills Available Under GSA Contract!

Makita's new line of 2.0 Amp Hour (Ah) Cordless Driver-Drills are now available through the GSA New Item Program. These tools have the following features:

Powerful 9.6V, 12V or 14.4V high performance motor with externally accessible brushes.

2.0 Amp Hour battery. These latest technology batteries provide for longer run time than conventional cordless tool batteries.

Superior torque-to-weight ratios.

Ergonomic shape that is compact and well balanced.

Two-speed gear selection switch.

17 torque settings in both high and low speed.

Keyless Jacobs® chuck with Hand-Tite® feature for easy bit installation and removal.

Each driver-drill is supplied with two batteries with plastic terminal covers, a one-hour battery charger, two combination Phillips/ slotted end screwdriver bits, and a plastic carrying case.

NSN: 5130-01-438-2392
Model No: 6203DWAE
Description: 9.6 volt, 3/8" chuck Driver-Drill Kit

1-24 units: \$151.43
25+ units: \$146.89



NSN: 5130-01-438-2391
Model No: 6213DWAE
Description: 2 volt, 3/8" chuck Driver-Drill Kit

1-24 units: \$173.22
25+ units: \$168.02

NSN: 5130-01-438-2393
Model No: 6313DWAE
Description: 12 volt, 1/2" chuck Driver-Drill Kit

1-24 units: \$184.12
25+ units: \$178.59

NSN: 5130-01-438-2390
Model No: 6333DWAE
Description: 14.4 volt, 1/2" chuck Driver-Drill Kit

1-24 units: \$200.54
25+ units: \$194.44

NSN: 5130-01-438-2394
Model No: 6233DWAE
Description: 14.4 volt, 3/8" chuck Driver-Drill Kit

1-24 units: \$189.56
25+ units: \$183.87

Government customer purchase prices are subject to change throughout the contract period. Verify prices with GSA at time of order.

Contact: arlene.tittle@gsa.gov
Phone: (816) 926-7588
DSN: 465-7588

Quality Tools for Your Office Needs

The Tools and Appliances Center's Office Tool Kit can help you replace those unorganized, hard-to-find tools presently being kept all over the office. This kit is contained in a single custom-zipper tool case where you will find:

- * Adjustable Wrench
- * 16' Steel Tape Measure
- * Cushion Grip Pliers
- * Cushion Grip Needle Nose Pliers
- * Office Scissors
- * Utility Knife
- * Jeweler's Repair Kit
- * Two Sizes Phillips Screwdrivers
- * Hex Key Set
- * Two Sizes Flat-Tip Screwdrivers
- * Claw Hammer
- * Tweezers

The Office Tool Kit (National Stock Number 5180-01-336-7141) is available from the depots for \$102.49, and is immediately available.

This item is available for purchase with the I.M.P.A.C.® Card through **GSA Advantage!**™ or order using FEDSTRIP/MILSTRIP or MUFFIN procedures.



Contact: tom.slezak@gsa.gov
Phone: (816)926-3470
DSN: 465-3470



KIPPER TOOL COMPANY - NEW ITEMS

CORDLESS 18 VOLT POWER TOOL KIT

GSA CONTRACT #GS-06F-78429

Kipper Tool Company Item #KTC-CDSK-WA

Weight: 110 LBS. - Cubic Feet: 7.9

NSN 5180-01-436-8531

KIPPER TOOL COMPANY - 1-800-295-9595

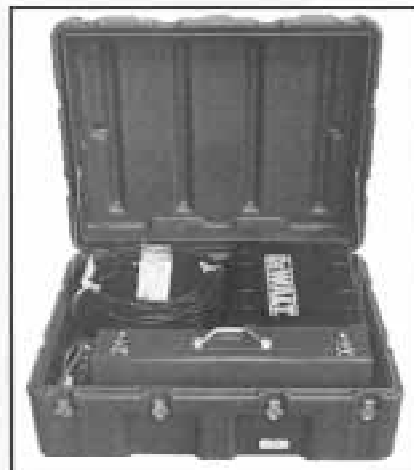

KIPPER TOOL COMPANY - NEW ITEMS

CORDLESS 18 VOLT POWER TOOL KIT KTC-CSDK-WA NSN 5180-01-436-8531

SPECIFICATIONS

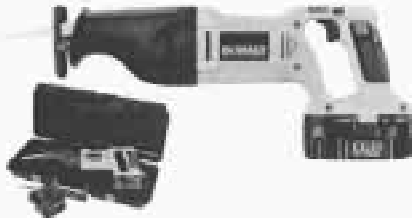

(1) DW936K
18 VOLT CORDLESS RECIPROCATING SAW
w/CHARGER, BATTERY, CASE & BLADE
ASSORTMENT NSN 5130-01-444-4681



(1) KTC RUL 9598
HOLE SAW KIT - 3/4" TO 2-1/2" HOLE SAWS,
plus MANDRELS & CASE



(1) DW997K
**18 VOLT 1/2" CHUCK CORD-
LESS DRILL/DRIVER/HAMMER-
DRILL w/CHARGER**
BATTERY & CASE
NSN 5130-01-444-4664

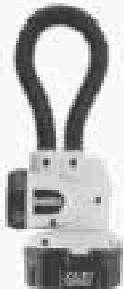

(1) KTC DW919WB
18 VOLT CORDLESS
FLOODLIGHT



(1) KTC D125 "DIGITAPE"
DIGITAL TAPE MEASURE,
1" X 25'
NSN 5210-01-412-8020



(1) DW936K
18 VOLT CORDLESS 5-3/8" CIRCULAR TRIM
SAW w/CHARGER, BATTERY & CASE
NSN 5130-01-446-1303



.. PLUS THESE ESSENTIAL ACCESSORIES

(1) KTC MDR 18172
24 PIECE DRILL INDEX - JL-HD 1/16" TO 1/2" X
32NDS & CASE

(1) KTC MB-10
MASONRY BIT SET, 10 PIECE, 3/16" TO 1/2" &
DAL w/ROLL POUCH

(1) KTC DW9054
5-3/8" 24T CARBIDE TIP SAW BLADE

(1) KTC GEN 185 - 1/2
1/2" COUNTERSINK

(1) KTC GEN 185 - 5/8
5/8" COUNTERSINK

(1) KTC GEN 185 - 3/4
3/4" COUNTERSINK

(1) KTC GEN 55
1-3/4 - 7-7/8" SINGLE CUTTER

(1) KTC USW 82100 +3
100' 12/3 BLACK EXTENSION CORD plus
TRIPLE OUTLET

(2) KTC EST 46
SAFETY GOGGLES

(1) KTC OUA 3001
POCKET MAGNETIC BIT KIT, 10 PIECE,
PHILIPS, SLOTTED, SQUARE & STAR, w/CASE

(1) KTC SEC 3022-0709
TRANSPORT/STORAGE CASE,
H. DUTY, LOCKABLE, WEATHERPROOF
(shown on floor)

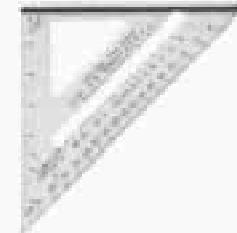

(1) RAS1
SPEED SQUARE,
7" w/MANUAL
NSN 5210-01-308-5737

Not Available on GSA Advantage!SM

For more information:

Call Arlene Tittle at (816) 926-7588

or email to: arlene.tittle@gsa.gov

Call KIPPER TOOL 1-800-295-9595 for COMPONENT PART REPLACEMENT

Order from GSA FEDSTRIP or MILSTRIP • NSN 5180-01-436-8531 •

Take Advantage of More Rapid Stock Availability!!

During the last few years the items shown below were actually removed from depot stock and filled by contractor Direct Deliveries to the customer. This has occasionally created some problems for receipt of these orders within the customer's required timeframes. In order to deal with this concern, the Tools & Appliances Center has returned the National Stock Numbers shown below to depot stock.

NSN:	5120-00-169-2986
Description:	Torque Multiplier
Price:	\$2,540.30
NSN:	5120-00-337-9652
Description:	Torque Multiplier
Price:	\$3,712.74
NSN:	5120-00-482-2543
Description:	Torque Multiplier
Price:	\$4,866.10
NSN:	5120-00-961-9813
Description:	Impact Wrench Set
Price:	\$2,232.14
NSN:	5120-00-961-9815
Description:	Impact Wrench Set
Price:	\$5,657.86
NSN:	5130-00-494-1132
Description:	Electric Rotary Tool Kit
Price:	\$3,339.43
NSN:	5130-00-596-4506
Description:	Pin Rivet Gun
Price:	\$4,118.36
NSN:	5130-00-712-4855
Description:	Flexible Swaging Tool
Price:	\$10,256.62
NSN:	5130-00-889-9020
Description:	Electronic Impact Wrench
Price:	\$2,337.53

NSN: 5130-01-087-6840
Description: Electronic Impact Wrench
Price: \$1,921.34

NSN: 5180-00-292-0087
Description: Rivet Puller Tool Kit
Price: \$1,820.42

NSN: 5180-00-313-3045
Description: Electrician's Tool Kit
Price: \$2,095.63

NSN: 5180-00-356-4602
Description: Telephone and Machine Repair Kit, TE50B
Price: \$3,190.55

NSN: 5180-00-408-1863
Description: Telephone Elect. Tool Kit
Price: \$879.04

NSN: 5180-00-596-1501
Description: Pipefitter's Tool Kit
Price: \$3,085.00

NSN: 5180-00-596-1510
Description: Sheetmetal Worker's Tool Kit
Price: \$1,488.15

NSN: 5180-00-596-1546
Description: Engineer's Pioneer Tool Kit
Price: \$3,150.00

NSN: 5180-00-611-7924
Description: Medical Equipment Tool Kit
Price: \$3,200.95

NSN: 5180-00-799-8860
Description: Tube Flaring Tool Kit
Price: \$8,845.34

NSN: 5180-01-089-1229
Description: Riveter's Tool Kit
Price: \$966.95

These items are available for purchase with the I.M.P.A.C.® Card through **GSA Advantage!**™ or order using FEDSTRIP/MILSTRIP or MUFFIN procedures.

Contact: tom.slezak@gsa.gov
Phone: (816)926-3470
DSN: 465-3470



**Watch these
pages for
additional
information
about the
upcoming
General
Products and
Services Expo**

**March 31 -
April 1, 1999
San Antonio, TX**

**web site:
http://
expo.gsa.gov/**



Survival/Multi-Purpose Knives

Over the last several years some of the best selling items in the GSA, Tools and Appliances Center's stock program have been the "survival" and multi-purpose knives used by virtually all areas of the Government. Just recently the contractor has made a positive commercial change to ensure the safety of all users of these item(s).

This enhancement, known as the Multi-Plier® Multi-Lock™ automates the lock in place for the ten major components of this tool in order to ensure safety. Once your use is completed, pressure on the lock release permits a quick, easy release, and closure, of the component back into the "tool box which fits in the palm of your hand". Even with this addition the tool continues to measure 5 1/8" when closed.

Five (5) of these NSN's are available in the stock program for immediate order.

NSN: 5110-01-346-5339
Description: Stainless Steel with black synthetic heavy duty sheath
Price: \$43.04

NSN: 5110-01-346-5340
Description: Stainless Steel with leather sheath
Price: \$46.28

NSN: 5110-01-346-5341
Description: Black finish with black ballistic cloth sheath
Price: \$46.28

NSN: 5110-01-394-6249
Description: Needle Nose S/S with black synthetic heavy duty sheath
Price: \$50.07

NSN: 5110-01-385-7354
Description: Stainless Steel Tool Kit with black synthetic heavy duty sheath, coupler and six screw driver bits
Price: \$51.22

These items are available for purchase with the I.M.P.A.C.® Card through **GSA Advantage!**™ or order using FEDSTRIP/MILSTRIP or MUFFIN procedures.

Contact: tom.slezak@gsa.gov
Phone: (816)926-3470
DSN: 465-3470

New Item

Toolfinder A Tool Recovery System

A misplaced tool can be the greatest threat to aircraft safety and flight readiness. The Toolfinder Recovery System is your most potent weapon in the fight against tool Foreign Object Damage (FOD). The total responsibility for aircraft safety and reliability rests on the maintenance team's shoulders. The pressure of quickly returning aircraft to the



NSN: 5180-01-449-4996
U/I: KT
Price: \$11,788.74

flightline is often intense on maintenance personnel. Errors like misplacing a tool can keep an aircraft grounded until that tool is located.

The Toolfinder Recovery System has been developed to reduce the time spent locating misplaced tools which could lead to serious damage if not found. Since Toolfinder can quickly detect tools lodged in critical areas where visual inspection isn't possible, down time and risk of tool FOD is greatly reduced.

Toolfinder can relieve some of the pressure of your job, helping you to keep your aircraft in the sky.

Order using FEDSTRIP/MILSTRIP or MUFFIN procedures.

Contact: arlene.tittle@gsa.gov
Phone: (816) 926-7588

**Visit the Tools
and Appliances
Center
Homepage**

**http://
www.r6.gsa.gov/
tac**



New Item

Need Portable Cooling Systems?

Avenger Model 14CAP Portable Cooling System

Provides 14,000 BTU's cooling, 1phase, 115V, 20 amps, 238 lbs. shipping weight, standard 4-way adjustable supply grille (not shown), flexible supply duct is available.

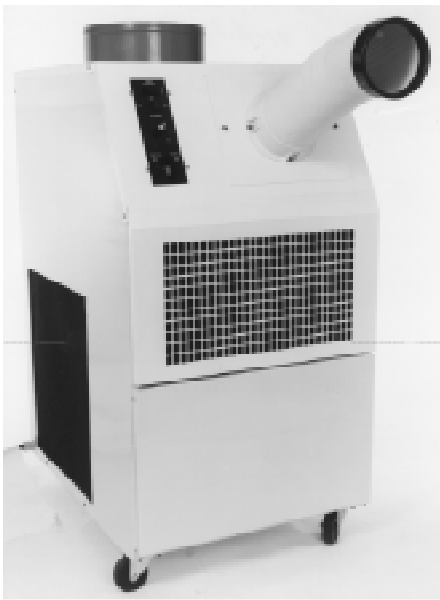

NSN: 4120-01-452-1996
U/I: BX
Price: \$2,952.06

Avenger Model 30CAP Portable Cooling System

Provides 30,000 BTU's cooling, 1phase, 220V, 20 amps, 335 lbs. shipping weight, standard 4-way adjustable supply grille (not shown), flexible supply ducts are available.



NSN: 4120-01-452-1997
U/I: BX
Price: \$4,068.35

Order using FEDSTRIP/MILSTRIP or MUFFIN procedures.

Contact: arlene.tittle@gsa.gov
Phone: (816) 926-7588



Leather Tool Belt

This electrician's style, leather tool belt has a tape sling, hammer loop and snap hook, furnished by Stone Belt ARC, Inc., under the JWOD Program. The Air Force, Navy, Department of Justice and Department of Interior have all purchased these tool belts in large quantities over the last year. Whether your repair needs are large or small, your maintenance and repair staff will enjoy using this durable, reasonably priced tool belt.

For proper fit, order about six inches longer than regular belt size.

NSN: 5140-00-529-2517
Description: Belt, Tool, Repairman's (Size 34)
U/I: EA
Price: \$7.22

NSN: 5140-00-529-2694
Description: Belt, Tool, Repairman's (Size 38)
U/I: EA
Price: \$7.13

NSN: 5140-00-529-2691
Description: Belt, Tool, Repairman's (Size 44)
U/I: EA
Price: \$7.91

The JWOD Tool Belt is available through **GSA Advantage!**TM or by using FEDSTRIP/MILSTRIP or MUFFIN procedures.

Contact: debby.kurle@gsa.gov
Phone: (816) 926-1134

CORRECTION...CORRECTION

Spring 1997 Catalog Correction

The catalog incorrectly lists the price on 5180-00-177-7033 as \$257.28.

The correct price is: 4444.48



Crowfoot Wrenches Available Through GSA's Stock Program

Use for flare nuts and aircraft fittings in hard-to-reach areas.

Strong, chrome-plated steel attachment has a female drive opening at one end and an open-style wrench at the other. It attaches to the male square drive end of the socket wrench handle or extension bar. Open-end, box-style crowfoot socket wrench attachment has a slot and a 12-point wrenching configuration.

3/8" DRIVE SOCKETS with square female drive opening

NSN: 5120-00-189-7896
Opening: 11/16"
Head Thickness: 11/16"
U/I: EA
Price: \$10.56

NSN: 5120-00-189-7898
Opening: 3/4"
Head Thickness: 23/32"
U/I: EA
Price: \$11.39

NSN: 5120-00-189-7895
Opening: 13/16"
Head thickness: 23/32"
U/I: EA
Price: \$10.94

NSN: 5120-00-181-6765
Opening: 7/8"
Head Thickness: 3/4"
U/I: EA
Price: \$12.51

NSN: 5120-00-541-4075
Opening: 15/16"
Head Thickness: 3/4"
U/I: EA
Price: \$12.86

NSN: 5120-00-229-2772
Opening: 1"
Head Thickness: 25/32"
U/I: EA
Price: \$13.52

NSN: 5120-00-181-6764
Opening: 1-1/16"
Head Thickness: 25/32"
U/I: EA
Price: \$13.72

1/2" DRIVE SOCKETS with 1/2" female drive opening

NSN: 5120-00-229-2773
Opening: 1-1/8"
Head thickness: 7/8"
U/I: EA
Price: \$15.17

NSN: 5120-00-229-2774
Opening: 1-3/16"
Head Thickness: 7/8"
U/I: EA
Price: \$18.16

NSN: 5120-00-181-6757
Opening: 1-3/8"
Head Thickness: 15/16"
U/I: EA
Price: \$19.95

NSN: 5120-00-181-6758
Opening: 1-7/16"
Head Thickness: 15/16"
U/I: EA
Price: \$21.38

NSN: 5120-00-181-6755
Opening: 1-1/2"
Head Thickness: 15/16"
U/I: EA
Price: \$21.16

These items are available for purchase with the I.M.P.A.C.[®] card through **GSA Advantage!**[™] or by using FEDSTRIP/MILSTRIP or MUFFIN procedures.

Contact: joann.mahaney@gsa.gov
Phone: (816)926-3495
DSN: 465-3495

New Item

The Super Tork Fastening Tool Kit

The TDA Fastening Tool has a ratcheting head which can maneuver into seven different positions. Its chrome plated and hardened body is 300% stronger than any other ratcheting screwdriver design available. This kit comes with 41 attachments including Metric and SAE Sockets, Phillips bits, slotted bits, hex bits, and star bits all neatly packaged in a blow molded carrying case. No shop, garage or mechanic should be without this multi-purpose tool. It could be the only screwdriver you'll ever need.

Order by using FEDSTRIP/MILSTRIP or MUFFIN procedures.

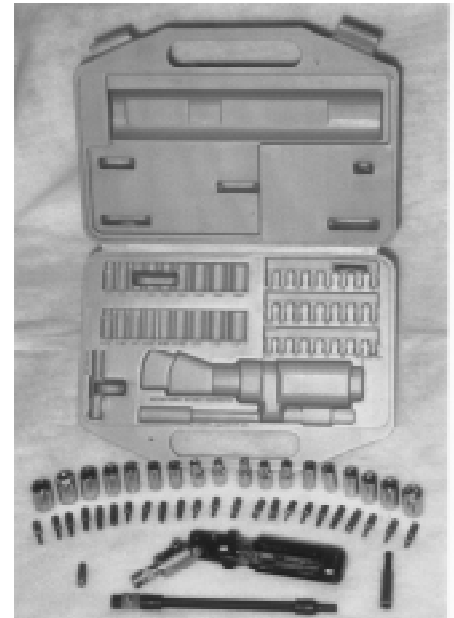

NSN: 5120-01-455-2275
U/I: KT
PRICE: Call for price breaks
MOQ: 1

Contact: arlene.tittle@gsa.gov
Phone: (816) 926-7588



Are you looking for the perfect Appliance...check out the Appliances and Services Acquisition Program (ASAP)!

Order using FEDSTRIP/MILSTRIP or MUFFIN procedures or through GSA Advantage!TM.

This program offers you choices in vendor and product lines through the availability of over 1200 new appliances' National Stock Number's (NSN's) under contract with quality, brand-name vendors. Each NSN in this program is assigned to a specific manufacturer's model number. Check out some of the choices available on GSA Advantage!TM

NOTE: Effective October 1, 1998, Appliances will be available on Multiple Award Schedules (MAS).

Frigidare FMT116 Space Save Microwave

Compact microwave mounts above a rangetop to save space * 850 watts cooking power * 1.1 cu. Ft. oven cavity * Electric touch pad controls * 5 cooking modes, 10 heat settings, 6 cooking programs * Digital clock-timer * Interior oven light * Blackoven window * 120 volts, 60 Hz * 15-13/32" h X 24-7/8" w X 14" d.

NSN: 7310-01-428-1870
Price: \$324.59

White-Westinghouse FSE747 Electric Clothes Dryer

Affordable price in a convenient single-family electric dryer * 5.5 cu. Ft. drum capacity * Program settings for 3 heat selections, 3 auto-drying cycles and 4 timed cycles up to 70 minutes * Adjust-

able end-of-cycle signal * Heat sensor * RH door opens wider for easier accessibility * 4 leveling legs * Rear exhaust with additional knockout * 1/4 HP motor * Requires 4500 heating watts, 30 amps 208/240 volts, 60 Hz * 36" h X 26-7/8" w X 25-1/4" d

NSN: 3510-01-428-3742
Price: \$380.41

White-Westinghouse FWT445 Clothes Washer

Deluxe features on a convenient front loading single-family washer * 2.7 cu. Ft. tub capacity * Automatic water level selection * Program settings for 8 wash cycles, 4 wash/rinse temperatures, 2 wash and agitate/spin speeds * Automatic liquid bleach dispenser * Safety lock lid * Self-leveling front legs, rear rollers * Requires 15 amps, 120 volts, 60 Hz * 36" h X 26-3/4" w X 24-3/4" d.



NSN: 3510-01-428-3730
Price: \$761.91

MicrofridgeTM MF-3 (Black)

Combination Refrigerator, Freezer and Microwave. Runs all 3 appliances on a single cord * Microwave oven permanently fixed to the refrigerator * Refrigerator has 2.9 cu. Ft. fresh food compartment * Separate door * Door storage for small packages, * Interior light * 2- shelves * Adjustable temperature control * Freezer has 0.7 cu. Ft. compartment * Separate door * 2 Ice trays * Microwave has 600 watts power * 2 power cooking levels * 30 minute timer with audible signal * Glass carousel * Window in door * Operates on 120 volts, 60 Hz * maximum dimensions: 45" h X 21" w X 26-1/2" d.



NSN: 4110-01-355-3015
Price: \$469.79*

*For Price Breaks on MicrofridgesTM and more information contact Janna Babcock at (816) 926-1299 or E:mail janna.babcock@gsa.gov



Order using FEDSTRIP/MILSTRIP or MUFFIN procedures.

Microfridge™ MF-3 (White)

Combination Refrigerator, Freezer and Microwave. Runs all 3 appliances on a single cord * Microwave oven permanently fixed to the refrigerator * Refrigerator has 2.9 cu. Ft. fresh food compartment * Separate door * Door storage for small packages * Interior light * 2 shelves * Adjustable temperature control * Freezer has 0.7 cu. Ft. compartment * Separate door * 2 Ice trays * Microwave has 600 watts power * 2 power cooking levels * 30 minute timer with audible signal * Glass carousel * Window in door * Operates on 120 volts, 60 Hz * maximum dimensions: 45" h X 21" w X 26-1/2" d

NSN: 4110-01-442-4309

Price: \$469.79*

*For Price Breaks on Microfridges™ and more information contact **Janna Babcock** at (816) 926-1299 or Email janna.babcock@gsa.gov

Staber System 2301 Clothes Washer

Horizontal-Axis top loading single-family washer offers economical operation. * 2.0 cu. Ft. tub capacity * Stainless steel tub and wash basket * Variable water level selection * Program settings for 3 wash cycles, 3 wash/rinse temperatures, 3 wash and agitate/spin speeds * Automatic liquid bleach and fabric softener dispenser * Safety lock lid * Motor rated 1/2 HP * Requires 8.0 amps, 120 volts, 60 Hz * 42" h X 27" w X 26" d.

NSN: 3510-01-445-1784

Price: \$1084.74

White-Westinghouse MGF352BF Self-Cleaning Gas Range

Oven has 4.05 cu. Ft. capacity with broiler * Removable black glass oven door with window * Removable oven storage drawer * Interior oven light * Digital clock * Free standing for flush-to-wall installation * 2 removable racks with 5 adjustable heights * 4 cooktop burners * Burner controls located on the manifold, oven controls located on the backguard * Electronic ignition * Convertible from LP to Natural Gas * Requires 120 volts, 60 Hz * 45-5/16" h X 29-7/8" w X 25-3/8" d.



NSN: 7310-01-441-2701 (White)

Price: \$475.24

White-Westinghouse MEF356BF Self-Cleaning Electric Range

Radiant rangetop provides more even cooking surfaces * Oven has 4.05 cu. Ft. capacity, saves time and work * Removable black glass oven door with window * Interior oven light * 2 removable oven

Radiant rangetop provides more even cooking surfaces * Oven has 4.05 cu. Ft. capacity, saves time and work * Removable black glass oven door with window * Interior oven light * 2 removable oven racks with 5 adjustable heights * Removable oven storage drawer * Three 6" and one 8" radiant surface elements with "ON" safety indicator lights * Burner and oven controls located on backguard * Lift-up cooktop * Electric digital clock with timer * Requires 40/35 amps, 208/240 volts, 60 Hz * 46-5/16" w X 29-7/8" w X 25-3/8" d.



NSN: 7310-01-444-9055 (White)

Price: \$497.04

Sharp R-430AK Standard Microwave

Low profile design in a portable/tabletop oven * 1.2 cu. Ft. oven capacity * 1000 watts cooking power * Electric touchpad controls * Program cooking with 8 cooking modes, 10 heat settings * Digital clock with automatic oven timer * Full black oven window * Interior oven light * Food carousel * Requires 120 volts, 60 Hz, 13.0 amps, 1.5KW * 12-1/8" h X 21-5/8" w X 17-1/8" d.

NSN: 7310-01-444-9059 (Black/Stone)

Price: \$155.66



Fedders A3T12F2AG 12,000 BTU Window/Wall Air Conditioner

Quiet cooling for home or office, mounts in window or through the wall. Removes 3.9 pints/hour moisture * 4 Air direction controls and fresh air intake * Up to 310 CFM air circulation * Rated 9.0 EER * 115 volts, 60 Hz, 12.0 amps, 1330 watts * Fits 24" – 39" window width * 15-3/4" h X 23-3/4" w X 22-1/2" d

NSN: 4120-01-445-1765 (Gray)
Price: \$370.60

Portatemp PAC02 7,000 BTU Portable Air Conditioner

Free standing air cooled unit rolls on casters to provide spot cooling. Removes up to 38 pints of moisture/24 hours to increase comfort * Up to 320 CFM air circulation * Rated 8.9 EER * 115 volts, 60 Hz, 6.5 amps, 780 watts * Interior cabinet size:
28-1/2" h X 22-1/2" w X 14" d.

NSN: 4120-01-444-1916
Price: \$1,197.91

Amana 7QZ21RC 6,600 BTU Window Air Conditioner

Highly efficient single room cooling comfort. Removes 2.0 pints/hour moisture * 2 air direction controls * Up to 180 CFM air circulation * Rated 10.0 EER * 115 volts, 60 Hz, 6.2 amps, 660 watts * Fits 13-1/8" – 19" window width * 13-1/8" h X 19" w X 20-1/16" d.

NSN: 4120-01-444-8452 (gray)
Price: \$358.88

Amana RSL669T Standard Microwave

Tabletop mounting plus portable convenience * 1000 watts cooking power * Electronic touchpad controls, 10 heat settings * Digital clock with automatic oven timer * Interior oven light * Food carousel * Requires 120 volts, 60 Hz, 20 amps, 1.5KW * 14-1/4" h X 21-3/4" w X 17-9/16" d.

NSN: 7310-01-444-8436 (Almond)
Price: \$241.38

Amana LE8317W2 Electric Clothes Dryer

Convenient single family dryer has a big 6.6 cu. ft. drum capacity * Program settings for 6 time drying and 2 auto-drying cycles, 3 heat selections * End-of-cycle signal * RH door opens wide for easier accessibility * 4 leveling legs * Motor rated 1/3 HP * Requires 30 amps, 5000 watts, 120/240 volts, 60 Hz * 43-1/4" h X 26-7/8" w X 28" d.

NSN: 3510-01-444-8441
Price: \$302.43

Amana ADU 5000DB Built-in Dishwasher

5 Programmable cycles, 4 Pushbutton controls, 3 Wash levels – all work together to get dishes sparkling clean * Cycles for pots & pans, light and normal & heavy wash * Drying "heat off" option * Detergent dispenser * Upper and lower rack, utensil basket * 120°F inlet water capability * Uses 9.0 gallons water per cycle * 50 cycles/kwh energy factor * 4 leveling legs, changeable door panel * 120 volts, 60 Hz, 15 amps * 34" h X 24" w X 24" d.

NSN: 7320-01-444-8448
(Black/Almond)
Price: \$321.45

Microkitchinn™ MK-8M

Combination Refrigerator, Freezer, Microwave and Coffee Maker. All on a single power cord * Total assembly dimensions: 69.63" h X 23.63" w X 24.5" d * 7.5 cu. Ft. refrigerator * Interior light * Reversible door * Automatic cold control * Push button defrost * Adjustable shelves * 2 vegetable crispers * 2 egg racks * Dairy compartment, 2.5 cu. Ft. Freezer compartment w/separate door * 600 watt Microwave * 15 minute timer * Removable glass cooking tray * Push button door release * Storage/workspace area and 4 cup personal coffee maker * Energy Management System (EMS) * Electric Load Management System * Unit supplied with 6 ft. power cord with 3 prong grounded plug * Maximum Load Total Assembly 950 watts, 120 volts, 60 Hz.



NSN: 4110-01-444-9053
Price: \$858.92

For more information:
Contact: janna.babcock@gsa.gov
Phone: (816) 926-1299



Defense Logistics Support Command

Ft. Belvoir, VA

Active Noise Reduction (ANR) Headsets And Accessories

The deafening roar of today's high-powered aircraft significantly interferes with communications--the vital link among commanders and front-line crews. It also increases fatigue, thus, reducing alertness. Long term exposure can cause permanent hearing damage. In fast-paced modern combat, noise can mean far more than a moment's discomfort or confusion. It can contribute to the loss of life and equipment. Defense Supply Center, Columbus, realizes the importance of ANR Headsets and has recently established the following National Stock Numbers (NSNs):

NSN: 5695-01-446-1028
Part No: 011696
Description: Aviation Headset with Straight Cord, High Impedance Electret Boom Microphone, Deluxe Carrying Case, Owners Manual
Price: \$965.00

NSN: 5965-01-446-1033
Part No: 011697
Description: Aviation Headset with Coiled Cord, High Impedance Electret Boom Microphone, Deluxe Carrying Case, Owners Manual
Price: \$965.00

NSN: 5965-01-446-1041
Part No: 002925
Description: Cushion Ear - Clear Comfort Silicon-Gel Ear Cushion Kit (one pair)

Price: \$35.00
NSN: 5965-01-446-1044

Part No: 016003
Description: Filter, Acoustical - One Foam Windscreen w/O-Ring

Price: \$2.00

NSN: 5965-01-446-1052
Part No: 016007
Description: Headband, Headset - One Foam Windscreen w/O-Ring

Price: \$25.00

NSN: 5965-01-446-1058
Part No: 019577
Description: Filter, Acoustical - One Pair Headset Cup Inner Foam

Price: \$13.50

NSN: 5965-01-447-9731
Part No: 015994
Description: Headset, Accessory, Communication Cables for Portable use (Fixed Wing), Stereo Phone and Microphone Plugs

Price: \$86.00

NSN: 5965-01-447-9750
Part No: 015998
Description: Headset, Accessory - Communication Cables for Portable Use (Helicopter) U174/U Plug

Price: \$86.00

NSN: 5965-01-447-9754
Part No: 015999
Description: Headset, Accessory - Installed Installation Kit Panel Connector w/6' Prewire Harness, Installation Instructions.

Price: \$31.00
NSN: 5965-01-447-9758
Part No: 011434
Description: Headset, Accessory - Nicad Battery Pak, 110V with Belt clip, 110V Charger, Owners Manual

Price: \$150.00

NSN: 5965-01-447-9762
Part No: 011435
Description: Headset, Accessory, Nicad Battery Pak, 220V with Belt Clip, 220V Charger, Owners Manual

Price: \$150.00

NSN: 5965-01-447-9764
Part No: 016001
Description: Headset, Accessory, Alkaline Battery Pak, Alkaline Cell Holder, Battery Case with Belt Clip

Price: \$25.00

For more information about these new S9E items, contact the Marketing Office, DSN 850-7594 or 1-800-643-8825.



Your Computer Needs A Bath!

Integrating cleaning into a hardware maintenance plan is like flossing regularly. You know you should do it, but if you're like most people, you probably don't. The Defense Supply Center, Columbus, recently assigned National Stock Number (NSN) 7035-01-450-8599 to a cleaning kit that is a safe, non-flammable, non-butyl formula that removes dirt, dust, food, grease, oil, toner and other stains. This kit was specifically designed to help troops clean and maintain field electronic equipment including base computer units, telephones, military electronics and all office equipment.

This kit consists of:

- 13" storage box
- 12 oz. canned air
- 5 toner wipes
- keyboard brush
- 2 sided detail cloth
- 3.5 diskette cleaner
- 16 oz. Computer Bath Power cleaner
- Lambswool duster
- Large detail brush
- 100" long wood handle cotton swabs
- Non-abrasive scrub pad

These computer cleaning tools have been developed for high efficiency cleanup and perform in all-terrain environments and extreme conditions. For further information about this new item, contact DSN 850-8555 or 1-800-643-8825.

Catalog For Flat Washers

A helpful new catalog exclusively for identifying flat washers is now available from the Defense Industrial Supply Center. The Commodity Business Unit, DISC-J, has developed this technical reference catalog for the purpose of informing various engineering/design activities, both military and civilian, of the fastener products available within the Federal Supply System. The flat washers listed

include any which are described with the following properties: Carbon Steel, Alloy Steel, Corrosion Resistant Steel (CRES), Cadmium Plate, Passivation, or Anodize. You may request a copy of this catalog by calling James McMullen at (215) 697-0502 or by DSN 442-0502 pr by fax using extension 3648.

EPA Approved Refrigerants Now Easily Available

Class 1 ozone-depleting chemicals (ODCs) are substances which have been shown to deplete the earth's protective ozone layer. The United States has banned the manufacture and importation of Class I ODCs and has sharply raised the federal tax on such chemicals. Obviously, these are just two of the environmental and economic reasons to switch to non, or less ozone-depleting chemicals to get your job done.

Under the Clean Air Act's Significant new Alternatives Policy (SNAP) the Environmental Protection Agency (EPA) identifies and publishes lists of alternatives to Class I ozone-depleting chemicals. It does not allow the introduction of new products that simply present different adverse effects on human health or the environment than those of the product being replaced.

Defense Supply Center Richmond, has added an alternative refrigerants category to the 1998 DLA Environmental products catalog. These alternative refrigerants are EPA SNAP-approved and are easily obtainable through the Federal Supply System. This cost is substantially lower than the Class I ODCs they are intended to replace and usually much lower than local purchase prices, especially overseas.

These new refrigerants, however, are not 'drop in replacements' for any Class I ozone-depleting chemicals. Regardless of which system is involved, it is impera-

tive the system manager approve the use of the new refrigerant and that appropriate retrofit work be carried out where needed.

Each of the following items is made to American Refrigeration Institute Standard 700, requires the system manager's approval and retrofit work, and comes with a disposable cylinder except where noted.

Refrigerant: R-123
NSN: 6830-01-391-3106
Size: CY (100 lbs.)
Price: \$542.64
Equip/Use: Stationary equipment

Refrigerant: R-123
NSN: 6830-01-391-3111
Size: CY (200 lbs.)
Price: \$1,291.25
Equip/Use: Stationary equipment

Refrigerant: R-123
NSN: 6830-01-391-3108
Size: CY (625 lbs.)
Price: \$3,983.70
Equip/Use: Stationary equipment

Refrigerant: R-124
NSN: 6830-01-391-3107
Size: CY (30 lbs.)
Price: \$373.97
Equip/Use: Stationary Equipment

Refrigerant: R134a
NSN: 6830-01-412-6362
Size: CY (30 lbs.)
Price: \$104.96
Equip/Use: Automotive

Refrigerant: R-134s
NSN: 6830-01-390-9622
Size: CY (30 lbs.)
Price: \$104.96
Equip/Use: Stationary equipment

Refrigerant: R401A
NSN: 6830-01-391-3101
Size: CY (30 lbs.)
Price: \$180.63
Equip/Use: Mobile and stationary

Continued next page



Refrigerant: R401B
NSN: 6830-01-391-3109
Size: CY (30 lbs.)
Price: \$169.79
Equip/Use: Mobile and stationary

Refrigerant: 402A
NSN: 6830-01-391-3105
Size: CY (27 lbs.)
Price: \$279.53
Equip/Use: Mobile and stationary

Refrigerant: 402B
NSN: 6830-01-391-3103
Size: CY (13 lbs.)
Price: \$162.82
Equip/Use: Mobile and stationary

Refrigerant: R404A
NSN: 6830-01-392-0960
Size: CY (33 lbs.)
Price: \$563.95
Equip/Use: Mobile and stationary
(reusable cylinder)

Refrigerant: R404B
NSN: 6830-01-391-3104
Size: CY (24 lbs.)
Price: \$247.90
Equip/Use: Mobile and stationary

Refrigerant: R-406A
NSN: 6830-01-433-7032
Size: CY (25 lbs.)
Price: \$367.28
Equip/Use: Mobile and stationary

For more information on alternative refrigerants call Dean Crawford, DSCR's equipment specialist for gases at DSN 695-3230, commercial (804) 279-3230 or e:Mail dcrawford@dcsr.dla.mil

For more information on DLA's Environmental Products catalog call Stephen Perez at DSN 695-6054, commercial (804) 279-6054, or e:Mail sperez@dcsr.dla.mil

More information EPA's SNAP Program is available on its hotline at (800) 296-1996. Overseas callers can dial (301) 614-3396. EPA's SNAP web site is at <http://www.epa.gov/ozone/title6/snap>

DISC Takes Over HEPP

Effective 1 January 1998, the Defense Industrial Supply Center (DISC) has taken over management of the Heavy Equipment Procurement Program (HEPP) from Defense Supply Center, Columbus, (DSCC). DISC is committed to serving the needs of their customers and will continue at the same level of service that they had received from DSCC. The following arrangements were agreed upon:

1. The DSCC surcharge would not be increased,
2. DISC will continued to accept MIPRs including CAT I Acceptance MIPRs,
3. The DSCC contracts will be utilized,
4. A group of Contracting Specialists from DISC was established to work directly with the major manufacturers of Equipment.

Contacts by Federal Stock Class (FSC) are as follows:

FSC 2420, 3825, 3910, 5410, 5430

Judy Henry
Phone: (215) 697-2585
DSN: 442-2585

FSC 3810, 4930

Cathy Ford
Phone: (215) 697-3859
DSN: 442-3859

FSC 3930

Darrell Moresi
Phone: (215) 697-3006
DSN: 442-3006

FSC 3740, 3895, 4630, 4910, 4940

Joe McHenry
Phone: (215) 697-3157
DSN: 442-3157

FSC 2230, 2410, 3805, 3820, 4540

Pat Greensweig
(215) 697-3823
DSN 442-3823

Fillers And Spacers

The Defense Industrial Supply Center has completed three Commercial Item Descriptions (CIDs) for the procurement of Rotary Sweeper Brush Fillers and Spaces for airport snow and ice removal. CID A-A-55630 is used for Continuous Fillers, CID ApAp55631 is used for Strip Fillers and CID A-A-55632 is used for Sweeper Brush Spacers. These CIDs along with the already existing CID A-A-55527 for Tufted Fillers may now be used to procure 20 national Stock Number items in Federal Supply Class 3825.

For information on procuring Rotary Sweeper Brush Fillers and Spacers, call Lou Cooker, DISC-HBD, at DSN 442-5646. For Technical information concerning these items, call Chris Armellini, DISC-BBEE at DSN 442-66612 or commercial (215) 697-6661.

Visit our Web Site:

<http://www.supply.dla.mil>



CSD Seminars

Customer Service Directors in the following regions will conduct FSS Information Seminars for local customers. While our target audience is new employees in supply and procurement/contracting, updated material will be presented that may be of use to experienced personnel. The following are tentative dates and locations. Exact dates and locations will be announced in regional mailings. Seminars are free; however, lodging and transportation, if required, are the responsibility of the attending agency.

NORTHEAST & CARIBBEAN REGION

Connecticut, Maine,
Massachusetts,
New Hampshire, New York,
New Jersey, Rhode Island,
Puerto Rico, Vermont, and the
Virgin Islands

Massachusetts, New Hampshire and
Vermont

Locations..... Dates
Supply Seminars:

Augusta, ME..... August 19, 1998
Manchester, NH..... September 9, 1998
Boston, MAOctober 1998

GSA Advantage!TM Training (2 - 2-1/2 hr. Sessions):

Brunswick NAS, ME..... August 1998
Pease AFB, MA September 17, 1998

Contact: pam.lapointe@gsa.gov
Phone: (617) 565-7302

Connecticut and Rhode Island

Locations Dates
Danbury, CT August 1998

Contact: robert.cobbett@gsa.gov
Phone: (617) 565-7303

**New York, New Jersey, Puerto Rico
and the Virgin Islands**

Locations Dates
Albany, NY..... August 1998
Atlantic City, NJNovember 1998

Contact: Christine Lincoln, Christine
Keen or Debbie Paralemos (212) 264-
3592 or
e-mail: christine.lincoln@gsa.gov

MID-ATLANTIC REGION

Delaware, Maryland,
Pennsylvania, Virginia
Washington, DC and
West Virginia

(Would you like a special seminar for a group of 20 or more on a specific subject or at your location? Call Katie Meehan 215/656-5541)

Locations Dates
Washington, DC..... August 1998
Washington, DC..... September 1998
Washington, DC..... December 1998

Contact: janiece.mcneill@gsa.gov
Phone: (202) 619-8900

Locations Dates
York, PA..... July 22, 1998
Philadelphia, PA September 1998

Contact: peter.carovillano@gsa.gov
Phone: (215) 656-3868

Locations Dates
Norfolk, VA August 1998

Contact: john.engle@gsa.gov
Phone: (757) 441-3115

SOUTHEAST SUNBELT REGION

Alabama, Florida, Georgia,
Kentucky, Mississippi, North
Carolina, South Carolina,
Tennessee

Locations Dates
Louisville, KY August 11, 1998
Charleston, SC..... August 13, 1998
Birmingham, AL..... August 20, 1998
Lexington, KY August 25, 1998
Pensacola, FLSeptember 17, 1998
Knoxville, TN.....September 22, 1998
Huntsville, AL October 22, 1998

Contact: adrianr.finney@gsa.gov
Phone: (404) 331-3026

GREAT LAKES REGION

Illinois, Indiana, Michigan,
Minnesota, Ohio and Wisconsin

Locations..... Dates
Scott AFB, IL..... August 12, 1998
Fermi Labs, IL September 17, 1998

Contact: george.deszcz@gsa.gov
Phone: (630) 369-3368

Locations..... Dates
Milwaukee, WI August 17, 1998
VAMC North Chicago, IL
..... September 15, 1998

Contact: elbert.bryant@gsa.gov
Phone: (847) 360-1889

Locations..... Dates
Iron Mountain, MI August 18, 1998
Marquette, MI August 20, 1998
Detroit, MI September 23, 1998

Contact: rick.burkart@gsa.gov
Phone: (616) 969-3985



Locations..... Dates
Ft. Snelling, MN August 17, 1998
Minneapolis, MN.... September 14, 1998
St. Paul, MN September 28, 1998

Contact: john.barnicle@gsa.gov
Phone: (612) 681-1625

Locations Dates
Crane, IN August 25, 1998

Contact: gary.dugan@gsa.gov
Phone: (317) 377-7016

Locations Dates
WPAFB, Dayton, OH... August 11, 1998
Fed Bldg, Dayton, OH.. August 26, 1998
WPAFB, Dayton, OH
.....September 11, 1998
WPAFB, Dayton, OH
.....September 29, 1998

Contact: kay.hurley@gsa.gov
Phone: (330) 375-5548

Locations..... Dates
Chicago, IL August 12, 1998
Chicago, IL September 23, 1998

Contact: ed.stanek@gsa.gov
Phone: (312) 886-8941

HEARTLAND REGION **Iowa, Nebraska, Kansas,** **and Missouri**

Locations..... Dates
St. Louis, MO August 1998
Davenport, IA August 1998
Des Moines, IA..... August 1998

Contact: charlene.musick@gsa.gov
Phone: (816) 823-1240
Fax: (816) 926-1661

GREATER SOUTHWEST **REGION** **Arkansas, Louisiana,** **New Mexico,** **Oklahoma and Texas**

Locations..... Dates
Dallas/Ft. Worth, TX..... August 1998
Little Rock, AR..... October 1998
El Paso, TX..... November 1998
Houston, TX..... January 1999
Corpus Christi, TX..... February 1999
New Orleans, LA March 1999
San Antonio, TX April 1999
Albuquerque, NM May 1999
Oklahoma City, OK June 1999

Contact: betty.russell@gsa.gov
Phone: (817) 978-2892
Fax: (817) 978-2540

ROCKY MOUNTAIN **REGION** **Colorado, Montana,** **North Dakota, South Dakota,** **Utah and Wyoming**

Locations..... Dates
Cheyenne, WY September 1998
Grand Junction, CO October 1998
Denver, CO November 1998

Contact: lynne.jones@gsa.gov
Phone: (303) 236-7543
cindy.dietz@gsa.gov
Phone: (303) 236-7427

PACIFIC RIM REGION **California, Hawaii, Nevada,** **Pacific and Far East**

Locations..... Dates
Las Vegas, NV..... September 1998

Contact: dilys.sunabe@gsa.gov
Phone: (213) 526-7500

Locations Dates
Redding, CA..... August 1998
San Francisco, CA..... October 1998
Monterey, CA November 1998

Contact: leslie.patterson@gsa.gov
Phone: (415) 522-2786

Locations Dates
Schofield Barracks, HI May 1999

Contact: melinda.eyre@gsa.gov
Phone: (808) 541-1776

NORTHWEST/ARCTIC **REGION** **Washington, Oregon, Idaho,** **Alaska**

FSS Seminars: A 2-day overview of FSS retail, stock, special order and schedule programs, as well as discussion of travel, traffic, fleet management and **GSA Advantage!**TM, GSA's on-line shopping service. Great for anyone new to procurement or needing a refresher on what GSA has to offer.

Symposiums: An interactive, 1 day update of what's new in the procurement area. Offers a half-day of **GSA Advantage!**TM training.

Made in GSA Day: A half day showcase of products and publications available through GSA Federal Supply Service.

Locations..... Dates
1-day Symposium, Coeur d' Alene, ID August 1998
1-day Symposium, Lewiston, ID August 1998
Made in GSA Day, Eugene, OR September 1998
1-day Symposium, Eugene, OR September 1998

Contact: patti.lanzetti@gsa.gov or
sharon.sciacqua@gsa.gov or
bobL.brown@gsa.gov
Phone: (253) 931-7516,
Fax: (253) 931-7203



**For Questions Or Assistance,
Please Contact Your
Customer Service Director**

AZ	- Phoenix.....	(602) 379-6619
CA	- Bell	(213) 526-7500
	- San Diego.....	(619) 235-4706
	- San Francisco.....	(415) 522-2786
CO	- Denver	(303) 236-7546 or 236-7543 or 236-7427
DC	- Washington.....	(202) 619-8920
FL	- Kennedy Space Center	(407) 867-2833
GA	- Atlanta	(404) 331-3026
IL	- Chicago.....	1-888-333-3477
MA	- Boston	(617) 565-7302
MO	- Kansas City	(816) 926-1620
MD	- Baltimore	(410) 962-4422
NY	- New York	(212) 264-3592
PA	- Oakdale	(412) 644-4854
PA	- Philadelphia.....	(215) 656-3868
TX	- Ft Worth.....	(817) 978-2892
	- San Antonio.....	(210) 472-6119
VA	- Chesapeake	(757) 441-3115
WA	- Auburn	(253) 931-7516

Overseas:

Europe, Northern Africa, and the Middle East - Frankfurt, Germany
DSN: 330-6085 or 330-7985

International Direct Dial

011-49-69-699-7985 or 011-49-69-699-6085

Pacific and Far East - Honolulu, Hawaii

(808) 541-1776

DSN 438-4960

U.S. GOVERNMENT
General Services Administration (7CPNL)
PO Box 6477
Ft Worth, TX 76115-6477

BULK RATE POSTAGE & FEES PAID GSA PERMIT No. G-30
--

Official Business

Penalty for Private Use \$300

Address Corrections Requested



**U.S. General Services Administration
Federal Supply Service**

