

Waste Analysis At Facilities That Generate, Treat, Store, And Dispose Of Hazardous Wastes

A Guidance Manual

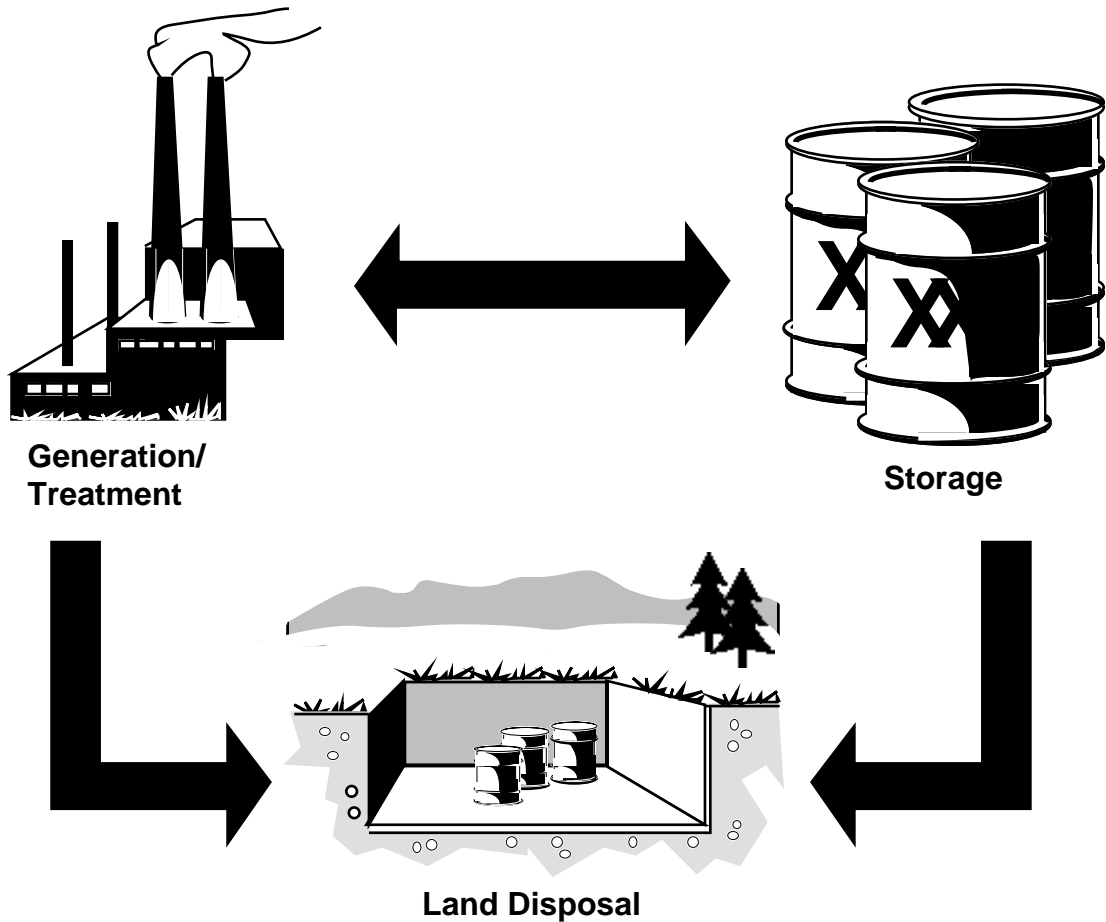

Waste Analysis at Facilities That Generate, Treat, Store, and Dispose of Hazardous Wastes

A Guidance Manual

This guidance document was developed by the U.S. Environmental Protection Agency's Office of Waste Programs Enforcement.

NOTICE

Development of this document was funded, wholly or in part, by the United States Environmental Protection Agency under Contract No. 68-W0-0006. It has been subjected to the Agency's review process and approved for publication as an EPA document. Specifically, EPA Headquarters, several EPA Regional Offices, one additional federal agency, seven state environmental agencies and/or organizations, and nearly a dozen private companies and industry associations reviewed and submitted comments on the document.

The policies and procedures established in this document are intended solely as guidance to assist in implementation of and compliance with promulgated regulations. They are not intended and cannot be relied upon to create any rights, substantive or procedural, enforceable by any party in litigation with the United States. The Agency reserves the right to act at variance with these policies and procedures and to change them at any time with or without public notice. For example, EPA is in the process of issuing new rules concerning the definition of hazardous waste. The new rules will supersede those discussed in this document concerning the definition of hazardous waste. In addition, this document references the treatment standards promulgated in the Land Disposal Restrictions regulations. These treatment standards also are subject to change by the Agency. However, regardless of changes in these existing rules, the overall format, content, procedures, and implementation of a waste analysis plan as presented in this document will not change.

USER'S GUIDE

This guidance manual will assist facility owners and operators, as well as other facility personnel, in preparing waste analysis plans (WAPs) and conducting waste analyses. This manual has been designed to be useful to all facility personnel regardless of their level of experience in environmental compliance issues. To achieve this broad application, the **Introduction** provides background information on the principal topics that are discussed throughout this manual, including:

- Resource Conservation and Recovery Act (RCRA)
- Land Disposal Restrictions (LDR) regulations
- Waste analysis
- WAPs
- Purpose and organization of this manual.

The Introduction also contains a flow diagram on how to use this manual effectively. The remainder of this manual is divided into four parts -- the contents of each part are discussed below.

Part One contains guidance on determining what your waste analysis responsibilities are for your facility and how you can meet these responsibilities.

Part Two contains detailed guidance on documenting and conducting waste analysis once you have identified your waste analysis responsibilities. In particular, Part Two contains guidance on important waste analysis components, including selecting the:

- Content and organization of a WAP
- Waste analysis parameters
- Sampling procedures
- Laboratory testing and analytical methods
- Waste re-evaluation frequencies.

Part Three contains a checklist that you should reference to ensure that you have addressed all of the waste analysis responsibilities relevant to your facility. The sections in the checklist follow the organization developed in Part Two for preparing a WAP.

And finally, **Part Four** contains five sample WAPs that should be used as guides when developing your own site-specific WAP. These sample WAPs are:

- Generator
- Generator treating to meet LDR treatment standards
- On-site treatment facility -- Stabilization Unit
- Off-site treatment facility -- Incineration
- Landfill.

The sections in the sample WAPs also follow the organization developed in Part Two for preparing a WAP except for sample WAPs numbers four and five, which have been reorganized slightly to accommodate the special case where a TSDF receives waste from off site.

Proceed to the Table of Contents



TABLE OF CONTENTS

	<u>Page</u>
USER'S GUIDE	iii
INDEX OF APPENDICES	vii
INDEX OF FIGURES	vii
INDEX OF TABLES	viii
LIST OF ACRONYMS	x
INTRODUCTION	Introduction-1
PART ONE: RCRA AND WASTE ANALYSIS — AN OVERVIEW	
1.0 How Does The RCRA Subtitle C Program Work?	1-1
1.1 Does The RCRA Program Apply To Your Facility?	1-2
1.2 Identifying/Classifying Hazardous Waste	1-3
1.3 Do You Have Any Waste Analysis Responsibilities?	1-4
1.4 What Waste Analysis Requirements Must You Meet?	1-9
1.4.1 General Waste Analysis Requirements	1-9
1.4.2 Specific Waste Analysis Requirements	1-10
1.5 How Can You Meet The Waste Analysis Requirements For Your Facility?	1-11
1.5.1 Option One: Selecting Sampling And Analysis	1-12
1.5.2 Option Two: Selecting Acceptable Knowledge	1-13
1.6 Uses Of Waste Analysis And A WAP	1-17
1.7 Summary	1-19
PART TWO: DOCUMENTING AND CONDUCTING WASTE ANALYSIS	
2.0 Content And Recommended Organization Of A WAP	2-1
2.1 Facility Description	2-5
2.1.1 Description Of Facility Processes And Activities	2-5
2.1.2 Identification/Classification And Quantities Of Hazardous Wastes Generated Or Managed At Your Facility	2-6
2.1.3 Description Of Hazardous Waste Management Units	2-7

2.2	Selecting Waste Analysis Parameters	2-8
2.2.1	Criteria For Parameter Selection	2-9
2.2.2	Parameter Selection Process	2-11
2.2.3	Rationale For Parameter Selection	2-11
2.2.4	Special Parameter Selection Requirements	2-11
2.3	Selecting Sampling Procedures	2-19
2.3.1	Sampling Strategies	2-19
2.3.2	Selecting Sampling Equipment	2-23
2.3.3	Maintaining And Decontaminating Field Equipment	2-32
2.3.4	Sample Preservation And Storage	2-32
2.3.5	Establishing Quality Assurance/Quality Control Procedures	2-33
2.3.6	Establishing Health And Safety Protocols	2-37
2.4	Selecting A Laboratory And Laboratory Testing And Analytical Methods	2-39
2.4.1	Selecting A Laboratory	2-39
2.4.2	Selecting Testing And Analytical Methods	2-40
2.5	Selecting Waste Re-Evaluation Frequencies	2-44
2.6	Special Procedural Requirements	2-45
2.6.1	Procedures For Receiving Wastes Generated Off Site	2-45
2.6.2	Procedures For Ignitable, Reactive, And Incompatible Wastes	2-48
2.6.3	Procedures For Complying With LDR Requirements	2-49
2.7	Summary	2-49

PART THREE: CHECKLIST

3.0	Checklist	3-1
-----	-----------------	-----

PART FOUR: SAMPLE WAPS

4.0	Introduction to Sample WAPs	4-1
	Sample WAP #1—Generator Only	4-7
	Sample WAP #2—Generator Treating To Meet LDR Treatment Standards	4-22
	Sample WAP #3—On-Site Treatment Facility—Stabilization Unit	4-31
	Sample WAP #4—Off-Site Treatment Facility — Incinerator	4-43
	Sample WAP # —Landfill	4-64

INDEX OF APPENDICES

APPENDIX	Page
Appendix A: Hazardous Waste Identification	A-1
Appendix B: Regulatory Summary	B-1
Appendix C: Waste Analysis Data Flow Responsibilities	C-1
Appendix D: Regulatory Citations (40 CFR §§264/265.13) For Conducting Waste	
Analysis	D-1
Appendix E: Overview Of Major Hazardous Waste Management Units	E-1
Appendix F: Glossary Of Terms	F-1
Appendix G: References	G-1

INDEX OF FIGURES

FIGURE	Page
I-1 Guide To Using This Manual	Intro-7
1-1 Hazardous Waste Identification	1-5
1-2 Waste Analysis Data Flow	1-8
2-1 Waste Analysis Parameter Selection Process	2-12
2-2 Illustration Of Random, Stratified Random, and Systematic Sampling	2-22
2-3 Composite Liquid Waste Sampler (Coliwasa)	2-25
2-4 Weighted Bottle	2-26
2-5 Dipper	2-27
2-6 Thief Sampler	2-28
2-7 Sampling Triers	2-29
2-8 Hand Augers	2-30
2-9 Example Chain-of-Custody Record	2-38
2-10 Analytical Methods Selection Flowchart	2-43
2-11 Shipment Screening	2-46
4-1 Thompson Manufacturing, Inc., Waste Generation Scenario	4-15
4-2 Sequence Of Procedures Sets For Determining Reactivity Group	4-20
4-3 Reactivity Group Designations and Waste Compatibility Matrix	4-21
4-4 Schematic Of Generator Treating In 90-Day Accumulation Tanks	4-27
4-5 Sample WAP #2 - Treatment Tank Apparatus	4-30
4-6 Thompson Manufacturing, Inc., Schematic Of Waste Treatment Facility Using S/S Operations	4-36
4-7 Thompson Manufacturing, Inc., Schematic Of Batch S/S Treatment Process Unit	4-40
4-8 Sparky Incineration, Inc., Facility Layout	4-52
4-9 Sparky Incineration, Inc., Treatment System	4-53
4-10 Sparky Incineration, Inc., Pre-Acceptance Procedures	4-55
4-11 Sparky Incineration, Inc., Incoming Waste Shipment Procedures	4-56
4-12 Sparky Incineration, Inc., Examples Of Pre-Process, In-Process, And Post-Process Activities Related To Decanting	4-59
4-13 Sparky Incineration, Inc., Procedures For Designating Compatible Storage Units	4-60
4-14 Sparky Incineration, Inc., Hazardous Waste Sampling Flow Diagram	4-62
4-15 Rottaway Landfill, Inc., Facility Layout	4-70
4-16 Rottaway Landfill, Inc., Layout Of Each Landfill Cell	4-71
4-17 Rottaway Landfill, Inc., Pre-Acceptance Procedures	4-73
4-18 Rottaway Landfill, Inc., Incoming Waste Shipment Procedures	4-74

INDEX OF FIGURES (continued)

FIGURE	Page
4-19 Procedures For Designating Compatible Storage Units	4-75
A-1 Hazardous Waste Identification Flow Chart	A-2

INDEX OF TABLES

TABLE	Page
1-1 Facility Type And Waste Analysis Responsibilities	1-6
2-1 Reference Guide To Key Issues For Consideration When Developing WAPs	2-2
2-2 Key Elements In Waste Analysis	2-4
2-3 Description Of Listed Wastes	2-6
2-4 Description Of Characteristic Wastes	2-7
2-5 Examples Of Waste Analysis Parameters	2-13
2-6 Sampling Approach Overview	2-21
2-7 Major Sample Types	2-23
2-8 Applicability Of Sampling Equipment To Wastestreams	2-31
2-9 Examples Of Sample Collection And Analytical Techniques: Containerization, Preservation, And Holding Times	2-34
2-10 Laboratory QC Techniques	2-41
2-11 Waste Profile Sheet	2-50
4-1 Guide To The Sample WAPs	4-2
4-2 Scenario Overview Sample WAP #1 — Generator Only	4-3
4-3 Scenario Overview Sample WAP #2 — Generator Treating To Meet LDR Treatment Standards	4-3
4-4 Scenario Overview Sample WAP #3 — On-Site Treatment Facility	4-4
4-5 Scenario Overview Sample WAP #4 — Off-Site Treatment Facility	4-4
4-6 Scenario Overview Sample WAP #5 — Landfill	4-5
4-7 Model Outline Of Sample WAPs	4-6
4-8 Thompson Manufacturing, Inc., Identification/EPA Classification Of Hazardous Wastes Generated	4-16
4-9 Thompson Manufacturing, Inc., Examples Of Criteria And Rationale For Selected Parameters For Wastes Generated	4-17
4-10 Thompson Manufacturing, Inc., Examples Of Waste Sampling Methods, Equipment, And Procedures	4-18
4-11 Thompson Manufacturing, Inc., Examples Of Testing/Analytical Methods For Wastes Generated	4-19
4-12 Thompson Manufacturing, Inc., Identification/EPA Classification Of Hazardous Wastes	4-28
4-13 Thompson Manufacturing, Inc., Criteria And Rationale For Selected Parameters For HF Neutralization Process	4-29
4-14 Thompson Manufacturing, Inc., Identification/EPA Classification Of Hazardous Wastes Treated Using S/S	4-37
4-15 Thompson Manufacturing, Inc., Concentration Ranges For S/S Wastes	4-38

INDEX OF TABLES (continued)

TABLE	Page
4-16	Thompson Manufacturing, Inc., Examples Of Testing/Analytical Methods For S/S Wastes 4-39
4-17	Thompson Manufacturing, Inc., Criteria and Rationale For Selected Parameters 4-41
4-18	Thompson Manufacturing, Inc., Frequencies Of Testing And Analysis Of S/S Paint Sludge Wastes 4-42
4-19	Sparky Incineration, Inc., Identification/EPA Classification Of Hazardous Wastes Treated By Incineration 4-54
4-20	Example Waste Receipt Analysis Report 4-57
4-21	Sparky Incineration, Inc. Fingerprint Analysis Used To Sample Incoming Wastes 4-58
4-22	Sparky Incineration, Inc., Examples Of Selected Parameter Rationale, Criteria, And Special Considerations 4-61
4-23	Sparky Incineration, Inc., Examples Of Sampling Methods And Equipment Used 4-63
4-24	Rottaway Landfill, Inc., Identification/EPA Classification Of Hazardous Wastes Managed At Rottaway Landfill 4-72
4-25	Rottaway Landfill, Inc., Fingerprint Analysis Used To Sample Incoming Wastes 4-76
4-26	Rottaway Landfill, Inc., Selected Parameters: Rationale, Criteria, And Special Considerations 4-77
4-27	Rottaway Landfill, Inc., Sampling Methods And Equipment 4-78

LIST OF ACRONYMS

Acronym	Definition
ASTM	American Society for Testing and Materials
BIF	Boiler and Industrial Furnace
Btu	British Thermal Unit
CFR	Code of Federal Regulations
CWA	Clean Water Act
DOT	Department of Transportation
DRE	Destruction and Removal Efficiency
EP TOX TEST	Extraction Procedure Toxicity Test
EPA	Environmental Protection Agency
FR	Federal Register
H&S	Health and Safety
HSWA	Hazardous and Solid Waste Amendments
HW	Hazardous Waste
LDR	Land Disposal Restrictions
mg/l	Milligrams Per Liter
MTR	Minimum Technology Requirements
MSDS	Material Safety Data Sheet
NPDES	National Pollutant Discharge Elimination System
O/O	Owner and/or Operator
PCB	Polychlorinated Biphenyl
PFLT	Paint Filter Liquids Test
POHC	Principal Organic Hazardous Constituent
ppm	Parts Per Million
QA	Quality Assurance
QC	Quality Control
RCRA	Resource Conservation and Recovery Act
S/S	Stabilization/Solidification
SW-846	Test Methods for Evaluating Solid Wastes, Physical/Chemical Methods, U.S. EPA
SWDA	Solid Waste Disposal Act
TCLP	Toxicity Characteristic Leaching Procedure
TOC	Total Organic Carbon
TSDf	Treatment, Storage, or Disposal Facility
TSS	Total Suspended Solids
VOC	Volatile Organic Compound
WAP	Waste Analysis Plan
WWTP	Wastewater Treatment Plant

INTRODUCTION



In the Introduction, you will be introduced to:

- The Resource Conservation and Recovery Act (RCRA)
- Land Disposal Restrictions (LDR) regulations
- Waste analysis
- A waste analysis plan (WAP)
- The purpose and organization of this manual.

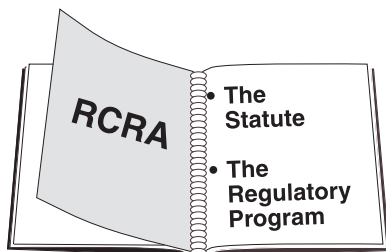

Who Needs To Comply With RCRA?

- Generators
- Transporters
- TSDFs

Congress passed the Solid Waste Disposal Act (SWDA) in 1965 for the primary purpose of improving solid waste disposal methods. SWDA was amended several times, most significantly by the Resource Conservation and Recovery Act (RCRA) of 1976, and the Hazardous and Solid Waste Amendments (HSWA) of 1984; collectively, these acts are referred to as **RCRA**. RCRA was the first federal law to address **hazardous waste**, and was designed to ensure that the generation, transportation, treatment, storage, and disposal of hazardous wastes are conducted in a manner that protects human health and the environment.

The U.S. Environmental Protection Agency (EPA) developed a regulatory program to implement RCRA. This resulted in EPA regulating thousands of **generators, transporters, and treatment, storage, and disposal facilities (TSDFs)**. EPA has granted many states the authority to operate their own state RCRA programs in place of all or part of the federal RCRA program, provided that these programs are at a minimum fully equivalent to, no less stringent than, and consistent with the federal RCRA program. In fact, state programs are often broader in scope than the federal RCRA program (in which case the requirements that are beyond the coverage of the federal program are not authorized by EPA). Therefore, if your facility generates, transports, treats, stores, or disposes of hazardous waste, you must be sure that you are operating in compliance with all applicable state requirements, as well as any portions of the federal RCRA program that are not covered under the EPA-approved state RCRA program.

[Note: For purposes of this manual, use of the term "RCRA program" refers to the federal RCRA Subtitle C program and/or an authorized state RCRA program. Similarly, the use of "EPA" refers to the U.S. EPA and/or a state agency authorized to conduct the federal RCRA program. Federal regulations are cited in this manual. However, if your facility is in an authorized state, the equivalent state regulations are applicable.]

What Is Waste Analysis?

Why Conduct Waste Analysis?

- To Determine If Waste Is Hazardous
- To Identify/Classify Waste
- To Determine Waste Management Options

What Are The Land Disposal Restrictions (LDR) Regulations?

The cornerstone of the RCRA program, and the focus of this guidance manual, is the ability of facility personnel to identify properly, through waste analysis, all wastes that they generate, treat, store, or dispose of. **Waste analysis involves identifying or verifying the chemical and physical characteristics of a waste by performing a detailed chemical and physical analysis of a representative sample of the waste or, in certain cases, by applying acceptable knowledge of the waste** (acceptable knowledge includes process knowledge and is discussed further in Part One). You must conduct proper waste analysis to determine whether your waste is defined as a hazardous waste under RCRA, to identify/classify the waste according to RCRA, and to ensure that your waste is managed properly. How your hazardous waste is classified under RCRA will determine the legal methods available to you for treatment, storage, or disposal of the waste. Waste analysis, therefore, is the pivotal activity that you must conduct properly to ensure that your facility is in compliance with the myriad applicable regulations for proper waste treatment, storage, or disposal. For example, waste analysis is necessary to comply with the **Land Disposal Restrictions (LDR)** regulations.

HSWA required EPA to develop and implement the LDR regulations, which apply to all persons who generate or transport hazardous wastes as well as owners and operators of TSDFs (40 CFR Part 268). **Broadly stated, the LDR regulations established treatment standards (expressed as concentration levels or methods of treatment) for the majority of hazardous wastes regulated under RCRA and ultimately destined for land disposal.** Most RCRA hazardous wastes are subject to the LDR program. These wastes are known as "restricted" wastes. **Restricted** wastes are those RCRA hazardous wastes for which EPA has established a treatment standard (as well as a small group of wastes for which no treatment standards have been established but which Congress, in HSWA, has specifically designated as ineligible for land disposal). HSWA established a series of deadlines requiring EPA to promulgate treatment standards for groups of hazardous wastes. EPA responded by issuing a series of rulemakings establishing treatment standards for these hazardous



Why Is Waste Analysis Critical To Complying With LDR Regulations?

wastes, and effective dates for these treatment standards. Once an effective date has passed for a given waste, LDR treatment standards must be met before the waste can be land disposed, unless the waste is eligible for a variance, extension, or exemption. Wastes which are eligible for a case-by-case extension (40 CFR §268.5), a no migration exemption (40 CFR §268.5), or a national capacity variance can be land disposed without meeting treatment standards, provided that they are disposed in a surface impoundment or landfill that meets the minimum technological requirements. Once a waste is restricted, at a minimum it is subject to the waste analysis, notification, and recordkeeping requirements of 40 CFR §268.7, even though some restricted wastes may be eligible for land disposal without first meeting treatment standards.

"Prohibited" wastes are a subset of restricted wastes; prohibited wastes are those restricted wastes which are ineligible for land disposal. Prohibited wastes have treatment standards in effect; do not meet all treatment standards; and no extensions, exemptions, or variances apply (see 53 FR 31208, August 17, 1988). Once a waste has been treated to meet the applicable treatment standards, it is no longer prohibited from land disposal, but is still subject to the waste analysis, notification, and recordkeeping requirements of 40 CFR §268.7. As explained above, wastes for which no treatment standards have been promulgated, and which are not specifically designated by HSWA as ineligible for land disposal, are neither restricted nor prohibited, and are not currently subject to the LDR program.

The LDR regulations dramatically increased the importance of proper waste analysis to ensure that all treatment standards are met prior to land disposal. For example, if you:

- **Generate** hazardous waste, you must test the waste, or use knowledge of the process generating the waste, to determine if the waste is restricted from land disposal. In addition, you must notify any subsequent facilities that will treat, store, or dispose of the waste of its LDR status.
- **Treat** hazardous waste, you must test the waste to determine if treatment residues meet the established treatment standards, and you must notify any subsequent receiving facility of the LDR status of the waste.
- **Dispose** of hazardous waste, you must test the waste to assure that the wastes or treatment residues are in compliance with applicable LDR treatment standards before land disposal. In addition to testing, you must have adequate

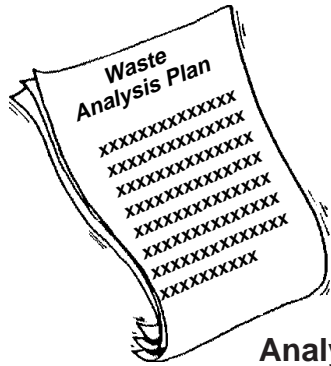

What Is A Waste Analysis Plan?

What Facilities Must Develop A WAP?

documentation from the generator, treater, or storer that the wastes meet the LDR treatment standards.

- **Store** hazardous waste, you must test the waste, or use knowledge of the waste, to determine if the waste is restricted from land disposal. In addition, you must notify any subsequent facilities that treat, store, or dispose of the waste of its LDR status.

Failure to comply with the LDR regulations can result in enforcement actions against your facility.

[Note: Detailed information on LDR requirements as they pertain to waste analysis is found in 40 CFR §268.7; and 55 FR 22669.]

A waste analysis plan (WAP) documents the procedures that you use to obtain a representative sample of the waste and to conduct a detailed chemical and physical analysis of this representative sample. The WAP also can describe special handling procedures for proper transportation, treatment, storage, or disposal of the wastes.

A WAP is required for all TSDFs, as well as generators treating hazardous waste in tanks, containers, or containment buildings to meet LDR standards. Although only these facilities are required to develop and follow a formal WAP (as discussed further in Part One), formal documentation of waste analysis procedures in a WAP offers every facility, whether a generator or TSDF, many advantages, including:

- Allowing for planning and analyzing several waste analysis options before making a selection
- Establishing a reliable and consistent internal management mechanism for properly identifying wastes on site
- Ensuring that all participants in waste analysis have identical information (e.g., a hands-on operating manual), thereby promoting consistency and decreasing the likelihood that errors will be made
- Ensuring that facility personnel changes or absences do not lead to lost information
- Reducing your liabilities by decreasing the instances of improper handling or management of wastes

A WAP Can Only Benefit You If You Use It!



What Is The Purpose Of This Manual?

- Assisting in demonstrating to EPA that you are in compliance with all regulations applicable to proper waste identification (e.g., LDR regulations), thereby ensuring a safe operating environment and protection of human health and the environment.

These (and other) benefits can only be realized if you use your WAP properly!



Thus far in the Introduction, you have been introduced to the LDR regulations, waste analysis, and the definition of a WAP -- all of which are essential components of the RCRA program.

The following section contains information on how to use this manual efficiently and effectively.

Purpose And Organization Of This Guidance Manual

The purpose of this guidance manual is to provide you with sufficient background on the RCRA program to enable you to: **first**, determine whether waste analysis and WAP requirements apply to your facility; and **second**, conduct waste analysis properly and develop good WAPs. To assist you in these pursuits, this manual will achieve the following objectives:

Part One

- Introduce you to how the RCRA regulatory program works
- Provide you with guidance on determining whether your facility is regulated under RCRA as a generator or a TSDF (this will involve determining whether the waste you generate, treat, store, or dispose of is considered a hazardous waste under RCRA) (See also Appendix A)
- Alert you of your responsibilities to develop a WAP and/or conduct waste analysis (if you determine that your facility is regulated under RCRA)

Part Two

- Provide you with general and facility-specific guidance on the procedures for developing a useful WAP and conducting waste analysis

**This Manual Updates
The 1984 WAP Guidance
Manual And Includes:**

- **New Regulations**

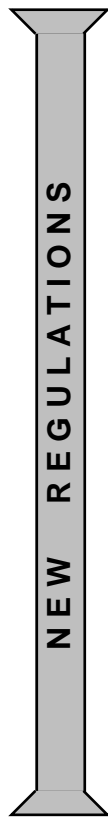

- **New Waste Sampling
And Analyses
Techniques**

Part Three

- Provide you with a checklist to assist you in conducting waste analysis and preparing a WAP

Part Four

- Present five facility-specific sample WAPs.

Figure I-1 will assist you in using this manual. Figure I-1 is designed to help you locate in the manual the information you may need for conducting waste analysis and preparing a WAP.

This manual replaces the 1984 EPA manual, entitled "Waste Analysis Plans: A Guidance Manual." This updated manual will be of greater assistance to you because it includes information on new federal regulations concerning waste analysis that were promulgated since the last manual was published. The following is a list of these regulations:

- LDR regulations (40 CFR Part 268), including the Phase I rule (57 FR 37194) regulating containment buildings (40 CFR Parts 264/265, Subpart DD)
- Boiler and industrial furnace regulations (40 CFR Part 266)
- Tank systems (40 CFR §§264.190-199 and §§265.190-201)
- Miscellaneous units (40 CFR §§264.600-603 and 265 Subpart P and Q)
- Toxicity characteristic rule and the Toxicity Characteristic Leaching Procedure (TCLP) (40 CFR §261.24 and Part 261 Appendix II)
- Organic air emissions from TSDFs (40 CFR Parts 264/265 Subparts AA and BB)
- Prohibition of liquids in landfills (40 CFR §§264/265.314).

[Note: The relevant waste analysis requirements for each of the above referenced regulations are summarized in Appendix B.]

This manual also expands on the previous version by incorporating technical advances in waste sampling and analytical methods.

How Should This Manual Be Used?



Figure I-1 Guide To Using This Manual

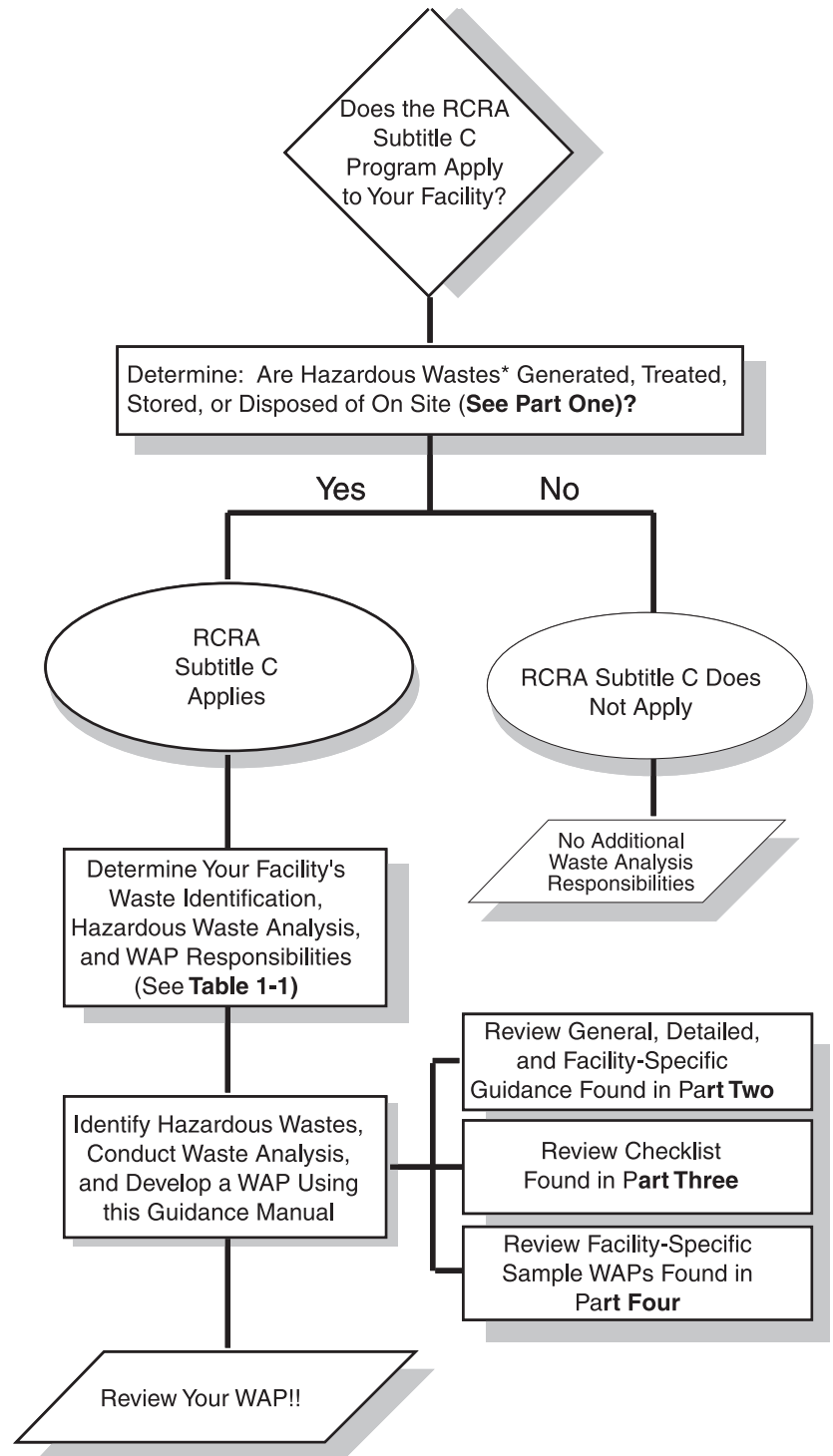

* Hazardous wastes under RCRA are solid wastes and are designated as either listed or characteristic, pursuant to the regulations in 40 CFR Part 261.

Summary



In the Introduction, you reviewed the key elements of the RCRA Subtitle C program, including LDRs, waste analysis, and WAPs. In addition, you reviewed how to use the remainder of the manual most efficiently.

In Part One, you will review how the RCRA program works, determine your waste analysis responsibilities, and review your options for meeting your responsibilities.

Proceed to Part One



PART ONE: RCRA AND WASTE ANALYSIS -- AN OVERVIEW



In Part One, you will be introduced to:

- How the RCRA Subtitle C program works
- How to determine if the RCRA Subtitle C program applies to your facility
- How to determine your waste analysis responsibilities
- What waste analysis methods can be used to satisfy your responsibilities
- Why you should always conduct waste analysis, and develop and follow a WAP.

How Are Hazardous Waste Facilities Regulated Under RCRA?

What Is Required In A RCRA Permit Application?

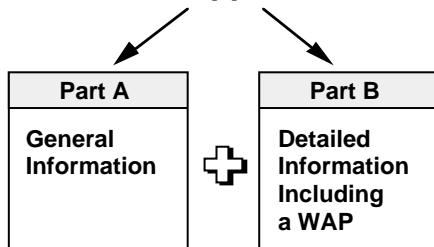

1.0 How Does The RCRA Subtitle C Program Work?

The RCRA regulations establish administrative requirements and facility operating standards for generators, transporters, transfer facilities, and TSDFs. They also set technical standards for the design and safe operation of TSDFs. To ensure that all relevant administrative requirements, and operating and technical standards are adhered to, owners/operators of TSDFs, with few exceptions, must apply for and obtain a **RCRA Subtitle C operating permit** from EPA before operating their facility legally. The permit application covers all aspects of the design, operation, and maintenance of a facility, and is divided into two parts -- Part A and Part B.

Detailed requirements for Part A and Part B of the permit application are found in 40 CFR Part 270. In summary:

- **Part A** is a short, standard form that summarizes general information about a facility, including the name of the owner/operator, a list of the types of wastes managed at the facility, a facility layout diagram, and the activities requiring a permit.
- **Part B** is a much more extensive document, submitted in a narrative, tabular, and schematic format, that describes the facility operations in detail. This information is to include, but not be limited to: a general description of the facility; a **WAP**; information on the design and operation of all hazardous waste management units; procedures to prevent hazards; a contingency plan; and special informa-

Can A Facility Operate Without A Permit?

tion where applicable (such as a description of the ground water monitoring program).

If you are a TSDF (see Table 1-1) that was in existence on November 19, 1980 (the effective date of the first RCRA permitting standards), or are in existence when any new regulation is promulgated that makes your facility subject to the RCRA program, you may be allowed to operate for an interim period under **interim status**. You may operate under interim status by filing Part A of the permit application, complying with the notification requirements of section 3010 of RCRA (where applicable), and complying with the operating standards set in 40 CFR Part 265. Under interim status, you are treated as "having been issued a permit," pending EPA's decision to grant or deny the permit application.

After receiving a completed Part B permit application, including a WAP, EPA will review the application and its components for accuracy and completeness. Where necessary, EPA will request additional information. Several iterations of a permit application may be necessary before EPA will consider the application satisfactory. When the application has been determined by EPA to be accurate and complete, EPA will prepare a draft permit for public comment. After reviewing all comments, EPA will make the permit decision either to grant or deny issuance of the permit.

1.1 Does The RCRA Program Apply To Your Facility?

Does Your Facility Generate, Treat, Store, Or Dispose Of Hazardous Waste?

All generators and TSDFs are subject to the RCRA program. Therefore, **to determine whether your facility is regulated, you must determine whether you are generating, treating, storing, or disposing of hazardous wastes as defined by RCRA.** This is accomplished by doing one or more of the following:

- Identifying the process that generated the waste, and the typical waste composition from that process
- Determining whether the waste is hazardous, per 40 CFR Part 261
- Conducting waste testing or analysis to verify your determination.

How Are Hazardous Wastes Identified/ Classified?

Even after you have determined whether RCRA applies to your facility, you need to re-evaluate your status periodically to verify that conditions affecting the composition of your wastes have not changed.

1.2 Identifying/Classifying Hazardous Waste

Provided below are brief RCRA statutory and regulatory definitions of hazardous waste. Hazardous wastes are a subset of solid wastes; therefore, a material cannot be classified as a hazardous waste if it is not within the universe of solid waste. **RCRA §1004 (27) defines solid waste as:**

"Any garbage, refuse, sludge from a wastewater treatment plant, or air pollution control facility, and other discarded material, including solid, liquid, semisolid, or contained gaseous material, resulting from industrial, commercial, mining, and agricultural operations and from community activities."

Statutory Definition of Hazardous Waste

The statutory definition of hazardous waste is defined in Section 1004(5) of RCRA as follows:





"A solid waste, or combination of solid waste, which because of its quantity, concentration, or physical, chemical, or infectious characteristics may -- 1) cause, or significantly contribute to an increase in mortality or an increase in serious irreversible, or incapacitating reversible, illness; or 2) pose a substantial present or potential hazard to human health or the environment when improperly treated, stored, transported, or disposed of, or otherwise managed."

Regulatory Definition of Hazardous Waste

The RCRA statute directs EPA to develop regulations for clearly identifying solid waste materials that satisfy this statutory definition. Consequently, the regulatory definition of hazardous waste was published in 40 CFR Part 261 in 1980. Pursuant to 40 CFR Part 261, **solid wastes** generally are defined as **hazardous wastes** in two ways. First, solid wastes are hazardous wastes if they are **listed** by EPA as hazardous wastes in 40 CFR Part 261 Subpart D. Second, solid wastes are also hazardous wastes if they exhibit any of the four characteristics found in 40 CFR Part 261 Subpart C. These **characteristics** are ignitability, corrosivity, reactivity, or toxicity (based on the **Toxicity Characteristic Leaching Procedure (TCLP)**). Hazardous wastes can be both listed and characteristic.

Are Your Wastes Listed And/OR Characteristic Wastes?

You must determine whether your wastes qualify as either listed or characteristic wastes or both, and you must document this to ensure compliance with all applicable regulations. Figure 1-1 can assist you in making this hazardous waste determination.

Listed Wastes Wood preservative: K001 Inorganic pigment: K002-K008 Explosives: K044-K047 Spent Solvents: F001-F005 (See 40 CFR Part 261 for complete account of listed wastes)	and/or	Characteristic Wastes  Ignitable  Corrosive  Reactive  Toxic
--	--------	---

You should review these definitions as well as **Appendix A** of this manual to obtain more detail on the criteria for identifying/classifying hazardous wastes, and a methodology for determining whether the solid waste at your facility qualifies as a hazardous waste.

Have You Identified Your Activity (Facility) Type?

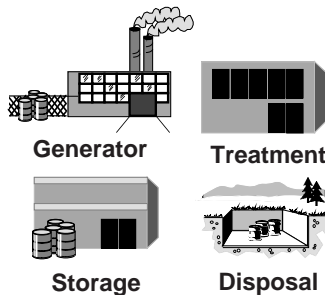

1.3 Do You Have Any Waste Analysis Responsibilities?

If you determine that the waste at your facility is hazardous you then need to determine (or re-evaluate) your facility type(s) as defined under RCRA, because the required facility operating standards, including waste analysis requirements, vary among generators and TSDFs. To properly identify your facility type(s), consult the regulations set forth in 40 CFR Parts 262, 264, 265, and 270. The first two columns of Table 1-1 will assist you with this determination.

What Are Your On-Site Responsibilities?

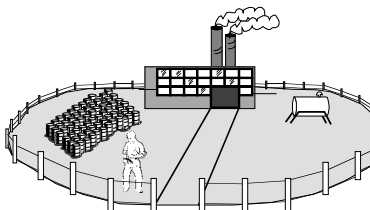
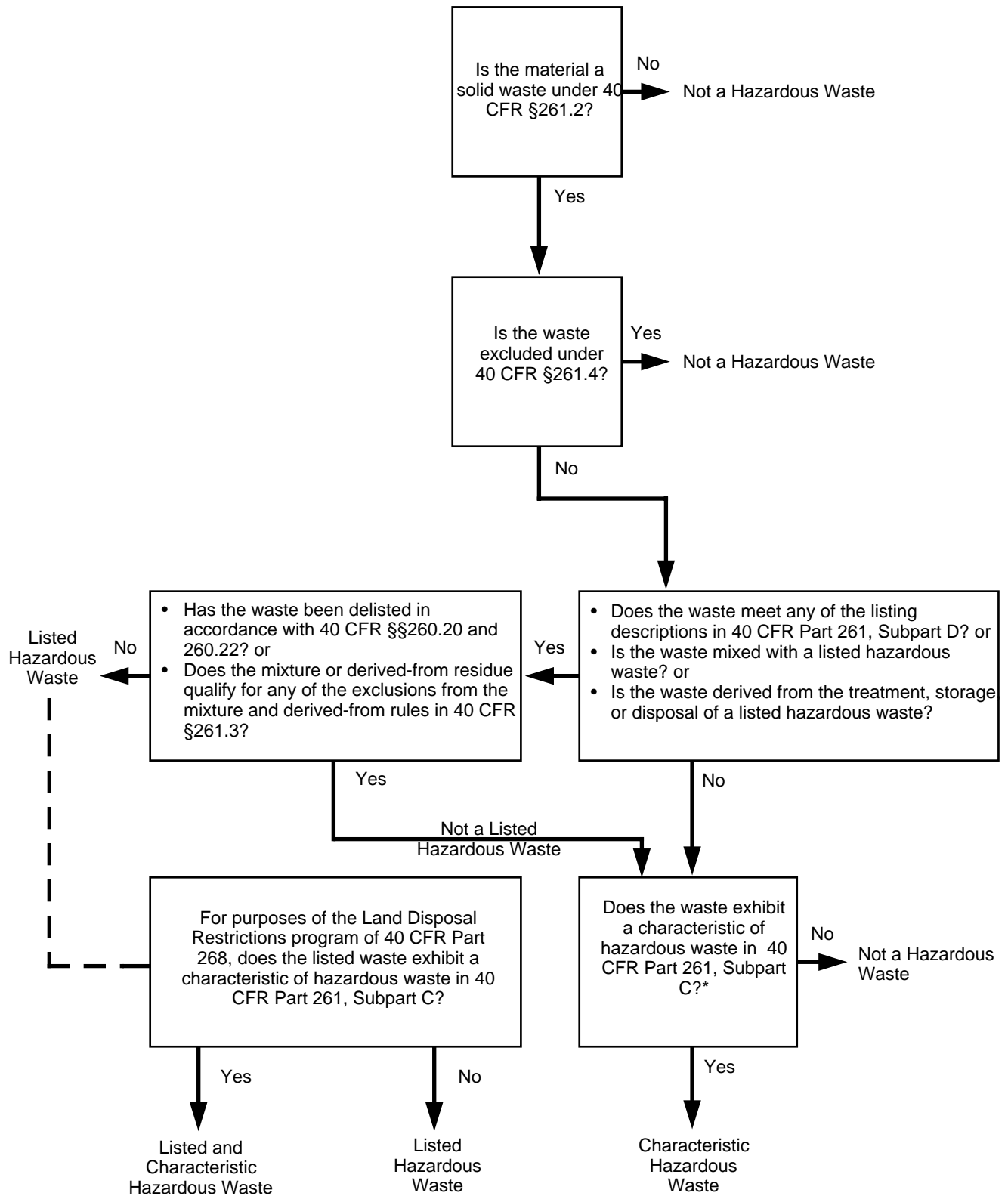

Table 1-1 also summarizes the RCRA responsibilities, if any, of generators and TSDFs regarding obtaining a RCRA operating permit, identifying wastes, conducting waste analysis, and developing WAPs. **Appendix B** contains a more detailed summary of applicable regulations. The responsibilities for conducting waste analysis and preparing a WAP vary from facility to facility depending on site-specific conditions. For example, if you are a:

- Generator of a solid waste, pursuant to 40 CFR §262.11, you must determine if that waste is a hazardous waste by analyzing the waste or applying knowledge of the waste.

[Note: The RCRA regulations for these generators (40 CFR Part 262) do not expressly refer to the term "waste analysis" as the process of identifying, testing,

**Figure 1-1
Hazardous Waste Identification**



* Note exception for mixtures of characteristic wastes and mining/mineral processing wastes in 40 CFR §261.3(a)(2)(i).

**TABLE 1-1
Facility Type And Waste Analysis Responsibilities**

YOU ARE A ...	If the Following Activities Occur at Your Facility:	Is a RCRA Permit Necessary?	Is Hazardous Waste Identification Required?*	Waste Analysis Activities	Waste Analysis Plan Activities															
Generator	You generate a hazardous waste at your facility and you do not treat prohibited hazardous waste in tanks, containers, or containment buildings to meet LDR treatment standards. You treat a prohibited hazardous waste* in tanks, containers, or containment buildings.	No	↑	↑	None															
	You generate hazardous waste in volumes >1000 kg per month and accumulate the waste on site for longer than 90 days.	No																		
Storage Facility	You generate hazardous waste in volumes between 100 and 1000 kg per month and accumulate the waste on-site for longer than 180** days. You receive hazardous waste from off-site locations and store the waste in units such as: • containers • tanks • surface impoundments • waste piles • containment buildings	↑	Yes	Make hazardous waste determination and conduct analysis.	<ul style="list-style-type: none"> • Keep plan on site. • Follow the plan at your site. • Notify EPA when new wastes are managed. • Follow the waste analysis requirements for your specific treatment, storage, or disposal unit. 															
Recycling Facility	You store recyclable materials on site prior to entering the recycling process. <i>[Note: The recycling process itself is exempt from regulation except as provided in 40 CFR §261.6(d), and storage of the recyclable materials listed in 40 CFR §§261.6(a)(2) and (a)(3) is not subject to the permitting requirements.]</i>					Yes														
Treatment Facility**	You keep hazardous waste* on site 10 days or less for transfer to another location but you do not alter the waste in any way other than bulking. You treat hazardous waste by any number of processes, which are designed to change the physical, chemical, or biological character or composition of the waste so as to render the waste non-hazardous, less hazardous, safer to transport, safer to store, safer to dispose of, or reduced in volume. Examples of these processes and their possible associated treatment units include: <table border="0" style="width: 100%;"> <tr> <td style="width: 50%;">Example Process</td> <td style="width: 10%;"></td> <td style="width: 40%;">Example Treatment Unit</td> </tr> <tr> <td>Thermal Destruction</td> <td>→</td> <td>Incinerator</td> </tr> <tr> <td>Stabilization/Solidification</td> <td>→</td> <td>Stabilization Unit</td> </tr> <tr> <td>Cyanide Destruction</td> <td>→</td> <td>Tanks, containers</td> </tr> <tr> <td>Neutralization</td> <td>→</td> <td>Tanks, containers, surface impoundments</td> </tr> </table>					Example Process		Example Treatment Unit	Thermal Destruction	→	Incinerator	Stabilization/Solidification	→	Stabilization Unit	Cyanide Destruction	→	Tanks, containers	Neutralization	→	Tanks, containers, surface impoundments
Example Process		Example Treatment Unit																		
Thermal Destruction	→	Incinerator																		
Stabilization/Solidification	→	Stabilization Unit																		
Cyanide Destruction	→	Tanks, containers																		
Neutralization	→	Tanks, containers, surface impoundments																		
Disposal Facility	You dispose of a hazardous waste* by means of depositing, injecting, dumping, spilling, leaking or placing these wastes into or on any land or water so that the waste or any of its constituents may enter the air or waters (including groundwater).	↓	↓	None	None															
Transporter/ Transfer Facility		No. (A DOT Transportation License is necessary.)	↓	None	None															

9-1

* TSDFs may accept the generator's certification and any waste analysis data. Transporters and transfer facilities generally use the manifest to satisfy waste identification needs.

** Generators of between 100 and 1000 kg of hazardous waste per month may accumulate waste on site for up to 270 days if the off-site receiving facility is at a distance of 200 miles or more (40 CFR §262.34(e)).

*** Certain activities that meet the definition of treatment do not require RCRA permits as listed in 40 CFR §264.1(g).

and applying knowledge of the waste to determine if the waste is hazardous. Nonetheless, the process that is required of generators to identify their wastes is identical to the one required of facilities which are expressly required to conduct waste analysis. Therefore, the term "waste analysis," as used in this manual will refer to the process of identifying wastes per 40 CFR §262.11, and characterizing wastes per 40 CFR §264.13 and §265.13.]

- Generator that treats a waste, that is prohibited from land disposal, in tanks, containers, or containment buildings to meet an LDR treatment standard, you must not only identify your waste, and conduct waste analysis, but also develop a written WAP and submit the plan to EPA 30 days prior to conducting treatment, pursuant to 40 CFR §268.7.
- TSDF with a RCRA permit or interim status, you also need to identify your wastes, conduct waste analysis, develop a written WAP, and submit the plan to EPA, pursuant to 40 CFR Parts 264/265.

What Are Your Responsibilities If You Send Wastes Off Site?

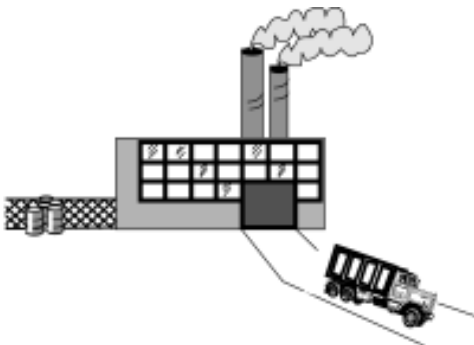

In addition to conducting waste analysis and developing and following a WAP, if required, **you must forward waste analysis information to the TSDF that subsequently receives your waste.** For example, if you are:

- A generator of a hazardous waste who sends waste off site for treatment, storage, or disposal, you should provide the waste analysis information, the applicable RCRA codes (e.g., K061), and the applicable LDR treatment standards. In addition, the generator may provide the TSDF with a description of the process that generated the waste. The information will help ensure, among other things, that your waste can be accepted according to the facility permit.
- An owner/operator of a treatment facility, you must provide waste analysis information (including any information supplied by the generator, as well as waste analysis data developed by your facility before and after treatment) to any off-site storage or disposal facility receiving the waste to ensure that the waste is managed in compliance with LDR requirements and their permit.

To Whom Should You Provide Waste Analysis Data?

- Off-site TSDFs
- Transfer Station Facilities
- Transporters

What Are Your Waste Analysis Data Flow Requirements?

In addition to generators and TSDFs, Table 1-1 indicates that waste transporters and waste transfer facilities also have hazardous waste identification requirements. These facilities are not required to conduct waste analysis or develop waste analysis plans. **However, to ensure safe handling, transporters and transfer station owner/operators need to know the identity of the wastes they are handling.** These facilities generally rely on the information provided by the generator or the TSDF offering the waste as presented on the hazardous waste manifest. Therefore, the accuracy and completeness of the waste analysis performed by the generators and TSDFs is critical to them and to the many individuals who come in contact with these materials while they are in transit.

Figure 1-2 depicts the transfer of waste analysis information that needs to occur among facilities. In addition, **Appendix C** provides a summary chart of the specific information that should be sent by generators and TSDFs with each shipment of waste.

It is advantageous for all facilities involved to provide detailed waste analysis information with each shipment of waste, and for the receiving facility to verify, through waste analysis, the infor-

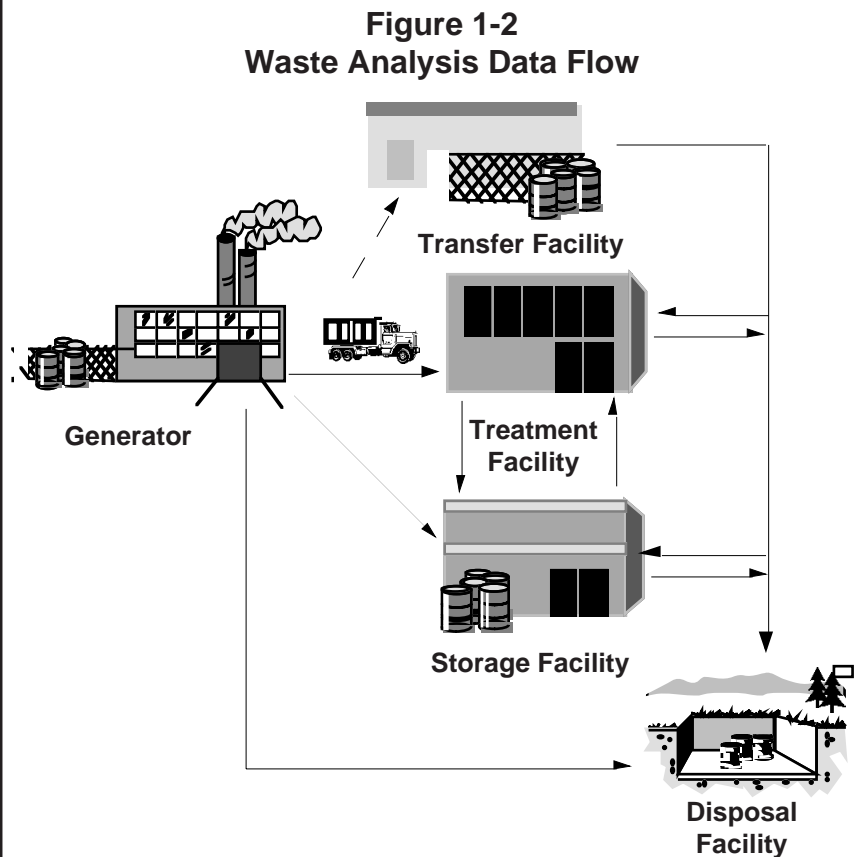

What Are Your Waste Analysis Requirements?

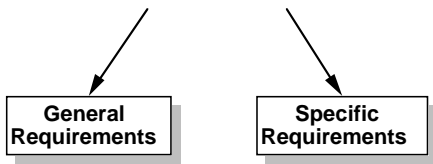

What Are General Waste Analysis Requirements?

mation that the generator or sender of the waste provided. By following these steps, there is an increased likelihood that the waste will be treated, stored, or disposed of properly.

1.4 What Waste Analysis Requirements Must You Meet?

Once you have determined what your facility's waste analysis responsibilities are (using Section 1.3), you must determine what waste analysis regulatory requirements apply to your facility. **RCRA contains general and facility-specific waste analysis requirements applicable to each facility type (i.e., generators and TSDFs).**

1.4.1 General Waste Analysis Requirements

The general requirements for conducting waste analysis are included in:

- 40 CFR §262.11 for generators that do not treat, store, or dispose of hazardous waste
- 40 CFR §268.7(a)(4) for generators treating in tanks, containers, and/or containment buildings to meet LDR treatment standards
- 40 CFR §264.13 for permitted TSDFs, including 40 CFR §264.13(a)(4) and (c) for all off-site TSDFs (generators who treat prohibited wastes in tanks, containers, and/or containment buildings to meet LDR treatment requirements should also follow the general waste analysis provisions in 40 CFR §§264.13/265.13)
- 40 CFR §265.13 for TSDFs operating under interim status.

*[Note: 40 CFR §264.13 and §265.13 are included verbatim in **Appendix D** of this manual.]*

To meet the general waste analysis requirements, all TSDFs should, and generators treating in tanks, containers, and/or containment buildings to meet LDR treatment standards must, obtain a detailed chemical and physical analysis of a representative sample of any waste that they generate, treat, store, or dispose of. These general requirements, as documented in a WAP, are designed to ensure that you have sufficient knowledge of your wastes to manage them properly, including identifying:

- Procedures to ensure that the waste expected at the off-site TSDF, if applicable, is the waste described in the manifest
- Parameters to be analyzed
- Sampling methods
- Testing and analytical methods
- Frequency for re-evaluating wastes; or frequency of spot check or fingerprint analysis (for off-site TSDFs)
- Acceptance/rejection criteria for each wastestream (for off-site TSDFs).

For generators that are not treating hazardous waste in tanks, containers, and/or containment buildings to meet LDR treatment standards, you need only conduct waste analysis; no formal WAP is required, although 40 CFR §262.40 imposes recordkeeping requirements for generators performing waste analysis.

*[Note: **Part Two** of this manual provides a full account of all general waste analysis requirements and guidance on meeting these requirements.]*

1.4.2 Specific Waste Analysis Requirements

In addition to the general waste analysis requirements, RCRA also contains waste analysis requirements for specific waste management methods. These requirements are different for permitted facilities and interim status facilities [40 CFR §264.13(b)(6) versus §265.13(b)(6)]. Specific waste analysis requirements apply to the operation of tanks, containers, incinerators, and other specified TSDF units. Specific waste analysis requirements also include the application of special regulatory requirements, such as:

- Managing ignitable, reactive, or incompatible wastes.
- Placing bulk, containerized, or non-containerized liquid hazardous wastes in a landfill. As of May 8, 1985, placement of bulk or non-containerized liquid hazardous wastes or hazardous wastes containing free liquids (whether or not absorbents have been added) in any landfill is prohibited. However, placement of containerized liquid hazardous waste in a landfill is permissible under certain conditions. For example, landfill disposal is allowed when the containerized hazardous waste has been mixed

What Are Specific Waste Analysis Requirements?

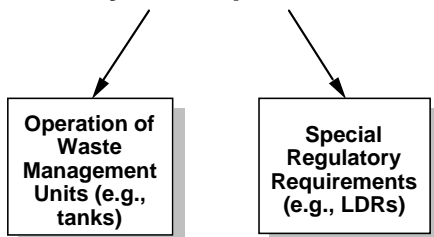

with a nonbiodegradable sorbent so that free-standing liquid is no longer observed. Criteria for choosing such a sorbent are outlined in 40 CFR §264.314(e) and §265.314(f).

- Complying with the LDR requirements. For example, EPA ordinarily requires that treatment and disposal facilities do independent corroborative testing (i.e., periodic detailed physical and chemical analysis) on their waste to ensure compliance with LDR treatment standards and prohibitions. Treatment facilities may rely on information provided to them by generators or treaters of the waste; however, EPA clearly states in 55 FR 22669 that "**the restricted waste testing requirement is not superseded by the ability of the facility to rely on information supplied by the generator or treater.**" This preference for corroborative testing, even though it arguably may be redundant, is designed to ensure that the waste is what others have represented it to be (even if the generator also tested the waste or certified that it meets LDR requirements) and provides reinforcement that it will meet LDR treatment standards prior to land disposal.

1.5 How Can You Meet The Waste Analysis Requirements For Your Facility?

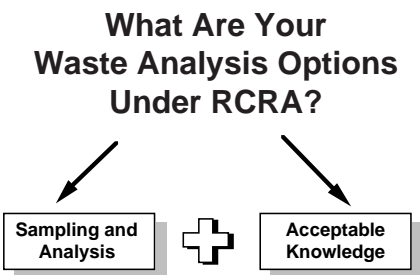

You can meet general and specific waste analysis requirements using several methods or combinations of methods. Wherever feasible, the preferred method to meet the waste analysis requirements is to conduct **sampling and laboratory analysis** because it is more accurate and defensible than other options. (The procedures and equipment for both obtaining and analyzing samples are discussed in Part Two of this manual, and are described in Appendices I and II of 40 CFR Part 261.)

However, generators and TSDFs also can meet waste analysis requirements by applying **acceptable knowledge**. Acceptable knowledge can be used to meet all or part of the waste analysis requirements.

Acceptable knowledge can be broadly defined to include:

- "**Process knowledge**," whereby detailed information on the wastes is obtained from existing published or documented waste analysis data or studies conducted on hazardous wastes generated by processes similar to that which generated the waste. As mentioned previously, EPA lists (i.e., F, K, P, and U lists) certain hazardous

**Compliance Is Best Ensured
Through Sampling and
Analysis**

wastes in 40 CFR Part 261. The K-listed wastes, for example, contain wastes generated from specific sources. Examples of K-listed wastes include:

- K001 -- Bottom sediment sludge from the treatment of wastewaters from wood preserving processes that use creosote and/or pentachlorophenol.
- K062 -- Spent pickle liquor generated by steel finishing operations of facilities within the iron and steel industry.

K-listed wastes, therefore, are identified by comparing the specific process that generated the waste to those processes listed in 40 CFR §261.32 (rather than conducting a chemical/physical analysis of the waste). Similarly, any waste described in the F, P, or U list has already been designated as hazardous by EPA. Therefore, with many listed wastes the application of acceptable knowledge is appropriate because the physical/chemical makeup of the waste is generally well known and consistent from facility to facility.

- **Waste analysis data** obtained from facilities which send wastes off site for treatment, storage, or disposal (e.g., generators).
- **The facility's records of analysis performed before the effective date of RCRA regulations.** While seemingly attractive because of the potential savings associated with using existing information (such as published data), the facility must ensure that this information is current and accurate.

1.5.1 Option One: Selecting Sampling And Analysis

Because RCRA is a self-implementing program, the burden is on you, the individual facility owner/operator, to demonstrate that you are operating in compliance with all applicable regulations. Any violations that occur at your facility, regardless of any good faith effort you may have made to obtain information, are your facility's sole responsibility. **For example, if you own/operate a TSDF, accept waste from an off-site facility, and rely on the information provided by the generator or TSDF sending you waste, your facility is still responsible for accurately identifying/classifying the waste.**

When Might Full-Scale Analysis Be Used?

Therefore, to ensure compliance with RCRA you should conduct a full-scale, or under certain circumstances an abbreviated-scale, sampling, and laboratory testing program for all wastes prior to managing the wastes. **Full-scale analysis** (e.g., EPA's SW-846 methods or equivalent) may be necessary when:

- A generator begins a new process or changes an existing process
- Wastes are received by a facility for the first time
- A generator has not provided appropriate laboratory information to an off-site TSDF
- An off-site TSDF has reason to suspect that the wastes shipped were not accurately identified by the generator
- EPA changes RCRA waste identification/classification rules.

When Might Fingerprint Analysis Be Used?

Abbreviated waste analysis, often referred to as “**fingerprint analysis**,” is conducted generally for parameters (e.g., specific gravity, color, flash point, presence of more than one phase, pH, halogen content, cyanide content, percent water) that will give information that can be used to help verify that the waste generated, or received by an off-site TSDF, matches the expected characteristics for that waste. For example, at an off-site TSDF, fingerprint analysis can be used to indicate that the waste received matches the description on the manifest, and that the waste matches the waste type that the facility has agreed to accept. Because the owner/operator of a TSDF already knows the detailed chemical and physical properties of a waste, the appropriate fingerprint or spot check parameters can be chosen easily, since the purpose of the fingerprint or spot check is only to verify that each waste arriving at the gate of the TSDF is the actual waste expected. The number and character of fingerprint parameters and the criteria for acceptance/rejection of the waste will be discussed in Part Two of this manual.

1.5.2 Option Two: Selecting Acceptable Knowledge

When Might Acceptable Knowledge Be Used?

Generators and TSDFs may use acceptable knowledge alone or in conjunction with sampling and laboratory analysis. As previously stated, an off-site TSDF is not relieved of its responsibility to obtain accurate waste analysis data despite the submission of erroneous information provided to the TSDF by the generator. As discussed briefly on the previous page, however, there are situa

tions where it may be appropriate to apply acceptable knowledge, including:

- Hazardous constituents in wastes from specific processes are well documented, such as with the F-listed and K-listed wastes.
- Wastes are discarded unused commercial chemical products, reagents or chemicals of known physical, and chemical constituents. Several of these fall into the P-listed and U-listed categories (40 CFR §261.33).
- Health and safety risks to personnel would not justify sampling and analysis (e.g., radioactive mixed waste).
- Physical nature of the waste does not lend itself to taking a laboratory sample. For example, to conduct waste analysis of surface-contaminated construction debris, such as steel girders, piping, and linoleum, it may be necessary to use a combination of laboratory analysis and process knowledge. The process knowledge would be applied to identifying the composition of the base construction materials (e.g., steel). One could then collect surface "wipe" samples and conduct laboratory analysis to determine the representative concentrations of any contaminants present. If the base materials are porous, such as gypsum, the contamination could be determined by conducting analysis on the extracts obtained from a solvent wash.

Acceptable knowledge is not an appropriate substitute for fingerprint or spot check procedures except in the unique case when the TSDF is accepting properly manifested waste from another site owned by the same company.

Why Document Acceptable Knowledge?

If you use acceptable knowledge in addition to or in place of sampling and analysis, EPA, in enforcement cases, looks for documentation that clearly demonstrates that the information relied upon is sufficient to identify the waste accurately and completely. Documenting both the acceptable knowledge (e.g., knowledge of the process that generated the F-listed or K-listed waste) as well as any analytical data is essential for identifying constituents applicable to LDR standards.

How Can You Verify Data Supplied By A Generator?

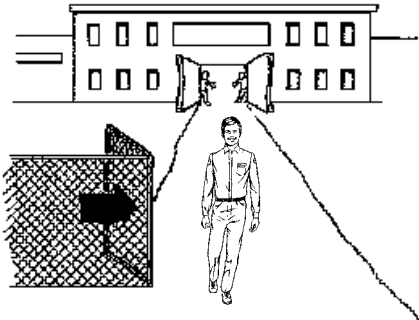

Why Is It Critical To Re-Evaluate Your Use Of Acceptable Knowledge Periodically?

Special Concerns When Using Acceptable Knowledge

There are several special concerns that you should be aware of if you rely on acceptable knowledge to manage your wastes. **First**, if you own/operate an off-site TSDF and rely, on information supplied by a generator, you should, if possible, become thoroughly familiar with the generator's processes to verify the integrity of the data. This can be accomplished by (1) conducting facility visits of generators and/or (2) obtaining split samples for confirmatory analysis. **Second**, if you use process descriptions and existing published or documented data as acceptable knowledge, you should scrutinize carefully whether:

- There are any differences between the process in the documented data and your process
- The published or documented data that were used are current.

These issues are of concern, for example, because EPA recently revised the criteria that qualify a waste as a hazardous waste due to being characteristically toxic. Not only were the number of constituents deemed hazardous increased, but also the prescribed test method was modified [i.e., the TCLP replaced the Extraction Procedure Toxicity Test (EP TOX Test)].

Therefore, if you have been using acceptable knowledge you need to review your waste analysis or waste characterization data to determine if you manage any solid wastes that are now regulated as hazardous wastes. In addition, you need to determine if your existing data is sufficient to identify any new constituent concentration limitations (i.e., demonstrate compliance with LDR requirements). The following examples highlight these concerns:

- A paint manufacturer used process knowledge to identify the hazardous waste constituents of six paint colors. During an EPA audit, the company produced the waste analysis documents that had been generated years earlier and re-evaluated periodically. EPA noted that the company now manufactured eight colors. Through testing, EPA discovered that one of the paints required barium as a coloring agent. Barium is a metal that can render a waste characteristically toxic (by the TCLP) if found in concentrations greater than 100 parts per million (100 ppm) per 40 CFR §261.24. This manufacturer was found to be out of compliance because the level of barium was greater than the maximum concentration for the toxicity charac-

teristic, and the manufacturer's waste analysis data was inaccurate.

- At a pulp paper mill, wastewater effluent became subject to RCRA after the promulgation of the new toxicity characteristic (TC) rule due to the presence of chloroforms generated by the bleaching process in concentrations greater than 6 ppm in an extract of the waste. Chloroform was not regulated prior to the TC rule.
- EPA recently promulgated an interim final rule on ignitable and corrosive wastes requiring D001 and D002 wastes that are not managed in Clean Water Act, Clean Water Act-equivalent, or Class I Safe Drinking Water Act systems to be treated for underlying hazardous constituents (i.e., be treated to F039 levels for F039 constituents). An example of a waste affected by this rule is a corrosive (D002) waste that is incinerated. When determining which, if any, F039 constituents are present in their waste, generators need only monitor for those F039 constituents which are reasonably expected to be present in the waste. Generators may rely on either knowledge of the raw materials used, the process, and the potential reaction products; or a one-time analysis for the entire list of F039 constituents. Subsequent analyses may then be limited to the F039 constituents found in the initial sampling and analysis. Off-site TSDFs should ensure that the generator's waste analysis results and/or process descriptions are accurate, up-to-date, and representative of the ignitable or corrosive waste. Off-site TSDFs should also ensure that if any changes in waste generation (e.g., a change in raw materials used) occur, the generator re-evaluates its initial determination of which F039 constituents are present in the untreated waste. EPA recommends that another analysis of the F039 list of hazardous constituents be made if such changes occur.

In addition, where documented studies are used as acceptable knowledge, you should ensure that information is based on valid analytical techniques. The ability of analytical equipment to detect low concentrations of contaminants has improved over the years and constituents that once were determined to be "non-detectable" may, in fact, be detectable using the sophisticated equipment available today.

Although EPA recognizes that sampling and analysis are not as economical or convenient as using acceptable knowledge, they do usually provide advantages. Because accurate waste identifica-

Keep Abreast Of New Regulations And Analytical Techniques (e.g., LDR, TCLP)

tion is such a critical factor for demonstrating compliance with RCRA, misidentification can render your facility liable for enforcement actions with respect to permit conditions, LDR requirements, annual reporting, and other RCRA requirements. In addition, accurate waste analysis is critical for meeting some of the requirements of other regulatory programs such as effluent discharges under the Clean Water Act, and transportation requirements regulated by the Department of Transportation.

As the above examples illustrate, you are cautioned to keep abreast of current regulatory developments in the RCRA program that may effect the classification of your waste, and to re-evaluate your wastes frequently using current analytical methods and/or process knowledge, particularly any time a rule affecting RCRA waste identification/classification is finalized.

REFERENCE THIS MANUAL OFTEN!

(Even If You Have Obtained a Permit)

As noted previously, this manual provides you with guidance for conducting waste analysis and developing a complete WAP. However, even after waste analysis procedures have been developed, documented, and implemented at your facility, and/or you have received your RCRA operating permit, you should refer to this manual whenever you re-evaluate your waste analysis procedures. Re-evaluating your waste analysis procedures is necessary when:

- Processes are changed, or other factors affecting waste identification have occurred
- Permits are modified or re-issued
- Regulations affecting the definition of hazardous wastes are promulgated, which may result in an increase in the number, or types, of hazardous wastes managed at your facility
- Regulations are promulgated affecting management of existing wastes at your facility.

1.6 Uses Of Waste Analysis And A WAP

Waste analysis and WAPs serve many critical functions for facility personnel if written in a clear, logical, and easily reviewable manner. Even if a facility is not required to develop a written WAP, EPA recognizes that it may be advantageous for you to develop one, and follow it on site because it can assist you in

What Are The Benefits To Facility Personnel?

demonstrating compliance with a host of RCRA requirements, and also reduce liabilities associated with incidents which might result from incorrect waste identification. It is important to emphasize, however, that **a WAP can only be helpful to the extent that it is used.**

Some of the many useful functions available to facility personnel who conduct waste analysis and use a WAP were highlighted earlier in this manual. Additional benefits to facility personnel include conducting proper activities relating to:

- Ensuring waste compatibility with other waste and non-waste materials
- Ensuring that waste received by off-site facilities matches the waste designated on the manifest or LDR notification
- Responding to spills
- Developing proper training programs for compliance with OSHA, and developing RCRA contingency plans
- Facilitating proper labeling and documenting wastes for on-site management and off-site transport
- Complying with recordkeeping requirements
- Evaluating incidents resulting from mishaps.

How Can A WAP Help Demonstrate Compliance To EPA?

WAPs also are useful to permit writers at EPA. A good WAP will go a long way toward providing satisfaction to EPA that appropriate RCRA concerns are met. The WAP will also assist you in demonstrating to EPA:

- The adequacy of your RCRA permit application, with respect to appropriate hazardous waste treatment, storage, and disposal methods
- Your compliance with the LDR regulations
- That proper waste analysis procedures are in place.

1.7 Summary



In Part One, you learned what your waste analysis and WAP responsibilities are under the RCRA program, and how to meet these responsibilities (i.e., sampling and analysis, and acceptable knowledge). You also learned why it is critical that you develop and follow a WAP and always conduct waste analysis properly. For example, you must develop a well-documented WAP and conduct waste analysis properly to:

- Ensure proper identification, treatment, storage, and disposal of hazardous wastes, thereby avoiding permit violations and properly responding to accidents (e.g., fires and spills)
- Facilitate review of the permit application (if applicable) by EPA
- Assist in demonstrating compliance with all applicable RCRA regulations (e.g., LDR treatment standards) and permit operating conditions
- Avoid enforcement actions taken in response to inadequate waste analysis or WAPs.

In Part Two, you will review the "nuts and bolts" of how to prepare a WAP and conduct waste analysis.

Proceed to Part Two



PART TWO: DOCUMENTING AND CONDUCTING WASTE ANALYSIS



In Part One, you identified your waste analysis and WAP responsibilities, and reviewed the methods you may use to meet these responsibilities (i.e., laboratory testing and analysis, and acceptable knowledge). In Part Two, you will learn:

- What information should be included in a WAP
- How the information may be organized to facilitate easy use and review
- How to conduct waste analysis, including selecting waste analysis parameters, and sampling and testing methods, as well as identifying special waste management considerations (e.g., LDR requirements).

2.0 Content And Recommended Organization Of A WAP

To facilitate conducting waste analysis and developing a WAP, Table 2-1 provides a list of key questions arranged by facility type, that when analyzed sequentially, provide an overview of the key elements that should be considered when planning, documenting, and conducting waste analysis activities at your facility. Answers to the questions posed in Table 2-1 will be based on facility-specific considerations. Relevant facility-specific factors include:

- The type of facility (i.e., generator, storage, treatment, or disposal) and the status of the facility (i.e., no permit is required, the facility is permitted, or the facility is operating under interim status)
- The characteristics and quantities of wastes generated
- The types of units that are used to manage wastes on site.

You should also use Table 2-1 as a roadmap for using this manual. In fact, because many of the questions are common to all facility types, they can be grouped into six major elements that all facility types should address in their waste analysis plans. **These six elements are used to illustrate the content and recommended organization of a WAP.** Table 2-2 also includes the section of this manual in which each element is addressed, and a brief description of the guidance that is provided for each section in this manual.

**Table 2-1
Reference Guide To Key Issues For Consideration When Developing WAPs**

Generators		Treatment Facilities		Storage Facilities		Disposal Facilities	
Generator Only	Treat in tanks, containers, or containment buildings	On-Site Only	Off-Site Only	On-Site Only	Off-Site Only	On-Site Only	Off-Site Only
<p>1. What is the description of the facility where wastes are generated and/or managed? (Section 2.1)</p> <p>2. What processes result in hazardous waste generation? (Section 2.1)</p> <p>3. What is the description of the hazardous wastes that are generated? What are the waste classifications, EPA waste codes, and treatability groups, of the hazardous wastes generated? (Section 2.1)</p> <p>4. What waste parameters will be identified for testing, analysis, and/or monitoring, and what is the rationale for selecting these parameters? (Section 2.2.)</p> <p>5. What sampling procedures (collection strategies, equipment, sample preservation methods, and QA/QC procedures) will be used? (Section 2.3)</p> <p>6. How will a laboratory be selected? (Section 2.4)</p> <p>7. What testing and analytical methods will be used? (Section 2.4)</p> <p>8. What frequency for re-evaluating the waste will be established? (Section 2.5)</p> <p>9. Are additional provisions for meeting LDR regulations required? (Section 2.6)</p>	<p>Address all Generator Only information, from items 1 through 9 in column one. In addition, answer the following:</p> <p>Before Treatment</p> <p>10. What are the applicable treatment standards with respect to the LDR regulations? (Sections 2.1 and 2.6)</p> <p>After Treatment</p> <p>11. Have all the LDR treatment standards been met? (Section 2.6)</p>	<p>Address all Generator Only information, from items 1 through 9 in column one, in addition, answer the following:</p> <p>Before Treatment</p> <p>10. What are the treatment or process design limitations for optimal safe use of equipment and materials? (Sections 2.1 and 2.2)</p> <p>11. What are the other operational acceptance limits applicable to permit and technological considerations? (Sections 2.1 and 2.2)</p> <p>12. What are the applicable treatment standards with respect to the LDR regulations? (Section 2.6)</p> <p>After Treatment</p> <p>13. Did the treatment standards or is additional sampling and analysis necessary to make this determination? (Sections 2.1, 2.2, 2.3, 2.5, and 2.6)</p> <p>14. What new wastes, waste codes, and treatability groups were generated? (Section 2.1)</p> <p>15. Are there any additional applicable treatment standards with respect to LDR regulations? (Section 2.1 and 2.6)</p>	<p>Address all Generator Only information, from items 1 through 9 in column one, in addition, answer the following:</p> <p>Before Acceptance</p> <p>10. How will the identification of wastes from off site be verified? (Sections 2.2, 2.5 and 2.6)</p> <p>11. Will corroborative testing be conducted using full-scale analysis, fingerprinting, or other process such as acceptable knowledge? (Sections 2.2, 2.4, 2.5 and 2.6)</p> <p>12. How will wastes be screened for contaminants that are incompatible with the treatment process? (Section 2.2)</p> <p>Before Treatment</p> <p>13. What are the treatment or process design limitations for optimum safe use of equipment and materials? (Sections 2.1 and 2.2)</p> <p>14. What are the other operational acceptance limits applicable to permit and technological considerations? (Sections 2.1 and 2.2)</p> <p>15. What are the applicable treatment standards with respect to LDR regulations? (Section 2.6)</p>	<p>Address all Generator Only information, from items 1 through 9 in column one, in addition, answer the following:</p> <p>10. Will managing wastes (e.g., mixed bulk chemicals) change the chemical properties, such that issues 13-16 must be addressed? (Section 2.1)</p> <p>How will the initial waste characterization change? (Section 2.2)</p> <p>What additional sampling and analysis are required at the storage facility? (Sections 2.2 and 2.3)</p> <p>Will a new waste identification be required and how will it be verified? (Section 2.5)</p> <p>What are the applicable treatment standards with respect to LDR regulations as a result of any blending or mixing that may have occurred? (Section 2.1, 2.5, and 2.6)</p> <p>14.</p>	<p>Address all Generator Only information, from items 1 through 9 in column one, in addition, answer the following:</p> <p>Before Acceptance</p> <p>10. How will the identification of wastes from off site be verified? (Sections 2.5 and 2.6)</p> <p>11. Will corroborative testing be conducted using full-scale analysis, fingerprinting or other process such as acceptable knowledge? (Sections 2.2, 2.4, 2.5 and 2.6)</p> <p>12. How will wastes be screened for contaminants that are incompatible with the storage process? (Section 2.2)</p> <p>After Acceptance</p> <p>13. Will managing wastes (e.g., mixed bulk chemicals) change the chemical properties, such that issues 16-19 below must be addressed? (Section 2.1)</p> <p>How will the initial waste characterization change? (Section 2.2)</p> <p>What additional sampling and analysis is required at the storage facility? (Sections 2.2 and 2.3)</p> <p>Will new waste identification be required and how will it be verified? (Section 2.5)</p> <p>16.</p>	<p>Address all Generator Only information, from items 1 through 9 in column one. In addition, answer the following:</p> <p>10. Have all wastes designated for land disposal met applicable LDR treatment standards? (Sections 2.1 and 2.6)</p> <p>Is it necessary to conduct additional (corroborative) testing? (Sections 2.5 and 2.6)</p> <p>11.</p>	<p>Address all Generator Only information, from items 1 through 9 in column one. In addition, answer the following:</p> <p>Before Acceptance</p> <p>10. How will the identification of wastes from off site be verified? (Sections 2.2, 2.5 and 2.6)</p> <p>11. How will wastes be screened for contaminants that are incompatible with the disposal process? (Section 2.2)</p> <p>After Acceptance</p> <p>12. What type of corroborative testing will be conducted, such as full-scale testing and analysis, fingerprinting, or other process such as acceptable knowledge? (Sections 2.4, 2.5, and 2.6)</p> <p>Have all wastes received on site for disposal met applicable LDR treatment standards? (Sections 2.1 and 2.6)</p> <p>Are additional procedural requirements applicable for wastes from off site? (Sections 2.6)</p> <p>14.</p>

**Table 2-1
Reference Guide To Key Issues For Consideration When Developing WAPs**

Generators		Treatment Facilities		Storage Facilities		Disposal Facilities	
Generator Only	Treat in tanks, containers, or containment buildings	On-Site Only	Off-Site Only	On-Site Only	Off-Site Only	On-Site Only	Off-Site Only
		<p>After Treatment (cont'd)</p> <p>16. What additional parameters of the treated materials (residues) will need to be monitored, and why? (Section 2.2)</p> <p>17. How will the treated wastes be sampled? (Sections 2.3 and 2.4)</p> <p>What testing/ analytical methods will be used to analyze the waste? (Section 2.4)</p>	<p>After Treatment (cont'd)</p> <p>16. Did the treatment achieve LDR standards or is additional sampling and analysis necessary to make this determination? (Sections 2.1, 2.2, 2.3, 2.5, and 2.6)</p> <p>17. What new wastes/waste codes and treatability groups were generated? (Section 2.1)</p> <p>Are there any additional applicable treatment standards with respect to LDR regulations? (Section 2.1 and 2.6)</p> <p>What additional parameters of the treated materials (residues) will need to be monitored, and why? (Section 2.2)</p> <p>How will the treated wastes be sampled? (Section 2.3 and 2.4)</p> <p>What testing/ analytical methods will be used to analyze the waste? (Section 2.4)</p> <p>21. analyze the waste? (Section 2.4)</p>		<p>17. What are the applicable treatment standards with respect to LDR as a result of any blending or mixing that may have occurred? (Sections 2.1, 2.5, and 2.6)</p>		

**Table 2-2
Key Elements In Waste Analysis**

KEY ELEMENT OF A WAP	SECTION OF THIS MANUAL	SECTION INCLUDES GUIDANCE ON:
Facility Description	Section 2.1	Describing important facility-specific processes and activities.
Selecting Waste Analysis Parameters	Section 2.2	Identifying and selecting the individual waste parameters for each waste that will be sampled and analyzed, as well as the rationale for the selection. ¹
Selecting Sampling Procedures	Section 2.3	Selecting the appropriate sampling procedures for effective waste characterization. ²
Selecting a Laboratory and Testing and Analytical Methods	Section 2.4	Selecting the appropriate laboratory testing or analytical methods. ³
Selecting Waste Re-evaluation Frequencies	Section 2.5	Determining when it is necessary to re-evaluate the adequacy of the waste analysis. ⁴
Special Procedural Requirements	Section 2.6	Identifying any special procedures that will need to be followed when: <ul style="list-style-type: none"> - Receiving wastes generated off site⁵ - Ensuring safe management of ignitable, reactive, and incompatible wastes⁶ - Demonstrating compliance with the LDR treatment standards.⁷

The first five elements (Sections 2.1 through 2.5) apply to all facilities, but the sixth element (Section 2.6, Special Procedural Requirements) applies only if you are involved in the activities identified. For example, if you are strictly a generator, you may not be concerned with issues related to the receipt of wastes from off-site generators. Therefore, you should review element six, note those subsections that apply to your facility, and skip those that do not apply.

¹ 40 CFR §§264/265.13(b)(1)

² 40 CFR §§264/265.13(b)(3)

³ 40 CFR §§264/265.13(b)(2)

⁴ 40 CFR §§264/265.13(b)(4)

⁵ 40 CFR §§264.265.13(c)

⁶ 40 CFR §§264/265.13(b)(6)

⁷ 40 CFR §§264/265.13(b)(6)

While there is no required format for a WAP, addressing these six elements in the order given generally will provide you with a document that satisfies all applicable regulations. However, EPA personnel may request additional information that is not referenced in this manual, such as site-specific data that is necessary for the development of an effective WAP for your facility.

These six major elements are discussed in the following six sections of this manual (Sections 2.1 through 2.6). In these sections, detailed guidance is provided on how to address each of the major elements when conducting waste analysis and developing a WAP. Where appropriate, these sections include footnotes which designate applicable regulatory citations.

2.1 Facility Description

The facility description is an important element of an effective waste management program (including a WAP). The facility description should provide sufficient, yet succinct, information so that implementing officials and WAP users can clearly understand the type of:

- Processes and activities that generate or are used to manage the wastes
- Hazardous wastes generated or managed
- Hazardous waste management units.

These three areas are discussed separately below; your presentation of this information should be tailored to your facility-specific conditions in a format that most clearly presents the information.

If your facility has an existing RCRA permit or is in the process of developing a permit application, the majority of facility description information will be available from other sections of the permit. However, it is useful to include a summary of this information in the WAP. **At a minimum, the WAP should reference where in the permit (or permit application) facility description information may be obtained.**

2.1.1 Description Of Facility Processes And Activities

As a hands-on tool for ensuring compliance with applicable regulatory requirements and/or permit conditions, the WAP should provide a description of all on-site facility processes and activities that are used to generate or manage hazardous wastes (or reference applicable sections of the permit or permit application). This information should include facility diagrams, narrative process descriptions, and other data relevant to the waste management processes subject to waste analysis. As stated previously, since many TSDFs, especially off-site facilities, utilize the WAP as an operating manual, it is advisable to incorporate process descriptions directly into the document.

In addition to describing on-site processes and activities, off-site TSDFs should reference in their WAPs that a brief description of each generator's processes contributing wastes to the facility will be obtained, updated, and kept on file as part of the operating record (which is reviewed by EPA/state inspectors). If you own or operate a TSDF, this data will enhance your knowledge of off-site generation processes and, therefore, improve your ability to determine the accuracy of generator waste classification.

2.1.2 Identification/Classification And Quantities Of Hazardous Wastes Generated Or Managed At Your Facility

In Section 1.2 of this manual, the major concepts associated with identifying and classifying wastes as RCRA listed or characteristic hazardous wastes were enumerated. Using these principles, the WAP should clearly identify:

- Each hazardous waste generated or managed at your facility
- Each process generating these wastes
- Rationale for identifying each waste as hazardous
- Appropriate EPA waste classifications (e.g., EPA waste code, classification under LDR regulations as wastewater or nonwastewater).

If you generate or manage a RCRA *listed* waste, you may choose, but are not required, to present this relevant information as provided in Table 2-3.

**TABLE 2-3
Description Of Listed Wastes**

FACILITY	IDENTITY OF HAZARDOUS WASTE	PROCESS GENERATING THIS WASTE	RATIONALE FOR HAZARDOUS WASTE DESIGNATION	EPA WASTE CODE	LDR	
					Waste-Water	Non-Waste-Water
FACILITY A Semi-Conductor Manufacturer	Spent degreasing solvents (trichloroethylene)	Degreasing from machinery in Bldg. 12	Contains 25% trichloroethylene, cutting oils, and other non-hazardous degreasing solvents	F001	Wastewater	
FACILITY B Wood Preserving Facility	Bottom sediment sludge	Treatment of wastewater from wood preserving process	Process used pentachlorophenol	K001	Non-wastewater	

In addition to identifying all listed wastes generated or managed, you may need to conduct testing and/or analysis to determine whether you also generate or manage any RCRA characteristic wastes (e.g., for purposes of complying with LDR requirements). (A description of the sampling and analysis, including appropriate method references, that you would employ to appropriately identify characteristics is provided in Sections 2.3 and 2.4 of this manual.) If wastes are identified as characteristic, you may choose to present relevant information as illustrated in Table 2-4.

As a supplement to the above information, this portion of the WAP also should provide a listing of any wastes or waste properties that are known not to be manageable by the facility (i.e., inappropriate

wastes). Collectively, the identification of appropriate and inappropriate waste types will enhance the facility's ability to develop effective sampling and analytical procedures as part of the overall waste analysis program.

**TABLE 2-4
Description Of Characteristic Wastes**

FACILITY	IDENTITY OF HAZARDOUS WASTE	PROCESS GENERATING THIS WASTE	RATIONALE FOR HAZARDOUS WASTE DESIGNATION	EPA WASTE CODE	LDR	
					Waste-Water	Non-Waste-Water
FACILITY A Pharmaceutical Manufacturer	Toxic	Analgesic cream (see Process #A-106 or Schematic 12)	Benzene > 0.5 ppm	D018	Wastewater	
FACILITY B Hazardous Waste Treatment Facility	Toxic	Incineration	Waste residues contain > 1.0 ppm Cd	D006	Non-wastewater	

2.1.3 Description Of Hazardous Waste Management Units

The final component of the facility description portion of the WAP should include a description of each hazardous waste management unit at the facility. As a supplement to generic facility process and activity discussions, these descriptions should provide more detailed information regarding the specific operating conditions and process constraints for each hazardous waste management unit.

A hazardous waste management unit is defined in the RCRA regulations as a contiguous area of land on or in which there is significant likelihood of mixing hazardous waste constituents in the same area.⁷ Examples given in the regulations include:

- Container storage areas [*Note: A container alone does not constitute a unit; the unit includes containers and the land or pad upon which they are placed.*]⁸
- Tanks and associated piping and underlying containment systems
- Surface impoundments
- Landfills
- Waste piles

⁷ 40 CFR §260.10

⁸ 40 CFR §260.10

- Containment buildings
- Land treatment units
- Incinerators
- Boilers and industrial furnaces
- Miscellaneous units.

Appendix E contains an overview of the hazardous waste management units listed above.

In your WAP, the description of the hazardous waste management units at your facility should be provided in narrative and schematic form. The narrative description should include the following:

- A physical description of each management unit, including dimensions, construction materials, and components.
- A description of each waste type managed in each unit.
- The methods for how each hazardous waste will be handled or managed in the unit; for example:
 - If hazardous and non-hazardous wastes will be mixed or blended, the methods for how these activities will be conducted should be described. In certain circumstances, the hazardous waste may continue to be regulated under the "mixture" or "derived-from" rules.⁹
 - If a surface impoundment will be used for neutralization of corrosive wastes, the mechanism for achieving neutralization should be described.
- Process/design considerations necessary to ensure that waste management units are operating in a safe manner and are meeting applicable permit-established performance standards. This information should define specific physical and chemical operating constraints that must be observed to ensure process integrity. For example, flow injection incineration facilities typically require wastes which have certain minimum and maximum levels of viscosity, heat content, and particulates for effective treatment.¹⁰
- Prohibitions that apply to the facility (e.g., PCBs in the incinerator feed, storage of corrosive basic waste, unpermitted RCRA hazardous waste codes).

2.2 Selecting Waste Analysis Parameters

An accurate representation of a waste's physical and chemical properties is critical in determining viable waste management options. Accordingly, facility WAPs must specify waste parameters that provide sufficient information to ensure:

⁹ Refer to 40 CFR §261.3(a)(2)(iv) and §261.3(c)(2)(i)

¹⁰ Refer to Section 2.2 of this manual for a discussion of process and design considerations as they relate to the selection of waste analysis parameters

- Compliance with applicable regulatory requirements (e.g., LDR regulations, newly identified or listed hazardous wastes)
- Conformance with permit conditions (i.e., ensure that wastes accepted for management fall within the scope of the facility permit, and process performance standards can be met)
- Safe and effective waste management operations (i.e., ensure that no wastes are accepted that are incompatible or inappropriate given the type of management practices used by the facility).

Attention to the above factors when developing a WAP will orient you toward the major considerations for selecting waste analysis parameters. **You should keep in mind that the parameter selection process is a repetitive process, and that you should determine final parameters in consultation with the permit writer.** The following discussion provides more definitive guidance in determining specific parameters to be incorporated into your WAP.

2.2.1 Criteria For Parameter Selection

Waste analysis parameters must be selected to represent those characteristics necessary for safe and effective waste management. Due to the diversity of hazardous waste operations and the myriad of operating variables, the identification of the most suitable parameters to be sampled and analyzed can be complex, especially for large TSDFs. To this point, relevant waste analysis parameter selection criteria can be developed and reviewed systematically to efficiently identify parameters of interest. Generally, these selection criteria may be organized into the following categories:

- Waste identification
- Identification of incompatible/inappropriate wastes
- Process and design considerations.

Each major category of these selection criteria is described in detail below.

Waste Identification

A prerequisite step in proper waste management is the identification of hazardous wastes in accordance with regulatory and permit requirements. Generators and TSDFs must evaluate (through testing or applying acceptable knowledge) solid wastes to determine if the wastes are hazardous in accordance with the RCRA characteristics and listings set forth in 40 CFR Part 261 Subparts C and D. In addition, as a result of the LDR regulations, they must determine whether hazardous wastes are restricted from land disposal. Accordingly, an effective waste analysis plan not only specifies the parameters necessary to ensure that wastes generated and/or accepted are accurately identified and fall within the scope of the facility permit (where applicable), but also includes provisions to ensure that applicable LDR requirements are fulfilled. TSDFs may consult variety of reference materials pertaining to the types of wastes to be managed when specifying parameters to corroborate waste identification under RCRA, including:

- 40 CFR Part 261, Appendices VII and VIII (i.e., the basis for listing hazardous wastes, and hazardous constituents, respectively)
- Industry and trade association hazardous waste profile studies
- EPA Background Documents, for RCRA listed and characteristic hazardous wastes.

Identification Of Incompatible/Inappropriate Wastes

Regulatory requirements¹¹ and good management practices dictate that incompatible (e.g., ignitable, reactive) or inappropriate wastes be identified prior to waste management. If combined, incompatible wastes are capable of spontaneous combustion, toxic gas generation, or explosions. Furthermore, accepting wastestreams inappropriate for your facility operations may violate permit conditions. Examples of inappropriate wastes could include PCBs and dioxin-containing wastes. The selection of waste parameters, therefore, must include measures to address these types of wastes.

Suitable parameters for incompatible¹² and inappropriate wastes will vary according to facility-specific operating and permit conditions. Parameters and analytical methods for ignitable and certain reactive wastes (i.e., cyanide- and sulfide-bearing wastes) are contained in chapters seven and eight of SW-846, respectively. The EPA document: "A Method for Determining the Compatibility of Hazardous Wastes" (EPA/600/2-80-076)¹³ contains guidance on evaluating qualitatively the compatibility of various types of wastes.

Process And Design Considerations

The effectiveness of waste facility operations and associated management units are subject to both process and equipment design limitations, which may be generically referred to as **operating acceptance limits**. These operating constraints determine the range of wastes and related properties that may be managed in a given process while maintaining regulatory and permit compliance. Thus, the facility WAP must include provisions to ensure that physical and chemical analyses provide the information required to identify any waste properties that may exceed operating limitations. Potential risks to personnel, facility structures, and compliance status that may result from exceeding facility operational limitations emphasize the need to identify relevant parameters affecting treatment, storage, and disposal prior to acceptance for management. Similarly, **because potential waste composition changes may occur while wastes are being managed on site, process and design requirements impacting the selection of waste analysis parameters must be reviewed for all phases of waste management (i.e., pre-process, in-process, and post-process)**. For example, where multiple treatment processes are used, waste composition changes resulting from a pretreatment process may preclude its subsequent management by certain other hazardous waste units at the facility.

Since operational acceptance limits determine the range of physical and chemical properties that are acceptable for a given waste management operation, waste analysis parameters must be selected to provide a qualitative and quantitative measure of these conditions. Typically, these waste analysis parameters are used to determine if waste properties exceed certain thresholds, which may indicate that (1) the waste composition is atypical of that normally handled by the facility; and/or, (2) acceptance or further management (without pretreatment) of the waste may compromise the performance goals of the waste management process.

In addition, these waste analysis parameters must ensure that applicable regulatory requirements and permit conditions are met while protecting waste management unit performance goals and

¹¹ 40 CFR §§264/265.17

¹² See related discussion in Section 2.2.3

¹³ This document can be obtained from the National Technical Information Service (NTIS) (Document No. PB-80221005).

structural integrity. **Major factors to consider when identifying parameters to measure for operational acceptance limits are listed below:**

- Types of waste to be managed
- Volumes of waste to be managed
- Method of treatment, if applicable, being employed (e.g., stabilization)
- Types of units in which the wastes will be managed
- Construction materials of the unit
- Location of the unit.

This list is not exhaustive and, therefore, other operational factors applicable to your facility should be considered.

2.2.2 Parameter Selection Process

As stated previously, a systematic evaluation of relevant waste analysis criteria (i.e., those associated with waste identification, identification of incompatible/inappropriate wastes, and process and design considerations) is useful for efficiently identifying waste parameters. To this end, Figure 2-1 illustrates a waste analysis parameter selection process, which can be used to develop a comprehensive inventory of waste parameters through the application of a stepped approach. Since this tool is most useful when applied to each hazardous waste management unit individually (or each class of units, if identical), it is envisioned that parameter selections for each unit will be developed through separate iterations of the flow process. Concurrent with the use of the flowchart for individual operating units, attention should be given to any process variables that require different parameters according to pre-process, in-process, and post-process considerations.

To supplement the information provided in Figure 2-1, examples of commonly identified waste analysis parameters for the major hazardous waste management units are provided in Table 2-5.

2.2.3 Rationale For Parameter Selection

Along with identifying waste analysis parameters, the RCRA regulations¹⁴ require that the WAP provide the rationale for the selection of each parameter. The rationale must describe the basis for the selection of the waste analysis parameter and how it will measure necessary physical and chemical waste properties to afford effective waste management within regulatory, permit, process and design conditions. This information will provide EPA permit reviewers and WAP users with critical information regarding the viability of parameter selection. Furthermore, the determination of the rationale applied for each parameter is useful in determining its adequacy for incorporation into the WAP, and may help eliminate extraneous waste analysis parameters. For reference purposes, Table 2-5 also provides the rationale for commonly selected waste analysis parameters for various waste management units.

2.2.4 Special Parameter Selection Requirements

WAPs must also include procedures and parameters for complying with the specialized waste management regulatory requirements established for particular hazardous waste management units. These regulatory requirements include special waste analyses for the following:

- Facilities managing ignitable, reactive, or incompatible wastes
- Landfills
- Incinerator

¹⁴ 40 CFR §§264/265.1(b)(1)

**FIGURE 2-1
Waste Analysis Parameter Selection Process**

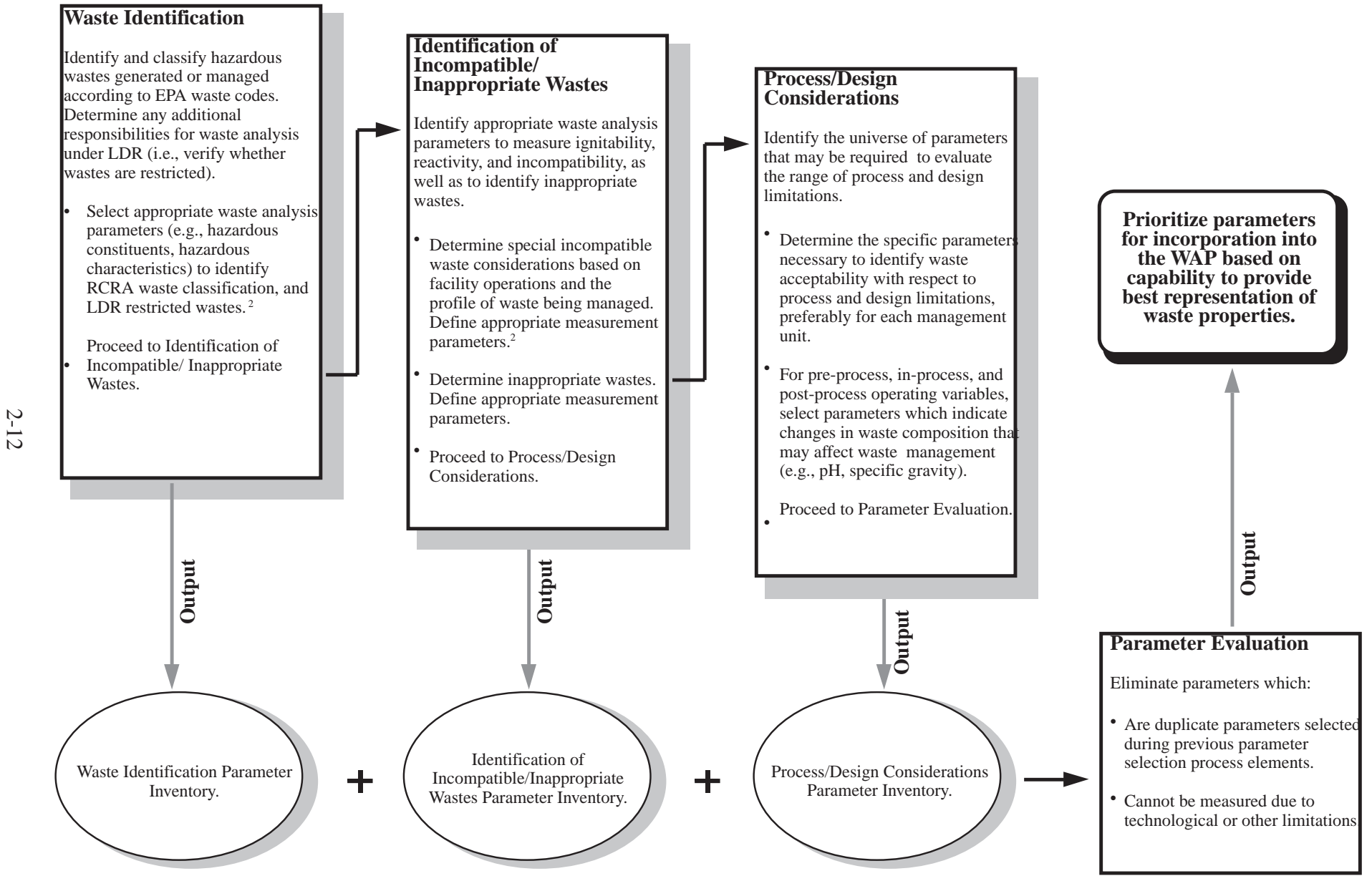

¹ Parameter selection can be enhanced by referencing EPA Background Documents, Appendix VII and VIII of 40 CFR Part 261, and industry/trade association waste profile studies.

² Refer to the EPA document "A Method for Determining the Compatibility of Hazardous Wastes" (EPA/600/2-80-76).

**TABLE 2-5
Examples Of Waste Analysis Parameters**

WASTE MANAGEMENT UNIT TYPE	WASTE PARAMETER(S)	MEDIA TYPE¹	RATIONALE FOR SELECTION
Containers	<ul style="list-style-type: none"> • pH • Flash Point • Total and Amenable Cyanide/Sulfide • Appropriate Hazardous Constituent(s) 	<p>L, SI</p> <p>L</p> <p>L, SI, So</p> <p>L, SI, So</p>	<p>Identify wastes that may compromise container structural integrity.</p> <p>Identify appropriate storage conditions (e.g., out of direct sunlight).</p> <p>Identify potential reactivity and relevant health and safety precautions.</p> <p>Identify constituent(s) for compliance with the permit limits and for safe handling of the waste.</p>
Tanks	<ul style="list-style-type: none"> • pH • Flash Point • Halogens • Total and Amenable Cyanide/Sulfide • Oxidizing Potential • Appropriate Hazardous Constituent(s) 	<p>L, SI</p> <p>L</p> <p>L, SI, So</p> <p>L, SI, So</p> <p>L, SI, So</p> <p>L, SI, So</p>	<p>Identify wastes that may compromise structural integrity of tanks and ancillary equipment.</p> <p>Determine applicable requirements to treat, deactivate or separately manage ignitable wastes to ensure compliance with 40 CFR §§264/265.198.</p> <p>Identify wastes with potential to corrode tanks and ancillary equipment.</p> <p>Identify potential reactivity and relevant health and safety precautions.</p> <p>Identify potential reactivity and requirements to treat, deactivate, or separately manage reactive wastes to ensure compliance with 40 CFR §§264/265.198.</p> <p>Identify constituent(s) for compliance with the permit limits and for safe handling of the waste.</p>
Surface Impoundments	<ul style="list-style-type: none"> • pH • Total Suspended Solids (TSS) • Flashpoint • Oxidizing Potential • Total and Amenable Cyanide/Sulfide • Total Chlorine 	<p>L, SI</p> <p>L, SI</p> <p>L</p> <p>L, SI, So</p> <p>L, SI, So</p> <p>L, SI, So</p>	<p>Identify wastes that may degrade unit structures or systems.</p> <p>Identify wastes that may not be readily amenable to pumping or unit conveyance systems.</p> <p>Determine applicable requirements to treat or deactivate ignitable wastes to ensure compliance with 40 CFR §§264/265.229.</p> <p>Identify potential reactivity and requirements to treat or deactivate reactive wastes to ensure compliance with 40 CFR §§264/265.229.</p> <p>Identify potential reactivity and relevant health and safety precautions.</p> <p>Identify wastes that may degrade liners/geotextile integrity.</p>

¹ Liquid (L), Sludge (SI), Solid (So)

**TABLE 2-5
Examples Of Waste Analysis Parameters (continued)**

WASTE MANAGEMENT UNIT TYPE	WASTE PARAMETER(S)	MEDIA TYPE ¹	RATIONALE FOR SELECTION
Surface Impoundments (continued)	<ul style="list-style-type: none"> • Total Petroleum Hydrocarbons • Liner Compatibility Tests • Appropriate Hazardous Constituent(s) 	<p>L, SI, So</p> <p>L, SI, So</p> <p>L, SI, So</p>	<p>Identify wastes that may degrade polypropylene geotextiles.</p> <p>Identify wastes that may permeate or degrade synthetic liner materials.</p> <p>Identify constituent(s) for compliance with the permit limits and for safe handling of the waste.</p>
Waste Piles	<ul style="list-style-type: none"> • pH • Total Amenable Cyanide/Sulfide • Oxidizing Potential • Ketones • Total Chlorine • Liner Compatibility Tests • Appropriate Hazardous Constituent(s) 	<p>L, SI</p> <p>L, SI, So</p> <p>L, SI, So</p> <p>L, SI, So</p> <p>L, SI, So</p> <p>L, SI, So</p> <p>L, SI, So</p>	<p>Identify wastes that may corrode unit components.</p> <p>Identify potential reactivity and relevant health and safety considerations.</p> <p>Identify potential reactivity and requirements to treat or deactivate reactive wastes to ensure compliance with 40 CFR §§264/265.256.</p> <p>Identify wastes that may degrade polyvinylchloride (PVC) unit components. PVC integrity is degraded at ketone concentrations above 30,000 ppm.</p> <p>Identify wastes that may degrade PVC unit components. PVC is susceptible to selected chlorinated aliphatics (e.g., chloroform, methylene chloride) and chlorinated aromatics (e.g., chlorobenzene) at high concentrations (i.e., above 50,000 ppm).</p> <p>Identify wastes that may permeate or degrade synthetic liner materials.</p> <p>Identify constituent(s) for compliance with the permit limits and for safe handling of the waste.</p>
Land Treatment Units	<ul style="list-style-type: none"> • pH • Total Metals • Total and Amenable Cyanide/Sulfide • Electrical Conductivity • Appropriate Hazardous Constituent(s) 	<p>L, SI</p> <p>L, SI, So</p> <p>L, SI, So</p> <p>L, SI</p> <p>L, SI, So</p>	<p>Identify wastes that may require pretreatment to ensure optimum effectiveness of land treatment process.</p> <p>Quantify metal concentrations to ensure that rates of application do not exceed limits specified in 40 CFR §§264/265.276.</p> <p>Identify potential reactivity and relevant health and safety considerations.</p> <p>Determine treatment performance effects from electrical conductivity.</p> <p>Identify constituent(s) for compliance with the permit limits and for safe handling of the waste.</p>

¹ Liquid (L), Sludge (SI), Solid (So)

**TABLE 2-5
Examples Of Waste Analysis Parameters (continued)**

WASTE MANAGEMENT UNIT TYPE	WASTE PARAMETER(S)	MEDIA TYPE¹	RATIONALE FOR SELECTION
Landfills	<ul style="list-style-type: none"> • Free Liquid Content (Paint Filter Liquids Test) • pH • Total Chlorine • Total Nitrogen • Liner Compatibility Tests • Total and Amenable Cyanide/Sulfide • Chemical Compatibility Evaluations • Appropriate Hazardous Constituent(s) 	<ul style="list-style-type: none"> L, Sl, So L, Sl L, Sl, So L, Sl, So L, Sl, So L, Sl, So L, Sl, So L, Sl, So 	<ul style="list-style-type: none"> Identify the presence/absence of free liquids to ensure compliance with 40 CFR §§264/265.314. Identify wastes that are not allowed to enter a landfill. Identify wastes that may degrade the integrity of chlorosulfonated polyethylene landfill liners. Identify wastes that may compromise chlorosulfonated polyethylene liners. Identify wastes that may permeate or degrade synthetic liner materials. Identify potential reactivity and relevant health and safety precautions. Identify potential incompatibilities. Identify constituent(s) for compliance with the permit limits and for safe handling of the waste.
Incinerators	<ul style="list-style-type: none"> • Heat Content • Percent Moisture • Ash Content • Chlorine Content • pH • Total Metals • Part 261, Appendix VIII Constituents • Viscosity 	<ul style="list-style-type: none"> L, Sl, So L, Sl, So L, Sl, So L, Sl, So L, Sl L, Sl, So L, Sl, So L, Sl 	<ul style="list-style-type: none"> Identify wastes that may inhibit incinerator combustion or require blending with high-Btu wastes. Identify wastes with excessive moisture content. Identify wastes with high particulate content that may compromise air emission compliance and incinerator performance. Determine conformance with operational acceptance limits for chlorine content to ensure compliance with HCl controls under 40 CFR §§264/265.343. Identify wastes that may corrode incinerator system components. Identify wastes that may affect incinerator performance or exceed permit feedstream and air emission limits. Identify prohibited constituents not represented by Principal Organic Hazardous Constituents (POHCs) selected for trial burn. Identify wastes that may require blending for effective pumping and nebulization (flow injection incinerators only).

¹ Liquid (L), Sludge (Sl), Solid (So)

**TABLE 2-5
Examples Of Waste Analysis Parameters (continued)**

WASTE MANAGEMENT UNIT TYPE	WASTE PARAMETER(S)	MEDIA TYPE¹	RATIONALE FOR SELECTION
Incinerators (continued)	<ul style="list-style-type: none"> Appropriate Hazardous Constituent(s) 	L, SI, So	Identify constituent(s) for compliance with the permit limits and for safe handling of the waste.
Boilers and Industrial Furnaces (BIFs)	<ul style="list-style-type: none"> pH Viscosity Btu Value² Ash Content Total Metals (Ag, As, Ba, Be, Cd, Cr, Pb, Hg, Sb, Tl) Chlorine Content Appropriate Hazardous Constituent(s) 	<p>L, SI</p> <p>L, SI</p> <p>L, SI, So</p> <p>L, SI, So</p> <p>L, SI, So</p> <p>L, SI, So</p> <p>L, SI, So</p>	<p>Identify wastes that may corrode system components.</p> <p>Identify wastes that may not be amenable to normal conveyance systems.</p> <p>Identify wastes that are prevented from management in BIFs (i.e., <5,000 Btu/lb.).</p> <p>Identify wastes with high particulate content that may compromise compliance with 40 CFR §266.105 and BIF performance.</p> <p>Identify wastes that may affect BIF performance or exceed feedstream and air emission limits in 40 CFR §266.106.</p> <p>Determine conformance with operational acceptance limits for chlorine content to ensure compliance with 40 CFR §266.107.</p> <p>Identify constituent(s) for compliance with the permit limits and for safe handling of the waste.</p>

¹ Liquid (L), Sludge (SI), Solid (So)

² Units that certify compliance with 56 FR 7183 regulations are exempted from the <5,000 btu/lb. limitation.

- TSDF process vents and equipment
- Boilers and industrial furnaces.¹⁵

Sampling, analytical, and procedural methods that will be used to meet additional waste analysis requirements for specific waste management units must be included, where applicable, in your WAP.¹⁶ For reference purposes, these special requirements are discussed below.

Ignitable, Reactive, And Incompatible Waste Analysis Requirements

WAPs must include provisions to ensure that waste management units meet the special requirements for ignitable, reactive, and incompatible wastes.¹⁷ Incompatible wastes, if brought together, could result in heat generation, toxic gas generation, and/or explosions. A WAP must, therefore, address measures to identify potentially ignitable, reactive, and incompatible wastes. Standard tests to identify **ignitable wastes** are contained in section 7.1 of SW-846. Although EPA does not currently have an approved set of test procedures for **reactivity**, specialized methods contained in sections 7.3.3.2 and 7.3.4.2 of SW-846, respectively, have been developed to determine if a cyanide- or sulfide-bearing waste exhibits the reactivity characteristic. Additionally, reference should be made to "Design and Development of a Hazardous Waste Reactivity Testing Protocol" February, 1984 (EPA-600/2-84-057) for suggested fingerprint analysis procedures. Finally, waste **compatibility** determinations can serve to establish compatibility between wastes of interest for a given process. An EPA document, "A Method of Determining the Compatibility of Hazardous Wastes" 1980 (EPA-600/2-80-076)¹⁸, contains procedures to evaluate qualitatively the compatibility of various categories of wastes.

Special Requirements For Bulk And Containerized Liquids In Landfills

Owners/operators of hazardous waste landfills must ensure that free liquids are not placed into the landfill and that restrictions on containerized liquids are met.¹⁹ Specifically, bulk and/or non-containerized liquids or wastes containing free liquids may not be placed into a landfill. In addition, containers holding free liquids should not be placed in a landfill unless all free-standing liquids: (1) have been removed by decanting, or other methods; (2) have been mixed with a nonbiodegradable absorbent or have been solidified so that free-standing liquid is no longer observed; or (3) have been otherwise eliminated. Limited exceptions to the placement of containers holding free liquids in landfills include: very small containers, containers designed to hold free liquids for reasons other than storage (e.g., batteries, capacitors), and lab packs. You should also describe the procedures that will be used to determine whether a biodegradable sorbent has been added to the waste in the container.

Waste Analysis Parameter Considerations For Incineration Facilities

Permitted incineration facilities must include routine analyses for prescribed waste parameters that are required as a result of the trial burn.²⁰ Trial burns (or comparable information) are required before an incinerator is permitted to operate. A "trial burn plan," required for these tests, includes analyzing each hazardous waste to be incinerated for certain hazardous constituents listed in 40 CFR

¹⁵ 40 CFR §§264/265.17, §264.314, §§264/65.341, §§264/265.1034(d), §§264/265.1063(d), §266.102(a), §266.103(a).

¹⁶ 40 CFR §§264/265.13(b)(5)

¹⁷ 40 CFR §§264/265.17

¹⁸ This document can be obtained through the National technical Informatino Service (Document No. PB-80221005).

¹⁹ 40 CFR §§264/265.314

²⁰ 40 CFR §§264.341

Part 261, Appendix VIII. In almost all cases, the low concentration of hazardous waste constituents in many wastes presents problems in the calculation of the destruction and removal efficiency (DRE). These problems stem from the inability to attain sufficiently low detection limits in the analysis of the stack emissions in order to calculate an acceptable DRE (i.e., 99.99 percent or higher). Therefore, in order to calculate an acceptable DRE during a trial burn, one or more representative principal organic hazardous constituents (POHCs) are chosen during the negotiation for the trial burn conditions. These POHCs are added to the waste (spiked) at high concentrations. The increased concentration of the POHCs in the waste allows the use of achievable detection limits for the stack gases for the calculation of the DRE. The calculation of an acceptable DRE is based on a comparison of the analytical results for the selected POHCs in the stack gases and in the waste. From this trial burn and the associated analytical information it provides, specific waste analysis parameters will be included in the facility permit. These parameters will encompass physical and chemical measures necessary to ensure that the composition of the incinerator waste feed meets applicable permit and operating limits. Examples of these parameters are provided in Table 2-5.

TSDF Process Vent Analysis Requirements

TSDF owners/operators are required to identify and meet specific technical requirements for all process vents associated with distillation, fractionation, thin-film evaporation, solvent extraction, and stripping processes that manage wastes with a 10 ppmw (ppm by weight) or greater total organics concentration on a time weighted annual average basis.²¹ The applicability of these process vent requirements is established by measuring total organic concentrations in the waste using SW-846 Methods 9060 or 8240. The determination that relevant processes are managing organic waste below the regulated threshold must be made as follows: (1) by the effective date that the facility becomes subject to the requirements; and, (2) for continuously generated wastes, annually, or whenever there is a change in the process or waste being managed.

Equipment Leak Waste Analysis Requirements

TSDF owners/operators must also determine if equipment contains or contacts organic wastes with 10 percent or greater total organic content. This trigger threshold may be determined by using the following: (1) methods described in American Society of Testing and Materials Methods D 2267-88, E 169-87, E 260-85; (2) Method 9060 or 8240 of SW-846; or, (3) applying knowledge of the nature of the hazardous wastestream or the process by which it was produced. If the organic concentrations meet these regulated levels, emission control and monitoring standards apply to each valve, pump, compressor, pressure relief device, open-ended valve or line, flange or other connector and associated air emission control device or system.

Waste Analysis Requirements For Boilers And Industrial Furnaces

On February 21, 1991, EPA published the final rule entitled "Burning of Hazardous Waste in Boilers and Industrial Furnaces." These regulations establish control standards for emissions of toxic organic compounds, toxic metals, hydrogen chloride, chlorine gas, and particulate matter from the burning of hazardous wastes in boilers and industrial furnaces (BIFs). These rules also subject owners and operators of these devices to the general facility standards applicable to hazardous waste TSDFs, including waste analysis and WAP preparation.

To gain a RCRA permit to burn hazardous waste in BIFs, owners and operators must conduct a trial burn to establish specific permit and operating conditions. In association with the trial burn, a waste composition analysis must be conducted which describes the concentration of the hazardous constitu-

²¹ 40 CFR §§264/265.1034(d)

ents listed in 40 CFR Part 261, Appendix VIII, for each hazardous waste to be burned in these devices. In almost all cases, the low concentration of hazardous waste constituents in many wastes presents problems in the calculation of the DRE. These problems stem from the inability to attain sufficiently low detection limits in the analysis of the stack emissions in order to calculate an acceptable DRE (i.e., 99.99 percent or higher). Therefore, in order to calculate an acceptable DRE during a trial burn, one or more representative principal organic hazardous constituents (POHCs) are chosen during the negotiation for the trial burn conditions. These POHCs are added to the waste (spiked) at high concentrations. The increased concentration of the POHCs in the waste allows the use of achievable detection limits for the stack gases for the calculation of the DRE. The calculation of an acceptable DRE is based on a comparison of the analytical results for the selected POHCs in the stack gases and in the waste. From this trial burn and the associated analytical information it provides, specified waste analysis parameters will be included in the facility permit. Throughout normal operation, the owner or operator must conduct sampling and analysis, as specified in the facility WAP, to ensure that hazardous waste fired into the BIF is within the physical and chemical composition limits specified in the operating permit.

2.3 Selecting Sampling Procedures

Sampling is the physical collection of a representative portion of a universe or whole of a waste or waste treatment residual. To be representative, a sample must be collected and handled by means that will preserve its original physical form and composition, as well as prevent contamination or changes in concentration of the parameters to be analyzed. For a sample to provide meaningful data, it is imperative that it reflect the average properties of the universe from which it was obtained, that its physical and chemical integrity be maintained, and that it be analyzed within a dedicated quality assurance program.

Due to the diversity of hazardous wastes and the number of possible waste management scenarios (e.g., drums, roll-off boxes, tankers, lugger boxes), the type(s) of sampling procedures you will need to employ will be variable. The following subsections discuss the proper procedures and considerations for sample collection, sample preservation, sample shipping, quality assurance and quality control, and occupational health and safety.

You can choose to use sampling methods specified in the regulations in 40 CFR Part 261, Appendix I, or you may choose to petition EPA for equivalent testing and analytical methods.²² To be successful with this petition, you must demonstrate to the satisfaction of EPA that the proposed method is equal, or superior, to the specified method.

Only EPA-prescribed methods, referenced in Appendix I to 40 CFR 261, are discussed in this guidance manual. These prescribed methods have two sources: the American Society for Testing and Materials (ASTM) methods, or EPA's SW-846. In particular, SW-846 has been developed by EPA to assist the regulated community in meeting analytical responsibilities under the RCRA program.

2.3.1 Sampling Strategies

The development and application of a sampling strategy is a prerequisite to obtaining a representative sample capable of producing scientifically viable data. These strategies should be selected or prepared prior to actual sampling to organize and coordinate sampling activities, to maximize data accuracy, and

²² The procedures for making this petition can be found in 40 CFR §260.21.

to minimize errors attributable to incorrectly selected sampling procedures. At a minimum, a sampling strategy should address the following:

- Objectives of collecting the samples
- Types of samples needed (e.g., grab or composite)
- Selection of sampling locations
- Number of samples
- Sampling frequency
- Sample collection and handling techniques to be used.

In addition, the following factors should also be taken into consideration since they can influence the sampling development process:

- Physical properties of the wastes to be sampled
- Chemical properties of the wastes to be sampled
- Special circumstances or considerations (e.g., complex multi-phasic wastestreams, highly corrosive liquids).²³

Based upon the data objectives and considerations addressed in the sampling strategy, two major sampling approaches may be employed to collect representative samples. These approaches are summarized as follows:

- **Authoritative Sampling** - where sufficient historical, site, and process information is available to accurately assess the chemical and physical properties of a waste, authoritative sampling (also known as judgement sampling) can be used to obtain representative samples. This type of sampling involves the selection of sample locations based on knowledge of waste distribution and waste properties (e.g., homogeneous process streams) as well as management units considerations. Accordingly, the validity of the sampling is dependent upon the accuracy of the information used. The rationale for the selection of sampling locations is critical and should be well documented.
- **Random Sampling** - due to the difficulty of determining the exact chemical and physical properties of hazardous wastestreams that are necessary for using authoritative sampling, the most commonly used sampling strategies are random (not to be confused with haphazard) sampling techniques. Generally, three specific techniques -- **simple, stratified, and systematic random** -- are employed. By applying these procedures, which are based upon mathematical and statistical theories, representative samples can be obtained from nearly every waste sampling scenario.²⁴

Table 2-6 provides an overview of both authoritative and random sampling definitions, applicability, and limitations. Figure 2-2 illustrates the typical sampling distribution associated with each of the individual types of random sampling.

²³ For complex wastes (oily sludges, multi-phasic wastes), a representative sample may require that the wastes be homogenized prior to sampling or other techniques applied. More detailed information pertaining to the sampling of these waste types can be obtained from the references in 40 CFR Part 261, Appendix I, your laboratory representative, or EPA permitting officials.

²⁴ For more information on statistical methods and examples of random sampling techniques, refer to EPA's SW-846, Chapter Nine.

**TABLE 2-6
Sampling Approach Overview**

SAMPLING STRATEGY	DEFINITION	APPLICABILITY	ADVANTAGES/DISADVANTAGES
Authoritative	Technique where sample locations are selected based on detailed knowledge of the wastestream without regard to randomization.	Wastestreams of known physical/chemical properties and concentrations.	Requires in-depth knowledge of properties and constituents of wastestreams. Rationale for sample selection must be well documented and defensible.
Random (simple, stratified, systematic)	Techniques where sample selection and location are determined through the application of statistical methods.	Used to collect representative samples where data is insufficient to justify authoritative sampling (e.g., wastestreams of unknown or variable concentration).	See discussions below for each respective random sampling technique.
• Simple Random	All locations/points in a waste or unit from which a sample can be attained are identified, and a suitable number of samples are randomly selected.	Used to collect representative samples of wastes that are heterogeneous throughout the entire wastestream or unit (e.g., multiple drums of unknown origin).	<p><u>Advantages:</u> Most appropriate where little or no information is available concerning the distribution of chemical contaminants.</p> <p><u>Disadvantages:</u> May misrepresent wastestreams with areas of high concentration or stratification.</p>
• Stratified Random	Areas of nonuniform properties or concentrations are identified and stratified (segregated). Subsequently, simple random samples are collected from each stratum of the waste or unit.	Used to collect representative samples from waste or units that are known to have areas of nonuniform properties (strata) or concentration (hot spots) (e.g., surface impoundment with multiple waste layers).	<p><u>Advantages:</u> Provides for increased accuracy of wastestream representation if strata or a typically high or low concentration area is present.</p> <p><u>Disadvantages:</u> Requires greater knowledge of wastestream than for simple random sampling and may require sophisticated statistical applications.</p>
• Systematic Random	The first sampling point is randomly selected but all subsequent samples are collected at fixed space intervals (e.g., along a transect or time intervals).	An alternate procedure used to collect representative samples from modestly heterogeneous wastestreams that provides for simplified sample identification.	<p><u>Advantages:</u> Provides for easier sample identification and collection than other techniques.</p> <p><u>Disadvantages:</u> May misrepresent wastestreams with unknown areas of high concentration or stratification.</p>

FIGURE 2-2
Illustration Of Random, Stratified Random, And Systematic
Sampling (e.g., Roll-off Boxes)
(axes are distance in feet)

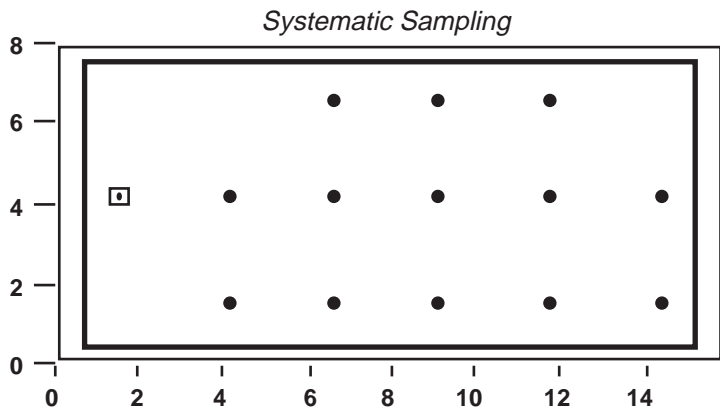
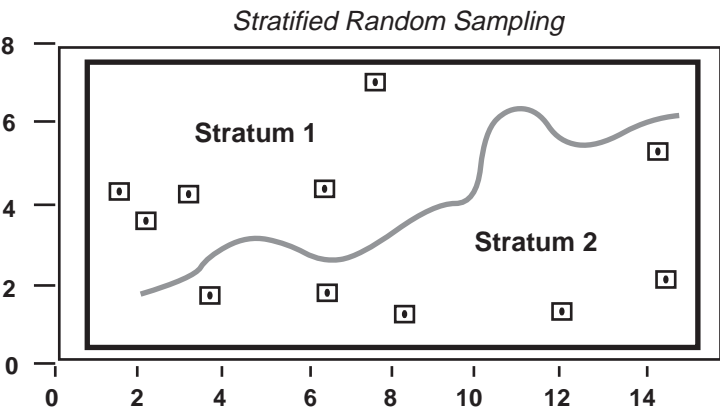
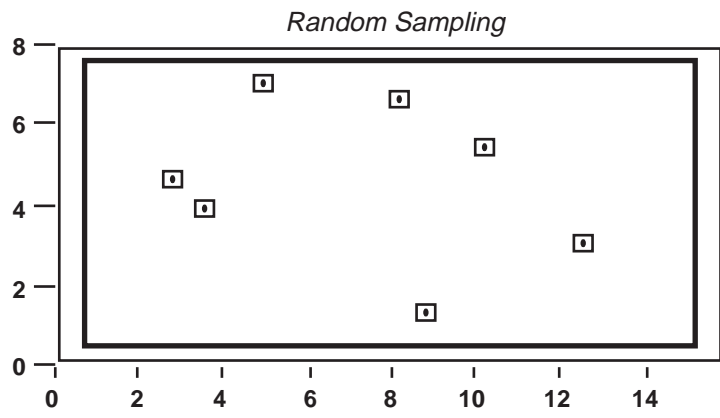

LEGEND:

- Sample Area Boundary
- Strata Boundary
- Randomly Selected Sample Location
- Sample Location Determined Systematically

An additional element in the design of an effective sampling strategy is the selection of appropriate sample types. Based on the desired analytical objectives of the sampling (e.g., initial waste identification versus recharacterization), analytical considerations, and available resources (for sampling and analysis), two basic types of samples, grab and composite, are taken in random sampling, as described in Table 2-7.

**TABLE 2-7
Major Sample Types**

SAMPLING STRATEGY	DEFINITION	APPLICABILITY	ADVANTAGES/ DISADVANTAGES
GRAB	A sample taken from a particular location at a distinct point in time	Most common type used for random sampling. Useful in determining wastestreams variability (e.g., range of concentration) when multiple or frequent samples are obtained.	<u>Advantages:</u> Simplest technique, best measure of variability. <u>Disadvantages:</u> May require larger number of samples than compositing to obtain representative sample.
COMPOSITE	A number of individually collected samples that are combined into a single sample for subsequent analysis.	Used where average or normalized concentration estimates of a wastestreams constituents are desired.	<u>Advantages:</u> Reduces analytical costs. May reduce the number of samples needed to gain accurate representation of a waste. <u>Disadvantages:</u> Only provides the average concentrations of a wastestream (i.e., information about concentration range is lost).

A detailed description for implementing these sampling strategies and the optimum application for each strategy are discussed in SW-846, Chapter Nine, entitled "Sampling Plan."

2.3.2 Selecting Sampling Equipment

Three broad criteria relating to the waste should be considered when determining the most appropriate type of sampling equipment to use for a given sampling strategy:

- Physical parameters
- Chemical parameters
- Waste-specific (e.g., oily sludges) or site-specific factors (e.g., accessibility issues).

Specific **physical parameters** affecting this selection include whether the wastes are:

- Free flowing or highly viscous liquids
- Crushed, powdered, or whole solids
- Contained in soil or groundwater
- Homogeneous or heterogeneous, stratified, subject to separation with transport, or subject to other physical alterations due to environmental factors.

Chemical parameters of the waste can also significantly affect the waste collection effort. The person collecting the sample should ensure that the sampling equipment is constructed of materials that are not only compatible with wastes, but are not susceptible to reactions that might alter or bias the physical or chemical characteristics of the waste. Examples in which the sampling equipment material may potentially yield false analytical results would be the release of organic compounds from certain plastics, or of heavy metals (e.g., cadmium, nickel, lead) from metal alloys used in sampling corrosive wastestreams.

Waste- and site-specific factors may also affect the use of sampling devices. Examples in which unique waste-specific properties may affect the use of common sampling equipment include the collection of oily sludges or highly corrosive wastes. Examples of special site-specific situations involving complex sampling activities include the collection of representative samples from waste management units with limited accessibility. In addition to determining the type of sampling equipment used, the waste- and site-specific factors also may require modification of the chosen equipment so that it can be applied to the waste.

Once the physical, chemical, waste- and site-specific factors associated with the wastestream to be sampled have been identified and evaluated, appropriate sampling equipment can be selected. The equipment most typically used in sampling includes:

- Composite liquid waste samplers (coliwesas), weighted bottles, and dippers for liquid wastestreams
- Triers, thieves, and augers for sampling sludges and solid wastestreams
- Bailers, suction pumps, and positive displacement pumps for sampling wells for groundwater evaluations.

A **coliwasa** (See Figure 2-3) is most appropriate when sampling free-flowing liquids and slurries in drums, shallow tanks, pits, and similar waste containers. The stream Coliwasa consists of a glass or metal tube equipped with an end closure that can be opened and closed while the tube is submerged in material to be sampled. If samples are to be taken from areas with limited accessibility, a **weighted bottle or dipper** (see Figures 2-4 and 2-5, respectively) may be used to obtain a sample of a free flowing liquid or slurry.

A **thief** (see Figure 2-6), which consists of two slotted concentric tubes, is recommended for sampling dry granules or powdered wastes whose particle diameter is less than one-third the width of the slots in the thief. The outer tube has a conical pointed tip that allows the thief to penetrate the waste which is being sampled. The inner tube can be rotated to open and close the sampler so that a sample can be collected from the waste stream. A sampling **trier** (see Figure 2-7) is a tube cut in half lengthwise with a sharpened tip that allows penetration of the tube into adhesive solids and allows granulated materials to be loosened. Generally, the trier is 61 to 100 cm long with a diameter between 1.27 and 2.54 cm. It is used to sample solid wastes whose diameter is less than one-half that of the trier. **Augers** (see Figure 2-8), which consist of sharpened spiral blades attached to a hard metal central shaft, are used to sample hard or packed solid wastes. Augers can be one foot to several feet long.

A more detailed description of each type of sampling equipment is presented in SW-846 Chapter Nine, entitled "Sampling Plan." For guidance purposes, Table 2-8 presents examples of common types of sampling equipment and their applicability for sampling various types of waste streams. Waste-specific conditions at your facility may indicate that the recommended equipment in Table 2-8 is inappropriate. Accordingly, it is best to develop a sampling strategy with equipment that is tailored to your site. Consult with a

FIGURE 2-3
Composite Liquid Waste Sampler (Coliwasa)

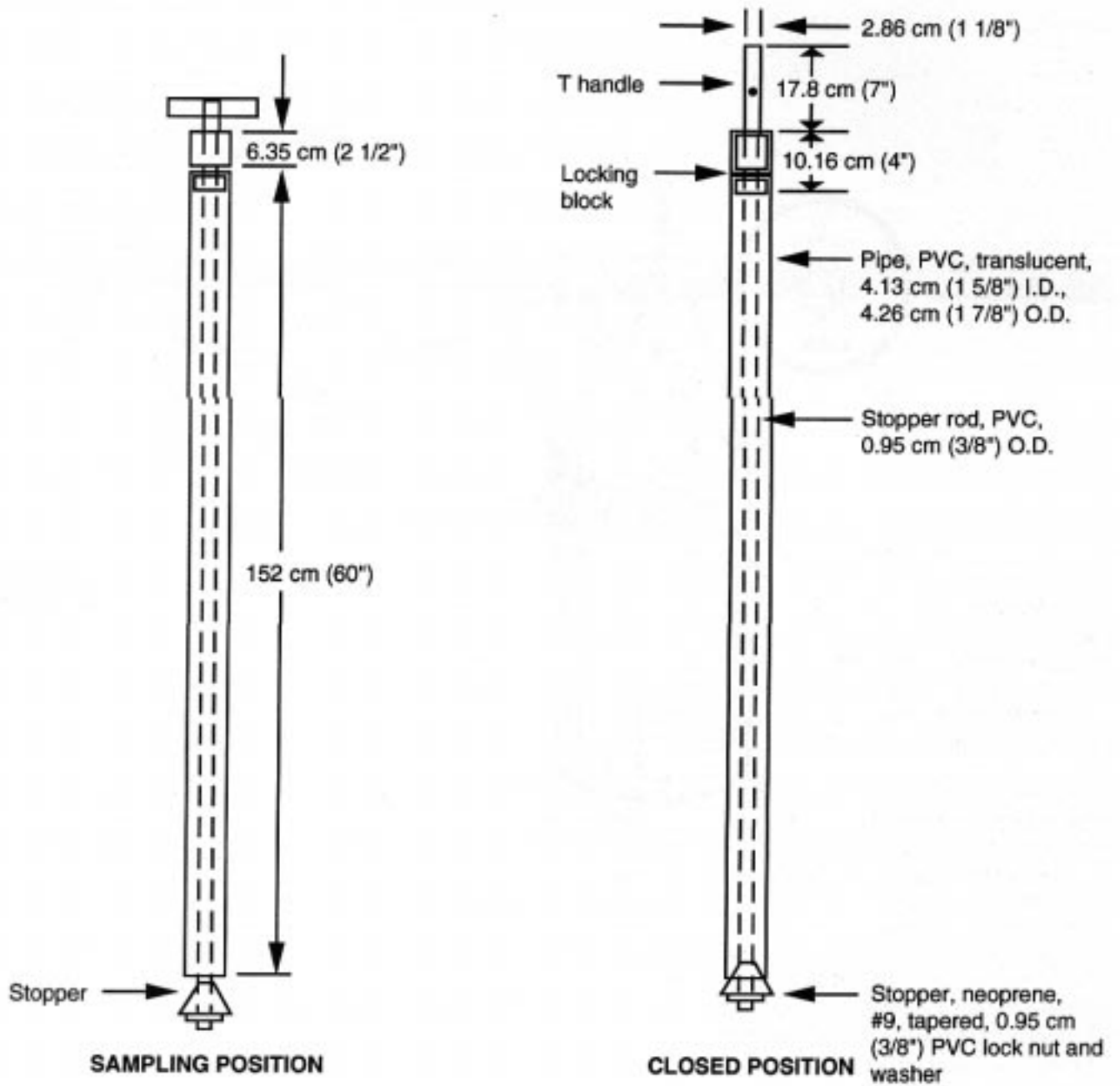

FIGURE 2-4
Weighted Bottle

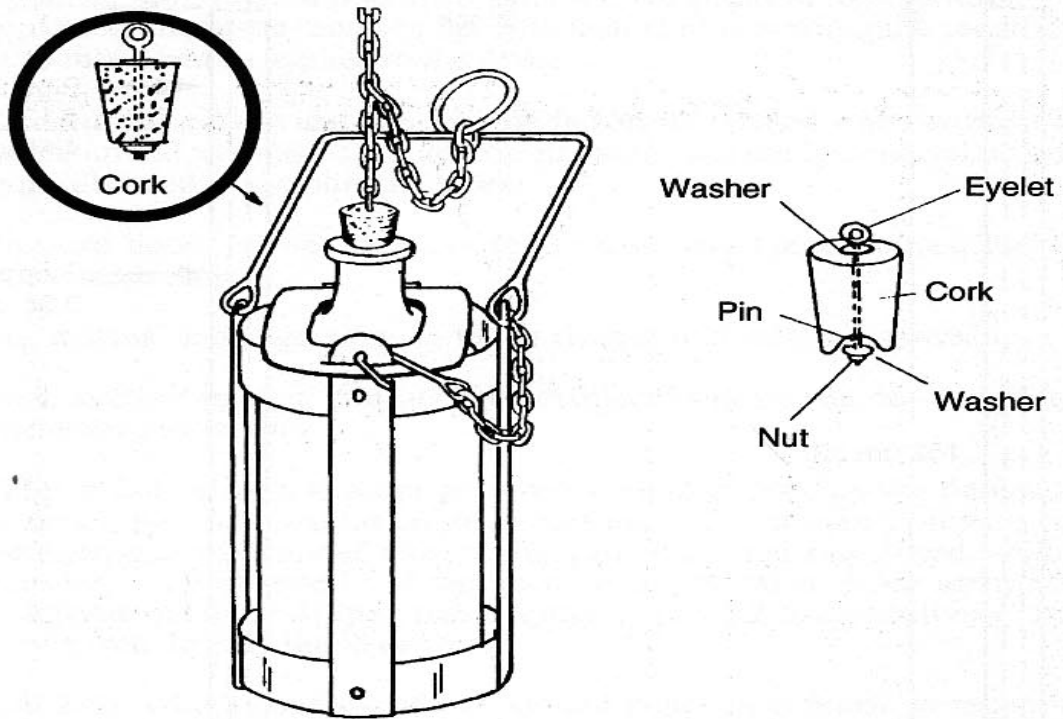

FIGURE 2-5
Dipper

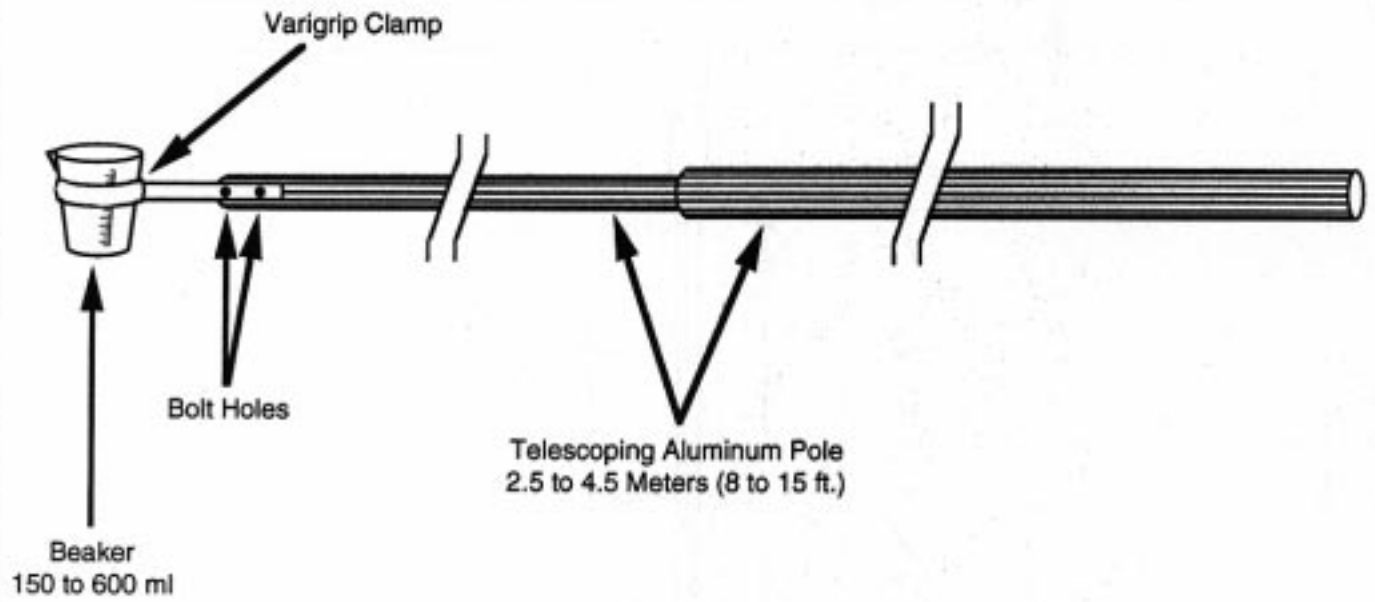

FIGURE 2-6
Thief Sampler

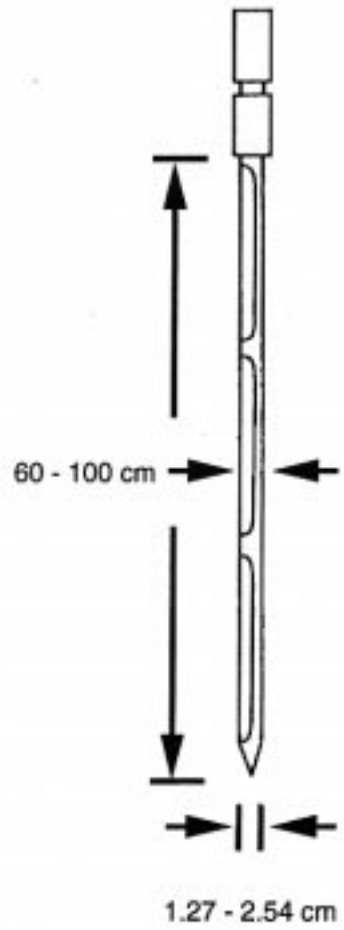

FIGURE 2-7
Sampling Triers

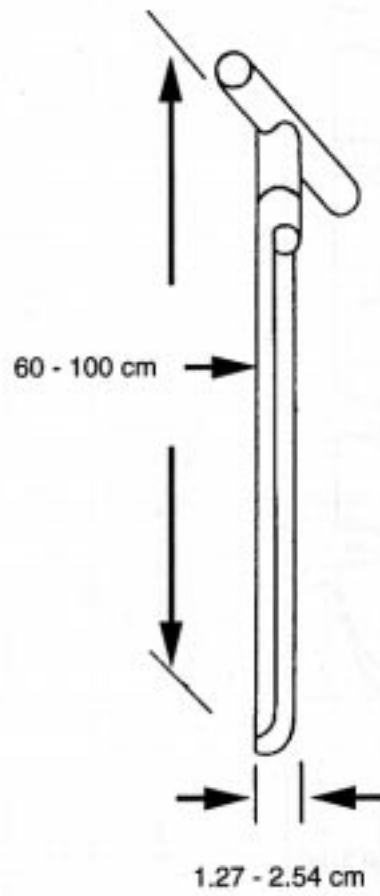
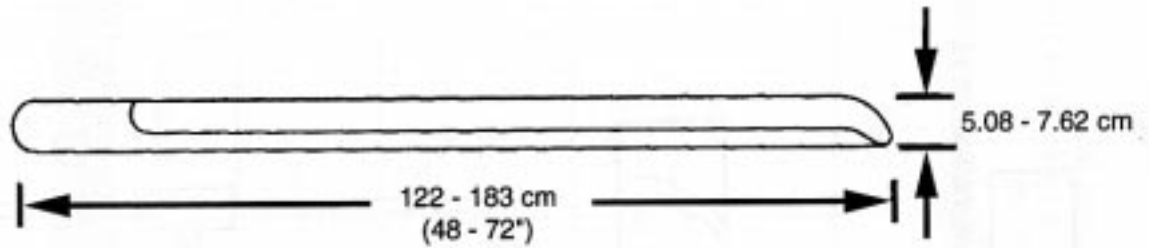

FIGURE 2-8
Hand Augers



(a)
Closed-Spiral Auger



(b)
Open-Spiral Auger

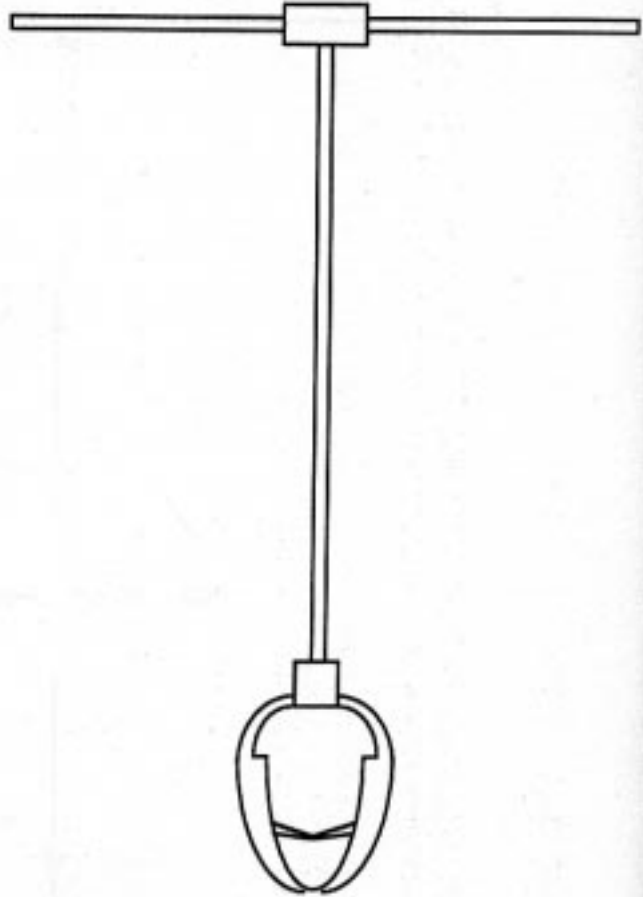

(c)
Iwan Auger

**TABLE 2-8
Applicability Of Sampling Equipment To Wastestreams**

WASTE TYPE	Waste Location or Container								
	DRUM	SACKS AND BAGS	OPEN-BED TRUCK	CLOSED-BED TRUCK	STORAGE TANKS OR BINS	WASTE PILES	PONDS, LAGOONS, & PITS	CONVEYOR BELT	PIPE
Free-flowing liquids and slurries	Coliwasa	N/A	N/A	Coliwasa	Weighted bottle ^a	N/A	Dipper	N/A	Dipper
Sludges	Trier	N/A	Trier	Trier	Trier	b	b	b	b
Moist powders or granules	Trier	Trier	Trier	Trier	Trier	Trier	Trier	Shovel	Dipper
Dry powders or granules	Thief	Thief	Thief	Thief	b	Trier	Thief	Shovel	Dipper
Sand or packed powders and granules	Auger	Auger	Auger	Auger	Thief	Thief	b	Dipper	Dipper
Large-grained solids	Large Trier	Large Trier	Large Trier	Large Trier	Large Trier	Large Trier	Large Trier	Trier	Dipper

^a When the tank is adequately agitated or a recirculation line is accessible, samples can be collected through a side tap.

^b This type of sampling situation can present significant logistical sampling problems, and sampling equipment must be specifically selected or designed based on site and waste conditions. No general statement about appropriate sampling equipment can be made.

knowledgeable EPA representative, industry group, or a specialist if you are uncertain how to select the appropriate equipment.

2.3.3 Maintaining and Decontaminating Field Equipment

Some analyses, such as pH, can be performed at the facility using field equipment. This equipment must be properly maintained, and where appropriate, calibrated to ensure data quality from the analyses. Maintenance of equipment can include routine cleaning, oil changes, or routine replacement of worn equipment components. The guidelines set forth in the operator's manual of each piece of equipment should be followed since proper maintenance varies by model manufacturer. At a minimum, the equipment should be inspected, lubricated, and calibrated prior to any field work to ensure proper operation.

All equipment that comes in contact with the waste should be free from materials which can influence (i.e., contaminate) the true physical or chemical composition of the waste. Therefore, all equipment and containers should be cleaned thoroughly and decontaminated prior to use. Additionally, sampling equipment should be properly decontaminated after each sampling event. These procedures generally consist of an initial step to remove all loose debris and soil from the sampling equipment, followed by a thorough cleaning process including washing with an inert detergent solution (such as alconox). As a final step, the equipment is rinsed with an appropriate solvent (e.g., volatile alcohols, acetone, or hexane for organics; nitric acid for inorganics) followed by several rinses with deionized water.

The level of decontamination that is necessary during and after sampling is dependent upon the degree of contamination and the sensitivity of the analytical tests to be performed. Where materials and equipment are to be reused, proper decontamination procedures should be followed to diminish the potential for cross-contamination of samples. If subsequent storage of the equipment does not preserve the cleanliness of the decontaminated equipment, the equipment may require additional decontamination prior to the next sampling event.

Sample containers may be supplied by a laboratory equipment manufacturer or by your analytical laboratory. For manufacturer-supplied containers, a certificate of analysis or other documentation should be obtained which describes the contaminant levels inherent to the sample containers. In either case, appropriate quality control measures, as described in subsequent sections, should be taken. Furthermore, as a general rule, used containers that have not been decontaminated should be avoided to reduce the potential of cross-contamination.

2.3.4 Sample Preservation And Storage

Once the sample has been collected, sample preservation techniques, if applicable, must be employed to ensure that the integrity of the waste remains intact while the samples are in transport to the laboratory and/or while temporarily stored at the laboratory prior to analysis. Sample preservation is generally not applicable for highly concentrated samples. However, low concentration samples require preservation. If a sample is not preserved properly, the constituents of concern in the sample may be chemically, physically, or biologically altered through degradation or other processes (e.g., volatilization, oxidation). Examples of typical sample preservation techniques include the following:

- Preserving the sample with appropriate chemicals, for example:
 - Adding sodium thiosulfate to inhibit organochlorine reactions
 - Adding acid preservatives to liquids containing metals
 - Adding acid preservatives to liquids to suppress biological activity.
- Refrigerating samples, for example:
 - Refrigerating nonliquid samples (i.e., soils, sediments, sludges)
 - Refrigerating liquid samples for nonvolatile organic analysis.
- Storing and shipping samples in the appropriate container with an appropriate lid type, for example:
 - Storing samples containing light sensitive organic contaminants in amber glass bottles with teflon-lined lids
 - Storing samples of an aqueous or solid matrix intended for organic analysis in glass bottles with teflon-lined lids (polyethylene containers are not typically appropriate for samples intended for organic analyses because the polyethylene plastics can contribute organic contaminants which may result in biased results)
 - Shipping and storing samples intended only for the analysis of metals and other inorganics in glass or polyethylene bottles with polyethylene-lined lids.

Appropriate preservation methods allow samples to be stored without concern for physical or chemical degradation for the period of time between sample collection and analysis. However, the effectiveness of preservation diminishes over time, thereby potentially affecting the sample's integrity. Accordingly, EPA has established standardized holding times, based upon the chemical constituent of interest, that must be met to assure the viability of resulting analytical data. Table 2-9 gives examples of proper sample containers, preservation methods, and holding times for the analytical parameters most commonly associated with hazardous waste evaluation. For a more detailed list of proper sample containers and preservation techniques, one should refer to SW-846.

2.3.5 Establishing Quality Assurance/Quality Control Procedures

Quality assurance (QA) is the process for ensuring that all data and the decisions based on that data are technically sound, statistically valid, and properly documented. Quality control (QC) procedures are the tools employed to measure the degree to which these quality assurance objectives are fulfilled. As the first component of data acquisition in relation to waste analysis, sampling techniques should incorporate rigorous QA/QC procedures to ensure the validity of sampling activities. Since a facility's compliance with applicable permitting and regulatory requirements may be based on a relatively few number of analytical measurements, any event (e.g., unidentified contamination, dilution, improper handling) that may compromise the acquisition of a representative sample is significant. Thus, it is important for QA/QC procedures to be established in the WAP and stringently followed. Each facility should implement its own QA/QC procedures because each facility will have its own unique QA/QC requirements. Additionally, all persons involved in sampling activities should be fully aware of applicable QA/QC procedures. More detail on what is required for QA/QC is provided in SW-846.

TABLE 2-9
Examples of Sample Collection And Analytical Techniques:
Containerization, Preservation, And Holding Times^a

Matrix/Parameters To Be Analyzed	Sample Container Type and Materials	Preservation Method	Maximum Holding Time
SOLIDS:			
Volatile organics (total)	Widemouth glass w/teflon liner	Cool to 4° C	14 days
Semivolatile organics (total)	Widemouth glass w/teflon liner	Cool to 4° C	14 days for extraction 40 days for analysis
Pesticides, herbicides, and insecticides (total EPA scan)	Widemouth glass w/teflon liner	Cool to 4° C	14 days for extraction 40 days for analysis
Polychlorinated biphenyls (PCBs)	Widemouth glass w/teflon liner	Cool to 4° C	14 days for extraction 40 days for analysis
Dioxins and furans	Widemouth glass w/teflon liner	Cool to 4° C	14 days for extraction 40 days for analysis
Mercury (total)	Widemouth glass w/teflon liner	Cool to 4° C	28 days for extraction 28 days for analysis
Chromium (VI)	Widemouth glass w/teflon liner	Cool to 4° C	24 hours
All other metals (total)	Widemouth glass w/teflon liner	None	6 months for extraction 6 months for analysis
pH	Widemouth glass w/teflon liner	None	Analyze immediately
Total organic halogens (TOX)	Widemouth glass w/teflon liner	Cool to 4° C	7 days
Total organic carbon (TOC)	Widemouth glass w/teflon liner	Cool to 4° C	28 days
Toxic volatile organics, per TC rule	Widemouth glass w/teflon liner	Cool to 4° C	14 days for TCLP 14 days for analysis
Toxic semivolatile organics, per the TC rule	Widemouth glass w/teflon liner	Cool to 4° C	14 days for TCLP 7 days for extraction 40 days for analysis
TC pesticides and herbicides	Widemouth glass w/teflon liner	Cool to 4° C	14 days for TCLP 7 days for extraction 40 days for analysis
Concentrated Waste Samples w/teflon liner	Widemouth glass	None	14 days
Metals (TCLP) w/teflon liner 6 months for analysis	Widemouth Glass	Cool to 4° C	6 months for TCLP
Mercury (TCLP) w/teflon liner 28 days for analysis	Widemouth Glass	Cool to 4° C	28 days for TCLP

^a Highly concentrated samples generally do not require preservation. When chemical preservation is required, care must be taken to ensure that incompatible preservations are not added. For example, an aqueous sample that is to be analyzed for metals should not have acid added to it if the sample also contains cyanides.

TABLE 2-9
Examples of Sample Collection And Analytical Techniques:
Containerization, Preservation, And Holding Times^a

Matrix/Parameters To Be Analyzed	Sample Container Type and Materials	Preservation Method	Maximum Holding Time
LIQUIDS:			
Metals (TCLP)	Widemouth glass	Cool to 4° C	6 months for TCLP 6 months for analysis
Mercury (TCLP)	Widemouth glass	Cool to 4° C	28 days for TCLP 28 days for analysis
Volatile organics	40 mL VOA Vial	Cool to 4° C; pH<2 HCl; Na ₂ S ₂ O ₃	14 days
Semivolatile organics	1 Liter Amber glass	Cool to 4° C Na ₂ S ₂ O ₃	7 days for extraction 40 days for analysis
Pesticides, herbicides, and insecticides	1 Liter Amber glass	Cool to 4° C pH: 5-9	7 days for extraction 40 days for analysis
Polychlorinated biphenyls (PCBs)	1 Liter Amber glass	Cool to 4° C	7 days for extraction 40 days for analysis
Dioxins and furans	1 Liter Amber glass	Cool to 4° C Na ₂ S ₂ O ₃	7 days for extraction 40 days for analysis
Metals (total)	1 Liter polyethylene	Cool to 4° C pH<2 HNO ₃	6 months for analysis
Mercury (total)	1 Liter polyethylene or Widemouth glass	Cool to 4° C pH<2 HNO ₃	13 days (plastic) 38 days (glass)
Chromium (VI)	500 mL Amber glass	Cool to 4° C	24 Hours
pH	Glass or polyethylene	None	Analyze immediately
Total organic halogens (TOX)	1 Liter Amber glass	Cool to 4° C pH<2 H ₂ SO ₄	7 days
Total organic carbon (TOX)	1 Liter Amber glass	Cool to 4° C; pH<2 HCl or H ₂ SO ₄	28 days
Concentrated Waste Samples	Widemouth Glass w/teflon lines	None	14 days

^a Highly concentrated samples generally do not require preservation. When chemical preservation is required, care must be taken to ensure that incompatible preservations are not added. For example, an aqueous sample that is to be analyzed for metals should not have acid added to it if the sample also contains cyanides.

Source: EPA's SW-846, and Methods for Chemical
Analysis of Water and Wastes (600/4-79-020)

QA

In many ways, QA can only be measured qualitatively. For example, to assure that samples are taken with the same level of precision each time, QA procedures can be as simple as making sure that the personnel collecting the sample are trained and experienced. Additionally, a chain-of-custody protocol is a useful qualitative tool for documenting the time and location of sample collection activities. The WAP should provide facility-specific procedures, including:

- Sample strategy (including type of samples to be collected)
- Sampling numbers and locations
- Preservation reagents and techniques, as appropriate
- Chain-of-custody procedures
- Types of sampling equipment and sample containers
- Analytical procedures
- Decontamination procedures
- Field and laboratory QC procedures (see related discussions below)
- Relevant health and safety considerations.

Variations from the WAP should be documented and the reasons for deviating from WAP procedures need to be provided.

QC

QC procedures, as tools to measure the attainment of QA objectives, lend themselves to be measured more quantitatively. For example, one QC procedure involves taking samples in duplicate or triplicate and sending them to the analytical laboratory. If the analytical results of the duplicates are similar to the original sample, the original sample is assumed to be representative (i.e., good QA procedures were followed). However, if sample results are highly variable, one could infer that the sample collection procedures are not adequate for collecting a representative sample, or that one or more of the samples collected were inadvertently contaminated. Highly variable analytical results indicate that you should re-evaluate the sampling program (to include the collection of more samples) or employ a different sampling strategy due to unforeseen or special site conditions.

QC measures that can be taken throughout the sampling process to ensure the integrity of the overall program include:

- **Field Blanks** - are prepared in the field by filling a clean container with pure deionized water and appropriate preservative, if any, for the specific sampling activity being undertaken. If contaminants are found to be present in the field blank, it might be assumed that environmental factors (such as airborne contamination), sampling procedures (causing cross-contamination), or equipment (that is contaminated) were contributing to the levels of hazardous waste constituents found in the sample.
- **Trip Blanks** - are sample containers that are prepared with an inert material (such as deionized water) that are carried into and out of the field but are not opened at any time during the sampling event. If the trip blank is found to be contaminated, the source of the contamination would be assumed to be the container itself, the environment in which the trip blank was prepared, or some other source located outside the sample area.
- **Equipment Blanks** - are prepared prior to sampling by running pure deionized water over sampling equipment and collecting the water into a clean sample container. If the equipment

blank is found to be contaminated, the source of contamination could be assumed to be from the equipment used during the sampling operations.

- **Split Samples** - are collected by actually splitting a sample volume in half and dispensing it into two different containers. Typically, split samples are collected for enforcement purposes. The facility splits samples with the enforcement authority as a check on the facility's own analytical program and data recordkeeping.
- **Field Duplicates** - are independent samples that are taken from the same location at the same time and are used to measure the effectiveness of obtaining representative samples. The precision (reproducibility of analytical data) resulting from field duplicates provides an accurate reflection of the variance inherent to the waste composition and the sampling technique.

If blanks and duplicates are collected for analysis, they should be treated as regular samples, which would include conducting proper preservation and storage techniques as well as completing the proper paper work (e.g., chain-of-custody documentation) accompanying the samples. The facility should determine, based on its own data quality objectives, whether and when to collect QC samples.

Chain-Of-Custody

Chain-of-custody procedures should be specified in the WAP. These procedures involve the possession of samples from the time they are obtained until they are disposed or shipped off site for analysis. At a minimum, the procedures should specify that the following information be recorded when samples of waste or treatment residuals are collected: (1) the type of waste collected, including a brief description and the manifest number and waste code(s); (2) names and signatures of samplers; (3) sample number, date and time of collection, and designation as a grab or composite, including what type of composite; (4) names and signatures of any persons involved in transferring samples; and (5) if applicable, the shipping number, such as an airbill number, for samples shipped to off-site laboratories. An example chain-of-custody record is shown on Figure 2-9.

2.3.6 Establishing Health And Safety Protocols

Safety and health considerations should be taken into consideration when conducting sampling at your facility. Employees who perform sampling activities must be properly trained with respect to the hazards associated with waste materials, as well as with any waste handling procedures that will assist in protecting the health and safety of the sampler.

In addition, the employees must be trained in the proper protective clothing and equipment that must be used when performing sampling activities. Examples of the safety procedures for which personnel at your facility may need to be trained, depending on site-specific situations, may include:

- Training in the common routes of exposure (inhalation, contact ingestion) that might be encountered when taking samples
- Instruction in the proper use of safety equipment, such as Draeger tube air samplers to detect air contamination that employees potentially could be exposed to during sampling
- Proper use of protective clothing and, where applicable, respiratory equipment to guard against exposure.

FIGURE 2-9 Example Chain-Of-Custody Record

PROJECT NO.	PROJECT NAME					PARAMETERS					INDUSTRIAL HYGIENE SAMPLE	Y N	
SAMPLERS: <i>(Signature)</i>					(Printed)						REMARKS		
FIELD SAMPLE NUMBER	DATE	TIME	COMP	GRAB	STATION LOCATION					NO. OF CONTAINERS			
Relinquished by: <i>(Signature)</i>			DATE / TIME		Received by: <i>(Signature)</i>			Relinquished by: <i>(Signature)</i>				DATE / TIME	
(Printed)					(Printed)			(Printed)				(Printed)	
Relinquished by: <i>(Signature)</i>			DATE / TIME		Received for Laboratory by: <i>(Signature)</i>			DATE / TIME		Remarks			
(Printed)					(Printed)								

2-38

You are advised to consult the Occupation Safety and Health Act (OSHA), pursuant to 29 CFR §1910.120, to determine the required training that must be given to your employees. It is optional whether you include these procedures in your WAP. The inclusion of health and safety procedures, however, enhances the use of the WAP as a hands-on operating tool at your facility.

2.4 Selecting A Laboratory And Laboratory Testing And Analytical Methods

2.4.1 Selecting A Laboratory

The use of proper analytical procedures is essential to acquiring useful and accurate data. Obtaining accurate results requires an analytical laboratory that has demonstrated experience in performing waste sample analyses. When selecting a laboratory, preference should be given to those that are capable of providing documentation of their proven analytical capabilities, available instrumentation, and standard operating procedures. Furthermore, the laboratory should be able to substantiate their data by systematically documenting the steps taken to obtain and validate the data. The following discussion provides guidance on the factors to be considered when selecting an analytical laboratory.

The analytical laboratory that you select should exhibit demonstrated experience and capabilities in three major areas:

- Comprehensive QA/QC programs (both qualitative and quantitative)
- Technical analytical expertise
- Effective information management systems.

The relevant considerations associated with assessing laboratory strengths in each of these areas is described in more detail below.

Comprehensive QA/QC Programs

Parallel to sampling activities, QA/QC considerations are an integral part of laboratory analytical operations. Laboratory QA is undertaken to ensure that analytical methods generate data that are technically sound, statistically valid, and can be documented. Individual QC procedures are the tools employed to measure the degree to which these QA objectives are met. Accordingly, you should ensure that the laboratory addresses the following program elements.

Qualitative QA/QC Elements

Documentation is a very important aspect of maintaining QA/QC procedures in the laboratory. An essential part of any QA program in the laboratory or in the field is the initiation of a **chain-of-custody protocol**. This protocol allows tracking of the samples from collection through data analysis and reporting. The chain-of-custody protocol for laboratories begins with the immediate inspection of samples upon arrival for analysis and includes checking for documentation of adherence to the proper preservation techniques, proper accompanying paper work (e.g., chain-of-custody, shipping papers), proper sample containers, and inspection of the sample itself for signs of anomalies which could jeopardize the sample integrity (i.e., evidence of tampering, broken containers).

The laboratory should be able to meet the established holding times for the analytical parameters of interest. Holding times that are exceeded can result in the data being judged invalid. This can lead to the need to conduct re-sampling of the waste or EPA questioning the facility's compliance status. A credible laboratory will provide all the documentation neces-

sary, preferably in the form of a standard operating procedure (SOP), to demonstrate that holding times for the required analyses are always met.

Quantitative QA/QC Elements

Besides the qualitative measures associated with chain-of-custody procedures, quantitative measures should also be used by the laboratory to monitor QA/QC. These measures include the analysis of method blanks, duplicates, matrix spikes, and surrogate spikes. Table 2-10 presents the major QC techniques used by most analytical laboratories to ensure data quality. A well qualified laboratory will routinely employ these QA/QC procedures to evaluate the precision and accuracy of its analytical instrumentation to determine if inadvertent contamination has occurred or if other factors exist which could affect data quality.

Technical Analytical Expertise

The analytical laboratory you select should be proficient in using the established EPA analytical methods for hazardous waste determinations. The laboratory should also be knowledgeable of any current developments in analytical methods that could effect data quality. To ensure that the required information regarding waste composition is provided, a good laboratory will have a working knowledge of the regulatory levels and prescribed analytical methods for routinely analyzed contaminants (e.g., TC constituents).

When selecting an analytical laboratory, you also should consider its ability to consistently achieve the **detection limits** (i.e., the lowest level of quantification possible for a given analyte) that you request. Detection limits must be adequate to ensure sufficiently low levels of parameter identification to meet prescribed regulatory or permitting thresholds. The importance of these considerations is illustrated effectively by laboratories that are equipped with only limited or outdated analytical instrumentation. These operations may be incapable of meeting more stringent analytical requirements established in recent regulations such as the TC rule or recently promulgated LDR requirements, and thereby compromise your ability to validate compliance with applicable waste management requirements.

Information Management

Finally, the laboratory should maintain effective information management systems. These systems are necessary to ensure the availability of all relevant data generated in association with a given sample set (e.g., chain-of-custody records, accuracy and precision information, and analytical results). Additionally, all analytical reports provided should present information in a clear and concise manner. A credible laboratory will work with you to tailor its reports to meet your specific requirements. This is advantageous to assure that you use the information correctly to verify regulatory compliance or to evaluate process performance. The laboratory also should be able to provide the information needed to prove data validation (i.e., QA/QC documentation).

2.4.2 Selecting Testing And Analytical Methods

To be useful in sustaining regulatory and permit compliance, the WAP must specify testing and analytical methods which are capable of providing reliable data to ensure safe and effective waste management. The selection of an appropriate methodology is dependent upon the following considerations:

- Physical state of the sample (e.g., solid or liquid)
- Analytes of interest (e.g., volatile organics)
- Required detection limits (e.g., 1/5 to 1/2 of the regulatory thresholds)

TABLE 2-10
Laboratory QC Techniques

QC TECHNIQUE	PURPOSE	DESCRIPTION	RATE
Method Blank	Ensure that any contamination resulting from analytical equipment or process is identified.	Method blanks are artificial samples, usually comprised of distilled deionized water, that are submitted to the same laboratory preparation and analytical process as your samples. If any contaminants are present in this artificial sample after preparation and analysis, it can be inferred that previous samples or laboratory practices caused erroneous or biased results.	Performed at least once with each analytical batch with a minimum of once per 20 samples.
Duplicates	Evaluate the precision of the analytical process.	Two samples of the waste are obtained from one sample container and both are subjected to the same preparation and analysis.	Performed at least once with each analytical batch with a minimum of once per 20 samples.
Matrix Spike	Evaluate the efficiency, accuracy, and precision of the method being employed to analyze the samples.	Compounds of interest are "spiked" (added) into the sample prior to any preparation methods. The recoveries of the spiked compounds are then used to evaluate the efficiency of the method in detecting the compounds of interest.	Performed at least once with each analytical batch with a minimum of once per 20 samples.
Certified Reference Material	Evaluate the methods' efficiency and accuracy.	A sample of known analyte composition and concentration that is used as a benchmark standard.	Performed at least once with each analytical batch with a minimum of once per 20 samples.
Surrogate Spikes	Evaluate the methods' efficiency and accuracy.	Organic compounds which resemble the analytes of interest in chemical composition, extraction properties, and chromatographic properties. The recovery of the surrogate spike is used to indicate the effectiveness of the analytical process.	Performed at least once with each analytical batch with a minimum of once per 20 samples.

- Information requirements (e.g., detection monitoring, verify compliance with LDR treatment standards).

Analytical methods consist of two distinct phases -- a **preparation phase** and a **determination phase**. The use of an appropriate combination of preparation and determination procedures is necessary to ensure the accuracy of data generated from your facility waste management program.

Preparation Phase

Preparation methods are selected based upon a consideration of the factors presented above in section 2.4.2 as well as any special requirements associated with the type of analytical determination being performed. These procedures are designed primarily to accomplish one or more of the following:

- Extract the analytes of interest from the sample matrix
- Adjust physical properties (e.g., pH)
- Facilitate chemical conversions necessary for analysis
- Concentrate analytes to allow trace determinations.

Some samples intended for organics analysis that are either highly contaminated or contain extraneous contaminants that are capable of adversely affecting the analysis may require an additional procedure, known as a cleanup step, during sample preparation. These cleanup procedures remove potential interferences from the sample, thereby making it more amenable to subsequent analysis. The most common organic chemical cleanup procedures are florisil column, silica gel column, or gel permeation. The decision to perform a cleanup step usually is made by the analytical laboratory and often involves sophisticated technical judgements concerning sample composition, chemical interactions, and specific analytical limitations. Therefore, this manual will only reference sample cleanup procedures that may be used. If more information is required on the application of a particular cleanup method, the information can be obtained from SW-846.

Determination Phase

The application of a sample preparation method and, where required, a cleanup step, should be accompanied by an appropriate determination procedure specific to the analyte of interest. Analytes are divided into classes (e.g., metals, volatile organic compounds), and for each analytical class, a standard method has been developed to identify and quantify them. For example, organic compounds are typically analyzed by gas chromatography (GC) or gas chromatography-mass spectroscopy (GC-MS), while metals are analyzed by atomic absorption spectroscopy (AA) or inductively coupled argon plasma (ICAP) spectroscopy.

Due to the number of available preparation and determination options, Figure 2-10 is presented to facilitate the selection of the most appropriate preparation and analytical methods to use when performing waste analysis. For both inorganic and organic determinations, this figure provides the recommended SW-846 methods to be employed in the analysis of hazardous wastes for hazardous waste constituents (i.e., Part 261, Appendix VIII).

In addition to SW-846, the following references provide information on approved methods for analyzing waste samples:

- American Society for Testing and Materials (ASTM)
- "Design and Development of a Hazardous Waste Reactivity Testing Protocol," U.S. Environmental Protection Agency, EPA Document No. 600/2-84-057 (February 1984)
- "The Toxicity Characteristic Rule" (55 FR 11862)

FIGURE 2-10
EPA Designated (SW-846)^a
Analytical Methods Selection Flowchart

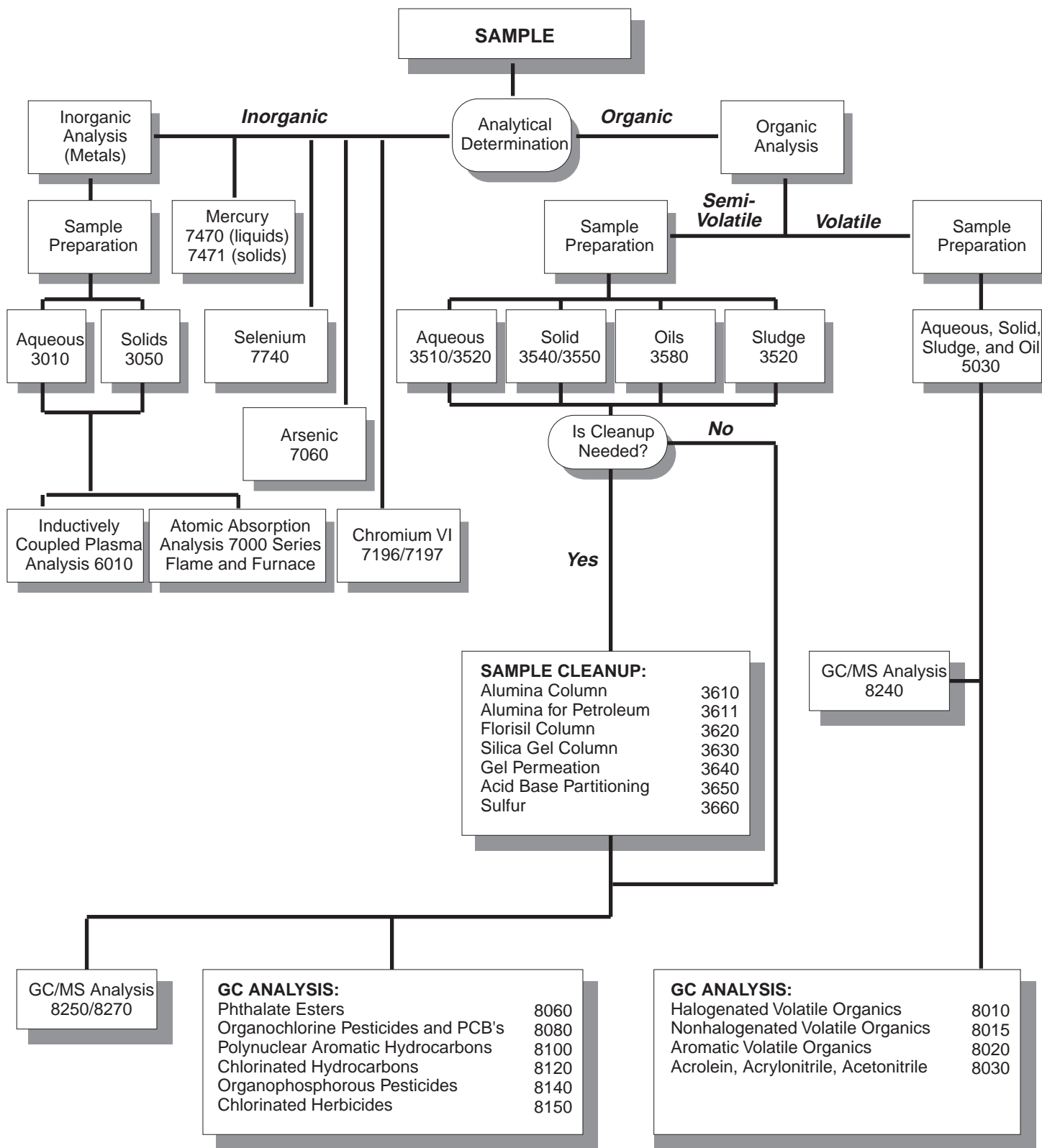

^a Test Methods for Evaluating Solid Wastes, SW-846, Third Edition and Updates. Numbers in the boxes are the SW-846 Method numbers.

- "Methods for Chemical Analysis of Water and Wastes", EPA Document No. 600/4-79-020 (Revised March 1983).

When identifying potential analytical methods to incorporate into your WAP, you can choose to use methods specified in SW-846 and other documents such as ASTM methods, or when an EPA method is required, such as determining whether a waste is corrosive or exhibits the toxicity characteristic, you can choose to petition to use an equivalent analytical method. To be successful with this petition, you must demonstrate to the satisfaction of EPA that the proposed method is equal to or superior to the method specified in the regulations. The procedures for making such a petition can be found in 40 CFR §260.21.

[NOTE: Chapter One of SW-846 describes Data Quality Objectives (DQOs) as the overall level of uncertainty that a decision maker is willing to accept in the results derived from environmental data. This level of uncertainty is used to specify the quality of the measurement data required, usually in terms of objectives for precision, bias, representativeness, comparability, and completeness. DQOs should be established before the initiation of field or laboratory work. Please refer to Chapter One of SW-846 for more detail.]

2.5 Selecting Waste Re-Evaluation Frequencies

The RCRA regulations state that "waste analysis must be repeated as often as necessary to ensure that it is accurate and up to date."²⁵ At a minimum, the analysis must be repeated as follows:

- When the TSDF is notified, or has reason to believe that the process or operation generating the hazardous wastes has changed²⁶
- When the generator has been notified by an off-site TSDF that the characterization of the wastes received at the TSDF does not match a pre-approved waste analysis certification and/or the accompanying waste manifest or shipping paper (the generator may be requested to re-evaluate the waste).²⁷
- Off-site combustion facilities should characterize all wastes prior to burning to verify that permit conditions will be met (i.e., fingerprint analysis may not be acceptable).

Although there are no required time intervals for re-evaluating wastes, you must develop a schedule for re-evaluating the waste on a regular basis. You will need to make an individual assessment of how often the wastes analysis is necessary to ensure compliance with your interim status or Part B permit operating conditions.

Off-site TSDFs will want to be particularly thorough in developing a schedule for re-evaluating wastes that will (1) confirm that the information provided by the generator is correct, and (2) detect any changes in the waste properties while managing the waste. When receiving wastes from off-site generators, conducting corroborative testing and or analysis will provide added protection. It is common practice for TSDFs that receive wastes from an off-site generator (or other facility) to require the submittal of a Waste Profile Sheet (or comparable document) to the TSDF as a pre-acceptance condition. A Waste Profile Sheet provides a comprehensive description of each wastestream. An example Waste Profile Sheet is provided as Table 2-11, located at the end of Part Two. Additionally, the TSDF may request that the generator also provide a representative sample of the waste to be analyzed by the TSDF, to confirm the generator's waste profile description.

Most facilities that receive wastes from off site sample a percentage of the wastes when they are received,

²⁵ 40 CFR §§264.13(a)(3)/265.13(a)(3)

²⁶ 40 CFR §264.13(a)(3)(i)

²⁷ 40 CFR §264.13(a)(3)(ii)

and check each waste container for "**selected fingerprint analysis parameters.**" Fingerprint analyses are used to provide an **indication** of whether the waste has been accurately identified by the generator on the hazardous waste manifest, LDR notification/certification, pre-acceptance contract or other documentation. Choosing the appropriate fingerprint analysis parameters requires facility-specific determinations based on several factors that are discussed in detail in the next section (i.e., Section 2.6).

Fingerprint analysis is never a substitute for conducting a complete waste analysis and, therefore, may not be defensible if a waste is misidentified by the generator and passes the fingerprint test. Though the generator is responsible for properly identifying and classifying the waste, the TSDF will be held liable by enforcement authorities if it violates its permit conditions and any other applicable regulations. The decision to conduct abbreviated corroborative testing using fingerprint analysis on a few select parameters, or to conduct a complete analysis to verify the profile, is ultimately determined by the off-site facility with this in mind.

2.6 Special Procedural Requirements

2.6.1 Procedures For Receiving Wastes Generated Off Site

Off-site hazardous waste management facilities are required to comply with additional regulations²⁸ regarding screening and analysis procedures that help minimize the potential for the facility to accept incorrectly identified or unacceptable waste shipments. The off-site facility's WAP must specify the waste analysis data that the generator of the waste provides to substantiate its waste determination. It is important that the WAP includes descriptions of the procedures to be taken by the TSDF to determine how well the generator's data represents the wastes to be managed. The TSDF should determine whether recharacterization of the waste is necessary if a shipment of a particular waste is determined, through pre-acceptance screening, to be significantly different from the waste as characterized and identified from the pre-shipment sample and/or waste manifest. These procedures and waste recharacterization procedures should be specified in the WAP. Alternatively, the owner/operator may reject the entire shipment of waste and return the waste to the generating facility.

An off-site facility should, at a minimum, visually inspect and compare the contents of each shipment to the accompanying manifest to identify the wastes. The shipment received on site should be sampled and analyzed to the extent necessary to verify that it meets permit specifications and regulatory requirements. Some off-site facilities accomplish this by performing a systematic process of screening and analysis which allows for monitoring key indicator parameters. In some cases, however, more stringent waste analysis may be required. Figure 2-11 provides a methodology that can be used to screen waste shipments.

Shipment screening is especially necessary for off-site facilities given the variety of wastes typically managed. The level of screening required for an off-site facility is a function of the facility operator's knowledge about the generation process. Off-site facilities should require that the generator provide detailed information regarding:

- The process that generates the waste
- The physical and chemical description of the waste

²⁸ 40 CFR §§264/265.13(c)

FIGURE 2-11
Shipment Screening

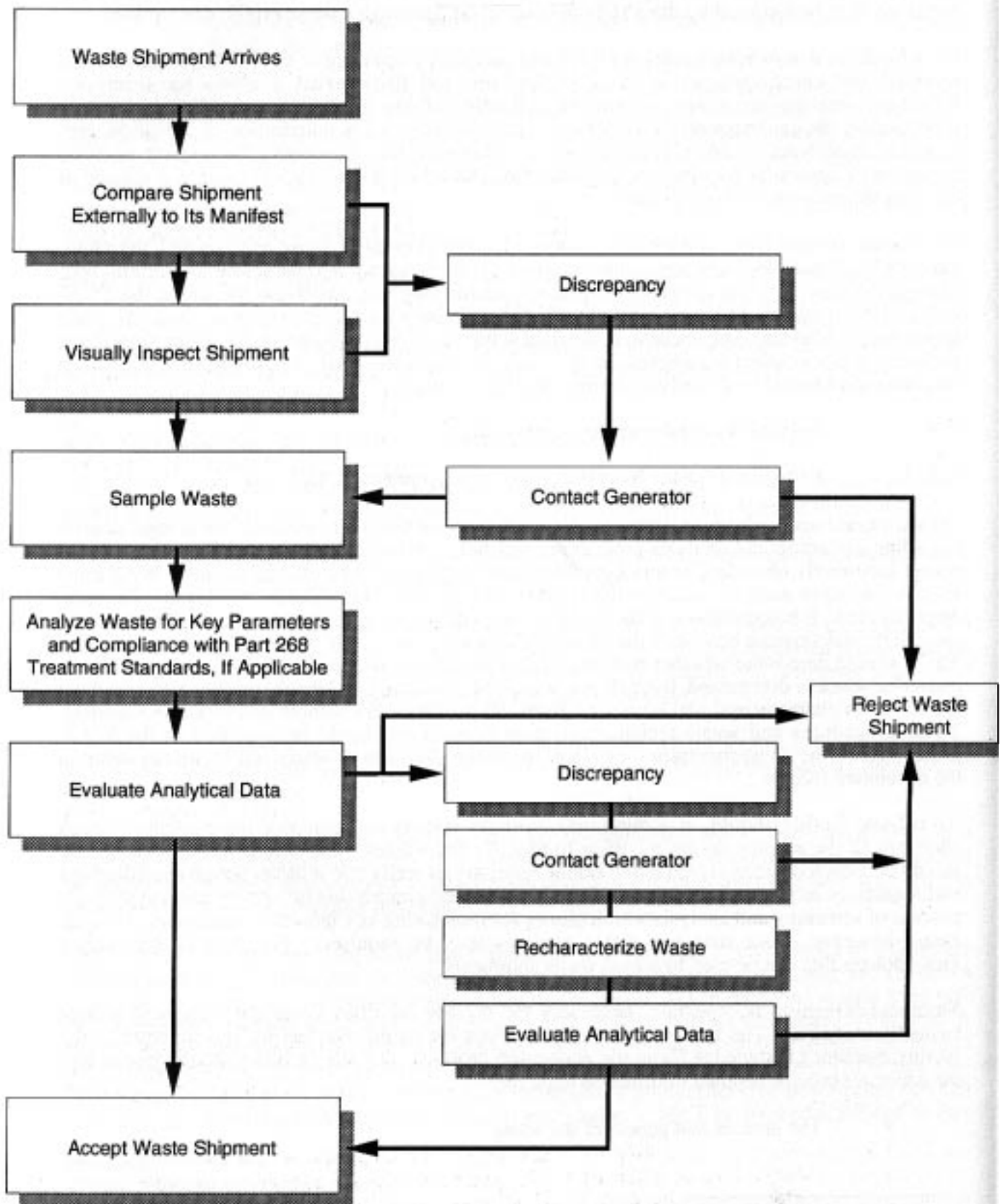

- The analytical procedures and results used to characterize the waste or process knowledge documentation
- EPA hazardous waste codes
- Certifications and notifications as applicable to LDR wastes.

As discussed in the previous section (Section 2.5), as a pre-acceptance procedure, most commercial TSDFs will require that the generator provide all of this information in the form of a Waste Profile Sheet. An example of a Waste Profile Sheet is provided in Table 2-11 located at the end of Part Two.

Fingerprint analysis, including the application of associated analytical test methods, should be performed during the pre-acceptance phase of waste management as a complement to information gained from the generating facility. Typically, waste shipments are sampled and analyzed for a few key chemical and physical parameters to substantiate the waste composition designated on the accompanying shipping paper or manifest. This practice expedites waste characterization and minimizes the time and labor involved in shipment receiving activities. Key parameters are selected from the initial waste characterization parameters measured before you agree to handle the generator's wastes. When selecting fingerprint parameters, you should consider those parameters that can be used to:

- Identify wastes that are not permitted
- Determine whether the wastes are within the management unit's operational acceptance limits
- Identify the potential ignitability, reactivity, or incompatibility of the wastes (refer to Section 2.2.1)
- Indicate any changes in waste composition that may have occurred during transportation or storage (e.g., a spent solvent used in paint thinning processes that has been documented to be free of chlorine and fluorine should not exhibit high total halogen concentrations.)

Generally, at a minimum, at least two parameters should be selected for fingerprint analysis of wastes prior to acceptance at an off-site TSDF. At least one parameter should be qualitative (e.g., color or phase) and the other should be quantitative (e.g., pH, specific gravity, flash point). Each qualitative and quantitative parameter should have acceptance, rejection, and further testing criteria associated with it.

While fingerprint parameters are often a subset of the full waste characterization parameters, this may not always be the case. For example, one may use screening tests to detect constituents that are not normally present in the waste, even though the initial waste profile does not identify the specific contaminant. Most facilities, for example, will test or require information pertaining to PCB content with each shipment.

Although key parameters can be used to obtain quickly a representation of waste composition, owner/operators should be aware that EPA will generally measure compliance in enforcement actions based on a comprehensive analysis of hazardous constituents and properties associated with a particular waste. As a result, the selection of key parameters must be based on sufficient waste profile knowledge and testing data to ensure accurate waste representation.

2.6.1.1 Re-Evaluation Of Wastes Received At Off-Site Combustion Facilities

Though fingerprint analysis and screening may be adequate for many TSDFs, additional information may be required for off-site combustion facilities. In particular, the WAP must specify procedures that ensure compliance with the site-specific waste feed restrictions. These restrictions are developed after the trial burn, become part of the permit, and specify restrictions on operating conditions and waste feed composition.

At a minimum, an off-site combustion facility must analyze the wastes it receives for prohibited constituents, (e.g., PCBs; dioxin-containing wastes; reactive wastes; and Part 261, Appendix VIII constituents not represented by the POHCs selected for the trial burn), thermal input, ash content, chloride, total toxic metals, (e.g., antimony, arsenic, barium, beryllium, cadmium, chromium, lead, mercury, nickel, selenium, silver, thallium, vanadium, and zinc), and other parameters as necessary (e.g., viscosity, percent solids, solids size, and specific gravity).

Each batch of waste to be burned must be analyzed. A typical scenario would include: receive waste, conduct fingerprint analysis, blend wastes in feed or burn tank, and analyze the batch for the above referenced constituents and parameters.

On-site facilities may use a lower frequency of analysis but the frequency must be based on a firm statistical basis.

As noted in Section 2.5, though the **generator is responsible for properly classifying the wastes, enforcement authorities will hold the combustion facility responsible and liable for any permit or other regulatory violation.**

2.6.2 Procedures For Ignitable, Reactive, And Incompatible Wastes

WAPs must include provisions to ensure that waste management units meet the special requirements for ignitable, reactive, and incompatible wastes.²⁹ Incompatible wastes, if brought together, may result in heat generation, toxic gas generation, and/or explosions. Therefore, a WAP must address measures to identify potentially ignitable, reactive, and incompatible wastes. The information provided by the waste manifest and fingerprint testing can be supplemented with other testing to identify incompatible wastes. Standard tests to identify **ignitable** wastes are contained in section 7.1 of SW-846. Although EPA does not currently have an approved set of test procedures for **reactivity**, specialized methods contained in sections 7.3.3.2 and 7.3.4.2 of SW-846, respectively, have been developed to determine if a cyanide or sulfide waste exhibits the reactivity characteristic. Additionally, reference should be made to "Design and Development of a Hazardous Waste Reactivity Testing Protocol" (EPA-600/52-84-057) for suggested reactivity fingerprint analysis procedures. Finally, waste **compatibility** determinations can serve to establish compatibility between wastes of interest for a given process. An EPA document, "A Method of Determining the Compatibility of Hazardous Wastes" (EPA-600/2-80-076)³⁰, contains procedures to evaluate qualitatively the compatibility of various categories of wastes.

²⁹ 40 CFR §§264/265.17

³⁰ This document can be obtained from the National Technical Information Service (NTIS) (Document No. PB-80221005).

2.6.3 Provisions For Complying With LDR Requirements

Generators and TSDFs have special waste analysis requirements under the LDR program. Regulations in 40 CFR §268.7 require generators and TSDFs to conduct waste analysis to determine the regulatory status of wastes with respect to the treatment standards in 40 CFR Part 268, Subpart D. Generally, hazardous wastes must meet applicable treatment standards prior to land disposal. These treatment standards are expressed in two ways: as constituent concentrations in the waste (either an extract of the waste as determined by the TCLP, or in the total volume of the waste referred to as a total waste analysis) or as specified treatment technologies. Wastes with concentration-based treatment standards must be evaluated to determine if applicable constituent concentration levels have been attained. This can be accomplished by applying waste analysis procedures as either (1) testing the waste, or (2) using knowledge of the process or materials used to produce the waste (for generators only). For (2), this knowledge should be supplemented with analytical data on the regulated constituents.

For treatment standards expressed as concentrations in the waste extract (40 CFR §268.41 and §268.46), the TCLP (EPA Method 1311 of SW-846) must be employed to obtain an extract of the waste (there are certain exceptions where Method 1310, the Extraction Procedure Toxicity Test, can be used as an alternative for those arsenic- and lead-containing waste codes listed in 40 CFR §268.40(a)). The extract will be tested subsequently for the specific constituents associated with the treatment standard. Treatment standards based on total waste concentrations in 40 CFR §268.43 should be verified using an appropriate total waste analysis procedure for its respective constituents. Please note that many wastes have treatment standards expressed as both extract concentrations and total waste concentrations.

For wastes with treatment standards expressed as specified technologies in 40 CFR §268.42, and for hazardous debris treated to meet the alternative debris treatment standards in 40 CFR §268.45, verification through analysis is not necessary. Instead, compliance with these treatment standards should be documented in the facility operating record to verify that the appropriate treatment technologies have been employed prior to land disposal.

2.7 Summary



In Part Two, you have learned what information should be included in your WAP, and how the information should be organized. In particular, you reviewed how to select:

- Waste analysis parameters
- Sampling procedures
- Analytical and testing methods
- Waste re-evaluation frequencies.

In addition, you learned about special procedural requirements (e.g., for off-site TSDFs).

In Part Three, you will be presented with a checklist of key elements of a WAP. This checklist should be reviewed while developing or modifying your WAP.

TABLE 2-11 Example Waste Profile Sheet *

1. WASTE PROFILE #: _____

EPA Facility ID #: _____

DO NOT LEAVE BLANK SPACES. PLEASE SUBMIT THIS FORM TYPE-WRITTEN.

I. GENERATOR INFORMATION

2. Generator Name: _____ 3. EPA ID #: _____
4. Mailing Address: _____
5. Plant Address: _____
6. Business Contact: _____ Phone #: _____
7. Technical Contact: _____ Phone #: _____

The following information is required to comply with RCRA 40 CFR §§264/265.13 (O.A.C. 3745-65-13) General Waste Analysis.

II. GENERAL WASTE INFORMATION

8. Waste Material Name: _____ 9. Generator Code: _____
(Optional)
10. Describe process that generates waste: _____ 11. SIC Code: _____
12. Is your company the original generator of the waste? No Yes If not, provide the name of the original generator:

13. If this waste is a still bottom, are you the original generator of the feed stock? No Yes
14. Rate of Generation: _____ Current accumulation: Drums _____ Bulk _____
(Gal.)
15. Check all types of containerization for which you request quotation.
- | | |
|---|---|
| <input type="checkbox"/> 55-Gallon Steel Drum (SC)
<input type="checkbox"/> 30-Gallon Steel Drum
<input type="checkbox"/> 85-Gallon Steel Drum (Without inside container)
<input type="checkbox"/> 85-Gallon Salvage Drum (With fiber or steel drums inside)
<input type="checkbox"/> Palletized small containers | <input type="checkbox"/> 55-Gallon Fiber Drum
<input type="checkbox"/> 5-Gallon Pail
<input type="checkbox"/> Bulk (For bulk shipments, waste viscosity must be < 5000 cps)
<input type="checkbox"/> Other (Specify) |
|---|---|
- Overall dimensions of material on pallet: _____ x _____ x _____ (High)
 Dimensions of pallet only: _____ x _____ x _____ (High)
 What are the small containers on the pallet? _____ (1 qt. Bottles, 8 oz. Aerosol Cans, etc.)

III. WASTE STREAM CHEMICAL COMPOSITION**

16. COMPONENTS INCLUDING 40 CFR 261 APPENDIX VII HAZARDOUS CONSTITUENTS	CONCENTRATION RANGE (UNITS)	AVERAGE % MUST TOTAL 100%	TLV (IF PUBLISHED) ACGIH	OSHA
_____	_____ to _____	_____	_____	_____
_____	_____ to _____	_____	_____	_____
_____	_____ to _____	_____	_____	_____
_____	_____ to _____	_____	_____	_____
_____	_____ to _____	_____	_____	_____
_____	_____ to _____	_____	_____	_____
_____	_____ to _____	_____	_____	_____

* If applicable, this Waste Profile Sheet is a new revision of a previously submitted Waste Profile Sheet dated _____ Attach to this Form any additional information which must be known to treat, store, or dispose of the waste in accordance with RCRA §§264/265.13, including but not limited to data developed under RCRA Part 261, Laboratory Analysis Technical Publications or Material Safety Data Sheets.

** 40 CFR 261 Appendix VIII constituents should be identified for combustion facilities, even if not present in high enough concentrations to significantly contribute to the 100% composition.

IV. SPECIFIC ANALYSIS OF WASTE

17. Method used to obtain a representative sample of the analyzed waste (i.e., grab, composite, etc.) Sampling methods are described in RCRA 40 CFR 261 Appendix 1.

Generator's Knowledge & MSDS

In completing the next two items, do not leave blanks. If the specific element is not present, indicate "None".

18. Organic Bound	CONCENTRATION	
	RANGE	AVERAGE
Sulfur	_____ to _____	_____
Chlorine	_____ to _____	_____
Fluorine	_____ to _____	_____
Bromine	_____ to _____	_____
Iodine	_____ to _____	_____
Nitrogen	_____ to _____	_____
Phosphorus	_____ to _____	_____

(Base % WT on Molecular Structure)

19. Metals (Actual Content)

Arsenic _____ ppm	Mercury _____ ppm
Barium _____ ppm	Nickel _____ ppm
Cadmium _____ ppm	Selenium _____ ppm
Chromium _____ ppm	Silver _____ ppm
Lead _____ ppm	Thallium _____ ppm
Aluminum _____ %	Silicon _____ %
Magnesium _____ %	Sodium _____ %

20. Does this waste contain PCBs?
 No Yes. If yes, give the concentration regardless of amount and attach supporting documentation: _____ ppm
21. Does this waste contain insecticides, pesticides, herbicides, or rodenticides?
 No Yes. If yes, identify each in the space below and the concentrations:
 _____ ppm
 _____ ppm
 (Include Safety Data Sheets for each)
22. Does this waste contain Dioxin? No Yes
23. Does this waste contain free cyanide > 250 ppm?
 No Yes
24. Does this waste contain free sulfide > 250 ppm?
 No Yes

V. TOXICITY

25. Check Applicable Data
- | | |
|---------------------------------------|---------------|
| _____ Eye | Explain _____ |
| _____ Inhalation | Explain _____ |
| _____ Dermal | Explain _____ |
| _____ Ingestion | Explain _____ |
| _____ Other | Explain _____ |
| _____ Carcinogen (suspected or known) | Explain _____ |

WASTE PROFILE #: _____
 VI. PHYSICAL PROPERTIES

26. Physical state at 70° F (Circle)
 Liquid _____ Semisolid _____ Solid _____
 Slurry _____ Sludge _____ Gas _____
 Viscosity at 70° F _____ CPS
27. Is material pumpable? No Yes
 Varies (Explain): _____
28. Is waste multi-layered? No Yes
 If yes, please describe and quantify each layer:
 1. (Top) _____ %
 2. _____ %
 3. _____ %
29. Dissolved Solids: _____ % WT
30. Suspended Solids: _____ % WT
31. BTU Value/lbs: _____
32. Ash Content (% by WT): _____
33. Flash Point: _____ ° F
34. Vapor Pressure at 70° F: _____
35. Specific Gravity: _____
36. pH: _____
37. Corrosivity: _____ mpy
38. Color: _____
39. What is the Reactivity Group Number(s) for this waste?

In accordance with "Design and Development of Hazardous Waste Reactivity Testing Protocol," EPA Document No. EPA-600/2-84-057, February 1984.

40. Is this material stable? No Yes
 If no, explain: _____

41. Is this material shock sensitive? No Yes
 If yes, explain:

VIII. EPA INFORMATION

42. Is this waste hazardous as defined by RCRA 40 CFR Part 261? No Yes
 If yes, list the applicable EPA Hazardous Waste Number(s) and explain why you have assigned the number(s). For example, if you assign D001, the reason for selection is that the flash point is less than 140° F. If you assign F002, the reason for selection may be that the waste is the still bottom from the recovery of methylene chloride:

43. If the answer to #42 is yes, list CERCLA reportable quantities, found in 40 CFR §302.4:

EPA Hazardous Waste Number(s)	Reason for Selection
_____	_____
_____	_____
_____	_____
_____	_____
_____	_____

44. If the waste is not hazardous as defined by federal regulations but is hazardous as defined by state regulations in which the waste was generated, please provide the state hazardous waste number(s). Also provide any state hazardous numbers that are not included in the federal regulations:

State Hazardous Waste Number(s)	Reason for Selection
_____	_____
_____	_____
_____	_____
_____	_____
_____	_____

IX. SAMPLING INFORMATION

45. Sample source (e.g., drum, lagoon, pond, tank, vat, etc.): _____

Date Sampled: _____ Sampler's Name/Company: _____

46. Generator's Agent Supervising Sampling: _____ 47. No sample required (Provide rationale)

X. LAND DISPOSAL RESTRICTIONS INFORMATION

48. Identify ALL characteristic and listed EPA hazardous waste numbers that apply (as defined by 40 CFR 261). For each waste number, identify the subcategory (as applicable, check none, or write in the description from 40 CFR 268.41, 268.42, and 268.43).

REF #	A. EPA HAZARDOUS WASTE CODE(S)	B. SUBCATEGORY		C. APPLICABLE TREATMENT STANDARDS			D. HOW MUST THE WASTE BE MANAGED? ENTER THE APPROPRIATE LETTER (A-D) FROM BELOW
		ENTER THE SUBCATEGORY DESCRIPTION IF NOT APPLICABLE CHECK NONE		PERFORMANCE-BASED (CHECK AS APPLICABLE)	SPECIFIED TECHNOLOGY IF APPLICABLE ENTER THE CFR 268.42 TABLE 1 TREATMENT CODE(S)	268.42	
		DESCRIPTION	NONE				
1							
2							
3							
4							
5							
6							

To list additional EPA waste numbers and categories, use additional page and check here: _____

Management under the land disposal restrictions:

- A. RESTRICTED WASTE REQUIRES TREATMENT? No Yes
- B.1. RESTRICTED WASTE TREATED TO PERFORMANCE STANDARDS? NO Yes Method _____
- B.2. RESTRICTED WASTES FOR WHICH THE TREATMENT STANDARD IS EXPRESSED AS A SPECIFIED TECHNOLOGY (AND THE WASTE HAS BEEN TREATED BY THAT TECHNOLOGY) NO Yes Method _____
- B.3. GOOD FAITH ANALYTICAL CERTIFICATION FOR INCINERATED ORGANICS? NO Yes Method _____
- C. RESTRICTED WASTE SUBJECT TO A VARIANCE? No Yes Date/Type _____
- D. RESTRICTED WASTE CAN BE LAND DISPOSED WITHOUT FURTHER TREATMENT? No Yes

XI. DOT INFORMATION

In accordance with the Department of Transportation 49 CFR Parts 171 through 177, complete the following:

- 49. DOT Proper Shipping Name: _____
- 50. DOT Hazard Class: _____
- 51. DOT UN or NA Number: _____
- 52. Container Label(s): _____
(For containers of 110 gallons or less)
Additional Description _____
- 53. Placards: _____

Generator's hazardous waste shipments must also comply with the labeling requirements of RCRA 40 CFR Part 262.

- 54. Is this waste a soil and/or debris? No: ___ Yes, Soil: ___ Yes, Debris: ___ Yes, Both: ___

<p>55. COMPLETE ONLY FOR WASTES INTENDED FOR FUELS OR INCINERATION</p> <p style="text-align: center;">TOTAL</p> <p>Antimony as Sb _____ ppm</p> <p>Beryllium as Be _____ ppm</p> <p>Potassium as K _____ ppm</p> <p>Sodium as Na _____ ppm</p> <p>Bromine as Br _____ *ppm/%</p> <p>Chlorine as Cl _____ *ppm/%</p> <p>Fluorine as F _____ *ppm/%</p> <p>Sulfur as S _____ *ppm/%</p> <p>* Indicate ppm or %.</p>	<p>56. RECLAMATION, FUELS OR INCINERATION PARAMETERS (Provide if information is available)</p> <p style="text-align: center;">RANGE</p> <p>A. Heat Value (BTU/lb.) _____</p> <p>B. Water: _____</p> <p>C. Viscosity (cps): _____ @ _____°F _____100°F _____150°F</p> <p>D. Ash: _____%</p> <p>E. Settleable solids: _____%</p> <p>F. Vapor Pressure @ STP (mm/Hg): _____</p> <p>G. Is this waste a pumpable liquid? <input type="checkbox"/> No <input type="checkbox"/> Yes</p> <p>H. Can this waste be heated to improve flow? <input type="checkbox"/> No <input type="checkbox"/> Yes</p> <p>I. Is this waste soluble in water? <input type="checkbox"/> No <input type="checkbox"/> Yes</p> <p>J. Particle size: Will the solid portion of this waste pass through a 1/8-inch screen: <input type="checkbox"/> No <input type="checkbox"/> Yes</p>
---	---

57. Special Handling Information _____

ACCOUNTABILITY STATEMENT

58. I hereby certify that all information submitted in this and all attached documents contains true and accurate descriptions of this waste. Any sample submitted is representative as defined in 40 CFR 261 Appendix I or by using an equivalent method. All relevant information regarding known or suspected hazards in the possession of the generator has been disclosed. I authorize (_____) to obtain a sample from any waste shipment for purposes of recertification.

Authorized Signature Printed (or typed) Name and Title _____
Date

Proceed to Part Three 

PART THREE: CHECKLIST

	Yes	No	Comments
1. Facility Description			
a. Are all processes that generate hazardous waste identified?			
b. Is sufficient information provided for each process to confirm that all hazardous wastes are identified?			
c. Have all hazardous waste management units been identified?			
d. Are descriptions of all hazardous waste management units provided?			
e. Have all hazardous and solid wastes been identified for each unit?			
f. Have the methods of waste management (e.g., stabilization) been described for each unit?			
g. Are process design limitations defined for each hazardous waste management unit?			
h. Have operational acceptance limits been established for each hazardous waste management unit?			
i. Are procedures in place to determine whether wastes are outside of their respective acceptance ranges?			
j. Do operational acceptance limits include applicable regulatory restrictions?			
2. Selecting Waste Parameters			
a. Are parameters for waste analysis identified (and, if applicable, included in the WAP)?			
b. Does the WAP identify a rationale for the selection of each waste analysis parameter?			
c. Does the WAP include parameters for the special waste analysis requirements in 40 CFR §§264/265.17, 264/265.314, 264/265.341, 264/265.1034(d), and 266.102(b), if applicable?			

**Part Three (continued)
Checklist**

	Yes	No	Comments
d. Have operational acceptance limits been defined as they relate to waste properties and process?			
e. Do operational acceptance limits include regulatory restrictions?			
f. Do waste analysis parameters address applicable operational acceptance limits?			
3. Selecting Sampling Procedures			
a. Has the number of sampling locations been identified?			
b. Are sampling procedures for each waste type identified?			
c. Are descriptions and justifications provided for any modified or non-standard procedures, as approved by EPA?			
d. Have decontamination procedures for sampling equipment been developed?			
e. Have sampling strategy techniques (e.g., grab, composite) been specified?			
f. Are procedures for sampling multi-phase wastes (if applicable) addressed?			
g. Has all sampling equipment been identified?			
h. Have the number and types of sampling containers been specified?			
i. Have sample preservation techniques been specified?			
j. Are sampling quality assurance and quality control procedures identified?			
k. Are proper packing and shipping procedures documented?			
l. Have procedures for the maintenance of all sampling equipment been documented?			
m. Are the precision and accuracy of sampling equipment stipulated?			
n. Are health and safety procedures for the protection of sampling personnel specified?			

**Part Three (continued)
Checklist**

	Yes	No	Comments
4. Selecting A Laboratory And Laboratory Testing And Analytical Methods			
a. Are laboratory and analytical methods specified for each waste managed at the facility? If not, is other information (i.e., acceptable knowledge) used to demonstrate waste analysis?			
b. Has a rationale been specified for each analytical and test method?			
c. Do the selected analytical methods meet all regulatory requirements for the identification of each hazardous waste (e.g., each hazardous waste characteristic)?			
d. Are descriptions and justifications provided for any modified or non-standard methods, as approved by EPA?			
e. Have chain-of-custody procedures for samples been specified (if necessary)?			
f. Does the laboratory have an adequate QA/QC program?			
g. Have QA/QC procedures for each analytical procedure been identified?			
5. Selecting Waste Re-Evaluation Frequencies			
a. Have site-specific criteria for waste re-evaluations been specified?			
b. Is re-evaluation accomplished with adequate frequency?			
c. Are mechanisms in place for re-evaluating the sampling program each time the waste-generating processes change?			
d. Do the re-evaluation procedures specify criteria for the acceptance of wastes received from off-site generators?			
e. Do you notify off-site facilities (i.e., treatment, storage, and/or disposal facilities) of changes in waste characterizations due to process changes or other factors?			

**Part Three (continued)
Checklist**

	Yes	No	Comments
6. Special Procedural Requirements, Where Applicable			
a. Are procedures in place to verify the sources of the information provided from off-site generators or TSDFs (if applicable)?			
b. Have criteria been established for the preacceptance procedures of wastes based on information from off-site generators or TSDFs?			
c. Are procedures for waste inspections in place?			
d. Have fingerprint analysis parameters been developed?			
e. Have criteria been established for the acceptance of wastes based on the results of fingerprint analysis?			
f. Is there a methodology for identifying ignitable, incompatible, or reactive wastes?			
g. Are procedures in place to conduct testing to determine whether wastes are incompatible with each hazardous waste management unit on site?			
h. Have all wastes restricted under the LDRs been identified?			
i. Are procedures in place to ensure that wastes meet applicable LDR treatment standards prior to land disposal?			

Proceed to Part Three



PART FOUR: SAMPLE WAPs



In Part Four, you will review five abbreviated sample WAPs that have been developed to illustrate the following:

- Suggested outlines for WAPs representing five different types of facilities
- The content and level of detail recommended in a complete WAP.

The sample WAPs were developed in accordance with the guidance provided in Parts One, Two, and Three of this manual.

4.0 Introduction To Sample WAPs

Part Four contains five abbreviated sample WAPs that you should use as guidance when developing your facility's WAP. You should consult Table 4-1 to determine the most appropriate sample WAP to use in developing your facility's WAP. **However, regardless of which sample WAP you review, you should first review Sample WAP #1 because it provides the background data and information used in Sample WAPs #2, #3, #4, and #5.**

The sample WAPs illustrate the recommended format and present excerpts of sample text for all key sections. **Excerpts of sample text are highlighted using italicized and indented text, and all figures and tables are located at the end of each respective sample WAP.** Unlike these sample WAPs, the WAP you develop for your facility should provide more narrative discussions and graphical presentations of relevant waste analysis considerations.

The sample WAPs address five waste management scenarios. These five scenarios are:

- Generator only (i.e., no treatment)
- Generator treating to meet LDR treatment standards
- On-site treatment facility
- Off-site treatment facility
- Landfill.

Each scenario depicts the fate of one or more of the hazardous wastes (HW) that are generated from the manufacturing processes of a fictitious generator and TSDf called Thompson Manufacturing, Inc. Two other fictitious TSDfS — Sparky Incinerator, Inc., and Rottaway Landfill, Inc. — are used for treatment and land disposal of Thompson's wastes. Detailed information on each of the five waste management scenarios used to develop the sample WAPs is provided in Tables 4-2 through 4-6.

[Note: A WAP for generators who are NOT engaged in any treatment activities is included as Sample WAP #1; however, as stated previously in this manual, these facilities are encouraged but not required to develop a WAP.]

**TABLE 4-1
Guide To The Sample WAPs**

IF YOU ARE A ...	SEE SAMPLE WAP #:	SYNOPSIS OF SCENARIO
<p>Generator, and you ...</p> <ul style="list-style-type: none"> - Send all hazardous wastes generated to an off-site TSDf and/or send wastewaters to a POTW. 	1	<p>- Generator Only -</p> <p>Thompson is a generator, pursuant to 40 CFR Part 262, that sends all of its hazardous wastes off site for treatment and or disposal at commercial TSDFs.</p>
<ul style="list-style-type: none"> - Treat in tanks, containers, and/or containment buildings to meet LDR treatment standards. Neutralized wastes are discharged to an on-site wastewater storage tank (non-RCRA regulated). 	1 and 2	<p>- Generator Treating to Meet LDR Treatment Standards -</p> <p>Thompson continues to be a generator in accordance with Scenario 1, but the company elects to treat acid wastes on site in tanks to meet LDR treatment standards, pursuant to 40 CFR §268.7.</p>
<p>Generator and/or TSDf, and you ...</p> <ul style="list-style-type: none"> - Treat hazardous wastes on site. 	1 and 3	<p>- On-Site Treatment Facility -</p> <p>In addition to treating in tanks and containers (per Scenario 2, above), Thompson receives a permit to treat metal-containing wastes in an on-site stabilization unit.</p>
<ul style="list-style-type: none"> - Own or operate treatment unit or units that receive(s) hazardous wastes from off site. 	1 and 4	<p>- Off-Site Treatment Facility -</p> <p>All solvent-bearing hazardous wastes generated at Thompson are sent to Sparky Incineration, Inc.</p>
<ul style="list-style-type: none"> - Own or operate a landfill that receives hazardous wastes that are generated on site or off site. 	1 and 5	<p>- Landfill -</p> <p>Rottaway Landfill, Inc. operates as a TSDf that accepts stabilized hazardous wastes from Thompson and ash from Sparky.</p>

TABLE 4-2
Scenario Overview Sample WAP #1
—Generator Only—

Thompson Manufacturing, Inc., is a semiconductor manufacturing facility that sends all of the hazardous wastes it generates to an off-site TSDf for treatment and/or disposal. The scenario depicted in Sample WAP #1 is shown below.

Process/Activity Generating HW	Wastes Generated	EPA Waste Code	LDR NWW or WW ¹	Treatment/Disposal Method and Location
Parts Preparation - Electroplating	Wastewater Treatment Sludge	F006	NWW	Sent off site to Solid Stabilization, Inc.*
- Parts Drying	Solvents	F002	NWW	Sent off site to Sparky Incineration, Inc.
- Machining	Cutting Oils, Metal Shavings and Scraps	N/A	N/A	Sent off site to a reclaimer *
Painting - Cleanup	Solvents	F003	NWW	Sent off site Sparky Incineration, Inc.
- Waste Paint	Waste Paint Residues	D008 D009	NWW NWW	Sent off site to Solid Stabilization, Inc.*
Clean Room - Glass Etching	Hydrofluoric Acid (HF)	D002	WW	Sent off site to Corrosive Neutralizes, Inc.*
--				

¹ NWW- Nonwastewater; WW - Wastewater

* These facilities are not addressed in the sample WAPs (i.e., not applicable)

TABLE 4-3
Scenario Overview Sample WAP #2
—Generator Treating To Meet LDR Treatment Standards—

Thompson elects to conduct on-site treatment of the acid wastes (D002) generated in the clean room. This treatment occurs in tanks for the purpose of meeting LDR treatment standards. All other wastes generated at Thompson continue to be sent to off-site TSDFs (see Sample WAP #1). The scenario depicted in Sample WAP #2 is shown below.

Process/Activity Generating HW	Wastes Generated	EPA Waste Code	LDR NWW or WW	Treatment/Disposal Method and Location
Clean Room - Acid Etching	Hydrofluoric Acid (HF)	D002	WW	On-Site Treatment in Tanks (Neutralization)

TABLE 4-4
Scenario Overview Sample WAP #3
—On-Site Treatment Facility—

In addition to treating acid wastes to meet LDR treatment standards (see Sample WAP #2), Thompson elects to conduct on-site treatment, using stabilization, of the electroplating wastewater treatment sludges (F006) and waste paint residues (D008 and D009). All other hazardous wastes continue to be sent off site to a commercial TSDF (see Sample WAP #1) or treated on site in tanks (see Sample #2). The scenario depicted in Sample WAP #3 is shown below.

Process/Activity Generating HW	Wastes Generated	EPA Waste Code	LDR NWW or WW	LDR Treatment Standard
Electroplating - Wastewater Treatment	Sludge	F006	NWW	See Scenario Overview Sample WAP #5
Painting - Parts Cleanup	Waste Paint Residues	D008, D009	NWW	Pb 5 mg/l Hg 0.2 mg/l

TABLE 4-5
Scenario Overview Sample WAP #4
—Off-Site Treatment Facility—

Thompson has always sent its solvent wastes, generated in the electroplating and painting processes, off site to Sparky Incineration, Inc. (see Sample WAP #1). For this fourth scenario, we have chosen to go to Sparky Incineration, Inc., and develop a sample WAP for the wastes that Sparky receives from Thompson. (All other hazardous wastes generated at Thompson continued to be managed in accordance with Sample WAPs #2 and #3.) The scenario depicted in Sample WAP #4, which addresses the incineration activities at Sparky Incineration, Inc., is shown below.

Name of Generator/ EPA ID No.	Process/Activity that Generates Wastes	Waste Description	EPA Waste Code	LDR NWW or WW	LDR Treatment Standard (mg/kg)
Thompson Manufacturing, Inc. EPA ID No. GFA068291377	Parts Preparation - Parts Drying	Solvents (trichlorofluoromethane, CFC-11)	F002	NWW	33
	Painting - Parts Cleanup	Solvents (Acetone)	F003	NWW	160

TABLE 4-6
Scenario Overview WAP #5
—Landfill—

All of the wastes that are generated at Thompson Manufacturing, Inc., are ultimately disposed of in the Rottaway Landfill. This landfill, therefore, receives incinerated waste residues from Sparky Incineration, Inc., and it receives stabilized wastes from Thompson Manufacturing, Inc. The scenario depicted in Sample WAP #5, which addresses the landfilling of waste at Rottaway, is shown below.

Name of Generator/ EPA ID No.	Process/Activity Generating HW	Waste Description	EPA Waste Code	LDR NWW or WW	LDR Treatment Standard ¹
Thompson Manufacturing, Inc., EPA ID No. GFA068291377	Stabilization	Treated Solids From Electroplating Wastewater Treatment	F006	NWW	Cd 0.066 Cr 5.2 Pb 0.51 Ni 0.32 Ag 0.072 CN (total) 590 mg/kg CN (amenable) 30 mg/kg
	Stabilization	Treated Paint Solids	D008, D009	NWW NWW	Pb 5 Hg 0.2
	Neutralization	Sludge Residues From Tank Treatment	N/A		
Sparky Incineration, Inc., EPA ID No. SIT043377911	Incinerated Waste Solvents From Painting Process, Originally Generated at Thompson	One of Many Wastes Contributing to Incineration Slag	F003	NWW	acetone 160 mg/kg
	Incinerated Waste Electroplating Solvents Originally Generated at Thompson	One of Many Wastes Contributing to Incineration Slag	F002 (trichloro- fluoro- methane, CFC-11)	NWW	trichlorofluoro- methane 33 mg/kg

¹ The LDR treatment standards for metals are for the constituent concentrations in the TCLP extract in mg/l. For all other constituents the standards are the concentrations in the total waste analysis in mg/kg.

Each sample WAP generally follows the format discussed in Part Two of this guidance manual; therefore, each has six sections. However, you may choose to arrange the sections in any order that works best for your facility. For example, you will note that Sample WAPs #4 and #5 have been rearranged slightly due to facility-specific circumstances (e.g., receiving wastes from off site). The model outline generally used in the sample WAPs is provided below.

TABLE 4-7
Model Outline Of Sample WAPs

I. Facility Description

- A. Description of Facility Processes and Activities
- B. Identification/EPA Classification and Quantities of Hazardous Wastes Managed
- C. Description of Hazardous Waste Management Units

II. Selecting Waste Analysis Parameters

- A. Criteria and Rationale for Parameter Selection
- B. Special Parameter Selection Requirements

III. Selecting Sampling Procedures

- A. Sampling Strategies and Equipment
- B. Sampling Preservation and Storage
- C. Sampling QA/QC Procedures
- D. Health and Safety Protocols

IV. Selecting a Laboratory, and Laboratory Testing and Analytical Methods

- A. Selecting a Laboratory
- B. Selecting Testing and Analytical Methods

V. Selecting Waste Re-Evaluation Frequencies

VI. Special Procedural Requirements

- A. Procedures for Receiving Wastes From Off-Site Generators
- B. Procedures for Ignitable, Reactive, and Incompatible Wastes
- C. Procedures To Ensure Compliance With LDR Requirements

[Note: Figures and tables can be found after the text portion of each respective sample WAP.]

SAMPLE WAP #1 — GENERATOR ONLY

[Note: This is an example of what a generator's WAP would look like if a generator regulated under 40 CFR Part 262 elected to develop a WAP. As noted in Parts One and Two of this guidance manual, generators do not have a regulatory obligation to develop a WAP unless the generator is also involved in an activity for the treatment, storage, or disposal of hazardous waste regulated under 40 CFR Parts 264, 265, or 268 (i.e., 40 CFR §268.7). In addition, this sample WAP provides background data and information used in Sample WAPs #s 2, 3, 4, and 5.]

I. FACILITY DESCRIPTION

As discussed in Section 2.1 of this manual, the Facility Description section of your WAP should address the following areas:

- Description of the processes and activities used to generate or manage the wastes
- Identification/classification and quantities of hazardous wastes generated and managed
- Description of the hazardous wastes management units.

Each of these areas is discussed below.

A. Description Of Facility Processes And Activities

The overview of the facility processes should include a description of the types of products that are manufactured and the processes used to manufacture the products. A facility layout and a schematic showing the relationship between the operations and hazardous wastes that are generated should be included along with the narrative description. For example:

Thompson Manufacturing, Inc., is a semiconductor manufacturing company that produces small glass and metal electronic components used to make various models of toy dolls and trucks. There are three processes that generate wastes, as follows:

- *Operation A: Clean Room Operations*
- *Operation B: Parts Preparation*
- *Operating C: Painting.*

These three processes and the solid and hazardous wastes that they generate are illustrated in Figure 4-1, and described below:

Operation A: Clean Room Operations involve processing small glass parts by etching these parts with hydrofluoric acid (HF) jet guns, making indentations and holes in the parts in accordance with the manufacturing design criteria.

Operation B: Parts Preparation involves three activities: (1) electroplating chromium onto nickel parts, (2) machining the parts into desired shapes and lengths, and (3) parts drying. Electroplating involves taking small nickel metal parts and dipping them in acid solutions containing chromium and running an electric current through the solution, thereby allowing the chromium to become plated onto the nickel parts. Electroplating generates waste acids that are sent to the wastewater treatment facility that discharges

under an NPDES permit. The parts are removed from the plating baths and sent to parts cutting. The parts are cut into desired shapes and lengths using lathes and other heavy machinery. Machining activities generate waste cutting oils. Finally, the metal parts are dried by dipping the parts into solvent baths and allowing the parts to dry in the air drying chambers. Parts drying activities generate waste solvents.

Operation C: Painting involves the formulation of various grade paints for industrial applications. The paint is a water reducible paint containing 5% organics. Off-specification paints and sludge process residues are removed daily and placed into dedicated waste drums. Piping and paint mixing basins associated with the process are cleaned weekly with acetone.

A detailed facility engineering drawing of these processes is provided [Note: A facility drawing is not included in this sample WAP.]

In addition, the WAP should include, a brief description of the waste handling activities that occur on site. For example:

Wastewaters are piped directly to the on-site wastewater treatment facility which discharges under an NPDES permit. The other wastes are collected from operations A, B, and C in 55-gallon accumulation drums located in the process area. The drums are pre-labeled so that operators will place the wastes in the correct drum. Each day these drums are collected and transferred to the temporary container storage area where wastes are staged prior to shipment off site. Upon receipt at the container storage area, a random number of drums are inspected against the waste profile data that has been developed for each wastestream to see if the waste appears to match the description on the waste profile sheet. A sample of this waste profile sheet was provided in Table 2-11.

B. Identification/EPA Classification And Quantities Of Hazardous Wastes Generated

Wastes that are generated at Thompson Manufacturing, Inc., should be described in detail in this section. We have provided a sample list in Table 4-8. A narrative discussion of each column should accompany this type of table. For example, the discussion of chemical analysis (column 7) and applicable LDR treatment standard (column 8) might read as follows:

Laboratory analysis has indicated that the concentration of many constituents of the waste (e.g., trichlorofluoromethane, CN, Cd, Cr, Pb, Ni, acetone, Hg, and Pb) as provided in column 7 of Table 4-8 exceed LDR treatment standards provided in column 8. Consequently, these wastes will be sent off site, with appropriate LDR notification, for treatment and disposal.

C. Description Of Hazardous Waste Management Units

Because Thompson Manufacturing, Inc., is strictly a generator pursuant to 40 CFR Part 262, there are no permitted hazardous waste management units at this facility.

You should, however, briefly describe the wastewater treatment plant, and the sludge press, including its waste feed locations and sludge output locations. For example, you might address whether:

- The sludge is collected in a hopper

- The sludge hopper is protected from precipitation
- Procedures are in place to ensure that the wastes will be shipped off site within 90 days.

Because wastes are temporarily stored prior to being sent off site to a TSDF, you should also include a description of the physical and chemical properties of the drum storage area and drum storage arrangements so that compatibility considerations necessary for safe storage can be adequately addressed. In addition, you should discuss the procedures for receiving wastes at the drum storage area. For example, the following information might be included:

The temporary drum storage capabilities for Thompson Manufacturing are limited by the amount of space available for holding drums and the spill containment capacity of the area. Approximately twenty, 55-gallon drums may be maintained on site in the storage area at any given time, in one of the three containment areas. The storage pad consists of a lined concrete slab with three spill containment areas of 60 gallons each (more than 10 percent of the total capacity of the seven drums that can be stored in each area, but equal to the capacity of one drum). One compartment shall be used exclusively for waste hydrofluoric acid (D002), another for electroplating wastewater treatment sludges (F006), and the remaining compartment for the solvent (F002, F003) and waste paint residues (D008, D009). The storage area is sheltered and maintained at 60 degrees Fahrenheit to minimize waste storage problems associated with climatic variations. Daily inspections of the storage area are conducted to ensure that container integrity is maintained.

The 55-gallon drums are used to contain the hazardous wastes generated from Thompson Manufacturing's clean room, parts preparation, and painting operations. For each respective operation, Department of Transportation (DOT) specification drums were selected based on the physical and chemical properties of the wastes to be managed. Specifically, DOT specification 17E closed head and DOT specification 17C open head drums are used to store liquid (solvents, corrosives) and solid (F006, toxic paint sludges) wastestreams, respectively. For noncorrosive wastestreams, including toxic metals and solvents, metal drums are used for temporary waste accumulation. Conversely, acid wastes generated from glass etching and electroplating are stored in polyethylene drums to minimize risks of rupture or leakage. Incompatible wastes will be separated by a containment wall to prevent mixing if drums leak or break.

II. SELECTING WASTE ANALYSIS PARAMETERS

As discussed in Section 2.2 of this manual, this section of your WAP should address the following areas:

- Criteria and rationale for parameter selection
- Special parameter selection requirements.

A. Criteria And Rationale For Parameter Selection

Generally, waste parameters are selected based on three categories:

- Waste identification
- Identification of incompatible/inappropriate wastes
- Process and design considerations.

An example of what information can be provided in this section includes:

Since our facility's operating constraints are only physical (the amount of available waste storage and spill containment capacity), the waste analysis parameters that must be measured are those associated with confirming the identification/classification and compatibility of the wastes.

To facilitate waste identification and parameter selection, we have reviewed 40 CFR 261, Appendix VII - Basis for Listing Hazardous Wastes (i.e., F002, F003, F006, D002, D008, and D009) — for the hazardous wastes generated by Thompson Manufacturing. The results of this evaluation were cross-referenced with chemical analyses of the wastes performed by an independent laboratory (Buchanan Laboratory) to identify our wastes and the parameters, and the associated rationale, necessary to ensure proper waste management.

Based on our in-depth knowledge of the raw materials and physical/chemical processes of each of Thompson Manufacturing's activities, as well as analytical results, the parameters that were selected to confirm accurate waste identification (including those identified in the 40 CFR Part 261 Appendix VIII, hazardous constituents) for each hazardous waste are illustrated in column 7 of Table 4-8. (Table 4-9 presents the rationale for select parameters.) To ensure complete characterization of listed wastes for compliance with the LDR regulations, knowledge of the process, and where necessary, testing has been used to determine if the hazardous wastes exhibit any of the four characteristics (i.e., ignitability, corrosivity, reactivity, and toxicity characteristic (TC)). Results of these characteristic determinations also provide the necessary information to verify that appropriate compatibilities are maintained during waste storage.

The wastes generated by Thompson Manufacturing must be amenable to safe storage in 55-gallon drums for up to 90 days. The wastes we generate meet this criterion because: 1) the storage drums were selected to be compatible with each respective wastestream that we generated, and 2) our manufacturing processes yield wastestreams that exhibit minimal variability in composition.

B. Special Parameter Selection Requirements

This section of your WAP should include any sampling, analytical, and procedural methods that will be used to comply with specialized waste management requirements established for waste management units. For example:

As stated previously under the facility description portion of this WAP, each type of wastestream (e.g., corrosive, spent solvent) will only be accumulated with wastes of identical process origin. However, since incompatibilities may arise from mixing corrosives with cyanide-bearing F006 wastes, separate color-coded waste drums will be used as a precautionary measure to ensure that corrosives are isolated. In addition, a short-turn-around-time cyanide test (see sample analysis testing procedures below) will be performed for each batch of F006 waste to be transferred to the on-site storage area. Any F006 waste exhibiting a cyanide concentration of greater than 150 mg/kg will be stored in a special isolated area until off-site shipment can be arranged. This additional safety measure will minimize the

III. SELECTING SAMPLING PROCEDURES

As discussed in Section 2.2 of this manual, this section of your WAP should address the following areas:

- Sampling strategies and equipment
- Sample preservation and storage
- Sampling QA/QC procedures
- Health and Safety Protocols.

A. Sampling Strategies And Equipment

This section should discuss how you will obtain a representative sample of each wastestream, including the sampling strategy and sampling equipment. For example:

We sample one drum per wastestream from each process area since: 1) we generate relatively small volumes of waste, and 2) the waste has a very low potential for varying in composition within each process area, as verified through historical analysis. Specific waste sampling methods, equipment, and sample handling procedures to be used for each of Thompson Manufacturing's wastes are illustrated in Table 4-10.

B. Sample Preservation And Storage

This section should discuss the sampling preservation, if applicable, and storage techniques you will use to ensure the integrity of the sample. Site-specific sample language for the sampling preservation and storage requirements, however, are not provided in Sample WAP #1 because this information was covered extensively in Section 2.3.

C. Sampling QA/QC Procedures

This section should include a description of the process used to ensure that all data collected is of high quality. For example:

All sampling conducted for the purpose of characterizing wastes generated by Thompson Manufacturing will use appropriate QA/QC procedures, including chain-of-custody from sample collection through delivery to the analytical laboratory, and compatible storage containers. Additionally, Thompson Manufacturing will limit the number of personnel who perform sampling to two individuals to ensure the highest levels of consistency and accuracy. Both individuals receive annual training in the proper use of sampling and analysis equipment identified in Table 4-10 and Table 4-11.

D. Health And Safety Protocols

This section is not required to be included in a WAP but is included in Sample WAP #1 to emphasize that because the WAP may function as a stand-alone document, all information pertaining to health and safety protocols and procedures appropriate to WAP activities should be included. For example:

During all sampling activities, precautions will be taken to ensure that drums do not expel gases and/or pressurized liquids. All personnel will be properly trained in safety and handling techniques.

Subsequent sample APs will not include a Health and Safety Protocols section.

IV. SELECTING A LABORATORY, AND LABORATORY TESTING AND ANALYTICAL METHODS

As discussed in Section 2.2 of this manual, this section should address how you will:

- Select an analytical laboratory
- Select testing and analytical methods.

A. Selecting A Laboratory

This section should discuss the criteria you have used to select a laboratory (see Section 2.4.1 of this manual). For example:

We have selected Buchanan Laboratory to perform all of the detailed quantitative chemical analyses specified in our WAP. In particular, this laboratory has:

- *A comprehensive QA/QC program*
- *Technical analytical expertise*
- *An effective information system.*

B. Selecting Testing And Analytical Methods

This section should discuss how reliable analytical testing data is going to be obtained. For example:

The selection of analytical testing methods for the wastestreams generated by Thompson Manufacturing was based on the following four considerations:

- *Physical state of the waste (e.g., viscous sludge)*
- *Analytes of interest (e.g., acetone)*
- *Required detection limits (e.g., regulatory thresholds)*
- *Information requirements (e.g., verify compliance with LDR treatment standards, waste classification).*

Collectively, these factors contributed to the selection of the analytical procedures designated in Table 4-11. In the event that Thompson becomes subject to new regulatory requirements, additional testing methodologies will be incorporated into Table 4-11 as appropriate.

V. SELECTING WASTE RE-EVALUATION FREQUENCIES

As discussed in Section 2.5 of this manual, this section should discuss how you will ensure that your data are accurate and up-to-date. For example:

In accordance with the requirements of the off-site TSDFs used to treat and/or dispose of our hazardous wastes, semi-annual samples will be taken from each process at Thompson

Manufacturing for the purposes of conducting comprehensive physical and chemical analyses. This information will be used to determine the appropriateness of current waste handling, storage, and characterization regimes. Specifically, these wastes will be subjected to the appropriate tests (several of these are specified in Table 4-11).

VI. SPECIAL PROCEDURAL REQUIREMENTS

As discussed in Section 2.6 of this manual, this section should address:

- Procedures for receiving wastes from off-site generators
- Procedures for ignitable, reactive, and incompatible wastes
- Procedures to ensure compliance with LDR requirements.

A. Procedures For Receiving Wastes From Off-Site Generators

Ordinarily, this section should describe waste acceptance procedures. However, since Thompson Manufacturing does not receive wastes from off-site generators, no additional procedures are applicable to the receipt of off-site wastes.

B. Procedures For Ignitable, Reactive, And Incompatible Wastes

This section should address procedures that ensure safe management of wastes. For example:

Thompson Manufacturing has instituted a rigorous analytical program to provide information concerning a waste's ignitability, reactivity, or incompatibility prior to treatment. Specifically, wastes are evaluated against applicable hazardous waste characteristics to determine the presence of potentially ignitable, reactive, or incompatible wastes that may damage the treatment process and/or associated facilities/personnel. Ignitability data will be obtained by using process knowledge and the appropriate Setaflash open or closed cup apparatus for the given liquid hazardous waste. Potential reactivity characteristics will be assessed through the use of process knowledge and, for cyanide containing wastes, by applying EPA SW-846 Method 7.3.3.2 to determine the amount of free cyanides released when the waste is exposed to pH conditions of 2.0. Any wastes identified as having a potential to liberate greater than 150 mg/kg of cyanide will be segregated from all other wastes and stored in a specially bermed drum storage cell.

In addition to determining whether wastes designated for treatment exhibit hazardous characteristics, such as ignitability and reactivity, wastes may be subject to a compatibility evaluation. This evaluation uses the procedures delineated in the EPA document entitled "Design and Development of a Hazardous Waste Reactivity Testing Protocol," February 1984, EPA 600/2-84-057. These test procedures are used to classify wastes based on gross chemical composition for designation according to specific reactivity groups. A flowchart representing the procedures to classify the waste as acid, base, oxidizing, reducing, reactive, and primarily organic or inorganic is shown in Figure 4-2.

The results of the testing procedures yield reactivity group designations (See Figure 4-3). These designations are subsequently used in the compatibility matrix in Figure 4-3 to determine the potential effects of mixing the waste with wastes of other reactivity groupings likely to be encountered. In cases where incompatibility is indicated (or compatibility cannot be proven), the waste will be handled as incompatible and will be ineligible for common storage. We will maintain this type of information for each wastestream generated.

C. Procedures To Ensure Compliance With LDR Requirements

This section should discuss the applicable LDR requirements and how these requirements will be satisfied. For example:

Solid wastes may require off-site treatment if they are determined to be listed wastes (e.g., F006) or if they exhibit hazardous characteristics. In accordance with the LDR regulations (40 CFR Part 268), wastes shipped off site may need to be analyzed to determine whether the waste meets the applicable LDR treatment standards contained in 40 CFR Part 268, Subpart D. Testing will be conducted only to certify that the waste meets LDR treatment standards. If it is known that the wastes do not meet applicable LDR treatment standards based on process knowledge, no testing is necessary. Each waste for which a treatment standard has been set will be evaluated for the applicable parameters in 40 CFR Part 268, Subpart D. All analytical results completed in support of LDR requirements will be retained within the facility operating record.

Wastes resulting from facility operations that exceed applicable LDR treatment standards will be sent off site to a permitted treatment facility. LDR notifications will be supplied with the shipment of waste with the information required under 40 CFR §268.7. In addition to the LDR notification, any additional data for the wastestream (e.g., Waste Profile Sheet, analytical data) will be provided to the designated treatment facility.

All wastes, if any, that are determined through analysis to meet treatment standards as specified in 40 CFR Part 268, Subpart D will be land disposed in a permitted facility without further treatment. An LDR certification, including all analytical records to support the certification, will be prepared and accompany the shipment of waste to the receiving facility.

**FIGURE 4-1
Thompson Manufacturing, Inc.
Waste Generation Scenario**

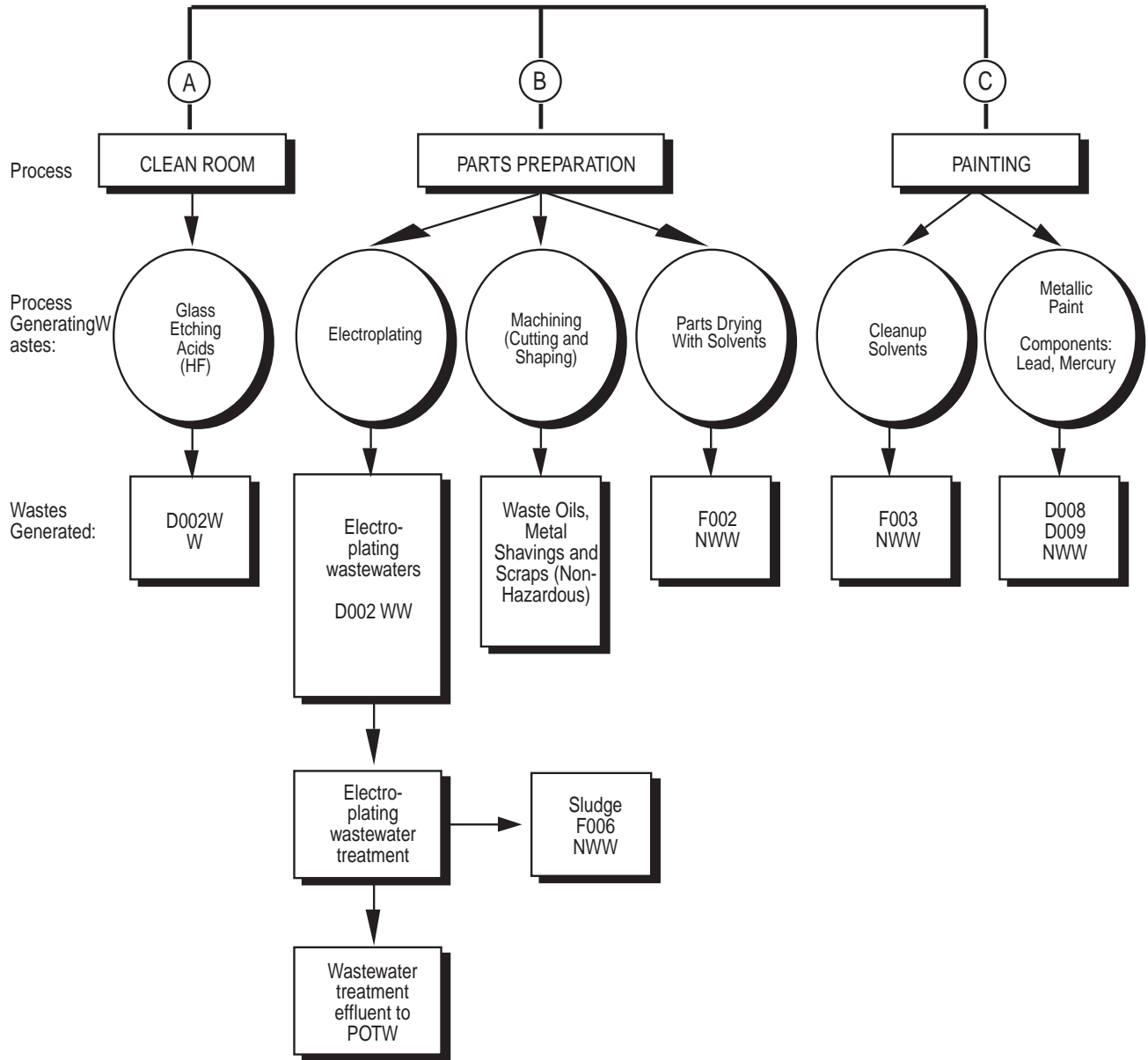

**TABLE 4-8
Thompson Manufacturing, Inc.
Identification/EPA Classification Of Hazardous Wastes Generated**

①	②	③	④	⑤	⑥	⑦	⑧		
WASTES GENERATED	PROCESS GENERATING THE WASTE	BASIS FOR HAZARD CLASSIFICATION	EPA WASTE CODE	HAZARDOUS PROPERTIES OF WASTES	LDR		CHEMICAL ANALYSIS ¹	LDR TREATMENT	
					NWW	WW	Original Waste	Treatment Standard ²	Designated Treatment Facility
Solvent waste	Parts preparation	Knowledge/testing	F002	Toxic	X		45% Trichlorofluoromethane	33	Sparky Incinerator
Waste water treatment sludge	Electroplating	Knowledge/testing	F006	Toxic, potentially reactive	X		CN 170	CN (total) ³	Solid Stabilization
							Cd 210	CN (amenable) ⁴	
							Cr 1,500	Cd 0.066	
							Pb 580	Cr 5.2	
							Ni 1,100	Pb 0.51	
Ag <DL ⁵	Ni 0.32								
							Ag 0.072		
Paint cleanup solvent waste	Painting process	Knowledge/testing	F003	Ignitable	X		Pure Acetone	160	Sparky Incinerator
Paint sludge	Painting process	Testing	D008, D009	Toxic	X		Pb 460	Pb 5	Solid Stabilization
							Hg 120	Hg 0.2	
Glass etching waste	Clean room operation	Testing	D002	Highly corrosive pH = 1.2		X	35% HF pH = 1.2	Deactivation	Corrosive Neutralization

¹ Represents the highest values detected in 50 samples. The values reported for metals are for the TCLP extract in mg/l. The values reported for other parameters are from total waste analysis in mg/kg.

² This standard must be achieved to meet LDR treatment standards, if applicable. The LDR treatment standards for metals are for the constituent concentrations in the TCLP extract of the waste in mg/l. All other standards are the concentration in the total waste analysis in mg/kg.

³ LDR treatment standard value for F006 in WWTP sludge is 590 mg/kg.

⁴ LDR treatment standard value for F006 in WWTP sludge is 30 mg/kg.

⁵ DL = Detection Limit (0.01 mg/l).

TABLE 4-9
Thompson Manufacturing, Inc.
Examples Of Criteria And Rationale For Selected Parameters For Wastes Generated

WASTE	WASTE PARAMETER(S)	RATIONALE FOR SELECTION
D002 (Hydrofluoric acid)	- Corrosivity (pH and steel degradation test)	Used to determine compatible sampling and storage equipment
F006 (Wastewater Treatment Sludge)	- Free Cyanides	Used to determine reactivity group number and levels of cyanides in wastes. (Wastes with >150 ppm cyanide will be stored separately from all other wastes)
	- Metals (Ag, Cd, Cr, Ni, Pb)	Used to verify conformance with applicable treatment standards.

TABLE 4-10
Thompson Manufacturing, Inc.
Examples Of Waste Sampling Methods, Equipment, And Procedures ¹

WASTE DESCRIPTION	SAMPLE COLLECTION METHOD	SAMPLING EQUIPMENT	SAMPLE PRESERVATION AND STORAGE
Hydrofluoric Acid Waste (D002)	Specific drums to be sampled will be selected using the sampling method for containers as described in SW-846, Section 9.2.3 (grab samples taken)	Polyethylene Coliwasa (inert to hydrofluoric acid)	None required, immediate analysis conducted
Spent Solvents (F002, F003)	Specific drums to be sampled will be selected using the sampling method for containers as described in SW-846, Section 9.2.3 (grab samples taken)	Glass Coliwasa (inert to chlorinated organics)	Storage in 250 ml amber glass containers with teflon-lined caps at 4 degrees Celsius prior to analysis
Paint Sludges (D008, D009)	Specific drums to be sampled will be selected using the sampling method for containers as described in SW-846, Section 9.2.3 (grab samples taken)	Glass dipper (due to high viscosity, semi-solid physical nature of the waste)	Storage in 250 ml amber glass containers with teflon-lined caps at 4 degrees Celsius prior to analysis
Electroplating Wastewater Treatment Sludge (F006)	Specific drums to be sampled will be selected using the sampling method for containers as described in SW-846, Section 9.2.3 (grab samples taken)	Glass dipper (due to high viscosity, semi-solid physical nature of the waste)	Storage in 250 ml amber glass containers with teflon-lined caps at 4 degrees Celsius prior to analysis

¹ Residues from sampling and analysis are subject to the waste identification requirements of 40 CFR 262.11 (hazardous waste determination), and depending on that determination may be subject to LDR requirements.

TABLE 4-11
Thompson Manufacturing, Inc.
Examples Of Testing/Analytical Methods For Wastes Generated

WASTE DESCRIPTION	SAMPLE EXTRACTION/ PREPARATION METHOD	TESTING/ANALYTICAL METHOD
Hydrofluoric Acid (D002)	N/A	<ul style="list-style-type: none"> • Corrosivity [SW-846, Method 9040 (pH meter)]
Spent Solvents (F002, F003)	SW-846, Method 5030 as incorporated into SW-846, Method 8240	<ul style="list-style-type: none"> • ASTM - D891, Method A for specific gravity ² • ASTM Method D-3278 for ignitability • SW-846, Method 8240 for acetone and methylene chloride
Paint Sludges (D008, D009)	Toxicity Characteristic Leaching Procedure (TCLP) (SW-846, Method 1311 followed by SW-846, Method 3010 for lead only)	<ul style="list-style-type: none"> • SW-846, Method 6010 for lead, 7470 for mercury
Electroplating Wastewater Treatment Sludge (F006)	Initial analysis of reactivity (cyanide) using SW-846, Section 7.3.3.2. ¹ If the waste does not meet the definition of reactivity, SW-846 Method 3050 is used to prepare samples for metals analysis.	<ul style="list-style-type: none"> • SW-846, Method 6010 for lead; SW-846, Method 7421 issued for cadmium, chromium, nickel, and silver

¹ F006 waste samples are tested for reactivity because if any samples exhibit the characteristic of reactivity, they are subject to special handling procedures (containment laboratories) to ensure minimal employee exposure to toxic fumes during metals analysis.

² Specific gravity is measured to ensure that wastes are monophasic.

FIGURE 4-2
Sequence Of Procedures Sets For Determining Reactivity Group¹

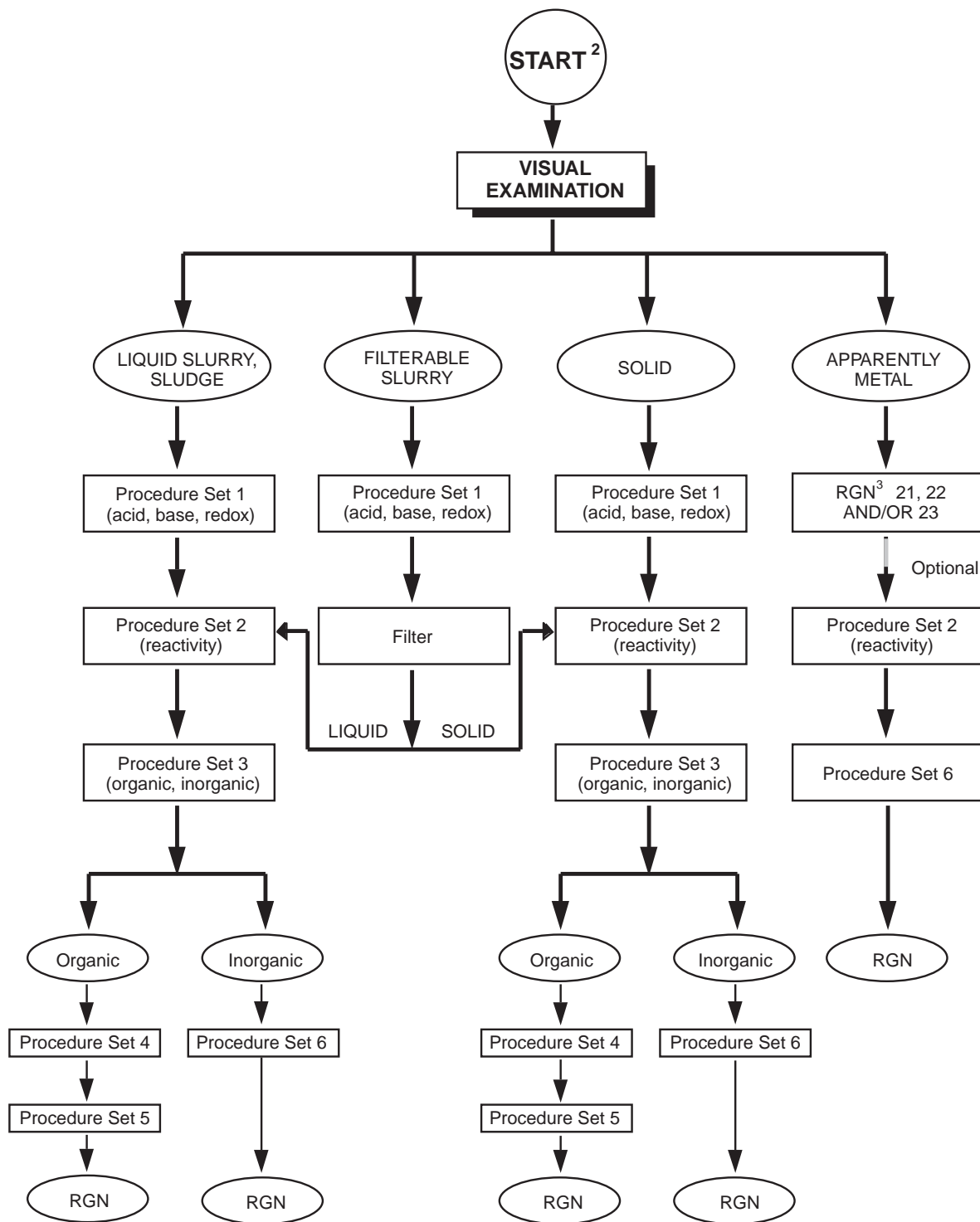

¹ Procedure sets are identified in EPA's "Design and Development of a Hazardous Waste Reactivity Testing Protocol" (EPA 600/2-84-057, February 1984).
² Based upon its knowledge of the waste, a generator may only need to use parts of the following sequence to confirm the generator's knowledge of the material.
³ RGN = Reactivity Group Number.

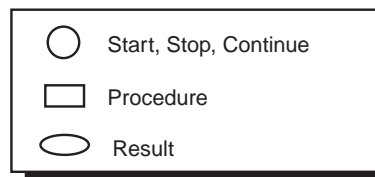

**SAMPLE WAP #2 — GENERATOR TREATING TO MEET
LDR TREATMENT STANDARDS**

Sample WAP #2 is designed to assist generators who are treating to meet LDR treatment standards in units regulated under 40 CFR §262.34 (i.e., accumulation tanks, containers, and containment buildings) and therefore are required to develop WAPs pursuant to 40 CFR §268.7(a)(4). While generators who treat waste in exempt units, such as elementary neutralization units, are not specifically required to develop and maintain WAPs, many such generators will elect to develop a WAP as a practical precautionary measure. Developing a voluntary WAP will assist the generator in fully characterizing the properties and physical/chemical makeup of the waste. In addition, following a detailed WAP will assist generators in monitoring for any underlying hazardous constituents in their ignitable (D001) or corrosive (D002) wastes. (See discussion of interim final rule on ignitable and corrosive wastes on pp. 1-15 and 1-16). In Sample WAP #2, Thompson Manufacturing neutralizes a D002 waste in an elementary neutralization unit. Because Sample WAP #2 is designed to assist both generators who are required to develop WAPs and generators who voluntarily develop a WAP, in the following scenario Thompson Manufacturing elects to follow the generator standards in 40 CFR §262.34 for the elementary neutralization unit, and thus chooses to develop and follow a voluntary WAP, although this is not specifically required.

*[Note: You should review Sample WAP #1 before reviewing this sample WAP to obtain the requisite background information. Only information unique to this scenario will be included in this sample WAP; for example, under this scenario only hydrofluoric acid wastes will be addressed. **In addition, except as necessary for clarity, only sample language is provided in this and subsequent sample WAPs.** Explanatory text can be reviewed in Sample WAP #1.]*

I. FACILITY DESCRIPTION

A. Description Of Facility Processes And Activities

The facility description for this scenario, including waste handling procedures, is identical to that provided in Sample WAP #1 with the following additional information regarding treatment of hydrofluoric (HF) acid wastes. Under this scenario:

Hydrofluoric (HF) acid waste generated during glass etching processes will be transferred from the satellite accumulation areas regulated under 40 CFR §262.34(c) to an on-site treatment tank apparatus in compliance with the accumulation provisions of 40 CFR §262.34(a). Neutralization of the acid wastes will be conducted in a 200-gallon polyethylene tank and will be conducted within the 90-day accumulation period afforded large quantity generators. As a result, Thompson Manufacturing is not required to obtain a hazardous waste treatment, storage, and disposal permit provided that: 1) treatment activities are limited to 40 CFR §262.34 accumulation tanks, containers, or containment buildings or an exempt unit such as an elementary neutralization unit or wastewater treatment unit; and 2) treatment of hazardous wastes is accomplished within the 90-day allowable accumulation period (for units regulated under §262.34) (refer to Figure 4-4).

B. Identification/EPA Classification And Quantities Of Hazardous Wastes

The identification/EPA classification of hazardous wastes (e.g., glass etching wastes) is provided in Table 4-12. Thompson treats the HF acid waste on site using neutralization to pH 7.1 to meet LDR treatment standards.

C. Description Of Hazardous Waste Management Units

You should describe the design and construction of the treatment tanks as well as provide an overview of the processes involved in the treatment. For example:

The central accumulation tank apparatus used by Thompson Manufacturing is schematically depicted in Figure 4-5. Tank construction consists of steel-reinforced polyethylene with special resistance to highly corrosive materials, both acidic and alkaline. The tank is equipped with inlet and outlet piping as well as a large top port for tank maintenance and waste sampling. Additionally, the tank has sludge removal ports that can be easily accessed to remove any precipitation sludges arising from neutralization activities. Ancillary pumping and mixing equipment is constructed of corrosion-resistant materials, primarily polyethylene.

HF acid waste from clean room operations is stored in accordance with the satellite accumulation provision of 40 CFR §262.34(c) in 25-gallon polyethylene DOT 17E closed head drums. When approximately 20 gallons of waste are accumulated, the drum is transferred by dolly to the facility's central accumulation tank. The waste is pumped into the accumulation tank using a low horsepower portable liquid pump inert to corrosive materials. The transfer area has a cement berm, coated with an epoxy that is resistant to HF acid, capable of containing 100 gallons. The addition of waste to the central accumulation storage tank is recorded according to date, time, and volume in the operating log for the tank. Through the use of this operating document, Thompson tracks the amount of waste being accumulated and the relative time on site to ensure that the 90-day accumulation period is not exceeded.

When the central accumulation tank has reached 50% capacity (approximately every 45 days), neutralization of the corrosive waste is initiated. Facility personnel create an alkaline slurry (pH of approximately 11-12) amenable to pumping by mixing 50 gallons of water with one-half drum of caustic soda in a 100-gallon polyethylene mixing basin. This alkaline slurry is pumped into the accumulation tank at a constant rate of 0.5 gallons per minute. Neutralization is monitored with a corrosion-resistant combination pH meter/agitator. Addition of the alkaline slurry is continued until the pH of the waste in the accumulation tank reaches and maintains equilibrium at a pH of 7. Subsequent to neutralization, duplicate grab samples are taken from the accumulation tank, one through the top sampling port and another through the discharge outlet sampling port. (See Figure 4-5.) After a 24- to 36-hour waiting period to allow for sample analysis, wastewaters are discharged to an on-site storage tank if a pH of 7 +/- 0.5 is maintained and no other hazardous characteristics are exhibited. The volume and date of waste discharge is recorded in the operating record for the central accumulation tank.

II. SELECTING WASTE ANALYSIS PARAMETERS

A. Criteria And Rationale For Parameter Selection

HF acid wastes generated by Thompson Manufacturing must be amenable to safe accumulation in tank storage for a 90-day period. Because of the uniform concentration and monophasic nature of these wastes, the primary waste analysis parameter of concern is corrosivity. As a result, pH measurements are taken during all facets of waste handling to ensure that facility personnel handle these wastes in a safe manner (HF acid is particularly dangerous to the health and safety of employees who handle the wastes) and recognize potential compatibility concerns. To supplement testing data, we have researched the corrosive properties associated with HF acid and have selected tank and handling materials

capable of ensuring its proper containment, thereby protecting personnel and the environment.

Aside from corrosive waste concerns, Thompson's treatment processes result in the generation of salt precipitates which are formed during acid neutralization. These precipitates have been tested and do not exhibit any hazardous waste characteristics. Thompson removes all precipitates from the central accumulation tanks for analysis once every 90 days for measurements against the hazardous characteristics contained in 40 CFR §§261.21-.24. When applicable, Thompson sends the precipitates off-site for treatment for F039 underlying hazardous constituents.

Since the operating limitations associated with Thompson Manufacturing's short-term waste storage are primarily the compatibility of HF acid with the tank materials and ancillary equipment, the rationale for the selection of all waste analysis parameters were based on the regulatory responsibility to ensure accurate waste classification and safe storage. To this end, a combination of our process knowledge and analytical testing yielded the inventory of hazardous constituents that must be verified to confirm the accuracy and consistency of Thompson Manufacturing's waste classification. Table 4-13 provides an overview of the parameters selected and the rationale for selection.

B. Special Parameter Selection Requirements

No special requirements are associated with quantifying the degree of corrosivity and related hazards during each phase of HF acid handling at the facility, including treatment activities.

III. SELECTING SAMPLING PROCEDURES

A. Sampling Strategies And Equipment

We sample HF acid wastes emanating from Thompson clean room operations at four different locations: 1) at satellite accumulation; 2) prior to transfer to the central storage/treatment tank; 3) in the accumulation tank after treatment has been achieved; and 4) immediately prior to discharge to the facility's on-site wastewater storage tank. Due to the low potential for phase separation and the uniformity of the acid waste as identified through extensive testing and historical records, random grab samples are used to characterize HF acid wastestreams (both treated and untreated). Refer to Table 4-10 for specific waste sampling methods, equipment, and sample handling procedures for HF acid waste.

B. Sample Preservation And Storage

There are no sample preservation requirements associated with the HF acid treatment process because all analyses are conducted immediately.

C. Sampling QA/QC Procedures

All sampling conducted for the purpose of characterizing wastes generated by Thompson Manufacturing will use appropriate QA/QC procedures, including chain-of-custody procedures from sample collection through delivery to the analytical laboratory, and compatible storage containers. Additionally, Thompson Manufacturing will limit the number of personnel who perform sampling to two individuals to ensure the highest levels of consistency and accuracy. Both individuals receive annual training in the proper use of applicable sampling and analysis equipment (e.g., pH meter).

IV. SELECTING A LABORATORY, AND LABORATORY TESTING AND ANALYTICAL METHODS

A. Selecting A Laboratory

We have selected Buchanan Laboratory to perform all of the detailed quantitative chemical analysis specified in our WAP. In particular, this laboratory has:

- *A comprehensive QA/QC program*
- *Technical analytical expertise*
- *An effective information system.*

B. Selecting Testing And Analytical Methods

The selection of analytical testing method for the HF acid wastestream generated by Thompson Manufacturing was based on the following four considerations:

- *Physical state of the waste*
- *Characteristic of interest (e.g., corrosivity)*
- *Required pH range*
- *Information requirements (e.g., verify compliance with LDR treatment standards, waste classification).*

Collectively, these factors contributed to the selection of the testing/analytical procedure designated in Table 4-11. In the event that Thompson becomes subject to new regulatory requirements, additional testing methodologies will be incorporated into Table 4-11 as appropriate.

V. SELECTING WASTE RE-EVALUATION FREQUENCIES

In accordance with the requirements of the disposal facility used by Thompson, semi-annual samples will be taken from the glass etching process at Thompson Manufacturing for the purposes of conducting comprehensive physical and chemical analyses. This information will be used to determine the appropriateness of current waste handling, storage, and characterization regimens. Specifically, these wastes will be subjected to the appropriate physical and chemical tests for fluoride and metals.

VI. SPECIAL PROCEDURAL REQUIREMENTS

A. Procedures For Receiving Wastes From Off-Site Generators

Since Thompson Manufacturing does not receive wastes from off-site generators, no procedures are applicable to the receipt of off-site wastes.

B. Procedures For Ignitable, Reactive, And Incompatible Wastes

All precautions for reactivity and incompatibility were addressed in Sample WAP #1. There are no additional procedures for managing and treating HF acid wastes.

C. Procedures To Ensure Compliance With LDR Requirements

Since Thompson is treating hazardous waste in tanks regulated under 40 CFR §262.34 to meet applicable LDR treatment standards, this WAP serves to document the facility's procedures for complying with the LDR rules. Specifically, Sections I-V described the procedures for obtaining representative samples of HF acid wastestreams, both before and after treatment. The results of pre-treatment waste analysis will determine the specific treatment process requirements, including NaOH addition and treatment time, necessary to appropriately deactivate HF acid wastes to meet the LDR treatment standards in 40 CFR 268 Subpart D. The results of post-treatment waste analysis will determine whether the hazardous characteristic (i.e., corrosivity) has been removed. The WAP has been filed with the appropriate EPA Regional Administrator in accordance with 40 CFR §268.7(a)(4)(ii).

In addition to the development of a WAP, Thompson will prepare appropriate LDR notifications and certifications for waste treated on site or sent to an off-site TSDF. Records of this documentation, including waste testing results, will be maintained for a minimum of five years.

FIGURE 4-4
Schematic Of Generator Treating In 90-Day Accumulation Tanks

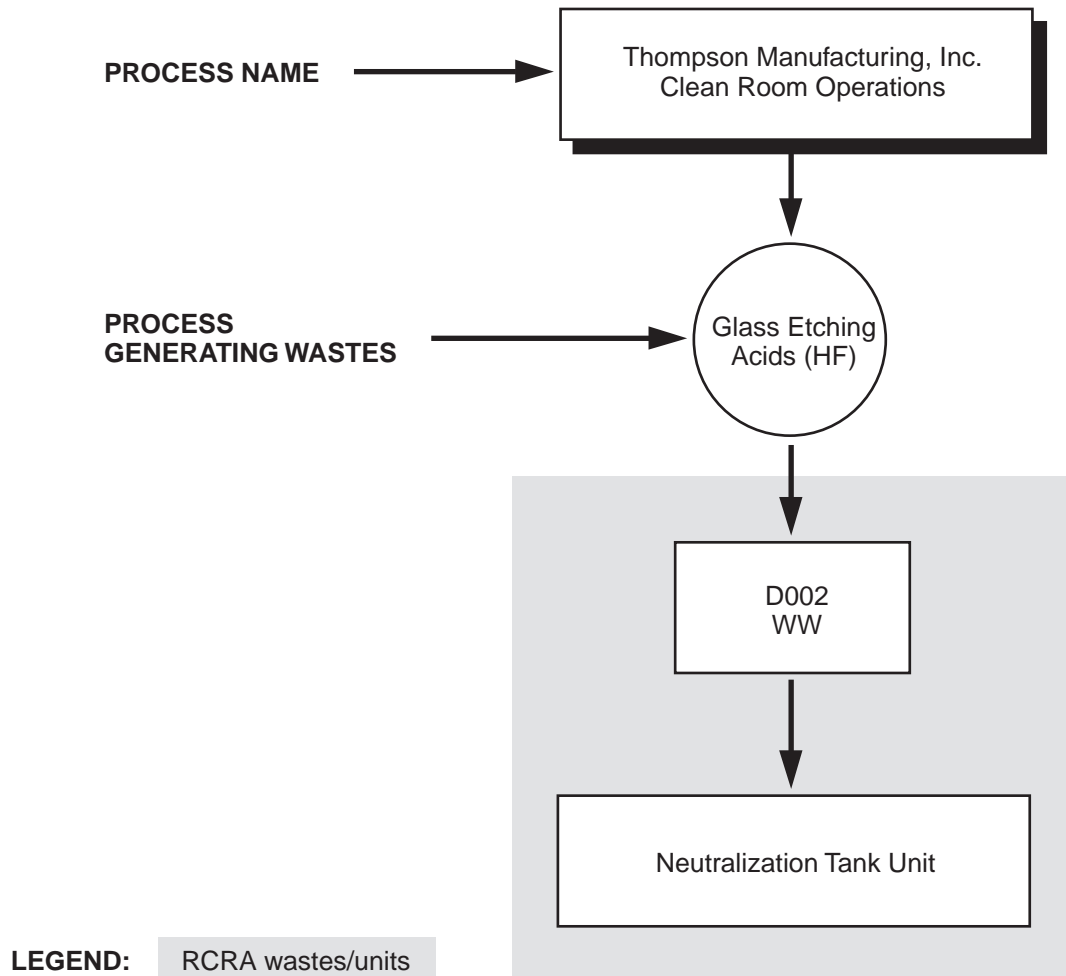

**TABLE 4-12
Thompson Manufacturing, Inc.
Identification/EPA Classification Of Hazardous Wastes Treated In Tanks**

①	②	③	④	⑤	⑥		⑦		⑧	
WASTE GENERATED	PROCESS GENERATING THE WASTE	BASIS FOR HAZARD CLASSIFICATION	EPA WASTE CODE	HAZARDOUS PROPERTIES OF WASTE	LDR		CHEMICAL ANALYSIS ¹		LDR TREATMENT	
					NWW	WW	Original Waste	Post Treatment	Treatment Standard ²	On-Site Treatment
Glass etching acid waste	Clean room operation	Testing	D002	Highly corrosive pH = 1.2		X	35% HF pH = 1.2	pH = 7.1	Deactivation	Thompson Manufacturing, Inc., as described in Section I.C

¹ Represents the highest values detected in 50 samples.

² This is the standard that must be achieved to meet LDR treatment standards.

TABLE 4-13
Thompson Manufacturing, Inc.
Criteria And Rationale For Selected Parameters For HF Neutralization Process

WASTE	WASTE PARAMETER(S)	RATIONALE FOR SELECTION
D002 (Hydrofluoric acid)	- Hydrofluoric acid concentration	Used to determine relative quantities of neutralizing agent needed to treat waste properly
	- pH - Corrosivity towards steel	Used to determine appropriate and compatible sampling, monitoring and storage equipment (tanks and containers)
Neutralized Acid Waste-waters	-pH	Used to determine acceptability of neutralized wastewaters for discharge from treatment tank to storage tank

FIGURE 4-5
Sample WAP #2 - Treatment Tank Apparatus
(Description Of Hazardous Waste Management Unit) ¹

4-30

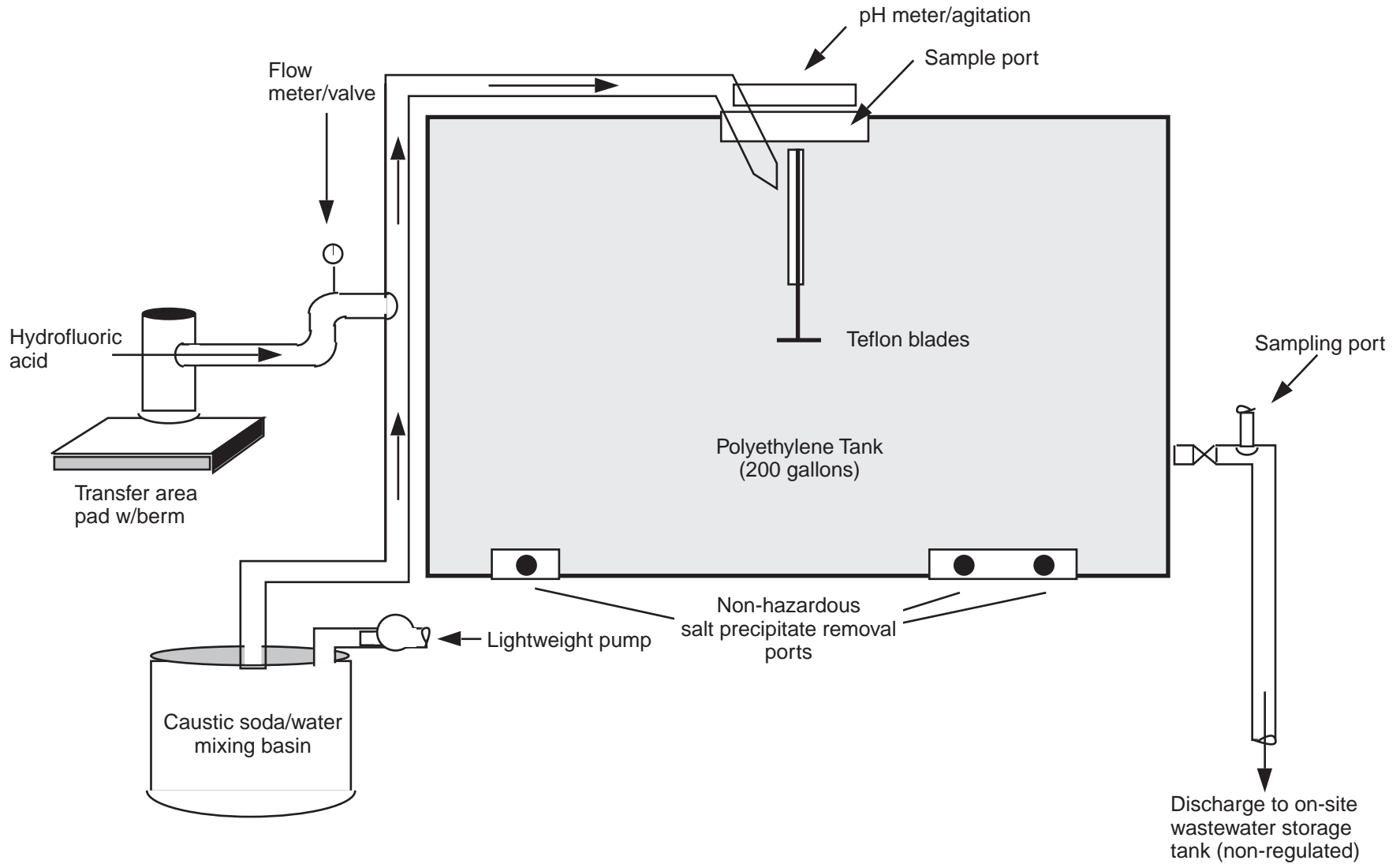

¹ Note that all storage and mixing tanks will be contained within a bermed area to contain a release in the event of tank failure.

SAMPLE WAP #3 — ON-SITE TREATMENT FACILITY (STABILIZATION UNIT)

[Note: You should read Sample WAP #1 before reviewing this sample WAP to obtain the requisite background information. Under this scenario, Thompson Manufacturing operations are the same as with Sample WAPs #1 and #2. Thompson, however, has determined that it can successfully treat, using stabilization/solidification (S/S), two wastestreams: the wastewater treatment plant sludge (F006) and paint wastes (D008 and D009). Thompson executives determined that they would apply for a treatment permit under RCRA. This sample WAP will address only the S/S unit for the WAP that is required in the RCRA permit application; in reality, Sample WAPs #2 and #3 would be merged into one WAP in the permit application. To conserve space, we have not gone into the level of detail that you would need to provide in your WAP.]

I. FACILITY DESCRIPTION

A. Description Of Facility Processes And Activities

The facility description under this scenario is identical to that provided in Sample WAP #1 with the additional information regarding treatment using Stabilization/Solidification (S/S) of WWTP sludge and paint wastes. We have presented this information in a process flow diagram in Figure 4-6. You should also include a narrative description of your facility's processes, including the pre-treatment and S/S treatment operations, in your WAP; or, at a minimum, reference where this information may be found in other parts of the permit application.

B. Identification/EPA Classification And Quantities Of Hazardous Wastes

Wastes generated from Thompson Manufacturing that will be treated in the S/S treatment unit are presented in Figure 4-6 and Table 4-14. The identity of the wastes during each stage of treatment is provided in Table 4-15. A discussion of each waste presented in the figures and tables should be provided in this section similar to what was discussed in Sample WAP #1. For example, if your WAP had Table 4-14, you might state:

The Basis for Hazard Classification (in Table 4-14, column 3) is derived from process knowledge and testing. Process knowledge is based on knowledge that the waste is generated as described by the listing conditions and on screening the material safety data sheets (MSDSs) prior to accepting a purchasing agreement from a chemical or materials vendor for materials used in the manufacturing processes. The waste classification is also verified using the testing and analytical methods specified in this WAP in Table 4-16.

C. Description Of Hazardous Waste Management Units

Because, under this scenario Thompson is applying for a RCRA permit, the description of the hazardous waste management units applicable to the facility's permit application are also applicable to this WAP. Therefore, this section will include a description of all applicable units that are used to manage hazardous wastes. Unit descriptions should include:

- The drum storage accumulation area (discussed in Sample WAP #1)
- The S/S unit and all its component parts.

The S/S unit dimensions, size and throughput; S/S treatment chemicals and materials (e.g., lime, water); and the chemical reactions and products should be described here. For example:

The S/S unit comprises the following vessels located in a bermed area adjacent to the WWT plant (see Figure 4-7):

- *Paint waste holding tank (1,000 gal)*
- *Solids collection roll-off box (40 yd³)*
- *S/S treatment vessel (100 yd³)*
- *Chemical/materials holding tanks, such as:*
 - *Water tank (2,000 gal)*
 - *Lime tank (500 gal)*
 - *Hypochlorite tank (500 gal)*
 - *Cement (bentonite) tank (100 yd³).*

II. SELECTING WASTE ANALYSIS PARAMETERS

A. Criteria And Rationale For Parameter Selection

The criteria and rationale for selecting the parameters in Table 4-17 are:

- *The original waste, as generated*
- *Verification of treatment operations (in process)*
- *Determination of optimum mix ratios (during treatment)*
- *Verification that treatment was successful (post-treatment).*

At each stage of treatment, the operator will take a sample of the material and test it for critical treatment parameters pursuant to the tables listed above.

If the wastes do not meet the in-process S/S treatment operational limitations, adjustments will be made to the process until they are treated adequately. During treatment, the operator will take samples to determine whether the process is proceeding appropriately per the treatment quality control procedures. Upon completion of treatment, grab samples will be taken of each batch to assure treatment was successful.

Each batch will be sampled to verify the success of the treatment ...

B. Special Parameter Selection Requirements

There are no special parameter selection requirements for this on-site treatment unit.

III. SELECTING SAMPLING PROCEDURES

A. Sampling Methods And Equipment

Sampling methods and equipment include those presented in Table 4-10 in Sample WAP #1. In-depth descriptions of the sampling activities may also be necessary for:

- The frequency of each sampling activity at individual sampling locations

- The calibration and decontamination procedures associated with the sampling procedures.

We have not addressed all of these important issues in this sample WAP. Refer to Section 2.3 of this manual for an in-depth discussion.

B. Sampling Preservation And Storage

We will not present site-specific information for the sampling preservation and storage requirements since this information was covered extensively in Section 2.3.

C. Sampling QA/QC Procedures

All sampling conducted for the purpose of characterizing wastes generated and treated by Thompson Manufacturing will use appropriate QA/QC procedures, including chain-of-custody from sample collection through delivery to the analytical laboratory, and compatible storage containers. Additionally, Thompson Manufacturing will limit the number of personnel who perform sampling to two individuals to ensure the highest levels of consistency and accuracy. Both individuals receive annual training in the proper use of sampling and analysis equipment.

IV. SELECTING A LABORATORY, AND LABORATORY TESTING AND ANALYTICAL METHODS

A. Selecting A Laboratory

We have selected Buchanan Laboratory to perform all of the detailed quantitative chemical analyses specified in our WAP. In particular, this laboratory has:

- *A comprehensive QA/QC program*
- *Technical analytical expertise*
- *An effective information system.*

B. Selecting Testing And Analytical Methods

Examples of the selected testing and analytical methods to be used for S/S for this WAP scenario are provided in Table 4-16.

V. WASTE RE-EVALUATION

Table 4-18 provides a summary of the waste testing and analysis frequencies and methods for select parameters that might be used during the S/S treatment of Thompson's paint sludge wastes. (Additional parameters as found in Table 4-15 would also be applicable, as would equivalent data for the WWTP sludge post-treatment residues.) Table 4-18 addresses the waste re-evaluation frequency and testing methods for identification/classification of the original waste, the pre-treatment waste, during treatment waste, and post-treatment waste. This data is necessary to monitor treatment effectiveness and to comply with LDR requirements. For example, post-treatment data will be used to complete a Waste Profile Sheet prior to sending the wastes to an off-site landfill.

Per Section 2.5 of this manual, it is up to the individual facility, in consultation with regulators, to determine the appropriate frequency of re-evaluation. There is no set formula for establishing re-evaluation frequencies.

VI. SPECIAL PROCEDURAL REQUIREMENTS

A. Additional Procedures For Receiving Wastes From Off-Site Generators

Since Thompson does not receive wastes from off-site generators, no additional procedures are applicable to the receipt of off-site wastes.

B. Procedures For Ignitable, Reactive, And Incompatible Wastes

Thompson has instituted a rigorous analytical program to provide information concerning a waste's ignitability, reactivity, or incompatibility prior to treatment. Specifically, wastes are evaluated against applicable hazardous waste characteristics to determine the presence of potentially ignitable, reactive, or incompatible wastes that may damage the treatment process and harm associated facilities/personnel. Ignitability for liquids will be determined by using process knowledge and the appropriate Setaflash open or closed cup apparatus for the given liquid hazardous waste. For solids, ignitability will be based on process knowledge. Potential reactivity characteristics will be assessed through the use of process knowledge, and for cyanide containing wastes, by applying EPA method 7.3.3.2, to determine the amount of free cyanides released when the waste is exposed to pH conditions of 2.0. Any wastes identified as having a potential to liberate greater than 150 mg/kg of cyanide will be considered ineligible for treatment. Results of these analyses for original wastes, pre-treatment and post-treatment wastes are presented in Table 4-15.

In addition to determining whether wastes exhibit hazardous characteristics, such as ignitability, wastes are subject to a compatibility evaluation. This evaluation uses the procedures delineated in the EPA document entitled "Design and Development of a Hazardous Waste Reactivity Testing Protocol," February 1984, EPA 600/2-84-057. These test procedures are used to classify wastes based on gross chemical composition for designation according to specific reactivity groups. A general representation of the procedures to classify the waste as acid, base, oxidizing, reducing, reactive, and primarily organic or inorganic is shown in Figure 4-2 and Figure 4-3 in Sample WAP #1.

The results of the testing procedures described in EPA 600/2-84-057 yields a reactivity group designation (See Figure 4-3 in Sample WAP #1). Once a waste is designated, its reactivity group is subsequently compared against the compatibility matrix, Figure 4-3 in Sample WAP #1, to determine which wastes are compatible with each other. In cases where incompatibility is indicated (or compatibility cannot be proven), the waste will be handled as incompatible and sent off-site to an appropriate TSDF. We will maintain documentation of this type of information for each wastestream destined for treatment.

C. Procedures To Ensure Compliance With LDR Requirements

S/S treatment will be performed on the two wastestreams [i.e., WWTP sludge (F006) and paint waste residues (D008/D009)] in separate batch operations. Each treated wastestream will be

stored on site in a covered roll-off box and sent to Rottaway Landfill as a separate waste. All treatment equipment will be decontaminated prior to treating the other wastestream. Therefore, for LDR purposes, each wastestream is treated as an individual waste. In accordance with the LDR regulations (40 CFR Part 268), all treated wastes shipped off site will be analyzed to determine whether the waste meets the applicable LDR treatment standards contained in 40 CFR §§268.41-43. Each waste destined for off-site disposal will be tested for the applicable parameters in 40 CFR §§268.41-43 to ensure that accurate LDR notifications and certifications are provided. All analytical results completed in support of LDR requirements will be retained within the facility operating record.

Wastes resulting from S/S operations that exceed applicable LDR treatment standards will be either retreated until the numeric LDR standards are met or sent off site for further treatment to attain the numeric LDR standards. LDR notifications will be supplied with the shipment of waste with the information required under 40 CFR §268.7. In addition to the LDR notification, any additional data for the wastestreams (e.g., Waste Profile Sheets, analysis provided by Thompson Manufacturing) will be provided to the subsequent permitted TSDF.

The F006 wastes that are determined through analysis to meet treatment standards as specified in 40 CFR §§268.41-43 will be land disposed in a RCRA Subtitle C permitted facility without further treatment. An LDR notification and certification, including all analytical records to support the certification, will be prepared and will accompany the shipment of waste to the next receiving facility.

The D008/D009 wastes, treated separately, can be disposed of in a Subtitle D landfill if they are determined after treatment to have attained the LDR treatment standards and no longer exhibit any hazardous waste characteristics.

FIGURE 4-6
Thompson Manufacturing, Inc.
Schematic Of Waste Treatment Facility Using S/S Operations ¹

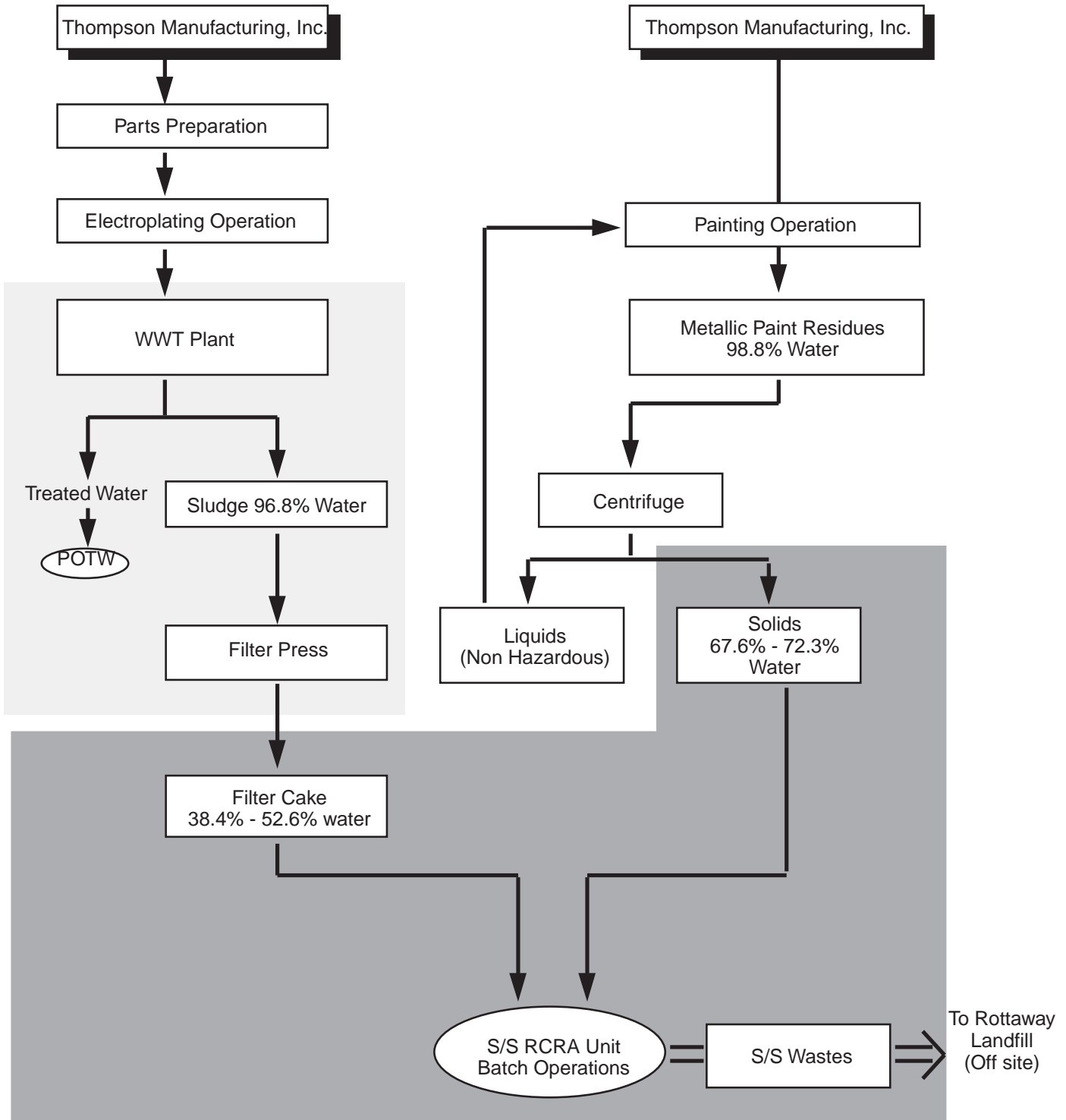

¹ You may choose to provide detailed engineering drawings.

- = RCRA exempt unit, per POTW discharge permit [40 CFR §261.4(a)(2), §264.1(g)(6), §265.1(c)(10)]
- = RCRA Regulations apply

**TABLE 4-14
Thompson Manufacturing, Inc.
Identification/EPA Classification Of Hazardous Wastes Treated Using S/S**

①	②	③	④	⑤	⑥	⑦	⑧	
WASTE GENERATED	PROCESS GENERATING THE WASTE	BASIS FOR HAZARD CLASSIFICATION	EPA WASTE CODE	PHYSICAL STATE OF WASTES	DESIGNATED STAGING AREA ON SITE	CHEMICAL ANALYSIS ¹	TREATMENT	
						Original Waste	LDR WW or NWW	Treatment Standard ³
WWTP Sludge	Wastewater Treatment	Process Knowledge/ Testing	F006	Solid (NWW)	Storage Area A	CN 170 mg/kg	NWW	CN (Total) ⁴
						Cd 210 mg/l		CN (amenable) ⁵
						Cr 1,500 mg/l		Cd .066
						Pb 580 mg/l		Cr 5.2
						Ni 1,100 mg/l		Pb .51
						Ag <DL ⁶		Ni .32
						pH = 8.0-10.0		Ag .072
						% H O = 38.4-52.6 ²		
						% organics <1%		
Paint Sludge	Painting Operations	Process Knowledge/ Testing	D008, D009	Solid (NWW)	Storage Area A	Pb 460	NWW	Pb 5
						Hg 120		Hg 0.2
						pH = 6.3-7.5		
						% H O = 67.6-72.3		
% organics = 1.6-3.8								

¹Highest values detected in 50 samples. The values reported for metals are for the TCLP extract in mg/l; the values reported for cyanide are for the total waste analysis in mg/kg.

²Ranges found in all samples.

³This standard must be achieved to meet LDR treatment standards, if applicable. The LDR treatment standards for metals are for the constituent concentrations in the TCLP extract of the waste in mg/l. The cyanide standard is the concentration in the total waste analysis in mg/kg.

⁴LDR treatment standard value for F006 in WWTP sludge is 590 mg/kg.

⁵LDR treatment standard value for F006 in WWTP sludge is 30 mg/kg.

⁶DL = Detection Limit (0.01 mg/l).

TABLE 4-15
Thompson Manufacturing, Inc.
Concentration Ranges For S/S Wastes (Original Waste,
Pre- And Post-Treatment Wastes)

	Ag (mg/l)	CN⁻ (mg/kg)	Cd (mg/l)	Cr (mg/l)	Hg (mg/l)	Ni (mg/l)	Pb (mg/l)	pH	% H₂ O	% Organics
Original Waste Concentrations ¹										
• WWTP Sludge	ND 0.01	130-170	180-210	1,000- 1,500	0.0002	900- 1,100	490-580	8.0-10.0	38.4-52.6	<1
• Paint Residue Sludge	ND 0.01	ND 0.05	0.1	ND 0.03	80-120	ND 0.04	420-460	6.3-7.5	67.6-72.3	1.6-3.8
Pre-Treatment Concentrations ¹										
• Filtered WWT Sludge	ND 0.01	0.076	200-240	1,200- 1,600	0.0002	1,000- 1,200	530-600	4.6-5.5	-	-
• Dewatered Paint Sludge	ND 0.01	ND 0.05	0.1	ND 0.03	90- 130	ND 0.04	440-480	5.7-7.8	-	-
Post-Treatment Concentrations ¹										
• S/S Treated WWT Sludge	ND 0.01	ND 0.05	0.01-0.04	1-2	0.0002	0.1-0.2	0.3-0.4	5.9-8.3	17.5-53.7	-
• S/S Treated Paint Sludge	ND 0.01	ND 0.05	ND 0.01	ND 0.03	0.1-0.15	ND 0.04	0.2-0.4	6.2-8.3	18.1-48.6	-

¹ Values reported for metals are from the TCLP extract in mg/l.
Values reported for other constituents are for total waste analysis mg/kg.

ND - Not Detected. Value given is the detection limit.

TABLE 4-16
Thompson Manufacturing, Inc.
Examples Of Testing/Analytical Methods For S/S Wastes

WASTE DESCRIPTION	SAMPLE EXTRACTION/ PREPARATION METHOD	TESTING/ANALYTICAL METHOD
Paint Sludges (D008, D009)	Toxicity characteristic leaching procedure (TCLP) SW-846, Method 1311, followed by SW-846, Method 3010 (for lead only).	<ul style="list-style-type: none"> • SW-846, Method 6010 for lead, 7470 for mercury.
Electroplating Wastewater Treatment Sludge (F006)	Initial analysis of reactivity (cyanide) using SW-846, Section 7.3.3.2. ¹ If the waste does not meet the definition of reactive, use SW-846, Method 1311, followed by SW-846, Method 3010.	<ul style="list-style-type: none"> • SW-846, Method 6010 for cadmium, chromium, nickel, and lead.

¹ F006 waste samples suspected of exhibiting the characteristic of reactivity are subjected to special handling procedures (containment laboratories) to ensure minimal employee exposure to toxic fumes during metals analysis.

FIGURE 4-7
Thompson Manufacturing, Inc.
Schematic Of Batch S/S Treatment Process Unit ¹

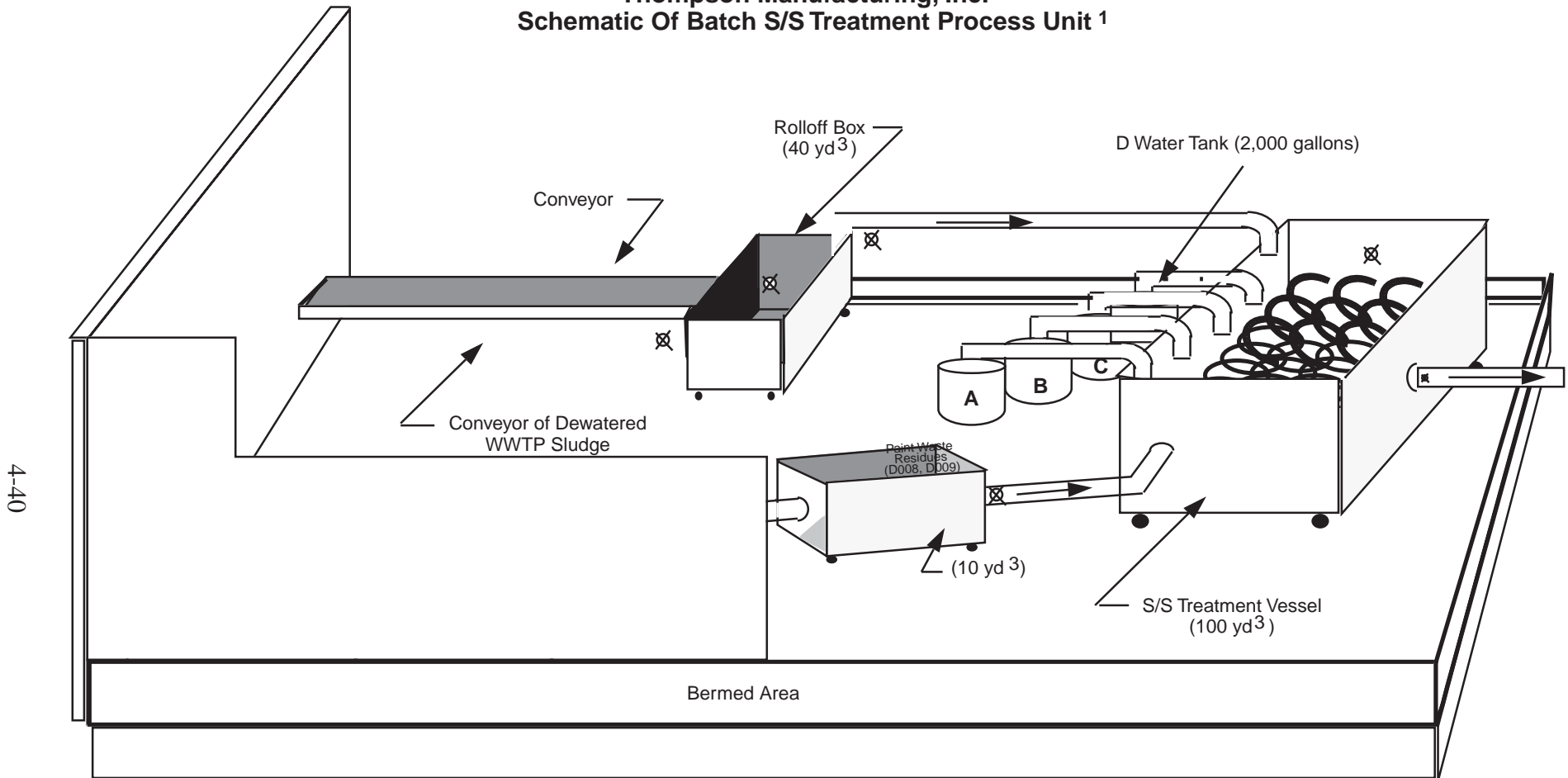

4-40

Note: The treatment area has an impermeable roof overtop.

- LEGEND:**
- A Hypochlorite Tank (500 gallon)
 - B Lime tank (500 gallons)
 - C Cement (bentonite) mixer (100 yd³)
 - D Water Tank (2,000 gallons)
 - ⊗ Sample collection point

¹ Your WAP would probably contain a detailed engineering drawing (rather than this schematic), available from (or referenced to) other sections of your RCRA permit application.

TABLE 4-17
Thompson Manufacturing, Inc.
Criteria And Rationale For Selected Parameters*

CRITERIA	RATIONALE							
	ORIGINAL WASTE AS GENERATED		PRE-TREATED (Dewatered) WASTES		TREATMENT IN PROCESS		POST-TREATMENT	
	WWT Sludge	Paint Sludge	WWT Sludge	Paint Sludge	WWT Sludge	Paint Sludge	WWT Sludge	Paint Sludge
% moisture	1 (See Footnote)	1	2	2	3	3	4	4
pH	1	1	2	2	3	3	4	4
% organics	1	1	2	2	3	3	4	4
TCLP metals	1	1	2	2	3	3	4	4
Ag	1	1	5	5	-	-	4	4
Ba	1	1	5	5	-	-	4	4
CN	1	1	5	5	-	-	4	4
Cr	1	1	5	5	-	-	4	4
Cd	1	1	5	5	-	-	4	4
Ni	1	1	5	5	-	-	4	4
Pb	1	1	5	5	-	-	4	4

* All analytical criteria are based on Testing and Analytical Methods, specified in Table 4-16. (The results of analysis would also need to be provided in your WAP.)

Criteria Legend

- 1 To obtain waste characterization/EPA Classification.
- 2 To determine the optimum S/S operating parameters (conducted semi-annually for verification purposes) (i.e., determine optimum mix ratios of treatment materials).
- 3 To verify treatment process operations.
- 4 To verify treatment process was successful.
- 5 To recharacterize waste feed (conducted semi-annually for verification purposes).

TABLE 4-18
Thompson Manufacturing, Inc.
Frequencies And Methods Of Testing And Analysis For S/S Paint Sludge Wastes

PARAMETER	CRITERIA	Original Waste	Post Centrifugation	During S/S Treatment	Post S/S Treatment
% H ₂ O/free liquids	Rate: Method:	each batch D95 or ASTM ¹ D1796	each batch ASTM D2216 PFLT	N/A	each batch ASTM D2216 PFLT
% Organics	Rate: Method:	each batch APHA Method 5310 ²	each batch APHA Method 5310 ²	N/A	N/A
Density	Rate: Method:	each container ASTM D2937	each batch ASTM D2937	each batch ASTM D2937	each batch ASTM D2922
Hardness	Rate: Method:	N/A	N/A	N/A	each batch ASTM C823-75
Comprehensive Strength	Rate: Method:	N/A	N/A	N/A	each batch (2 random tests) ASTM D2166-66 or C109
Viscosity	Rate: Method:	each container ASTM D2170	N/A	once/month CRD-611-80	N/A
% Solids	Rate: Method:	each container	N/A	N/A	N/A
Permeability Method	Rate: Method:	N/A	N/A	each batch (10 ⁻⁴ -10 ⁻⁸ cm/s)	each batch (10 ⁻⁴ -10 ⁻⁸ cm/s)

Note: This table would be complemented with a table that gives the criteria and rationale for testing these parameters. In addition, the desired test results should be tabulated. The test results should be recorded and maintained in the facility operating record.

¹ ASTM - American Society of Testing and Materials.

² APHA - American Public Health Association, Standard Methods for the Examination of Water and Wastewater, 17th Edition, 1989.

SAMPLE WAP #4 — OFF-SITE TREATMENT FACILITY (INCINERATOR)

[Note: You should review Sample WAP #1 before reviewing this sample WAP to obtain an understanding of the wastes to be managed by Sparky Incineration (e.g., F002 and F003 spent solvents). The organization of this WAP varies from Sample WAPs #1, #2, and #3 to accommodate the unique waste acceptance and handling activities that exist at a TSDF that receives wastes from off site, such as an incineration facility. The major organizational change in this WAP is addressing Special Procedural Requirements in Section II, rather than in Section VI. Further, the Special Procedural Requirements Section of this WAP has been expanded to include specialized procedures for in-process and post-process analysis requirements. An incinerator WAP will typically be very detailed, however, due to space limitations only brief excerpts of required information are provided here. Wherever possible, this sample WAP uses graphics to illustrate key information. You may choose to use graphics, engineering drawings, or other schematics as well; however, each graphic must be supported by descriptive text (which we have covered minimally in this document).]

I. FACILITY DESCRIPTION

A. Description Of Facility Processes And Activities

This section should include facility diagrams and an overview of the primary process (i.e., incineration), secondary processes (e.g., scrubbing the exhaust, wastewater treatment of scrubber water), and related activities that are conducted on site (e.g., waste acceptance, management and handling activities).

Because the WAP is a component of the permit application and a final permit, a facility diagram and description of the incineration process will probably be available from other portions of the permit (or permit application). All information previously cited in the permit (or permit application) relevant to the WAP should be repeated, or at a minimum, referenced in the WAP. Site information that is probably available in other RCRA permit applications sections might include a facility diagram, process activity descriptions, waste management activities, and identification and location of waste feed areas (see Figures 4-8 and 4-9).

B. Identification/EPA Classification And Quantities Of Hazardous Wastes Managed In The Incinerator

Wastes received by Sparky (e.g., solvent wastes from Thompson) and treated in the incinerator should be described in this section in detail. Table 4-19 provides an example of incinerator hazardous waste identification and EPA classification. A narrative discussion of each column in the table should accompany the table. For example, the discussion of chemical analysis (column 7) and LDR treatment standards (column 8) might read as follows:

The chemical characterization of the wastes received by Sparky Incineration is specified in Table 4-19. This information includes the original chemical composition of the waste (provided by the generator) and the designated LDR treatment standards.

The EPA prescribed LDR treatment standard is provided in column 8. The post-treatment concentration provided in column 7 must meet or be less than the LDR treatment standard in column 8 before treatment residues can be sent off site to Rottaway Landfill for land disposal.

C. Description of Hazardous Waste Management Units

For each unit, sufficient detail to support a discussion of the waste acceptance, handling and management procedures must be included. There are 10 hazardous waste management units at Sparky Incineration identified as Areas A-J in Figure 4-8. A description of each waste management unit should be provided in the WAP, including a diagram of the waste management areas (Figure 4-8) and their physical and chemical descriptions. The level of descriptive detail provided will vary. Generally, sufficient information should be provided to demonstrate that waste will be handled and treated safely and will prevent releases to the environment. Examples of issues that might be discussed in the description of the waste management units at your facility may include:

- How are incompatible wastes adequately segregated?
- Is all of the equipment compatible with the wastes managed?
- Are the storage areas adequately bermed?
- Based on the treatment capacity, is there adequate storage capacity to maintain safe storage of incoming materials?

The 10 major waste management areas that have been provided in this example are:

- Incinerator (Area A) (Figure 4-9)
 - Drum staging area
 - Air pollution control scrubber and auxiliary equipment (filter press)
 - Associated labs
- Container storage (Area B)
 - Incoming liquid organic wastes (with included inorganic constituents)
 - Incoming solid organic wastes ¹
- Empty container storage (Area C) (four areas segregated according to original waste type)
- Tank farm (Area D) (8,000 gallons each)
- Blow down water storage tanks (Area E) (4,000 gallons each)
- Ash hopper (Area F)
- Scrubber sludge hopper (Area G)
- Truck off-loading area (Area H)
- Wastewater treatment facility (Area I)

¹ This storage area will not be discussed in Sample WAP #4 because we are addressing only the liquid wastes emanating from Thompson Manufacturing that are being managed at Sparky Incineration.

- Waste receipt (temporary staging) and QC area (Area J)

Each unit at the facility should be described in further detail. For example, when describing the tank farm, the size of the tanks, the number of tanks, and the composition of the wastes designated for each tank should be provided.

II. SPECIAL PROCEDURAL REQUIREMENTS

A. Procedures For Receiving Wastes From Off-Site Generators

This section has been purposefully moved up to Section II (from Section VI in Sample WAPs #1, #2, and #3) for off-site TSDFs. Generally, this section should address the pre-acceptance procedures and incoming waste shipment procedures used to verify the identity of wastes received from off-site generators.

Pre-Acceptance Procedures (Pre-Shipment Screening)

In Sections 2.5 and 2.6 of this guidance, we described the Waste Profile Sheet as a mechanism that off-site facilities can use to determine whether a waste is acceptable. As a pre-acceptance procedure, Sparky Incineration also requires that a Waste Profile Sheet be provided along with a representative sample of the waste. A schematic of these procedures is provided in Figure 4-10.

Incoming Waste Shipment Procedures (Waste Acceptance Procedures)

Once a waste is approved for receipt at the facility, the incoming waste shipment procedures will be followed. A flow diagram of these procedures, which can be augmented with text, is provided in Figure 4-11. Below is a potential excerpt from a WAP, describing the incoming waste shipment procedures.

Each day, a list of incoming shipments that are expected and have been “registered” (received pre-approval for acceptance for that day) is made available to the guard at the receiving gate. When wastes are received at the gate, all the accompanying paperwork (e.g., LDR notifications/certifications, manifests, waste profile ID#) is inspected for conformance with the registration.

If there are no discrepancies in the waste shipment paperwork, the driver is instructed to proceed to the QC Area (waste receiving area, Area J). At this area, each drum is physically inspected. A Waste Receipt Inspection Form is completed (see Table 4-20). If discrepancies in the physical parameters are found, the container is immediately identified and brought to the attention of the supervisor, and the procedures for resolving discrepancies with the generator are followed (refer again to Figure 4-11).

Sparky Incineration will analyze each shipment for selected fingerprint parameters, including chloride content, total metals, ash content, heating value, and prohibited Part 261, Appendix VIII constituents. Sparky has established standard parameters for each sampling event. A table of fingerprint analysis parameters for all shipments to be analyzed or tested at Sparky is provided in Table 4-21. Note that for each wastestream, a unique organic and inorganic parameter profile will be established and that this profile is included in the Waste Receipt Analysis Report (see Table 4-20).

Acceptance/rejection criteria are described completely in qualitative terms for parameters such as color, phase, layers, turbidity, and viscosity, and in quantitative terms for parameters such as percent water, specific gravity, flash point, pH, PCBs cyanide, etc. Examples of two fingerprint/spot check parameters and appropriate acceptance/rejection criteria follow:

EXAMPLE #1 - COLOR

The analysis of color shall consist of the use of the Grumbacher Color Compass, and appropriate sampling procedures.

Sample Evaluation Criteria: Using the sampling procedures and the Grumbacher Color Compass, the color of each representative sample is determined. The sixteen (16) possible color choices are: colorless; white; brown; black; yellow; yellow-green; green; blue-green; blue; blue-violet; violet; red-violet; red; red-orange; orange and orange-yellow. Lighter intensities of a color (equivalent to mixtures of the color with white) are considered for purposes of this permit to be the named color.

Sample Acceptance/Rejection Criteria: The color of the representative sample of the received waste shall be compared with the color of the pre-shipment sample. If the pre-shipment sample is colorless, white, brown, or black and the shipment sample is not that color, the waste shall be rejected.

If the pre-shipment sample is yellow, yellow-green, green, blue-green, blue, blue-violet, violet, red-violet, red, red-orange, orange, or orange-yellow, the waste shall be rejected if the color is more than one color removed from the color of the waste, using a Grumbacher Color Compass.

EXAMPLE #2 - SPECIFIC GRAVITY

The measurement of specific gravity to satisfy the fingerprint/spot check procedures of this permit shall consist of the use of only one of the following two methods: ASTM D891, Method A (Hydrometer) or ASTM D2111-71 (Hydrometer). Appropriate sampling procedures are described elsewhere.

Sample Evaluation Criteria: The specific gravity of each representative shipment sample shall be determined.

Sample Acceptance/Rejection Criteria: The specific gravity of the representative sample of the received waste shall be compared with the specific gravity of the pre-shipment sample. The shipment shall be rejected if the specific gravity of the received waste is not within 0.10 units of the specific gravity of the pre-shipment sample.

Though fingerprint analysis and screening may be adequate in many cases, additional information may be required for off-site combustion facilities. In particular, the WAP must specify procedures that ensure compliance with the site-specific waste feed restrictions. These restrictions are developed after the trial burn, become part of the permit, and specify restrictions on operating conditions and waste feed composition.

At a minimum, an off-site combustion facility must analyze the wastes it receives for prohibited constituents, (e.g., PCBs; dioxin-containing wastes; reactive wastes; and Part 261, Appendix VIII constituents not represented by the POHCs selected for the trial burn), thermal input, ash content, chloride, total toxic metals, (e.g., antimony, arsenic, barium, beryllium, cadmium, chromium, lead, mercury, nickel, selenium,

silver, thallium, vanadium, and zinc), and other parameters (e.g., viscosity, percent solids, solids size, and specific gravity) as necessary.

Each batch of waste to be burned must be analyzed. A typical scenario would include: receive waste, conduct fingerprint analysis, blend wastes in feed or burn tank, and analyze batch for constituents and parameters discussed above. On-site facilities can have a lower frequency of analysis but this frequency must be based on a firm statistical basis.

As noted in Section 2.5, though the generator is responsible for properly classifying the wastes, enforcement authorities will hold the combustion facility responsible and liable for any permit or other regulatory violation.

Whenever forms, SOPs, or other resources are used at your facility to meet a requirement, such as waste handling procedures, copies of all these documents need to be provided in your WAP. Examples could include:

- Waste Receipt Analysis Report (See Table 4-20)
- Procedures to Determine Reactivity of Suspicious Wastes (See Figure 4-2 in Sample WAP #1).

B. Special In-Process And Post-Process Procedures

Generally, the diversity and magnitude of wastes received by off-site facilities requires specialized in-process and post-process waste analysis procedures to ensure permit compliance, treatment effectiveness, and safe operation. To this end, you may want to incorporate these considerations into the “Special Procedural Requirements” section of your WAP.

In-Process Operational Procedures

This section, which is generally very detailed, may include process monitoring requirements and protocols to meet the operating conditions of the permit. Incinerators have numerous process monitoring requirements such as testing, wastestreams, ash content, total metals, and so forth (See 40 CFR Parts 264/265 Subpart O).

All process operational procedures that are necessary must be presented and described, including any special procedures unique to your facility. The following list of special operational procedures activities may require attention in your WAP:

- Decanting drums into tanks (Figure 4-12)
- Solids solidification (discussed in Sample WAP #3)
- Procedures for designating compatible storage units (Figure 4-13).

Any sampling and analysis procedures that are conducted in relation to these activities (such as waste feed analysis or process monitoring) would be discussed in Section III of this WAP.

Post-Process Waste Handling Procedures

Post-process waste handling procedures that will demonstrate that the treatment has been successful are based on process or permit constraints. A description of these procedures must be included in the WAP. All of the testing, analytical, and monitoring requirements that will be necessary to make this demonstration should be included in the WAP. The appropriate testing to meet LDR requirements [40 CFR 268.7(b)] should also be addressed. Consequently, for Sparky this section may address waste analysis and waste handling of the following residue streams:

- Ash
- Scrubber sludge
- Refractory brick waste
- Blowdown waters.

The sampling and analysis and monitoring procedures for all post-process wastes should be described in Section III of this WAP.

Recordkeeping

As part of your facility operating record, all portions of your WAP, including procedures and sampling results, should be kept on site.

C. Procedures For Ignitable, Reactive, And Incompatible Wastes

Sparky Incineration has instituted a rigorous analytical program to provide information concerning a waste's ignitability, reactivity or incompatibility prior to treatment. Specifically, incoming wastes are evaluated against applicable hazardous waste characteristics to determine the presence of potentially ignitable, reactive, or incompatible wastes that may damage the treatment process and harm facilities/ personnel. Ignitability data for liquids will be obtained by using process knowledge and the appropriate Setaflash open or closed cup apparatus for the given liquid hazardous waste.

Potential reactivity characteristics will be assessed through the use of both process knowledge and, for cyanide containing wastes (that may be generated by generators other than Thompson), by applying EPA method 7.3.3.2 to determine the amount of free (potentially reactive) cyanides released when the waste is exposed to pH conditions of 2. Any wastes identified as having a potential to liberate greater than 150 mg/kg of cyanide will be considered ineligible for treatment by Sparky Incineration.

In addition to determining whether wastes designated for treatment exhibit hazardous characteristics, such as ignitability, wastes received for incineration at Sparky Incineration are subjected to a compatibility evaluation. This evaluation uses the procedures delineated in the EPA document entitled "Design and Development of a Hazardous Waste Reactivity Testing Protocol," February 1984, EPA 600/2-84-057. These test procedures are used to classify wastes based on gross chemical composition for designation according to specific reactivity groups (refer to Figure 4-2 and Figure 4-3 in Sample WAP #1).

The results of the testing procedures described in EPA 600/2-84-057 (refer to Figure 4-2 in Sample WAP #1) yields a reactivity group designation. These designations are subsequently compared against the compatibility matrix, Figure 4-3, to determine the potential effects of

mixing with wastes of other reactivity groupings. In cases where incompatibility is indicated (or compatibility cannot be proven), the waste will be handled as incompatible and will be ineligible for treatment by Sparky Incineration. We will maintain documentation of this type of information for each wastestream received for treatment.

D. Procedures To Ensure Compliance With LDR Requirements

A facility that accepts wastes from off-site generators, treats wastes on site, and sends wastes off site for further treatment and disposal must be concerned with LDR requirements during waste acceptance, on-site waste management (i.e., treatment) and shipment off site. Sparky Incineration, for example, should incorporate LDR considerations into the following procedures:

- Pre-Acceptance Procedures
- Incoming Waste Shipment Procedures
- Process Operational Procedures
- In-Process and Post-Process Waste Handling Procedures.

Sample language from Sparky Incineration's WAP may include:

Wastes received at Sparky Incineration will initially be subjected to a review of the accompanying LDR notification along with the preliminary inspection given to the wastes. Any discrepancies in the LDR notification and the associated manifest, analytical records, or Waste Profile Sheet will deem the shipment ineligible for receipt unless additional clarifying information can be provided by the generator. All information obtained to document LDR compliance will be maintained in the facility operating record. For a continuous incineration process, Sparky Incineration will also provide its procedures for determining which waste codes and accompanying LDR treatment standards apply to specific batches of ash.

Incineration residues remaining after treatment of wastes (received from Thompson Manufacturing and other generators) will require off-site disposal as a result of the derived-from-rule for listed wastes or if the residue exhibits hazardous characteristics. In accordance with the LDR regulations (40 CFR Part 268), all wastes shipped off site will be analyzed to determine whether the waste meets the applicable LDR treatment standards contained in 40 CFR §§268.41-43. Testing of results will be used to ensure that accurate LDR notifications and certifications are provided. All analytical results completed in support of LDR requirements will be retained within the facility operating record.

Wastes resulting from Sparky Incineration's operations that exceed applicable LDR treatment standards will be sent for further off-site treatment to meet LDR treatment standards in 40 CFR §§268.41-43. LDR notifications will be supplied with the shipment of waste and will contain the information required under 40 CFR §268.7. In addition to the LDR notification prepared by Sparky Incineration, any additional relevant and applicable data obtained from the generators (e.g., Waste Profile Sheets, original LDR notifications, analysis provided by generators) will be provided to the subsequent permitted TSDF where incineration residues will be sent.

Wastes that are determined through analysis to meet treatment standards as specified in 40 CFR §§268.41-43 will be land disposed in a RCRA Subtitle C permitted facility without further treatment. An LDR notification and certification, including appropriate analytical records to

support the certification, will be prepared and supplied with each shipment of waste to the receiving facility.

III. IDENTIFICATION OF WASTE PARAMETERS

A. Criteria And Rationale For Parameter Selection

Table 4-22 gives examples of incinerator parameter criteria and rationale that would be applicable to incoming waste materials. The criteria and rationale for parameter selection are designed to meet treatment operating conditions (e.g., equipment limitations), permit operating conditions, and special regulatory requirements such as compliance with LDR requirements (40 CFR Part 268). Parameters selected to demonstrate conformance with operating (40 CFR §264.345) and permit conditions include prohibited 40 CFR Part 261, Appendix VIII constituents; heating value; ash content; chloride content; total metals; viscosity; percent solids; solids size; and specific gravity.

B. Special Parameter Selection Requirements

In many cases, special parameters should be tested to ensure that the wastes meet permit conditions. An example of a special parameter for your facility might include sampling for the presence of PCBs, which are regulated under the Toxic Substances Control Act (TSCA) and generally are not regulated under RCRA. (Although PCBs may be regulated as a California List Waste under the LDR requirements and regulated under RCRA by some states.)

IV. SELECTING SAMPLING PROCEDURES

An overview of the operations which require sampling and analysis is provided in Figure 4-14, and the sampling associated with decanting liquids is provided in Figure 4-12. Generally, testing and analysis will be required during all three phases of treatment: pre-process, in-process, and post-process.

A. Sampling Strategies And Equipment

Your WAP must address the appropriate sampling method for obtaining a sample of each parameter for every waste. Table 4-23 provides as an example tabular format to represent sampling information specific to your operations. This type of table should be accompanied by supporting narrative.

B. Sample Preservation And Storage

We will not present site-specific information for the sampling preservation and storage requirements since this information was covered extensively in Section 2.3. You should provide similar information in your WAP.

C. Sampling QA/QC Procedures

All sampling conducted for the purpose of characterizing waste generated or treated by Sparky Incineration will use appropriate QA/QC procedures, including chain-of-custody from sample collection through delivery to the analytical laboratory, and compatible storage containers. Additionally, Sparky

Incineration will limit the number of personnel who perform sampling to two individuals to ensure the highest levels of consistency and accuracy. Both individuals receive annual training in the proper use of sampling and analysis equipment.

V. SELECTING A LABORATORY, AND LABORATORY TESTING AND ANALYTICAL METHODS

A. Selecting A Laboratory

We have selected Buchanan Laboratory to perform all of the detailed quantitative chemical analyses specified in our WAP. In particular, this laboratory has:

- *A comprehensive QA/QC program*
- *Technical analytical expertise*
- *An effective information system.*

B. Selecting Testing And Analytical Methods

The selection of analytical testing methods for wastestreams received and treated at Sparky Incineration was based on the following considerations:

- *Physical state of the waste*
- *Analytes of interest*
- *Required detection limits*
- *Information requirements (e.g., verify compliance with LDR treatment standards).*

VI. SELECTING WASTE RE-EVALUATION FREQUENCIES

The selected re-evaluation frequency for wastes treated in the incinerator must be established for waste acceptance, waste handling (e.g., blending), and waste treatment in the incinerator. At a minimum, each batch of waste burned will be analyzed for prohibited 40 CFR Part 261, Appendix VIII constituents; total metals; PCBs; dioxin-containing wastes; heat value; ash content; chloride; viscosity; solids content; solids size; and specific gravity.

In addition, the trial burn, permit application, and permit must specify the frequency for sampling operating parameters unique to incinerators (40 CFR §§270.19, 264.344, and 265.341). Refer to Section 2.5 of this manual for assistance.

FIGURE 4-8
Sparky Incineration, Inc. Facility Layout ¹

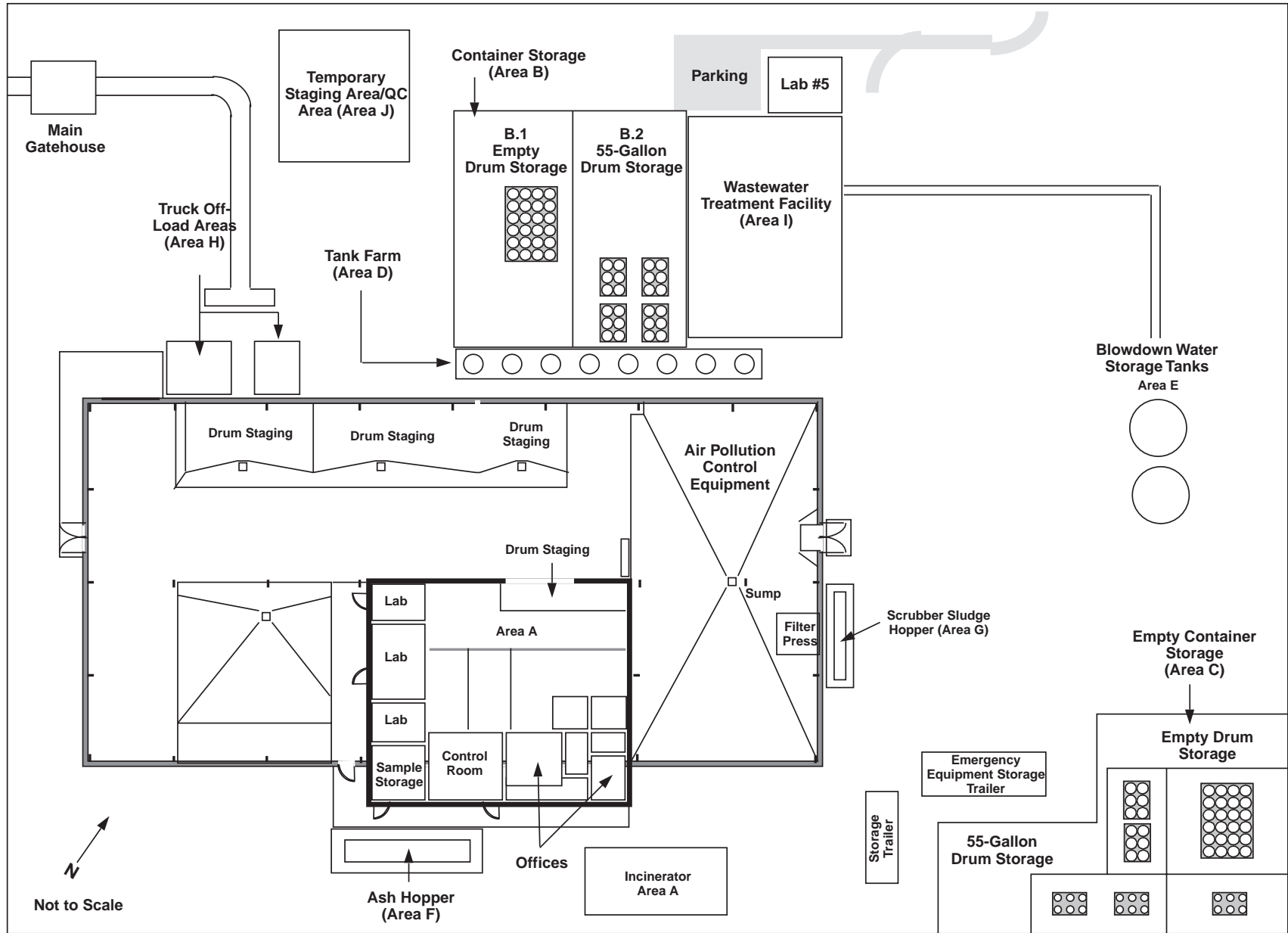

4-52

¹ A detailed diagram of each hazardous waste management unit (Areas A-H) would be provided if necessary.

FIGURE 4-9
Sparky Incineration, Inc.
Treatment System

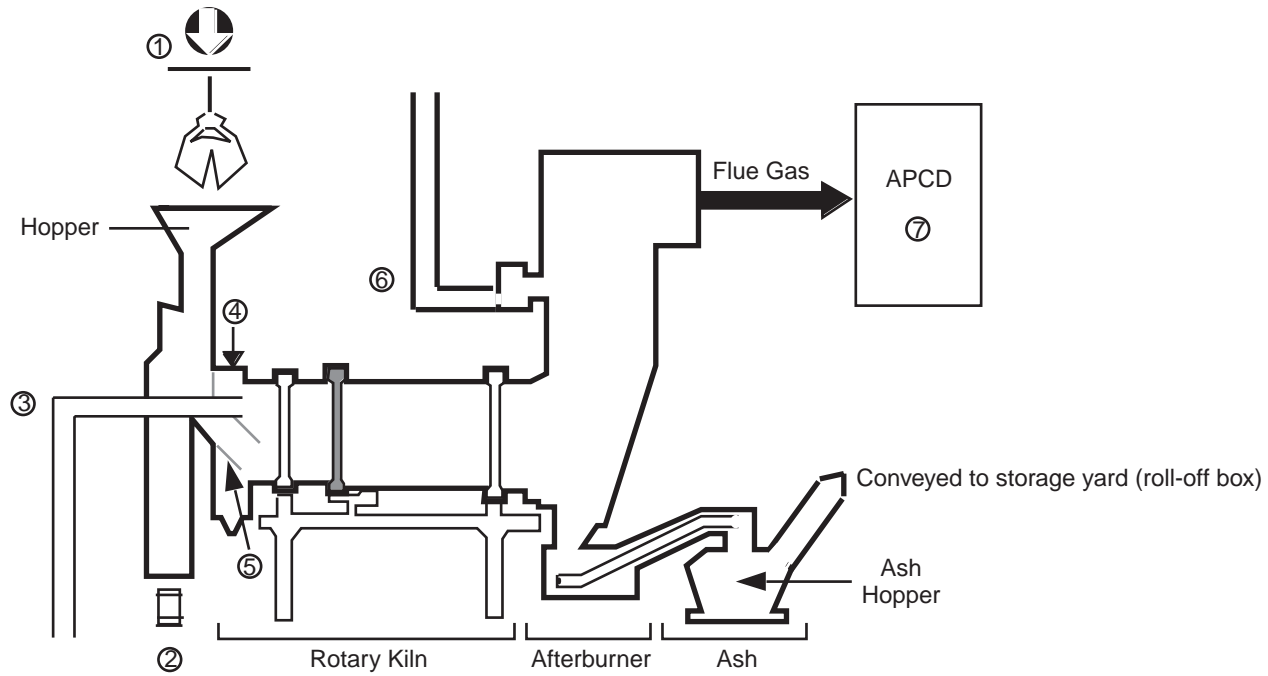

- ① SOLID WASTE (Fiber Drums)
- ② BARREL CHARGING
- ③ LIQUID WASTE FEED
- ④ EXHAUST AIR FROM TANKS
- ⑤ AUXILIARY FUEL OIL
- ⑥ LIQUID FUEL FROM TANK FARM
- ⑦ AIR POLLUTION CONTROL UNIT

**TABLE 4-19
Sparky Incineration, Inc.
Identification/EPA Classification Of Hazardous Wastes Treated By Incineration**

①	②	③	④	⑤	⑥	⑦		⑧		
WASTE GENERATOR NAME, WASTE PROFILE #	PROCESS GENERATING THE WASTE	BASIS FOR HAZARD CLASSIFICATION ¹	EPA WASTE CODE	PHYSICAL STATE OF WASTES	DISPOSITION ON SITE	CHEMICAL ANALYSIS		TREATMENT		
					Designated Waste Management Staging Area	Original Waste ¹	Post Treatment ² (mg/kg)	LDR		Designated Treatment Standard ³ (mg/kg)
								NWW	WW	
Thompson Manufacturing WPN 683 ⁴	Parts Preparation (Parts Drying)	Process Knowledge/Testing	F002	Liquid	Area B (Incoming Liquids)	35% CFC-11 (trichloro-fluoro-methane)	2	X		33
Thompson Manufacturing WPN 239 ⁴	Painting (Cleanup Solvents)	Process Knowledge/Testing	F003	Liquid	Area B (Incoming Liquids)	98% acetone	10	X		160

4-54

¹ Provided by the generator

² Values shown are for the total waste analysis.

³ The EPA treatment method or alternative will be specified. (Value shown is for the total waste analysis.)

⁴ WPN = Waste Profile Number

FIGURE 4-10
Sparky Incineration, Inc.
Pre-Acceptance Procedures

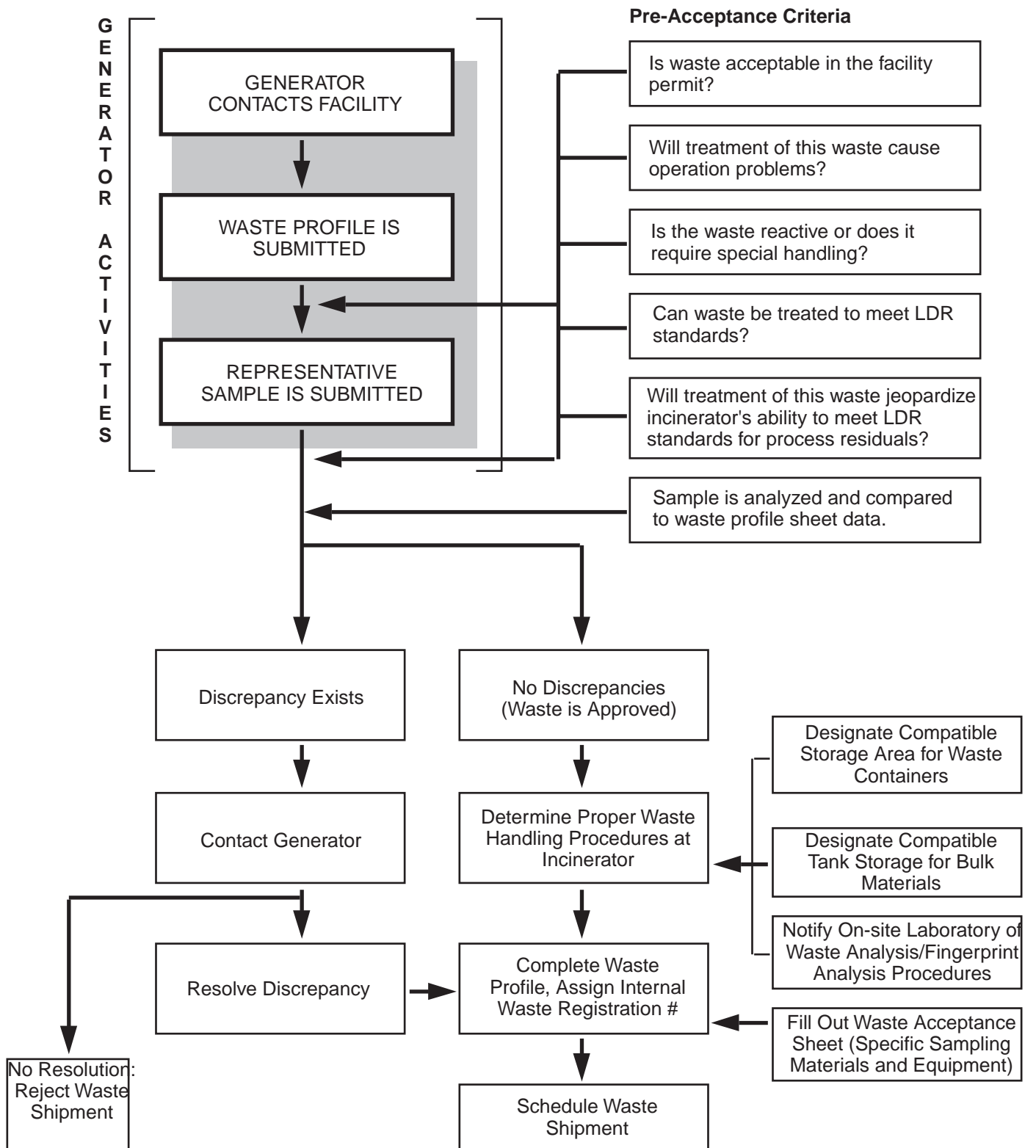
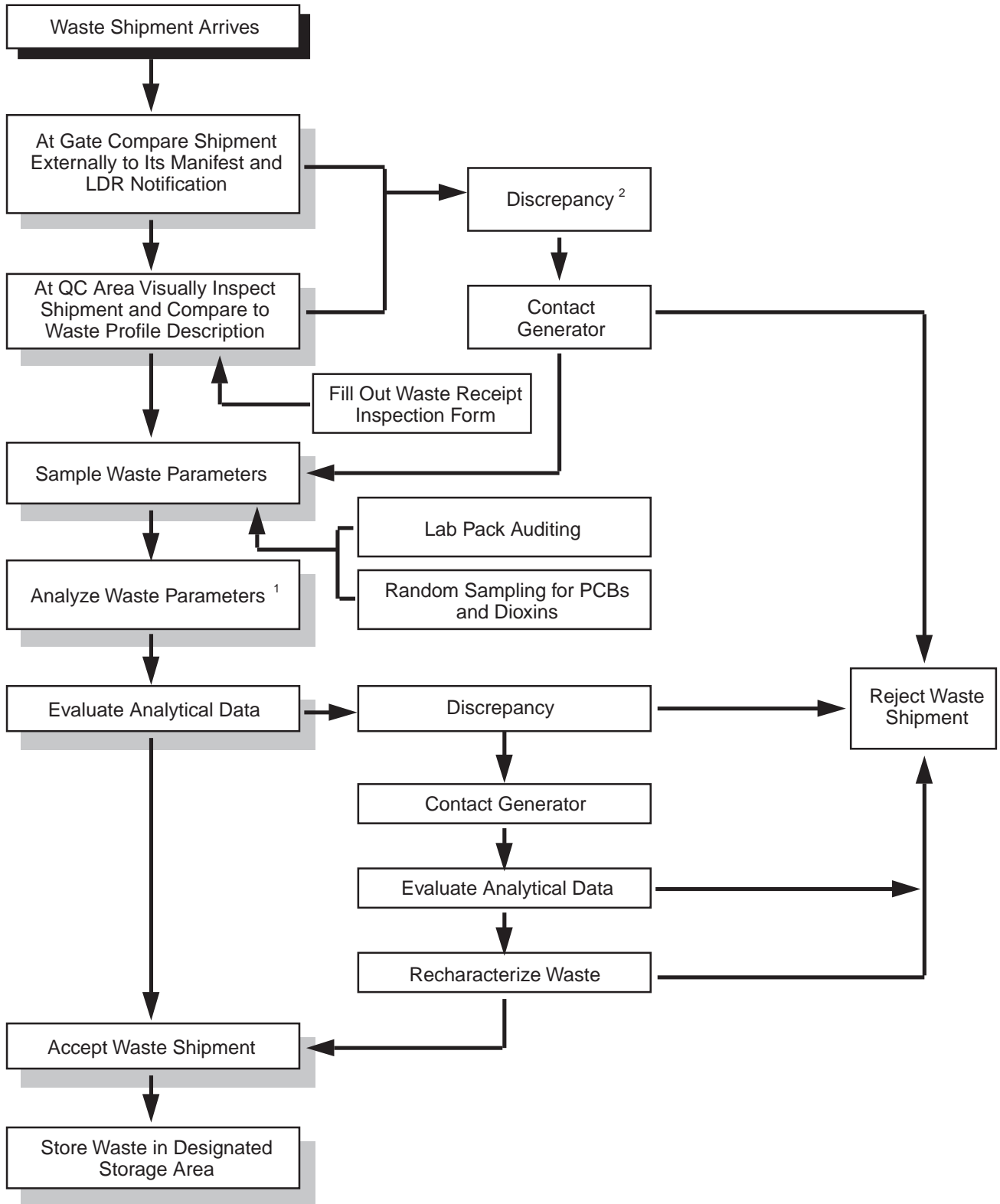

FIGURE 4-11
Sparky Incineration, Inc.
Incoming Waste Shipment Procedures
(Waste Acceptance Procedures)



¹ Each time a new waste is shipped, and at least twice a year, the waste is re-analyzed for all Waste Profile parameters.
² If discrepancy is found, the next shipment from this generator is subject to increased level of analysis.

TABLE 4-20
Example Waste Receipt Analysis Report^{1,2}

Generator:					Profile Number:					Date Received:			
Waste Name:					Work Order Number:					Manifest Number:			
Transporter:					Trailer Number:					Line No. of No.			
Waste Codes:										Authorization #:			
PCB / Non-PCB										Storage Area:			
Approved As:					Manifested Qty _____ X _____ gals.					Drum Numbers: _____ thru:			
Received As:					Received Qty _____ X _____ gals.					Compatibility Group:			
Screen	Test	SWAR	Profile	Received	Conforms	Analyst	Test	SWAR	Profile	Received	Conforms	Analyst	
	Oxidizer				Yes No		Flam Pot				Yes No		
	CN				Yes No		Water Mx				Yes No		
Analysis	Radioactivity				Yes No		pH				Yes No		
	SP. Gr.				Yes No		% Cl				Yes No		
	% Water				Yes No		% F				Yes No		
	% Ash				Yes No		% Br				Yes No		
	Btu/lb				Yes No		% S				Yes No		
Physical Description	PCB mg/kg				Yes No		Compatibility				Yes No		
	Color				Yes No		Paint Filter				Yes No		
	Phases				Yes No		Viscosity				Yes No		
Non-Conformity	Layers				Yes No		Turbidity				Yes No		
	Discrepancies												
Resolution:													
Contact Person/Company:						Phone Number:			Date:		Time:		
Sampling Information				Date: _____		Time: _____		Comments:					
Container No.'s Sampled:													
				Manifest Info Correct:		Yes No		Name:		Date:			
				Supplemental Analysis Required		Yes No		If Yes, Attach Analysis					
Total No. of Samples:				Storage Compatibility Test Required: Yes No									
Sampler's Name:				Signature:				Burn Approval: Yes No		Repack Approval: Yes No			
								Maximum # of Charges/Cycle:		Maximum lbs/Container			
Sample Delivery to Lab:			Date: _____		Time: _____		Lab Number						
Received By (Name):			Signature:				Due to:						
							Pump Drum Approval: Yes No						
Received Waste Conforms To Preacceptance Analysis and Should			To Be Pumped As:		Second Fuel		Lean Water						
Be Accepted. Yes No			Date: _____		Time: _____		Date: _____						
Chemist's Name			Signature:				Chemist's Name		Signature:				

Fingerprint Parameters

4-57

¹ Complete only those items that are applicable to your TSDF.

² Each TSDF should develop acceptance/rejection criteria for fingerprint parameters and should include those on a form similar to this example.

TABLE 4-21
Sparky Incineration, Inc.
Fingerprint Analysis Used To Sample Incoming Wastes

CHEMICAL PARAMETERS	PHYSICAL PARAMETERS	VISUAL PARAMETERS
Cyanide* PCBs* % Cl* % F* % Br* % S* Organic Parameters** (Prohibited Part 261, Appendix VIII Constituents) Inorganic Parameters (Total metals)**	% Ash % Water* Radioactivity* Specific Gravity* Flammability* Flash Point* pH* Water Reactive Heating Value	Color* Phases* Viscosity* Turbidity* Layers*
<p>* Checked each time the waste is shipped (other parameters are tested only when initial or updated representative samples is provided).</p> <p>** Unique parameters will be selected for each waste stream and designated in the Waste Profile Sheet.</p>		

FIGURE 4-12
Sparky Incineration, Inc.
Examples Of Pre-Process, In-Process, And Post-Process
Activities Related To Decanting

4-59

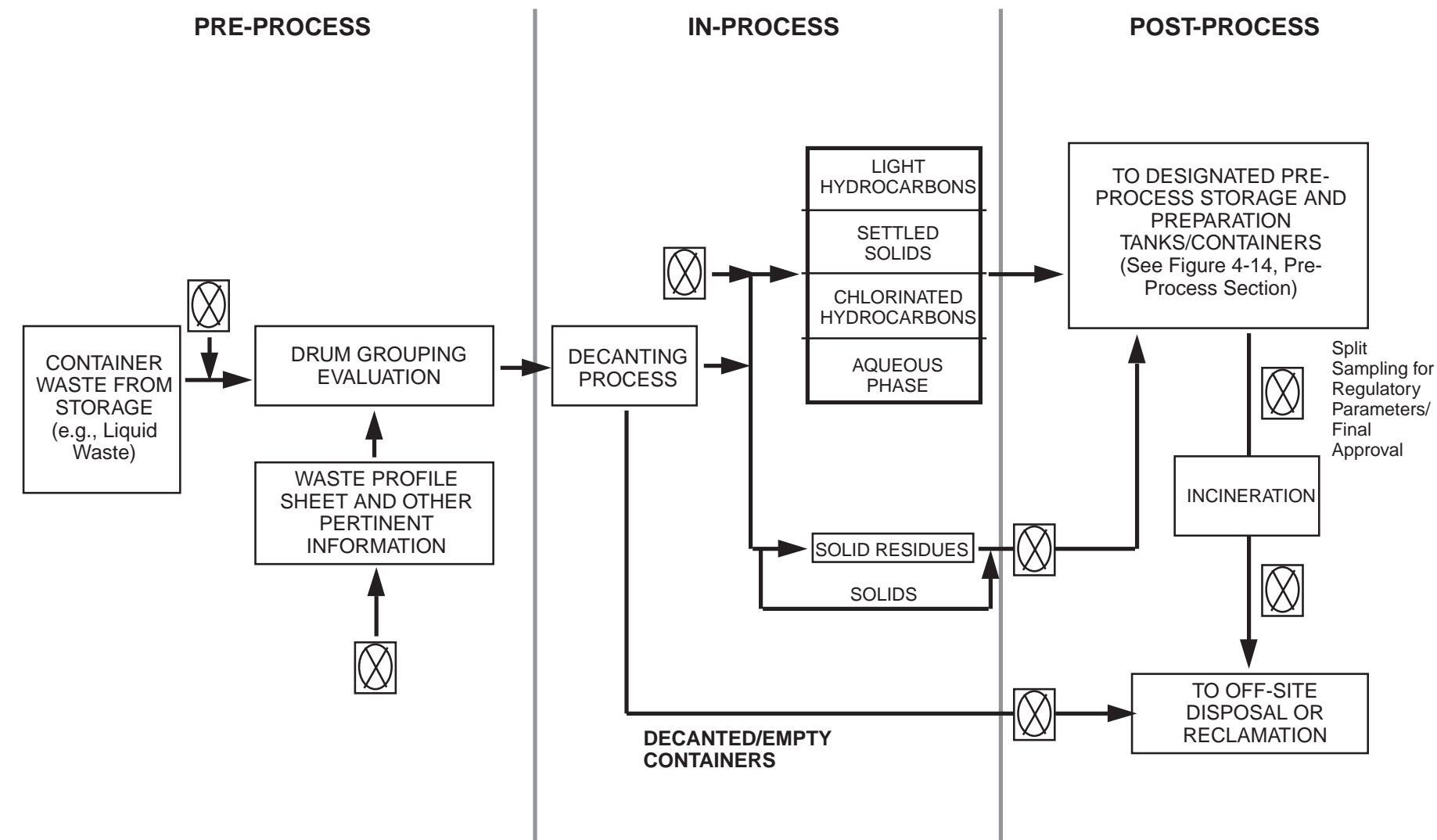

 = Sample

FIGURE 4-13
Sparky Incineration, Inc.
Procedures For Designating Compatible Storage Units



* Your WAP should designate the types of analysis or parameters that will be necessary to conform or deny the storage of wastes in designated storage units.

TABLE 4-22
Sparky Incineration, Inc.
Examples Of Selected Parameter Rationale, Criteria, And Special
Considerations

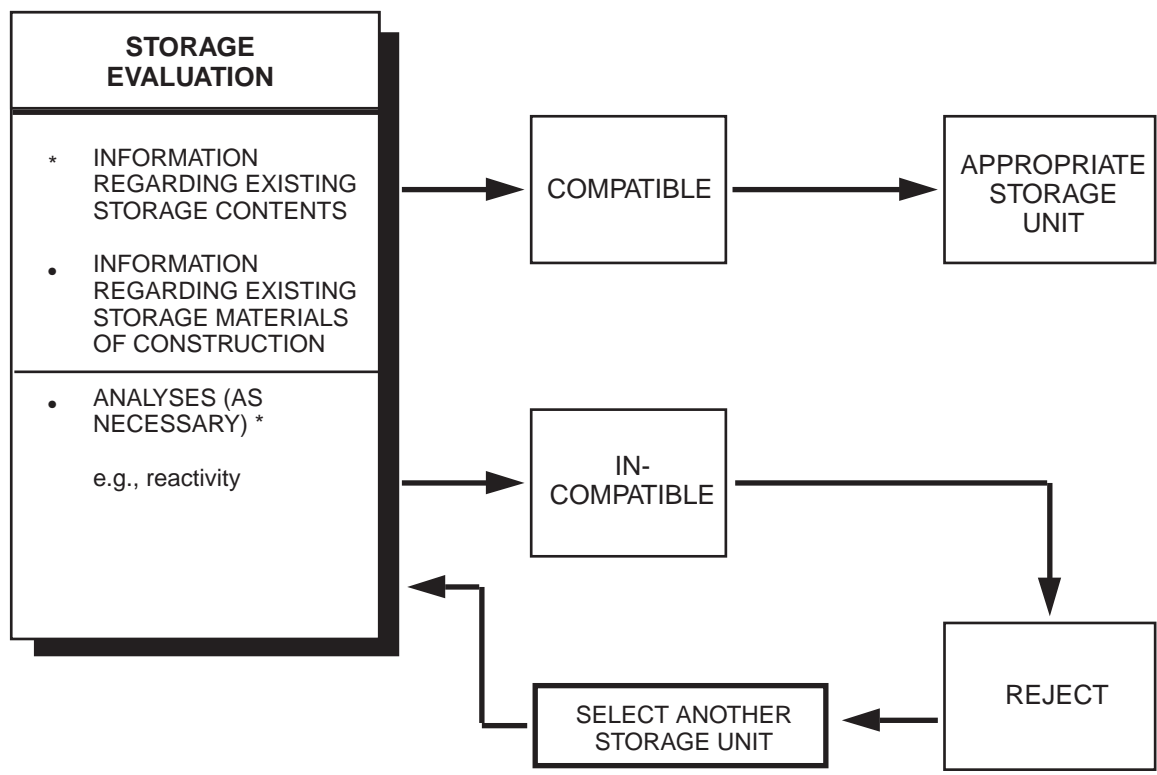
WASTE	PARAMETERS	CRITERIA	RATIONALE	SPECIAL CONSIDERATIONS
F002	trichlorofluoromethane (CFC-11)	33 mg/kg ¹	To determine if LDR prohibition levels are exceeded	F002 and F003, including incinerator residuals (e.g., ash), must meet applicable LDR treatment standards before land disposal
F003	acetone	160 mg/kg ¹	To determine if LDR prohibition levels are exceeded	None
F002, F003,	Ignitability	>60° Celsius	To verify waste identification and to identify ignitables for safe handling	None
F002, F003	Heat of Combustion	1,000 Btu/lb. minimum heat of combustion is permit limit	To assess burning efficiency	None
All Wastes	PCBs	50 mg/kg	To determine presence in sample	PCBs not acceptable in the facility permit above 50 mg/kg

¹ These analyses would be used to demonstrate compliance with LDR treatment standards after treatment by incineration.

FIGURE 4-14
Sparky Incineration, Inc.,
Hazardous Waste Sampling Flow Diagram

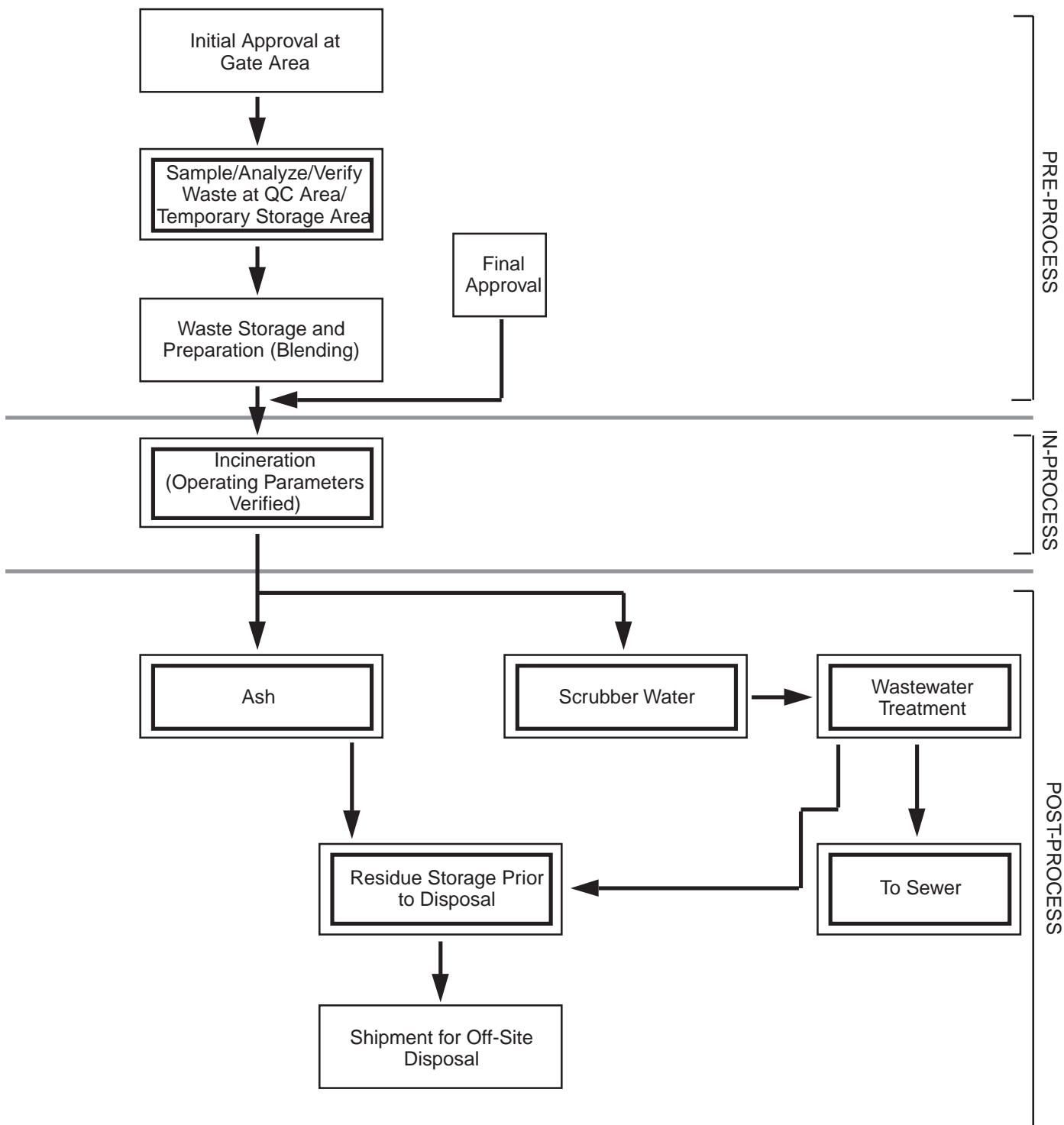

 Activities/Processes That Require Sampling

TABLE 4-23
Sparky Incineration, Inc.
Examples Of Sampling Methods And Equipment Used

SAMPLE MATERIAL	SAMPLE METHOD	SAMPLE EQUIPMENT
Fly ash-like material	ASTM D 2234-76 ^a or ASTM E 300 ^a	Tube sampler ^d , trier, auger, scoop, or shovel
Containerized liquids (e.g., tank, drums) ^c	SW-846 ^b or ASTM E 300 ^a	Coliwasa/tube sampler ^d , weighted bottle, bomb, or tank sampling ports

- ^a-- American Society for Testing Materials, 1982. Annual Book of ASTM Standards, Philadelphia, PA, or most recent edition.
- ^b-- Test Methods for Evaluating Solid Waste, 1980, SW-846, 2nd Edition, U.S. Environmental Protection Agency, Office of Water and Waste Management, Washington, DC, or most recent edition.
- ^c-- The specific equipment is dependent on the type of container. See SW-846 for specific examples. See also Section 2.2.
- ^d-- Personal Protection and Safety Training Manual (Cincinnati, Ohio: U.S. Environmental Protection Agency, National Training and Operational Technology Center, 1981), pp. 3-1 and 3-4.

SAMPLE WAP #5 - LANDFILL

[Note: You should review Sample WAP #1 before you review this sample WAP to obtain an understanding of the wastes to be managed by Rottaway Landfill (e.g., treated F002, F003, D008, and D009 wastes). The organization of this WAP is similar to the organization of the incinerator WAP and, therefore, varies from the organization of Sample WAPs #1, #2, and #3 to accommodate the unique waste acceptance and handling activities that exist at a TSDf that receives wastes from off site, such as a land disposal facility. The major organizational change in this WAP is addressing the Special Procedural Requirements in Section II, rather than in Section VI. Further, the Special Procedural Requirements Section has been expanded to include unique waste analysis and evaluation requirements necessary for proper landfill operation. A landfill WAP will generally be very detailed, however, due to space limitations in this guidance manual only brief excerpts of required information are provided here. Wherever possible, this sample WAP uses graphics to illustrate key information. You may choose to use graphics, engineering drawings, or other schematics as well; however, each graphic must be supported by descriptive text (which we have covered minimally in this document).]

I. FACILITY DESCRIPTION

A. Description Of Facility Processes And Activities

This section should include facility diagrams and an overview of the landfill activities (e.g., waste acceptance, handling and management activities) that are conducted on site.

Because the WAP is a component of the permit application and a final permit, a facility diagram and description of the site activities will probably be available from other portions of the permit (or permit application). All information previously cited in the permit (or permit application) that is relevant to the WAP, should be repeated in the WAP or, at a minimum, referenced in the WAP. For example, information that is probably available in other RCRA permit application sections may include a facility diagram; a general description of the types and quantities of wastes received, stored, and landfilled (see Section I.B below); a brief description of the activities that are relevant to waste handling procedures and the identity and locations of waste staging and storage areas. (See Figures 4-15 and 4-16.) For clarity, you may choose to present this information in tabular or graphic formats with supportive text.

B. Identification/EPA Classification And Quantities Of Hazardous Wastes

Wastes received at the landfill are described in this section. We have provided the list in tabular form in Table 4-24. A discussion of each column in the table should accompany the table. For example, the discussion of Chemical Analysis (column 7) and LDR treatment standards (column 8) might read as follows:

The chemical characterization of the wastes received at Rottaway is specified in Table 4-24. This information includes the chemical composition of the treated waste (provided by the generator) and the designated LDR treatment standards.

The EPA prescribed LDR treatment standard is provided in column 8. The post-treatment concentration provided in column 7 must meet or be less than the LDR treatment standard in column 8 prior to land disposal.

C. Description Of Hazardous Waste Management Units

There are 10 hazardous waste management units at Rottaway Landfill. A description of each is provided below. This description includes a diagram of the facility layout (Figure 4-15) and the waste management areas (Figure 4-16).

- *Main Gate (Area A)*
- *Container Storage (Area B)*
- *Container Storage (Areas C and D)*
- *Container Storage (Area E)*
- *Cell A (Area F)*
- *Cell B (Area G)*
- *Cell C (Area H)*
- *Cell D (Area I)*
- *Temporary Drum Storage (Area J)*
- *Incompatibles Storage (Area K).*

The waste management and handling procedures in each unit at the facility should be described in further detail. Physical parameters relevant to these procedures should also be provided. For example, when describing the drum storage areas, information such as the size and number of containers, and the composition of the wastes designated for each area should be provided.

II. SPECIAL PROCEDURAL REQUIREMENTS

A. Procedures for Receiving Wastes From Off-Site Generators

This section has been purposefully moved up to Section II (from Section VI in Sample WAPs #1, #2, and #3) for off-site TSDFs. Generally, this section should address the pre-acceptance procedures and incoming waste shipment procedures used to verify the identity of waste received from off-site generators.

Pre-Acceptance Procedures (Pre-Shipment Screening)

In Sections 2.5 and 2.6 of this manual, we described the Waste Profile Sheet as a mechanism that off-site facilities can use to obtain the detailed physical and chemical description of each waste stream from the generator.

Rottaway Landfill requires that the off-site generator supply a Waste Profile Sheet and a representative sample of the waste. Figure 4-17 shows how the Waste Profile Sheet is used as a component of the Pre-Acceptance Procedures that are followed at Rottaway.

Incoming Waste Shipment Procedures (Waste Acceptance Procedures)

After a waste is approved for receipt at the facility, the wastes are subjected to incoming waste procedures shown in Figure 4-18. Each step of these procedures must be described in detail. For example:

Rottaway's wastes acceptance and handling procedures [developed in conformance to 40 CFR 264.13(c)] include ensuring that the information provided by the generator is correct and verifiable. In addition, Rottaway will generate independent information by physically inspecting each wastestream and testing for fingerprint analysis parameters.

A sample is extracted from each container using the methods and equipment specified in the Waste Acceptance Sheet (a Sample Waste Acceptance Sheet is not provided in this sample WAP). The sample is analyzed for the individual fingerprint analysis parameters specified for that waste, per Section III of this WAP (see Table 4-25).

A Waste Receipt Analysis Report is filled out (see Table 4-20). If discrepancies are found, the container is immediately identified and brought to the attention of the supervisor, and the procedures for resolving discrepancies with the generator are followed (see Figure 4-18). [Note: Although fingerprint analysis is acceptable for initial acceptance of an incoming waste, a thorough analysis of all appropriate LDR regulated constituents is required for each batch prior to land disposal.]

The criteria for selecting fingerprint analysis parameters are provided in Sections 2.5 and 2.6 of this manual. In general, these are developed as a screening guide for determining whether incoming wastes as received will conform to the Waste Profile Sheet (See Figure 4-17).

B. Special Landfill Waste Analysis And Evaluation Procedures

Given the magnitude and diversity of waste potentially received by landfill operations, specialized waste analysis and evaluation procedures are necessary to ensure permit compliance, landfill unit integrity, and safe waste disposal. To this end, you will want to include unique waste analysis provisions or protocols in the "Special Procedural Requirements" section of your WAP. For example:

On-Site Waste Management and Handling

After initial acceptance of a waste at Rottaway Landfill, the proper landfill cell is determined based upon the following information:

- *Waste receipt analysis report*
- *Fingerprint analyses*
- *Comprehensive sample analyses*
- *Generator information.*

Collectively, this data is used to carry out the landfill cell designation procedures illustrated in Figure 4-19.

Once an appropriate designation has been made, the waste can be moved from the temporary storage (Area J) to long-term container storage (Areas C and D). If necessary, appropriate steps will be conducted to ensure that all landfilled wastes have no free liquid content. Moisture content and paint filter liquids tests should be conducted before and after any waste pre-treatment to remove liquids content. A waste identification review is performed after any pre-

treatment to identify changes in the wastes classification or physical/chemical properties that may affect its acceptability for disposal in accordance with LDR requirements or the facility permit.

Prior to actual placement of waste into one of Rottaway's landfill cells, the relevant analysis for appropriate LDR regulated constituents of the waste will be reviewed to verify the acceptability of the waste for disposal. The identity of the waste, including any physical/chemical changes that have occurred during storage or liquids removal is reviewed for permit compliance and potential incompatibilities with existing landfill wastes and components. After approval, the container contents and registration number are recorded and disposal initiated.

C. Procedures For Ignitable, Reactive, And Incompatible Wastes

Rottaway Landfill has instituted a rigorous analytical program to provide information concerning a waste's ignitability, reactivity, or incompatibility prior to treatment. Specifically, incoming wastes are evaluated against applicable hazardous waste characteristics to determine the presence of potentially ignitable, reactive, or incompatible wastes.

Potential reactivity characteristics will be assessed through the use of both process knowledge and, for cyanide-containing wastes (that may be generated from generators other than Thompson), by applying EPA method 7.3.3.2 to determine the amount of free (potentially reactive) cyanides released when the waste is exposed to pH conditions of 2. Any wastes identified as having a potential to liberate greater than 150 mg/kg of cyanide will be considered ineligible for disposal at Rottaway Landfill.

In addition to determining whether wastes exhibit hazardous characteristics, wastes received at Rottaway Landfill are subjected to a compatibility evaluation. This evaluation uses the procedures delineated in the EPA document entitled "Design and Development of a Hazardous Waste Reactivity Testing Protocol," February 1984, EPA 600/2-84-057. These test procedures are used to classify wastes based on gross chemical composition for designation according to specific reactivity groups (refer to Figure 4-2 and Figure 4-3 in Sample WAP #1).

The results of the testing procedures described in EPA 600/2-84-057 (refer to Figure 4-2 in Sample WAP #1) yields a reactivity group designation. These designations are subsequently compared against the compatibility matrix, Figure 4-3, to determine the potential effects of mixing with wastes of other reactivity groupings. In cases where incompatibility is indicated (or compatibility cannot be proven), the waste will be handled as incompatible and will be ineligible for land disposal at Rottaway. We will maintain this type of information for each wastestream received for disposal.

D. Procedures To Ensure Compliance With LDR Requirements

A facility that accepts wastes from off-site generators for disposal must be concerned with LDR requirements in waste acceptance and on-site waste management. Prior to waste shipment approval, Rottaway's pre-acceptance procedures (see Section II.A of this WAP) should be used to screen wastes for LDR compliance when wastes are received on site. The incoming waste procedures require that all documentation (e.g., manifest, the LDR notification and certification) be reviewed against waste profile descriptions and the sample analytical results.

Upon waste receipt, discrepancies in the LDR notification/certification and the associated manifest, analytical records, or waste profile sheet will deem the shipment ineligible for disposal unless additional clarifying information can be provided by the generator. The incoming waste acceptance procedures (see Section II.C of this WAP) also require that a physical inspection be conducted to ascertain whether the waste is in fact meeting LDR requirements. All information obtained to document LDR compliance will be maintained in the facility operating record (see Waste Management and Handling Procedures in Section II.C of this WAP).

III. IDENTIFICATION OF WASTE PARAMETERS

A. Criteria And Rationale For Parameter Selection

The criteria and rationale for the selection of all wastes analysis parameters must be included in the WAP. This selection of parameters is based on the factors given in Section 2.2 of this guidance manual. An example of some of the waste parameter selection criteria and rationale for Rottaway Landfill is presented in Table 4-26. These parameters should be discussed in detail in your WAP.

B. Special Parameter Selection Requirements

The WAPs for landfills must include provisions for the selection of special parameters necessary to ensure permit compliance and proper operation of the facility. For landfills, this portion of your WAP should address the waste analysis parameters and tests that will be performed to ensure compliance with the special requirements for bulk and containerized liquids in 40 CFR §§264/265.314. Specifically, these should include, at a minimum, moisture content and paint filter liquid test evaluations to provide assurance that wastes being landfilled contain no free liquid content. Additional special parameters may be required to meet unique permit requirements specific to your operation.

IV. SELECTING SAMPLING PROCEDURES

Section 2.3 of this guidance manual highlighted the components of a Sampling Procedures Section of a WAP, which should include:

- A. Sampling Methods and Equipment
- B. Sample Preservation and Storage
- C. Sampling QA/QC Procedures.

A. Sampling Methods And Equipment

Your WAP must describe the appropriate sampling method that will be used to obtain samples of wastes destined for management at the facility. Table 4-27 is provided as an example of the type and content of information you may choose to provide for sampling methods and equipment.

B. Sample Preservation And Storage

We will not present site-specific information for the sampling preservation and storage requirements since this information was covered extensively in Section 2.3. You will want to provide similar information in your WAP.

C. Sampling QA/QC Procedures

All sampling conducted for the purpose of characterizing wastes managed by Rottaway Landfill will use appropriate QA/QC procedures, including chain-of-custody from sample collection through delivery to the analytical laboratory, and compatible storage containers. Additionally, Rottaway Landfill will limit the number of personnel who perform sampling to two individuals to ensure the highest levels of consistency and accuracy. Both individuals receive annual training in the proper use of sampling and analysis equipment.

V. SELECTING A LABORATORY AND LABORATORY TESTING AND ANALYTICAL METHODS**A. Selecting A Laboratory**

This section should discuss the criteria you have used to select a laboratory. For example:

We have selected Buchanan Laboratory to perform all of the detailed quantitative chemical analyses specified in our WAP. In particular, this laboratory has:

- *A comprehensive QA/QC program*
- *Technical analytical expertise*
- *An effective information system.*

B. Selecting Testing And Analytical Methods

The selection of analytical testing methods for the wastes received by Rottaway Landfill was based on the following considerations:

- *Physical state of the wastes*
- *Analytes of interest*
- *Required detection limits*
- *Information requirements (e.g., verify compliance with LDR treatment standards).*

VI. WASTE RE-EVALUATION

The selected re-evaluation or testing frequency for wastes accepted at a landfill should be established for all sampling activities associated with:

- Pre-acceptance procedures
- Waste acceptance procedures
- Waste handling at the site.

The RCRA permit application and permit must specify the frequency for each sampling parameter specified. The frequency criteria may be provided with other information in the permit (see Table 4-26). Refer to Part Two, Section 2.5, of this guidance manual for assistance.

FIGURE 4-15
Rottaway Landfill, Inc.
Facility Layout *

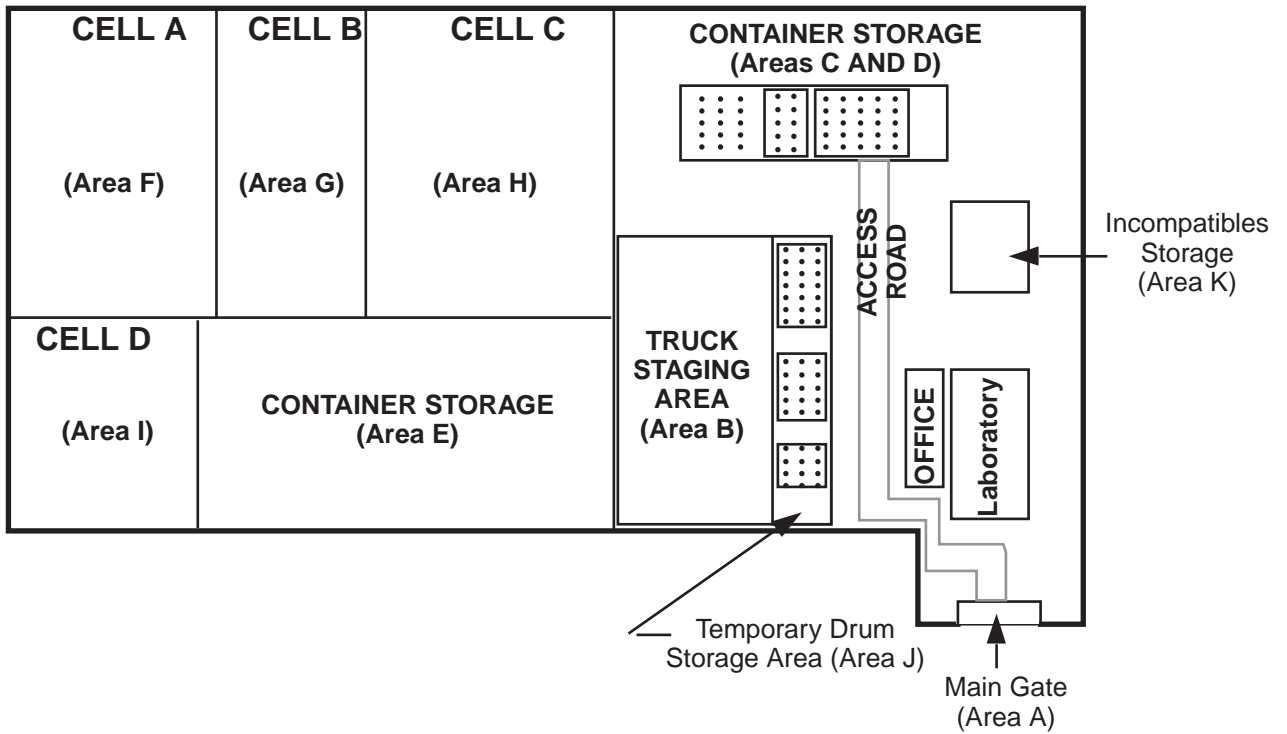
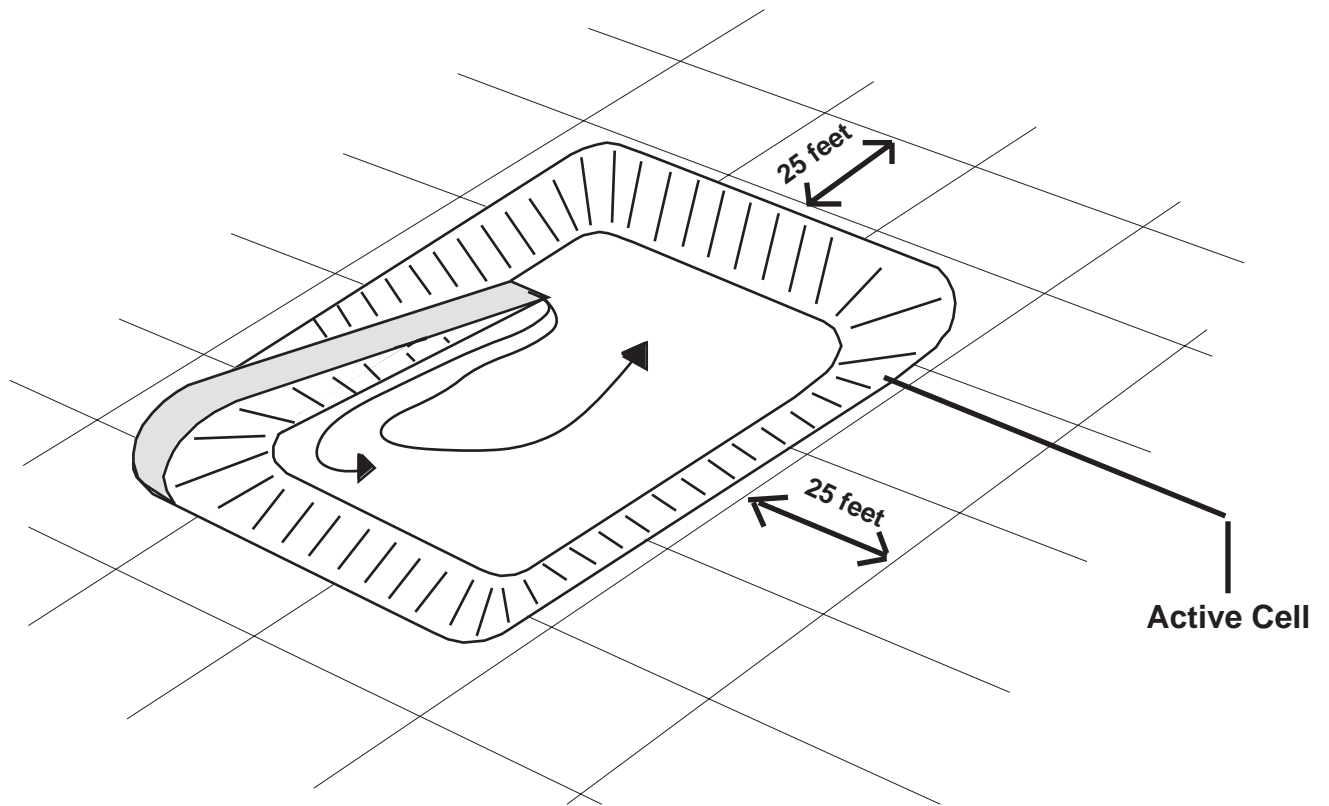

FIGURE 4-16
Rottaway Landfill, Inc.
Layout Of Each Landfill Cell



**TABLE 4-24
Rottaway Landfill, Inc.
Identification/EPA Classification Of Hazardous Wastes Managed At Rottaway Landfill**

①	②	③	④	⑤	⑥	⑦	⑧	
WASTE GENERATOR NAME, WASTE PROFILE #	PROCESS GENERATING THE WASTE	BASIS FOR HAZARD CLASSIFICATION	EPA WASTE CODE	PHYSICAL STATE OF WASTES	DESIGNATED STAGING AREA ON SITE	CHEMICAL ANALYSIS ¹	TREATMENT	
						Waste Received	LDR ²	Treatment Standard ³
							WW or NWW	
Sparky Incineration WPN 1003 ⁴	Incineration (ash)	Process Knowledge/ Testing	F002, F003	Solid	Area G Cell B ⁵	Trichlorofluoromethane 2.0 mg/kg	NWW	33 mg/kg
						Acetone 10 mg/kg		160 mg/kg
Thompson Manufacturing WPN 2806 ⁴	Solidification of paint and electroplating WWT plant sludges	Process Knowledge/ Testing	F006	Solid	Area F Cell A ⁵	CN (Total) 15 mg/kg	NWW	CN (Total)
						CN (Amenable) 0.2 mg/kg		590 mg/kg
						Cd 0.03 mg/l		30 mg/kg
						Cr 1.5 mg/l		Cd .066 mg/l
						Pb 0.35 mg/l		Cr 5.2 mg/l
						Ni 0.15 mg/l		Pb 0.51 mg/l
						Ag <DL ⁶		Ni 0.32 mg/l
	Ag .072 mg/l							

¹ Metal values are reported for the TCLP extract in mg/l. All other values are reported as total waste analysis in mg/kg.

² Provided by the generator/certification received from generator.

³ The EPA treatment standard or alternative will be specified. This is the standard that must be achieved, per LDR, (if applicable) or wastes will be rejected. The values for the metals are expressed as the concentration in the TCLP extract in mg/l. All other values are expressed as the total waste analysis in mg/kg.

⁴ WPN = Waste Profile Number

⁵ Corresponds to Figure 4-15.

⁶ DL = Detection Limit (0.01 mg/l)

FIGURE 4-17
Rottaway Landfill, Inc.
Pre-Acceptance Procedures

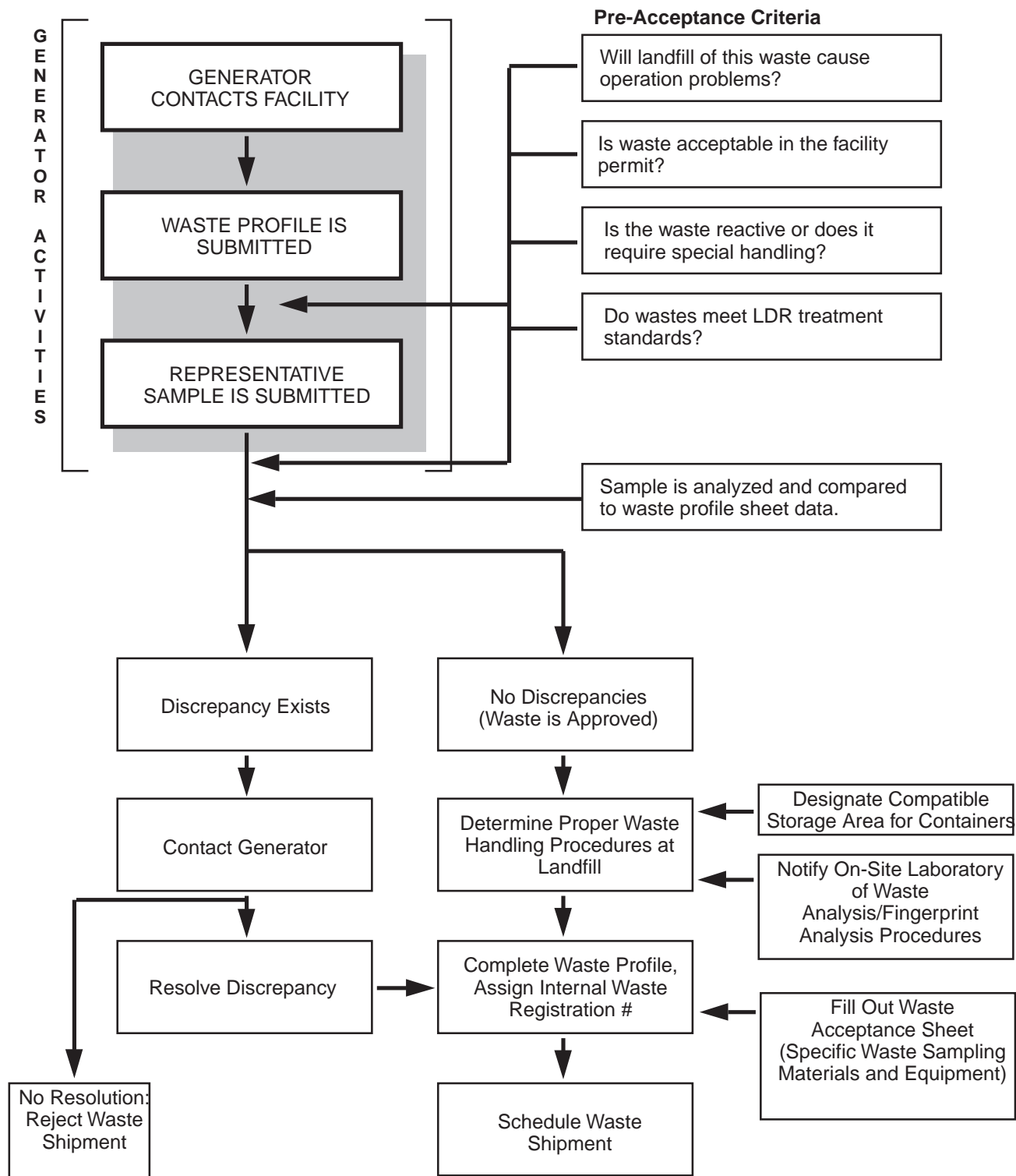
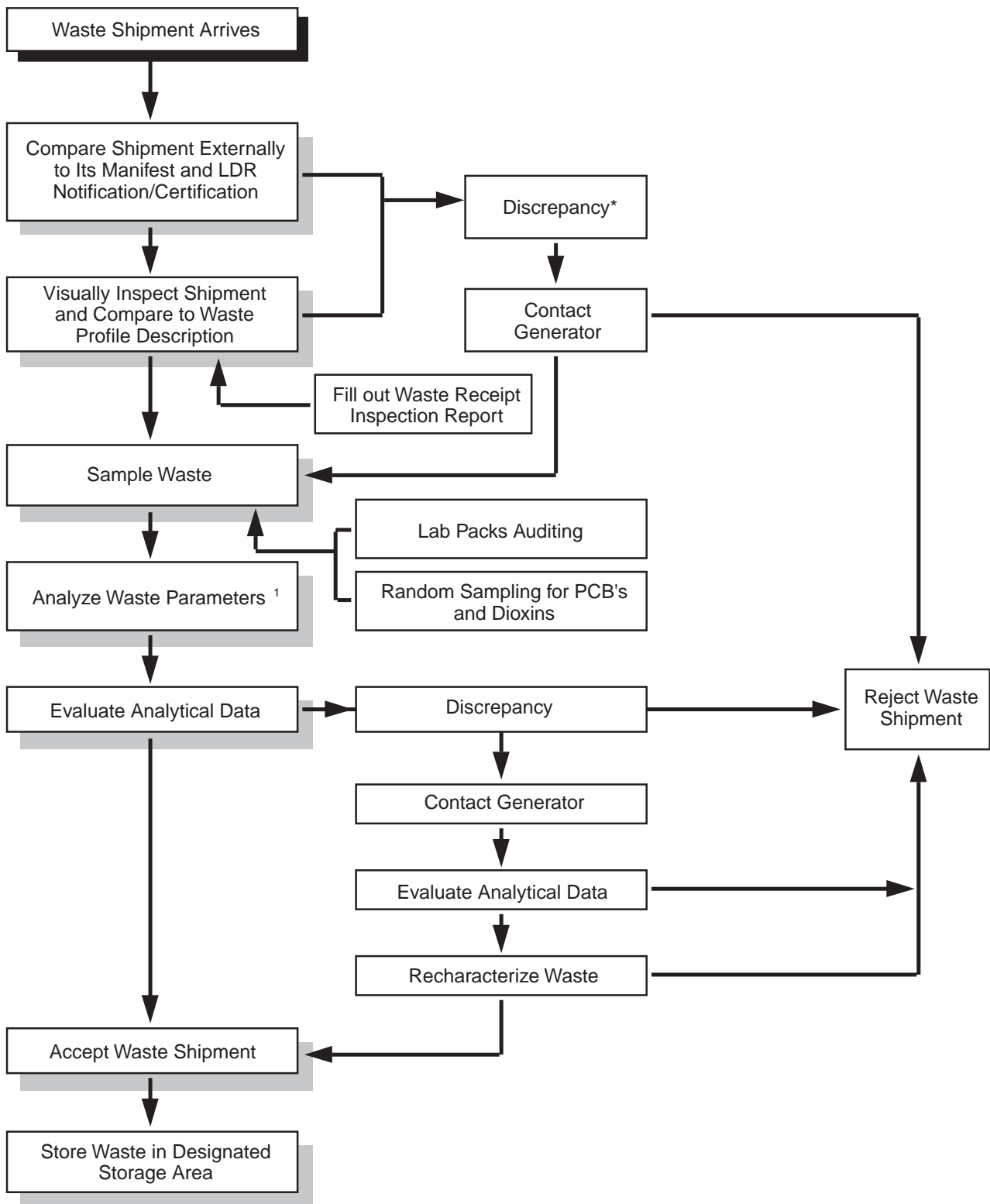
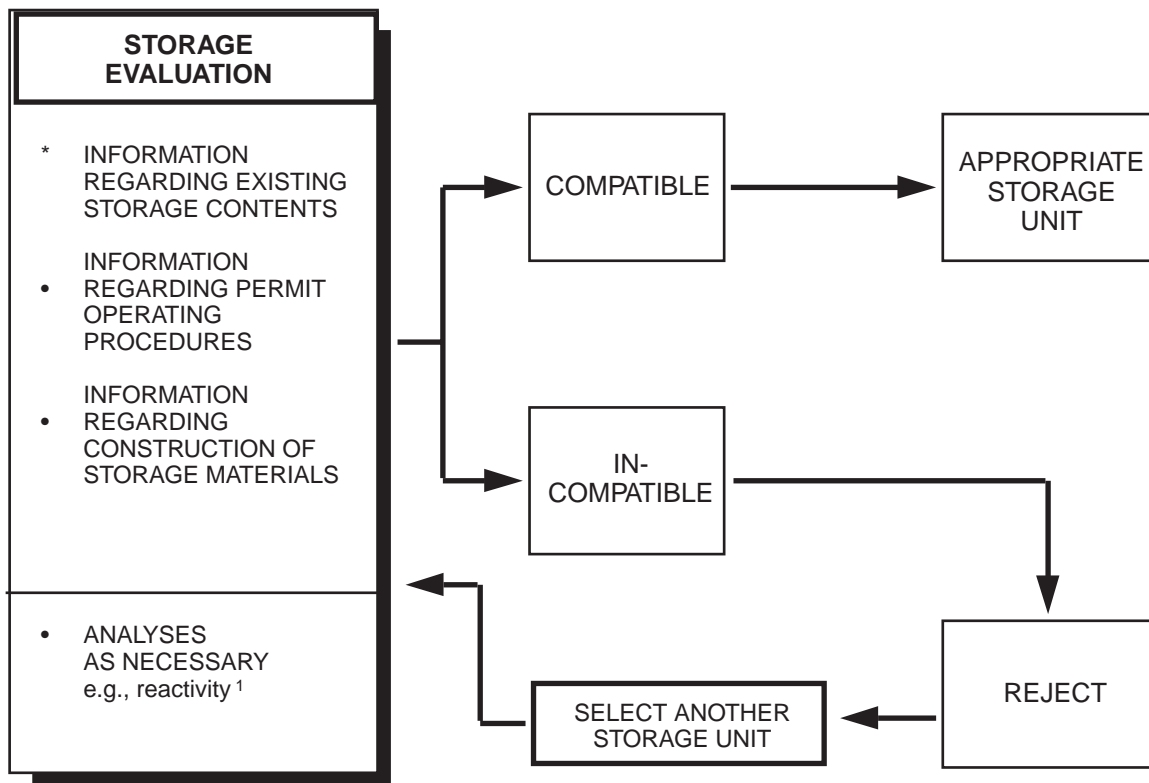

FIGURE 4-18
Rottaway Landfill, Inc.
Incoming Waste Shipment Procedures (Waste Acceptance Procedures)



¹ If discrepancy is found, the next shipment from this generator is subject to increased level of analysis.

FIGURE 4-19
Procedures For Designating Landfill Storage Units (Cells)



¹ Your WAP will designate the types of analysis or parameters that will be necessary to confirm or deny the storage of wastes in designated storage units.

TABLE 4-25
Rottaway Landfill, Inc.
Fingerprint Analysis Used To Sample Incoming Wastes

CHEMICAL PARAMETERS	PHYSICAL PARAMETERS	VISUAL PARAMETERS
Cyanide* PCBs* % Cl* % F* % Br* % S* Organic Parameters** (Prohibited Part 261, Appendix VIII Constituents) Inorganic Parameters (TCLP metals)**	% Water* Radioactivity* Specific Gravity*	Color* Phases* Viscosity* Turbidity* Layers*
* Checked each time the waste is shipped (other parameters are tested only when initial or updated representative samples are provided. ** Unique parameters will be selected for each waste stream and designated in the Waste Profile Sheet.		

TABLE 4-26
Rottaway Landfill, Inc.
Selected Parameters: Rationale, Criteria, And Special Consideration

WASTE	PARAMETERS	CRITERIA	RATIONALE	FREQUENCY	SPECIAL CONSIDERATIONS
F002 Ash	trichlorofluoromethane	33 mg/kg	To determine if above LDR treatment standards	Each batch	Must use total waste analysis to demonstrate compliance
F003 Ash	acetone	160 mg/kg	To determine if above LDR treatment standards	Each batch	Must use total waste analysis to demonstrate compliance
All wastes	PCBs	<50 mg/kg	To determine presence of PCBs	Each batch	PCBs above 50 mg/kg not acceptable in the facility's permit
F006 Slag	Reactivity	<150 mg/kg of CN	To ensure that no significant concentrations of CN are released	Each batch	Reactive wastes will not be land disposed
F006 Slag	Cd Cr Ni Pb Ag CN (Total) CN (Amenable)	Cd .066 mg/l Cr 5.2 mg/l Ni .32 mg/l Pb .51 mg/l Ag .072 mg/l CN (Total) 590 mg/kg CN (Amenable) 30 mg/kg	To determine if concentration exceed LDR treatment standards	Each batch	Must meet treatment standards in both 268.41 - 268.43

¹ Metal values are reported as the concentration in the TCLP extract in mg/l. All other values are reported for the total waste analysis in mg/kg.

TABLE 4-27
Rottaway Landfill, Inc.
Sampling Methods And Equipment

WASTE MATERIAL	SAMPLING METHOD	SAMPLING EQUIPMENT	SAMPLING STRATEGY
Fly ash-like material	ASTM D 2234-76 ^a or ASTM E 300 ^a	Tube sampler ^d , trier, auger, scoop, or shovel	Simple random (grab)
Containerized liquids (e.g., tank, drums) ^c	SW-846 ^b or ASTM E 300 ^a	Coliwasa/tube sampler ^d , weighted bottle, bomb, or tank sampling ports	Simple random (grab)
<p>^a-- American Society for Testing and Materials, 1982. Annual Book of ASTM Standards, Philadelphia, PA, or most recent edition.</p> <p>^b-- Test Methods for Evaluating Solid Waste, 1980, SW-846, 2nd Edition, U.S. Environmental Protection Agency, Office of Water and Waste Management, Washington, DC, or most recent edition.</p> <p>^c-- The specific equipment is dependent on the type of container. See SW-846 for specific examples. See also Section 2.2.</p> <p>^d-- Personal Protection and Safety Training Manual (Cincinnati, Ohio: U.S. Environmental Protection Agency, National Training and Operational Technology Center, 1981), pp. 3-1 and 3-4.</p>			

APPENDIX A

HAZARDOUS WASTE IDENTIFICATION

EPA was granted the authority to develop criteria for the identification of hazardous wastes under Section 3001 of RCRA. Under Section 1004 of RCRA, a hazardous waste is defined as a solid waste, or a combination of solid wastes which, because of its quantity, concentration, or physical, chemical, or infectious characteristics, may cause, or significantly contribute to an increase in mortality or an increase in serious irreversible or incapacitating reversible illness, or pose a substantial present or potential hazard to human health or the environment when improperly treated, stored, transported, disposed, or otherwise managed. The regulatory definition of a hazardous waste is found in 40 CFR §261.3. Solid wastes are defined by regulation as hazardous wastes in two ways. First, solid wastes are hazardous wastes if EPA lists them as hazardous wastes; the lists of hazardous wastes are found in 40 CFR Part 261, Subpart D. EPA lists wastes based on criteria in 40 CFR §261.11. Wastes listed by EPA as hazardous contain hazardous constituents, are acutely hazardous, and/or exhibit the characteristics of ignitability, corrosivity, reactivity, or toxicity. Second, EPA identifies the characteristics of a hazardous waste based on criteria in 40 CFR §261.10. Accordingly, solid wastes are hazardous if they exhibit any of the following four characteristics of a hazardous waste: ignitability, corrosivity, reactivity, or toxicity (based on the results of the TCLP). Descriptions of these hazardous waste characteristics are found in 40 CFR Part 261, Subpart C. Exclusions to the regulatory definitions of solid waste and hazardous waste are found in 40 CFR §261.4.

[Note: EPA is in the process of issuing new rules on the definition of hazardous waste. Regardless of changes in the rules, the format, content, procedures, and implementation of a WAP will not change.]

Generators must conduct a hazardous waste determination according to the hierarchy specified in 40 CFR §262.11. Figure A-1 can be used to assist in making this hazardous waste determination, and can serve as a roadmap when reviewing the rest of Appendix A. Persons who generate a solid waste first must determine if the solid waste is excluded from the definition of hazardous waste under the provisions of 40 CFR §261.4. If the waste is not excluded, the generator must determine if it is listed as a hazardous waste; if the waste is not listed, or for the purposes of complying with the LDR requirements in 40 CFR Part 268, the generator must determine if the waste exhibits a characteristic of a hazardous waste, either by testing the waste or by utilizing knowledge about the process or materials used to generate the waste.

Listing Determination

Once the generator determines that a solid waste is not excluded, then he/she must determine if the waste meets one or more of the hazardous waste listing descriptions. The hazardous waste lists include wastes from nonspecific sources (termed “F-listed wastes,” after the F prefix in the hazardous waste codes); these wastes include spent solvents, electroplating wastes, and dioxin-bearing wastes. The hazardous waste listings also include wastes from specific sources (i.e., K-listed wastes), including wastes from wood preserving operations, organic and inorganic chemical production, pesticide formulation, explosives manufacturing, petroleum refining, iron and steel production, pharmaceutical manufacturing, and the lead, zinc, copper, and aluminum industries. The third group of hazardous waste listings include discarded unused commercial chemical products, off-specification products, and spill residues of such products (i.e., P- and U-listed wastes).

**FIGURE A-1
Hazardous Waste Identification**

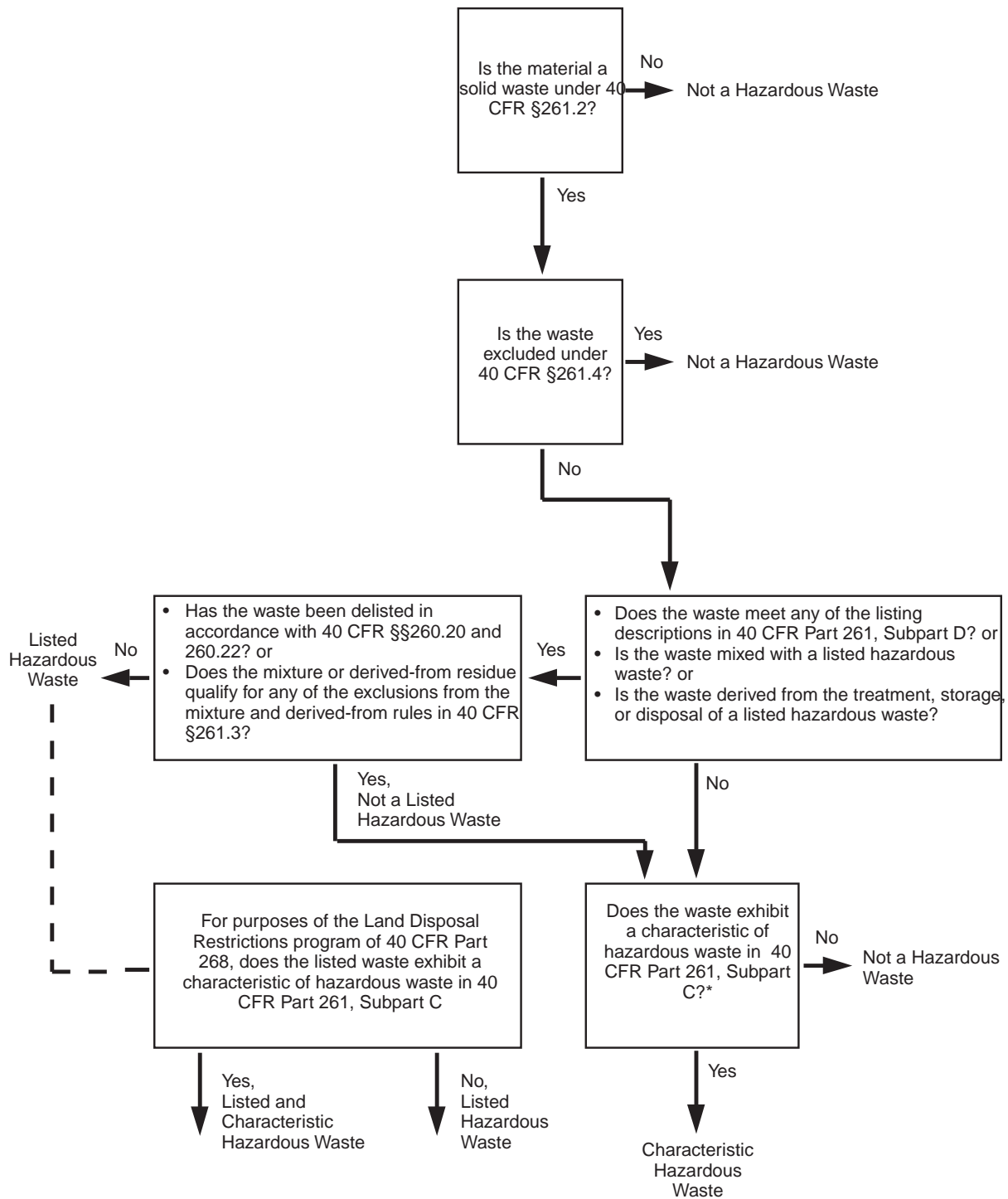

* Note exception for mixtures of characteristic wastes and mining/mineral processing wastes in 40 CFR §261.3(a)(2)(i).

The hazardous waste listings also apply to certain mixtures of solid wastes. Under the “mixture rule” in 40 CFR §§261.3(a)(2)(iii) and (iv), mixtures of listed hazardous wastes and solid nonhazardous wastes are defined as hazardous wastes and retain their listing designations unless the hazardous waste in the mixture is listed solely based on a particular characteristic (that is, ignitability [I], corrosivity [C], reactivity [R], toxicity [E]) and the mixture no longer exhibits any of these hazardous waste characteristics. For example, a mixture of a spent methylene chloride formulation (listed as F002 because of its hazardous constituents) and used oil would be defined as a hazardous waste and be designated as F002 whether or not the mixture exhibited a hazardous waste characteristic. The mixture remains a hazardous waste unless the generator successfully petitions to delist the waste according to procedures outlined in 40 CFR §260.22.

The hazardous waste listings also apply to solid wastes that are derived from the treatment, storage, or disposal of a listed hazardous waste. The “derived-from rule” (40 CFR §261.3(c)(2)) defines residual solid wastes derived from the treatment, storage, or disposal of a listed hazardous waste as a hazardous waste. Examples of wastes defined as hazardous through the derived-from rule include ash resulting from the incineration of off-specification toluene (U220), and leachate resulting from the disposal of API separator sludge from the petroleum refining industry (K051) in a landfill. As with the mixture rule, a generator may petition EPA to delist a waste that is derived from a listed waste.

EPA also regulates mixtures of hazardous wastes and other materials that are not solid wastes. The “contained-policy” states that materials containing a listed hazardous waste must be managed as hazardous wastes until the listed waste can be removed from the mixture. This provision mainly applies to mixtures of listed hazardous wastes and environmental media (e.g., contaminated ground water, contaminated soil) that cannot be regulated by the mixture rule. An example of a waste regulated under the contained-in policy is soil contaminated with cyanides that has been excavated from under a tank that contains spent cyanide plating bath solutions from an electroplating operation (F007); this soil would be managed as F007.

Characteristics Determination

A solid waste that does not meet a listing for a hazardous waste must be evaluated by the generator to determine if it exhibits a characteristic of a hazardous waste. A generator must evaluate such wastes to determine if they exhibit any of the four characteristics of a hazardous waste: ignitability, corrosivity, reactivity, and toxicity. This evaluation involves testing the waste or using knowledge of the process or materials used to produce the waste.

A waste is defined as **ignitable** according to a definition in 40 CFR §261.21. A waste is ignitable if it is a liquid and its flash point is less than 140° F (60° C). EPA Test Method 1010 (Pensky-Martens Closed Cup Method), EPA Test Method 1020 (Setaflash Closed Cup Method), or equivalent methods may be used to test for ignitability. A waste may also be defined as ignitable if it is an oxidizer or an ignitable compressed gas as defined in Department of Transportation (DOT) regulations in 40 CFR Part 173, or if it has the potential to ignite under standard temperature and pressure and burn persistently and vigorously once ignited. Wastes that are ignitable are classified as EPA Hazardous Code D001. Examples of ignitable wastes are certain spent solvents (e.g., mineral spirits) and off-specification jet fuels.

The characteristic of **corrosivity** is described in 40 CFR §261.22. A waste is corrosive if it is aqueous (defined as amenable to pH measurement) and its pH is less than or equal to 2 or greater than or equal

to 12.5. The tests used for this pH determination are EPA Test Method 9040 (pH Electrometric Measurement), EPA Test Method 9041 (pH Paper Method), or an equivalent method. A waste is also corrosive if it is a liquid and it corrodes steel at a rate of more than 0.25 inches per year under conditions specified in EPA Test Method 1110. Corrosive wastes are designated as EPA Hazardous Waste Code D002. Corrosive wastes include spent sulfuric acid and concentrated waste sodium hydroxide solutions that have not been neutralized.

A waste exhibits the characteristic of **reactivity** if it meets any of the criteria in 40 CFR §261.23. Only the reactivity criterion for cyanide- and sulfide-bearing wastes, however, has an established test method. EPA guidance provides that a waste is considered reactive under 40 CFR §261.23(a)(5) if it releases more than 250 mg of hydrogen cyanide per kg of waste or 500 mg of hydrogen sulfide per kg of waste as measured by the test methods in SW-846 Sections 7.3.3.2 and 7.3.4.2, respectively. Wastes that exhibit the characteristic of reactivity are classified as EPA Hazardous Wastes Code D003.

The final characteristic of a hazardous waste is the **toxicity characteristic** (TC). Generators who opt to test their waste for this characteristic must develop an extract of the waste according to the Toxicity Characteristic Leaching Procedure (TCLP - EPA Test Method 1311) found in Appendix II to 40 CFR Part 261. The extract is then subsequently analyzed using one or more of several methods listed below. The results of the analysis are compared to regulatory thresholds for 40 constituents in 40 CFR §261.24. Test methods in this step may include the following:

- EPA Test Methods 3010 and 6010 - for arsenic, barium, cadmium, chromium, lead, silver, and selenium
- EPA Test Method 7470 - mercury
- EPA Test Methods 3510 and 8080 - pesticides
- EPA Test Method 8240 - for volatile organics
- EPA Methods 3510 and 8270 - semivolatile organics
- EPA Test Method 8150 - herbicides.

If the extract from the TCLP procedure contains levels of any of the 40 constituents at or above regulatory thresholds, the waste is considered a hazardous waste. Wastes that exhibit the toxicity characteristic are classified as EPA Hazardous Waste Codes D004 through D043. Examples of wastes that may exhibit the characteristic of toxicity include petroleum wastes, wastes from organic chemical manufacturing, and pesticide and herbicide wastes.

Certain states may also have requirements for identifying hazardous wastes in addition to those described above. States authorized to implement the RCRA or HSWA programs under Section 3006 of RCRA may promulgate regulations that are more stringent or broader in scope than federal regulations. For example, certain states have broadened the scope of the hazardous waste listings by specifically listing used oil as a hazardous waste. Some states also regulate hazardous wastes based on total (versus extract) waste analysis of individual hazardous constituents.

APPENDIX B

REGULATORY SUMMARY

This appendix presents a brief summary of relevant RCRA regulatory requirements. It is not meant to be a complete or detailed description of all applicable RCRA regulations. For more information concerning specific requirements, consult the Federal Registers cited herein and the Code of Federal Regulations, Title 40 Parts 261, 264, 265, 266, and 268.

Land Disposal Restrictions (LDR) (40 CFR Part 268)

The 1984 Hazardous and Solid Waste Amendments (HSWA) to RCRA prohibit the land disposal of specific groups of hazardous waste, unless it has been determined that there will be no migration of the hazardous constituents. The amendments also required EPA to establish treatment standards for all listed and characteristic wastes, expressed as concentration levels or methods of treatment, that will reduce their toxicity and make them safe for land disposal. These treatment standards are found in Part 268, Subpart D. LDRs apply to all generators and transporters of hazardous waste as well as to owners and operators of treatment, storage, and disposal facilities (TSDFs).

Generators must determine whether their waste is subject to LDRs for each hazardous waste at the point of generation. HSWA requires that both listed **and** characteristic determinations be made for each waste. The generator can make this determination based on knowledge of the waste, by conducting a total waste analysis, or by testing the waste extract. If a generator determines the waste is prohibited from land disposal and elects to treat the waste on site (in accumulation tanks, containers, or containment buildings regulated under 40 CFR §262.34), a written waste analysis plan (WAP) must be developed to describe the procedures the generator will carry out to comply with the treatment standards. The plan must be kept on site in the generator's records and it must be submitted to the Regional Administrator. Although no specific criteria are established for generators developing a WAP in accordance with 40 CFR §268.7(a)(4), the plan should be written in accordance with the procedures prescribed in this manual (i.e., describe the physical and chemical analysis that will be conducted on a representative sample of the waste(s) being treated, and specifically describe the frequency of testing). WAPs are not required from generators who are treating for purposes other than meeting LDR treatment standards. The generator of the waste must provide notification to any facility receiving their waste as to the status of the waste with respect to LDR. If the waste meets the applicable LDR treatment standard, the generator must provide certification to the receiving facility.

Treatment/storage facilities are responsible for including in their WAP (40 CFR §§264.13/265.13) procedures used to corroborate that correct treatment standards have been selected for incoming wastes and provisions for testing the waste to verify that it meets the LDR treatment standard(s). These facilities will receive the generators' certification and any available waste analysis data provided by the generator (40 CFR §§264.73, 265.73). However, upon subsequent management of the waste, the treatment/storage facility, like the generator who ships directly to a disposal facility, must certify to the disposal facility that the waste meets the applicable treatment standards.

The disposal facility receives certifications that the waste meets LDR treatment standards from generators and treatment/storage facilities. The results of waste analysis or other information on the waste's properties should also be provided by generators or treaters of the waste. The disposal facility must conduct sampling and analysis of incoming wastes to verify that wastes meet the relevant treatment standards for the specific waste. The procedures for waste sampling and analysis, including the frequency of testing, must be documented in the facility's WAP.

Further discussion of LDRs is available in “Land Disposal Restrictions: Summary of Requirements,” February 1991, OSWER 9934.0-1A.

Boilers And Industrial Furnaces (40 CFR Part 266, Subpart H)

Boilers and Industrial Furnaces (BIF) that burn hazardous waste as fuel for energy or materials recovery, have previously been exempt from obtaining RCRA operating permits. A new rule, finalized on February 21, 1991, regulates the burning of hazardous waste in boilers and industrial furnaces. This rule imposes new operating and regulatory standards on BIFs. Many of the RCRA standards currently applied only to incinerators now also apply to BIFs burning hazardous waste as fuel.

The regulatory standards for BIFs became effective on August 21, 1991, and apply to cement kilns; lime kilns; aggregate kilns; smelting, melting, and refining furnaces; and halogen acid furnaces. The new BIF rule regulates all industrial furnaces processing hazardous waste fuel for energy, material recovery, or destruction except for furnaces that process hazardous waste for metals reclamation (recycling) or those burning small quantities of wastes as fuel.

Under the new rule, EPA requires some facility owners and operators to obtain operating permits by imposing similar operating conditions as those required of incinerator facilities. The rule further requires facilities to operate only under conditions specified in the permit and to comply with standards for controlling and monitoring the amount of pollutants released to the atmosphere from burning activities.

As specified in 40 CFR Part 266 (Subpart H), facility owners and operators must demonstrate to EPA that furnaces can be operated without releasing unacceptable amounts of particulate materials (dusts), toxic metals, hydrochloric acid, carbon monoxide, chlorine, hydrocarbons, and dioxin/furans into the atmosphere. In addition, waste fuels must be sampled and analyzed prior to burning. Prior to obtaining a permit, the owner/operator is required to perform an analysis of the hazardous waste to be managed to identify the presence of the listed hazardous chemical constituents (Appendix VIII of 40 CFR Part 261). The results of the analyses are used by the permit writer to establish operating conditions for the facility. Throughout normal operation, the facility owner/operator must conduct sampling and analysis to ensure that the hazardous waste, and other fuels burned in the boiler or industrial furnace are within specific limits established in the permit for the facility. A WAP must be developed that describes how samples of waste fuel are collected and analyzed to determine physical and chemical characteristics of the fuel. The WAP must include the information specified in 40 CFR §264.13.

To qualify for interim status under the new rule, owners/operators of “existing” BIF facilities must have submitted a RCRA Part A application and certificate of precompliance by August 21, 1991. A certificate of compliance, including air emissions testing results, was required by August 21, 1992. During interim status, BIFs must meet the interim status standards for boilers contained in 40 CFR §266.103.

Tank Systems (40 CFR Parts 264/265, Subpart J)

On July 14, 1986, EPA established operating standards for facility owners and operators that accumulate, store or treat hazardous waste in tanks. These regulations detailed in 40 CFR Parts 264/265 Subpart J, establish technical standards and operating procedures for tank systems that include requirements for installation, leak testing and detection, corrosion protection, structural integrity, secondary containment, responses to leaks in the environment, closure and post closure care. Separate standards are established in 40 CFR Part 280 for tanks storing petroleum and other hazardous substances that are not RCRA hazardous wastes.

If you operate a tank system that is used to manage hazardous waste, you must comply with the general standards for treatment, storage, and disposal facilities, including preparation of a WAP.

Miscellaneous Units (40 CFR Part 264, Subpart X)

On December 21, 1987, EPA established standards for locating, designing, constructing, operating, and maintaining miscellaneous units that are used to store, treat, or dispose of hazardous waste. These units include geologic repositories, deactivated missile silos, thermal treatment units, open burning/open detonation units for explosive wastes, some chemical, physical, and biological treatment units and any other units not previously regulated in 40 CFR Part 264 (e.g., containers, tanks, surface impoundments, waste piles, land treatment units, landfills, incinerators, underground injection wells, and research development and demonstration projects). Facility owners and operators of treatment storage and disposal facilities must comply with these requirements if they are managing wastes in miscellaneous units.

The regulation requires facility owners/operators to obtain operating permits and meet various environmental performance criteria. These criteria were established to prevent the release and migration of wastes from these units from adversely affecting human health and the environment. The regulations require owners/operators to submit detailed information on the environmental features of the facility and waste characteristics as part of their permit application.

Other standards of this regulation require owners and operators to demonstrate compliance with the TSDF standards specified in 40 CFR Part 264 Subparts A-H, including monitoring, analyses, inspection, response and corrective action.

Permits issued by EPA under this regulation require owners and operators of miscellaneous units to perform general waste analysis, as outlined in 40 CFR §264.13 and to develop a WAP.

Toxicity Characteristic And TCLP (40 CFR Part 261, Subpart C)

Waste defined as hazardous, may be found to exhibit certain hazardous **characteristics** or it may be designated as a **listed** waste based on its origin. The four characteristics that may define a waste as hazardous are ignitability, corrosivity, reactivity, and, until recently, Extraction Procedure (EP) toxicity. The Extraction Procedure Toxicity Test (EP TOX Test) measures the potential for the toxic constituents in the waste to leach and migrate to surrounding media. The EP TOX Test was used by

EPA to measure the potential for landfilled wastes to present a public health hazard and, thus, be classified as a hazardous waste.

HSWA directed EPA to examine and revise the EP TOX Test established under RCRA. On March 29, 1990, EPA promulgated the Toxicity Characteristic (TC) rule which replaced the EP TOX Test with the Toxicity Characteristic Leaching Procedure (TCLP), identified 25 additional organic hazardous waste constituents of concern, and established regulatory threshold levels for these organic chemicals (55 FR 11798). The modified and improved leaching test and the addition of 25 more constituents of concern greatly increased the amounts of wastes considered hazardous.

Air Emissions From TSDFs (40 CFR Parts 264/265, Subparts AA And BB)

The organic air emission regulations establish standards to minimize the release of organic emissions to the atmosphere from process vents and equipment. These requirements apply to TSDF hazardous waste management (and recycling) units that manage waste with organic concentrations above specified levels. Facility owners/operators are required to identify and meet specific technical requirements for all process vents associated with distillation, fractionation, thin-film evaporation, solvent extraction, and stripping processes that manage wastes with a 10-ppmw (ppm by weight) or greater total organics concentration on a time-weighted annual average basis.¹ Additionally, TSDFs with equipment (e.g., pumps, valves, compressors) that contains or contacts hazardous wastes exceeding a total organic concentration of 10 percent or greater must meet emission control and monitoring standards. Specific equipment subject to these regulatory provisions include pumps, compressors, valves, pressure relief devices, flanges, or other connectors.

A determination of the applicability of the organic air emissions standards is made based on direct measurement of the organic concentration of the waste using specified analytical procedures, or knowledge of the process from which it was produced. The methods used and the results of the waste determination must be documented in the WAP for the facility.

For facilities subject to the process vent and equipment leak standards that exceed applicable emission criteria, control devices or techniques must be implemented to minimize the release of organic vapors. These emission controls must comply with applicable design, monitoring, testing and recordkeeping requirements established under 40 CFR Parts 264/265 Subparts AA and BB.

The implementation schedule for the organic emissions standards is dependent upon your existing facility status. Facilities that are newly permitted or obtain interim status after the December 21, 1991, effective date of the rule must comply with the organic air emissions standards immediately. Interim status facilities in operation at the time of the rule's effective date, however, had an additional 18 months to install and operate control devices. Finally, facilities that have been issued a final permit prior to December 21, 1991, are not required to comply with the new standards until such time that the permit is reviewed or reissued.

¹40 CFR §§264/5.1034(d)

Prohibition Of Liquids In Landfills (40 CFR Part 264/265, Subpart N)

On July 15, 1985, EPA amended the standards for permitted landfills and interim status landfills to ban the placement of bulk or non-containerized, liquid hazardous or non-hazardous waste, or hazardous waste containing free liquids in any landfill. EPA interprets the ban on “placement” to include, but not be limited to: (1) placing bulk liquids into a landfill cell where the liquids are solidified and then transferred to another cell, and (2) placing treated bulk liquids still in liquid form into a landfill prior to solidification. For non-hazardous liquids, an exemption exists if the owner/operator can demonstrate that: (1) the only available alternative for these non-hazardous liquids is a landfill or unlined surface impoundment, which already contains hazardous waste, and (2) the disposal of the non-hazardous liquids in the landfill will not present a risk of contamination to any underground source of drinking water.

Hazardous and nonhazardous liquids may be placed into landfills after being chemically and physically treated so that free liquids are no longer present in the waste. If waste is mixed with a sorbent to remove free liquids, the sorbent must be nonbiodegradable. Examples of such sorbents are provided in 40 CFR §§264.314(e) and 265.314(f). If wastes are to be treated with sorbents which are not specifically listed, the sorbent must be tested using specified ASTM methods to ensure that it is nonbiodegradable.

Landfills, regulated under RCRA as treatment, storage, and disposal facilities, must perform general waste analysis, as outlined in 40 CFR Part 264 and develop a WAP. The waste analysis must demonstrate the absence or presence of free liquids in either containerized or bulk waste, using Method 9095 (Paint Filter Liquids Test) as described in “Test Methods for Evaluating Solid Wastes, Physical/Chemical Methods” (SW-846) or another equivalent test method. Waste analysis must also be used to determine whether containerized wastes have been mixed with biodegradable sorbents.

Appendix C
Table C-1
Waste Analysis Data Flow Responsibilities

Scenario	Notification ¹		Summary of Notification Responsibilities	Certification ²	
	Notifies Whom?	How Often?		Certifies to Whom?	How Often?
Generator manages a restricted waste that does not meet the treatment standards/prohibition levels; sends it off site for storage or treatment (40 CFR §268.7(a)(1))	Treatment, storage, or recycling facility	With each shipment	<ul style="list-style-type: none"> EPA hazardous waste code(s) Corresponding concentration-based or technology-based treatment standards, or prohibition level Manifest number Waste analysis data 	N/A ³	N/A
Generator manages a restricted waste, and determines that the waste can be land disposed without further treatment (40 CFR §268.7(a)(2))	Storage, recycling, or disposal facility	With each shipment	<ul style="list-style-type: none"> EPA hazardous waste code(s) Corresponding concentration-based or technology-based treatment standards, or prohibition level Manifest number Waste analysis data 	TSD facility	With each shipment
Generator's waste is subject to a case-by-case extension under §268.5, exemption under §268.6, or a nationwide variance under (40 CFR §268.7(a)(3))	Facility receiving waste (MTR unit)	With each shipment	<ul style="list-style-type: none"> EPA hazardous waste code(s) Corresponding concentration-based or technology-based treatment standards, or prohibition level Manifest number Waste analysis data The date the waste is subject to the prohibitions Statement that waste is not prohibited from land disposal 	N/A	N/A
Small quantity generator (100-1,000 kg/month) subject to tolling agreement pursuant to 40 CFR §262.20(e), (40 CFR §268.7(a)(10))	Recycling facility	With initial shipment	<ul style="list-style-type: none"> EPA hazardous waste code(s) Corresponding concentration-based or technology-based treatment standards, or prohibition level Manifest number Waste analysis data 	N/A	N/A

¹ A full description of the notification responsibilities is documented in 40 CFR §268.7

² Certifications requirements are presented in 40 CFR §268.7

³ N/A denotes not applicable

Appendix C
Table C-1
Waste Analysis Data Flow Responsibilities (continued)

Scenario	Notification ¹		Summary of Notification Responsibilities	Certification ²	
	Notifies Whom?	How Often?		Certifies to Whom?	How Often?
Generator sending lab pack containing restricted wastes, and is applying alternate lab pack standard in 40 CFR §268.42, Appendix IV or V (40 CFR §268.7(a)(8) and (a)(9))	Treatment or storage facility	With each shipment	<ul style="list-style-type: none"> All EPA hazardous waste codes Five letter technology code: INCIN Manifest number Waste analysis data 	Treatment or storage facility	With each shipment
TSD facilities sending restricted waste off-site for additional treatment or storage (40 CFR §268.7(b)(6))	Must meet same notification and certification requirements applicable to generators				
Treatment facilities sending restricted wastes off site to land disposal facilities (LDFs) (40 CFR §268.7(b)(4))	Land disposal facility	With each shipment	<ul style="list-style-type: none"> EPA hazardous waste code(s) Corresponding concentration-based or technology-based treatment standards, or prohibition level Manifest number Waste analysis data 	Land disposal facility	With each shipment
Generator or TSD facility sending characteristic waste that has been rendered non-hazardous to a subtitle D land disposal facility (40 CFR §268.9)	Regional Administrator or authorized State	One time ⁴	<ul style="list-style-type: none"> Name and address of subtitle D facility Description of waste, as generated Concentration-based or technology-based treatment standards or prohibition level applicable to waste at time of generation 	Regional Administrator or authorized State	One time ⁴

¹ A full description of the notification responsibilities is documented in 40 CFR §268.7

² Certifications requirements are presented in 40 CFR §268.7

³ N/A denotes not applicable

⁴ This requirement reflects changes in the LDR Phase I Rule (57 FR 37271, August 18, 1992)

APPENDIX D

REGULATORY CITATIONS FOR CONDUCTING WASTE ANALYSIS

40 CFR §264.13 General Waste Analysis

The following is an excerpt from 40 CFR 264 that contains the regulatory requirements for waste analysis plans for hazardous waste treatment, storage, and disposal facilities.

(a)(1) Before an owner or operator treats, stores, or disposes of any hazardous wastes, or non-hazardous wastes if applicable under §264.113(d), he must obtain a detailed chemical and physical analysis of a representative sample of the wastes. At a minimum, the analysis must contain all the information which must be known to treat, store, or dispose of the waste in accordance with this part and part 268 of this chapter.

(2) The analysis may include data developed under Part 261 of this chapter, and existing published or documented data on the hazardous waste or on hazardous waste generated from similar processes.

[*Comment:* For example, the facility's records of analyses performed on the waste before the effective date of these regulations, or studies conducted on hazardous waste generated from processes similar to that which generated the waste to be managed at the facility, may be included in the data base required to comply with paragraph (a)(1) of this section. The owner or operator of an offsite facility may arrange for the generator of the hazardous waste to supply part of the information required by paragraph (a)(1) of this section, except as otherwise specified in 40 CFR 268.7(b) and (c). If the generator does not supply the information, and the owner or operator chooses to accept a hazardous waste, the owner or operator is responsible for obtaining the information required to comply with this section.]

(3) The analysis must be repeated as necessary to ensure that it is accurate and up to date. At a minimum, the analysis must be repeated:

(i) When the owner or operator is notified, or has reason to believe, that the process or operation generating the hazardous wastes, or non-hazardous wastes if applicable under §264.113(d), has changed; and

(ii) For off-site facilities, when the results of the inspection required in paragraph (a)(4) of this section indicate that the hazardous waste received at the facility does not match the waste designated on the accompanying manifest or shipping paper.

(4) The owner or operator of an offsite facility must inspect and, if necessary, analyze each hazardous waste movement received at the facility to determine whether it matches the identity of the waste specified on the accompanying manifest or shipping paper.

(b) The owner or operator must develop and follow a written waste analysis plan which describes the procedures which he will carry out to comply with paragraph (a) of this section. He must keep this plan at the facility. At a minimum, the plan must specify:

(1) The parameters for which each hazardous waste, or non-hazardous waste if applicable under §264.113(d), will be analyzed and the rationale for the selection of these parameters (i.e., how analysis for these parameters will provide sufficient information on

the waste's properties to comply with paragraph (a) of this section);

(2) The test method which will be used to test for these parameters;

(3) The sampling method which will be used to obtain a representative sample of the waste to be analyzed. A representative sample may be obtained using either:

(i) One of the sampling methods described in Appendix I of Part 261 of this chapter;

or

(ii) An equivalent sampling method.

[*Comment:* See §260.21 of this chapter for related discussion.]

(4) The frequency with which the initial analysis of the waste will be reviewed or repeated to ensure that the analysis is accurate and up to date; and

(5) For off-site facilities, the waste analyses that hazardous waste generators have agreed to supply.

(6) Where applicable, the methods which will be used to meet the additional waste analysis requirements for specific waste management methods as specified in §§264.17, 264.314, 264.341, 264.1034(d), 264.1063(d), and 268.7 of this chapter.

(7) For surface impoundments exempted from land disposal restrictions under §268.4(a), the procedures and schedules for:

(i) The sampling of impoundment contents;

(ii) The analysis of test data; and

(iii) The annual removal of residues which are not delisted under §260.22 of this chapter or which exhibit a characteristic of hazardous waste and either:

(A) Do not meet applicable treatment standards of Part 268, Subpart D; or

(B) Where no treatment standards have been established:

(1) Such residues are prohibited from land disposal under §268.32 or RCRA section 2004(d); or

(2) Such residues are prohibited from land disposal under §268.33(f).

(c) For off-site facilities, the waste analysis plan required in paragraph (b) of this section must also specify the procedures which will be used to inspect and, if necessary, analyze each movement of hazardous waste received at the facility to ensure that it matches the identity of the waste designated on the accompanying manifest or shipping paper. At a minimum, the plan must describe:

(1) The procedures which will be used to determine the identity of each movement of waste managed at the facility; and

(2) The sampling method which will be used to obtain a representative sample of the waste to be identified, if the identification method includes sampling.

(3) The procedures that the owner or operator of an off-site landfill receiving containerized hazardous waste will use to determine whether a hazardous waste generator or treater has added a biodegradable sorbent to the waste in the container.

[*Comment:* Part 270 of this chapter requires that the waste analysis plan be submitted with Part B of the permit application.]

40 CFR §265.13 General Waste Analysis

The following is an excerpt from 40 CFR 265 that contains the regulatory requirements for waste analysis plans for hazardous waste treatment, storage, and disposal facilities operating under interim standards.

(a)(1) Before an owner or operator treats, stores, or disposes of any hazardous wastes, or non-hazardous wastes if applicable under §265.113(d), he must obtain a detailed chemical and physical analysis of a representative sample of the wastes. At a minimum, the analysis must contain all the information which must be known to treat, store, or dispose of the waste in accordance with this part and part 268 of this chapter.

(2) The analysis may include data developed under Part 261 of this chapter, and existing published or documented data on the hazardous waste or on waste generated from similar processes.

[*Comment:* For example, the facility's records of analyses performed on the waste before the effective date of these regulations, or studies conducted on hazardous waste generated from processes similar to that which generated the waste to be managed at the facility, may be included in the data base required to comply with paragraph (a)(1) of this section. The owner or operator of an offsite facility may arrange for the generator of the hazardous waste to supply part of the information required by paragraph (a)(1) of this section, except as otherwise specified in 40 CFR 268.7(b) and (c). If the generator does not supply the information, and the owner or operator chooses to accept a hazardous waste, the owner or operator is responsible for obtaining the information required to comply with this section.]

(3) The analysis must be repeated as necessary to ensure that it is accurate and up to date. At a minimum, the analysis must be repeated:

(i) When the owner or operator is notified, or has reason to believe, that the process or operation generating the hazardous wastes, or non-hazardous wastes, if applicable under §265.113(d), has changed; and

(ii) For off-site facilities, when the results of the inspection required in paragraph (a)(4) of this section indicate that the hazardous waste received at the facility does not match the waste designated on the accompanying manifest or shipping paper.

(4) The owner or operator of an offsite facility must inspect and, if necessary, analyze each hazardous waste movement received at the facility to determine whether it matches the identity of the waste specified on the accompanying manifest or shipping paper.

(b) The owner or operator must develop and follow a written waste analysis plan which describes the procedures which he will carry out to comply with paragraph (a) of this section. He must keep this plan at the facility. At a minimum, the plan must specify:

(1) The parameters for which each hazardous waste, or non-hazardous waste if applicable under §264.113(d), will be analyzed and the rationale for the selection of these parameters (i.e., how analysis for these parameters will provide sufficient information on the waste's properties to comply with paragraph (a) of this section);

(2) The test method which will be used to test for these parameters;

(3) The sampling method which will be used to obtain a representative sample of the waste to be analyzed. A representative sample may be obtained using either:

- (i) One of the sampling methods described in Appendix I of Part 261 of this chapter; or
- (ii) An equivalent sampling method.

[*Comment:* See §260.21 of this chapter for related discussion.]

(4) The frequency with which the initial analysis of the waste will be reviewed or repeated to ensure that the analysis is accurate and up to date;

(5) For off-site facilities, the waste analyses that hazardous waste generators have agreed to supply; and

(6) Where applicable, the methods which will be used to meet the additional waste analysis requirements for specific waste management methods as specified in §§265.193, 265.225, 265.252, 265.273, 265.314, 265.375, 265.402, 254.1034(d), 254.1063(d), and 268.7 of this chapter.

(7) For surface impoundments exempted from land disposal restrictions under §268.4(a), the procedures and schedules for:

(i) The sampling of impoundment contents;

(ii) The analysis of test data; and

(iii) The annual removal of residues which are not delisted under §260.22 of this chapter or which exhibit a characteristic of hazardous waste and either:

(A) Do not meet applicable treatment standards of Part 268, Subpart D; or

(B) Where no treatment standards have been established:

(1) Such residues are prohibited from land disposal under §268.32 or RCRA section 2004(d); or

(2) Such residues are prohibited from land disposal under §268.33(f).

(c) For off-site facilities, the waste analysis plan required in paragraph (b) of this section must also specify the procedures which will be used to inspect and, if necessary, analyze each movement of hazardous waste received at the facility to ensure that it matches the identity of the waste designated on the accompanying manifest or shipping paper. At a minimum, the plan must describe:

(1) The procedures which will be used to determine the identity of each movement of waste managed at the facility; and

(2) The sampling method which will be used to obtain a representative sample of the waste to be identified, if the identification method includes sampling.

(3) The procedures that the owner or operator of an off-site landfill receiving containerized hazardous waste will use to determine whether a hazardous waste generator or treater has added a biodegradable sorbent to the waste in the container.

APPENDIX E

OVERVIEW OF MAJOR HAZARDOUS WASTE MANAGEMENT UNITS

Containers

Containers are portable devices used to treat, store, transport, dispose, and handle waste materials. They include metal drums and pails, polyfiber bags, plastic drums and carboys, or durable fiberboard paper drums or pails. They do not include tanks, which are regulated separately, as discussed below. Metal and plastic drums and pails are the most commonly used containers; however, durable fiber drums (used most often to store and transport solids designated for incineration) and drums constructed of other materials are also widely used. Before selecting a container for storage or treatment of the waste, you should identify its physical and chemical characteristics. The selection of waste analysis parameters will be dependent upon the specific characteristics of the wastes you manage and the construction materials of the container used at your facility. You should consider performing laboratory analysis on a sample of your wastes for parameters such as flash point, pH, reactivity, and moisture content.

Tanks

Tanks are stationary devices constructed primarily of non-earthen materials designed to contain an accumulation of hazardous waste(s). They do not have to be totally enclosed and they are generally distinguished from surface impoundments because they are self-supporting (i.e., they do not need external support materials, such as earth). They are generally constructed of metal, fiberglass, or rugged plastics.

Surface Impoundments

Surface impoundments are natural depressions, man-made excavations, or diked areas, formed primarily of earthen materials, used to contain an accumulation of liquids or wastes containing free liquids. Examples of surface impoundments are ponds, lagoons, and holding, storage, settling and aeration pits. Surface impoundments can be used as treatment, storage, or disposal units.

Although surface impoundments are constructed primarily of earthen materials, they often can have components made of synthetic materials, such as liners and leak detection systems. Synthetic materials that are most often used in the construction of liners include high-density polyethylene, chlorinated polyethylene, and polyvinyl chloride. Leak detection and leachate collection systems can be constructed from a number of geosynthetic textile materials, including polyethylene, polypropylene, and polyester. Surface impoundments may be equipped with a variety of high-strength polymer plastic piping (e.g., polyvinyl chloride) to aid in the removal of liquids that have accumulated in leachate collection systems, a component of the leak detection system.

Landfills

Landfills are disposal units where hazardous wastes are placed in or directly on land. In the RCRA regulations, waste piles, surface impoundments, land treatment units, underground injection wells, salt dome formations, mines, or caves are not regulated as landfills. Landfills are usually man-made excavations, but their designs invariably include the use of synthetic materials for liners, caps, and leachate collection

systems. These synthetic materials may include high-density polyethylene, chlorinated and sulfurated polyethylene, polyvinyl chloride (PVC), and other geosynthetic textiles.

Containment Buildings

Containment buildings are enclosed structures used to store or treat hazardous waste. They must be completely enclosed to prevent exposure to precipitation and wind, and be constructed of man-made materials of sufficient strength and thickness to support themselves, the waste contents, and any personnel and heavy equipment that operate within the unit.

Wastes managed in containment buildings cannot be in liquid form (i.e., flow under their own weight to fill the vessel in which they are placed, or be readily pumpable). Containment buildings must have a primary barrier designed and constructed of materials to prevent hazardous wastes from being accidentally or deliberately placed on the land beneath or outside the unit. They must also have controls to prevent fugitive dust emissions and the tracking of materials from the unit by personnel or equipment. Containment buildings used to manage hazardous wastes containing free liquids must include a primary barrier to prevent migration of hazardous constituents into the barrier and a liquid collection and removal system that will minimize the accumulation of liquid on the primary barrier; and be equipped with secondary containment including (1) a secondary barrier and (2) a leak detection, collection, and removal system. Under certain conditions, containment buildings may serve as secondary containment for tanks placed within the containment building.

As with tanks and containers, generators may accumulate and treat their hazardous wastes within these containment buildings without obtaining a RCRA Subtitle C permit. Generators treating hazardous wastes in order to comply with the applicable land disposal restrictions treatment standards must develop and follow a written waste analysis plan.

Waste Piles

Waste piles are areas used for non-containerized storage or treatment of solid, non-flowing wastes on the land. Waste piles are normally underlain by liners constructed of concrete or other materials, which act as barriers to prevent direct contact of the waste with the soil below the unit. Waste piles that are protected from wind, precipitation, and surface water run-on, and that are not containment buildings, are subject to reduced regulations. Waste piles and their associated liners and leak detection systems can be constructed of synthetic materials, including high-density polyethylene and PVC for liners, and a number of different geosynthetic textiles (e.g., polyester polypropylene) for leak detection apparatus. Waste piles also use a variety of high-strength polymer plastic pipes for the removal of leachate and other liquids that have accumulated in leachate collection systems; these are often made of polyvinyl chloride. Because of the impact of the Land Disposal Restriction program, most hazardous wastes cannot be placed on a waste pile until they meet the applicable LDR treatment standards in 40 CFR Part 268, Subpart D.

Land Treatment Units

Land treatment units are units where hazardous waste is applied or incorporated into the soil surface. Land treatment units are typically units consisting of natural soils where natural biological and chemical degradation and attenuation processes immobilize, transform, or degrade hazardous constituents over

time. These soils are normally prepared in a manner that maximizes these reactions in the upper layers of soil (the treatment zone), and minimizes processes that might inhibit beneficial reactions or result in the release of hazardous constituents (such as surface water run-off). Because of the impact of the LDR program, most hazardous wastes cannot be placed in a land treatment unit until they meet the applicable LDR treatment standards, unless a no migration exemption has been granted under 40 CFR §268.6.

Incinerators

Incinerators are complex enclosed devices that use controlled flame combustion to treat hazardous waste and render them less toxic or hazardous. Incinerators also use infrared radiation or plasma-arc technology to incinerate wastes. Under RCRA, boilers, industrial furnaces, sludge dryers, and carbon regeneration units are regulated separately from incinerators. Incinerators are usually constructed of stainless steel or some other material that is resistant to both high temperatures and normal corrosion processes.

Boilers and Industrial Furnaces

Boilers and industrial furnaces are devices that burn hazardous waste(s) primarily to recovery materials or energy. These units differ from incinerators because they are not used solely to destroy wastes, but instead process hazardous wastes for their heating value or material content. Boilers, which are enclosed devices that use controlled flame combustion, (1) have physical provisions to recover and export thermal energy; (2) are designed with the combustion chamber and the energy recovery sections as one unit; (3) have a thermal energy recovery efficiency of at least 60 percent; and (4) export and use at least 75 percent of recovered energy. Industrial furnaces are similar to boilers, but they may also be used to recover materials, as well as energy. Examples of industrial furnaces include cement kilns, lime kilns, aggregate kilns, coke ovens, blast furnaces, and smelting, melting, and refining furnaces. Boilers and industrial furnaces are typically constructed of stainless steel or other non-corrosive materials to resist the effects of heat and corrosives generated during the combustion process.

Miscellaneous Units

Miscellaneous units include a variety of types of units that are not covered by any other permit standards under RCRA. A miscellaneous unit is any unit that is used to treat, store, or dispose of hazardous waste that is not otherwise regulated. Therefore, a miscellaneous unit is not: a container, tank, surface impoundment, waste pile, land treatment unit, landfill, incinerator, boiler, industrial furnace, underground injection well, or a unit that qualifies for a permit as a research, development, or demonstration unit. Examples of miscellaneous units include carbon regeneration units, open burning units, open detonation units, and sludge dryers.

APPENDIX F

GLOSSARY OF TERMS

Certification: A written statement of professional opinion and intent signed by an authorized representative that acknowledges an owner's or operator's compliance with applicable LDR requirements. Certifications are required for treatment in surface impoundment exemption requests, applications for case-by-case extensions to an effective date, no-migration petitions, and waste analysis and recordkeeping provisions applicable to any person who generates, treats, stores, or disposes of hazardous wastes (excluding generators that do not treat on site and send waste off site to be treated). The information referenced by the certification must be true, accurate, and complete. There are significant penalties for submitting false information, including fines and imprisonment.

Disposal Facility: A facility or part of a facility at which hazardous waste is intentionally placed into or on any land or water, and at which waste will remain after closure.

Extraction Procedure Toxicity Test: The Extraction Procedure Toxicity Test (EP Tox Test) was used to determine if a waste exhibited the characteristics of toxicity. The EP Tox Test (method 1310 in EPA's SW-846) was designed to assess the leaching potential of waste destined for land disposal. It has now been replaced by the TCLP.

Facility: All contiguous land, structures, or other appurtenances, and improvements on the land, used for treating, storing, or disposing of hazardous waste. A facility may consist of one or several treatment, storage, or disposal operational units (e.g., one or more landfills, surface impoundments, or combinations of them).

Fingerprint Analysis: Sampling and analysis of several key chemical and physical parameters of a waste to substantiate or verify the composition of a waste as determined previously during a full-scale waste characterization. Fingerprint analysis is typically used by generators and off-site TSDFs to expedite waste characterization of frequently generated or received wastes. Parameters for analysis may be a subset of the parameters used during full-scale characterization, or they may be parameters that are not normally present in the waste to verify the absence of certain constituents.

Generator: Any person, by site, whose act or process produces hazardous waste identified or listed in Part 261 of RCRA or whose act first causes a hazardous waste to become subject to regulation.

Hazardous and Solid Waste Amendments (HSWA): Amendments to RCRA in 1984, that minimize the nation's reliance on land disposal of hazardous waste by, among other things, requiring EPA to evaluate all listed and characteristic hazardous wastes according to a strict schedule to determine which wastes should be restricted from land disposal.

Hazardous Waste: Waste that, because of its quantity, concentration, or physical, chemical, or infectious characteristics, may cause or significantly contribute to an increase in mortality or an increase in serious irreversible, or incapacitating reversible, illness, or pose a substantial present or potential hazard to human health or the environment when improperly treated, stored, transported, or disposed of, or otherwise managed. Hazardous wastes are listed in 40 CFR Part 261 and/or exhibit one of the four characteristics in 40 CFR Part 261 (i.e., ignitability, corrosivity, reactivity, and toxicity).

Hazardous Waste Code: The number assigned by EPA to each hazardous waste listed in 40 CFR Part 261, Subpart D, and to each characteristic waste identified in 40 CFR Part 261, Subpart C.

Interim Status: Provision of RCRA that allows a facility to operate without a permit provided 1) the facility was in existence on November 19, 1980; 2) the facility is in existence on the effective date of a new regulation that lists a waste as a hazardous waste or establishes a new characteristic of hazardous waste; or 3) the facility is in existence on the effective date of a new regulation that regulates a hazardous waste management unit for the first time. In both circumstances, Part A of the permit application must be submitted to EPA by a specified date (with Part B submitted voluntarily or “called in” by EPA at a subsequent date). The intent of interim status is to allow a facility to continue to operate for a short time period pending approval of their permit application.

Lab Pack: A lab pack is an overpacked container, usually a steel or fiber drum, containing small quantities of chemicals of the same hazardous class.

Land Disposal Restrictions: Provision of HSWA that prohibits the land disposal of hazardous wastes into or on the land unless EPA finds that it will not endanger human health and the environment. EPA must develop levels or methods of treatment that substantially diminish the toxicity of the waste or the likelihood that hazardous constituents will migrate from the waste that must be met before the waste is land disposed. Strict statutory deadlines were imposed on EPA to regulate the land disposal of specific hazardous wastes, concentrating first on the most harmful. EPA has met all of the Congressionally mandated dates.

Notification: When restricted wastes are being shipped off-site for treatment, storage, disposal, or are managed on-site, EPA has established a tracking system that requires that notifications and certifications be sent to the receiving facility or if applicable to EPA or the appropriate EPA representative. These requirements are outlined in 40 CFR 268.7. For example, notification requirements include the EPA Hazardous Waste Number, corresponding treatment standards or prohibition levels, the manifest number, and waste analysis data.

Off-Site Facility: A facility that receives and manages hazardous waste from another facility that is not geographically on site.

On-Site Facility: A facility that manages only those hazardous wastes that are generated on its own geographic site.

Prohibited Wastes: Prohibited wastes are a subset of restricted wastes (under the LDR regulations) that have established treatment standards but do not meet the respective treatment standards, nor have a variance or waiver in effect and are, therefore, currently ineligible for land disposal.

RCRA Subtitle C Permit: An authorization via a permit from EPA that allows a facility to treat, store, and/or dispose of hazardous wastes. The permit includes administrative requirements, and facility operating and technical standards for each type of waste management unit that is being permitted. [Facility owners/operators must submit a two-part (Part A and Part B) permit application to obtain a permit.]

Resource Conservation and Recovery Act (RCRA): The Resource Conservation and Recovery Act of 1976 regulates hazardous waste generation, storage, transportation, treatment, and disposal.

The Act was amended three times: most significantly, on November 8, 1984. The 1984 amendments called HSWA significantly expanded the scope and requirements of RCRA.

Restricted Wastes: Restricted wastes are those RCRA hazardous wastes that are subject to the LDR program. A waste is restricted if EPA has established a treatment standard for it, or if it has been specifically designated by Congress as ineligible for land disposal. While some restricted wastes may be eligible for land disposal without meeting treatment standards, all restricted wastes are, at a minimum, subject to the waste analysis, notification, and recordkeeping requirements of 40 CFR §268.7.

Storage Facility: A facility that holds hazardous waste for a temporary period, at the end of which the hazardous waste is treated, disposed of, or stored elsewhere.

Subtitle C Facility: A facility that manages hazardous wastes as defined by RCRA. These facilities may include disposal facilities (e.g., landfills, surface impoundments), treatment facilities, (e.g., incinerators) and storage facilities.

Subtitle D Facility: A facility which manages non-hazardous wastes as defined by RCRA. These facilities may include disposal facilities (e.g., landfills), treatment facilities (e.g., incinerators), and storage facilities.

Toxicity Characteristic Leaching Procedure (TCLP): The TCLP is designed to determine the mobility of both organic and inorganic contaminants in liquids, solids, and multiphase wastes. Originally promulgated in the November 7, 1986 Solvents and Dioxins Rule, this testing procedure was initiated for evaluation of the solvent- and dioxin-containing wastes prior to land disposal. Effective September 25, 1990 (for large quantity generators), or March 29, 1991 (for small quantity generators), the TCLP replaced the EP Tox Test for determining if a waste exhibits the hazardous characteristic of toxicity. In addition, under the TCLP rule, 26 contaminants were added to the original 14 contaminants subject to toxicity characteristic determination.

Transporter: A person engaged in the offsite transportation of hazardous waste by air, rail, highway, or water.

Treatment Facility: A facility that uses any method, technique, or process, including neutralization, designed to change the physical, chemical, or biological character or composition of any hazardous waste so as to neutralize such waste, or to render such waste either non-hazardous or less hazardous; safer to transport, store, or dispose of; or amenable for recovery, amenable for storage, or reduced in volume.

Waste Analysis: Obtaining a detailed chemical and physical analysis of a representative sample of a waste. The analysis may include data developed using sampling and laboratory analysis, as well as existing published or documented data on the waste or on a waste generated from similar processes.

Waste Analysis Plan (WAP): Document describing the procedures that will be carried out at a facility to meet waste analysis requirements.

APPENDIX G

REFERENCES

1. A Method for Determining the Compatibility of Hazardous Wastes, EPA-600/2-80-076, U.S. Environmental Protection Agency, Cincinnati, Ohio, 1980. 149pp. Available from the National Technical Information Service (NTIS), PB80-221-005.
2. Design and Development of a Hazardous Waste Reactivity Testing Protocol. EPA-600/52-84-057, U.S. Environmental Protection Agency, Municipal Environmental Research Laboratory, Cincinnati, Ohio, 1984. Available from NTIS, PB84-158-807.
3. Characterizing Heterogeneous Wastes: Methods and Recommendations. U.S. Environmental Protection Agency, ORD, U.S. Department of Energy, EPA/600/R-92/033, February 1992. Available from Environmental Research Information, Cincinnati, OH 45268.
4. EPA Memorandum. "Guidance on Petroleum Refinery Waste Analyses for Land Treatment Permit Application." April 3, 1984.
5. Guidance Manual for Hazardous Waste Incinerator Permits. SW-966, U.S. Environmental Protection Agency, Washington, D.C., 1983. Available from NTIS, PB86-100-577.
6. Hazardous Waste Land Treatment. SW-874, U.S. Environmental Protection Agency, Washington, D.C., 1983. 671 pp. Available from NTIS, PB89-179-014.
7. Identification and Listing of Hazardous Waste Under RCRA, Subtitle C, Section 3001. Listing of Hazardous Waste (40 CFR 261.31 and 261.32). Available from NTIS, PB81-190035, U.S. Environmental Protection Agency, Washington, D.C., 1980. 853 pp.
8. Methods for Chemical Analysis of Water and Waste. U.S. Environmental Protection Agency, Washington, D.C., 1983. EPA-600/14-79-020.
9. Permit Applicants' Guidance Manual for the General Facility Standards of 40 CFR 264. SW-968, U.S. Environmental Protection Agency, Washington, D.C., 1983. Available from NTIS, PB87-151-064/AS.
10. Permit Applicants' Guidance Manual for Hazardous Waste Land Treatment, Storage, and Disposal Facilities. SW-84-004, U.S. Environmental Protection Agency, Washington, D.C., 1983. Available from NTIS, PB89-115-695.
11. Standard Methods for the Examination of Water and Wastewater, 17th edition. American Public Health Association, Washington, D.C., 1989. Available from the Water Pollution Control Federation, Washington, D.C., #S0037.
12. Test Methods for Evaluating Solid Waste, Physical/Chemical Methods. SW-846, Third Edition as amended by Update I, U.S. Environmental Protection Agency, Washington, D.C., 1987. Available from NTIS, PB88-239-223.

13. Toxic and Hazardous Industrial Chemicals Safety Manual for Handling and Disposal with Toxicity and Hazard Data. The International Technical Information Institute, Tokyo, Japan, 1976. 591 pp.

