

THE ECOLOGY OF POOLS 11-13 OF THE UPPER MISSISSIPPI RIVER: A Community Profile

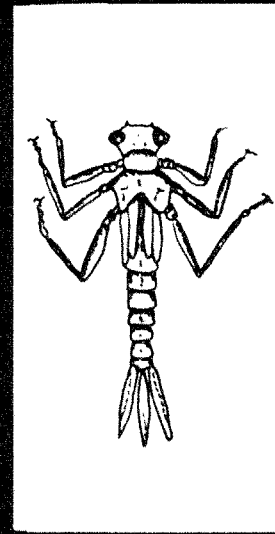
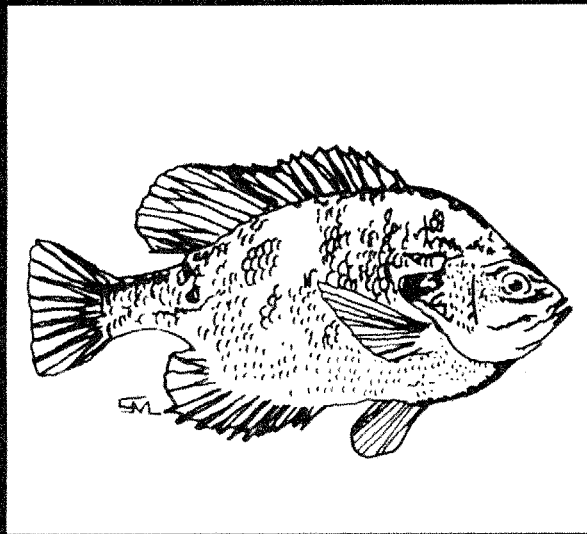
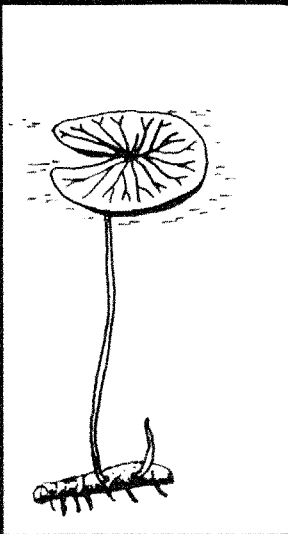

Fish and Wildlife Service

Corps of Engineers

U.S. Department of the Interior

U.S. Department of the Army

Biological Report 85(7.8)
December 1986

**THE ECOLOGY OF POOLS 11-13 OF THE UPPER MISSISSIPPI RIVER:
A COMMUNITY PROFILE**

by

James W. Eckblad
Department of Biology
Luther College
Decorah, IA 52101

Order No. 84110-0064-84

Project Officer

Walter G. Duffy
National Wetlands Research Center
U.S. Fish and Wildlife Service
1010 Gause Boulevard
Slidell, LA 70458

Performed for

National Wetlands Research Center
U.S. Fish and Wildlife Service
NASA-Slidell Computer Complex
1010 Gause Boulevard
Slidell, LA 70458

Cover--Top, from left: waterlily (Nymphaea sp.), bluegill (Lepomis macrochirus), and damselfly (Zygoptera). Bottom: Pool 13, Upper Mississippi River.

This report should be cited as follows:

Eckblad, J.W. 1986. The ecology of Pools 11-13 of the Upper Mississippi River: a community profile. U.S. Fish Wildl. Serv. Biol. Rep.85 (7.8). 90 pp.

PREFACE

This report is one of a series of U.S. Fish and Wildlife Service community profiles synthesizing the available information for selected ecosystems. This profile focuses on the Pool 11 to 13 reach of the Upper Mississippi River. This 93-mi portion of a large, complex river system includes a matrix of habitat types ranging from floodplain forest to the standing waters of backwater lakes to the running waters of side channels and the river's main channel.

The portion of river considered in this profile lies within the largest continuous Federal refuge in the Midwest. However, in addition to providing a suitable natural habitat for the river biota, this river system has a variety of other uses. These include the use of the river for municipalities, industry, commercial navigation, commercial fishing, sport fishing, hunting, recreational boating, and camping. These uses often alter the environment, affecting other uses, and may put particular stress on the habitats of the river biota.

A consideration of the Pool 11 to 13 river reach as a whole reveals major gaps in our present knowledge of its structure and function. Previous studies have usually focused on particular taxa or habitats, and few investigations have viewed the river as an interacting ecosystem. A schematic ecosystem model is

presented in this report to suggest the scope of data needed in future studies if we are to better clarify ecological relationships.

This community profile will focus on a particular section of a large river, rather than attempt either to discuss large river ecosystems in general, or to treat comprehensively the entire Upper Mississippi River. The information will be reviewed for various biotic groups from typical river habitats within this 93-mi reach. The paucity of relevant data available for some components is reflected in the brevity of some sections of this report. It is hoped that future studies will go beyond the periodic monitoring of resources and focus on ecosystem functioning.

Although not intended primarily as a management document, this community profile should be useful to environmental planning groups and ecosystem managers, as well as students and professional river ecologists.

Comments about or requests for this publication should be directed to the following:

Information Transfer Specialist
National Wetlands Research Center
U.S. Fish and Wildlife Service
1010 Gause Boulevard
Slidell, Louisiana 70458

CONTENTS

	<u>Page</u>
PREFACE	iii
FIGURES	vi
TABLES.	viii
CONVERSION TABLE.	x
ACKNOWLEDGMENTS	xi
CHAPTER 1 HISTORICAL DEVELOPMENT	1
1.1 Introduction	1
1.2 Geological History	2
1.3 Early History.	3
1.4 Early Navigation	6
1.5 The 9-ft Navigation Channel.	8
1.6 The Historical Mussel Fishery.	10
1.7 River Habitats	11
1.8 Ecological Theory and the Upper Mississippi River.	13
CHAPTER 2 HYDROLOGY, SEDIMENTS, AND WATER QUALITY.	15
2.1 Overview	15
2.2 River Flow Characteristics	16
2.3 Pool Sediment Budgets	17
2.4 Wing Dam Structures.	19
2.5 Sediment Transport to Backwaters	20
2.6 Main Channel Dredging.	21
2.7 Water Quality and Influent.	23
CHAPTER 3 AQUATIC MACROPHYTES.	26
3.1 Overview	26
3.2 Main Channel	27
3.3 Main Channel Border.	28
3.4 Side Channels.	28
3.5 Backwater Lakes and Sloughs.	28
CHAPTER 4 PLANKTON	33
4.1 Overview	33
4.2 Main Channel	34
4.3 Main Channel Border.	34
4.4 Side Channels.	34
4.5 Backwater Lakes and Sloughs.	37

	<u>Page</u>
CHAPTER 5 MACROINVERTEBRATES	38
5.1 Overview	38
5.2 Main Channel	39
5.3 Main Channel Border.	42
5.4 Side Channels.	43
5.5 Backwater Lakes and Sloughs.	44
CHAPTER 6 FISH	47
6.1 Overview	47
6.2 Main Channel	53
6.3 Main Channel Border.	53
6.4 Side Channels.	54
6.5 Backwater Lakes and Sloughs.	55
CHAPTER 7 OTHER BIOTA.	58
7.1 Floodplain Forest.	58
7.2 Dredge Spoil Areas	59
7.3 Birds.	59
7.4 Mammals.	62
7.5 Amphibians and Reptiles.	62
7.6 Endangered and Threatened Species.	64
CHAPTER 8 FLUXES BETWEEN HABITATS.	67
8.1 Overview	67
8.2 Transport Between Pools.	67
8.3 Delivery to Backwaters	67
8.4 Transport Out of Backwaters	69
8.5 Fish Movement.	70
CHAPTER 9 HUMAN USES AND THE FUTURE.	71
9.1 Recreational Use	71
9.2 Industrial Use	72
9.3 Commercial Navigation.	72
9.4 A Shallow Reservoir System	73
9.5 Some Possible Future Changes	75
REFERENCES.	77

FIGURES

<u>Number</u>		<u>Page</u>
1	The Pool 11 to 13 reach of the Upper Mississippi River	1
2	The Upper Mississippi River, its drainage basin, and dams.	2
3	Southernmost extent of each of the four major glacial advances near the Upper Mississippi River	2
4	Bluffs along the Upper Mississippi River, Pool 13.	4
5	Generalized cross section of a bluff	4
6	Ordovician fossils	5
7	Cross section of a rock and brush wing dam	7
8	Wing dam extending out from Iowa shore in Pool 13.	8
9	Two tainter gates of Dam No. 12.	9
10	Lock and Dam No. 12 at Bellevue, Iowa.	10
11	A 5-mi reach of Pool 13 showing different habitat types.	12
12	Schematic model of the Upper Mississippi River	14
13	Profile of Pools 11 to 13.	15
14	Tailwaters of Pool 13 showing depth contours	16
15	Pool 13 showing "island-braided" reach of river.	17
16	Schematic diagram of sediment budget	19
17	Relative distribution of aquatic habitats.	27
18	Aquatic macrophytes common to the Upper Mississippi River.	30
19	Zooplankton common to the Upper Mississippi River.	33
20	Benthic macroinvertebrates common to the Upper Mississippi River.	41
21	Wing dam study sites in Pool 13.	44

<u>Number</u>		<u>Page</u>
22	Availability and use by paddlefish of habitat types in Pools 12 and 13.	53
23	Green Island Levee District and Brown's Lake	56
24	Relative distribution of floodplain cover types.	58

TABLES

<u>Number</u>		<u>Page</u>
1	Pleistocene time chart	3
2	Slope coefficients for water-level equations	18
3	Summary of land use for drainage basins.	20
4	Sediment budget for Pools 11 to 13	20
5	Characteristics of Iowa wing dams.	21
6	Main channel features and modeling estimates of sediment transport to backwaters.	22
7	Mean annual volume dredged from three pools.	23
8	Estimated mean water chemistry parameters from two locations	23
9	Point-source discharges to Pools 11 to 13.	24
10	Habitat areas other than main channel and borders.	29
11	Surface areas of various habitat types for Pools 11 to 13.	31
12	Genera of phytoplankton from habitats of the Mississippi River	35
13	Genera of zooplankton from habitats of the Mississippi River	36
14	Classification of feeding types in macroinvertebrates.	39
15	Trophic type and life habitat of dominant macroinvertebrates	40
16	Mussels sampled from Pools 11 to 13.	42
17	Most abundant macroinvertebrate taxa from different habitats within Pool 13	43
18	Macroinvertebrate taxa from grab samples and artificial substrates from Pool 13.	45
19	Relative abundance of fish of Pools 11 to 13	47
20	Feeding relationships of some fish of Pools 11 to 13	50
21	Total number of fish collected per hour from different habitats.	51

<u>Number</u>		<u>Page</u>
22	Similarity between fish communities of Pools 12 and 13	52
23	Total commercial fish catch for Pools 11 to 13	52
24	Mean catch for major families of fish before and after notching of three wing dams.	54
25	Sport-fishery harvest from Cassville Slough, Pool 11	55
26	Comparison of biomass sampled from Brown's Lake and Green Island . .	56
27	Surface areas of various terrestrial habitat types	59
28	Relative seasonal abundance of birds	60
29	Relative abundance of mammals.	63
30	Relative abundance of amphibians and reptiles.	63
31	Federal and State endangered and threatened species.	64
32	Problem side-channel areas of Pools 11 to 13	68
33	Outdoor recreational activities in the Pool 11 to 13 area.	71
34	Day use for fishing and hunting in Pools 11 to 13.	71
35	Percentage of fishermen using various habitats in Pools 11 to 13 . .	72
36	Principal species sought by interviewed anglers fishing Pools 11 to 13	73
37	Estimated annual recreation use and expenditures for Pools 11 to 22	73
38	Day use for miscellaneous recreational activities.	74
39	Changes in area of off-channel habitats, 1956-75	75

CONVERSION TABLE

Metric to U.S. Customary

<u>Multiply</u>	<u>By</u>	<u>To Obtain</u>
millimeters (mm)	0.03937	inches
centimeters (cm)	0.3937	inches
meters (m)	3.281	feet
meters (m)	0.5468	fathoms
kilometers (km)	0.6214	statute miles
kilometers (km)	0.5396	nautical miles
square meters (m ²)	10.76	square feet
square kilometers (km ²)	0.3861	square miles
hectares (ha)	2.471	acres
liters (l)	0.2642	gallons
cubic meters (m ³)	35.31	cubic feet
cubic meters (m ³)	0.0008110	acre-feet
milligrams (mg)	0.00003527	ounces
grams (g)	0.03527	ounces
kilograms (kg)	2.205	pounds
metric tons (t)	2205.0	pounds
metric tons (t)	1.102	short tons
kilocalories (kcal)	3.968	British thermal units
Celsius degrees (°C)	1.8(°C) + 32	Fahrenheit degrees

U.S. Customary to Metric

inches	25.40	millimeters
inches	2.54	centimeters
feet (ft)	0.3048	meters
fathoms	1.829	meters
statute miles (mi)	1.609	kilometers
nautical miles (nmi)	1.852	kilometers
square feet (ft ²)	0.0929	square meters
square miles (mi ²)	2.590	square kilometers
acres	0.4047	hectares
gallons (gal)	3.785	liters
cubic feet (ft ³)	0.02831	cubic meters
acre-feet	1233.0	cubic meters
ounces (oz)	283.5	milligrams
ounces (oz)	28.35	grams
pounds (lb)	0.4536	kilograms
pounds (lb)	.00045	metric tons
short tons (ton)	0.9072	metric tons
British thermal units (Btu)	0.2520	kilocalories
Fahrenheit degrees (°F)	0.5556(°F - 32)	Celsius degrees

ACKNOWLEDGMENTS

The body of literature cited includes State and Federal reports with limited circulation, as well as references from the published scientific literature. Comments and reference materials from a number of individuals were helpful in preparing this report. They include Gail Peterson, Jerry Rasmussen, Leslie Holland, and Hannibal Bolton of the Fish and Wildlife Service; Gary Ackerman, Tom Boland, John Pitlo, Bill Aspelmeier, and Bob Sheets of the Iowa Conservation Commission; Bill Bertrand, Bill Fritz, and

Herman Hier of the Illinois Department of Conservation; and Pam Thiel and Willis Fernholz of the Wisconsin Department of Natural Resources. The author, however, accepts full responsibility for all statements, interpretations, and original data presented. Funding for the preparation of this report was provided by the Rock Island District, U.S. Army Corps of Engineers, and by the National Wetlands Research Center, U.S. Fish and Wildlife Service.

CHAPTER 1. HISTORICAL DEVELOPMENT

1.1 INTRODUCTION

This profile focuses on a 93-mi reach of the Upper Mississippi River that includes Navigation Pools 11, 12, and 13 (Figure 1). This reach extends from Dubuque, IA, and East Dubuque, WI, on the north to Clinton, IA, and Fulton, IL, on the south. It forms the eastern border of four Iowa counties and the western border of one county in Wisconsin and two in Illinois.

There are 27 lock and dam systems on the upper Mississippi, extending from Lock and Dam Number 1 at Minneapolis, MN, to Number 27 at St. Louis, MO. Each lock and dam system creates a pool; thus, Pools 11 to 13 were created by the construction of Locks and Dams 11, 12, and 13. While locks and dams are numbered from north to south, river miles (RM) are numbered from the confluence of the Ohio River upstream to Minneapolis. Hence, the river miles for the Pools 11 to 13 area are numbered from RM 522.5 on the south end of Pool 13 to RM 615.1 on the north end of Pool 11.

This section of the river lies within the largest continuous Federal wildlife refuge in the Midwest: the Upper Mississippi River Wildlife and Fish Refuge. The area is a portion of a large, complex river system that contains many habitat types, ranging from floodplain forest to the standing waters of backwater lakes to the running waters of side channels and the river's main channel.

In addition to providing habitat for its biota, the river has many other uses, including municipal and industrial water supplies, commercial navigation, commercial and sport fishing, hunting, recreational boating, and camping. These uses result in environmental alterations

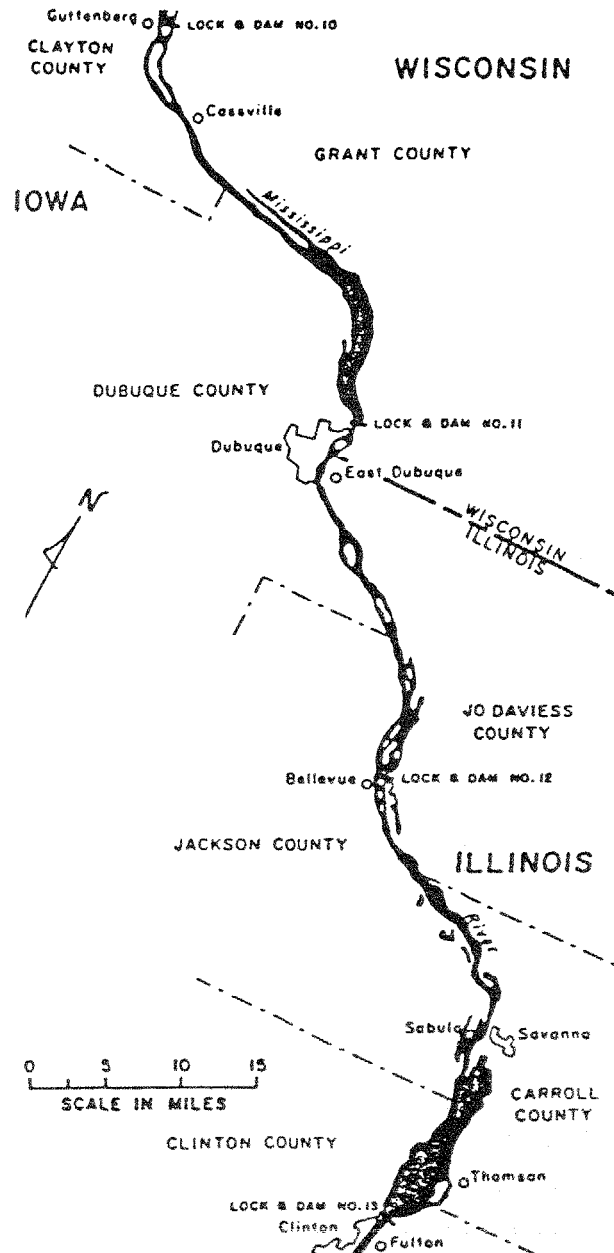

Figure 1. The Pool 11 to 13 reach of the Upper Mississippi River.

that can affect other users and may also stress the habitats of community biota.

Consideration of the entire Pool 11 to 13 reach reveals major gaps in the present knowledge of its structure and function. Most previous studies have focused on particular taxa or habitats; few have viewed the river as an interacting ecosystem.

1.2 GEOLOGICAL HISTORY

From its source in a densely timbered region near the geographical center of the North American continent, the Mississippi River flows about 2,500 mi to its

mouth in the Gulf of Mexico. The Upper Mississippi River--1,366 mi from Lake Itasca, MN, to the confluence with the Ohio River at Cairo, IL (Figures 1,2)--is thousands of years older than the lower Mississippi. In the geologic past, an ocean gulf reached northward between the Ozark Plateau and the southern Appalachian Highlands. Here began the ancient delta by which the Mississippi extended its course, forming the rich floodplain through which the present river winds almost 1,200 mi to the gulf.

The Pleistocene Ice Age began in the Upper Midwest about two million years ago. During this period there were multiple advances of continental glaciation; four major glacial advances are usually recognized. These major glacial periods (each named for the State it made its greatest advance into) were separated by warmer interglacial periods (named for the region where the geologic history of that period is especially well-displayed; Figure 3). The Nebraskan Glacier moved as far south as where the Missouri River now flows

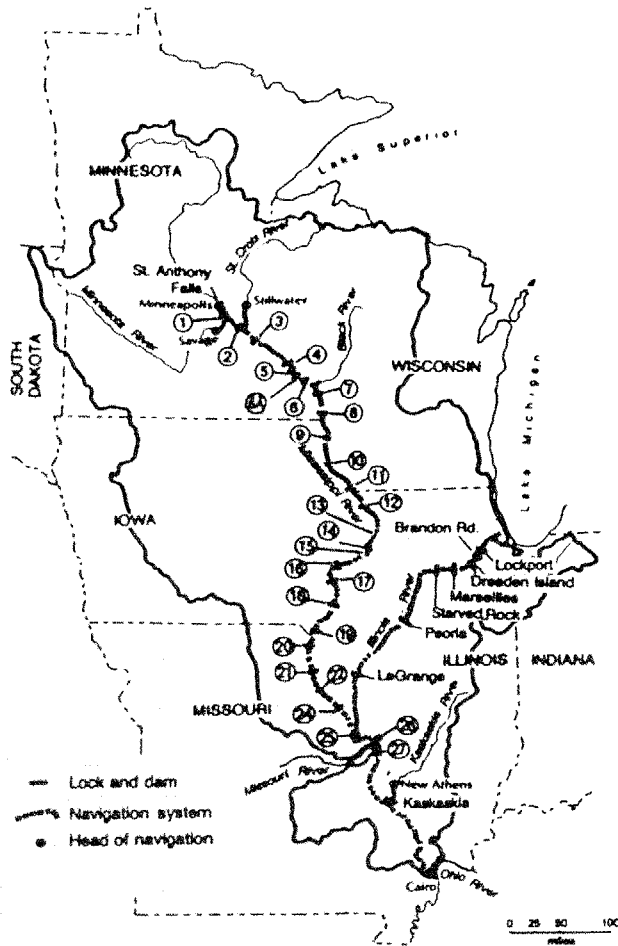

Figure 2. The Upper Mississippi River, its drainage basin, and dams.

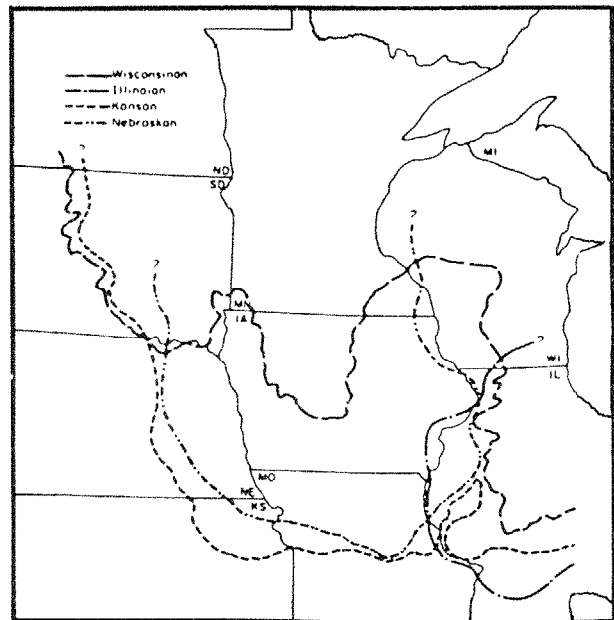

Figure 3. Southernmost extent of each of the four major glaciers in the vicinity of the Upper Mississippi River (after Troeger 1983).

eastward from Kansas City to St. Louis. The Kansan Glacier was quite similar in its southern advancement along the Mississippi River Valley, and its till layer is similar to the Nebraskan in appearance. The Illinoian Glacier reached the Mississippi River Valley from the east and did not extend far into Iowa or Missouri. The Wisconsin glaciation did not extend as far south as Iowa along the Mississippi River Valley.

Glacial scouring during the Nebraskan, Kansan, and Illinoian periods helped form the Mississippi River Valley. However, glacial meltwater at the end of the more recent Wisconsin period resulted in massive erosion and subsequent deposition that shaped the Mississippi River Valley's present basic physiographic pattern. These Pleistocene events are summarized in Table 1.

The bluffs along the river valley are composed primarily of sedimentary rocks laid down in shallow warm Ordovician seas from about 450 to 500 million years ago (Figure 4). The Jordon Formation, Prairie du Chien Group, St. Peter Sandstone, Platteville Formation, Decorah Formation, and Galena Limestone are typical layers which form the bluffs (Figure 5).

The environment in the Upper Midwest during the Ordovician period was probably similar to the shelf environments off the western and southern coasts of Florida today--a shallow marine environment with well-oxygenated water and periodic wave agitation (Anderson 1983). All major invertebrate groups had evolved by the Ordovician period, when warm shallow seas were well-suited to marine benthic invertebrates and marine algae. The rock record of the river bluffs preserve an abundance of these organisms as fossils; some of the more common forms are shown in Figure 6.

1.3 EARLY HISTORY

Recorded history on the Upper Mississippi River began in the 1600's with the arrival of the French. By this time the effigy mound builders were gone and the valley was occupied by the Chippewa, Sioux, Winnebago, Sac, Fox, and other

Table 1. Pleistocene time chart (after Harris et al. 1977).

Time	Years before present	Process and sediment
Recent		Formation of modern soils and present-day topography
	10,000	
Wisconsin Glaciation		Several glacial advances and retreats; river bed deposition and repeated deposits of windblown loess (silt)
	75,000	
Sangamon Interglacial		Soil formation; erosion
Illinoian Glaciation		Glacier briefly entered the Mississippi Valley
Yarmouthian Interglacial		Soil formation; erosion
Kansan Glaciation ^a		Glacier reached to central Missouri
Aftonian Glaciation ^a		Soil formation
Nebraskan Glaciation ^a		Glacier reached to central Missouri
	1.5 Million	

^aNot readily recognizable.

native Americans. Archeologists have used the shell and bone heaps near old village sites to reveal how native Americans depended heavily on the river and its wildlife (Rahn 1983). Such heaps explored in 1868 at Sabula and Bellevue, IA, had 14 species of bivalves and the snail *Viviparus*, all of which were still found in the Mississippi at that time (Carlander

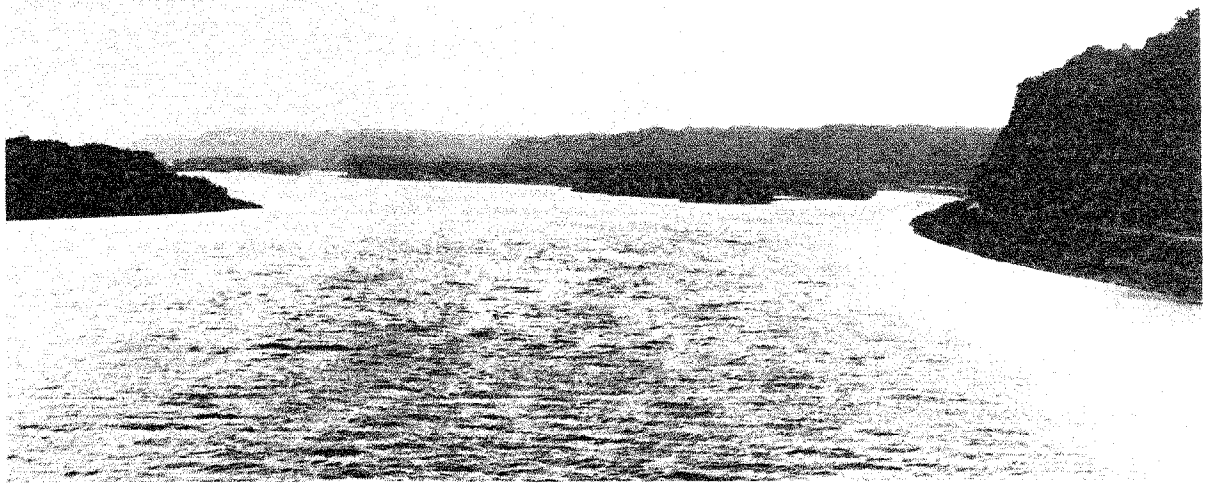

Figure 4. Bluffs along the Upper Mississippi River, Pool 13, upstream from the bridge at Savanna, IL.

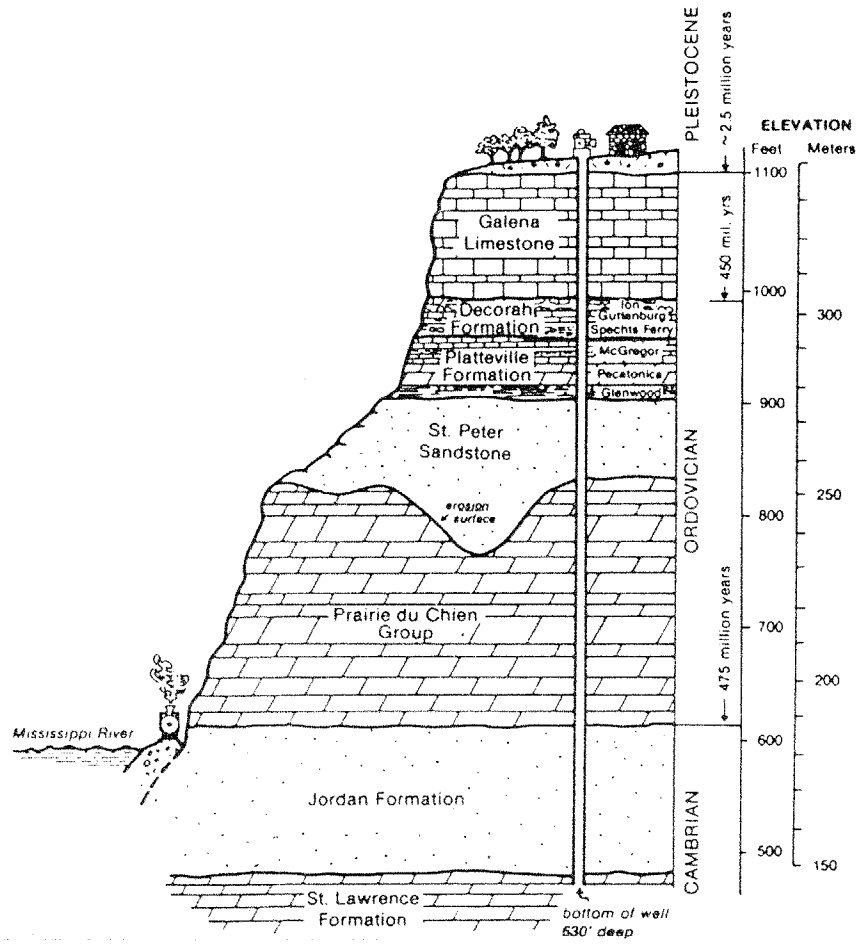

Figure 5. Generalized cross section of a Mississippi River bluff showing Ordovician rock layers (from Anderson 1983).

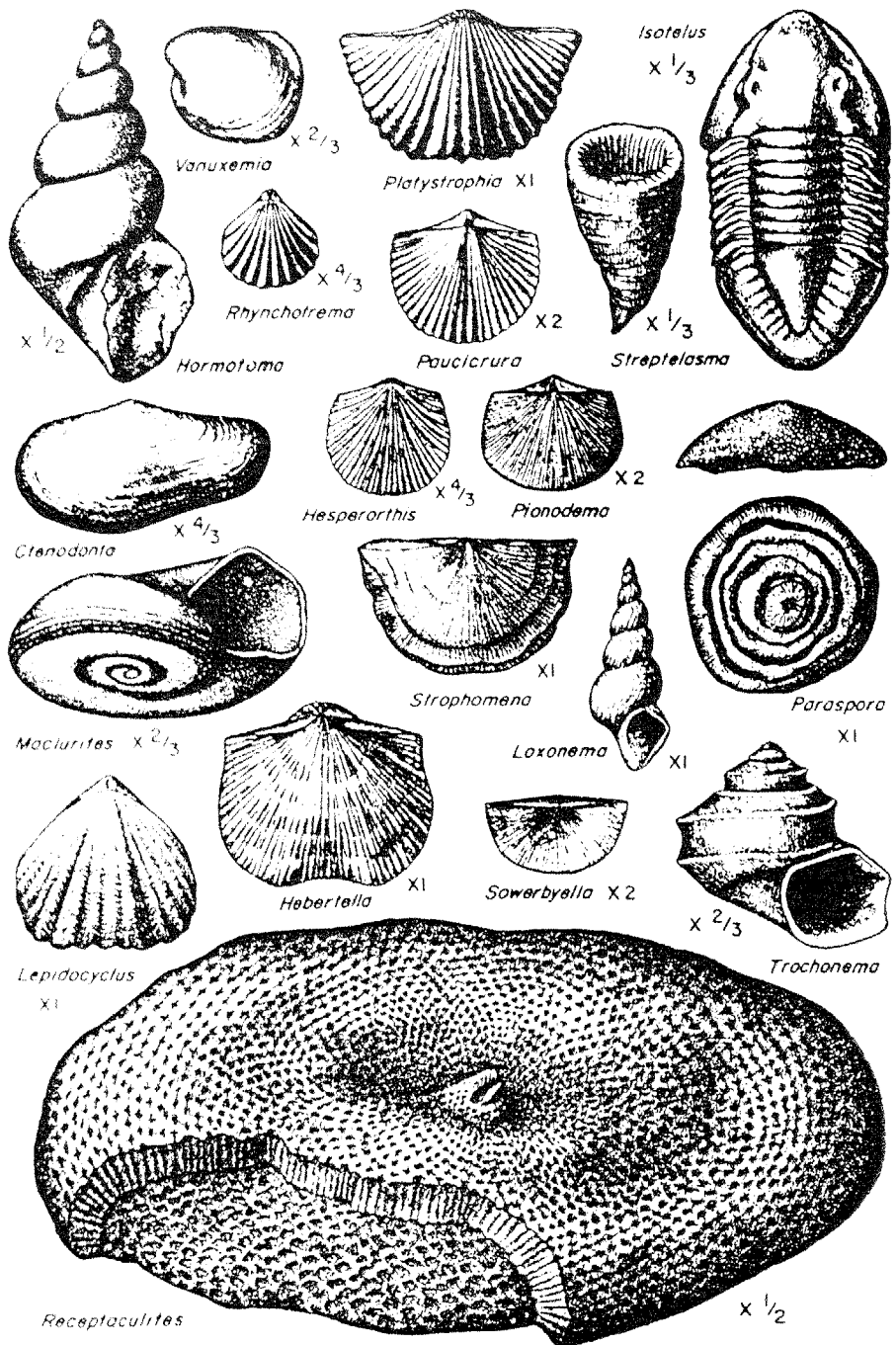

Figure 6. Ordovician fossils, including representative gastropods (Hormotoma, Loxonema, Trochonema, Maclurites), clams (Vanuxemia, Ctenodonta), branchiopods (Platystrophia, Paucicrura, Hesperorthis, Pionodema, Strophomena, Lepidocyclus, Hebertella, Sowerbyella, Rhynchotrema), bryozoans (Paraspora), corals (Streptelasma), trilobites (Isotelus), and algae (Receptaculites) (after Anderson 1983).

1954). These shell and bone heaps also contained the remains of catfish, freshwater drum, snapping turtles, soft-shelled turtles, geese, buffalo, and deer. Oak and elm trees growing on top of the heaps were at least 200 years old, and no articles of modern civilization were found (Rau 1884).

As an old man, the remarkable war chief Black Hawk reminisced about how his people, the Sac and Fox tribes, depended on the river. He told how they planted and tended corn until it was knee-high, at which time the villagers left for their summer occupations (Black Hawk 1932). This village was probably in the vicinity of Dubuque, IA. Black Hawk recalled that some of the old men and women went to work in the lead mines, young men journeyed westward to hunt buffalo and deer, and some older men and women fished and gathered reeds to make mats. After about 6 weeks, everyone returned to the village with their gifts. The hunters offered dried meat, miners presented lead, and others contributed dried fish and mats for the winter lodges. "This is a happy season of the year - having plenty of provisions such as beans, squash, and other produce, with our dried meat and fish, we continue to make feasts and visit each other until our corn is ripe" (Black Hawk 1932).

The diaries and journals of many early explorers, missionaries, and fur traders make reference to the wildlife observed in the Upper Mississippi Valley. Accounts by Jean Nicolet, Groseilliers and Radisson, Father Marquette, Father Hennepin, Zebulon Pike, and Henry Rowe Schoolcraft pointed out the most impressive creatures without attempting to catalog the fauna or flora. For example, Father Marquette observed about the paddlefish (Polyodon spathula): "On casting our nets, we have taken sturgeon and a very extra-ordinary kind of fish; it resembles a trout with this difference, that it has a larger mouth, but smaller eyes and snout. Near the latter is a large bone . . . three fingers wide and a cubit long: the end is circular and as wide as the hand. In leaping out of the water the weight of this often throws it back" (Carlender 1954). Writers some distance from the Mississippi River were

likewise enthusiastic about its wildlife, as shown by Thomas Jefferson in his Notes on Virginia: "The Mississippi will be one of the principal channels of future commerce for the country westward of the Allegheny This river yields turtle of a peculiar kind, perch, trout, gar, pike, mullets, herrings, carp, spatula fish of fifty pound weight, catfish of one hundred pound weight, buffalo fish and sturgeon."

To settlers using the resources of the Mississippi River, the harvesting of fish and wild game was a God-given right. Pioneering families and early farm families found wild game a staple that supplemented crops and livestock (Rahn 1983). As a result, there was resistance to early attempts by States to impose fishing or hunting restrictions in an attempt to manage fish and wildlife populations. In 1924 an act of Congress created the Upper Mississippi River Wildlife and Fish Refuge, a wildlife and habitat resource shared by the States of Illinois, Iowa, Wisconsin, and Minnesota. The refuge extends some 284 mi from the Chippewa River, WI, to Rock Island, IL, and includes the Pool 11 to 13 reach of river. The establishment of the 200,000-acre refuge helped the four States coordinate management efforts for fish and wildlife species. Communication between States was further enhanced in 1943 through the establishment of the Upper Mississippi River Conservation Committee, a group of conservation representatives from the four States plus Missouri.

1.4 EARLY NAVIGATION

Early river travel and commerce in small boats probably had little impact on the river ecosystem. As an expanding America entered the 19th century, the Mississippi River consisted of a series of relatively deep pools separated by shallow bars and rapids. Both main channel and side channel reaches were subject to periodic obstruction by rocks and snags. Two major developments in water transportation in the early 1800's greatly increased the importance of waterway transportation: the invention of the steam-powered boat by Robert Fulton and the development of extensive canals

connecting major bodies of water. The Erie Canal connected the Hudson River to Lake Erie in 1825, and the Illinois-Michigan Canal connected the Great Lakes and the Mississippi River. During this period the Upper Mississippi River was navigable to St. Paul only during high water stages; during low water, depths of 3 ft were common. Nevertheless, by 1840 a heavy river commerce had developed between St. Louis and the head of navigation at St. Anthony Falls in Minneapolis. Steamboats carried freight and passengers, including many settlers, to the Upper Midwest.

The Western Rivers Improvement Act in 1852 placed river and harbor improvement more firmly under the direction of the U.S. Army Corps of Engineers. Funding included \$15,000 to complete dredging of the harbor at Dubuque. This work consisted of cutting a channel from the harbor across the Mississippi to the main channel along the Illinois shore. Additional harbor improvements were also sought for Dubuque to accommodate its busy commerce: in 1854 commercial statistics listed 672 steamboat arrivals, bringing 97,633 tons of goods with a value of almost \$5 million. Exports from Dubuque reached 11,736 tons in 1854 (Tweet 1975).

River traffic on the lower Mississippi reached its peak in the 1840's, but the upper river continued to experience growth in river traffic through the 1880's. The move for an improved navigation channel became a central theme of the Committee on Improvement of the Mississippi River, convened by the St. Louis Merchant's Association in 1865 (Tweet

1975). The beginning of permanent navigation improvements on the upper Mississippi can be traced to the Congressional Act of 1866, which made appropriations for the repair, preservation, and completion of certain public works, and for surveys of the upper Mississippi with the understanding that a 4-ft channel was an eventual goal. Twelve years later, in 1878, Congress authorized the development of a 4.5-ft channel between St. Paul and St. Louis to be accomplished by narrowing the channel through wing and closing dams. The Rivers and Harbors Act of 1907 authorized the deepening of the channel to a 6-ft depth.

Wing dams were constructed perpendicular to the main stream current using alternate layers of willow mats and stone (Figure 7). The rocks, obtained from small quarries in the bluffs along the river, had to be between 6 and 10 inches and cut into cubes. The finished dam was designed to be high enough so that its top would be about 4 ft above low water. Wing dams were usually spaced five-sevenths of the channel width apart with the line of the dam pointing upstream 105 to 110° in straight reaches, 100 to 102.5° in concave reaches, and from 90 to 100° when the curve was convex (Tweet 1975). Usually these dams were built in series with the shorter ones on the upstream end. The action of the current around the end of the wing dams scoured the channel and sand was deposited in the eddies downstream from a dam; the typical water turbulence immediately downstream for a submersed wing dam in Pool 13 is shown in Figure 8. At the shore end of the wing dam, revetment was necessary to prevent the current

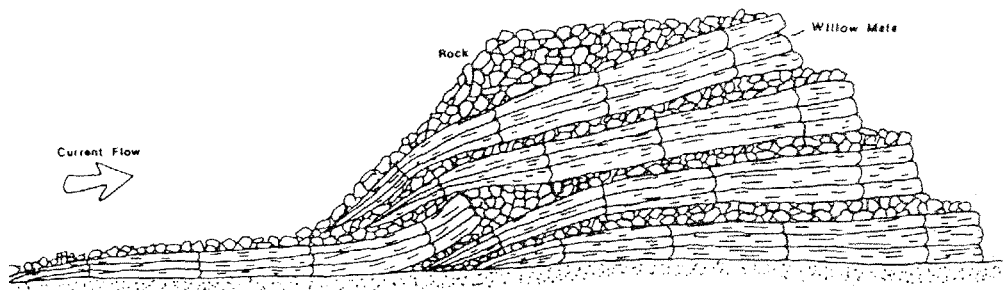

Figure 7. Cross section of a rock and brush wing dam on the Upper Mississippi River (from Boland 1980).



Figure 8. Wing dam extending from the Iowa shore in Pool 13 at river mile 555.5. Note the turbulence on the downstream side of the structure.

from washing the shore away. The shores opposite the wing dams were usually riprapped with rock so that the increased velocity of the current would not erode the banks. In the 93-mi reach of river which includes Pools 11 to 13, current navigation charts show an average of almost four wing dams per mile.

The engineering report by Ockerson in 1898 provides one of the better descriptions of the river at the end of the 19th century (Tweet 1975). Ockerson noted that between St. Anthony Falls and the mouth of the Missouri, the "banks are low, and oscillations between high and low water rarely exceed 25 ft. In the upper half of this reach, the river is divided into a great many sloughs, which serve as high-water channels, but are often nearly or quite dry at low water. The water carries but little sediment; bank erosion is comparatively slight; for 21 miles it flows through a lake of slack water 30 ft deep (Lake Pepin); the flow in two places is interrupted by rapids where the bed of the stream is solid rock (Rock Island and Keokuk); in the upper portion, the navigation depth at low water sometimes

gets down to 2.5 ft, and navigation is usually suspended during the winter season for a period of four months or more in consequence of the river being frozen. The low-water slope averages about 0.5 ft per mile. The low-water discharge is about 25,000 cu. ft per second. High water generally comes in May and June, and the low-water season usually begins about the first of September and lasts until navigation is closed by ice."

1.5 THE 9-FT NAVIGATION CHANNEL

The Rivers and Harbors Act of 3 July 1930 authorized the Corps of Engineers to construct, by means of locks and dams supplemented by dredging, a channel with a minimum depth of 9 ft and a minimum width of 300 ft from Minneapolis to St. Louis. There was considerable controversy over this project and opposition from groups like the Isaac Walton League of America. The League suggested the 9-ft channel would be detrimental to the river environment and they wanted erosion and pollution to be controlled before the project began. On the other hand, the

U.S. Bureau of Biological Survey concluded from results of studies on the biological effects of Lock and Dam 19 on the Mississippi at Keokuk, IA, that the project might benefit waterfowl and muskrats if water levels were stabilized (Olson and Meyer 1976). Most proponents of the project argued in terms of economic growth and progress. Firms dealing in commercial river traffic, which had lost out to the railroads, wanted the project completed, as did many industries and farmers along the river in anticipation of lower freight rates.

Though earlier channel improvement projects progressed at a leisurely pace over several decades, the whole system of 26 locks and dams on the Upper Mississippi River was virtually completed from 1930 to 1940. Much of the earlier channel modification with wing dams had only localized effects, but the 9-ft project altered the shape of the river along nearly every mile. It was no longer possible to wade across the river during low flow periods, and slack water pools covered floodplain forests, creating numerous small willow islands. Water levels in floodplain backwater lakes were stabilized during low flows providing aquatic habitat for a variety of fish and wildlife (Green 1960).

The Rock Island District of the Corps of Engineers built all but one of the

locks and dams from No. 10 at Guttenberg, IA, to No. 22 at Saverton, MO (Tweet 1975); after construction, the operation and maintenance of Lock and Dam No. 10 was taken over by the St. Paul District of the Corps of Engineers. Locks had electrically operated miter gates and were 110 by 600 ft, with an auxiliary lock 110 by 269 ft. Dams usually consisted of a long earthen dike with spillways, and a combination of roller gates and tainter gates adjacent to the lock. The tainter gate was essentially a pie-shaped wedge pointed downstream and hinged between piers, with the curved surface upstream forming a dam against the water (Figure 9). These gates moved up and down and could vary the amount of water flow from nothing to a completely unobstructed flow when the gate was lifted entirely above the surface. The roller gate was a cylinder which was raised or lowered to control the level of water passing beneath. The original intention was to use the roller sections of the dams to pass the normal flow of water, reserving the tainter sections for times of flood and high water. However, the uneven flow of water through the dams caused extensive scouring below them, and now all gates are maintained at about the same level.

The three locks and dams that create Pools 11 to 13 were built by the Rock Island District of the Corps of Engineers (Figure 10). Normal pool elevations

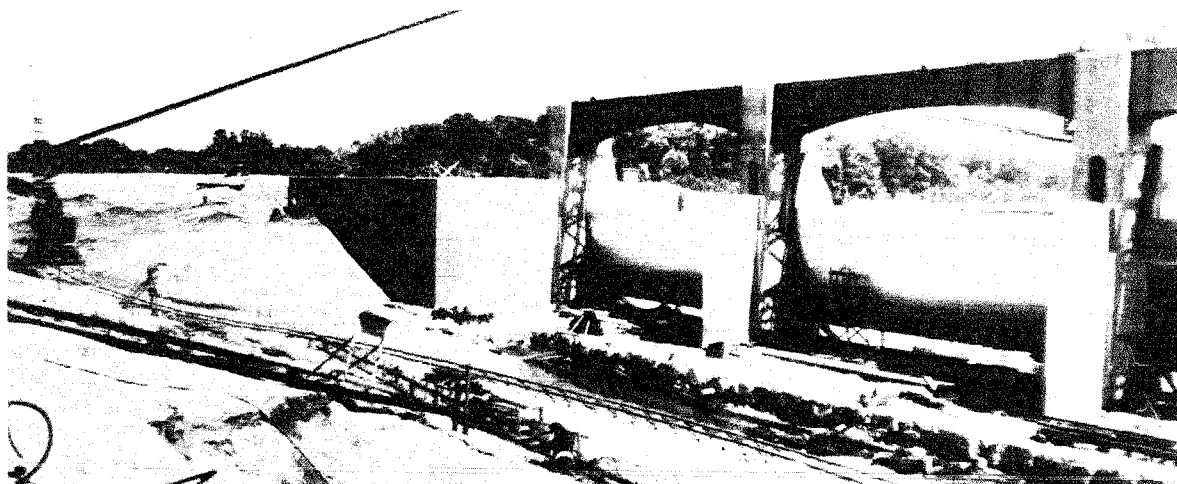

Figure 9. The northwest side of two tainter gates of Dam No. 12, June 1937.

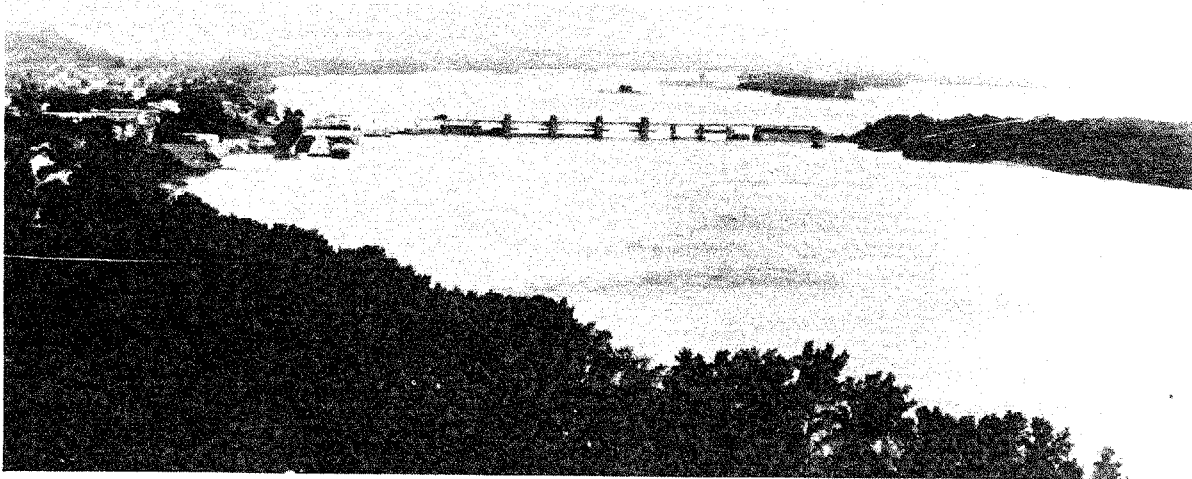

Figure 10. The figure shows Lock and Dam No. 12 at Bellevue, IA, looking north, with Pool 12 visible at the upper portion of the figure and the tailwater of Pool 13 in the lower portion of the figure.

change from 603 to 583 ft above mean sea level as you travel downstream from Pool 11 to Pool 13.

1.6 THE HISTORICAL MUSSEL FISHERY

The history of mussel fishing on the Upper Mississippi River shows the same "feast or famine" trends characteristic of other industries based on the harvest of finite natural resources. Interest began with the discovery of freshwater pearls in the mid-1880's and expanded when the first pearl button factory was built at Muscatine, IA, in 1891. By 1899 the mussel fishing grounds extended 167 mi from Fort Madison to Sabula, IA; by 1902 the grounds had expanded northward into Wisconsin and Minnesota and it was estimated that 20,000 men were clamming on the Mississippi (Knott 1979). The crowfoot bar, or brail, was the most popular technique and as many as 300 fisherman were sometimes fishing on a productive mussel bed (Smith 1899). A survey in 1898 noted the depletion of mussel beds and suggested this was due to constant fishing even during spawning season, the taking of small mussels, and the wasteful taking of mussels, especially during the winter (Smith 1899).

Problems with mussel taxonomy are apparent when one looks at the 1898 survey

data where over 400 species were recognized (Smith 1899). Many of Smith's species were not considered valid by Grier and Mueller (1922) and they reported only 63 species. A 1931 survey by Ellis noted the presence of 39 species (van der Schalie and van der Schalie 1950), after species normally found only in small streams and invalid species were deleted from Grier and Mueller's list. However, there was general agreement that the mussel beds were being rapidly depleted in the early 1900's. The well-known research on mussel biology conducted at the Fairport Biological Station grew out of this concern for a depleted resource (Carlander 1954).

Overfishing and the introduction of new synthetic buttons contributed to the decline of the mussel fishery by the mid-1920's. Probably the most striking changes in mussel fauna were the drastic decline in the ebony shell (*Fusconaia ebena*) and the yellow sandshell (*Lampsilis teres*). The loss of suitable habitat and deteriorating water quality, along with overfishing, may have been responsible for these changes (Fuller 1978). A small mussel fishery still exists on the Upper Mississippi River, but most productive mussel beds lie either north or south of the Pool 11 to 13 reach of river.

1.7 RIVER HABITATS

There are three relatively distinct longitudinal zones in most of the navigation pools. The upstream portion of each pool, except for the region immediately below the dam, is most like the original river. In this portion of the pool, marsh vegetation is limited and deep side channels and wooded islands are common. In the middle portion of the pool, water levels have been stabilized, often covering old hay meadows and forming shallow backwater lakes that may support extensive stands of emergent marsh vegetation. In the portion of the river immediately upstream from a dam, water was impounded to a depth which precluded the development of marsh vegetation. At present, this portion of the pool is relatively deep, with open water and usually little marsh habitat.

A number of aquatic habitat classification schemes have been suggested for the Mississippi River, and the more general ones usually refer to the main channel, main channel border, side channels, and backwater lakes and sloughs. These four habitat types have relatively well-defined boundaries and they are mutually exclusive, i.e., a particular location can be classified as belonging to only one of these habitat types. The portion of the main channel and channel border immediately downstream from a lock and dam, however, can also be referred to as tailwater habitat, with its boundaries dependent on river flows. The four basic mutually exclusive habitat types are shown for a portion of Pool 13 just north of Savanna, IL (Figure 11), and will be described briefly.

Main Channel

The main channel includes the portion of river also known as the navigation channel; its boundaries are defined by combinations of wing dams, river banks, islands, and buoys and other markers. The main channel reach from a lock and dam to 0.5 mi downstream can also be called the tailwaters. A minimum 9-ft depth and 300-ft width is maintained in the main channel by the Corps of Engineers. A current is always present and it varies directly with flow rates. The bottom type

is a function of current velocity and there are often benthic sand dunes oriented perpendicular to the flow. The substrate is primarily sand in the upper reaches of a pool, changing to silt over sand in the lower section. Patches of gravel are present in a few areas. The main channel is subject to scouring during flood periods and by the passage of towboats in the shallower stretches. No rooted aquatic vegetation is present.

Main Channel Border

The main channel border is the zone between the 9-ft channel and the river bank. It includes all areas in which submergent wing dams occur along the main channel; these may be "islands" of very high biological productivity. Buoys often mark the channel edge of this zone. Where the main channel is defined only by the bank, a narrow border still occurs and often the banks have rock riprap. Dredge spoil has been placed in some sections of this zone, sometimes covering wing dams. This substrate is mostly sand in the upper sections of the pool and silt in the lower. Little or no rooted aquatic vegetation is present. The 0.5-mi reach of the main channel border immediately downstream from a dam can also be considered part of the tailwaters.

Side Channels

Side channels include all departures from and influents to the main channel and main channel border, in which there is current during normal river stage. There is considerable variety in this habitat type, ranging from fast flowing water-courses with high banks to sluggish streams winding through marshy areas. Undercut or eroded banks are common along side channels near their departure from the main channel. Erosion occurs mainly in the upper sections of the pools where banks are highest and the current may be swifter. Closing or diversion dams are often present where side channels leave the main channel or main channel border. The substrate usually varies from sand in the upper reaches to silt in the lower. In the swifter current there is no rooted aquatic vegetation, but vegetation is common in the shallower areas having silty bottoms and low current velocities. The

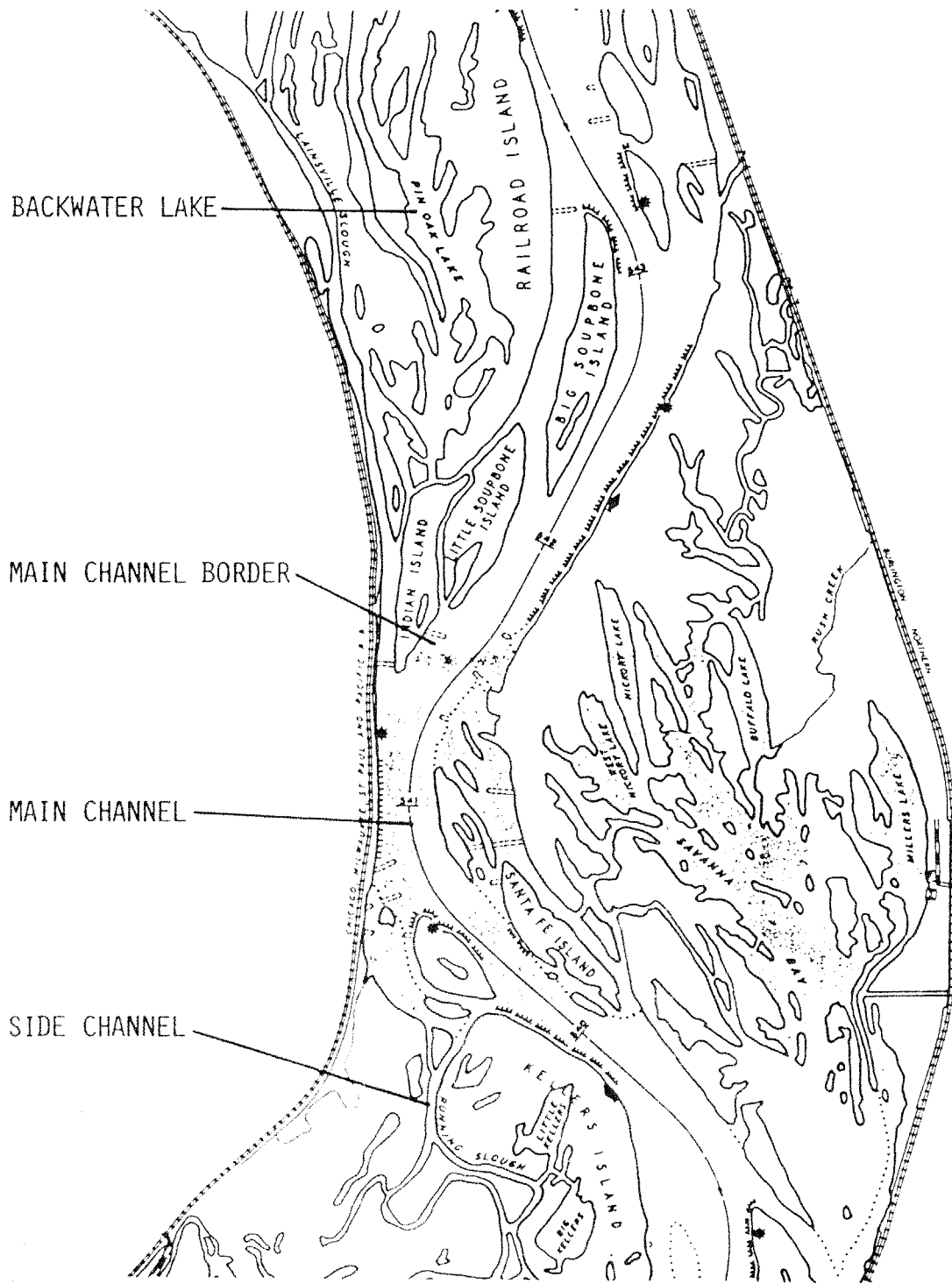

Figure 11. A 5-mi reach of Mississippi River Pool 13 showing the four major habitat types.

navigation maps for Pools 11 to 13 show 113 side channels (57 effluents from and 56 influents to the main channel) in this 93-mi reach of river.

Backwater Lakes and Sloughs

Backwater lakes and sloughs include the variety of standing water habitats where current is variable depending on river stage. These floodplain basins are shallow with silt or clay substrates, often consisting of layers 2 ft or more thick. The basins often have rooted aquatic vegetation, both submergent and emergent, giving rise to marsh habitat around their margins. Sometimes slough habitats are listed separately, based upon the absence of current at normal river stage. However, for this report they will be considered along with the other standing water aquatic habitats; they can also be considered as one of the latter seral stages in riverine succession from aquatic to marsh habitat.

Chapters 3 through 6 will focus on these four aquatic habitat types. The terrestrial communities of the floodplain forest and dredge spoil deposits will be considered in Chapter 7.

1.8 ECOLOGICAL THEORY AND THE UPPER MISSISSIPPI RIVER

Most early studies of streams focused on the ecology of individual organisms (e.g., Forbes 1928; Reinhard 1931). The concept of streams as ecosystems did not emerge until the late 1950's (e.g., Margalef 1960; Cummins 1974).

The complexity and diversity of flowing-water ecosystems may explain why it has been difficult for ecologists to establish unifying principles that apply to lotic ecosystems. This may be particularly true for large river systems

like the Upper Mississippi River. The Pool 11 to 13 reach includes a matrix of habitats ranging from standing-water to flowing-water systems.

Vannote et al. (1980) suggested that streams represent a longitudinal continuum of physical gradients and associated biotic adjustments. This has been referred to as the "river continuum concept," and it proposes that system-level processes (cycling of organic matter and nutrients, ecosystem metabolism, net metabolism) in downstream areas are linked to instream processes in upstream areas (Minshall et al. 1983). It has not yet been determined to what extent this concept can be applied to a large river--where inputs from backwaters may override upstream effects. In any case, the "river continuum concept" does provide a useful paradigm for future studies of river ecosystems (Barnes and Minshall 1983).

All of the studies used in preparing this report on Pools 11 to 13 were conducted without reference to a unifying paradigm like the "river continuum concept." Most studies cited here are descriptive and focus on a particular taxa of organisms or a particular habitat type. However, a simple ecosystem model of the Upper Mississippi River can help illustrate the principal relationships between various components (Figure 12). The dashed line surrounding Figure 12 signifies the "open" nature of this dynamic system, and the model is general enough to apply to a specific habitat or to use as a holistic description of the ecosystem. The size of storage boxes in Figure 12 will vary, depending upon the portion of the habitat being considered and the time of year. For example, according to this model, the autotrophic macrophytes would dominate in shallow backwater lakes during late summer, while algae would be the principal autotroph in the main channel.

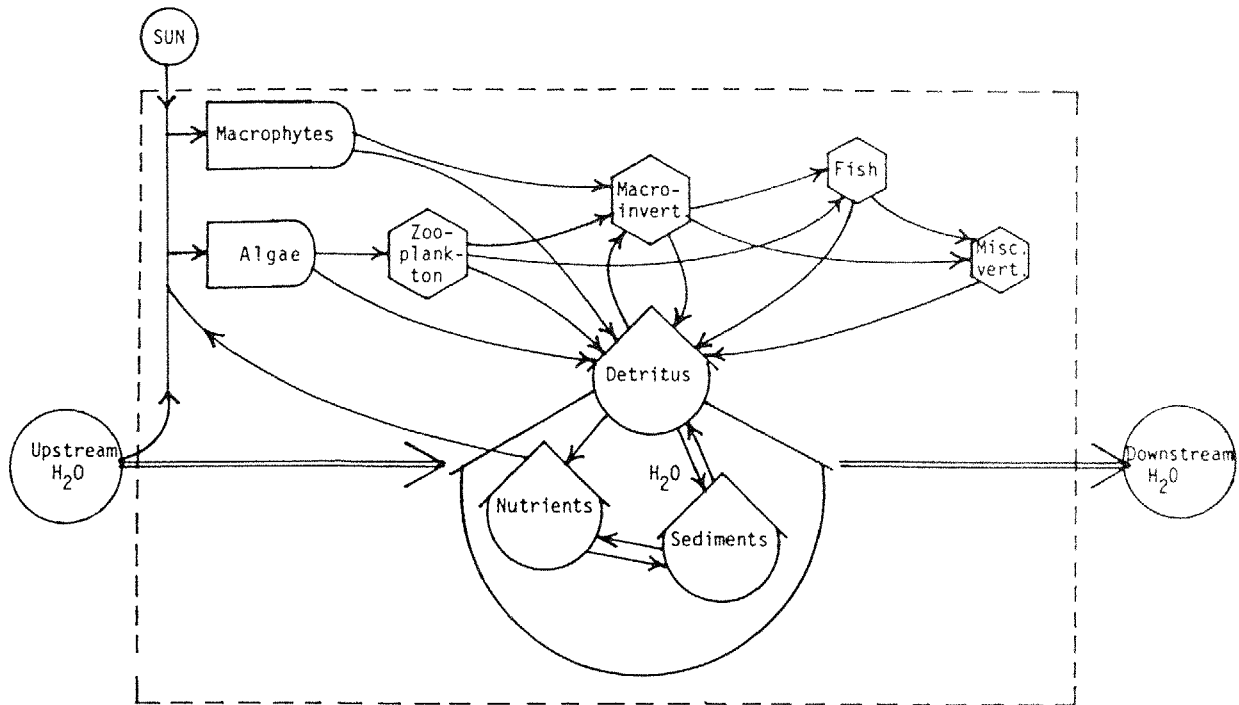

Figure 12. Schematic model of the Upper Mississippi River showing flows and storages of materials and energy (symbols after Odum 1983); not all possible relationships are shown. This model may apply to separate components of the system (e.g., backwater lakes) or to the entire ecosystem.

CHAPTER 2. HYDROLOGY, SEDIMENTS, AND WATER QUALITY

2.1 OVERVIEW

The locks and dams of the Upper Mississippi River form a series of "steps" in a "river stairway" (Figure 13). River traffic ascends this stairway when moving upstream and descends when moving downstream. The 27 locks and dams, extending from Number 1 at Minneapolis, MN, to Number 27 at St. Louis, MO, regulate river flows to maintain the minimum 9-ft depth in the main channel. The tailwaters of a pool, immediately downstream from the lock and dam, often contain deeper waters (Figure 14). The water-level elevations are also more variable in the tailwaters,

as shown by Stang and Millar (1984) for Pool 13 tailwaters where elevations varied by as much as 10 ft during 1983.

Rivers are dynamic alluvial systems that change landscapes in spite of the apparent stability provided by lock and dam systems. Simons et al. (1975) suggest that it is the rule, rather than the exception, that banks will erode, sediments will be deposited, and floodplains, river islands, and side channels will undergo modifications with time. The time interval for this change may vary from a few weeks to well beyond the normal human lifespan.

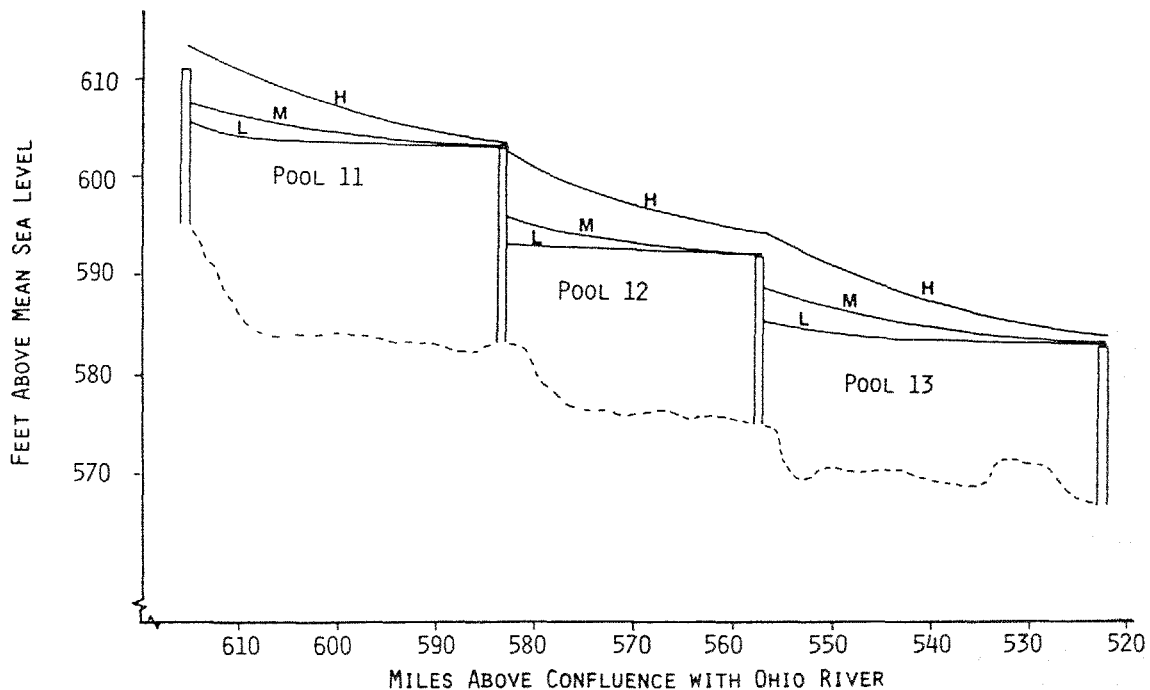

Figure 13. Profile of Pools 11 to 13 of the Upper Mississippi River. Lower dashed line approximates pre-impoundment riverbed; lines L, M, and H correspond to water levels under low-, moderate-, and high-flow models, respectively.

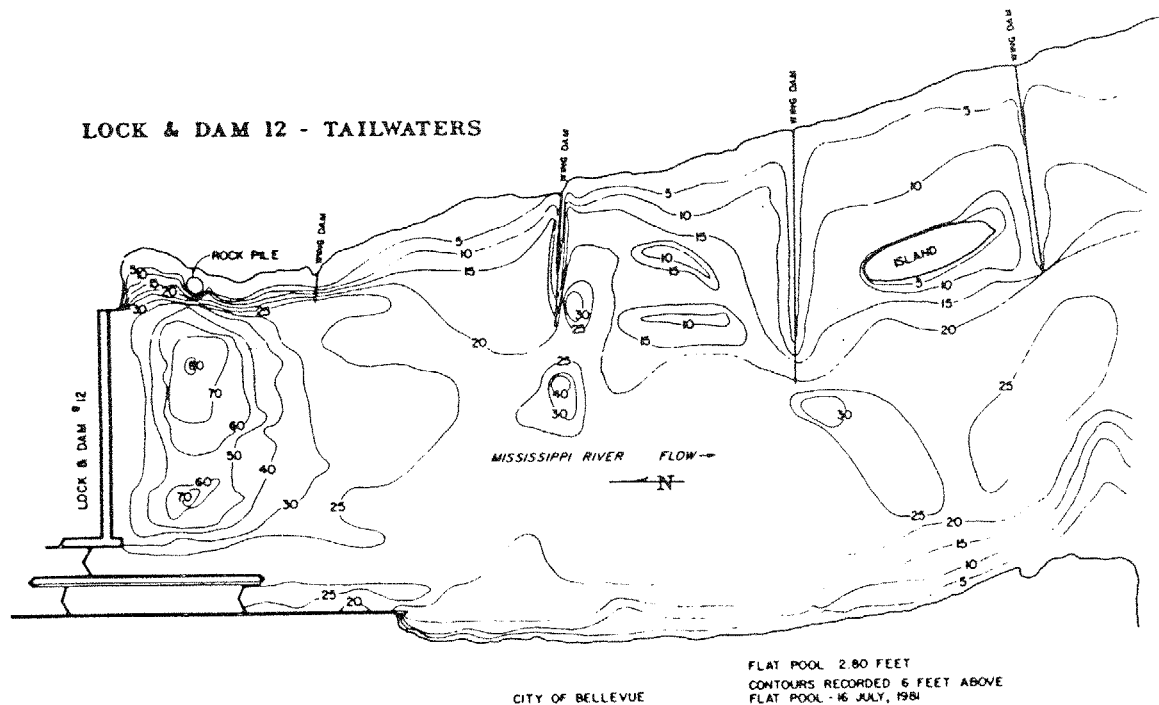

Figure 14. Tailwaters of Pool 13 showing depth contours in feet (Iowa Conservation Commission, Des Moines).

The dynamic nature of the Upper Mississippi River has resulted in many reaches which are "island-braided" in character (Figure 15). Lane (1957) suggested that a braided riverine system usually results from (1) overloading, where the river receives more sediment than it can carry, giving rise to the deposition of part of that load, and (2) steep slopes, which eventually produce a wide shallow channel where bars and islands form readily. Lane concluded that overloading, ever since Pleistocene glaciation, has been the primary cause for the braided morphology of the upper Mississippi. Simons et al. (1975) suggested that when aggradation has progressed to the stage where the river can carry the entire sediment load delivered by its tributaries, it seems probable that there will be a main channel largely free from islands, sloughs, lakes, ponds, and secondary channels. However, this should take a very long time as the entire width of the valley would need to be filled, probably until the river's slope is as steep as in pre-glacial times.

The GREAT II Water Quality Work Group (GREAT II 1980a) suggested that the most important sources of pollution to the Mississippi River in this reach were municipal and industrial point source discharges and nonpoint source discharges from erosion of agricultural land within tributary basins. The urban centers of Guttenberg, IA, Cassville, WI, Dubuque, IA, Bellevue, IA, Savanna, IL, and Sabula, IA, are potential locations of point source discharges. The Turkey and Maquoketa Rivers are the major tributaries carrying sediments to the Mississippi in this reach. In addition, commercial navigation and channel maintenance dredging can influence water quality.

2.2 RIVER FLOW CHARACTERISTICS

The U.S. Army Corps of Engineers maintains daily records of flows at Locks and Dams 11 to 13, as well as elevation readings for pools (upstream sides of dams) and adjacent tailwaters (downstream sides of dams). The water-level elevation



Figure 15. Pool 13 of the Upper Mississippi River viewed facing south showing "island-braided" reach of river at about RM 555.

(in ft above mean sea level) within a pool usually varies, being higher at the upstream end; the slope of this water level within a pool varies with the quality of flow (Figure 13). Under low flow conditions, the major change in surface water elevation occurs at the locks and dams. At higher flows, a substantial change in the elevation of surface waters occurs within the reach of the pool, making it somewhat difficult to get accurate water-level values for a given location.

The numerous side channels in the Pool 11 to 13 reach enable water to move away from the main stem of the river and into backwaters. The areas of inundated side channels fluctuate as water levels change, and there are concomitant changes in their flow volume, modified by any change in velocity. Water level is probably the single most important factor influencing the movement of water out of the main channel, and it can be quite variable because of flow and dam-operation practices. Modeling of water levels within a pool helps define this dynamic system.

Water-level equations have been developed for Pools 11 to 13 (Table 2). Flow data from 1981 to 1983 were used in developing exponential equations

which estimate water levels (in ft above mean sea level) at a given river mile (RM) within a pool using the level at the dam and the flow regime (high, moderate, or low). Flow data and river stages indicated that about 70% of the change in water level within a pool occurs upstream from a pool's midpoint because the bottom is more steeply graded in this region; this relationship was used to develop separate equations from the dam upstream to the midpoint, and from the midpoint upstream to the next dam. The slope coefficients represent an "instantaneous" slope, which increases at higher flows and is higher upstream from the midpoint within a pool (Table 2).

A more accurate water-level estimate will allow future models to better predict flows to backwater habitats. Side channel cross-section areas for Pools 11 to 13 would be needed to accomplish such modeling.

2.3 POOL SEDIMENT BUDGETS

A budget for the sediment regime should quantitatively describe the origins, destinations, and rates of movement of sediments from the watersheds involved. Nakato (1980) attempted such a

Table 2. Slope coefficients for water-level equations^a for Pools 11 to 13 at low, moderate, and high flows.^b

Pool	Slope coefficients at different flows		
	Low flow	Moderate flow	High flow
<u>11</u>			
(DM = 583.00)			
(MM = 599.05)			
Dam water level	602.99	602.89	603.67
S ₁	0.00002996	0.00013833	0.00029758
S ₂	0.00007595	0.00032294	0.00068851
<u>12</u>			
(DM = 556.70)			
(MM = 569.85)			
Dam water level	591.99	591.93	594.84
S ₁	0.00003082	0.00014632	0.00028073
S ₂	0.00007316	0.00033903	0.00065062
<u>13</u>			
(DM = 522.50)			
(MM = 539.70)			
Dam water level	583.11	582.90	583.90
S ₁	0.00004086	0.00016136	0.00031082
S ₂	0.00009458	0.00037576	0.00071853

^aWater-level equations for a given river mile (RM) within a pool shown below:

$$\text{If } RM < MM: WL_{RM} = WL_{DM} e^{S_1(RM-DM)}$$

$$\text{If } RM > MM: WL_{RM} = WL_{DM} e^{S_1(MM-DM) + S_2(RM-MM)}$$

where: WL = water level in feet above mean sea level
 RM = river mile above entrance of the Ohio River
 DM = river mile of the lock and dam for that pool
 MM = mid-point river mile for that pool
 e = base of natural logs (2.7182...).

^bMonthly means used for low flow data from July 1980 (23.9 x 1000 cfs at Lock and Dam No. 11), moderate flow data from July 1981 (60.1 x 1000 cfs at Lock and Dam No. 11), and high flow data from April 1982 (127.8 x 1000 cfs at Lock and Dam No. 11); data provided by George E. Johnson, Hydraulics Branch Chief, Rock Island Corps of Engineers, Rock Island, IL.

budget for a reach of the Mississippi River including Pools 11 to 13, although field data were not complete and mathematical predictive methods were used in some cases. The resulting sediment budget depended upon a detailed pool-by-pool estimate of an input-output balance, including sediment inputs at the upstream boundary tributaries, sediment removal from the pool by dredging, sediment deposition or scour within the pool, and sediment output at the downstream boundary (Figure 16).

The budget analysis considered two principal tributary watersheds entering from the west (Turkey River and Maquoketa River) and two from the east (Grant/Platte Rivers and Galena/Apple/Plum Rivers). The combined 3.5-million acre sub-basin drains into the Upper Mississippi River in the Pools 11 to 13 area (Table 3). This heavily farmed basin has only 14.5% forest land, and it was estimated that mean cropland erosion was 12.6 tons per acre per year (Nakota 1980). About 91.4% of the eroded material was estimated to be silt and clay. The GREAT II Sediment and Erosion Work Group recommended land treatment measures throughout this sub-basin because of the high rates of erosion (GREAT II 1980d).

The estimated sediment budget for Pools 11 to 13 is presented in Table 4. In this analysis, Nakato (1980) estimated sedimentation rates by comparing topographic maps, although in Pool 13 there was a problem with insufficient cross-sectional data. The data do suggest relatively high sediment inputs from the tributaries in Pool 11 (primarily the Turkey River), and lower sediment inputs to Pool 12 which has smaller tributaries. Although direct estimates of sedimentation are not available for Pools 11 to 13, estimates from Pool 14 give mean rates of sediment deposition of 3.76 cm/yr (= 1.48 inches/yr) during 1954-64, and deposition of 1.17 cm/yr (= 0.46 inches/yr) for the 1965-80 time period (McHenry et al. 1984).

2.4 WING DAM STRUCTURES

Wing dams and closing dams on the Upper Mississippi River were constructed to help maintain 4.5-ft and 6-ft

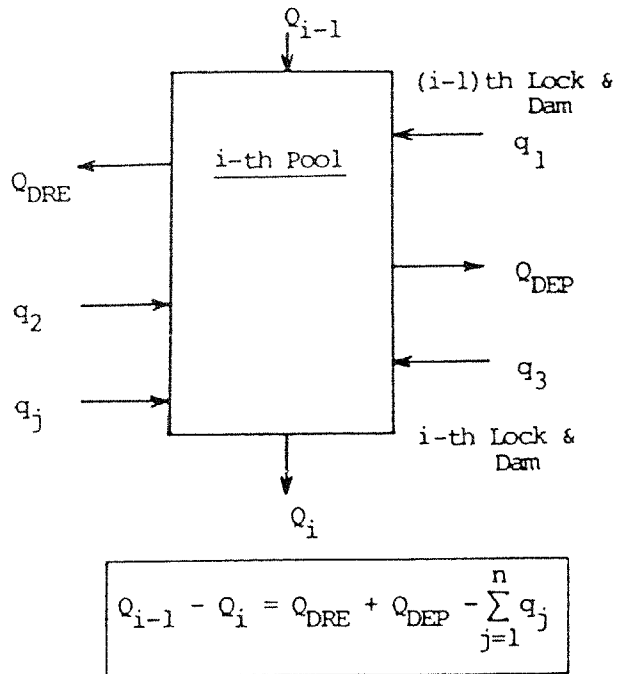

Q_{i-1} : Total sediment discharge coming into the i -th pool (tons/yr)

Q_i : Total sediment discharge coming out from the i -th pool (tons/yr)

q_j : Total sediment discharge from the j -th tributary of the pool (tons/yr)

n : Number of tributaries

Q_{DRE} : Total amount of dredged material (tons/yr)

Q_{DEP} : Total amount of sediment deposited in the pool (tons/yr)

Figure 16. Schematic diagram of the sediment budget for the i -th pool (from GREAT II 1980g).

navigation channels. Most structures in Pools 11 to 13 were constructed from 1895 to 1930, and the navigation maps show the presence of 366 wing dams and 25 closing dams. Most of these structures are below water level at normal pool elevations. There are three emergent wing dams on the Illinois side just downstream from Lock and Dam No. 13, between River Miles (RM) 548 and 548.5.

Table 3. Summary of land use for the drainage basin of Pools 11 to 13 of the Upper Mississippi River (GREAT II 1980g).

Land use	Acreage (X1000)	Percent
Cropland	2,304	65.8
Pasture	562	16.1
Forest	508	14.5
Other	127	3.6
Total	3,501	100.0

The physical features of wing dams along the Iowa channel border of the Mississippi River have been recently studied (Pitlo 1981), and some summary values for Pools 11 to 13 are presented in Table 5. Since construction, there has been extensive loss of wing dam habitat, primarily due to sedimentation by sand. In some cases, entire areas around or between adjacent structures have become extensive shallow sand flats. Mean current velocities over the dam were 55% and 69% higher, respectively, than 30 m upstream or 30 m downstream from the structure. Maximum depths usually

occurred on the downstream side, and depths were greater for dams on outside bends than dams projecting out from inside bends of the river. Sand and silt were the dominant substrate types, with the percent sand generally decreasing downstream.

2.5 SEDIMENT TRANSPORT TO BACKWATERS

Simons et al. (1981) attempted to develop a model to predict the quantity of sediment that moves from the main channel through side channels to backwater lakes and ponds. The basic model is expressed as:

$$Q_s = A_s V_s C_s$$

where Q_s = annual volume of sediment entering the side channels of a river reach
 A_s = total cross-sectional area of side channels in the river reach
 V_s = mean velocity of the water entering the side channels
 C_s = mean concentration of sediment in the water entering the side channels.

Table 4. Sediment budget for Pools 11 to 13 of the Mississippi River (after Nakato 1980).

Pool parameter	Pool 11	Pool 12	Pool 13
River mile	615.1-583.0	583.0-556.7	556.7-522.5
Water surface (mi ²)	32.97	20.30	46.87
Normal pool elevation (ft)	603.0	592.0	583.0
Total sediment input to pool (tons/yr)	5.04×10^6	5.01×10^6	2.03×10^6
Total sediment output from pool (tons/yr)	5.01×10^6	2.03×10^6	1.98×10^7
Input from tributaries (tons/yr)	1.06×10^6	4.00×10^4	6.42×10^5
Mean annual dredging (1945 - 1978; tons/yr)	1.16×10^5	2.50×10^4	1.26×10^5
Mean sediment deposition (tons/yr)	9.74×10^5	3.00×10^6	No Data
Mean aggradation (inches/yr)	0.26	1.32	No Data
Time period used to evaluate sedimentation	1938-51	1939-44	No Data

Table 5. Characteristics of Iowa wing dams of the Mississippi River, with special emphasis on those of Pools 11 to 13 (after Pitlo 1981).

Dam parameters	Pool 11	Pool 12	Pool 13	Total Iowa ^a wing dams
Number constructed	92	50	73	595
% covered or eroded by 1979	23	30	39	32
Length (m) at time of construction	15,426	8,929	13,467	117,870
% reduction in length (m) by 1979	40	38	27	53
Mean water depth (m) over dam ^b	1.5	1.8	1.7	1.7
Mean maximum depth (m) 30 m upstream from dam ^b	4.8	3.9	4.4	4.2
30 m downstream from dam ^b	5.6	4.6	5.9	5.1
Substrate types near dam (%) ^b				
Sand	87.2	80.1	76.2	77.4
Silt	10.2	15.9	16.2	15.1
Gravel	2.7	2.5	7.0	4.9
Boulder	-	1.5	0.6	2.5
Mean current velocity (m/s) ^b				
30 m upstream	0.24	0.41	0.31	0.30
On the wing dam	0.37	0.62	0.50	0.50
30 m downstream	0.21	0.39	0.28	0.28

^aValues based upon data from wing dams from Pools 9 to 19 along the Iowa side channel border.

^bValues based upon representative wing dams from within each pool.

A series of simplifying assumptions, including empirically derived power-function coefficients, were used to estimate A_s , V_s , and C_s . For example, main channel velocity was used in empirical power functions to estimate both side channel velocity and the concentration of sediment in water entering side channels. The estimated annual transport of sediment to backwaters of Pools 11 to 13 is shown in Table 6.

2.6 MAIN CHANNEL DREDGING

The Rivers and Harbors Act of 1930 authorized dredging to maintain a navigation channel at a minimum 9-ft depth. Mean annual volumes dredged in

Pools 11 to 13 from 1945 to 1979 are given in Table 7. Large volumes were dredged per pool prior to 1945 during the transition from the 6-ft to 9-ft navigation channel. Since 1945, the annual dredging needed has been strongly related to mean annual water discharge (Simons et al. 1981). When flows are high, large quantities of sediment enter the Mississippi River from tributaries and nonpoint sources throughout the drainage basin. This sediment is deposited when velocity becomes insufficient to keep the particles in suspension.

The dredged material, known as "spoil," is moved by hydraulic pipeline and placed along the bank of the river. This dredge spoil may be moved again,

Table 6. Main channel features and modeling estimates of sediment transport to backwaters (after Simons et al. 1981).

Pool	River reach (river miles)	Mean width of main channel (ft)	Velocity in main channel (ft/s)	Dredging (1945-1972)		Sediment entering side channels and backwater areas ^a (ft ³ x 10 ⁶ /yr)
				Volume (yd ³ x 10 ³)	Frequency (yr)	
11	615.1-613.3	600		279	7	8.1-18.5
11	613.3-611.5	600	4.9-1.4	351	9	1.4-3.2+
11	611.5-613.3	800		700	17	13.0-28.0
11	609.2-611.5	700		426	11	+
11	608.2-609.5	700		303	6	0
11	606.3-608.2	800		442	7	14.7-33.6
11	603.8-606.3	1,000		184	3	4.4-10.1+
11	602.5-603.8	900		0	0	2.2-5.0+
11	600.5-596.8	900	6.3-1.2	226	3	11.0-24.0+
11	596.8-594.0	800		0	0	x
11	594.0-590.0	800		0	0	x
11	590.0-583.0	1,000	6.2-0.6	0	0	x
12	583.0-580.5	1,000	5.1-1.1	58	1	3.4-7.7
12	580.5-577.5	1,000		185	6	0.6-1.3
12	577.5-574.0	1,200		0	0	9.1-20.8
12	574.0-572.1	1,400		0	0	1.5-3.5+
12	572.1-570.0	1,300		43	1	0.8-2.8
12	570.0-566.8	1,300	5.3-0.8	174	5	4.7-10.9+
12	566.8-562.0	1,400		133	3	4.5-10.2+
12	562.0-560.0	1,200		84	2	1.7-3.9+
12	560.0-556.7	1,000	2.6-0.3	0	0	x
13	556.7-555.3	1,000	4.7-1.1	482	8	2.4-5.3
13	555.3-554.0	1,400		0	0	1.4-3.5+
13	554.0-550.5	1,600		78	3	0.7-1.6+
13	550.5-549.0	1,400		333	5	0.5-1.3+
13	549.0-546.0	1,600		1,190	15	4.3-9.5
13	546.0-544.0	1,000	4.7-1.0	222	3	0.1-0.2+
13	544.0-542.0	900		124	2	1.4-3.1+
13	542.0-540.0	1,200		146	2	6.2-14.2+
13	540.0-537.5	1,000		0	0	0.2-0.4+
13	537.5-535.0	1,000		417	8	0.2-0.4+
13	535.0-532.8	1,000		98	4	0.7-1.6+
13	532.8-530.5	900		75	2	x
13	530.5-528.5	900		0	0	x
13	528.5-522.5	1,200	8.6-1.7	165	2	x

^aRange is for 50% confidence interval using the sediment transport equation.

x = open water areas.

+ = sediment enters side channels and backwater areas also through the upstream-reach side channels.

Table 7. Mean annual volume dredged from three pools of the Upper Mississippi River (Simons et al. 1981)

Time period	Volume (1,000 yd ³)		
	Pool 11	Pool 12	Pool 13
1945-54	111.2	25.7	59.6
1955-64	101.0	17.5	141.0
1965-72	69.0	27.9	126.0
1973-79	51.4	3.3	45.1
1945-79 wt. mean	86.7	19.4	95.1

however, due to wind or water erosion. If transported back into the river, it may increase local turbidity and be deposited in side channels or backwater lakes and ponds. Water quality may also be degraded during dredging as turbidity downstream is elevated, or as potentially toxic chemicals, strongly adsorbed to fine sediments, are resuspended in the water.

2.7 WATER QUALITY AND INFLUENTS

The Mississippi River is relatively well-buffered with seven major ions: bicarbonate, calcium, magnesium, sodium, chloride, sulfate, and potassium. These ions tend to increase in concentration as they move downstream; data from 1976 show an increase from approximately 240 mg/l at RM 726 to 410 mg/l at RM 44 (GREAT II 1980a).

Within this "bicarbonate type" river system, nutrient concentrations are usually much lower than the major ions. Nitrogen and phosphorous mean levels from the Pool 11 to 13 reach of river were less than 1 mg/l (Table 8). These nutrients can be quite variable depending on allochthonous inputs and the physiological activity of the aquatic biota. The changes in relative amounts and concentrations of different forms of nitrogen, especially elevated NH₃-N levels, can also indicate the entry of organic pollutants. These elevated levels

Table 8. Mean water chemistry parameters from two locations in the Pool 11 to 13 reach of the Upper Mississippi River (from GREAT II 1980a).

Parameter	Concentration (mg/l)	
	Dubuque, IA	Savanna, IL
NO ₃ -N	0.54	0.66
NH ₃ -N	0.12	0.09
PO ₄ -P	0.17	0.20
Cu	0.30 ^a	
Pb	0.08 ^{a,b}	
Mn	0.15	
Fe	0.6 ^{a,b}	

^aSome samples exceeded EPA standards for aquatic life.

^bSome samples exceeded EPA standards for drinking water.

are often correlated with inputs high in biological oxygen demand (BOD) (GREAT II 1980a). Larger tributaries (e.g., Turkey River and Maquoketa River) tend to increase nutrient levels in the river reach just downstream from where they join the Mississippi.

A dissolved oxygen (DO) concentration of at least 5 mg/l is generally accepted as necessary to maintain a diverse aquatic fauna (McKee and Wolf 1963). Dissolved oxygen levels appear to be adequate throughout the Pool 11 to 13 reach of the Upper Mississippi River, although there have not been detailed studies of this parameter. The most likely oxygen depletion zone would occur downstream from Dubuque, IA, which contributes the highest single BOD input within this 93-mi river reach. There may also be some temporary oxygen depletions in productive backwater lakes and ponds, especially in shallow zones during winter after periods of prolonged ice cover.

The point sources entering Pools 11 to 13 include effluents from 9 municipal sewage treatment plants, 10 mobile home parks, and 3 electric utility companies (Table 9). Up to 277 million gal per day (= 429 ft³/s) of river water from eight different locations may be used for cooling in this river reach; under low

Table 9. Point-source discharges to Pools 11 to 13 (from GREAT II 1980a).^a

Pool	River mile	Name of facility	Comments about discharge
11	614	Guttenburg STP	600 BOD ₅ ; 60 lb NH ₃ -N; to Miners Creek
	608	Wis. Power & Light	165 MGD flow
	607.4	Rapid Dye & Molding Co.	0.024 MGD flow; 6 BOD ₅ ; to Furnace Creek
	606.8	Dairyland Power Coop.	46.5 MGD flow
	606.5	Cassville STP	0.144 MGD flow; 14 BOD ₅
	592	Potosi STP	0.251 MGD flow; 21 BOD ₅
	585.6	Lore MHP	to Little Maquoketa
11	585.6	John Deere Co.	17 MGD flow; 550 BOD ₅ ; 55 lb NH ₃ -N; Pb & Zn; to Little Maquoketa
	585.6	Flexsteel Ind.	(0.002) MGD flow; Cooling water; to Little Maquoketa
12	581	Dubuque WTP	(0.011) MGD flow
	581	Caradco Div.	(0.715) MGD flow; Cooling water
	581	Fisher, Inc.	(0.648) MGD flow; Cooling water
	581	Interstate Power Co.	(61.1) MGD flow; Cooling water
	581	Keystone Gelatin Co.	(0.756) MGD flow; Cooling water
	581	Midland Labs Inc.	(0.003) MGD flow; Cooling water
	581	U.S. Industrial Co.	(2.31) MGD flow; Cooling water
	581	Dubuque Stamping & Mfg.	(0.027) MGD flow; Storm sewer discharge
	581	Molo Sand & Gravel	
	581	Knapp MHP	
	581	Granada Gardens MHP	
	581	Westgate MHP	
	581	Light MHP	
	581	Table Mound MHP #2	
	579	American Oil Co.	to Catfish Creek
	579	Dubuque Sand & Gravel	Quarry water; to Catfish Creek
	579	Twin "T" MHP	25 BOD ₅ ; to Catfish Creek
	579	Table Mound MHP	to Catfish Creek
	579	Deckert MHP	to Catfish Creek
	579	Dubuque STP	35,000 BOD ₅ ; 9.8 MGD flow; 2,861 lb NH ₃ -N
12	579	East Dubuque STP	400 BOD ₅ ; 0.300 MGD flow; 75 lb NH ₃ -N
	573	Apple R. Chemical	200 BOD ₅ ; 0.593 MGD flow; 250 lb NH ₃ -N
	560	Chestnut Mtn. Lodge	(0.014) MGD flow
13	557	Bellevue WTP	
	556	Bellevue STP	350 BOD ₅ ; 0.170 MGD flow; 85 lb NH ₃ -N
	550	U.S. Ordinance	74 BOD ₅ ; (0.300) MGD flow; 13 lb NH ₃ -N; to Apple River
	537	Savanna STP	375 BOD ₅ ; 0.500 MGD flow; 54 lb NH ₃ -N
	537	Eaton Corp.	Noncontact cooling water; Plum R. to Savanna Slough
	535	Sabula STP	190 BOD ₅ ; 0.100 MGD flow; 7 lb NH ₃ -N
	527	Thomson STP	50 BOD ₅ ; 0.055 MGD flow; 13 lb NH ₃ -N

^aKey to abbreviations:

STP - sewage treatment plant
MHP - mobile home park
MGD - million gallons per day

WTP - water treatment plant
BOD₅ - 5-day Biological Oxygen Demand
(flow) - design flow volume (in mg/l).

flow conditions of 10,000 ft³/s, this represents 4.3% of the river's flow. Thermal plumes downstream from effluents vary greatly in volume and hydrologic behavior. Downstream from the largest heated effluent in this reach of river, plumes 5 °F above ambient water temperature covered from 1.3% to 6.7% of the river in cross section (GREAT II 1980a). The major environmental problem within these thermal mixing zones is the heat shock to which fish and ichthyoplankton may be exposed. The magnitude of this impact on the total fishery of the Mississippi River has not been determined.

Polychlorinated biphenyls (PCB's) are one of three types of toxic compounds that have been identified in effluents entering the Mississippi River. PCB's have very low water solubility, but they are fat soluble and, like chlorinated hydrocarbon insecticides, PCB's can accumulate in animal tissue many thousands of times their concentration in the water. They are directly toxic to humans and levels as low as 2.5 mg/kg PCB's in human diets have been linked with a variety of physiological dysfunctions (Hora 1976). Studies since 1970 have indicated that virtually all fish downstream from major urban areas contained PCB's (GREAT II 1980a). During 1975-77, samples of rough fish and game fish in Pool 11 (near Cassville, WI) had 1.01 and 0.12 mg/kg PCB's, respectively, in their tissues; similar data from Pool 12 (near Dubuque, IA) showed PCB concentrations of 0.22 and 0.23 mg/kg. At both sampling locations and throughout the Mississippi upstream from St. Louis, it appears that PCB fish contamination has increased since the early 1900's. One of the few studies of PCB's in freshwater mussels found levels that did not exceed 0.11 mg/kg for four species sampled from Pool 15 (BPD 1984).

A second category of toxic compounds found in the Mississippi River is pesticides. Samples during the period 1968-76 from Pool 12 (at Dubuque, IA) had levels of 0.45 µg/l Dieldrin, 0.20 µg/l

DDE, and 0.05 µg/l DDT. Dieldrin is present in higher concentrations than either DDE, a breakdown product of DDT, or DDT itself. The acceptable limits in fish flesh set by the Food and Drug Administration (FDA) for DDT (5 mg/kg) have not recently been exceeded for fish in the Pool 11-13 reach; but the limits for Dieldrin (0.3 mg/kg) probably have been exceeded. Samples upstream from this reach, at RM 663, have shown Dieldrin levels of 2 µg/kg in fish flesh, and samples just downstream at Clinton, IA, had levels of 12 µg/kg (GREAT II 1980a). Chronic exposure of humans to low-level pesticide contamination is probably of more concern at present than acute toxicity from either drinking water or fish.

Heavy metals represent a third category of toxic compounds. Some samples from the Mississippi River at Dubuque, IA, exceeded EPA standards for copper, lead, and iron (Table 8). The toxicity of heavy metals is influenced by a variety of environmental parameters (such as temperature and alkalinity) but it appears that, with the possible exception of mercury, heavy metals are not being concentrated in the biota of the Mississippi River. Fish and other aquatic animals seem to accumulate most heavy metals at rates which depend as much on their habitats as their diets.

Water quality may also be influenced by the resuspension of bottom sediments by barge traffic. If sediments contain toxic materials, barge passage may release these pollutants. Simons et al. (1981) noted that the resuspension of contaminated sediments may increase the pollutant intake of certain fish species if they ingest sediments to which pollutants are adsorbed. Bhowmik et al. (1981) found that changes in water chemistry increased if sediments were resuspended during vessel passage. For example, during low flows, disturbance of fine-grained sediments by barge passage may decrease DO levels as high-oxygen-demand organic materials are resuspended.

CHAPTER 3. AQUATIC MACROPHYTES

3.1 OVERVIEW

Our consideration of biotic components begins with the larger macroscopic primary producers in this aquatic system. These autotrophs are responsible, especially in off-channel areas, for much of the carbon fixed by the Upper Mississippi River system. Aquatic macrophytes of rivers are very mixed taxonomically, but most are vascular flowering plants. These communities have been referred to as an unstable, complex mosaic of species which show numerous structural adaptations to the aquatic environment (Westlake 1975). The emphasis in this chapter, and in subsequent discussions of other biotic components, will be on the dominant species and how their biologies illustrate the structure and function of this dynamic riverine system. Recent guides to the literature of the aquatic macrophytes of the Upper Mississippi River have been provided by Mohlenbrock (1983) and Peck and Smart (1985).

Three major forms of aquatic macrophytes can usually be found on the Upper Mississippi River:

- emergent
- floating
- submergent.

Emergents are rooted in the substrate, which is near or below water level for much of the year, but their leaves and reproductive organs are aerial; examples include arrowhead (*Sagittaria latifolia* and *S. rigida*), bulrush (*Scirpus fluviatilis*), cattail (*Typha* sp.), and reed canary grass (*Phalaris* sp.). Floating macrophytes are usually rooted in the substrate with leaves floating on the water surface and

reproductive organs floating or aerial; white water-lily (*Nymphaea* sp.) and floating pondweed (*Potamogeton natans*) are examples. The American lotus (*Nelumbo lutea*) has large circular floating leaves which often become emergent as the plant matures. Duckweed (*Lemna* sp.) is a small floating plant that is not rooted in the substrate. Submergents are usually rooted, with leaves entirely below the surface; examples include wild celery (*Vallisneria americana*), curly pondweed (*Potamogeton crispus*), watermilfoil (*Myriophyllum* sp.), and common elodea (*Elodea canadensis*). In addition, some, like coontail (*Ceratophyllum demersum*), are not normally rooted but are often entangled in other plants.

If the macrophyte zonation of lakes were extended to rivers, one would expect river edges to be lined by emergents, with floating macrophytes in slightly deeper water and submergents in still deeper water. However, local conditions such as current, bank slope, and wind exposure vary greatly and often the complete range of macrophyte zones are not seen in rivers (Westlake 1975).

A variety of environmental factors may limit the distribution and productivity of aquatic macrophytes in Pools 11 to 13. It is now known that aquatic macrophytes may rely on both root and shoot uptake of nutrients (Denny 1972), and that nutrient levels of $\text{NO}_3\text{-N}$ and $\text{PO}_4\text{-P}$ can influence growth; optimum growth occurs at concentrations common on the Upper Mississippi (Peltier and Welch 1969; Mulligan and Baranowski 1969). In many river systems, including the Upper Mississippi, the annual throughput of nutrients is many times that needed for optimum macrophyte growth (Westlake 1968;

Ladle and Casey 1971); Westlake (1975) suggested that nutrients are often not as important in limiting macrophytes as other factors.

Light is a well-known limiting factor of plant growth, and the relatively turbid waters of the Mississippi River may greatly reduce light levels just a few cm below the surface. The uppermost leaves of submergent macrophytes may be light-saturated while leaves deeper within the plant stand receive subsaturating radiation. Thus, turbidity can reduce overall macrophyte productivity, with submergent macrophytes being the form most directly affected (Westlake 1966).

The influence of flow upon substratum is well-known (Hynes 1970), and correlations between substrates and riverine plant beds have been observed (Westlake 1975). Lower flows and smaller sediments are usually present in the backwater lakes and ponds of the Upper Mississippi River; these habitats have the larger stands of aquatic macrophytes. Marsh vegetation, much of which is emergent macrophytes, is more common for those pools which have large areas of backwater lakes and ponds (Figure 17). The Pool 11 to 13 reach is near the southern edge of the portion of the Upper

Mississippi in which there is an extensive development of marsh vegetation. Pools further south have smaller areas of backwaters and, hence, less marsh vegetation.

The characteristics of selected aquatic macrophyte communities within the four principal habitat types of Pools 11 to 13 are discussed in the remaining sections of this chapter.

3.2 MAIN CHANNEL

The relatively deep waters and fast current of the main channel make this habitat unsuitable for the growth and reproduction of most species of aquatic macrophytes. However, macrophytes are commonly seen floating in the main channel, usually after having been uprooted and transported out of backwater areas. Probably the most noticeable aquatic macrophytes of the main channel are duckweed (*Lemna* sp.) and watermeal (*Wolffia* sp.), the latter being the world's smallest flowering plant. These floating plants usually multiply and develop in waters with very little current, but higher waters following heavy summer rains can flush these habitats to produce large blankets of green

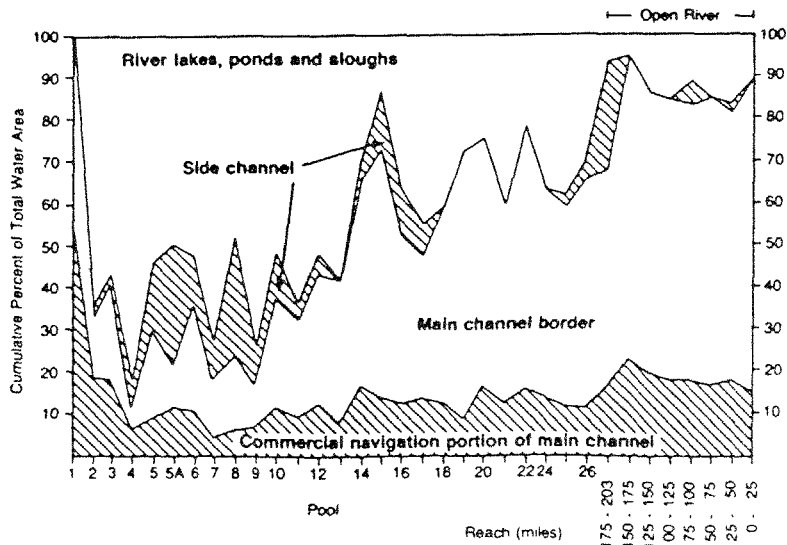

Note Pools 1 and 2 from 1973 data.
Pools 3 to Reach 0-25 from 1975 data.

Figure 17. Relative distribution of aquatic habitats on the Upper Mississippi River (from UMRBC 1982).

duckweed and watermeal on the water's surface. These green patches are usually in reaches of the river downstream from side channels which drain backwater lakes and ponds.

A considerable quantity of partially decomposed macrophyte tissue is transported via the main channel during the higher flows of early spring. These plants, remains from the previous season's growth, from upstream backwaters, are a source of organic carbon that can be used by a variety of microbes and aquatic invertebrates. This seasonal transport facilitates the redistribution of organic matter within and among habitats of this complex river system.

3.3 MAIN CHANNEL BORDER

Even though almost 30% of the water area for Pools 11 to 13 is main channel border habitat (Figure 17), relatively little of this habitat is well-suited to the growth of aquatic macrophytes. These waters have variable depths and currents, many of which are often beyond the tolerance limits of most aquatic macrophytes. However, in localized areas during low water stages, some plant communities may appear similar to those of backwater lakes and ponds (see Section 3.5). Higher waters can greatly reduce primary productivity, and intermittent bed scouring can limit the macrophyte beds. Along some revetment structures of the channel borders, aquatic mosses can be found near the water surface. Little is known about the importance of these scattered aquatic plant communities or the dynamics of this riverine ecosystem (GREAT II 1980b).

3.4 SIDE CHANNELS

Less than 3% of the aquatic habitat in Pools 11 to 13 is classified as side channel (Figure 17), but emergent stands of arrowhead and other aquatic macrophytes grow along some shoreline reaches. Macrophytes are essentially excluded from steep-banked and deeper side channels, but may develop in small localized stands in shallower bays and on alluvial deposits. There are few sites where submerged or floating macrophytes have developed in

side channels, although there have been few studies to evaluate their populations (GREAT II 1980b).

3.5 BACKWATER LAKES AND SLOUGHS

As shown in Figure 17, over 50% of the total aquatic area of Pools 11 to 13 consists of backwater lakes and ponds. Aquatic macrophytes are well-adapted for these standing water habitats, and about 20% of the available area is occupied by emergent, floating, or submerged forms (Table 10). The categories "submerged aquatic vegetation" and "aquatic and moist soil vegetation" of Hagen et al. (1977) would include the aquatic macrophytes. Their totals for the percent of surface area covered ranged from 18.3% for Pool 11 to 23.3% for Pool 13.

The presence of backwater lakes and sloughs at about the midpoint location of a pool (i.e., halfway between adjacent dams) is usually necessary for the development of extensive macrophyte stands (Green 1960; UMRBC 1982). Marsh vegetation is relatively limited in the upstream reach of a pool where deeper sloughs and wooded islands are common. Impoundment in the late 1930's backed up water over islands and old hay meadows now in the middle reach of each pool, forming large areas of relatively shallow water which provided permanent aquatic habitat for macrophytes. In the downstream reach of each pool, water was impounded to a depth which often precluded the development of marsh vegetation (Green 1960).

Some aquatic macrophytes common to the Pool 11 to 13 reach of river are shown in Figure 18. Arrowhead plants (*Sagittaria* sp.) are probably the most abundant emergent macrophyte on the Upper Mississippi, accounting for over 3% of the total surface area of Pools 11 to 13 (Table 11). These species may be able to withstand greater current velocity and thus have a competitive advantage over other emergent species in river and tidal systems (Whigham et al. 1978).

Arrowhead leaves vary in size and shape with the species and depth of water.

Table 10. Habitat areas other than main channel and main-channel borders (Hagen et al. 1977).

Habitat Type	Area (acres)			Total	% Total
	Pool 11	Pool 12	Pool 13		
Open Water	9,920	5,473	11,993	27,386	43.0
Unvegetated	159	42	237	438	0.7
Submerged aquatic vegetation	1,855	506	1,332	3,693	5.8
Aquatic and moist soil vegetation	2,287	1,916	4,871	9,074	14.3
Herbaceous vegetation	471	308	986	1,765	2.8
Woodland vegetation	6,993	5,185	4,055	16,233	25.5
Agriculture	506	160	2,507	3,173	5.0
Developed	446	849	564	1,859	2.9
Total	22,637	14,439	26,545 ^a	63,621	100.0

^aDoes not include approximately 6,500 acres controlled by the Savanna Proving Grounds.

On a single plant, lower, submerged leaves are narrow and grasslike, with more ovate leaves developing near the surface. The emergent leaves are relatively stiff and more arrow-shaped. As water levels drop and more of the plant becomes emergent, the narrow ribbonlike leaves of the stem drop off and wider emergent ones develop. Two species found in Pools 11 to 13 vary in their emergent leaves, with a linear or elliptical blade present in S. rigida and a more variable arrow-shaped leaf in S. latifolia (Sculthorpe 1967).

Of the arrowhead species present in the Upper Mississippi River, S. latifolia is the most abundant, forming numerous monotypic beds along the margins of sloughs and edges of backwater lakes and ponds (Mohlenbrock 1983). Sagittaria rigida is a much less abundant species and

Mohlenbrock (1983) reports it occurring only as far south as Pool 8; Clark et al. (1983) found S. rigida as far south as Pool 13, but absent from Pool 19. It has been suggested that S. rigida is a shorter, less robust plant than S. latifolia, and that greater water depths, wave action, turbidity, and pollutant levels south of Pool 15 limit its distribution.

Clark et al. (1983) studied stands of S. latifolia and S. rigida from four sites in Pool 13, as well as other sites in Pools 19 and 20. Plant beds were sampled in Pool 13 at four sites: Lower Brown Lake, Upper Spring Lake, south of Cook Island, and the Elk River Delta. The stands of S. latifolia averaged about 4 acres in size, while S. rigida occurred in smaller patches, scattered more widely within other vegetation. However, the



Figure 18. Aquatic macrophytes common to the Upper Mississippi River: (a) Sagittaria, showing emergent leaves and flowers; (b) Scirpus, showing triangular stem; (c) Sparganium, with staminate flower clusters above pistillate flowers; (d) Phragmites, showing terminal flower cluster; (e) Nymphaea, showing deeply notched leaf; (f) Nelumbo, emergent or floating leaf with large yellow flower; (g) Myriophyllum, showing submergent and emergent leaves; (h) Ceratophyllum, with small hornlike projections on leaves (from Eckblad 1978).

plant density within stands was greater for S. rigida (146.5 stems/m²) than for S. latifolia (54.4 stems/m²).

The maximum standing-crop estimates reported for mature arrowhead beds of the Mississippi River range from about 400 to

1,000 g/m²/yr for aboveground vegetation (Sefton 1976; Eckblad et al. 1977; Rada et al. 1980; Clark et al. 1983). These are somewhat higher estimates than those reported for arrowheads of tidal wetlands (Whigham et al. 1978). It appears that overall net primary production of arrow-

Table 11. Surface areas of various habitat types for Pools 11-13.

Habitat	Area (Acres)				% Total
	Pool 11	Pool 12	Pool 13	Total	
Shoreline					
Urban	1,287	2,152	6,587	10,026	9.3
Trees (>20 ft tall)	9,017	6,495	13,965	29,477	24.3
Trees (<20 ft tall)	255	185	412	852	0.7
Salix/brush	2	10	537	549	0.4
Levee grass & brush	-	20	112	132	0.1
Cropland	1,167	907	7,050	9,124	7.5
Upland meadow	107	375	2,397	2,879	2.4
Sand/mud	75	30	40	145	0.1
Lowland meadow	72	210	1,687	1,969	1.6
Aquatic					
Emergent macrophytes					
<i>Polygonum</i> (smartweed)	12	5	202	219	0.2
<i>Phalaris</i> (reed canary grass)	150	37	90	277	0.2
<i>Scirpus fluviatilis</i> (bulrush)	37	12	707	756	0.6
<i>Typha</i> (cattail)	10	7	82	99	<0.1
<i>Sparganium</i> (bur reed)	-	-	25	25	<0.1
<i>Sagittaria</i> (arrowhead)	970	1,157	1,790	3,917	3.2
<i>Zizania</i> (wild rice)	5	2	5	12	<0.1
Misc. emergent macrophytes	37	197	632	866	0.7
Floating macrophytes					
<i>Nelumbo</i> (Am. lotus)	185	195	2,042	2,422	2.0
<i>Nymphaea</i> (water lily)	-	-	77	77	<0.1
Submergent macrophytes					
Misc. submergent species	3,810	1,900	1,920	7,630	6.3
Open water	15,890	9,570	24,272	49,732	41.0
Total	33,088	23,466	64,631	121,185	100.0

head beds of the Mississippi River, above- and belowground, is at least 600 g/m²/yr (Eckblad et al. 1977); this translates to an annual autochthonous input of about 2.67 tons/acre. *Sagittaria* annual net production, using area data from Table 11, would be an estimated 2,590 tons for Pool 11, 3,089 tons for Pool 12, 4,779 tons for Pool 13. These rates are well below those for some pools further north--for example, Pool 9 estimates would be 9,516 tons/yr--but the rates represent a significant portion of the total organic matter fixed within the pools.

Light penetration, wind exposure, and substrate characteristics are considered

factors limiting the water depth in which arrowheads occur (Sculthorpe 1967). It is also possible that germination may be inhibited via the phytochrome system when water exceeds a critical depth (Nobel 1983). Neither species of arrowhead from Pools 11 to 13 grew in water depths greater than 50-60 cm, and peak standing crops were recorded in August. Flowering also occurred in August, though *S. rigida* flowered several weeks earlier than *S. latifolia* (Clark et al. 1983). Arrowhead are known to undergo vegetative propagation through the formation of tubers (corms) in the fall (Sculthorpe 1967); in some cases it may be the usual form of reproduction. These underground tubers

mature in late fall, and the common name "duck potato" attests to the fact that they may be sought after by waterfowl. They have also been used by man for food (Baker 1978). Muskrats eat small portions of the plant but shred still more in cuttings for lodges (Weller 1981; Clay 1983), and a variety of insects are known to live in close association with arrowheads (Klots 1966).

The American lotus (Nelumbo lutea) is the dominant floating macrophyte in the backwaters of this reach of river, covering extensive areas especially in Pool 13. Its sometimes emergent and large saucerlike leaves can be several feet in diameter. The less common white waterlily (Nymphaea sp.) can be distinguished from the American lotus by its deeply notched leaves, somewhat purplish on the underside, and white flowers. The distinctive large yellow flowers of the American lotus give rise to a top-shaped receptacle, in which holes mark the location of seeds, which are popular in dried flower arrangements. The seeds can be an important source of food for waterfowl (GREAT II 1980d), and the tuberous rootstocks were used as food by Native Americans.

The submergent macrophytes of the backwater lakes and ponds of Pools 11 to

13 include wild celery, curly pondweed, milfoil, waterweed, and coontail. Stands of wild celery (Vallisneria americana) may form in quiet shallow waters, with their long ribbonlike leaves arising from creeping rootstocks. They are reported to provide good cover for small fish, and food to muskrats, fish, and birds (Fassett 1957). Curly pondweed (Potamogeton crispis), named for its distinctive leaf margins, is also used by a variety of aquatic forms for food and refuge (Berg 1949). Milfoil (Myriophyllum sp.) can form dense submersed beds in quiet waters and may either be rooted or free-floating. It is used as food by muskrats and its seeds are eaten by birds. Waterweed (Elodea canadensis) stems contain busy whorls of oval-shaped leaves and are well-known as aquarium plants. Coontail (Ceratophyllum demersum), also known as hornwort, has whorls on forked leaves, with marginal teeth or horns forming densely busy stem tips. This is one of the few genera without roots and it may be used for food by muskrats and birds (Fassett 1957). Although the overall surface area occupied by these and other submergent macrophytes was estimated as slightly greater than that for emergents (Table 11), their net primary productivity is probably less. Additional studies are needed to better estimate the primary productivity of the submerged and floating macrophytes of backwater ponds and lakes.

CHAPTER 4. PLANKTON

4.1 OVERVIEW

The presence of phytoplankton and zooplankton in large rivers is well-known and documented (Hynes 1970). This diverse assemblage, once referred to as the potamoplankton (Zacharias 1898), includes both autotrophs (i.e., phytoplankton) and heterotrophs (i.e., zooplankton), with the several trophic levels represented. The zooplankton are most often herbivores, but

in the Mississippi River system there are also a number of carnivorous taxa (e.g., cladocerans like Leptodora sp. and Polyphemus sp.). Some common planktonic forms are shown in Figure 19.

Centric diatoms (Chrysophyta) are often the dominant phytoplankton type in large rivers (Swale 1969), with small green algae (Chlorophyta) becoming more common in midsummer, especially in slower

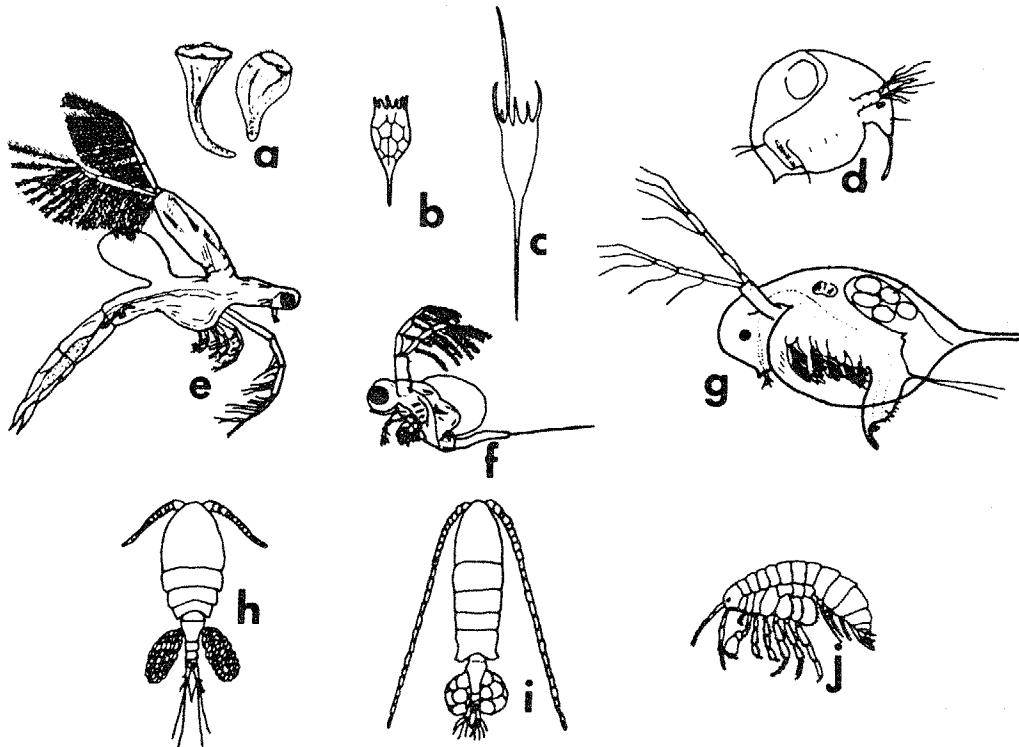

Figure 19. Zooplankton common to the Upper Mississippi River: (a) two forms of the protozoan ciliate Stentor; (b) the rotifer Keratella; (c) the rotifer Kellicottia; (d) the cladoceran Bosmina; (e) the cladoceran Leptodora; (f) the cladoceran Polyphemus; (g) the cladoceran Daphnia, showing brood pouch with parthenogenetic eggs; (h) a cyclopoid copepod with double egg sack; (i) a calanoid copepod with single egg sack; (j) the amphipod Hyalella (from Eckblad 1978).

reaches (Patrick et al. 1969; Lack 1971; Houghton 1972). Current velocity, substratum, temperature, turbidity, water chemistry, competition, and herbivory are limiting factors for river algae (Whitton 1975). These minute plants may constitute the major primary producers in river habitats (Hynes 1970); however, the data available are inadequate to answer this question directly for the Pool 11 to 13 reach of the Mississippi River.

River zooplankton usually develop best in the slower moving portions of the habitat (Winner 1975), where reduced current velocity and silt deposition and deeper water resemble characteristics of standing-water systems. Dominant taxa are often the polychaete rotifers and the microcrustaceans Cladocera and Copepoda. Cummins (1972) suggested that these organisms are able to compensate for their weak swimming ability by having high reproductive rates with short generation time adequate to replace populations that drift downstream. Many zooplankton are either phytoplanktonphagic or detritophagic, and serve as an important link between the primary producers and the macroinvertebrates and fishes (see Figure 11).

Studies dealing with the plankton of the Mississippi River and its major tributaries include Kofoid (1903, 1908) on the Illinois River; Purdy (1923) on the Ohio River; Berner (1951) on the Lower Missouri River; and Galtsoff (1924), Wiebe (1927), Reinhard (1931), Eddy (1934), and Dorris (1958) on the Upper Mississippi. These studies were reviewed by Schramm and Lewis (1974), who compiled a listing of phytoplankton (Table 12) and zooplankton (Table 13) abundant in the Mississippi River. They recognized that few rivers have the habitat diversity of the Mississippi River, and equal amounts of information were not available for each habitat type. Interpretations of their findings will be presented for habitats within the Pool 11 to 13 reach in the sections which follow.

4.2 MAIN CHANNEL

The review by Schramm and Lewis (1974) suggested that Chrysophyta are dominant in the phytoplankton for habitats

strongly under the influence of current, while Cyanophyta and Euglenophyta show reduced abundance and diversity. They found that the Rotifera were dominant zooplankters of the main channel, both in numbers and diversity. Cladocera were also abundant in the main channel, with copepods somewhat reduced in numbers and diversity. As noted by GREAT II (1980b), studies have not been conducted on the main channel plankton of the Pool 11 to 13 reach, but trends similar to those for phytoplankton probably exist.

4.3 MAIN CHANNEL BORDER

Compared to the main channel, phytoplankton of the channel border generally showed a somewhat reduced diversity, while Chrysophyta increased and Chlorophyta decreased in abundance (Schramm and Lewis 1974). Filamentous Cyanophyta greatly increase in the channel border, presumably due to decreased current and differences in substrate. Phytoplankton production in the main channel border was found to be lower than production in other habitats (Galtsoff 1924), although estimates were limited.

The channel border shows reduced numbers of Rotifera compared with the main channel (Schramm and Lewis 1974); Galtsoff (1924) found increased zooplankton numbers near bank areas but decreased abundance behind emergent rock dikes.

4.4 SIDE CHANNELS

Limited data from side channels do not warrant generalizations about the numbers or diversity of either phytoplankton or zooplankton from the Pool 11 to 13 reach. However, studies from other river reaches suggest the importance of side channels in the transport of plankton from backwater lakes and ponds to the main channel of the river. For example, Zacharias (1898), Fritsch (1905), Kofoid (1908), Purdy (1930), and Berner (1951) indicated that phytoplankton are transported from backwater habitats. More recent quantitative studies of the transport via side channels further document the importance of these running channels (see Chapter 8).

Table 12. Genera of phytoplankton abundant in samples from habitats of the Mississippi River (compiled by Schramm and Lewis 1974).^a

Taxon	Main channel	Channel border	Side channel	Backwater lakes/ponds
Cyanophyta				
<u>Microcystis</u>	+	+		+
<u>Aphanocapsa</u>	+	+		
<u>Anabaena</u>	+	+		+
<u>Coelosphaerium</u>	+	+		
<u>Merismopedia</u>	+			
<u>Lyngbya</u>	+	+		
<u>Clathrocystis</u>				+
<u>Aphanizomenon</u>				+
<u>Oscillatoria</u>				+
Chlorophyta				
<u>Pediastrum</u>	+	+		+
<u>Closterium</u>	+			+
<u>Eudorina</u>	+			+
<u>Scenedesmus</u>	+	+		+
<u>Pleolorina</u>	+			+
<u>Platydorina</u>	+			
<u>Pandorina</u>	+			+
<u>Dictyosphaerium</u>	+			
<u>Tetraspora</u>	+			
<u>Chlorella</u>	+	+		
<u>Volvox</u>				+
<u>Ulothrix</u>				+
<u>Spirogyra</u>				+
<u>Zygnema</u>				+
<u>Chaetophora</u>				+
<u>Cladophora</u>				+
Euglenophyta				
<u>Euglena</u>	+			+
<u>Phacus</u>	+			+
Chrysophyta				
<u>Asterionella</u>	+	+		
<u>Melosira</u>	+	+	+	+
<u>Synedra</u>	+	+	+	+
<u>Fragillaria</u>	+		+	+
<u>Stephanodiscus</u>	+	+		+
<u>Cyclotella</u>	+			+
<u>Diatoma</u>	+			
<u>Nitzschia</u>	+		+	
<u>Siurella</u>	+			
<u>Navicula</u>	+	+	+	
<u>Synura</u>	+	+		
<u>Pleurosigma</u>	+	+		
<u>Actinastrum</u>	+			+
<u>Cyrosigma</u>			+	

^a + = abundant in collections.

Table 13. Genera of zooplankton abundant in samples from habitats of the Mississippi River (compiled by Schramm and Lewis 1974).^a

Taxon	Main channel	Channel border	Backwater lakes/ponds
Protozoa			
<u>Ceratium</u>	+		+
<u>Peridinium</u>	+		
<u>Diffugia</u>	+		+
<u>Arcella</u>	+		+
<u>Codorella</u>	+		+
<u>Paramecium</u>	+		+
<u>Stentor</u>	+		+
<u>Vorticella</u>	+		
<u>Trachelomonas</u>			+
Rotifera			
<u>Keratella</u>	+	+	+
<u>Brachionus</u>	+		
<u>Polyarthra</u>	+	+	+
<u>Synchaeta</u>	+	+	
<u>Filinia</u>	+		+
<u>Pedalia</u>	+		+
<u>Noteus</u>		+	+
<u>Triarthra</u>		+	+
<u>Asplanchna</u>			+
<u>Lecane</u>			+
<u>Euchlanis</u>			+
<u>Rattulus</u>			+
Cladocera			
<u>Bosmina</u>	+	+	+
<u>Chydorus</u>	+	+	+
<u>Diaphanosoma</u>	+		
<u>Daphnia</u>	+		+
<u>Simocephalus</u>		+	
<u>Leptodora</u>	+		+
<u>Sida</u>			+
<u>Moina</u>			+
Copepoda			
<u>Cyclops</u>	+	+	+
<u>Diaptomus</u>			+

^a + = abundant in collections.

4.5 BACKWATER LAKES AND SLOUGHS

Schramm and Lewis (1974) noted that both phytoplankton and zooplankton populations are usually more abundant in backwater lakes and ponds, and production is also highest in these habitats (Galtsoff 1924). Relative numbers suggest that Chlorophyta and Cyanophyta are more dominant in the phytoplankton of backwaters, although their diversities may be lower than in the main channel. A number of filamentous green algae (e.g., Zygnema, Ulothrix, Spirogyra, and Cladophora) are typical in the standing waters of backwater lakes and ponds. The filamentous

blue-green Aphanizomenon can develop blooms in backwaters, and their small grasslike form is visible without any magnification.

The zooplankton are also usually more abundant in the backwaters than in the main channel, although the Rotifera are often reduced in numbers. Protozoans, cladocerans, and copepods show increased abundance and diversity in backwater lakes and ponds, and studies in Pools 19 and 20 suggest that plankton diversity is related to habitat diversity (Jahn and Anderson, in press).

CHAPTER 5. MACROINVERTEBRATES

5.1 OVERVIEW

The macroinvertebrates constitute a diverse assemblage of organisms, often playing a key role in the transfer of matter and energy to higher trophic levels (see Figure 11). Some macroinvertebrates exist well away from bottom substrates (e.g., many chironomids, amphipods, and oligochaetes), but most are properly classified as benthic organisms. Cummins (1975) has suggested that macroinvertebrates of rivers function as temporary storage bins for organic compounds, which are eventually all converted to carbon dioxide; their distribution and abundance are usually influenced by current velocity, substrate particle size, predation, and access to food. Other investigators have also identified turbidity, water-level fluctuations, depth, and dissolved oxygen as major factors affecting the benthos of large rivers (Richardson 1921; Forbes 1928; Ellis 1936; Lyman 1943; Barnickol and Starret 1951; Berner 1951; Mikulski 1961).

The relationship between sediment particle size and different current regimes has been recognized in erosional and depositional habitats (Moon 1939). In rapidly flowing waters (erosional habitats) all but the more coarse substrates are washed away, while in areas of reduced current (depositional habitats) finer sediments are deposited. Macroinvertebrates usually show adaptations for living in specific habitat types: for example, fauna from erosional habitats often have adaptations for attachment, clinging, or avoidance of current (Vogel 1981; Koehl 1984). Fauna from depositional habitats, on the other hand, are variously adapted for sprawling, climbing, or burrowing, and often have mechanisms to prevent fouling of respiratory surfaces,

such as the currents generated by the tracheal gills of *Hexagenia* sp. mayflies, which keep well-oxygenated water moving through their burrows. The main channel reaches are most often erosional habitats, backwater lakes and ponds are primarily depositional habitats, and channel borders or side channels may be intermediate between these two habitat types.

Most macroinvertebrates are non-selective feeders (Hynes 1970; Cummins 1975), usually taking a wide range of food items of acceptable size. Several feeding patterns can usually be identified for benthic organisms as shown in Table 14. In addition, the feeding activity of one organism may embrace several trophic types, as illustrated by some chironomid species which engage in browsing, suspension feeding, and deposit feeding (Monakov 1972; Cummins 1973).

Fisher (1982) suggested that an organism's mobility and normal position can be used in defining its life habitat (Table 15). Benthic macroinvertebrates are mobile, sedentary, or attached, or epifaunal (most active at or on the sediment-water interface) or infaunal (most active below the interface). Sediment characteristics will influence the suitability of various habitats for these organisms and, likewise, their presence may influence the reworking of sediments, especially in backwater lakes and ponds. Shallow infaunal suspension feeders, such as sphaeriid clams, affect only the upper 1-3 cm of sediment. Infaunal subsurface deposit feeders, such as tubificid oligochaetes, and deeper infaunal mobile suspension feeders, such as unionid clams, are capable of thoroughly mixing sediments within their life zones (McCall et al. 1979).

Table 14. Classification of feeding types in macroinvertebrates of the Upper Mississippi River (modified from Walker and Bambach 1974).

Trophic type	Description	Examples
Suspension feeding	Remove fine particulate organic matter (FPOM) from suspension in water mass without the need to dismember particles; detritivore collectors	Bivalves, sphaeriid bivalves
Deposit feeding	Remove FPOM from sediment either selectively or non-selectively without the need to dismember particles; detritivore collectors	Oligochaetes, amphipods, burrowing mayflies, chironomids
Browsing	Acquire food by scraping plant material from surfaces or by chewing or rasping aquatic macrophytes; shredders and scrapers and detritivore collectors	Gastropods, chironomids, net-building caddisflies, crayfish
Carnivory	Active capture of living animals	Leeches, chironomids, odonates
Scavenging	Consume coarse particulate organic matter (CPOM) from dead organisms	Leeches, chironomids, crayfish
Parasitism	Obtain nutrition from the fluids or tissues of host organisms	Leeches

Mussel populations have been studied in portions of Pools 11 to 13 (van der Schalie and van der Schalie 1950; Ackerman 1976a, 1976b; Fuller 1978; Cawley 1978a; Perry 1979; Ecological Analysts, Inc. 1981; Thiel 1981). Several general macroinvertebrate surveys have also been conducted (Cawley 1978b; Hubert et al. 1983), but the need for additional surveys for this reach of river has been noted (GREAT II 1980b). Some of the dominant macroinvertebrate fauna of specific habitats will be discussed in following sections. Benthic macroinvertebrates common to this reach of river are shown Figure 20.

5.2 MAIN CHANNEL

Though they are also common in other habitat types, freshwater bivalves or mussels are probably the best-known group of macroinvertebrates in the main channel. Twenty-five species of mussel have been reported for the Pool 11 to 13 reach of river (Table 16). The five most abundant species accounted for almost 70% and the 10 most abundance species accounted for almost 90% of the mussels collected during 1977 and 1978 surveys (Fuller 1978; Cawley 1978a). The study by Cawley involved intensive sampling over a limited area in Pool 12 (in the vicinity of RM 581.5),

Table 15. Trophic type and life habitat of dominant macroinvertebrates of the Upper Mississippi River (modified from Fisher 1982).

Taxon	Length scale (cm)	Typical population density (m ⁻²)	Primary trophic type	Mobility	Activity zone
Annelida					
Oligochaeta	1-10	10-10 ⁵	Subsurface deposit feeding	Sedentary (can be mobile)	Infaunal
Hirudinea	1-30	1-10 ²	Multiple trophic types	Mobile	Epifaunal
Arthropoda					
Amphipoda	0.5-1	10-10 ³	Surface deposit feeding	Mobile	Epifaunal
Decapoda	5-20	1-10 ²	Multiple trophic types	Mobile	Epifaunal
Ephemeroidea	1-4	10-10 ³	Subsurface deposit feeding	Sedentary (can be mobile)	Infaunal
Hydropsychidae	0.5-2	10-10 ⁴	Surface browsing	Sedentary (can be mobile)	Epifaunal
Chironomidae	1-2	10-10 ⁴	Multiple trophic types	Sedentary (can be mobile)	Infaunal
Odonata	1-10	1-10	Carnivore	Mobile	Epifaunal
Mollusca					
Sphaeriidae	0.5-1.5	10-10 ³	Suspension feeding	Sedentary (can be mobile)	Infaunal
Unionidae	3-20	1-10 ²	Suspension feeding	Sedentary (can be mobile)	Infaunal

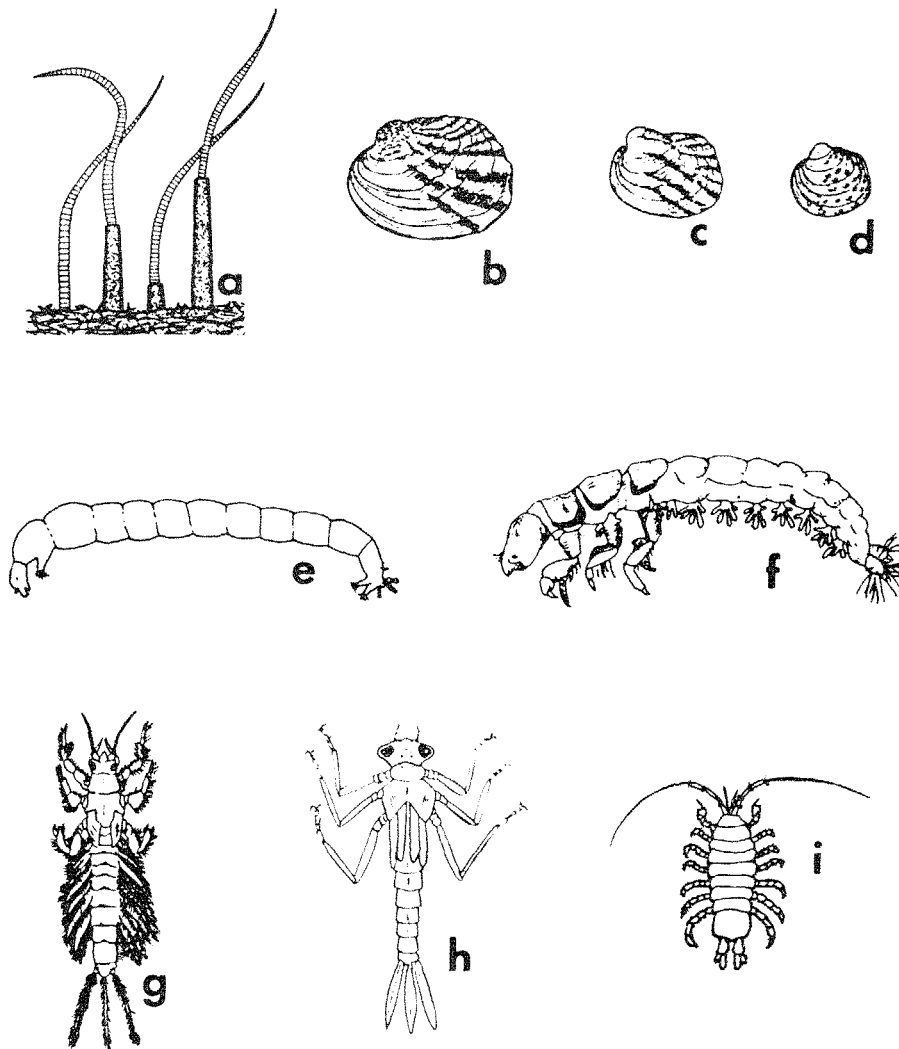

Figure 20. Benthic macroinvertebrates common to the Upper Mississippi River: (a) *Tubifex* sp., a segmented worm; (b) a wash-board mussel, *Megaloniais gigantea*; (c) three-ridge mussel, *Amblema plicata*; (d) a pimple-back mussel, *Quadrula pustulosa*; (e) midge larvae, Chironomidae; (f) caddisfly larvae, Hydroptychidae; (g) burrowing nymph of the mayfly *Hexagenia*; (h) damselfly nymph; (i) aquatic isopod, *Asellus* (from Eckblad 1978).

while Fuller sampled less from more sites in Pools 11 and 13. Both studies showed similar trends for the most abundant species (Table 16). The endangered *Lampsilis higginsii* has been reported in this reach of river (Havlik 1980).

Studies during the winter showed relatively few macroinvertebrates in

the main channel in Pool 12 during the time of ice cover (Cawley 1978a). Extensive sampling from Pool 13 by Hubert et al. (1983) during February and March revealed 20 macroinvertebrate taxa from the main channel (Table 17). Fewer taxa were present in main-channel samples than in samples from other river habitats; oligochaetes were most

Table 16. Mussels sampled from Pools 11 and 13 during 1977 (Fuller 1978), and from Pool 12 during 1978 (Cawley 1978a).

Mussel species	Pool 11	Pool 12	Pool 13	Totals	Percentage
<i>Quadrula quadrula</i>	14	82	27	123	6.6
<i>Q. nodulata</i>	5	3	5	13	0.7
<i>Q. pustulosa</i>	16	58	38	112	6.0
<i>Tritogonia verrocosa</i>		1		1	0.1
<i>Fusconaia flava</i>	25	154	18	197	10.6
<i>Megalonaia gigantea</i>	29	55	8	92	4.9
<i>Amblyma plicata</i>	227	421	87	735	39.5
<i>Elliptio dilatata</i>	19			19	1.0
<i>Obliquaria reflexa</i>	13	51	22	86	4.6
<i>Proptera alata</i>	4	3	5	12	0.6
<i>P. laevissima</i>	1	8	4	13	0.7
<i>Leptodea fragilis</i>	1	12	32	45	2.4
<i>Ellipsaria lineolata</i>	2	11	11	24	1.3
<i>Truncilia truncata</i>	2	58	6	96	5.1
<i>T. donaciformis</i>	6	15	103	124	6.7
<i>Obovaria olivaria</i>	4	18	42	64	3.4
<i>Ligumia recta</i>		2	2	4	0.2
<i>Carunculina parva</i>	3		1	4	0.2
<i>Lampsilis higginsi</i>		3		3	0.1
<i>L. ovata ventricosa</i>	4	22	13	39	2.1
<i>Arcidens confragosus</i>	4	6	6	16	0.9
<i>Lasmigona complanata</i>	1		1	2	0.1
<i>Anodonta imbecillis</i>	3	3		6	0.3
<i>A. grandis</i>	12	10	5	27	1.4
<i>Strophitus undulatus</i>	5		2	7	0.4
Number of individuals	404	994	464	1,862	100.0
Number of species	22	21	21	25	

abundant, followed by chironomids. Both winter studies showed a strong relationship between benthic fauna and the substrates, with sand substrate having the lowest numbers and lowest diversity.

5.3 MAIN CHANNEL BORDER

Hall (1980) studied the macroinvertebrates adjacent to and on wing dams in Pool 13 (Figure 21). His 52 taxa taken with a Ponar grab and 33 taxa recorded from artificial substrates probably make up the most complete listing of benthos for this reach of river (Table 18). He found that *Oligochaeta* comprised 51% of the density and *Hexagenia* sp. made up 64%

of the biomass for benthos collected with a Ponar grab. Hydropsychid caddisflies dominated samples from artificial substrates placed on wing dams, as was also shown by Eckblad (1981) and by Seegert et al. (1984). Hall (1980) also found that benthic density, biomass, and number of taxa were greater upstream from wing dams than downstream; this corresponded to greater percentages of silt-clay substrates upstream.

Overall, Hall (1980) determined that the substrate percent of silt-clay was positively related to total density, biomass, and diversity of benthic invertebrates, oligochaetes, *Hexagenia* sp., and chironomids. Wing dams with sandy

Table 17. Most abundant macroinvertebrate taxa, February-March 1983, with mean number per Peterson grab sample from different habitats within Pool 13 (adapted from Hubert et al. 1983).

Taxon	Main channel	Main channel border	Side channel	Slough ^a	Backwater lake ^a
Nematoda	14.83	19.68	16.76	176.48	42.05
Oligochaeta	94.39	165.77	138.40	482.87	185.08
Ostracoda	0	0.58	15.09	23.21	71.53
<u>Hexagenia</u>	0.06	13.05	21.32	37.10	6.06
<u>Cheumatopsyche</u>	5.15	0.42	0	0.66	0
<u>Potamyia</u>	3.33	0.45	0	0.66	0
Ceratopogonidae	0.72	8.26	54.54	59.43	77.62
Chironomidae	15.31	461.26	94.42	70.68	243.45
<u>Sphaerium</u>	4.94	0	3.97	4.81	27.23
No. of taxa	20	19	13	15	13
No. per sample for all taxa	144.87	671.51	353.06	861.57	660.89

^aThese two habitats, both of which show little current, have been considered as backwater lakes and ponds throughout this report.

substrates (e.g., No. 28 shown in Figure 21) had lower benthic density, biomass, and diversity. Rock substrates (i.e., rocks within wire baskets) had 14.3 times as many macroinvertebrates and 14.3 times as much mean biomass as equivalent areas sampled with a Ponar grab. These "islands of rock in a sea of sand" represent erosional habitats, while Ponar grab samples were taken from depositional habitats.

Hubert et al. (1983) found that the abundance of macroinvertebrates in the channel border was second only to that of sloughs, with chironomids being most abundant (Table 17). They did not sample from wing dams and as a result they obtained very few caddisflies (i.e., Cheumatopsyche and Potamyia).

5.4 SIDE CHANNELS

One of the best-studied side channels of the Pool 11 to 13 reach is Cassville Slough in Pool 11. This side channel extends about 6.5 mi from a spillway over Dam 10 to near Cassville, WI. A relatively large side channel with a sand and silt substrate, it supported a mussel fishery prior to the late 1930's (Ackerman 1977). Sampling during 1977 noted the presence of 13 species of mussel plus 10 other taxa of macroinvertebrates. The hickory nut (Obovaria olivaria), three-ridge (Amblema pliocata), and pig toe (Fusconaia flava) made up over 53% of the mussels, while burrowing mayflies (Hexagenia) and chironomids (Chironomidae) accounted for 95% of the other macroinvertebrates (Ackerman 1977).

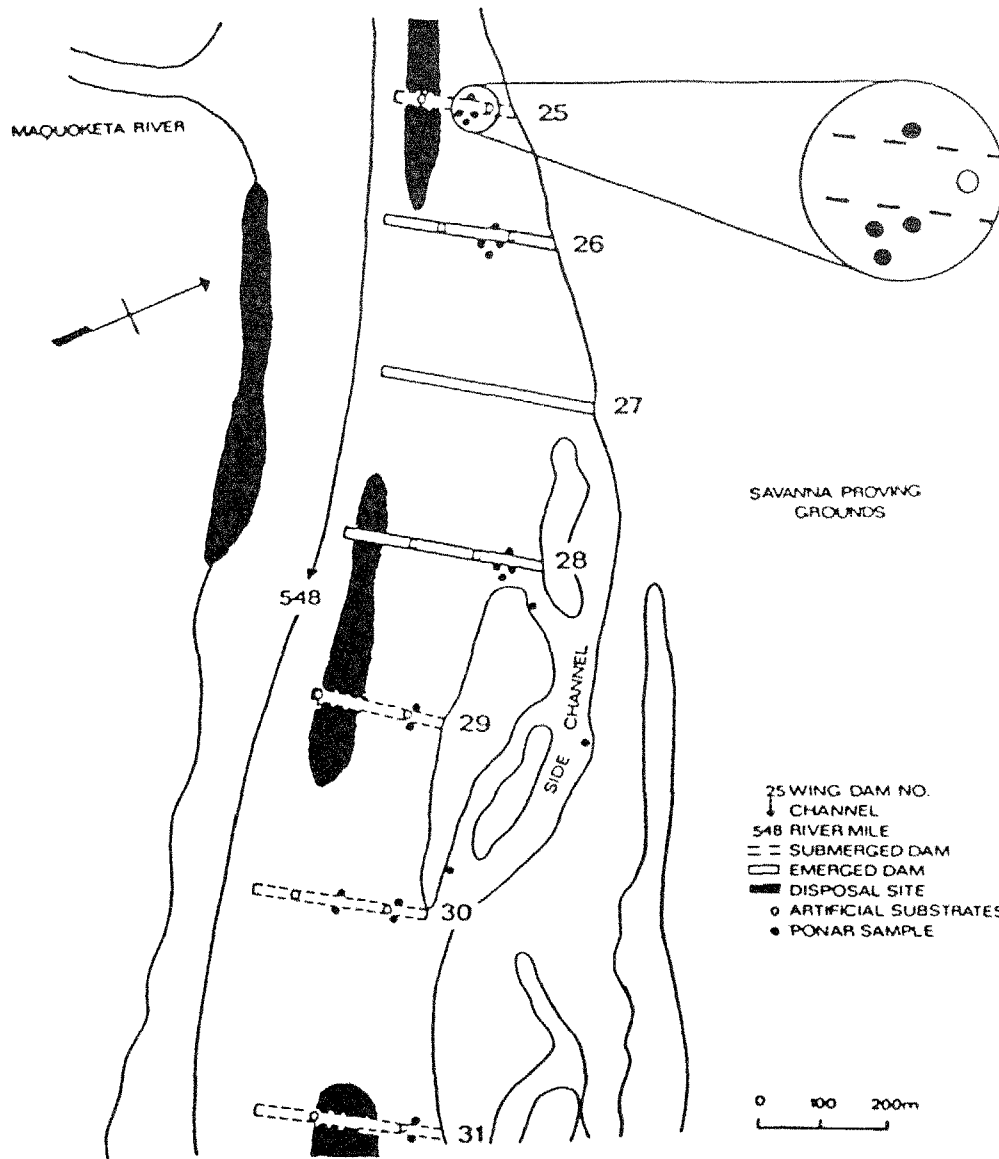

Figure 21. Wing dam study sites in Pool 13, 8 mi south of Bellevue, IA (after Hall 1980).

5.5 BACKWATER LAKES AND SLOUGHS

A number of studies have found that *Oligochaeta*, *Hexagenia*, Chironomidae, and *Sphaerium* are four taxa very common in backwater habitats. These taxa made up about 69% of the macroinvertebrates sampled in Pool 13 backwaters (Table 17). The relative number of benthos in backwaters support the general impression that

these can be the most productive habitats on the Upper Mississippi River.

The oligochaetes of backwaters are usually subsurface deposit feeders that derive most of their nutrition from bacteria and ingest large volumes of sediment in order to extract the small fraction of nutrient material present. Interspecific competition is avoided by selective digestion of the bacteria within the

Table 18. Macroinvertebrate taxa collected with Ponar grab and artificial substrates from Pool 13 in 1978 and 1979 (data from Hall 1980).^a

Taxon	Ponar grab	Artificial substrates
Platyhelminthes		
Turbellaria	x	x
Tricladida	x	x
Nematoda	x	
Annelida		
Oligochaeta	x	x
Hirudinea		
Glossiphoniidae	x	
Helobdella sp.	x	
Placobdella sp.	x	x
Arthropoda		
Crustacea		
Asellus sp.	x	x
Gammarus sp.		x
Hyalolella azteca	x	x
Arachnoidea		
Hydracarina	x	
Insecta		
Plecoptera		
Perlesta placida	x	
Ephemeroptera		
Baetis sp.	x	x
Baetisca sp.	x	
Brachycercus sp.	x	x
Caenis sp.	x	x
Hexagenia spp.	x	x
H. bilineata	x	
H. limbata	x	
Stenacron sp.		x
Stenonema sp.	x	x
Paraleptophlebia sp.	x	
Ephoron album	x	
Odonata		
Dromogomphus sp.	x	
Gomphus sp.	x	x
Ophiogomphus sp.	x	
Pantala sp.		x
Anomalagrion hastatum	x	
Argia sp.		x
Ischnura sp.		x

(continued)

Table 18. (Concluded).

Taxon	Ponar grab	Artificial substrates
Hemiptera		
Neoplea striola		x
Megaloptera		
Sialis sp.	x	x
Trichoptera		
Hydropsychidae (misc.)	x	x
Cheumatopsyche sp.	x	x
Hydropsyche sp.	x	x
H. orris	x	x
Potamyia flava	x	x
Oecetis sp.	x	x
Neureclipsis sp.	x	x
Lepidoptera		
Acentropus sp.	x	
Coleoptera		
Elmidae (misc.)		x
Dubiraphia sp.	x	
Stenelmis sp.	x	x
Diptera		
Ceratopogoniidae	x	x
Chironomidae	x	x
Culicidae	x	
Chaoborus sp.	x	x
Empididae	x	
Muscidae	x	
Stratiomyidae	x	
Mollusca		
Gastropoda		
Lymnaea sp.	x	
Physa sp.		x
Pelecypoda		
Corbicula manilensis	x	
Pisidium sp.	x	
Sphaerium sp.	x	
Fusconaia flava	x	
Lasmigona compressa	x	
Leptodea fragilis	x	x
Obliquaria reflexa	x	
Obovaria olivaria	x	
Number of taxa	52	33

^ax = present.

sediment, which leads to a degree of collaboration as the feces of one species can be the preferred food for another (Brinkhurst 1972). Many species are able to withstand low oxygen levels and may become the dominant benthic taxa in near-anaerobic backwaters (Brinkhurst and Cook 1974).

The burrowing mayfly Hexagenia is a deposit feeder whose distribution and abundance are influenced by dissolved oxygen and substrate particle size (Paloumpis and Starret 1960; Swanson 1967; Fremling 1970). Data from Pool 13 suggested a positive correlation between Hexagenia numbers and small substrate particle size (Hubert et al. 1983). These benthic insect nymphs can be important in the diet of Mississippi River fishes (Hoopes 1960); pools with the highest Hexagenia densities, namely Pools 9 and 19 (Carlson 1968; Eckblad et al. 1977), also support higher fish populations.

The midge larvae, family Chironomidae, are found in almost all habitats of the Mississippi River: in soft sediments,

in leaves and stems of plants, on rocks or in decaying wood, in algal mats, and parasitic on other insects. The complete range of feeding habits is present in this family. Most members of the subfamily Tanypodinae are predaceous on each other, other midge larvae, crustaceans, and small worms. Many species are leaf miners on Potamogeton and waterlilies. Many in the subfamilies Orthoclaadiinae and Chironomidae feed primarily on diatoms and other algae.

Fingernail clams (Sphaerium) can be very abundant in the benthos of backwater lakes. They are hermaphroditic, and a single individual may be enough to extend a species distribution. Some have suggested that certain species (e.g., Sphaerium transversum) are tolerant of organic pollution (Fuller 1974), but there is real concern that in some reaches of the river, fingernail clam populations have been drastically reduced in recent years. For example, changes in species composition and abundance of fingernail clams have been reported for Pool 19 (Jahn and Anderson, in press).

CHAPTER 6. FISH

6.1 OVERVIEW

The fish of the Mississippi River are a diverse group of cold-blooded vertebrates. With the exception of the lampreys, they all have jaws, paired fins, and usually additional unpaired fins. The fish have a sense of touch, sight, smell, taste, and hearing. Some are able to make sounds by vibrating their air bladders or grinding their teeth. The skin of fish is slimy and usually covered with overlapping scales, a combination that waterproofs their body and reduces friction as they move through the aquatic medium. Lampreys and catfish are "naked" or lacking in scales; paddlefish and carp are partially so, having scales or prickles in some areas only; eels and burbot appear to be without scales but actually have small, deeply embedded scales. The feeding habits of Mississippi River fish are equally diverse: the fish are parasites (the lampreys), plankton feeders, benthos feed-

ers, vegetation feeders, and feeders on fish or other vertebrates.

Distribution and relative abundance are more completely known for Upper Mississippi River fish than for most other faunal groups. Of the 147 fish species documented to occur in the river, 66 are considered common to abundant in certain portions of the river (Van Vooren 1983). Population dynamics, energetics, and certain other characteristics needed to describe the ecology of these fish require further study.

Ninety-six fish species are reported for the Pool 11 to 13 reach of river (Table 19): 6 species are considered abundant, 31 are considered common, and 14 are considered rare in one or more of these three pools. These species occupy several trophic levels in the general model presented in Chapter 1 (Figure 11). Some fish species feed primarily on plank-

Table 19. Relative abundance^a of fish of Pools 11 to 13 (after Van Vooren 1983).

Species	Pool 11	Pool 12	Pool 13
Chestnut lamprey (<i>Ichthyomyzon castaneus</i>)	U	U	U
Silver lamprey (<i>I. unicuspis</i>)	O	O	O
Lake sturgeon (<i>Acipenser fulvescens</i>)	R		R
Shovelnose sturgeon (<i>Scaphirhynchus platyrhynchus</i>)	O	O	O
Paddlefish (<i>Polyodon spathula</i>)	O	O	O
Longnose gar (<i>Lepisosteus osseus</i>)	C	C	C
Shortnose gar (<i>L. platostomus</i>)	C	C	C
Bowfin (<i>Amia calva</i>)	C	C	C
American eel (<i>Anguilla rostrata</i>)	U	U	U
Skipjack herring (<i>Alosa chrysochloris</i>)			H
Gizzard shad (<i>Dorosoma cepedianum</i>)	A	A	A
Goldeye (<i>Hiodon alosoides</i>)	H	R	H

(continued)

Table 19. (Continued).

Species	Pool 11	Pool 12	Pool 13
Mooneye (<i>H. tergisus</i>)	C	C	C
Rainbow trout (<i>Salmo gairdneri</i>)	X		X
Brown trout (<i>S. trutta</i>)	X		
Brook trout (<i>Salvelinus fontinalis</i>)	X		X
Mudminnow (<i>Umbra limi</i>)			X
Northern pike (<i>Esox lucius</i>)	C	C	C
Central stoneroller (<i>Campostoma anomalum</i>)	X		
Common carp (<i>Cyprinus carpio</i>)	A	A	A
Goldfish (<i>Carrassius auratus</i>)	X		
Mississippi silvery minnow (<i>Hybognathus nuchalis</i>)	U	U	U
Speckled chub (<i>Hybopsis aestivalis</i>)	C	C	C
Silver chub (<i>H. storeriana</i>)	C	C	C
Golden shiner (<i>Notemigonus crysoleucas</i>)	O	O	O
Pallid shiner (<i>Notropis amnis</i>)	H		R
Emerald shiner (<i>N. atherinoides</i>)	A	A	A
River shiner (<i>N. blennioides</i>)	A	A	A
Ghost shiner (<i>N. buechanani</i>)	R	R	R
Common shiner (<i>N. cornutus</i>)	H		R
Bigmouth shiner (<i>N. dorsalis</i>)	O	O	O
Pugnose minnow (<i>N. emiliae</i>)	O	O	O
Spottail shiner (<i>N. hudsonius</i>)	C	C	C
Rosyface shiner (<i>N. rubellus</i>)	R		
Spotfin shiner (<i>N. spilopterus</i>)	C	C	C
Sand shiner (<i>N. stramineus</i>)	O	O	O
Weed shiner (<i>N. texanus</i>)	U	U	
Mimic shiner (<i>N. volucellus</i>)	H		
Suckermouth minnow (<i>Phenacobius mirabilis</i>)	U		U
Southern redbelly dace (<i>Phoxinus erythrogaster</i>)	X		
Bluntnose minnow (<i>Pimephales notatus</i>)	O	O	O
Fathead minnow (<i>P. promelas</i>)	U	U	U
Bullhead minnow (<i>P. vigilax</i>)	A	A	A
Creek chub (<i>Semotilus atromaculatus</i>)	H		
River carpsucker (<i>Carpionodes carpio</i>)	C	C	C
Quillback (<i>C. cyprinus</i>)	C	C	C
Highfin carpsucker (<i>C. velifer</i>)	O	O	O
White sucker (<i>Catostomus commersoni</i>)	X	X	X
Blue sucker (<i>Cycleptus elongatus</i>)	U		O
Northern hog sucker (<i>Hypentelium nigricans</i>)	R	R	
Smallmouth buffalo (<i>Ictiobus bubalus</i>)	C	C	C
Bigmouth buffalo (<i>I. cyprinellus</i>)	C	C	C
Black buffalo (<i>I. niger</i>)	R	R	R
Spotted sucker (<i>Minytrema melanops</i>)	C	O	O
Silver redhorse (<i>Moxostoma anisurum</i>)	U	R	U
River redhorse (<i>M. carinatum</i>)	R		R
Golden redhorse (<i>M. erythrurum</i>)	U	U	U
Shorthead redhorse (<i>M. macrolepidotum</i>)	C	C	C
Greater redhorse (<i>M. valenciennesi</i>)	R		
Blue catfish (<i>Ictalurus furcatus</i>)			H
Black bullhead (<i>I. melas</i>)	O	O	O
Yellow bullhead (<i>I. natalis</i>)	O	O	U
Brown bullhead (<i>I. nebulosus</i>)	O		R
Channel catfish (<i>I. punctatus</i>)	C	C	C

(continued)

Table 19. (Concluded).

Species	Pool 11	Pool 12	Pool 13
Stonecat (<i>Noturus flavus</i>)	U	U	U
Tadpole madtom (<i>N. gyrinus</i>)	U	U	U
Flathead catfish (<i>Pylodictus olivaris</i>)	C	C	C
Pirate perch (<i>Aphredoderus sayanus</i>)	H		
Trout-perch (<i>Percopsis omiscomaycus</i>)	O		U
Burbot (<i>Lota lota</i>)	R		
Brook silverside (<i>Labidesthes sicculus</i>)	C	C	C
White bass (<i>Morone chrysops</i>)	C	C	C
Yellow bass (<i>M. mississippiensis</i>)	O	U	U
Rock bass (<i>Ambloplites rupestris</i>)	C	R	R
Green sunfish (<i>Lepomis cyanaellus</i>)	O	O	O
Pumpkinseed (<i>L. gibbosus</i>)	C	C	C
Warmouth (<i>L. gulosus</i>)	U	O	U
Orangespotted sunfish (<i>L. humilis</i>)	C	C	C
Bluegill (<i>L. macrochirus</i>)	A	A	A
Smallmouth bass (<i>Micropterus dolomieu</i>)	O	U	U
Largemouth bass (<i>M. salmoides</i>)	C	C	C
White crappie (<i>Pomoxis annularis</i>)	C	C	C
Black crappie (<i>P. nigromaculatus</i>)	C	C	C
Crystal darter (<i>Ammocrypta asprella</i>)	H		
Western sand darter (<i>A. clara</i>)	O	O	O
Mud darter (<i>Etheostoma asprigene</i>)	H		O
Fantail darter (<i>E. flabellare</i>)	H		
Johnny darter (<i>E. nigrum</i>)	U	U	U
Banded darter (<i>E. zonale</i>)	X		
Yellow perch (<i>Perca flavescens</i>)	C	O	O
Logperch (<i>Percina caprodes</i>)	C	C	C
Slenderhead darter (<i>P. phoxocephala</i>)	H		
River darter (<i>P. shumardi</i>)	C	C	C
Sauger (<i>Stizostedion canadense</i>)	C	C	C
Walleye (<i>S. vitreum</i>)	C	C	C
Freshwater drum (<i>Aplodinotus grunniens</i>)	C	C	C

^aKey to symbols:

- X - Probably occurs in the pool only as a stray from a tributary water.
- H - Records of occurrence are available for this pool, but the species has not been recorded in the last 10 years.
- R - Considered to be rare in this pool.
- U - Uncommon; does not usually appear in sample collections; populations are small.
- O - Occasionally collected; not generally distributed; local concentrations may occur.
- C - Commonly taken in most sample collections throughout the pool.
- A - Abundantly taken in all river surveys.

ton, some feed primarily on benthic organisms, some feed on both benthos and fish, and others feed primarily on other fish (Table 20). Many of the fish of commercial or sport value are benthic feeders

and consumers of other fish. The fish that rely on benthos as a food source are indirectly dependent on zooplankton, phytoplankton, and macrophytic vegetation. The fish preyed upon by predatory fish may

Table 20. Feeding relationships of some fish of Pools 11 to 13 (after Schramm and Lewis 1974).

Feeding habit
Primarily on plankton
Gizzard shad
Golden shiner
Bullhead minnow
Bluntnose minnow
Mississippi silvery minnow
Paddlefish
Primarily on benthos
Mooneye
Bigmouth buffalo
Smallmouth buffalo
River carpsucker
Silver chub
Brook silverside
Freshwater drum
Yellow bullhead
Orangespotted sunfish
Bluegill
Shovelnose sturgeon
Benthos and fish
American eel
Channel catfish
White bass
Green sunfish
Warmouth
Black crappie
White crappie
Primarily on fish
Bowfin
Longnose gar
Shortnose gar
Flathead catfish
Largemouth bass
Skipjack herring
Walleye
Sauger

themselves have fed upon benthos, phytoplankton, or zooplankton. In addition, almost all fish feed on plankton for at least a brief period during their early developmental stages. It was pointed out long ago that the plankton supply is a good index of the food supply for young fish (Forbes and Richardson 1913).

Monthly sampling from Pools 12 and 13 with a 230-volt AC shocker provides comparative data on habitat use by fish (Table 21). Although there was some variability between months, more fish were taken from the backwater lakes and sloughs than from other habitats. Bluegills, black crappie, white crappie, and largemouth bass were more abundant in the backwater lake and slough habitat. Smallmouth buffalo were most abundant for the channel border habitat, and gizzard shad and carp were abundant from all four habitats. Overall, fish diversity was very similar between habitats.

Backwater lakes and sloughs had 25 species that were also present in tailwaters, while channel borders had 20 species that were also present in side channels (Table 22). Total fish abundances in each of the four habitats were used to calculate a community similarity, and the tailwater and side channel habitats had the greatest similarity in fish communities. The lowest similarity was found between the fish community of the channel border and backwater lakes and sloughs.

The carp, smallmouth buffalo, and freshwater drum were among the most abundant fish in the habitats sampled by Bertrand and Miller (1973): these three species are also important to the commercial catch within Pools 11 to 13 (Table 23). In 1979, Pool 13 ranked first in commercial fish harvest within the Rock Island District of the Upper Mississippi River. Most of the 13 fish taxa important to the commercial catch were also found to be relatively common by Bertrand and Miller (1973). Finding these same taxa in diverse habitats suggests that they are making use of the entire river system, with time of year, water level, and fish age influencing habitat preference to some degree.

Table 21. Total number of fish collected per hour from different habitat types of Pools 12 and 13 during 1972 (data from Bertrand and Miller 1973).

Month/ parameter	Tailwater (main channel)	Main channel border	Side channel ^a	Backwater lake and slough ^a
<u>Month</u>				
April				38
May	32		4	34
June	166	176	51	188
July	218	98	88	248
August	70	124	104	142
September	67	72	93	225
October	125	96	89	95
November	36	110		144
<u>Parameter</u>				
Means	102	112.7	71.5	139.2
Number of taxa	28	24	24	29
Simpson's index of diversity ^b	0.908	0.886	0.896	0.895

^aNumbers based upon the mean of samples from two sites.

^bThis diversity measure considers the number of individuals in each species (n_i) and the total number of individuals (N) as shown below:

$$\text{Simpson's Diversity} = 1 - \frac{n_i(n_i - 1)}{N(N - 1)}$$

Simpson (1949) showed that if two individuals are taken at random from a community, the probability that the two will belong to the same species is $1 - \text{Simpson's Diversity}$. Hurlburt (1971) reviewed diversity indices and concluded that Simpson's Diversity was the most biologically meaningful, because it refers to the probability of an inter-specific encounter.

Fishery studies conducted in the Pool 11 to 13 reach of river include those dealing with the effectiveness of different sampling gear (Starrett and Barnickol 1955; Dunham 1970; Helms 1974; Pitlo 1981; Pierce et al. 1981; Rasmussen 1984; Stang and Millar 1984), movement

patterns of various species (Gengerke 1977; Southall 1982; Hurley et al. 1983; Stang and Nickum 1983), and their fecundity and survival rates (Helms 1974; Gengerke 1977; Goeman 1983). There have been very few studies on nongame species or on the feeding habits of many species.

Table 22. Similarity between fish communities of Pools 12 and 13, determined using number of species present in both habitats and the Morisita's Index for sampling (data from Bertrand and Miller 1973).

Location	Morisita's Index of Similarity ^a		
	Channel border	Side channel	Backwater lake and slough
Tailwater	(22) 0.772	(22) 0.925	(25) 0.805
Backwater lake and slough	(21) 0.540	(21) 0.791	
Side channel	(20) 0.707		

^aThis index is computationally related to Simpson's Diversity and may range from 0 (no similarity) to approximately 1.0 (identical); it gives the probability that randomly drawn fish from each of the two habitats will belong to the same species, relative to the probability of randomly selecting two fish of the same species from one of the two habitats (Morisita 1959).

Table 23. Total commercial fish catch (in lb) for Pools 11 to 13 during 1979 (data from UMRCC 1981).

Species	Pool 11	Pool 12	Pool 13
Carp	106,540	94,573	212,554
Buffalo	141,362	192,929	244,937
Drum	62,034	31,034	106,178
Catfish	57,819	83,078	153,974
Bullhead	1,916	812	3,480
Carp sucker	3,838	676	9,566
Redhorse and sucker	6,191	206	2,829
Sturgeon	1,500	1,530	4,300
Paddlefish	860	1,789	23,224
Gar	2,456	887	4,109
Bowfin	1,450	250	710
American eel	59	32	294
Mooneye and goldeye	12		3,660
Other	491	1,320	256
Total	386,516	409,116	770,071
Rank based on totals for Pools 11 to 22	5	4	1

6.2 MAIN CHANNEL

The fish fauna of the main channel is quite diverse, especially in the tailwater reaches of the river. This section will include reviews of several studies of the main channel fishes of Pool 11 to 13, along with a comprehensive survey of main channel fishes.

The stomach contents of shovelnose sturgeon of Pool 13 were analyzed April-November 1972 (Schofield 1975; Friedlein 1978; Ingram 1979). The studies concluded that shovelnose sturgeon were opportunistic and fed on the available benthic invertebrate populations; caddisflies, mayflies, and midge larvae were particularly important in their diet.

Populations of walleye and sauger were estimated in the tailwaters of Pool 11 (at Guttenberg, IA) and in the tailwaters of Pool 13 (at Bellevue, IA) in order to better understand and manage the sport harvest of these two species (Boland and Ackerman 1982). During 1980-81, walleye numbers were estimated at 19,397 at Guttenberg and 23,241 at Bellevue. In 1981-82, their estimated populations dropped to 9,183 and 10,709 at Guttenberg and Bellevue, respectively. Sauger estimates were 60,476 and 51,811 at Guttenberg and Bellevue, respectively, in 1980-81; their numbers were slightly higher in 1981-82. Boland and Ackerman (1982) concluded that both the walleye and sauger fisheries are in satisfactory condition in these two areas in terms of populations, growth rates, and age group distributions.

A 1979-80 survey of the main channel from RM 500 to 513.5 recorded 39 fish species. Of the 2,692 total fish sampled, the most abundant species were channel catfish (59.0%, mostly young fish), silver chub (12.0%), mooneye (10.3%), shovelnose sturgeon (9.4%), freshwater drum (2.5%), flathead catfish (1.7%), and river darter (1.7%). Species diversities increased with distance upstream. Sampling gear used included gill net, trammel net, hoop net, bottom trawl, midwater trawl, seine, and electrofishing (LGL 1981). However, the bottom trawl was the most effective sampling gear type; seining and electrofishing were least effective.

6.3 MAIN CHANNEL BORDER

The paddlefish (*Polyodon spathula*) is one of the more interesting fish found in the channel border habitat. These fish are reported to swim near the surface, where they feed primarily on copepods, cladocerans, and insects. Recent radio-telemetry studies of paddlefish in Pools 12 and 13 found that they favored main channel border and tailwater habitats (Figure 22). There were some differences in habitat preference in different seasons and years, but main channel border was selected in all periods except summer 1981 (Southall and Hubert 1984). Paddlefish were often found within 100 m of an artificial structure (locks and dams, wing dams, rock piles, and revetments), in scour holes or eddies created by the structure.

A preference for backwater habitat was noted during the postspawning period and into the summer. The rich plankton populations of backwaters are thought to provide prime feeding habitat for paddlefish, especially during summer (Marcoux 1966; Rosen et al. 1982), and the transport out of these habitats may provide favorable feeding areas along the main channel border (Southall and Hubert 1984).

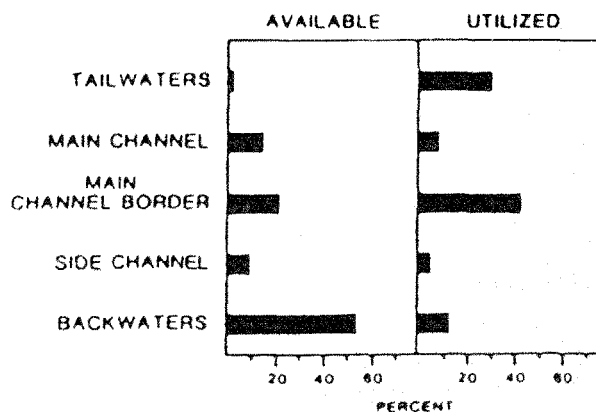

Figure 22. Availability and use by paddlefish of habitat types in Pools 12 and 13 combined, Upper Mississippi River, spring 1981 (from Southall and Hubert 1984).

It has only recently been documented that wing dams and closing dams provide important habitat for a variety of Upper Mississippi River fish species. Holzer (1978) collected 31 fish species from various Mississippi River habitats: 20 of these were associated with wing dam habitat. Pitlo (1981) sampled fish on 24 wing and closing dams, and captured 38 species (5,000 individuals). Sport fish made up nearly 40% of the catch and included freshwater drum, walleye, sauger, white bass, black crappie, white crappie, channel catfish, flathead catfish, bluegill, and northern pike. Pitlo (1981) also showed that shallow structures with elevations within 5 ft of the river surface produced significantly higher numbers and a greater diversity of fish. More detailed radiotelemetry studies of walleye in Pool 13 showed that 32% of all observations were made at wing dams, especially during lower flow periods (Pitlo 1983).

Most wing dams of the channel border are submergent, but there are several in Pool 13 that are emergent. An experimental study was designed to assess the impact of placing a notch in three of these wing dams, located between RM 547.4 and RM 548.6 (see Figure 21). Pierce (1980) reported fishery data for the "prenotching" phase of this study, noting the presence of 52 fish species (38 of which were near or on wing dams). Three wing dams were notched during May-July 1979, and the "postnotching" results were presented by Corley (1982). Increased velocities were noted immediately downstream from notches, along with some transport of sand, but there were no appreciable effects on fish populations (Table 24). Prenotching and postnotching fishery comparisons, based on sampling using baited and unbaited hoop nets and electrofishing, showed no changes that could be attributed to the wing dam notching (Corley 1982).

6.4 SIDE CHANNELS

Cassville Slough (RM 608.5 to RM 615) has probably received more study than any other side channel in the Pool 11 to 13 reach of river. This long, narrow side channel occupies about 806 surface acres,

Table 24. Mean catch with standard deviations (based on three seine hauls at each site) for major families of fish before and after notching of three wing dams of Pool 13 (from Corley 1982); differences before and after were not significant ($p>0.05$).

Family	Before		After	
	Mean	SD	Mean	SD
Cyprinidae	19.7	17.1	7.6	6.1
Ictaluridae	3.6	5.8	0.4	0.5
Percidae	3.3	2.7	1.6	0.4
Catostomidae	1.2	0.2	0.3	0.3
Percichthyidae ^a	0.5	0.3	2.7	3.5
Centrarchidae	13.7	19.1	3.1	3.8
Sciaenidae ^b	6.0	4.1	0.5	0.8

^aConsisted only of white bass (*Morone chrysops*).

^bConsisted only of freshwater drum (*Aplodinotus grunniens*).

contains 4,004 acre-ft of water, has a mean depth of about 4.9 ft, and a maximum depth of 50 ft (Ackerman 1978).

An extensive creel survey, taken during 10% of the daylight hours, found 24,500 anglers fishing 65,530 h and catching 86,288 fish (45,844 lb) (Table 25). Sport-fishing pressure was about 81 man-h/acre with a catch rate of 1.32 fish/h. The sport fishery was dominated by black crappie and the majority of the harvest occurred during late summer and early fall; the dominant method was still fishing with live bait (minnows or worms). Stable water levels and decreased turbidity in late summer and early fall have been suggested as factors influencing increased fishing success (Ackerman 1978).

The commercial fish catch from Cassville Slough during this same time period was estimated at 94,974 lb (Ackerman 1978). The principal fish caught were buffalo (45.1%), freshwater drum (19.3%), carp (15.4%), and channel

Table 25. Sport fishery harvest from Cassville Slough (1 July 1977 to 30 June 1978) of Pool 11 of the Upper Mississippi River (adapted from Ackerman 1978).

Species	Total caught	% of Catch	Total weight ^a (lb)	lb/acre
Black crappie	44,525	51.6	17,810	22.2
Bluegill	15,359	17.8	4,608	5.7
Freshwater drum	7,334	8.5	6,601	9.2
White crappie	5,091	5.9	2,036	2.5
White bass	4,573	5.3	2,744	3.4
Walleye	2,761	3.2	4,142	5.1
Channel catfish	1,639	1.9	2,131	2.6
Largemouth bass	1,553	1.8	1,864	2.3
Sauger	868	1.0	777	1.0
Rock bass	690	0.8	276	0.3
Flathead catfish	518	0.6	1,036	1.3
Smallmouth bass	345	0.4	311	0.4
Yellow perch	345	0.4	104	0.1
Northern pike	173	0.2	554	0.7
Bullhead	173	0.2	122	0.2
Carp	86	0.1	295	0.4
Suckers	86	0.1	129	0.2
Gar	52	<0.1	52	0.1
Gizzard shad	43	<0.1	9	<0.1
Bowfin	35	<0.1	42	0.1
Mooneye	26	<0.1	21	<0.1
Paddlefish	18	<0.1	180	0.2
Total	86,293	100.0	45,844	58.0

^aMean weights published by Rasmussen (1979) were used to estimate total weights.

catfish (13.4%). The commercial fish yield was 119.1 lb/acre. Ackerman (1978) indicates that commercial yields have dropped in Cassville Slough during recent decades due to a combination of factors, including excessive sedimentation and increased water flows which have led to a more lotic environment.

6.5 BACKWATER LAKES AND SLOUGHS

The backwater lakes and sloughs of the Upper Mississippi River have been shown to provide favorable conditions for most fish species (Schramm and Lewis 1974), although some species seem to prefer more lotic conditions at least

during a portion of the year. A number of fish probably use backwaters during their early life stages, and may then be dispersed in the drift out of these habitats (Eckblad et al. 1984).

Abiotic parameters (e.g., velocity, dissolved oxygen, turbidity, water temperature) of backwater lakes and sloughs differ substantially from the parameters of other river habitats. A number of studies have shown correlations between various environmental parameters and fish catch rates. For example, in sampling from various habitats on the Mississippi River, Gutreuter (1980) found a significant negative correlation ($p < 0.05$) between current velocity and catch rate

for gizzard shad, largemouth bass, bluegill, and white crappie (all species common to backwaters). In contrast, he found a positive correlation between current velocity and catch rate for channel catfish and flathead catfish. Other variables also influenced catch rates; for example, dissolved oxygen levels of bottom waters were negatively correlated with catch rates for largemouth bass, bluegill, and white crappie (Gutreuter 1980).

The fishery of the shallow, bilobed, 835-acre backwater lake known as Brown's Lake was sampled during 1979 (Figure 23). Its fishery was compared with that of the Green Island Levee and Drainage District

(RM 546 to 548), which consists of approximately 700 acres of small ponds and sloughs suitable for fish habitation (Boland and Reetz 1979). However, the diked Green Island backwater habitat has very little water exchange and may be subject to low water levels, especially during winter months.

In both study areas (Brown's Lake and Green Island), a total of 41 fish species, numbering 7,406 individuals (5,888 lb), were collected using experimental gill nets (1,590 h), frame nets (1,702 h), and electrofishing (13 h). Brown's Lake supported 39 fish species, while the Green Island area had only 17 species. Among the species present in Brown's Lake, but not found in Green Island, were walleye, sauger, white bass, channel catfish, freshwater drum, smallmouth buffalo, gizzard shad, and three species of carpsucker. The biomass of fish collected, adjusted for sampling time, showed the much more abundant fishery of Brown's Lake (Table 26). The numerical populations of bluegill, white crappie, black

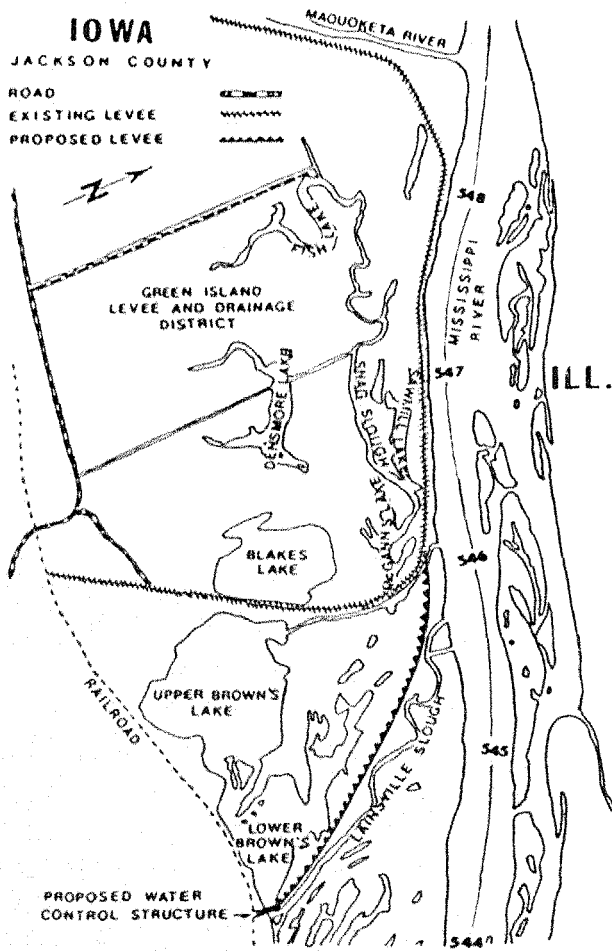

Figure 23. Green Island Levee District and Brown's Lake, Pool 13, Upper Mississippi River (from Boland and Reetz 1979).

Table 26. Comparison of biomass sampled (lb per h) for all gear types combined for major sport and commercial fish at Brown's Lake and Green Island, 1979 (from Boland and Reetz 1979).

Species	Brown's Lake combined total (lb/h)	Green Island combined total (lb/h)
White crappie	0.345	0.004
Black crappie	0.346	0.025
Bluegill	0.238	<0.001
Largemouth bass	0.167	<0.001
Northern pike	0.192	0.154
Walleye	0.058	0
Sauger	0.138	0
White bass	0.179	0
Black bullhead	0.100	0.571
Carp	4.258	1.879
Bigmouth buffalo	0.375	0
Smallmouth buffalo	0.375	0
Freshwater drum	0.188	0
Channel catfish	0.054	0

crappie, and largemouth bass were all more than seven times greater in Brown's Lake than in Green Island. This study illustrates the variability that can exist even between adjacent backwater habitats. Levee construction in the Green Island area appears to have simpli-

fied the environment and reduced fish species diversity. Low water levels along with a record snow cover during the winters of 1977-78 and 1978-79 probably resulted in fish kills in the Green Island area which also contributed to low species diversity (Boland and Reetz 1979).

CHAPTER 7. OTHER BIOTA

7.1 FLOODPLAIN FOREST

Most of the undeveloped floodplain in the Pool 11 to 13 reach contains floodplain forest (Figure 24). The forest dominates the upstream half of each pool, while the downstream half has a greater percentage of open water area. The dominant trees are usually American elm (*Ulmus americana*), red maple (*Acer rubrum*), green ash (*Fraxinus pennsylvanica*), silver maple (*Acer saccharinum*), river birch (*Betula nigra*), and black willow (*Salix nigra*); trees over 20 ft tall provide most of the cover (Table 27). The black willow and river birch are common at elevations close to normal pool level, the soft maples occur at a little higher elevation, and the elm and ash grow at still higher elevations above water level.

The understory vegetation often consists of wood nettle (*Laportea canadensis*), though green dragon (*Arisaema dracontium*) is also common. Patches of sensitive fern (*Onoclea sensibilis*) are present locally, but are not common. Poison ivy (*Rhus radicans*) may be abundant in those places where more light reaches the forest floor; common elder (*Sambucus canadensis*) is also common in open sunny areas.

GREAT II (1980b) noted the lack of studies on the floodplain forests of the Upper Mississippi River. The floodplain forest of the Pool 11 to 13 reach has not been studied in detail, but studies elsewhere (e.g., Wilson 1970; Keammerer et al. 1975) have suggested its importance as a habitat for other biota. The tall trees

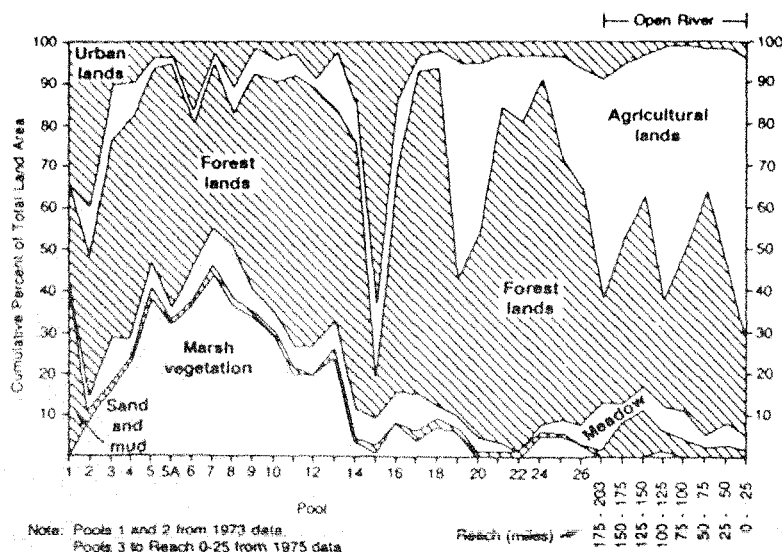

Figure 24. Relative distribution of floodplain cover types on the Upper Mississippi River (from UMRBC 1982).

Table 27. Surface areas (acres) of various terrestrial habitat types of Pools 11 to 13.

Habitat type	Pool 11	Pool 12	Pool 13	Total	% of Total
Urban	1,287	2,152	6,587	10,026	18.2
Trees (>20 ft tall)	9,017	6,495	13,965	29,477	53.4
Trees (<20 ft tall)	255	185	412	852	1.5
Salix/brush	2	10	537	549	1.0
Levee grass and brush	-	20	112	132	0.2
Cropland	1,167	907	7,050	9,124	16.5
Upland meadow	107	375	2,397	2,879	5.2
Sand/mud	75	30	40	145	0.3
Lowland meadow	72	210	1,687	1,969	3.6
Total	11,982	10,384	32,787	55,153	100.0

provide sites for heron and egret nesting rookeries. (Two major rookeries occur in the Pool 12 area.) The floodplain forest provides habitat for white-tailed deer and other smaller mammals.

7.2 DREDGE SPOIL AREAS

Between 1945 and 1975 mean annual dredging in Pools 11 to 13 was over 201,000 yd³ (see Section 2.6 and Table 7). Dredge spoil placement on the Upper Mississippi River floodplain can disturb the existing biota, principally through covering the existing communities and through subsequent wind and water transport of spoil to adjacent side channels or backwaters. For example, GREAT II (1980d) identified 14 side channels in Pools 11 to 13 as areas having problems because of the placement nearby of dredge spoil. In another study (GREAT II 1980h), 21 disposal sites were identified in Pool 11, 51 in Pool 12, and 147 in Pool 13. Unfortunately, few of these habitats have been studied.

Growth rates of black willow and silver maple at the Pleasant Creek Public Use Area (Pool 13; RM 553) were studied by Cawley (1975). He compared two stands: a spoiled area that had received 30,388 yd³ of spoil in 1962 and 48,075 yd³ in 1973, and an unspoiled stand immediately south and downstream of the spoiled area. He

measured xylem rings and found that silver maple added 5.66 mm annually (from 1951 to 1961). However, after the placement of dredge spoil at this location, the mean annual rate was 4.44 mm (1962 to 1974). Cawley also noted that growth rates of black willow decreased following spoil placement.

7.3 BIRDS

Pools 11 to 13 are heavily used by both resident and migrating birds. The area's cultivated fields, pastures, wooded stream courses, forested islands, marshland, and sandy beaches provide excellent habitat for birds that vary widely in their needs for food, nesting, and protective cover (Table 28). In addition to the 126 species known to nest in this region, another 132 species occur but do not nest (GREAT II 1980e).

It is estimated that several thousand of the waterfowl using the Mississippi Flyway stop briefly to rest and feed on each of these three pools (GREAT II 1980e). The surface-feeding mallards are usually the most common, with teal, wood duck, and baldpate somewhat less abundant.

Predatory marsh and shore birds, such as the great blue heron, find most of their prey in shallow backwaters. Nine

Table 28. Relative seasonal abundances of birds that nest in the Pool 11 to 13 area (from GREAT II 1980e).^a

Bird species	Spring	Summer	Fall	Winter
Double-crested cormorant	C	C	C	
Great blue heron	A	A	A	R
Green heron	C	C	C	
Great egret (common egret)	C	C	O	
Black-crowned night heron	C	C	C	
Yellow-crowned night heron	U	U	U	
Least bittern	U	U	U	
American bittern	U	U	U	
Canada goose	C	C	C	
Mallard	A	C	A	C
Black duck	C	O	C	O
Green-winged teal	C	R	C	R
Blue-winged teal	A	U	A	
Wood duck	C	C	C	O
Hooded merganser	C	O	C	
Red-tailed hawk	C	C	C	C
Red-shouldered hawk	O	O	O	U
Broad-winged hawk	O	O	O	
Bald eagle	C	U	R	C
Marsh hawk	C	C	C	O
American kestrel (sparrow hawk)	O	O	O	R
Ruffed grouse	C	C	C	C
Bobwhite	O	O	O	O
Ringed-necked pheasant	C	C	C	C
Gray partridge	O	O	O	O
King rail	U	U		
Virginia rail	U	U	O	
Sora	A	A	C	
Common gallinule	R	R		
American coot	A	C	A	R
Killdeer	C	C	C	R
American woodcock	R	R	R	
Upland sandpiper (upland plover)	O	O	O	
Spotted sandpiper	C	C	C	
Solitary sandpiper	C	C	C	
Rock dove	C	C	C	C
Mourning dove	C	C	C	O
Yellow-billed cuckoo	C	C		
Black-billed cuckoo	C	C		
Screech owl	C	C	C	C
Great horned owl	C	C	C	C
Barred owl	C	C	C	C
Long-eared owl	U	U	U	U
Short-eared owl	U	U	U	U
Saw-whet owl	U	U	U	U
Whip-poor-will	C	C		
Common nighthawk	A	A	O	
Chimney swift	A	A		
Ruby-throated hummingbird	C	C		
Belted kingfisher	C	C	O	U

(continued)

Table 28. (Continued).

Bird species	Spring	Summer	Fall	Winter
Common flicker (yellow-shafted)	C	C	C	U
Pileated woodpecker	O	O	O	O
Red-bellied woodpecker	C	C	C	C
Red-headed woodpecker	C	C	C	R
Yellow-bellied sapsucker	C		C	
Hairy woodpecker	C	C	C	C
Downy woodpecker	C	C	C	C
Eastern kingbird	A	C	R	
Great crested flycatcher	C	C	R	
Eastern phoebe	C	C	O	
Willow flycatcher	C	C	U	
Least flycatcher	A	A	U	
Eastern wood pewee	C	C	U	
Horned lark	C	C	C	O
Tree swallow	A	A	U	
Bank swallow	C	C	U	
Rough-winged swallow	O	O	U	
Barn swallow	A	A	U	
Cliff swallow	O	O	U	
Purple martin	A	A	U	
Blue jay	C	C	C	C
Common crow	A	A	A	C
Black-capped chickadee	C	C	C	C
Tufted titmouse	C	C	C	C
White-breasted nuthatch	C	C	C	C
House wren	A	A	O	
Long-billed marsh wren	C	C	C	
Short-billed marsh wren	O	O	O	
Grey catbird	C	C	O	
Brown thrasher	C	C	O	
American robin	C	C	C	R
Wood thrush	C	C	C	
Eastern bluebird	C	C	C	R
Blue-gray gnatcatcher	U	U		
Cedar waxwing	C	C	C	O
Loggerhead shrike	C	C	C	R
Starling	A	A	A	A
Bell's vireo	U	U		
Yellow throated vireo	C	C	C	
Red-eyed vireo	C	C	O	
Prothonotary warbler	C	C		
Blue-winged warbler	O	O		
Yellow warbler	A	A	O	
Cerulean warbler	R			
Ovenbird	O	O	O	
Louisiana waterthrush	O	O	O	
Kentucky warbler	R	R		
Common yellowthroat	A	A	O	
Yellow-breasted chat	R	R	O	
American redstart	A	A	A	
House sparrow	A	A	A	A

(continued)

Table 28. (Concluded).

Bird species	Spring	Summer	Fall	Winter
Bobolink	O	O	O	
Eastern meadowlark	C	C	C	O
Western meadowlark	O	O	O	O
Yellow-headed blackbird	O	O	O	
Red-winged blackbird	A	A	A	R
Orchard oriole	U	U	O	
Northern oriole (Baltimore)	C	C	O	
Brewer's blackbird	U	O	U	R
Common grackle	A	A	A	U
Brown-headed cowbird	A	A	U	R
Scarlet tanager	O	O	O	
Cardinal	C	C	C	C
Rose-breasted grosbeak	C	C		
Indigo bunting	C	C	O	
American goldfinch	A	A	A	C
Rufous-sided towhee	A	A	A	C
Savannah sparrow	O	O	O	
Grasshopper sparrow	O	O	O	
Henslow's sparrow	R	R	U	
Vesper sparrow	O	O		
Lark sparrow	O	O		
Chipping sparrow	A	A	A	
Field sparrow	C	C	C	R
Swamp sparrow	C	C	O	
Song sparrow	A	A	C	R

^a Key to symbols:

A - abundant (present in large numbers)

C - common (certain to be seen but seldom in large numbers)

U - uncommon (present in smaller numbers or not always seen)

O - occasional (seldom seen, present in most years)

R - rare (present only in some years).

separate heron rookeries have been identified in the Pool 11 to 13 reach (Thompson and Landin 1978; Nelson 1980).

7.4 MAMMALS

Fifty-two mammal species are known to occur in the vicinity of Pools 11 to 13 (Table 29). Thirty-three species are considered common, the others rare. Among the most abundant are muskrat, raccoon, beaver, opossum, fox, skunk, and white-tailed deer. GREAT II (1980b) noted the absence of any specific studies on the mammals in this river reach although some general environmental studies in nearby

pools have documented mammal occurrence. Though these studies provide some data, they usually lack quantification and cover short timespans, thus making them only useful primarily as species lists for local areas.

7.5 AMPHIBIANS AND REPTILES

Twenty amphibian species and 41 reptile species occur in the vicinity of the Pool 11 to 13 reach of the Upper Mississippi River (Table 30). Ten amphibian species and 14 reptile species are considered common or abundant. No

Table 29. Relative abundance of mammals of the Upper Mississippi River (after GREAT II 1980e).

Common name	Occurrence
Virginia opossum	Common
Eastern mole	Common
Masked shrew	Rare
Least shrew	Common
Short-tailed shrew	Common
Keen's myotis	Common
Little brown myotis	Common
Indiana bat	Rare
Least myotis	Rare
Silver-haired bat	Rare
Eastern pipistrel	Rare
Big brown bat	Common
Red bat	Common
Hoary bat	Rare
Evening bat	Rare
Eastern cottontail	Common
White-tailed jackrabbit	Rare
Woodchuck	Common
Thirteen-lined ground squirrel	Common
Franklin's ground squirrel	Rare
Eastern chipmunk	Common
Gray squirrel	Common
Fox squirrel	Common
Southern flying squirrel	Common
Plains pocket gopher	Common
Beaver	Common
Western harvest mouse	Common
White-footed mouse	Common
Deer mouse	Common
Southern bog lemming	Rare
Meadow vole	Common
Prairie vole	Common
Woodland vole	Rare
Muskrat	Common
Nutria	Rare
House mouse	Common
Norway rat	Common
Meadow jumping mouse	Rare
Coyote	Common
Red fox	Common
Gray fox	Common
Raccoon	Common
Ermine	Rare
Long-tailed weasel	Common
Least weasel	Rare
Mink	Common
Badger	Rare

(continued)

Table 29. (Concluded).

Common name	Occurrence
River otter	Rare
Striped skunk	Common
Spotted skunk	Rare
Bobcat	Rare
White-tailed deer	Common

Table 30. Relative abundance of amphibians and reptiles of the Upper Mississippi River (after GREAT II 1980e).

Common name	Occurrence
Mudpuppy	Common
Central newt	Rare
Spotted salamander	Rare
Smallmouth salamander	Uncommon
Eastern tiger salamander	Common
Dark-sided salamander	Common
Four-toed salamander	Rare
American toad	Uncommon
Fowler's toad	Abundant
Northern spring peeper	Common
Gray tree frog	Common
Blanchard's cricket frog	Varied
Western chorus frog	Varied
Pickerel frog	Common
Northern leopard frog	Common
Southern leopard frog	Common
Northern crawfish	Uncommon
Green frog	Varied
Wood frog	Uncommon
Bullfrog	Common
Alligator snapping turtle	Very rare
Common snapping turtle	Common
Stinkpot	Uncommon
Illinois mud turtle	Very rare
Blanding's turtle	Very rare
Eastern box turtle	Uncommon
Ornate box turtle	Uncommon
Western painted turtle	Abundant
Red-eared slider	Varied
False map turtle	Uncommon
Map turtle	Common
Smooth softshell	Uncommon
Eastern spiny softshell	Common
Western slender glass lizard	Uncommon

(continued)

Table 30. (Concluded).

Common name	Occurrence
Six-lined racerunner	Varied
Five-lined skink	Uncommon
Broad-headed skink	Varied
Western worm snake	Uncommon
Prairie ringneck snake	Common
Plains hognose snake	Uncommon
Eastern hognose snake	Common
Western smooth green snake	Rare
Blue racer	Common
Black rat snake	Uncommon
Western fox snake	Uncommon
Bullsnake	Uncommon
Prairie kingsnake	Uncommon
Speckled kingsnake	Rare
Milk snake	Uncommon
Western ribbon snake	Common
Eastern plains garter snake	Rare
Eastern garter snake	Common
Midland brown snake	Common
Northern red-bellied snake	Uncommon
Copperbelly water snake	Uncommon
Graham's water snake	Common
Diamondbacked water snake	Common
Northern water snake	Common
Northern copperhead	Varied
Eastern massasauga	Uncommon
Timber rattlesnake	Common

specific studies on these taxa have been identified for this reach of river (GREAT II 1980b).

7.6 ENDANGERED AND THREATENED SPECIES

Seventy species listed by either Federal or State agencies as endangered or threatened are reported for the Pool 11 to 13 reach of the Upper Mississippi River (Table 31). Because agencies have used different selection criteria, these lists vary considerably. For example, Wisconsin lists the pickerel frog as threatened, while GREAT II (1980e) listed this species as common (Table 30).

Information on endangered species is usually only available for an extensive geographical region and is often quite general in terms of locations of specific populations, as well as the biology of these species. More extensive sampling of all habitats within these three pools might reveal the presence of additional endangered or threatened species.

Table 31. Federal and State endangered and threatened species within the Pool 11 to 13 reach of the Upper Mississippi River (after GREAT II 1980e and Illinois Administrative Code 17:1:c).^a

Species	Federal	Wisconsin	Iowa	Illinois
Plants				
Northern wild monkshood	T	T		
Carex media		E		
Pink milkwort		E		
White lady's slipper		T		
Tubercled orchid		T		
Hairy meadow parsnip		E		
Invertebrates				
Higgins-eye pearly mussel	E	E	E	E
Iowa pleistocene snail			E	E
Fat pocketbook pearly mussel	T			E
Orange-footed pearly mussel	E			E

(continued)

Table 31. (Continued).

Species	Federal	Wisconsin	Iowa	Illinois
Invertebrates (continued)				
Pink mucket pearly mussel	E			E
Rough pigtoe pearly mussel	E			E
Sampson's pearly mussel	E			E
Tubercule-blossom pearly mussel	E			E
White cat's paw pearly mussel	E			E
White wartyback pearly mussel	E			E
Fish				
Striped shiner		E		
Crystal darter		E		
Goldeye		T		
Speckled chub		T		
Pallid shiner		T		
Blue sucker		T		
Black buffalo		T		
River redhorse		T		
Mud darter		T	T	
Lake sturgeon			T	
Pallid sturgeon			E	
Skipjack herring			T	
Western sand darter			T	
Grass pickerel			T	
Bluntnose darter			T	
Chestnut lamprey			T	
Weed shiner			T	
Amphibians				
Pickerel frog		T		
Central newt			E	
Reptiles				
Five-lined skink			T	
Western slender glass lizard			E	
Blanding's turtle		T	T	
Ornate box turtle	E		T	
Stinkpot			T	
Western ribbon snake		E		
Massasauga		E	T	
Black rat snake			T	
Graham's water snake			T	
Birds				
Bald eagle	E ^b	E		E
American peregrine falcon	E	E	E	E
Arctic peregrine falcon	E			
Cooper's hawk		T	T	E
Red-shouldered hawk		T	E	E
Osprey		E		E
Marsh hawk			E	E
Swainson's hawk				E

(continued)

Table 31. (Concluded).

Species	Federal	Wisconsin	Iowa	Illinois
Birds (continued)				
Broad-winged hawk			T	
Double-crested cormorant		E		E
Great egret		T		T
Forster's tern		E		E
Barn owl		E	E	
Long-eared owl			T	T
Short-eared owl				T
Upland sandpiper			E	E
Blue-winged warbler			T	
Northern harrier			E	
Wilson's phalarope				E
Common gallinule				T
Yellow rail				E
Black-crowned night heron				E
Black rail				E
Yellow-headed blackbird				E
Veery				T
Brown creeper				E
Mammals				
Indiana bat	E		E	E
Keen's myotis			T	
Bobcat			E	T
Black bear			E	
River otter			T	T
Woodland vole			E	E
White-tailed jackrabbit				E

^aE = endangered, T = threatened

^bBald eagle is listed as threatened in Wisconsin on Federal listings.

CHAPTER 8. FLUXES BETWEEN HABITATS

8.1 OVERVIEW

The Upper Mississippi River ecosystem is regulated by flows among various system components (see Figure 11). In addition to the fluxes between habitats within a pool, there is between-pool transport, primarily in a downstream direction. Tables 10 and 11 summarize each pool's characteristics and provide background for the discussion of fluxes among pools.

Data are not currently available to permit the construction of valid models of energy flows or nutrient budgets between pools or within pools in the Pool 11 to 13 reach of the Upper Mississippi River. The acquisition of these data should have a high priority in the design of future studies.

8.2 TRANSPORT BETWEEN POOLS

The movement of materials follows the downstream movement of water from Pool 11 to Pool 12 to Pool 13. Materials may be dissolved or suspended in the water, or moved along the bottom as bedload. The quantity of material moved is influenced by the volume of water, which averaged 47,800 ft³/s at Lock and Dam 12 from 1970 to 1979 (Hall 1980). If materials were in transport at a concentration of 1 mg per liter (= 1 ppm) this would be an annual transport of about 94 million lb. The dissolved concentrations reported for the river at Dubuque, IA, (see Table 8) suggest an annual transport of about 51 million lb of nitrate nitrogen, 11 million lb of ammonia nitrogen, and 16 million lb of phosphate. These represent only the dissolved fraction of the transported materials, and it is likely that over 50% of the transport would be in suspended materials plus bedload. In any case, a

substantial amount of nutrients and potentially toxic compounds are in transport through this dynamic river ecosystem.

The three pools vary in the retention of materials, as indicated by the retention of sediments. Sediment modeling by Nakato (1980) suggested that sediment retention ($1 - \text{output}/\text{input} \times 100$) is very low for Pool 11 (<1%), while it is >50% for Pool 12 (see Table 4).

8.3 DELIVERY TO BACKWATERS

Probably the most obvious evidence of transport to backwater habitats is the accumulation of sediments in side channels that flow toward backwater lakes. The modeling of sediment transport to backwaters (Simons et al. 1981) was described in Section 2.5. Over 50 troubled side channel areas in Pools 11 to 13 were identified by the GREAT II Side Channel Work Group; most of these problems were related to the deposition of sediment (Table 32). One of these sites in Pool 13 is Lainsville Slough, at RM 545.8 (see Figure 23). This side channel, which joined the main channel to the Upper and Lower Brown's Lake area, became plugged with debris and sediment. In August 1976, the Corps of Engineers constructed a new opening at RM 545.6 and riprapped the entrance. This backwater opening was judged by the Side Channel Work Group (GREAT II 1980d) as the most successful of those conducted. GREAT II (1980d) predicted that over the next 50 years, losses of backwater habitat acreage due to sediment accumulation will range from 22% to 49% in Pools 11 to 13.

Adsorbed materials are also being delivered to backwaters, along with sediments in transport. These adsorbed

Table 32. Problem side-channel areas identified for the Pool 11 to 13 reach of the Upper Mississippi River (GREAT II, 1980d).

River mile	Site name	Problem description
614.9	Cassville Slough	Closing structure impedes flow to backwaters
614.5	Swift Slough	Sedimentation; dam prevents flow
613.9	Ackerman's Cut	High flows contribute to sedimentation of Cassville Slough
612 - 614	Cassville Slough	Sedimentation in backwaters
613 - 614.5	Goetz Is. Side Channel	Blocked by sand
613.2	Goetz Island	Spoil-blocked backwaters
612.5	Goetz Slough	Sedimentation in backwaters aggravated by spoil
612.3 - 613		Spoil in side channel
610 - 611		Spoil in backwaters
605.9	Jack Oak Slough	Erosion and redeposition in side channel
604.9 - 605.7	Jack Oak Island	Sedimentation aggravated by regulatory structures
604.3	N. Buena Vista	Spoil in backwaters
604	Sand Cut	Erosion and redeposition
603	Bunker Chute	Closing structure prevents access
602.5	Coal Pit Chute	Blocked by natural accretion of sand
602.5	Bertom Lake	Sedimentation in backwaters
601.3	Kruse's Bar	Blocked by natural accretion
600.3		Blocked by natural selection
599.5		Sedimentation in backwaters
597 - 598.5	Hurricane Island and Chute	Spoil in backwaters and regulatory structures gone
583.1	Dam 11 and U.S. 61	Dam prevents flow to backwaters
582	Stump Island	Sedimentation in backwaters aggravated by Dam 11
580 - 582	Dubuque Area	Complete loss of backwaters, presumably Hamm Island
578 - 579	Indust. Chemical Light	Spoil, natural accretion and development-impacted backwaters
574.2	Molo Slough	Spoil from pipeline construction
574	Below Menominee River	Sedimentation in backwaters
572.6	Nine Mile Island	Spoil in entrance to side channel
569	Deadman Slough	Sedimentation in side channel
566.7 - 569	Below Sinsinawa R.	Sedimentation in backwaters
564 - 566	Harris Slough	Sedimentation in backwaters
563.5	Stone Slough	Sedimentation in backwaters
561.5-562.5	Aiken's Landing	Sedimentation in backwaters
560.8	Wise Lake Cut	Sedimentation in cut
556.7 - 560	Above dam 12	Sedimentation in lower pool
556.7	Dam 12	Dam prevents flow to backwaters
550.7		Sedimentation (possibly spoil) in mouth of side channel
550.1	Casey's Island	Spoil in side channel
546.5	Savanna Proving Ground	Sedimentation or spoil in backwaters

(continued)

Table 32. (Concluded).

River mile	Site name	Problem description
545.8	Lainsville Slough	Side channel blocked by debris and sediment
544 - 546	Brown's Lake	Sedimentation in backwaters
543.3	Marcus Bottoms	Sedimentation in backwaters
541.9	Pin Oak Lake	Blocked by debris and sediment
539.5-541	Savanna Bay	Sedimentation in backwaters
540 - 541.5	Santa Fe Island	Spoil and redeposition in area
538.8	Boy Scout Island	Sedimentation in side channel
535.6 - 540	Sabula/Keller Islands	Sedimentation
533.5 - 537	Savanna Island	Sedimentation in backwaters
531 - 534	Spring Lake Levee	Breaks in levee contribute to sedimentation of lake
531 - 533.5	Savanna Slough	Creation and enlargement of dredged-material island
532	Cook's Island	Sedimentation in backwaters
531	Big Slough	Sedimentation due to breaks in Spring Lake Levee
528	Thomson	Side channel blocked by fill-subsequent sedimentation
524 - 526	Potter's Slough	Sedimentation in side channel

materials include nutrients, which can stimulate plant growth, and potentially toxic compounds.

8.4 TRANSPORT OUT OF BACKWATERS

Backwaters are known to provide the feeding and breeding habitat for much of the fauna associated with the world's large rivers (Welcomme 1979). Extensive littoral zones support autochthonous carbon fixation and nutrient cycling through aquatic macrophytes. This probably serves as the principal energy source to support the large populations of benthic macroinvertebrates often found in backwater lakes (Carlson 1968; Eckblad et al. 1977). Flow through backwaters is generally reduced (as a percent of total river flow) during periods of low river flow (Eckblad 1981), which results in reduced flushing times for these habitats. Populations suited to standing water are likely to show increased productivity during such periods. When higher flows return there is considerable potential for the transport of biological material out of these backwaters.

Until recently, little quantitative data had been collected on the transport of material out of Mississippi River backwaters. Studies in 1981 showed that drift densities of the macroinvertebrates and fish larvae of side channels fed by backwaters were many times higher than numbers from the main channel (Eckblad et al. 1984). Subsequent studies in Pool 13 have shown a similar trend for drifting insects (Shaeffer and Nickum 1984a) and larval fishes (Shaeffer and Nickum 1984b). More complete seasonal data are still needed to evaluate annual carbon transport out of backwaters, but this type of sampling can provide a very useful basis for evaluating the productive role of these diverse backwater systems.

The importance of understanding the origins and fate of organic transport in river ecosystems has been stressed by many investigators (e.g., Cummins 1979). Transport of organic matter from backwaters through side channels may enter the main channel as a "point source" input of high quality food readily available to many organisms at higher trophic levels. This organic matter may contribute to the

rapid macroinvertebrate colonization of submerged objects (e.g., wing dams) present along the channel border. Input of organic matter from side channels may also partially explain the nonrandom distribution of macroinvertebrate populations in large river systems.

8.5 FISH MOVEMENT

In recent years, radio transmitters have been implanted in fish to better document their movement within and between pools. The movements of shovelnose sturgeon, paddlefish, walleye, and sauger have been thus studied in the Pool 11 to 13 reach of river.

Shovelnose sturgeon have been shown to be relatively sedentary and are most often found at bottom-current velocities between 20 to 40 cm/s (Hurley et al. 1983). They are most active during spring spawning and are capable of moving over a distance of 11 km per day. Homing behavior (return to a previously occupied area) is found in shovelnose sturgeon.

Wing dams and closing dams provide valuable habitat for this species (Hurley et al. 1983).

Radio transmitters on 17 paddlefish in 1980 and 1981 showed their distinct tendency to move upstream, especially during the prespawning period in spring (Southall and Hubert 1984). Upstream movements led to the congregation of fish downstream from dams, and in 1981, when dam gates were fully opened, a number of fish moved upstream to the next pool. The high mobility of paddlefish in the Upper Mississippi River was also demonstrated by Gengerke (1978). Within-pool movements to favored habitats were discussed in Section 6.3.

Upstream movements for northern pike (Gengerke 1977) and walleye and sauger (Iowa State Conservation Department 1958) are well-known. These species tend to congregate in the tailwaters below locks and dams. The use of the tailwaters by these and other fish species may make them particularly vulnerable if there were hydroelectric development at these low-head dams (Holland et al. 1984a).

CHAPTER 9. HUMAN USES AND THE FUTURE

9.1 RECREATIONAL USE

The diverse environments of Pools 11 to 13 provide equally diverse forms of recreation (Table 33). Most recreation is either water-oriented or enhanced by the presence of the river and its valley. Boating appears to be the most popular single activity. User surveys suggest that a typical river outing consists of taking a boat on a short excursion to a nearby dredge spoil beach or anchorage, meeting other boaters, and spending the day swimming, picnicking, and sunbathing (UMRBA 1983).

Sportfishing and waterfowl hunting are among the most popular recreational activities on Pools 11 to 13 (Table 34). Day-use estimates suggest about five times as much recreational use by anglers as by waterfowl hunters. Based upon the mean for the three pools, use is projected to increase by 19% by the year 2000, and by 38% by the year 2025 (GREAT II 1980f).

Table 33. Outdoor recreational activities in the Pool 11 to 13 reach of the Upper Mississippi River System (after UMRCC 1982).

Boating	Bicycling
Swimming	Ice Skating
Water skiing	Snowmobiling
Hiking	Sunbathing
Bird watching	Fishing
Ice fishing	Camping
Cross-country skiing	Canoeing
River watching	Hunting
Picnicking	Trapping
Sightseeing	Driving for pleasure
Sailing	

Numerous popular sportfishing areas occur within the Pool 11 to 13 reach. Aerial surveys for sport fishermen in Pools 12 and 13 showed that tailwaters, sloughs, and backwater lakes were favored fishing areas (Table 35). There were some between-year differences, as well as between-pool differences. For example, Pool 13 has more extensive backwater lake habitat so it is not surprising that a higher percentage of its fishermen would be found in this habitat. Fish common to backwaters (e.g., bluegill and crappie) were sought after by about one-third of

Table 34. Day use for fishing and hunting in Pools 11 to 13 (after GREAT II 1980f).^a

Use and Year	Person-days		
	Pool 11	Pool 12	Pool 13
Fishing 1977-78			
day use	355,283	388,836	383,810
2000 (projected)	435,577	472,202	440,076
2025 (projected)	517,115	543,865	499,029
Hunting 1977-78			
day use	66,237	74,064	87,536
2000 (projected)	81,209	89,943	100,368
2025 (projected)	96,411	103,593	113,814

^aData should be used primarily for comparison of recreational use between pools.

Table 35. Percentage of fishermen using various habitats, from 1973 and 1974 aerial surveys in Pools 12 and 13 (Bertrand 1974).

Habitats	Pool 12		Pool 13	
	1973	1974	1973	1974
Tailwater	30.7	21.6	15.6	26.7
Main channel border	9.9	3.6	5.4	2.2
Side channel	6.2	3.0	3.9	3.9
Slough	25.5	30.3	17.9	9.6
Backwater lake	23.4	30.4	56.7	57.2
Pond	4.3	9.1	0.9	0.4

the anglers interviewed in Pool 13 (Table 36). Walleye, sauger, and channel catfish were also favored sport fish in both Pool 11 and Pool 13.

It has been estimated that over \$200 million has been spent annually on recreation on the Mississippi River within the Rock Island District (Table 37). About 29% of these expenditures are related to fishing, and less than 2% related to waterfowl hunting. About two-thirds of the district's recreational expenditures are related to activities other than fishing or hunting. Heading this list is boating, followed by substantial recreational use of the area for picnics, camping, swimming, and water skiing (Table 38).

Recent surveys suggest that about 60% of the users live within 25 mi of the river (UMRBA 1983). Three-fourths of those living less than 10 mi from the river visit more than twice a month. Of those who travel more than 200 mi, about one-fifth come at least twice a month.

9.2 INDUSTRIAL USE

Nine municipalities and 10 mobile home parks use the river in the Pool 11 to 13 reach to dispose of domestic sewage

(see Section 2.7 and Table 9). Three electric utilities along with five other industries may withdraw up to 277 million gal per day (= 429 ft³/s) for cooling water; under low flow conditions of 10,000 ft³/s this would represent 4.3% of the river's total flow. These uses of the river are likely to influence overall water quality as discussed in Section 2.7. Twelve other industries use the river primarily for transportation; most of these are located at Dubuque, IA, the largest city along this section of river.

9.3 COMMERCIAL NAVIGATION

In 1977 about 15 million tons of commerce passed through the Pool 11 to 13 reach of river. This is projected to grow to about 25 million tons by the year 1990, and with unconstrained growth could reach about 50 million tons by the year 2040 (UMRBC 1982). It has been estimated that by the year 2000, with a 2.5% annual growth in commercial traffic, over 60% of the tows traveling through Pools 11 to 13 will experience delays of about 90 min during lockages (GREAT II 1980c). It is anticipated that there will be continuing political pressure to improve the situation for commercial transportation.

Constraints which might limit the growth of barge traffic on the Upper Mississippi River include lock capacity, channel width and depth, navigational aids, horizontal and vertical clearance of bridges, legal constraints, terminals, barge fleeting areas, available equipment, winter ice conditions, and general economic conditions (GREAT II 1980c). In addition, other uses of the river (e.g., recreation) may conflict with additional barge traffic.

The passage of a commercial tow can impact the river system in several ways. One way is resuspension of sediments, resulting in increased turbidity, release of adsorbed nutrients and toxic compounds, changes in dissolved oxygen levels, and subsequent transport of sediment to productive backwater habitats (Lubinski et al. 1981a). In addition, there may be dramatic localized changes in current velocity (Eckblad 1981). These

Table 36. Principal species sought by interviewed anglers fishing Pools 11 and 13 in 1967-68 (after Wright 1970).

Species	Numbers and percentages of anglers			
	Pool 11		Pool 13	
	Number	Percent	Number	Percent
Bluegill and Crappie	235	14.6	1,477	32.9
Walleye and Sauger	111	6.9	172	3.8
Channel catfish	81	5.1	295	6.6
Bullheads	10	0.6	110	2.5
Largemouth bass	57	3.6	101	2.3
White bass	2	0.1	30	0.7
Freshwater drum	12	0.8	11	0.2
Northern pike	2	0.1	1	0.0
Carp	1	0.1	6	0.1
Yellow perch	-	-	157	3.5
Any species	1,090	68.0	437	9.7

Table 37. Estimated annual recreational use and expenditures for the Pool 11 to Pool 22 reach of the Upper Mississippi River (after UMRCC 1982).^a

Activity	Activity days	Expenditure	
		Av/person/day (\$)	Total (\$)
Sport fishing	4,899,411	12.50	61,242,637
Waterfowl hunting	205,000	17.00	3,485,000
Other recreation	8,905,605	15.00	133,584,075
Total	14,010,016		198,311,712

^aThe recreational use data in this table were obtained through surveys conducted during different seasons between the years 1972 and 1981.

abiotic factors are known to influence the structure and function of river ecosystems. For example, increased turbidity reduces light transmission, which has been shown to inhibit germination of aquatic macrophytes (Wetzel and McGregor 1968); it has also been shown that lower macrophyte population numbers are correlated with higher tow-traffic levels on the Upper Mississippi River (Lubinski et al. 1981b). A more complete discus-

sion of the environmental impacts of commercial navigation is presented in UMRBC (1981).

9.4 A SHALLOW RESERVOIR SYSTEM

The channel modifications and concomitant ecological changes on the Upper Mississippi River have been summarized by Fremling and Claflin (1984).

Table 38. Day use for recreational activities, excluding fishing and hunting in Pools 11 to 13 (after GREAT II 1980f).^a

Activity and year	Person-days		
	Pool 11	Pool 12	Pool 13
Picnicking			
1977-1978 day use	72,261	104,924	101,003
2000 (projected)	88,592	127,420	115,810
2025 (projected)	105,176	146,757	131,323
Camping			
1977-78 day use	54,196	67,892	87,536
2000 (projected)	66,444	82,448	100,368
2025 (projected)	78,882	94,960	113,814
Swimming			
1977-78 day use	42,152	24,688	20,201
2000 (projected)	51,679	29,981	23,162
2025 (projected)	61,823	34,531	26,265
Waterskiing			
1977-78 day use	30,109	37,032	53,868
2000 (projected)	36,913	44,972	61,765
2025 (projected)	43,823	51,797	76,039
Boating			
1977-78 day use	337,218	364,148	417,477
2000 (projected)	413,429	442,221	478,679
2025 (projected)	490,821	509,334	542,804

^aData should be used primarily for comparison of recreational uses between pools.

They note that the low-head navigation dams constructed in the 1930's transformed a free-flowing river into a series of shallow impoundments that occupied most of the river's floodplain. The aquatic surface area was both increased and stabilized, resulting in increased aquatic production. However, during the half century since impoundment, the role of these shallow reservoirs as sediment traps has reduced their initial diversity and productivity. The river's tributaries have steeper gradients than the river itself now has and deliver sediments faster than they are removed, causing the valley floor to aggrade. Other human influences within the watershed (e.g., deforestation and agricultural development) have increased the rate of sediment delivery from uplands to the river valley. It is cause for concern that present rates

of aggradation could fill major backwater areas within 50 to 100 years (McHenry et al. 1984). Some of these changes between 1956 and 1975 were addressed by GREAT II (1980d) and are shown in Table 39.

The backwater habitats of the Mississippi River are often subject to very poor water circulation during periods of low flow. Allochthonous materials can be delivered to and entrapped in backwaters during high-flow periods when surrounding lands are overtopped with water. This results in the accumulation of sediments and associated nutrients that can stimulate plant growth and accelerate the process of eutrophication (Smart 1977). Such a progression towards hypereutrophy in a shallow impoundment usually reduces the diversity of the aquatic biota.

Table 39. Changes in area of off-channel habitats between 1956 and 1975 (from GREAT II 1980d).

Type of change	Area (acres)		
	Pool 11	Pool 12	Pool 13
Aggradation fill			
Natural sedimentation	495	427	1,178
Spoil disposal	126	28	79
Fill for development	153	36	0
Erosion excavation			
Loss of forested areas	72	11	2
Excavation/borrow for fill	0	55	2
Other changes			
Clearing of woodlands for agriculture	204	2	20
Development of agricultural lands	12	69	42
Development of other habitats	7	151	24
Vegetation of dredged spoil	19	14	0
Pool Total	967	798	1,348

9.5 SOME POSSIBLE FUTURE CHANGES

As the Mississippi River continues to be a multiple-use resource, there will continue to be proposed changes that might perturb the present dynamic system. In recent years such changes as the establishment of a 12-ft navigation channel (as opposed to the present 9-ft channel), the dredging of backwater habitats, the building of more closing dams, the extending of the navigation season through the winter months, and the open-channel disposal of dredge spoil have all been suggested. Studies on the specific impacts of these activities are incomplete and further evaluation would be needed to more accurately predict their consequences for the Pool 11 to 13 reach of river.

The establishment of the Small-Scale Hydroelectric Development Program by the U.S. Department of Energy in 1977 stimulated a search for hydroelectric generating capabilities at presently undeveloped sites. The low-head dams of the Upper Mississippi do not currently have hydroelectric generating capabilities, but a number of them have been considered for future development; thus far this development has not been economically justifiable. A variety of concerns about how this development might influence river biota have been expressed (e.g., Holland et al. 1984b). Additional studies will be needed, particularly on the impacts of fluctuating water levels, to determine the stress imposed on the tailwater communities and the water supplies to productive backwater habitats.



REFERENCES

- Ackelson, M.C. 1978. Recreation facility inventory, 1978. Upper Mississippi River Conservation Committee, Rock Island, Ill.
- Ackerman, G.L. 1976a. Survey of freshwater mussels of the Upper Mississippi River. Upper Mississippi River Conservation Committee, Rock Island, Ill. 9 pp.
- Ackerman, G.L. 1976b. Clamming the Mississippi River. Iowa Conserv. 35:14-15.
- Ackerman, G.L. 1977. Pre-alteration study of fishery and morphology of Cassville Slough. Iowa Conservation Commission. Work Proj. Rep. 77-II-C-15, Des Moines.
- Ackerman, G.L. 1978. Pre-alteration study of the fisheries of Cassville Slough. Iowa Conservation Commission, Work Proj. Rep. 78-II-C-14, Des Moines.
- Ackerman, G.L. 1980. Freshwater mussel survey of Swift Slough. U.S. Army Corps of Engineers, 6 pp.
- Anderson, W.I. 1983. Geology of Iowa. Iowa State University Press, Ames. 267 pp.
- Baker, H.G. 1978. Plants and civilization, 3rd ed. Wadsworth Publ. Co., Belmont, Calif. 198 pp.
- Barnickol, P.G., and W.C. Starrett. 1951. Commercial and sport fishes of the Mississippi River between Caruthersville, Missouri, and Dubuque, Iowa. Ill. Nat. Hist. Surv. Bull. 25(5):267-350.
- Barnes, J.R., and G.W. Minshall, eds. 1983. Stream ecology, application and testing of general ecological theory. Plenum Press, New York. 399 pp.
- Berg, C.O. 1949. Limnological relations of insects to plants of the genus *Potamogeton*. Trans. Am. Micros. Soc. 68:279-291.
- Berner, L.M. 1951. Limnology of the lower Missouri River. Ecology 32:1-12.
- Bertrand, B.A. 1974. Fishing the Mississippi. Illinois Department of Conservation. Division of Fisheries, Springfield, Ill. 28 pp.
- Bertrand, B.A., and T. Miller. 1973. Fish population survey of aquatic habitat types in Pools 12 and 13 of the Mississippi River. Illinois Department of Conservation, Division of Fisheries, Springfield. Unpubl. mimeo. 14 pp.
- Bhowmik, N.G., J.R. Adams, A.P. Bonini, C. Guo, D. Kisser, and M. Sexton. 1981. Resuspension and lateral movement of sediment by tow traffic on the Upper Mississippi and Illinois Rivers. Report for Environmental Work Team, UMRBC Master Plan, Minneapolis, Minn. 112 pp.
- Bilby, R.E., and G.E. Likens. 1980. Importance of organic debris dams in the structure and function of stream ecosystems. Ecology 61:1107-1113.
- Black Hawk. 1932. Life of Black Hawk. State Historical Society of Iowa, Iowa City. 155 pp.
- Boland, T. 1980. A classification of the wing and closing dams on the Upper Mississippi River bordering Iowa. Iowa Conserv. Commission, Des Moines Fish and Wildlife Management Workgroup, Great River Environmental Action Team, DACW 25-79-C 0056.

- Boland, T., and G. Ackerman. 1982. Investigations of tailwater walleye and sauger fisheries of the Upper Mississippi River. Project No. 82-II-C-11. Iowa Conservation Commission, Des Moines.
- Boland, T., and G. Reetz. 1979. Species composition, catch-per-unit-effort and seasonal distribution of fishes of Brown's Lake and the Green Island Drainage District. Iowa Conservation Commission, Project No. 79-II-C-ADDED, Des Moines.
- Botkin, B.A. 1955. A treasury of Mississippi River folklore. American Legacy Press, New York. 620 pp.
- BPD (Brice, Petrides--Donohue). 1984. Chemical analyses of sediments and mussel tissue, Pool 15, Upper Mississippi River. U.S. Army Corps of Engineers, Rock Island, Ill. 19 pp.
- Brinkhurst, R.O. 1972. The role of sludge worms in eutrophication. U.S. Environ. Protect. Agency, Ecol. Res. Ser. EPA-72-004.
- Brinkhurst, R.O. and D.G. Cook. 1974. Pages 143-156 in C.W. Hart, Jr., and S.L.H. Fuller, eds. Pollution ecology of freshwater invertebrates. Academic Press, New York.
- Brunet, P.J. 1977. The Corps of Engineers and navigation improvement on the channel of the Upper Mississippi River to 1939. M.A. Thesis. University of Texas at Austin. 195 pp.
- Carlander, H.B. 1954. History of fish and fishing in the Upper Mississippi River. Upper Mississippi River Conservation Committee. Rock Island, Ill. 96 pp.
- Carlson, C.A. 1968. Summer bottom fauna of the Mississippi River, above dam 19, Keokuk, Iowa. Ecology 19:162-169.
- Cawley, E.T. 1975. Tree growth rates on spoil areas in Pool 13, Upper Mississippi River. U.S. Army Corps of Engineers, Rock Island, Ill. 8 pp.
- Cawley, E.T. 1976. Tree growth rates on spoil areas in Pool 13, Upper Mississippi River. U.S. Army Corps of Engineers, Rock Island, Ill.
- Cawley, E.T. 1977. Study of the environmental impacts of dredging by the Dubuque Sand and Gravel Co. in Pool 12 of the Upper Mississippi River. U.S. Army Corps of Engineer, Rock Island, Ill. Undesignated letter/rep. 7 pp.
- Cawley, E.T. 1978a. Biological impacts study of winter navigation Pool 12, Upper Mississippi River. U.S. Army Corps of Engineers, Rock Island, Ill. 17 pp.
- Cawley, E.T. 1978b. Report of a mussel survey of the 561 Mississippi River Bridge Site (Mile 581.5) of the Upper Mississippi River. Iowa Department of Transportation, Des Moines.
- Clark, W.R., R.T. Clay, K.R. Utterson, and K.L. Johnson. 1983. Relationship of substrate to the distribution and production of *Sagittaria* in the Upper Mississippi River. U.S. Fish and Wildlife Service, Letter Order No. NCR-LO-83-C9, Rock Island, Ill.
- Clay, R.T. 1983. Population characteristics and habitat of muskrats on Pool Nine, Upper Mississippi River. M.S. Thesis. Iowa State University, Ames. 72 pp.
- Corley, S.D. 1982. Influence of wing dam notching on fish, aquatic macroinvertebrates, hydrographic relief, current velocity, substrate, water temperature, and dissolved oxygen in Pool 13, Upper Mississippi River. M.S. Thesis. University of Wisconsin, Stevens Point. 219 pp.
- Cummins, K.W. 1972. What is a river? Zoological description. Pages 33-52 in R.T. Oglesby, C.A. Carlson, and J.A. McCann, eds. River ecology and man. Academic Press, New York.
- Cummins, K.W. 1973. Trophic relationships of aquatic insects. Annu. Rev. Entomol. 18:183-206.

- Cummins, K.W. 1974. Structure and function of stream ecosystems. *BioScience* 24:631-641.
- Cummins, K.W. 1975. Macroinvertebrates. Pages 170-198 in B.A. Whitton, ed. *Studies in ecology*. Vol. 2: River ecology. University of California Press, Los Angeles.
- Cummins, K.W. 1979. The natural stream ecosystems. Pages 7-24 in J.V. Ward and J.A. Stanford, eds. *The ecology of regulated streams*. Plenum Press, New York.
- Davis, S., and E.T. Cawley. 1975. A survey of the freshwater mussels (Pelecypoda) of the Mississippi River in Pool 12. Loras College, Dubuque, Iowa.
- Denny, P. 1972. Sites of nutrient absorption in aquatic macrophytes. *J. Ecol.* 60: 819-829.
- Dorris, T.C. 1958. Limnology of the middle Mississippi River and adjacent waters. *Am. Midl. Nat.* 59(1):82-111.
- Dunham, L.L. 1970. Fish sampling by electro-fishing gear below ten navigation dams on the Mississippi River. Illinois Department of Conservation, Urbana.
- Dunstan, T.C., and E. Fawks. 1981. Documentation of bald eagle wintering areas and populations in Illinois. Illinois Department of Conservation, Urbana. 113 pp.
- Eckblad, J.W. 1978. Laboratory manual of aquatic biology. Wm. C. Brown Co. Dubuque, Iowa. 231 pp.
- Eckblad, J.W. 1981. Baseline studies and impacts of navigation on the benthos and drift, on the quantity of flow to side channels, and on the suspended matter entering side channels of Pool 9 of the Upper Mississippi River. Environmental Work Team document for the Comprehensive Master Plan for the Management of the Upper Mississippi River, Upper Mississippi River Basin Commission, Minneapolis, Minn.
- Eckblad, J.W., N.L. Peterson, K. Ostlie, and A. Temte. 1977. The morphometry, benthos and sedimentation rates of floodplain lake in Pool 9 of the Upper Mississippi River. *Am. Midl. Natur.* 97:433-443.
- Eckblad, J.W., C.S. Volden, and L.S. Weilgart. 1984. Allochthonous drift from backwaters to the main channel of the Mississippi River. *Am. Midl. Natur.* 111:16-22.
- Ecological Analysts, Inc. 1981. Survey of freshwater mussels (Pelecypoda: Unionacea) at selected sites in Pools 11 through 24 of the Mississippi River. U.S. Army Corps of Engineers, Rock Island, Ill. 188 pp.
- Eddy, S. 1934. A study of freshwater plankton communities. *Ill. Biol. Monogr.* 12(4):1-93.
- Ellis, J.M., G.B. Farabee, and J.B. Reynolds. 1979. Fish communities in three successional stages of side channels in the stages of side channels in the Upper Mississippi River. *Trans. Mo. Acad. Sci.* 13:5-20.
- Ellis, M.M. 1936. Erosion silt as a factor in aquatic environments. *Ecol.* 17:29-42.
- Fassett, N.C. 1957. A manual of aquatic plants. University of Wisconsin Press, Madison. 405 pp.
- Fisher, J.B. 1982. Effects of macrobenthos on the chemical diagenesis of freshwater sediments. Pages 177-218 in P.L. McCall and M.J.S. Tevesz, eds. *Animal-sediments*. Plenum Press, New York.
- Fleener, G.G., and M.B. Gogel. 1979. Mississippi River recreational facilities guide, Minneapolis, Minnesota, to the mouth of the Ohio River. Upper Mississippi River Conservation Committee, Rock Island, Ill. 66 pp.
- Forbes, S.A. 1928. The biological survey of a river system, its objects, methods, and results. *Bull. Ill. Nat. Hist. Surv.* 17(7):277-284

- Forbes, S.A., and R.E. Richardson. 1913. Studies on the biology of the Upper Illinois River. Ill. Nat. Hist. Surv. 9(10). 95 pp.
- Fremling, C.R. 1970. Mayfly distribution as a water quality index. U.S. Environ. Protect. Agency (Washington, D.C.) Water Pollut. Control Res. Ser. No. 16030 DQH. 37 pp.
- Fremling, C.R., and T.O. Clafin. 1984. Ecological history of the Upper Mississippi River. Pages 5-24 in J.G. Wiener, R.V. Anderson, and D.R. McConville, eds. Contaminants in the Upper Mississippi River. Ann Arbor Science Book. Butterworth Publisher, Boston, Mass.
- Friedlein, M.T. 1978. A fall season stomach content analysis of the shovelnose sturgeon in Pool 13 of the Upper Mississippi River. B.A. Thesis. Loras College, Dubuque, Iowa. 19 pp.
- Fritsch, F.E. 1905. The plankton of some English rivers. Annu. Bot. London 19:163-167.
- Fuller, S.L.H. 1974. Clams and mussels (Mollusca: Bivalvia). Pages 215-273 in C.W. Hart, Jr. and S.L.H. Fuller, eds. Pollution ecology of freshwater invertebrates. Academic Press, New York.
- Fuller, S.L.H. 1978. Freshwater mussels (Mollusca: Bivalvia: Unionidae) of the Upper Mississippi River: observations at selected sites within the 9-foot channel navigation project on behalf of the United States Army Corps of Engineers. Am. Midl. Nat. 111:16-22.
- Galtsoff, P.S. 1924. Limnological observations in the Upper Mississippi. Bull. Bur. Fish. 39:347-438.
- Gengerke, T.W. 1977. Northern pike investigations. Iowa Conserv. Comm. Complet. Rep. Proj. No. 2-225-R Des Moines.
- Gengerke, T.W. 1978. Paddlefish investigations. Iowa Conserv. Comm. Fish. Sect. Commer. Fish. Invest. Proj. Complet. Rep. 2-255-R, Des Moines.
- Goeman, T.J. 1983. Freshwater drum spawning and fecundity in the Upper Mississippi River. Proc. Iowa Acad. Sci. 90:132-133.
- Great River Environmental Action Team (GREAT II). 1980a. Water quality work group appendix. Rock Island, Ill. 216 pp.
- Great River Environmental Action Team (GREAT II). 1980b. Literature review of fish and wildlife resources annotated bibliography. U.S. Army Corps of Engineers, Rock Island, Ill. 384 pp. + appendixes.
- Great River Environmental Action Team (GREAT II). 1980c. Commercial transportation work group appendix. Rock Island, Ill. Various pagings.
- Great River Environmental Action Team (GREAT II). 1980d. Side channel work group appendix. Rock Island, Ill. 229 pp.
- Great River Environmental Action Team (GREAT II). 1980e. Fish and wildlife management work group appendix. Rock Island, Ill. 361 pp.
- Great River Environmental Action Team (GREAT II). 1980f. Recreation work group appendix. Rock Island, Ill. 470 pp.
- Great River Environmental Action Team (GREAT II). 1980g. Sediment and erosion work group appendix. Rock Island, Ill. 83 pp.
- Great River Environmental Action Team (GREAT II). 1980h. Channel maintenance handbook (supplement to main report, GREAT II). Rock Island, Ill. 35 pp + exhibits.
- Great River Environmental Action Team (GREAT II). 1980i. Cultural resources work group appendix. Great River Environmental Action Team, Rock Island, Ill.
- Green, W.E. 1960. Ecological changes on the Upper Mississippi River Wildlife and Fish Refuge since inception of the 9-foot channel. U.S. Fish and Wildlife Service, Winona, Minn. 17 pp.

- Grier, N.M., and J.F. Mueller. 1922. Notes on the naiad fauna of the Upper Mississippi. II. The naiades of the Upper Mississippi drainage. *Nautilus* 36:46-103.
- Gutreuter, S.J. 1980. Factors affecting fish community structure and habitat preference in Mississippi River backwaters. M.S. Thesis. University of Missouri, Columbia. 126 pp.
- Hagen, R., L. Werth, and M. Meyer. 1977. Upper Mississippi River habitat inventory final report. Remote Sensing Laboratory, University of Minnesota, St. Paul. 18 pp + appendices.
- Hall, T.J. 1980. Influence of wing dam notching on aquatic macroinvertebrates in Pool 13, Upper Mississippi River: the prenotching study. M.S. Thesis. University of Wisconsin, Stevens Point. 168 pp.
- Harris, S.E., C.W. Horrell, and D. Irwin. 1977. Exploring the land and rocks of southern Illinois. Southern Illinois University Press, Carbondale. 240 pp.
- Haslam, S.M. 1978. River plants--the macrophytic vegetation of watercourses. Cambridge University Press, New York. 369 pp.
- Havlik, M.E. 1980. The historic and present distribution of the endangered naiad mollusk, *Lampsilis higginsii* (Lea, 1857). *Bull. Am. Malacol. Union, Inc.*: 19-22.
- Helms, D. 1974. Shovelnose sturgeon in the Mississippi River, Iowa. *Iowa Conserv. Tech. Ser.* 74-3. 33 pp.
- Holland, L.E., and M.L. Huston. 1983. A compilation of available literature on the larvae of fishes common to the Upper Mississippi River. U.S. Army Corps of Engineers, Rock Island, Ill. Letter Order No. NCR-LO-83-C9. 364 pp.
- Holland, L.E., D. Huff, S. Littlejohn, and R. Jacobson. 1984a. Analysis of existing information on adult fish movements through dams on the Upper Mississippi River. U.S. Army Corps of Engineers, St. Paul, Minn.
- Holland, L.E., T. Hornung, M. Huston, and D. Duval. 1984b. Analysis of existing information on ichthyoplankton drift through dams on the Upper Mississippi. U.S. Army Corps of Engineers, St. Paul, Minn.
- Hoopes, D.T. 1960. Utilization of mayflies and caddisflies by some Mississippi River fishes. *Trans. Am. Fish. Soc.* 89:32-34.
- Holzer, J.A. 1978. Determination and significance of wing dams, riprap, and sand as fishery habitat. In Mississippi River work unit annual report, 1977-78. Wisconsin Department of Natural Resources, La Crosse.
- Hora, M.E. 1976. Polychlorinated biphenyls (PCBs) in the Upper Mississippi River Basin--Minnesota-Wisconsin PCB Interagency Task Force. Minnesota Pollution Control Agency, Roseville.
- Horowitz, R.J. 1978. Temporal variability patterns and the distribution of stream fishes. *Ecol. Monogr.* 48:307-321.
- Houghton, G.U. 1972. Long-term increases in planktonic growth in the Essex Stour. *Wat. Treat. Exam.* 21:299-308.
- Hotchiss, N. 1967. Underwater and floating-leaved plants of the United States and Canada. Bureau of Sport Fisheries and Wildlife, Washington, D.C. 124 pp.
- Hubert, W.A., G.E. Darnell, and D.E. Daniel. 1983. Evaluation of wintering benthic macroinvertebrates of Pool 13 of the Upper Mississippi River. U.S. Army Corps of Engineers, Rock Island, Ill. Report letter Order No. NCR-LO-83-C12.
- Hurlburt, S.H. 1971. The nonconcept of species diversity: a critique and alternative parameters. *Ecology.* 52:577-586.
- Hurley, S.T. 1983. Habitat associations and movements of shovelnose sturgeon in Pool 13 of the Upper Mississippi River. M.S. Thesis. Iowa State University, Ames. 82 pp.

- Hurley, S.T., W.A. Hubert, and J.G. Nickum. 1983. Habitat associations and movements, with reference to spawning, of shovelnose sturgeon in Pool 13. Iowa Cooperative Fishery Unit, Iowa State University, Ames.
- Hynes, H.B.N. 1970. The ecology of running waters. University of Toronto Press, Canada. 555 pp.
- Ingram, K.M. 1979. A summer season stomach content analysis of the shovelnose sturgeon in Pool 13 of the Mississippi River. B.S. Thesis. Loras College, Dubuque, Iowa.
- Iowa State Conservation Department. 1958. Progress report: walleye and sauger studies in the Mississippi River in Iowa, 1958. Iowa State Conserv. Dep. Proj. No. F-53-R, Job No. 2.
- Jahn, L.A., and R.V. Anderson. In press. The ecology of Pool 19 and 20 of the Upper Mississippi River: an ecological profile. U.S. Fish Wildl. Serv. Biol. Rep.
- Johnsgard, P.A. 1975. Waterfowl of North America. Indiana University Press, Bloomington.
- Keammerer, W.R., W.C. Johnson, and R.L. Burgess. 1975. Floristic analysis of the Missouri River bottomland forests in North Dakota. Can. Field-Nat. 89:5-19.
- Klopatek, J.M. 1978. Nutrient dynamics of freshwater riverine marshes and the role of emergent macrophytes. Pages 195-216 in R.E. Good, D.F. Whigham, and R.L. Simpson, eds. Freshwater wetlands-ecological processes and management potential. Academic Press. New York.
- Klots, E.B. 1966. The new field book of freshwater life. G.P. Putnam's Sons, New York. 398 pp.
- Knott, M.J. 1979. The pearl button industry and its impacts on the Mississippi River mussel fauna. Page 11-17 in Rasmussen, J.L., ed. Proceedings of the UMRCC symposium on Upper Mississippi River bivalve mollusks. Upper Mississippi River Conservation Committee, Rock Island, Ill.
- Koehl, M.A. 1984. How do benthic organisms withstand moving water? Am. Zool. 24:57-70.
- Kofoid, C.A. 1903. Plankton studies IV. The plankton of Illinois River 1894-1899 with introductory notes on the hydrography of the Illinois River and its basin. Ill. State Lab. Nat. Hist. Bull. 6:95-635.
- Kofoid, C.A. 1908. The plankton of the Illinois River, 1894-1899. Part 2: Constituent organisms and their seasonal distribution. Bull. Ill. State Lab. Nat. Hist. 8:2-360.
- Lack, T.J. 1971. Quantitative studies on the phytoplankton of the Rivers Thames and Kennet at Reading. Freshwater Biol. 1:213-224.
- Ladle, M., and H. Casey. 1971. Growth nutrient relationships of Ranunculus penicillatus var. calcareus in a small chalk stream. Pages 53-64 in Proceedings of the Evergreen Weed Research Council, third international symposium on aquatic weeds.
- Lane, E.W. 1957. A study of the shape of channels formed by natural streams flowing in erodible material. U.S. Army Corps of Engineers, Mo. River Div. Sediment Ser. No. 9, Omaha.
- LGL Ecology Research Association, Inc. 1981. Study of fish in the main channel of the Mississippi River miles 500 and 513.5. Fish and Wildlife Management Work Group, GREAT II. U.S. Fish and Wildlife Service, Rock Island, Ill.
- Lubinski, K.S., H.H. Seagle, N.G. Bhowmik, J.R. Adams, M.A. Sexton, J. Buhnerkempe, R.L. Allgire, D.K. Davie, and W. Fitzpatrick. 1981a. Information summary of the physical, chemical and biological effects of navigation. Upper Mississippi River Basin Commission, Minneapolis, Minn. 131 pp.
- Lubinski, K.S., M.J. Wallendorf, and M.C. Reese. 1981b. Compilation and correlation of data related to physical, biological and navigation system conditions of the Upper Mississippi River System. Upper Mississippi River

- Basin Commission, Minneapolis, Minn. 84 pp.
- Lyman, F.E. 1943. A pre-impoundment bottom fauna study of the Watts Bar Reservoir area (Tennessee). *Trans. Am. Fish. Soc.* 72:52-62.
- Magee, D.W. 1981. Freshwater wetlands--a guide to common indicator plants of the northeast. University of Massachusetts Press, Amherst. 245 pp.
- Marcoux, R.G. 1966. Occurrence of a melanistic paddlefish (*Polyodon spathula*) in Montana. *Copeia* 1966:876.
- Margalef, R.C. 1960. Ideas for a synthetic approach to the ecology of running waters. *Int. Rev. Gesamten Hydrobio.* 45:133-153.
- Marzolf, G.R. 1980. The potential effects of clearing and snagging on stream ecosystems. U.S. Fish Wildl. Serv. FWS/OBS-78/14. 38 pp.
- Mathiak, H.A. 1979. A river survey of the unionid mussels of Wisconsin 1973-77. Sand Shell Press, Horicon, Wis. 75 pp.
- McCall, P.L., M.J.S. Tevesz, and S. F. Schwegien. 1979. Sediment mixing by *Lampsilis radiata siliquoidea* (Mollusca) from western Lake Erie. *J. Great Lakes Res.* 5:105-111.
- McDonald, D.B., and J.L. Konefes. 1977. Pre and post habitat conditions resulting from 9 ft. navigation channel, Upper Mississippi River, Pool 11-12. U.S. Army Corps of Engineers Contract No. DACW-25-76-M-1855. 8 pp.
- McHenry, J.R., J.C. Ritchie, C.C. Cooper, and J. Verdon. 1984. Recent rates of sedimentation in the Mississippi River. Pages 99-117 in J.G. Wiener, R.V. Anderson, and D.R. McConville, eds. Contaminants in the Upper Mississippi River, Ann Arbor Science Book, Butterworth Publ., Boston, Mass.
- McKee, J.E., and H.W. Wolf, eds. 1963. Water quality criteria. The resources agency of California State Water Resources Control Board. Sacramento. 548 pp.
- Mikulski, J.W. 1961. Ecological studies upon bottom communities in the River Wisla (Vistula). *Verh. Int. Ver. Limnol.* 14:372-375.
- Minshall, G.W. 1978. Autotrophy in stream ecosystems. *BioScience* 28:767-771.
- Minshall, G.W., R.C. Petersen, K.W. Cummins, T.L. Bott, J.R. Sedell, C.E. Cushing, and R.L. Vannote. 1983. Interbiome comparison of stream ecosystem dynamics. *Ecol. Monogr.* 53: 1-25.
- Mohlenbrook, R.H. 1983. Annotated bibliography of the aquatic macrophytes of the Upper Mississippi River - Cairo to St. Paul. U.S. Fish and Wildlife Service, Ecological Services, Contract No. 14-16-0003-83-041. Rock Island, Ill.
- Monakov, A.K. 1972. Review of studies on feeding of aquatic invertebrates conducted at the institute of Biology of Inland Waters. *Acad. Sci. USSR, J. Fish. Res. Board Can.* 29:363-383.
- Moon, H.P. 1939. Aspects of the ecology of aquatic insects. *Trans. Soc. Br. Ent.* 6:39-49.
- Morista, M. 1959. Measuring of interspecific association and similarity between communities. *Mem. Fac. Sci. Kyushu Univer. Ser. E (Biol.)* 3:65-80.
- Mulligan, H.F., and A. Baranowski. 1969. Growth of phytoplankton and vascular aquatic plants at different nutrient levels. *Verh. Int. Ver. Theor. Angew. Limnol.* 17:802-810.
- Musgrove, J.W. 1977. Waterfowl in Iowa. Iowa Conservation Commission, Des Moines. 130 pp.
- Nakato, T. 1980. Sediment-budget study of the Upper Mississippi River. GREAT II reach. Sediment and Erosion Control Work Group, Great River Environmental Action Team II, Rock Island, Ill.
- Nelson, D.A. 1980. Unique and sensitive areas within the Rock Island District, Upper Mississippi River. U.S. Army Corps of Engineers, Rock Island, Ill.

- Nicklaus, R.H. 1977. Heron-egret-cormorant rookery directory. Wildlife Technical Section, Upper Mississippi Conservation Committee, Quincy, Ill.
- Nikolski, G.V. 1933. On the influence of the rate of flow on the fish fauna of the rivers of Central Asia. *J. Anim. Ecol.* 2:266-281.
- Nobel, P.S. 1983. Biophysical plant physiology and ecology. W.H. Freeman & Co., San Francisco, Calif. 608 pp.
- Odum, H.T. 1983. Systems ecology: an introduction. John Wiley and Sons, New York. 644 pp.
- Olson, K.N., and M.P. Meyer. 1976. Vegetation, land and water surface changes in the upper Mississippi River basin over the period 1939-1973. Project Contract No. DACW-37-74-C-00043. U.S. Army Corps. of Engineers, St. Paul, Minn. 19 pp.
- Paloumpis, A.A., and W.C. Starrett. 1960. An ecological study of benthic organisms in three Illinois River flood plain lakes. *Am. Midl. Nat.* 64:406-435.
- Patrick, R., Crum. B. and J. Coles. 1969. Temperature and manganese as determining factors in the presence of diatom or blue-green algal floras in streams. *Proc. Nat. Acad. Sci.* 64:472-478.
- Peck, J.H., and M.M. Smart. 1985. Bibliography to Upper Mississippi River aquatic and wetland plant literature. *Proc. Iowa Acad. Sci.* 92:78-84.
- Peltier, W.H., and E.B. Welch. 1969. Factors affecting growth of rooted aquatics in a river. *Weed Sci.* 17: 412-416.
- Perry, E.W. 1979. A survey of Upper Mississippi River mussels, 2nd ed. Pages 118-139 in J.L. Rasmussen, ed. *Compendium of fishery information on the Upper Mississippi River.* Upper Mississippi River Conservation Committee, Rock Island, Ill.
- Peterson, G., ed. 1984. Upper Mississippi River Resources Inventory (Hannibal, MO to Guttenberg, IA). U.S. Fish and Wildlife Service, Rock Island, Ill.
- Pierce, R.B. 1980. Upper Mississippi River Wing Dam notching: the pre-notching fish study. M.S. Thesis, University of Wisconsin, Stevens Point. 269 pp.
- Pierce, R.B., D.W. Coble, and S. Corley. 1981. Fish catches in baited and unbaited hoop nets in the Upper Mississippi River N. *Am. J. Fish Manage.* 1:204-206.
- Pitlo, J. 1981. Wing dam investigations. Iowa Conser. Comm. Compl. Rep. Proj. No. 2-350-R. Des Moines.
- Pitlo, J. 1983. Wing and closing dam investigations. *Conserv. Comm. Proj. No. F-96-R-2.* Des Moines.
- Purdy, W.C. 1923. A study of the pollution and natural purification of the Ohio River I: Plankton and related organisms. U.S. Pub. Health Serv. Bull. 131:5-78.
- Purdy, W.C. 1930. A study of the pollution and natural purification of the Ohio River. I: Plankton and related organisms. U.S. Pub. Health Serv. Bull. 198. 212 pp.
- Rada, R.G., M.M. Smart, and T.O. Claflin. 1980. A characterization of navigation Pool 9, Upper Mississippi River, and site selections to determine impacts of commercial and recreational navigation. River Studies Center, La Crosse, Wis. 114 pp.
- Rahn, M. 1983. A history of wildlife and hunting on the Upper Mississippi River. Upper Mississippi River Conservation Committee, Rock Island, Ill. 105 pp.
- Rasmussen, J.L., ed. 1979. A compendium of fishery information on the Upper Mississippi River. Upper Mississippi River Conservation Committee, Rock Island, Ill. 375 pp.
- Rasmussen, J.L., ed. 1980. Proceedings of the UMRCC Symposium on Upper Mississippi River bivalve mollusks. Upper

- Mississippi River Conservation Committee, Rock Island, Ill. 269 pp.
- Rasmussen, J.L. 1980. Directory of field biologists and law enforcement officers along the Upper Mississippi River (revised: June 1980). Upper Mississippi River Conservation Committee, Rock Island, Ill.
- Rasmussen, J.L. 1984. Experimental primacord detonation to sample fish populations of Upper Mississippi River (UMR) main channel border habitat. U.S. Fish and Wildlife Service, Rock Island, Ill. 22 pp.
- Rau, C. 1884. Prehistoric fishing in Europe and North America. Smithsonian Institution, Washington, D.C.
- Reinhard, E.G. 1931. The plankton ecology of the Upper Mississippi, Minneapolis to Winona. Ecol. Monogr. 1:395-464.
- Richardson, R.E. 1921. The small bottom and shore fauna of the middle and lower Illinois River and its connecting lakes, Chillicothe to Grafton, its valuation, its sources of food supply, and its relation to the fishery. Bull. Ill. State Nat. Hist. Surv. 13:363-522.
- Rosen, R.A., D.C. Hales, and D.G. Unkenholz. 1982. Biology and exploitation of paddlefish in the Missouri River below Gavins Point Dam. Trans. Am. Fish. Soc. 111:216-22.
- Schnick, R.A., J.M. Morton, J.C. Mochalski, and J.T. Beall. 1982. Mitigation and enhancement techniques for the Upper Mississippi River system and other larger river systems. U.S. Fish Wildl. Serv. Resour. Publ. 149. 714 pp.
- Schofield, E.N. 1975. Springtime food items of the shovelnose sturgeon Scaphirhynchus platorhynchus (Rafinesque) in Pool 13 of the Mississippi River. B.S. Thesis. Loras College, Dubuque, Iowa. 16 pp.
- Schramm, H.L., Jr., and W.M. Lewis. 1974. Study of importance of backwater chutes to a riverine fishery. U.S. Army Corps of Engineers Waterways Experiment Station, Contract DACW30-73-C-0015. Vicksburg, Miss. 145 pp.
- Sculthorpe, C.D. 1967. The biology of aquatic vascular plants. Edward Arnold Publ. Ltd., London. 610 pp.
- Seegert, G., R. Lewis, and R. Bockelman. 1984. Aquatic studies of the main channel border habitat of Pool 5A on the Upper Mississippi River. U.S. Army Corps of Engineers, St. Paul, Minn.
- Sefton, D.F. 1976. The biomass and productivity of aquatic macrophytes in navigation pool 8 of the Upper Mississippi River. M.S. Thesis. University of Wisconsin, La Crosse. 175 pp.
- Shaeffer, W.A., and J.G. Nickum. 1984a. Relative abundance of macroinvertebrates found in habitats associated with backwater area confluences on the Upper Mississippi River, Pool 13. Iowa Coop. Fish. Res. Unit, Iowa State Univ. (Ames). J. Pap. J-11536.
- Shaeffer, W.A., and J.G. Nickum. 1984b. Importance of habitats associated with backwater area confluences as nursery areas for fishes of the Upper Mississippi River, Pool 13. Iowa Coop. Fish. Unit. Iowa State Univ. (Ames). J. Pap. J-11538.
- Simons, D.B., P.F. Lagasse, Y.H. Chen, and S.A. Schumm. 1975. The river environment--a reference document. U.S. Fish and Wildlife Service. Twin Cities, Minn.
- Simons, D.B., R.M. Li, Y.H. Chen and S.S. Ellis. 1981. Water quality in the Upper Mississippi River system affected by sediment resuspension due to the navigation activities. Upper Mississippi River Basin Commission, Minneapolis, Minn. 57 pp.
- Simpson, E.H. 1949. Measurement of diversity. Nature 163:688.
- Smart, M.M. 1977. Nitrogen and phosphorus cycling by Nymphaea tuberosa and Ceratophyllum demersum in Lake Onalaska. Navigation Pool No. 7 of the Upper Mississippi River. M.S. Thesis. University of Wisconsin, La Crosse.

- Smith, H.M. 1899. The mussel fishery and pearl button industry of the Mississippi River. Bull. U.S. Fish Comm. 8:289-314.
- Southall, P.D. 1982. Paddlefish movement and habitat use in the Upper Mississippi River. M.S. Thesis. Iowa State University, Ames. 100 pp.
- Southall, P.D., and W.A. Hubert. 1984. Habitat use by adult paddlefish in the Upper Mississippi River. Trans. Am. Fish. Soc. 113:125-131.
- Stang, D.L., and J.G. Nickum. 1983. Radio tracking of catfish and buffalo under winter conditions in Pool 13, Upper Mississippi River. U.S. Fish and Wildlife Service, Rock Island, Ill.
- Stang, D.L., and J.G. Millar. 1984. Evaluation of environmental impacts of thalweg disposal of dredged material - interim report, phase I. U.S. Army Corps of Engineers, Rock Island, Ill. Letter Order No. NCR-LO-83-C1.
- Starret, W.C., and P.G. Barnickol. 1955. Efficiency and selectivity of commercial fishing devices used on the Mississippi River. Bull. Ill. Nat. Hist. Surv. 26:325-366.
- Swale, E.M.F. 1969. Phytoplankton in two English rivers. J. Ecol. 57:23.
- Swanson, G.E. 1967. Factors influencing the distribution and abundance of *Hexagenia* nymphs (Ephemeroptera) in a Missouri River reservoir. Ecology 48:216-225.
- Thiel, P.A. 1981. A survey of unionid mussels in the Upper Mississippi River (Pools 3 through 11). Wis. Dep. Nat. Resour. Tech. Bull. 124. 24 pp.
- Thompson, D.H. 1977. Declines in populations of waterbirds nesting within the floodplain of the Upper Mississippi River. Pages 26-37 in Proceedings of the Colonial Waterbird Group Conference, 20-23 October 1977, Dekalb, Ill.
- Thompson, D.H., and M.C. Landin. 1978. An aerial survey of waterbird colonies along the Upper Mississippi River and their relationship to dredged material deposits. U.S. Army Corps Eng. Exp. Stn. Tech. Rep. D-78-13. 103 pp.
- Troeger, J.C. 1983. From rift to drift: Iowa's story in stone. Iowa State University Press, Ames. 152 pp.
- Tweet, R. 1975. A history of the Rock Island District Corps of Engineers. U.S. Army Corps of Engineers Rock Island, Ill. 171 pp.
- UMRBA. 1983. Recreation in the Upper Mississippi River System: an overview of facility needs. Upper Mississippi River Basin Association, St. Paul, Minn. 27 pp.
- UMRBC. 1981. Technical report D, environmental report. Comprehensive master plan for the management of the Upper Mississippi River system. Upper Mississippi River Basin Commission, Twin Cities, Minn.
- UMRBC. 1982. Comprehensive master plan for the management of the Upper Mississippi River system; 23 environmental studies. Upper Mississippi River Basin Commission, Twin Cities, Minn.
- UMRCC. 1981. Proceedings of the 37th annual meeting Upper Mississippi River Conservation Committee, St. Louis, Mo. 132 pp.
- UMRCC. 1982. Outdoor recreation: big business on the Upper Mississippi River system. Upper Mississippi River Conservation Committee, Rock Island, Ill.
- U.S. Army Corp of Engineers - Rock Island. 1974a. Draft environmental impact statement for Upper Mississippi River 9-foot navigation, Pool 11. Rock Island, Ill.
- U.S. Army Corps of Engineers - Rock Island. 1974b. Draft environmental impact statement for Upper Mississippi River 9-foot navigation, Pool 12. Rock Island, Ill.
- U.S. Army Corps of Engineers - Rock Island. 1974c. Draft environmental impact statement for Upper Mississippi

- River 9-foot navigation. Pool 13. Rock Island, Ill.
- U.S. Army Corps of Engineers. 1981. Tabulation and analysis of waterborne movements on the Upper Mississippi River, 1969-1978. Upper Mississippi River Basin Commission, Minneapolis, Minn.
- Vannote, R.L., G.W. Minshall, K.W. Cummins, J.R. Sedell, and C.E. Cushing. 1980. The river continuum concept. *Can. J. Fish. Aquat. Sci.* 37:370-377.
- van der Schalie, H., and A. van der Schalie. 1950. The mussels of the Mississippi River. *Am. Midl. Natur.* 44:448-466.
- Van Vooren, A. 1983. Distribution and relative abundance of Upper Mississippi River fishes. Upper Mississippi River Conservation Committee, Fish Technical Section, Rock Island, Ill. 18 pp.
- Vogel, S. 1981. Life in moving fluids - the physical biology of flow. Willard Grant Press, Boston, Mass.
- Walker, K.R., and R.K. Bambach. 1974. Feeding by benthic invertebrates: classification and terminology for paleoecological analysis. *Lethaia* 7:67-78.
- Wapora, Inc. 1976. Effects of the E. J. Stoneman Generating Station on the biota of the Mississippi River. Dairyland Power Coop, La Crosse, Wis. 79 pp.
- Water Quality Work Group. 1980. An inventory of point source discharges to the Mississippi River, Guttenberg, IA to Saverton, MO. Great River Environmental Action Team (GREAT II), Rock Island, Ill.
- Welcomme, R.L. 1979. Fisheries ecology of floodplain rivers Longman Group Ltd, London. 317 pp.
- Weller, M.W. 1981. Freshwater marshes, ecology and wildlife management. University of Minnesota Press, Minneapolis. 146 pp.
- Westlake, D.F. 1966. The biomass and productivity of *Glyceria Maxima*. I. Season changes in biomass. *J. Ecol.* 54:745-753.
- Westlake, D.F. 1968. The biology of aquatic weeds in relation to their management. Proc. 9th Br. Weed Control Conf. 371-379.
- Westlake, D.F. 1975. Macrophytes. Pages 106-128 in Whitton, B.A. ed. River ecology. Vol. 2. University of Calif. Press. Los Angeles.
- Wetzel, R.G., and D.L. McGregor. 1968. Axenic culture and nutritional studies of aquatic macrophytes. *Am. Midl. Nat.* 80:52-63.
- Whitton, B.A. 1975. Algae. Pages 81-105 in B.A. Whitton, ed. Studies in ecology. Vol. 2: River ecology. University of Calif. Press, Los Angeles.
- Wiebe, A.H. 1927. Biological survey of the Upper Mississippi River, with special reference to pollution. *Bull. U.S. Bur. Fish.* 43:137-167.
- Whigham, D.F., J. McCormick, R.E. Good, and R.L. Simpson. 1978. Biomass and primary productivity in freshwater tidal wetlands of the middle Atlantic Coast. Pages 3-20 in R.E. Good, D.F. Whigham, and R. L. Simpson, eds. Freshwater wetlands: ecological processes and management potential. Academic Press, New York.
- Wilson, R.E. 1970. Succession in stands of *Populus deltoides* along the Missouri River in southeastern South Dakota. *Am. Midl. Nat.* 83:330-342.
- Winner, J.M. 1975. Zooplankton. Pages 155-169 in B.A. Whitton, ed. Studies in ecology. Vol. 2: River ecology. University of California. Press, Los Angeles.
- Wolf, A., and E. Anderson. 1983. River otter habitat utilization in northeastern Illinois. Illinois Department of Conservation, Springfield, Ill.

Wright, K.J. 1970. The 1967-1968 sport fishery survey of the Upper Mississippi River. Upper Mississippi River Conservation Committee, Quincy, Ill.

Zacharias, O. 1898. Das potamoplankton. Zool. Anz. 21:41-48.

REPORT DOCUMENTATION PAGE		1. REPORT NO. Biological Report 85(7.8)	2.	3. Recipient's Accession No.
4. Title and Subtitle The Ecology of Pools 11-13 of the Upper Mississippi River: A Community Profile			5. Report Date December 1986	6.
7. Author(s) James W. Eckblad*			8. Performing Organization Rept. No.	
9. Performing Organization Name and Address			10. Project/Task/Work Unit No.	
			11. Contract(C) or Grant(G) No. (C) (G)	
12. Sponsoring Organization Name and Address National Wetlands Research Center U.S. Fish and Wildlife Service Department of the Interior Washington, DC 20240			13. Type of Report & Period Covered	
			14.	
15. Supplementary Notes *Dep. of Biol., Luther College, Decorah, IA 52101				
16. Abstract (Limit: 200 words) The once free flowing Upper Mississippi River has now been extensively modified into a series of pools by the installation of a series of dams and navigation locks intended to accommodate shipping. Each dam creates a pool in the river and serves to maintain water depths sufficient for the passage of commercial barges. This publication reviews the ecological information available for Navigation Pools 11 through 13 of the Upper Mississippi River, an area extending from above Prairie du Chien, WI, to near Clinton, IA. This report reviews the geologic history and present physiography of the area. Biological populations inhabiting or associated with the pools are described the ecological interactions are discussed. The final chapter describes human impacts on the Pool 11-13 reach of the river and reviews management options designed to minimize these impacts.				
17. Document Analysis a. Descriptors rivers, wetlands, fishes, mammals, invertebrates, birds, aquatic plants b. Identifiers/Open-Ended Terms Mississippi River, navigation, locks and dams, dredging, runoff, nutrient cycling, Navigation Pools 11-13 c. COSATI Field/Group				
18. Availability Statement Unlimited availability		19. Security Class (This Report) Unclassified		21. No. of Pages x + 88
		20. Security Class (This Page) Unclassified		22. Price

(See ANSI-Z39.18)

OPTIONAL FORM 272 (4-77)
(Formerly NTIS-35)
Department of Commerce