

July 2004

# Environmental Technology Verification Report

MECHATRONICS INSTRUMENTS BV  
AIRRMONIA AMMONIA ANALYZER

Prepared by  
Battelle

**Battelle**  
*The Business of Innovation*

In collaboration with the  
U.S. Department of Agriculture

Under a cooperative agreement with

 **EPA** U.S. Environmental Protection Agency

ET ✓

ET ✓

ET ✓

July 2004

# **Environmental Technology Verification Report**

ETV Advanced Monitoring Systems Center

**Mechatronics Instruments BV  
AiRRmonia Ammonia Analyzer**

by  
Ken Cowen  
Ann Louise Sumner  
Amy Dindal  
Karen Riggs  
Zack Willenberg

Battelle  
Columbus, Ohio 43201

and  
Jerry Hatfield  
Richard Pfeiffer  
Kenwood Scoggin

USDA National Soil Tilth Laboratory  
Ames, Iowa 50011

## **Notice**

The U.S. Environmental Protection Agency (EPA), through its Office of Research and Development, has financially supported and collaborated in the extramural program described here. This document has been peer reviewed by the Agency. Mention of trade names or commercial products does not constitute endorsement or recommendation by the EPA for use.

## Foreword

The U.S. Environmental Protection Agency (EPA) is charged by Congress with protecting the nation's air, water, and land resources. Under a mandate of national environmental laws, the Agency strives to formulate and implement actions leading to a compatible balance between human activities and the ability of natural systems to support and nurture life. To meet this mandate, the EPA's Office of Research and Development provides data and science support that can be used to solve environmental problems and to build the scientific knowledge base needed to manage our ecological resources wisely, to understand how pollutants affect our health, and to prevent or reduce environmental risks.

The Environmental Technology Verification (ETV) Program has been established by the EPA to verify the performance characteristics of innovative environmental technology across all media and to report this objective information to permittees, buyers, and users of the technology, thus substantially accelerating the entrance of new environmental technologies into the marketplace. Verification organizations oversee and report verification activities based on testing and quality assurance protocols developed with input from major stakeholders and customer groups associated with the technology area. ETV consists of seven environmental technology centers. Information about each of these centers can be found on the Internet at <http://www.epa.gov/etv/>.

Effective verifications of monitoring technologies are needed to assess environmental quality and to supply cost and performance data to select the most appropriate technology for that assessment. Under a cooperative agreement, Battelle has received EPA funding to plan, coordinate, and conduct such verification tests for "Advanced Monitoring Systems for Air, Water, and Soil" and report the results to the community at large. Information concerning this specific environmental technology area can be found on the Internet at <http://www.epa.gov/etv/centers/center1.html>.

## **Acknowledgments**

The authors wish to acknowledge the support of all those who helped plan and conduct the verification test, analyze the data, and prepare this report. We would like to thank Ernie Bouffard, Connecticut Department of Environmental Protection; Rudy Eden, South Coast Air Quality Management District; Roy Owens, Owens Corning; and Jim Homolya, Bruce Harris, and Linda Sheldon, U.S. Environmental Protection Agency, for their careful review of the verification test/QA plan and/or this verification report. We would also like to thank René Otjes, Netherlands Energy Research Foundation ECN, for his participation in the verification test. We also thank Amy Morrow and Diane Farris of the U.S. Department of Agriculture National Soil Tilth Laboratory for their assistance in performing the reference sample analysis.

# Contents

	Page
Notice .....	ii
Foreword .....	iii
Acknowledgments .....	iv
List of Abbreviations .....	viii
1 Background .....	1
2 Technology Description .....	2
3 Test Design and Procedures .....	4
3.1 Test Design .....	4
3.2 Site Descriptions .....	5
3.2.1 Site Description—Phase I .....	5
3.2.2 Site Description—Phase II .....	6
3.3 Test Procedures .....	6
3.3.1 Accuracy, Linearity, Precision, and Response Time .....	6
3.3.2 Calibration and Zero Drift .....	7
3.3.3 Interference Effects .....	7
3.3.4 Comparability .....	8
4 Quality Assurance/Quality Control .....	10
4.1 Equipment Calibrations .....	10
4.1.1 Reference Method Sampling Equipment .....	10
4.1.2 Analytical Equipment .....	10
4.1.3 Meteorological Equipment .....	11
4.1.4 Ammonia Dilution System .....	11
4.2 QA/QC Samples .....	11
4.2.1 Field Blanks .....	11
4.2.2 Denuder Breakthrough Checks .....	13
4.2.3 Duplicate Samples .....	16
4.2.4 Laboratory Blanks .....	17
4.2.5 Calibration Checks .....	18
4.2.6 Gas Standard Dilution Checks .....	18
4.3 Audits .....	19
4.3.1 Performance Evaluation Audit .....	19
4.3.2 Technical Systems Audit .....	20
4.3.3 Audit of Data Quality .....	20
4.4 QA/QC Reporting .....	20
4.5 Data Review .....	21

5	Statistical Methods and Reported Parameters	22
5.1	Relative Accuracy	22
5.2	Linearity	22
5.3	Precision	23
5.4	Response Time	23
5.5	Calibration and Zero Drift	23
5.6	Interference Effects	23
5.7	Comparability	24
6	Test Results	25
6.1	Relative Accuracy	27
6.2	Linearity	29
6.3	Precision	30
6.4	Response Time	31
6.5	Calibration and Zero Drift	31
6.6	Interference Effects	33
6.7	Comparability	33
6.8	Ease of Use	36
6.9	Data Completeness	37
7	Performance Summary	40
8	References	42
	Appendix A. AiRRmonia Checklist	A-1

## Figures

Figure 2-1.	AiRRmonia Ammonia Analyzer	2
Figure 3-1.	Phase I Test Site	5
Figure 3-2.	Installation at the Phase I Field Site	6
Figure 3-3.	Phase II Test Site	7
Figure 3-4.	Reference Method Sampling Cartridge	8
Figure 4-1.	Denuder Breakthrough During Phase I as a Function of Integrated Ammonia Concentration	14
Figure 4-2.	Denuder Breakthrough During Phase II as a Function of Integrated Ammonia Concentration.	15
Figure 4-3.	Analysis of Diluted Ammonia Standards Using the Denuder Reference Method	19
Figure 6-1.	Phase I Meteorological Conditions and AiRRmonia Ambient NH <sub>3</sub> Measurements	25
Figure 6-2.	Phase II Meteorological Conditions and AiRRmonia Ambient NH <sub>3</sub> Measurements	26
Figure 6-3.	Phase I Relative Accuracy Results for the AiRRmonia	27

Figure 6-4.	Phase II Relative Accuracy Results for the AiRRmonia	28
Figure 6-5.	Results of Linearity Check of the AiRRmonia During Phase I	29
Figure 6-6.	Results of Linearity Check of the AiRRmonia During Phase II	30
Figure 6-7.	Comparison of Ambient Reference Measurements with Averages from the AiRRmonia During Phase I	34
Figure 6-8.	Comparison of Ambient Reference Measurements with Averages from the AiRRmonia During Phase II	34
Figure 6-9.	Scatter Plot of the AiRRmonia Averages versus Ambient Reference Method Measurements for Phase I	35
Figure 6-10.	Scatter Plot of the AiRRmonia Averages versus Ambient Reference Method Measurements for Phase II	35

### Tables

Table 4-1.	Minimum Detectable Ambient NH <sub>3</sub> Concentrations During Phase I	12
Table 4-2.	Minimum Detectable Ambient NH <sub>3</sub> Concentrations During Phase II	13
Table 4-3.	Denuder Breakthrough Checks During Phase I	15
Table 4-4.	Denuder Breakthrough Checks During Phase II	16
Table 4-5.	Duplicate Reference Method Samples	17
Table 4-6.	Data Recording Process	21
Table 6-1.	Relative Accuracy Results	28
Table 6-2.	Calculated Precision of AiRRmonia	31
Table 6-3.	Response Time Determinations	32
Table 6-4.	Calibration and Zero Checks During Phase II	32
Table 6-5.	Interference Effect Evaluation	33
Table 6-6.	Activities Performed During Phase I	38
Table 6-7.	Activities Performed During Phase II	39
Table 7-1.	Performance Summary of the AiRRmonia	41



## List of Abbreviations

AFO	animal feeding operation
AMS	Advanced Monitoring Systems
CI	confidence interval
cm	centimeter
DL	detection limit
EPA	U.S. Environmental Protection Agency
ETV	Environmental Technology Verification
FIA	flow injection analysis/analyzer
L	liter
Lpm	liters per minute
µg	microgram
µm	micrometer
mg	milligram
mL	milliliter
NIST	National Institute of Standards and Technology
NH <sub>3</sub>	ammonia
NH <sub>4</sub> <sup>+</sup>	ammonium
ppb	part per billion
%D	percent difference
QA	quality assurance
QC	quality control
QMP	quality management plan
r <sup>2</sup>	coefficient of determination
RA	relative accuracy
RPD	relative percent difference
RSD	relative standard deviation
SD	standard deviation
TSA	technical systems audit
USDA	U.S. Department of Agriculture

---

## **Chapter 1 Background**

The U.S. Environmental Protection Agency (EPA) supports the Environmental Technology Verification (ETV) Program to facilitate the deployment of innovative environmental technologies through performance verification and dissemination of information. The goal of the ETV Program is to further environmental protection by accelerating the acceptance and use of improved and cost-effective technologies. ETV seeks to achieve this goal by providing high-quality, peer-reviewed data on technology performance to those involved in the design, distribution, financing, permitting, purchase, and use of environmental technologies.

ETV works in partnership with recognized testing organizations; with stakeholder groups consisting of buyers, vendor organizations, and permittees; and with the full participation of individual technology developers. The program evaluates the performance of innovative technologies by developing test plans that are responsive to the needs of stakeholders, conducting field or laboratory tests (as appropriate), collecting and analyzing data, and preparing peer-reviewed reports. All evaluations are conducted in accordance with rigorous quality assurance (QA) protocols to ensure that data of known and adequate quality are generated and that the results are defensible.

The EPA's National Exposure Research Laboratory and its verification organization partner, Battelle, operate the Advanced Monitoring Systems (AMS) Center under ETV. The AMS Center, in collaboration with the U.S. Department of Agriculture's (USDA) National Soil Tilth Laboratory, recently evaluated the performance of the Mechatronics Instruments AiRRmonia ammonia (NH<sub>3</sub>) analyzer.

---

## Chapter 2 Technology Description

The objective of the ETV AMS Center is to verify the performance characteristics of environmental monitoring technologies for air, water, and soil. This verification report provides results for the verification testing of the AiRRmonia. The following is a description of the AiRRmonia, based on information provided by the vendor. The information provided below was not subjected to verification in this test.

The AiRRmonia is a stand-alone, single-point monitor that measures  $\text{NH}_3$  concentrations continuously in ambient air. The AiRRmonia draws an air sample through a folded channel system in the sampling block. This channel system is positioned on a Teflon, gas-permeable membrane with an aqueous absorption solution counter-flow on the opposite side of the membrane. The  $\text{NH}_3$  in the air sample permeates the membrane at an air flow rate of one liter per minute (Lpm) and forms ammonium ions in the absorption solution. Almost all aerosols bypass the sampling channel, without penetration of the membrane, thereby limiting interference effects from ammonium-laden aerosol. After dissolution of the  $\text{NH}_3$  in the absorption solution, the sample solution flows into the detector block through a de-bubbling chamber. In the detector block, a sodium hydroxide solution mixes with the sample solution, and the sample solution passes along a second Teflon membrane. At this step in the process, gaseous  $\text{NH}_3$  penetrates the membrane and is dissolved in purified water flowing on the opposite side of the membrane. A conductivity cell monitors the initial water conductivity, and a second conductivity cell measures the amount of ammonium and hydroxide after the membrane exchange. The difference in conductivity, corrected for temperature drifts, is the measure of the original  $\text{NH}_3$  content in the sampled air. Monitoring process parameters and an automated check by a blank and a standard ammonium ( $\text{NH}_4^+$ ) solution control the performance of the AiRRmonia.



**Figure 2-1. AiRRmonia  
Ammonia Analyzer**

The AiRRmonia is housed in a weatherproof box (Figure 2-1) and contains a membrane diffusion sampler, a detector block with a diffusion membrane, and two conductivity cells. An air pump and mass flow controller are used for the air sampling. A three-channel syringe pump is used to deliver the aqueous solutions at fixed flow rates.

---

The AiRRmonia also includes bottles for water, standard solution, diluted sodium hydroxide, and waste. A processor and a display with key entries are used for programming, and an internal data logger stores monitoring and diagnostic data.

The AiRRmonia power requirements are 115 to 230 volts, 50 to 60 Hertz, and 10 Watts (120 Watts including heater). It is 62 centimeters (cm) wide, 40 cm deep, and 50 cm high and weighs 23 kilograms. An optional extension box for a 2-month solution supply has the same dimensions. Data are recorded at a default interval of 2 minutes, which can be changed. Average values of the measured parameters (time, date, air flow, detector temperature, conductivity of purified water, and conductivity of the sample after diffusion) are logged, as well as the calculated  $\text{NH}_3$  concentrations. Results of the calibration check also are logged. The cost of the AiRRmonia is \$27,000 U.S., plus \$2,500 U.S. for optional accessories.

---

## Chapter 3 Test Design and Procedures

### 3.1 Test Design

Livestock agriculture is thought to be the primary source of atmospheric NH<sub>3</sub> in the United States and accounts for approximately 70% of NH<sub>3</sub> emissions in the United States.<sup>(1)</sup> As a result, a means to accurately quantify these emissions is needed. The objective of this verification test was to verify the AiRRmonia's performance in measuring gaseous NH<sub>3</sub> in ambient air at animal feeding operations (AFOs).

This verification test was conducted according to procedures specified in the *Test/QA Plan for Verification of Ambient Ammonia Monitors at Animal Feeding Operations*,<sup>(2)</sup> with the exception of six deviations that are addressed later in this report. The verification test was conducted in two phases, each at separate AFOs. The first phase of testing was conducted between September 8 and October 3, 2003, at a swine finishing farm near Ames, Iowa. The second phase was conducted between October 20 and November 14, 2003, at a cattle feedlot in Carroll, Iowa. These sites were selected to provide realistic testing conditions, which were expected to exhibit a wide range of NH<sub>3</sub> concentrations during the test periods.

The verification test was designed to evaluate the following performance parameters:

- Relative accuracy
- Linearity
- Precision
- Response time
- Calibration/zero drift
- Interference effects
- Comparability
- Ease of use
- Data completeness.

During each phase of the verification test, the AiRRmonia response to a series of NH<sub>3</sub> gas standards of known concentration was used to quantify relative accuracy (RA), linearity, precision (repeatability), and calibration/zero drift. The AiRRmonia response time, the time to reach 95% of the stable signal, was also assessed during the delivery of the NH<sub>3</sub> standards. During Phase II, interference effects were quantified from the AiRRmonia response to various chemical species that may be present at AFOs; the potential interferent gases were delivered

both in the presence and absence of NH<sub>3</sub>. The AiRRmonia response to ambient air was also evaluated during both phases as the comparability to simultaneous determinations by an ambient NH<sub>3</sub> reference method (acid-coated denuders). Additionally, the ease of use of the AiRRmonia was evaluated based on operator observations. Data completeness was determined based on the amount of data collected as a percentage of the amount of data that could have been collected.

### 3.2 Site Descriptions

The AiRRmonia was installed at the Phase I and II testing locations by a vendor representative. Battelle and USDA staff worked with the vendor representative to establish procedures for operating the AiRRmonia during this verification test. The vendor representative trained Battelle and USDA staff to check several instrument parameters to verify the operation of the AiRRmonia and identify signs of malfunction, which was done on a daily basis. A checklist, provided by the vendor representative and included as Appendix A, was completed by Battelle and USDA staff when regular maintenance activities were performed. In the event of an instrument malfunction, Battelle and/or USDA staff contacted the vendor representative and could conduct minor troubleshooting procedures upon request, but were not expected to make any major repairs. The vendor representative remained on-site until the first day of testing, at which time the testing activities were conducted by Battelle and/or USDA staff. The vendor representative returned to the test site after the completion of Phase I to install the AiRRmonia at the Phase II test site.

#### 3.2.1 Site Description—Phase I

Figure 3-1 shows a schematic diagram of the swine farm during Phase I of the verification test. The AFO included ten animal barns arranged in two parallel rows of five, with each barn housing up to 2,000 swine. The urine and feces from the swine exited the barns through metal gratings in the floor and were deposited in two nutrient lagoons located on the southern end of the AFO. The perimeter of the AFO was lined with trees, with agricultural fields surrounding the AFO perimeter. A temperature-regulated instrument trailer was placed on-site during the test to house some of the monitoring equipment and to provide a sheltered work space. A scaffolding platform was erected outside the trailer onto which the AiRRmonia was placed for Phase I of testing. The AiRRmonia was placed on the platform in such a way that the inlet, which is located near the base of the AiRRmonia, was near the edge of the platform and approximately two meters above the ground. Figure 3-2 shows the AiRRmonia installed on the platform.

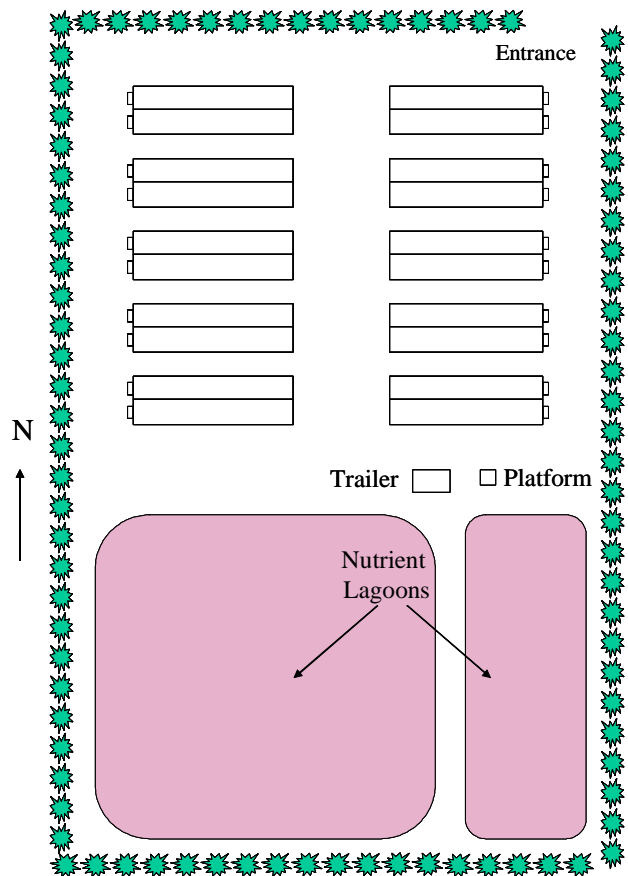

Figure 3-1. Phase I Test Site



**Figure 3-2. Installation at the Phase I Field Site**

### ***3.2.2 Site Description—Phase II***

Figure 3-3 shows a schematic diagram of the cattle feedlot during Phase II of the verification test. The instrument trailer used in Phase I of this verification test was also used in Phase II and was in a harvested corn field surrounded on three sides by cow pens. The farm was surrounded on all sides by corn fields, most of which had been harvested. Approximately 2,000 to 3,000 head of cattle were on the farm during the verification test. To facilitate the verification test activities performed during Phase II, the AiRRmonia was installed inside the instrument trailer and a stainless steel inlet line was used to supply outside air to the AiRRmonia. An auxiliary pump was used to continuously flush the inlet line at a high flow rate (approximately 10 Lpm). The inlet was mounted on a tripod on the west side of the trailer at a height of approximately 1.5 meters.

## **3.3 Test Procedures**

### ***3.3.1 Accuracy, Linearity, Precision, and Response Time***

During the first week of each phase of testing, the AiRRmonia was independently supplied with compressed  $\text{NH}_3$  gas standards to achieve  $\text{NH}_3$  concentrations over a range from 0 to 10,000 parts per billion (ppb) (Phase I) or 0 to 2,000 ppb (Phase II) to simulate the range expected in

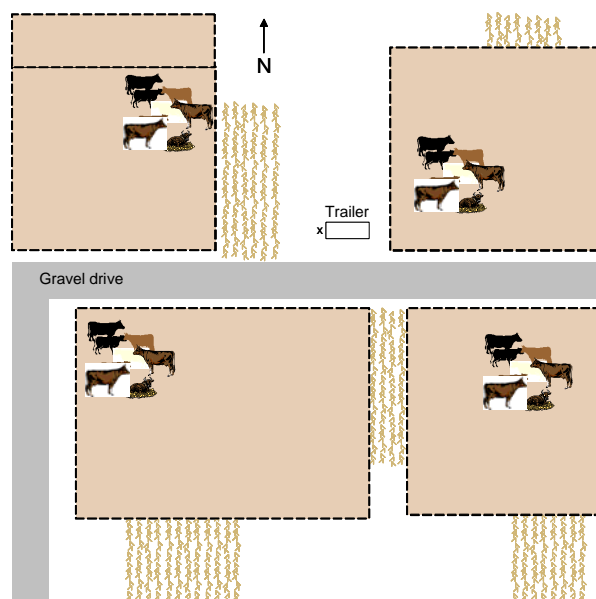

**Figure 3-3. Phase II Test Site**

ambient air during each phase. The gases delivered to the AiRRmonia were prepared by diluting higher-concentration  $\text{NH}_3$  standard gases (i.e., 100 to 500 parts per million) in zero air using a calibrated dilution system provided by the USDA. The standard configuration of the AiRRmonia has a linear operating range of 0 to 750 ppb, as reported by the manufacturer. To accommodate the expected higher concentrations at the AFOs, the manufacturer changed the sample flow rate to increase the operating range by approximately one order of magnitude.

The  $\text{NH}_3$  gas was supplied to the AiRRmonia for between 30 minutes and one hour at each concentration level. Accuracy and linearity were established based on the continuous digital data set recorded by the AiRRmonia during the periods when the  $\text{NH}_3$  gas was supplied. Data were used for the calculations once the signal had stabilized at a constant concentration (i.e., the signal did not appear to be increasing or decreasing with time). The time required to reach 95% of the change in the stable reading for each concentration was also recorded for the AiRRmonia. These data were used to assess the response time of the AiRRmonia.

### ***3.3.2 Calibration and Zero Drift***

On Monday, Wednesday, and Friday of the first and last weeks of testing during each phase, the AiRRmonia was supplied with an  $\text{NH}_3$  gas standard at nominally 1,000-ppb and zero air to check the calibration and zero drift of the AiRRmonia, respectively. Zero air and the 1,000 ppb  $\text{NH}_3$  standard were each supplied for approximately one hour, during which time the measured concentrations were recorded by the AiRRmonia.

### ***3.3.3 Interference Effects***

During Phase II, the AiRRmonia was independently supplied with a series of potential interference gases (hydrogen sulfide, nitrogen dioxide, 1,3-butadiene, and diethylamine) to assess any impact the gases have on the AiRRmonia response. The interferent gases were supplied from diffusion tubes (VICI Metronics, Poulsbo, Washington) at concentrations of approximately 100 to 300 ppb in zero air and 500 ppb  $\text{NH}_3$  standard as carrier gases.



The process for supplying the interferent gases was as follows: zero air was supplied to the AiRRmonia until a stable reading was achieved. The interferent gas was added to the zero air flow and supplied to the AiRRmonia until a stable reading was observed (at least two minutes). The AiRRmonia was flushed for at least two minutes with zero air, and the next interferent gas was delivered. This process was repeated for the four interferent gases. A 500-ppb NH<sub>3</sub> standard was then supplied to the AiRRmonia until a stable reading was achieved. The interferent gas was added to the NH<sub>3</sub> standard for delivery to the AiRRmonia, and the process outlined above was repeated, delivering the 500-ppb NH<sub>3</sub> standard for at least 2 minutes between each interferent gas.

### 3.3.4 Comparability

The comparability of the AiRRmonia with a standard reference method was established by comparing the average AiRRmonia readings with time-integrated NH<sub>3</sub> samples collected using citric-acid-coated denuders. The reference samples were collected based on procedures described in the EPA Compendium Method IO-4.2, *Determination of Reactive Acidic and Basic Gases and Acidity of Fine Particles (< 2.5 μm)*.<sup>(3)</sup>

For this test, NH<sub>3</sub> samples were collected using a ChemComb Model 3500 Speciation Sampling Cartridge (Rupprecht & Patashnick Co., East Greenbush, New York). Figure 3-4 shows a schematic illustration of the ChemComb sampling cartridge. Samples were collected by drawing ambient air through an impactor at a nominal rate of 10 Lpm to remove particulate matter with aerodynamic diameters greater than 2.5 micrometers (μm). The air was passed through two or more citric-acid-coated denuders to collect gaseous NH<sub>3</sub>. A single Teflon filter was used to collect the particulate matter that passed through the denuder. For Phase I, air flow was controlled using diaphragm pumps with needle valves. During Phase II, automated Partisol Model 2300 speciation samplers (Rupprecht & Patashnick Co., East Greenbush, New York) were used. The Partisol samplers were equipped with mass-flow controlled sampling systems that were pressure- and temperature-corrected. This improved the accuracy of the sampled air volume and also reduced the overall labor requirements. The samplers had not been available during Phase I.

The procedures that were used for preparing and coating the denuders were based on the procedures given in the ChemComb Operating Manual<sup>(4)</sup> and the test/QA plan<sup>(2)</sup>. The denuders were coated in an NH<sub>3</sub>-free glove box at a USDA National Soil Tilth Laboratory facility in Ames, Iowa, and stored in an

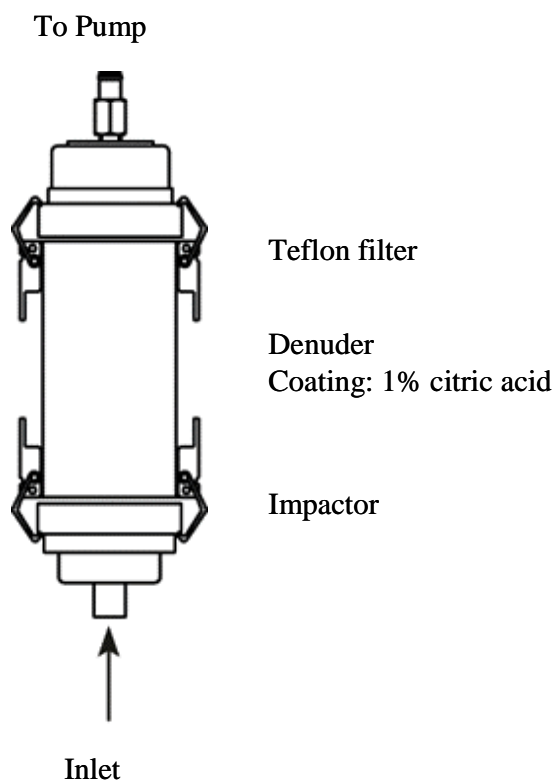

**Figure 3-4. Reference Method Sampling Cartridge**

---

NH<sub>3</sub>-free glove box until they were installed in the ChemComb sampling cartridge and transported to the test site. Cartridges were assembled in the laboratory and transported to the test site. All denuders were used within 72 hours of being coated and within 24 hours of being transported to the field.

Reference samples were collected during the second and third weeks of testing during each phase. To capture diurnal variations in NH<sub>3</sub> concentrations, sampling was conducted on approximately the following schedule: 8:00 a.m. to 12:00 p.m., 12:00 p.m. to 2:00 p.m., 2:00 p.m. to 4:00 p.m., 4:00 p.m. to 8:00 p.m., and 8:00 p.m. to 8:00 a.m., so that five sets of samples were collected in each 24-hour period. The short-term (2-hour and 4-hour) sampling captured the midday peaks in NH<sub>3</sub> concentrations, whereas the 12-hour sampling captured overnight, generally low, concentrations. After sampling, the sampling media were retrieved and transported to the USDA laboratory for extraction and analysis. During Phase I, sampling was conducted at two locations: the instrument trailer and near the AiRRmonia inlet. Duplicate samples were obtained at each location. Sampling was conducted daily, Monday through Friday, during the two-week reference sampling period. During Phase II, the reference sampling for single point monitors was conducted at one location near the monitor inlets at the instrument trailer. Duplicate samples were also obtained at this site. The sampling schedule for Phase II deviated from the test/QA plan in that sampling was conducted every other day, including weekends, during the two-week sampling period. The schedule allowed sufficient time for sample transportation and processing between sampling days.

Extraction and analysis of the denuders were performed as described in the test/QA plan,<sup>(2)</sup> with one exception. The water volume used to extract the denuders was increased from 10 milliliters (mL), as specified in the test/QA plan, to 20 mL. The volume was increased to accommodate the sample volume requirements of the analysis method described below. A deviation was filed to address this change, which does not impact the quality of the reference data. Samples were extracted in an NH<sub>3</sub>-free glove box and stored in acid-washed scintillation vials to prevent contamination. The samples were analyzed by USDA by flow injection analysis (FIA) using a Lachat QuikChem Automated Flow Injection Ion Analyzer (Lachat Company, Loveland, Colorado) according to QuikChem Method No. 10-107-06-2-A. This method involves heating the NH<sub>3</sub> sample with salicylate and hypochlorite in an alkaline phosphate buffer, which produces an emerald green color proportional to the NH<sub>3</sub> concentration. The color was intensified by adding sodium nitroprusside and monitored photometrically.

When possible, samples were analyzed within 24 hours of extraction, as specified in the test/QA plan. When analysis within 24 hours of extraction was not possible, the samples were stored frozen until the analysis could be performed, in accordance with the test/QA plan.

---

## **Chapter 4**

### **Quality Assurance/Quality Control**

QA/quality control (QC) procedures were performed in accordance with the quality management plan (QMP) for the AMS Center<sup>(5)</sup> and the test/QA plan for this verification test.<sup>(2)</sup>

Six deviation reports were filed during this test and have been addressed in this report. In summary, a change was made in the reference sampling schedule and equipment for Phase II (Section 3.3.4), the denuder extraction volume was increased (Section 3.3.4), some percent difference values measured for duplicate reference samples exceeded 10% (Section 4.2.3), laboratory blank thresholds were redefined (Section 4.2.4), the order in which laboratory blanks and calibration check standards were submitted for analysis was changed (Section 4.2.4 and 4.2.5), and not all of the test data were reviewed within two weeks of the end of the test phase (Section 4.5). None of these deviations impacted the quality of this verification test.

#### **4.1 Equipment Calibrations**

##### ***4.1.1 Reference Method Sampling Equipment***

Reference method sampling was conducted based on the procedures described in the EPA method<sup>(3)</sup> and the ChemComb operating manual.<sup>(4)</sup> A single-point calibration of the flow rate through each of the sampling systems (i.e., pump, flow controller, filter pack, denuder, impactor) was performed prior to starting each phase using a flow meter with a National Institute of Standards and Technology (NIST)-traceable calibration. The flow rate of each sampler was checked at the beginning and end of each sampling period using an in-line flow meter. The flow rate was readjusted if the flow check was not within  $\pm 5\%$  of the nominal flow rate of 10 Lpm (i.e., 9.5 Lpm to 10.5 Lpm). All calibration results were documented for inclusion in the verification test data files. For Phase II, flows were controlled by the pressure- and temperature-corrected mass flow controllers used in the USDA's Partisol samplers. These samplers shut off automatically if the flow deviated by  $\pm 5\%$  from the 10 Lpm setpoint for more than 5 minutes, and the data were flagged. Actual sample volumes were recorded by the samplers.

##### ***4.1.2 Analytical Equipment***

The reference samples were analyzed in the USDA laboratory using FIA. A five-point calibration was measured on the FIA for the reference sample analysis prior to each analytical session by the USDA staff performing the analysis. The calibration was conducted according to

---

the manufacturer's recommendations and included concentrations of NH<sub>3</sub> standard solutions throughout the operating range of the FIA. The calibration was acceptable if the coefficient of determination ( $r^2$ ) of the calibration curve was greater than 0.99. The FIA detection limit (DL) was 0.03 milligrams per liter (mg/L) and was determined as three times the standard deviation of repeated measurements of a low-level NH<sub>3</sub> standard. Any analytical results that fell below the FIA DL were used without any further adjustment.

Calibration check standards were analyzed after every fifteenth sample in the batch. These calibration checks were considered acceptable if the measured concentration agreed within 10% of the standard solution concentration. If a calibration check failed to agree within 10% of the standard concentration, the FIA was recalibrated; all analyses since the last acceptable calibration check were repeated. All calibration results were documented for inclusion in the verification test data files.

#### ***4.1.3 Meteorological Equipment***

The sensors used for meteorological monitoring had been calibrated by the manufacturer (Met One Instruments, Inc., Grants Pass, Oregon) within one year of their use in this verification test. The calibration results were included in the verification test data files.

#### ***4.1.4 Ammonia Dilution System***

The USDA NH<sub>3</sub> dilution system (Envionics, Tolland, Connecticut) employs three heated mass flow controllers and valves dedicated for the dilution of compressed NH<sub>3</sub> mixtures. The output flow rates were verified using an independent, NIST-traceable flow meter and agreed to within 10%.

### **4.2 QA/QC Samples**

#### ***4.2.1 Field Blanks***

At least 10% of all reference samples collected were field blanks. The field blanks were collected by installing the sampling media (i.e., denuder and filters) in the sampling train without drawing any air through the train. The media were recovered and handled as normal samples. Field blanks were collected at each of the sampling locations and during each of the sampling periods (e.g., 8:00 a.m. to 12:00 p.m.). Field blank results were used to detect potential sample contamination (defined in the test/QA plan as field blank values greater than 5% of any reference samples for that day) and also to determine the reference method DL.

The reference method DL was determined from the field blank results and reported in terms of an NH<sub>3</sub> mass corresponding to three times the standard deviation of the NH<sub>3</sub> mass collected on the field blanks. Reference method DLs were determined for each phase and were more than six times higher than the equivalent FIA DL [0.6 microgram ( $\mu\text{g}$ ) NH<sub>3</sub> per 20-mL sample].

The reference method DLs, reported as NH<sub>3</sub> masses, were used to determine the minimum detectable NH<sub>3</sub> concentration for each phase. Since the mass of NH<sub>3</sub> collected by the reference

method is a function of the sampling time, flow rate, and the ambient ammonia concentration, the minimum (time-integrated) ambient NH<sub>3</sub> concentration detectable by the reference method varies depending on the sample period duration. (This assumes a constant flow rate.) For example, to collect 100 µg NH<sub>3</sub>, the ambient NH<sub>3</sub> concentration must be 20 ppb for a 12-hour sample and 120 ppb for a 2-hour sample. Accordingly, the minimum time-integrated ambient NH<sub>3</sub> concentrations that could be detected from the collection of 2-, 4-, and 12-hour samples at a nominal flow rate of 10 Lpm were calculated from the reference method DL for each phase.

#### 4.2.1.1 Phase I

During Phase I of testing, a total of 11 field blanks were collected (10% of reference samples). The sample cartridges were exposed to ambient air (caps removed) for approximately the time it would take to connect the cartridges to the pump tubing. The caps were then replaced and the cartridges handled in the same way as regular reference samples. The average NH<sub>3</sub> mass collected on the field blanks was 5.3 µg, with a range of 1.5 to 7.0 µg. This range of collected NH<sub>3</sub> mass corresponded to 0.5% to 6.5% of the NH<sub>3</sub> mass collected on any of the reference samples on the corresponding days during which the field blanks were collected. Two of the Phase I field blanks were above 5% of the minimum reference sample mass for that corresponding day. These field blanks collected 5.6 µg NH<sub>3</sub>, which was slightly above the average field blank NH<sub>3</sub> mass during Phase I; however, the field blanks were collected on days that exhibited lower ambient NH<sub>3</sub> levels, resulting in a relatively large percentage of the reference mass (6.5% and 5.9%). These field blanks did not show unusually high levels of contamination, and it does not appear that they had a significant impact on the Phase I reference method results. The standard deviation of the NH<sub>3</sub> collected on field blanks for Phase I was 1.6 µg, and the Phase I reference method DL was 10.1 µg NH<sub>3</sub>. The minimum detectable integrated ambient NH<sub>3</sub> concentrations are shown in Table 4-1 for 2-, 4-, and 12-hour samples. During Phase I, all measured NH<sub>3</sub> levels were greater than these minimum NH<sub>3</sub> concentrations, with a minimum measured value of 107 ppb for a 2-hour sample.

**Table 4-1. Minimum Detectable Ambient NH<sub>3</sub> Concentrations During Phase I**

	<b>2-Hour Sample</b>	<b>4-Hour Sample</b>	<b>12-Hour Sample</b>
Minimum detectable NH <sub>3</sub> concentration	12.1 ppb	6.0 ppb	2.0 ppb
Number of reference samples collected	46	45	19
Number less than the minimum detectable NH <sub>3</sub> concentration	0	0	0

#### 4.2.1.2 Phase II

During Phase II of testing, the reference sampling was conducted somewhat differently than in Phase I, in that all the reference sampling cartridges and field blanks were installed in the sampler prior to the first sampling period on a given day. The reference sample and field blank cartridges were thus exposed to the ambient environment for a period of approximately 24 hours. Nonetheless, the average measured NH<sub>3</sub> mass in the field blanks for Phase II was

somewhat lower than in Phase I. A total of 14 field blanks were collected in Phase II. The average NH<sub>3</sub> mass collected on these blanks was 2.5 µg NH<sub>3</sub> and the range was 0.5 to 4.6 µg NH<sub>3</sub>. The mass collected on the field blanks ranged from 1.2% to 55.0% of the smallest reference sample mass collected on the same day, with an average of 19.2%. These percentages are not indicative of unusually high levels of contamination, but rather are a result of relatively low ambient NH<sub>3</sub> levels at the AFO. The impact of these blank levels on the results of this verification test may be manifested as a small positive bias of the reference method results relative to the readings of the technologies being verified. This bias would be most pronounced on days with low ambient NH<sub>3</sub> concentrations. The highest field blank percentages were measured on days when the integrated ambient NH<sub>3</sub> levels were as low as 6 ppb, which is approaching the 4.9-ppb minimum detectable ambient NH<sub>3</sub> concentration for a 2-hour sample. Assuming an ambient air sample volume of 1.2 cubic meters, the smallest volume collected during Phase II, the maximum field blank value corresponds to an ambient concentration of 5.5 ppb. Thus, the sample handling may account for up to 5.5 ppb of the measured values.

The standard deviation of the NH<sub>3</sub> collected from field blanks for Phase II was 1.4 µg, which resulted in a 6.6 µg NH<sub>3</sub> Phase II reference method DL. The minimum detectable ambient NH<sub>3</sub> concentrations for 2-, 4-, and 12-hour samples (at a nominal flow rate of 10 Lpm) are shown in Table 4-2. During Phase II, one measured NH<sub>3</sub> concentration in ambient air fell below the minimum detectable NH<sub>3</sub> concentration, as summarized in Table 4-2.

**Table 4-2. Minimum Detectable Ambient NH<sub>3</sub> Concentrations During Phase II**

	<b>2-Hour Sample</b>	<b>4-Hour Sample</b>	<b>12-Hour Sample</b>
Minimum detectable NH <sub>3</sub> concentration	7.9 ppb	4.0 ppb	1.3 ppb
Number of reference samples collected	56	56	29
Number less than minimum detectable NH <sub>3</sub> concentration	2	0	0

## **4.2.2 Denuder Breakthrough Checks**

### **4.2.2.1 Phase I**

Use of backup denuders is called for in the test/QA plan during periods when breakthrough greater than 10% of the front denuder is observed or expected. Owing to the high NH<sub>3</sub> levels observed during Phase I, all reference samples collected during Phase I included at least one backup denuder, and most samples (>70%) included two backup denuders. These backup denuders were used to check the degree of NH<sub>3</sub> breakthrough. The breakthrough checks were conducted at both of the sampling locations and included checks during each of the five sampling periods (i.e., 8:00 p.m. to 8:00 a.m., 8:00 a.m. to 12:00 p.m., etc.). Figure 4-1 shows the percentage of NH<sub>3</sub> collected on the backup denuders relative to the front denuder (i.e., breakthrough) as a function of the average NH<sub>3</sub> concentration for each of the sampling period

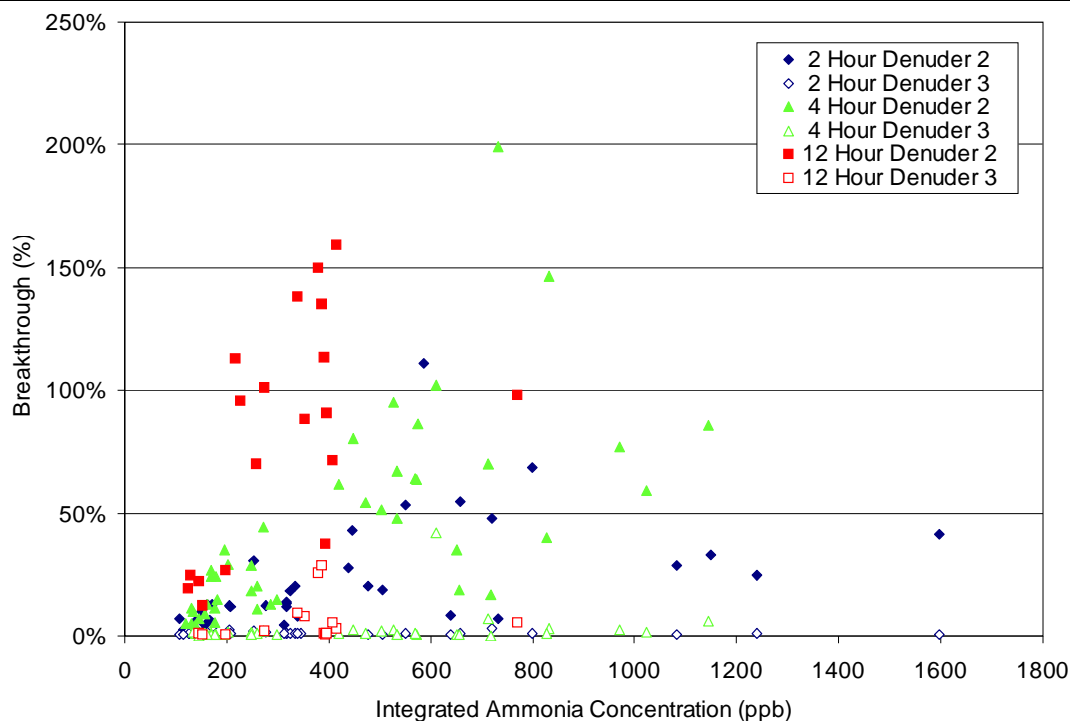

**Figure 4-1. Denuder Breakthrough During Phase I as a Function of Integrated Ammonia Concentration**

lengths (combined data from both sampling locations). The solid symbols in this figure represent the first backup denuder (identified as Denuder 2 in the legend), and the open symbols represent the second backup denuder (identified as Denuder 3 in the legend). This figure illustrates that the first backup denuder captured a significant fraction of  $\text{NH}_3$  relative to the front denuder during many of the sampling periods (up to 200% of the front denuder). The second backup denuder captured more than 10% of the  $\text{NH}_3$  on the front denuder in only three cases. It is unlikely that  $\text{NH}_3$  was lost due to breakthrough of the second backup denuder for these or any of the reference samples. Therefore, these samples were not eliminated from the reference data. The relatively high collection of  $\text{NH}_3$  on the first backup denuder may have been caused by displacement by species with a higher affinity for the citric acid coating. Presumably these species would remain on the front denuder, so it is unlikely that  $\text{NH}_3$  was lost as a result. Table 4-3 summarizes the results of the breakthrough checks for Phase I.

#### 4.2.2.2 Phase II

The  $\text{NH}_3$  levels measured during Phase II were significantly lower than observed during Phase I. Thus, the sampling approach was changed such that all samples still included one backup denuder, but, only 19% of the samples collected during Phase II included two backup denuders. Figure 4-2 shows the percentage of  $\text{NH}_3$  collected on the backup denuders relative to the front denuder as a function of the average  $\text{NH}_3$  concentration during the corresponding sampling period, using the same symbols as in Figure 4-1. Data for all three Phase II sampling locations

**Table 4-3. Denuder Breakthrough Checks During Phase I**

	2-Hour Samples		4-Hour Samples		12-Hour Samples	
	1 <sup>st</sup> Backup Denuder (%)	2 <sup>nd</sup> Backup Denuder (%)	1 <sup>st</sup> Backup Denuder (%)	2 <sup>nd</sup> Backup Denuder (%)	1 <sup>st</sup> Backup Denuder (%)	2 <sup>nd</sup> Backup Denuder (%)
Percent of reference samples with denuder	100	72	100	80	100	74
Average concentration as % of concentration on front denuder	19.4	1.2	42.4	2.5	82.5	6.5
Maximum concentration as % of concentration on front denuder	111.0	3.6	199.3	41.7	159.2	28.8
Percent of samples with breakthrough greater than 10% of front denuder	57	0	82	3	100	14

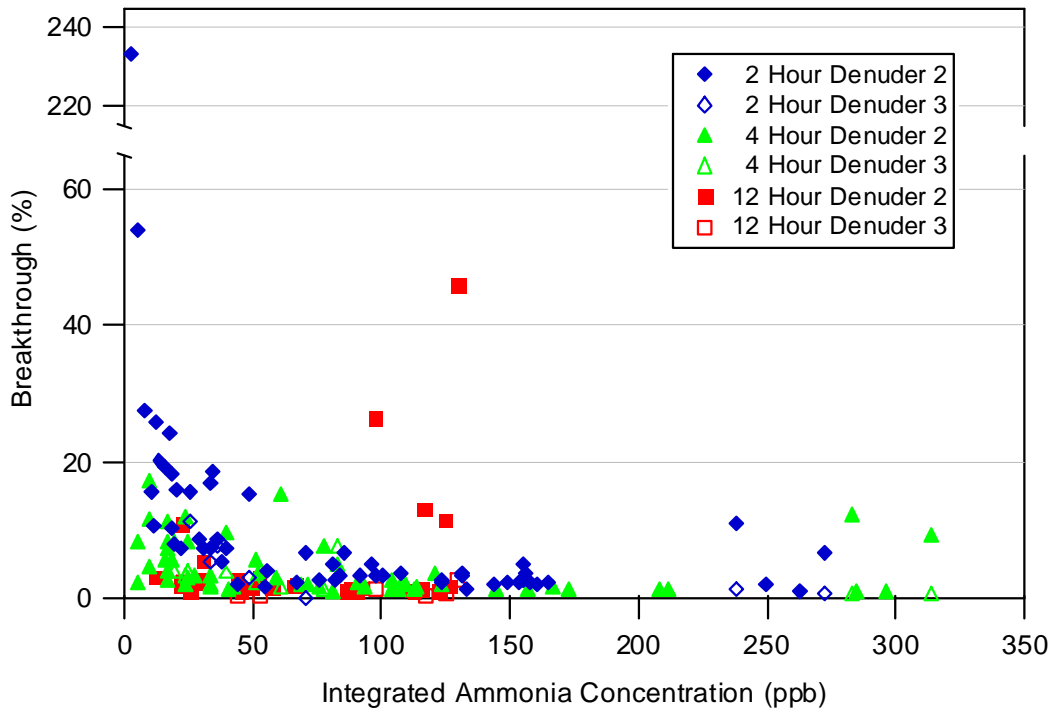

**Figure 4-2. Denuder Breakthrough During Phase II as a Function of Integrated Ammonia Concentration**



are included here. In general, breakthrough onto the first backup denuder (Denuder 2 in the figure legend) was low, with an average breakthrough of 8.6%. As shown in the figure, many of the high breakthrough values (i.e., greater than 10%) observed on the first backup denuder (Denuder 2 in the legend) occurred at very low NH<sub>3</sub> concentrations where the mass of NH<sub>3</sub> collected was similar to that collected for field blanks. The high values do not indicate that breakthrough occurred, but rather that the measurements were near the DL of the reference method. High breakthrough of the first backup denuder also occurred at higher NH<sub>3</sub> concentrations and/or long sample durations. Although these high breakthrough values may indicate that breakthrough of the first backup denuder occurred, the second backup denuder (Denuder 3 in the figure legend) was in place to collect the remaining NH<sub>3</sub>. With the exception of one sample that occurred at a low ambient NH<sub>3</sub> concentration, breakthrough observed on the second backup denuder was always less than 10% of the amount collected on the front denuder. Thus, it is unlikely that NH<sub>3</sub> was lost as a result of breakthrough of the first or second backup denuders. Table 4-4 summarizes the results of the breakthrough checks for Phase II.

**Table 4-4. Denuder Breakthrough Checks During Phase II**

	2-Hour Samples		4-Hour Samples		12-Hour Samples	
	1 <sup>st</sup> Backup Denuder (%)	2 <sup>nd</sup> Backup Denuder (%)	1 <sup>st</sup> Backup Denuder (%)	2 <sup>nd</sup> Backup Denuder (%)	1 <sup>st</sup> Backup Denuder (%)	2 <sup>nd</sup> Backup Denuder (%)
Percent of reference samples with denuder	100	18	100	18	100	24
Average concentration as % of concentration on front denuder	8.6	4.1	4.4	2.8	5.2	1.1
Maximum concentration as % of concentration on front denuder	[233.3] <sup>(a)</sup> 53.8	11.3	17.2	7.5	45.9	2.5
Percent of samples with breakthrough greater than 10% of front denuder	29	10	10.7	0	17.2	0

<sup>(a)</sup> Suspect value rejected based on Q-test and not included in other calculations. This value corresponded to an NH<sub>3</sub> concentration that was less than the minimum detectable NH<sub>3</sub> concentration.

### 4.2.3 Duplicate Samples

For at least 10% of the reference samples, duplicates were collected using a collocated sampling train (within 1 meter). These duplicate samples were collected at both of the sampling locations during Phase I, and only at the trailer location during Phase II, and were collected during each of the sampling periods. The relative percent difference (RPD) between the duplicate samples was calculated by dividing the absolute difference of the sample concentrations by the average of the sample concentrations.

Table 4-5 summarizes the results of the duplicate sampling for both Phases I and II. During Phase I, a total of 18 sets of duplicate samples were collected. Eight of the duplicate samples

were collected at the sampling location next to the trailer, and the other 10 duplicate samples were collected at the sampling location next to the scaffold. The duplicate samples showed absolute RPD values between 0.6% and 22%. The average RPD for Phase I was 9%. During Phase II, duplicate samples were collected during every sampling period at the sampling location next to the trailer, resulting in a total of 35 duplicate measurements. The absolute RPD varied between 0.7% and 32%, with an average of 7%. Although the average RPD values are comparable in Phases I and II, the absolute differences are significantly smaller during Phase II. For both phases combined, the absolute RPD for 13 of the duplicate samples exceeded the QA limit of 10% specified in the test/QA plan. To verify the quality of the reference method, NH<sub>3</sub> gas standards were delivered to the reference method. Repeated delivery of the same concentration standard gave an average RPD of 1.3%. Thus, it is probable that the exceedences were caused by non-uniformity in the air sampled and did not impact the quality of the reference method itself. However, some contributions may result from small variations in sampling flow rates and analytical uncertainties.

**Table 4-5. Duplicate Reference Method Samples**

	Phase I		Phase II	
	RPD (%)	Absolute Difference (ppb)	RPD (%)	Absolute Difference (ppb)
Average	9	28	7	5
Maximum	22	109	32	18
Minimum	0.6	1	0.7	0.6
Number of duplicate samples		18		35
Number with RPD >10%		6		7

#### 4.2.4 Laboratory Blanks

Laboratory blank solutions were prepared for the FIA using distilled, deionized water. In each analytical batch, at least 10% of the number of reference samples analyzed were laboratory blanks and were submitted to the laboratory as blind samples. The analysis of the laboratory blanks deviated from the test/QA plan in that, rather than submitting the blanks routinely (e.g., every tenth sample), the blanks were interspersed among the other samples and submitted as blind samples.

During Phase I, a total of 31 laboratory blank samples were analyzed. The analytical results from the laboratory blanks indicated no apparent drift in the calibration of the FIA, and none of the blank values were greater than 5% of the lowest measured reference sample on that day. (Note: The test/QA plan indicates that laboratory blanks should not exceed 5% of any concentration measured on that day. As written, this threshold includes field blanks and backup denuder

---

samples. A deviation report has been filed to change this threshold so that it applies only to composite reference samples and does not include samples that would be expected to have low concentrations, such as field blanks.) During Phase II, a total of 27 laboratory blank samples were analyzed. Similarly, the analytical results from the laboratory blanks indicated no apparent drift in the baseline of the FIA, and none of the blank values was greater than 5% of the lowest measured reference sample on that day.

#### **4.2.5 Calibration Checks**

In addition to analyzing every 15th calibration check samples, as described in Section 4.1.2, at least 10% of the samples were submitted to the laboratory as blind calibration check samples. These blind calibration check samples were prepared by diluting NIST-traceable  $\text{NH}_4^+$  standard stock solution.

During Phase I, 38  $\text{NH}_4^+$  blind calibration check samples were prepared from 15 different standard solutions, ranging in concentration from 0.4 to 8 mg/L  $\text{NH}_3$ . Measured concentrations for 10 of these calibration check samples differed from the delivered standard concentration by more than 10%, and the full set of measured values was on average 1.9% lower than the delivered concentration. It should be noted that the calibration check samples were prepared from  $\text{NH}_4^+$  standards that were diluted from a 1,000-mg/L stock solution and that errors may have occurred during the dilution process. For example, nine of the 10 calibration check samples that failed were prepared from four different standard solutions. Of these four standard solutions, a total of 10 samples were submitted to the laboratory for analysis, and 9 of the samples fell outside the 10% acceptance criterion. Of the 28 additional samples submitted to the laboratory from the 11 other prepared standard solutions, only one fell outside the 10% acceptance criterion, and the concentration of that standard solution was near the quantitation limit of the FIA. As such, it is likely that the preparation of the standard solutions contributed to the failure of the calibration check samples, rather than the calibration of the FIA.

During Phase II, 24 calibration check samples were prepared from four different standard solutions. Measured concentrations for six of these calibration check samples differed from the delivered standard concentration by more than 10%, and the full set of measured values was on average 4.4% lower than the delivered concentration. Of the six calibration check samples that failed, five were prepared from two of the four standard solutions. It is possible that the failures may be attributable to inadvertent dilution or degradation of the standard solutions used, since these standards were prepared prior to submission of the first samples and failed consistently only near the end of the analysis period. The sixth calibration check sample that failed may be associated with a transcription error in the submission log.

#### **4.2.6 Gas Standard Dilution Checks**

At each of the nominal  $\text{NH}_3$  levels to be used for the accuracy and linearity checks, at least one sample of the dilution of the  $\text{NH}_3$  gas standard was collected using the reference method. These samples were analyzed as regular samples and used to check the accuracy of the dilution system. Figure 4-3 shows the measured  $\text{NH}_3$  captured by the sampling cartridges versus the  $\text{NH}_3$  delivered during the dilution checks.

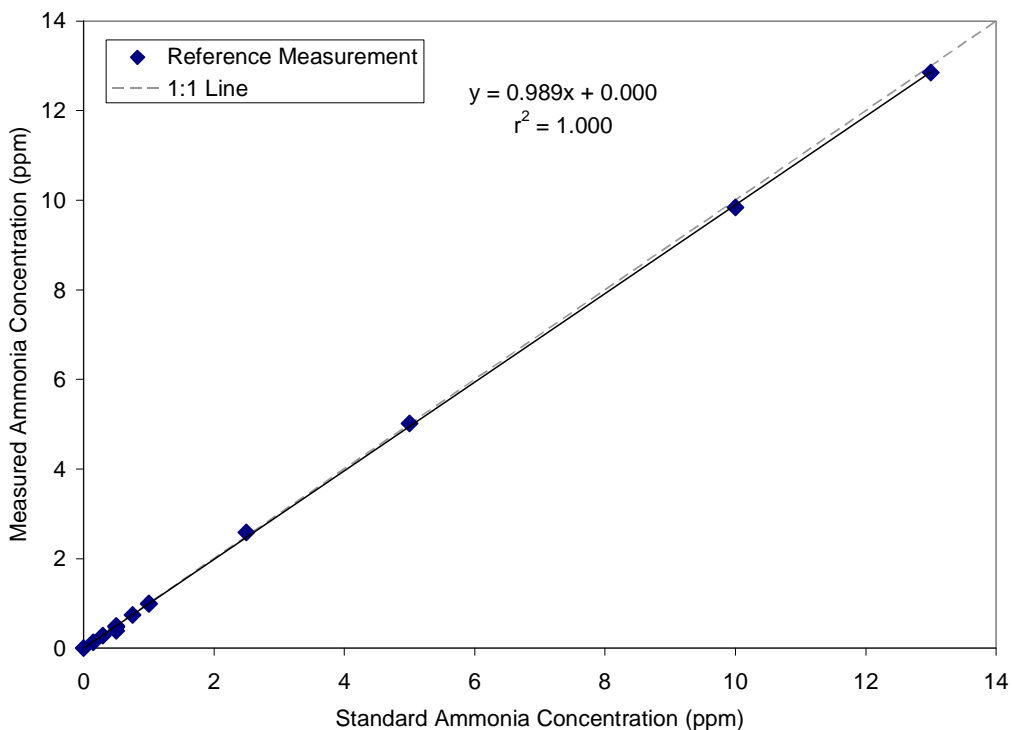

**Figure 4-3. Analysis of Diluted Ammonia Standards Using the Denuder Reference Method**

A dilution check was conducted before Week 2 of Phase I. However, the sampling line was thought to have not been flushed with the diluted  $\text{NH}_3$  sample prior to collecting the check samples, and the measured concentrations did not agree within 10% of the expected concentration. Consequently, the dilution check was repeated prior to Phase II, and the results are shown in Figure 4-3. The average RA of the measured concentrations was 4% and indicates that the  $\text{NH}_3$  gas standards as delivered by the dilution system were accurate with respect to the reference method.

## 4.3 Audits

### 4.3.1 Performance Evaluation Audit

A performance evaluation audit was conducted to assess the quality of the measurements made in this verification test. This audit addressed only those measurements that factor into the data used for verification, i.e., the sample flow rate and the analytical laboratory measurements. This audit was performed once during the verification test by analyzing a standard or comparing a reading to a reference that was independent of standards used during the testing.

---

The flow rates of the reference method sampling assemblies were audited once during each phase of testing using a flow meter independent of the meter used to calibrate the flow rate. During Phase I, agreement between the audit flow rate and the nominal flow rate indicated a bias in the calibrated flow rates. The flow rates were recalibrated. The bias was later attributed to a faulty audit flow meter, and the original flow calibrations were verified against a second audit flow meter.

The performance of the FIA was audited by analyzing an  $\text{NH}_4^+$  standard independent of those used for the calibration, but were the same as those used for the calibration checks described in Section 4.2.5. These samples were provided as blind audit samples, and the operator of the FIA was not aware of the concentrations of the samples. In several cases, agreement between the measured concentration and the standard concentration was not within  $\pm 10\%$  (ranged from -43% to 64%). The cause of the discrepancy was investigated but could not be identified. It is possible that some of the discrepancy is attributable to uncertainties associated with dilution of the stock 1,000 mg/L  $\text{NH}_4^+$  standard solution. Multiple solutions were prepared, and only some of those solutions showed discrepancies with the analytical results. The relative agreement between the reference samples collected during the gas standard dilution check (performed between Phases I and II) and their expected values provide additional verification of the accuracy of the FIA.

#### ***4.3.2 Technical Systems Audit***

Battelle's ETV Quality Manager performed a technical systems audit (TSA) of the performance of this verification test during each phase of the test. The purpose of this TSA was to ensure that the verification test was being performed in accordance with the test/QA plan<sup>(2)</sup> and that all QA/QC procedures were implemented. As part of the audit, Battelle's ETV Quality Manager reviewed the reference sampling and analysis methods used, compared actual test procedures to those specified in the test/QA plan, and reviewed data acquisition and handling procedures. Observations and findings from this audit were documented and submitted to the Battelle Verification Test Coordinator for response. The records concerning the TSA are permanently stored with the Battelle Quality Manager.

#### ***4.3.3 Audit of Data Quality***

At least 10% of the data acquired during the verification test was audited. Battelle's Quality Manager traced the data from the initial acquisition, through reduction and statistical analysis, to final reporting, to ensure the integrity of the reported results. All calculations performed on the data undergoing the audit were checked during the technical review process.

### **4.4 QA/QC Reporting**

Each audit was documented in accordance with Sections 3.3.4 and 3.3.5 of the QMP for the ETV AMS Center.<sup>(5)</sup> Once the audit report was prepared, the Battelle Verification Test Coordinator ensured that a response was provided for each adverse finding or potential problem and implemented any necessary follow-up corrective action. The Battelle Quality Manager ensured that follow-up corrective action was taken. The results of the TSA were sent to the EPA.

## 4.5 Data Review

Records generated in the verification test were reviewed before these records were used to calculate, evaluate, or report verification results. Table 4-6 summarizes the types of data recorded. The review was performed by a technical staff member involved in the verification test, but not the staff member who originally generated the record. The person performing the review added his/her initials and the date to a hard copy of the record being reviewed. In some cases, entries in the laboratory record books or on field data sheets were not reviewed within two weeks after completion of each phase. A deviation report was filed to address this.

**Table 4-6. Data Recording Process**

<b>Data to be Recorded</b>	<b>Responsible Party</b>	<b>Where Recorded</b>	<b>How Often Recorded</b>	<b>Disposition of Data<sup>(a)</sup></b>
Dates, times of test events (site activities, etc.)	USDA/ Battelle staff	Laboratory record books/field data sheet.	Start/end of test, and at each test activity.	Used to organize/check test results; manually incorporated in data spreadsheets as necessary.
Reference method sampling data	USDA/ Battelle staff	Laboratory record books, chain-of-custody forms, or file data sheets as appropriate.	At least at start/end of reference sample, and at each change of a test parameter.	Used to organize/check test results; manually incorporated in data spreadsheets as necessary.
Meteorological conditions	Battelle	Meteorological station data logger.	Continuously.	Used to assess meteorological conditions during testing as necessary.
Ammonia analyzer readings	Vendor or designee	Data acquisition system (data logger, personal computer, laptop, etc.).	Continuously at specified acquisition rate throughout analyzer operation.	Electronically transferred to spreadsheets.
Reference sample analysis and results	USDA/ Battelle staff	Laboratory record books, data sheets, or data acquisition system, as appropriate.	Throughout sample handling and analysis process.	Transferred to spreadsheets.

<sup>(a)</sup> All activities subsequent to data recording were carried out by Battelle.

---

## Chapter 5

### Statistical Methods and Reported Parameters

The statistical methods presented in this chapter were used to verify the performance parameters listed in Section 3.1.

#### 5.1 Relative Accuracy

The percent difference (%D) of the average AiRRmonia response to each NH<sub>3</sub> gas standard was calculated according to Equation 1:

$$\%D = \frac{\bar{x} - x_n}{x_n} \times 100 \quad (1)$$

where  $\bar{x}$  is the average AiRRmonia response to an NH<sub>3</sub> gas standard of nominal concentration  $x_n$ . For each phase of testing, the RA with respect to all of the gas standards ( $n$ ) delivered to the AiRRmonia was calculated using Equation 2:

$$\text{Average RA} = \frac{1}{n} \left( \sum_{i=1}^n |\%D_i| \right) \times 100 \quad (2)$$

#### 5.2 Linearity

Linearity was assessed by a linear regression analysis using the compressed gas standard concentrations as the independent variable and results from the AiRRmonia as the dependent variable. Linearity was expressed in terms of slope, intercept, and  $r^2$  and was calculated independently for each phase of the verification test. The 95% confidence interval (CI) for the slope and intercept was also calculated.

---

### 5.3 Precision

Precision was calculated in terms of the percent relative standard deviation (RSD) of AiRRmonia measurements of several NH<sub>3</sub> gas standards. The mean and standard deviations of those readings were calculated. The RSD was then determined as:

$$\text{RSD} = \frac{\text{SD}}{\bar{x}} \times 100 \quad (3)$$

where SD is the standard deviation of the AiRRmonia readings and  $\bar{x}$  mean of the AiRRmonia readings. Precision was calculated independently for each phase of testing.

### 5.4 Response Time

Response time was assessed in terms of both the rise and fall times of the AiRRmonia when sampling NH<sub>3</sub> gas standards or zero air. Rise time (i.e., 0% to 95% response time for the change in NH<sub>3</sub> concentration) was determined from the AiRRmonia response to a rapid increase in the delivered NH<sub>3</sub> concentration. Once a stable response was achieved with the gas standard, the fall time (i.e., the 100% to 5% response time) was determined in a similar way, switching from the NH<sub>3</sub> standard back to zero air or a lower concentration NH<sub>3</sub> gas standard. Rise and fall times were determined for the AiRRmonia during each phase of testing. Response times are reported in terms of seconds (s). It should be noted that response times include the time associated with equilibration of NH<sub>3</sub> on the tubing and inlet surfaces during delivery of the gas standards.

### 5.5 Calibration and Zero Drift

Calibration and zero drift are reported in terms of the mean, RSD, and range (maximum and minimum) of the readings obtained from the AiRRmonia in the repeated sampling of the same NH<sub>3</sub> standard gas and of zero air. For zero drift, the SD is reported instead of the RSD since dividing the SD by a value approximately equal to zero is not meaningful. The calibration and zero drift were calculated independently during each phase of testing so that up to six NH<sub>3</sub> standard and zero readings (Monday, Wednesday, and Friday for two weeks) were used for this calculation in each phase. This calculation, along with the range of the data, indicates the day-to-day variation in zero and standard readings.

### 5.6 Interference Effects

The extent of interference was calculated in terms of the ratio of the response of the AiRRmonia to the interfering species, relative to the actual concentration of the interfering species. For example, if 100 ppb of an interfering species resulted in a 1-ppb increase in the NH<sub>3</sub> reading of the AiRRmonia, the interference effect was reported as 1% (i.e., 1 ppb/100 ppb). The interference effect was reported separately for each interferent, both in the absence and in the presence of NH<sub>3</sub>.



---

## 5.7 Comparability

Comparability between the AiRRmonia results and the reference method results with respect to ambient air was assessed by linear regression using the reference method  $\text{NH}_3$  concentrations as the independent variable and results from the AiRRmonia as the dependent variable. Comparability was expressed in terms of slope, intercept, and  $r^2$  and was calculated independently for each phase of the verification test. If the measured concentration of  $\text{NH}_3$  did not vary by at least a factor of five during each phase of testing, then comparability for that phase was calculated using Equation 1 and reported as a percent difference rather than in terms of the linear regression results.

---

## Chapter 6 Test Results

The results of the verification test of the AiRRmonia are presented in this section. The values presented in this section are based on 2-minute average readings recorded by the AiRRmonia.

Figure 6-1 shows the ambient data set collected by the AiRRmonia in the bottom panel along with the wind direction, wind speed, and ambient temperature data from Phase I. The shaded regions indicate the NH<sub>3</sub> reference method sampling periods. The average ambient NH<sub>3</sub> concentration measured by the AiRRmonia was 364 ppb with a range of 18 to 3,463 ppb. The meteorological conditions, which were recorded as one-hour averages, varied widely over the duration of Phase I. The average ambient temperature, calculated using the meteorological monitoring station, during Phase I of the test was 14°C with a range of -4 to 29°C. The average relative humidity was 66%. Winds were predominantly from the southeast and northwest, with

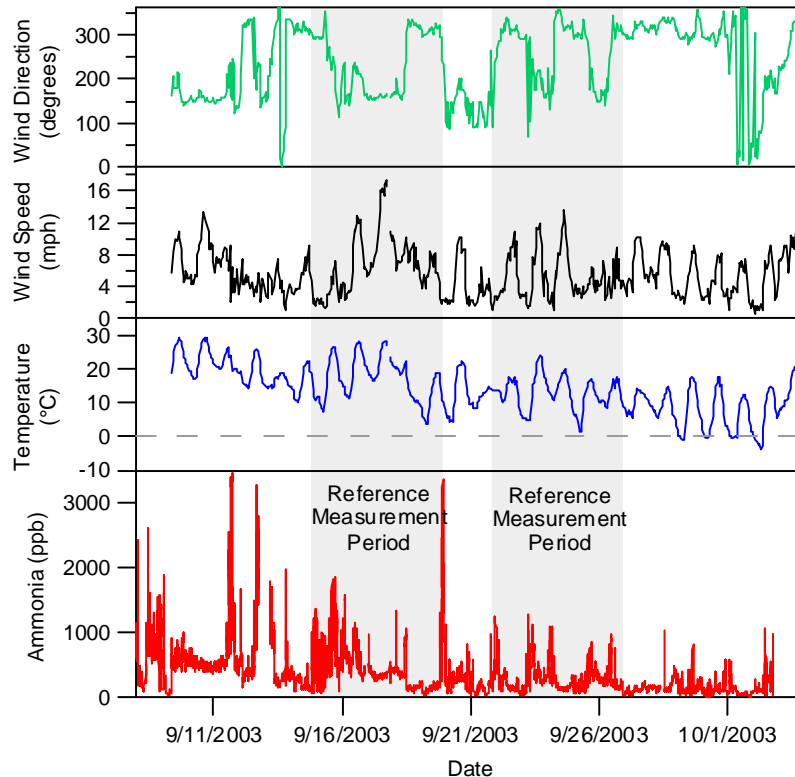

**Figure 6-1. Phase I Meteorological Conditions and AiRRmonia Ambient NH<sub>3</sub> Measurements**

wind speeds up to 17 miles per hour(6 miles per hour average). When winds were observed from the southeast, the monitors were exposed to emissions from the nutrient lagoons, whereas the monitors sampled barn emissions during periods of northerly winds.

Meteorological conditions during Phase II are presented in Figure 6-2. The average ambient temperature was 4.5°C (range = -10 to 29°C) and the average relative humidity was 75%. Winds were predominantly from the northwest and quite variable in speed, averaging 7 miles per hour (30 miles per hour maximum). Figure 6-2 shows the Phase II wind direction, wind speed, and ambient temperature data and the ambient NH<sub>3</sub> data set collected by the AiRRmonia (bottom panel). The shaded region shows the period during which NH<sub>3</sub> reference measurements were conducted. The dashed black line in the bottom panel indicates the first observation of the AiRRmonia malfunction discussed later in this section. The AiRRmonia measurements ranged from 17 to 615 ppb during Phase II, and averaged 112 ppb, excluding data during the apparent malfunction.

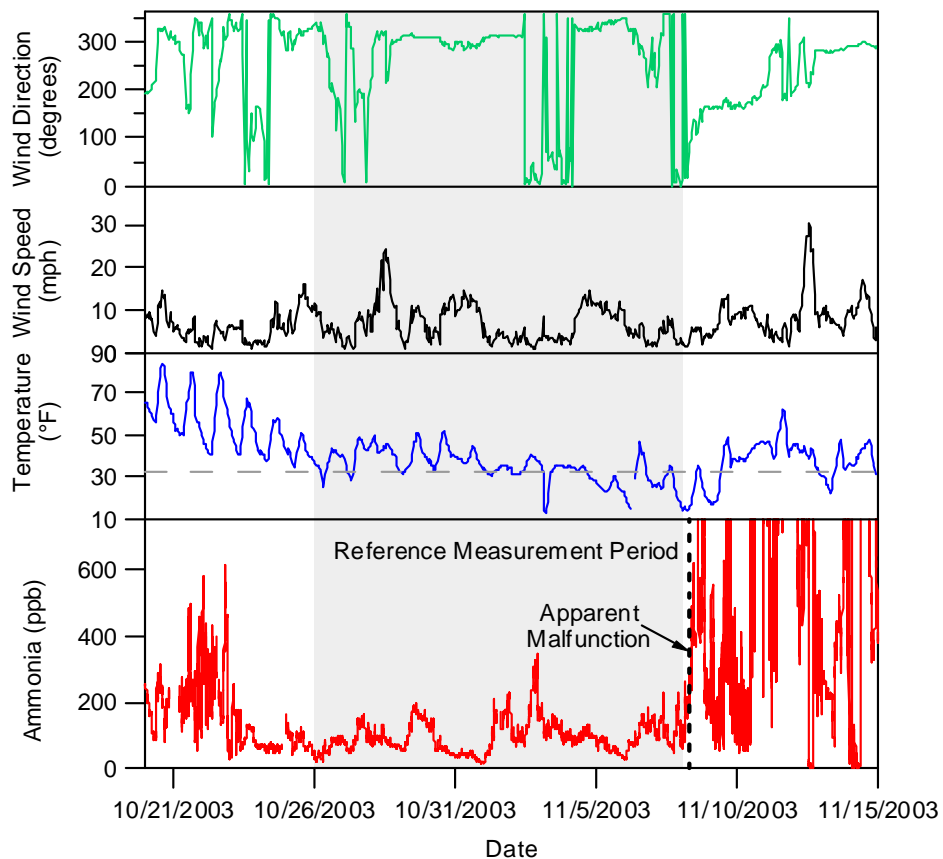

**Figure 6-2. Phase II Meteorological Conditions and AiRRmonia Ambient NH<sub>3</sub> Measurements**

## 6.1 Relative Accuracy

During the first week of each phase of the verification test, the AiRRmonia was supplied with compressed NH<sub>3</sub> gas standards at a variety of concentrations to assess RA. The compressed NH<sub>3</sub> gas standards were diluted in zero air and delivered to the inlet of the AiRRmonia at a flow rate of 5 Lpm.

Figures 6-3 and 6-4 present the NH<sub>3</sub> concentrations recorded by the AiRRmonia during the RA checks along with the nominal NH<sub>3</sub> concentration levels supplied to the AiRRmonia for Phase I and Phase II, respectively. The averages of the measurements at each nominal NH<sub>3</sub> concentration are presented in Table 6-1 along with the calculated %D values, the number of data points at each concentration, and the average RA for each phase.

During Phase I, the %Ds of the AiRRmonia ranged from 26 to 44, and the average RA was 34%. During Phase II, the %D of the AiRRmonia ranged from 1.0 to 4.0, and the average RA was 2.4%. The cause of the observed differences between the calculated RA in the two phases is not clear. During both RA checks, the gas standards were delivered directly to the AiRRmonia inlet (i.e., bypassing the sampling line used during Phase II). Fresh reagent solutions were prepared for the AiRRmonia at the beginning of each phase.

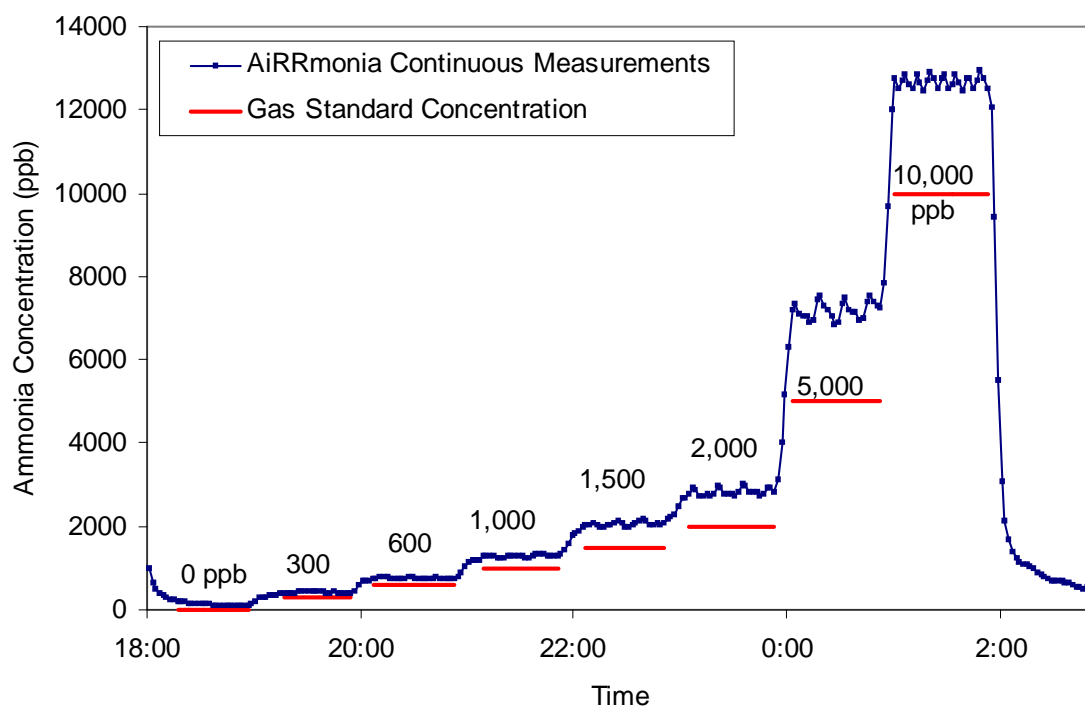

**Figure 6-3. Phase I Relative Accuracy Results for the AiRRmonia**

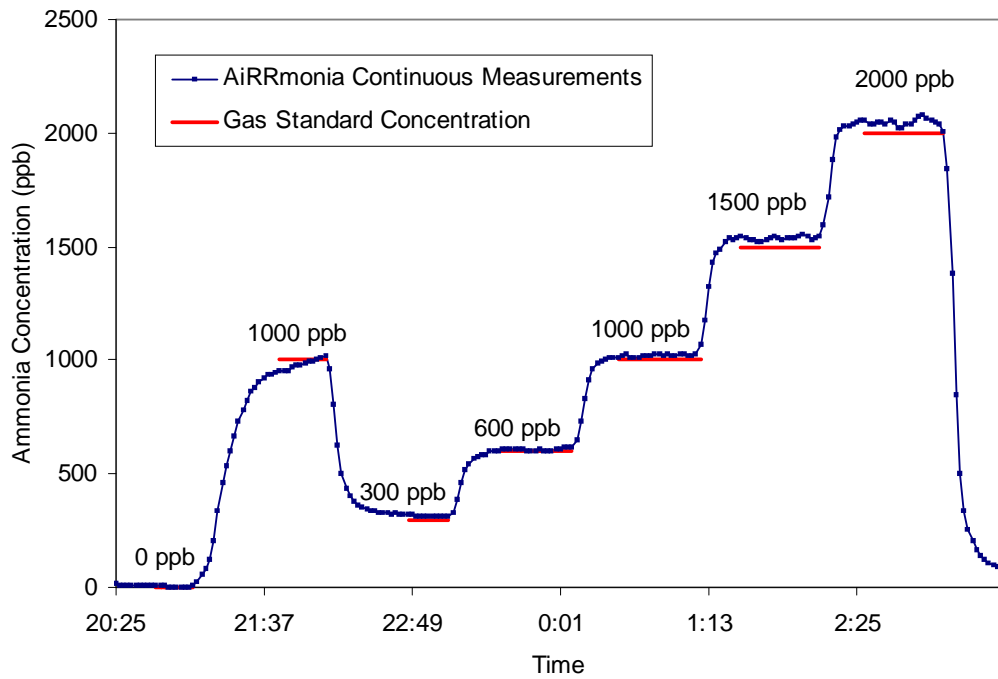

**Figure 6-4. Phase II Relative Accuracy Results for the AiRRmonia**

**Table 6-1. Relative Accuracy Results**

NH <sub>3</sub> Gas Standard Concentration (ppb)	Phase I			Phase II		
	Average Measured Concentration (ppb)	Number of Data Points	%D	Average Measured Concentration (ppb)	Number of Data Points	%D
0	89	2	NA	0	4	NA
300	403	4	34	312	7	4.0
600	753	19	26	606	15	1.0
1,000	1,297	15	30	1,021	17	2.1
1,500	2,062	18	37	1,537	20	2.5
2,000	2,839	21	42	2,045	20	2.3
5,000	7,202	21	44			
10,000	12,682	23	27			
Average RA			34%	2.4%		

NA = not applicable.

## 6.2 Linearity

Figures 6-5 and 6-6 show the results of the linearity check for Phase I and Phase II, respectively. During Phase I, a linear regression of the AiRRmonia response versus the gas standard concentration, over the range from 0 to 10,000 ppb, showed a slope of 1.29 ( $\pm 0.08$ ), an intercept of 136 ( $\pm 344$ ) ppb, and an  $r^2$  of 0.9957, where the numbers in parentheses represent the 95% CI. During Phase II, the AiRRmonia showed a linear response, over the range from 0 to 2,000 ppb, with a slope of 1.02 ( $\pm 0.01$ ), an intercept of -2.4 ppb ( $\pm 15.3$ ), and an  $r^2$  of 0.9999. Several of the  $\text{NH}_3$  standard concentrations fell outside of the AiRRmonia linear range reported by the manufacturer, which was 0 to 750 ppb.

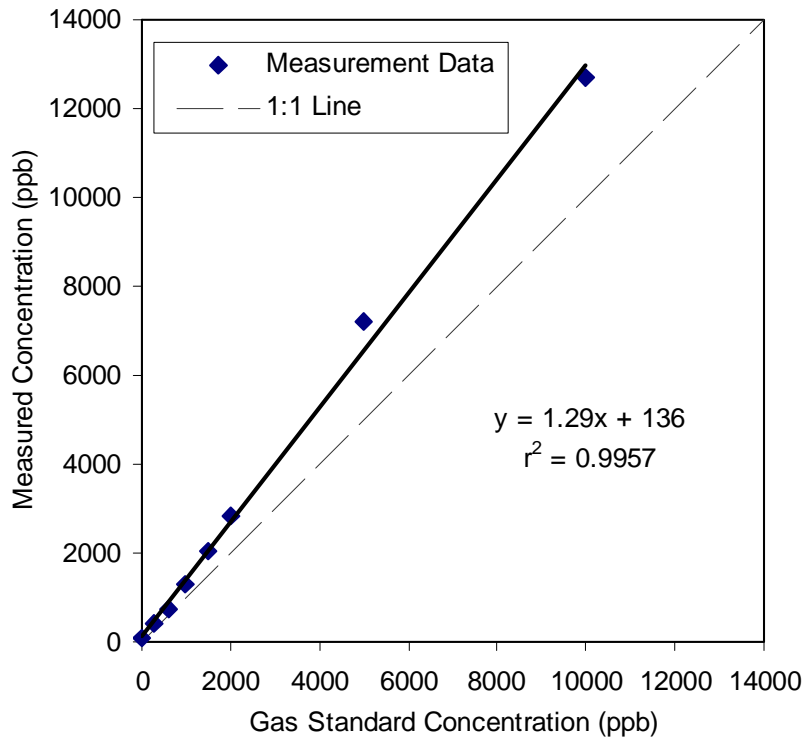

**Figure 6-5. Results of Linearity Check of the AiRRmonia During Phase I**

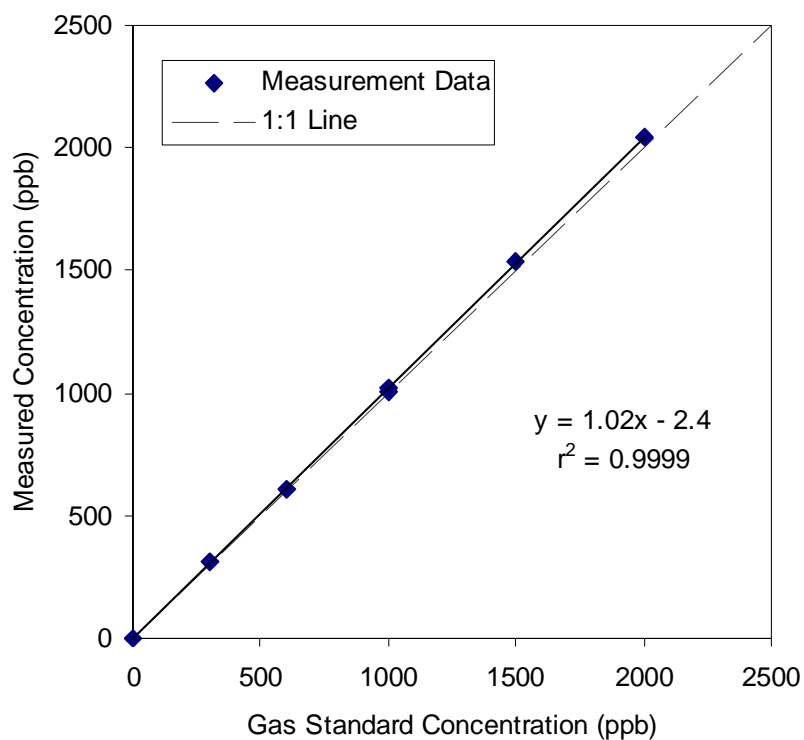

**Figure 6-6. Results of Linearity Check of the AiRRmonia During Phase II**

### 6.3 Precision

Table 6-2 presents the calculated precision of the AiRRmonia measured during the accuracy and linearity checks. During Phase I, the AiRRmonia readings varied from 0.8 to 3.0% RSD, with an average precision of 2.1%. During Phase II, the precision of the AiRRmonia readings ranged from 0.5% to 1.0% RSD, with an average precision of 0.7%.

**Table 6-2. Calculated Precision of the AiRRmonia**

NH <sub>3</sub> Gas Standard Concentration (ppb)	Phase I		Phase II	
	Average Measured Concentration (ppb)	RSD (%)	Average Measured Concentration (ppb)	RSD (%)
300	403	0.8	312	1.0
600	753	1.8	606	0.9
1,000	1,297	2.0	1,021	0.5
1,500	2,062	2.7	1,537	0.5
2,000	2,839	2.9	2,045	0.8
5,000	7,202	3.0		
10,000	12,682	1.2		
Average RSD		2.1		0.7

#### 6.4 Response Time

Response time was determined during each phase from the amount of time required for the AiRRmonia to reach 95% of the change in the stable concentrations during the accuracy/linearity checks calculated from the change in NH<sub>3</sub> concentration. Table 6-3 presents a summary of the response time determinations for the AiRRmonia.

It should be noted that the response time summarized in Table 6-3 does not include a delay of approximately 15 minutes that is inherent in the response of the AiRRmonia due to the time required for the sample to diffuse through the interface membrane and be transferred through the reaction chamber to the conductivity detector. The measured response times may be impacted by the equilibrium of the NH<sub>3</sub> gas standard on the sample line and inlet surfaces.

#### 6.5 Calibration and Zero Drift

The calibration/drift checks were conducted by supplying an NH<sub>3</sub> gas standard and zero air to the AiRRmonia on Monday, Wednesday, and Friday during the first and last weeks of each phase. During both phases, the AiRRmonia was supplied with an NH<sub>3</sub> gas standard at a nominal concentration of 1,000 ppb, and zero air to check the calibration and zero drift, respectively. Unfortunately, no response to these gases was apparent in the data recorded by the AiRRmonia during Phase I, suggesting that the supply of the gas was not successful. Because the response of the AiRRmonia was not monitored by the operators in real time during these checks, it was not realized that the checks were unsuccessful until after the conclusion of Phase I.



**Table 6-3. Response Time Determinations**

Change (ppb)	Phase I				Phase II			
	Rise Time		Fall Time		Rise Time		Fall Time	
	seconds	minutes	seconds	minutes	seconds	minutes	seconds	minutes
0 – 300	1,200	20	–	–	(b)		–	–
300 – 600	840	14	–	–	1,200	20	–	–
600 – 1,000	960	16	–	–	1,080	18	–	–
1,000 – 1,500	960	16	–	–	840	14	–	–
1,500 – 2,000	960	16	–	–	721	12	–	–
2,000 – 5,000	600	10	–	–	(a)	(a)	–	–
5,000 – 10,000	480	8	–	–	(a)	(a)	–	–
2,000 – 0	–		1,439 <sup>(b)</sup>	(24) <sup>(b)</sup>	–		1,080	18
1,000 – 300	–		(a)	(a)	–		1,200	20

<sup>(a)</sup> Not all nominal NH<sub>3</sub> concentration levels were measured during both RA checks.

<sup>(b)</sup> Fall time measured from an ambient NH<sub>3</sub> concentration of 2,068 ppb.

The results of the Phase II calibration and drift checks are summarized in Table 6-4. The values reported in this table are based on the average readings during the calibration and zero checks when the readings of the AiRRmonia had stabilized (i.e., the signal was not visibly increasing nor decreasing). All calibration and zero checks took place during the first week of Phase II, during which time no drift was apparent in the response to zero air or the NH<sub>3</sub> standard. Malfunction of the AiRRmonia prevented completing further checks during the final week.

**Table 6-4. Calibration and Zero Checks During Phase II**

Check Number	Zero Check					Calibration Check <sup>(a)</sup>				
	Mean (ppb)	SD <sup>(b)</sup> (ppb)	Maximum (ppb)	Minimum (ppb)	Number of Data Points	Mean (ppb)	RSD (%)	Maximum (ppb)	Minimum (ppb)	Number of Data Points
Week 1, Monday	0.5	0.5	1.0	-0.1	4	1,004	1.1	1,019	991	5
Week 1, Wednesday	26 <sup>(c)</sup>	2.4	32	24	11	1,019	1.0	1,035	1,003	12
Week 1, Friday	-2	1.9	3	-4	12	1,010	0.6	1,020	1,001	10

<sup>(a)</sup> 1,000 ppb NH<sub>3</sub> nominal concentration.

<sup>(b)</sup> Standard deviation reported for zero drift check since the RSD is not meaningful for near-zero values.

<sup>(c)</sup> It should be noted that the AiRRmonia signal continued to decrease gradually, even after one hour of delivery of zero air.

## 6.6 Interference Effects

The effect of potential interferent gases on the response of the AiRRmonia was assessed by supplying the AiRRmonia with a series of four gases (hydrogen sulfide, nitrogen dioxide, 1,3-butadiene, diethylamine) in zero-air and 500-ppb NH<sub>3</sub> matrices. During the course of testing in Phase II, an abrupt change in the response of the AiRRmonia was observed on November 8. This change correlated with the observation of air bubbles in the sample solution stream and the appearance of a sinusoidal waveform in the signal output, and may have been caused by a malfunction in the sample solution pumping system. Although the AiRRmonia was not operating properly during the interference test, some information may still be gained from the data collected during this period. Using the response of the AiRRmonia to a 500-ppb NH<sub>3</sub> standard, the AiRRmonia measured concentrations were adjusted to account for the observed change in instrument sensitivity. Because of the increased noise associated with the sinusoidal wave, the uncertainty in the AiRRmonia measurements during this period is on the order of  $\pm 25$  ppb, and the interference gas concentrations delivered had an uncertainty of approximately  $\pm 15$  to 43 ppb (as reported by the manufacturer for uncertified permeation tubes). The response of the AiRRmonia during the introduction of these gases is summarized in Table 6-5. No apparent instrument response was observed for hydrogen sulfide in a zero air matrix. The interference effect of hydrogen sulfide could not be quantified due to noise introduced from testing activities. No apparent instrument response was observed for nitrogen dioxide, or 1,3-butadiene. Diethylamine appeared to affect the instrument response in a zero-air matrix. However, the presence of an NH<sub>3</sub> impurity in the diethylamine standard or the release of NH<sub>3</sub> from the sample lines during delivery could not be ruled out.

**Table 6-5. Interference Effect Evaluation**

Gas	Interferent Gas Concentration (ppb)	Interference Effect (%)	
		Zero-Air Matrix	500-ppb NH <sub>3</sub> Matrix
Hydrogen sulfide	285	0.2 <sup>(a)</sup>	<sup>(b)</sup>
Nitrogen dioxide	95	0.8 <sup>(a)</sup>	-2 <sup>(a)</sup>
1,3-Butadiene	95	0.8 <sup>(a)</sup>	0 <sup>(a)</sup>
Diethylamine	96	25 <sup>(c)</sup>	-6 <sup>(a)</sup>

<sup>(a)</sup> Signal not significantly different from baseline without interferent gas.

<sup>(b)</sup> Noise introduced from testing activities prevented reliable quantification of the interference from this compound.

<sup>(c)</sup> The presence of an ammonia impurity in the diethylamine gas standard or the release of NH<sub>3</sub> from the sample lines during delivery could not be ruled out.

## 6.7 Comparability

Figures 6-7 and 6-8 show the NH<sub>3</sub> concentrations measured using the reference method along with the corresponding average readings of the AiRRmonia for the reference sampling periods during Phase I and Phase II. These data are also presented in Figures 6-9 and 6-10 as scatter plots to illustrate the correlation between the reference and the AiRRmonia data.

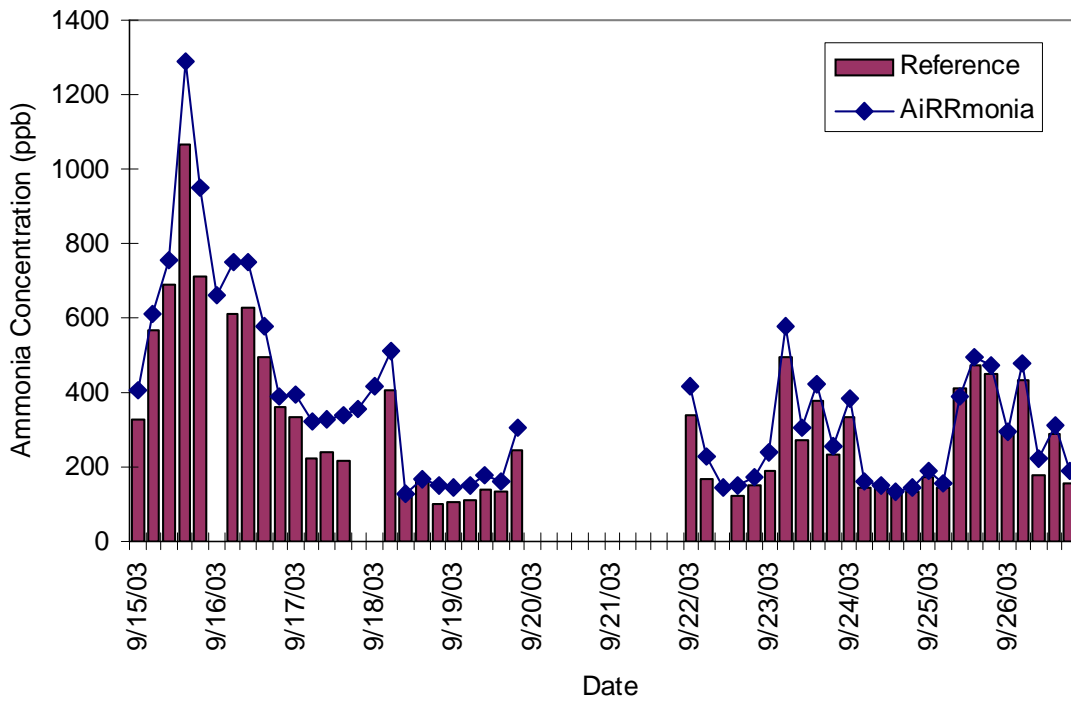

**Figure 6-7. Comparison of Ambient Reference Measurements with Averages from the AiRRmonia During Phase I**

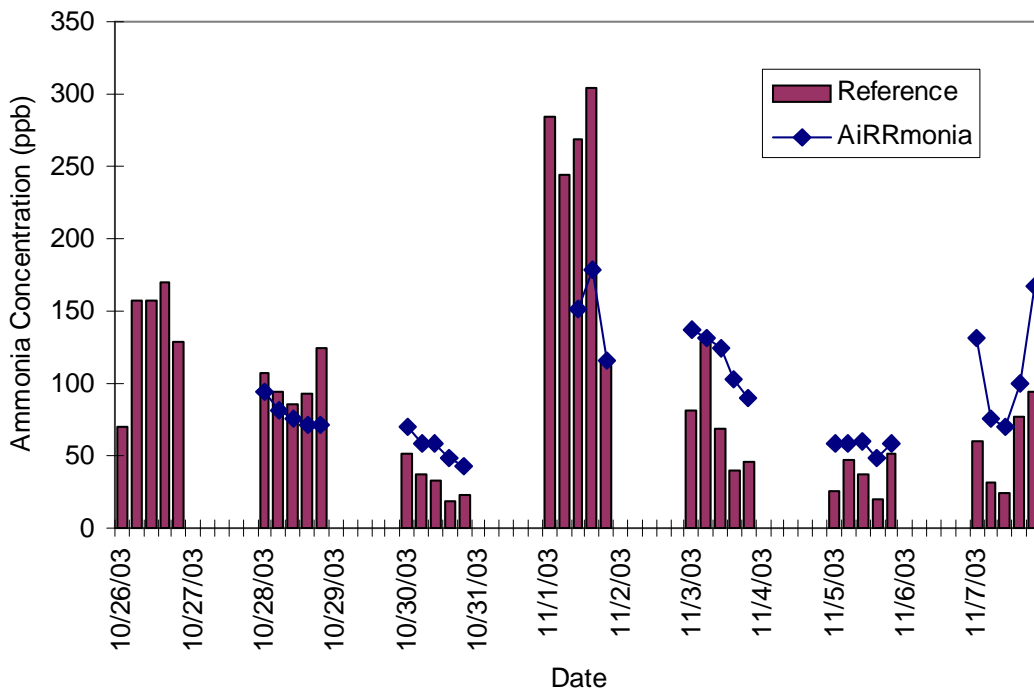

**Figure 6-8. Comparison of Ambient Reference Measurements with Averages from the AiRRmonia During Phase II**

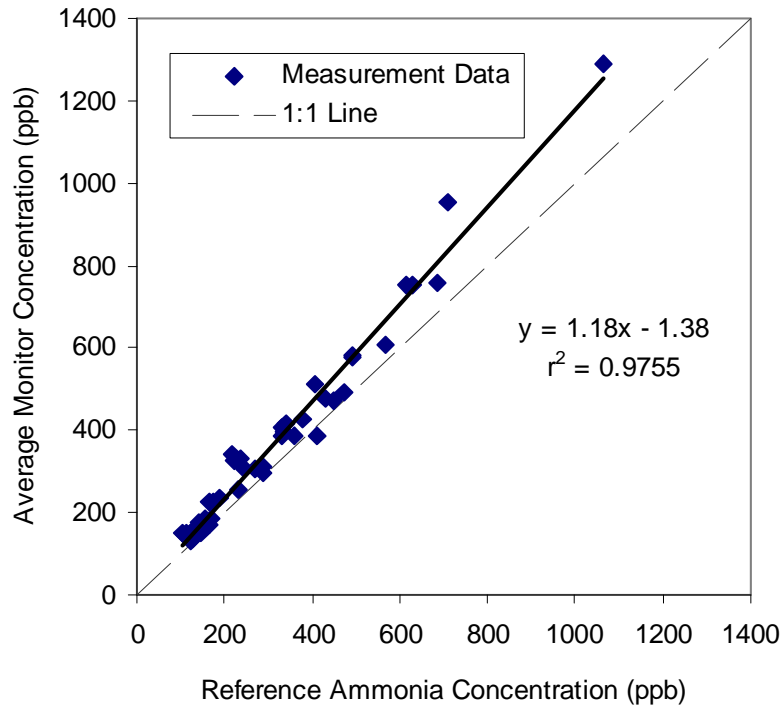

**Figure 6-9. Scatter Plot of the AiRRmonia Averages versus Ambient Reference Method Measurements for Phase I**

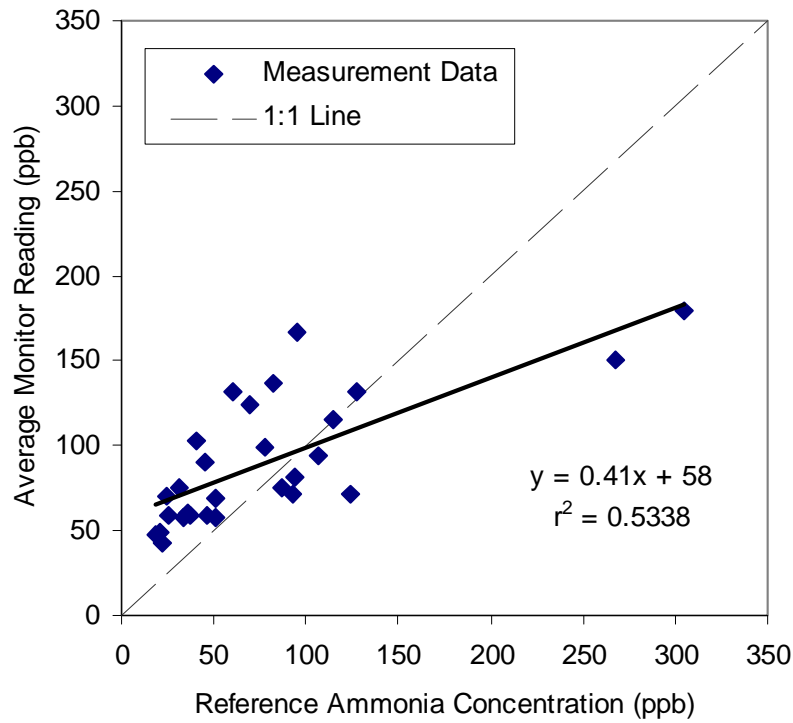

**Figure 6-10. Scatter Plot of the AiRRmonia Averages versus Ambient Reference Method Measurements for Phase II**

---

A linear regression of the AiRRmonia response versus the reference method results was calculated for each phase. For Phase I, the linear regression results showed a slope of 1.18 ( $\pm 0.06$ ), an intercept of -1.38 ( $\pm 20.9$ ), and an  $r^2$  value of 0.9755. For Phase II, the linear regression results showed a slope of 0.41 ( $\pm 0.15$ ), an intercept of 58 ppb ( $\pm 16$ ), and an  $r^2$  value of 0.5338. The extended stainless steel sampling line and auxiliary pump were used only during Phase II, but were bypassed during the gas standard delivery for the Phase II RA, calibration/zero drift, and interference checks. Thus, any change in performance that may have resulted from the addition of the stainless steel inlet and auxiliary pump would not have been apparent during those checks, but would influence the Phase II comparability check. It should be noted that the AiRRmonia was installed in the instrument trailer (instead of outdoors) during Phase II to facilitate the testing activities.

## 6.8 Ease of Use

Although the AiRRmonia was installed by a vendor representative, the installation process was straightforward and could be completed by an operator with minimal experience and the AiRRmonia manual. The vendor representative spent approximately three days on the installation, which included time to make adjustments to the airflow system to allow for operation at the high ambient ammonia levels expected at the test site. An appropriate power converter (110 V) was also needed for operation in the United States. Daily checks were performed by verification test staff, and the checklist shown in Appendix A was also completed. The checks were quick and straightforward and could be completed by an inexperienced user with minimal instruction. On one occasion, the keypad on the AiRRmonia stopped responding. The operator restarted the system without incident and no data appeared to have been lost. Otherwise, no problems with the AiRRmonia software were encountered. The AiRRmonia resumed measurement following a power loss during Phase I without operator intervention. The AiRRmonia generated approximately 4 L of liquid waste per month under continuous use, which was fully contained within the solution box. The waste, which consisted of a dilute sodium hydroxide solution, was disposed of at the USDA laboratory.

The delivery of gas standards to the AiRRmonia during Phase I was somewhat awkward because the dilution equipment and compressed gas cylinders were difficult to position on/near the outdoor scaffold platform; however, the delivery was not difficult once the AiRRmonia was installed in the instrument trailer during Phase II. Under normal ambient measurement conditions, the delivery of gas standards is not necessary because the AiRRmonia uses an automated liquid calibration. During Phase I, the AiRRmonia was not equipped with a graphed display of the real-time measurements. While individual values could be read off the display, the operators were not able to determine that some of the gas standard delivery attempts had failed until after the data had been downloaded and plotted. However, a spare laptop computer was located and was easily interfaced to the AiRRmonia during Phase II so that the measurement data could be viewed in real time.

---

Tables 6-6 and 6-7 present a summary of activities involving the AiRRmonia during Phases I and II and include periods during which power outages occurred. At the end of Phase I, lamps and tarps were positioned by verification test staff around the AiRRmonia to protect it from below-freezing temperatures. Probably as a result, the AiRRmonia overheated; approximately 23 hours of data were lost, but not included in the data completeness calculation since this activity was not requested by the vendor representative. Between Phase I and Phase II, vendor staff replaced the reagent solutions used by the AiRRmonia. This solution change was performed because it was thought that the solutions had been contaminated by the high  $\text{NH}_3$  levels present in Phase I. The vendor representative also installed an inlet system for Phase II that allowed the stainless steel ambient sampling line to be flushed constantly at a flow rate of approximately 10 Lpm to reduce the impacts of wall loss. During the last week of Phase II, bubbles were observed in the waste flow of the AiRRmonia, and a sinusoidal component in the signal became apparent. While the instrument continued to function, the calibration was uncertain. The only data used from this period were for the interference test. It was determined after the test that the bubbles were caused by a leaking syringe pump.

The AiRRmonia stored the full data sets for each phase and data did not need to be downloaded during the test. However, data could be downloaded by connecting a laptop computer running the AiRRmonia software to the instrument via a serial cable. The AiRRmonia software downloaded the data in text format (semicolon delimited) for the entire test at one time. No problems were encountered when downloading data from the AiRRmonia. Data files for each 4-week phase were approximately 1 megabyte in size and contained the ambient measurement data as well as various instrument parameters and internal calibration data.

## **6.9 Data Completeness**

During Phase I, data completeness for the AiRRmonia was 99%. Most of the data loss was caused by automated internal calibrations performed by the instrument for 3 hours once per week. Ambient data were not recorded during this period. Data completeness during Phase II was 59%. The periodic oscillation observed in the data, which may have been related to the air bubbles observed in the waste flow, and apparent increased sensitivity prevented the use of the ambient data and also did not allow all of the verification tests to be completed. The final calibration and zero drift checks could not be performed, and the interference check conducted during the last week of the test was somewhat questionable.

**Table 6-6. Activities Performed During Phase I**

<b>Date</b>	<b>Time Offline<sup>(a)</sup> (minutes)</b>	<b>Down Time<sup>(b)</sup> (minutes)</b>	<b>Service Time<sup>(c)</sup> (minutes)</b>	<b>Activity</b>
9/08/03	30			Supplied zero air and NH <sub>3</sub> standard <sup>(d)</sup>
9/10/03	95			Supplied zero air and NH <sub>3</sub> standard <sup>(d)</sup>
9/12/03	645			Supplied zero air and NH <sub>3</sub> standard <sup>(d)</sup>
9/16/03		200		Automated internal calibration
9/17/03		60		Power loss, instrument recovered without user intervention
9/20/03			5	No response from keypad, required user restart, no data loss
9/28/03		200		Automated internal calibration
9/29/03	180			Supplied zero air and NH <sub>3</sub> standard <sup>(d)</sup>
9/30/03			30 <sup>(e)</sup>	Operator installed heat lamps and tarp to warm instrument and insulate from below-freezing ambient temperatures <sup>(e)</sup>
10/02/03	150			Supplied zero air and NH <sub>3</sub> standard <sup>(d)</sup>
10/02/03		1,380 <sup>(e)</sup>		18:00 Instrument failure caused by overheating from heat lamps <sup>(e)</sup>
<b>Totals</b>	<b>1,100</b>	<b>460</b>	<b>5</b>	<b>99% data completeness<sup>(f)</sup> and 5-minute service time.</b>

<sup>(a)</sup> Time Offline = time that the AiRRmonia was taken offline for zero or standard gas measurements. The period over which time offline was evaluated began at 8:00 a.m. on 9/8/03 and ended at the conclusion of testing at 5:00 p.m. on 10/03/03. The amount of time was rounded to the nearest 5 minutes.

<sup>(b)</sup> Down Time = time that the AiRRmonia was not operating or was operating but not reporting reliable measurements. The period over which down time was evaluated began at 8:00 a.m. on 9/8/03 and ended at the conclusion of testing at 5:00 p.m. on 10/03/03. The amount of time was rounded to the nearest 5 minutes.

<sup>(c)</sup> Service Time = time spent conducting routine operation and maintenance activities and troubleshooting problems. The period over which service time was evaluated began at 8:00 a.m. on 9/8/03 and ended at the conclusion of testing at 5:00 p.m. on 10/03/03. The amount of time was rounded to the nearest 5 minutes.

<sup>(d)</sup> Testing activity performed by Battelle/USDA operator.

<sup>(e)</sup> The lamps and tarp were situated to warm the instrument during sub-freezing temperatures. This activity was not requested nor endorsed by the vendor representative and was the suspected cause of the instrument failure. Thus, the down time experienced as a result of this activity was not included in the calculation of the AiRRmonia available time.

<sup>(f)</sup> Data completeness = the ratio of time that the AiRRmonia was not experiencing down time to the total time available for monitoring ambient NH<sub>3</sub> mixing ratios from the start of testing on 9/8/03 to the end of testing on 10/3/03. The total time that was available for monitoring during Phase I (less 1,380 minutes<sup>(e)</sup>) was 35,160 minutes or 586 hours.

**Table 6-7. Activities Performed During Phase II**

<b>Date</b>	<b>Time Offline<sup>(a)</sup> (minutes)</b>	<b>Down Time<sup>(b)</sup> (minutes)</b>	<b>Service Time<sup>(c)</sup> (minutes)</b>	<b>Activity</b>
10/20/03	870			Supplied zero air and NH <sub>3</sub> standard <sup>(d)</sup>
10/22/03	120			Supplied zero air and NH <sub>3</sub> standard <sup>(d)</sup>
10/23/03	2,100 <sup>(e)</sup>			Instrument sampling room air
10/24/03	120			Supplied zero air and NH <sub>3</sub> standard <sup>(d)</sup>
10/26/03	2,880 <sup>(e)</sup>			Instrument inlet became disconnected, sampling room air.
11/01/03		200		Automated internal calibration
11/08/03		14,040 <sup>(f)</sup>		Periodic oscillation visible in data ~12:00 a.m.
11/08/03		200		Automated internal calibration
11/09/03				Bubbles in waste flow observed
11/10/03	55			Supplied zero air to instrument, no visible response, no calibration check completed
11/11/03			10	Added water to reservoir, checked pH of solutions
11/12/03	240			Supplied zero air and NH <sub>3</sub> standard <sup>(d)</sup>
11/14/03	690			Performed interference tests <sup>(d)</sup>
<b>Totals</b>	<b>7,075</b>	<b>14,440</b>	<b>10</b>	<b>59% data completeness<sup>(g)</sup> and 10-minute service time.<sup>(c)</sup></b>

- (a) Time Offline = time that the AiRRmonia was taken offline for zero or standard gas measurements. The period over which time offline was evaluated began at 8:00 a.m. on 10/20/03 and ended at the conclusion of testing at 6:00 p.m. on 11/14/03. The amount of time was rounded to the nearest 5 minutes.
- (b) Down Time = time that the AiRRmonia was not operating or was operating but not reporting reliable measurements. The period over which down time was evaluated began at 8:00 a.m. on 10/20/03 and ended at the conclusion of testing at 6:00 p.m. on 11/14/03. The amount of time was rounded to the nearest 5 minutes.
- (c) Service Time = time spent conducting routine operation and maintenance activities and troubleshooting problems. The period over which service time was evaluated began at 8:00 a.m. on 10/20/03 and ended at the conclusion of testing at 6:00 p.m. on 11/14/03. The amount of time was rounded to the nearest 5 minutes.
- (d) Testing activities performed by Battelle/USDA operator.
- (e) The AiRRmonia was not operated as intended by the vendor. This time should not be considered when evaluating the instrument.
- (f) While the AiRRmonia continued to run and record data, the accuracy of data after this point can not be verified. Tests conducted during the last week of the test suggest that the instrument was no longer stable during the period beginning when the periodic oscillation is apparent until the end of the test on 11/17/03. It should also be noted that the interference test was conducted during this period.
- (g) Data completeness = the ratio of time that the AiRRmonia was not experiencing down time to the total time available for monitoring ambient NH<sub>3</sub> mixing ratios from the start of testing on 10/20/03 to the end of testing on 11/14/03. The total time that was available for monitoring during Phase II was 35,220 minutes or 587 hours.



---

## **Chapter 7**

### **Performance Summary**

The performance of the AiRRmonia was evaluated in two phases in this verification test. Table 7-1 presents a summary of the performance of the AiRRmonia during this verification test.

**Table 7-1. Performance Summary of the AiRRmonia**

Parameter	Results	
	Phase I	Phase II
Relative accuracy	Average RA = 34% %D range = 26% to 44%	Average RA = 2.4% %D range = 1.0% to 4.0%
Linearity	Range = 0 to 10,000 ppb Slope = 1.28 ( $\pm$ 0.08) Intercept = 136 ppb ( $\pm$ 344) $r^2 = 0.9957$	Range = 0 to 2,000 ppb Slope = 1.02 ( $\pm$ 0.01) Intercept = -2.4 ppb ( $\pm$ 15.3) $r^2 = 0.9999$
Precision	Average RSD = 2.1% Range = 0.8% to 3.0%	Average RSD = 0.7% Range = 0.5% to 1.0%
Response time	Rise time = 480 to 1,200 seconds (8 to 20 minutes) Fall time = 1,439 seconds (24 minutes)	Rise time = 721 to 1,200 seconds (12 to 20 minutes) Fall time = 1,080 to 1,200 seconds (18 to 20 minutes)
Calibration/ zero drift	<ul style="list-style-type: none"> <li>No response to zero air or the NH<sub>3</sub> gas standards apparent in the AiRRmonia data; supply of gas standards was unsuccessful.</li> </ul>	<ul style="list-style-type: none"> <li>No apparent drift in response to zero air or a 1,000-ppb NH<sub>3</sub> gas standard during Week 1. No results available from Week 4<sup>(a)</sup></li> </ul>
Interference effects	Interference check conducted during Phase II	<ul style="list-style-type: none"> <li>Hydrogen sulfide (285 ppb): no apparent effect</li> <li>Nitrogen dioxide (95 ppb): no apparent effect</li> <li>1,3-Butadiene (95 ppb): no apparent effect</li> <li>Diethylamine (95 ppb): no apparent effect in 500 ppb NH<sub>3</sub>, 25% change observed in zero air<sup>(b)</sup></li> </ul>
Comparability	Slope = 1.18 ( $\pm$ 0.06) Intercept = -1.38 ppb ( $\pm$ 20.9) $r^2 = 0.9755$	Slope = 0.41 ( $\pm$ 0.15) <sup>(c)</sup> Intercept = 58 ppb ( $\pm$ 16) $r^2 = 0.538$
Ease of use	<ul style="list-style-type: none"> <li>Daily checks were simple and quick</li> <li>Lack of plotted display increased uncertainty in success of testing activities</li> <li>Little skill required to operate</li> <li>No data download necessary</li> </ul>	<ul style="list-style-type: none"> <li>Daily checks were simple and quick</li> <li>Little skill required to operate</li> <li>No data download necessary</li> <li>Interface to laptop computer allowed on-site verification of testing activities</li> <li>Syringe pump malfunction resulted in ~40% data loss</li> </ul>
Data completeness	99%	59%

<sup>(a)</sup> Data were not available due to malfunction of the AiRRmonia.

<sup>(b)</sup> The presence of an NH<sub>3</sub> impurity in the diethylamine gas standard or the release of NH<sub>3</sub> from the sample lines during delivery could not be ruled out.

<sup>(c)</sup> An extended stainless steel sampling line and auxiliary pump were used in Phase II, but were bypassed for all other Phase II checks.

---

## Chapter 8 References

1. *National Air Pollutant Trends, 1900-1998*. EPA-454/R-00-02, U.S. Environmental Protection Agency, Office of Air Quality Planning and Standards, Research Triangle Park, North Carolina, 27711.
2. *Test/QA Plan for Verification of Ambient Ammonia Monitors at Animal Feeding Operations*, Battelle, Columbus, Ohio, September 2003.
3. *Determination of Reactive Acidic and Basic Gases and Acidity of Fine Particles (<2.5  $\mu\text{m}$ )*, Environmental Protection Agency Compendium Method IO-4.2, EPA/625/R-96/010A, U.S. Environmental Protection Agency, Office of Research and Development, Cincinnati, Ohio, 45268.
4. *Operating Manual, ChemComb Model 3500 Speciation Sampling Cartridge*, Revision A, January 2000, Rupprecht & Patashnick Co., Inc. East Greenbush, New York, 12061.
5. *Quality Management Plan (QMP) for the ETV Advanced Monitoring Systems Center*, U.S. EPA Environmental Technology Verification Program, prepared by Battelle, Columbus, Ohio, Version 4.0, December 2002.



**Appendix A**  
**AiRRmonia Checklist**

---

**AiRRmonia Checklist**  
**ETV Verification of Ambient Ammonia Monitors**  
**at Animal Feeding Operations**

Check liquid box

Open lid of solvent box. Unscrew waste bottle lid.

See if waste flow drips.

See if waste flow is free of frequent air bubbles.

Close lids

Check Monitor box

Open lid of monitor box

Find airflow on display by pressing F2.

See if airflow value is between 0.95 and 1.05 Value = \_\_\_\_\_

See if value detector 1 is below 150 Value = \_\_\_\_\_

See if value detector 2 is below 5000 Value = \_\_\_\_\_

Close lid of monitor box

Check weather prediction (*Phase I only*)

See if local temperature remains above 3 °C or 37 °F

Predicted temperature range: \_\_\_\_\_

Action

If any of above issues fails, note in logbook and contact:

Vendor Representative

Contact Information

Signature: \_\_\_\_\_

Date: \_\_\_\_\_

Comments: \_\_\_\_\_

\_\_\_\_\_

\_\_\_\_\_

\_\_\_\_\_