

“On the shore dimly seen...”: an Archeological Overview
Fort McHenry National Monument and Historic Shrine
Baltimore, Maryland

by

Charles D. Cheek, Ph.D.
Joseph Balicki
and
John Pousson

Prepared by

John Milner Associates, Inc.
5250 Cherokee Avenue, 4th Floor
Alexandria, Virginia 22312

and

Fort McHenry National Monument and Historic Shrine
East Fort Avenue
Baltimore, Maryland 21230-5393

2000

TABLE OF CONTENTS

	<i>page</i>		<i>page</i>		<i>page</i>
List of Figures	iv				
Preface	v				
Acknowledgments	v				
1. Introduction	1	3.3 Sally Port Complex	50	4.3 Fort Grounds	79
1.1 Methods	1	3.3.1 Gorge	50	4.3.1 Original Fort Grounds	79
1.2 Organization	2	3.3.2 Ramp	51	4.3.1.1 Upper and Lower Water Batteries	81
1.3 Archeological Site Formation Processes	2	3.3.3 Sally Port Passageway Floor	51	4.3.1.2 Upper Water Battery ('Ravelin') Barracks ..	82
1.4 Glossary of Military Architectural Terms	3	3.3.4 Traverse	51	4.3.1.3 Gun Shed and Store House	83
2. Historic Context and Site Development	7	3.3.5 Bombproofs	52	4.3.1.4 Hospital (1813)	85
2.1 Prehistoric and Early Historic Background	7	3.3.6 Guardhouses/Prisons	53	4.3.1.5 Married Soldiers' Quarters	87
2.2 Historic Context: the Defense of Baltimore	8	3.4 Star Fort Interior Structures	53	4.3.1.6 Boundary Wall and Entrance Gate (1817-37)	87
2.3 Episodes of Development	15	3.4.1 Powder Magazine	53	4.3.1.7 Seawall	88
2.3.1 Fort Whetstone	15	3.4.2 Wells and Cistern	54	4.3.2 Addition to Fort Grounds (1836-37)	89
2.3.2 First American System	16	3.4.3 Shot Furnaces	55	4.3.2.1 Tavern	91
2.3.3 Second American System	16	3.4.4 Residential Structures	55	4.3.2.2 Boundary Wall and Entrance Gate	91
2.3.3.1 Pre-Bombardment	16	3.4.4.1 Commanding Officer's Quarters	55	(1837-Present)	91
2.3.3.2 Post-Bombardment	16	3.4.4.2 Junior Officers' Quarters	56	4.3.2.3 Civil War Magazine	91
2.3.4 Mid-1800s	16	3.4.4.3 Enlisted Men's Barracks No. 1	57	5. Previous and Future Research at Fort McHenry	95
2.3.5 Civil War	18	3.4.4.4 Enlisted Men's Barracks No. 2	57	5.1 A Chronology of Previous Research	95
2.3.6 1866-1912	19	3.4.5 Privies and Water Closets	57	5.1.1 Early Investigation: 1958-1966	95
2.3.7 World War I Hospital	22	3.4.5.1 Commanding Officer's Privy	58	5.1.2 Research and Compliance: 1974-1983	95
2.3.8 War Department Restoration	22	3.4.5.2 Junior Officers' Privy	58	5.1.3 Cultural Resource Management: 1984-1998	96
2.3.9 National Park Service	23	3.4.5.3 Water Closet Behind Barracks No. 2	59	5.2 Potential Future Research	97
3. Archeological and Historical Research Results: Star Fort ..	25	3.4.7 Guardhouses	59	5.2.1 Architectural Features: Star Fort Components ...	98
3.1 Local Geology and Topography	25	3.4.8 Flagstaffs	59	5.2.1.1 Fort Whetstone	98
3.1.1 Geology	25	3.5 Moat, Counterscarp, and Glacis	60	5.2.1.2 Star Fort	98
3.1.2 Original Site Topography	25	4. Archeological and Historical Research Results:		5.2.1.3 Sally Port	99
3.1.3 Modifications of Site Topography	27	Outworks and Grounds	69	5.2.1.4 Star Fort Interior Structures	99
3.2 Star Fort Components	31	4.1 Ravelin	69	5.2.1.5 Moat	100
3.2.1 Scarp Wall	31	4.1.1 Scarp Walls	69	5.2.2 Architectural Features: Outworks and Grounds .	100
3.2.2 Parapet	33	4.1.2 Parapet and Breast-height Wall	70	5.2.2.1 Ravelin	100
3.2.3 Breast-height Wall	36	4.1.3 Terreplein, Banquettes, and Gun Emplacements .	70	5.2.2.2 Water (Outer) Battery	100
3.2.4 Terreplein and Banquettes	36	4.1.4 Entrance Passageway	71	5.2.2.3 Upper and Lower Water Batteries	101
3.2.5 Gun Emplacements	40	4.1.5 Drainage	71	5.2.2.4 Additional Structures on Original Grounds	102
3.2.6 Parade Wall	43	4.1.6 Magazine	71	5.2.2.5 Structures within the 1836-37Addition ...	102
3.2.7 Parade Ground	44	4.1.7 Ravelin Privy	72	5.2.2.6 Comparative Research	103
3.2.8 Star Fort Drainage and Postern	46	4.2 Water (Outer) Battery	72	5.2.3 Anthropological Research Topics	103
3.2.8.1 Rampart Drainage	47	4.2.1 Parapet	74	6. References Cited	105
3.2.8.2 Parade Ground - Surface Drainage	47	4.2.2 Revetment (Breast-height) Wall	75	Appendixes:	
3.2.8.3 Parade Ground - Subsurface Drainage	48	4.2.3 Terreplein, Banquettes, and Gun Emplacements .	76	A. Annotated Bibliography of Archeological Research	
3.2.8.4 Postern	48	4.2.4 Shot Furnaces	76	B. Annotated Bibliography of Selected Historical Maps and	
		4.2.5 Magazines, Bombproofs, and Traverses	77	Plans of Fort McHenry	
		4.2.5.1 Magazines	77	C. Tabular Chronology of Previous Archeological	
		4.2.5.2 Bombproofs	77	Investigations	

LIST OF FIGURES

	<i>page</i>		<i>page</i>		<i>page</i>
1. Detail of USGS Baltimore East 7.5 minute quadrangle, showing the vicinity of Fort McHenry	1	19. Detail of Delafield's plan of the proposed outer battery at Fort McHenry, 1836	30	36. Structures in the powder magazine vicinity	53
2. Simplified composite plan of Fort McHenry	3	20. DeVille drawing, 1629, showing counterforts, and the configuration of Fort McHenry's counterforts	32	37. Structures in the enlisted men's barracks vicinity	54
3. Schematic cross section of a fort	4	21. Comparative historical and schematic archeological profiles of Fort McHenry's parapet and terreplein	34	38. Detail of Lee's <i>Fort McHenry</i> , 1834, showing elevation and cross-section of typical quarters within fort.	56
4. Berthier's <i>Port et Rade de Baltimore</i> , 1782	7	22. Detail of Delafield's plan of proposed outer battery, 1836, showing profile	35	39. Grade changes at the southeast front of Fort McHenry, 1803-1840.	61
5. Detail of Folie's <i>Plan of the Town of Baltimore and Its Environs</i> , 1792	8	23. Detail of Smith's <i>Fort McHenry</i> , 1840, showing the profile d-d'	37	40. The ravelin at Fort McHenry, showing its counterfort system and the former entrance passageway.	69
6. <i>Fort McHenry</i> , 1803	10	24. JMA's plan of excavations in bastion 4	39	41. Stages of development, water battery vicinity, ca. 1800 - present	73
7. Detail of Poussin's <i>Plan and Profiles of Fort McHenry</i> , 1819, showing plan of the fort	11	25. Detail of <i>Fort McHenry, Md.</i> , ca. 1833, showing armament	41	42. Detail of Craighill's <i>Plan of Water Battery at Fort McHenry</i> , 1866	74
8. Detail of Lee's <i>Fort McHenry</i> , 1834, showing the general plan of the fort	12	26. Detail of Thompson's <i>Fort McHenry, Md.</i> , 1837	42	43. Profiles of archeological excavations at the water battery's revetment wall	75
9. Butler's <i>Fort McHenry</i> , ca. 1840	13	27. Detail of Smith's <i>Fort McHenry, Baltimore</i> , 1840	43	44. Craighill's <i>Plans and Sections of Service Magazines</i> , 1866	78
10. Brick's <i>Plan and Sections of Drill Ground at Fort McHenry</i> , 1858	14	28. Detail of Brewerton's <i>Fort McHenry, Md.</i> , 1861	44	45. Structures on the grounds of Fort McHenry, ca. 1800-1835	80
11. Moore's sketch plan of Fort McHenry, 1864	17	29. Detail of <i>Fort McHenry, Md.</i> , ca. 1833, showing cross-section of parade wall	45	46. Archeological excavations and features east and northeast of the ravelin	81
12. <i>Fort McHenry, Md., Showing Armament</i> , 1864	19	30. Detail of Lee's <i>Fort McHenry</i> , 1834, showing fort's interior structures and parade ground	46	47. Possible ramp footings, 1776 lower water battery	82
13. <i>Plan and Reservation, Fort McHenry</i> , ca. 1890	20	31. Profile of JMA's test unit 1, north wall, 1988	47	48. Archeological excavations and features north and northwest of the fort	83
14. Detail of an electrical system plan, data from Toltz's <i>General Hospital No. 2, Fort McHenry</i> , 1917-18	21	32. Conjectural plan of Fort McHenry's original subsurface drainage system	49	49. The gun shed and store house ca. 1873	84
15. An aerial view of Fort McHenry National Monument and Historic Shrine	22	33. Sequence of development of postern tunnel	50	50. Detail of Lee's <i>Fort McHenry</i> , 1834, show plans and elevations of hospital and married soldier's quarters	86
16. <i>Artesian Well at Fort McHenry</i> , ca. 1861	25	34. Structures at the sally port	51	51. Remnants of possible ca. 1795-98 magazine or bombproof	88
17. Detail of Berthier's <i>Port et Rade de Baltimore</i> , 1782	26	35. Cross-section through the rampart northwest of the sally port	52	52. Structures on the grounds of Fort McHenry, ca. 1840-1912	90

PREFACE

Preparation of this overview of Fort McHenry's archeology was begun in the fall of 1991, consistent with the June 1991 task directive for Package No. 276, in which the potential need for such an overview was identified, along with the more immediate need for updated archeological base maps. The vehicle, initially, for acquiring both the updated base maps and the overview was an indefinite quantities contract for archeological services which then existed between the Eastern Applied Archeology Center (a Rockville-, later Silver Spring-, Maryland, based field office of the Denver Service Center, abolished in 1999) and the Alexandria, Virginia, office of the cultural resource management firm of John Milner Associates, Inc. Work Order No. 3 of that contract, CX-2000-1-0008, as modified during the course of the project, provided for preparation of an outline and 30% draft (December 17, 1991); a 50% draft (February 18, 1992); and a 90% draft (November 5, 1992). Following production of the latter draft, it was recognized that the need for focused archeological investigations to assess, and possibly mitigate, the impacts of construction under the package would result in the overview being in some respects outdated as soon as it had been completed, if its completion was scheduled to occur before the field work was performed and its results analyzed. Consequently the overview, entitled *Review and Synthesis of Archeological Documentation, Fort McHenry National Monument and Historic Shrine, Baltimore, Maryland*, was taken to a 95% complete draft stage (February 26, 1993), but was not finalized until now, under a much altered organizational context, with a different title, and with the addition of John Pousson, formerly the NPS project archeologist, and now the park archeologist, as the third coauthor. In the meanwhile, during 1993-95, the archeologists at John Milner Associates pursued the assessment and mitigation investigations needed for the first major phase of construction under the package, while Pousson, in 1998-99, provided archeological mitigation for the second phase.

The long gestation of this report, one might imagine, should have resulted in resolution, or at least clarification, of virtually all outstanding interpretive questions concerning the archeological resources of Fort McHenry, but it has not. There is not even complete agreement among the coauthors of this report concerning the most likely explanation of certain sets of data, let alone between them and previous investigators. Progress has nonetheless been made in the interpretation of resources, some of them very significant, and the delineation of problems, that have previously been neglected or misunderstood. The field investigations conducted beginning in 1993, aided in large measure by the drafting of the review and synthesis, have built on previous work, and hopefully this now-final (but in some ways yet-to-be-completed) overview, if it accomplishes nothing more, will provide a foundation upon which the archeologists of the future at Fort McHenry can build.

JOHN POUSSON

ACKNOWLEDGMENTS

The authors thank all those – and they are legion – who aided them in conducting archeology at, and about, Fort McHenry. It is impossible to give appropriate precedence among those to whom we are grateful, let alone even acknowledge all those to whom we are indebted, so a simple, partial listing will need to suffice: Donna J. Seifert, the project manager for John Milner Associates, and Douglas C. Comer, the former chief of the Applied Archeology Center, and the government's technical representative for the contract under which most of this report was drafted; John Tyler, Kayci Cook, and Laura Joss successively superintendents at Fort McHenry between 1991 and 2000; Denver Service Center architects, engineers, and project managers Tony Donald, Tom Fields, Randy Copeland, Tom Lubert, Mike Giller, Bill Witmer, Jana Chalk, Michele D'Arcy and Paul Newman; DSC compliance specialist Steve Whissen; former Applied Archeology Center archeologists Jed Levin and Ed Morin; NPS Regional Office archeologists Dave Orr and Brooke Blades, architect John Ingle, and historian/compliance coordinator Diann Jacox; and David Wright, the principal architect for the project with Grieves, Worrall, Wright and O'Hatnick.

An especially hardy, heartfelt thanks is extended to all the staff of Fort McHenry, and particularly to Scott Sheads, the park's historian, conscience, and keeper of reports and plans; Anna von Lunz, the park's curator and, in the role of compliance coordinator, the one who helps us make the tough calls; and Greg McGuire, the facilities manager, who with the help of his able team keeps the place working.

Thank you all.

CHARLES D. CHEEK
JOSEPH BALICKI
JOHN POUSSON

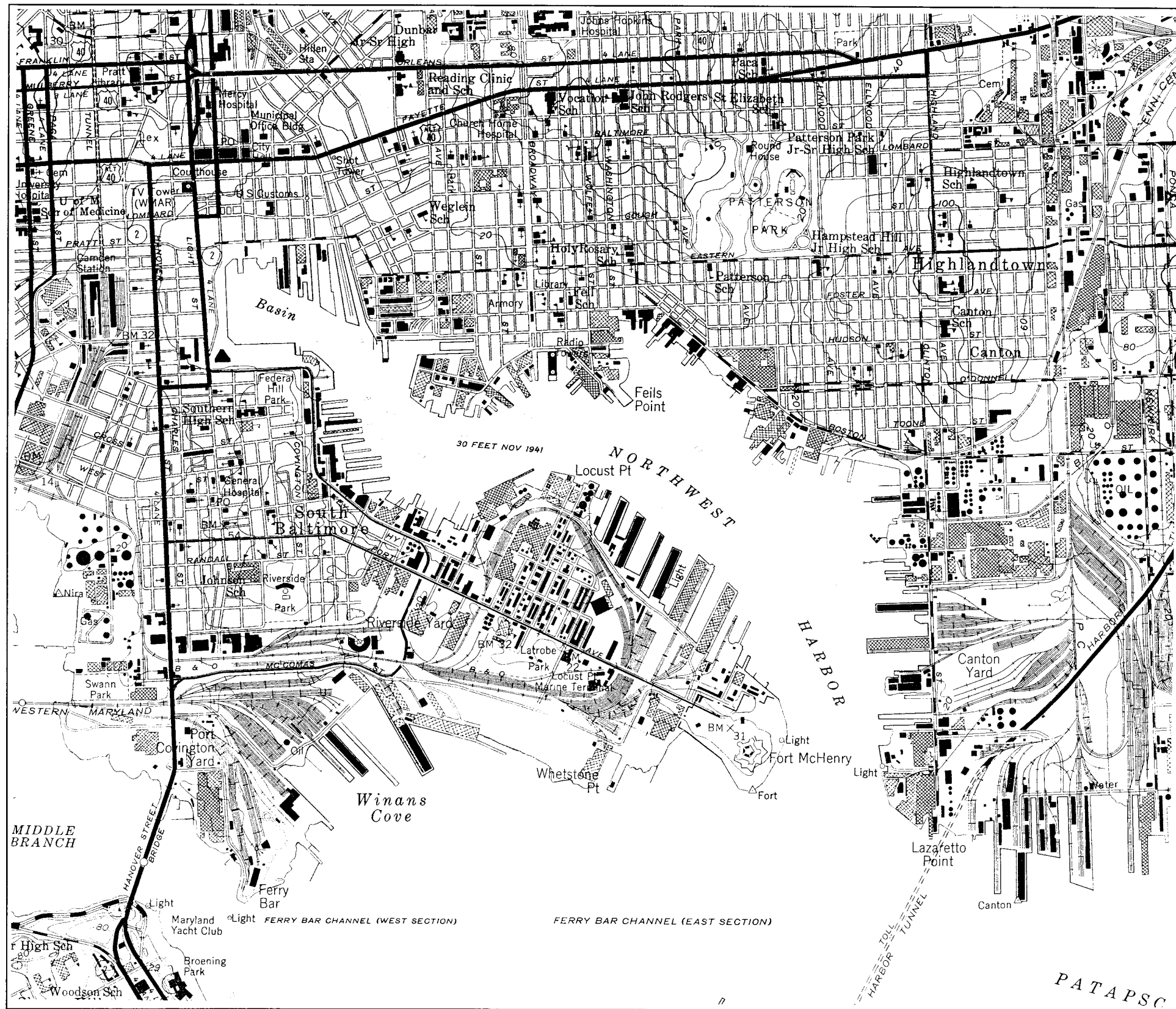

Figure 1. Detail of USGS Baltimore East 7.5 minute quadrangle, 1953 (photorevised 1966 and 1974), depicting the vicinity of Fort McHenry

1. INTRODUCTION

This report provides an overview of the archeological resources of Fort McHenry National Monument and Historic Shrine (Maryland state site no. 18BC13), in Baltimore, Maryland (Figure 1). The report is based on the results of previous historical, architectural, and archeological investigations, including testing and data recovery excavations performed in 1993-95 in conjunction with an on-going program of masonry repair and rehabilitation at the fort (NPS Pkg. No. FOMC 276). As originally drafted, in 1992-93, this report only concerned resources in the immediate areas of the star fort, the water battery, the boundary wall, and the Civil War magazine, because of the greater immediate need for an assessment of potential impacts on resources in those areas. The report has now been revised both to incorporate the results of the 1993-95 excavations, and to review documentation concerning resources elsewhere within the boundaries of the fort. These changes have been made in order for the report to provide the most current interpretations of all the site's resources, and to make it fully applicable to various drainage system rehabilitation alternatives under consideration during planning for a second phase of work.¹ It is also hoped that with these revisions the report will better serve the park's general resource management needs.

This report identifies, to the extent that it can, the locations of major features, as well as areas that have been disturbed by the alterations, repairs, and uses of the fort over the past two centuries. It is particularly concerned with features which reflect the changing military functions of the fort. Minor features, common throughout the fort, are also considered. The locations and extent of structural remains, and of other notable features, are depicted in several figures included in the report; these spacial data will also be incorporated within a Geographical Information System (GIS) under development for the park, which correlates areas excavated, and subsites and features identified, with the reports in which the excavations and findings are discussed, and with any historical plans on which they appear.

1.1 Methods

Relevant historical maps, research reports, historic structure reports, and archeological reports have been examined by the research team, for the summaries and interpretations they provide concerning the more important primary historical documents pertaining to the fort's construction and alteration. The historical documents themselves, copies of which are available at the park, having been assembled in the files of the National Park Service's 1957-58 Historical and Architectural Research Project (HARP), have also been used in interpreting the original and changing form of the fort. The HARP files include copies of most of the items pertaining to the fort within the National Archives collections of military documents.

Other document collections have been examined as well to determine if additional material on the fort has come to light since the HARP research effort.² No additional material was discovered, however.

Annotated bibliographies concerning reports and historical maps and plans appear in appendixes. Regarding the reports, the annotations identify the explicit or implicit research goals, the findings, and the locations and extent of the excavations. The latter are also depicted on figures prepared for this report. The major findings are discussed in the body of the report; minor findings are simply noted in the annotated bibliography. Regarding the maps and plans, the annotations concern their purposes, the major structures they depict, and any significant errors or ambiguities in them.

The research team studied pertinent sections of historical and architectural reports and carefully examined graphic documentation (maps, plans, illustrations, and photographs). Through this study, the team identified specific episodes in the site's development that resulted in the creation or alteration of archeological resources, and delineated the locations and other characteristics of such resources. Thompson and Newcomb's 1974 historic structure report, the manuscript reports by Bradford, Cotter and Nelson, Mullaly, Nelson, Smith, and Walsh, prepared in 1958 at the conclusion of the HARP project, and Scott Sheads' 1995 monograph concerning the fort, have proven to be the most useful interpretive guides to the history of the fort's physical development.

1.2 Organization

A brief discussion of the general processes that account for the archeological characteristics of Fort McHenry, or of any archeological site, is provided in the next subsection of this introduction. Readers who are unfamiliar with archeological research as conducted at historic sites might benefit from review of the archeological concepts provided there. The introduction also contains a glossary of military architectural terms, along with a composite plan and a generic fort cross section. Section 2 of the report provides a discussion of the historical context of the developments at the fort, followed by a chronological review of the fort's history, focusing on major periods of physical change and how they relate to the evolving uses made of the fort. Sections 3 and 4 review the results of the archeological and historical investigations associated with the major structures at the fort. The investigations are reported by architectural group, e.g., star fort, ravelin, moat, etc., and by areas of the fort's grounds, in part to facilitate the use of this document during restoration and other design development for the fort. Major architectural and archeological features are discussed within each of the various subsections, with as much integration as possible of information from the historical documents, particularly nineteenth century plans, with the findings of the archeological

investigations. Section 5 discusses the potential for further research at Fort McHenry. There are also the two appendices described above.

1.3 Archeological Site Formation Processes

Fort McHenry is above all else a single, massive, architectural and landscape-architectural feature, albeit one composed of many more-or-less interconnected parts, among them the fort's archeological components, consisting of a multitude of strata, features, and artifacts. The strata and features are typically such subsurface elements of the site as layered fill deposits, former ground surfaces, wall footings, foundations of demolished structures, filled privy pits, abandoned and buried gun emplacements, flag pole braces, wells, utility lines, etc. Located in association with these site elements are diverse military and non-military artifacts: 1814 mortar fragments, buttons, ceramic sherds, friction primers, bottle glass, shoes, coins, bones, seeds, brick, mortar, etc. Collectively, these elements form the archeological record of the fort. As does the architecture of the site, and its documentary record, the archeological record reflects complex interactions between social, economic, and technological processes. By means of the recovery, recording, and analysis of the various strata, features, and artifacts, archeologists can gain insight into the cultural processes and depositional histories that led to the formation of the archeological record. Where, as at Fort McHenry, there is also an abundance of architectural and document-based historical data to be considered, the analysis of the archeological record must be integrated with historical and historic architectural research, and vice versa. A result of such an interdisciplinary approach, in some instances, is an apparent loss of archeology's distinctiveness as an avenue of research, but counterbalancing this is a more accurate and detailed interpretation of what occurred in the past.

Schiffer, in introducing his analysis of various ways archeological sites are formed, emphasized the need for this integrated study of the past:

The objects that survive to be examined by the archaeologist exist in two forms: the historical record and archaeological record. The historical record consists of artifacts that, because of a change in form, function, or user, are retained within living societies (rather than being discarded). . . . The archaeological record, on the other hand, contains culturally deposited objects that are no longer part of an ongoing society. After recovery from the natural environment, these items of stone, pottery, and countless other materials provide the archaeologist with evidence of past lifeways.³

At Fort McHenry, the archeological record, in conjunction with the historical record, has contributed to an understanding of the development of the fort's military architecture, modifications associated with the adoption of new technologies, material responses to real or perceived external threats, the social and economic position of the fort's garrison, and

the adaptations of the site for use as an immense military hospital, and as the cultural monument and shrine which it is at present.

Wherever there is a physical record of human activity, natural and human processes have interacted to create it. The processes that account for archeological deposits can be termed formation processes. Schiffer has defined four types of culturally produced formation processes: cultural deposition, disturbance, reclamation, and reuse.⁴ While these formation processes are discussed separately below, it should be borne in mind that they interact: construction activities, for instance, can result in cultural deposition, disturbance, reuse, and reclamation. At Fort McHenry there is clear evidence of each of these processes, and of their interaction, as well as of the operation of natural processes.

Cultural deposition is the discard of objects. Friction primers serve as a good example of this type of deposition at Fort McHenry.⁵ These artifacts, found during several archeological investigations at the fort, were each used for one specific event, firing a single artillery round, and then discarded.⁶ There was no further use made of spent friction primers, and they were, for the most part, intentionally discarded. The same is true for broken sherds of ceramic and glass, except where their context indicates otherwise. Many artifacts, however, represent accidental loss, and such artifacts, military buttons for example, have also been recovered at the fort.

Another principal formation process is disturbance. Disturbance processes create, modify or move archeological resources, but unlike the reclamation process, discussed below, the resources are not removed from the archeological record.⁷ In general, archeological deposits representing earlier activities at a site will be obliterated, redeposited, partially destroyed, or masked by more recent episodes of activity. At Fort McHenry, disturbances associated with the construction, maintenance or refurbishing, and removal of buildings and other structures at the fort, have played a major role in the formation of the archeological record. For example, the filling of the embrasures and platforming the bastions, while creating new surfaces of occupation, resulted in the burial of earlier features and surfaces. The process is exemplified as well by the depositional histories of the parapet, the breast-height wall, and the terreplein: construction of the breast-height wall in 1837-39 destroyed portions of the earlier configurations of both the parapet and terreplein.

Archeological formation by reuse is sometime difficult to detect, but once recognized its importance becomes obvious; this is certainly the case at Fort McHenry. A reuse formation process is one wherein an object which otherwise might have been discarded or replaced is retained.⁸ Fort McHenry itself, as a feature which has been retained and reused to serve a function other than originally intended, is a major example.

The fourth formation process, reclamation, has contributed the least to the formation of the fort's archeological record, even though our understanding of that record would not exist without reclamation, actual or contemplated. Reclamation processes are the re-introduction of archeological resources from their archeological context to another context. Archeological investigations, wherein artifacts have been removed from the ground for analysis, and are then stored or displayed, continue to be the major reclamation process at work at the fort; the exhibit containing the fort's original flag pole brace illustrates this process.

In addition to cultural processes, environmental factors contribute to the formation of archeological resources. The preservation of artifacts, to an extent, is determined by exposure or lack of exposure to particular environmental factors. Together with cultural formation processes, environmental formation processes determine which archeological resources decay and which are preserved to be recovered by archeologists. For example, a stratum at the base of the ravelin privy was found to contain botanical remains, leather, and wood.⁹ These artifacts were preserved because of a combination of localized environmental factors (moisture and lack of oxygen) that favored preservation. Processes of soil mixing, or pedoturbation, can result in the vertical and lateral movement of artifacts within a site.¹⁰ Vertical movement of artifacts upward or downward can create difficulties in evaluating the date of any particular stratum. Either type of movement, if pervasive, can make purposeful arrangements or artifact patterns unrecognizable.

The combined interaction of natural and cultural formation processes often results in complex stratigraphy, within which numerous features and artifacts may be contained. An understanding of a site's stratigraphy is a key to its analysis and interpretation. The stratigraphy of a site like Fort McHenry can be interpreted following two straightforward rules:

All archeological techniques grow out of two rules so simple that many a lecture audience thinks them funny. They are: (1) If soil layer A covers level B, B was deposited first, and (2) each level or stratum is dated to a time after that of the manufacture of the most recent artifact found in it. These are the laws of stratigraphy, and in theory they are never wrong. The ground is made up of a series of layers, some deposited by man others by nature, and it is the excavator's job to take them apart in the reverse of the order in which they were laid down.¹¹

The manner in which artifacts enter, and remain in, the archeological record further complicates the interpretation of archeological resources. Artifacts in any particular stratum represent either primary or secondary refuse. Artifacts which are found in contexts where they were used and discarded represent primary refuse. At Fort McHenry, such things as friction primers in the immediate vicinity of early nineteenth century gun emplacements, or bullets near the foundation of a rifle-range target butt, are examples of primary refuse.¹² Artifacts discarded or redeposited away from the

immediate contexts of use represent secondary refuse. Sherds of biscuit ware, most likely debris from a ceramics factory, recovered within twentieth century fill soils in the fort's moat, exemplify secondary refuse.¹³

Most artifacts at Fort McHenry relate, directly or indirectly, to construction activities or to historical occupation of the site. Archeological features are likewise affected by formation processes, and their interpretation, as well as the interpretation of artifacts, often depends on a grasp of how the various processes have interacted. Basic to interpretation, frequently, are the purposes, however obscure they might be, and the constraints on action, which existed historically for those whose duty it was to protect and defend this place, and much else beyond it.

1.4 Glossary of Military Architectural Terms

A specialized vocabulary was developed, primarily between the sixteenth and nineteenth centuries, which historically was essential to the planning, construction, and use of fortifications, and which remains necessary for any detailed discussion of a fort. Therefore, the following glossary has been included to give brief definitions of key terms for readers who may be unfamiliar with the terms. The glossary has been adapted from previous works.¹⁴ It should be noted that military personnel associated with Fort McHenry during its history were not all familiar with the exact meaning of these terms; in addition, usage was not always as precise as these definitions imply. Consequently, historical maps and other documents can occasionally be misleading or at least technically inaccurate. For example,

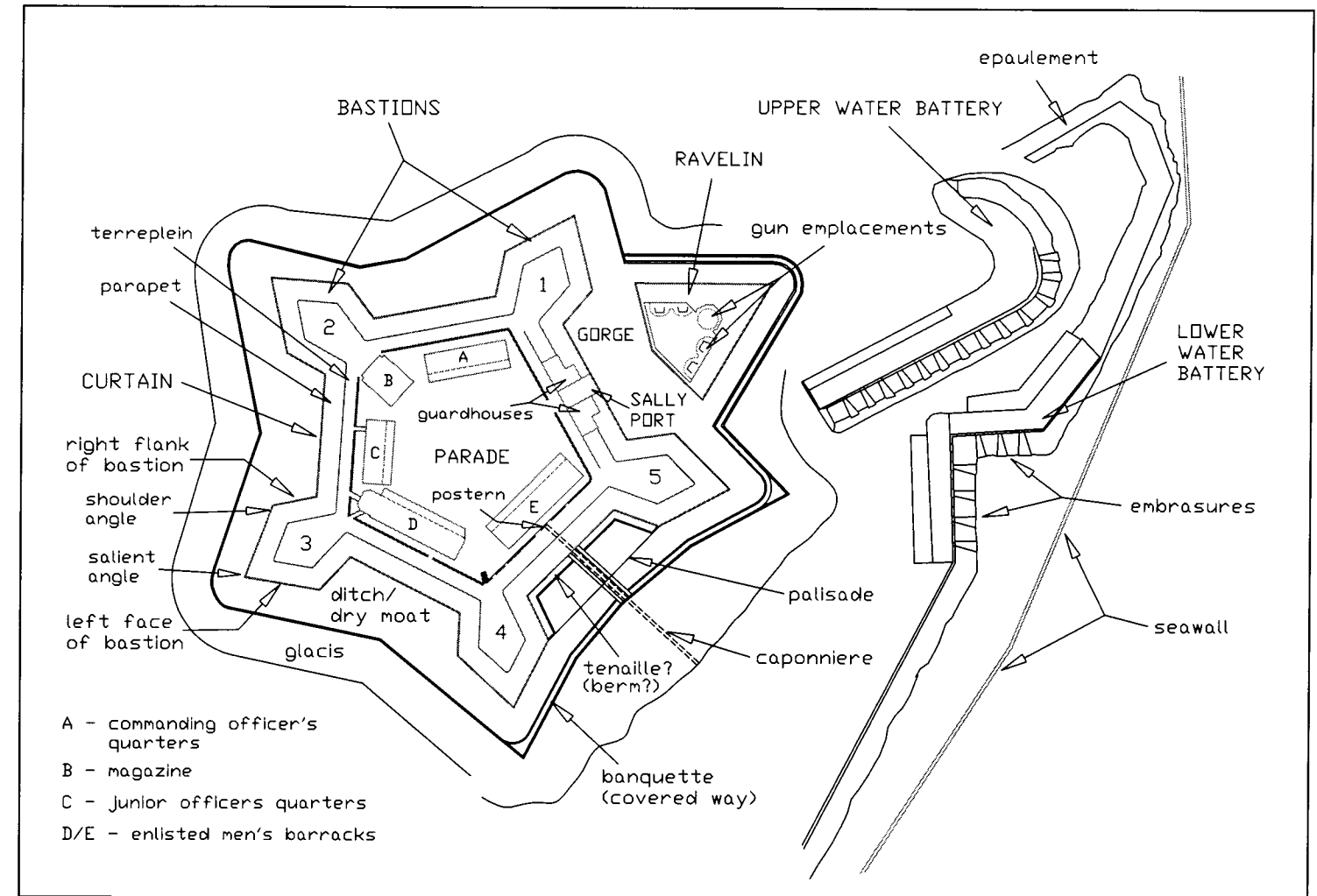

Figure 2. Simplified composite plan of Fort McHenry, ca. 1820-1840.

the outer battery is very frequently referred to as the water battery, from the mid-nineteenth century to the present. Figures 2 and 3 identify several of the architectural elements and features defined below.

abatis A defensive feature consisting of felled trees, with branches pointed and interlaced, lying parallel to each other and oriented in the direction from which attackers would approach, to impede them.

advanced ditch A ditch at the exterior base of a glacis, designed to obstruct attacking infantry. At Fort McHenry, an advanced ditch was planned for the outer (water) battery but not constructed.

banquette A continuous step or ledge at the base of the parapet, sufficiently high to enable the defenders standing upon it to fire over the crest of the parapet.

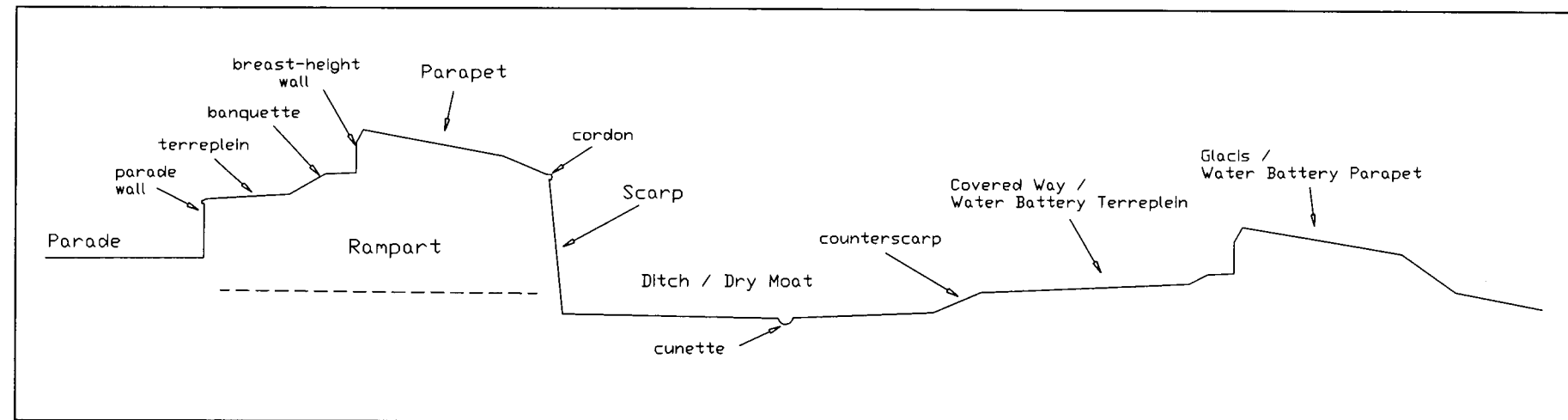

Figure 3. Schematic cross-section of a fort.

bastion A work consisting of two faces and two flanks, all of the angles being salient. Two bastions are connected by a curtain. Viewed from the interior of the fort the bastion is divided at the salient, creating right and left faces and flanks.

bombproof A structure sufficiently thick and strong so as to be resistant to damage from artillery fire.

breast-height wall A masonry revetment at the interior of a parapet. Fort McHenry's original parapet revetments were of sod, laid up like brick on the steeply sloped interior face of the parapet. This revetment was replaced by a brick wall in 1837.

caponniere A covered passage across the ditch of a fortified place designed to provide flanking fire and/or to shelter communication with the outer-works.

casemate Interior gun chamber behind a fort wall. The gun was fired through a protected opening in the wall (casement). Casemates protected the guns and gunners and allowed a fort's guns to be arranged in tiers. Casemates were used in some Second American system forts (e.g., Castle Williams, New York, NY) and were typical in Third American System forts (e.g., Fort Carroll, Baltimore, MD).

coping The highest or covering course of a wall (see *cordon*).

cordon The coping of the scarp, beneath the outer slope of the parapet. The cordon projects outward from the face of the scarp, to protect the wall from weathering and as an obstacle to scaling the wall.

counterforts Masonry buttresses at the interior of revetment walls, designed to strengthen the walls and aid them in supporting the weight of the rampart fill.

counterscarp The vertical or nearly vertical side of the ditch, opposite the scarp and nearest the besiegers. In permanent works a counterscarp is generally faced or revetted to inhibit the descent into the ditch.

covert way (covered way) A space at the outer edge of the ditch, between it and the glacis, which served as a protected walkway and assembly area for defending infantry. Fort McHenry's covert way was equivalent to a banquette interior to a parapet-like glacis.

cunette A trench in the bottom of a dry ditch which functioned to drain water and obstruct the enemy.

curtain That part of the fortifications between two bastions or two gates.

curtain angle In plan, angle formed between the curtain and the flank of a bastion.

demi-lune See ravelin.

ditch (dry moat) The excavation around a defensive work from which the earth for parapet and ramparts is obtained. Ditches may be wet (moat) or dry, with the latter the preferred in later forts.

embrasures An opening in the parapet. Parapet embrasures are smallest at the interior opening and wider towards the exterior. This widening is called the splay.

en barbette A gun mount set upon a platform high enough to fire over the parapet wall rather than through an embrasure.

enfilade Gunfire directed along the length of some element of defensive works (ditch, parapet, wall, etc.). Enfilade fire is effective because more of the position is exposed to the gunfire.

epaulement A parapet-like elevation built up of earth or other materials to protect troops from enfilade fire.

face (of the bastion) The faces are the two parts of the bastion that form the salient angle.

flank (of the bastion) The parts of the bastion that join the faces to the ramparts. The line of fire from a flank would run parallel to the wall that it abuts and defends.

glacis A slope of earth, usually sodded, that inclines from its crest, which forms a parapet above the covered way, towards the country. Its object is to bring assailants into a conspicuous line of fire as they approach the fort.

gorge At Fort McHenry, the space between the ravelin and the fort. More commonly, the interior opening into a bastion between two curtain angles.

gun emplacement A location on which an artillery piece was positioned. In order to mount a gun either a platform or a traverse circle and pintle were constructed.

horn work A work composed of a bastioned front and two long sides called branches or wings, built to enclose an area adjacent to a fort.

magazine A storehouse for gunpowder, cartridges, arms, provisions, etc.

oblique fire Gun fire directed at a position from an angle approaching 45 degrees. The positioning of guns to fire at an oblique angle was considered disadvantageous. A major flaw of Fort Whetstone was that the redoubt's guns covered the water battery and seaward approach at oblique angles.

outer battery At Fort McHenry this is the proper term for the works built in 1836-40 on the exterior of the fort, extending from the ravelin to the left shoulder of bastion 3. These works are also referred to as the water battery.

palisade A high fence constructed of a row of closely spaced wooden stakes. At Fort McHenry there was an 1813-14 palisade between the angles of bastions 4 and 5. Palisades were also erected during the Civil War to enclose the gorge and the water battery. Also referred to as a stockade.

parade The interior ground surface of a fort which served as a drill and assembly area. As Fort McHenry was enlarged, areas exterior to the fort proper were employed as drill grounds.

parade wall The interior revetment wall of the rampart, which encircles the parade.

parapet Breastworks, walls, and bulwarks of earth, wood, brick, iron, stone, etc., located on the uppermost part and exterior edge of the rampart.

pintle In gunnery, an upright pivot pin on which a gun chassis turns.

platform Platforms were commonly an important component of gun emplacements, providing an even surface for use of the guns and preventing their sinking or recoiling into the ground. For wooden platforms, joists were set into the ground and wooden planking put down on them to create a deck. To counteract the recoil force exerted on gun carriages, platforms were usually raised in the back. This slowed the recoil and aided in returning guns to firing position. Mortar platforms were constructed in the same fashion but they were level, not raised in the rear. The platform for 32-pound gun on a marine carriage was typically 15 to 18 ft. across.

postern (tunnel) A secondary gate and passageway through the ramparts for access to the ditch or outworks. Also used as a drain. The postern at Fort McHenry may, originally, have been simply a drain, only becoming a postern with structural modifications dating ca. 1813-14.

quoin In masonry, hard brick or stone, usually distinctively arranged, employed to reinforce the external angles of a structure. The salient and shoulder angles of Fort McHenry's bastions have sandstone quoins, as do the angles of the ravelin.

ramp An oblique or sloping interior road to mount the terreplein of the rampart.

rampart The broad embankment or mass of earth surrounding a fortified place. A rampart forms the body of the place. The exterior revetment wall is called a scarp (escarp) and the interior wall is generally referred to as the parade wall.

ravelin A work constructed beyond the main ditch, opposite a curtain, composed of two faces and forming a salient angle. It has its own ditch, and there is usually a counterscarp opposite its scarp. Alternately called a demi-lune.

redoubt A small fort of varying shape, usually of a temporary nature.

revetment A retaining structure built to hold back the earth of which the works are composed; they may be made of sod, timber, masonry or other materials.

salient angle The projecting angle formed by the two faces of the bastion.

sally port An opening or passageway, which, if under the rampart, is usually vaulted, for use by the garrison of a fort in making sorties and attacking besiegers. When not in use, sally ports are closed by massive gates of timber and iron.

scarp The faces of the fort, interior to the surrounding ditch.

shot furnace A furnace for heating solid cannon shot prior to firing at ships. The hot shot would set fire to the wooden ships, rigging, and sails.

shoulder (angle of the bastion) The angle formed by one face and one flank of the bastion.

sortie A surprise attack on besiegers by troops descending from within a fort.

star fort An inclosed field work in the shape of the heraldic representation of a star.

tenaille A small trench protected by a low embankment located within the ditch and bordering the scarp walls of the fort.

terreplein The broad surface of the rampart, exterior to the parade and interior to, and below the level of, the parapet and the banquette.

traverse A mound of earth or a masonry wall which separates gun emplacements, building entrances, or other positions, protecting them from enfilading fire. Traverses also confine the effects of bombs fired into a fort.

traverse circle In gunnery, a circular plate of iron fastened to a masonry bed on which the traverse wheels that support the gun chassis roll.

toise This is an archaic French unit of measure which did not have a fixed equivalent in English measures. A toise varied between 6.0 and 6.5 ft. Modern sources fix a toise at 6.396 ft. Lee H. Nelson suggested in 1958 that, as used on the 1803 plan of Fort McHenry, a toise equaled 6.0 ft.¹⁵ The plan's scale is 1 inch = 7.5 toises.

water battery A battery, consisting of two or more guns, that is nearly level with the water. At Fort McHenry there are no above-grade remnants

of either the original, 1776-1831 water batteries, or the 1873-1928 water battery. The existing outer battery is commonly termed the water battery.

END NOTES

1. The drainage system work was implemented in 1999 as NPS Pkg. No. FOMC 276B. The results of the archeology conducted in 1998 as mitigation of the effects of the project (Pousson 1999a), and observation made during monitoring of construction in 1999 (Pousson 1999c), have, to the extent feasible, been integrated into this overview.

2. These included the Historic American Building Survey files at the Library of Congress; Tousard's letterbook from 1796 to 1802, and his journal for 1791 through 1792, at the Hagley Museum and Library at Euletherian Mills, Delaware; the Maryland Historical Society's manuscript collection and accessions since 1958; and various library collections. This research was undertaken in association with archeological investigations of the moat conducted in 1988. No additional material pertaining to the physical nature of the fort was found (Cheek et al. 1989).

3. Schiffer 1987:3.

4. Schiffer 1987.

5. A friction primer is a copper tube with a twisted wire running through it at right angles and filled with a fuse composition. A loop (lanyard key) was made at the end of the wire to serve as an attachment for a lanyard. The tube was inserted into the cannon vent and imbedded in the powder, when the lanyard was pulled the friction created ignited the fuse composition and, in turn, the powder charge. (Peterson 1969:116; Manucy 1985:26-27; Gooding 1988:51; Herskovitz 1978:53.)

6. Joseph and Cheek 1985:56; Cheek et al. 1989:78; Stokinger and Blades 1979a:35; Aivazian et al. 1982; Stokinger et al. 1982.

7. Schiffer 1987:121.

8. Schiffer 1987:28.

9. Stokinger et al. 1982:48-49.

10. Wood and Johnson 1978:315-381.

11. Noel Hume 1987:68.

12. Cheek et al. 1989:56-60.

13. Joseph and Cheek 1985:57. The term biscuit is commonly applied to a ceramic body after it has undergone an initial firing but prior to decoration in preparation for final firing.

14. Duane 1810; Office of The Chief of Engineers 1918; Thompson and Newcomb 1974:127-130; Robinson 1977:197-205; and McGarry 1981:118-123.

15. Nelson 1961:24.

2. HISTORIC CONTEXT AND SITE DEVELOPMENT

2.1 Prehistoric and Early Historic Background

The vicinity of Baltimore, in fact the entire lower Patapsco River area, evidently had no Native American villages or hamlets when visited by Capt. John Smith in 1608. It differed in that regard from the Potomac and Patuxent River areas to the south, which were relatively densely populated. The large size of villages along the Patuxent, reflecting a greater degree of aggregation of the population there, was especially notable, and the likelihood that this aggregation was for defensive purposes is one clue concerning why the Patapsco was unpopulated. To the north of the Patapsco, as he approached the mouth of the Susquehanna River and the head of the Chesapeake Bay, Smith encountered the warring groups that had very likely altered long-standing patterns of subsistence and settlement in the Upper Chesapeake, especially on the Western Shore, perhaps only a few decades or generations previously. These groups, the ethnohistorically elusive "Massawomeck," and the much better known Susquehannock, were not only at war with one another, but they also both engaged in predatory raiding of Algonquian-speaking groups to the south. Indeed, one very basic reason why the Native Americans of Southern Maryland welcomed the 1634 establishment and later expansion of the colony at Saint Mary's City was for the protection from raiding that, at least in theory, these powerful European allies could provide.¹

The limited investigations that have been conducted of prehistoric sites in the vicinity of Baltimore clearly attest to the area having been populated during the Late Woodland period (A.D. 900-1600) by people culturally similar to groups to the south.² Although we cannot be certain, it is likely that these groups all spoke closely-related Algonquian languages, or dialects of the same language. Prior to their apparent abandonment of the Baltimore vicinity some time before the arrival of Europeans, people there may have been affiliated in some fashion, if only for purposes of trade, with the Patuxent along the river of the same name, or with the Nanticoke on the Western Shore, or with the Conoy grouping of various Algonquian-speaking bands or tribes, among which the Piscataway, on the Maryland shore of the Potomac south of the Washington, D.C., were predominant.

In very general terms, before Europeans arrived in the Chesapeake Algonquin groups there had for centuries relied for subsistence on a wide variety of wild and domesticated plants, as well as on the hunting and trapping of animals, fishing, and the collection of shellfish.³ The occupation of coastal sites was part of complex subsistence systems in which there was also transient or short-term occupation of stations located in interior settings as well, with villages, hamlets, or base stations most often situated on or adjacent to the flood plains of rivers or other large streams, in order for horticulture to contribute significantly to the diet.

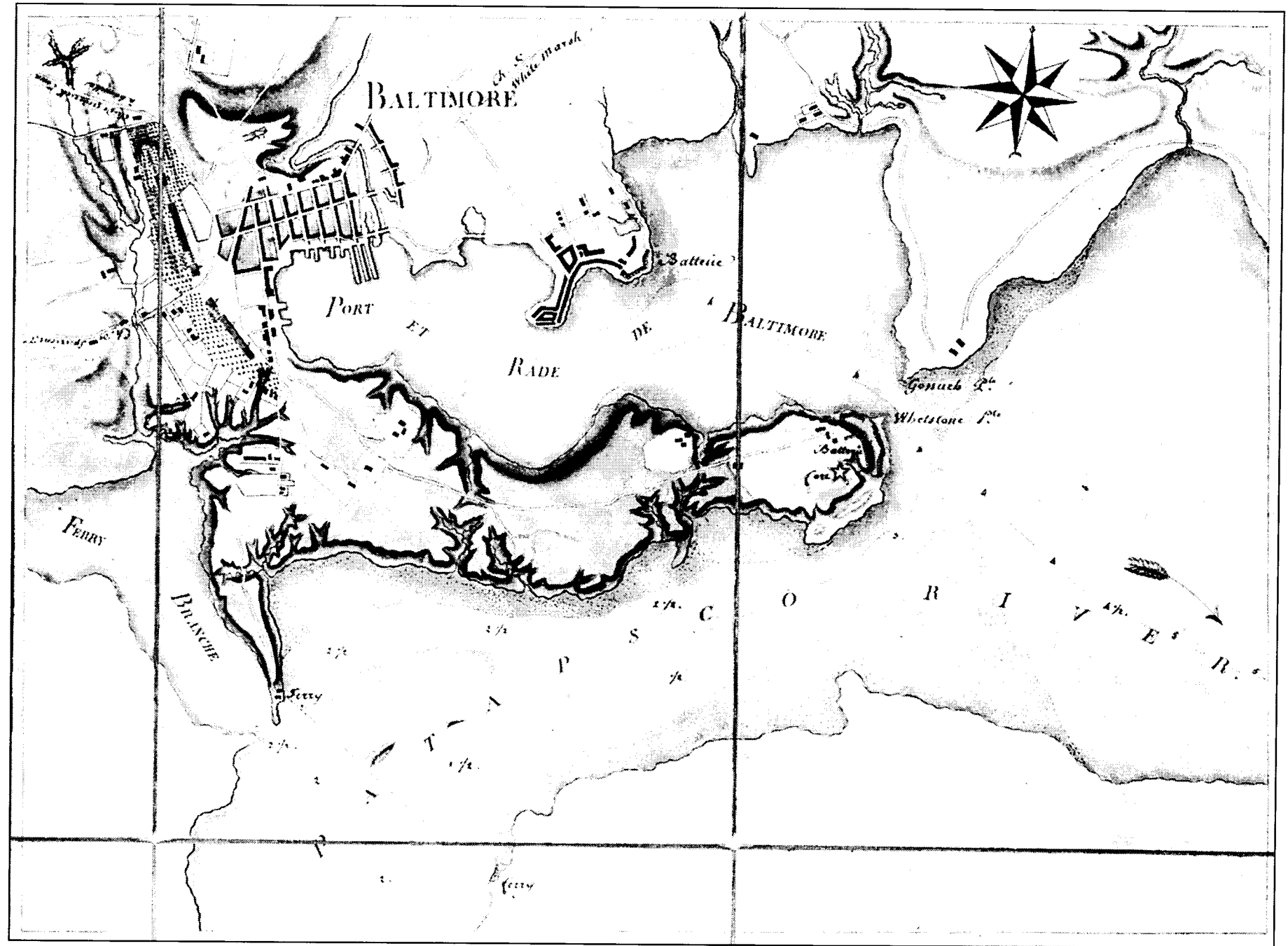

Figure 4. Louis Alexander Berthier's *Port et Rade de Baltimore*, 1782.

Although they also may have been Algonquian-speaking, the cultural and linguistic identity of groups represented by the Middle (A.D. 500-900) and Early (1000 B.C.-A.D.500) Woodland components found on sites in the Baltimore vicinity is more uncertain.

Prehistoric sites in the vicinity also have components, or isolated artifacts, representing earlier periods of antiquity, the Paleo-Indian (10,000-8000

B.C.) and Archaic (8000-1000 B.C.). Lifeways during most of the Archaic, if not the Paleo-Indian, are unlikely to have been radically different than they would be later, but horticulture would not have been practiced, and the mobility of groups, at least early on, would probably have been greater. There would have been diverse, on-going adaptations to changing local, regional, and global environmental conditions, which included the post-Pleistocene rise of sea level, the amelioration of climatic conditions, and the

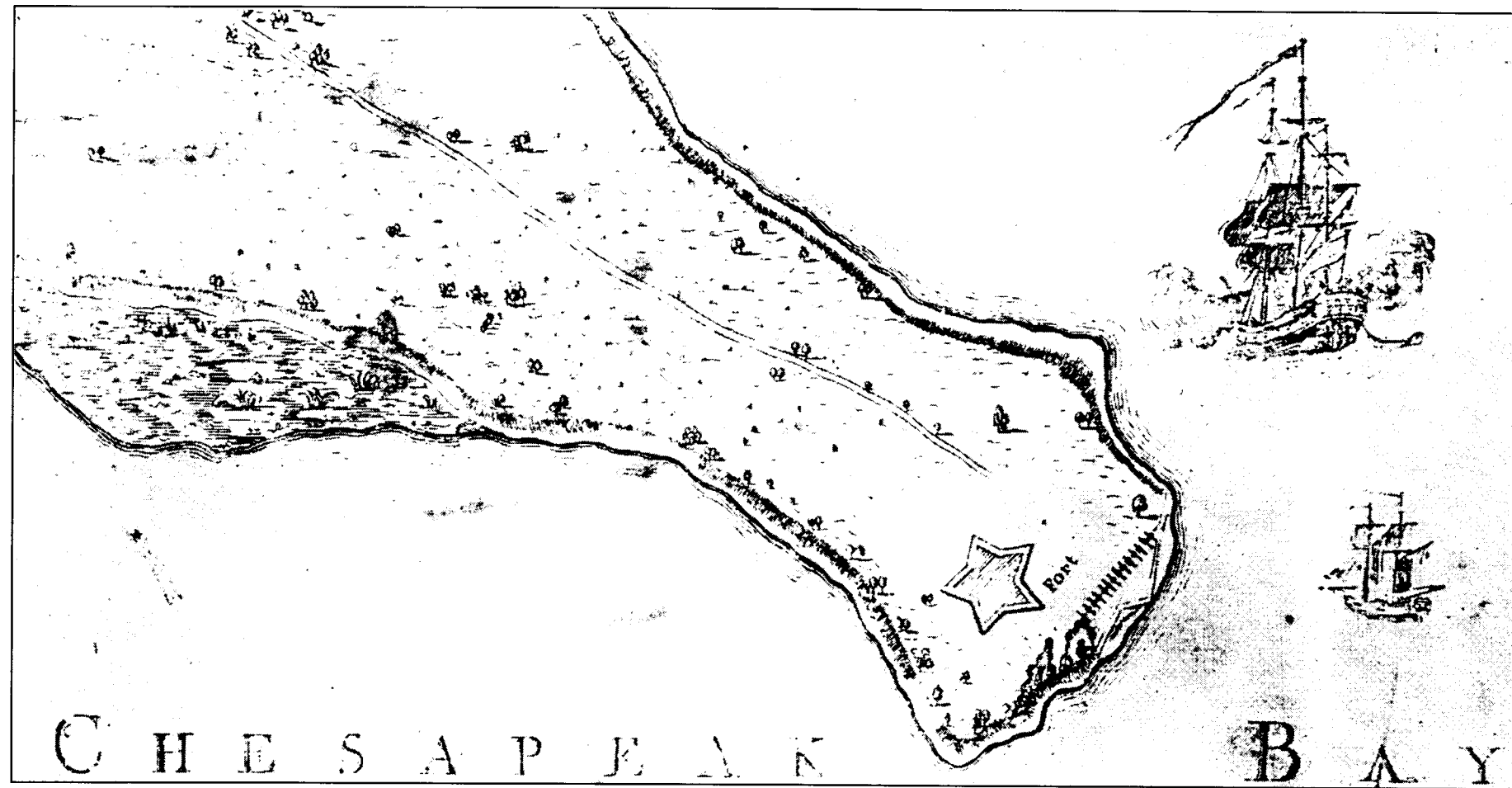

Figure 5. Detail of Folie's *Plan of the Town of Baltimore and Its Environs*, 1792.

development of more abundant floral and faunal resources, such as runs of anadromous fish, and shellfish beds and other estuarine resources.⁴

In the mid- to late-seventeenth century, European settlers had begun establishing farmsteads—mostly for the cultivation of tobacco—on the “necks” of land jutting into the tidal rivers of the Baltimore vicinity, and by 1660, to accommodate settlement, Baltimore County had been established. Settlement was to some extent made possible by a disastrous defeat the Susquehannock had suffered at the hands of the League of the Iroquois in 1652; under the peace agreement they negotiated with the Maryland colony in response, which gave them access to more firearms, the Susquehannock ceded large territories on both sides of the bay.⁵ Baltimore’s hinterland about this time was populated, sparsely, by scattered groups or households of Nanticoke and perhaps of other Algonquian tribes, displaced from areas on the Eastern Shore and elsewhere which they had previously occupied, and there was evidently continual friction between these groups and European settlers.⁶ There were also raiding parties of Iroquois groups (to whom the Nanticoke had become tributary), most notably the Seneca,

which passed through the area on their way to attack groups to the south. The incidence of such raiding appears to have increased after 1676, when the Susquehannock, having with Maryland’s encouragement relocated to a fort along the Potomac, were dealt with treacherously—having five of their chiefs murdered—by an undisciplined, combined force of Maryland and Virginia militia; the latter event helped precipitate Bacon’s Rebellion, the last and perhaps the least sensible of the early Indian wars in Virginia. European settlement was also facilitated by the precipitous decline, due in large part to disease, in the populations of Native American; decreases of as much as 90% had occurred within some groups by 1700.⁷

By the end of the seventeenth century, further migration of the remnants of Algonquian-speaking groups in southern Maryland was underway, the Conoy moving up the Potomac, and eventually to Pennsylvania; at the same time groups on the Eastern Shore were being confined to ever-smaller reservations. While the former dominance of the group was evidenced by the assignment of four Nanticoke to serve as huntsmen, and perhaps as translators, to a garrison of Rangers established in the Baltimore vicinity in

1696 for the protection of settlers from “wandering Indians,” by 1744 the main body of the Nanticoke had also removed to Pennsylvania.⁸ By the mid-eighteenth century only remnants of that and other tribes remained in Maryland, where, while surviving into the present, they historically were classified as “free Negroes,” and commonly discriminated against.

2.2 Historic Context: the Defense of Baltimore

The evolution of the defenses of Baltimore represents a dynamic process to which political, economic, technological, and geographic factors contributed. The structures and archeological deposits at Fort McHenry are the product of this complex interplay of factors. How the fort came to be—what was done there, and for what reasons—is in some ways more compelling than the fort itself. The military usage of Fort McHenry from the late eighteenth to the early twentieth century reflects the changing political climate, as well as advances in military technology. The underlying rationale for the fort, until modern times, has been the strategic view that seacoast defenses were an integral part of the national defense policy and a primary deterrent to attack. The basic tenets underlying the seacoast fortification policy were to create a defense that would make attack logistically unattractive or, failing this, to make the attack costly to the invader.⁹ This section places Fort McHenry within this historical context, and briefly discusses the twentieth-century establishment of a military hospital at the fort, and the efforts by the army and the National Park Service (NPS) to repair and restore the fort.

The growth of Baltimore into a regional and, eventually, national transportation hub, and a manufacturing and distribution center, played a significant role in Fort McHenry’s history. Baltimore, founded in 1729, is located adjacent to the Patapsco River, about 14 miles upstream from its confluence with the Chesapeake Bay.¹⁰ Baltimore was a small port at first, concentrating on exporting tobacco. The city expanded as agriculture in the Maryland interior switched from tobacco to grain production. Although Baltimore was growing in population and economic importance prior to the Revolutionary War, it was this war that spurred the city’s rapid development into a major regional urban center.¹¹ Military engagements associated with the Revolutionary War bypassed Baltimore, but the city prospered economically. The iron industry, ship building, and agricultural processing mills established Baltimore as a principal supplier to the Continental war effort. In addition, Baltimore was the terminus of an as-yet poorly developed road network connecting the coast with the Upper Potomac, Shenandoah, and Ohio valleys, and favorably positioned along the colonies’ main north-south road. By the end of the eighteenth century Baltimore was the fifth busiest port in the United States, trading extensively with Europe and the West Indies, and ranked as the third commercial city in the country.¹² Baltimore continued to expand during the nineteenth

century, and both manufacturing and transportation continued to play significant roles in the growth of the city.

During the Revolutionary War, seacoast fortifications were crucial to the defense of economically important port cities. The Baltimore harbor defenses were centered on Whetstone Point, a peninsula formed by the confluence of the North West and Ferry branches of the Patapsco River.¹³ Construction there of an earthen redoubt, of the militarily more important water batteries associated with it, and of a boom to obstruct the channel into Baltimore's harbor began in 1776.¹⁴

As illustrated on maps dating to 1781-92 (Figures 4 and 5), the redoubt had the form of a true heraldic star.¹⁵ No buildings or guns were shown within it. The two water batteries, each with numerous gun embrasures, were located along the shoreline below the fort. Water batteries were then the main deterrent against a naval attack, due to the effectiveness of firing red-hot cannonball so as to ricochet them off the water's surface into any attacking wooden ships. The redoubt served to defend the batteries from landward attack, and as a second line of defense if the batteries were captured. Construction of the defenses at Whetstone Point, in the absence of an effective national War Department, was initiated by the Maryland Council of Safety, and implemented by local residents and militia lacking formal training in military engineering.¹⁶ Nonetheless, the fort and its batteries clearly commanded the channel into the harbor and its approach, and may very well have deterred British naval action against the city. During the later stages of the Revolutionary War, military operations did not threaten Baltimore. Consequently, the city's fortifications were reduced and some of Fort Whetstone's armament was removed for use elsewhere. The fort was evidently never completed once the perceived threat to Baltimore had decreased.¹⁷

Following the Revolutionary War, the size of the Continental Army was reduced. The national military's primary function was to provide protection from Native American attacks along the expanding western frontier, and to guard military stockpiles.¹⁸ External threats along the Atlantic and Gulf of Mexico coasts were perceived as minimal. In 1781, Whetstone Point was sold to private concerns, and the fort would remain in private hands for the next 13 years. Prior to the military use of Whetstone Point, iron ore and red ocher were mined there by the Principio Company. Mining resumed after the war.¹⁹

The political instability in Europe caused by the French Revolution threatened to draw the United States into conflict with Great Britain. Friction between the two countries centered on British support of Native American groups blocking American expansion along the frontier, and on Great Britain's maritime policies which threatened American neutrality and shipping. As a result, in 1794, the federal government of the United States

initiated a program of construction of seacoast fortifications. Remarkably, the assumptions underlying this program would continue to help shape the strategic defense policy of United States into the mid-twentieth century.²⁰

Federal funding was authorized in 1794 for construction of a series of forts which would protect strategic seaports along the coast of the Atlantic Ocean and the Gulf of Mexico. Federal guidelines were non-specific; individual fort plans, construction methods, and materials, while subject to the approval of state governors, were left to the engineer assigned to each proposed fort location; the engineers were handicapped, however, by limited funds and a short construction timetable. The works built during this initial flurry of military construction would come to be known as the defenses of the First American System of fortifications (1794-1804).²¹ Because the United States military had virtually no trained engineers at the end of the eighteenth century, construction was contracted to independent military architects, many of them French.²² Seacoast fortifications dating to this system are dissimilar in form, each reflecting the background of their individual architects, and most, being earthworks, were not durable.²³

Work at Whetstone Point under the First American System consisted of the reconstruction of the water batteries and the construction of a new star fort, soon to be named in honor of James McHenry, the Secretary of War. The work was guided by the plans of three successive French architects: Major John Jacob Ulrich Rivardi (1794-1797), Major Louis Tousard (1798), and Jean Foncin (1799-1800). Rivardi's plans, as implemented, were apparently limited to the reconstruction of the water batteries, although his observations concerning the inadequacy of the old star fort lay behind the efforts of his successors. Construction of the existing fort began under Tousard's plan, but was completed under a substantially revised plan prepared by Foncin (Figure 6).

Political friction between France and the United States arose in the late eighteenth century when the French navy began seizing United States ships suspected of engaging in trade with Great Britain. This resulted in the Quasi-War with France. This international tension affected the French engineers employed by the United States government; they came under suspicion and, finally, many were dismissed. None of the French engineers associated with the construction of Fort McHenry were dismissed. In fact, Tousard was placed in charge of all seacoast defenses in 1798, although official recognition of this position was not formalized for two years because of the political difficulties involved in placing a foreign national in charge of the nation's defenses.²⁴

Political tension with both France and Britain eased at the turn of the century, and no substantial, federally-funded construction was undertaken at the beginning of the nineteenth century.²⁵ Repair work and some construction were undertaken, however, by local and state governments.

By 1805, warfare in Europe again affected the neutrality of the United States and its maritime trade, and once again the main antagonist was Britain's Royal Navy. The need to staff ships during Great Britain's conflict with France led to a policy in which American maritime neutrality was violated: American ships were boarded and crew members impressed into service aboard British ships. Additionally, an American expansionist policy toward the western frontier added to the tension with Great Britain. The perceived threat along the United States' coasts increased and the program of seacoast fortification construction was renewed. Construction during this period is designated as the Second American System (1807-1814). The fortifications constructed during the Second System were more elaborate than those of the First System; in general their configuration, plan, and construction were supervised by the American military in a more coordinated effort with American-trained architects involved in construction. Although the construction was nationally coordinated, the Second System is marked by a dissimilarity between fortifications. Fort McHenry, in form, construction materials, and function, lies between the First and Second systems.²⁶

The Second American System included not only the remodeling and strengthening of existing harbor defenses, but also new construction to protect an increased number of strategic points along the coastline. Wade presents twenty major First-System fortifications; the number of major seacoast fortifications increased to thirty-one, for the Second System.²⁷ This reflects the growth of economically important commercial cities, especially along coastal New England, and the acquisition of the Louisiana territories. As with the First System, numerous minor fortifications and batteries were constructed to augment the major fortifications, or to protect less strategic ports.

Construction associated with the Second System was essentially completed by the War of 1812, but localized construction to strengthen existing fortifications was a continuing process.²⁸ This was the case with Fort McHenry. Political tension led to an American declaration of war against Great Britain in June of 1812. The population of Baltimore reacted to the declaration of war against Britain by building and sponsoring a large number of privateers. The intent of these vessels was to capture ships and cargos of the British merchant fleet. The British response was to place a naval blockade at the entrance of the Chesapeake and Delaware bays. Further offensive operations along the Atlantic coast by the British had to wait until the end of Wellington's Iberian Peninsula Campaign against Napoleonic France.²⁹ In 1813, Fort McHenry underwent a flurry of construction activity to strengthen the fortification.³⁰ Several important defensive features were introduced, most notably the ravelin, and the bastion embrasures were filled and the bastions themselves platformed so that the guns could be fired en barbette (Figure 7).

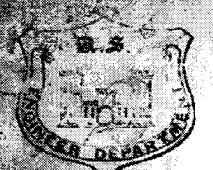

Drawer 51.
Sheet 1.

*Wm. H. B. ...
1427-1836*

Fort McHenry 9th November 1803
 125 ft. 83 Bastions.
 60 Barracks.
 7 Officers Houses.
 8 Commanding Officers House.
 9 Powder Magazine.
 10 Custom.
 11 Gal.
 12 Bridge.
 13 Water Conduick on the Fort.
 14 Water Conduick in the Ditch.
 15 Old Barracks.
 16 Old Battery.
 17 New Battery.
 18 Water conduick.
 19 Boat to Baltimore.
 A Area and garden of a Tavern before.
 B Low ground.
 YD Embrazures are marked on the Batteries to designate the places of pointing the Guns over the parapets.

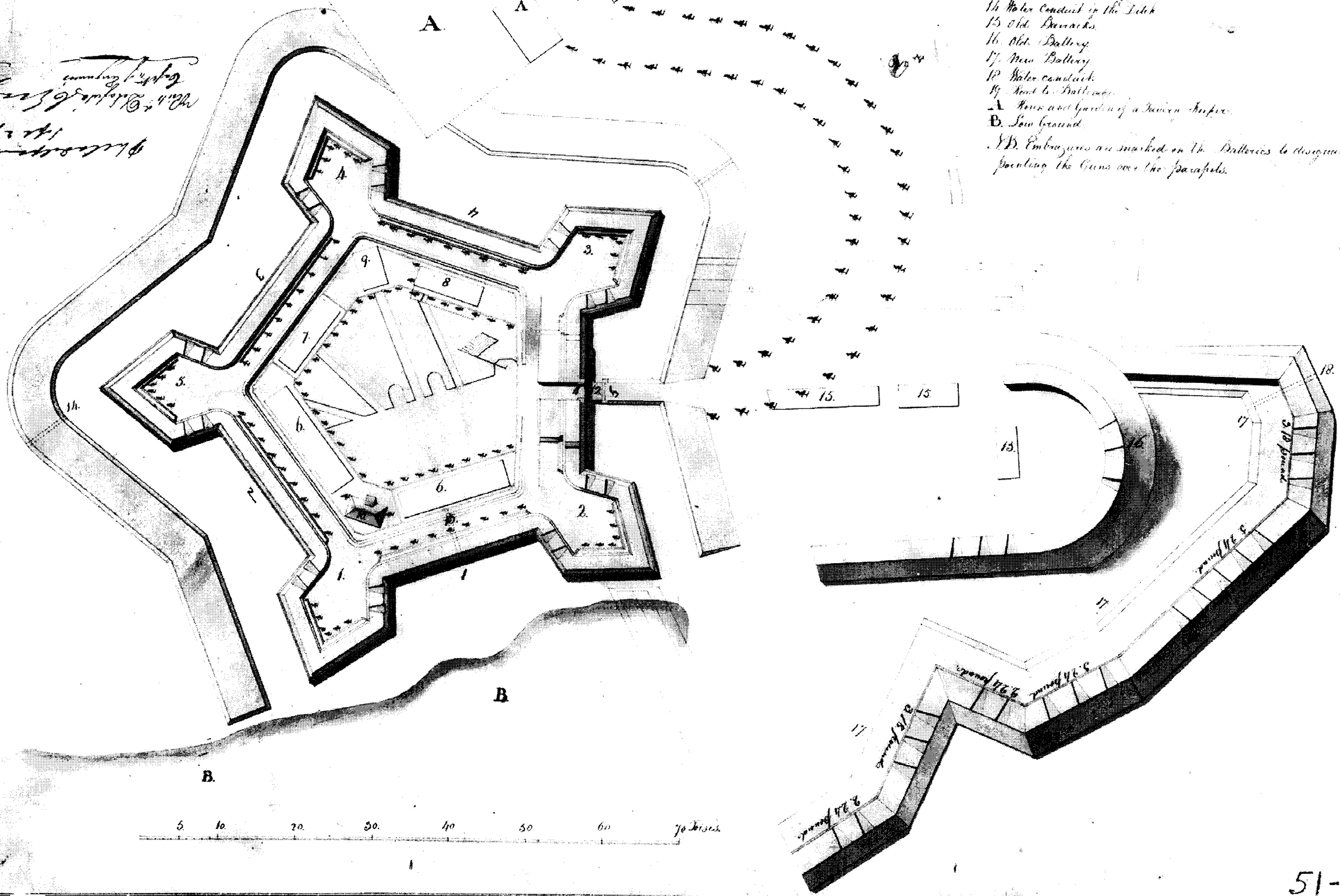

51-1

Figure 6. Fort McHenry, 1803.

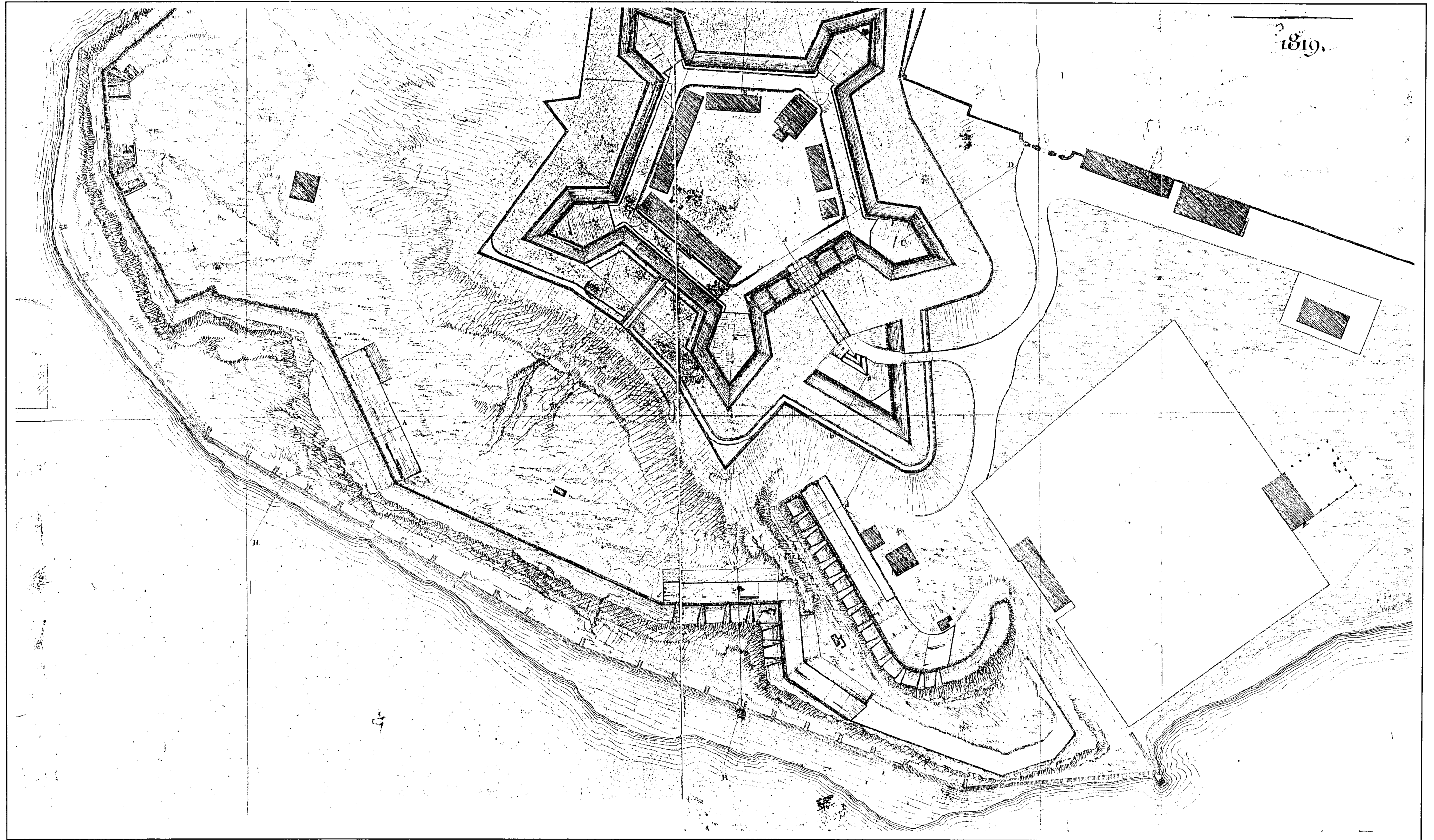

Figure 7. Detail of Capt. William Tell Poussin's *Plan and Profile of Fort McHenry*, 1819, showing the plan of the fort.

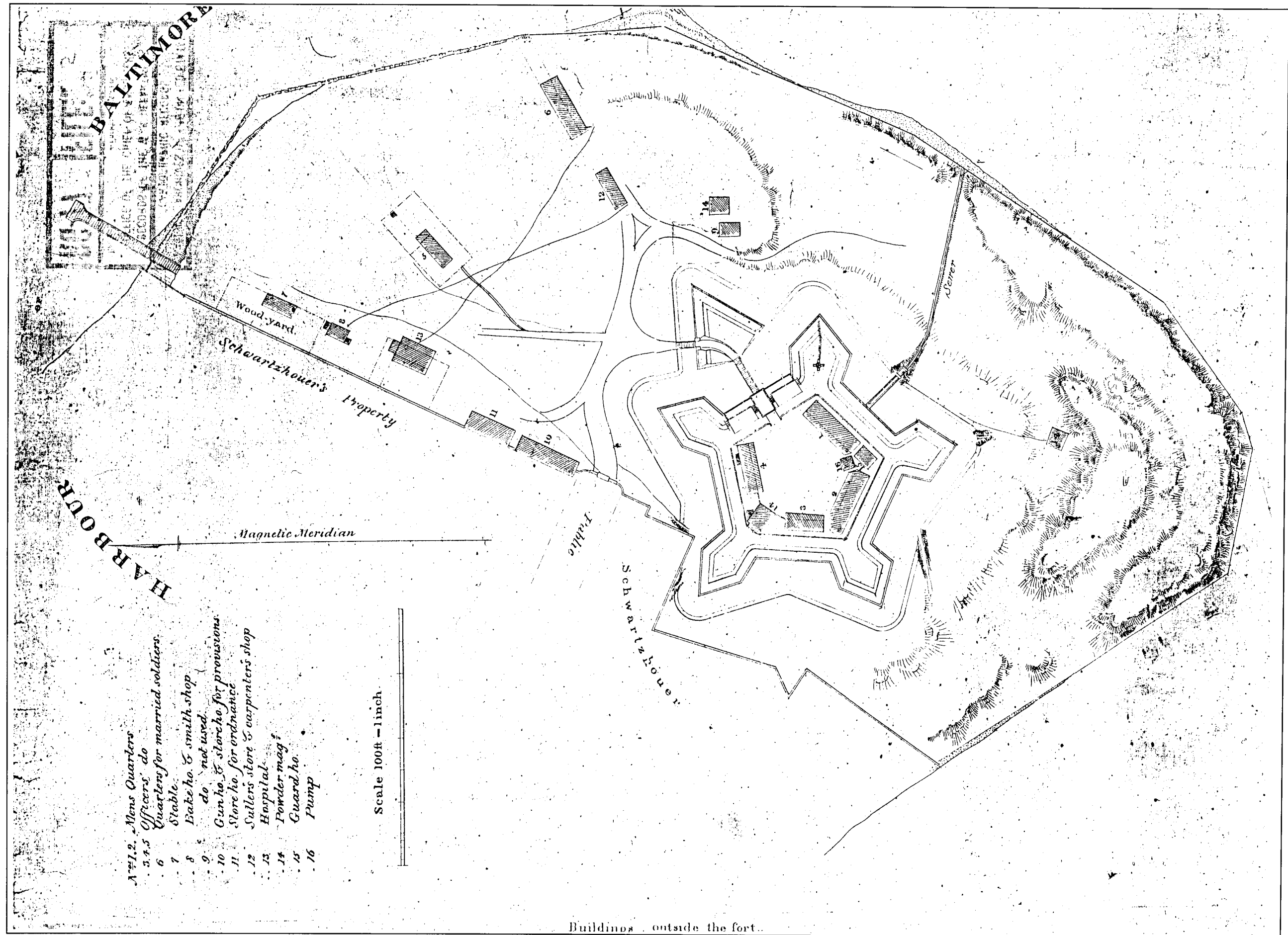

Figure 8. Detail of Lt. Thomas I. Lee's Fort McHenry, 1834, showing the general plan of the fort.

In August of 1814, a British land force captured Washington, D.C. From there the British army and navy moved against Baltimore with an offensive that involved coordinated land and naval attacks.³¹ The bombardment of Fort McHenry, which lasted about 24 hours on September 13-14, 1814, was part of the ensuing four-day battle. The assault failed, and the British forces withdrew to the Chesapeake Bay. The steadfastness of the Fort McHenry garrison, the defiant display of the national flag, and Francis Scott Key's composition of what would become the national anthem eventually led to the fort becoming a symbol of American patriotism. The British withdrawal reflects the advantages seacoast fortifications enjoyed over naval forces: the contemporary military doctrine was that seacoast fortifications could not be taken by naval forces without overwhelming superiority.³² In the aftermath of the bombardment of Fort McHenry, a number of deficiencies that had become apparent while the fort was under fire were remedied.

In 1817, the federal government enacted a program of seacoast fortifications which are known as the Third System (1817-1867). Unlike the prior two systems, the Third System was not initiated as a response to immediate threats from foreign governments. Rather, the Third System was initiated as an integrated system of fortifications to deter attack along the coast, and implemented by a group within the military who determined policy and priorities and reviewed plans. The program included plans for the replacement of older fortifications, although in actuality many older fortifications were retained and incorporated into the overall system (Figure 8). Construction to upgrade the aging forts was undertaken in response to perceived inadequacies and changing technologies. Implementation of the Third System resulted, nonetheless, in a significant reduction in the number of defended positions along the coast.³³

Fort McHenry remained the key element in the defensive works protecting Baltimore. Construction of the fort's existing water (outer) battery, was undertaken in the mid-1830s, the original water batteries having been removed ca. 1831, and new guns were mounted in 1840. With the acquisition of adjacent land in 1836-37, the overall size of the fort's property was more than doubled (Figures 9 and 10).

Due to the city's larger size, and Fort McHenry's incapacity to fully protect it, a new, much larger, Third System fort was planned, to be located on an artificial island in the Patapsco River about seven miles southeast of the city. In 1847, Robert E. Lee began the construction of this fort, named Fort Carroll in 1850.³⁴ Completion of this fort would have made Fort McHenry obsolete, except as added protection in the event that Fort Carroll somehow failed to repel an attack. However, until Fort Carroll could be completed (which was not to occur before its design was made obsolete by the development of rifled guns), the military would continue to view Fort

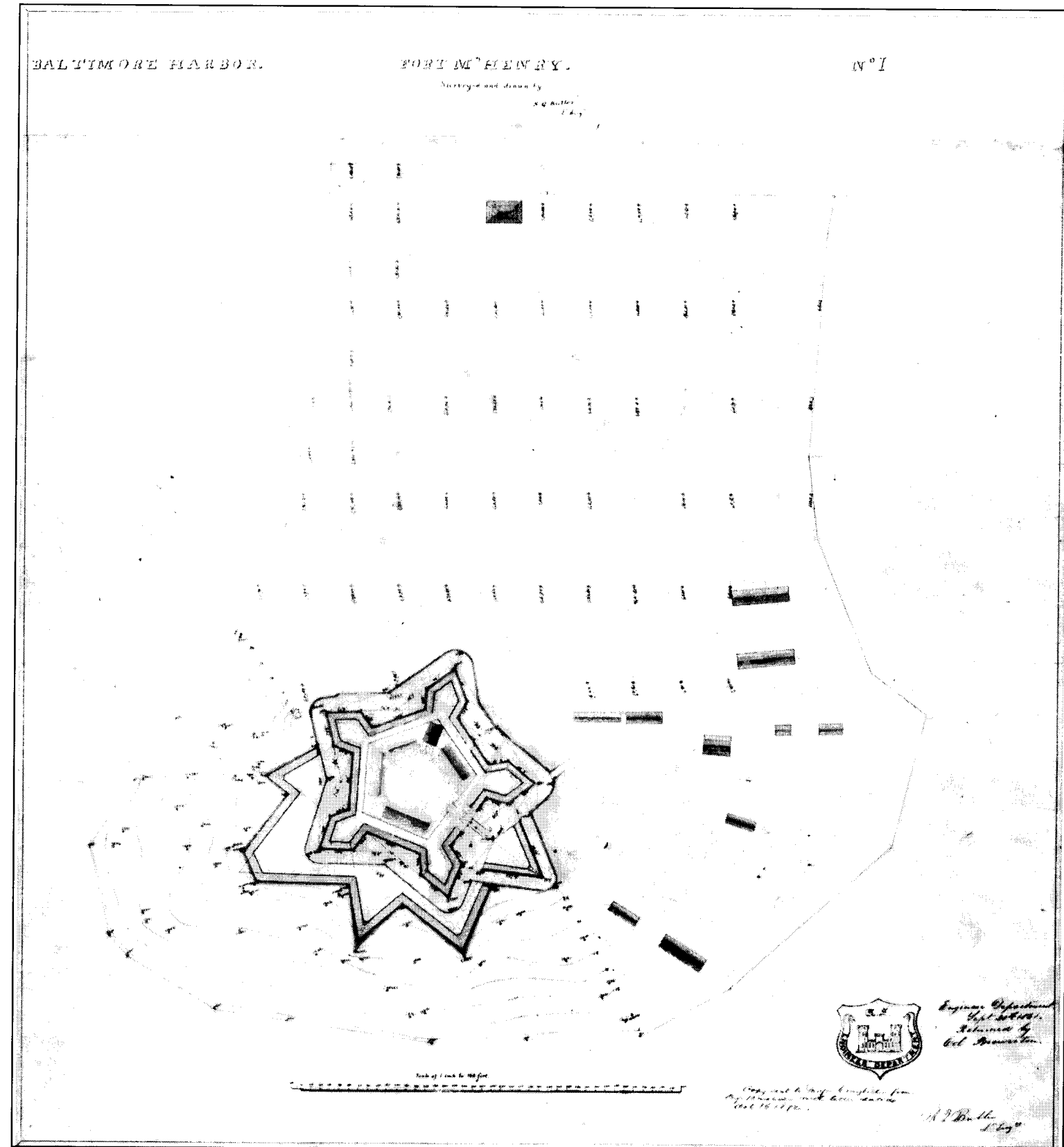

Figure 9. Lt. R. Q. Butler's Fort McHenry, ca. 1840.

PLAN AND SECTIONS OF DRILL GROUND AT FORT M^C HENRY MD.
 including ordnance store-rooms, stables, hospital grounds, hospital and graveyard.

Drawn and surveyed by Samuel Brick Lt. 1st Regt. Md. Artillery
 by Lt. Samuel Brick for 1858.

Drawer 51.
Sheet 21.

EXPLANATIONS.

Scale for horizontal distances... 1 inch to 100 feet.
 The numbers on the plan denote the distance of the adjacent point above
 a horizontal line drawn through the point on the corner of the wall
 from the point of observation.
 The lines of level are 50 feet apart for the first three, commencing
 on the South side and 100 feet for the rest; the distance from stakes to
 stakes for these lines is 100 feet for the first three and 200 feet for the rest.
 The height of the surface is as follows commencing at the ordnance
 ground:
 10 fathoms 10 feet, 20 do 100 feet, 30 do 100 feet, 40 do 100 feet, 50
 do 100 feet, 60 do 100 feet, 70 do 100 feet, 80 do 100 feet, 90 do 100 feet,
 100 do 100 feet, 110 do 100 feet, 120 do 100 feet, 130 do 100 feet,
 140 do 100 feet, 150 do 100 feet, 160 do 100 feet, 170 do 100 feet,
 180 do 100 feet, 190 do 100 feet, 200 do 100 feet, 210 do 100 feet, 220
 do 100 feet, 230 do 100 feet, 240 do 100 feet, 250 do 100 feet, 260
 do 100 feet, 270 do 100 feet, 280 do 100 feet, 290 do 100 feet, 300
 do 100 feet, 310 do 100 feet, 320 do 100 feet, 330 do 100 feet, 340
 do 100 feet, 350 do 100 feet, 360 do 100 feet, 370 do 100 feet, 380
 do 100 feet, 390 do 100 feet, 400 do 100 feet, 410 do 100 feet, 420
 do 100 feet, 430 do 100 feet, 440 do 100 feet, 450 do 100 feet, 460
 do 100 feet, 470 do 100 feet, 480 do 100 feet, 490 do 100 feet, 500
 do 100 feet, 510 do 100 feet, 520 do 100 feet, 530 do 100 feet, 540
 do 100 feet, 550 do 100 feet, 560 do 100 feet, 570 do 100 feet, 580
 do 100 feet, 590 do 100 feet, 600 do 100 feet, 610 do 100 feet, 620
 do 100 feet, 630 do 100 feet, 640 do 100 feet, 650 do 100 feet, 660
 do 100 feet, 670 do 100 feet, 680 do 100 feet, 690 do 100 feet, 700
 do 100 feet, 710 do 100 feet, 720 do 100 feet, 730 do 100 feet, 740
 do 100 feet, 750 do 100 feet, 760 do 100 feet, 770 do 100 feet, 780
 do 100 feet, 790 do 100 feet, 800 do 100 feet, 810 do 100 feet, 820
 do 100 feet, 830 do 100 feet, 840 do 100 feet, 850 do 100 feet, 860
 do 100 feet, 870 do 100 feet, 880 do 100 feet, 890 do 100 feet, 900
 do 100 feet, 910 do 100 feet, 920 do 100 feet, 930 do 100 feet, 940
 do 100 feet, 950 do 100 feet, 960 do 100 feet, 970 do 100 feet, 980
 do 100 feet, 990 do 100 feet, 1000 do 100 feet.

- P. Fort McHenry
- Q. Ordnance store-rooms
- R. Stables
- S. Hospital grounds
- T. Hospital
- U. Graveyard
- V. Wall
- W. Wall
- X. Wall
- Y. Wall
- Z. Wall
- aa. Wall
- ab. Wall
- ac. Wall
- ad. Wall
- ae. Wall
- af. Wall
- ag. Wall
- ah. Wall
- ai. Wall
- aj. Wall
- ak. Wall
- al. Wall
- am. Wall
- an. Wall
- ao. Wall
- ap. Wall
- aq. Wall
- ar. Wall
- as. Wall
- at. Wall
- au. Wall
- av. Wall
- aw. Wall
- ax. Wall
- ay. Wall
- az. Wall
- ba. Wall
- bb. Wall
- bc. Wall
- bd. Wall
- be. Wall
- bf. Wall
- bg. Wall
- bh. Wall
- bi. Wall
- bj. Wall
- bk. Wall
- bl. Wall
- bm. Wall
- bn. Wall
- bo. Wall
- bp. Wall
- bq. Wall
- br. Wall
- bs. Wall
- bt. Wall
- bu. Wall
- bv. Wall
- bw. Wall
- bx. Wall
- by. Wall
- bz. Wall
- ca. Wall
- cb. Wall
- cc. Wall
- cd. Wall
- ce. Wall
- cf. Wall
- cg. Wall
- ch. Wall
- ci. Wall
- cj. Wall
- ck. Wall
- cl. Wall
- cm. Wall
- cn. Wall
- co. Wall
- cp. Wall
- cq. Wall
- cr. Wall
- cs. Wall
- ct. Wall
- cu. Wall
- cv. Wall
- cw. Wall
- cx. Wall
- cy. Wall
- cz. Wall
- da. Wall
- db. Wall
- dc. Wall
- dd. Wall
- de. Wall
- df. Wall
- dg. Wall
- dh. Wall
- di. Wall
- dj. Wall
- dk. Wall
- dl. Wall
- dm. Wall
- dn. Wall
- do. Wall
- dp. Wall
- dq. Wall
- dr. Wall
- ds. Wall
- dt. Wall
- du. Wall
- dv. Wall
- dw. Wall
- dx. Wall
- dy. Wall
- dz. Wall
- ea. Wall
- eb. Wall
- ec. Wall
- ed. Wall
- ee. Wall
- ef. Wall
- eg. Wall
- eh. Wall
- ei. Wall
- ej. Wall
- ek. Wall
- el. Wall
- em. Wall
- en. Wall
- eo. Wall
- ep. Wall
- eq. Wall
- er. Wall
- es. Wall
- et. Wall
- eu. Wall
- ev. Wall
- ew. Wall
- ex. Wall
- ey. Wall
- ez. Wall
- fa. Wall
- fb. Wall
- fc. Wall
- fd. Wall
- fe. Wall
- ff. Wall
- fg. Wall
- fh. Wall
- fi. Wall
- fj. Wall
- fk. Wall
- fl. Wall
- fm. Wall
- fn. Wall
- fo. Wall
- fp. Wall
- fq. Wall
- fr. Wall
- fs. Wall
- ft. Wall
- fu. Wall
- fv. Wall
- fw. Wall
- fx. Wall
- fy. Wall
- fz. Wall
- ga. Wall
- gb. Wall
- gc. Wall
- gd. Wall
- ge. Wall
- gf. Wall
- gg. Wall
- gh. Wall
- gi. Wall
- gj. Wall
- gk. Wall
- gl. Wall
- gm. Wall
- gn. Wall
- go. Wall
- gp. Wall
- gq. Wall
- gr. Wall
- gs. Wall
- gt. Wall
- gu. Wall
- gv. Wall
- gw. Wall
- gx. Wall
- gy. Wall
- gz. Wall
- ha. Wall
- hb. Wall
- hc. Wall
- hd. Wall
- he. Wall
- hf. Wall
- hg. Wall
- hh. Wall
- hi. Wall
- hj. Wall
- hk. Wall
- hl. Wall
- hm. Wall
- hn. Wall
- ho. Wall
- hp. Wall
- hq. Wall
- hr. Wall
- hs. Wall
- ht. Wall
- hu. Wall
- hv. Wall
- hw. Wall
- hx. Wall
- hy. Wall
- hz. Wall
- ia. Wall
- ib. Wall
- ic. Wall
- id. Wall
- ie. Wall
- if. Wall
- ig. Wall
- ih. Wall
- ii. Wall
- ij. Wall
- ik. Wall
- il. Wall
- im. Wall
- in. Wall
- io. Wall
- ip. Wall
- iq. Wall
- ir. Wall
- is. Wall
- it. Wall
- iu. Wall
- iv. Wall
- iw. Wall
- ix. Wall
- iy. Wall
- iz. Wall
- ja. Wall
- jb. Wall
- jc. Wall
- jd. Wall
- je. Wall
- jf. Wall
- jj. Wall
- jk. Wall
- jl. Wall
- jm. Wall
- jn. Wall
- jo. Wall
- jp. Wall
- jq. Wall
- jr. Wall
- js. Wall
- jt. Wall
- ju. Wall
- ju. Wall
- kv. Wall
- kw. Wall
- kx. Wall
- ky. Wall
- kz. Wall
- la. Wall
- lb. Wall
- lc. Wall
- ld. Wall
- le. Wall
- lf. Wall
- lg. Wall
- lh. Wall
- li. Wall
- lj. Wall
- lk. Wall
- ll. Wall
- lm. Wall
- ln. Wall
- lo. Wall
- lp. Wall
- lq. Wall
- lr. Wall
- ls. Wall
- lt. Wall
- lu. Wall
- lv. Wall
- lw. Wall
- lx. Wall
- ly. Wall
- lz. Wall
- ma. Wall
- mb. Wall
- mc. Wall
- md. Wall
- me. Wall
- mf. Wall
- mg. Wall
- mh. Wall
- mi. Wall
- mj. Wall
- mk. Wall
- ml. Wall
- mm. Wall
- mn. Wall
- mo. Wall
- mp. Wall
- mq. Wall
- mr. Wall
- ms. Wall
- mt. Wall
- mu. Wall
- mv. Wall
- mw. Wall
- mx. Wall
- my. Wall
- mz. Wall
- na. Wall
- nb. Wall
- nc. Wall
- nd. Wall
- ne. Wall
- nf. Wall
- ng. Wall
- nh. Wall
- ni. Wall
- nj. Wall
- nk. Wall
- nl. Wall
- nm. Wall
- nn. Wall
- no. Wall
- np. Wall
- nq. Wall
- nr. Wall
- ns. Wall
- nt. Wall
- nu. Wall
- nv. Wall
- nw. Wall
- nx. Wall
- ny. Wall
- nz. Wall
- oa. Wall
- ob. Wall
- oc. Wall
- od. Wall
- oe. Wall
- of. Wall
- og. Wall
- oh. Wall
- oi. Wall
- oj. Wall
- ok. Wall
- ol. Wall
- om. Wall
- on. Wall
- oo. Wall
- op. Wall
- oq. Wall
- or. Wall
- os. Wall
- ot. Wall
- ou. Wall
- ov. Wall
- ow. Wall
- ox. Wall
- oy. Wall
- oz. Wall
- pa. Wall
- pb. Wall
- pc. Wall
- pd. Wall
- pe. Wall
- pf. Wall
- pg. Wall
- ph. Wall
- pi. Wall
- pj. Wall
- pk. Wall
- pl. Wall
- pm. Wall
- pn. Wall
- po. Wall
- pp. Wall
- pq. Wall
- pr. Wall
- ps. Wall
- pt. Wall
- pu. Wall
- pv. Wall
- pw. Wall
- px. Wall
- py. Wall
- pz. Wall
- qa. Wall
- qb. Wall
- qc. Wall
- qd. Wall
- qe. Wall
- qf. Wall
- qg. Wall
- qh. Wall
- qi. Wall
- qj. Wall
- qk. Wall
- ql. Wall
- qm. Wall
- qn. Wall
- qo. Wall
- qp. Wall
- qq. Wall
- qr. Wall
- qs. Wall
- qt. Wall
- qu. Wall
- qv. Wall
- qw. Wall
- qx. Wall
- qy. Wall
- qz. Wall
- ra. Wall
- rb. Wall
- rc. Wall
- rd. Wall
- re. Wall
- rf. Wall
- rg. Wall
- rh. Wall
- ri. Wall
- rj. Wall
- rk. Wall
- rl. Wall
- rm. Wall
- rn. Wall
- ro. Wall
- rp. Wall
- rq. Wall
- rr. Wall
- rs. Wall
- rt. Wall
- ru. Wall
- rv. Wall
- rw. Wall
- rx. Wall
- ry. Wall
- rz. Wall
- sa. Wall
- sb. Wall
- sc. Wall
- sd. Wall
- se. Wall
- sf. Wall
- sg. Wall
- sh. Wall
- si. Wall
- sj. Wall
- sk. Wall
- sl. Wall
- sm. Wall
- sn. Wall
- so. Wall
- sp. Wall
- sq. Wall
- sr. Wall
- ss. Wall
- st. Wall
- su. Wall
- sv. Wall
- sw. Wall
- sx. Wall
- sy. Wall
- sz. Wall
- ta. Wall
- tb. Wall
- tc. Wall
- td. Wall
- te. Wall
- tf. Wall
- tg. Wall
- th. Wall
- ti. Wall
- tj. Wall
- tk. Wall
- tl. Wall
- tm. Wall
- tn. Wall
- to. Wall
- tp. Wall
- tq. Wall
- tr. Wall
- ts. Wall
- tt. Wall
- tu. Wall
- tv. Wall
- tw. Wall
- tx. Wall
- ty. Wall
- tz. Wall
- ua. Wall
- ub. Wall
- uc. Wall
- ud. Wall
- ue. Wall
- uf. Wall
- ug. Wall
- uh. Wall
- ui. Wall
- uj. Wall
- uk. Wall
- ul. Wall
- um. Wall
- un. Wall
- uo. Wall
- up. Wall
- uq. Wall
- ur. Wall
- us. Wall
- ut. Wall
- uu. Wall
- uv. Wall
- uw. Wall
- ux. Wall
- uy. Wall
- uz. Wall
- va. Wall
- vb. Wall
- vc. Wall
- vd. Wall
- ve. Wall
- vf. Wall
- vg. Wall
- vh. Wall
- vi. Wall
- vj. Wall
- vk. Wall
- vl. Wall
- vm. Wall
- vn. Wall
- vo. Wall
- vp. Wall
- vq. Wall
- vr. Wall
- vs. Wall
- vt. Wall
- vu. Wall
- vv. Wall
- vw. Wall
- vx. Wall
- vy. Wall
- vz. Wall
- wa. Wall
- wb. Wall
- wc. Wall
- wd. Wall
- we. Wall
- wf. Wall
- wg. Wall
- wh. Wall
- wi. Wall
- wj. Wall
- wk. Wall
- wl. Wall
- wm. Wall
- wn. Wall
- wo. Wall
- wp. Wall
- wq. Wall
- wr. Wall
- ws. Wall
- wt. Wall
- wu. Wall
- wv. Wall
- ww. Wall
- wx. Wall
- wy. Wall
- wz. Wall
- xa. Wall
- xb. Wall
- xc. Wall
- xd. Wall
- xe. Wall
- xf. Wall
- xg. Wall
- xh. Wall
- xi. Wall
- xj. Wall
- xk. Wall
- xl. Wall
- xm. Wall
- xn. Wall
- xo. Wall
- xp. Wall
- xq. Wall
- xr. Wall
- xs. Wall
- xt. Wall
- xu. Wall
- xv. Wall
- xw. Wall
- xx. Wall
- xy. Wall
- xz. Wall
- ya. Wall
- yb. Wall
- yc. Wall
- yd. Wall
- ye. Wall
- yf. Wall
- yg. Wall
- yh. Wall
- yi. Wall
- yj. Wall
- yk. Wall
- yl. Wall
- ym. Wall
- yn. Wall
- yo. Wall
- yp. Wall
- yq. Wall
- yr. Wall
- ys. Wall
- yt. Wall
- yu. Wall
- yv. Wall
- yw. Wall
- yx. Wall
- yy. Wall
- yz. Wall
- za. Wall
- zb. Wall
- zc. Wall
- zd. Wall
- ze. Wall
- zf. Wall
- zg. Wall
- zh. Wall
- zi. Wall
- zj. Wall
- zk. Wall
- zl. Wall
- zm. Wall
- zn. Wall
- zo. Wall
- zp. Wall
- zq. Wall
- zr. Wall
- zs. Wall
- zt. Wall
- zu. Wall
- zv. Wall
- zw. Wall
- zx. Wall
- zy. Wall
- zz. Wall

Original kept
 in S. 11. 2153.
 Here with S. 11. 2153.

Engineer Department
 Sept. 30th 1861.
 Returned by Col. Brewster.

Copy sent to Gen. M. Ferriss 2, 7 1/2
 with letter of Oct 25/61 (Brig Gen)

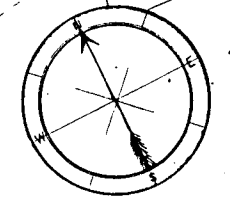

51-21

Figure 10. Lt. Samuel Brick's Plan and Sections of Drill Ground at Fort McHenry, 1858.

McHenry as an integral part of the defense of Baltimore. In addition to defending Baltimore from a naval attack, the fort was an important component of the city's landward defenses.³⁵

The Civil War ushered in a very active period of construction at the fort. The defenses of the fort were upgraded during the war and in the immediate post-war years (Figures 11 and 12). At the beginning of the war, several expedient defensive features were constructed; during and immediately after the war more permanent improvements were added. One of the fort's roles during the war was dictated by the adamantly pro-South sentiment of much of the population of Baltimore.³⁶ The fort functioned as an important symbol of federal control. In fact, much of the fort's armament was directed toward the city, a material as well as symbolic demonstration of real power. During the war, the fort was an important staging area, and both political and military prisoners were there.³⁷

Advances in military technology during and immediately after the Civil War prompted the redesign of the defenses of Baltimore, as well as elsewhere along the American seacoast. The introduction of rifled cannon in the years preceding the Civil War, and the use of these guns on ships in battle situations, led to the rethinking of seacoast defenses. Destruction of Fort Pulaski, Georgia, after a long-range bombardment by federal troops, demonstrated the vulnerability of masonry Third-System forts to rifled artillery fire. Consequently, these advances, along with advances in ship armor (i.e., ironclad ships), rendered Third-System forts, constructed entirely out of masonry, obsolete.³⁸

The vulnerability of Fort Carroll placed renewed emphasis on Fort McHenry's role in the defense of Baltimore. In 1872, construction began at Fort McHenry on a large earthen water battery. Part of this battery was completed by 1876, but subsequent to this no money was appropriated for several years for any seacoast defenses, and construction of Fort McHenry's last battery was never completed as planned.³⁹ The military preparedness of the United States declined during this period, and expenditures on it decreased, because external foreign threats were perceived to be low. Fort McHenry continued to function as a military post, but its primary function was as a garrison and not for coastal defense (Figure 13).

In 1885 the Secretary of War, William C. Endicott, headed a special board which reviewed the entire system of seacoast defenses. The de-emphasis on the military in the 1870s, coupled with the advances in artillery, had rendered United States seacoast defenses inadequate and obsolete. The system of seacoast fortifications implemented following this review is known as the Endicott Era.⁴⁰ No improvements were made in Fort McHenry's armament, however, and the fort remained essentially unchanged. Rather, in the 1890s, new forts were established at the confluence of the Patapsco River and Chesapeake Bay. Fort Smallwood on

the south bank and Fort Howard on the north effectively ended Fort McHenry's function as a seacoast fortification. Additionally, to augment the defenses at Forts Smallwood and Howard, new gun emplacements were built at Fort Carroll, and opposite that fort, on the western shore of the Patapsco, Fort Armistead was built.⁴¹ Eventually, advancements in military technologies made these forts obsolete; by 1940 two batteries at the mouth of the Chesapeake Bay protected the entire bay.⁴² But these, and in fact all other seacoast fortifications, were themselves soon obsolete.

Fort McHenry remained a military post until 1912, but in its final years functioned only as a garrison. For two years the fort was unused, but in 1915 Baltimore assumed control and established a city park at the fort.⁴³ The army returned in 1917 and Fort McHenry became the site of intense construction activity. U.S. Army General Hospital No. 2, a hospital complex consisting of over 109 buildings with 3,000 beds, was built on the fort grounds.⁴⁴ The star fort, water batteries, and Civil War magazine were minimally affected by construction, but other structures and the grounds elsewhere were extensively altered (Figure 14).

In 1925, Fort McHenry was made a national park under the administration of the War Department.⁴⁵ The buildings associated with the general hospital were demolished beginning in 1925-26, and by 1928 the restoration of the surviving historic structures of the fort had commenced. The park was formally dedicated that same year, but the army's work on the buildings and grounds continued into the 1930s. Included with the work performed in 1929 was the removal of the 1870s water battery and its concrete magazines. In 1933, Fort McHenry was transferred to the Department of the Interior, and the NPS began its administration of the repair and restoration of the fort, with the assistance of the Work Projects Administration (WPA).

2.3 Episodes of Development

The history of Fort McHenry can be divided into nine major episodes of related construction activities, modifications, or rehabilitations. These nine episodes are: Fort Whetstone, First American System, Second American System, mid-1800s, Civil War, 1866-1912, World War I Hospital, War Department Restoration, and National Park Service. The Second American System can be further divided into pre- and post-bombardment sub-episodes. This section presents, for each of the nine episodes and two sub-episodes, a summary of the activities at Fort McHenry which may have left traces in the archeological record.

The episodes of Fort McHenry's history provide the basis for placement of the fort's archeological resources in their most readily-understood context. More than two-hundred years of nearly continuous occupation and repair,

modification, and construction at Fort McHenry have resulted in archeological resources with links to each of the episodes and sub-episodes. The more important construction activities, modifications, or rehabilitations are outlined here; details relating to individual fort features are provided in sections 3 and 4.

2.3.1 Fort Whetstone (1776-1780)

The first fortifications on Whetstone Point, constructed beginning in 1776, were an earthen star fort and two associated water batteries.⁴⁶ This earlier fort had nearly the same location as the existing fort (Figures 1 and 4). The fortifications had not been finished prior to their abandonment in the early 1780s, and they were in a decayed state when construction resumed on the site under the First System.⁴⁷ The only additional structures known to have been associated with Fort Whetstone were a guardhouse, barracks (possibly two or three), a flagstaff, a wharf, and one end of a boom which, in 1776-78, extended across the ship channel to Gorsuch Point. There may also have been a well, perhaps located in the upper water battery, and in 1794 there was reported to be a spring in the lower battery.⁴⁸

In 1794, John Jacob Rivardi, a trained military engineer, assessed the Revolutionary War period defenses at Fort Whetstone, and determined that they were defective, which he attributed to the lack of schooling in fortification method and theory on the part of the fort's original builders.⁴⁹ Rivardi suggested that the water batteries would both be vulnerable to enfilading fire from any ship that might succeed in passing up the North West Branch into the harbor; a low hill, however, protected the lower battery from any such fire from the Ferry Branch of the river. With regard to the star fort, the major engineering faults observed by Rivardi were that all the artillery fire fort was oblique, and that the re-entrant angles could not be defended. Rivardi also noted that mining activity had created a 'deep pit' where there should have been a road between the southwest ends of the upper and lower batteries, and a magazine.

Although the builders of Fort Whetstone had no formal training in military architecture, and the works were as a consequence imperfect, the site itself was well-chosen, and suited for reuse. When construction on the new star fort began, parts of the old earthwork were probably incorporated into the ramparts in an effort to economize and speed construction. Fort Whetstone's water batteries were modified and remained in use for another three decades; a few other structures also remained in use for more limited periods. Archeological deposits associated with Fort Whetstone and its batteries would have been severely impacted by the construction of Fort McHenry and by the construction and demolition of other, more recent structures around the fort.

2.3.2 *First American System (1794-1804)*

Modification of Fort Whetstone's water batteries, beginning in 1794, was the initial work at the site under the First System; these batteries would survive well beyond the Second System. The only buildings shown in proximity to the water batteries on the 1803 plan of the fort are three 'old barracks,' presumably remaining from the late 1770s (on an 1806 plan, however, the old barracks closest to the star fort is disconcertingly depicted as unfinished, and it may not have existed at all). A tavern had been built by 1797 immediately outside the fort's entrance, on property subsequently made part of the fort.

Construction on the existing star fort, begun in 1798, was completed by 1802 (Figure 6). With minor modifications, the form of the fort has survived to the present. The parade and parade buildings were built at this time, as was most of the fort's dry moat. All but one of the buildings were originally one-story high, and, although substantially modified, are still standing.⁵⁰ A roof structure, perhaps a hip roof over a brick vault, was situated over a cistern located between enlisted men's barracks 1 and 2, up until the cistern's abandonment and filling sometime prior to 1819.

2.3.3 *Second American System (1807-1814)*

2.3.3.1 Pre-bombardment

Following the completion of Fort McHenry, very little new construction occurred prior to 1813. A possible guardhouse (or detached kitchen), adjacent to the commanding officer's quarter, and privies, adjacent to the magazine, appear within the fort prior to 1806, while exterior to it, in 1807-08, a gun shed and combination store house and stable were built. By 1811, there was a frame barracks outside the fort as well, and the 'old barracks' of 1770s (or 1790s) origin are likely to have been demolished by then.⁵¹

When the War of 1812 began, the defenses at Fort McHenry were viewed as inadequate to repel a concerted British attack, provoking a flurry of construction in 1813-14.⁵² As originally built, the sally port entrance was unprotected, making the interior of the fort susceptible to enfilade fire. The fort's ravelin was built to correct this deficiency (Figure 7).⁵³ The ravelin is one of the first architectural features at the fort designed by an American-trained engineer.⁵⁴ In addition to the ravelin, several other important defensive features were added. The embrasures on the bastion flanks were filled, the bastions platformed and the gun emplacements within the fort modified so the guns could be fired en barbette. Brick traverses were constructed at the entrance of the parade magazine and on the parade at the interior entrance of the sally port. A well was excavated on the parade in an effort to secure a reliable water source for the fort. This well supplanted

the cistern, which may then have been removed; at the same time, a shot furnace may have been built in the vicinity.

Outside the fort, the dry moat and glacis were completed, with a caponniere beneath for communication between the fort and the water batteries, and the water batteries were again modified. By 1814, with the possible exception of a 1770s well, earlier structures associated with the water batteries had been replaced by newer structures, including shot furnaces, magazines, a laboratory (?), and the frame barrack noted previously.⁵⁵ A hospital was built in 1813 about 160 yards north of the present ravelin. Most if not all of these buildings, along with a few built later (including two 1814-1815 magazines), appear on an 1819 plan of the fort, although the absence of any functional identification of structures on that plan makes interpretation of several of them uncertain.

Many of Fort McHenry's archeological resources relate to construction activities associated with the improvements to the defenses of the fort implemented at this time. The traverses, well, filled embrasures, and several other features of this episode exist only in the archeological record. But while some structures, such as the ravelin, are still standing, others, particularly several of those associated with the water batteries, may have been obliterated, along with the batteries themselves.

2.3.3.2 Post-bombardment

The British naval bombardment of September 13, 1814, accentuated some of the fort's flaws. The parade magazine, for example, sustained a direct hit, and could easily have been destroyed.⁵⁶ Almost immediately after the bombardment construction projects began again, notably the bombproofing of the magazine and the parade well, the construction of personnel bombproofs on either side of the sally port, and the construction of new water battery magazines. The sally port's masonry arch may have been built at the same time, and its brick traverse removed (Figures 6 and 7). Questions regarding the original configuration of the sally port, however, remain unresolved.⁵⁷

The bombproofing of the parade magazine involved the construction of a large brick structure which enclosed and incorporated the original building. With the bombproofing of the parade magazine, the section of the (originally) sloping, sodded embankment behind the magazine was replaced by a brick wall, which still exists. The characteristics of the superstructure of well's bombproof are unknown, although it was presumably brick; its brick footings survive, along with the well shaft, as archeological features.

The fort's first boundary wall and entrance gateway, which in their design appear to have been afterthoughts, were built along its property line, and

across the entire width of Whetstone Point, in 1816-17; the back walls of the 1807-08 gun shed and store house were incorporated into the boundary wall.⁵⁸ Sometime between 1814 and 1819, what would later (prior to 1834) become a guardhouse was constructed over the site of the 1800-1814 cistern, which may also have necessitated the removal of an 1814 shot furnace.⁵⁹ In 1816-19 the fort's first seawall was built.⁶⁰

2.3.4 *Mid-1800s*

No true Third System fortifications were constructed at Fort McHenry, as Fort Carroll was expected, when completed, to constitute the primary defenses for Baltimore. Nonetheless, the defenses at Fort McHenry were more-or-less constantly upgraded or repaired, and the fort's property was significantly enlarged. Several major features were constructed at this time, and important modifications were made to various existing structures. Work was of such intensity between 1836 and 1839 that the fort was evacuated.⁶¹ As was the case both before and after the 1814 bombardment, improvements addressed perceived deficiencies, but not all of them were related to defense. From a defensive viewpoint, in fact, work such as the addition of second stories to the parade buildings was inappropriate.

The 1829 refurbishing of the parade ground residential buildings involved construction of second stories in place of smaller, dormer-windowed attic rooms, and of two-story porches facing onto the parade.⁶² A two-story addition was constructed to join the commanding officer's quarters to its previously detached kitchen, a former guardhouse. The cellars beneath the buildings were for the most part abandoned about the same time.

Construction was undertaken in 1835 to build a guardhouse-prison on either side of the sally port, entailing modifications to the personnel bombproofs underneath. Rooms were added on to these guardhouse-prisons in 1857.⁶³ With the completion of the sally port guardhouses in 1835, the earlier guardhouse between enlisted men's barracks 1 and 2 was demolished; a new shot furnace, possibly the second to be located there, was constructed in the latter area sometime between 1836 and 1839.⁶⁴

The structure of the star fort itself was also modified during the mid-1800s. The original sodded embankment separating the parade from the more elevated terreplein surrounding it was replaced in 1834 by a stone revetment wall, giving the parade its existing configuration. In 1837, the parapet was improved by the addition of a breast-height wall, which was further extended in height in 1839. At the same time, the sandstone (?) coping at the top of the fort's scarp wall was replaced with granite.⁶⁵

Work was also performed between 1835 and 1840 to increase and modernize the fort's armament. Gun traverses were constructed along the

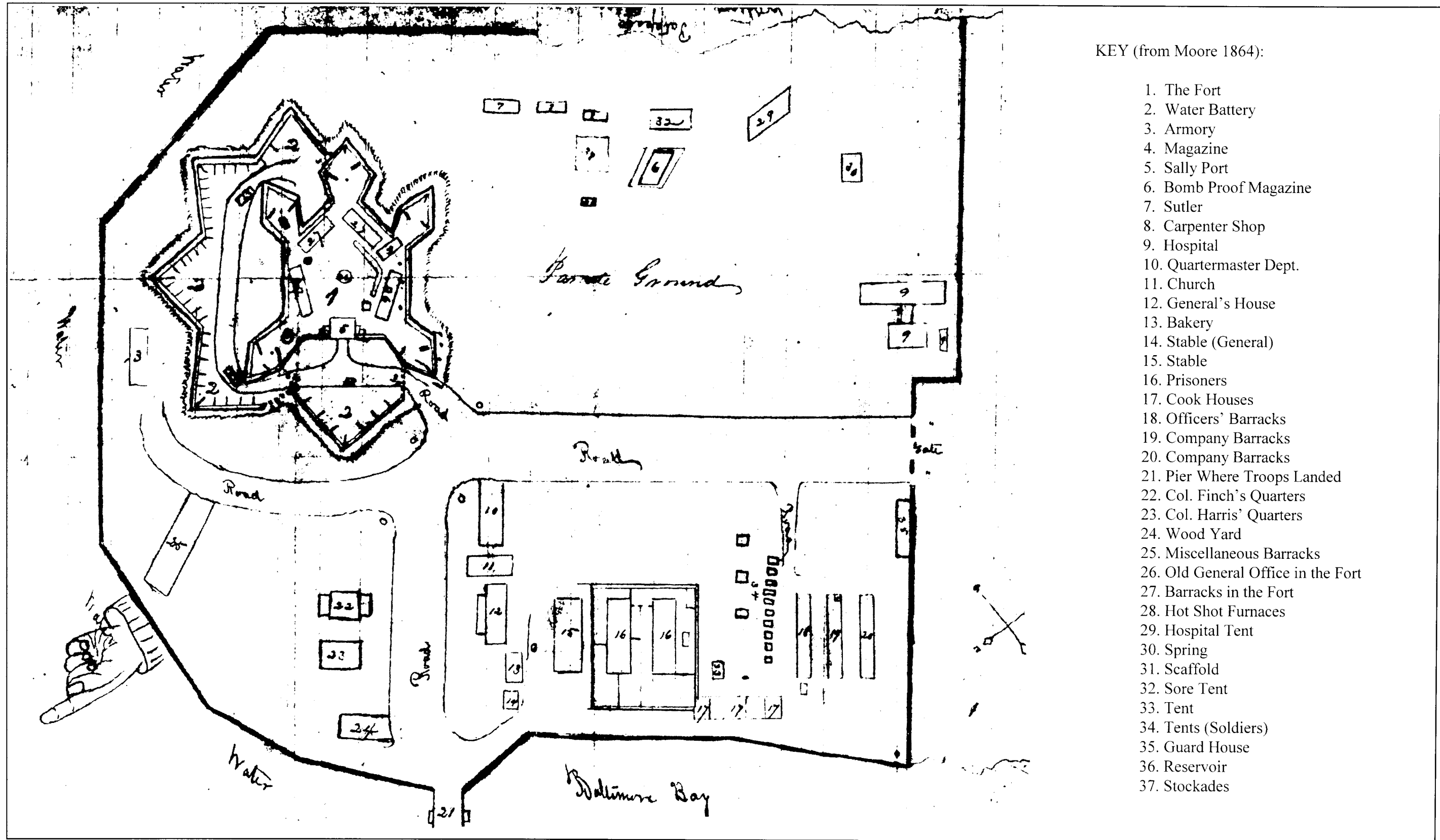

KEY (from Moore 1864):

1. The Fort
2. Water Battery
3. Armory
4. Magazine
5. Sally Port
6. Bomb Proof Magazine
7. Sutler
8. Carpenter Shop
9. Hospital
10. Quartermaster Dept.
11. Church
12. General's House
13. Bakery
14. Stable (General)
15. Stable
16. Prisoners
17. Cook Houses
18. Officers' Barracks
19. Company Barracks
20. Company Barracks
21. Pier Where Troops Landed
22. Col. Finch's Quarters
23. Col. Harris' Quarters
24. Wood Yard
25. Miscellaneous Barracks
26. Old General Office in the Fort
27. Barracks in the Fort
28. Hot Shot Furnaces
29. Hospital Tent
30. Spring
31. Scaffold
32. Sore Tent
33. Tent
34. Tents (Soldiers)
35. Guard House
36. Reservoir
37. Stockades

Figure 11. Pvt. Robert R. Moore's sketch plan of Fort McHenry, 1864.

fort's curtains between bastions 3 and 5, and at the shoulders of all the bastions (Figure 9). Of equal importance, work began in 1836 on the existing water (outer) battery.⁶⁶ The slow decay and abandonment of the earlier upper and lower water batteries, a process evidently completed by 1831, had left a gap in the fort's defenses. The new battery, with emplacements for thirty-nine guns (a mix of 24-, 32-, and 42-pounders), was completed in 1840; its two shot furnaces were evidently built in 1842.⁶⁷ As work began on the water battery, the caponniere that had previously extended from the outer end of the postern tunnel and beneath the dry moat and glacis was removed, and in its place an 18 inch diameter cast iron sewer was laid extending beneath the moat and the water battery out to the seawall. Previously, at some point between 1819 and 1834, a brick 'sewer' had been built between the outer end of the (truncated) caponniere and the seawall, along a more easterly alignment than the later cast iron sewer.

The construction of the water battery necessitated the reconfiguration of the ravelin entrance. The earlier entrance road/passageway system—through the ravelin and across a pair of bridges over the dry moat—did not allow for the expeditious movement of troops and materials between the fort and the water battery. By 1839, the passageway through the ravelin was closed, and at the same time, seven gun emplacements were built on the ravelin. The bridges were removed and an entrance ramp to the sally port constructed. An opening was made through the counterscarp and glacis northwest of the ravelin for the roadway to pass directly into the dry moat.

The gradual abandonment of the original water batteries, culminating in the construction of the new water battery, was accompanied by the removal of other early structures, some of which may be represented among the archeological features of the site. The early batteries' shot furnaces (?), which appear on the 1819 plan of the fort, had been removed sometime prior to 1834, as had a small structure of unknown function (possibly an 1814 magazine) located about 250 feet east of the left face of bastion 4. The two powder magazines built immediately after the bombardment survived until at least 1834, as had an unused bakehouse (the construction date for which is unknown), adjacent to the upper battery's magazine.⁶⁸ These three structures were undoubtedly removed during the 1836-40 construction of the new water battery, and the regrading of the area between the water battery and the seawall. The remainder of the early structures exterior to the fort, all of them located to the northwest of the upper water battery, evidently continued in use until the Civil War, and in some cases beyond, although most of their functions were changed.

The fort's first cemetery is likely to have been one of the structures removed during the regrading of the area between the new battery and the seawall. Poussin's 1819 plan and Lee's 1834 plan both depict a small hill, about 300 ft. south of bastion 4's salient; on this hill were drawn, on the 1819 plan, sets of hachures indicating eight small mounds, one with some sort of

masonry monument; at that location on the 1834 plan was drawn an iconic gravestone with a cross. The hill may have begun to be used as a burial ground during the late 1790s; presumably the remains of the four men killed during the 1814 bombardment, were also first buried there. The same hill had been noted by Rivardi, in 1794, as having formed an epaulement protective of the right side of the lower battery. Prior to the removal of this hill (which plans dating to 1836 and ca. 1840 indicate was reduced in elevation by as much as 7-8 ft.), and before the soil from it was used as fill in low-lying areas, the remains of those previously interred there were presumably moved to the post's mid- to late-nineteenth century cemetery, in the southern part of the 1836-37 addition to the fort's property.⁶⁹

Among other construction activity in the mid-1800s was the removal, in 1829, of the earth fill over the bombproofs to waterproof them with sheet lead. The small traverse at the entrance to the parade magazine was also removed in 1829. In 1835 the trees which were planted on the bastions, terreplein, and parade were removed. In 1836-39, a new section of the stone seawall was constructed. In 1842 the privy southwest (?) of the parade magazine burned down, and was replaced by a brick privy at the same location. Additionally, the interior slopes of the parapet of the star fort and water battery were clapboarded in 1844.

The addition of about 28 acres to the fort's property in 1836-37, which was done in part to prevent the encroachment of development that could have compromised the defensibility of the fort, also created the opportunity for construction of newer facilities that would not themselves interfere significantly with the fort's defenses.⁷⁰ The boundary wall was reconstructed along the new property line in 1837, and a new hospital was built adjacent to it, directly south of the entrance gateway, in 1840. A guardroom was built directly northeast of the gateway. Three large brick stables were built in 1840-43 northwest of the old hospital, which about this time became the post's commanding officer's quarters.⁷¹ By the 1850s, in the southern part of the additional property, there were two ordnance storerooms, of brick, and a cemetery. The additional property as a whole was identified as a drill ground on an 1858 plan.

2.3.5 Civil War

Improvements to Fort McHenry were again undertaken at the beginning of the Civil War, and the fort's mission was altered as a consequence of its location within a city in large part sympathetic to the Confederacy. Expedient improvements included the construction of palisades enclosing the gorge and the water battery, and the installation of an abatis at the base of the glacis of the water battery and adjacent (directly interior) to the counterscarp elsewhere. Ordnance was mounted and repositioned as necessary to direct the fort's greatest firepower landward (Figure 12).

Serious consideration was also given to the construction of a large earthen horn work to the north and west of bastion 2, and a large new powder magazine, with a design based on that of magazines in Florida and Massachusetts, was planned, and built (1863), to serve this work, even though the horn work itself was not constructed.⁷²

The inadequacy of the parade magazine was a more immediate issue, and in 1861 the army reconfigured the sally port bombproofs to serve as powder magazines. The work involved the installation of ventilators and the division of each bombproof into two chambers. A reliable, secure water source for the garrison was also a priority, and by October of 1861 a 142-foot-deep artesian well, with a manual pump and an adjacent water tank or reservoir, had been constructed on the parade.⁷³ Pipes extending through the sally port supplied hydrants on the fort's grounds. Until ca. 1870, the parade well constructed just before the War of 1812 also remained in use. Another well (or a spring) was located southwest of the 1840 hospital, and by the 1870s, if not previously, there were also some sort of "wells" (hydrants?) both north and southeast of the commanding officer's quarters.

The armament plan adopted for the fort at the beginning of the war underwent minor changes later in the war. Many gun emplacements were temporary but several required secure platforms or concrete gun emplacements. A major change in the fort's armament, begun in 1864 but not completed until 1866, consisted of the construction emplacements for five 15 in. Rodman guns, four in the water battery and one on the ravelin.⁷⁴ Construction of these new emplacements necessitated modification of the battery's revetment wall, and the removal of several older emplacements.

The property added to the grounds of the fort in 1836-37 became more intensively utilized during the course of the war. Two of the three brick stables built in 1840-43 became prisons (the other one continued to be used for stables). A carpenter's shop and a blacksmith's shop were established in the vicinity of the ordnance storerooms near the cemetery, as was a sutler's store; the storerooms themselves were demolished toward the end of the war, and a gun shed and quartermasters' stables established in the vicinity. Several new barracks and officers' quarters were also built, along with a frame addition to the 1840 hospital. A larger guardhouse took the place of the 1840s guardroom northeast of the entrance gateway.

Despite the existence of these new facilities, tent encampments were periodically established in at least one part of the newer section of the fort's grounds (outside the present park boundaries, about 240 ft. northwest of the existing bus parking area), and, in the older part, between the water battery and the seawall. It may have been to serve the latter camp that the sutler's store was moved, late in the war, to a site at the seawall southeast of the postern drain. A hospital tent and a 'sore house' were located in the vicinity of the detached magazine.

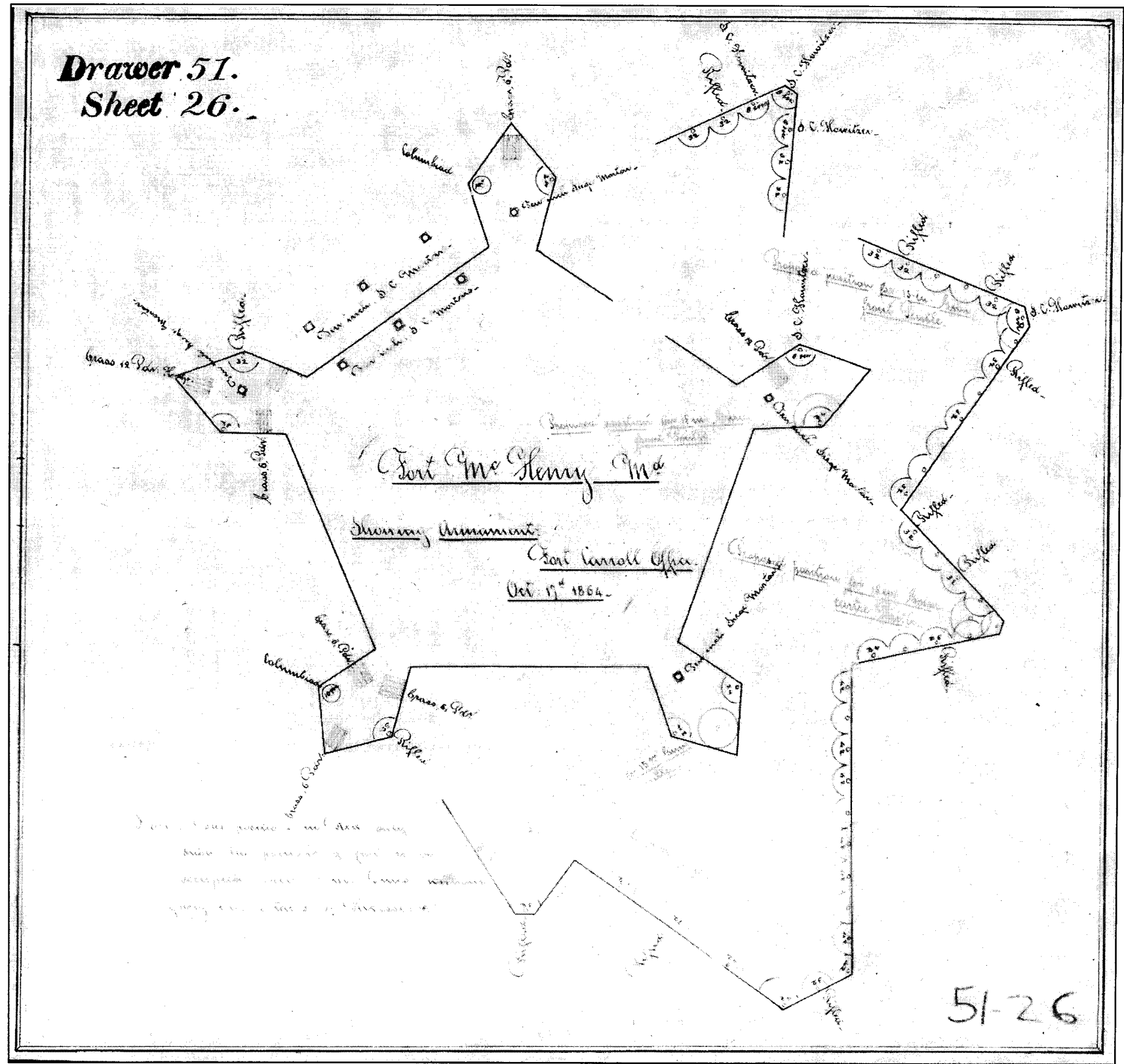

Figure 12. Fort McHenry, Md., Showing Armament, 1864.

Until very late in the war, if not its end, the area between the 1840 hospital and the star fort, southwest of the entrance roadway, served as a parade ground; a scaffold, employed directly for one execution and as the site of another, was evidently erected near the cemetery along the southwest edge of this area in 1864.⁷⁵ On plans dating to the 1870s, the 'drill ground' is located to the northeast of the entrance roadway.

2.3.6 1866-1912

Construction continued at Fort McHenry in the immediate post-war years. The work concentrated initially, 1865-67, on completion of improvements to the water (outer) battery begun during the Civil War, and the construction, ca. 1867, of three officers' quarters, aligned with one another along the entrance road in the east corner of the drill ground. After a very brief episode of construction during the 1870s, during which work began on a new water battery, Fort McHenry's obsolescence for coastal defensive purposes was increasingly obvious, and no Endicott era or subsequent armament improvements were made.

While the sally port bombproofs had been adapted for powder storage during the war, and a detached magazine had been built, there were as yet no magazines in the water battery and the ravelin, despite the construction of new gun emplacements there. It was recognized that the new armament required larger powder charges, however, and that additional magazines, located closer to the armament, were also required. This need was met in 1866 with the construction of three magazines, one in the ravelin and the others in the water battery; two bombproofs and a free-standing earthen traverse in the water battery were built at the same time. The earth mounds over the magazines and bombproofs allowed them to function as traverses, as well. The water battery's shot furnaces were presumably removed during the construction of these magazines and bombproofs.

The fort's water supply continued to be a concern to the garrison. In 1873 the manual pump on the parade was replaced by a steam pump; associated with this pump were a pump house and storage tanks.⁷⁶ Water continued to be piped to hydrants on the fort grounds. With the water system for Baltimore City extended to the fort in 1884, the steam pump, pump house and storage tanks were demolished. It is unclear if entirely new water lines were laid at this time; some older lines, including the one extending through the sally port, may have been incorporated into the new system. The fort's sewage system at this time consisted of a series of lines extending from its various buildings to the seawall.

In belated recognition of the radically changed situation of fortifications which rifled artillery had brought about, in 1873 construction began at Fort McHenry of a massive earthen water battery. The battery was designed to

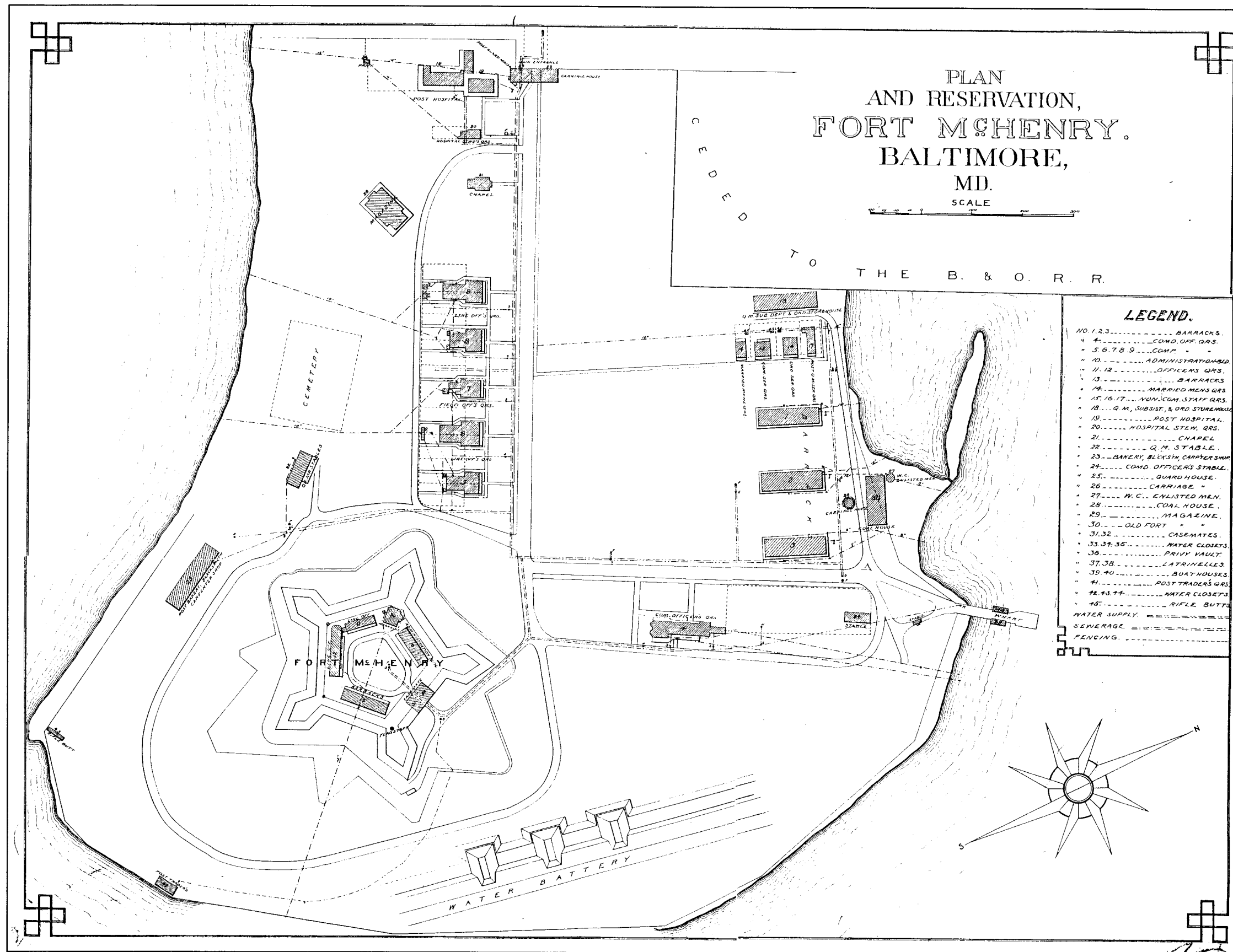

Figure 13. Plan and Reservation, Fort McHenry, ca. 1890.

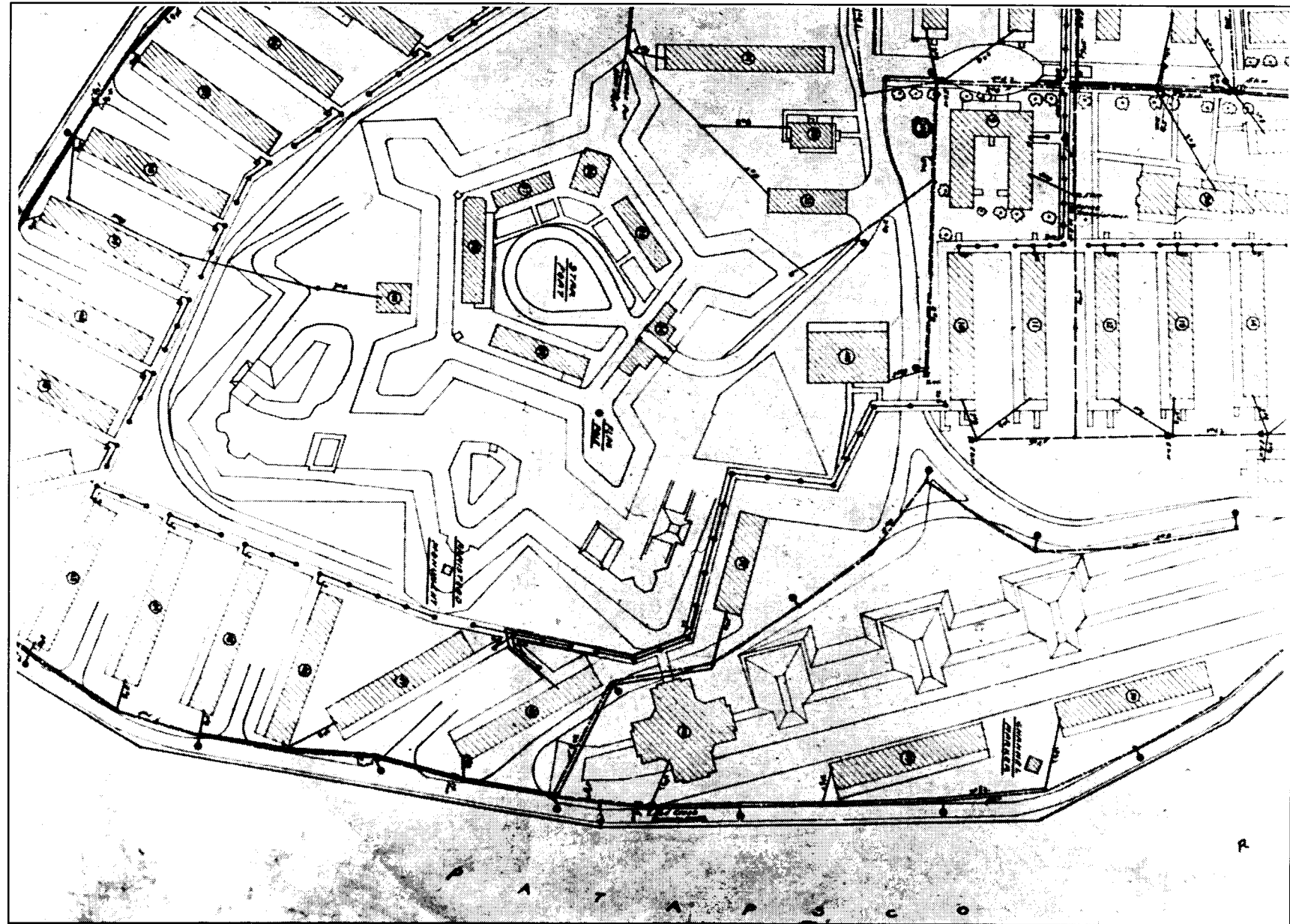

Figure 14. Detail from an electrical system plan, data from Toltz's *General Hospital No. 2, Fort McHenry*, 1917-18.

be armed with twenty-five 15-in. guns.⁷⁷ Part of it, a section capable of mounting ten guns (Figure 13), with three earth-covered, reinforced concrete traverse magazines, was completed, but by 1876 construction had ceased. The ground disturbances associated with the construction and subsequent (1920s) demolition of this battery were similarly massive, and, as discussed below, destructive of archeological resources, particularly those associated with the original upper and lower water batteries.

By 1888, except for the commanding officer's quarters (originally the post's hospital), and the 1814-19 stables to its north, all the earlier structures in the

older area of the fort's grounds northeast of the fort had evidently been removed. Gone by then were: an 1806-11 barracks, which had been the sutler's store and carpenter's shop in 1834, and which served as officers' quarters during and after the Civil War; the 1819-34 married soldiers' quarters, which had also been officers' quarters during and after the war; officers' quarters built ca. 1814-19 east of the original post hospital, and an adjacent structure built some time later (Civil War?) which also served as officers' quarters; the 1807-1808 gun shed and store house; a Civil War period chapel; and an 1819-34 bakehouse and blacksmiths' shop. By 1912, an octagonal bandstand stood at the former location of the gun shed's

southwest end. Various changes were also made in area of the former ordnance storerooms west of the fort and southeast of the cemetery. The quartermasters' stables, shortly converted to house the post's bakery, blacksmiths' shop, and carpenters' shop, was located southwest of bastion 3, while the stables came to occupy a structure on the site of one of the ordnance storehouses; only the latter stables survived into the twentieth century. The location of the sutler's store along the seawall shifted, by 1888, to a location about 250 ft. to the southwest of its 1864-73 site.

Northwest of the star fort, on the property acquired in 1836-37, a new pattern of use emerged after the Civil War (Figure 13). The two ca. 1840 stables that had been used as prisons during the war became barracks; the third of the ca 1840 stables continued to be used for stables, but by 1888 it too had become barracks. Two more officers' quarters were built along the entrance road in 1872-74, directly northwest of the ca. 1867 quarters. A schoolhouse/chapel was built ca. 1879-80 north of the Civil War Magazine, replacing the one which had stood near the commanding officer's quarters during the war. Following the 1878 cession, to a dry dock company, of a three-acre parcel in the north corner of the property (the site of temporary barracks during the war, and laundresses quarters ca. 1873), three non-commissioned officers' quarters, a married men's quarters, and a new ordnance storehouse were built adjacent to that parcel (on what would later become the site of Baltimore's immigration station).⁷⁸ In 1895, a new post hospital was built, replacing the 1840 hospital (and forcing the removal of the ca. 1886, two-story hospital stewards' quarters); the post cemetery was removed the same year.⁷⁹

Inside the star fort itself, in 1894, the porches of all but one of the former residential building were removed (the exception being enlisted men's barracks 1) and the former junior officers' quarters was converted into a single-story bakery. A single-story frame addition at the southwest end of the bakery connected it to the 1829 brick addition at the northwest end of enlisted men's barracks 1. The former commanding officer's quarters, which for many years had served as the post administration building, had by now become a storehouse and supply room; a new administration building had been constructed very near the site of the 1790s-1836 tavern.

The fort was used for training purposes during the Spanish American War, and afterwards, but its value to the U.S. Army had become negligible. The fort's last garrison departed in 1912. A 3-acre section of the fort's grounds, in its north corner, was transferred to the Treasury Department in 1913, for use as the site of the U.S. Immigration Station for the Port of Baltimore, and while this facility was being built, the former post hospital was used to care for sick immigrants. The remainder of the fort was leased to the City of Baltimore in 1914, for use as a park, and a bathing beach and swimming pool were established in 1915 in the northwest area of the property.⁸⁰

2.3.7 World War I Hospital

The U.S. Army returned to Fort McHenry in 1917, and began construction of General Hospital No. 2 to care for soldiers ill or wounded as a result of service in World War I (Figure 14). The adjacent immigration station and its buildings were also made part of the hospital. Except where the immigration station had been built, structures which had existed in 1912 remained, and were adapted for use within the hospital complex. The only structures removed were two small buildings southwest of the 1895 hospital (one of them probably quarters for hospital staff, the other a latrine), and the quartermasters' stables west of the fort.

Five pre-Civil War buildings, other than those within the star fort, were reused by the World War I hospital: the 1813 hospital (the commanding officer's quarters from ca. 1840 until 1912), which served as the hospital's post exchange (building 90); the 1814-19 stable northeast of the 1813 hospital, which became a fire chemical station and animal house (building 91); and the three 1840-43 stables in the northeastern part of the 1836-37 addition to the fort's property (buildings 87-99). The latter structures, two of them used as prisons during the Civil War; were all made into barracks after the war, and continued to be used as barracks by the hospital. A few Civil War era and several post-war structures also remained in use. In all, there were 29 buildings within the fort, and 8 in the immigration station complex, adapted for hospital usage. Also remaining, although not particularly useful, was the 1873-75 water battery.

Development of the hospital continued in 1919, resulting in construction of more than 70 new buildings, some of them frame structures, other built of structural ceramic tile, the majority of them wards; at its peak, the hospital had beds for more than 3,000 patients. New roadways were established, enclosed frame corridors were built to connect most of the new buildings, and new utilities were installed. The need for the hospital was soon past, however; after serving, in 1920-23, as a veterans' hospital, the facility was shut, and planning began for the establishment of a national park.

It would be difficult to exaggerate the impact of the hospital's construction and subsequent demolition on archeological resources within the grounds surrounding the fort, ravelin, and water battery. Not only were innumerable earlier strata and features disturbed or destroyed, but a vast array of new archeological features was created. It should be noted, however, that, to judge by plans made before and during the hospital's existence, the basic topography of the fort's grounds changed very little during development of the hospital, and many significant earlier archeological resources remain buried below the surface of the grounds, despite the impact. Further, the potential significance of the archeological remains of the hospital itself now must also be taken into account.

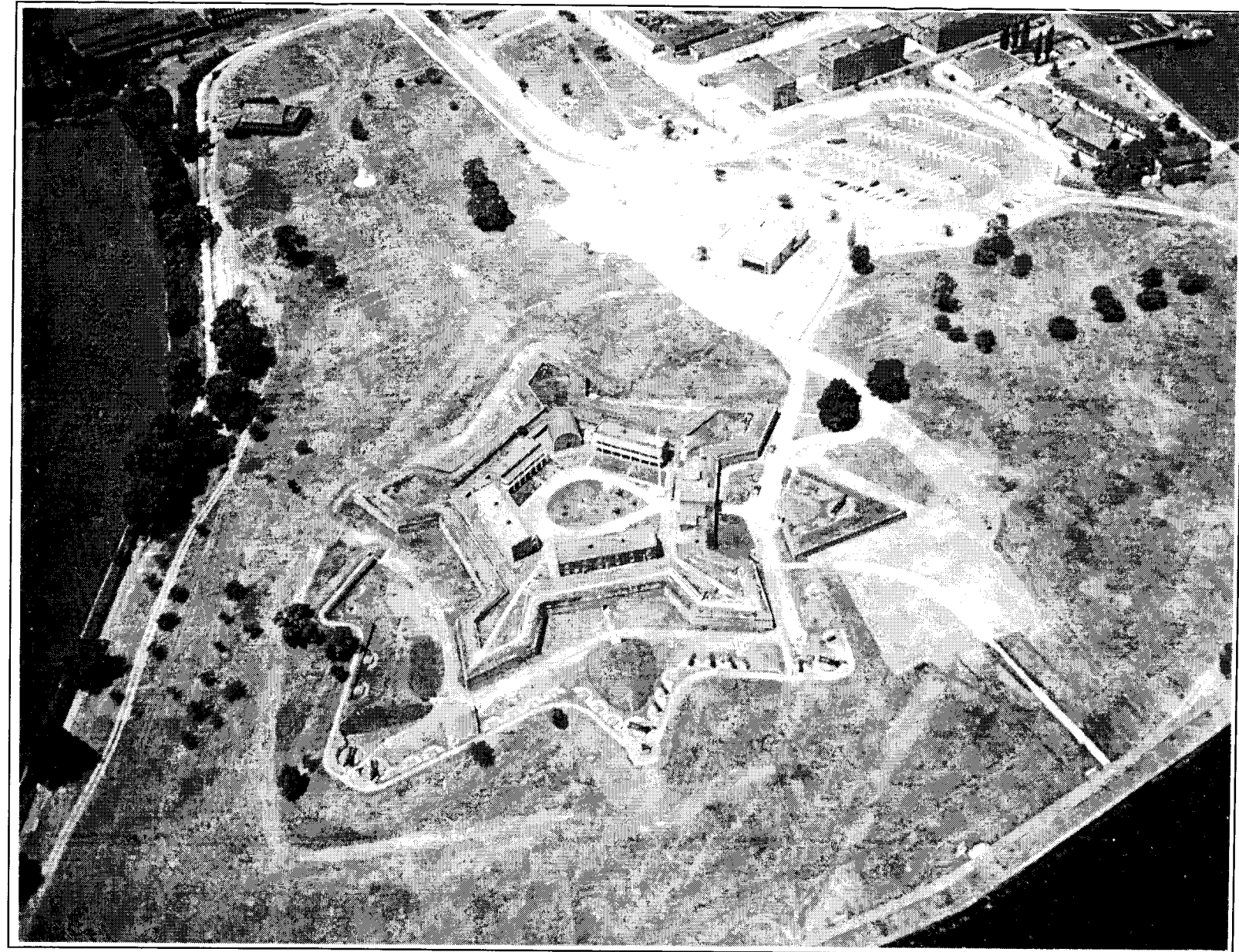

Figure 15. An aerial view of Fort McHenry National Monument and Historic Shrine from the southeast, ca. 1964.

Development of the hospital had less impact within the star fort, and in the area of its ravelin and water battery. The buildings were all adapted for the hospital's use, new utilities were installed, extending through the sally port, and light posts were installed on the fort's parapet, at the salient of each bastion. A powerhouse, presumably with coal-fired boilers, was situated in the dry moat, northwest of bastion 4. An enclosed corridor extended around the exterior of the water battery, and along the glacis northwest of the fort; paralleling this corridor along most of its course was a corduroy roadway. The dry moat, counterscarp, and glacis in the immediate vicinity of bastion 3 were in effect destroyed by the latter structures; these elements

of the fort were disturbed in other locations as well, particularly northeast of bastion 2, northwest of bastion 1, and on both sides of the ravelin.⁸¹

2.3.8 War Department Restoration

In 1925 Fort McHenry became a national park administered by the War Department, and planning for the restoration of the fort began.⁸² Within a year most of the buildings of the hospital complex had been removed, but major architectural and landscaping work could only begin when funding

was made available, in 1928. It was then, and continuing into 1930, that the buildings interior to the star fort, and the grounds exterior to it, were restored to a semblance of their mid-nineteenth century appearance. The 1928-29 removal of the 1873-75 water battery and the concrete magazines incorporated into its traverses was among the larger undertakings on the grounds of the fort. Most of the earth from the water battery was employed as fill in low areas immediately to its northwest, very likely the same areas as had been excavated to construct the battery; the concrete from the magazines was used as riprap at the base of the seawall.⁸³ The filling of the low areas made it possible to enlarge a parking lot which had been established east of the ravelin in 1917; the lot remained in use for visitor parking until 1964. The reconstruction of the dry moat, counterscarp, and glacis north and west of the fort, described as "the building of a musketry embankment," was accomplished during 1929 as part of a general grading, harrowing, and seeding contract.⁸⁴

Architectural restoration work undertaken by the army in 1929 included cleaning out the sally port magazines, rebuilding sections of the star fort scarp walls, and rebuilding damaged portions of the parade buildings. The outside walls and the brick pavements on the first floor of each of the parade buildings were repaired, and the porches of the residential buildings were replaced.⁸⁵ Some of the architectural elements added to the buildings at this time did not reflect any specific historic period. The junior officers' quarters, which had undergone extensive modification in 1894, was restored to its original configuration. Electrical service was extended to all the buildings at the fort, and new water and sewer lines were installed.

2.3.9 National Park Service

The U.S. Army's administration of the fort continued until 1933, when Fort McHenry was transferred from the War Department to the Department of the Interior, and the National Park Service commenced its administration of the site. Work on drains, sidewalks, gutters, sewers, septic tanks and other elements of the site was performed in conjunction with the Works Project Administration (WPA).

Major utility lines were installed through the ramparts of the star fort in the mid-1930s. A steam utility line was placed through the curtain wall between bastions 1 and 2. This steam utility line extended to the parade between the commanding officer's quarters and the parade magazine. The second utility line is a high tension transformer vault and electric corridor. The vault was built on the terreplein at the left angle of bastion 1. The electric corridor was constructed through the parapet at this location. The original breast-height wall was removed by this construction.⁸⁶ In 1939, the WPA assisted the NPS with a complete repointing of the brickwork of the fort's scarp and breast-height walls, which included the excavation of

trenches down to the walls' footings. The brickwork in the ravelin and the water battery may have been repointed about the same time, although no trenches were excavated for the work in those areas.

During World War II the military returned to Fort McHenry. A U.S. Coast Guard training facility was established in 1942 in the northeastern one-third of the park, and numerous frame barracks and classrooms were built in the area east of the park's existing parking lot, built in 1964. The site of the parking lot itself, where stables, prisons, and barracks had been located from 1843 until 1923, was evidently made into a baseball field.⁸⁷

Beginning in 1956, as part of its Mission 66 program, the NPS began planning for substantial improvements in the physical facilities of the park, the condition of historic structures, and the quality of interpretation.⁸⁸ Among the initial efforts was the Historical and Archeological Research Project (HARP) of 1957-58, which resulted in the establishment of the collection of copies of primary documentation concerning the fort noted above, as well as concise interpretive reports concerning the fort's development and historical context. The HARP effort served as the foundation for Nelson's 1961 Historic American Buildings Survey report and for the 1974 Historic Structure Report by Thompson and Newcomb, as well as for all future interpretive plans. The new facilities, built in 1964, included a new visitor's center and a new and substantially larger parking lot; the visually intrusive lot adjacent to the ravelin was removed. New maintenance facilities and staff housing were also constructed, in the northwestern corner of the park, and various alterations and improvements were made in the park's landscape (Figure 15). The archeology performed at Fort McHenry during the 1950s and 1960s is discussed below.

Several attempts have been made in more recent years to evaluate and remedy the moisture problems which contribute to the deterioration of the fort's brickwork. In 1975, a french drain was constructed at the base of the scarp wall between bastions 4 and 5. The drain occupies the same relative position as the tenaille shown on the 1819 map (Figure 7). Kurtz exposed portions of the drain in an attempt to locate the tenaille.⁸⁹ The french drain is a 2-ft-wide-by-2-ft deep, gravel-filled pit which parallels the scarp wall at a distance of 2 ft, and contains a plastic pipe. Kurtz concluded that the drain did little to aid the drainage of the star fort.

In 1990 a more elaborate drainage system was installed to aid drainage of the star fort. This system included the installation of 27 drains through the scarp wall, installation of a drain running at the base of the scarp wall in the dry moat, and installation of exit drains. A drainage trench was excavated from the salient of bastion 1 to the salient of bastion 3. At a minimum this trench is 3.0 ft. wide. This trench drains into a new drain to the sea wall opposite the salient of bastion 3 and a connection to an existing drain in the proximity of bastion 1.⁹⁰

END NOTES

1. Akerson 1988; Wilke and Thompson 1977:48; but also see Faust 1985:252-255.
2. Akerson 1988:13-16.
3. Feest 1978; Wilke and Thompson 1977:50, 53.
4. Funk 1978; Tuck 1978.
5. Jennings 1978:364-366.
6. Akerson 1988.
7. Feest 1978:242-243.
8. Akerson 1988; Feest 1978:242-243.
9. Lewis 1970:7-8.
10. Dozer 1976:294
11. Wesler et al. 1981:109
12. Dozer 1976:294-297, 323
13. Baltimore City is located on the North West Branch. The entrance to Baltimore's inner harbor is a narrow channel between Whetstone Point and Lazaretto (Gorsuch) Point.
14. Bradford 1958:1; Thompson and Newcomb 1974:9-10.
15. The redoubt was a true star fort because it lacked curtains between its (pseudo-) bastions.
16. Bradford 1958:1-5
17. Thompson and Newcomb 1974:9-10
18. Wade 1977:5
19. Bradford 1958:3-4, 17.
20. Bradford 1958: 76; Wade 1977:6; Lewis 1970:3-6. U.S. military policy until World War II, except during the Civil War, emphasized coastal fortifications over other forms of defense.
21. Lewis 1970:21-25. Figure 1; Wade 1977:179, 94a. Appendixes F and H.
22. Thompson and Newcomb 1974:11; Cheek et al. 1989:6.
23. Lewis 1970:37
24. Wade 1977:66, 73-95
25. Wade 1977:179
26. Cheek et al. 1989:9; Lewis 1970. Construction under the Second System included open batteries, masonry-faced forts, and masonry forts. The only new fortification technology implemented during the Second System were forts composed entirely of masonry.
27. Lewis 1970:25-36. Figure 1; Wade 1977:94a, 273a. Appendixes F, G, and H.
28. Wade 1977:280

29. Sheads 1986:8-10
30. Thompson and Newcomb 1974:21
31. See Sheads 1986 for a comprehensive history of the battle.
32. Lewis 1970:footnote 2.
33. Lewis 1970:9-13, 37, 39.
34. Lewis 1970:54.
35. Fort McHenry is only one of several forts that defended approaches to Baltimore. Others include Forts Federal Hill, Marshall, and Number One.
36. Dozer 1976:442, 445-447.
37. Moore 1864, in Ashcraft 1964; Thompson and Newcomb 1974:60.
38. Lewis 1970:50,67. Masonry seacoast fortifications were common until the Civil War. Until rifled artillery became standard issue on ships, naval bombardment, unlike siege-gun bombardment, was not accurate enough to repeatedly hit small areas which would eventually allow a wall to be breached. Projectiles for rifled artillery could be elongated and thus made more massive than round projectiles. Consequently, with rifling, the impact delivered by naval guns increased, along with their range and accuracy, and masonry forts could be demolished by naval fire.
39. Thompson and Newcomb 1974:77; Lewis 1970:69-70, 77; Sheads 1995:68.
40. Lewis 1970:75-100. The system is characterized by dispersed gun-and-mortar batteries within massive emplacements constructed of earth and concrete. Guns mounted on disappearing carriages became popular.
41. Fort Carroll was also incorporated into this system. In the late 1890s three modern rifled guns were added to the fort. Lewis 1970:54.
42. Lewis 1970:141, Figure 1.
43. Sheads 1995:76-78.
44. Thompson and Newcomb 1974:82-83; Sheads 1995:79-80.
45. Thompson and Newcomb 1974:82-87; Sheads 1995:87-88.
46. Bradford 1958:1; Thompson and Newcomb 1974:9-10.
47. Nelson 1961:15; Thompson and Newcomb 1974:12.
48. Bradford 1958:4-14.
49. Nelson 1961:12-15; Bradford 1958:74-80.
50. Parade buildings include two enlisted men's barracks, commanding officer's quarters, junior officers' quarters, powder magazine, and cistern. Additionally, the 1806 map shows a guardhouse between the commanding officer's quarters and bastion 1.
51. Bradford 1958:56-65.
52. Sheads 1986:13; 1995:19.
53. Walsh 1958:10.
54. Wadsworth 1814.
55. Bradford 1958:56-65.
56. Sheads 1986:96. Fortunately, the fort's garrison had moved the powder from the magazine to the landward side of the dry moat, and the British bomb failed to explode.
57. Thompson and Newcomb 1974:27; Sheads 1995:49; Nelson 1961:33-34, 57; Stokinger 1983b:16.
58. Smith 1958:12.
59. Stokinger 1980:57.
60. Brown and Long 1986:17.
61. Sheads 1995:49-50.
62. Nelson 1958:29-43.
63. Nelson 1958:29-43.
64. Thompson and Newcomb 1978:42; Stokinger et al. 1980:58.
65. Thompson and Newcomb 1974:39-52; Joseph and Cheek 1985:10.
66. Thompson and Newcomb 1974:44.
67. Sheads 1995:51.
68. Bradford 1958:56-65.
69. Sheads 1995:70-71.
70. Brown and Long 1986:19-20.
71. Sheads 1995:50, 70-71, 79.
72. Stokinger 1976a:4-5.
73. Thompson and Newcomb 1974:60-61.
74. Engineer Department 1864.
75. Sheads 1995:62-64.
76. Thompson and Newcomb 1974:68.
77. Thompson and Newcomb 1974:77.
78. Sheads 1995:70.
79. Sheads 1995:70-71, 76.
80. Sheads 1995:76-78. Sheads' suggestion that one end of the courtyard of the Civil War magazine was modified at this time for use as a pair of bathhouses is mistaken. That modification evidently occurred in 1933 (Stokinger 1976a:15).
81. Excavations conducted in the moat in 1998, in the vicinity of the water battery and northwest of the ravelin, revealed that, in some locations, hospital-related development had little impact on earlier resources (Pousson 1999a).
82. Thompson and Newcomb 1974:83-87.
83. Smith 1958:35.
84. Smith 1958:18.
85. Thompson and Newcomb 1974:85.
86. Kurtz 1989:113.
87. Sheads 1995:91-93.
88. Sheads 1995:92-94.
89. Kurtz 1989:66-67, 118, Figure 29.
90. Additional drainage work was implemented under package no. FOMC 276 in 1998 and 1999 (Pousson 1999a, 1999c).

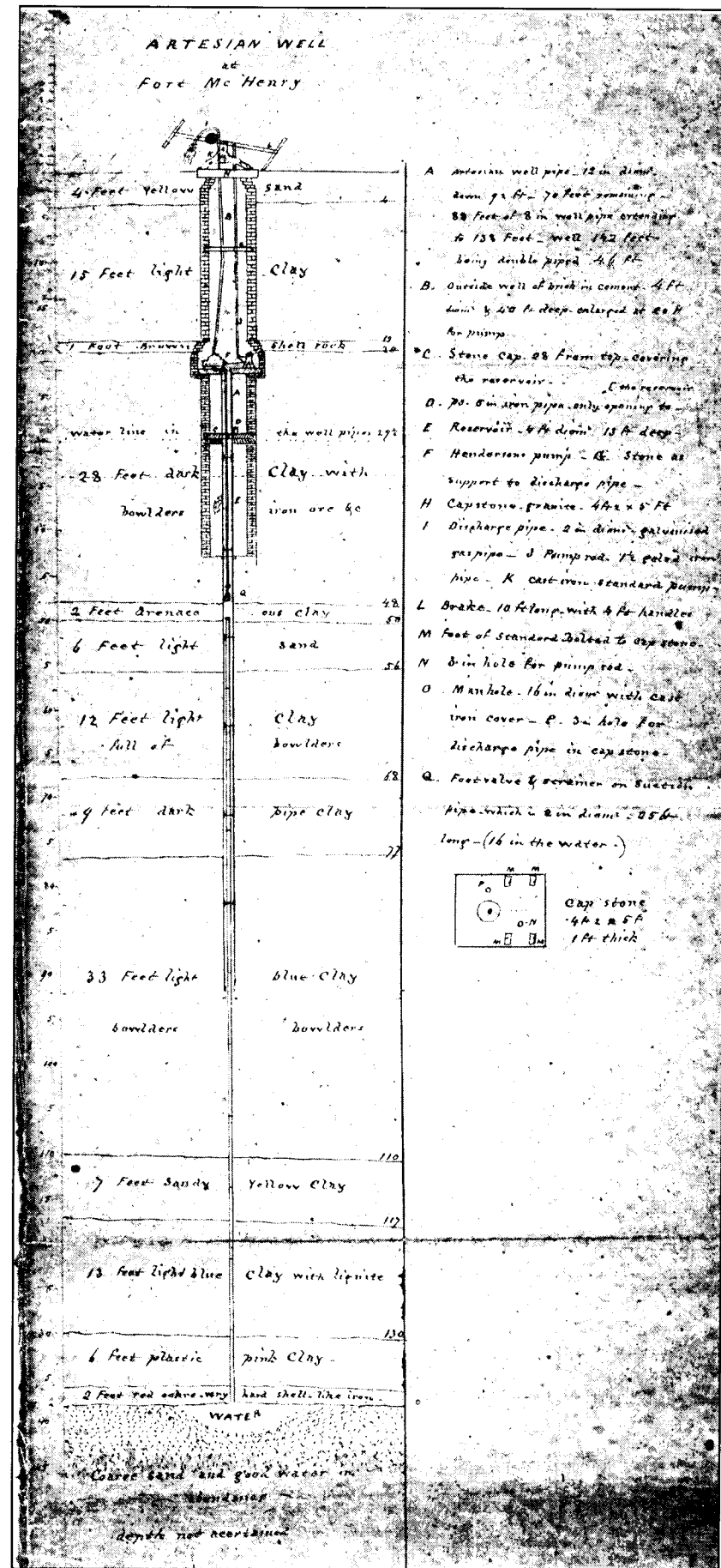

Figure 16. Artesian Well at Fort McHenry, ca. 1861.

3. ARCHEOLOGICAL AND HISTORICAL RESEARCH RESULTS: STAR FORT

3.1 Local Geology and Topography

The composition of the native soils of the site of Fort McHenry, and the contours imposed on its surface over the long span of geologic time, were fundamental conditions of the site's historical development. The soils remain the substrate, and, where disturbed and redeposited as fill, the matrix, of the archeological resources within the fort and on its surrounding grounds. The discussion that follows is intended as a brief introduction to what underlies the site's now highly developed, although seemingly simple, landscape; the discussion ignores the arbitrary division between this section of the report, which otherwise deals with the archeology of just the star fort itself, and the next section, dealing with the grounds.

3.1.1 Geology

The natural surface soil of the site of Fort McHenry is a shallow mantle of Patapsco formation, sand-facies strata¹, sediments "deposited in and adjacent to channels of low gradient streams" during the Cretaceous age, popularly known as the age of dinosaurs (140 to 65 million years before present).² The soil is described as "well-sorted, medium to fine grained quartz sand" within a "minimal clay-silt matrix." The 4 ft. thick layer of yellow sand noted as the surface stratum below the fort's parade, in the excavation and boring record for the 1861 artesian well (Figure 16), represents the local remnants of the formation. Also representative is the dark yellowish brown silty sand subsoil, overlain by dark yellowish brown silt, found in a 1988 archeological excavation 1.5 to 5.3 ft. below the parade's existing grade (grade there being about 1-1.5 ft. higher than it was in the early- to mid-nineteenth century).³ The thickness of the sandy strata evidently varies markedly, however, and the interface with underlying soils must be uneven, since dense natural clays are reportedly present within two feet of the existing surface of the fort's parade in several locations.⁴ Underlying the sandy surface soils at the site of the fort are Arundel formation, clay facies strata, also of Cretaceous age, but with deposition occurring "within a flood plain—back swamp complex with variable sediment input." Arundel formation clays, which the 1861 well boring record documents extending to a depth of 137 ft. below the historical surface of the parade, are "composed essentially of red and brown clay, but including layers and concretionary masses of sandstone cemented with iron oxide or iron carbonate and geodes and nodules of iron carbonate and limonite that formerly were worked extensively as iron ore." Below the Arundel clay is Patuxent formation sand, which constituted the aquifer for the 1861 well.

During the 10,000 years of the most recent geologic period, the Holocene, the predominant processes shaping the site of Fort McHenry have been gradual erosion, associated with the point's exposed and elevated situation, and, over the past few thousand years at this location, the gradual rise of sea level, and the encroachment of tidal waters on previously dry land, which resulted in an acceleration of erosion. If it were not for the fort's seawall, much more of the site of the fort would by now have been lost to the Patapsco River.

Poor drainage within and around Fort McHenry is a direct consequence of the clayey composition of the Arundel formation soils, which were used as fill in constructing the fort, and into which excavations were made for the fort's footings. It is, as well, a major element in the most intractable problem for the long-term maintenance of the fort's masonry structures; the infiltration of moisture into the fort's masonry fabric, and its retention due to poor drainage, causes or contributes to various structural failures. Permanent, practical solutions to the problem have been difficult to design and implement, but the archeology which has accompanied efforts at resolving the problem over the past several years has at least helped clarify the nature of the problem.⁵

3.1.2 Original Site Topography

The 1782 Rochambeau collection map (Berthier 1782) shows Fort Whetstone, the original earthen redoubt at the site, configured as a 'true' heraldic star, situated on the southeast edge of a plateau at the east end of Whetstone Point (Figure 17). Surrounding this plateau there appears to have been a somewhat less-elevated terrace or bench, on the northeastern part of which the fort's upper water battery had been constructed. Grade was lower still, of course, toward the shoreline of the point, where the lower water battery was located. Intruding into the terrace at the south end of the upper water battery, east of the star fort, is what looks like a small ravine. This ravine-like feature is likely to have been created in establishing a roadway to facilitate communication among the three elements of the fortifications: the redoubt on the plateau, the upper battery on the terrace, and the lower battery along the shoreline. Rivardi's 1794 letters to the Secretary of War and the Governor of Maryland imply this,⁶ but they also suggest that exposure of iron ore deposits in the area had encouraged additional excavation, between 1781 and 1794, to exploit the ore. Along the shoreline south and southwest of the fort there were small hillocks, most likely remnants of the once larger terrace, isolated as a result of erosion or earlier mining activity. Rivardi remarked, in his letter to the Governor, that the easternmost of these hillocks functioned as an epaulement for the right flank of the lower battery. The 1819 and 1834 plans of Fort McHenry indicate that remnants of a hillock to the fort's south served as the site of the fort's original cemetery, prior to its ca. 1836-37 removal.

No archeological excavations have yielded data that could be definitively interpreted as representing the original surface of the plateau at the site of the fort, or as remnants of the 1776 redoubt. Neither has clear evidence been found of the localized excavations likely to have been made at an early date into the surfaces of both the plateau and the terrace to provide the fill needed for the redoubt's rampart and the batteries' parapets, presumably because of more extensive subsequent excavation and filling. Construction of Fort McHenry almost certainly entailed removal of soil in the areas of its parade ground and ditch, to provide the fill used to create its rampart and portions of its glacis. At the same time, parts of the earthen embankments of the earlier redoubt would have been incorporated into the rampart of Fort McHenry, as fill which could be left in place in some areas, or redeposited in others. The absence of evidence of the original ground surface in the area of the fort's parade ground, and the presence of buried layers of relatively homogeneous humic (former surface?) soils within the rampart, slightly above the historical level of the parade but well below the terreplein's surface, are consistent with this model of what occurred. The very limited exposures of the possible former surface, however, leaves open the alternative possibility that the one or more of the humic layers that have been found derive from the earlier redoubt.

The humic layer most likely to represent the original surface of the plateau was identified by Kurtz during excavations made in 1989 where part of the terreplein over the postern tunnel had collapsed, very close to where the southeastern margin of the original plateau would have been located. The excavations documented a dark soil containing charcoal fragments at approximately 7.5 ft. below the terreplein's surface, at an elevation of about 32.5 ft. above mean sea level (amsl).⁷ The soil underneath this deposit appeared to be subsoil. The surface is slightly higher than that of the parade immediate to the northwest, which suggests that minimal excavation occurred at this, the lowest side of the parade. The existing upward slope of the parade to the northwest very likely corresponds to the original slope in the surface of the plateau, but the removal of surface soils in the area of the parade would most likely have amounted to a reduction in elevation of no more than 1-3 ft. The highest ground of the site historically, following the construction of Fort McHenry, appears to have been in the area immediately outside the ditch northwest of bastion 2; this area presently remains the highest ground, although its present elevation is supplemented by twentieth-century fill. The highest ground of the site prior to its development may have been very near the location of the magazine within the area of the fort's parade.

The original surface of the plateau might also have been represented in an excavation made in 1993 on the ramp northwest of the sally port, which revealed a layer of light olive brown silt 4 ft. below the surface, at an elevation of about 34 ft. amsl.⁸ Prehistoric pottery sherds recovered from the base of the overlying deposit may have originated from the surface of



Figure 17. Detail of Berthier's *Port et Rade de Baltimore*, 1782.

the deeper layer, suggesting an age of at least several hundred years for this context. The 1.5 ft. thick overlying deposit, the upper part of which yielded a 1775 British half-penny, may derive from Fort Whetstone era activities. Above this were strata associated with the construction and modification of Fort McHenry.

Possibly direct evidence of the redoubt was discovered in another 1989 excavation. Kurtz's test excavation in bastion 5 found two artifact-bearing layers, beneath largely-sterile fill, between 5 and 6 ft. below the surface of the terreplein, or approximately 2.5 ft. above the level of the stratum representing a possible original ground surface in the postern vicinity, 90 ft. to the southwest. The upper layer contained more artifacts than the lower, which was described by Kurtz as having an appearance "more characteristic of sod layering." These layers may have sloped down toward the exterior of the fort, which could reflect the slope of one of the original walls of the redoubt, or perhaps the natural slope of the plateau. The artifacts included hand-painted polychrome pearlware in the shades typical of the early nineteenth-century, blue hand-painted pearlware, creamware, and possibly white salt-glazed stoneware.⁹ The discovery of late eighteenth-century artifacts, together with what appear to be early nineteenth-century artifacts, suggests the deposits were laid down no earlier than during the construction of the Fort McHenry. However, it would be unusual for stratified layers with such distinctive characteristics as these to represent redeposited artifact-bearing contexts; furthermore, exclusively

clean fill appears to have been used in other areas of the fort during its construction.

Archeological evidence for the elevations and extent of original ground surfaces in the immediate vicinity of the star fort has proven equally difficult to come by. Within the ditch, excavations have succeeded in documenting various episodes of cutting and filling, but no evidence of intact, pre-fortification surfaces have been discovered in the ditch itself, probably because no such evidence remains there. Outside the ditch proper, however, early fortification era surfaces have been found which suggest widely varying minimum elevations for the original terrace surfaces northeast and south of the fort, and what may be the maximum elevation of the plateau directly northwest of the fort. With regard to the later elevation, Smith, in his 1958 investigation of the location and alignment of the boundary wall, observed the buried surface of the fort's glacis northwest of bastion 2, "sloping downward and outward from a crest next to the ditch." Elsewhere in his discussion, Smith notes that the top of the stratum, corresponding to the mid-nineteenth century ground surface in the vicinity, and very likely the same as the site's original surface, was about 1.5 ft. below grade.¹⁰ The equivalent elevations, for the crest of the glacis, are approximately 34-35 ft. amsl.

Investigation in 1963 of a ca. 1794(?)–1813 brick barracks foundation, about 40-90 ft. northeast of the ravelin's salient, provides one of the probable terrace elevation. Along the exterior southeast side of the foundation there was what appeared to have been a brick walkway, about 4 ft. below grade and .5 ft. lower than the brick floor on the structure's interior.¹¹ This walkway, at an estimated elevation of approximately 19–19.5 ft. amsl, is likely to represent grade in part of the upper battery, as developed on the terrace.¹² An 1819 profile through the gun platform of the upper battery depicts the platform as having been only about 6 ft. below the level of the parade, apparently in the 26-27 ft. amsl range; this is likely to be inaccurate. The original, natural contours throughout the area were undoubtedly modified during development of the fortifications, and the barracks walkway elevation is probably somewhat lower than the original grade here, while the platform elevation is higher. The elevations of the nineteenth century ground surface a few hundred feet north of the upper water, at either end of the sites of the gun shed and store house, where the original terrace was not as extensively modified, is about .5 to 1.7 below existing grade, with an apparent range of about 15.7 ft. to 24.5 ft. amsl.¹³

Toward the opposite side of the fort, in the area of the water battery southwest of bastion 4, excavations made in 1994 and 1995 revealed a thin, long-buried, cultural surface layer overlying subsoil at a depth of 3.5 ft. below the battery's terreplein and 8.5 ft. below its parapet.¹⁴ This layer, with an elevation of about 27 ft. above Baltimore City datum (abcd), equivalent to 26.15 ft. amsl, most likely developed on a surface created by

excavation into the terrace during the construction of Fort McHenry. (The poorly developed humic aspect of this former surface was the primary indicator that the terrace here would originally have been somewhat higher.) The surface, which remained at grade for more than three decades, was historically documented at about the same elevation on Delafield's 1836 plan of the fort, just prior to its burial beneath fill deposited during development of the water battery.

Archeological evidence of the original topography in the broad, generally low area east of the fort, in the vicinity of the earliest section of the lower water battery, is very sparse, and not simply because little archeology has been done there. Smith's 1958 effort to determine if there were extant remnants of the upper and lower water batteries succeeded primarily in documenting the extensive ground disturbances associated with the construction and demolition of the 1873-75 water battery. A presumably early brick feature, discussed below, was nonetheless discovered between 1.5 and 2.5 ft. below grade, extending into undisturbed subsoil.¹⁵ The elevation of the truncated top of this feature, with an approximate range of from 11.9 to 13.7 ft. amsl (being more elevated toward the west), may represent the general grade in this vicinity subsequent to the final abandonment of the lower water battery ca. 1830; given the presence of subsoil within a foot below the tops of these features, and possibly higher, these elevation very likely provide an indication of the minimum original grade of that vicinity. An 1819 profile suggests elevations of 17-19 ft. amsl for a nearby section of the lower battery. Other archeological testing in the immediate area, adjacent to the seawall, yielded no evidence of original grade. But the 1975 discovery, during archeological monitoring, of the foundation of a ca. 1825-67 married soldiers' quarters provided additional evidence of the approximate elevation of original grade toward the shoreline of Whetstone Point.¹⁶ A small section of brick pavement was discovered along the southeast side of that foundation, about .75 ft. below grade, at an elevation of approximately 11.5-12 ft. amsl. The location corresponds to an area north of, and somewhat lower than, the lower water battery, as depicted on the 1803 and 1819 plans of the fort. A detail depicting the southeast facade of these quarters, on Lee's 1834 plan of the fort, suggests that elevations from one end of the building to the other would have ranged, northeast to southwest, from about 9.5 to 13 ft. amsl.

3.1.3 Modifications of Site Topography

Topographic data contained in historical maps, plans and profiles, particularly Berthier's map (1782), plans prepared by Poussin (1819), Lee (1834), Delafield (1836), Butler (ca. 1840), and Brick (1858), and various late nineteenth through early twentieth century plans, compensate to some extent for the dearth of archeological data concerning the extent of the alterations made in Fort McHenry's topography during the first century of

the fort's existence. As discussed above, Berthier's map (Figure 17) indicates the notable original topographic features at the site: the high-ground plateau at the southeast end of Whetstone Point, with elevations of about 30-35 ft. amsl; an uneven, presumably sloping terrace or bench at the margins of the plateau, with elevations of 15-30 ft. amsl; and a low-lying shoreline area, with elevations of 5-15 ft. amsl. Also depicted, in addition to the fortifications themselves, are hillocks within the area of low ground south and southeast of the redoubt, and what is likely to have been an artificial cut into the terrace, made for the purpose of communication among the fortification components. The low ground, as a distinct element of the landscape, had very likely been at least partially produced by earlier mining activity, accompanied by erosion.

The 1803 plan of the fort (Figure 6) gives no specific topographic information, other than by shading, and by the legend characterization of the area south and southeast of the fort as "low ground"; since the plan does not extend to the shoreline of the site, the hillocks are not depicted. It may be assumed that, in accordance with common practice, the development of Fort McHenry, as well as of Fort Whetstone before it, entailed substantial local excavation for the construction of earthen-fill features (rampart, parapet, glacis, etc.). The dry moat surrounding the fort was undoubtedly the main source of fill soil, but the parade ground within the fort, the apparent assembly area in the upper battery, and portions of the grounds immediately exterior to the uppermost, parapet-like section of the glacis are also likely to have been among the areas excavated to secure fill.

The 1819 and 1834 plans, with their hachure-style relief depiction, show the continuation of large-scale landscape modification at the fort. They both document the filling of low ground, that nearest the fort in 1813-14, when the fort's ditch and glacis were completed and the lower battery extended into the area of the point south of the fort. The hillock south of the fort, the site of the fort's original cemetery, is also shown by both plans. The four profiles which accompany the 1819 plan (Figure 18) provide a wealth of elevation data, although much of it is ambiguous due to the apparent underestimation (?) on that plan of the true height of the fort. The ca. 1829-31 removal of the remnants of the water battery parapets, platforms, revetment, etc. is also evident on 1834 plan. One of the reasons given for "graduating the ground around the fort" in 1831 was "to prevent water from standing in low places and becoming stagnant." A "considerable extent of marsh, immediately in front of the fort," was reportedly reclaimed.¹⁷

Actual spot elevations, above a high water datum, accompanied by three-foot interval contour lines, distinguish Delafield's 1836 plan of the southern half of the original grounds of Fort McHenry, prepared to guide that area's regrading in conjunction with the development of the outer (water) battery (Figure 19).¹⁸ On the evidence of the 1836 plan, the low ground in that area had elevations of between 6 and 15 ft. amsl. Much of the surface of this

low ground, and the features and deposits of artifacts within it, are likely to remain intact beneath the fill deposited in 1836-40, which raised grade by as much as 10 ft. The hillocks of the 1781 map, as modified in 1813-14 when additional sections of the lower water battery were built, evidently had elevations of 15 to 24 ft. amsl (within the range essentially of the terrace fringing the plateau, from which the hillocks had presumably been separated by mining activity and erosion). With the 1836-40 lowering of grade at the former location of the hillocks, by as much as 8 ft., their surfaces and most if not all of the features associated with them, most notably the fort's original cemetery, would have been destroyed. Butler's ca. 1840 plan document these landscape alterations.

The last major fortification-related alteration of Fort McHenry's topography was that entailed by the construction, in 1873-76, of one section of a massive new water battery, which had three concrete magazines incorporated into it. The parapet of this battery was supposed to have been about 26-29 ft. amsl (actually above a nineteenth century high water datum, but approximating present-day amsl elevations), and its narrow terreplein about 17-18 ft. amsl.¹⁹ The elevation of most of that area had previously been in the range of 6-15 ft. amsl. A large part of the fill needed for construction of these elevated components of the battery was apparently taken from a roughly triangular area, about 500 ft. long by 50 to 170 ft. wide, immediate northwest of the battery, where elevations, previously in the 6-18 ft. amsl range, were reduced to 3-12 ft. amsl.²⁰ Archeological resources likely to have existed previously within this borrow area, most notably remnants of the ca. 1811 upper water battery barracks (identified as the sutler's store and carpenters' shop in 1834, and as officers' quarters during the Civil War) and of one of two 1814-15 magazines (most likely demolished in 1836-40), were almost certainly destroyed; many of the resources in the area of the filled components of the battery, however, were evidently preserved, as discussed below.

Substantial filling at Fort McHenry during the latter part of the nineteenth century was otherwise confined to areas where the fort's seawall was being completed, modified, or repaired, notably along the southwest and northeast margins of the 1836-37 addition to the property of the fort. Stokinger, during his monitoring of a water main replacement project in 1982, documented 1-5 ft. deep fill deposits in the northeastern section of the property, and of up to 3.5 ft. in its western corner. In 1983, during monitoring of the installation of a septic tank near the statue of Orpheus, Stokinger also discovered a late nineteenth century fill deposit, in excess of 11 ft. deep, at what had been a severely eroded location along the shoreline of the fort's grounds, northwest of its ca. 1837-1895 cemetery. There were two particularly noteworthy issues that arose during the later part of the nineteenth century concerning the seawall, and the fill placed behind it. One concerned potential damages which, it was thought, might result from the on-going mining of iron from the bed of the river, during the 1870s and

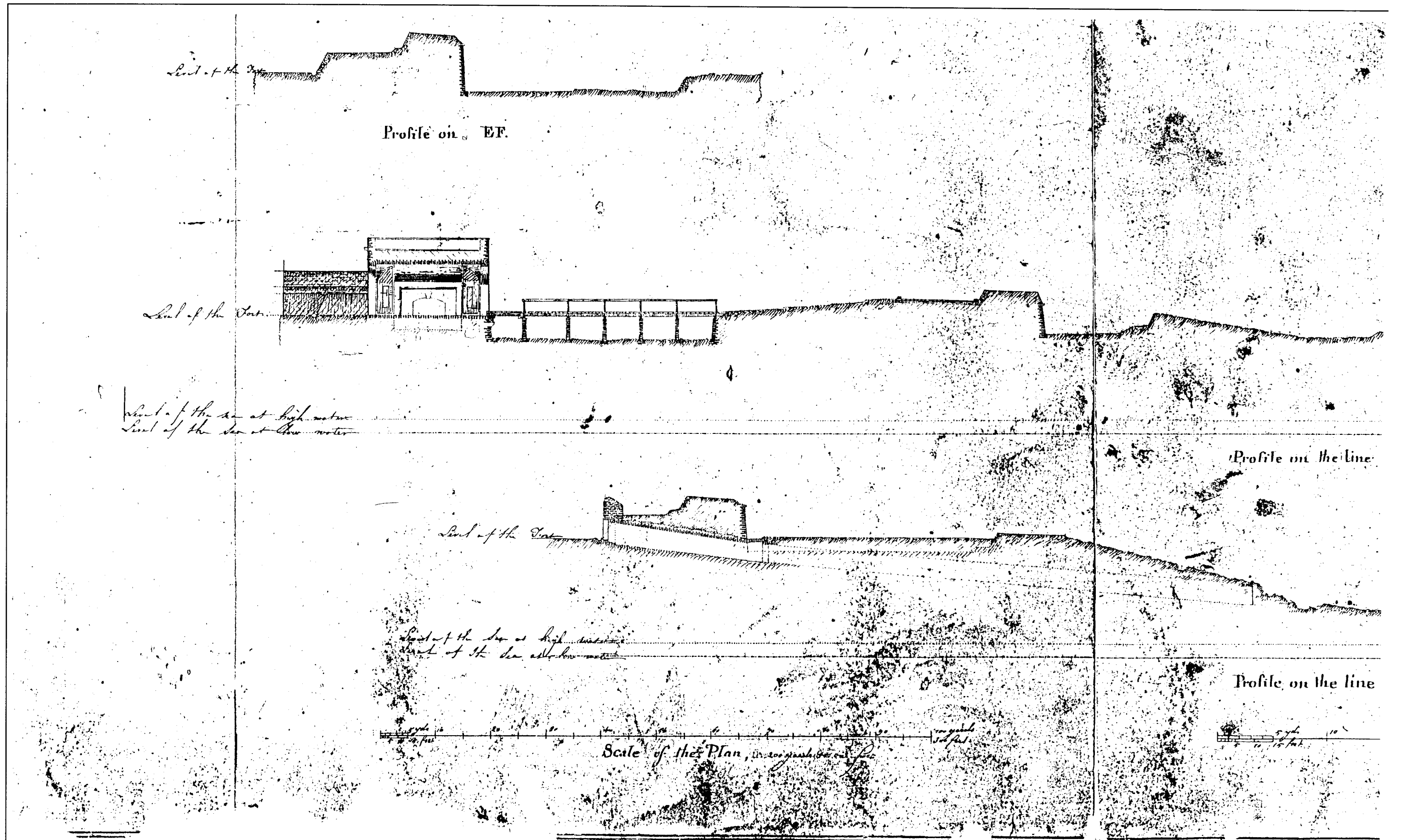
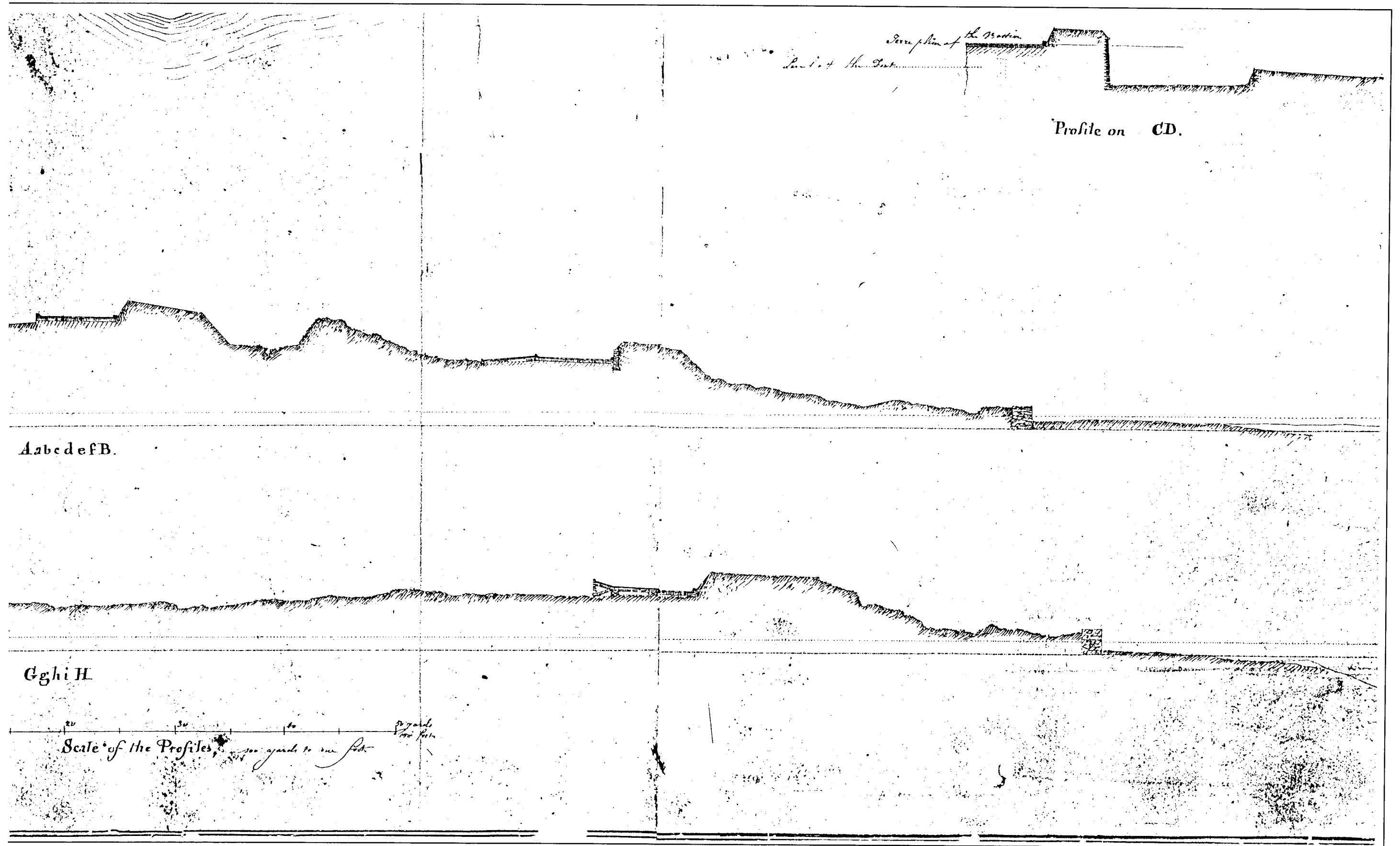

Figure 18. Detail of Capt. William Tell Poussin's *Plan and Profiles of Fort McHenry*, 1819, showing profiles: Aa...fB through sally port, gorge,



ravelin, and water batteries; CD through left face of bastion 1; EF through bastion 2-3 curtain; Gg...iH through postern, moat (caponniere), glacis, and lower water battery.

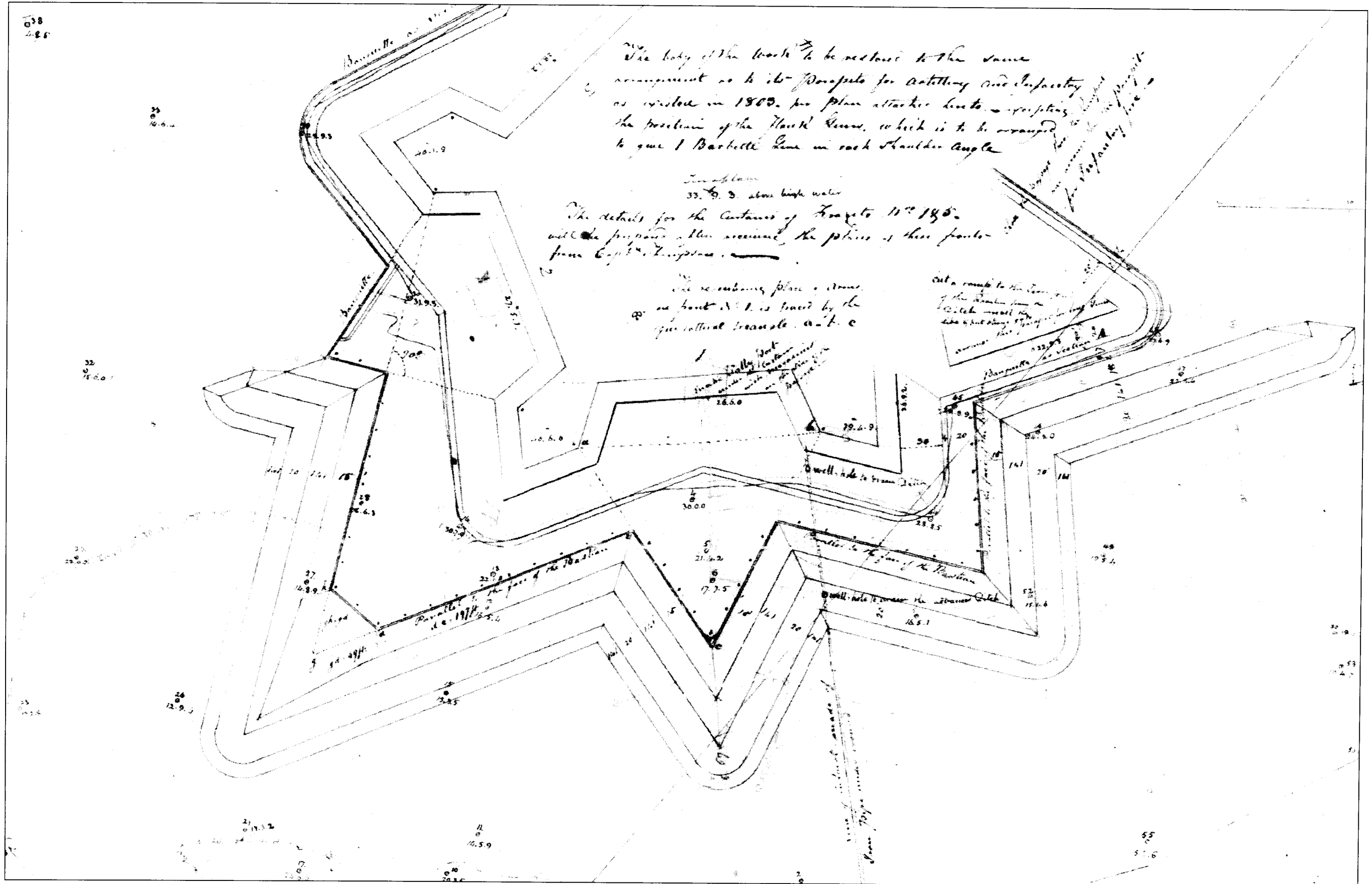

Figure 19. Detail of Capt. Richard Delafield's plan of the proposed outer Battery at Fort McHenry, 1836.

1880s, within 10-30 ft. of the wall.²¹ The other was a sanitation and health issue, raised repeatedly by the post's surgeons with regard not only to noxious debris which occasionally accumulated along the fort's northeast shoreline, but also to the composition of the fill itself, and the potentially deleterious effects of uncontrolled filling.²²

The last episode of large-scale topographic modification at Fort McHenry was that which occurred in 1929-30, followed the ca. 1925-27 demolition of the World War I hospital. A major element of the work done at that time was the remove of the 1873-76 water battery. Smith's research indicates that more than 6,000 cu. yds. of earth and concrete were removed, that nearly all the earth was "used as fill in low areas northwest of the water battery," presumably the 1870s borrow area adjacent to the battery, and that the concrete from the battery's magazines was employed as rip-rap along the base of the seawall.²³ At the same time, considerable effort was expended in obliterating all surface traces of the demolished hospital structures, by deposition throughout the site of as much as 1-1.5 ft. of top-dressing over their bulldozed remains, and in restoring the appearance of the ditch, counterscarp, and glacis north and west of the fort.²⁴

3.2 Star Fort Components

The star fort is composed of a complex array of masonry and earth-fill features, at the core of which, surrounded by the rampart, is the parade or parade ground. To reduce the complexity of the fort's composition to manageable proportions, the discussion here focuses on the following architectural elements: the scarp wall; the parapet; the parapet revetment, commonly referred to as the breast-height wall; the terreplein and the infantry banquettes; the gun emplacements; the parade wall (occasionally referred to as the terreplein revetment or terreplein wall); the parade ground; and drainage-related features, including the postern or postern tunnel. The sally port and associated features, although obviously part of the star fort, are discussed separately in subsection 3.3, while other individual structures within the star fort, including historically documented but non-extant structures, are considered in subsection 3.4. Subsection 3.5 provides a discussion of the fort's dry moat, counterscarp, and glacis. The fort's outworks—its ravelin and outer battery—and its grounds, on part of which earlier outworks were situated, are the subject of section 4 of the this report. A glossary of military architectural terms is provided in section 1.4, above, for those who may be unfamiliar with this specialized nomenclature.

Various historical plans and profiles, and other historical documentation, have provided basic information concerning the locations, use, and other characteristics of both extant (but often altered) and non-extant (but archeologically surviving) elements of Fort McHenry, as should be apparent from the citations. Capsule descriptions of the most important

maps and plans are given in appendix B of this report. Particularly notable are: the 1803 plan, the earliest depiction of the fort; the 1819 Poussin plan and profiles, the first plan made after the fort's alteration in 1813-15; a ca. 1833-34 plan and cross-sections showing both contemporary armament and the planned construction of the parade wall; the 1834 Lee plans and building elevations (and one partial building cross-section); the 1835 Gratiot plan, evidently based on the 1819 plan, on which existing and proposed new features are sketched; the 1836 Delafield plan and profile, the only early plan to provide precise and detailed elevation data; the 1837 Thompson plan and profiles, showing the design of the outer battery then being built; and the 1840 Smith plan and profiles, showing the 'as-built' characteristic of the fort following the extensive program of improvements initiated in 1835-36. Various mid-nineteenth through early twentieth century plans of the fort, and the 1917-20 plans of U.S. Army General Hospital No. 2, are also informative, but in a very real sense, except for the changes made in the deployment of armament within the fort during the Civil War, the theater of developmental "action" at Fort McHenry after 1840 had moved to areas outside the fort proper.

Archeological investigations have contributed to an understanding of many elements of the star fort. Much of the primary information derives from projects which examined water infiltration problems within the star fort, including two conducted by John Milner Associates, Inc. (JMA), in 1984 and 1988, and one conducted by the National Park Service, Mid-Atlantic Region, in 1989.²⁵ These projects examined the scarp wall's foundation and configuration, the parapets, the breast-height wall, the terreplein, the parade ground, and part of the dry moat. Additional studies pertaining to the star fort were Rutsch's 1974 drainage systems investigations, the 1979 parade wall investigations of Stokinger and Blades, and various investigations sponsored by the Denver Service Center (DSC) concerning structures on the parade ground.²⁶ The most recent DSC-sponsored archeological projects, which accompanied planning and design for a program of masonry rehabilitation, were implemented by JMA in 1993 and 1994, and by Pousson in 1995 and 1998.²⁷

3.2.1 Scarp Walls

The scarp walls (the exterior walls of the star fort, including the walls of the bastions and the curtain walls between them) are battered walls of brick facing on a stone inner wall, all resting on a foundation of roughly dressed stone. The salient and shoulder angles of the bastions are faced with sandstone quoins. Although the overall structure of the fort's walls has not changed, pervasive water-infiltration problems²⁸ have regularly damaged the brickwork, necessitating periodic repair and replacement. Several investigations have exposed and documented the moat side of the scarp wall's foundation, and the uppermost portion of the inner wall has been

examined in one project, but the interior face of the inner wall, and the foundations beneath the rampart, have not been archeologically investigated.²⁹

Duffy has suggested, on the basis of documentary research, that fort wall foundations were built from the outside in.³⁰ The archeological investigations of the foundation supports this idea, since the stone foundation was generally placed against the exterior of the foundation builders' trench, abutting the impermeable natural clays of Whetstone Point. In other cases, there was a narrow builders' trench between the foundation and the clay.³¹ The foundation itself is composed of roughly cut and irregularly laid granite. Only the upper surface and face of the top stone shows evidence of being smoothed.

In some exposures, the foundation is laid in roughly three courses: the upper and lower levels are composed of substantial stones while the middle course is composed of smaller stones and chinking stones. Gaps between the stones are the norm, and few stones are flush. The mortar which once filled all the gaps has leached out in many areas.³² The foundation steps out 8 in. from the base of the curtain wall and has a height of about 1.75 - 2 ft. The brick face of the scarp wall is 2 ft. thick; the inner, mortared stone wall is likely to be 5-5.5 ft. wide at its base and it is about 3 ft. wide at its top. There is evidently considerable variation in the elevation of the top of the scarp wall foundation: at the salient of bastion 2, on the northwest side of the fort, it has an elevation of about 29.9 ft. amsl, while along the curtain wall between bastions 3 and 5, the southwest and southeast side of the fort, its estimated elevation is 26-27 ft. amsl.³³ An adjustment was evidently made, reducing the effect of this difference in elevation, by variation in the wall's height: the top of the coping stone above the top of the foundation ranges from about 12.5-13 ft. at bastion 2 to about 14-15 ft. between bastions 3 and 5, with the resulting elevation ranging from about 40-41 ft. amsl along the southeast side of the fort to about 42-43 ft. amsl at bastion 2 and along the bastion 1-2 curtain.

Counterforts, which function as stone buttresses, have been documented beneath Fort McHenry's parapet, adjoining the interior side of the inner wall.³⁴ The counterforts and the earth fill of the rampart between them were intended to help prevent the collapse of the scarp wall under bombardment. In contrast to the foundations, Fort McHenry's counterforts were constructed of dressed stone, and laid up without chinking stones.³⁵ The counterforts are commonly rectangular in plan, about 4.65 ft. wide by 5 ft. front-to-back, perpendicular to the scarp wall. There are triangular counterforts, however, interior to the salient angles and shoulders of the bastions. Each bastion face and flank wall has one rectangular counterfort behind it, while each of the curtain walls has four or five rectangular counterforts, one centrally located (except at the sally port, and presumably above the postern) and two more situated on each side, approximately 3

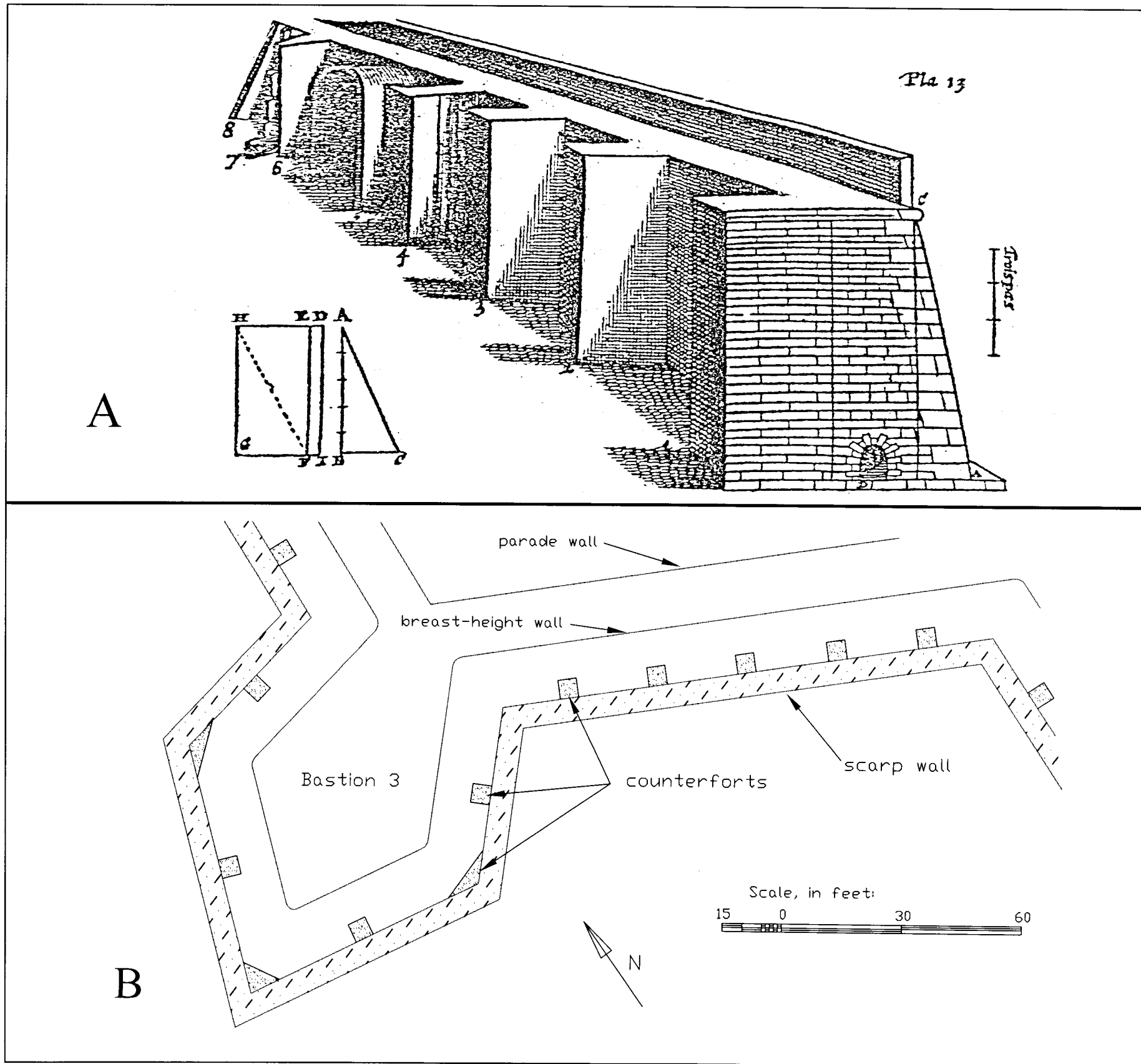

Figure 20. A - DeVilleville's drawing, 1629, showing counterforts (Duffy 1975:42); B - Configuration of Fort McHenry's counterforts (based on Joseph and Cheek 1985: Figure 18).

toises (18-19 ft.) apart.³⁶ The counterfort design reflects common eighteenth-century European methods of fort construction, and more directly the design paradigm of Jean Foncin, the fort's French (and French-trained) military architect (Figure 20).

The outer face of the scarp wall was capped with cordon or coping stones, which may originally have been sandstone, like the quoins. In 1829 much of the stonework of the wall, presumably the coping, had to be repointed and partially reset; slate and a water-cement mortar were employed in an effort to keep water from percolating behind the scarp wall's brick face.³⁷ In 1837, Thompson replaced the original coping with Patapsco granite, a single course 3 ft. wide by .5 ft. thick; the trenching done to remove the original coping stones is clearly evident in the stratigraphy of the parapets (Figure 21B). No evidence of the earlier stone has been found in archeological excavations, either on the parapets or in the moat below, but broken bits of slate and mortar are found on portions of what is evidently the 1829-37 moat surface.³⁸

The scarp wall's height may have been altered slightly when the coping stones were replaced, but historical alterations of grade within the moat, particularly between the fort and the outer battery, are likely also to have contributed to changes in the wall's relative height. The 1819 profiles (Figure 18) indicate that the scarp wall coping was about 12-13 ft. above the moat. Although a profile detail on a ca. 1833-34 plan indicates a 14.5 ft. height for the wall's coping, an 1836 profile (Figure 22) indicates a height of 13.5 ft. in one location, while the plan it accompanied (Figure 19) documents, with spot elevations, that there was roughly 1.5 ft. of variation in the moat's absolute height. Profiles prepared in 1837 and 1839 indicate coping heights of between 13 and 14 ft. (There are discrepancies, however, in the latter profiles, between the configuration of features as drawn, and as indicated by the stated dimensions and annotated elevations within the drawings. Some of the dimensions in the 1840 profiles indicate, for instance, that the scarp wall coping was about 8 ft. above the level of the parade, rather than the 6.5 ft. which the drawings by themselves suggest, and more nearly level with the banquettes than with the terreplein. This naturally raises questions regarding the drawings' precision.)

Archeological investigations which have, in places, revealed the mid- to late nineteenth century moat surface, beneath 1.5-3 ft. of twentieth century fill, indicate that the relative height of the scarp wall varies from 13.5 ft. to 15.5 ft. The scarp wall height variation, and discrepancies among the historical profiles, and between them and the archeological findings, are very likely attributable in part to measurement error (historically and recently), but there clearly is substantial variability in the absolute elevations of the wall and of the moat's surface at different locations. The findings also suggest, as discussed below (Section 3.5), that the moat may in fact have been deepened in places, possibly more than once, during the

nineteenth century. It was recommended that the moat be deepened both in 1813 and in 1835.³⁹ The 1835 proposal called for earth to be taken from the moat to raise the heights of the fort's parapet and counterscarp.

3.2.2 Parapet

The earliest indications of the cross-sectional characteristics of Fort McHenry's parapet are the profiles on the 1819 plan. Subsequent parapet profiles are provided on plans dating to 1836, 1837, 1840, and 1886. Delafield's 1836 profile documents the initial design for construction of the parapet revetment wall (the breast-height wall), while the 1837 (Thompson) and 1840 (Smith) profiles document the two episodes of the wall's construction, and associated modifications of the parapet. The 1886 profile indicates that the 1840 contours had been reduced by erosion. Archeological information comes primarily from the 1985 report by Joseph and Cheek, and from the 1999 Cheek, Balicki and Abel report concerning work performed in 1993, 1994, and 1995. Additional documentary information from the fort's archives rounds out the development picture.

The only major element of the fort to have been altered more than its parapet are the brick faces of its scarp wall. Like any elevated, sloping, earthen feature, the parapet has suffered from erosion even when well maintained, and covered with a healthy layer of sod, and erosion has been more rapid when the sod cover has not been well maintained. Further, during the major renovations of the fort of the late 1830s, the earlier (i.e., original) interior revetment—the sodded slope down to the terreplein—was replaced with a brick revetment wall (the breast-height wall), resulting in the destruction of most of the physical evidence of the earlier slope, and otherwise damaging the original deposits; at the same time, of course, new features associated with this construction activity were created.

The parapet has had three major design phases. Among the most notable elements in the initial phase, from construction, ca. 1800, until 1813, were the two embrasures on each flank of each bastion, twenty of them in all. Under the second design, between 1813 and the reconstruction of the parapets in the 1830s, the embrasures had been filled in, but the parapets were evidently not otherwise altered, except by erosion, and possibly by repair. The third design, dating to 1837-39, involved the construction of the breast-height wall and of a more elevated parapet. This configuration has been maintained, by periodic repair of erosion, up to the present.

The 1819 profiles of the fort indicate that the parapet then had the following characteristics: a steep slope up (1:1) on its exterior, directly above, and rising 1.5-2 ft. higher than, the scarp wall cordon; a gentler slope (1:12 or less) over the bulk of its width, cresting about 15 ft. interior to and 2.5-3 ft. above the level of the cordon; and a very steep slope down (1.75:1) on its

interior side. The overall width of the parapet was 16-18 ft. Archeological evidence was discovered in 1994 which indicates that the original interior face of the parapet was revetted with sod, i.e., that the sod there had been stacked rather like brick against the parapet's steep interior slope, instead of having been laid over it like a blanket and pegged in place. (In another of the 1994 excavations, discussed below, the nearly vertical sides of one of the fort's embrasures were found to have been similarly revetted.) It is not known (and cannot be determined archeologically, due to previous impacts), if the steep outer slope of the parapet had also been revetted with sod, but it may have been; most likely the gentle slope of the greater part of the parapet would have simply been covered with a blanket of sod.

The crest of the parapet as depicted in the 1819 profiles was approximately 3.5-4 ft. higher than the level of the infantry banquettes, 5-6 ft. higher than the terreplein, 11-12 ft. higher than the fort's parade, and about 39-40 ft. above a high water datum (Figure 22). The precision of all these elevations is questionable, however, and they must be used cautiously. Delafield's 1836 plan and profile (Figure 19 and 22) give elevations for the parade (a surface then not significantly changed from that of 1819) of 33.9-34.5 ft. above high water, compared with the implicit 1819 elevation for the parade of about 28 ft. above high water. The 1836 elevations for the pre-revetment wall parapet were in the 43.8-44.25 ft. range, a height of about 2.5-3 ft. above the cordon and 10 ft. above the parade. It appears that the 1819 profiles generally understate elevations, of at least the higher surfaces and features, by about 5 ft.

In 1837, a brick revetment wall, commonly known as the breast-height wall, replaced the parapet's interior slope; in 1839 this wall was heightened by 18 inches. In conjunction with these episodes of construction, the elevation of the crest of the parapet was to be increased by about 2-2.5 ft., to a height of about 4.5-5 ft. above the level of the cordon, 6-7 ft. above the terreplein, and about 12.5 ft. above the parade; the 1837 profiles indicate elevations for the parapet crest of 46 ft. above a high water datum. The fill soils deposited following the 1837-39 construction of the breast-height wall are a key component of the stratigraphy of the parapet, although one which has yielded ambiguous artifactual data. Analysis of the artifacts retrieved from the 1837-39 fill strata indicates that many of them were very likely already contained within the fill when it was transported to the parapet. The source of the fill, however, has not been determined. In 1835, the Chief of Engineers had recommended, among various other improvements, raising the parapet and covertway (counterscarp?) by 18-24 inches, with fill earth to be taken from the ditch. This may, in fact, have been the procedure followed in 1837-39, when the breast-height wall was built and the parapet raised by 2-2.5 ft. above its previous level.

Lt. G. T. Beauregard in 1844 had a clapboard surface built onto the interior slope of the parapet, above the breast-height wall, presumably to prevent

erosion. Archeological evidence of this, in the form of remnants of posts, has been found within the 1839 fills during investigations.⁴⁰ The clapboards remained in place at the beginning of the Civil War, as documented by a ca. 1861 photograph of the 24-pounder at the left shoulder of bastion 4 (gunmount no. 8); when they were removed is not known.⁴¹

The 1886 profile indicates substantially reduced parapet elevations—42 ft. at the top of the outer slope (compared with about 43-44 ft. in 1837-40) and 44.35 ft. at the parapet crest (compared with 46 ft.), again above high water. Part of the difference may be due to upward migration of the datum due to sea level rise, but the fact that other elevations on the 1886 profile are consistent with those of the 1836-40 profiles suggest that most of the change is due to post-1840 erosion. Erosion most likely continued into the early twentieth century.⁴² There is clear archeological evidence of an erosional surface, in the form of a humic zone, somewhat below the level indicated on the 1886 profile. This zone was apparently the surface in 1917-18, when excavations were made for the installation of electrical lines early in the development of the World War I hospital. The humic character of this surface may indicate that erosion had lessened considerably sometime before 1917, or that the installation of the lines occurred after the sodding of the parapets, which perhaps also occurred in 1917. Following 1917 there was at least one additional parapet resodding episode, in 1937, and probably others as well.

The slight evidence of the earliest parapet surface, beneath the fill strata of 1837-39, indicates that erosion had most likely affected the original profile as well. The greyish brown sandy clay shown in the schematic profile (Figure 20B) probably represents the surface of the 1803 parapet, slightly below the elevation depicted in the 1819 profiles. Artifacts found on the interpreted 1803 grade also suggest that it had been an erosional surface prior to deposition of additional fill during the 1837-39 period. Among these artifacts are three military buttons that date between 1808 and 1820.⁴³ The original massive fills of the parapet core, clearly evident below the interpreted original surface, are composed of redeposited mottled clays and silty clays native to Whetstone Point. Artifacts were scarce, but the presence of one piece of creamware (dated 1763 to the early 1800s⁴⁴), and the absence of later ceramics, provide an indication that these deposits are indeed associated with the 1798-1803 construction of the fort.

The interior slope of the original parapet was for the most part destroyed when the breast-height wall was built, beginning in 1837, along the same alignments. Remnants of what must have been the upper part of the slope have been identified, however, in some parapet excavations. A more complete section of the sod-revetted interior slope was documented in 1994, as discussed below, interior to the angle between the right flank of bastion 1 and the northwest end of the northeast (sally port) curtain wall. The original parapet, as shown on the 1803 and 1834 plans, had larger-radius

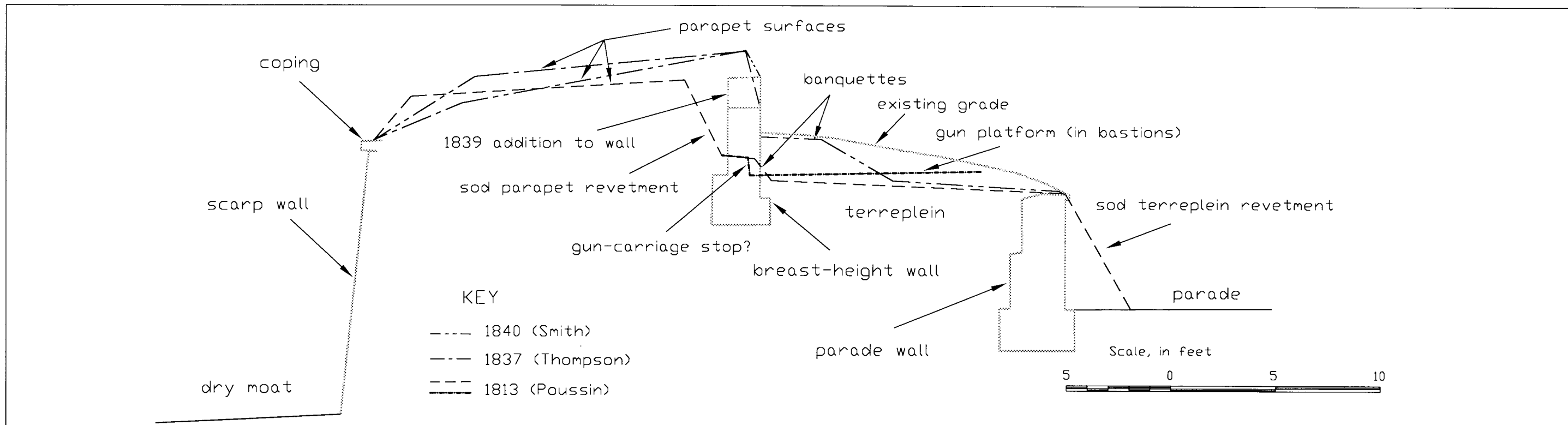

Comparative overlay of historical cross-sections of Fort McHenry's parapet and terreplein, 1819-1840.

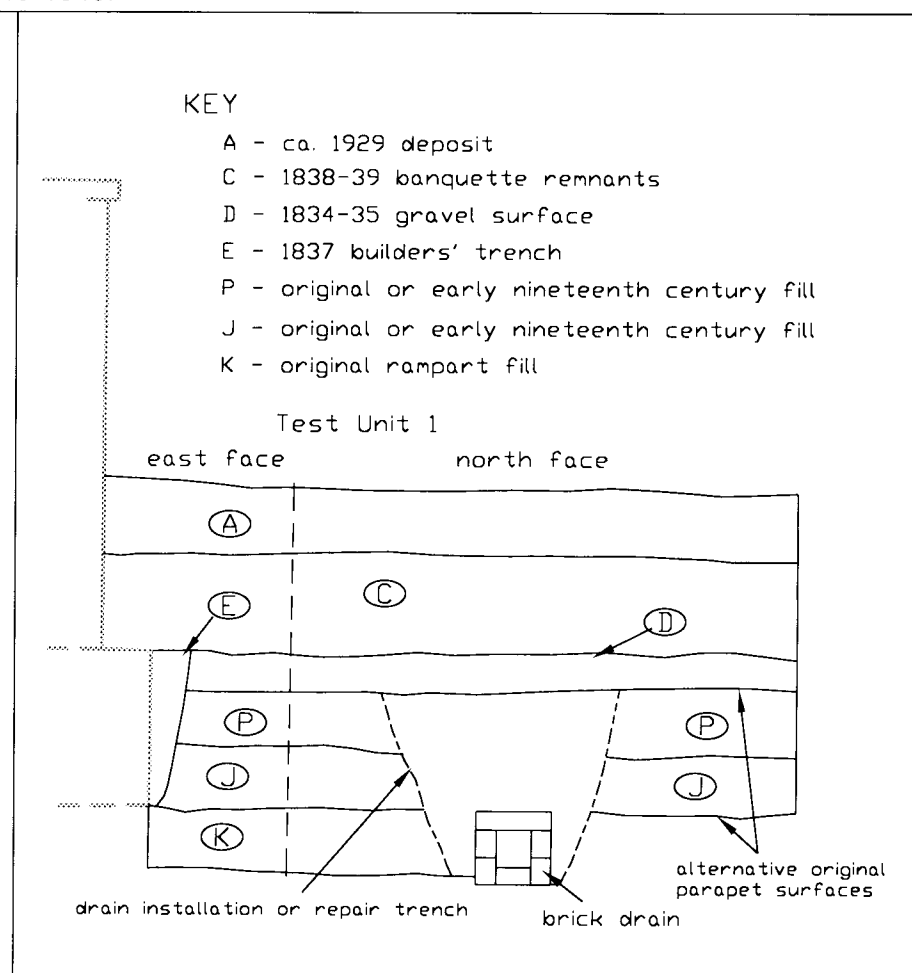
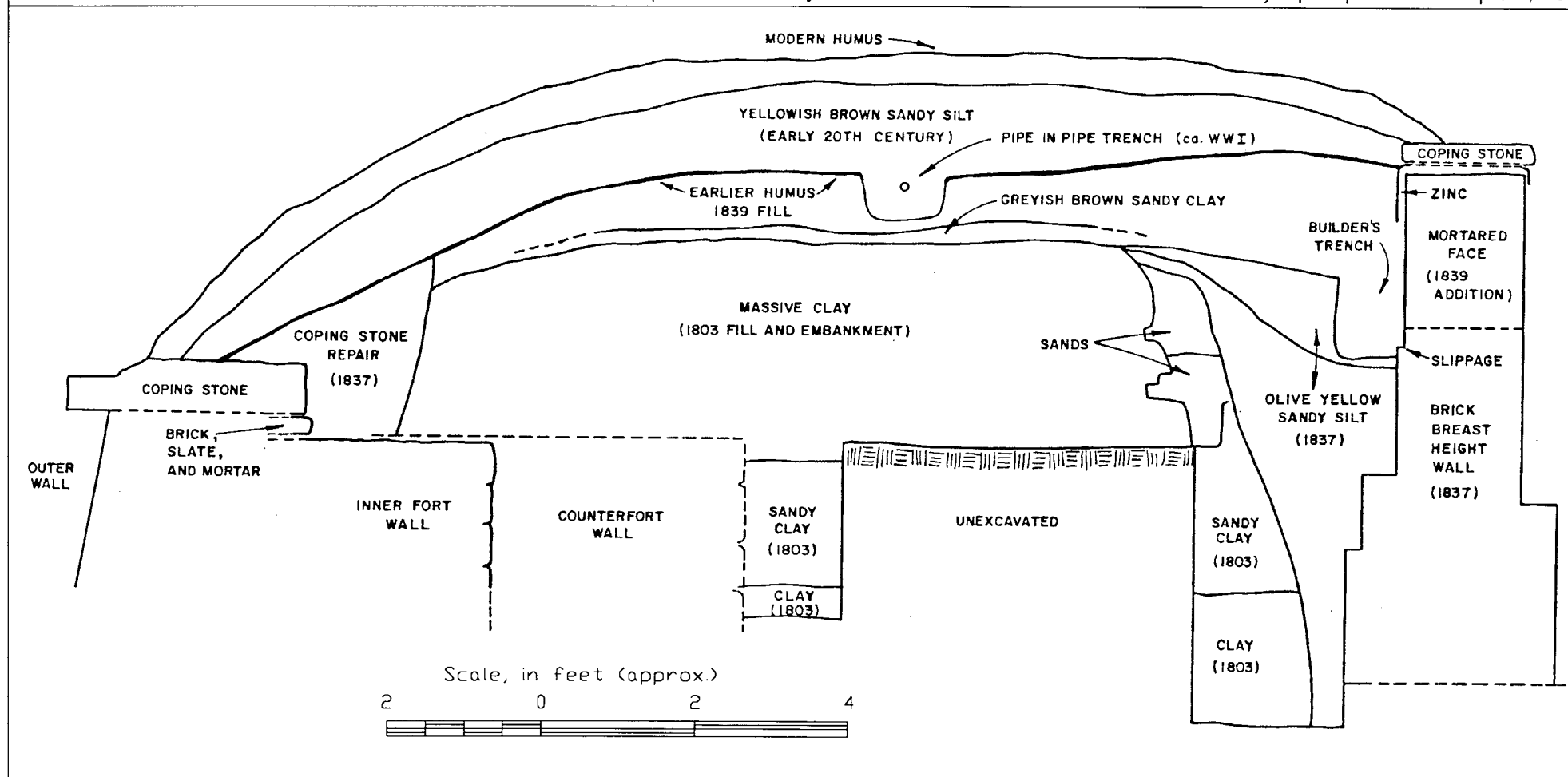

Composite archeological profile of Fort McHenry's parapet (Joseph and Cheek 1985: Figure 12)

Reflected profile of terreplein excavation (Cheek et al. 1989: Fig. 4-14)

Figure 21. Comparative overlay of historical cross-sections and archeological profiles of Fort McHenry's parapet and terreplein.

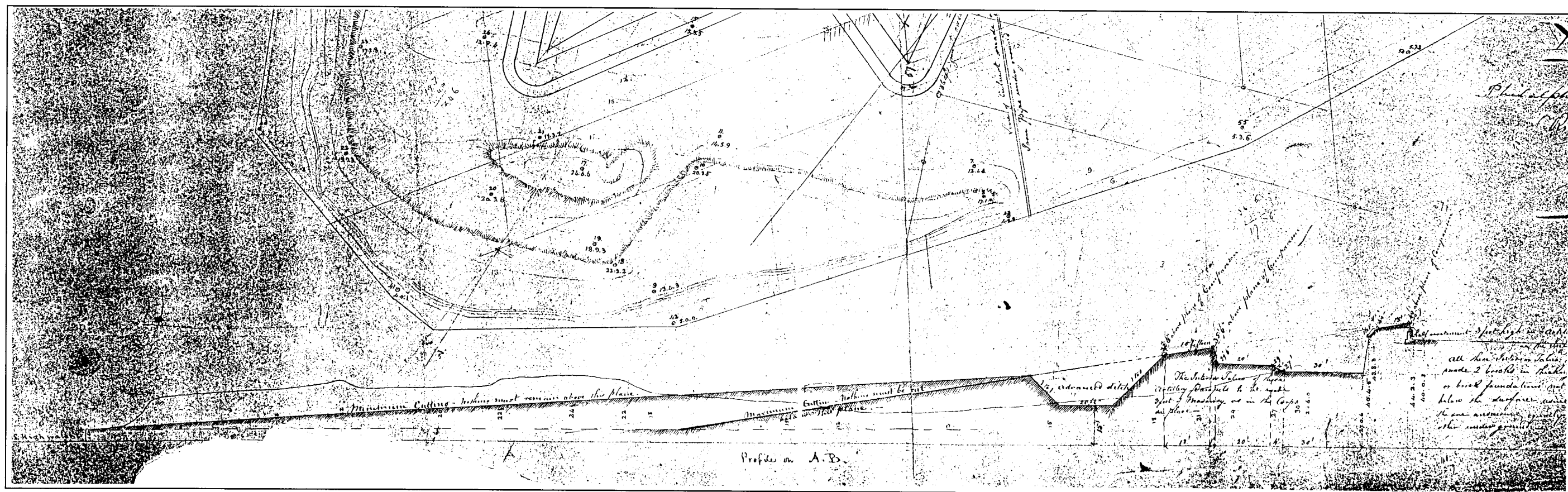

Figure 22. Detail of Capt. Richard Delafield's Project for an exterior battery to Fort McHenry, 1836, showing the profile of the fort and battery.

curves at the bastion-curtain wall angles than did the later breast-height wall, resulting in the preservation of the original interior slope revetment behind (i.e., on the parapet side of) the wall at these locations.

Except at its two ends, the parapet of the northeast curtain wall, on either side of the sally port between bastions 5 and 1, has undergone massive alterations, as a result of the 1814-15 construction there of subterranean bombproofs, the possible vaulting of the sally port entrance at the same time, and the construction of guardhouses in 1835 and of additions to them in 1857. As depicted in 1803, the parapet and terreplein here were originally terraced (stepping down toward bastions 1 and 5) have had a greater height on either side of the sally port than elsewhere. The 1819 plan, reflecting the post-bombardment construction of the bombproofs, depicts relatively sharp angles at both ends of the interior face of the parapet, where it joined the flanks of bastions 1 and 5, and a narrower terreplein; the plan also indicates that the earlier banquette had been removed. Both Poussin's 1819 plan and Lee's 1834 plan show sets of steps, differently configured, that provided access, by way of the parapet, between the terreplein and the "observatory," as the platformed roof of the sally port was called.⁴⁵ These steps are absent from plans dating to 1837

and later. The parapet along this curtain was clearly unlike this component of the fort elsewhere, particularly after the construction of the 1814 bombproofs and the 1835 guardhouses.

An excavation made in 1994, to document one of the sets of observatory steps, on the parapet at the juncture of the northeast curtain with the left flank of bastion 1, failed to locate clear evidence of such steps. It did reveal remnants of the sod revetted interior slope of the 1803-1814 parapet, with the rounded-corner aspect of the 1803 plan.⁴⁶ Deposited against this slope were early fill soils for which there appears to be no simple interpretation; they may represent modification of the parapet in 1814 or 1835, or original construction. The strata and features at this location are for the most part truncated, both to the northwest and to the southwest, by the builders' trench for the 1837 breast-height wall.

Archeological excavations were made in 1993 on the parapet above the postern tunnel, along the curtain between bastions 4 and 5, in the expectation of documenting a trench believed to have been associated with repair of the tunnel in 1835, follow its supposed collapse. No trace of such a trench was discovered, and the stratigraphy in that area was similar to the

parapet's stratigraphy elsewhere.⁴⁷ This appears to indicate either that the postern tunnel below the parapet was not rebuilt in the 1830s, or that, if it was rebuilt, it was not through a "cut-and-cover" method.

The 1994 investigation of one of the ca. 1800-1813 embrasures (the one on the left flank of bastion 3 nearest the adjacent curtain) confirmed the 1803 plan's depiction of these features' locations and configuration, and indicated that the floor of the embrasure would have been about .5 ft. above the scarp wall cordon, 3-3.5 ft. above the terreplein, and 2-3 ft. below the crest of the parapet.⁴⁸ Previously discovered archeological evidence of an embrasure was ambiguous.⁴⁹ The original embrasure configuration would have helped protect guns and their carriages from incoming fire, but would also have severely restricted the guns' field of fire. The 1813 filling of the embrasures and the platforming of the bastions made it possible for the guns to be aimed at a broader array of targets, but also made the guns more vulnerable to enemy fire. As it happened, two of the deaths that resulted from the 1814 bombardment occurred when guns in bastion 3 (described at the time as the southwest bastion) were twice hit by British fire.⁵⁰

3.2.3 Breast-height Wall

The parapet revetment or breast-height wall, which replaced the original sloping sod revetment, is a relatively well-understood feature of the fort. The wall was designed in 1836 and built in 1837; in 1839 its height was augmented by an 18 in. addition. In appearance the wall has remained basically unchanged since then.⁵¹ Construction activity is evidenced by the builders' trenches on both the parapet and the terreplein sides of the wall.⁵² Trenching for construction of the wall destroyed nearly all of the previous physical interrelationship between, on the one hand, the terreplein deposits and, on the other, the original parapet fill. Several archeological excavations, however, on either side of the wall, have provided data that augments the documentary record.

As first illustrated in the 1836 plan and profile, the breast-height wall was designed as a "half revetment 3 feet high on artillery parapets and 2 [ft.] 3 [in.] high (above plane of Banquettes) on the infantry parapets," with a foundation which extended 2 ft. below grade (Figure 22). Thompson's 1837 plan and profiles depict the initial construction of the wall, to a height of only 1.5 ft. above the banquettes, while Smith's 1840 plan and profiles document the final as-built characteristics of the wall, as modified by an increase in its height in 1839 to 2.9-3 ft. above the banquettes (Figure 23). With only minor exceptions, the archeological investigations of the parapets, the terreplein, and bastion 3 and 4 confirm the basic reliability of the documentary record.⁵³

The parapet revetment is composed of brick, has two step outs on the rear and one on the front. The base of the wall is thirty inches wide, while the stem is sixteen. The height of the wall in 1837 was sixty inches, with an eighteen-inch extension occurring in 1839. The zinc sheathing and the coping stone were added at that time. The interior face of the earlier wall was parged with a reddish sandy mortar, and the later extension was parged with a lime mortar.⁵⁴

By the early 1900s, erosion or modification of the long neglected banquettes had evidently resulted in as much as a 4-ft- high exposure (reveal) of the breast-height wall. Deposition of .5-1 ft. of additional fill on the terreplein ca. 1929, resulted in the present-day 2.5-3.5 ft. height of the wall above grade. When the wall was repointed in 1939 by a WPA team, an access trench was excavated in the terreplein to the top of the footer. The trench, which averaged about 1.5 ft. wide, destroyed most of the connecting stratigraphy between the 1838-39 banquettes and the wall.

3.2.4 Terreplein and Banquettes

Fort McHenry's terreplein—the working surface on the fort's rampart interior to the parapet—and its banquettes—the infantry firing steps

adjacent to the parapet's interior revetment—are distinct features, but their construction histories and the archeological data relevant to them are intertwined to such an extent that they can only be considered effectively together. The 1803 plan of the fort depict the fort's original terreplein as having been about 18 ft. wide (including the banquettes), accessed by 9 ft. wide ramps that ascend from the level of the parade on either side of the interior portal of the fort's sally port. It was probably about 6 ft. higher than the parade and 4.5 ft. lower than the crest of the parapet. Banquettes, 3 ft. wide, were situated at the faces of the bastions and along the curtain walls. Except along the sally port curtain, trees spaced 9-12 ft. apart were aligned in rows parallel to the banquettes, 3-4 ft. toward the fort's interior. At the parade edge of the terreplein was a sod revetted slope. Following completion of the fort ca. 1803, the terreplein and banquettes underwent two major episodes of documented historical alteration, the first in 1813-15 and the second between 1834 and 1840.

In 1813-14, the level of the terreplein within the bastions, and perhaps to some extent elsewhere, was raised by filling, and the bastion surfaces were platformed, so that guns could be fired *en barbette*, over the parapets, with greater maneuverability. At the same time the original embrasures in the flanks of the parapets were filled. The original banquettes at the bastions' faces were either removed or covered by the platforms, and trees previously located interior to these banquettes were also removed. The 1819 profile through the terreplein of bastion 1 ('Profile on CD') suggests a thickness of .2 ft. for the plank deck of the timber platform, attached to what was presumably a set of .7 ft thick timber sleepers, most likely embedded in the fill of the bastion surface. Archeological excavations in and near bastion 4, however, while revealing a layer of fill likely to have been deposited in 1813-14, have provided no direct evidence of either the deck or the sleepers. At the parapet margins of the platforms there was a curb-like structure, probably of timber, which may have served both as a bumper or stop for the gun carriages, and as a substitute for a banquette.

With the construction of bombproofs beneath the rampart on either side of the sally port in 1814-15, the parapet, banquettes, and terreplein there were replaced by more elevated terraces, and the ramps widened to about 12 ft. At the same time, bombproofing of the parade magazine require that a brick revetment wall be substituted for the sloping terreplein revetment there. The 1819 plan, and the profile showing the postern tunnel (profile G-H), also depict a brick structure built into the terreplein revetment and centered over the upper end of the tunnel; as discussed below, this structure very likely dates to 1813-15.

The terreplein was more extensively altered between 1834 and 1840, during implementation of a series of projects. The replacement of the terreplein's sod revetment was completed in 1833-34 with construction of the fort's existing stone parade wall. Resurfacing (graveling) of the terreplein

evidently began in 1834; however, trees along the curtains were apparently not removed until 1835, and the resurfacing is unlikely to have been completed before then.⁵⁵ In 1835-36, gun emplacements (pintle blocks and traverse circles) were constructed at the shoulders, presumably, of some of the bastions, and evidently along the curtain wall between bastions 4 and 5; construction of additional gun emplacements, and the reconstruction of some of the earlier emplacements, took place in 1837 and 1839. In 1838-39, following the initial construction of the breast-height wall, new banquettes were built extending around the entire perimeter of the terreplein, except at the locations of the gun emplacements, and along the sally port curtain, where there was no terreplein.⁵⁶

Modifications of some emplacements, and of portions of the banquettes, were made in 1861-65 to accommodate Civil War era armament, but the terreplein otherwise appears to have remained unaltered until the late 1920s; the elevation of the banquettes was reduced by erosion, however. During the U.S. Army's ca. 1927-30 restoration of the fort, additional fill was placed on the terreplein, covering the banquettes and gun emplacements.⁵⁷ In 1939 a trench was excavated to the top of the breast-height wall's footing by WPA workmen, for repointing the wall; the trench destroyed much of the interface of the 1838-39 banquettes with the wall.

A major focus of archeological investigations on the terreplein has been the identification of surfaces and deposits corresponding to particular historical grades and episodes of development. This effort has to an extent been made more difficult by ambiguities and inconsistencies, on historical plans and profiles of the fort, in indications of elevations. Nearly the sole graphic, non-archeological indication of what may have been the terreplein's original grade, and of the height of the banquettes above that grade, are two of the 1819 profiles. Archeological investigation of the terreplein, however, has revealed an ephemeral, patchy, ca. 1803-13 (?) surface that appears to be deeper than the surface documented by the 1819 profiles.⁵⁸ There is, as well, historical documentation of the 1835 discovery of a privy within the south bastion (bastion 4), covered by boards at a depth of about 2 ft. below 1835 grade⁵⁹; this feature must have been buried beneath fill deposited during the 1813-14 platforming of the bastions, and the elevation at which it was found is approximately the same as that of the archeologically documented early surface.

In any case, one of the 1819 profiles, keyed E-F and located at the center of the curtain between bastions 2 and 3, depicts a 20 ft. wide terreplein (although the accompanying plan indicates an 18 ft. width), 5.5 ft. above the higher, northwestern part of the parade, and 2.25 ft. below the level of the scarp wall cordon. Another 1819 profiles, keyed GghH, and located at the center of the curtain between bastions 4 and 5, has the terreplein, about 17.5 ft. wide, situated 6.5 ft. above a lower part of the parade (where drainage from the parade emptied into the postern), and 2.8-3 ft. below the

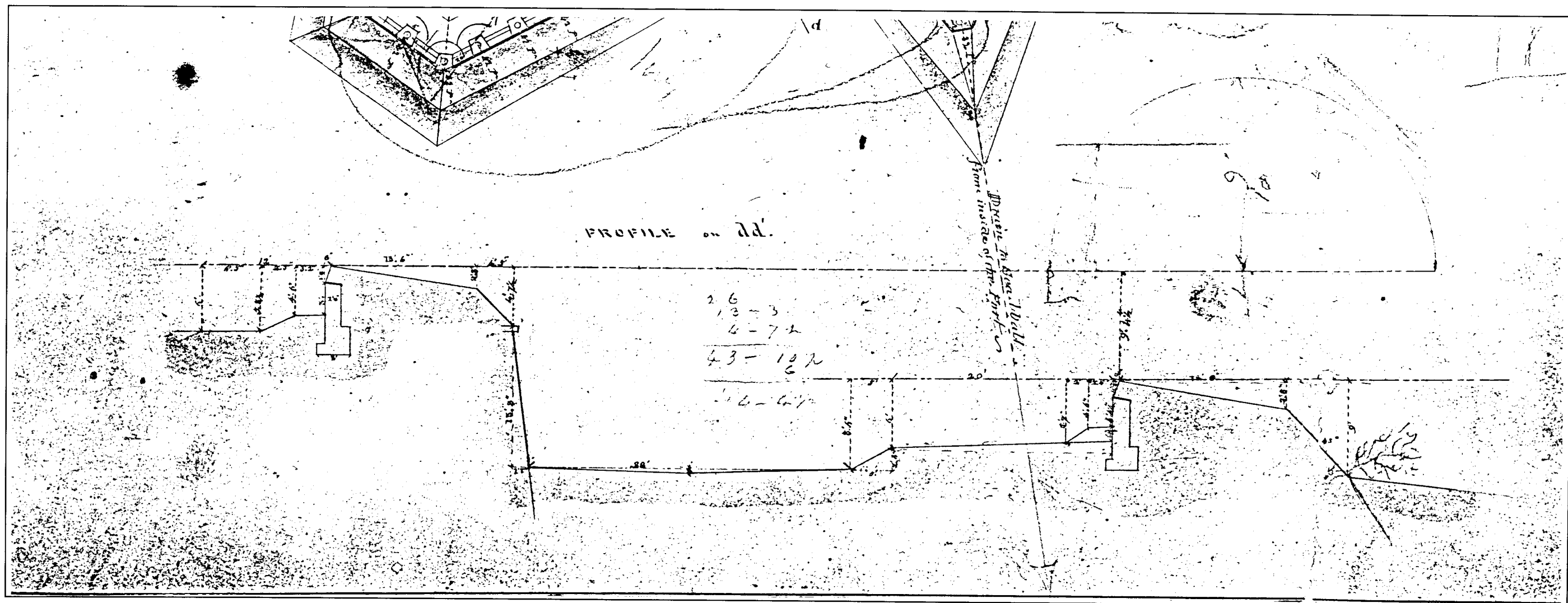

Figure 23. Detail of Capt. Fred A. Smith's *Fort McHenry*, 1840, showing the profile d-d', through left face of bastion 4 and the water battery. The abatis depicted exterior to the outer battery's parapet is a Civil War era feature, added, along with certain other details, during the war, when the drawing was evidently at the fort in the possession of Col. Henry Brewerton.

level of the cordon. In both these profiles, the terreplein appears to have sloped only very slightly, if at all, down toward the top of the sloping sod revetment. The banquettes on both profiles are depicted as having been 3 ft. wide at their bases, 2 ft. wide at their surfaces, and about 1.5 ft. high. The 1819 profile through the left face of bastion 1, keyed C-D, indicates that the gun platform there, with a noticeable slope down toward the parapet, ranged from 6 to 6.5 ft. above (a higher part of) the parade, and 1.5 to 2 ft. below the level of (a possibly more elevated section of) the cordon.

Comparison among these profiles, or between them and later profiles, is hampered by the absence of any single, constant, vertical datum. Nevertheless, the known historical drainage patterns of the fort's parade, and the greater absolute elevation of the scarp wall on the north and

northwest side of the fort, suggest that the difference in actual elevation between the platform in bastion 1 and the terreplein along the curtain between bastions 4 and 5 may have been closer to 2.5-3 ft., rather than the .5-1 ft. implied by direct comparison. The slight differences in the relative height of the parapet, which was depicted as having been 4.5-5 ft. above the bastion platform, and 5-5.5 ft. above the terreplein along the curtains, together with comparison among all the profiles, suggests that the gun platforms were only slightly higher than contemporaneous terreplein surfaces nearby; one implication of this is that portions of the terreplein outside the bastions may also have been filled in 1813-14.

The next historical indications of the terreplein's elevation are the ca. 1833-34 plan and cross-section, prepared for construction of the parade wall,

which show that the outer face of the wall, and the top of its coping, were designed to coincide vertically and horizontally with the top of the earlier sloping revetment; the indicated 7.5 ft. height of the wall above the parade seems exaggerated, however, by comparison with either earlier (1819) or later information. A building cross-section on Lee's 1834 plan, prepared soon after completion of the parade wall, includes (as an element of a depiction of a bridge onto the terreplein from the second story of a typical residential building), an image of the nearly level terreplein, 6.5 ft. higher than the parade, and about 18 ft. wide (Figure 38, below). The inner slope of the parapet is shown, but there is no banquette.

The 1836, 1837, and 1840 plans and profiles, documenting the design and construction of the outer battery, the breast-height wall, various gun

emplacements, and other improvements, indicate that grade of the terreplein was raised so that its elevation, relative to the higher parapets associated with the breast-height wall, was similar to what it had been relative to the previously lower parapets. Delafield's 1836 plan indicated specific terreplein elevations, above the level of the parade's center, of 5.5 ft. at the salient of bastion 5, 6 ft. at bastion 3, 6.5 ft. at bastion 4, and 8 ft. at bastion 2 (bastion 1 is not depicted). A profile on the same plan indicated that the level of bastion 3, most likely of the surface established following the 1834-35 (or earlier) removal of the 1813-14 gun platform, was about .5 ft. below that of the cordon, and 4 ft. below the contemporaneous (pre-breast-height wall) parapet; no banquette is depicted. Relative to the cordon, the terreplein elevations seem exaggerated, or the cordon elevation itself may be understated. The differences in elevations for the bastions, however, are generally consistent with Lt. Henry Thompson's 1835 observation that "one part of the fort is at least 16 or 17 inches higher than the other, so that the Guns will have to be in two planes." The archeological surfaces most likely to represent 1836 grade in bastions 3 and 4 appear to have the same .5 ft. difference in elevation as documented in the 1836 plan.⁶⁰ Apparently, the highest elevations on the fort's terreplein were then, as at present, in bastions 1 and 2 and along the curtains in their vicinity.

Profiles on Thompson's 1837 plan of the fort indicated the terreplein of bastion 4 was 4.5 ft. above the level of the parade, while the terreplein along the curtain between bastions 1 and 2 was 5.5 ft. above the parade; in both locations the terreplein was depicted as being at the same level as the scarp wall coping. Similar profiles are included on Smith's 1840 plan, which documents the 1839 heightening of the top of the breast-height wall by 1.5 ft. Again, however, there are discrepancies in the 1840 profiles. The dimensions noted within the drawings suggest that the cordon, relative to the fort's interior features, was 1-1.5 ft. higher than as depicted, roughly 8 ft. above the level of the parade, rather than 6.5 ft., and more nearly level with the banquettes than with the terreplein. What the dimensions in the profiles of 1840 indicate, more so than the graphics themselves, is that by comparison with the 1819 profiles, a slope, down from the banquettes to the parade wall, had been established along the curtain walls between the bastions, by deposition of .5-1 ft. of fill along the breast-height wall side of the terreplein, not including the banquettes (Figure 21A).

What transpired in the bastions during the mid- to late-1830s is somewhat more complex. The wooden gun platforms may have been removed earlier, during the 1820s, but earth fill was most likely deposited in their place in the mid-1830s. This is suggested by the continuity of ca. 1833-36 strata between the platformed areas of the bastions and nearby, non-platformed sections of the terreplein. The relatively thin aspect of the strata in the bastions suggests that the platforms consisted mainly of the .2 ft. thick planking. There are likely to have been sleeper beams of some sort as well, embedded in the underlying fill, but archeological evidence for such beams

has not been discovered, possibly due to disturbances associated with the platforms' removal.

The various inconsistencies in the historical depictions of the fort's early nineteenth century elevations make these depictions, however valuable for general indications of the fort's characteristics, unreliable as a basis for precise interpretation of archeological strata, without very careful evaluation. For example, the graphical depictions of the fort's rampart contained in the 1837 and 1840 profiles, compared with the 1819 profiles, imply that the terreplein's grade was raised by as much as 2 ft. between those dates. If, however, instead of just the graphics, the dimensions included in the 1840 profiles are also employed as a basis for comparison, the magnitude of the change in grade is reduced to .5-1 ft. One consequence of this newly recognized characteristic of the 1837 and 1840 profiles is that models proposed previously for alterations of the terreplein's grade,⁶¹ based partly on consideration of the graphical elements of the 1840 profiles, but not on the metrical elements, need to be refined.

One of the models in question posited that the terreplein surface documented by the 1819 profiles was essentially the same as the original, 1803 surface, except in the bastions, which were platformed in 1813. Strata corresponding to such a surface (determined partly on the basis of comparison between ambiguous, or erroneous, details of the 1837-40 profiles and only somewhat less ambiguous details of the 1819 profiles, employing the cordon as a vertical datum) were identified within several archeological excavations (although not consistently in all excavations where such strata might be predicted), at a depths of 1.5-2 ft. below strata interfaces corresponding to 1835-38 terreplein surfaces (not including the 1838-39 banquettes), matching apparent differences in grade between the 1819 profiles and the (graphical) 1837-40 profiles.

The archeological evidence by itself, supplemented with other historical documentation, had suggested an alternative model, in which a stratum interface less than .5 ft. below the 1835-38 terreplein surface corresponds to the original, 1803-19 terreplein surface. This model was previously thought to have discounted the reliability of the historical profiles, particularly that of the 1819 profiles, as the basis for identifying the early historical grades, and to have placed the supposed 1803-19 surface higher than was believed to be indicated by the 1819 profiles. At the same time this model was unavoidably vague in attributing the patchiness of the first model's original surface to its derivation from haphazard, construction-era (1798-1803) depositional processes, or to subsequent disturbances. Unexplained by this model, and contradicting it to some extent, is the complexity of what are supposed to be pre-1803 fill deposits, the presence within those strata of features of unidentified function, and the apparent presence of at least a few post-1815-20 artifacts.

The latter model, however, is actually more consistent than is the first with the historical profiles, purged to the extent that they can be of apparent graphical errors. Further, the various problems with the model are not as perplexing as they had once seemed. There appears to be a need, nonetheless, for a third model, as well as for further investigation, because it now seems less likely that the 1819 profiles document the original, ca. 1803 grades, in all areas, and more likely that filling was performed in 1813-15, not just in the bastions, but on at least some of the remainder of the terreplein as well. Such filling would account for the existence of the more deeply buried, although ephemeral, archeological reflection of an original surface. The third model posits that, rather than just the two early historical terreplein surfaces previously thought to have existed—ca. 1803 through ca. 1835, and ca. 1835 through 1929—there were, in some areas at least, three—the original, ca. 1803 through 1813-14 surface; the intermediate, 1814-15 through 1834 surface; and the final, pre-modern, 1835 through 1929 surface.

A stratigraphic break corresponding to the ca. 1803-35 surface of the first model, or the ca. 1803-14 surface of the third model, occurs at a depth of 3-3.5 ft. below existing grade of the terreplein in and near bastion 4, and is found as well in most other terreplein excavations (Figure 21C).⁶² The break is not as obvious as one might expect of a surface that constituted grade for 10 years, or 30 years, but it does exist, and it does appear to have been an exposed surface for some length of time prior to the late 1830s. Over this surface is ca. 1813-14 (?) fill varying in thickness from .7 to 1.5 ft., into which a number of features of unidentified function intrude.⁶³ On top of this fill are two or three additional strata. The bottom stratum, which contains artifacts, including whitewares, does not exist in some profiles while in others it is as much as .3 ft. deep. Above this bottom layer, where it is present, or directly over the lower, ca. 1813-14 (?) fill, are two layers which are sometimes separated by a thin clay layer. The lower of the two layers contains reddish brown sand and fragments of iron ore. The upper of the two contains a brown sand and brick fragments. Both contain gravel, and are similar to historical surfaces of parts of the fort's parade ground.

The uppermost of these gravelly layers, the one containing brown sand and brick fragments, is presumably attributable to the 1834-35 graveling of the terreplein surface. Both gravelly strata were cut by 1835-39 construction excavations for brick traverse-circle footings, and for the breast-height wall.⁶⁴ Fill composing the banquettes, reestablished in 1838-39, has been identified in a number of units directly overlying the uppermost gravel surface.⁶⁵ Overlying the remnants of the banquettes, the remainder of the terreplein, and the gun emplacements are later deposits, most notably fill placed on the terreplein ca. 1929.

The first model supposes that the lower gravelly stratum, along with the other strata beneath the 1834-35 gravel surface and above the ca. 1803

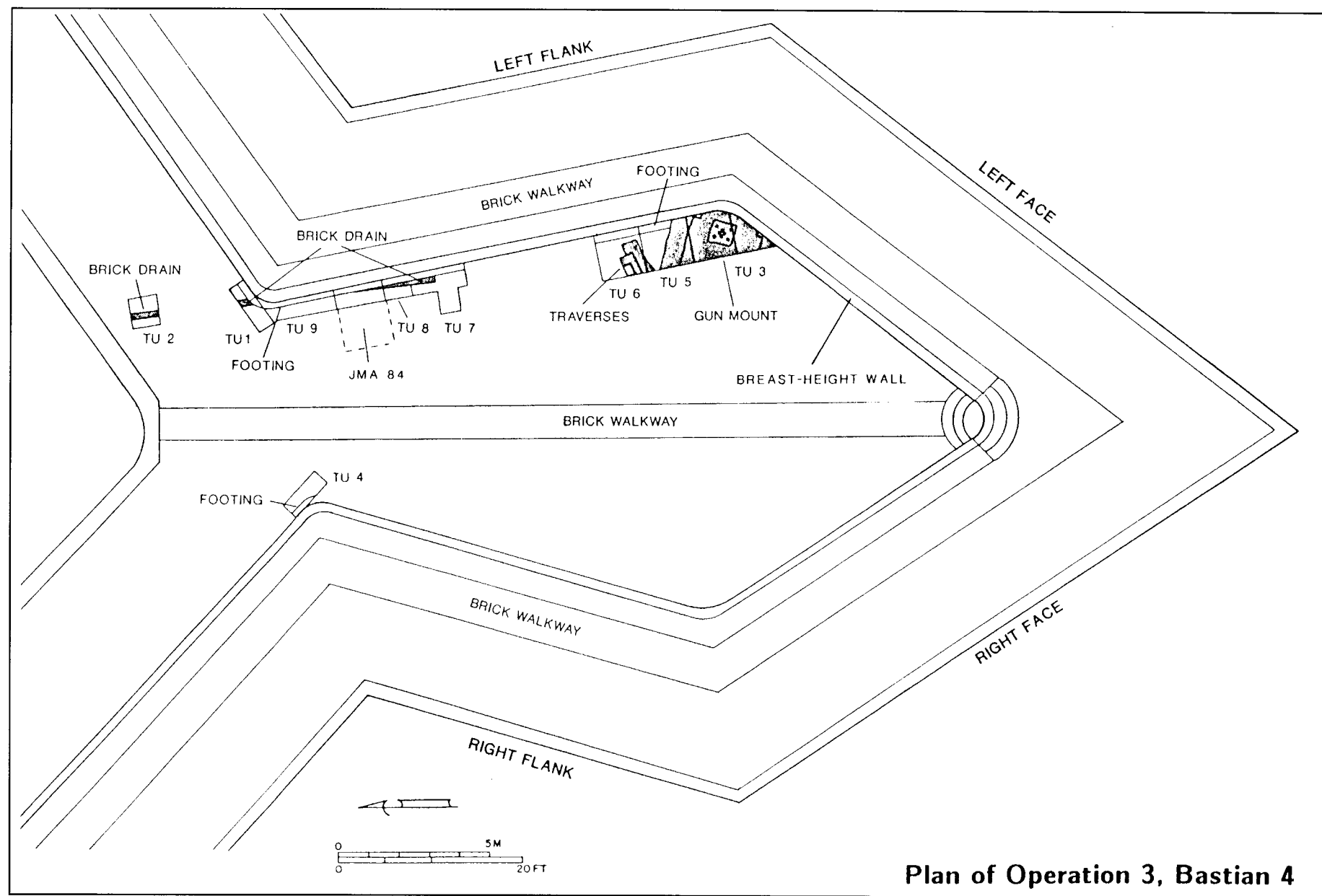

Figure 24. Plan of excavation in bastion 4, showing the ca. 1814-15 (?) brick drain and 1837-39 gun emplacement (Cheek et al. 1989:Figure 4-9).

surface, derive from the developments occurring between 1819 and 1834, most likely beginning with the 1833-34 construction of the parade wall. Under the second model, the gravelly stratum directly below the 1834-35 gravel surface, the one containing reddish brown sand and iron ore fragments (together, presumably, with portions of the whiteware-containing stratum beneath it), constitutes the ca. 1803-34 surface. Under the third model, the gravelly stratum directly below the 1834-35 gravel surface constitutes a surface established between 1803 and 1819, most likely in 1814-15. The whiteware-containing stratum remains anomalous except under the first model.

There are, in fact, various inconsistencies with historical documentation, and unexplained archeological findings, under each of the models, but the third model appears to account for more of the data than the others. The first model, contrary to earlier interpretations of these documents, does not correspond well with all of the information contained in the historical profiles, particularly not with the metrical data in the 1840 profiles. The second model, previously thought to require the discounting of the historical profiles, actually fits well, in some locations, with the adjusted profile data, but it provides no basis for interpretation of the complexity of strata and features beneath the hypothesized 1803-34 terreplein surface,

suggesting only that they have to be assigned to the period of the fort's construction, despite the apparent presence of whiteware, made after 1815 at the earliest, in one of these features. The third model's primary weakness is its *ad hoc* quality: the model suggests that where there is archeological evidence of one or more earlier surfaces, below the level of the terreplein supposedly documented by the 1819 profiles, then post-1803 / pre-1819 filling may be the explanation. Where, on the other hand, such evidence is lacking, and the earliest surfaces appear to correspond to the 1819 profiles, it is accepted that little or no change of grade is likely to have occurred between ca. 1803 and 1833-34. At least until additional research is performed, however, simple empiricism may be the only interpretive course to follow, particularly given the differences of elevation across the fort at any specific time as well as over time.

It is noteworthy that there appears to be little by way of consistent horizontal breaks in the stratigraphy between the formerly platformed expanse of bastion 4, at least, and nearby areas of the terreplein, which seems to indicate either that very little filling accompanied the platforming of the bastions, or, more likely, that the platforms were relatively thin, and that the filling that occurred when they were built, and following their removal, was not confined to the areas directly beneath them. Although Cheek and Balicki have previously remarked that the gravelly strata were both either less apparent, or absent, where the bastion 4 platform had been, this is not altogether clear in the profiles of the bastion 4 excavations.⁶⁶ The 1993 excavation in bastion 3 documented the presence of two gravelly strata, taken together about .8-1 ft. thick, the upper one of which, at least, was most likely deposited during the 1834-35 resurfacing of the terreplein; beneath the lower of these strata, and above the presumed initial surface of the terreplein, was .5 ft. of silty loam fill likely to have been deposited in 1813-14 as (part of?) the base for the gun platform.⁶⁷

Among the more enigmatic features found on the terreplein of the fort, but ones which may eventually provide the key to solving some of the stratigraphic problems there, are the remnants of two brick drains which formerly extended from the left flanks of bastions 3 and 4 directly toward the sloping revetment (Figure 24). The existence of these drains was first revealed when one was discovered by Stokinger and Blades in 1975, during monitoring of the reconstruction of a section of the terreplein wall. Additional work was done in 1984, 1988 and 1993 by JMA, and by NPS in 1989.⁶⁸ No other drains have been discovered elsewhere on the fort's terreplein, and it is now believed that no others exist.

The apparent intake of the bastion 4 drain was situated approximately 32 ft northwest of the bastion's left shoulder, and its outlet presumably debouched on the original sloped terreplein revetment about 35-36 ft. further to the northwest. Although this drain has previously been interpreted as a nearly original feature, built ca. 1803-13, it now seems

more likely to be a post-1813/ pre-1819 feature. Both drains were presumably constructed at the same time, and evidently abandoned prior to, or at the time of, construction of the parade wall, in 1833-34. They may have been installed to remedy drainage problems which developed following the 1813-14 construction of gun platforms within the bastions, or possibly when additional filling occurred on the terreplein near the bastions about the same time.⁶⁹ The drains are composed of unmortared bricks, their channels a single stretcher course (.35 ft.) wide. The drains' walls consisted of two stretcher courses, of bricks laid on edge, and each channel was covered with a header course, spanning the drains' .8 ft. exterior width. Bricks stacked nearly 1 ft. high, found at the south end of the bastion 4 drain, are presumably remnants of its intake. The intake appears to be situated just south of the former location of the gun platform's north edge, and where the platform's east edge would have abutted the parapet revetment. The intake's height appears to match the thickness of the platform. The bastion 4 drain, except for its intake, was situated 4.1-4.9 ft. below existing grade in the bastion, where part of it was situated beneath the foundation of the 1837 breast-height wall, and 3.4-4.2 ft. below grade north of the bastion.

On the terreplein north of the former location of bastion 4's gun platform, the drain is within a trench entirely beneath the 1834-35 gravel stratum and the 1838-39 banquettes; it is unclear if this trench extends down from the surface of the problematic lower gravel layer, or from a slightly deeper surface. Although this may be a repair trench, indicating maintenance of an original, ca. 1803-13 feature, it is more likely to be the builders' trench for the drain, indicating that its installation followed the raising of the terreplein's grade, most likely ca. 1813-15. Since the configuration of the drain suggests that it was associated with the 1813-14 platform, and since one model of the local stratigraphy has the surface from which the associated trench was dug being established about the same time, it seems reasonable to assume that the trench was dug for the initial installation of the drain. No installation or repair trench was evident above or adjacent to the bastion 3 drain. Three details, however, suggest that the installation of the bastion 3 drain occurred in or soon after 1813-14: the drain's location 3 ft. below grade, at the base of, but not entirely below, fill deposited ca. 1813-14; the uneven surface of the immediately overlying layer of (ca. 1815?) fill; and the lesser compaction of the (pre-1803?) fill directly adjacent to the lower part of the drain.⁷⁰

Excavation in 1993 on the terreplein within bastion 3 at the predicted location of the intake of the bastion 3 drain yielded no evidence of survival of any remnants of that drain's southwest end, possibly because the drain there was slightly higher than the drain at bastion 4, or because its alignment coincided more closely with that of the breast-height wall. An anomalous soil feature was found, however, in an archeological excavation on the adjacent parapet, where a gun embrasure was documented. The

feature, in the west corner of JMA's unit B4, consisted of fill, within what may have been a small pit, slightly darker and more homogeneous than the adjacent soils.⁷¹ Although the feature might have had an undetermined relationship to the adjacent embrasure, it may, alternatively, have been associated with installation of the intake of the bastion 3 drain; if so, the bastion 3 drain was somewhat longer than the bastion 4 drain, 38-39 ft. rather than 35-36 ft., and it would have extended slightly further into the area of the 1813-14 gun platform.

The 1838-39 infantry banquettes have been identified in nearly all of the excavations made on the terreplein adjacent to the breast-height wall. Masonry gun emplacements and remnants of the wooden platforms of Civil War era armament, as discussed below, have also been documented by archeological excavation. In addition to the bastion 4 brick drain discussed above, Stokinger and Blades, during the 1975 monitoring of the parade wall's reconstruction, discovered robbed builders' trenches associated with what may have been a traverse, or less likely a magazine, over the entrance of the postern tunnel. This feature is discussed further below, in conjunction with the postern tunnel. Other notable features that historical documentation indicates were located on the fort's terreplein include: the bastion 4 privy (ca. 1803-1813); the bastion 2 sentry box (ca. 1814-1820s?), depicted on the 1819 plan; the bridges from the second stories of all the residential buildings (2 from the commanding officer's quarters, 1 from each of the others, 5 in all; these bridges presumably date to the 1829 construction of the second stories); the bastion 5 flagstaff (ca. 1828-1959), discussed below; and Civil War era sentry (?) tents in all the bastions.

3.2.5 Gun Emplacements

Over the course of Fort McHenry's many decades as a seacoast fortification, the armament of the star fort was periodically reconfigured, upgraded, and improved. The various artillery pieces, and their carriages, required various sorts of gun platforms, traverse circles, and pintle blocks, collectively known as gun emplacements. Although no archeological investigations have specifically focused on the star fort's gun emplacements, they have been examined and recorded when incidentally uncovered.⁷²

Historical documentation prior to 1840 is generally non-specific regarding the arrangement of armament within the star fort. The characteristics of its original armament are not known, but the number and locations of the embrasures shown by the 1803 plan on the flanks of the fort's bastions suggests that provision was made for placement of a maximum of twenty guns within the fort; these very likely would have been smaller caliber guns (12-pounders or less), as their purpose would have been to defend, at short range, against any direct assault aimed at scaling the fort's scarp walls. Larger guns (18-pounders or more), capable of longer-range fire, would

have been placed in the water batteries.⁷³ The apparent absence originally of gun platforms within the fort also implies that the guns deployed there were of smaller caliber, mounted as they must have been on field carriages.

As part of the preparations for an expected assault during the War of 1812, the embrasures were filled and the bastions platformed. The platforms made possible the positioning of heavier ordnance in the bastions, without the risk of having their recoil drive them into the ground. The platforms, decks of wooden planks nailed or treenailed to joists set into the ground,⁷⁴ sloped down slightly toward the parapet, to slow the guns' recoil and aid returning them to firing position. This reconfiguration of the fort's armament allowed the guns to be fixed *en barbette*, for firing over the parapets.⁷⁵ Mullaly simply indicated that during the War of 1812, following the platforming of the bastions and the elimination of the embrasures, the star fort was armed with twenty-one guns of varying calibers.⁷⁶ Walsh provided a more detailed, albeit more confusing, description of disposition of the guns within the fort in May of 1813:

On the five bastions were four thirty-two pounders, fourteen twenty-four pounders, and there were twelve eighteen pounders available, on traveling carriages in event of land attack, with traveling furnaces.... The heavy guns were placed on the flanks of the bastions. The lighter—field pieces—were set on the flanks with infantry [presumably the bastion faces, and possibly the curtains]; a mistake in armament which Decius Wadsworth [then Chief of Ordnance, War Department] pointed out but which was uncorrected.⁷⁷

Sheads' research indicates that by September of 1814 American-made 18- and 24-pounders were mounted on Toussard carriages within the star fort.⁷⁸

Fort McHenry in 1813 acquired forty additional guns (tubes, sans carriages) – twelve 18-pounders and twenty-eight 36-pounders – from a damaged French warship, *L'Eole*, which had been berthed in Baltimore for some years. By September of 1814 most if not all of these guns were positioned on the fort's water batteries, using naval carriages.

Although Fort McHenry's guns could not match the fire-power and range of the ordnance on British vessels during the bombardment of September 13-14, 1814, their presence, and the fact that they remained manned during 25 hours of nearly continuous fire, prevented the attacking ships from advancing into positions from which they would have supported the land-force deployed to assault Baltimore.⁷⁹

The fort's armament was not documented again until ca. 1833-34, when, on the plan prepared for the construction of the parade wall, twenty-three guns are depicted within the fort (Figure 25). (In a different hand and at an unknown date, but most likely ca. 1834-35, traverse circles, but not guns, were sketched on the same plan, at the right shoulders of bastions 3 and 4.) Most of the guns, apparently on field carriages, are depicted massed along the bastion faces and flanks, and the curtain, between the salients of

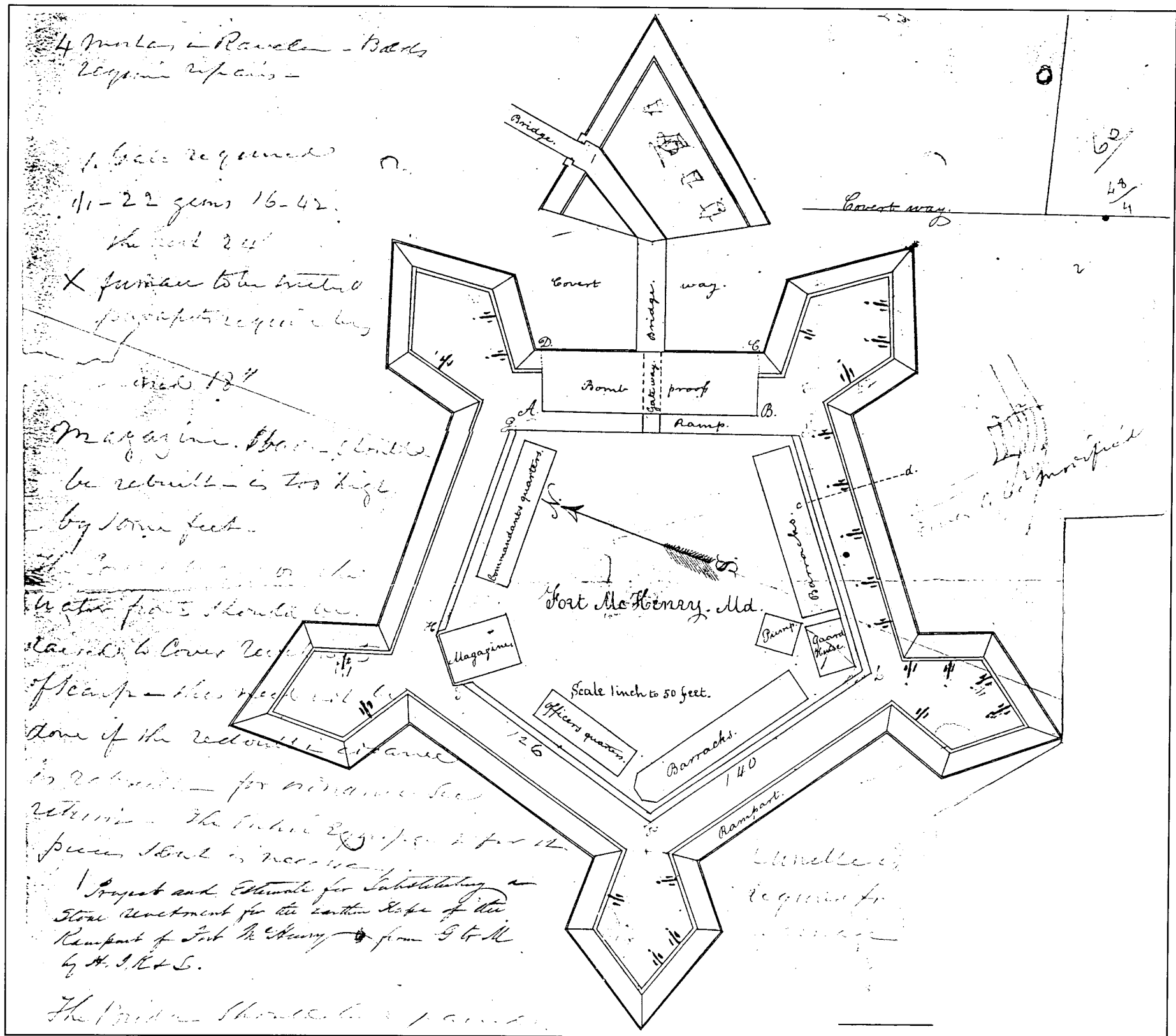

Figure 25. Detail of Fort M'Henry, Md., ca. 1833, showing the fort's armament.

bastions 4 and 5, commanding the Northwest Branch, the channel into Baltimore's harbor. A note on the plan indicates "[?] - 22 guns 16 - 42 [pounders?] the rest 24 [pounders?]," but there is no indication of which size guns were positioned where, whether the bastions still had platforms, and whether the arrangement was as existed or a proposal. The 1835 Gratiot plan depicts front-pintle, traverse-circle emplacements for twenty guns, ten at the bastion shoulders and five each along the curtains between bastions 3 and 4 and bastions 4 and 5. (Although the Gratiot plan also depicts platforms in the bastions, much of the plan appears to have been a copy of the basic elements of the fort as depicted on the 1819 plan, and the platforms might not have actually existed at that time.) The Gratiot plan's arrangement of guns was evidently implemented at least in part, except possibly for the emplacements along the curtain between bastions 3 and 4.

Beginning in 1835-36, and continuing in 1837-39, at least fifteen front-pintle, traverse circle emplacements were built within the fort. Eleven emplacements were reported to be nearly finished in January of 1836, five of which are likely to have been on the terreplein along the curtain between bastions 4 and 5, the remaining six most likely at various bastion shoulders; the bastion platforms, if they still existed, were removed when the latter emplacements were built. Following the 1836-37 start of development of a new water battery, and the 1837 construction of the breast-height wall, the 1837 Thompson plan (Figure 26) indicated that there were, or would soon be, emplacements at all the bastion shoulders, and at the salients of bastions 1, 2 and 3; the emplacements along the curtain wall are not depicted, having apparently been abandoned. All the emplacements in the ravelin and the water battery were sequentially numbered on the 1837 plan, but the only ones numbered in the star fort were those in bastions 4 and 5, possibly because the other emplacements in the fort had not yet been built, or rebuilt, or perhaps because guns were not expected to be routinely mounted at them. All ten of the bastion shoulder emplacements were reported to have been completed in October of 1838,⁸⁰ but there is no evidence that the bastion salient emplacements were ever built. In October of 1839 Thompson reported to the army's new chief engineer that ten "traverses and foundation blocks, all of granite, have been taken up, and relaid in conformity with your plan"⁸¹; it is unclear whether some error had occurred during the earlier construction of the emplacements, or if a change had been made in the type of gun carriages that they would be employed. Smith's 1840 plan (Figure 27) depicted the rebuilt emplacements at the bastions' shoulders, and indicated that 24-pounders, then the fort's lightest ordnance for developed, *en barbette* positions, would be mounted at all of them.

A detailed armament report prepared in September of 1861, as the Civil War began, and an accompanying plan (Figure 28), indicate that substantial changes were made in preparing the fort to defend itself against possible attack.⁸² Anticipation of a potential landward assault resulted in the positioning of heavier armament, and additional guns, in bastions 1, 2, and

3, and along the curtain between bastions 1 and 2, to cover the road from Baltimore, which had been placed under martial law due to the secessionist sympathies of much of its population. There were still six 24-pounders mounted, but at the remaining emplacements there were two 10-inch columbiads, one 8-inch sea coast howitzer, and one 42-pounder. There were also a 12-pounder brass field howitzer, a 12-pounder brass mountain howitzer, two 6-pounder brass field guns, and four mortars, all mounted, "upon their appropriate carriages and en barbette," on platforms in the bastions; three mortars were mounted on platforms on the terreplein along the curtain between bastions 1 and 2 (and three more were positioned in the ditch below that curtain). There also were two light mortars on platforms on the terreplein near bastions 5 and 3. Construction of wooden, center pintle emplacements for the 10-inch columbiads, at the opposing shoulders of bastions 1 and 3, facing the fort's landward entrance road, required the removal of at least the uppermost elements of the earlier masonry emplacements at those locations. An 1864 armament plan indicates the changes that occurred in the deployment of guns in the star fort during the war; rifled 32-pounders were then positioned in bastions 2 and 3, as well as at several emplacements in the outer battery, and additional brass field guns were positioned on platforms at the flanks of bastions 2 and 3.

At the end of the Civil War there was briefly a plan to install 15-inch Rodman guns at the salient of bastion 4 and the right shoulder of bastion 5, but the plan was not carried out. Following the war, most of the fort's guns and gun carriages were dismantled and put in storage. The only armament mounted in the star fort ca. 1880 were the 10-inch columbiad in bastion 3 and the mortar in the center of bastion 4. By the time of the fort's 1912 decommissioning, or soon thereafter, all of the guns had been removed.⁸³ The gun emplacements at the shoulders of the bastions remained exposed until the army's restoration in the 1920s, at which time they were buried beneath fill. In 1938, in bastion 5, the emplacements' traverse circles were removed to accommodate the mounting of ceremonial Rodman guns.⁸⁴

Few archeological deposits have been identified at the star fort that derive from its early armament. Strata associated with the platforming of the bastions have been recognized on bastions 3 and 4,⁸⁵ and features and strata representing filled embrasures have been identified on the left flanks of bastion 2 and 3.⁸⁶ Remnants of masonry gun emplacements were revealed in excavations in bastion 4, where a nearly intact 1839 traverse circle was found overlapping remnants of an 1835-38 circle.⁸⁷ The pintle block was found to have been constructed of concrete and the traverse footings of brick and concrete. The traverse stone, which originally held the iron rail on which the gun carriage wheels ran, was granite. Associated with the emplacement were two blocks of granite set into the revetment. These may have been stops added in 1842 to prevent the guns from being turned too far, but it remains to be determined if this was their actual function.⁸⁸ A traverse circle footing was discovered in 1989 along the curtain between

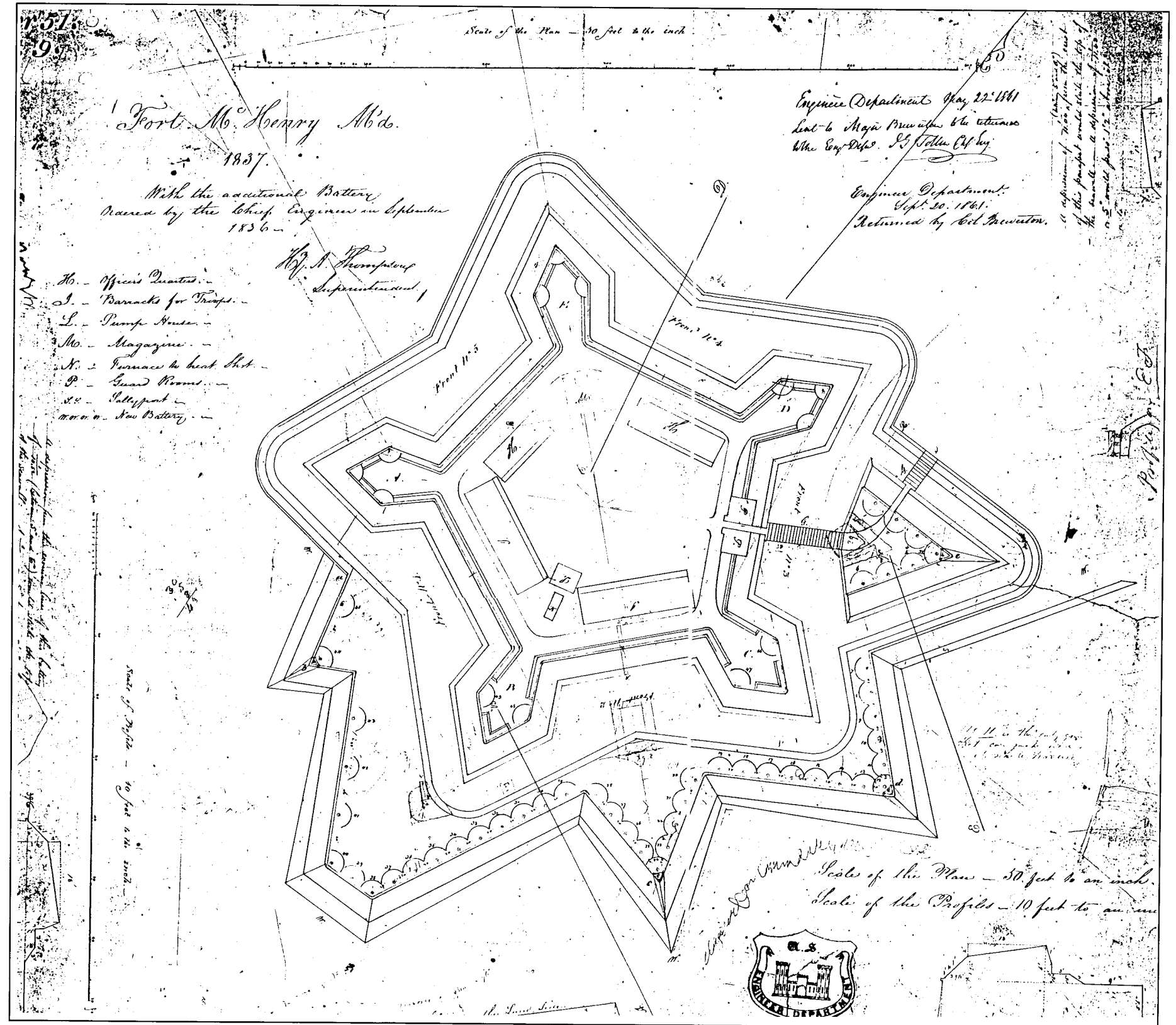

Figure 26. Detail of Henry A. Thompson's Fort McHenry, Md., 1837, with additions ordered by the Chief Engineer in Sept. 1836.

bastions 4 and 5, where an emplacement most likely built in 1835 had been abandoned by 1838-39.⁸⁹ Remnants of the Civil War era platform for a brass, 6-pounder field gun were encountered at the left flank of bastion 3, in one of the 1993 excavation made by JMA,⁹⁰ and what are likely to be remnants of a platform for a light mortar, also dating to the Civil War, were located in 1989 by Kurtz adjacent to the right angle of bastion 5.⁹¹

Resistivity anomalies were identified during a geophysical study conducted in 1984 adjacent to the right faces and flanks of bastions 3 and 4.⁹² In bastion 4, the anomaly is likely to be a reflection of the ca. 1835-39 right bastion shoulder gun emplacements. A comparable anomaly was absent in bastion 3, where the gun emplacement at the right shoulder had been removed at the beginning of the Civil War, and replaced with a center-pintle timber-platform emplacement for a 10-inch columbiad; there was no apparent reflection of the columbiad's platform. An anomaly identified at the right flank of bastion 3 is likely to reflect the presence there, as on the left flank of the same bastion, of remnants of a timber platform for a brass 6-pounder, also constructed during the Civil War.

3.2.6 Parade Wall

The original parade revetment was a battered (i.e., inclined from vertical) 'wall' of sod, 5-7 ft. high. There was a 4-ft.-wide space between the revetment's base and the back walls of the residential buildings in the fort, and about 8 ft. between the top of the revetment and the buildings (slightly more space may have been provided behind the officers' quarters). When the powder magazine was bombproofed in 1814, the sod revetment behind it was replaced with a brick revetment wall. The existing, granite parade wall was built in 1833-34, replacing the remainder of the sod revetment. The sod revetment was shown on the 1803 plan of the fort, with lines indicating its top and bottom. It was more clearly depicted in the profiles on the 1819 fort plan (Figure 18). The design for the granite parade wall, as shown by a ca. 1833-34 plan and cross-section (Figures 25 and 29), involved the removal of the earlier revetment, and no traces of it have been found. Behind the commanding officer's quarters, the parade wall was aligned 10 ft. back from the building, compared to its alignment 8 ft. back from the barracks, to accommodate a small addition to those quarters; a slightly wider area (9 ft.) was provided behind the junior officers' quarters as well. As a result the terreplein behind these buildings is 1-2 ft. narrower than behind the barracks.

Portions of the 1833-34 stone parade wall were reconstructed in 1975, and archeological monitoring was performed by Bill Stokinger and Brooke Blades to document the characteristics of the wall as originally built, and to determine whether or not strata and features pre-dating and post-dating the wall's construction were evident behind it.⁹³ It was established that the

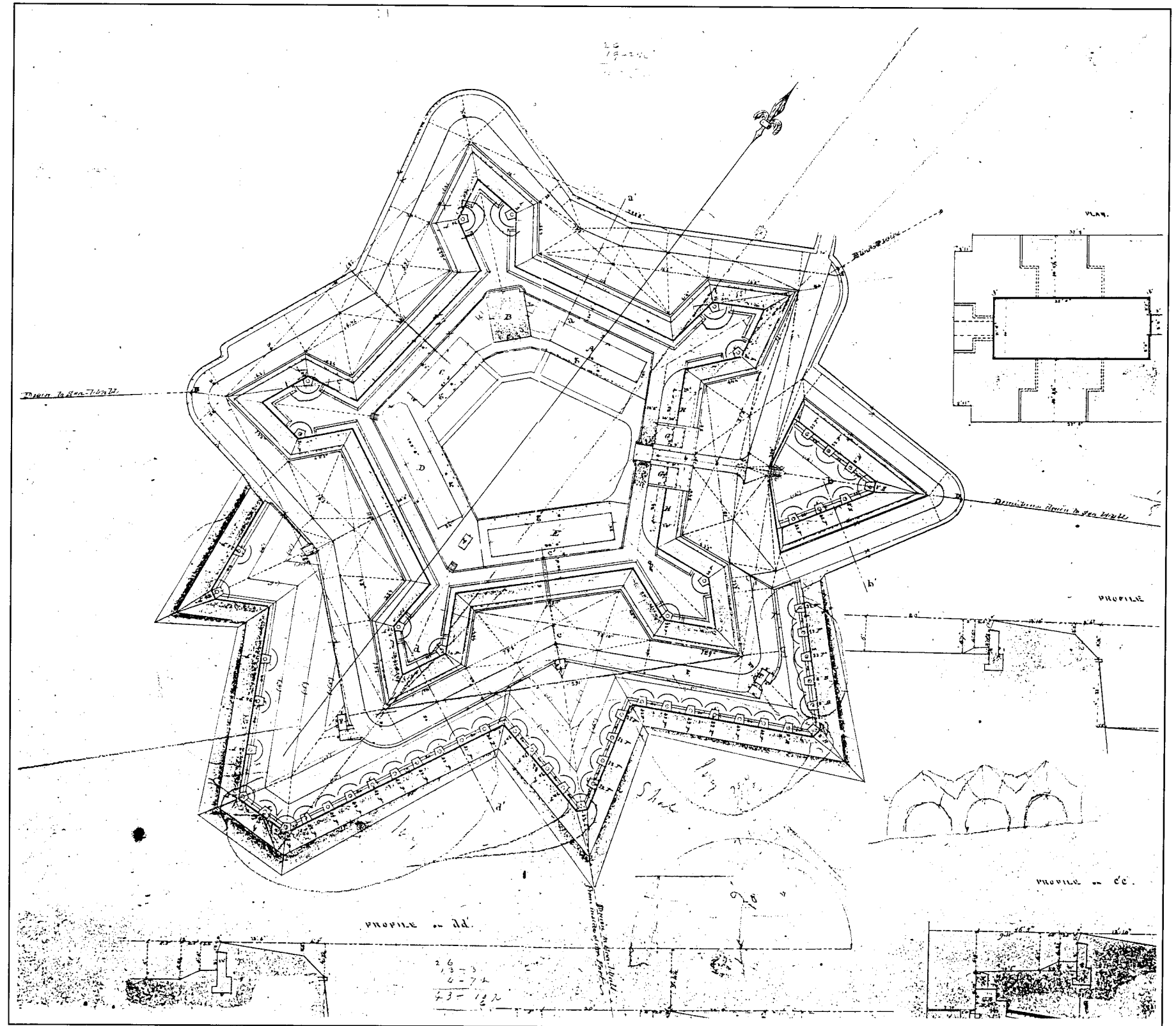

Figure 27. Detail of Capt. Fred A. Smith's *Fort McHenry, Baltimore*, from dimensions furnished by Capt. Henry A. Thompson, 1840.

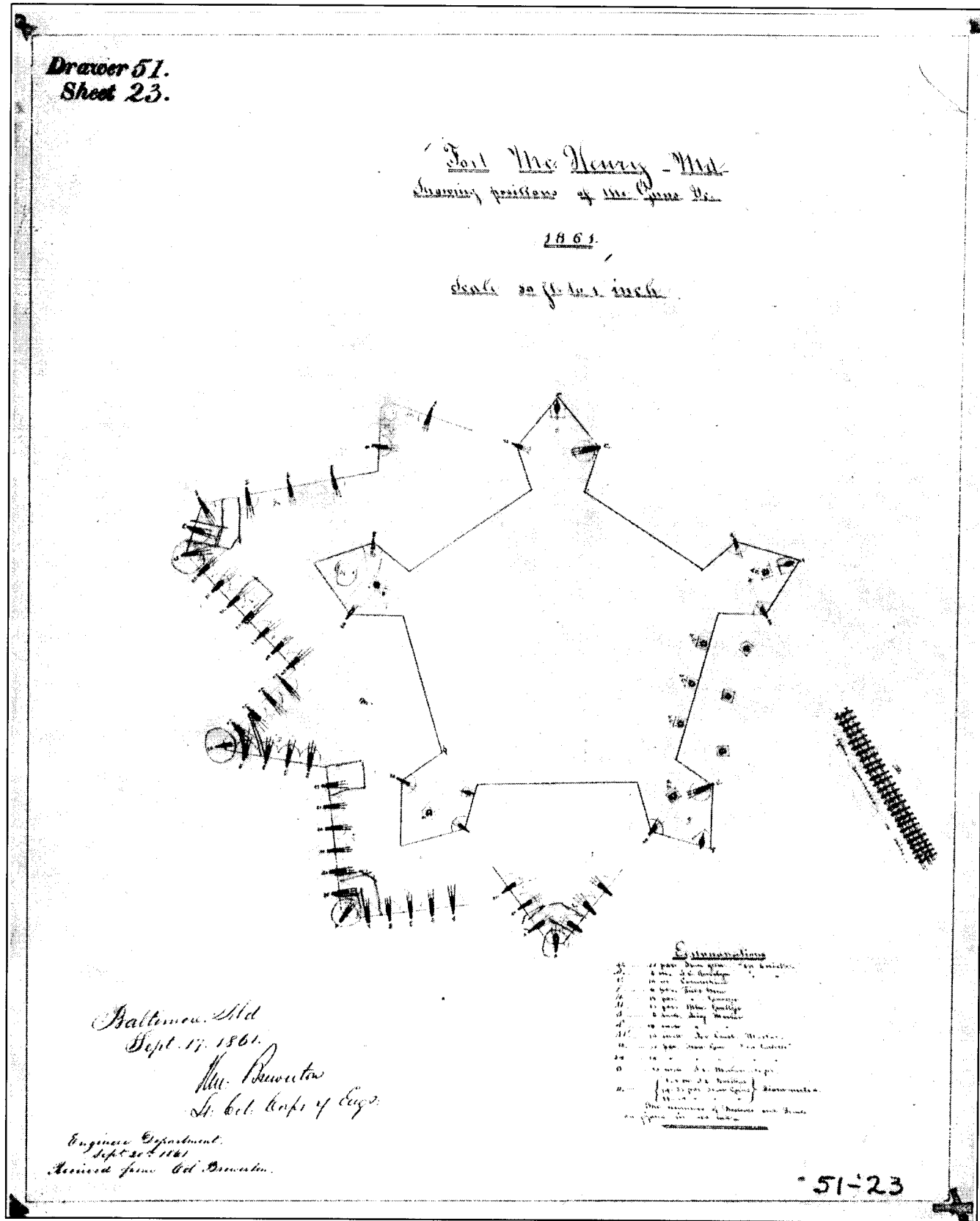

Figure 28. Detail of Lt. Col. Henry Brewerton's *Fort McHenry, Md., Showing positions of the Guns, etc., 1861.*

wall, as built, generally conformed to the specifications for it detailed in the ca. 1833-34 plan, and in a letter from Gratiot to Thompson. The major differences between the plan and the as-built characteristics of the wall were in its height above the grade of the parade, which was rendered as 7 ft. 6 in. on the plan, but which in actuality was only 5-7 ft. There were also differences in the width and depth of its foundation, designed to be 2 ft. deep, beginning at grade, by 4 ft. wide, but built with a .5 ft. depth, beginning 1 ft. below grade, and a 3-4 ft. width. Accommodation for drainage from behind the wall was presumably the reason for gaps in the dry-laid footing, but the clayey composition of the soils into which the footing had been set, and which filled the builders' trench behind the wall, undoubtedly subverted that aspect of the design.

The exposure of the stratigraphy of the terreplein behind the wall indicated that, in at least some areas, the top of the parade wall's coping was level with or slightly higher than contemporaneous gravel surfaces/pathways on the terreplein. Among the features discovered within the terreplein were remnants of a brick drain, which was subsequently found to originate along the left flank of bastion 3, as discussed above, and the robbed builders' trenches for the 1813-14 (?) structure over the postern tunnel, discussed in conjunction with the postern tunnel, below. Also discussed below is the evidence found of the massive trench excavated for the repair or modification of the parade end of the postern tunnel. Several artifacts, many of them temporally and functionally diagnostic, were retrieved during the course of the monitoring, and remnants of the footings of an early twentieth century water closet (?) were identified abutting the base of the parade wall towards the northeast end of enlisted men's barracks no. 2. An excavation made at the sally port in 1982 revealed remnants of one of the original ends of the wall, southwest of the interior portal, arcing 5 ft. further into the area of the parade than the corresponding present end of the wall.⁹⁴

3.2.7 Parade Ground

The 1803 plan of the fort (Figure 6) depicts the parade as having had two sections. On the side fronting the officers' quarters and the powder magazine, and covering roughly three-fifths of the parade, were a set of irregular plots, colored green on the original of the plan, divided from one another by 7-8 ft. wide walkways; there was, presumably, either lawn or some other form of cultivation of these plots.⁹⁵ A 10 ft. wide portion of this area, directly in front of the commanding officer's quarters, appears to have been fenced. The remainder of the parade and the walkways were presumably paved, evidently with a consolidated layer of sand and gravel. On all sides of the parade except toward the sally port, there was a single row of trees spaced 12 ft. apart, standing approximately 7.5 ft. out from the buildings. Single trees were located at either end of the cistern, and there were two at the west end of the commanding officer's quarters. Surface

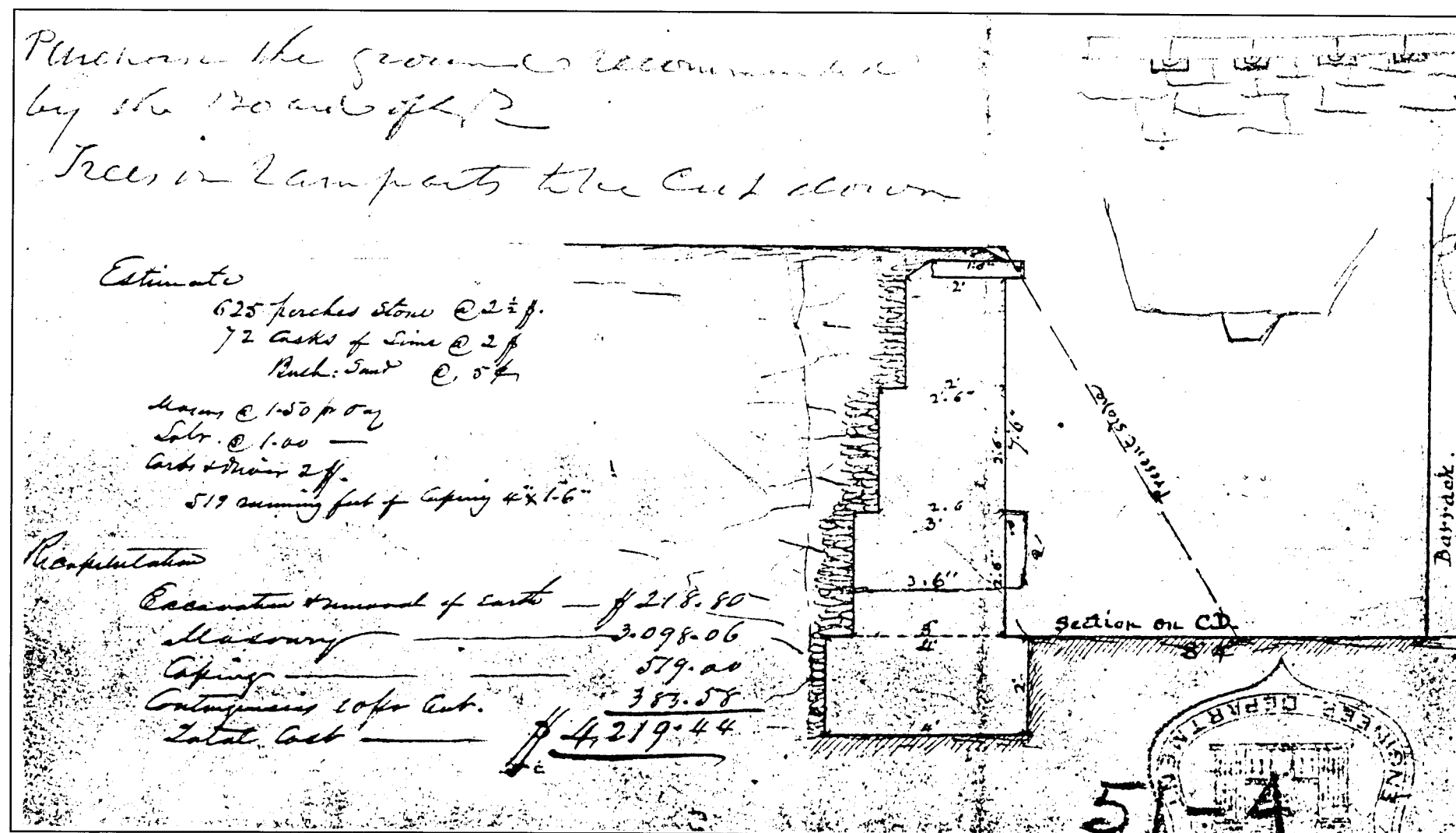

Figure 29. Detail of Fort McHenry, Md., ca. 1833, showing cross-section of parade wall behind enlisted men's barracks no. 2.

drains were also depicted on the 1803 plan, which, along with other data, indicate that the fort's powder magazine was on the more elevated side. The difference in elevation between the northwest side of the parade, where the magazine was located, and the southeast side, where the postern is now located was probably about 2-3 ft. The pre-postern feature on the 1803 plan into which the surface drains clearly emptied is identified simply as the "water conduit in the fort." An 1822 inspection report noted that the parade ground was planted as a flower garden,⁹⁶ suggesting, even more strongly than the 1803 plan, that much of the parade was cultivated.

The 1834 Lee plan (Figure 30), the next to depict the parade in any detail, shows the portion occupied by lawn or plots, reduced to one-quarter of the parade, confined to three 20-ft.-wide areas fronting the officers' quarters and the magazine, separated from one another and the rest of the parade by 4.5 ft. wide walkways. The flagstaff had been removed from the parade,

probably before 1819, and was instead located in bastion 5. None of the parade ground trees were depicted, most of them presumably having been removed when the 8-ft.-wide piazzas were built onto the residential buildings in 1829. The 1840 plan of the fort, although less detailed than the 1834 plan, indicates that few changes had occurred in the parade, beyond the removal of the bombproof over the well and of the guardhouse between the two barracks, and construction of a shot furnace at the site of the guardhouse. With the fort's transformation during and after the Civil War, there were more significant changes in the parade, beginning with the 1861 drilling of a new well at its center, and the installation of water lines from it to hydrants throughout the fort's grounds.⁹⁷ By 1872, when a steam-powered pump was installed over the well, the stage was set for the parade's final historical alteration, and by the early 1890s two major elements of the parade's present-day landscape existed: a tear-drop shaped lawn in the middle of the parade, offset slightly toward the enlisted mens'

barracks, and a surrounding gravel-surfaced (formerly shell-surfaced) loop roadway.⁹⁸ This last major change came about, in part, because by the late-1850s, if not earlier, the original core function of the star fort's parade ground, as the primary area of assembly for the troops garrisoned at the fort, had shifted to other locations within the fort's grounds.

Four reports contribute significant information on the development and composition of the parade ground. Stokinger monitored and recorded profile information from a water main installation in 1982, and conducted testing associated with investigation of parade ground gas leaks in 1983.⁹⁹ Also informative is Aivazian's 1982 report concerning work performed in 1978 in the vicinity of the 1813 well.¹⁰⁰ The fourth report documents investigation of the parade ground drain, part of a study of moat and drainage features made by JMA in 1988.¹⁰¹ Investigations of structures on the parade ground have not been designed to identify the sequence of changes on the parade; thus, stratigraphic information comparable to that identified by the preceding investigations is not available from them.¹⁰²

Most generally, archeological excavations on the parade have demonstrated that a definable stratigraphic sequence of development is preserved.¹⁰³ Reconstruction of the sequence is dependent, however, at least in part, on where excavations have been made. None of JMA's 1988 excavations was in the section in front of the officer's quarters, possibly covered in grass from ca. 1800 on. Stokinger's 1982 profiles are tied into the water main trench, and those in 1983 to the gas pipe locations, but the precise locations of the trenches are not altogether clear in the reports. Except for deeper features, the cultural sequence of strata below the parade generally extends to depths of only 1-2 ft. below the existing surface. Below that is strong brown/dark yellowish-brown sand, or sandy silt, almost certainly remnants of the original, natural surface soil of the site (Figure 31, strata D and G), overlying silty clay subsoil (stratum V) at depths of 5-5.5 ft. The clay subsoil has been noted at lesser depths in some excavations, however.

The natural sequence is capped by the probable initial cultural stratum, a clay layer (Figure 31, strata C and N) that may have been placed as a sealing cap to aid surface runoff, or as the base for the parade surface. Resting directly on this clay, at a depth of 1-1.2 ft. below the present surface, is a layer of pebbles and iron ore fragments in a strong brown sand (stratum T).¹⁰⁴ This most likely was the ca. 1800-1830 surface of the parade, but may have been just a construction era surface, ca. 1799-1800. Above this layer was another strong brown sand with pebbles and brick fragments (stratum R), in some areas separated from the underlying, ore-laden layer by a mottled clay layer (stratum S). The stratum R surface is likely to correspond with one or more of the episodes of development that began with the 1829 construction of second stories on the quarters and barracks, continued with 1833-34 construction of the parade wall and new surface drains, and concluded with the 1835-40 construction of gun

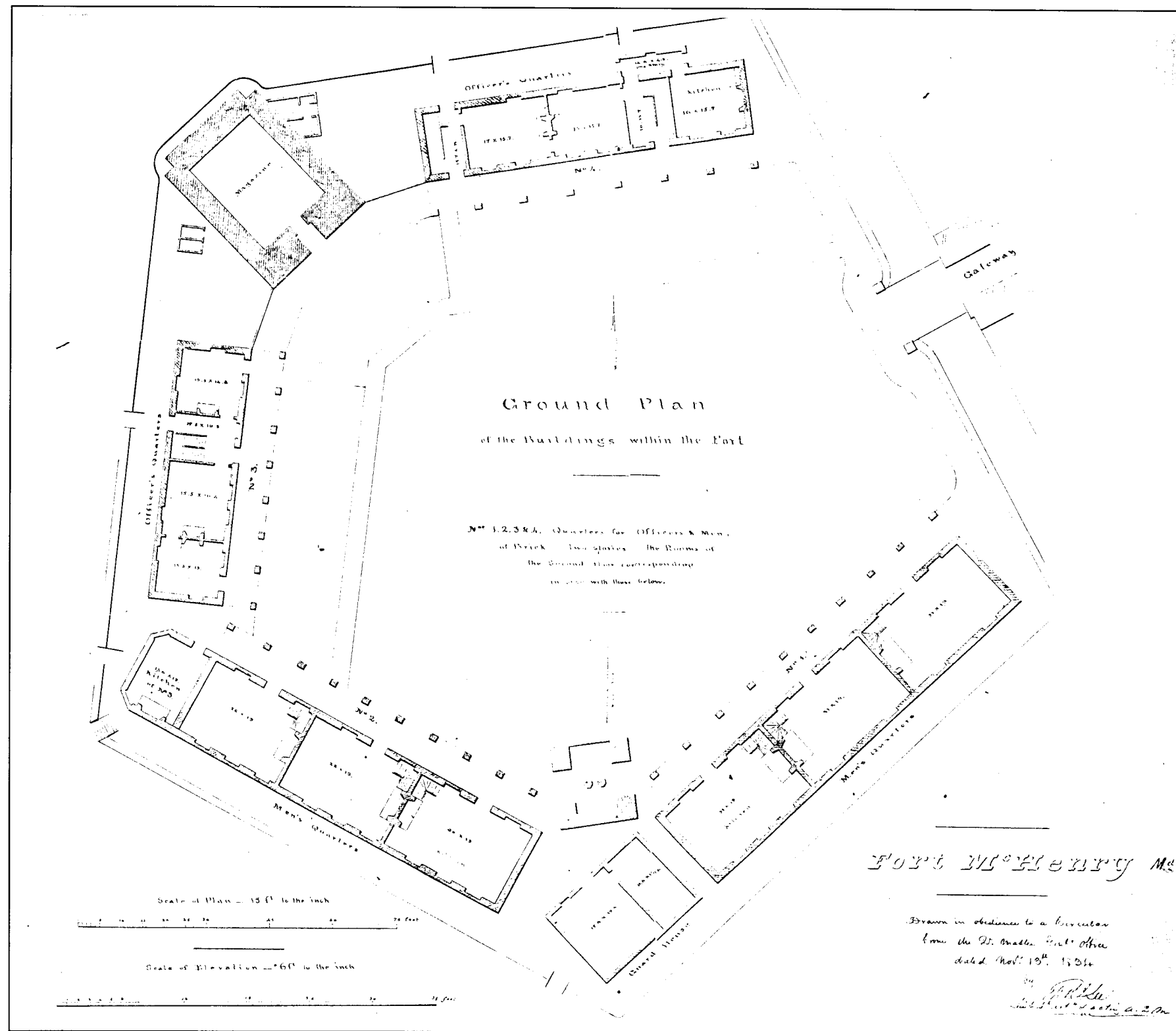

Figure 30. Detail of Lt. Thomas I. Lee's *Fort McHenry*, 1834, showing the fort's interior structures and the parade ground.

emplacements and the breast-height wall. (It is conceivable, however, that this stratum represents an earlier surface which remained at grade beyond the mid-nineteenth century.) Overlying the sand-pebble-brick-fragment surface in some areas was a scatter of crushed shell; the use of shell to surface roads and walkways is documented for the late-1870s; it may have been used earlier as well. The upper strata appear to be associated with the establishment of the central lawn, sometime after the 1861 well was installed (possibly ca. 1872, when a steam-engine powered pump), and with early twentieth century restoration activity.

The stratigraphy in the vicinity of the 1813 well shows some parallels to the sequence described above; nearly all of the sequence there, however, clearly post-dates the 1814-15 installation of the bombproof over the well. The bombproof is cut into a yellowish-brown to olive clay, and both this stratum and the bombproof foundation remnants are covered by a light brown sand; the bombproof is likely to have been demolished between 1837 and 1840, although the well itself remained in use until ca. 1870. Over the sand is a layer of packed yellow-orange clay and quartz cobbles which contains military artifacts from the 1830s to 1850s. Over the clay and cobbles were several layers with a high density of oyster shell.¹⁰⁵ The quartz cobbles seem to be in a different matrix than the strong brown sand found closer to the center of the parade and may have been an attempt to replicate the original parade surface with slightly different material. The artifacts found in this deposit presumably accumulated during its use, prior to the deposition of oyster shell in the 1870s.

Various disturbances of the parade followed its probable 1830s resurfacing, including the installation of water and gas lines, as well as the construction of the central well, the steam engine for pumping the water from the well, and the parade's oval roadway.¹⁰⁶ The upper-most layer of the parade ground today, in its central oval, is a layer of sod over the earlier strata. Further investigation could clarify the relationships between the various features that have been installed on or below the surface of the parade and the area's basic stratigraphy; it would not be surprising if such investigation forced revision of the interpretation of the stratigraphy presented here.¹⁰⁷

3.2.8 Star Fort Drainage and Postern

Fort McHenry's original drainage system has been the focus of considerable research at the fort, most notably the investigations conducted by Rutsch in 1974 and JMA in 1989. Archeological findings have proven consistent with historical research concerning fort construction during the seventeenth and eighteenth centuries: drainage at fortifications, at least surface drainage, was provided for, from the start of construction, by grading surfaces so that runoff was led to surface drains, which, in turn, were sloped to take the water to drains through the sally port and/or the

postern, which carried it to the fort's exterior. The archeology indicates that Fort McHenry's primary parade drainage system, designed as an element of the original fort, was a system of surface drains. This is, of course, what the 1803 plan of the fort also indicates.

There is more uncertainty regarding what provisions were commonly made for drainage of a fortification's rampart (see Figure 20A, however, for an example of rampart drainage), and for drainage of sub-surface architectural features within forts; the archeological findings at Fort McHenry in this regard have been similarly uncertain, or ambiguous. It is clear that the drainage of Fort McHenry's rampart, from an engineering and architectural standpoint, has long been inadequate, due either to an original design flaw, or to some inadvertent disabling, or neglect of maintenance, of an originally effective system. Likewise it is clear that by the late 1820s, if not earlier, whatever system existed for drainage of the cellars within the fort was no longer working adequately, forcing their abandonment. The earliest plans of the fort provide no answers concerning these questions, and the archeological interpretations offered below are necessarily tentative.

3.2.8.1 Rampart Drainage

The original plan for drainage from Fort McHenry's rampart evidently relied on surface runoff and the percolation of moisture into and through the rampart fill soils. Surface runoff from the parapets would have flowed over the cordon, dropping from there into the fort's ditch; runoff from the terreplein, presuming it was slightly sloped, would have been directed towards the interior revetment, and collected by the surface drain at its base. Deliberate provision may also have been made for the transpiration of excessive moisture from the rampart: Nelson and Walsh have both suggested that one of the purposes served by the trees originally planted on the fort's terreplein was that of ground water absorption.¹⁰⁸ No evidence of original weep holes, or of more elaborate drain outlets, have been found in any of the excavations at the base of the scarp wall. Further, as discussed below, Rutsch's 1974 hypothesis that the scarp wall's footing had been dry-laid in order for its open joints to function in the same fashion as weep holes has not been supported by later findings.

There were, however, two brick drains, at bastions 3 and 4, at least one of which extended beneath the level of earliest terreplein surface. As noted above, these features are less likely to be original and more likely to have been installed ca. 1813-15, in associated with the platforming of the bastions. It remains unclear what necessitated installation of drains only at these two bastions, and apparently not at the other three.

The continuity, as originally deposited, of the clayey fill soil composing the fort's rampart may to some degree have acted as a membrane, thereby

promoting surface runoff. There is, nonetheless, and very likely always has been, substantial retention of moisture within the fill of the rampart. The excavation of various trenches into the rampart fill may have worsened a preexisting problem, one basically attributable to the clayey composition of these soils, much if not all of it locally excavated from the geological formation underlying the naturally sandy surface soils of the site.

An alternative model for drainage from the rampart was proposed by Edward Rutsch in 1974, following the testing he performed that year along the scarp wall foundation below the surface of the ditch.¹⁰⁹ It appeared to Rutsch that the foundation had been dry-laid, with distinct gaps within the stonework. The reason for this, he suggested, was that the foundation had been engineered originally to allow water that had infiltrated the rampart

fill to flow through it, out onto the surface of the ditch. He argued, further, that this system's functionality had been destroyed by later filling within the ditch. Subsequent research, however, indicates that the foundations were mortared, not dry-laid, and that the ditch surface generally was at the level of the top of the foundation, not below it, as would have been necessary for otherwise impounded water to be released there.¹¹⁰

3.2.8.2 Parade Ground - Surface Drainage

The original plan for drainage from the surface of the parade ground is evidenced both by various historical plans, as well as by the existing system, which, as Rutsch documented, is a direct successor to the original

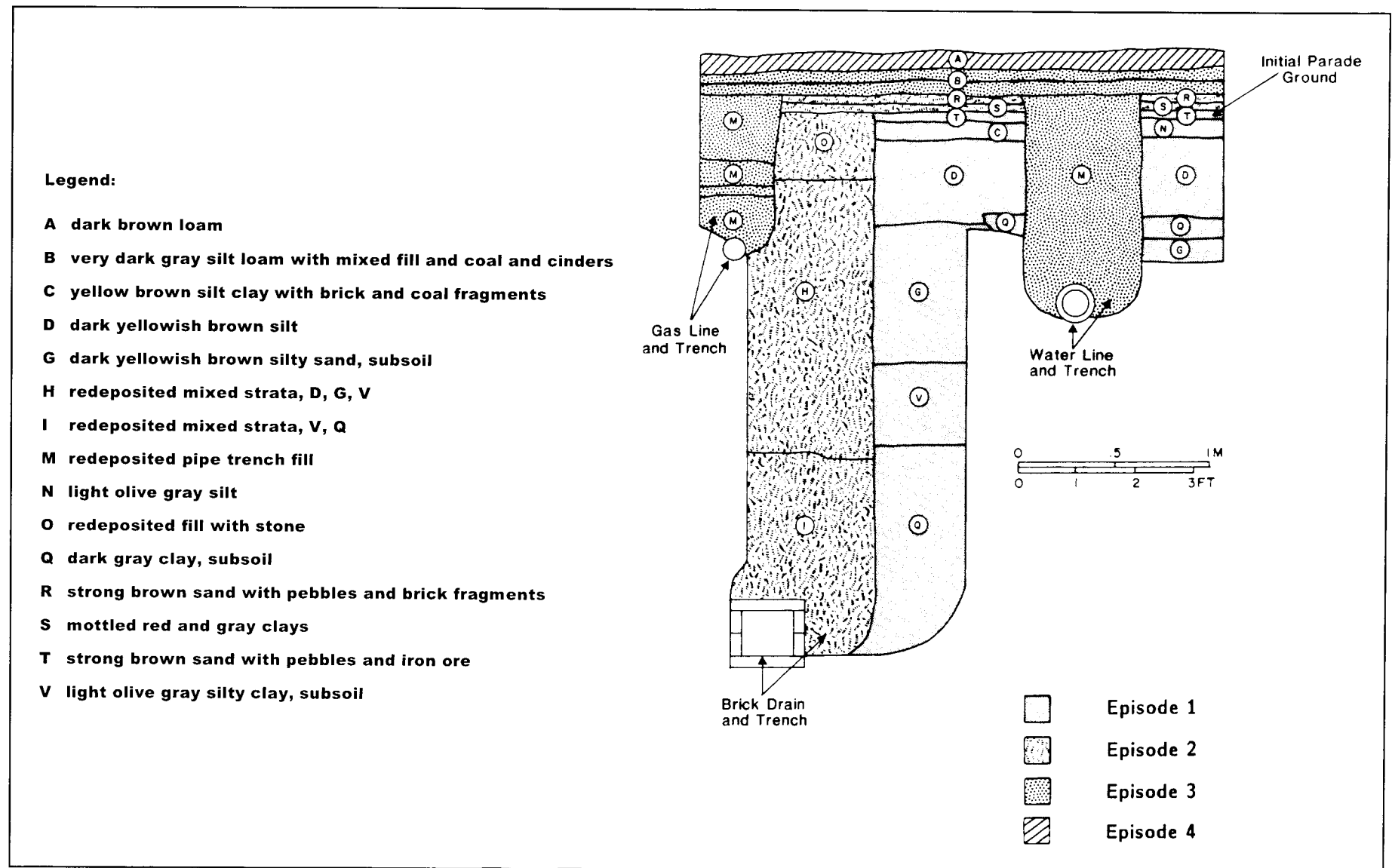

Figure 31. Profile of JMA's test unit 1, north face, 1988, showing the stratigraphy of the parade and the early drain (Cheek et al. 1989:Figure 4-19).

system.¹¹¹ Two loops of surface drains were depicted on the 1803 plan (Figure 6), aligned 4 ft. in front and in back of the buildings, with interconnections between the loops at a number of points. The outlet from the surface drains led to the “water conduit” behind enlisted men’s barracks no. 2. There is no indication of a drain beyond the scarp wall, and the outflow from the water conduit may have been onto the surface of the area immediate southeast of the fort, which was not enclosed by the fort’s counterscarp and glacis until 1813-14; the surface of that area is likely to have sloped down towards the low ground further to the southeast.

The same basic surface drainage system was still in existence in 1840, as depicted on the Smith plan of that year (Figure 27). With construction of the piazzas, however, the inner loop drain had been relocated to an alignment about 9 ft. in front of the buildings, and the outer loop had been relocated to an alignment near the base of the parade wall, 6.5-8.5 back from the buildings. The fort’s existing surface drainage system is basically a late-1920s or 1930s reconstruction of its 1830s configuration.

The postern was altered in 1813-14, and again in 1833-34 or 1836-38, as discussed below, which obviously would have affected drainage from within the fort. It has generally been thought that following the 1813-14 alteration, drainage from the fort’s surface drains flowed into the postern tunnel itself, and went from its lower end into a caponniere, which served as a passageway (as well as a water conduit?) beneath the ditch and the glacis.¹¹² (From a discovery made during monitoring of construction in 1999, it now appears that a separate drain was situated beneath the 1813-14 tunnel and the ditch section of the caponniere, with an inlet at the tunnel’s upper entrance, and an outlet about 40 ft. southwest of the lower end of the caponniere.¹¹³) The lower end of the caponniere was situated in low ground approximately 140 ft. southeast of the lower end of the postern, behind the central section of the lower water battery. When the low ground southeast of the fort was regraded ca. 1830, the caponniere (and the drain beneath it?) was evidently truncated, and a surface drain installed to carry the outflow from a point approximately 90 ft. southeast of the postern; this surface drain, labeled a sewer on Lee’s 1834 plan, trended in an easterly direction to the seawall. During the 1833-34 (1836-38?) postern alterations, a (new) drop inlet was established at the terminus of the surface drainage system within the fort, which connected with a vault-roofed masonry drainage conduit below the floor of the postern passageway, as shown in the cross-sections through the postern on the 1840 plan. In 1836-37 the caponniere and the surface drain to the seawall were replaced with an 18 in. diameter cast iron pipe. Sewer lines from latrines within the fort were evidently tied-in to the postern drain during the late nineteenth through early twentieth century; it was presumably when this system was established that the masonry conduit beneath the postern was replaced with iron pipe.

Archeological features deriving from nineteenth century surface drains have been documented adjacent to the northwest side of the powder magazine, where an officers’ privy was located, and in the vicinity of the ca. 1803-13 cistern, between the two enlisted men’s barracks, during work performed by Bryan Aivazian in 1978.¹¹⁴ Evidence of successive surface drains was also discovered at the edge of the parade adjacent to the sally port, in the course of a 1982 investigation of the sally port conducted by Dave Orr, Doug Campana, and Brooke Blades.¹¹⁵ Certain findings of the 1982 investigation suggested that a surface drain may have been located in the center of the sally port passageway floor¹¹⁶; no such drain is depicted on either the 1803 or the 1840 plan, however, and if it did exist, it is unlikely to have been a major element of the overall parade surface drainage system.

3.2.8.3 Parade Ground - Subsurface Drainage

A deeply buried, previously unknown, subsurface drain was encountered within the area of the fort’s parade in 1961, during installation of a water line. John Cotter was called upon to document the drain’s characteristics, and those of its installation trench, as revealed in the construction excavation.¹¹⁷ The drain’s trench (but not the drain) was again exposed in 1982, during Stokinger’s monitoring of the 1982 construction of a new, park-wide water system.¹¹⁸ What was either a continuation of the drain, or one built in a nearly identical fashion, with the same non-standard size brick, was discovered in 1984 in the southeastern part of the gorge, between the fort and the ravelin, north of the left flank of bastion 5, and documented by Brooke Blades.¹¹⁹ Finally, in 1988, archeological excavations conducted on the parade by JMA contributed more definitive information concerning the drain’s location, alignment, and stratigraphic context.¹²⁰

The bricks composing the top and bottom of the drain, laid perpendicular to the drain’s alignment, are all 13.5 in. long, while the drain’s sides were constructed of two courses of normal-sized, 8.5-in.-long bricks, laid on edge. The drain’s interior is 8.8 in. wide by 8.4 in. high. The segment of the drain found in the gorge was very similar, with a 7 in. wide by 8.5 in. high interior, but no mortar was observed there. JMA’s investigation determined that the drain’s brickwork had been mortared, and not, as previously thought, dry-laid. The water table beneath the parade was above the level of the drain, although the drain’s channel there, where exposed, was not blocked; the channel of the segment in the gorge, however, was filled with silt. The stratigraphic context of the drain indicates that it was installed either immediately prior to, or within a few year after, the placement of the parade’s first gravel surface (Figure 31). It may be an original feature of the fort, installed about the same time as the parade surface itself. Its clearly pre-dates later alteration of the parade, and its trench underlies the 1813-14 traverse interior to the sally port.

Projection of the alignment of the drain within the fort places its point of origin at the east corner of the filled cellar beneath the original northwest end of enlisted men’s barrack no. 1; with an adjustment of a few degrees, it would have exited the fort through the sally port (Figure 32). Presuming the segment of drain in the gorge is a continuation of the same drain, it turned approximately 60 degrees to the southeast after exiting the fort, so as to pass by the shoulder and left face of bastion 5, on its way to the nearest low ground, depicted on the 1803 plan as having been about 30 ft. southeast of the salient of bastion 5. Given the drain’s apparent fall across the parade, of approximate .15 ft. to 10 ft. of run, the intake would have been about 8.5 ft. beneath the ground floor of enlisted men’s barracks no. 1, and about 9 ft. below the floor of the sally port. The elevation of the segment in the gorge, 3-4 ft. below the surface, appears to be consistent with a slightly diminished rate of fall outside the fort.

The orientation and depth of the drain suggest that its origin was a floor drain in the cellar of enlisted men’s barracks no. 1.¹²¹ It was, most likely, part of a system of drains with branches coming from the cellars of all the residential buildings, possibly from the magazine’s below-grade ventilation space, and perhaps from the cistern. Two floor-level drain inlets, one of them very likely original, were noted upon excavation of the cellar of enlisted men’s barracks no. 2 in 1958 and 1966. The cellar drainage system may have been inadvertently disabled in 1813-14, when the fort’s dry moat and glacis were completed across the nearby low ground between bastions 4 and 5.¹²² The cellars were subsequently abandoned, and later filled, because of excessive dampness and drainage problems. After its complete excavation, for interpretive purposes, in 1966, the cellar beneath enlisted men’s barracks no. 2 was refilled in 1968, presumably because of drainage problems. The alternative function proposed by Rutsch—that the drain may have served as some sort of privy drain—seems improbable, particularly with the brickwork having been mortared, a fact unknown prior to the 1988 investigation.¹²³ Additional investigation, recommended previously, to further clarify the characteristics and function of the subsurface drainage system beneath the fort’s parade,¹²⁴ remains to be performed.

3.2.8.4 Postern

Drains at the location of the postern have served as the most important component of the star fort’s surface drainage system ever since the fort was built ca. 1798-1803. Construction of the postern tunnel, most likely in 1813-14, added the function of a line of communication between the fort’s interior and, initially, the pre-1830 water batteries, and, subsequently, the 1836-39 outer battery. The original drain functioned simply to carry runoff from the interior of the fort to its exterior. On the 1803 plan (Figure 6), this “water conduit in fort,” has a 3 ft. width, but other original characteristics are unknown. The 1803 plan does not depict a continuation of the drain

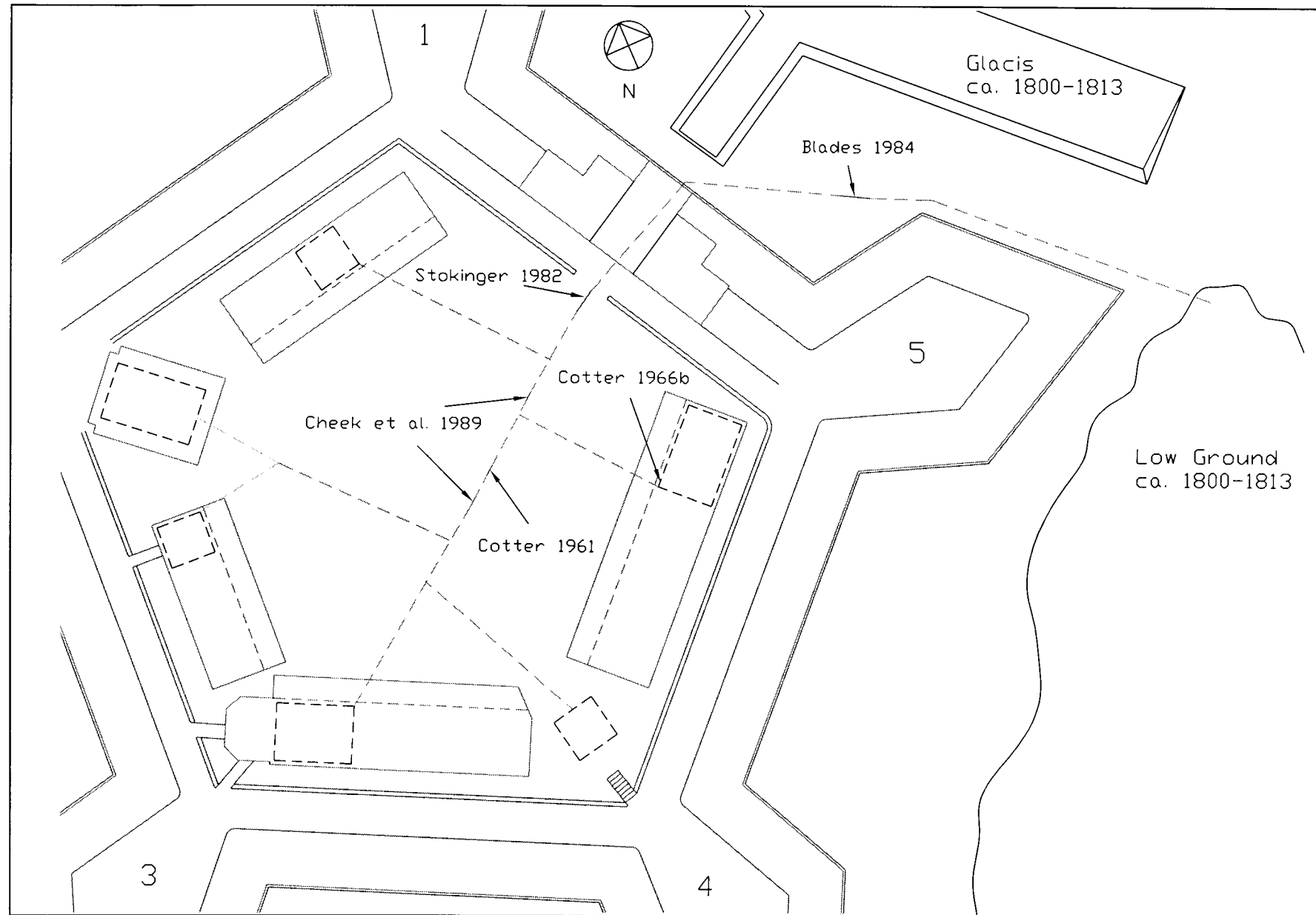

Figure 32. Conjectural plan of Fort McHenry's original subsurface drainage system. Arrows mark where the drain or its trench have been found.

across the area, later developed as part of the fort's ditch, between the scarp wall and the low ground further to the southeast, suggesting that outflow from drain was onto the surface of that area. Archeological excavation in the corresponding part of the ditch indicates that original grade was higher than the floor of the lower end of the postern. This suggests that if the original water conduit was as deep as the later tunnel there must have been a continuation of the drain originally, regardless of its absence from the 1803 plan. It is not known if the original "water conduit" was deepened in 1813-14, along with other modifications, in creating the first version of the postern tunnel, or if a entirely new structure was built¹²⁵ (Figure 33).

The 1819 plan and profile (Figures 7 and 18, profile G-H), depict a brick structure built into the terreplein revetment and centered over the upper, parade end of the tunnel. The structure was about 18 ft. long (in line with the revetment), 5 ft. wide, and 5 ft. high (above the terreplein); its height above the level of the parade, along the 4-ft.-wide passageway between the structure and enlisted men's barracks no. 1, was about 11.5 ft. The tunnel's 5 ft. high by 3 ft. wide opening was situated within the lower part of the structure. In profile, the top of the structure appears to have had a thin covering of earth. It may have been a magazine or shot furnace, but is more likely to have served as a traverse, protecting the postern tunnel's entrance

from bombardment-related damage. It was presumably built ca. 1813-14, and removed prior to 1834, possibly during the 1833-34 construction of the parade wall. Archeological evidence of the structure, in the form of remnants of two robbed trenches, were encountered in 1975, during archeological monitoring of the parade wall's partial reconstruction.¹²⁶ The two trenches, each about 1.5 ft. wide and 1 to 3 ft. below the present grade of the terreplein, were apparently associated with the structure's end walls; they were oriented perpendicular to the parade wall and were about 16.5 ft. apart, situated symmetrically to either side of the postern's upper portal.

The thickness of the postern tunnel's vaulted roof is not clear, but the 1819 profile implies that it was about 1-1.5 ft. The tunnel's ceiling was 2.5-4.5 ft. below the terreplein, and 10-11 ft. below the parapet. The lower portal of the postern, although enclosed by a structure which served to connect the postern with the caponniere (and possibly with tenailles to either side), extended from 10.5 ft. to 15 ft. below the scarp wall cordon, equivalent to between 2 ft. above and 2.5 ft. below the level of the nearby ditch surface. Along with the tunnel, and the possible traverse over the its upper end, it is evident from the 1819 plan that a caponniere below the fort's ditch and glacis was also developed in 1813-14.¹²⁷ Without that feature, the communication function of the postern could not have been fulfilled.

During the renovations implemented between 1833 and 1840, the postern was altered again. This second alteration probably began with construction of the parade wall in 1833-34.¹²⁸ Further alteration, or repair, may have occurred in 1835, following the collapse of the brick wall of the fort's sewer. As Thompson and Newcomb indicate, the term "sewer" was used as a synonym for the postern, and it is possible that a section of the postern collapsed and was repaired.¹²⁹ Alternatively, however, it may have been one of the walls of the caponniere that gave way, since it was also part of the sewer, as was the then relatively new drain, extending from a truncated caponniere to the fort's seawall, specifically labeled as a sewer on the 1834 plan. The post-alteration characteristics are, in any case, clearly depicted by longitudinal and transverse cross-sections on the 1840 plan of the fort.

In 1836-37, as development of the outer battery began, an 18-in.-diameter cast iron pipe was laid beneath it, and beneath a portion of the dry moat, where it was connected to a drop inlet. The drain extended to the seawall, replacing what remained of the 1813-14 caponniere as well as the ca. 1830 surface drain, but it apparently did not extend beneath the floor of the postern tunnel, and perhaps not across the area of the ditch nearest the fort's scarp wall. The 1840 cross-sections indicates that the postern drain was then a vault-roofed masonry conduit approximately 1 ft. high by 2 ft. 4 in. wide. An iron pipe that served as a combination drain and sewer is likely to have replaced the masonry conduit late in the nineteenth century.

During the partial reconstruction of the parade wall in 1975, one side of an alteration or repair trench over the postern tunnel was exposed; if

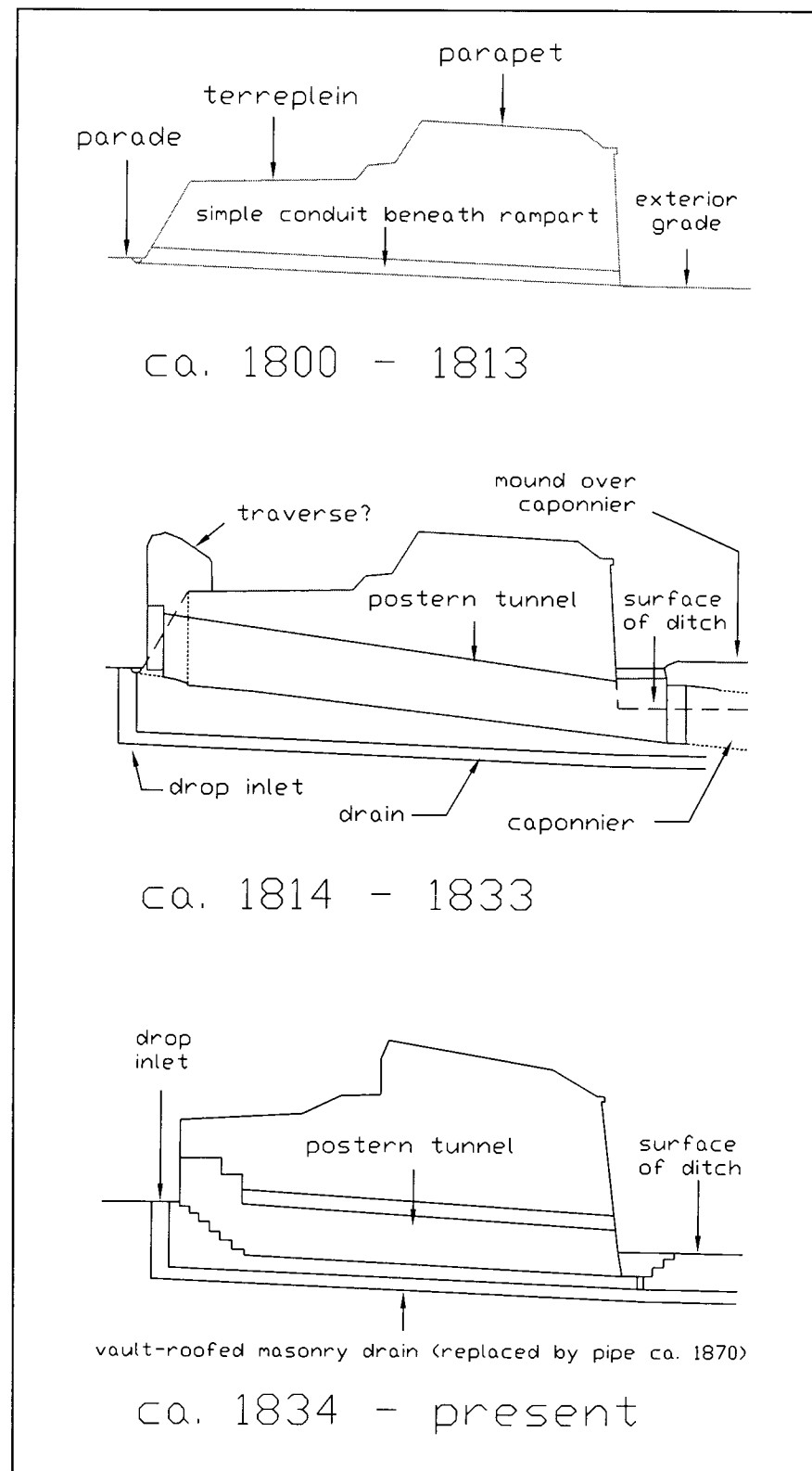

Figure 33. Sequence of development of postern tunnel; the ca. 1800-1813 configuration and the 1814-1833 drain are hypothetical.

symmetrical, the trench was apparently about 8 ft. wide.¹³⁰ Although the stratigraphy is not entirely clear, it suggests that the trench was excavated at the same time as, or soon after, the removal of the ca. 1813-14 traverse over the parade end of the postern, which probably occurred during the 1833-34 construction of the parade wall. In 1989, NPS archeological investigations examined a collapse of the terreplein above the postern.¹³¹ The top of the postern was exposed and the alteration/repair trench was again identified. The exterior surface of the postern was found to be covered with some type of cement, interpreted as a waterproof coating. The alteration/repair trench evidently cut through a stratum interpreted as corresponding to the gravel surface of the parade deposited in 1834-35, but which might have been earlier. A portion of a ca. 1835 (?) gun emplacement—the brick footing of a traverse circle—was also exposed in this excavation. The latter exposure was beyond the edge of the tunnel alteration/repair trench, however, and it was unclear whether or not the traverse circle extends over the trench. The precise sequential relationship between the gun emplacement and the trench consequently remains unclear, as does the dating of the trench.

3.3 Sally Port Complex

From initial construction in 1798-1803, up until the present, Fort McHenry's sally port has undergone numerous changes. The sally port entrance on the 1803 plan (Figure 6), which is its earliest depiction, appear to have been a simple, non-roofed passageway through the rampart of the curtain between bastion 1 and 5.¹³² A gate at the scarp, and a causeway interrupted by a small, presumably removable bridge at the exterior portal, were the only architectural defenses of this entrance, and there were no other structures directly associated with it. In 1813-14, prior to the bombardment, a brick traverse was constructed on the fort's parade interior to the sally port passageway, and a ravelin was built exterior to the entrance, immediately beyond the counterscarp, where the roadway had previously crossed the glacis via a ramp. A watercolor depiction of the September 13, 1814, bombardment of Fort McHenry, which is believed to have been painted soon after if not during the event, provides a somewhat distorted view of the fort, but shows what can only have been the sally port, and shows it with a vaulted or arched entryway.¹³³

In 1814-15, beginning immediately after the bombardment, bombproofs were built to either side of the sally port, with entrances adjacent to the passageway (Figure 33). The vaulted roof of the sally port may have been built, or rebuilt, at the same time, and a platform was established over the sally port which became known as the observatory. With the redeposition of fill over the bombproofs, the earlier parapet and terreplein here were replaced by terraces (Figure 7). There was yet another major episode of construction in 1835, when the guardhouses were added on the sides of the

entrance passage; additions were built onto the guardhouses in 1857. In addition to being the main entrance for men and materials, the sally port passageway has also been, since at least the 1860s, the main corridor for underground pipes and conduits.

Archeological investigations at the sally port, undertaken in 1982-83 in conjunction with the installation of a new water line and conduit, and repaving, have focused on the area of the gorge directly exterior to it, on the ramp at its entryway, and on the floor of the passageway.¹³⁴ Archeological testing has also been performed over the southeastern sally port bombproof in conjunction with HABS recordation, and more recently over the northwestern bombproof, and on the nearby ramp to the terreplein.¹³⁵

3.3.1 Gorge¹³⁶

The gorge is the area between the sally port curtain and the ravelin. As shown by the 1803 plan, the area was originally part of the fort's ditch, across which a causeway and bridge carried the entrance road. The bridge, adjacent to the sally port, was about 13-14 ft. wide by 14-15 ft. long, and is likely to have been removable. The causeway was eliminated during the 1813-14 construction of the ravelin, after which the gorge was crossed by a 62 ft. long by 16 ft. wide bridge, with a 10 ft. long by 9 ft. wide section adjacent to the sally port likely to have been removable or retractable. The bridge was supported by five pairs of brick piers, spaced 10-12 ft. apart (Figure 18, Profile on the line A...B). The deck of the bridge, approximately 7.5 ft. above the surface of the gorge, appears to have been at about the same elevation as the existing floor of the sally port, but 1.5 ft. higher than the contemporaneous sally port floor. Cartographic data suggests that the 1819 surface of the gorge is 2 to 4 ft. below its existing surface. There is, however, evidence for substantial, though poorly understood, variation in the characteristics of historical grade alterations in different areas of the gorge, and archeological estimates of the general change in elevation range from 1-2 ft. to 3-4 ft.¹³⁷

Archeological investigations within the gorge, conducted in conjunction with utility installation and repaving projects, have documented archeological deposits associated with construction of the ravelin, and evidence of at least ten episodes of paving in the gorge near the base of the ramp.¹³⁸ The pre-1813, pre-ravelin moat surface has not been specifically identified, and aside from bridge abutment piers incorporated into the scarp wall, no features associated with the original causeway and bridge have been revealed. Brick pier footings associated with the ca. 1814-39 bridge, and the contemporaneous surface of the gorge, however, have been identified, as described in the following subsection. Several historical and modern utility lines were encountered; the utilities converge in the area of the gorge and enter the star fort through the sally port.

The builders' trench for the 1866 ravelin magazine was found to extend 5 ft. into the gorge. Remnants of the foundations of a ca. 1866 stairway that provided access to the ravelin's terreplein were located along the gorge wall northwest of the ravelin magazine.¹³⁹ Various brick and ceramic drains have also been documented in the area of the gorge.¹⁴⁰ One of the brick drains, as noted above in the subsection concerning the fort's drainage, is likely to have been part of the original system for draining the cellars of the residential buildings inside the star fort. The others evidently originate within the bombproofs on either side of the sally port.

3.3.2 Ramp

The existing ramp immediately exterior to the sally port was first built ca. 1837-39 to replace the earlier bridge which crossed the gorge 7.5 ft. above its surface. This modification was made in large part to provide access, by way of the gorge, between the road which entered the fort grounds from the northwest, and the water (outer) battery to the east and south of the fort. Archeological investigations have been undertaken on the ramp in conjunction with the installation of modern utility lines and with a repaving project.¹⁴¹ Stokinger recovered archeological evidence of nine utility lines and identified five additional utility lines on historic maps which may have been destroyed by modern utilities. The scarp wall below the sally port entrance has been repeatedly damaged during the installation of the lines. Aside from the deeply buried brick drain which is presumed to extend through the sally port, and is likely to be nearly as old as the fort itself, the earliest of the various historical utility lines there is a water line installed during the Civil War. The sally port alignment, historically and presently, has the advantage over the alternatives of not requiring excavation or tunneling through the fort's rampart.

Investigations conducted in 1982 encountered two stone bridge supports, bonded into the scarp wall beneath the northwestern side of the exterior entrance to the sally port, their position indicating the likelihood that originally there had been four such supports spaced about 3.5 ft. apart.¹⁴² They are depicted on the 1819 profile through the sally port, bridge, and ravelin; they presumably supported the 1803-13 bridge as well as that of 1814-39. During the waterline installation monitoring project, at least two and possibly three of the freestanding brick piers associated with the 1814-39 bridge were also encountered.¹⁴³ The stratum found at the same depth as the remnant upper surfaces of these piers, approximately 4 ft. below existing grade in the vicinity of the lower end of the ramp, appears to represent the 1814-39 grade of the gorge. During the same monitoring project, a deep, early historic (1790s?), but otherwise unexplained earth-fill feature was discovered approximately 30 ft. northeast of the sally port

entrance, 2 ft. below the 1813-39 surface, and extending to a depth of more than 6 ft. below the existing gorge surface.

The 1839 brick ramp consists of two parallel brick walls supporting the fill on which the pavement of the road is laid. At the scarp, Orr et al. identified an undisturbed segment of the original earth ramp.¹⁴⁴ The investigations of the ramp identified a multitude of fill deposits represent the installation of utility lines, ramp paving, and construction of the brick side walls. Two probable early road grades were identified, and several modern paving episodes were also represented.¹⁴⁵ One late-nineteenth century surface gutter was identified on the ramp.¹⁴⁶

3.3.3 Sally Port Passageway Floor

Like the ramp, the sally port passageway floor has been the focus of archeological investigations associated with the installation of utility lines and with repaving; however, the original configuration of the passageway floor remains uncertain. Evidence was nonetheless found of two separate episodes of brick paving, ca. 1815-1844, and 1844 to the late nineteenth century.¹⁴⁷ In the late nineteenth century, the brick paving was replaced by oyster-shell, which was later overlaid with macadam. Grade beneath the earliest paving sloped toward the center of the passageway, suggesting that there had been a central drain; there was, however, very little slope between the interior and exterior ends of the passageway, and any drain there is unlikely to have been a substantial element of the parade's surface drainage system. Construction excavations would have long since destroyed all traces of any gutter. The surviving remnants of the early paving were not sufficient for interpretation of its pattern, but the later pavement evidently had been laid in a herringbone bond.¹⁴⁸ There is, further, documentation that the 1880s brick floor had been laid edgewise in a herringbone pattern, and that there were granite wheel tracks and a central gutter.¹⁴⁹ When the passageway's pavement was restored in 1983, however, the pattern adopted, i.e., a uniform herringbone pattern, the bricks laid flat, was one quite unlikely to reflect its historical pavement

During the sally port paving project, consistent with the general belief that the sally port vault was built (and the passageway walls supporting it rebuilt) at the same time as the bombproofs to either side, it was apparently assumed that the lowermost floor of the passageway postdated the 1814-15 construction of the bombproofs.¹⁵⁰ Stokinger, however, suggested that this episode of construction did not significantly impact the original floor of the passageway, implying that the passageway walls, and perhaps the vault itself, are original features of the fort.¹⁵¹ A narrow builders' trench was identified adjacent to the southeast bombproof entrance. If this feature was associated with the original construction of the bombproofs, it would lend support to the idea that the context into which it was dug, constituting the

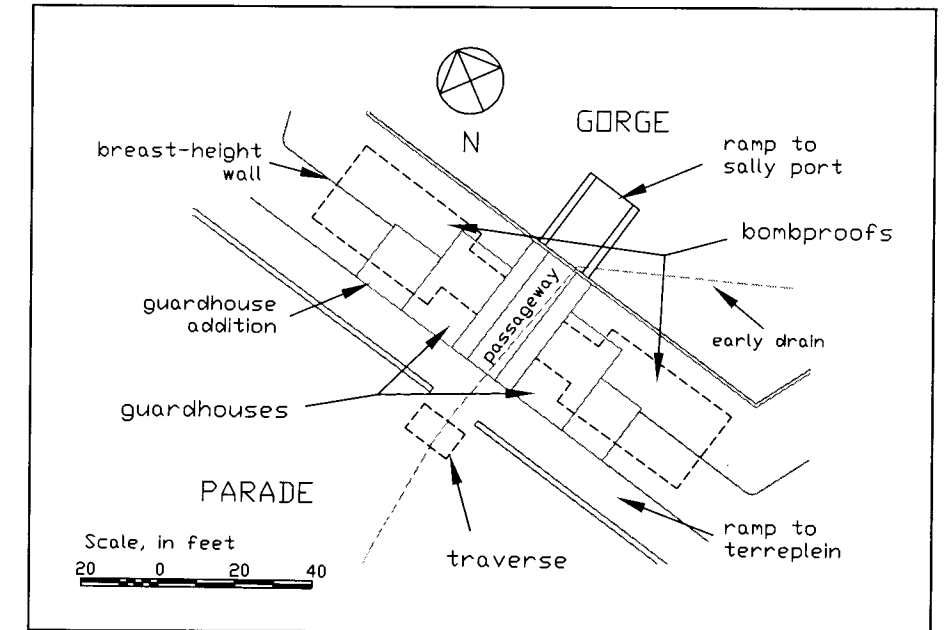

Figure 34. Structures at the sally port.

lowermost passageway floor, was original, ca. 1798-1803 fill. It would in addition imply that the passageway walls, for which no builders' trenches were identified, and perhaps the vault they support, are also original. It remains possible, however, as suggested following the 1982 investigation of the passageway, that the bombproof entrance builders' trench was associated with some post-1815 repair or alteration episode, possibly the 1835 modifications made to the bombproofs to accommodate construction of the guardhouses above them.

3.3.4 Traverse

In 1813, in anticipation of a British attack, a brick traverse interior to the sally port was among the elements recommended and built to strengthen the fort's defenses.¹⁵² A similar traverse was built about the same time in front of the magazine entrance. The sally port traverse, during any attack, would have been the final defense feature protecting the fort's interior, of use only if an enemy breached the gates, primarily by impeding artillery fire into the fort through the sally port. The need for the traverse was largely eliminated by the completion of the ravelin in 1814; it is not known if the traverse was removed prior or subsequent to the bombardment.¹⁵³ The traverse is not depicted on any of the known plans of the fort.

Remnants of the base of the sally port traverse were encountered during the 1982 investigations associated with the repaving of the sally port and the waterline installation.¹⁵⁴ These remnants, located 16 to 24 ft. from the interior end of the sally port, between depths of 1.5 and 3 ft. below grade,

consist of a foundation of poured mortar, 8 ft. wide by 13 ft. long (1 ft. longer than specified) by 1.5 ft. deep; embedded in the eastern quadrant of the foundation, between depths of 1 and 3 ft., was the base of a .75 ft. thick stone slab. The mortar had been poured into a pit, and the traverse built on top of it. (Underlying a portion of the poured mortar footing, and extending toward the sally port, is a trench believe to be associated with the fort's original subsurface drainage system.¹⁵⁵) The traverse superstructure, which documentation indicate was of brick, and 6 ft. high, had been completely removed, presumably ca. 1814-15.¹⁵⁶ The 1982 excavations found that installation of historical and modern utility lines has destroyed portions of the traverse remains; the 1982 installation of an 8-in. water main completed the destruction of the northwestern end of the traverse.

3.3.5 Bombproofs

Subterranean bombproofs were built on either side of the sally port in 1814-15, beginning immediately after the British bombardment of the fort. Prior to this there were no personnel bombproofs within the star fort. The initial design, for timber bombproof structures, was abandoned shortly after construction began, and vault-roofed brick structures were built instead, with entrances at the middle of the sally port passageway.¹⁵⁷ Historical records indicate that serious water infiltration problems existed from the beginning, and in 1829 it was recommended that the fill over the vaults be removed and a sheet lead covering be placed on them. Upon construction of the sally port guardhouses in 1835, the sections of the vaults at the entrance ends of the bombproofs were replaced by lower-roofed anterooms.¹⁵⁸ In 1857, additional prison and guard rooms were built over the bombproofs, abutting the sides of the guardhouses away from the sally port; further, but undocumented, modification of the bombproofs' vaults may have been made then as well. With the conversion of the bombproofs into magazines in 1861, new ventilators were built. Below-grade concrete 'roofs' over the vaults, and associated drains, partially documented by archeological testing in 1958 and 1993, may also have been built at that time, but this interpretation remains uncertain. In 1863 asphalt was applied to these roofs for waterproofing. Subsurface drains extend through the base of the scarp wall and into the gorge from the interior of each bombproof.¹⁵⁹ Iron pipes extending through the scarp wall above grade, on either side of the sally port, are likely to have been the outlets of the ca. 1861 (or earlier) brick drains, situated below grade within the rampart over the bombproofs, at the perimeters of the concrete roofs.¹⁶⁰

In 1958, two trenches were dug over the southeast bombproof (dungeon 2), to examine the relationship of the foundations of the guardhouse/prison to the bombproof's vault.¹⁶¹ The first trench, along the southeast wall of the guardhouse/prison, was abandoned without close study of the structure's foundation when an asphalt-coated concrete slab—presumed to be of

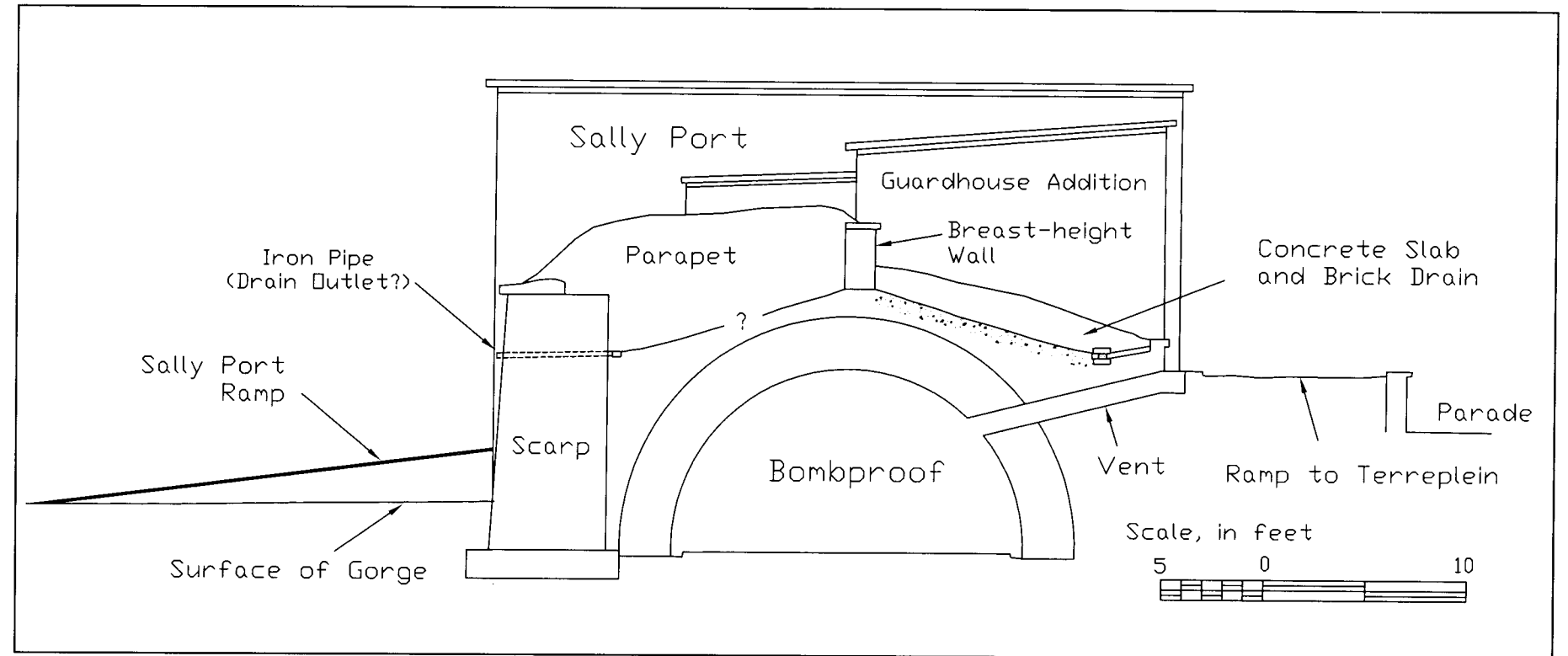

Figure 35. Cross-section through the rampart northwest of the sally port.

Portland cement, and modern in origin—was encountered 1-2 ft. below grade. The second trench, over the southeast end of the bombproof, exposed the end of the asphalt-coated slab “corresponding approximately with the end wall of the dungeon beneath..., adjacent to and beyond which, at lower elevations, were brick and lime mortar masonry of older date” There is no indication that lead sheeting supposed to have been put over the bombproof vaults in 1829 was encountered in 1958.

An excavation made by JMA in 1993 over the northwest sally port bombproof exposed an asphalt-coated concrete slab there as well, its surface sloping down from the base of the breast-height wall to a perimeter drain; the drain was found directly behind the low revetment wall along the ramp to the terreplein (Figure 35).¹⁶² The slabs over both bombproofs presumably extend over the full extent of the vaults, except where the guardhouses and perhaps their additions are located, below the parapet as well as interior to it, and the perimeter drains were presumably continuous as well. Pairs of iron drain pipes extend through the scarp wall on each side of the sally port, about 6.5 ft. above grade and 3.5 ft. below the cordon, and about .75 ft. below the level of the perimeter drain on the opposite side of the northwest bombproof. One of these pipes on each side is very likely the perimeter drain's outlet. The highest sections of the slabs are at (and perhaps beneath) the breast-height wall, over the center of each of the vaults; the slabs there, with an assumed thickness of about 1 ft., would rest

directly on top of the brick masonry of the vaults. The lower, outer sides of the slabs are several feet above, and extend 1-2 feet beyond, the exterior sides of the underlying vaults; regardless of their thickness, the sides of the slabs undoubtedly rest on the earth fill surrounding the vaults.

The brick drain associated with the concrete slab over the northwest bombproof, as exposed in 1993 behind the low revetment wall along the terreplein ramp, was 2 ft. below grade and about 3 ft. below the level of the slab adjacent to the breast-height wall. Its channel, .4 ft. wide by .25 ft. deep, and aligned parallel to and 2.5 ft. back from the revetment, was covered by bricks which had been set, but not mortared, length-wise over its top. A mortared brick pavement sloped down to the drain from the back side of the revetment. The drain is not presently functional.

The precise age of the slabs remains uncertain; they clearly were not original elements of the 1814-15 vaults beneath them, but were almost certainly added prior to 1863, when asphalt waterproofing was applied to them. There are at least two possible periods of origin: ca. 1835-37 and 1857-61. If (as remains to be determined) the slabs extend beneath the breast-height wall, and the fabric of the wall in these areas remains as originally built, then the slabs would date to, or before, 1837. Conceivably, in other words, the slabs date to the 1835 construction of the guardhouses. However, although the slab exposed in 1993 appeared to extend beneath the

wall of the northwest guardhouse addition, built in 1857, the floor of the addition is evidently lower than the slab; this implies that, if the slabs had been built ca. 1835-37, their partial removal would have accompanied 1857 construction; as of yet, no evidence of such removal, and subsequent repair, has been observed. If, however, the slab was laid when the addition was built, the footing for the addition's wall could have been formed into the slab. The apparent extension of the slab beneath the addition's wall may be an artifact of later work on the addition's wall, and if that is the case, the slabs would most likely date to the 1861 conversion of the bombproofs into magazines, when the incentive for waterproofing them was greatest.

The bombproof floor drainage system was examined in 1988.¹⁶³ Excavations in the gorge examined the locations where the drain from the southeast bombproof exited the fort. The original, ca. 1861 (?) brick drain and a twentieth-century ceramic-pipe replacement drain were encountered. Renovations in 1929 included repair or replacement of the brick drains and provision of new catchment basins.¹⁶⁴ The ceramic drain pipe, cemented to the older drain at the scarp wall, may have been installed as late as 1963.¹⁶⁵

3.3.6 Guardhouses/Prisons

The above-ground structures flanking the sally port inside the fort were built in 1835 as guardhouses, with portions of the underground bombproofs modified to accommodate them.¹⁶⁶ In time, the northwest building would become a one-room prison, while the southeast building remained a guardhouse. The buildings were enlarged in 1857 when small additions were built, a cell-block to the southeast and a guard room to the northwest. The buildings have been used for storage as well as their intended functions. Modern utilities that have been added to the interior of these buildings may have destroyed archeological deposits associated with their construction. A 1958 trench adjacent to the southeast addition was abandoned when a concrete slab, assumed to be modern (although in fact probably of mid-nineteenth century origin), was encountered.¹⁶⁷ A small excavation made in 1993 at the juncture of the breast-height wall with the northwest prison addition exposed modern drain lines and other utilities.¹⁶⁸ No other archeological investigations have examined the subsurface features which may be associated with these buildings.

3.4 Star Fort Interior Structures

3.4.1 Powder Magazine

The core of the powder magazine within Fort McHenry was evidently built between 1797-98 and 1800, as were the various other original structures inside the fort. Its site, on the more elevated side of the parade, may have

been selected to insure optimal drainage. The structure is first depicted on the 1803 plan of the fort. The otherwise similar 1806 plan depicts a 1 ft. wide curtain wall which enclosed triangular areas of the parade adjacent to the sides of the magazine, and extended across its front end, 6 ft. out from the entrance (Figure 36). This wall may have served as a defensive or safety barrier, but it is also likely to have provided privacy for the officers and their families residing in the buildings on either side. The privies which were documented in these areas beginning in 1834 were probably built many years earlier, possibly as early as the residences themselves.

The original magazine, of brick on stone foundations, had 5-ft.-thick side walls and 3-ft.-thick end walls; the characteristics of its original roof are not known, although it is likely to have been vaulted, and about 3-4 ft. thick. The magazine was not considered bombproof, however, which was a source of great concern prior to and during the 1814 bombardment. In 1813, a 8 ft. by 12 ft. traverse, "as high as the top of the window over the doorway," was built 8.5 ft. to 16.5 ft. out from the magazine's original entrance. The traverse was situated exterior to the alignment of the earlier curtain wall, but the 1.5 ft. wide gap between these structures suggests that the curtain wall is likely to have been partly removed when the traverse was built. Concern about the magazine's vulnerability as the bombardment commenced resulted in the removal of barrels of powder to the protected dry ditch or tenaille on the fort's landward side. One wall of the magazine was seriously damaged during the bombardment, when a corner of the structure sustained a glancing hit by a shell that fortunately failed to explode. Within two weeks of the bombardment the magazine had been repaired and bombproofed.¹⁶⁹ With construction of additional exterior brick walls, the thickness of its side walls was increased to 10.3 ft., its back wall to 6 ft., and its front wall to 8 ft.; the vault thickness was increased to 7.3 ft. A vaulted brick cap was built over the magazine's entrance, connecting the magazine's front wall to the traverse, which now stood only 3.5 ft. out from the doorway. The entire front section of the original curtain wall, and perhaps the rest of it as well, was undoubtedly removed at this juncture, if it had not been earlier. More than a year went by, however, before a new slate roof was constructed over the bombproofed magazine. The earliest known depiction of the bombproofed magazine is on the 1819 plan.

In 1829 the magazine traverse was removed, so that the doorway and the window over it could provide more light to the interior, and the building may briefly have been used as an office or storeroom. In 1836-37 the ventilation space below the magazine's timber floor was filled, and a brick floor installed; in 1837 as well, a high window on the magazine's back wall was replaced by a ventilation slot.¹⁷⁰ In 1839 the magazine was reported to be "in good order," except for the absence of a traverse. However, in both 1836 and 1839, it was noted that the height of the magazine's roof could make it a conspicuous target for enemy fire, and there was a continual problem then, as now, with dampness. Curtain walls, connecting the front

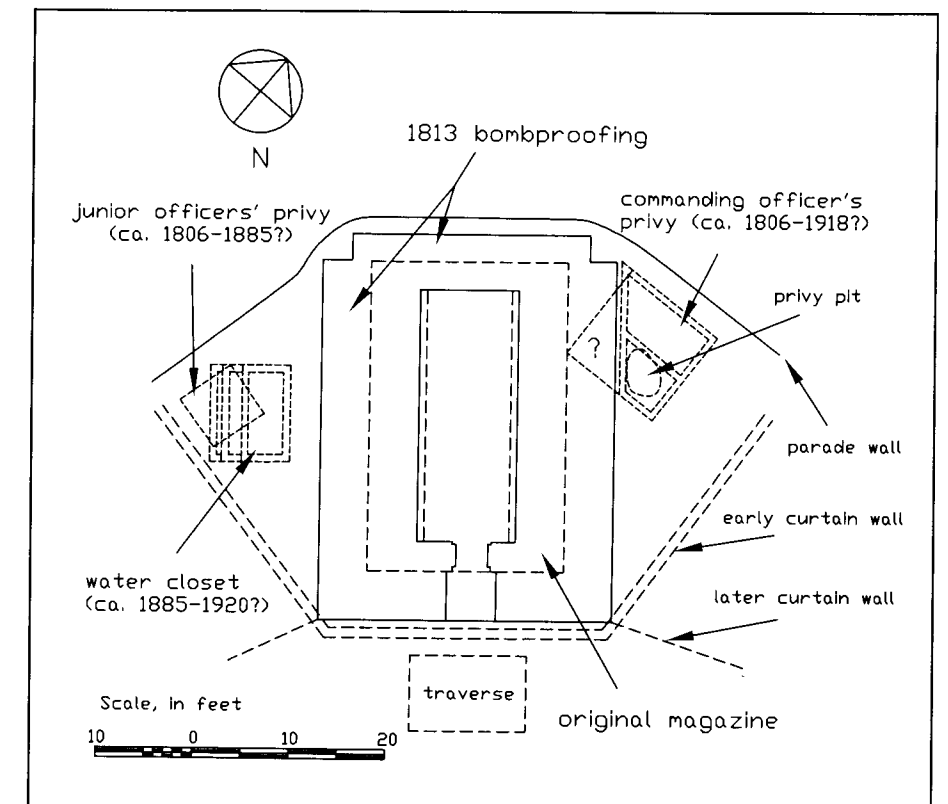

Figure 36. Structures in the powder magazine vicinity.

(south and east) corners of the magazine to the adjacent corners of the commanding officer's and junior officers' quarters, reappear on fort plans of 1834 and 1840, but are apparently later removed. Enlargement of the magazine was considered during the Civil War, but instead the bombproofs were converted to magazines, and the large detached magazine northwest of the fort was built.¹⁷¹ The magazine's existing inner door evidently dates to 1878, indicating that the structure continued to be well maintained during the post-war period. By the late 1880s or 1890s, however, the magazine was being used for coal storage, perhaps in connection with the conversion of the former junior officers' quarters into a bakery.

The only archeology to have focused on the parade magazine was that which accompanied the 1958 HABS recordation.¹⁷² One excavation was on the interior, "adjacent to the front wall and entrance, to permit examination of the footing from the interior," since the bombproofing prevented examination of the original structural footings from the exterior. Areas exterior to the front (southeast) end of the building and its southwest side were also studied, and the extension of the footing of the ca. 1806 curtain wall into the area northwest of the building was explored. On the interior, below two successive brick floors (the lower one presumably installed in 1836-37), was relatively clean, 1836-37 fill soil. The stone foundation of the magazine's original core was found to form a .5 ft. wide

ledge on the interior of the side walls; the ledge would have supported the magazine's pre-1836 floor joists. The depth of the ledge, as shown on the HABS drawings, was slightly less than 1 ft. below the existing brick floor. The base of the foundation was 5.7 ft. below the ledge. Ground water was encountered well above the base of the foundation, and the depth of the original ventilation space was not determined. Nearly all of the foundation of the 1813-29 traverse, and much of the ca. 1806 curtain wall base, were exposed exterior to the magazine. Blocked vents were discovered below grade along the magazine's southwest wall, where the soils were characterized as extensively disturbed. A concentration of fragments of ceramic (red-clay) roofing tile was discovered which was interpreted as possibly deriving from a former (original?) roof of the magazine or of its traverse. Several feet away from the magazine's southwest wall, the remains of a ca. 1885 (?) water closet (termed the junior officers' privy) were discovered, as discussed below. Although no exterior surface drain was noted adjacent the southwest wall, a 1978 investigation of the commanding officer's privy (which above the level of the drain had abutted the magazine's northeast wall) revealed such a drain there, and it is likely that drains were installed along both sides ca. 1814-15.

The footings of the ca. 1806 curtain wall, as exposed in the 1958 excavations, consisted of three parallel stretcher rows (withes) of mortared brick.¹⁷³ The footings were at least partially demolished during 1813-14, due to the traverse's construction and the bombproofing of the magazine. A section of the curtain wall's footings was also documented during excavations in 1980 at the site of the junior officers' privy.¹⁷⁴ The mortared brick remains of the traverse foundation were discovered in 1958, directly beneath the present brick walkway. The excavations established that the length of the traverse had been 12 ft., but the original width, beyond the surviving 6.5 ft., could not be ascertained, because of damage to its southeast side stemming from the installation of utility lines.¹⁷⁵

3.4.2 Wells and Cistern

A well was likely dug near the later site of Fort McHenry during the development of the 1776-80 fortifications, and Rivardi, in 1794, noted the presence of a spring in the lower water battery.¹⁷⁶ The locations of these features are unknown. There is a small circular feature on the 1819 plan of the fort, in the upper water battery approximately 90 ft. east of the tip of the ravelin, which may represent an otherwise undocumented, possibly early well. When the star fort was built, there was a cistern located on the parade between the two enlisted men's barracks.¹⁷⁷ For several years prior to the War of 1812, however, the garrison at the fort obtained drinking water from a city well in Baltimore, transporting it to the fort by boat in casks. In several attempts at establishing a fully reliable well at the fort, the water "had consistently proven unwholesome."¹⁷⁸

As part of the preparation for a British assault in 1813, a well was again attempted. A 12 ft. diameter excavation was made on the fort's parade, several feet north of the cistern, to a depth of nearly 40 ft., by shoring it like a mine shaft, at which point a cylinder of tongue-and-groove sheet piling had to be driven to extend the excavation through "soft strata of mud and water."¹⁷⁹ Overall, the 1813 well was 95 ft. deep, and yielded 18 gallons a minute of pure drinking water. This well would remain the major, if not only, source for the fort's drinking water until 1861. Immediately after the 1814 bombardment, a bombproof vault was constructed over the well. As shown on the detailed 1834 fort plan (Figure 30), the well's brick bombproof was approximately 19 ft. square, supported on corner pillars about 4.5 ft. square; the south side of the structure, towards the river, had a 3.5 ft. thick wall, while the north side, toward the parade, had a .5 ft. thick wall. There were 8 ft. wide openings at the east and west sides of the structure, towards the barracks. The well bombproof was evidently removed in 1837. The well itself remained in use until ca. 1870.

In 1861, at the beginning of the Civil War, an artesian well was bored to a depth of 142 ft. below grade in the middle of the parade ground, furnishing at that depth "an abundant supply of pure, fresh water." A more elaborate water supply system was then installed.¹⁸⁰

In 1868 the post surgeon noted that a manually-operated force pump lifted water from the well to a 3,322-gallon storage tank, also on the parade ground. Iron pipes led from the tank to various hydrants both within and without the old fort.¹⁸¹

In 1872-73, a steam engine and pump were installed in place of the manually-operated pump, to insure an adequate water supply as well as to relieve enlisted men of an onerous duty. An 8,000-gallon-capacity wooden tank was also erected, supplementing the original iron tank. A city water main was extended to the fort in 1884, and the steam engine and pump, and the tanks, were removed. A manual pump was reinstalled over the well, and remained there into the mid-twentieth century.

During archeological investigations in 1978, the area between the two enlisted men's barracks was excavated (Figure 37), and remains of the cistern were discovered 1-2 ft. below grade.¹⁸² The east end of the cistern's remnants had been destroyed during the installation of septic tanks adjacent to the west end of barracks 2, and its northwest corner had been damaged by installation of a steam conduit. The ca. 1815(?) -19 construction at the site of the cistern of what became a guardhouse, and the placement there, ca. 1836-37, following the removal of the guardhouse, of a shot furnace, had also resulted in minor damage. The cistern was estimated to have been about 16 ft. wide by 27 ft. long on its exterior, with a 10 by 21 ft. interior chamber enclosed within 3 ft. thick brick walls.¹⁸³ The upper sections of all of the cistern's wall remnants were canted towards the its interior, suggesting that chamber's roof had been vaulted; the 1803 plan, however, indicates that the cistern had a hipped roof. The floor of the cistern was

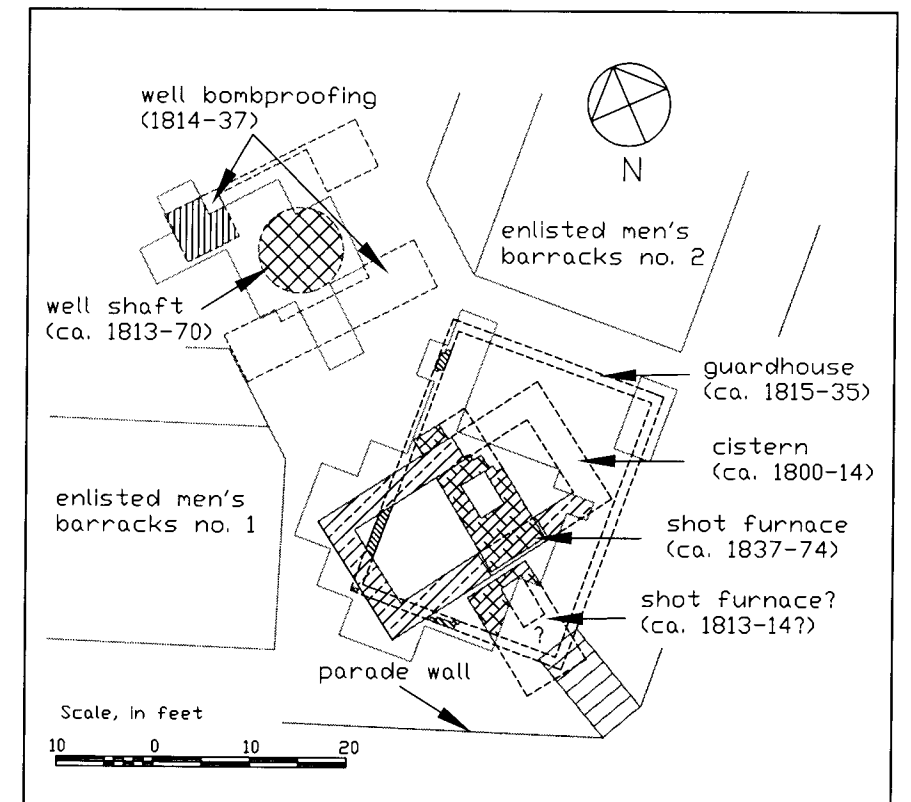

Figure 37. Structures in the enlisted men's barracks vicinity.

located nearly 8 ft. below grade, but mineral deposits on the interior of its walls indicated that there was generally only about 3 ft. of water stored in the cistern while it was in use. The approximate capacity of the cistern, in other words, was about 10,000 gallons, but it generally only contained about 4,500 gallons. Artifacts within the cistern fill were scarce and did not contribute to interpretation of the feature. No parade ground surface dating to the period of use of the cistern was identified.

Excavations made in 1978 also documented remnants of the 1813 well and its 1814 bombproof.¹⁸⁴ The well was found to have been a slightly elliptical brick cylinder with approximate internal and external diameters of 6 ft. and 9 ft. The spring-line of the brick dome covering the cylinder was found to be about 8.3 ft. below grade, and its interior apex was about 6.2 ft. below grade. An 4 inch wide iron brace was discovered within the fill immediately beneath the interior surface of the dome. Remnants of two openings through the dome into the well chamber—the first indication of the well discovered during excavation—were located on either side of the brace beginning 1-3 ft. below grade. The much-disturbed remains of two 1 ft. wide parallel walls were found 1.5 ft. below grade and 6 ft. apart on either side of the more northern of the two opening; these are likely to have served as footings for a pump platform. The second opening, according to a contemporary letter, was designed to provide access for maintenance.

Also found, about 1 ft. below grade, was the 5.5 by 6 ft. footing for the northwestern support pillar of the 1814 bombproof. Overlying the remains of this footing at a depth of .6-.9 ft. below grade was a layer of clay and cobblestone which very likely represents the ca. 1840 surface of the area. The remainder of the bombproof foundation was not exposed because of time constraints. The excavation that was accomplished, however, suggests that the installation of modern utility lines had largely destroyed the remains of the south foundation of the well bombproof.

A herringbone pattern brick walkway, aligned northeast-southwest, parallel to the end wall of enlisted men's barracks no. 1, was located about .5 ft. below grade overlying the remnants of one of the pump platform's footings; it appeared to terminate northwest of the more northern well opening. The walkway was undoubtedly a late nineteenth or early twentieth century feature, postdating abandonment of the well. Artifacts recovered from the well chamber indicate that filling, or disturbance of previously deposited fill (the latter possibly associated with the installation of utilities), continued into the twentieth century.

No archeological investigations have been specifically designed to investigate archeological features or deposits related to the 1861 artesian well. However, two projects encountered archeological remains associated with that well's steam pump, consisting of a stratum of grey sediments, and segments of the brick foundation of the steam engine and pump house.¹⁸⁵

3.4.3 Shot Furnaces

A shot furnace was reportedly in use in the star fort during the 1814 bombardment, but documentation of its location is lacking. It was most likely demolished soon after the bombardment.¹⁸⁶ More than twenty years elapsed before another shot furnace was constructed within the fort, ca. 1836-37; this later furnace's site, between the two enlisted men's barracks (Figure 37), was previously the site of the ca. 1800-14 cistern, and of the 1814-19 through 1835 guardhouse. The 1836-37 furnace is first depicted on a ca. 1835-36 overlay of Lee's 1834 plan of the fort.¹⁸⁷ The furnace also appears, presumably as a built structure, on the 1837 fort plan. It remained in existence into the 1870s; a note added to the 1873 fort plan indicated that the furnace had been removed, and it last appears on the 1874 plan. During and after the Civil War, as the capabilities of rifled artillery and iron-clad warships were demonstrated and recognized, shot furnaces quickly became archaic relics of an earlier age of warfare. The shot furnaces in Fort McHenry's outer battery had apparently been removed in 1866.

Among the structural features revealed during the 1978 archeological investigation in the cistern vicinity was the foundation of what may have been the 1814 shot furnace. This foundation, only partially exposed, was

about 6.5 ft. wide, with a 2.5 ft. wide interior void; if it extended south up to the alignment of the base of the original terreplein revetment, it would have been about 12 ft. long. (By way of comparison, the lower water battery's ca. 1814-19 shot furnace had apparent dimensions, on the 1819 plan of the fort, of 5 ft. by 13 ft.) It was discovered 1 ft. below grade immediately exterior to the center of the cistern's south wall. The feature matches no structure documented to have stood in this vicinity, but it is similar to, although apparently smaller than, the foundation of the 1836-37 shot furnace, which was also discovered, less than 2 ft. away. Remnants of a brick surface drain, most likely a post-bombardment repair of the original system, extended east-west over the top of this feature at a depth below grade of about .75 ft.¹⁸⁸

An early origin for the possible 1813-14 shot furnace foundation, and for the remnants of the brick drain over it, is suggested by their site—an area which, until ca. 1874, was continually encumbered by other structures. The fort's 1834 guardhouse, built ca. 1815(?) -19, extended over this feature, and the fort's second shot furnace was built less than 2 ft. away upon removal of the guardhouse, preempting other construction here for sixty years.¹⁸⁹ Further, the drain's alignment suggests that it more likely represents a modification of the ca. 1803-34, system than some part of the post-1835 system, which the 1840 plan indicates was located adjacent to the parade wall. Finally, a patch, apparently of concrete, to a damaged section of the possible early furnace foundation, thought to indicate a later construction date, may in fact indicate an earlier date, since the damaged section was located precisely where the robbed west wall footing of the guardhouse, built ca. 1815-19, would have intersected the foundation. Although a post-1851 button was evidently found in the disturbance associated with the patch, this artifact seems more likely to have been intrusive, than to be indicative of the structure having been built after that date. The one interpretive conjecture made in 1978 when the foundation was discovered—that it might represent a shot furnace built ca. 1874 to replace the furnace apparently demolished ca. 1873—is extremely improbable.

The 1836-37 shot furnace's foundation was situated almost entirely within the walls of the filled cistern, and interior to the remnants of the guardhouse's footings.¹⁹⁰ This furnace's dimensions are not entirely clear, in part because, while its south end overlapped the south wall of the cistern, its north end abutted the cistern's north wall, and a 1.6 ft. wide block of brick, apparently a continuation of the furnace foundation, was found abutting the opposite side of the cistern's wall. The dimensions were reported to have been 14 ft. by 6.65 ft., but the depiction within the report indicates a length, including the separate block of brick, of 15.5 ft. The 1837 fort plan depicted the furnace as somewhat larger than this; the 1840 and later plans show it somewhat smaller. A central void in this foundation, about 4 ft. long by 3 ft. wide, was determined to have been a structural attribute, rather than a fire pit or other functional element. The northeast

corner of the shot furnace has been destroyed by septic tank construction. Remnants of a brick drain line, corresponding to an element of the system depicted on the 1840 plan, was located extending over the top of the guardhouse's north wall footing, about 7 ft. northwest of the north end of the shot furnace; however, because of disturbances associated with the overlap between sequential structures, and with the more recent installation of utilities in the vicinity, no intact parade surfaces, contemporary to the structural features discovered, were identified. The artifacts retrieved contributed little to interpretation of the features.

3.4.4 Residential Structures

The four residential structures located on the parade within the star fort share, to a large extent, a common developmental history.¹⁹¹ As originally constructed ca. 1800, the buildings were all built of brick on stone foundations, and they all stood one-and-one-half stories high. They evidently did not have porches, but they did have cellar kitchens. A second story and a piazza were added to each of the buildings in 1829 (Figure 38). The cellars were, for the most part, abandoned when the second stories were built, but they were not filled until ca. 1836-39. Numerous changes occurred in the specific uses made of the buildings during their long history, particularly toward the end of the nineteenth century, at which time various utilities also began to be installed within the fort. During the 1929 restoration of Fort McHenry, the brick walls of all the residential buildings were to some extent dismantled and rebuilt. Additions or repairs to particular buildings are discussed individually below.

Historical documents, the historic structure report, and various archeological reports use different terminology to refer to the buildings within the star fort. In this report, the original designations will be used. All the buildings have been investigated, although with varying degrees of intensity.¹⁹² These investigations have contributed more to an understanding the architectural elements of the buildings than to their archeology, however.

3.4.4.1 Commanding Officer's Quarters

The commanding officer's quarters (structure A/1) is located on the north side of the parade, between the magazine and the guardhouse northwest of the sally port. Incorporated into it is a non-original building first depicted on the 1806 plan of the fort directly east of the commanding officer's quarters, reputed to have served initially as a guardhouse. The fort's guardhouse, presumably this structure, was converted ca. 1820 to officers' quarters, but by 1822 or 1824 what was almost certainly the same structure was serving as a detached kitchen for the commanding officer's quarter.¹⁹³ In 1829, at the same time that the second story and piazza were added, the

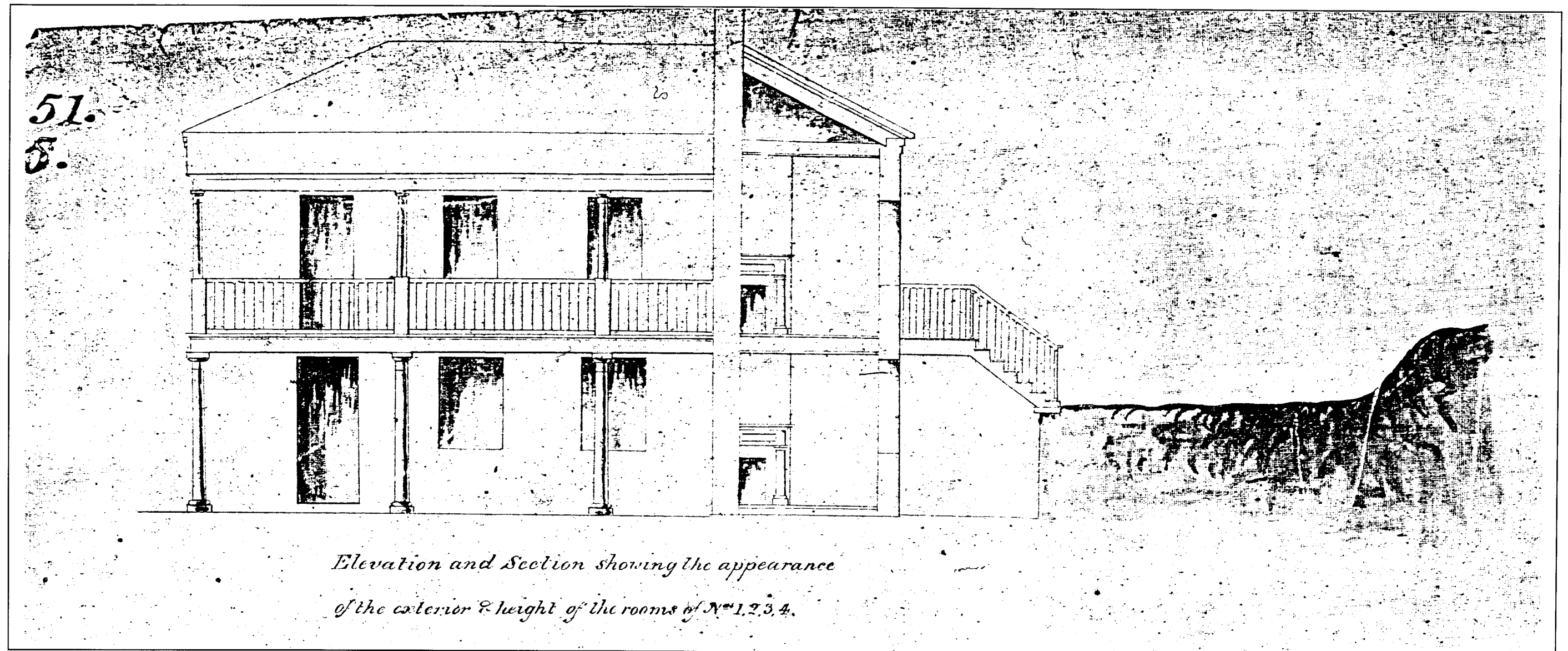

Figure 38. Detail of Lt. Thomas I. Lee's *Fort McHenry*, 1834, showing elevation and cross-section of typical quarters within fort.

commanding officer's quarters and the previously detached kitchen were joined into one building, with a second story running the combined length. The 1834 plan (Figure 30) depicts a passageway built onto the back wall of the quarters which served to connect the ground floor of the kitchen to the ground floor of the stair hall infill between the previously separate buildings. The function of commanding officer's quarters at Fort McHenry was relocated ca. 1840 to the post's former hospital, and the former commanding officer's quarters then became quarters for other, less senior officers. By the 1880s it served as married men's quarters, and as offices, and in 1895 it was converted into a quartermaster storehouse and office. It served as the commissary of the World War I hospital.¹⁹⁴

Excavations made in 1958 adjacent to the exterior of the quarters, as part of the HABS investigations, documented the presence of four cellar windows, and associated window wells, two on either side of the eastern 18 ft. of the original commanding officer's quarters.¹⁹⁵ An exterior stairwell would have been located at the east end of the original building, below the 1829 infill stair hall. The passageway north of the stair hall infill was investigated by Aivazian in 1978, and its footings, which measured 4 ft. by 14 ft. 3 in., were revealed and recorded. The 1829 ground surface was found to be 15 in. below the present surface. Excavations along the foundation of the commanding officer's quarters indicated that while the unseen portions of the foundations of the two separate buildings abutted, the walls above were bonded into one another.¹⁹⁶

3.4.4.2 Junior Officers' Quarters

The history of the junior officers' quarters (Structure C/3) is uncomplicated. This structure was built ca. 1800; received its second story and piazza in 1829; was used as married men's quarters in the 1880s; and was converted into a one-story bakery in 1894. It remained the bakery of the World War I hospital. There was originally a cellar, filled ca. 1836-39, beneath the northern 16 ft. of the building, accessed by a stairwell at its north end.

The only investigation of the junior officers' quarters was the set of HABS excavations, made in 1958 to locate the cellar windows and entrance.¹⁹⁷

The existence of two windows and window wells, one on each side of this building, and of the original north-end stairwell, was confirmed. The excavations, however, were not made archeologically, and it is unclear if other features or informative stratigraphic associations were encountered.

3.4.4.3 Enlisted Men's Barracks No. 1

The earliest modification of enlisted men's barracks no. 1 (Structure D/4) was an addition to its northwest end built between 1806 and 1819, most likely after 1814. This addition was over the original exterior stairwell to the cellar kitchen beneath the barracks, and it is not known how, or if, the addition accommodated this stairwell, or what purpose the addition served. Thompson and Newcomb suggest that it served as an officers' kitchen, but the basis for this suggestion is unclear.¹⁹⁸ In 1824, the sutler, or post trader, "occupied one room of the enlisted men's barracks and used its basement kitchen as his own."¹⁹⁹ The overlap between this early addition to the barracks and the stairwell access to its cellar suggests that it may have been here that the sutler was ensconced.

During the 1829 remodeling of this barracks, a two-story kitchen was constructed at its northwest end; the cellar was almost certainly abandoned at this point. Two rooms of the barracks reportedly served as officers' quarters in 1880, and by 1887 the building served as quarters for married enlisted men and their families. During the 1890s it was repaired and modified for use as two sets of officers' (or noncommissioned officers') quarters. It served as quarters for noncommissioned officers during the existence of the World War I hospital. In 1929, this structure's piazza was the only one then surviving, and it served as the model for reconstruction of all the others.²⁰⁰

The only investigations at enlisted men's barracks no. 1 have been the 1958 excavations to locate the cellar windows and examine the foundation,²⁰¹ Four windows and window wells were found, two on either side of the northwestern most 30 ft. of the original building. The depth of the foundation, except where the cellar was located, was determined to be approximately 3 ft.; at the cellar the foundations extended to about 8 ft. As at the officers' quarters, the 1958 excavations were non-archeological.

3.4.4.4 Enlisted Men's Barracks No. 2

Enlisted men's barracks no. 2 (Structure E/5) has had a history similar to that of its companion barracks, which it mirrors architecturally. The 1819 plan of the fort depicts an addition abutting the barracks' southwest end. (This addition may actually have been separated from the barracks by a 5 ft. wide passageway, as was depicted in 1833-34, when it was the fort's

guardhouse.) By the 1880s this barracks, like the other, was occupied by enlisted men's families, but in the 1890s it became the quartermaster's office and storehouse, and in 1917, the hospital's commissary storehouse.

Enlisted men's barracks no. 2, of all the residential buildings, has been the one most intensively investigated. Among the 1958 excavations at this building—besides those to locate the cellar windows and window wells here—was one made interior to the northeast end of the cellar, including the cellar's interior south corner.²⁰² This excavation confirmed the presence of an original fireplace within the cellar, its flue incorporated into the chimney of the ground floor fireplace directly above it. Hardware for a fireplace crane was also found. Remnants of a brick floor, or of the fireplace's hearth, were found at a depth of 7.5 ft. below the surface of the existing first story brick floor. A plugged drain was identified in the southeast (south) corner of the cellar, extending through the cellar's east (southeast) wall. The cellar stairwell entrance at the northeast end of the building was also partially exposed. Although the stratigraphy of the cellar fill was not recorded, the earth fill in the stairwell was described as "much mixed, but the few objects recovered...appear to be a homogeneous group, probably contemporary and of some antiquity at the fort."²⁰³

In the winter of 1966 the fill within the barracks no. 2 kitchen cellar was entirely removed, preliminary to the cellar's planned restoration as an interpretive exhibit.²⁰⁴ The cellar reportedly contained strata representative of several different fill episodes, some of which may have originated with the refilling of the 1958 excavation. Modern fill comprised the uppermost foot of the deposit. Beneath this were at least five differentiated strata, deposited when the cellar was originally filled (except where the 1958 excavation was located). Remnants of the brick hearth or floor paving were found to have survived only in front of the fireplace; the rest of the brick paving had apparently been robbed before the cellar was filled. The floor brick had been set onto a 2-in.-deep bed of sand, which covered the original clay floor. Embedded into the clay floor were charcoal fragments. No artifacts were recovered from either of the identified surfaces of the cellar floor. Standing water, reflecting the periodically high water table beneath the parade, was encountered at a depth of 3 to 4 ft.

In discussing the need for a perimeter drain to make the restoration of the cellar feasible, Cotter noted the presence of a sunken drain in back of the building at its approximate mid-point; this is presumably a reference to the postern drain's inlet. More importantly, he noted a sump box in the southwest (west) corner of the cellar, the location of which strongly suggests that it is original: the presence of a deep drain beneath the fort's parade ground, which is likely to be part of the original system for draining the residential buildings' cellars, would lead one to expect an original cellar drain somewhere along its interior, parade-ground side. The drain reportedly found in 1958, extending through the foundation in the southeast

(south) corner of the cellar, must have been an effort at providing drainage for the cellar by way of the postern tunnel, beneath which a drain was very likely installed during the tunnel's construction in 1813-14; remnants of the outlet end of a brick drain, in alignment with the south corner of the cellar, was found in 1999, in association with an early postern drain inlet.²⁰⁵

In 1968, due to ground-water and drainage problems, the restored cellar was refilled. A effective perimeter drain had evidently not been installed, and the very same problems that had forced the ca. 1829 abandonment of the cellars and their filling ca. 1836-39 had reoccurred.

3.4.5 Privies and Water Closets

Three privies, one water closet, and one possible water closet have been reported or depicted inside the star fort. The two privies located on either side of the parade magazine are relatively well documented, and have been investigated. The planked-over pit of a third privy was encountered on the south bastion (bastion 4) by soldiers constructing gun emplacements in 1835.²⁰⁶ There is no other documentation concerning this privy, and it has not been investigated. Its location beneath fill deposited in 1813 indicates that it must date to ca. 1803-13. It was filled with sand upon its discovery, to insure the stability of the gun emplacement being built.

Consistent with the original role of each of the adjacent quarters, the privy northeast of the magazine is commonly identified as the commanding officer's privy, while the one to the southwest is identified as the junior officers' privy (Figure 36). These privies are first depicted on the 1834 and 1840 plans of the fort, but they most likely existed earlier; how much earlier is not known, but it is noteworthy that they were both within areas enclosed prior to ca. 1806 by the curtain wall on either side of the original magazine, and they would have been aligned with that wall, as well as with the terreplein revetment. As depicted on all the fort plans which show it, and as documented archeologically, the commanding officer's privy abutted the 1814 bombproofing of the magazine; if, as seems likely, it had existed earlier, it was modified when the bombproofing was constructed.

There are several references made to the officers' privies in records of the 1840s and 1850s, including a report that one of them burnt in 1842, and was rebuilt of brick. Although there are no known plans or other documentation indicating the survival of these privies between 1860 and 1884, they very likely had remained in use throughout this period. Between 1884 and 1888 both privies were apparently transformed into water closets by provision of sewer and water connections, as documented by the 1888 plan of the fort that shows these utilities. Fort plans of 1903, 1904, and 1912, the last to show the privies, indicate that the original junior officer's privy had been replaced by a slightly larger structure, aligned with, and attached to, the

southwest side of the magazine. The privies/water closets were evidently removed during or at the end of development of the World War I hospital. It should be borne in mind that during the 1880s if not earlier (much earlier in the case of the commanding officer's privy), these privies had ceased to have the association with the fort's officers that their names imply.

A water closet was evidently built behind enlisted men's barracks no. 2 in 1917, when development of the World War I hospital began. The barracks, which had served as the quartermaster's office and storehouse during the last several years of the fort's active existence, had been made the hospital's commissary store.²⁰⁷ The water closet, which appears on plans of the hospital dating to 1917-19, was slated for removal in 1926. Part of its foundation was encountered, toward the northeastern end of enlisted men's barracks 2, during archeological monitoring of the partial reconstruction of the parade wall in 1975.²⁰⁸

A poorly documented one-story frame structure that, from ca. 1885 until ca. 1912, stood attached to the south end of the junior officer's quarters, between it and the northwest end of enlisted men's barracks no. 1, may also have served as a water closet. When this structure first appears on plans, the quarters and barracks were both occupied primarily by married enlisted men and their families. The 1888 plan of the fort indicates that this structure, along with the privies on either side of the magazine, had been provided with water and sewer connections.

3.4.5.1 Commanding Officer's Privy

Excavations conducted in 1978 directly northeast of the parade magazine revealed remnants of the foundation of the commanding officer's privy, its associated privy pit, and various utilities.²⁰⁹ The privy's irregular configuration was found to closely match the depiction of the structure on the 1834 Lee plan. A former brick surface drain adjacent to the magazine extended between the privy's foundation and the magazine, but the privy's superstructure may nonetheless have abutted the magazine, as depicted on plans. The privy's irregular shape—about 11 ft. wide by from 4 to 12 ft. long—was a result, in part, of its having been aligned with the terreplein revetment, and, notably, with the pre-1806 curtain wall, which had been located 9 ft. east of the privy. The irregular shape, along with the fact that a fully rectangular, 11-by-12 ft. version of the structure could have been accommodated at this location prior to the bombproofing of the magazine in 1814, together suggest that the commanding officer's privy derives from a pre-1814 structure. Such a derivation remains conjectural, however, in the absence of supporting documentary and archeological evidence.

There were two rooms within the privy. What may have been a washroom, with a storage alcove in its northeast corner, occupied the northern two-

third of the structure, an area about 5 ft. wide by 7-10 ft. long; remnants of a herringbone pattern brick floor were found here. The remaining, southeastern, corner of the structure, an area roughly 4 ft. wide by 3-6 ft. long, was situated over a brick-lined privy pit, now earth-filled, which itself had an irregular oval shape. A 4-in. diameter iron drain pipe extended over the privy pit fill, and was found to have been cemented to a 6-in. diameter ceramic drain/sewer pipe about 2 ft. beyond the pit; a 1-in. diameter water supply pipe extended through the areas of both the washroom and the privy. Cartographic research indicates that sewer and water pipes were connected to the privy by 1888. The iron drain pipe, however, appeared to have been installed following demolition of the privy, and its installation had resulted in the destruction of part of the privy's north foundation wall, and of most of the pavement in its northern room. The original point-of-origin and function of the iron drain pipe are not known, but the fact that it extends around the magazine's north corner suggests that it may have been installed as a second sewer line for the ca. 1885 water closet (junior officer's privy) on the opposite side of the magazine. If this is so, then that water closet must have remained in use for at least a limited period following the demolition of the water closet successor to the commanding officer's privy.

The privy pit fill was excavated and the stratigraphic sequence recorded in 1978. Early twentieth century artifacts (machine-manufactured bottle and jar fragments) in the lowermost fill context within the pit indicated that its earlier, nineteenth-century content had been removed. Excavation of the commanding officer's privy had been expected to supply data for the creation of a model of material-culture correlates to rank and socio-economic class at Fort McHenry, but it became clear during the excavation and analysis of the findings that the artifact data set could not be used for that purpose, because the necessary deposits no longer existed.²¹⁰ It had been thought, prior to the investigation, that the privy pit might have been sealed after the Civil War, and that it might not have been affected by the reuse of the site for a water closet at the end of the century. In fact, the pit was evidently cleaned-out, either ca. 1884-88 when the water closet conversion occurred, or ca. 1917-18 when the structure was demolished, and the pit filled. There were numerous nineteenth century artifacts in stratigraphically higher layers of the privy pit fill, but the origins of the fill soils, and of the artifacts they contained, are uncertain.

3.4.5.2 Junior Officers' Privy

Located on the southwest side of the magazine, the junior officers' privy first appears on the 1834 and 1840 plans of the fort. As with the commanding officers' privy, it may have been built many years earlier. Because fort records indicate that one of the officers' privies had burned to the ground in 1842, and given archeological evidence (and ambiguous and anachronistic cartographic evidence) for replacement of the original junior

officers' privy with a structure having a different design, it has been generally assumed that the junior officers' privy was reconstructed of brick at that time.²¹¹ It is unknown if, before its supposed 1842 reconstruction, the privy had a brick footing or brick-lined pit beneath it. Such features, if they had not existed previously, may have been built in 1842.

As depicted on the 1834 plan, the original junior officers' privy was a two-stall structure about 6 ft. wide by 6.5 ft. long, oriented, like the commanding officer's privy, parallel to the terreplein revetment and the ca. 1806 magazine curtain wall, but situated between 2 ft. and 10 ft. away from the bombproofed magazine. The privy was last depicted—with the same size, orientation, and location as previously—on the 1888 plan of the fort, although with water and sewer connections indicating its conversion into a water closet. The depiction may have combined improvements with elements copied from earlier, outdated plans, but it may also be that the 1842 (?) through ca. 1890 junior officers' privy had the same basic footprint as the original privy. Fort plans dating to 1894, 1903, 1904, and 1912 depict a 6-8 ft. by 10-12 ft. structure aligned with and attached to the southwest wall of the magazine, overlapping the site of the original junior officers' privy. It is clear that by 1894, if not earlier (i.e., ca. 1885), the junior officers' privy was replaced by a water closet. Plans of the World War I hospital do not show the privy/water closet; it was presumably demolished during the hospital's development, although it may have remained in use somewhat longer than the commanding officer's privy.

Archeological excavation by Smith in 1958 revealed the foundation of the water closet at the site of the junior officer's privy, and the abandoned water and sewer lines. All of the earth fill within the 6-8 ft. deep privy pit (or septic tank) was excavated and found to contain artifacts dating for the most part to ca. 1912-1918.²¹² Blackened masonry surfaces were attributed to fire-damage. Water and sewer lines (the latter of both iron and ceramic) were identified, which, together with the artifacts within the fill, were considered indicative of early twentieth century usage and abandonment. The fact that the privy foundation did not correspond to the 1834 depiction was recognized, but evidence of an earlier privy was not detected.

The privy building sequence was more thoroughly investigated in 1980, and evidence of the earlier privy was found.²¹³ A portion of the ca. 1806 magazine curtain wall was also exposed. The evidence of the earlier privy, or more precisely of a pit situated where that structure had been located, consisted of a sizable deposit of distinctive sand fill, extending to a depth of about 5.5 ft. below grade, within a pit that had formerly extended into the natural clay subsoil of the site.

Only the apparent southwest corner of this privy pit was identified, the others evidently having been situated within the area of the more recent privy pit/septic tank, and its depth was determined by coring rather than by

excavation. The southwest corner of the pit was approximately 3 ft. further to the southwest than that of the structure depicted on the 1834 plan, and its west and south edges were consequently closer to the parade wall and to (the remnants of) the ca. 1806 magazine curtain wall. This discrepancy in location may be due to a slight mapping error, or possibly to the pit having been enlarged, either when the privy was reconstructed ca. 1842, or when it was removed and rebuilt with a different design. Probing failed to reveal any evidence of a brick footing, or of a brick lining to the pit. If either one had existed, it had been removed along with the superstructure. The coring indicated that the night-soil once presumably contained in the privy pit had also been entirely removed. The age of the earlier privy—whether it was built ca. 1834 or many years earlier—and the date of its abandonment—whether it was in 1842, when one of the officers' privies burned, or ca. 1885-90—were not established.

The remains of the more recent water closet at the site of the privy, as exposed in both 1958 and 1980, consisted of a complex brick foundation between 3 ft. and 11 ft. southwest of the magazine. The earliest element of this privy was the section nearest the magazine, a 5 ft. by 10 ft. block with .7 ft. wide walls enclosing a 6-8 ft. deep pit. These are presumably the remains of the structure shown on the 1894 plan, alongside the magazine. Abutting the southwest side of the pit were two successive additional sets of brick wall footings, the first of which added 1.8 ft. to the width of the structure, the second another 1.1 ft.; with these additions the overall size of the structure (not including the area between the pit and the magazine) was about 8 ft. by 10 ft. The 1980 report suggested that the first of the two additions may have served to support a platform or passageway and that the second (with its "floor" completely covered with mortar) might have served as a urinal. The top courses of the foundation were determined, in 1980, to have been stained black from the lime-cinder mix used in the mortar, not from a fire as Smith had suggested in 1958.²¹⁴

Despite the 1958 and 1980 studies, we do not as yet have a fully reasonable and consistent interpretation of the data, documentary and archeological, concerning the successive privy and water closet structures southwest of the parade magazine. A possible outline of the chronology might be as follows: the original junior officer's privy, a frame structure built as early as ca. 1803-06, was replaced in 1842 by a brick structure, having the same basic size, footprint, and location as the first privy; this brick structure would have been converted into a water closet in 1884-88, its pit becoming a septic tank; by 1903, a newer, wood-frame (?) water closet was constructed at the site, with a footing and septic tank of brick salvaged from the 1842 structure; and at unknown dates between ca. 1903 ca. 1918-19 two small additions were made to increase this structure's capacity. More research would be needed to determine if this outline is correct.

3.4.5.3 Water Closet behind Enlisted Men's Barracks No. 2

In 1975, during archeological monitoring of reconstruction of part of the parade wall, a section of a brick foundation was exposed at the northeast end of the 8 ft. wide passageway between enlisted men's barracks no. 2 and the parade wall. The foundation is believed to derive from a World War I hospital-period water closet. This structure, about 20 ft. long by 8 ft. wide, was first depicted on 1917-19 plans of the hospital; it was removed ca. 1926. The exposed part of the brick foundation, about .7 ft. wide and 4 courses deep, between .7 and 1.6 ft. below grade, paralleled and abutted the parade wall. The bricks had been laid with unmortared vertical gaps between them, presumably so that the brickwork would not be a barrier to seepage of water through the dry-laid joints of parade wall foundation.²¹⁵

3.4.6 Guardhouses

Numerous guardrooms and guardhouses were constructed at Fort McHenry over the long span of its history. The earliest probable guardhouse was a structure depicted on the 1806 plan of the fort, although not on the 1803 plan, immediately east of the commanding officers quarters. There is, as well, an 1805 record of a sentry house; this may have been the same early guardhouse, or perhaps the small pentagonal sentry box depicted in 1819 at the salient of bastion 2, or, as Walsh suggested, some other structure nearer the sally port.²¹⁶ The need for a "proper guard house" was recognized by the fort's commander in 1813, but there it is uncertain if a new guardhouse was built at that time. In 1820, the fort's guardhouse (possibly the structure east of the commanding officer's quarters) was converted to officers' quarters, and the guard at that time occupied a wall tent.²¹⁷ The early guardhouse would subsequently become the commanding officer's kitchen, and in 1829 it was structurally joined to the quarters.

A structure built sometime between ca. 1815(1813?) and 1819 at the site of the fort's ca. 1800-1813 cistern, between the two barracks in the southern corner of the parade, was by 1833-34 the fort's guardhouse, as indicated on the fort plans of those years.²¹⁸ This building was first depicted, on the 1819 plan, as an addition attached to the southwest end of enlisted men's barracks no. 2, but later plans show a 5 ft. wide passageway between it and the barracks; Lee's 1834 plan of the parade ground structures indicates that one room – the prison room – was windowless. The structure may have been built as a guardhouse, but historical documentation for that is ambiguous. If it had not been built as a guardhouse, and prior to September of 1814, it is indeed perplexing that it would even have become the fort's guardhouse, given that lines-of-sight between it and the sally port must have been obstructed by the 1814 bombproof over the 1813 well, directly north of its window and doorway; it may have had the role as a temporary expediency, albeit one that persisted for a number of years.

Construction of new guardhouses on either side of the sally port in 1835 (discussed above with the sally port) made possible the 1837 removal of the earlier guardhouse, and the construction of a shot furnace at its former site. After the fort's property was enlarged in the 1830s, and its entrance gateway relocated to a site more than 1,000 ft. to the northwest, a separate series of guardrooms and guardhouses were developed at that gateway.

Archeological excavations made in 1978 at the site of the 1833-34 guardhouse documented its remnants, along with those of the cistern and shot furnace there (Figure 37). The investigation located portions of the guardhouse's southwest and northwest wall foundations; the full alignment of its southeast wall foundation was not investigated, but portions of it may also be preserved. The northeast foundation had been destroyed during the ca. 1935 installation of a septic tank. No intact surfaces contemporaneous with the period of use of the guardhouse were identified, although some of the artifacts retrieved from the area (e.g., tobacco pipe fragment) presumably reflect activities engaged in during its use.²¹⁹

3.4.7 Flagstuffs

One of the most important symbols of American patriotism is the flag flying over Fort McHenry, emblematic as it is of the events that inspired Francis Scott Key's composition of the "Star-Spangled Banner," the national anthem of the United States. Consequently, the location of the 1814 flagstaff has been a matter of particular interest at the fort, and the one problematic element of the fort's restoration definitively resolved, to the extent feasible, by means of archeological investigation. This archeology was one element of the work performed by G. Hubert Smith in 1958.

The 1803 plan of the fort (but not the 1806 plan) shows a flagstaff on the northeast side of the parade, about 30 ft. west of the parade end of the sally port. This was almost certainly the site of the flagstaff from which the American flag was flown on the morning of September 14, 1814, at the end of a 25-hour bombardment by British naval forces.²²⁰ On the 1819 plan there is a small 'x,' at nearly the same location as that of the 1803 flagstaff; however, a short, very faint, dotted line extending southeast from it suggests that this 'x' was not intended as a representation of the flagstaff.²²¹ What may have been another flagstaff, most likely erected sometime between ca. 1815 and 1819, is depicted on the 1819 plan, exterior to the star fort, approximately 53 ft. northeast of the officers' quarters southeast of the post hospital. These quarters are themselves believed to have been built subsequent to the bombardment.²²²

A request for funding for construction of a new flagstaff was made in 1828, and the materials for it were acquired in 1830.²²³ The flagstaff erected at that time, evidently with a 'step-around-the-mast' platform, was probably

the one in bastion 5, which until 1959 remained the site of a succession of flagstaffs. The 1834 and 1840 plans are the earliest to depict the bastion 5 flagstaff, although they show it in slightly different locations; on the 1834 plan, it was about 80 ft. west of the bastion's salient, but on the apparently more accurate 1840 plan, and on later plans, it was about 105 ft. west of the salient; the 1834 plan, however, shows important details: above-grade cross-braces and an 8-ft.-diameter platform. Numerous later plans, illustrations, and photographs show the succession of flagstaffs in bastion 5, the last one of which was erected ca. 1930. During the U.S. Army's restoration of the fort then under way, bastion 5 was evidently thought, in the absence of a thorough review of historical documentation, to have been the most likely site of the 1814 flagstaff. The last permanent bastion 5 flagstaff was removed in 1959, following the erection of a replica of the 1814 flagstaff on the parade ground.²²⁴

Among the areas Smith investigated in 1958 was the location which the 1803 plan indicated had been the site of the flagstaff. The investigation was made to insure that the flagstaff there was in fact a "built" feature, and not one that had only been proposed and designed. Excavation resulted in the discovery of the cross-brace for the original, ca. 1803 through 1829 (?) flagstaff.²²⁵ Based on the 1803 plan, a 10-by-10-ft. square was laid out west of the sally port. During excavation the square became a 14-by-10.5 ft. rectangle, between 6.35 ft. and 20.35 ft. west-southwest of the parade wall and between 9.7 ft. and 20.2 ft. north-northwest of the centerline of the sally port. At approximately 7.5 ft. below the parade ground surface, the two wooden timbers composing the horizontal cross-brace for the base of the flagstaff were exposed. The two timbers, with a half-lap joint at their midpoints, measured 9.5 ft. and 8 ft. long, approximately 18 in. wide, and 4 in. thick. A 9 in. square mortise had been cut vertically into the timbers' joint to receive the corresponding tenon at the base of flagstaff.²²⁶ No evidence of the base of the flagstaff itself was detected, presumably because it had been extracted ca. 1829, when the flagstaff was relocated. The builders' trenches for the braces, which could only be cursorily examined due to ground water, consisted of two cross trenches just wide enough for the braces. The flagstaff cross-brace was removed following its discovery, and it is currently one of the interpretive exhibits at Fort McHenry.

Consideration was given, in 1980, to archeological investigation of the bastion 5 flagstaff site. However, a thorough review of documentation indicated that the likelihood of intact features predating the ca. 1930 flagstaff was extremely low, and the excavation was not implemented.²²⁷

3.5 Moat, Counterscarp, and Glacis

The dry moat or ditch of an early nineteenth-century fort was composed minimally of the surface of a broad entrenchment—the moat proper—

exterior to the fort's scarp wall, a revetted embankment or counterscarp at the outer edge of the moat, and a glacis which sloped evenly down from its crest at the top of the counterscarp toward the surrounding country. The moat served as both a borrow area, to provide earth for construction of the fort's rampart, parapet, etc., and a defensive feature of the fort in its own right, impeding attackers and exposing them to fire from within the fort. The 1803 plan of Fort McHenry (Figure 6) shows its dry moat, counterscarp, and glacis extending around all but the southeastern side of the fort, opposite the curtain wall between bastions 4 and 5, where, beyond a shelf of higher ground more-or-less level with the moat, there was a broad area of low ground out to the river. There was also a gap, in the depiction if not on the ground, in the glacis and counterscarp, where a corner of the tavern keeper's garden, which remained private property until 1836, intruded on them. The moat was about 33 ft. wide adjacent to the faces of the bastions, with which the counterscarp was aligned, and 50-60 ft. wide along the curtains. The relative depth of the moat was not documented until 1819, following modifications made in 1813-14, which probably including deepening. It was most likely relatively level, but there were two water conduits—presumably brick drains—depicted on the 1803 plan extending beneath the glacis opposite the salients of bastions 1 and 3, which must have functioned to insure that the dry moat remained dry. The original height of the counterscarp is unknown, but it is unlikely to have been more than about 4 ft. The glacis was about 33-36 ft. wide; its regular, gentle slope down and away from the counterscarp apparently terminated, southwest and west of the fort, in a relatively steep exterior slope, again of unknown, but presumably slight, height.

In 1813-14 Fort McHenry's ditch, counterscarp, and glacis were completed, and a number of other defensive features introduced within it, largely in accordance with recommendations made by Col. Decius Wadsworth. At the same time the ditch was supposed to have been widened, to 35 ft., and deepened, and the counterscarp raised to a height of 5 ft.; it is unclear to what extent this complete program may have been implemented.²²⁸ The northeast and southeast fronts of the fort, facing out onto the water batteries, were those where the most notable features were built, as documented by the 1819 plan of the fort (Figure 7). A ravelin was constructed exterior to the northeast front, where the fort's sally port is situated, and the moat, counterscarp, and glacis were modified to extended around ravelin's faces and salient angle; the alignment of the revetment at the back side of the ravelin coincided with that of the earlier counterscarp.

At the southeast front, in addition to completion of the ditch, counterscarp, and glacis, a caponniere was evidently built, extending from the lower end of the postern, out to the area of low ground behind the central section of the lower water battery. In the area of the ditch, the caponniere was covered by a mound of earth 3.5 ft. higher than the surface of the ditch to either side (Figure 33). Also built at the southeast front was a 150 ft. long

palisade, extending from the left shoulder of bastion 4 to the right shoulder of bastion 5, completely enclosing the area adjacent to the curtain wall there. At the base of the scarp wall within this area, along the bastions' flanks as well as the curtain, was a 5 ft. wide feature of uncertain purpose. On the historical base map of the park's 1939 master plan, the entire area enclosed by the palisade is apparently interpreted as a tenaille; more recently, the 5 ft. wide feature by itself has been interpreted as a pair of tenailles, interconnected with the postern tunnel and caponniere.²²⁹ One aspect of the hachure-depicted relief on the 1819 plan, however, suggests that the feature was not a entrenched tenaille at all, but a berm or bench of more elevated ground, perhaps 2 ft. higher than the adjacent surface of the moat.²³⁰ Whether it was a berm or a tenaille, it was divided in half at the center of the curtain wall, where it abutted the scarp-wall end of the mound over the caponniere. The caponniere, palisade, and berm/tenaille are depicted on the 1835 Gratiot plan of the fort, as well as 1819 plan; but the Gratiot plan was to a large extent a copy of the 1819 plan, and the absence of the palisade and berm/tenaille from other early to mid-1830s plans suggests that these features had been removed in the 1820s. An 18-in.-diameter cast iron drain line replaced the caponniere in 1836-37.

As discussed below, an unambiguous tenaille was evidently excavated at the base of the scarp wall, along the northern and western sides of the fort, in 1813-14, but had probably been filled-in soon after the bombardment.

One reason it was proposed to raise the counterscarp to a height of 5 ft. in 1813 was for the moat to serve as a covered way, where troops could assemble and maneuver without being exposed to enemy fire. The counterscarp height, as depicted in 1819, ranges from 4.5 ft. to 5 ft.; it was highest opposite the southeast front of the fort. The 1819 plan and profiles (Figures 7 and 18) also document construction of a 3 ft. wide by 1.5 ft. high banquette adjacent to the counterscarp, extending along the southeast front of the fort and around the ravelin, from a point opposite the bastion 4's salient to a point opposite the right face of bastion 1. The surface of the moat, approximately 12.5 ft. below the scarp wall coping, is otherwise depicted (perhaps misleadingly) as having been relatively flat.

Fort McHenry's moat was probably a relatively unimpressive feature. In 1825 a foreign military officer even remarked that the fort had no counterscarp, indicating, more likely than not, only that it was sod- rather than masonry-revetted.²³¹ Erosion of the counterscarp and glacis, and of the banquettes, beginning soon after their construction, had also very likely taken its toll. Removal of soil from the ditch was again proposed in 1835, to provide fill for heightening the fort's parapet and counterscarp. There is no indication that the proposal was carried out then, but it may have been implemented later, when the parapet was heightened following the 1837-39 construction of the breast-height walls, and various moat drainage improvements were made. The profile on the 1836 Delafield plan indicates

that the counterscarp opposite the salient of bastion 4 then stood only about 3.5 feet above the moat surface, and it does not depict a banquette there. Spot elevations on the plan, however, suggest that other sections of the counterscarp retained heights of up to 4-4.5 ft. The reduction of the counterscarp's relative height, and the elimination of the banquette, may have been accomplished at least in part by filling.

The dry moat's original drainage system might also have fallen into a state of disrepair by the 1830s. If the ditch had been deepened in 1813-14, even slightly, this may have affected the original drainage patterns. The 1834 Lee plan, in any case, indicates that drainage ditches had been excavated through the counterscarp and glacis at several locations: two adjacent to the original boundary wall in the vicinity of bastion 2 (where runoff is as likely to have been brought into the ditch, as carried out of it); opposite the curtain wall between bastions 3 and 4; opposite the salient of bastion 4; and on either side of the caponniere at the southeast front of the fort.²³²

It is clear from the 1840 Smith plan that during the 1836-39 development of the water battery various improvements were also made to the dry moat, particularly to its drainage. No earlier plan indicated the presence of any formal drainage system with the moat itself, and all earlier profiles suggest that, in cross section, the moat's surface was relatively flat. The 1840 plan, however, depicts the installation of a cunette along the center of the moat, and the profiles on that plan show that the surface of the moat was sloped down toward the central cunette (Figures 23 and 27); notations on the plan indicate that the moat adjacent to the cunette was 6-9 in. lower than it was adjacent to the scarp and counterscarp. The establishment of this slope is likely to have involved excavation. Excavation is also likely to have been required to slope the cunette itself, for it to carry runoff to drainage outlets. New drain lines, probably of iron, extended from the outlets—at the base of the counterscarp opposite the salients of the ravelin and of bastion 3—out to the seawall; there was also an outlet for the cunette above (into) the 18 in. diameter, cast-iron, postern drain line, which had replaced the caponniere ca. 1836-37, and which also extended out to the seawall. The original drain opposite bastion 3, with a different alignment than the new drain there, had evidently been abandoned, but the one opposite the salient of bastion 1, although identified as a "blind drain," remained in use.²³³

The relative elevations of different sections of the moat are indicated by notes concerning drainage on the 1840 plan:

The drain A [opposite the salient of bastion 1] is 4 ft. 1¼" above drain D [opposite the salient of the ravelin]; drain B [opposite the salient of bastion 3], 1 ft. 11½" [above drain D]; drain C [the outlet into the postern drain line], 3 ft. 10½" [above drain D].

The approximate corresponding elevations, above Baltimore City Datum (abcd), given archeological findings discussed below, are: 22-22.5 ft. abcd for drain D at the ravelin's salient; 26-26.5 ft. abcd for drain C over the postern drain line; 24-24.5 ft. abcd for drain B at bastion 3; and 26-26.5 ft.

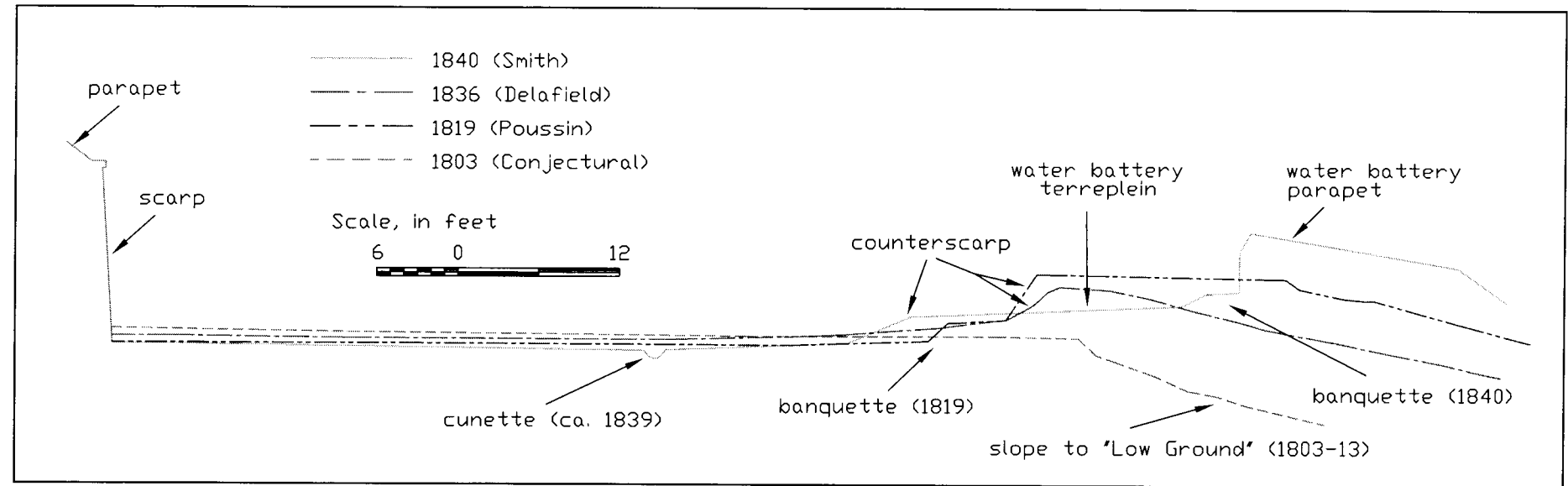

Figure 39. Grade changes along the southeast front of Fort McHenry, 1803-1840.

abcd for drain A at bastion 1. Information on the 1840 plan concerning the slope of the cunette suggests that moat elevations in the vicinity of bastion 2 were then about 28.5-29.5 ft. abcd, and in the vicinity of bastions 4 and 5, about 26.5-27.5 ft. abcd.

The relative depth of the dry moat seems to have increased between 1819 and 1840, although the evident lack of precision in the measurements incorporated into historical profiles makes this interpretation uncertain (Figure 39).²³⁴ Any deepening is likely to have been associated with drainage improvements, and with the borrowing of soil for use as fill elsewhere, and it may have been largely confined to the moat's center. The 1819 profiles suggest moat depths, below the coping, of about 12.5-13 ft., while the 1840 profiles suggest depths of about 13-14.5 ft. (Two profiles on an 1837 plan both indicate a moat depth of 13 ft., while single profiles dating to 1833-34 and 1836 indicate depths, respectively, of 14.5 ft. and 13.4 ft.) There may have been a more substantial increase in the depth of the moat adjacent to the southeast face of the ravelin, which an 1819 profile indicated was 8.5 ft. deep, beneath the ravelin scarp coping, but which 1837 and 1840 profiles indicated was 11 ft. deep. The 1836 Delafield plan provides a spot elevation in the moat along the southeast face of the ravelin which suggests a depth there of about 13 ft. The height of the counterscarp above the surface of the moat was depicted as having been about 4.5-5 ft. in both 1819 and 1840; the 1836 plan and profile indicated actual heights of only 3.5-4.5 ft., while profiles on the 1837 plan showed exaggerated (or proposed), counterscarp heights of 8 ft, with 2.5-3.5 ft. high banquettes. The height of the counterscarp opposite the southeast face of the ravelin was about 5 ft. on the 1819 profile, but slightly more than 6 ft. on the 1840 plan, consistent with a more substantial deepening of the moat there.

The development of the fort's water battery transformed the counterscarp in that area from the divide between the moat and the glacis into the boundary between the moat and the water battery's terreplein. The upper 1.5-2 ft. of the counterscarp—the crest of the glacis—may have been removed to construct the battery, but over most of the area occupied by the water battery's terreplein, and beneath virtually all of its parapet, fill was deposited atop the lower portions of the glacis, and over the even lower ground beyond, as discussed below. The water battery's terreplein was about 2-2.5 ft. higher than the moat surface, and ramps were constructed at several locations to facilitate transport of guns and ammunition between these two areas. The construction of the water battery also required that the road into the fort be rerouted; whereas previously the road had passed through the ravelin, after ca. 1839 it was accommodated by a 9-10 ft. wide notch through the glacis and counterscarp north of bastion 1. The road extended through this notch and onto the surface of the moat itself, prior to entering the fort by way of a newly-constructed ramp at the sally port.

Grading again accompanied drainage and other work within the moat in 1844.²³⁵ Two culverts were placed beneath the road in the moat then, the counterscarp was reportedly resodded, and some sort of barrier, probably a fence, was placed on the counterscarp (meaning, evidently, exterior to the glacis), along the northeast, north, and west fronts of the fort, to keep animals off the slopes; a fence is shown exterior to the glacis on plans and illustrations dating to the 1850s.²³⁶ It was also recommended in 1844 that the cunette be paved with brick to a width of 2-3 ft.; it is uncertain if this recommendation was ever implemented while the fort remained active.²³⁷

In 1861, at the beginning of the Civil War, three 10-in. mortars were mounted on platforms in the ditch between bastions 1 and 2, and the two

ends of the water battery, together with the gorge, previously open, were closed with palisades as an additional defensive measure.²³⁸ An abatis was also built. As sketched on the 1840 plan of the fort (which was evidently in use as a working drawing ca. 1861), and as depicted on other contemporary plans and illustrations, the abatis was situated, along the fort's landward side, within the ditch adjacent to the counterscarp, but in the area of the water battery, it was directly exterior to the battery's parapet (Figure 23). In 1866-67, when the battery's underground magazines and bombproofs were built, the surface of the water battery's terreplein in the vicinity of these structures was lowered so as to be continuous with the surface of the adjacent moat. The general elevation of what remained of the terreplein may have been reduced somewhat soon thereafter, while the adjacent moat's elevation may soon have been raised, by filling, so that by ca. 1900 the elevation difference between these two features was less pronounced. The boundary between them had disappeared, but about the same time plans of the fort begin showing walkways or paths there.

Massive disturbance of some sections of the moat, counterscarp, and glacis accompanied the development and later removal of the World War I hospital. Most heavily disturbed by construction during this period, and now occupied by ca. 1917-29 features and fill deposits, along with remnants of earlier resources, were the counterscarp and glacis in a few specific locations: exterior to the north and the southeast faces of the ravelin, exterior to the left face of bastion 1, exterior to the right face of bastion 2, and exterior to both faces of bastion 3. Portions of the moat in these areas, particularly in the vicinity of bastion 3, were also disturbed or destroyed; the earlier stratigraphy of the moat was also presumably destroyed at the site of a coal-fired power plant, adjacent to the curtain wall near the right flank of bastion 4. The U.S. Army's restoration of the fort in the late 1920s, following the hospital's removal, included the partial restoration, by filling, of the moat, counterscarp, and glacis, evident in the existing landscape north and west of the fort; the moat, counterfort, and glacis around the ravelin, built in 1813-14, were not restored.²³⁹

Information concerning the archeology of the moat comes from various investigations, notably those conducted by Rutsch in 1975, JMA in 1984 and 1988, and NPS in 1989 and 1998, as well as others.²⁴⁰ (Information concerning the moat in the area of the gorge, between the sally port and the ravelin, is presented in the sally port section of this report, above. Resources in areas occupied by the fort's glacis are discussed in the section concerning the grounds of the fort, below.)

A stratum corresponding to the earliest surviving nineteenth century surface of the moat has been identified in several excavations, in some locations containing fragments of mortar and slate, from the 1829 repairs or 1837 replacement of the cordon stones.²⁴¹ In some areas as well debris from the demolition of the hospital had been pressed into the moat's surface,

indicating that it was still exposed, or had again become exposed, ca. 1917-29, and that overlying layers of fill date to the army's ca. 1929 restoration; in a few excavations east and south of the fort, however, there were cinder and ash laden fill deposits some of which may date to the mid- to late nineteenth century.²⁴² While it was apparent that the moat had been created by excavation into native soils, it was unclear, in most areas, if there had been any further reduction of grade subsequent to original construction, as suggested by the apparent dearth of early nineteenth century artifacts, except within features. It was specifically noted that artifacts in the lowermost cultural stratum at the salient of the ravelin, where grading is very likely to have occurred in the 1830s, were predominantly of the ca. 1835-65 period.²⁴³ Grading and excavation which accompanied the development and demolition of the World War I hospital had clearly intruded on, or truncated, earlier deposits in some locations.

In any case, remnants of the moat's early to mid-nineteenth century surface were found buried beneath 1-3.5 ft. of mid-nineteenth through mid-twentieth century fill deposits, at approximate elevations of 25 ft. to 30 ft. amsl (26-31 ft. abcd). The original moat surface, a partially humicized subsoil, was evidently highest in the vicinity of bastion 2, at the divide between two drainage areas, one sloping down to the southwest, toward the successive drains in the vicinity of bastion 3, the other sloping down toward the drain opposite bastion 1 (the later slope was extended into the moat around the ravelin in 1844). The early (post ca. 1836?) elevation of the moat's surface at the salient of the ravelin (the 1840 plan's drain D vicinity) was found to be at an elevation of about 23 ft. amsl. The lowest elevations in the star fort's moat proper were at bastion 3 (the drain B vicinity), where the historical surface, below 2.5 to 3.5 ft. of fill, was about 25-26 ft. amsl. Remnants of the moat's original surface along the fort's southeast front were found at depths of 1 to 2.5 ft. below existing grade, at elevations of generally of about 26.5-27.5 ft. amsl; the lower elevations in this area were centered between bastions 4 and 5, where the caponniere had been located, and where the ca. 1840 drainage inlet (drain C) to the postern drain line was situated, while elevations were higher toward the salients of the bastions, where again drainage area divides were situated. The existing surface drainage pattern in the moat is similar to the historical pattern.

The most striking archeological discovery within the moat, made by JMA in 1984-88, was of an otherwise undocumented tenaille, or defensive trench, located directly adjacent to (and extending deeper than) the scarp wall's footing along the landward (north and west) sides of the fort, from the salient of bastions 1, around bastion 2, to the salient of bastion 3.²⁴⁴ The tenaille was interpreted as an element of the defenses of the fort during the 1814 bombardment. Its excavation and filling clearly preceded the repair or replacement of the cordon stones in 1829 or 1837, since the evidence of that work was stratified over the trench. Further, a fragment of a British 10-in. mortar shell and a military button from the early nineteenth century were

found in the trench. It had been known previously that a major part of the force of about one thousand men at the fort during the bombardment had been placed in the moat to defend against an enemy landing; it had not been known that these men had, most likely, excavated and occupied a tenaille on the landward side of the fort. The tenaille, 2.5-3 ft. deep by 4-5 ft. wide, was apparently filled soon after the bombardment; it does not appear on the 1819 plan. That plan does depict a feature, probably a berm, that has been interpreted as a separate tenaille, on the opposite, southeast side of the fort.

Archeological evidence for the berm/tenaille depicted by the 1819 plan was not found in the excavation made by Kurtz in 1989 adjacent to the right flank of bastion 5, where a portion of the feature had apparently been located.²⁴⁵ The only soil feature found beneath the historical surface was the narrow, truncated builder's trench associated with the footing of scarp wall of the fort. The historical surface soil, identified 1.5 ft. to 2 ft. below grade, at an elevation of about 27.5 ft. abcd, graded into and had apparently developed from the subsoil below it; its elevation was slightly above that of the top of the footing. Extending down to the top of the footing, however, and located directly above the builders' trench, was a ca. 1938 WPA repointing trench; the historical surface had been laterally truncated by the WPA trench.²⁴⁶ The deposits directly over the historical surface otherwise appeared to derive from the late-1920s demolition of hospital.

If the supposed tenaille here had been contemporaneous with the identified historical surface, then it would have had to have been located directly exterior to the scarp wall's footing. Thus the absence of evidence of the tenaille, and the presence instead of the fort's narrow builders' trench extending into subsoil, indicates either that the tenaille did not exist, or that if it did, both it and the moat surface with which it had been associated were substantially more elevated than the surviving historical surface.²⁴⁷ While the stratigraphy, together with the dearth of early nineteenth century artifacts, implies that grade in this vicinity was lowered in the 1820s or 1830s, it appears doubtful that grade was originally so much higher that all traces of the tenaille would have been destroyed. The relative elevation of the historical surface documented by Kurtz, about 14-14.5 ft. below the top of the scarp wall coping, is consistent with 1840 profiles, but 1.5-2 ft. lower than the comparable depth indicated on the 1819 profiles. Bearing in mind that the 1819 profiles consistently understate the elevation of fort and associated features, even this minimal indication of the amount of reduction of grade is likely to be exaggerated. The lack of archeological evidence of the tenaille, in other words, is more likely due to the 5 ft. wide feature adjacent to the scarp wall having been a berm, than to the destruction of such evidence.

Excavations were made by Pousson in 1998, to mitigate the anticipated impact of drainage system repairs, and of the reconstruction of the bombproof 1 revetment wall. These excavations, made in a few locations

along the southeast front of the fort, and across the outer edge of the moat and the counterscarp toward the west end of the north face of the ravelin, clarified certain issues associated with interpretation of the changes in historical grade in these areas. An excavation in the vicinity of bombproof 2, opposite the left face of bastion 4, overlapped the alignment of the ca. 1813-14 banquette, directly interior to the counterscarp; that excavation disclosed ephemeral evidence of the banquette, of a pre-1813 surface, and of a pre-1836 episode of filling within the outer part of the moat, which buried the banquette. The pre-1813 surface, which evidently had been truncated during the ca. 1813-14 development of the moat, banquette, and counterscarp in this vicinity, had an elevation of about 27 ft. abcd, but it appeared to have sloped up toward the fort, so that its elevation adjacent to the scarp wall may have been as much as 29-30 ft. abcd. (If, prior to 1813-14, there had been such a higher original surface elevation adjacent to the fort, then it could have been the from that elevation that the berm/tenaille feature was developed.) The banquette remnants, however, indicated that construction of at least the outer section of the moat involved excavation to depths of 1-1.5 ft. below the earlier surface. Filling of the outer section of the moat, which the 1836 Delafield plan and profile (Figures 19 and 22) indicates occurred prior to the 1836-40 development of the water battery, was evidenced by a deposit of relatively homogeneous fill which raised grade to an elevation of 27.5 ft., where it apparently remained until the 1860s, when the bombproofs were built and additional fill deposited.²⁴⁸

A complex stratigraphic sequence in the vicinity of bombproof 1, investigated by JMA in 1994 and Pousson in 1998, was found to represent a similar process of alteration of grade, although at this location original grade had been much lower, and the establishment of the ca. 1813-14 moat, banquette, and counterscarp had been entirely by means of filling.²⁴⁹

Concerning the caponniere depicted by 1819 through 1834 plans of the fort, there is little that archeology can contribute. It is possible that evidence of the builders' trench for this 1813-14 feature, or remnants of the feature itself, may survive within or below the installation trench for the 1836-37 postern drain line which replaced it, but this has yet to be demonstrated. The drain line installation trench, evidently about 9 ft. wide, and consequently large enough to have included at its outer edges the builders' trench for the caponniere, was revealed in one of Rutsch's excavations, and possibly in one of Kurtz's.²⁵⁰

There is archeological evidence, nonetheless, which may derive from one of the 1813-14 defensive features along the fort's southeast front: the palisade shown by the 1819 plan extending from the left shoulder of bastion 4 to the right shoulder of bastion 5. Kurtz's excavation at the right flank of bastion 5 may have failed to reveal the supposed tenaille, but within the southeast corner of the same excavation, where it overlapped the alignment of the palisade, a broken-off, slightly angled, vertical log was discovered,

in a truncated (?) pit or trench extending through the ca. 1840 historical surface and into subsoil; the depth to which the log extended was not determined. Excavations by Pousson in 1998, however, failed to locate any remnants of the palisade in the center of the southeast front, possibly because grade there, in the vicinity of the mound over the caponniere, had been lowered more substantially than elsewhere. Remnants of a separate, Civil War palisade, and of a defensive trench exterior to it, were found in one of JMA's excavations in 1988, extending from the left shoulder of bastion 3 toward the west end of the water battery parapet nearby.²⁵¹

Various drainage-related features have been found within the moat, including the ca. 1840 cunette. The cunette was best represented in one of JMA's 1988 excavations, in which a clay-filled, 4 ft. wide by 1.5 ft. deep, semicircular ditch was found in what had been the center of the moat, 15 ft. out from the left face of bastion 3, precisely where the 1840 Smith map indicated it was located. One of Rutsch's 1974 excavation also revealed a portion of the cunette, 12 ft. out from the right face of bastion 3, toward its salient, adjacent to disturbances and features deriving from the World War I hospital. If the cunette had been supplied with a brick lining in the mid-to late nineteenth century, the brick had evidently been robbed at some later date. A truncated (?), 1 ft. wide by .75 ft. deep trench located by Kurtz 11 ft. out from the curtain wall southwest of the postern may also have been a drainage feature, but is unlikely to derive from the ca. 1840 cunette, which was shown to have been 35 ft. to 50 ft. out from the fort's curtains.²⁵²

Historical drains have not been discovered, where previously anticipated, at the salients of the ravelin and bastion 3. Prior to the implementation of excavations at these locations it had been thought that formal drains, of iron pipe or brick conduit, might extend through the scarp wall foundations into (or through) the ramparts of the fort and of the ravelin. The locations tested, near two of the cunette's outlets, were those where it was believed most likely that such drains would be located, if they existed.²⁵³ Also tested, and likewise found not to possess evidence of a drain, was the vicinity of the right shoulder of bastion 5, where a proposed drain had been depicted on the 1836 Delafield plan.²⁵⁴

At number of post-1840 drain (or sewer) lines were discovered in the vicinity of bastion 3.²⁵⁵ One, a 4-in.-diameter cast iron pipe installed during or immediately after the development of the World War I hospital, was found by Rutsch about 2.5 ft. below grade extending southwest from an open terminus within 3 ft. of the salient of bastion 3. The orientation of this drain or sewer line suggests that it was either an extension added to the ca. 1840 drain beneath the glacis, or a replacement of that drain, installed to maintain surface drainage despite the construction of a more elevated roadway through the area. Rutsch also found an 8-in.-diameter ceramic pipe, about 30 ft. west of bastion 3, buried 6-7 ft. deep beneath, and partially within, a deposit of hospital construction debris, with a roughly

north-south alignment. It was suggested that this drain or sewer line could extend beneath the rampart of the fort, but it seems more likely that it was associated exclusively with the hospital structures exterior to the fort. Another 8-in.-diameter ceramic drain, perhaps a branch of the line documented by Rutsch, was found by JMA in 1988 at a similar depth, and in a stratigraphically analogous context, 28 ft. south of the left face of bastion 3. What may have been an earlier drain (but not the ca. 1840 drain) was found in JMA's excavations 6.5-7 ft. below grade 48-50 ft. south and southwest of bastion 3. More recent drainage features were evident in Kurtz's excavations between bastions 4 and 5, where a partial perimeter drain was installed ca. 1975, and in Pousson's 1998 excavation, which revealed the locations of drain lines installed by the WPA ca. 1938. A separate perimeter drainage system was installed along the north and west sides of the fort, adjacent to the base of the scarp wall, in 1989-90. There are several other twentieth century utility lines within the moat, particular in the area of the gorge, but also along the curtain between bastions 1 and 2, where there are two utility tunnels which extend beneath the fort's scarp wall and rampart, and along (and beneath) the walkway in the area of the water battery.

A World War I hospital roadway was found in excavations in the vicinity of bastion 3, and evidence of a contemporaneous, or more recent, road was also found by Kurtz in the area between bastions 4 and 5. Similar deposits were identified in Pousson's 1998 excavations. Possible evidence of late nineteenth through early twentieth century, cinder-paved walkways, within the area of the moat between the fort and the water battery, has been more difficult to interpret, since such evidence cannot easily be distinguished from contemporaneous ash and cinder laden fill.

Evidence of the nineteenth century counterscarp was found in the trench which Smith excavated in 1958 across the moat in the vicinity of bastion 2, in his successful attempt to locate remnants of the original boundary wall. Smith's description of the counterscarp, however, is cursory:

Beyond the ditch (northward), as the exploratory trench crossed the adjacent slope, it soon became clear that the surface grade (sloping gently downward and outward from a crest next to the ditch) here also [as in the ditch itself] had been materially raised.

Smith provided no indication of the counterscarp's precise location or profile; its crest was found at a depth below grade of approximately 1.5 to 2.5 ft. Smith suggested that the counterscarp in this vicinity had not been raised to the same height as elsewhere, and that the U.S. Army's 1929 restoration of the counterscarp and glacis, to a height of 3.5-4 ft. above the fill within adjacent areas of the ditch, is likely to have exaggerated their physical prominence. The counterscarp and glacis were also evident in a trench which Pousson excavated in 1998 opposite the north face of the ravelin, but in the 1994 and 1998 excavations adjacent to the southwest revetment of bombproof 1, evidence of the glacis was ambiguous.²⁵⁶

Neither Rutsch nor JMA found evidence of the original counterscarp and glacis in the vicinity of bastion 3, where it had apparently been obliterated during the development of the hospital. Buried remnants of what appeared to have been an early ground surface, beneath the locale of the glacis, were nonetheless found there, at about the same elevation, 25-26 ft. amsl, as the ditch in that vicinity. Excavation made in the area of the water battery in 1993-95 found evidence, southwest of magazine 3, of an early (ca.1800-1836) ground surface, situated exterior to the fort's original glacis, at an elevation of about 27 ft. abcd (26.15 amsl), beneath 1836-37 fill. Subsoil was found at an elevation of 28 ft. abcd, however, directly beneath ca. 1866 fill, at the northwest end of magazine 3, where construction of the water battery, and later of the magazine, had resulted in the removal of glacis deposits. Strata likely to represent truncated remnants of the glacis—here consisting of fill deposited in 1813-14 when the glacis was completed—were found adjacent to bombproof 1's southwestern revetment wall in 1994 and 1998.²⁵⁷

One additional historical feature within the moat which has been investigated archeologically is the ravelin privy, built ca. 1868-70 and demolished ca. 1874. The location of this structure adjacent to the ravelin, however, makes it more convenient to discuss it in conjunction with the ravelin itself, in the following section of this report. It may simply be noted here that a loamy stratum located immediately northeast of the privy, below 2 ft. of twentieth century fill, is the best candidate for the mid- to late-nineteenth century surface in the vicinity. This stratum, at an elevation of about 24.5 ft. abcd, was situated approximately 11.5 ft. below the top of the ravelin's scarp wall, which corresponds closely to the relative elevation indicated in the profile and notations of the 1840 plan. Demolition of the privy ca. 1874 extended to roughly the same depth.

Excavation in 1998 on the opposite side of the ravelin, and closer to the gorge, disclosed the presence of the moat's original surface at an elevation 24.5 ft. abcd; the mid-nineteenth through early twentieth century surface there, beneath 2.5 ft. of modern fill, was at 26 ft. abcd.²⁵⁸

END NOTES

1. A *facies*, as defined in geology, consists of a group of strata differing in physical composition or fossil content from another group of the same age; all of the formations represented at the site of Fort McHenry have both clay and sand facies.
2. Reinhardt and Crowley 1979; Vokes and Edwards 1957:47-48.
3. Cheek et al. 1989:63. Figure 4-19; Anonymous ca. 1861.
4. Stokinger and Blades 1979a; Stokinger et al. 1982:84-86.
5. A combination of injection of a urethane grout/soil-consolidant, to form a water-resistant membrane directly exterior to underground structures, and in some areas placement of shallowly-buried bentonite sheets, to redirect the percolation of rainfall, is the approach planned for the final phase of the fort rehabilitation project, in 2000-2001.
6. Bradford 1958: Appendixes.
7. Kurtz 1989:86, Figure 17. Virtually all statements in this report of elevations above mean sea level (amsl), above Baltimore City datum (abcd), or above other reference planes are estimates, based either on previous reports or, more commonly, on both the reports and available modern topographic maps and plans. In many instances their accuracy is unlikely to be greater than ± 1 ft. Pousson 1999a provides an appendix with a brief discussion of the importance of the various vertical datums employed at Fort McHenry.
8. Cheek et al. 1999:23-25. The elevation may, in fact, be about 34 ft. abcd.
9. Kurtz 1989: 96-99, Figure 23.
10. Smith 1958:17, 20.
11. Campbell 1963:10.
12. A similar walkway was revealed at a slightly higher elevation northwest of the west corner of the barracks during construction monitoring in 1999 (Pousson 1999c:13-16).
13. Powell 1964:2-3; Cotter 1966a.
14. Cheek et al. 1999:89-94, Figures 45-46. Although these figures indicate that elevations are referenced to mean sea level, other source material suggests that they are in fact referenced to the Baltimore City Datum.
15. Smith 1958:41-43; NPS 1958.
16. Stokinger and Blades 1979b:8-19.
17. Smith 1958:36-37.
18. Pousson 1999a, Appendix A, provides an estimate that Delafield's high water datum is presently, due to sea level rise, about .8 feet lower than the Baltimore City Datum.
19. Office of the Chief of Engineers 1886a, 1886b.
20. Concerning another possible borrow area, Brown and Long (1986:48-49) quote an 1884 letter which indicated that "ashes and refuse" would then be used "to fill up holes that were made by getting out dirt beyond the cemetery for the water battery": there is an eroded area along the fort's southwest shoreline in that area, however, documented by plans dating to 1858 (Figure 10, above) and 1870 (Brown and Long 1986:101, Illustration 10).
21. Brown and Long 1986:45-47.
22. Brown and Long 1986:43-45.
23. Smith 1958:18-19, 35-36.
24. Stokinger 1982:12-14; Smith 1958:16-21.
25. Joseph and Cheek 1985; Cheek et al. 1989; Kurtz 1989.
26. Aivazian 1982; Stokinger et al. 1982.
27. Cheek et al. 1999; Pousson 1996a, 1999a.
28. See Benatec Associates, Inc. 1984 for a recent discussion; also see Joseph and Cheek 1985:64-70.
29. Rutsch 1974; Joseph and Cheek 1985:16-25, 38-40; Cheek et al. 1989:33-48; Kurtz 1989:122.
30. Duffy 1975:40.
31. Joseph and Cheek 1985:Figure 6; Cheek et al. 1989:Figure 4-1; Kurtz 1989:Figure 29.
32. Both Kurtz (1989:65.n35) and Rutsch (1974) noted that there was no mortar in the sections of the foundation they exposed. However, mortar was definitely found between bastions 1 and 2, so it is more likely that the mortar has been dissolved by the constant flow of water through the foundation in these areas.
33. NPS 1958; Cheek et al. 1989:36-44, Figures 4-4 and 4-5; Kurtz 1989:118-127.
34. The width of the base of the scarp wall has not been determined archeologically. The top of the wall is approximately 4.5 ft. thick, including both the brick facing and the stone.
35. Joseph and Cheek 1985:43.
36. The counterforts varied from a "Common Plan" discussed by Cal. Decius Wadsworth. He remarks that the space between the counterforts was usually three times the breadth of the counterforts. In this case it is five times the breadth of the counterforts (Wadsworth 1814; Joseph and Cheek 1985:40-41, Figure 20).
37. Thompson, Henry, Lt., October 24, 1837, to Gratiot, National Archives, Record Group 107, Office of Civil Engineer, "SC FT-MC," 1811-1837; in Thompson and Newcomb 1974:46.
38. Joseph and Cheek 1985:19; Cheek et al. 1989:43.
39. Thompson and Newcomb 1974:21, 42, 104, 106.
40. Joseph and Cheek 1985:11-12, 38; Thompson and Newcomb 1974:56.

41. Sheads 1995:50.
42. Correspondence in 1893 between the engineering officer at Fort McHenry and the Chief of Engineers, cited by Thompson and Newcomb 1974:111, noted that the parapet at that time was "a low earthen slope...sustained by sods laid flat." The chief of Engineers advised that this was an acceptable peace-time arrangement. That same year all of the parapet slopes were described as being in bad condition.
43. Joseph and Cheek 1985:31-32, 56-57.
44. Noel Hume 1970:129-131.
45. Thompson and Newcomb 1974:30.
46. Cheek et al. 1999:30-36.
47. Cheek et al. 1999:36-43.
48. Cheek et al. 1999:44-51
49. Joseph and Cheek 1985, Appendix C, profile of Op. IV, Trench C, on the left flank of bastion 2.
50. Mullaly 1958:64-65.
51. Much of the breast-height wall within the star fort was reconstructed in 1998, to remedy severe structural deterioration. These reconstructed sections consist of steel-reinforced cinder-block backing walls with brick veneers (Pousson 1999a, Appendix C).
52. The builder's trench has been found in all excavations at the foot of the breast-height wall. See Joseph and Cheek 1985:Figure 14; Cheek et al. 1989:Figure 4-13; Kurtz 1989:Figure 26.
53. See Joseph and Cheek 1985:34,39; Thompson to Gratiot, Oct. 24, 1837, in Thompson and Newcomb 1974:46; Thompson to Totten, Oct. 17, 1839, in Thompson and Newcomb 1974:48-49; Smith 1840; Thompson 1839a. The exceptions include the form of the breast-height wall. The profile on the Smith map does not match the archeological record. The terreplein side of the wall has a taller footing and the parapet side has two outset ledges rather than one (compare the 1840 Smith map profile, Figure 23, with Figure 21B).
54. Joseph and Cheek 1985:39.
55. Thompson and Newcomb 1974:39-42.
56. Thompson and Newcomb 1974:43-52.
57. A map and notes detailing problems, and recommending improvements, given the deteriorated condition of the fort, shows the banquettes still visible in 1898 (Anonymous 1898). Historic photographs showing the breast-height wall between bastions 4 and 5 during the time of the construction of the World War I hospital show the banquettes still in existence (FOMC 2369).
58. Cheek et al. 1989:48-56; Cheek and Balicki 1993:33-38.
59. Thompson and Newcomb 1974:44, 106.
60. Cheek et al. 1999:52-54.
61. Cheek and Balicki 1993:33-38.
62. The exceptions are Unit E and Trench 4 near bastion 2 (Kurtz 1989:Figures 26 and 28). No undisturbed deposits have been tested in bastion 1.
63. Stokinger and Blades 1979a:Figure 10; Kurtz 1989: Figures 19, 23.
64. Although the 1835 Gratiot Map shows traverses planned along this curtain wall, there is no contemporaneous evidence that they were ever laid. However, an aerial photograph of the fort clearly shows the crop marks caused by the 5 buried traverses on the terreplein between bastions 4 and 5. (Lewis 1970:Figure 6).
65. Joseph and Cheek 1985:Figure 14; Kurtz 1989:Figure 19; Cheek et al. 1989:Figures 4-11, 4-13. The units illustrated are the only ones which extended far enough away from the breast-height wall to expose the slope of the banquette.
66. Cheek and Balicki 1993:38; Cheek, Balicki, and Joseph 1989:Figures 4-11--4-14; Joseph and Cheek 1985:Figure 14.
67. Cheek et al. 1999:52-56.
68. Stokinger and Blades 1979a:22-28, Figures 10, 11, Plates V, VI; Joseph and Cheek 1985:50-52, Figures 14, 25, Plate 13; Cheek et al. 1989:48-60, Figures 4-9, 4-12, 4-14, Plate 4-2; Kurtz 1989:106-108, Figure 27, Photo 4.
69. The bastion 4 drain was below both the gravel surfaces in that vicinity, as well as below the original terreplein surface as interpreted under models 1 and 3 (Cheek et al. 1989:53; Stokinger and Blades 1979a:21). The stratigraphy at bastion 3 suggests that the drain would have been above the level of the original terreplein (Kurtz 1989:Figure 27).
70. Kurtz 1989:106-111, Figure 27.
71. Cheek et al. 1999:44-51.
72. Cheek et al. 1989:58-59, Figure 4-15, Plate 4-3; Kurtz 1989:91, Figure 18.
73. The 1803 plan of the fort, with its note: "Embrasures are marked on the [water] batteries [only?] to designate the places for pointing the guns over the parapets," indicates that the lower water battery was then to be armed with 12 24-pounders and 6 18-pounders.
74. Scheel 1984:59-60; Gooding 1988:33, Figure 52-3.
75. Sheads 1986:13.
76. Mullaly 1958:3; Sheads 1989:13.
77. Walsh 1958:10; see also Thompson and Newcomb 1974:22.
78. Scott Sheads, personal communication, 1999.
79. Mullaly 1958:63-64. Mullaly indicates that the commander of Fort McHenry recognized that the fort's guns were not comparable to those of the Royal Navy. Requests for heavier guns and mortars went unheeded.
80. Thompson and Newcomb 1974:46.
81. Thompson and Newcomb 1974:49.
82. Thompson and Newcomb 1974:61-63. It should be noted that the designations of the bastions used in the report were the opposite of the present day designations: what were termed bastions 1 and 2 in 1861, in other words, are those presently designated bastions 5 and 4. The eleven "out work fronts" are the straight sections of the ravelin and water battery, numbered sequentially from the ravelin's north face to the southwest end of the battery, near bastion 3.
83. In 1895 the War Department had authorized the transfer of ordnance to military veterans organizations for ceremonial usage; under this program, Fort McHenry's 10-inch columbiads were sent to Willoughby, Ohio, where they remain (Sheads personal communication 1999).
84. The stonework of the traverse circles was discarded along the seawall, where it continues to supplement the rip-rap there (Sheads personal communication 1999). The concrete block which, until 1970, supported the ceremonial Rodman at the bastion's left shoulder was exposed in 1984 during an archeological investigation of the breast-height wall (Joseph and Cheek 1985:39-40).
85. Cheek et al. 1999:52-53; Cheek et al 1989:54-55
86. Cheek et al. 1999:44-51; Joseph and Cheek 1985:Appendix C.
87. Cheek et al. 1989:58-59, Figure 4-15, Plate 4-3; Thompson and Newcomb 1974:49.
88. Cheek et al. 1989:59, Figure 4-15; Plate 4-3.
89. Kurtz 1989:80-91.
90. Cheek et al. 1999:51-57.
91. Kurtz 1989:99-101:Figure 23 and 24; Brewerton 1861. However, the letter report from Brewerton to Totten listing the 1861 ordnance suggests that the 10-in. light seacoast mortars were not intended for permanent placement at the fort and that they were without carriages (Thompson and Newcomb 1974:63).
92. Fort McHenry NM&HS, Library, Special Collections.
93. Stokinger and Blades 1979a.
94. Orr et al. 1982:12-15. While Orr et al. suggested that the alteration of the ends of the parade wall occurred ca. 1916, Sheads' research indicates that the arching ends of the wall remained in existence until 1936 (Sheads 1997:3).
95. Walsh 1958:23.
96. Inspection Report of Fort McHenry, September 1822, RG 159, Records of the War Department, Office of the Inspector General, Selected Pages from Inspection Reports, 1814-1842, in Svejda 1969:73. It should be noted that the 1819 plan of the fort shows what appears to be a drill ground north of the ravelin. It is unknown if the parade function of the original parade ground had, for a time, migrated to this other location.
97. Thomas and Newcomb 1974:61.

98. Although there is documentary evidence for an 1898 episode of paving the roads "in and around the fort" (Sheads 1997:3), for use by vehicles delivering and removing supplies from the storehouses then occupying two buildings, a post-1883/pre-1894 photograph of the parade ground, together with other documentation, suggests that the central lawn and loop road may have originated during the 1870s, and may have been first paved with shell in 1879 (Thomas and Newcomb 1974:70, 154; Stokinger 1982:12). A plan of the fort from 1898 shows a circle road, which, if it had actually been constructed, would have destroyed the grass areas in front of the officers' quarters (Anonymous 1898).
99. Stokinger 1982, 1983a
100. Aivazian 1982: 84-100
101. Cheek et al. 1989:61-68.
102. Cotter and Nelson 1958; MacKenzie 1958; Smith 1958; Rutsch 1974; Stokinger and Blades 1979a; Aivazian 1982; Stokinger et al. 1982. Aivazian (1982:79) did not find any evidence of historic ground levels associated with the cistern or guard house, suggesting that the construction activity had erased all traces of a ground surface sequence. However, some evidence of an early ground surface was found near the 1814 well (Aivazian 1982:92).
103. Cheek et al. 1989:64-65.
104. Stokinger (1982:12) suggests that the initial surface was a quartz pebble and gravel deposit that has since been truncated. This deposit was not found during the 1988 JMA excavations (Cheek et al. 1989:64-65). The deep drain was excavated into the sand, pebbles, and iron ore level. Stokinger's draft profiles suggest that the drain trench was sealed by the lowest sand and pebble layer, suggesting that the drain was part of the early drainage system of the fort. On the other hand, his profile of the fills over the traverse at the interior edge of the sally port indicates that this sand and pebble layer went over the filled traverse trench foundation (Stokinger 1982:Figure 50). This could indicate that the sand and pebble layer is not the original surface of the fort's parade.
105. Aivazian 1982:92, Figure 53.
106. Cheek et al. 1989:67-68; Thompson and Newcomb 1974:61; Stokinger 1982:Fig. 13.
107. Closer examination of Stokinger's original field drawings would also contribute to improved interpretation of the parade's development and identification of the location of existing and abandoned utility lines. The xerox versions of the field drawings are not clear.
108. Nelson 1961:25; Walsh 1958:8-9.
109. Rutsch 1974:12-13, 19-21.
110. Cheek et al. 1989:35-36, Figures 4-2 and 4-5; Kurtz 1989:118-125. The 1814 tenaille along the north and west sides of the fort did extend below the top of the foundation, but it was not an original feature, and it was refilled within a few years of its excavation.
111. Rutsch 1974:5-12.
112. Rutsch 1974:8.
113. Pousson 1999c:8-12.
114. Aivazian 1982:32-33, 63-78, Figures 12, 29, 30, 39, and 40.
115. Orr et al. 1982:11-13, Figures 1 and 3.
116. Orr et al. 1982:5, Figure 2. Cartographic evidence, however, in the form of an 1819 profile, indicates that the sally port's surface was relatively flat, lacking the slope down toward the exterior one would expect if there had been a surface drain along its centerline.
117. Cotter 1961.
118. Cotter 1961; Aivazian 1982; Stokinger 1982, 1983b; Orr et al. 1982; Cheek et al. 1989.
119. Blades 1984.
120. Cheek et al. 1989:61-68, Figures 4-18--4-20.
121. Rutsch (1974:15-16) was the first to suggest that the deep drain documented by Cotter in 1961 might have been part of a system of drains for the cellars within the fort.
122. One of the original dry moat drains was found, in 1844, to be blocked about 30 yards beyond the counterscarp opposite bastion 1. This blockage might also have occurred during the alterations made to the fort in 1813-15 (Thompson and Newcomb 1974:108).
123. Rutsch 1974:15-17.
124. Cheek et al. 1989:99-102.
125. In addition, as disclosed by the findings of construction monitoring in 1999, and contrary to previous interpretations, there is likely to have been a separate drain installed beneath the floor of the postern tunnel in 1813-14 (Pousson 1999c:8-12).
126. Stokinger and Blades 1979a:23, Figures 7 and 10.
127. Thompson and Newcomb (1974:22) suggest that the caponniere, which had been recommended by Wadsworth in 1813, at the same time as the ravelin, "to provide safe communication" between the fort and the water batteries, was not built. They were, surprisingly, mistaken: the 1819, 1834, and 1835 plans of the fort all indicated the existence of the caponniere, in line with the postern directly southeast of the fort.
128. Lt. Henry Thompson indicated that alteration were made in the sewer in 1833-34, at the same time as construction of the parade wall (Thompson and Newcomb 1974:51).
129. Thompson and Newcomb 1974:40-41.
130. Stokinger and Blades 1979a:24, Figures 7 and 10.
131. Kurtz 1989:80-91.
132. Nelson (1961:57) and Stokinger (1983b:16) both suggest that the 1803 plan may be misleading in showing an open sally port passage. Their skepticism is due in part to an 1801 plan of Fort Independence, Boston, another Foncin-designed fort, which includes a depiction of an uncovered sally port passageway. Unlike the 1803 plan of Fort McHenry, however, the Fort Independence plan includes profiles and elevations, one of which indicate that the sally port passageway at Fort Independence was a brick vault covered with earth.
133. *Bombardment of Fort McHenry, September 13, 1814*. Artist unknown, Peale Museum, Baltimore. Reproduced in Thompson and Newcomb (1974:146-147, Illustration no. 3) and in Bradford (1958:33, n. 46, frontpiece and figure 12).
134. Orr et al. 1982; Stokinger 1982; Stokinger 1983b; Stokinger 1983c.
135. Smith 1958:67-68; Cheek et al. 1999:23-36.
136. Although part of the dry moat, the gorge will be discussed with the sally port; construction activities, features, and deposits in the gorge are more directly associated with the sally port than with the dry moat.
137. Stokinger 1982:12; Blades 1984.
138. Stokinger 1982; 1983b:41.
139. Stokinger 1983b:49.
140. Blades 1984; Cheek et al. 1989:68-72.
141. Orr et al. 1982; Stokinger 1982, 1983b.
142. Orr et al 1982:Plate V.
143. Stokinger 1982; Figures 19 and 20, 1983b: Figures 40 and 42.
144. Orr et al. 1982.
145. Stokinger 1983b:84.
146. Stokinger 1983b:83 Figures 44 and 41.
147. Orr et al. 1982:5.
148. Stokinger 1983b:34, 86.
149. Sheads 1997:2; Sheads notes further that the flooring documented for Fort McHenry's sally port is identical to what still exists at Fort Washington, Maryland.
150. Orr et al. 1982:8.
151. Stokinger 1983b:87.
152. Orr et al. 1982; Thompson and Newcomb 1974:113.
153. Sheads 1997 personal communication.
154. Orr et al. 1982.
155. Stokinger 1983b: Figures 48 and 50.
156. Orr et al. 1982:11. A March 1813 letter proposed that the gateway traverse be 8 ft. wide, 12 ft. long, and 6 ft. high.
157. Maximilien Godefroy, a Baltimore architect and engineer, is believed to have designed and supervised the construction of the sally port bombproofs. Nelson 1958:19-20.

158. Thompson and Newcomb 1974:99.
159. Thompson and Newcomb 1974:61, 101.
160. Speculatively, the very unevenly surfaced concrete floors of the bombproofs may be contemporaneous with the concrete roofs. The floors were evidently present prior to 1917, when one of the water lines laid during development of the World War I hospital required trenching beneath the southeast bombproof, where it is apparent that the floor is patched.
161. Smith 1958:67-68.
162. Cheek et al. 1999:25-30.
163. Cheek et al. 1989:68-72.
164. Thompson and Newcomb 1974:86.
165. Pousson 1999c:14-17.
166. Thompson and Newcomb 1974:99-100.
167. Smith 1958:67.
168. Cheek et al. 1999:25-30; as discussed elsewhere, although this excavation apparently revealed that the concrete slab over the bombproof extended beneath the wall of the guardhouse addition, other documentation indicates that the guardhouse addition's floor is lower than the slab's surface, which may indicate that the slab is more recent than the addition.
169. Thompson and Newcomb 1974:91; Nelson 1958:1-16.
170. Sheads, personal communication, 2000. However, one of the details on Smith's 1840 plan – a section of the magazine – (supplied, together with a plan of the magazine, to Smith by H. Thompson in 1839) shows what is likely to be the rear window. Nelson (1958:12-13) found flaws in Thompson's depiction, particularly of the vent locations and roof structure, but in one regard at least, Thompson's indication of the location of vent holes has been corroborated. During development of an exhibit in 1999, masonry patches indicative of long interior vent holes were discovered on the interior of the side walls, located as had been shown on Thompson's plan (although in section Thompson's vents there are short).
171. Stokinger 1976a:2.
172. Smith 1958:55-62.
173. Smith 1958:57-59, Plate VI.
174. Stokinger et al. 1982:66-91.
175. Nelson 1958:5-6; Smith 1958:59-60.
176. Bradford 1958:13-14; Rivardi 1994, quoted in Bradford 1958:85-86.
177. Just when the cistern was abandoned has not been determined. It was not a source of drinking water for several years prior to 1813, but it may have remained in use for other purposes, and as an emergency water supply, until the fall of 1813, when the fort's first reliable well was dug. A guardhouse was built over the site of the cistern by 1819, perhaps as early as the spring of 1814, but the presence of the foundation of a possible 1814 shot furnace interior to the footprint of the guardhouse suggests that the guardhouse was not built on the site until the 1815-19 period.
178. Thompson and Newcomb 1974:23.
179. Thompson and Newcomb 1974:23-25.
180. Anonymous [1861-73]; Moore 1864 in Ashcraft 1964.
181. Thompson and Newcomb 1974:68.
182. Aivazian 1982.
183. Aivazian 1982:70.
184. Aivazian 1982:84-102.
185. Cheek et al. 1989: 67-68, Figure 4-20; Stokinger 1983a:8-10.
186. Scott Sheads 1992, personal communication.
187. The plan which first depict the shot furnace, along with the sally port guardhouses, is RG 77, Dr. 51, Sht. 7.
188. Aivazian 1982:57-81.
189. Sheads has suggested (1998:1-2) that the fort's 1814 guardhouse/provost prison was the same structure as the guardhouse depicted on the 1819 and 1834 plans. If correct, this interpretation clearly rules out the possibility of the foundation south of the cistern having been the 1814 shot furnace.
190. Aivazian 1982:58-65.
191. Nelson 1961.
192. Smith 1958; Cotter and Nelson 1958; Cotter 1966b; Sarles 1968; Aivazian et al. 1982.
193. Thompson and Newcomb 1974:29, 89-91.
194. Sheads 1995:85.
195. Cotter and Nelson 1958.
196. Aivazian 1982:38-45, Figure 16. The bonding of the walls may be a result of their reconstruction in 1929, rather than of 1829 construction.
197. Cotter and Nelson 1958.
198. Thompson and Newcomb 1974:29.
199. Thompson and Newcomb 1974:31.
200. Thompson and Newcomb 1974:95-96.
201. Cotter and Nelson 1958.
202. Cotter and Nelson 1958.
203. Smith 1958:66-67.
204. Cotter 1966a.
205. Pousson 1999c:8-12.
206. Thompson and Newcomb 1974:44, 106.
207. Although a four-seat water closet was to have been built behind the storehouse ca. 1890, this was one aspect of a never-implemented plan to return the structure to its original use. A ca. 1905 photograph shows only a small, low shed where the water closet would later be located (Thompson and Newcomb 1974:75-76, 98, 168-169, Illustration 14).
208. Stokinger and Blades 1979a.
209. Aivazian 1982:23-38.
210. Aivazian 1982:35-38.
211. Thompson and Newcomb 1974:55.
212. Smith 1958:65.
213. Stokinger et al. 1982:66-91.
214. Smith 1958.
215. Stokinger and Blades 1979a:30; Toltz 1918.
216. Walsh 1958:20.
217. Thompson and Newcomb 1974:29.
218. Sheads has suggested (1998:1-2) that the guardhouse at the site of the cistern was built, as a guardhouse, by the spring of 1814. This contrasts with Walsh's conclusion that Armistead's 1813 request for a "proper guard house" had apparently not been fulfilled prior to the bombardment (1958:20). If correct, as noted above, it also means that the possible 1814 shot furnace foundation here cannot have had that origin.
219. Aivazian 1982:60-75.
220. A watercolor painted soon after the bombardment (see endnote no. 133, above) depicts the flagstaff within the fort.
221. Stokinger et al. (1982:92) must be credited with suggesting that close examination of the 1819 plan might reveal a depiction of the earlier flagstaff. The dotted line connecting the 'x' at the apparent location of the flagstaff to the end of the profile line A...B, indicates that the plan drafter's objective is more likely to have been to show some relationship between the 'x' and the profile, than to depict the flagstaff site.
222. Bradford 1958:65, Figure 14.
223. Thompson and Newcomb 1974:32; Sheads 1990:3.

224. A temporary flagstaff occupied bastion 5 in 1988-89, during reconstruction of the parade flagstaff (Sheads 1999:5).
225. Smith 1958:55-63; also see MacKenzie 1958; Smith 1963.
226. MacKenzie 1958.
227. Stokinger et al. 1982:91-98.
228. Thompson and Newcomb 1974:20-22.
229. Pousson 1999a:5.
230. The hachuring of the slopes on either side of the linear mound over the caponniere is shortened where the mound overlaps the 5 ft. wide feature, precisely the way it is where the mound overlaps the banquette, a feature that clearly was higher than the moat.
231. Thompson and Newcomb 1974:31.
232. The 1834-34 plan of the fort is annotated "Cunette is required"; the placement of the note within the area of the ditch may indicate where the cunette was needed. The 1836 Delafield plan depicts two of the same drainage ditches as the Lee plan, and conveyed a proposal for placement of a drainage "well hole" in the ditch near the right shoulder of bastion 5; the profile on this plan, however, as well as those on the 1837 plan, indicate that the cunette within the ditch had yet to be installed.
233. This "blind drain" was found, in 1844, to have been blocked approximately 30 yards beyond the counterscarp opposite bastion 1 (Thompson and Newcomb 1974:57). When the blockage might have occurred is not known, but it may have been during the alterations made to the fort during 1813-15. Upon the discovery of the blockage, the cunette from the north front ditch was rerouted so as to lead to the drain at the salient of the ravelin. It was proposed that the blind drain be extended to the seawall, but it is unlikely that this was done.
234. As discussed below, the findings of excavations made in 1998, in the area of the moat east of the salient of bastion 4 and near the ravelin, suggest, to the contrary, that the 1819 moat was *deeper*, at least adjacent to the counterscarp, than the 1840 moat.
235. Thompson and Newcomb 1974:56-57.
236. The 1844 work on the fence was evidently repair of an 1869 fence (Sheads 1997:4).
237. Brick-lined cunettes were built in the vicinity of the ravelin in 1929-30, during the army's restoration of the fort, as elements of a drainage system associated, in part, with a parking lot (Pousson 1999c:13-18).
238. Thompson and Newcomb 1974:60-65, 115; Moore 1864; Brewerton 1861.
239. There is, however, a swale along the north face of the ravelin, at the west end of which, in 1998, Pousson documented the preservation, beneath twentieth century deposits, of nineteenth century moat surfaces, along with remnants of the counterscarp and glacis.
240. Smith 1958:15-19, 68-69; Rutsch 1974:9, 20, Figures 8, 12, and 13; Joseph and Cheek 1985:16-20, 25-28, Figures 5, 6, 10, and 11; Cheek et al. 1989:33-48, Figures 4-1--4-8; Kurtz 1989:115-129, Table III, Figures 16, 29-32; Cheek et al. 1999:75-84; Pousson 1999a, 1999c.
241. Joseph and Cheek 1985:19; Cheek et al. 1989:43.
242. Smith 1958:17, 68; Rutsch 1974: 20, Figure 13; Kurtz 1989:121, 127-129, Figures 30 and 32; Cheek et al. 1999:80-81.
243. Joseph and Cheek 1985:26.
244. Joseph and Cheek 1985:19-21, Figure 6; Cheek et al. 1989:38-40, Figures 4-1 to 4-3.
245. Kurtz 1989:118-122.
246. A ca. 1975 french drain also intrudes on the historical surface, between 1.5 ft. and 3 ft. out from the scarp, but the disturbances associated with both the WPA trench and the french drain trench are largely confined to twentieth century deposits; and it appears very unlikely that either trench obliterated evidence of the ca. 1813 tenaille.
247. If, as suggest in a note previously, the tenaille was in fact a set of berms, somewhat higher than the ditch, rather than lower, then the absence of an archeological reflection is more easily explained.
248. Pousson 1999a.
249. Cheek et al. 1999:75-83.
250. Rutsch 1974: Figure 8; Kurtz 1989:128, Figure 32.
251. Cheek et al. 1989:45-46, Figures 4-3, 4-6, and 4-7.
252. Cheek et al. 1989:43, Figure 4-4; Kurtz 1989:125, Figure 30.
253. Joseph and Cheek 1985:27-28, Plate 4; Rutsch 1974; Cheek et al. 1989:44.
254. Kurtz 1989:125.
255. Rutsch 1974:24-27, Figures 12, 13; Cheek et al. 1989:46-47, Figure 4-4.
256. Smith 1958:15-19.
257. Cheek et al. 1999:81-83; Pousson 1999a.
258. Pousson 1999a:34-36.

4. ARCHEOLOGICAL AND HISTORICAL RESEARCH RESULTS: OUTWORKS AND GROUNDS

4.1 Ravelin

A ravelin is a defensive work constructed beyond the main ditch of a fortification, opposite a curtain requiring additional protection, often because of the presence within it of a gateway. It is generally composed of two faces, forming a salient angle. The main gateway at Fort McHenry—its sally port—lacked the protection of a ravelin until 1813-14, when, in anticipation of the British assault, Col. Decius Wadsworth recommended that one be built.¹ With the ravelin's construction in accordance with Wadsworth's recommendations,² the fort's entrance road passed through the body of the ravelin, crossing bridges over an extension of the moat along the north face of the ravelin, and over the gorge (Figure 7). The upper sections of the ravelin are (and were historically) approximately 5 ft. lower than corresponding elements of the star fort. Several major episodes of construction, however, have altered other aspects of the ravelin's original configuration. Archeological investigations focusing on ravelin's scarp walls, entrance, parapet, breast-height wall, banquettes, and magazine have contributed to an understanding of its historical development.³ The ravelin privy, an adjacent but otherwise unrelated ca. 1868-74 structure, is also discussed in this section. Another unrelated nearby structure—the upper water battery barracks, also referred to as the ravelin barracks—one of the oldest surviving historical features of the site, had been abandoned prior to the ravelin's construction; it is discussed below in the section concerning the original grounds of the fort.

4.1.1 Scarp Walls

The ravelin's scarp consists of battered brick walls, two faces and two gorge walls, resting on a brick foundation. In its foundation, as in various other characteristics, the ravelin's scarp contrasts with the star fort's, where the foundation was of stone. A profile on the 1819 plan indicates the ravelin's scarp, near the middle of its southeast face, rose only 8-9 ft. above the level of the adjacent ditch, suggesting that the elevation of the ditch was then slightly higher than present grade; profiles on 1837 and 1840 plans, however, indicate that the scarp at that time, at about the same location, stood 11 ft. above the level of the ditch; the wall's height very likely ranged from 10 to 12 ft. above the ditch during and after 1837-40, with the ditch sloped down towards the northeast for drainage purposes. The 1819 surface of the gorge was 5.5-6 ft. below the floor of the fort's sally port, and about 1.5 ft. lower in elevation than the ditch at the southeast face of the ravelin. The gorge surface was presumably raised by filling in 1837-40, both for drainage and to accommodate modifications of the fort's entrance.

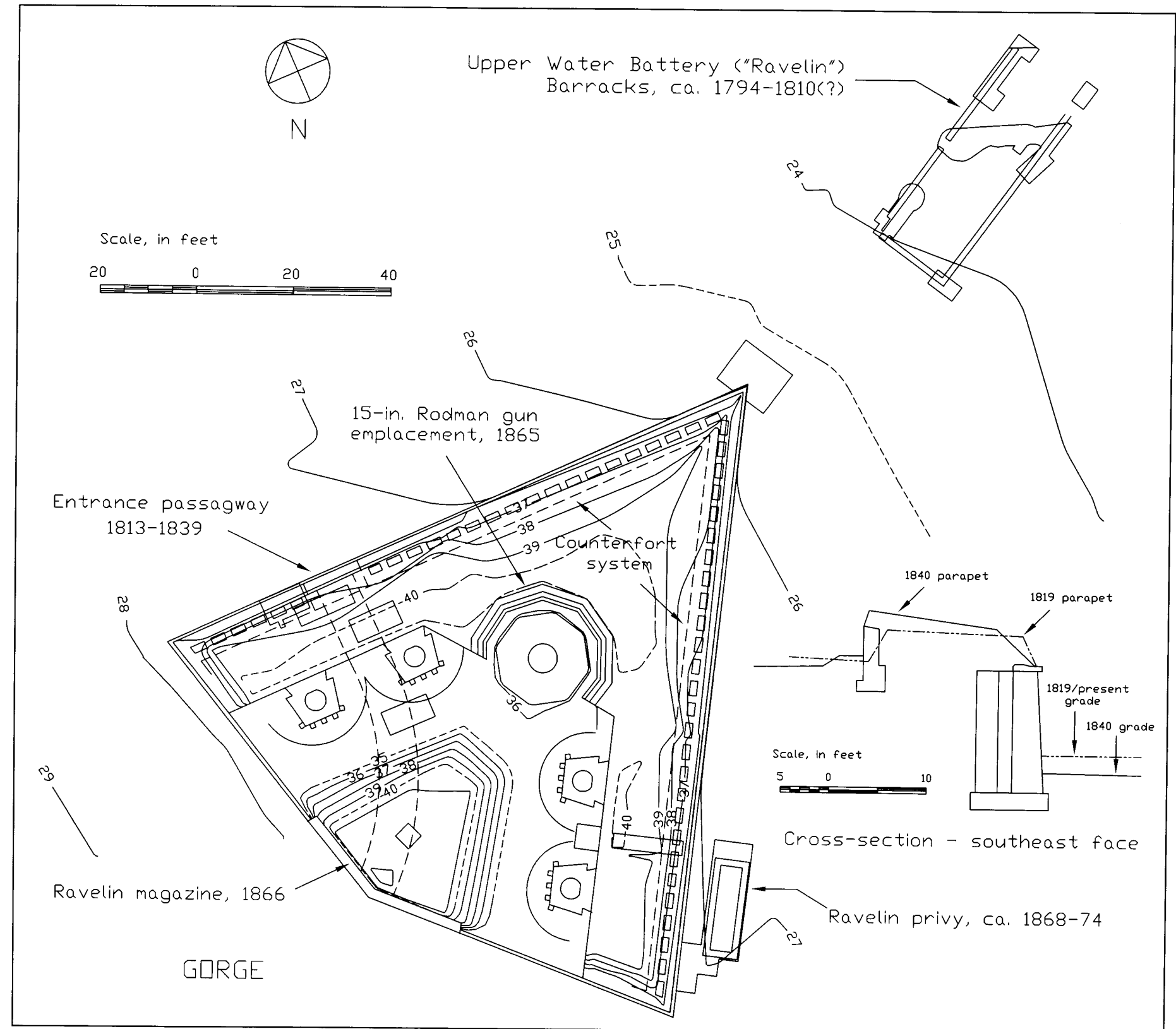

Figure 40. The ravelin at Fort McHenry, showing its counterfort system and the former entrance passageway.

As in the star fort, a counterfort system was built within the ravelin to strengthen its walls, but in contrast to the star fort, where common eighteenth-century European fortification design is reflected, the ravelin counterforts were built in accordance with an entirely different plan, apparently an innovation conceived of by Col. Decius Wadsworth. In 1814, Wadsworth, then the Chief Ordnance Officer of the War Department, detailed his plan to John Armstrong, Secretary of War, stating that in 1813 he had “made a partial trial of the Method at Baltimore . . . , the success of which answered my expectations.”⁴ Wadsworth’s 1814 proposal, slightly different from the plan employed in the ravelin at Fort McHenry, called for a set of brick walls and earth cells to be substituted for the stone counterforts commonly used to buttress scarp walls. Wadsworth estimated, on the basis of detailed calculations, that his system was not only cheaper to build but would also result in stronger walls.

Excavation in 1984 by JMA examined the uppermost section of the ravelin’s scarp, beneath the parapet of its southeast face, as well as its lowermost exterior surfaces below grade, at the salient angle. Among the discoveries was that of the ravelin’s counterfort system, which consists of an inner wall, parallel to the scarp wall, cross walls connecting the two parallel walls, and earth-filled cells between the cross walls (Figure 40). The system differs from Wadsworth’s 1814 proposal only in the dimensions of its elements. As built, the exterior wall, i.e., the scarp, is at its top 30-32 in. thick, while the inner wall is 24-27 in. thick; the distance between these walls is about 18 in. The cross walls are 18 in. wide and about 4.5 ft. apart on center.⁵ The cells formed between the walls are filled with silty sand. The exterior face of the scarp wall is battered, but the walls are otherwise vertical. The counterfort system is basically the same within the scarp of the ravelin’s north face, although with slight modification to accommodate the fort’s former entrance road.⁶ JMA’s 1984 excavation on the ravelin’s parapet also established that the scarp wall’s coping had been replaced, most likely in 1837, when the coping of the star fort’s scarp was replaced.

The 1839 closure of the ravelin entrance has been the only major alteration to the scarp (compare Figures 7 and 27). The entrance was bricked over and the patch’s brickwork bonded into the older portions of the wall. At various times in the past, deterioration of the scarp’s brickwork, resulting primarily from moisture infiltration, has been repaired.⁷

4.1.2 Parapet and Breast-height Wall

The ravelin’s original parapet, as documented by one of the profiles (AB) of the 1819 plan, was relatively flat, rising just .5 ft. front to back, with a height of 3.5-4 ft. above the level of the cordon of the ravelin’s scarp wall; its crest was just 3 ft. above the lowest level of the adjacent gun platform within the ravelin. Like the star fort’s original parapet it was sod-revetted,

at least on its interior. The profile of the ravelin’s parapet was not documented again until 1837-40, during and immediately after the episodic construction here, as elsewhere, of a brick breast-height wall. A steeper slope was then established, and the parapet’s crest heightened, so that the parapet stood 3 ft. to 5.15 ft. above the cordon, and 3.4 ft. to 5.6 ft. above the level of the terreplein, which was lower than the original gun platform had been. The height of the ravelin’s parapet is presently about 2-4 ft. above the cordon, 1 ft. lower than it was ca. 1840, due primarily to erosion.⁸

There have been archeological excavations on the ravelin’s parapet in conjunction with investigations of the ravelin passageway in 1980 and 1994, as described below, and as one element of JMA’s 1984 study of the fort.⁹ JMA’s 1984 trench on the southeast parapet, which resulted in the discovery of the counterfort system incorporated into the ravelin’s scarp, also revealed the fill soils of the ravelin’s original core, beginning at a depth of .75 ft. to 1.2 ft. below existing grade, beneath fill deposited in 1837-39. This interface was about .5 ft. lower than the parapet surface in the 1819 profile, presumably due to erosion of the 1813-19 surface prior to 1837. The stratigraphy of the parapet fill in the immediate vicinity of the passageway, on the north side of the ravelin, is not representative of the fill sequence elsewhere. Aside from the body of ca. 1839 fill used in closing the passageway, the uppermost parapet fill strata here, used to reestablish grade after the breast height had been built, were also more substantial—1.8 ft. to 3.5 ft. thick.

The ravelin’s breast-height wall, as built in 1837-39, lacks a stone coping, but is otherwise nearly identical to the star fort’s breast-height wall. Its back side, as exposed in the parapet excavation, was found to be stepped in the same manner as the star fort’s breast height, and there was a double set of builders’ trenches, reflecting the episodic, 1837 and 1839 construction of the wall. The plane of the back surface of the top 1.5 ft. of the wall, i.e., the 1839 addition, was also offset slightly from the plane of the earlier, lower section of the wall. An excavation adjacent to terreplein side of the breast-height wall, made in 1994 along the ravelin’s southeast side, revealed that here, in contrast to what is common within the star fort, there is no repointing trench associated with WPA work during the 1930s. Consequently, the stratigraphy associated with original construction of the wall is well preserved. The top of the .5 ft. wide ledge of the foundation of the breast-height wall was located 2 ft. below the top of the banquette, and .5 ft. below the level of ravelin’s terreplein. It was roughly level with the surface of the stratum that had been at grade in 1837, when construction of the wall began. The base of the foundation was 1.9 ft. below both the ledge and 1837 grade, corresponding with the instruction on Delafield’s 1836 plan that the foundations extend 2 ft. below the surface. The builders’ trench adjacent to wall, beneath the banquette fill, was .3 ft. wide.¹⁰

4.1.3 Terreplein, Banquettes, and Gun Emplacements

The only historical documentation for the original characteristics of the ravelin’s terreplein is again the 1819 plan and profile, which show that it was almost entirely occupied by a gun platform (Figures 7 and 18). Earthen features which most likely functioned as banquettes were situated at the ravelin’s salient and interior to the western end of its north face. The surface of the platform, 20 ft. wide, with curbs or gun stops front and back, was about .5 ft. higher along its back edge than it was adjacent to the parapet. It was approximate 1-1.5 ft. higher than the cordon of the ravelin’s scarp, and 2.5-3 ft. lower than the crest of the parapet. The banquettes appear to have been more-or-less level with the platform. The surface of the roadway through the ravelin, where it joined the bridge to the fort’s sally port, was about 3-3.5 ft. lower than platform, and 2 ft. below the level of the cordon. Archeological evidence, however, suggest that much of the roadway, including the floor of the passageway through the ravelin’s scarp, was at least 2 ft. lower, and roughly 4 ft. below the level of the cordon.

Although the ravelin’s gun platform provided sufficient space for three or four guns, Walsh’s research indicates that the ravelin’s original armament “consisted of a twelve-pounder apparently set to sweep the road with shot and defend against enemy landing.”¹¹ In 1833-34 there were four mortars positioned along the southeast side of the ravelin (Figure 25); their beds were reportedly in a state of disrepair, suggesting that they had been positioned there, following the removal of the original gun platform, for some length of time. In 1839, following construction of the breast-height wall, and after the closure of the ravelin passageway, front-pintle masonry emplacements were built for two 32-pounders, two 42-pounders, and three 8-inch howitzers (Figure 27); infantry banquettes, 3 ft. wide by 1.25 ft. high, were also built along the wall, between the emplacements.

At the end of the Civil War, an emplacement for a 15-in. Rodman gun was built at the salient of the ravelin, and the revetment wall there reconstructed. This emplacement supplanted those where the three howitzers had previously been mounted. Because of the difference in the alignment of the newer revetment, relative to the earlier revetment, remnants of the earlier wall, and possibly of one or more of the earlier emplacement, may have survived, although this remains to be determined through investigation. The ravelin’s infantry banquettes, which date back to ca. 1839, but which may have been modified or rebuilt in 1865, remain in existence, in contrast to other areas of the fort, where the banquettes have been destroyed or buried beneath fill.

The excavation made in 1994 adjacent to the breast-height wall along the ravelin’s southeast side, which documented the originality and integrity of the infantry banquette here, also revealed a buried, humic, pre-1837 surface, less than 1 ft. below grade and roughly 1.5 ft. below the level of the scarp

wall coping. This former surface, evidently 2.5-3 ft. lower than the 1813-19 gun platform, presumably developed following the platform's removal, and it represents a reduction of the grade of the ravelin's terreplein sometime after 1819. No traces of the post-1819, pre-1837 grade of the ravelin's terreplein were evident in a 1993 excavation north of the ravelin magazine, however. The latter excavation, made to determine the extent of disturbances associated with the magazine's 1866 construction, succeeded in documenting the survival there of remnants of the passageway surface, roughly 4 ft. below the level of the cordon.¹²

4.1.4 Entrance Passageway

The earliest documentation of the fort's entrance passageway through the ravelin is once more the 1819 plan and profile. The entrance roadway is depicted passing over a bridge from the glacis to the ravelin's north face scarp wall, between 37 and 47 ft. east of the west end of that wall, and the presence of a gate there is indicated by dotted lines. Interior to the gate the passageway widens to 12-15 ft., and interior to the ravelin's rampart it turns to the southwest to exit the ravelin, passing across a bridge over the gorge to the fort's sally port. The passageway surface is only shown, in profile, at the ravelin side of the bridge to the sally port, where its depth below the level of the cordon of the ravelin's scarp was depicted as having been only about 2 ft. The roadway was evidently lower, relative to the cordon, further interior to the ravelin, and passageway floor was at least 4 ft. below the cordon, or about 8 ft. below the crest of the ravelin's 1819 parapet, on the ravelin side of the bridge to the glacis. This would correspond to an approximate depth of 8.5-9 ft. below the crest of the existing parapet. By 1839 the entrance through the ravelin was closed and the ravelin assumed its present configuration (Figure 27). The ravelin entrance was changed in response to the changing armament of the fort, and to allow access to the new water battery. Sections of two gun emplacements built ca. 1839-40 were situated over the filled entrance.

The entrance passageway through the ravelin was investigated in 1980 during a DSC-sponsored project which examined the former entrance by means of excavation behind the scarp wall overlapping the west side of the passageway.¹³ Several architectural features were exposed, including the 1839 masonry and earth infill of the former entrance, and a recessed area that may have served as a socket for the west side of the gate or of the gateway framing¹⁴ Along the west side of the passageway interior to (south of) the original scarp wall masonry there were remnants of a whitewashed brick revetment wall. A stratum interpreted as the sand bed for the brick floor of the passageway was encountered at the base of the excavation, about 8.5 ft. below the crest of the parapet.

Excavation by JMA on the interior of the ravelin in 1993 documented the east edge of the entrance roadway there, at a depth of about 3 ft. below existing grade, corresponding to a depth below the parapet of about 8 ft.¹⁵ A single course of brick about 1 ft. wide, remnants of a curb or a very low revetment, marked the roadway's edge; the roadbed consisted of a thin layer of yellowish red sand overlying a brown sand, together forming a layer approximately .5 ft. thick, resting on the mixed loam and clay fill of the ravelin's core. Construction of the 1839 gun emplacements and the 1866 magazine were found to have resulted in the destruction of most of the original roadway through the ravelin's interior, and no pre-1839 ravelin terreplein surface was apparent.

An excavation made by JMA in 1994, on the parapet over the alignment of the passageway's east edge, and southwest of the 1980 excavation, documented a very ambiguous sloping break in the stratigraphy of the parapet fill at the approximate location of the passageway's edge, but did not find any clear indication of surviving remnants of either the passageway surface or a revetment wall alongside it there. However, the excavation, for safety reasons, ended with a 2.5 ft. deep slot trench at the base of a 5.5 ft. deep unit, and may not have extended to the full depth of the passageway.¹⁶

4.1.5 Drainage

Like the original drainage system of the star fort, the ravelin's original drainage system has been the focus of considerable research and concern. Damage caused by moisture infiltration, here as elsewhere, has always been a problem. Information on the ravelin's drainage has been obtained from the 1978 and 1980 DSC-sponsored archeological investigations, and from JMA's 1984 excavation.¹⁷ Study of the ravelin's drainage was also undertaken by Benatec Associates, Inc. in 1984.¹⁸ Historical documentation provides no information on the ravelin's drainage system, and no formal drainage features have been located during archeological investigations, although there are surface gutters around the gun emplacements.

The 1984 excavation in the ditch adjacent to the ravelin's salient was made to examine the foundation for drainage features.¹⁹ Smith's 1840 plan (Figure 27) shows an outlet for cunette, connected to a pipe to the seawall, beneath the counterscarp opposite of the salient of the ravelin; if there had been a drain through the ravelin's footing, it also would likely have been connected to this drain. However, there was no drain, or weep holes, in the section of foundation exposed. The foundation, composed of mortared brick, and jutting out .45 ft. from the base of the wall, is 1.75 ft. thick; its top is 2.5 ft. below existing grade and about 13 ft. below the top of the scarp wall. The stratigraphy within this excavation, while disturbed, suggested that grade here historically may have been as much as 1-1.5 ft. higher than the top of the footing, roughly 11.5-12 ft. below the top of the scarp wall.

One of the excavations made in 1978 at the site of the privy southeast of the ravelin extended to the top of the ravelin's foundation toward the southwest end of its southeast face. The top of the foundation was located about 4.5 ft. below grade, corresponding to about 13 ft. below the top of the scarp. The water table, however, was found only 2.5 ft. below grade, and consequently water gushed from the deteriorated mortar joints of the foundation when soil was removed from its face²⁰ There were, however, no formal drains or weep holes within the exposed segment of foundation. Although the interpretation at the time, based on previous work by Rutsch adjacent to the star fort, was that the gushing of water through the foundation indicated that it had been originally designed to serve a drainage function, subsequent archeological research, and analysis of historical plans, indicate quite clearly that this is not the case. Grade here was originally roughly equal to existing grade; even with later reductions of grade, at least prior to construction of the adjacent privy, the footing would have remained below the surface, making it unlikely that any significant amount of water impounded within the ravelin could have been released through the footing. The high water table made it impossible to document the stratigraphy at the base of the 1978 excavation, but early twentieth century filling apparently extended to a depth below that of the water table, suggesting that grade here had been reduced at least once after 1840, possibly when the privy was built. A trench associated with WPA repointing of the scarp was also encountered within this excavation.

4.1.6 Magazine

During the 1866 post-Civil War renovations to the fort's water battery, a magazine was built in the ravelin. The ravelin magazine (magazine no. 1) is a subterranean brick chamber accessed by two entrances along the gorge wall. The exterior wall of the magazine's antechamber now forms center section of the ravelin's gorge wall, and sections of the gorge wall to either side may have been substantially rebuilt upon construction of the magazine. It is unclear what provision, if any, was made for drainage from the magazine. Construction of the magazine disturbed several earlier elements of the ravelin. Any remnants here of the original passageway through the ravelin which survived its 1839 infilling would have been destroyed, together with the post-1839 stairway access to the ravelin's terreplein, directly opposite the sally port. Archeological investigation of the magazine's roof in 1984 exposed a bitumen-covered box which corresponds to part of the magazine's original ventilation system.²¹ Construction-era plans and cross-sections of the magazine indicate that its outer surfaces were coated with bitumen.²² Excavations did not reach the roof of the magazine, however. Excavation on the terreplein of the ravelin in 1993 revealed that the magazine's builders' trench extended about 7-9 ft. beyond the outer edges of the magazine's 4 ft. thick walls.²³

It is noteworthy, given the existence of a very deep, and early, fill deposit in the vicinity of the privy southeast of the ravelin, that the 1866 excavation made for construction of the ravelin magazine resulted in exposure of iron ore which was then sold for smelting.²⁴ Stokinger has suggested that the early fill deposit could reflect the existence in that vicinity of some part of a ca. 1780-94 mining pit, noted by Rivardi in 1794:

The communication from the lower to the upper works [batteries] ...has been destroyed by some persons who transformed the whole of the spot...into a deep pit, by digging for red ochre. I propose, therefore, to bring the whole of it to a gentle slope, in which it will be easy to cut a road for the cannon....²⁵

4.1.7 Ravelin Privy

Thompson and Newcomb, in their 1974 HSR, were the first to note, on the basis of textual documentation, the existence of a privy in the vicinity of the ravelin during the early 1870s. The initial result of their recommendation that archeological investigation of the privy be conducted was the finding of corroborating cartographic evidence, in the form of sketch plans of the fort dating to 1873 and 1874, which depicted the privy adjacent to the southwest end of the ravelin's southeast face. This determination of the privy's site occurred during background research conducted in advance of the recommended archeology, which was implemented in two phases (as part of separate projects) in 1978 and 1980.²⁶

The 1978 excavation resulted in discovery of the west corner of the privy's foundation about 1 ft. below grade, with its northwest wall aligned parallel to and 4.6 ft. southeast of the ravelin's southeast face (Figure 40). Exposure of a portion of the northeast end wall indicated that the structure had an exterior length of 20 ft. The walls were found to be 16 in. wide.

The second phase of investigation of the ravelin privy, in 1980, involved excavation of the northeast end of the privy vault, interior to the foundation, more controlled excavation exterior to the foundation (beyond its northeast end) than was possible in 1978, and the complete exposure of the top of its foundation. It was anticipated that analysis of the artifactual and other materials contained in the vault would provide a basis addressing a variety of research questions concerning the configuration and use of the privy, and the lifeways of those using it. It was in particular hoped that a broader cross-section of the fort's population would be represented here, and that comparison with the officers' privies within the fort would be especially enlightening. As with the officers' privies, however, nearly all of the original content of the ravelin privy had been removed when it was abandoned, and replaced with relatively clean fill.

The exterior width of the privy was determined to be about 7.8 ft., while its depth below existing grade was, on average, slightly more than 9 ft. The

uppermost fill stratum within the privy, along with the lowermost fill overlying the remnant top of the foundation, appear to reflect the gradual build-up of grade in this area between ca. 1875 and ca. 1925. These strata extend to a depth of roughly 1.5-2 ft. below the present surface, suggesting that grade in the area, right after the privy's abandonment, was similar to the grade established ca. 1840. The bulk of the fill within the privy was nearly devoid of cultural material, except for a layer of brick rubble 3-4 ft above the base of the privy, and a thin layer of mortar debris at the very base of the fill, overlying approximately .25 ft. of privy soil mixed with sand, pebbles and cinders. The latter stratum represents the remnants of the privy's contents during its last period of use, and it yielded a quantity of objects of organic origin, including ethnofaunal and ethnobotanical materials; among the artifacts, of late-nineteenth century age, were match sticks, leather lacing, woolen cloth, and shoe leather.²⁷

The privy foundation, which had the same depth as the vault, was footed on planks within a stratum of sandy soil, apparently fill, presumably deposited sometime prior to construction of the ravelin. The sandy fill deposit, as Stokinger suggested, may derive from work done during the 1790s to eliminate a mining pit that had been dug following the abandonment of Fort Whetstone in the early 1780s. The depth of the deposit, extending beyond 10 ft. below grade, was not determined.

Excavation exterior to the privy's northeast end revealed what are likely to be ca. 1875-1925 deposits extending 1-2.3 ft. below grade, below which were a series of fill strata, the origins of which are uncertain, due in part to the absence of a builders' trench for the privy, and in part to the dearth of artifacts, and the absence of diagnostic artifacts. A loamy stratum likely to have been the uppermost surviving nineteenth century surface, at an elevation of about 24.5 ft. abcd, was situated approximately 11.5 ft. below the top of the ravelin's scarp wall. This corresponds closely to the relative elevation of the moat surface indicated in the profile and notations on the 1840 plan. It is also at about the same depth as that to which the privy was demolished in 1874. The 1982 report suggested that a stratum-interface at 4 ft. below grade, at an approximate elevation of 22 ft. abcd, might represent grade contemporaneous with use of the privy, and that one at a depth of 5 ft., at about 21. ft. abcd, could represent the ditch's ca. 1840 surface. Both these strata are lower than the top of the footing of the ravelin's scarp, however, and appear unlikely to have been at grade for any extended period; their 1982 interpretation is also inconsistent with cartographic documentation.

It is possible, particularly in view of the absence of a builders' trench, that the entire sequence of strata between depths of 2.3 ft. and 6.5 ft. below grade (as deep as the excavation could safely be made) derives from the reestablishment of grade following construction of the privy. Alternatively, these strata may represent deposits made ca. 1800, during the construction

of the fort's original glacis, or filling associated with the 1813-14 construction of the ravelin, or some combination of these episodes. The absence of a builders' trench extending into these earlier strata, if they are earlier, might be due to construction of the privy's foundation flush with the walls of the excavation made for it.

Concerning the privy's history and use, Stokinger concluded that it had been built ca. 1868-70. Following the post surgeon's 1873 recommendation that the privy be abandoned, because of its poor condition and the apparent difficulty of keeping it clean, use of the privy was discontinued; its pit was filled in 1874.²⁸ Stokinger suggested further that although the structure is sometimes identified as an enlisted men's privy, it is likely to have been used by all of the garrison. The reported presence of a latrine along the road in the gorge vicinity in 1880 is not believed to indicate reuse of the ravelin privy, but the location of this ca. 1880 latrine is unknown.

4.2 Water (Outer) Battery²⁹

Fort McHenry's outer battery, commonly referred to as the water battery, consists of a series of gun emplacements, protected by a continuous, multi-angled parapet, extending from the ravelin to bastion 3 (Figure 41). The parapet revetment (breast height) wall is situated about 50 to 140 ft. out from the star fort's curtain; the parapet's elevation is about 9-10 ft. below that of the fort's parapet. From the base of the outer slope of the battery's parapet, the fort's grounds are contoured to slope more-or-less uniformly downward toward the seawall, in the manner of a glacis. The battery originally contained emplacements for thirty-nine guns; as modified at the conclusion of the Civil War, the battery contained twenty-six gun emplacements, two powder magazines, two bombproofs, and an earthen traverse. Two shot furnaces built within the water battery in 1842 were removed in the latter part of the nineteenth century, most likely in 1866.

Gratiot's 1835 plan was the first to indicate the site and basic outline of the battery, while the much more detailed 1836 Delafield plan shows the projected configuration of the battery superimposed over an existing-conditions topographic plan of the area it would occupy (Figure 19). Include with this plan is a profile from the fort to the seawall, which also superimposes projected elevations over the existing topography, showing the extent of cutting and filling that construction of the battery would entail (Figure 22). Construction of the water battery began in the fall of 1836 under the direction of Lt. Henry A. Thompson.³⁰ In general Delafield's plan was followed, except that the advanced ditch, which the plan depicts exterior to the battery's parapet, was not constructed. The advanced ditch would have served essentially the same function as the fort's dry moat. Work on the water battery and its gun emplacements was completed by 1840; its two shot furnaces, however, were not built until 1842.

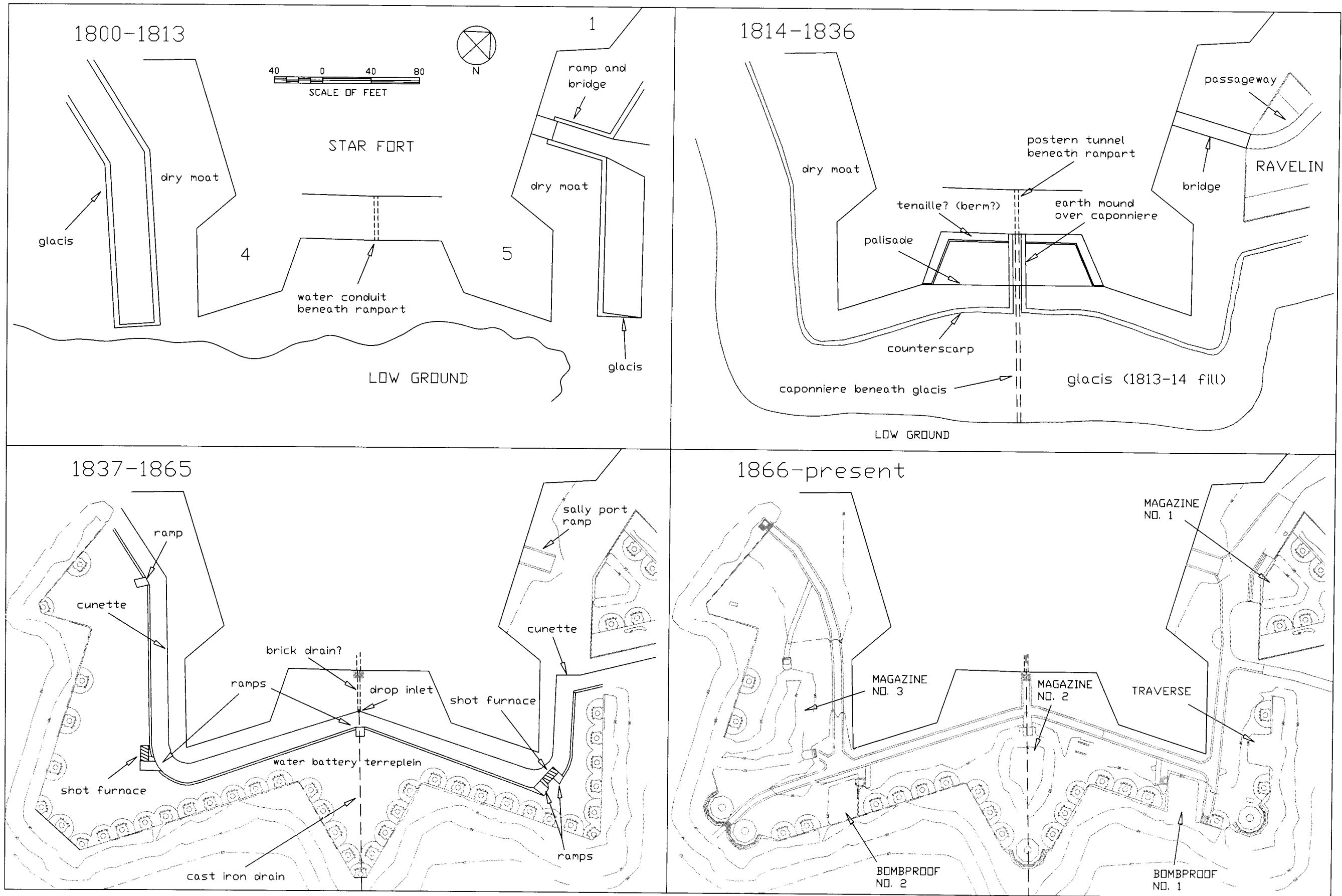

Figure 41. Stages of development of the water battery vicinity, ca. 1800 - present.

At the end of the Civil War, emplacements for four 15-inch Rodman guns were constructed at the salient angles of the water battery, and underground magazines and bombproofs, and an earthen traverse, were built. In addition, and presumably also in 1865-66, the extent of the dry moat behind the water battery was expanded while the extent of the battery's terreplein was reduced. An 1866 plan and profile (Figure 42) conveyed a proposal to lower the elevation of what remained of the terreplein, and to remove the battery's infantry banquette; the soil from these features would be used as fill to increase the height of the outer section of the battery's parapet. Early twentieth century filling in the area of the dry moat behind the battery completed the 'leveling' of the area, and there is at present very little topographic distinction between the surface of the ditch and the area which had formerly been occupied by the terreplein of the water battery.

Archeological investigations at and in the immediate vicinity of the water battery have been designed to document the characteristics of its revetment (breast-height) wall, to test for resources at two of the underground structures, to locate remnants of the ca. 1842-66 shot furnaces, and to examine drainage problems. They have succeeded in clarifying the construction history of the battery and of associated structures.³¹

4.2.1 Parapet

The water battery's parapet was constructed in 1837 on a base of fill deposited beginning in 1836. The stratigraphy of the parapet was examined during archeological testing adjacent to the revetment wall in 1984, 1993, and 1995.³² Strata associated with the original configuration were identified, as was fill added after the 1839 heightening of the revetment. Cartographic research identified historical profiles of the battery's parapet, and details showing the effects of erosion on different sections.³³

Underlying the fill composing the water battery's parapet, over most of its footprint, are remnants of the 1813-14 glacis, which was itself constructed by filling an area of low ground (Figure 39). The 1836 plan and profile suggest that remnants of the glacis lie roughly 6 ft. to 18 ft. below the level of the crest of the battery's parapet. The surface of the low ground which the 1803 plan shows had originally intruded into the area may be as deep as 20-25 ft. below the level of the parapet, particularly in the area of the salient southeast of the postern. The deep archeological testing that would be required to document the complete stratigraphic sequence underlying most of the battery's parapet has yet to be performed. A large part of the sequence was documented, however, in excavations made in the magazine 3 vicinity, at the northwestern end of the battery, in 1994 and 1995; a trench excavated over the postern drain line in 1998, exterior to the base of the outer slope of the battery's parapet, established the approximate elevation of the ground surface at that location prior to the battery's construction.

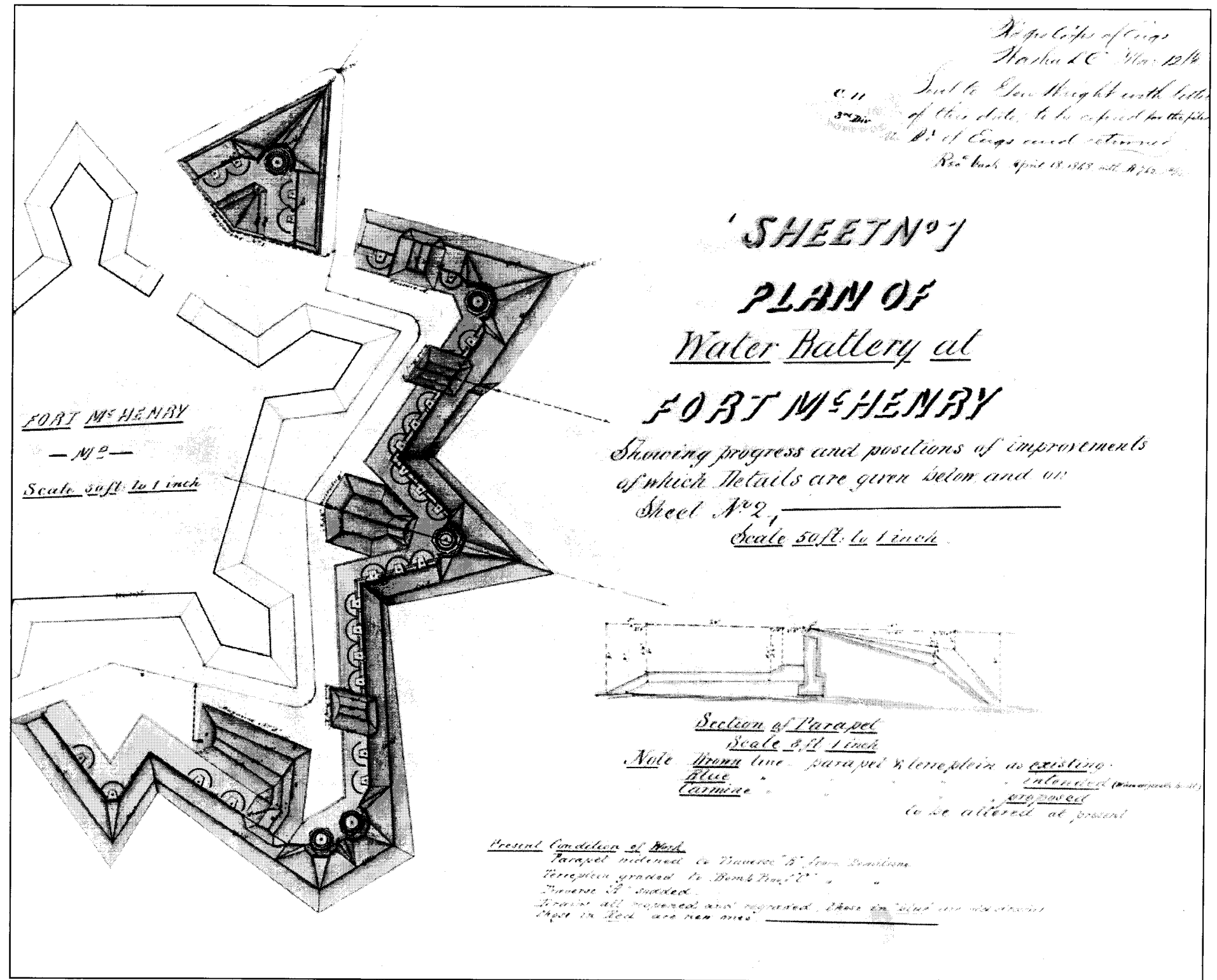

Figure 42. Detail of Major William D. Craighill's Plan of Water Battery at Fort McHenry, 1866

The western and northeastern ends of the water battery, unlike the central section, were constructed over and beyond the fort's ca. 1800 glacis, but not in the area of low ground shown on the 1803 plan. A portion of the area at the battery's western end, directly southwest of magazine 3, apparently remained outside the post-1813 glacis as well. A stratum interface evidently representing the ca. 1800 through 1836 ground surface in that vicinity was revealed in the 1994 and 1995 excavations.³⁴ The surface, 3.5 ft. below existing grade within the water battery, and 8.5 ft. below the top of the parapet, appeared to have been graded prior to the accumulation on it of early nineteenth century artifacts, primarily ceramic fragments; that grading most likely occurred during construction of the fort's original glacis. The elevation of the surface was approximately 27-27.5 ft. abcd (Figure 43). The excavation of a trench over the postern drain line in 1998, immediately southeast of the battery's parapet, revealed that the surface predating the battery's construction in that vicinity was about 6.5 ft. below grade, at an elevation of about 11.7 ft. abcd.³⁵

4.2.2 Revetment (Breast-height) Wall

The revetment wall completed in 1837 conformed to the original design for the various elements of the water battery, under which it was to rise 1.5 ft. above the surface of the infantry banquette. In 1839, however, when all of the fort's breast-height walls were made higher, Thompson reported to the army's chief engineer that:

In the outer Battery, the breast height wall has been raised 18 inches, with the necessary addition of new Sodding also 18 inches high; this wall, as well as that of the Ravelin has been covered with Zinc—a great part of the old wall had to be taken down & renewed in consequence of its having settled considerably in many places....³⁶

Previous to 1995, archeological investigation of the revetment wall had yielded evidence which suggested that the original, 1837 wall had been left in place in 1839, and that a new wall, 18 inches higher than the original, had then been built abutting the face of the original.³⁷ However, excavation in 1995 of a trench behind the wall to a depth of 9 ft. below the surface of the parapet, and demolition of a small segment of the upper part of the wall, has indicated that the 1837 wall was not removed or encapsulated during the 1839 reconstruction.³⁸ It is now evident that, at the locations studied, only .5-1 ft. of the upper part of the 1837 wall had been removed in 1839, along with the exposed face of the earlier wall, down to the level of the 1838 banquettes. The 1839 wall addition, 3 ft. high at its face and 1.5 to 2 ft. high at its back, was then built using a distinctive mortar, harder-setting than the one used in 1837. Among the structural problems which the existing revetment wall exhibits is shearing along the stepped juncture between the two components of the wall, with the upper, 1839 part being displaced by the force of the soil behind it, and with its movement resulting in damage to the immediately underlying brickwork of the 1837 wall.

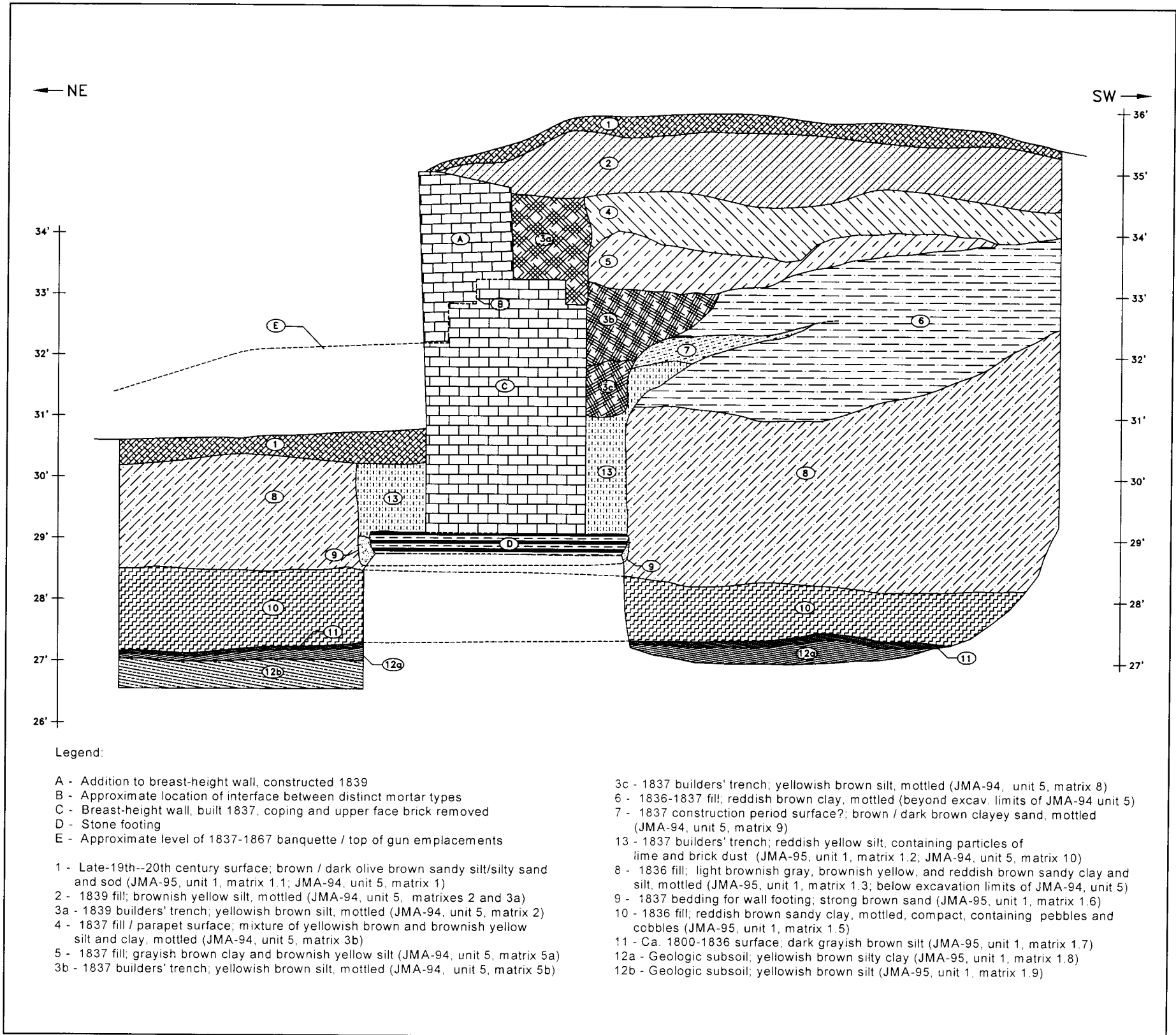

Figure 43. Profiles of archaeological excavations at the water battery's revetment wall, providing a partial cross-section of parapet, wall, and terreplein.

Construction of the 15-in. gun emplacements in 1865 required the alteration of the revetment wall. At each location, new revetment walls were built. Cartographic research indicates that these walls were constructed on the star fort side of, and offset from, the original revetment wall (compare Figure 42 with Figure 27). It is not known if the original revetment was removed or buried beneath fill. Construction of the two bombproofs in the water battery in 1866 must also have necessitated the removal of sections of the revetment wall, which these structures overlap. The construction that same year of magazine no. 3, however, and of the earthen traverse, may only have resulted in the burial of nearby sections of the wall beneath fill.

Restoration of the revetment was undertaken in 1929 and again in the 1980s. The 1929 restoration consisted of the repair and repointing of the entire revetment wall.³⁹ During the 1980s, a 75-ft. segment of revetment was rebuilt at the north end of the battery west of bomb proof 1, and a 160-ft. section was rebuilt at the west end of the battery opposite the left shoulder of bastion 3. The rebuilding in both locations involved the removal of the original wall and its reconstruction with modern materials. Reconstruction of the section at the battery's west end revealed two 1839 gun emplacements, along with other features; portions of these features were destroyed, unfortunately, in the absence of archeological monitoring, without recordation of their characteristics.⁴⁰ Further reconstruction, to be accomplished during implementation of an ongoing program of masonry rehabilitation at the fort, will be accompanied by archeological monitoring.

The soil strata associated with the revetment, where investigations have been conducted, consist exclusively of layers of fill deposited in creating the battery in 1836-37, and in building the parapet in 1837-39.⁴¹ Intruding into the fill are multiple builders' trenches associated with the revetment's construction (Figure 43). Only at the extreme northeastern and western ends of the battery might the builders' trenches for the revetment have been excavated into ca. 1800 fill soils composing the fort's original, incomplete glacis. The deeper stratigraphy believed to exist over most of the battery's site is discussed in the subsection concerning the battery's parapet, above.

4.2.3 *Terreplein, Banquettes, and Gun Emplacements*

The water battery's terreplein has been indistinguishable from the fort's ditch since at least the 1920s, and as a result it is not commonly recognized as a noteworthy element of the water battery. The 1836 through 1840 plans of the fort, however, show this broad platform of fill, elevated 2.5-3 ft. above the ditch, as an integral component of the battery. The boundary between the ditch and the terreplein had the same basic alignment as the earlier counterscarp, reflecting adaptive reuse of that earlier feature. The battery's terreplein was therefore situated over the area previously occupied by the more elevated sections of the fort's glacis (Figure 39). Like the

terreplein of the star fort, the battery's terreplein would have served as a work platform for the gun crews, protected from enemy fire by the battery's parapet. It may also have functioned of a covert way, insuring protected line of communication among the gun emplacements and providing an area of assembly for troops. The terreplein's width varied from 22 ft. to more than 100 ft., as a result of the battery's angular footprint. Five ramps, 4-8 ft. wide, were cut through the vestiges of the counterscarp to provide easier access between the ditch and the battery's terreplein (Figure 27).

The horizontal extent of the watery battery's terreplein was substantially reduced ca. 1865-1866, when the Rodman gun emplacements were added to the battery and underground magazines and bombproofs were built in the area. The 1866 plan (Figure 42) shows that the immediate vicinity of each of the magazines and bombproofs was graded so as to be continuous with the ditch. The soil removed from the terreplein, together with the spoil from the excavations made for the underground structures themselves, is likely to have been employed in the earth mounds built atop the structures. The 1866 plan proposed further that the grade of what remained of the terreplein be reduced by about 1 ft.; some additional grading presumably did occur, although how much is not known. Removal of the battery's banquettes, which was proposed at the same time, was implemented. Sometime after this, possibly prior to ca. 1900, certainly prior to ca. 1930, grade within the fort's ditch was raised by filling to the same level as that of the remnants of the battery's terreplein. The 1888 plan of the fort was the last to show the terreplein as a distinct component of the battery.

Banquettes were another original element of the water battery which, except for vestiges in the vicinity of the traverse at the northeast end of the battery, have disappeared. As depicted on plans and profiles, and as evidenced by staining on the sides of the stonework of the battery's gun emplacements, the banquettes were 2.35 ft. (top) to 4.35 ft. (base) wide by 1.25 ft. high; they were located along the entire length of the battery's breast-height wall, between all the emplacements. The surface of the banquettes, about level with the upper surface of the emplacements, was approximately 3.35 ft. below the top of the breast-height wall, and 4.5 ft. below the crest of the battery's parapet. The banquettes were presumably removed in 1867, or soon thereafter. The top of the breast-height wall is presently 4-4.5 ft. higher than the surface where the banquettes had been located.

Between 1837 and 1839, thirty-nine gun emplacements were built within the water battery (Figures 26 and 27). These emplacements, consisting of a foundation for a gun pintle and a traverse circle, presumably had the same specifications as those detailed by Thompson for emplacements constructed in the fort's bastions.⁴² At the end of the Civil War, emplacements for four 15-in. Rodman guns were constructed (Figure 42), supplanting ten of the original emplacements. The 15-in. gun emplacements opposite bastion 5 and opposite the postern each impacted three earlier emplacements, while

the two adjacent 15-in. gun emplacements opposite bastion 4 impacted four. Seven more of the original emplacements were impacted by the 1866 construction of the two water battery magazines, the two bombproofs, and the earthen traverse. The older emplacements were removed to accommodate the bombproofs, and were probably removed where the 15-in. gun emplacements were built as well; at magazines 3 and the earthen traverse, however, they may simply have been buried beneath fill. The twenty-two earlier gun emplacements that remained in use after 1865-66 were reinforced, and two of the traverse circles were reset.⁴³

A few archeological excavation units have been situated in the area of the water battery's terreplein, although the focus of these excavations was some other local feature. The data collected in these units, pertinent to the development and post-construction modification of the terreplein, is essentially negative: there does not appear to be a surviving archeological reflection of the terreplein's 1837-66 surface, and in some locations the fill associated with its development has very likely been entirely removed. The stratigraphic sequence found adjacent to the southwest revetment wall of bombproof 1 indicates that substantial grading accompanied the 1866 construction of the bombproof. The surface from which the bombproof was built, beneath 1.5 ft. of post-1866-67 fill, was at an elevation of about 28.5 ft. abcd, only a little more than 1 ft. above the level of the pre-1866 ditch nearby, suggesting that between 1 and 1.5 ft. of the battery's terreplein had been removed.⁴⁴ The absence of a stratum-interface reflecting the 1837-66 battery terreplein surface is presumably a consequence of the removal of that surface. Similarly, ca. 1866 and later strata and features extended to a depth of 2 ft. adjacent to the northwest side of magazine 3; there, however, in an area occupied by portions of the fort's original, ca 1800 glacis, the truncated stratum at the base of the excavation is culturally sterile subsoil.⁴⁵ Excavation adjacent to the water battery's revetment wall in the vicinity of magazine 3, discussed above, and adjacent to the 1842-66 shot furnace in the vicinity of bombproof 1, discussed below, also documented the probable removal of 1837-66 surfaces and features during the post-Civil War modifications of the battery.

4.2.4 *Shot Furnaces*

Two shot furnaces were constructed within the water battery in 1842,⁴⁶ at the sites, and with the dimensions, which had been indicated for them on the 1840 plan of the fort (Figure 27). One was located towards the northeast end of the water battery, opposite the salient of bastion 5, the other towards its west end, opposite the salient of bastion 4. There is very little known documentation for construction of these furnaces, and none for their removal, but they were most likely demolished during the construction in 1865-66 of the 15-in.-gun emplacements, magazines, and bombproofs. They are last clearly indicated on an 1864 plan.⁴⁷

Magazine 3's southeast entrance overlaps the site of the furnace opposite bastion 4, and most of that furnace was either removed or modified for reuse as the entrance's base. Testing in 1993 in the vicinity of the furnace site failed to find any remnants.⁴⁸ The test, however, was located northeast of the magazine's entrance, and electrical cables were encountered at the southwest end of the excavation, in the direction of the furnace's location, which prevented the unit's extension or deepening. Closer examination of historical plans now suggests that, if there are remnants of this furnace, they are more likely be located within 5 ft. of the southeast side of the entrance.

Archeological testing in 1993 did locate remnants of the furnace opposite bastion 5.⁴⁹ There had been no subsequent construction (except of modern walkways and utilities) at the location of this furnace, and its foundation is likely to be completely preserved, although the superstructure had evidently been robbed. The 3.5-ft.-long section of foundation which was exposed had been part of the structure's east wall, within, although at the edge of, the original terreplein of the water battery. The 1840 fort plan shows one ramp from the ditch to the terreplein along the north end of the furnace's east wall, and another immediately south of the furnace.

The stratigraphy adjacent to the furnace foundation, below a depth of 2 ft., consisted of two fill strata probably associated with the 1813-14 completion of the dry moat and glacis, overlain by fill that may have been deposited in 1813, possibly as part of the banquette, or more likely in 1836-37, early in the construction of the water battery. The builders' trench for the furnace was excavated into the latter stratum. Above the trench, and the stratum into which it was dug, was a .2-.5 ft. thick layer of fill that, when deposited, had abutted the furnace; it most likely represented post-construction grading, leveling this location with the surface of the water battery terreplein to the east. This stratum, at an elevation of 28 ft. abcd, was almost certainly vertically truncated in 1865-66, when the furnace was demolished and the horizontal extent of the terreplein was reduced. Intruding into it was the robbers' trench where the furnace superstructure had been removed, and over it was a series of deposits dating to the late-nineteenth through mid-twentieth century.

4.2.5 *Magazines, Bombproofs, and Traverses*

The two magazines and two bombproofs of the water battery, together with the magazine in the ravelin, were built in 1866 as improvements of the operational capabilities of the fort's outworks, in particular to insure an adequate nearby supply of powder for the 15-inch guns that had been mounted in 1865-66. The mounds of earth fill over (and, in the case of magazine 3, adjacent to) these subterranean structures enabled them to fulfill the additional function of serving as traverses. There was also a separate, freestanding earthen traverse at the northeastern end of the battery,

between the ravelin and the 15-in.-gun emplacement opposite bastion 5.⁵⁰ The traverse, and the traverse function of the magazines and bombproofs, were intended to protect the ravelin, sally port, and water battery from enfilade firing, and to confine any explosion to the immediate area of impact. Archeological investigations have been made of the magazines and bombproofs, as discussed below, but not at the traverse or in its vicinity.

4.2.5.1 *Magazines*

The water battery's two powder magazines, like the magazine in the ravelin, are subterranean chambers of brick, covered with an earthen mound (Figures 42 and 44).⁵¹ Magazine 2 is located opposite the postern, interior to one of the salient angles of the battery, where a 15-in.-gun emplacement was built in 1865. Magazine 3 is located opposite the right face of bastion 4, interior to a salient angle occupied by two 15-in.-gun emplacements; to enhance its traverse role, this magazine's earth mound was extended to join with the battery's parapet northwest of these emplacements. It is unclear what, if any, provision was made for drainage from the magazines' vaults. (Although magazine 2 is situated directly over the large cast-iron drain line from the postern, installed in place of the 1813-14 caponniere in 1836, the drain's elevation did not permit there to be an inlet, and the drain is simply exposed within the ventilation space below this magazine's wooden floor.) A short, relatively shallow drain was installed in 1866 between magazine 3's northwestern entrance and the cunette at the center of the ditch. In 1887 the magazines were reportedly were too damp to use for storing powder. Damage to the earth mounds over the magazines, presumably caused by erosion, was repaired several times in the late nineteenth century.⁵²

The first archeological investigation of the magazines consisted of JMA's monitoring of the excavation, by park personnel, of a single trench on the earth mound above magazine 3, during the course of a fort-wide archeological study of the fort's drainage.⁵³ The exposed section of magazine roof was found to be well preserved. A portion of the magazine's ventilation system was exposed, and the roof was examined for evidence of moisture damage. The exposed section of roof was found to be coated with bitumen. Cartographic research indicates that a waterproofing coat of bitumen was applied to all the magazines and bombproofs built in 1866.

Excavations made in 1993 at magazine 3's entrances revealed that earlier deposits there had been removed during the 1865-66 period.⁵⁴ Adjacent to the northwestern entrance, a thin lens of coal clinkers was found overlying subsoil at the base of the excavation, beneath fill that was continuous with the earth mound placed over the magazine when it was completed in 1866. A 1930s drain line was also encountered, with the same alignment as that of the 1866 drain; the earlier drain was presumably removed when the newer drain was installed. The most notable finding at magazine 3's

northwestern entrance, however, was the discovery of about four dozen bullets at the base of the mound. Apparently, either the magazine's mound was employed as a target butt for small arms fire, or shooting at the rats known to have populated the magazines was a routine pastime.

North of the northeastern entrance of magazine 3, the strata at the base of the excavation also consisted of subsoil; the overlying layer of sterile fill may have been associated with construction of the magazine, but may have been earlier. Possibly pre-1900 cinder-and-ash fill deposits, a lens of masonry sand (ca. 1917-19?), debris from demolition of the World War I hospital, and humic loam deposited ca. 1930 were found overlying the earlier fill. This excavation had been made in an effort to determine if remnants of one of the ca. 1842-66 shot furnaces were extant here, but as described above such evidence was not discovered, probably because the furnace had been located somewhat further to the south.

4.2.5.2 *Bombproofs*

The two water battery bombproofs, constructed in 1866 at the same time at the magazines, are also subterranean chambers of brick covered by earthen mounds. Alternative number or letter designations have been used for the structures, which in the 1930s were termed dungeons. Bombproof 1 (A) is located opposite the right face of bastion 5; bombproof 2 (B) is located opposite the salient and left face of bastion 4. Each of the bombproofs has structurally independent revetment walls along two sides; these revetments are essentially retaining walls for the earthen mounds over the bombproof vaults, which are interior to the walls and extend much deeper.⁵⁵ The sites of the bombproofs are mostly within the area of the 1836-40 water battery's terreplein, and of the 1813-14 segment of the fort's glacis.

Archeological investigation of bombproof 1 has consisted of JMA's monitoring, again in 1984, of an exploratory trench into the earthen mound made to examine the condition of its roof, the excavation in 1993 of three small units at the base of the structure's revetment wall, and the excavation in 1998 of two additional units along the wall.⁵⁶ At bombproof 2, archeological monitoring was conducted in 1975 during the demolition and construction excavations that preceded the reconstruction of the revetment walls there, but no other investigations have been undertaken.⁵⁷

It is noteworthy that quicksand was encountered during the construction of bombproof 1, which necessitated the excavation of a drainage trench, extending through the water battery parapet's and out to the seawall.⁵⁸ As a result, bombproof 1 evidently became the only underground structure exterior to the fort provided with a drain. A permanent masonry drain line—a brick trough with a stone cap—was installed in this drainage trench prior to its filling, and a drainage sump was incorporated into the

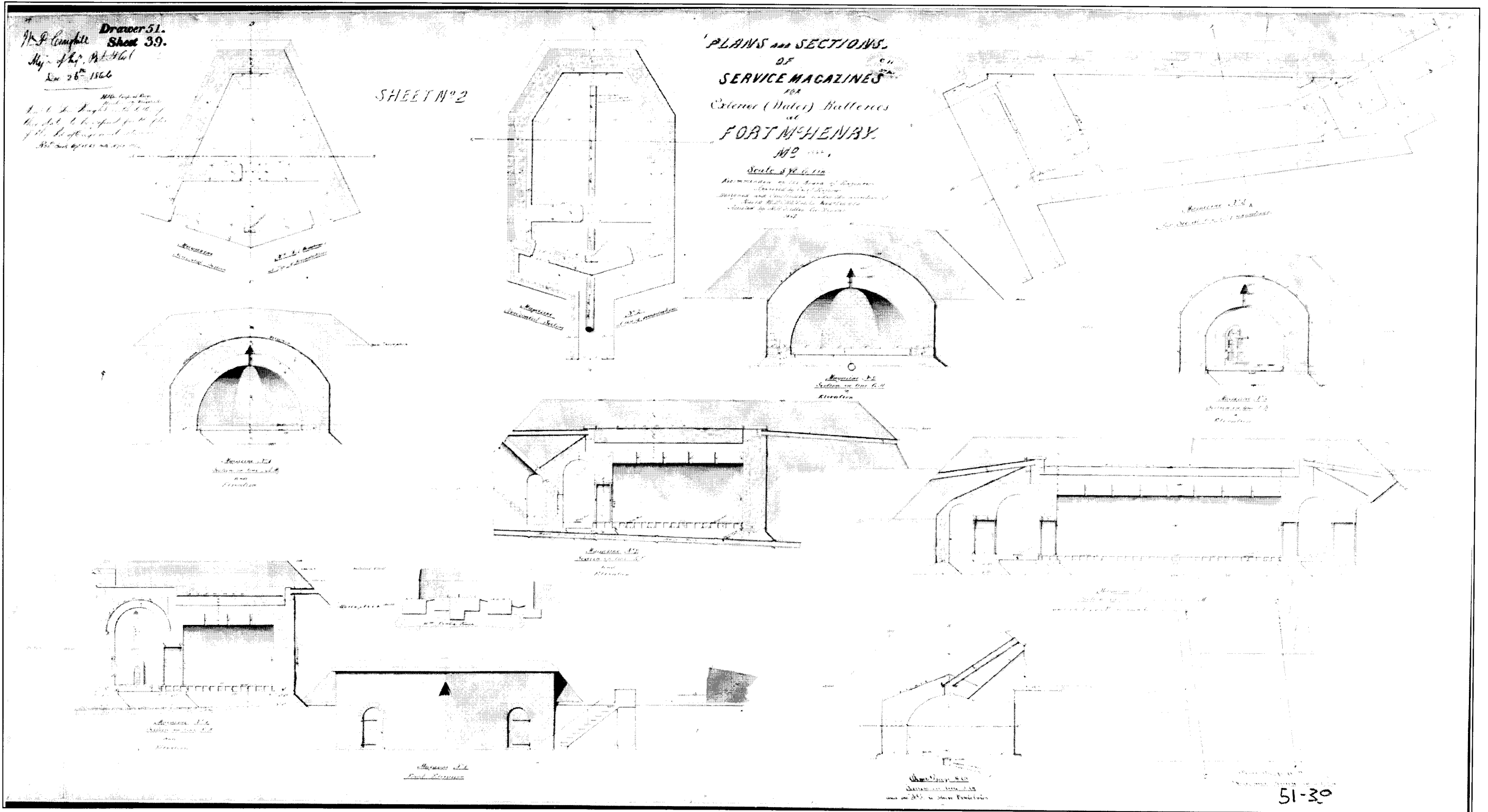

Figure 44. Major William D. Craighill's Plans and Sections of the Service Magazines for Exterior (Water) Batteries at Fort McHenry, 1866.

bombproof's floor. A 106 ft. section of this drain was reconstructed by WPA workmen in 1939, and a ceramic drain line was substituted for the remainder, which had been destroyed during construction of the World War I hospital.⁵⁹ The quicksand encountered in 1865 may have been an indirect result of the presence in this vicinity of the outlet for an original system of cellar drains originating within the star fort (Figure 32). The outlet is likely to have been blocked during the completion of the fort's ditch and glacis ca. 1813-14, but the drain or its trench may have continued to channel groundwater to this area well beyond that date.

The three excavations made in 1993, and the two in 1998, adjacent to the revetment walls of bombproof 1, revealed a series of fill strata extending deeper than the 3.5-4.5 ft. depth of the excavations themselves.⁶⁰ The strata at the base of the three excavations along the northwest revetment, like the basal strata adjacent to the shot furnace foundation 20 ft. to the northeast, are likely to derive from filling associated with the 1813-14 completion of the fort's ditch, counterscarp, and glacis. Augering and shovel testing done at the base of the 1998 units suggest that natural soils underlie the fill, along the northwest revetment and at the west corner, at depths below grade of 5.5-6.5 ft. Due to the location of the northwest revetment excavations within the post-1813 ditch, and interior to both the 1813-14 counterscarp and the 1836-40 water battery terreplein, it was initially thought that filling associated with creation of the water battery would not be represented here. However, strata were found which appear to have been deposited ca. 1837, including one which resembled the stratum adjacent to the nearby shot furnace which had been at grade when the furnace was built. These strata are both likely to have had a ca. 1836-37 origin. The stratigraphy of the excavation made in 1998 adjacent to the northwest revetment indicated that grade within the moat had been raised by nearly 1.5 ft. in at least two episodes after 1819 and before 1866; the later episode, ca. 1837, coincided with development of the water battery. Over the top of the ca. 1837 grade of the moat here, at an elevation of about 27.3 ft. abcd, a .1-.2 ft. thick layer of cinder-laden soil accumulated, or was deposited, prior to 1866.

The stratigraphy of the 1998 excavation along the southwest revetment suggested that, early in the development of the water battery, and prior to the deposition of the fill employed in creating the battery's terreplein, the counterscarp and upper part of the earlier glacis had been largely removed, without eliminating the glacis' slope downward to the southeast. This may have been done to dispense with a barrier to the movement of fill into the area of the battery. When the battery was completed, the moat here was apparently somewhat wider than before, resulting in the 1998 unit, toward the west corner of the structure, being within the area of the wider ditch, whereas the 1994 unit was within the area of the terreplein. The ca. 1840-66 ditch surface was found at an elevation of about 27.25 ft. abcd, while the truncated remnants of the battery's terreplein were at 28.6 ft. abcd.

The builders' trenches for the bombproof and its revetment walls were not altogether consistent from unit to unit, but it appears that there were two or three episodes of construction excavation and filling, the first consisting of a large, deep pit for the bombproof vault itself, the margins of which, after the vault was built, were filled to the level of the revetment walls' footings, or higher in some areas, necessitating reexcavation for installation of the trench-poured concrete footings. Due to a documented seasonal stoppage of work on the bombproofs late in 1866,⁶¹ after the installation of the walls' footings, but prior to construction of the walls themselves, small excavations were again made in 1867, to construct the brick walls. Following the completion of the bombproof, grade to the southeast of its entrance was reestablished at an elevation of about 29.6 ft. abcd, while to the northwest of the entrance, and along the northwest revetment wall, grade was initially in the 27.6-27.9 ft. abcd range. Sometime before 1912, probably during the 1880s or 1890s, a cast concrete drain line was installed at the bombproof's entrance, and grade was raised by about .5 ft.

The roof of bombproof 1, like that of magazine 3, was found to be well preserved where the earth fill over it was removed in 1984. No cracks or gaps were observed in the coating of bitumen applied to the bombproofs, and the magazines, when they were built.⁶²

The archeological monitoring performed by Bill Stokinger in 1975 at bombproof 2, during the reconstruction of the revetment walls there, documented the structural independence, but close proximity, of the revetment walls with the bombproof vault. Monitoring did not allow for detailed observation or interpretation of the local stratigraphy, but Stokinger did indicate that the poured concrete footings of the revetments appeared to be intrusive within the more massive disturbance associated with construction of the bombproof vault itself.⁶³ Stokinger also observed and recorded a variety of important architectural details, and argued cogently for the significance of the bombproofs as components within a complex, evolving system of coastal defensive works.

4.3 Fort Grounds

Archeological investigations conducted on the grounds of Fort McHenry have generally focused on particular structures. The emphasis initially, during work conducted by Smith in 1958, was on determining whether or not archeological evidence of major historical features—the original upper and lower water batteries, the original boundary wall, the 1790s tavern—had survived subsequent episodes of development. Later, during the 1960s, there was concern for the interpretation of certain bombardment-era structures, including the fort's hospital, gun shed, and store house, and the tavern. There was also the beginning of mitigation, by recordation, of the impacts of construction projects on the remnants of structures, an effort

that has continued up to the present with varying degrees of success. One outcome of this particularistic quality of the investigations, however, is that an understanding of the evolution of the complex of structures as a whole, and of their integration with one another in the context of a specialized cultural landscape, has only rarely been recognized as a research objective. Consequently, the following summaries of what is known, or can be guessed, about particular structures on the fort's grounds and their interrelationships only supplies a baseline or point-of-reference for more coherent future research.

Several individual structures—those for which there is substantial data—are discussed in this section of the report. It should be noted, however, that major portions of the grounds of the fort have not been archeologically investigated, and that there are many structures likely to be represented by intact archeological features which are not discussed individually here. This should not be construed as an assessment of the probable condition or significance of such resources. Cultural landscape issues are also largely neglected; consideration of the complex interrelationships among various structures, as well as of landscape features which facilitated their integration, for the most part lies beyond the scope of this archeological overview. Until additional and more comprehensive archeological research is performed, the best sources of data concerning landscape issues remain documentary in nature. It should be borne in mind, however, that archeology would be an essential component of any future landscape research at Fort McHenry. Finally, the development of U.S. Army General Hospital No. 2 at the end of World War I is also largely ignored in this discussion, except where the foundations of specific buildings have been exposed during investigation, or where the hospital's construction or demolition clearly affected the integrity of earlier features.

4.3.1 *Original Fort Grounds*

Fort McHenry's original grounds, at the southeastern end of Whetstone Point, were 24 acres in extent, occupying an area roughly 1,600 feet long (northeast to southwest) by 800 ft. wide. Roughly one-quarter of the area was occupied, by 1814, by the fort, the ravelin, the ditch and the glacis (Figure 45). Development exterior to the fort proper was concentrated in an area of about 9 acres to the north and east of the star fort, in keeping with a pattern established during Fort Whetstone's development (Figure 17), and as dictated by the site's topography and the locations of the fortifications.⁶⁴ Several other pre-twentieth century structures were also situated within the original grounds (before or after the enlargement of the post), but outside the main area of development: a probable 1790s-1830s cemetery south of bastion 4; the 1813-14 additions to the lower water battery; a small, ca. 1813 structure (shot furnace?) southeast of bastion 5; an 1814-15 magazine south of bastion 4; an unidentified, pre-1819, subterranean structure

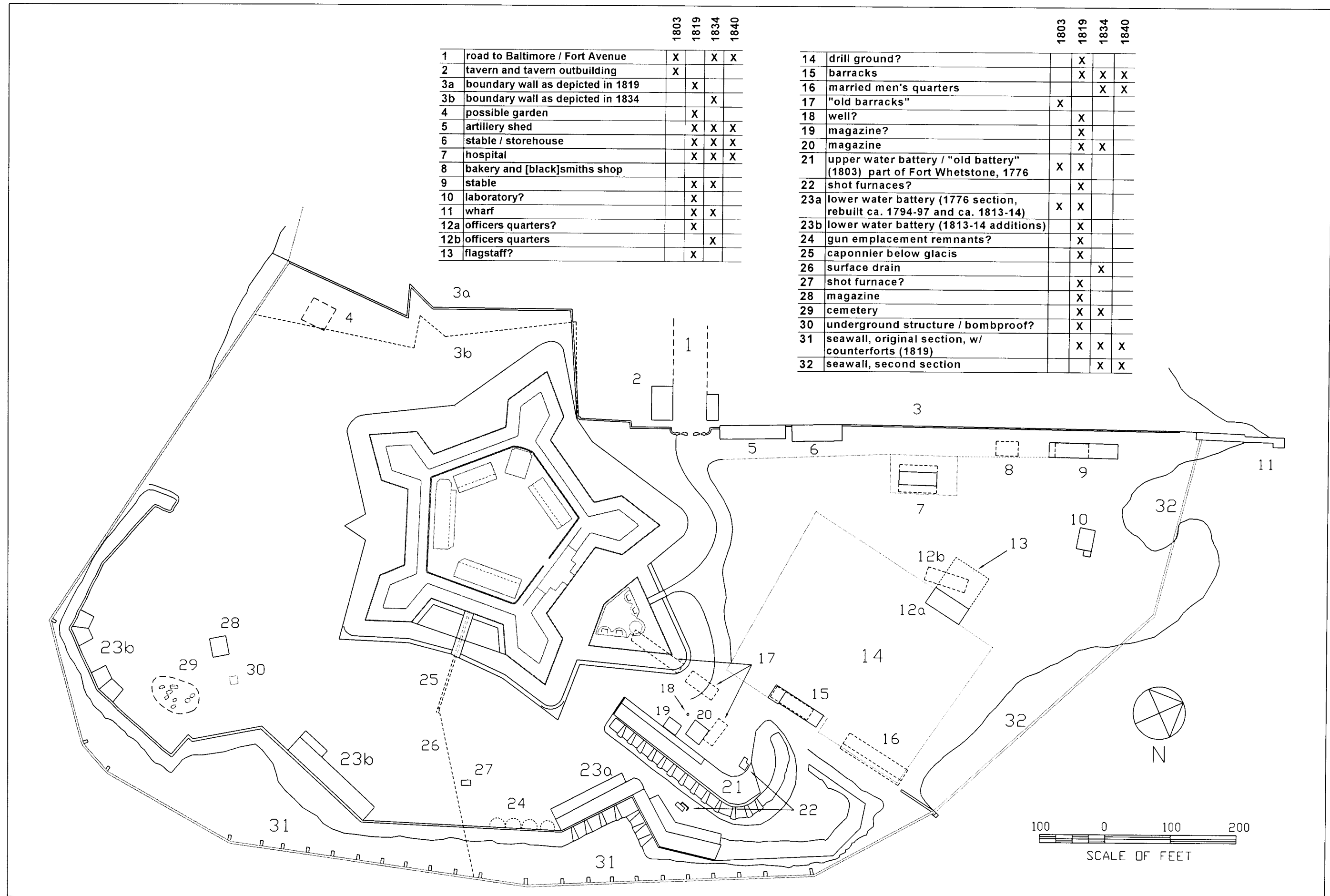

Figure 45. Structures on the grounds of Fort McHenry, ca. 1800 - 1835.

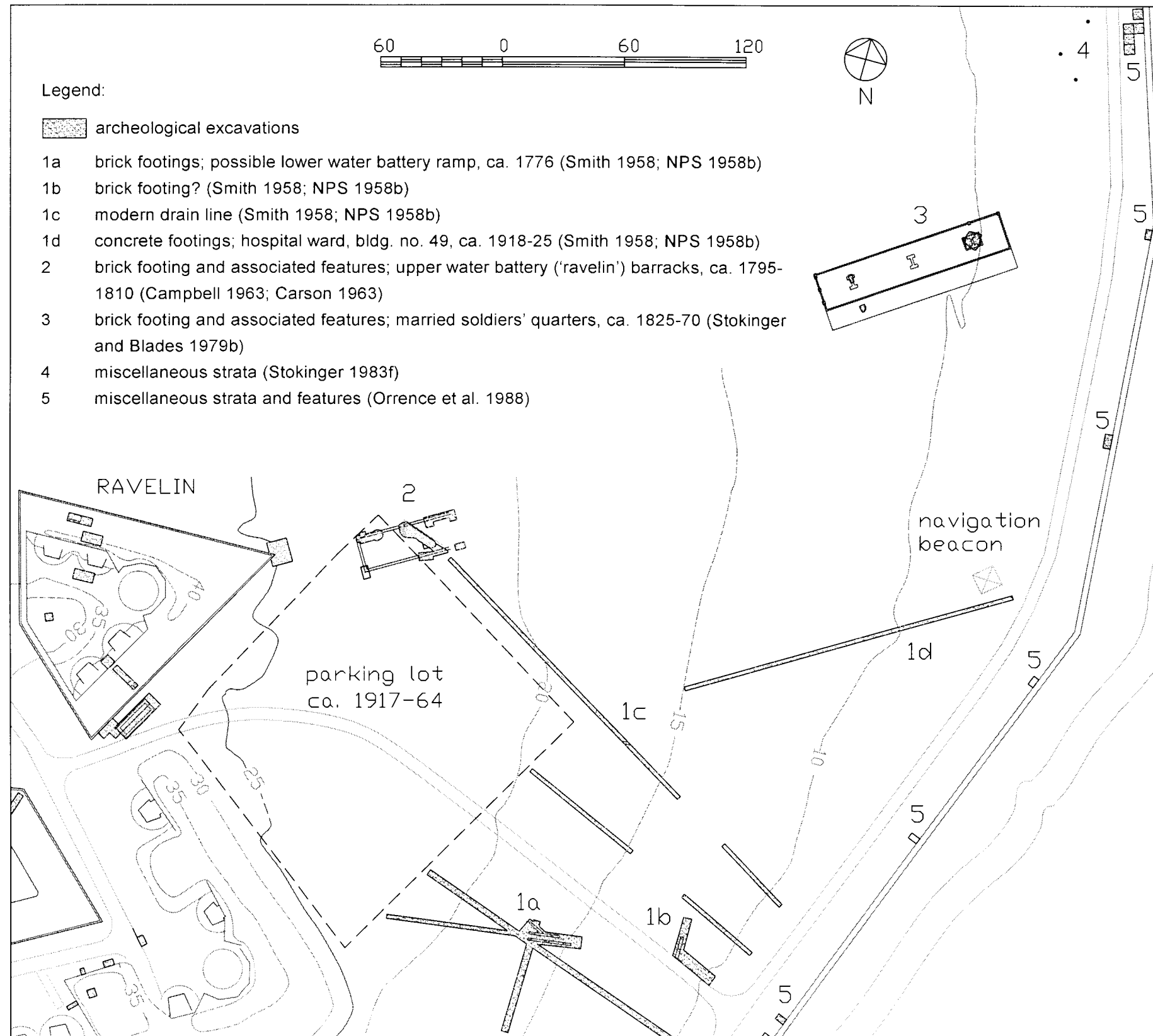

Figure 46. Archeological excavations and features east and northeast of the ravelin.

(bombproof?) near the latter magazine; a Civil War "armory," which only appears on Moore's 1864 plan; a sutler's store at successive locations along the seawall from the mid-1860s to the 1890s; and a combination bakery, blacksmith shop and carpenters' shop, originally the quartermasters' stables, dating to the 1870s through 1890s, southwest of bastion 3.

More structures, many of them contemporary with one another, were within the core area of development north and east of the fort, between 1776 and the 1880s. Of greatest importance militarily were the 1776 upper and lower water batteries. These batteries were repaired and modified in 1794-97 and again in 1813, before being removed ca. 1830. Other structures include: barracks dating to the 1770s and the 1790s, removed prior to 1813; a possible 1770s-1820s well; 1813-15 shot furnaces and magazines associated with the batteries; the 1807-1808 gun shed and store house; a ca. 1811 barracks, which served as the sutler's store and carpenters' shop in the mid-1830s; an 1816 laboratory; the 1813 post hospital; an 1850s-70s chapel; a massive 1870s water battery; officers quarters; married soldiers quarters; and privies, stables, shops, boathouses, wharves, etc.

A major turning point in the development of Fort McHenry was the post's expansion in 1836-37, which more than doubled its size. The ensuing construction of various newer buildings, many of them replacing older buildings on the fort's original grounds (or at least the functions of those older buildings), allowed the fort to be adapted for purposes beyond those for which it was originally designed. The Civil War, of course, was another turning point, after which, beginning about the same time as construction of the 1870s water battery, the structures remaining on the fort's original ground were methodically removed, so that by 1904 only a very few remained: the administration building, the commanding officer's quarters, the stables, and the wharf and boathouse northeast of the fort; the 1870s water battery; and the target butts of the rifle range southwest of the fort.

4.3.1.1 Upper and Lower Water Batteries

The water batteries built in 1776 as the primary works of Fort Whetstone were abandoned in the early 1780s, along with the earthen star redoubt, when the property was sold to private owners.⁶⁵ The fortifications were found to have deteriorated, due in large part to erosion, when their reconstruction began in 1794, under Rivardi's direction. Rivardi assigned foremost importance to redesign of the batteries, and to the correction of flaws in the original configuration of the works, and until 1798 little was done toward the rehabilitation or replacement of the star redoubt.⁶⁶

From 1798, when work began on the earlier fort's replacement (i.e., Fort McHenry proper), until 1813, little additional work appears to have been done on the water batteries. In 1813, however, with the U.S. at war with

Britain, General Samuel Smith requested that the lower battery be reconstructed and enlarged, as the most vital part of the fortifications.⁶⁷ Erosion had destroyed that battery's embrasures (if they had existed at all, in view of the note on the 1803 plan, Figure 6), and the river had encroached on the outer slope of its parapet. In accordance with Smith's request, the parapet was rebuilt, and extended to encompass the point south of the fort, so that the battery could command Ferry Branch as well as the Northwest Branch, the channel into Baltimore's Harbor. At the same time, a brick revetment wall was built along the interior of the central and northern sections of the lower battery's parapet; new gun platforms and ramps were built, both in the southern part of the original lower battery and in two locations along the new section south of the fort; and new embrasures were provided, at least in the area of the original battery. Smith would subsequently report that substantial removal of soil had been required in connection with the extension of the lower battery's parapet.⁶⁸ Less work was evidently needed to repair the upper battery in 1813, although its embrasures may have been constructed, or reconstructed, then. By the end of 1813 a total of thirty-six guns were mounted on the water batteries: there were most likely thirty guns on the lower battery, including fifteen 36-pounders, and six on the upper battery.⁶⁹

Although new magazines were built for the water batteries in 1814-15, it is unclear if, after this, the batteries themselves were maintained prior to their obliteration ca. 1830.⁷⁰ Neglect of the batteries may explain an otherwise confusing 1829 reference to "the old seawall in front of this work," as a possible source of salvageable brick.⁷¹ Since other documentary evidence indicates that the earliest sections of Fort McHenry's seawall, like later sections, were built of stone, this "old seawall" may, in fact, have been the brick revetment behind portions of the lower battery's parapet. Regrading throughout the area east and south of the fort during the 1830s, when the fort's existing outer (water) battery was built, is likely to have eradicated nearly all evidence of the earlier batteries, although some contemporary surfaces, and the foundation of at least one associated building, are known to have survived archeologically.⁷²

Two archeological features which may have been associated with the lower water battery were discovered by Smith in 1958.⁷³ Smith's basic findings, in test trenches excavated through the former locations of both of the early batteries (Figure 46), were that massive disturbance had occurred, and that relatively deep deposits of twentieth century fill predominated throughout the area. Smith attributed this to the construction and demolition of the 1873-75 water battery, and of the 1917-19 hospital. The only notable non-modern archeological feature which Smith found was a set of three brick walls about 230 ft. southeast of the ravelin's salient, 1.5 to 4.5 ft. below grade, beginning at an elevation of 13.3-13.7 ft. amsl.⁷⁴ All of the walls were a little more than 1 ft. wide, and had been laid, in a common bond, "sparingly in lime mortar." They had all originally been somewhat higher, but in their

horizontal extent they appeared to be intact. Two of the walls were oriented east-west, parallel to one another and about 3 ft. apart on-center. Both of these walls sloped down to the east by about .5 to .6 ft. along 10 ft. of the walls' lengths; the west ends of the walls were aligned but the northern wall was 15.4 ft. long while the southern was 21.7 ft. long. Abutting the north side of the more northern of the parallel walls was an 8.25 ft. long splayed wing wall, similar to the others, but with a northwest-southeast orientation, and a slope down to the southeast (Figure 47).

Smith was inclined initially to interpret this set of walls as deriving from the lower water battery, but in the end he concluded, for unstated reasons, that the feature was more likely to derive from some unknown post-1814 structure. The only other structure known to have stood near this location, however, aside from the earth fill of the 1873-75 water battery, was the World War I hospital's Red Cross Building, which, at its nearest, was 20 ft. to the south, and which is unlikely to have had a brick footing.

Although the feature's location apparently positions it beneath the parapet of the ca. 1795-1831 lower battery, there is documentary evidence which implies that, as originally configured, the 1776-82 lower battery at this location was situated slightly further to the southeast, closer to the river.⁷⁵ It is possible, in other words, that the walls had been associated with the water battery as configured during the Revolutionary War. The sloped coursing of their brickwork suggests that the walls may have served as footings for a ramp, extending from the lower end of a road from the upper battery, at the feature's more elevated west-northwest end, down to, the lower battery's gun platform, at its lower east end. It is noteworthy that the distance between the outer edges of the two parallel walls closely matches the 3.5-4 ft. wide wheel-base of a garrison carriage for a 32-pounder of the period. The type of carriage used for the 18-pounders mounted in the original lower water battery, however, is not known.⁷⁶

The origin of the other potentially early feature found by Smith in the lower water battery vicinity was also unclear. A 16 in. wide by 10 ft. long segment of apparently dry-laid brickwork was found 60 ft. east of the possible ramp footings, at an approximate 100 degree angle to their alignment, and at a depth of 1.5 ft. below grade (at an elevation of approximately 9.2 ft. amsl).⁷⁷ The original length of the brickwork could not be determined, and the absence of traces of mortar made it uncertain if the feature was the remains of a wall or footing. The orientation of the feature indicates that it does not derive from the lower battery's 1813 parapet revetment. It may be associated with the ca. 1795 battery's gun platform, it may have had an obscure relationship to the 1776 battery, or it may be no more than a minor element of the early twentieth century hospital landscape, as Smith suggested. The concrete footing of a World War I hospital ward (bldg. no. 49), as well as a modern ceramic drain line, were also revealed in Smith's excavations.

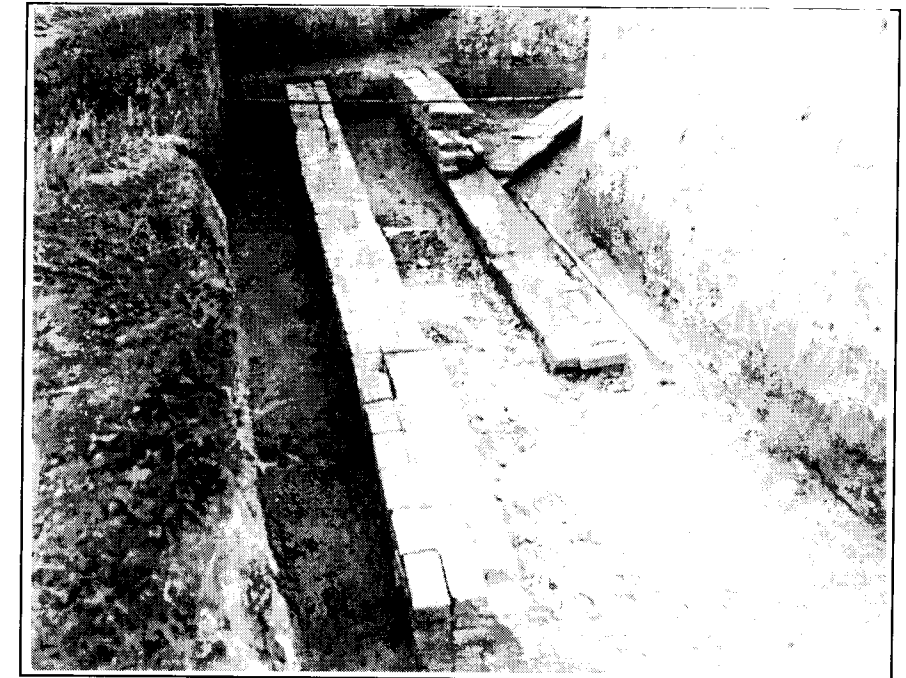

Figure 47. Possible ramp footings, 1776 lower water battery, viewed from the east, 1958.

4.3.1.2 Upper Water Battery (Ravelin) Barracks

Barracks were constructed at Fort Whetstone in 1776-77, but it is not clear if they, or any other buildings of that period, remained in existence in 1794, when the reconstruction of the fortifications began. In 1795-96, just prior to Fort McHenry's construction, barracks were again reportedly built.⁷⁸ The buildings identified on the 1803 plan of the fort as "old barracks," within the area of the upper water battery (Figures 6 and 45), may therefore derive from either 1776-82 or 1795-96. Although the Berthier maps of 1781 and 1782 show buildings in the area of the upper water battery, their configuration does not match that of the barracks on the 1803 plan; Folie's 1792 map does not show buildings, although perhaps only because of the schematic nature of its depiction of the fort.

An 1806 plan of the fort, very similar in most respects to the 1803 plan, shows the "old barracks" nearest the fort as a non-extant element of the site, presumably because it had been removed; the others were also soon demolished, possibly by 1811, certainly by 1813, when the ravelin was constructed. The ravelin covers half of the site of the barracks nearest the fort, while the ravelin's glacis was built up over most of the site of the barracks directly to the northeast; in 1814-15, a magazine was constructed adjacent to the site of the third barracks.⁷⁹

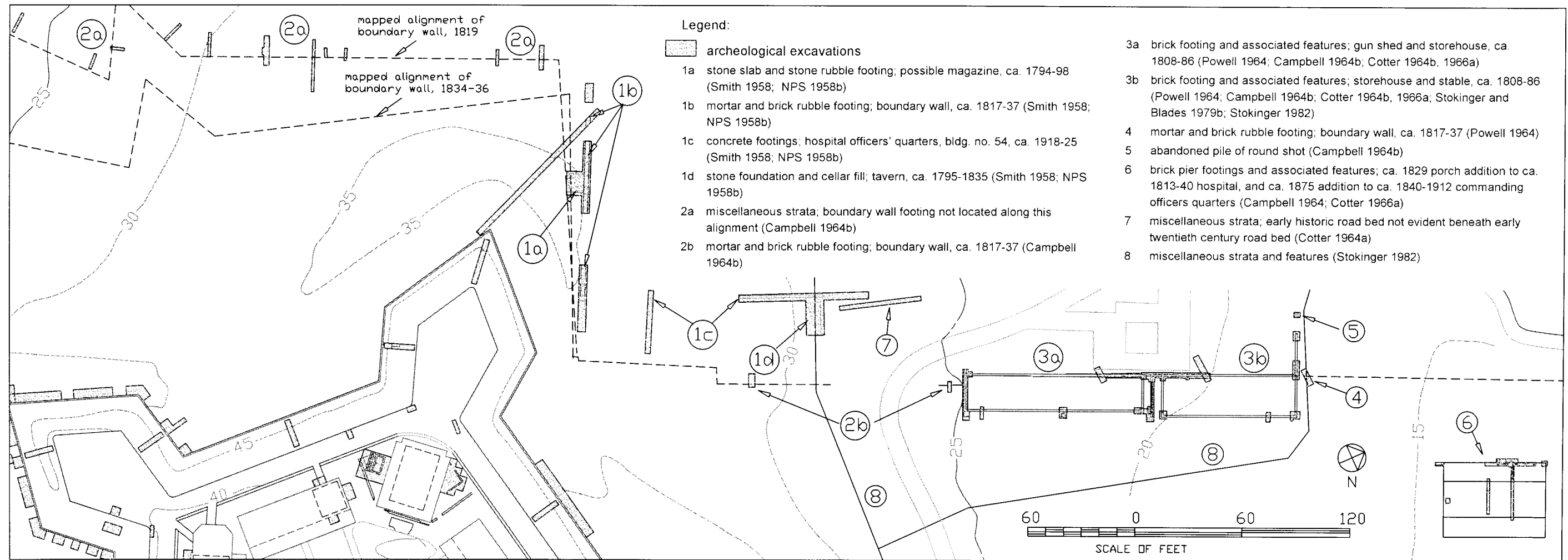

Figure 48. Archeological excavations and features along the original boundary north and northwest of the fort.

In 1963, an excavation for utilities revealed a displaced brick wall segment at the site of the northeastern "old barracks." Following this, Carson and Campbell conducted successive investigations of the site, in which they documented the building's foundation and associated features, and determined that it corresponded to the northeastern barracks depicted on the 1803 plan.⁸⁰ The foundation, 1.1 ft. wide, was of common-bond, lime-mortar construction; it was situated 40-90 ft. northeast of the ravelin's salient (Figure 46), beginning 1-3 ft. below grade, and extending up to 5 ft. below grade, with a basal elevation of about 19 ft. amsl. A herringbone pattern brick floor was found less than 1 ft. above the base of the northwestern wall foundation, at an elevation of roughly 19.6-19.7 ft. amsl. The floor was interrupted by 1 ft. wide, channel-like gaps, aligned with the building's short axis, and by a 3 ft. wide patch of rectilinear, non-herringbone patterned pavement, toward the eastern corner of the structure. The gaps may indicate where timber structures (bunks?) had been located. It was not determined if the gaps extended into the center of the barracks.

The threshold of a 3 ft. wide doorway was identified in the southeastern, wall, centered roughly 18 ft. southwest of the structure's hypothesized east corner. Walkway remnants were located immediately exterior to the southeastern wall, at an elevation of about 19.2-19.3 ft. amsl. During archeological monitoring of construction in 1999, remnants of another walkway were encountered the northwest of the barracks' west corner, at about 19.3-19.6 ft. amsl.⁸¹ The barracks was 18 ft. wide; no remnants of its northeastern end wall had survived, but on the basis of its historical depiction, Campbell suggested it had been about 48-50 ft. long. The artifacts found in association with these features, including a large U.S. one cent coin, buttons, a clay tobacco pipe fragment, and olive-green bottle fragments, are consistent with a 1794-1813 period of use for the structure.

At a higher elevation in the area, beneath 1 ft. of sandy fill soil, and 2.5-3.5 ft. above the level of the barracks floor, the crushed stone sub-pavement of a 1918-1962 parking lot was found. Extending through the barracks' foundations were modern iron and ceramic pipes. Topographic plans of

the fort from the late nineteenth and early twentieth centuries indicate that grading associated with construction of the 1873-75 water battery east of the barracks site may account for the destruction of the barracks' northeastern end wall; there is also a buried high-voltage electrical line in that vicinity. Smith's 1958 trenches documented the massive nature of the disturbances in the area of the 1870s battery.

4.3.1.3 Gun Shed and Store House

Fort McHenry's gun shed and store house (Figure 45 and 48) were built along the fort's property line in 1807-08, and remained in use at least into the early 1880s.⁸² By the 1850s, the function of these structures was supplemented by two ordnance storerooms west of bastion 3, adjacent to the post's cemetery, in an area which would remain occupied by various quartermaster department storage buildings, stables and shops over the next half century. By 1886, the final year in which the gun shed and store house

N^o 31 Quartermaster & Ordnance Store House.
Scale 10 feet to 1 inch.

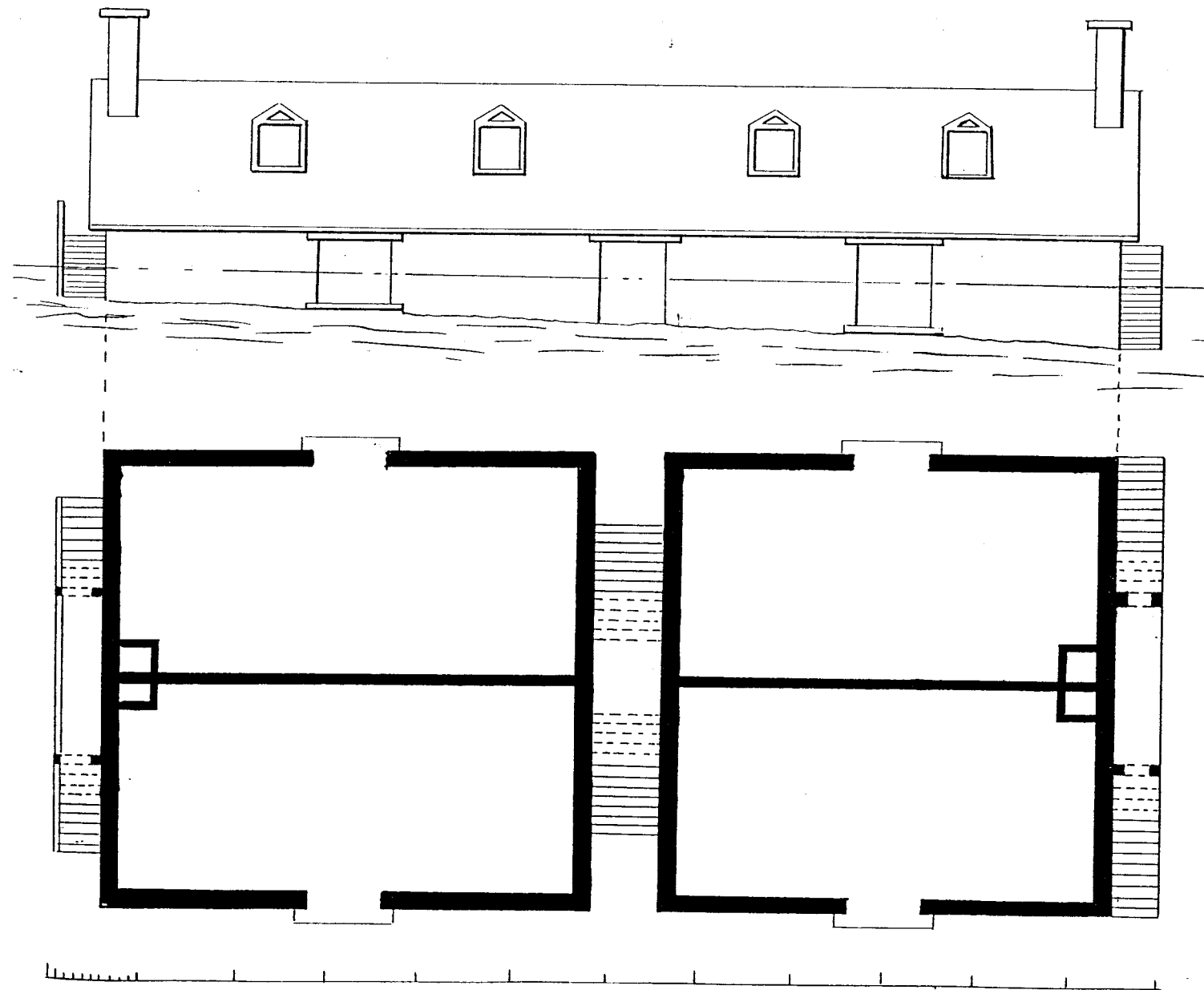

N^o 30 Entrance & Commissary Store House.
Scale 10 feet to 1 inch.

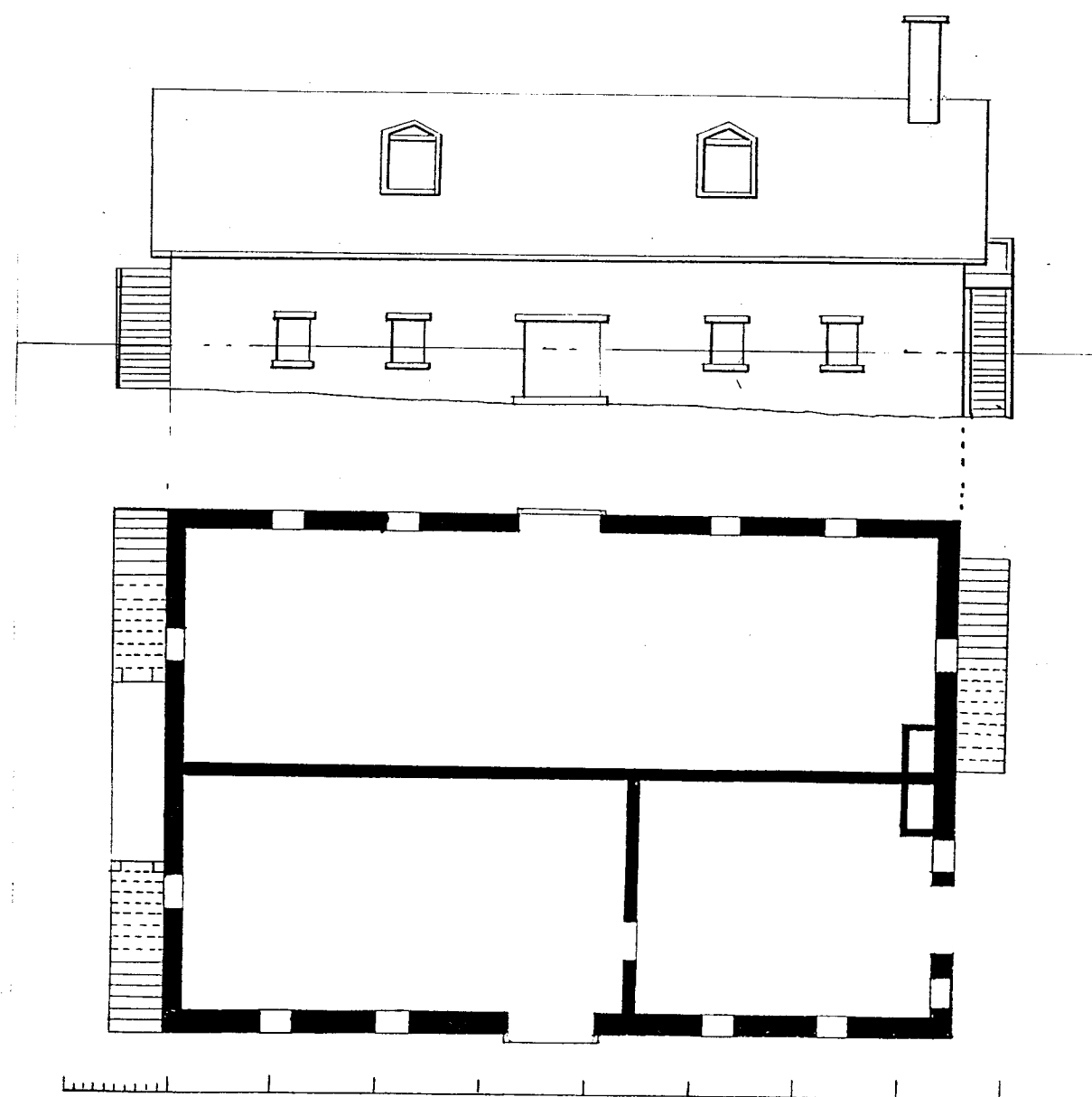

Figure 49. The gun shed and store house ca. 1873.

appear on a plan of the fort, another quartermaster department building had been constructed in what was then the northern corner of the post, and the older buildings were evidently removed soon thereafter. Both buildings were originally one and one-half stories in height. The gun shed was a short distance northeast of the roadway into the fort, while the store house was northeast of the gun shed. The upper half-story of the gun shed was evidently designed to be used for storage, and the building is sometimes referred to as the store and gun house. Similarly, the ground floor of the store house was intended to be adaptable, for use as a stable, artillery shed, or barracks, and it is sometimes referred to as the stable and store house. It presumably was used as a stable initially, at least until another stable was built, further to the northeast, sometime prior to 1819.

The primary functions of these two buildings appear to have remained basically the same throughout their existence, but supplementary functions are likely to have changed a number of times, and the buildings themselves modified to meet changing requirements. Plans of the fort continued to identify the earlier buildings as “ordnance and quartermaster storehouse[s]” or simply “quartermaster’s department.” Illustrations of the fort drawn during and just after the Civil War indicate that a telegraph line into the fort terminated at the gun shed; its upper half-story was undoubtedly being used for offices at that time. Building plans dating to 1873 indicate that both the gun shed and the store house had been doubled in size, by the construction of full-length additions to the northwest sides of the original structures (Figure 49); this may have occurred as early as the 1850s. The sketch plans of the fort of 1873 and 1874 seem not to depict the enlargement of the structures, but the 1886 plan of the fort, the last to show them, does show them as enlarged.⁸³

Several archeological investigations have been conducted at the sites of the gun shed and store house (Figure 48), and the presence there of a complex array of features is documented in the investigators’ reports.⁸⁴ The basic finding of the work is that the foundations of both buildings are well preserved, their remnant upper surfaces located .7 to 1.5 ft. below grade, at elevations of 18.3 to 20.5 ft. amsl. Grade in the area, both presently and originally, slopes down to the northeast, and the gun shed’s foundations are consequently more elevated than those of the store house.

The gun shed’s dimensions were determined by Campbell to be 101.25 ft. by 21.25 ft., although additional walls and piers, abutting and adjacent to its original foundations, complicated architectural interpretation, as did apparent differences in the width of the foundation, which in most locations was found to be 1.1 ft. wide, but in a few, 1.45 ft. wide.⁸⁵ Several of the features discovered derive from the pre-1873 enlargement of the buildings (due to the unavailability at the fort of copies of the 1873 building plans, the characteristics of the additions were unknown at the time of the investigations). The two ends walls of the gun shed were both found to

have 3 ft. long extensions to the southeast, which, together with pier-footings located the same distance from that building’s original southeast side wall, indicate a minor realignment of that wall of the gun shed, which brought it into alignment with store house’s southeast wall. The piers strongly suggest that the replacement southeast wall would have been of frame construction. A longer extension, to the northwest, of the gun shed’s southwestern end wall was also discovered; although its length was not determined; the 1873 plan indicates that it would have been about 24 ft. long, making the structure about 50 ft. wide. A wall footing located 5 ft. northeast of the gun shed’s original northeast end wall appears likely, as thought at the time of investigation, to represent another addition to the original gun shed. The fact that much of the gun shed’s original northeast wall appeared to have been demolished is consistent with this, as is the slightly exaggerated length of nearly 109 ft. depicted by the 1873 building plan. The stairs shown by the 1873 plans at the adjacent ends of the gun shed and the store house were almost certainly just a single set of stairs, used in common for access to upper stories of both buildings.

In 1966, Cotter reported finding an 8 in. wide wall 41 ft. southwest of the gun shed’s (original?) northeast end wall. This must have been the footing of the interior wall on the northeast side of the central stairs hall depicted by the 1873 plan, about 47 ft. northwest of the newer end wall.⁸⁶ Lee’s 1834 plan of the fort shows a partition wall approximately 25 ft. southwest of the (original) end wall. An annotation, likely to be attributable to Cotter, on one of the figures in the park’s copy of Campbell’s 1964 report,⁸⁷ indicates that a brick floor was found 3 ft. below grade in the (original) north corner of the gun shed. Campbell documented two superimposed brick pavements, and a relatively deep drain covered with stone slabs, within the area of the addition to the northeast end of the gun shed. The original northwestern walls of the gun shed and the store house coincided with the original boundary of the fort, and the northwest side of the 10 ft. space between the two buildings was found to have been in-filled with a brick wall, presumably in 1816-17 when the boundary wall was built. Campbell found evidence of a segment of the boundary wall southwest of the gun shed,⁸⁸ but its intersection with the gun shed’s foundation was not preserved, possibly due to the later construction at this end of the building of the stairs to the upper half-story, depicted in ca. 1860-65 illustrations and by the 1873 building plan.

The store house’s dimensions were determined to have been 75.5 ft. by 24.25 ft.⁸⁹ Although Cotter notes, in his 1966 report, that the building’s northwest foundation was 1.45 ft. wide, while its southeast foundation was 1.1 ft. wide, plans of earlier excavations indicate that at least the upper parts of all the building’s foundations were 1.1 ft. wide.⁹⁰ Due to the slope down to the northeast, the base of the store house’s northeast end wall was 6 ft. deeper than that of its southwest wall. Aside from the discovery of the stub end of what may once have been an 8 in. wide partition wall, on the interior

of the northwest wall approximately 15 ft. northeast of the building’s west corner, no original interior structural details are known. Cotter indicated that there was at least one brick walkway in the 5 ft. wide area between the store house and the supposed addition to the gun shed; the pavement may, in fact, have been situated beneath the stairs that filled the area. A 23 ft. long, 1.1 ft. wide brick wall was found extending northwest from the building’s north corner, terminating in a 1.5 by 2 ft. pier-like footing; Campbell suggested that this extension wall may have been the end wall of a post-1836 shed, possibly open to the northwest, attached to the northwest side of the store house; the 1873 building plan, however, indicates that it was the footing for the end wall of a fully enclosed addition to the store house. No investigation has attempted to determine if, as depicted on the 1819 plan of the fort, but not the 1834 plan, there had originally been exterior stairs (?) along the southeast half of the storehouse’s northeast wall.

The northwest extension of the northeast end wall of the store house (which the investigators termed the 1808 stable) was again revealed during a program of archeological monitoring and limited test excavations conducted by William Stokinger and Brooke Blades in June and July of 1975.⁹¹ The work, designed to mitigate the impacts of the installation of below-grade electrical lines, documented the characteristics of strata and features on both sides of the wall, which were found to contain temporally diagnostic, early nineteenth century artifacts. The general assessment was that the strata and features possessed a substantial degree of integrity.

Except for portions of the collection made by Stokinger and Blades, most of the artifacts retrieved at the sites of the gun shed and store house were apparently collected from disturbed, late-nineteenth through twentieth century fill soils overlying the foundations, and are unlikely to contribute to interpretation of the site. However, the solid iron shot found in two excavations may reflect disposal or abandonment of obsolete ordnance in the vicinity of where it had previously been stored. Powell found nine 18-pounder rounds, all about 5 in. in diameter, in what appeared to be a small ditch or swale immediately north of the store house’s north corner. Thirty-two feet northwest of the store house’s north corner, Campbell discovered at least six balls (Figure 3 of Campbell’s report suggests there were more, beyond the limits of his excavation) each reportedly weighing 100 lb.; they are likely to have been rounds for some type of 10 in. gun or mortar.⁹²

4.3.1.4 Hospital (1813)

Fort McHenry’s 1813-40 hospital was the oldest building exterior to the star fort to be adapted for use within the World War I hospital complex, and the oldest to be demolished in 1925-26, when most of the hospital structures were removed.⁹³ The building served longest—from ca. 1840 until 1912—as the post’s commanding officer’s quarters. It served as the post

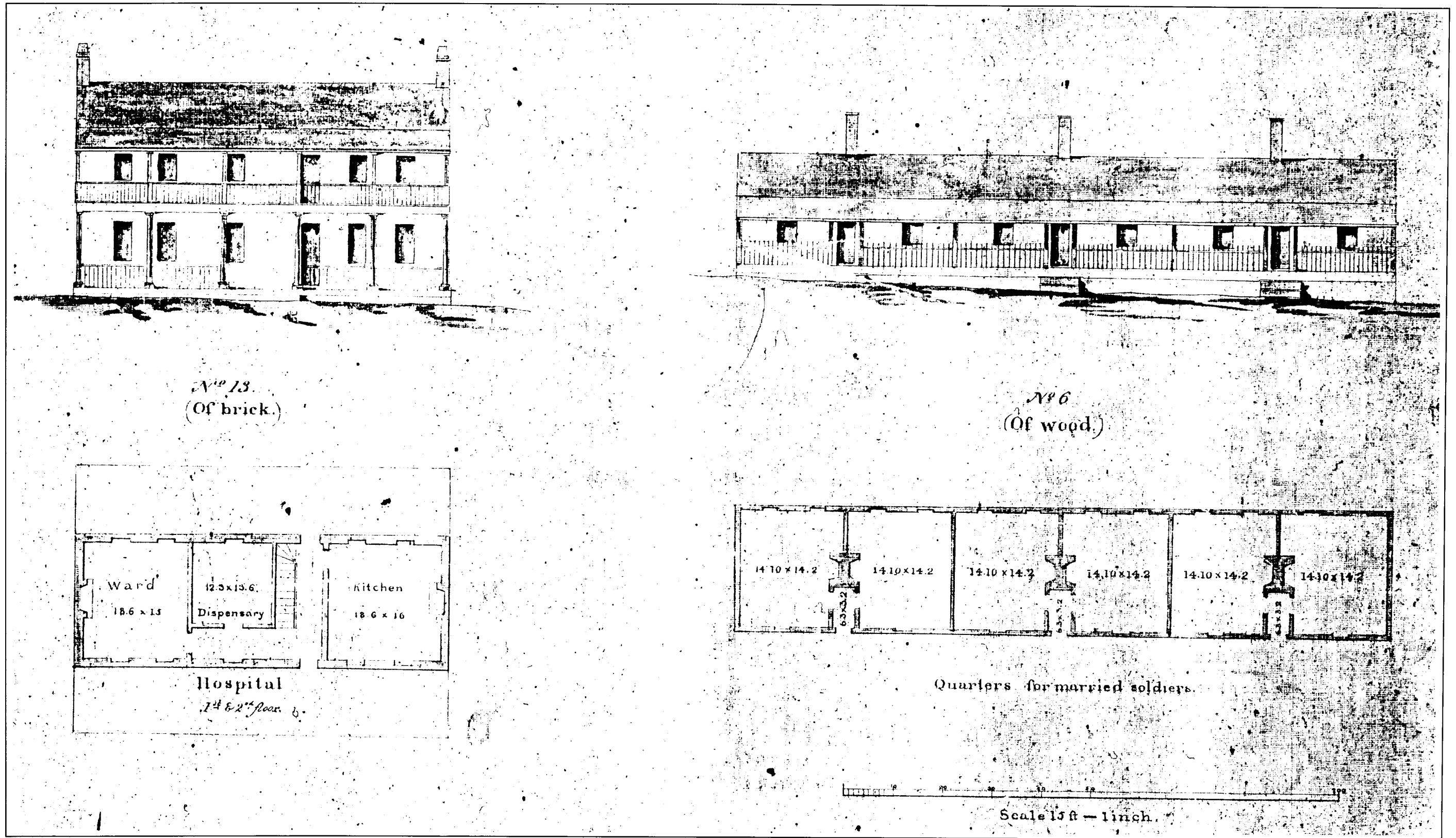

Figure 50. Detail of Lt. Thomas I. Lee's *Fort McHenry*, 1834, showing plans and elevations of the hospital and the married soldiers' quarters.

exchange during the 1917-23 operational life of hospital complex. A variety of alterations and additions were made to the structure during its 110 years of use. By the 1880s there were three components: a central core which derived from the 1813 hospital; a relatively long, narrow kitchen and service addition, built onto the northeast end of the core building ca. 1872-73; and a more substantial parlor addition, built onto the southwest end of the original building ca. 1875-76.⁹⁴ The latter addition had two protruding bays at its southwest end, facing the north side of the fort.

Lee's 1834 plan of the fort, which includes as details plans and elevations of several buildings, the hospital among them, provides the most complete and accurate image available of the 1813-1840 hospital (Figure 50). The original building, and the core of the later building, was about 57 ft. long by 20 ft. wide. The building had been modified in 1829, by the addition of 10 ft. deep porches along both the its southeast and its northwest sides, supported on six columns spaced about 11 ft. apart.⁹⁵ There were fireplaces at both ends of the structure, a 10 ft. by 20 ft. ancillary structure (kitchen?) attached to its northeast end, and two interior partition walls, 16 ft. northeast of the southwest end and 18 ft. southwest of the northeast end. The doorways on both sides were about 21 ft. southwest of the building's northeast end, but the porch railing and steps shown in the southeast elevation indicate that access onto the porches, 1.5 ft. to 2.5 ft. above grade, was at their center. The first floor was occupied by a ward, a small dispensary, a kitchen, and an L-shaped combination hallway and stair hall. There were presumably wards on the second floor as well, and perhaps the post surgeon's office and quarters.

A very incomplete archeological reflection of the 1813 hospital was found when its site was investigated by Campbell in 1964 and again by Cotter in 1966.⁹⁶ No clearly intact remains of the foundation of the hospital itself were found, but among an array of brick features discovered by Campbell were five which he was able to identify as footings of the porch along the northwest side of the hospital. The footings consisted of rectangular blocks of brick about 1.5 ft long by .75 ft. wide, spaced approximately 5 ft. apart. Campbell's interpretation of the location of the north corner of the porch was in error, however, in part because the northeastern most footing had not been preserved, and in part because Campbell had mistakenly inferred that the hospital was 51 ft. long rather than 57 ft.⁹⁷ Regardless of the footing's absence, the porch's corner was almost certainly about 5 ft. to the northeast of the location suggested by Campbell. A brick pavement which Campbell found extending northwest from the vicinity of one of the surviving porch footings would have been aligned with the doorway on the northwest side of the hospital, and may be a remnant of an original site feature, in use prior to construction of the hospital's porches.

Campbell's excavations also documented remnants of three walls associated with modifications and additions to the hospital. The smallest

of these was about 9 in. wide by 10.5 ft. long, and was oriented northwest-southeast in the area of the hospital's northwest porch; located about 18 ft. southwest of the probable northeast end of the building, this wall may coincidentally have been aligned with one of the hospital's interior partition walls. There were also two larger walls, 1.5 ft. wide, both of which appeared to be of more recent origin. One of these was aligned with the porch footings, extending an undetermined distance southwest from the southwest end of the porch; it was undoubtedly the northwest wall of the ca. 1875-76 addition to the southwest end of the former hospital. The other 1.5 ft. wide wall extended northwest from the porch footing directly northeast of the building's center; this wall may have been one of a pair (the other one not preserved) that supported the steps exterior to the porch.

Cotter's excavations revealed additional segments of non-original walls, masses of tumbled masonry, extensive disturbance, and evidence of burning, the latter perhaps related to demolition of the structure. Although Cotter noted a possible mortar-and-rubble footing at a depth of 3 ft. along the alignment of the hospital's southwest wall, water saturated soils between depths of 3 and 4 ft. prevented deeper excavation, and the integrity and origins of the footing were not confirmed.

Most if not all of the artifacts collected by Campbell and Cotter at the site of the hospital derived from fill soils overlying the remnants of the building's porch footings and its additions, and from other disturbed contexts. The artifacts mostly date to the late nineteenth through early twentieth century, but at least three early nineteenth century buttons—two of them U.S. Army Artillery uniform buttons—and early nineteenth century ceramic fragments, were also found.

4.3.1.5 Married Soldiers' Quarters

Fort McHenry's married soldiers' quarters first appears on the 1834 plan, but a letter prepared to accompany the plan described the building as 'old':

No. 6 is also of wood [like no. 5, an officers' quarters] & of one story—It is used as Quarters for married Soldiers, and contains Six rooms each about 14x14—this Building altho' old, answers the purpose for which it is used—⁹⁸

The structure was presumably built soon after the preparation of the 1819 plan. Construction prior to 1829 is suggested by remnants of brick pavement discovered adjacent to the structure in 1975; the porch along the quarters' southeast side depicted on the 1834 plan (Figure 50) would have covered the pavement, possibly indicating that the 1829 porch, like others built that year, was added to an already existing building. During the Civil War, if not earlier, the structure became officers' quarters, and on an 1864 plan it was keyed as being 'temporary.' The structure was removed in

1867. From ca. 1873 to 1929 its site was covered by the massive earthen parapet of the never-completed post-Civil War water battery.

In 1975, archeological monitoring of the installation of electrical lines, and limited testing at several locations in the vicinity, resulted in the exposure of features deriving from the married soldiers' quarters, including sections of the perimeter wall footing, and remnants of two of the building's three double fireplace and chimney blocks (Figure 48).⁹⁹ The features confirmed the general accuracy of the 1834 building plan, although the rooms were evidently slightly larger than indicated in Lee's 1834 letter. The perimeter wall footing consisted of a double row of brick about .75 ft. wide. Hearth footings associated with the easternmost chimney block were also .75 ft. wide, while the fireplaces' back wall footing was 1.1 ft. wide, and their cheek wall footings 1.5 ft. wide. The footings extended from .55 to 1.5 ft. below grade. Yellow sandy silt subsoil at a depth of 1.5 ft. was, on the building's interior at least, overlain by a mixture of topsoil and construction debris, above which, in the area of the hearths, was a mixture of clay and brick rubble that probably served as the base for the hearth pavement. Three strata, with a combined thickness of .6-.7 ft., overlaid the features and construction era strata; the lowermost of these was presumably associated with the building's 1867 demolition, but it derive at least in part from redeposition of occupation-era topsoil.

Among the artifacts found within the construction-era strata were an early nineteenth century uniform button, a copper collar (?) fastener, creamware ceramic creamware sherds, clay pipe bowl fragments, and cut nails. The button, dating to 1802-08, may have been lost here, or redeposited from elsewhere, prior to construction of the quarters; the dating of the other artifacts is consistent with their deposition during construction. The preservation of a small section of brick pavement along the southeast side of the structure, towards its southwestern end, which was noted above as suggesting that the porch was not original, also implies that strata at grade during occupation of the building are also likely to have survived.¹⁰⁰

4.3.1.6 Boundary Wall and Entrance Gate (1817-1837)

There was supposed to have been a plan formulated in 1797 for the construction of some sort of barrier, possibly a fence, along Fort McHenry's boundary, but the 1803 plan of the fort suggests that only the adjacent tavern property was fenced.¹⁰¹ A boundary wall was proposed in 1816, and its construction, along with that of an entrance gate, begun the same year, was completed by 1817 or 1818.¹⁰² This original boundary wall remained in place until 1837, at which time, adjacent property having been acquired, the wall and gate were dismantled, and the materials reused to construct a new wall and gate along the new boundary, where they remain. The 1819 and 1834 plans depict the wall's angular course, and show that the

northwest walls of the gun shed and store house were incorporated into it. The relatively elaborate entrance, with pedestrian gateways flanking a central vehicular gate, is best depicted on the 1819 plan; both plans suggest that there may have been an arch over at least the central gateway. As noted by a distinguished visitor to the fort during the 1820s, the original boundary wall would more likely have assisted than hindered an attacker,¹⁰³ but at least one jutting section appears to have been designed to enable defenders to direct fire along the exterior face of the wall.

Determination of the alignment of the original boundary wall was one goal of the first archeological investigations at Fort McHenry, conducted by G. Hubert Smith in 1958 as part of the HARP effort, and the wall's footings have been purposely or incidentally exposed during other investigations as well.¹⁰⁴ Using historical plans as a guide for locating the wall, Smith excavated a trench beginning at the salient of bastion 2, and aligned with the left face of the same bastion (Figure 48). The footing of the wall was encountered approximately 75 ft. north of the bastion, and further excavation revealed its extension for approximately 100 ft. to the southeast.¹⁰⁵ A short distance to the northwest, however, no traces of the footing were found. The wall itself had been robbed in its entirety throughout the area. The footing, 2.5 ft. wide by .5 ft. thick, consisted of a mass of lime mortar which evidently had been poured into a trench, and within which brick fragments were embedded. Its uneven remnant surface was 2 to 3.5 ft. below existing grade. The ground surface of the vicinity for

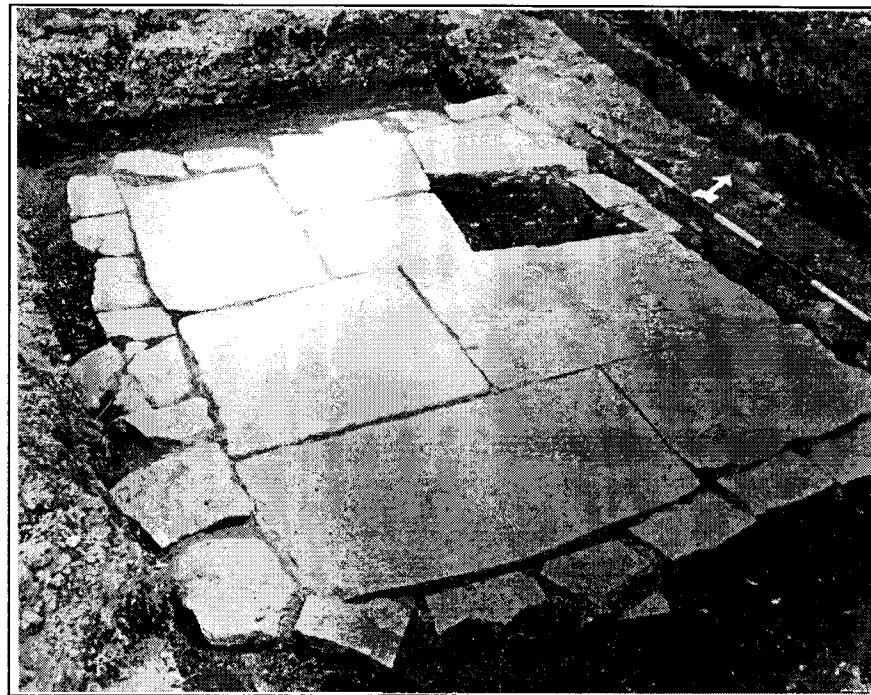

Figure 51. Remnants of possible ca. 1795-98 magazine or bombproof, viewed from the southeast, 1958.

a long period following the wall's demolition ca. 1837 was evidenced by a buried humic stratum approximately 1.5 ft. above the footing. Above this were fill deposits dating to the late 1920s, when the area was regraded following removal of the World War I hospital.

Abutting the interior side of the boundary wall's footing, about 50-60 ft. northeast of the salient of bastion 2, Smith discovered a small rectangular area paved with stone slabs; surrounding the pavement was a roughly dressed fieldstone edging or footing (Figure 51).¹⁰⁶ Other than suggesting a likely 1795-1836 period of construction for this feature, Smith offered no interpretation of it. Smith also encountered the concrete footings of one of the hospital structures (building no. 54, which served as officers' quarters), and the cellar and foundation of the 1790s-1836 tavern, discussed below. An 1803 U.S. one-cent coin and two Civil War period artifacts were discovered at or near the stone slab feature, but their association with it was uncertain. Lacking evidence, one may speculate that the feature derives from a 1794-97 bombproof or magazine. In 1794 Rivardi suggested that a bombproof or magazine could be incorporated into one of the bastion of a horn work which he recommended be built on the land side of the earthen star redoubt; he described the bastion's location as "the driest [sic] place of the whole point."¹⁰⁷ The location of the feature is, in fact, very nearly the highest ground of the entire site. Except for a drainage ditch on the 1834 plan,¹⁰⁸ there are no structures depicted at this location on any of the early plans of Fort McHenry. If the feature had indeed been associated with the 1794-97 period, the structure it represents was most likely removed during the 1798-1803 construction of the existing fort.

Additional sections of the original boundary wall's footing were exposed in separate 1964 investigations by Powell and Campbell. The section which Powell found, a 2.5 ft. wide rubble filled ditch, was northeast of the store house, more than 3 ft. below existing grade, and 1.5 to 2 ft. below original grade. Powell also documented the brick wall in-filling between the store house and the gun shed, contemporary with the boundary wall.¹⁰⁹

Campbell's attempt to locate sections of the boundary wall west of the fort, using the NPS historical base map (1960) as a guide, was unsuccessful. No clear remnants of the wall were discovered in any of the eleven trenches dug in that area.¹¹⁰ Campbell subsequently checked the correspondence between the NPS map and the two historical plans of the fort, of 1819 and 1834, which provide the best depiction of the wall, and found that the NPS map showed a more westerly location for the wall than either of the two historical plans. Campbell did locate wall footing remnants, however, along a section where all the plans show the same basic alignment, between the glacis opposite the right shoulder of bastion 2 and the site of the gun shed. Included were a wall footing segment about 8 ft. southwest of the gun shed, and a segment which had part of a 9 ft. jog in the wall's alignment, approximately 110 ft. northeast of bastion 2. Campbell described the

boundary wall's footing as "a distinct mortar-broken brick zone 20 inches wide." Following this exposure of the wall footing, and despite the failure to find the wall footing west of the fort, the 1819 plan appears to have been arbitrarily chosen as the basis for planting a hedge, no longer present, along the assumed alignment of the original boundary wall.

The fact that the alignment depicted by the 1819 plan was only confirmed where it matches the 1834 plan's depiction, along with other information, introduces doubt concerning the 1819 plan's accuracy in this regard. The alignment of the wall footing exposed by Smith in 1958 north of bastion 2 matches the 1834 depiction more closely than it does the 1819 depiction. Further, Delafield's 1836 plan depicts the southwest end of the boundary wall with essentially the same alignment as that on the 1834 plan. In short, the 1834 plan is probably more accurate than the 1819 plan in its depiction of the alignment of the original boundary wall (Figure 45).

Campbell also noted the presence of brick pavement in two separate areas along the alignment of the wall, southwest of a sharp curve in the existing walkway between the visitor center and the fort. Campbell suggested that the pavement in the two areas was continuous between them, and that it post-dated the 1837 removal of the original boundary wall. The pavement, 4.5 ft. wide, was revealed again during Cotter's investigation of the tavern site, discussed below. The pavement evidently derives from walkways along the north and west sides of the fort's 1890s-1912 administration building, which later served as a fire station (1917-23).¹¹¹

4.3.1.7 Seawall

Fort McHenry's existing granite seawall was built episodically, beginning in 1816-19, to remedy shoreline erosion.¹¹² Such erosion had been one of the factors that necessitated reconstruction of portions of the lower water battery in 1794 and again in 1813, and it was clearly seen as a major long-term threat to the integrity of the fortifications. Except for a 720 ft. long portion northeast of the fort, all sections of the wall within the fort's original boundaries were completed by the end of 1819, as shown on the plan of the fort made that year. The distinctive depiction of the northeast section of the wall on the 1834 plan of the fort suggests that it had to be completed when that plan was prepared. It most likely was completed in 1836-39, together with sections extending the seawall north and northwest of the fort, where additional property had been acquired in 1836-37. The seawall periodically required major repairs, and the sections northwest of the fort, now outside the park's boundaries, were realigned at least once between ca. 1880 and 1910, to accommodate changing usage of that area. The final section of the seawall, along the Ferry Branch shoreline west of the fort, was built in the 1890s.

Archeological excavations were made adjacent to the seawall in 1986-87, to determine the potential impact on resources of a rehabilitation project then about to begin; an Historic Structure Report (HSR) for the seawall was prepared at the same time.¹¹³ In several locations, at a depth of about 2.5 feet below grade, the archeological testing revealed deposits containing early nineteenth century artifacts; these deposits were evidently discontinuous, however, and in at least one location twentieth century fill deposits were found directly overlying subsoil at a depth of 3 ft. The most striking discovery was of the footing of a target butt associated with a rifle range in use during late nineteenth through the early twentieth century.

The early nineteenth century deposits were found in two locations along a portion of the seawall northeast of the fort, begun after 1819 and completed around 1839; one location was at the angle in the wall near the boat pier, the other approximately 300 ft. north of the navigation beacon east of the fort.¹¹⁴ Throughout this same area, deposits of oyster shell, used as ballast behind the wall during an 1890s seawall rehabilitation project, were also common. Early nineteenth century deposits were also discovered about 130 ft. northeast of the navigation beacon, toward the north end of the original section of the seawall, built between 1816 and 1819. All of the early deposits contained relatively high percentages of kitchen debris, including bone; several historical uniform buttons were also recovered. Some of the deposits, although not all, are likely to have been fill.

The section of the target butt footing exposed by excavation, 3 ft. in length, consisted of large blocks of cut granite, 1.5 ft. below the level of the coping of the adjacent seawall, which it abutted.¹¹⁵ It was discovered at an angle in the seawall approximately 530 ft. south-southwest of bastion 4, where a number of plans indicated the target butt had stood, with an overall length of about 32 ft. The rifle range itself extended nearly 1,000 ft. to the northwest, paralleling the seawall; a postmold that could derive from a target support was found approximately 10 ft. northwest of the target butt footing. More than 500 bullets and bullet fragments were also found in the area. Although it was not noted by the investigators, the target butt's location, where exposed, coincided with that of a counterfort, one of twenty-five such counterforts, each about 4 ft. wide by 8 ft. long, which the 1819 plan of the fort indicates were built along portions of the interior face of the seawall. The counterforts were evidently located at an interval of about 38 ft. along the two most exposed straight sections of the wall, and at each of the wall's angles (Figure 45). The target butt's footing, in other words, appears likely to represent reuse of an earlier feature, i.e. the counterfort, for a later purpose. Without further archeological investigation of the seawall, however, uncertainty remains concerning the footing's derivation from one of the seawall's counterforts.

Because of a single disconcerting documentary indication that the original seawall was built of brick, rather than stone, the originality of a large part

of the existing wall was called into question in the seawall archeological report; the HSR recognized the problem as well.¹¹⁶ In an 1829 letter, Maj. M. M. Payne, at the time Fort McHenry's commanding officer, suggested that "bricks can be obtained from the old seawall in front of" the fort for use elsewhere. There are, further, minor discrepancies in the depiction of the seawall's location on the 1819 plan of the fort, relative to its depiction on more accurate plans, which could be attributable to an otherwise undocumented post-1819 realignment of the earliest sections of the wall. Finally, no counterforts (excepting, possibly, the previously unrecognized original role of the target butt's footing) were found in the archeological excavations. The most likely explanation, however, for the 1829 reference to a brick seawall is that the origins of the parapet revetment wall of the fort's 1813-14 lower water battery were misunderstood, and it was consequently misidentified as an old seawall. An investigation designed to determine the presence or absence of the counterforts would very likely result in their discovery. Discrepancies noted in the location of the seawall as depicted in 1819 are well within that plan's degree of accuracy.

4.3.2 *Addition to Fort Grounds (1836-37)*

The ca. 1795-1836 tavern is the only structure in the area of the 1836-37 addition to the grounds of the fort that has been the specific focus of archeological investigation. Other archeological efforts in the area have been designed to mitigate the impacts of construction on resources, primarily by means of archeological monitoring of construction excavations. Most notable in this regard is the work done by Stokinger in 1974-75, at the Civil War Magazine, and in 1982, in connection with the installation of new water mains.¹¹⁷ (Because of funding problems with the 1982 project, associated in large part with construction delays and change orders to enable mitigation of impacts on resources, little analysis and interpretation of the findings could be accomplished.) Stokinger also monitored the 1983 installation of a septic tank in Orpheus Grove about 200 ft. southeast of the Civil War Magazine.¹¹⁸ The results, generally, provide only a limited basis for suggesting the characteristics archeological resources in the area; the discussion which follows is therefore preliminary.

The greatest potential for intact prehistoric resources at Fort McHenry is in the area of the 1836-37 addition, and Stokinger identified several features along the water main alignments, including pits and postmolds, that are likely to reflect prehistoric occupation of Whetstone Point. There is no indication in the documentary record, however, of early historical occupation in the area, and the Berthier maps of 1781 and 1782 both indicate that the closest building to the west of the Revolutionary War fortifications was situated a few hundred feet beyond the 1837 boundary wall's location. The tavern complex, consequently, may have been the only developed site in the area prior to its acquisition by the fort.

There was substantial development of the area as part of the fort, particularly during and after the Civil War (Figure 52), and much of that development was adapted for use within World War I hospital, before its wholesale removal in 1925-26.

There is a very high potential for preservation of structural features and other significant resources associated with mid-nineteenth through early twentieth century buildings and activities in the area. Among the features documented by Stokinger during the water main project were foundations of one of three 1840-1843 stables, in the northeastern part of the 1836-37 property addition; also documented was an associated outbuilding. Two of the stables, including the one documented by Stokinger, had been used as prisons during the Civil War, and as barracks afterwards. Stokinger also discovered: evidence of a possible palisade surrounding the Civil War prison compound; remnants of the mortuary of the World War I hospital complex, and of a nurses quarters; various nineteenth century sheet refuse deposits; and a multitude of former walks, roads, and pavements. Stokinger indicated that the significant resources in the area were generally buried beneath 1 ft. of fill, associated with twentieth century landscaping. Deeper fill deposits, extending 2.5 to 5 ft. below grade, were found in some areas, specifically along the 1837 boundary wall, in the vicinity of the new (1999) maintenance shop in the western corner of the park, beneath the visitor parking lot, and adjacent to the Naval Reserve and Corps of Engineers compounds northwest of the fort. The deepest deposits encountered were along the north and northeastern boundary of that area of the park, and the basal fill soils there were apparently older than other deposits; the shoreline in that area was evidently originally inland from the successive seawalls built there, beginning in the late-1830s.¹¹⁹

During 1983 monitoring of installation of the Orpheus Grove septic tank, stratified layers of ash, building debris (brick, mortar, and plaster fragments), and soil were found extending to a depth of more than 11 ft. below grade. These deposits appeared to date to the late nineteenth through early twentieth century, bracketing the ca. 1890 construction of the nearby section of seawall. The 1858 plan of Fort McHenry's drill ground (Figure 10)—the 1836-37 addition to the grounds—indicates that the location of the septic tank coincides with a large shoreline erosional feature, located 550-600 ft. west of bastion 2, with elevations about 10-20 ft. below those of the surrounding ground.¹²⁰ The steep slope, upward to the north, of soils at the base of the excavation, indicates that the septic tank excavation was located towards the northern margin of the erosional feature. The poured concrete foundation of the southwest corner of one of the World War I hospital buildings (building no. 29, a ward) was also encountered in the excavation, between depths of .6 ft. and 5.7 ft. below grade; the builders' trench for the foundation had been dug into the upper portion of the earlier deposits. The earlier deposits are significant, as Stokinger notes, both because they provide a reflection of patterns of land use, and of landscape evolution, for

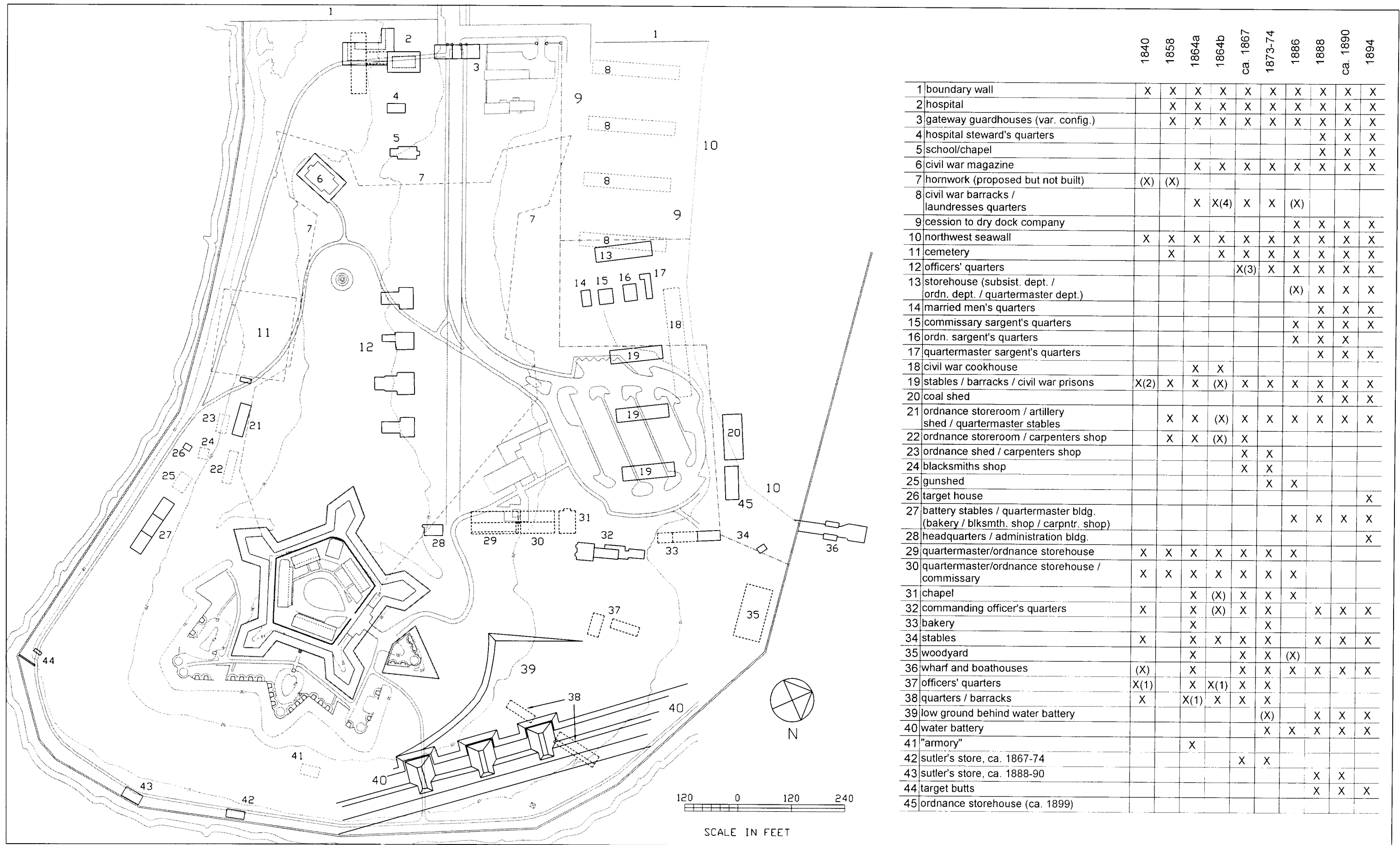

Figure 52. Structures on the grounds of Fort McHenry, ca. 1840 - 1899.

the period during which they accumulated, and because their artifactual content might yield insight into military lifeways of the era. The hospital ward foundation, of course, is also a significant structural remnant, reflecting an important period of the fort's history.¹²¹

4.3.2.1 Tavern

The earliest known documentation for the tavern adjacent to Fort McHenry indicates that it was in existence by 1797, but the precise date of its establishment is not known.¹²² It most likely dates no earlier than the mid-1790s, however. The tavern tract, which in 1811 consisted of 4.5 acres, had been part of the property (Upton Court) confiscated from the Principio Company during the Revolutionary War, and sold to private owners in 1782, following the abandonment of Fort Whetstone.¹²³ Clientele for the tavern, and the probable incentive for its establishment, appeared when the reconstruction of the fortifications began in 1794. As depicted on the 1803 and 1806 plans of the fort, the tavern, about 54 ft. long by 30 ft. deep, was located directly adjacent to the southwest side of the roadway into the fort, its southeast end abutting the fort's property line. It was a two-story brick structure. An ancillary building, possibly a stable, about 36 ft. long by 16 ft. deep, stood on the opposite side of the roadway.

The proximity of the tavern was periodically a matter of concern to the fort's commanders, and acquisition of the property was proposed in 1817 and again in 1833. Between late 1833 and 1836, when the property was finally purchased, the buildings were leased to the fort. It is not known what use the fort made of the buildings following 1833. Although Bradford implies that the buildings may have remained in use into the early 1840s, it is generally assumed that they were demolished in 1837, when the post was enlarged and the boundary wall relocated.¹²⁴

In 1958, Smith exposed a 20 ft. segment of the northeast foundation of the tavern, along with a 20 ft. by 8 ft. portion of its filled cellar, approximately 160 ft. northeast of the right shoulder of bastion 2.¹²⁵ The depth below existing grade of the foundation remnants and of the cellar were not recorded, and because of previous disturbance it was evidently impossible to determine their depth below original grade; neither were any corners of the structure exposed. The foundation, with a width of 1.5 ft. and a surviving height of no more than 2 ft., was of undressed slabs and angular pieces of a dark igneous rock, "sparingly laid in lime mortar," not regularly coursed, but set with flat surfaces facing toward the building's interior, i.e., its cellar. The cellar fill consisted of densely-packed construction debris, primarily bricks and brick fragments, together with lime mortar, plaster fragments (some painted), cut stone, coping and paving brick, fire-brick (marked 'BERRY'), and household and kitchen debris. Smith suggested that the cut stone and some of the special types of brick could reflect

demolition of the boundary wall at the same time as the filling of the tavern's cellar. A bomb shell fragment was also retrieved from the cellar fill. The cellar floor, below the site's present water table, consisted simply of the native clay into which the cellar had been excavated.

The tavern foundation was again investigated by Cotter in 1966.¹²⁶ Cotter's report indicates that the tavern's southwest (?) foundation was found beginning 3 to 5 ft. below grade, resting on a footing more than 6 ft. below grade. The cellar fill northeast (?) of the wall was apparently similar to that encountered by Smith. Once again, none of the building's corners were exposed. Cotter's report confusingly and contradictorily indicates that, when the location of the tavern was marked with brickwork at grade, the foundation he had exposed was assumed to derive from, not the southwest, but the northeast wall of the tavern. Following the only other archeological exposure of the tavern foundation and cellar, during the water main project, Stokinger noted that the at-grade brickwork supposedly marking the tavern's location is, in fact, incorrectly positioned.¹²⁷

4.3.2.2 Boundary Wall and Entrance Gate (1837-Present)

The existing fort boundary wall and entrance gate were built in 1837 with materials salvaged from the original, 1816 wall and gate.¹²⁸ Early maps suggest that the wall was constructed in an area where there had been no previous historical occupation. The entrance gate, at least as illustrated during the Civil War, lacked the arch(es) that appear to have characterized the original entrance gate. The wall's alignment has changed little, if any, over time, but the northeastern section of the wall presently marks the boundary of the U.S. Naval Readiness Center, rather than that of the park.¹²⁹ There are also newer openings through the wall, for the park's maintenance yard as well as for the naval facility, and the height of the wall has evidently been reduced in places. The wall, like its predecessor, was supposed to have been 9 to 10 ft. high. The top of the wall towards its southwestern end presently ranges from a height of 7 ft. above grade to a depth more than 2 ft. below grade. A substantial quantity of fill has been deposited adjacent to the wall since the 1920s, and over the top of its southwest end, but the greater part of the reduction in the height of the wall appears to be the result of the removal of several courses of brickwork.¹³⁰ It is possible, as well, that this area served a borrow area for soil employed in landscaping elsewhere, prior to the deposition of fill.

4.3.2.3 Civil War Magazine

The detached, Civil War Magazine was built in 1863-64, in response to the fort's need for a larger and more serviceable facility for the storage of gun powder and munitions, and in preparation for the development of a large

earthen horn work extending northwest from the star fort.¹³¹ Because the horn work was never built, the magazine's isolation, and its 600 ft. distance from the fort, make the selection of its site seem peculiar. Cartographic research indicates that the Civil War magazine's location, in the western part of the 1836-37 addition to the fort's property, had not been previously occupied by any structures.

Minor repair work associated with building maintenance has continued from completion of the building to the present. Alterations were made to the south courtyard of the building, and the courtyard's surrounding wall, in 1933, when the City of Baltimore established a bathhouse there, with separate sections for men and women.¹³² The bathhouse entrances built into the enclosing wall have since been sealed but are easily recognizable.

There have been no archeological investigations designed to investigate the Civil War magazine, but in 1974 Stokinger monitored the excavation of utility trenches adjacent to the building, documenting an array of features and earlier utilities, and recovering a number of late nineteenth through early twentieth century artifacts.¹³³ In addition to construction-related features, grounding elements for the magazine's lightning rods were found, consisting of 3-in.-wide straps of copper carefully buried beneath formed deposits of charcoal and gravel, directly northwest of either end of the building. One of these straps ended adjacent to an apparently intrusive poured-concrete pole support. Corners of two such supports were observed in the vicinity of the north corner of the magazine's perimeter wall; a 1926 oblique aerial photograph suggests that the pole supports, presumably for utilities, were associated with the World War I hospital.¹³⁴

END NOTES

1. Thompson and Newcomb 1974:22.
2. Joseph and Cheek 1985:45.
3. Aivazian 1982; Stokinger et al. 1982:50-65; Joseph and Cheek 1985; Cheek, Balicki, and Abel 1997.
4. Wadsworth 1814; Joseph and Cheek 1985:45-47.
5. A non-archeological excavation made in 1984 into the ravelin's parapet toward the west end of its north face also revealed the parallel walls and one cross wall, although the dimensions of these features, and their spacing were depicted as having been slightly different from those reported here, recorded in 1985 (Blades 1984; Joseph and Cheek 1985:45-47). The cross walls were again exposed along the north face of the ravelin in late September, 1997, during the partial reconstruction of the ravelin's north scarp wall. The 1997 exposure established that the interior face of the scarp wall was vertical, and that the cross walls and the scarp wall were constructed at the same time (Pousson 1997).
6. Blades 1984; Pousson 1997.

7. See Benatec Associates, Inc. 1984 for a recent discussion; also Joseph and Cheek 1985:65-66.
8. Joseph and Cheek 1985:43-44; Figure 19.
9. Stokinger et al. 1982:50-66; Cheek et al. 1999:60-66; Joseph and Cheek 1985:43-47.
10. Cheek et al. 1999:66-71.
11. Walsh 1958:12.
12. Cheek et al. 1999:64-67.
13. See Stokinger et al. 1982: Figure 23 for a reconstruction of the ravelin entrance and access bridges.
14. Stokinger et al. 1982:50-66.
15. Cheek et al. 1999:64-68.
16. Cheek et al. 1999:60-65.
17. Aivazian et al. 1982; Joseph and Cheek 1985:25-28.
18. Benatec Associates, Inc. 1984.
19. Joseph and Cheek 1985:25-28. Figures 10 and 11.
20. Aivazian 1982:52.
21. Joseph and Cheek 1985:48-49.
22. Corps of Engineers 1866.
23. Cheek et al. 1997:36-37. Figures 21 and 22.
24. Stokinger 1976a:3.
25. Rivardi 1794, quoted in Bradford 1958:76; Stokinger et al. 1982:39.
26. Thompson and Newcomb 1974:68-69, 71; Aivazian 1982:45-56; Stokinger et al. 1982:26-50.
27. Stokinger et al. 1982:48-49.
28. Yarrow 1870; Thompson and Newcomb 1974:68-69, 74; Stokinger et al. 1982:26-29.
29. The works existing today and commonly referred to as the water battery would more accurately be termed an outer battery. Traditionally, the term water battery refers to works adjacent to water. Water batteries were intended as the first line of defense if the seaward side of the fort were attacked. Fort McHenry's original upper and lower water batteries, first constructed as elements of Fort Whetstone beginning in 1776, were both located east of the star fort, closer to the shoreline. Nevertheless, the term water battery will be used here for consistence with other studies of the fort.
30. Thompson and Newcomb 1974:44-52, 114.
31. Stokinger 1975b; Joseph and Cheek 1985:48-50, 66; Cheek et al. 1997:57-60.
32. Joseph and Cheek 1985:49-50; Pousson 1996.
33. Delafield 1836; Office of the Chief Engineers 1886; Livermore 1869.
34. Cheek et al. 1999:92, 110-111.
35. Pousson 1999a.
36. Thompson and Newcomb 1974:49.
37. Joseph and Cheek 1985:49-50.
38. Pousson 1996.
39. Thompson and Newcomb 1974:117.
40. Scott Sheads 1992, personal communication.
41. Joseph and Cheek 1985:48-50; Pousson 1996a; Cheek et al. 1999:89-101.
42. Thompson 1839b.
43. Thompson and Newcomb 1974:64-66, 115-117. During reconstruction of the southwestern most section of the breast-height wall in the mid-1980s, previously buried remnants of two of the original gun emplacements were uncovered, and in large part demolished (Sheads 1994); consequently, only twenty of the original emplacements presently survive.
44. Cheek et al. 1999:81-83; Pousson 1999a.
45. Cheek et al. 1999:83-86.
46. Thompson and Newcomb 1974:55.
47. However, a rectangle on the 1888 fort plan at the site of the furnace in the bastion 5 vicinity may indicate the survival of that structure beyond the 1860s. It is noteworthy that there is a vague image of this shot furnace in a photograph taken ca. 1861, which has as its primary subject the gun and emplacement at the left shoulder of bastion 4 (Sheads 1995:50).
48. Cheek et al. 1999:83-86.
49. Cheek et al. 1999:72-76.
50. Office of Engineers of Harbor Defenses 1866.
51. Traditionally, these magazines have been numbered 1 through 3, with 1 assigned to the magazine within the ravelin. The numbering system is retained; refer to the section on the ravelin for the discussion of magazine 1.
52. Thompson and Newcomb 1974:117.
53. Joseph and Cheek 1985:48-50.
54. Cheek et al. 1999:83-86.
55. By means of historical research he conducted in 1975, Stokinger determined that the revetment walls date to 1867, some months after the construction of the bombproofs (Stokinger 1975b:1). In the report of operations for Fort McHenry for October of 1866 Maj. Craighill noted that it was "not though advisable" to build the walls that late in the year, but that the water battery would be "put in condition for winter—by thoroughly cleaning up, grading & policing—." This indicates that the depiction of one of the revetment walls on an 1866 cross-section of bombproof 1, and possibly that of the earthen mounds covering the vaults of the bombproofs, represents the design, rather than the as-built situation.
56. Joseph and Cheek 1985:48-50; Cheek et al. 1999:75-83; Pousson 1999a, 1999c. The revetment walls at bombproof 1, like those at bombproof 2 prior to their reconstruction, were badly out-of-plumb, and therefore were reconstructed in 1999.
57. Stokinger 1975b.
58. Thompson and Newcomb 1974:116-117.
59. Rutsch 1974:45, citing pg. 3 of the February 10, 1939, monthly report, park file A2615. The project required the excavation of 104 cu. yds. of earth along the alignment of the drain.
60. Cheek et al. 75-83; Pousson 1999a: Figures 15-17.
61. Stokinger 1975b:Appendix 3.
62. Joseph and Cheek 1985:48.
63. Stokinger 1975b:2.
64. The most thorough historical investigations to date of the physical development of the grounds of Fort McHenry are those by S. Sydney Bradford (1958), concerning the development of Fort Whetstone during the Revolutionary War as well as Fort McHenry's development up to 1814, and by Scott Sheads (1995), which has an especially valuable, although brief, presentation of the Civil War through World War I era of development. Primary cartographic resources—plans of the fort—nonetheless remain the only readily available source of information about many of the structures on the fort's grounds.
65. Bradford 1958:1-14.
66. Bradford 1958:15-26; Rivardi 1794, transcript copy in Bradford 1958:74-80.
67. Bradford 1958:32-33.
68. Bradford 1958:34-35.
69. Some interpretations put twenty guns on the lower battery and sixteen on the upper; Bradford 1958:35-39, 70-71.
70. Smith 1958:36-37.
71. Brown and Long 1986:17.
72. Stokinger (1983d) conducted limited testing and monitoring in 1983 where the southernmost section of the enlarged lower water battery of 1813-14 had been located, but no evidence of intact, early nineteenth century strata or features was detected.
73. Smith 1958:30-47.

74. Smith 1958:41-43. Figure 2; NPS 1958 [plan titled "Location of Archeological Diggings Outside of Star Fort"]
75. Bradford 1958:15-21; Rivardi 1794 (Bradford 1958:75-76).
76. Peterson 1969:37; Bradford 1958:9.
77. Bradford 1958:45-46.
78. Bradford 1958:11, 17-18.
79. Bradford 1958:39-41, 61, Figure 14.
80. Carson 1963; Campbell 1963.
81. Pousson 1999c:13-15.
82. Bradford 1958:63-64.
83. Office of the Chief of Engineers 1886b.
84. Campbell 1964a, 1964b; Carson 1961; Cotter 1964b, 1966a, Powell 1964.
85. Campbell 1964b 18-20, Figures 3-5.
86. Cotter 1966a.
87. Fort McHenry NH&HS. Library. FOMC CX1964/058 - Campbell 1964b: Figure 3.
88. Campbell 1964b:2, Figure 1.
89. Campbell 1964b:29.
90. Cotter 1966a.
91. Stokinger and Blades 1979b:4-8.
92. Powell 1964:2; Campbell 1964b, Figure 3.
93. Bradford 1958:56-61; Sheads 1995:79-85.
94. National Archives and Records Administration, Cartographic Division, Records Group 77, Miscellaneous Forts File, Fort McHenry, Maryland, Series B, Nos. 16 and 66.
95. Bradford 1958:58, note 5.
96. Campbell 1964b:30-32, Figure 6; Cotter 1966a.
97. Campbell and Cotter were both misled (Campbell inconsistently) by an erroneous graphical scale on Lee's 1834 plan, which indicated that the building details were at a 1 inch equals 20 feet scale, when in fact the scale was, as stated and drawn, 1 inch equals 15 feet. Campbell's suggestion that the porches were 14 ft. wide rather than 10 ft., and Cotter's assertion that the hospital had been 75 feet long by 28 feet wide, are both attributable to the latter error. Campbell also misinterpreted the orientation of the building details on the Lee plan, and consequently thought the walkway he had found was on the 'wrong' side of the building's centerline to have been associated with the building's northwest doorway.
98. Lee 1834, quoted in Stokinger and Blades 1979b:9.
99. Stokinger and Blades 1979:8-19.
100. The interpretation of the pavement offered by Stokinger and Blades—i.e., that at least part of the area beneath the porch remained at grade (1979:13)—is inconsistent with the building elevation detail on the Lee plan, which indicates that the floor of the porch where the pavement was located had been about 2.5 ft. above grade.
101. Smith 1958:11.
102. Letter from T. W. Maurice to W. K. Armistead, Nov. 6, 1816; Letter from Armistead to J. G. Swift, Dec. 31, 1817. Also see Smith 1958:12.
103. Karl Bonhard, Duke of Saxe-Weimar Eisenach: quoted in Smith 1958:13.
104. Smith 1958:9-29; Powell 1964; Campbell 1964b; Cotter 1964b, 1966a; Stokinger 1982.
105. Smith 1958:16-24; NPS 1958 [plan titled "Location of Archeological Diggings Outside of Star Fort"]
106. Smith 1958:21-23, Plates II and III; NPS 1958 [plan titled "Location of Archeological Diggings Outside of Star Fort"]
107. Rivardi 1994, transcript copy in Bradford 1958:74-80. "[T]he only method by which it is possible to render the place able of a good defense is to construct two small bastions, J and K;...a powder magazine could be constructed in the bastion K, as it is the driest place in the whole point, the platform itself serving as a bombproof" (Rivardi 1994, in Bradford 1958:78). The parallels between Rivardi's 1794 plan for the defense of the landward approach to the star redoubt and water battery, and the ca. 1861 plan for the defense of Fort McHenry, which involved construction of a horn work, and of a magazine—which became the so-called Civil War magazine—beneath one of that work's bastions, are striking.
108. The ditch was probably needed to drain an area where runoff would otherwise have been trapped between the base of the glacis and the 1817-37 boundary wall.
109. Powell 1964:2-4.
110. Campbell 1964b:1-5, Figures 1 and 2.
111. The National Archives possesses an excellent plan of the walkways at the fort in the 1890s. National Archives and Records Administration, Cartographic Division, Records Group 77, Miscellaneous Forts File, Fort McHenry, Maryland, Series B, No. 87 (1896).
112. Brown and Long 1986:11-79.
113. Orrence et al. 1988; Brown and Long 1986.
114. Orrence et al. 1988:14-35.
115. Orrence et al. 1988:35-40.
116. Brown and Long 1986:17; Orrence et al. 1988:46-47.
117. Stokinger 1976a, 1982.
118. Stokinger 1983c.
119. Stokinger 1982.
120. Brick 1858.
121. Stokinger 1983c.
122. Bradford 1958:65-69.
123. The tavern tract, estimated to be 5 ½ acres, had been owned by Philip Swartzauer, and was inherited by his widow upon his death in 1811. Although Bradford, 1958:67-68, states that the tract was purchased on Sept. 12, 1836, for \$12,001, Butler's 1840 *Plat of Lotts* gives a Nov. 16, 1836, date for conveyance of the tract, consisting of lots nos. 65, 67, and part of 66 (the other part of lot 66 having been purchased in 1798), from Richard W. Gill to the U.S.
124. Bradford 1958:68.
125. Smith 1958:24-29.
126. Cotter 1966.
127. Stokinger 1982:9.
128. Smith 1958:13-14.
129. Sheads 1995:69-85.
130. Pousson 1996.
131. Stokinger 1976a.
132. Thompson and Newcomb 1974:103; Stokinger 1976a:15. Stokinger's research indicates that the NPS, having taken over administration of the site from the army, ended the use of the southwest end of the magazine's courtyard as a bathhouse in 1934.
133. Stokinger 1976a.
134. The pole supports were more fully exposed during installation of conduit to the magazine in May of 2000, revealing that they had a different form and were more massive than they appeared to be when encountered in 1974. Probing in 1974 had suggested that the concrete 'piers' were roughly triangular in plan, with 1-ft. to 1.5-ft.-long sides; the exposure in 2000 demonstrated that they were roughly rectangular in plan, 2.4-2.6 ft. across, with slightly elliptical, off-center, cinder-filled pole holes .8-.9 ft. across. The 15 ft. separating the two pole supports seems excessively close, but they otherwise appear to have been elements of the same utility or lighting system, aligned east-west to the magazine's northwest.

5. PREVIOUS AND FUTURE ARCHEOLOGY AT FORT MCHENRY NATIONAL MONUMENT

5.1 A Chronology of Previous Research at Fort McHenry

The archeological investigations performed at Fort McHenry over the past forty years have been extremely varied in their scope, in the quality of their execution, and in the significance of their results. To characterize these investigations according to their main objectives or the methods employed, however, or by some other means, with the hope of determining which approaches worked well and which did not, would more likely distort our understanding of how and why the archeology was accomplished than improve on it. Past investigators have all wrestled with the difficulties not only of deciphering the often obscure import of the features, strata, and artifacts they have found, but also of securing institutional support, beyond acceptance of the need to document resources, especially when the relevance of the findings was not immediately clear. What could be done, under the circumstances, was. This brief chronological review is intended therefore only as a sequential ordering of the archeology of the fort, recognizing, although not exploring the fact, that archeology has its own historical context, and that the various projects are interconnected in time as well as space. Although not a guide, it may serve as an introduction to the archeology that will be performed at Fort McHenry in the future, however diverse its goals might be.

5.1.1 *Early Investigations: 1958-1966*

Archeology at Fort McHenry commenced in 1958, as an element of the Historical and Archeological Research Project (HARP), itself a local implementation of a nationwide NPS initiative known as Mission 66, whereby the quality of facilities, the condition of resources, and the accuracy of interpretation within national parks throughout the country would be improved for the fiftieth anniversary of the NPS in 1966. Archeologist G. Hubert Smith's contribution to HARP consisted of investigations of the 1817-37 boundary wall, the ca. 1795-1837 tavern, the area of the upper and lower water batteries, and, most notably, the 1814 flagstaff site.¹ Smith directed excavations at a few other locations as well, primarily in support of architectural investigations of structures at those locations. At the same time, John Cotter worked with Lee H. Nelson in collecting below-grade architectural data concerning the residential buildings within the fort.² The basic objectives were presented most concisely (if with more confidence than warranted in what had been, indeed could be, accomplished) in the introduction of the HARP report: "The National Park Service can now reconstruct Fort McHenry as it appeared in 1814, and present a clear, documented history of the Battle of Baltimore."³

For Smith and the NPS, the main purpose of archeology in parks that commemorate historical events, people, and structures—as an adjunct to architectural (and landscape architectural) investigations—was at the heart of his efforts, in keeping with the "restore and interpret" mode of fulfilling the mission of the NPS. This role clearly remains a basic justification for archeology, at national parks and elsewhere. It is noteworthy, however, that the only structure at Fort McHenry to have been restored on the basis, in part, of archeological confirmation for its existence and location has been the flagstaff. The more lasting (if not permanent) contribution which archeology has made to the park, and hopefully will continue to make, is in validating interpretive narratives: the record of the findings of archeological investigations, and the interpretation of those findings, together with historical record, provide the basis for the presentation to the public of the factual story of the physical development and use of the site.

Except for Cotter's return to the fort in 1961, to document a brick drain discovered below the parade ground during construction, five years would pass before additional archeology was implemented.⁴ It was again the chance exposure of the remains of a structure during utility work that led to investigations of the upper water battery barracks by Hamilton H. Carson and J. Duncan Campbell in 1963.⁵ In 1964, Cotter conducted two limited excavations, over the alignment of the 1819 fort road, and between the 1807-08 gun shed and store house, while Bruce Powell was called upon to insure that the design for a "plaza, east of the Visitor Center, did not encroach on the location of the historic boundary wall of the fort."⁶ Exposure of the footings of the gun shed and store house, by Powell as well as Cotter, and of remnants of the boundary wall, led to more thorough investigations by Campbell in 1964 (at which time he also excavated at the site of the 1814 hospital), and to archeology-aided construction in 1966 of landscape features to show the structures' locations.⁷ One of the Cotter's 1966 reports (he implemented two investigations that year also) was descriptively subtitled: "Archeological observations during the preparation of the Sites of the GUN SHED and STOREHOUSE; the TAVERN; and, the 1814 HOSPITAL for Interpretive Marking on the Grounds of Ft. McHenry —."⁸ Cotter's other 1966 investigation — "Archeological Observations on the Kitchen Excavation, Fort Building E" — represented a return to a structure he had first investigated with Nelson in 1958.⁹

The mid-1960s upswing of archeological activity at the fort, while in some cases maintaining the discipline's involvement with the "restore and interpret" aspect of the NPS mission, also demonstrated its necessarily ambiguous involvement with the "preserve and protect" aspect of the mission, just before such involvement was codified for all federal agencies by the National Historic Preservation Act of 1966. The ambiguity derives, of course, from the destructive nature of most types of archeological investigation and architectural restoration. Where the discovery of archeological resources, whether due to serendipitous findings during

construction, or to more deliberate, focused research, has led to multiple excavations or to some variant of restoration, the resulting reduction in the integrity of the resources or of their contexts has been the price we paid for a better understanding of them.

Following the development of new visitor facilities and interpretive programs in the 1960s, there was another long hiatus in archeological research at the fort. However, in 1974, after eight years of relative neglect of the fort's archeological and documentary record, two studies of long-term importance were prepared: the Historic Structure Report (HSR), by Erwin N. Thompson and Robert D. Newcomb; and an archeological study of the fort's original drainage system, by Edward S. Rutsch.¹⁰ Nelson had prepared thorough architectural documentation of the various structures of the fort in 1958-1961, as an outgrowth of his HARP work,¹¹ but the HSR was the first comprehensive overview of the history of the fort's physical development; it provided not only a reliable guide to the major construction episodes at the fort, and their historical context, but also a package of recommendations for architectural repair and restoration, and archeological investigations, that would guide a large part of the work implemented over the next several years. Rutsch's investigation, done following the HSR's completion (and at the same time as masonry repairs got under way), was intended to aid in identifying flaws in the fort's drainage systems which were suspected of being responsible for the water-infiltration related deterioration of the fort's masonry. The value of Rutsch's work, however, derives as much from his hypothesis, subsequently disproved, that the footing of the fort's scarp had originally possessed a drainage function, as from any specific findings. The clearly evident need for further study of the fort's drainage systems would be the other main impetus of investigations for several years. Most importantly, the need to view features and feature-complexes systematically, as components of an evolving architectural whole, integrated to the extent they could be with one another and with the contemporaneous landscape, had been better recognized.

5.1.2 *Research and Compliance: 1974-1983*

The ten years from 1974 to 1983 would be the most active period of archeological fieldwork at the fort of any over the past forty, due in part to the pace of construction and reconstruction. In 1974-75, before the archeology recommended in the HSR, and the additional study of the drainage systems stemming from Rutsch's work, could be undertaken, there were six construction projects that were accompanied by archeological monitoring and a limited amount of testing. The first of these projects was the installation of new utilities at the Civil War ("Detached") magazine.¹² The other five were: the installation of a brick walkway in the fort's water battery, and of a french drain adjacent to the scarp wall interior to the battery;¹³ the reconstruction of the revetment of bombproof 2, again in the

water battery;¹⁴ the reconstruction of roughly one-quarter of the parade wall inside the fort;¹⁵ and the installation of an extensive system of temporary electrical lines on the fort's grounds.¹⁶ Nearly all these projects, which had Bill Stokinger as the principal archeologist, with Brooke Blades assisting on two, resulted in significant discoveries. Clearly, however, these discoveries were accompanied by some degradation of the resources' integrity, and archeology was being employed, consistent with resource preservation law and policy, to sanction that loss, by providing documentation, however limited, of the resources' characteristics.

The two archeological investigations which addressed the recommendations of the HSR were those directed by Brian Aivazian in 1978, and Stokinger, Patricia E. Rubertone, and Lawrence E. Babits in 1980.¹⁷ These projects — in reality two phases of a single, complex project — involved field investigation of five locations interior to the star fort, and of one location in, and another adjacent to, the ravelin; it also involved documentary research concerning an eighth location — the mid-nineteenth through mid-twentieth century site of a flagstaff in bastion 5 — whereby it was determined that excavation there would not be worthwhile. A ninth research goal, that of documenting the original grade of the fort's parade, was abandoned without explanation, possibly because of the generally ambiguous nature of the stratigraphy found in the vicinity of the structures investigated; this goal would, however, be resurrected ten years later.

The 1978-80 investigations, as might be expected given their HSR origins, focused on determining the nature of remnants of specific, historically-documented structures: the 1814 well; the overlapping cistern, guardhouse, and shot furnace site, between the two enlisted men's barracks; the connecting passageway of the commanding officer's quarters; the so-called commanding officer's, junior officers', and enlisted men's (ravelin) privies; and the entrance passageway through the rampart of the ravelin. There was also an expectation that, in addition to supplying basic resource documentation, particularly architectural data, archeology might also provide a more precise chronology of the construction, use-history, abandonment, and demolition of the structures than could be secured from textual and cartographic documentation alone. This objective would be accomplished by means of thorough analysis of artifacts retrieved in a stratigraphically-controlled fashion.

Further, and more ambitiously, it was thought that artifact data from the privies would form the basis for analysis of the material-culture correlates of status and rank at the fort. In concept, and consistent with the academic training of archeologists, and with the decade-old intellectual ferment in the field commonly termed the "New Archeology," anthropologically-oriented historical archeology had arrived at Whetstone Point. In practice, however, practical (and appropriate) limits on excavation, along with the frequently incomplete degree of preservation, and the pervasiveness of disturbance and

filling, militated against even the simplest characterization of the ensembles of artifacts associated with particular organizational, residential or functional components of the fort's garrison; studies of status, along with the building of detailed chronologies, remain to be accomplished.

In 1982 and 1983, as in the mid-1960s, several archeological investigations were implemented in an effort to "preserve and protect" resources, given the anticipated consequences of construction projects. Foremost among these were Stokinger's monitoring of a large-scale water main replacement project, and the excavations made by Dave Orr, Brooke Blades, and Doug Campana at the fort's sally port.¹⁸ These projects, along with six monitoring and testing projects done by Stokinger in 1983 (associated with less extensive construction excavations, and excavations in less sensitive locales),¹⁹ again demonstrated the abundance and complexity of resources within the park, and the near-impossibility of having excavations of any sort made that did not reveal features, strata, and artifacts which often required further study and evaluation to determine their significance. This was particularly true of the water main project; as a result of cost-overruns arising, in part, from efforts (of mixed success) at avoidance of impacts on resources, analysis of the archeological findings was cut short, and only the most abbreviated of draft reports could be produced.

5.1.3 Cultural Resource Management: 1984-1998

The upshot of Rutsch's 1974 drainage systems study — three extensive, and cumulative, programs of investigation, involving a large number of excavations in and surrounding the fort — was initiated in 1984 by Charles Cheek and Joe Joseph, archeologists from the firm of John Milner Associates (JMA).²⁰ The 1984 drainage systems excavations were situated: at the footing of the fort's scarp wall, and the interior edge of the moat, along the curtain between bastions 1 and 2; at the footing of the ravelin's scarp, at its salient, and the adjacent section of its moat; on the terreplein along the left flank of bastion 4, in line with a drain discovered behind the parade wall in 1974; and at the postern drain line, towards its outlet at the seawall. Several excavations were also made on the parapet of the fort, one on the parapet of the ravelin, three on the mounds of earth over the underground structures exterior to the fort, and two on the parapet side of the water battery's breast-height wall. Cheek would return to the fort in 1988, this time with Joe Balicki, to continue the study of drainage systems, and of architectural and archeological features affected by the inadequacies of those systems, or simply located where excavation was deemed necessary.²¹ Within the moat, several excavations were made along the faces and flanks of bastion 3, and trenches were excavated out from the bastion, towards where the fort's counterscarp and glacis had been located. Additional excavations made also on the terreplein, in and near bastion 4, and testing was performed on the parade and in the gorge as well. Finally,

in 1989, Jim Kurtz, with the NPS, would make additional excavations, primarily on the fort's terreplein, but also in the moat between bastions 4 and 5.²² While there was a wealth of discoveries made during the course of these efforts, certain features that were sought were not found. It was now clear that historically the fort had lacked effective systems of subsurface drains for preventing or remedying water infiltration into the ramparts of the fort and the ravelin.

Done prior to, and separate from, the drainage investigations was Blades's brief investigation and report concerning features exposed in two locations in the spring of 1984: historical drain lines in the gorge and the counterfort system beneath the coping of the ravelin's northern scarp wall.²³ In addition, in the fall of 1984, a partially successful effort was made at employing a geophysical technique — resistivity — to locate counterforts beneath the parapet of the curtain between bastions 3 and 4, and gun emplacements below the terreplein of sections of those bastions.²⁴ Further, while the drainage investigations were being pursued, planning began for the rehabilitation of the fort's seawall, and in 1986-87, a mixed preservation-, restoration-, and interpretation-oriented study was made of the seawall's archeological context, in conjunction with preparation of an HSR. The archeology was conducted by Karen Orrence, Paula Zitzler, and Heather Bouslog, while Sharon Brown and Susan Long made the historical and architectural investigations for the HSR.²⁵ In 1989, to bring order to the task of understanding where the various archeological excavations which had been made were located, the regional office of the NPS contracted with JMA for preparation of archeological base maps for the park.²⁶

During the investigations of the 1980s, it became increasingly clear that for the features of the fort to be understood, extremely careful excavation and analysis had to be accompanied by detailed study of textual and cartographic documentation. In meeting this challenge, the investigations of the period exhibit a professionalism, and a technical maturity, that was not so much absent from earlier efforts, as it was uneven in them. The focus, however, had returned to detailed documentation of the physical development of the site, and to a very empirical approach for resolving often mundane architectural and engineering issues. There was, of course, continuity as well: archeology — both with what it found and what it did not find — served to sanction new construction, much of it intended to "preserve and protect" the masonry fabric of the fort, albeit at the expense of associated archeological strata and features.

Which brings us to the 1990s, the final decade of Fort McHenry's second century, and to development of a comprehensive plan for the rehabilitation and preservation of the fort's masonry structures. It was decided at the outset of this effort, led by the Baltimore firm of Grieves Worrall Wright & O'Hatnick (GWWO), that archeology would need to be an integral part of preservation planning and design, as much for the contribution it might

continue to make to understanding the problem of masonry deterioration at the fort, as for compliance purposes—the evaluation of the potential impacts of design alternatives on resources, and the mitigation of adverse impacts on significant resources, that would inevitably be required.²⁷ Consequently, in 1991, as work began on the comprehensive plan, work also began on preparation of the initial draft of this overview,²⁸ and in 1993, once design for masonry rehabilitation (and remediation of water infiltration problems) had progressed sufficiently, evaluative testing was performed where it appeared that significant resources could be affected.²⁹ In 1994 and 1995, following refinement of the design, and restructuring of the anticipated phasing of construction, data recovery excavations were undertaken where it appeared there would be unavoidable adverse impacts on significant resources during the first phase of construction, and where existing documentation of the resources was insufficiently detailed.³⁰ Responsibility for delineating what archeology was needed was the responsibility of DSC archeologist John Pousson, while its implementation, through the data recovery excavations for the first phase of construction, was handled by JMA archeologists Liz Abel, Cheek, and Balicki.

The excavations made in 1993-95 focused on the characteristics and contexts of the structures slated for rehabilitation, or adjacent to which new waterproofing and drainage would be installed below grade: the breast-height walls of the star fort, ravelin, and water battery; the earth fill of the parapet above postern tunnel; the northwest sally port bombproof; and the vicinities of magazine 1, in the ravelin, and of bombproof 1 and magazine 3 in the water battery. Various interpretive questions were addressed, and some of the results — including the establishment of the precise sequence of development of the water battery's breast-height wall, and the discovery below grade of a massive concrete "roof," over the sally port bombproof — had practical implications for design and construction. Naturally enough, many new questions arose as well.

The first phase of implementation of the rehabilitation work called for under the comprehensive plan took three years to complete, 1995 through 1998. This was much longer than expected, and it occurred despite the scaling back of what was included in the first phase; the reasons include various changes in design, as well as problems with the structuring and awarding of the construction contracts, and in their implementation. While this construction work was under way, there was archeological monitoring of an unrelated project — excavation by park personnel for construction of the foundation for a new maintenance structure — as well as archeological documentation of an exposure, during repair of the ravelin's north scarp wall, of that structure's counterfort system.³¹

Work on the first phase of construction was still under way in early 1998, when the completion of a modified design for a second phase made it possible to determine what additional data recovery excavations would be

necessary. Those excavations, made in July through September of 1998 by Pousson and Ed Morin, were for the most part located along the alignment of replacement drain lines, in the water battery and immediately northwest of the ravelin, where it appeared that early nineteenth century features and surfaces might be affected by construction; excavations were also made, once again, at bombproof 1, where the structure's revetment wall was slated for reconstruction, and over the postern drain line exterior to the battery, where a pit was to be excavated for the insertion of a polyethylene liner. Although the excavations yielded a more detailed understanding of the development of the fort's southeast front, and revealed the surviving remnants of the 1813-14 banquette interior to the counterscarp, they were unable to address all of the questions raised, including the question of the survival, in areas not affected by construction (and therefore not investigated), of remnants of a palisade built within the moat in 1813-14.³²

The process of evaluating resources, assessing the impacts of construction, and mitigating adverse impacts on significant resources, at Fort McHenry and elsewhere, has over the years become routine, although with enough of the esoteric about it to seem more than a little ritualistic. Decisions concerning how much, and what sort, of archeology is needed, and where and when it will be performed, are based on the interplay of, on the one hand, modern architectural and engineering concerns, with their own clearly apparent legitimacy, and, on the other, operational models for the locations, extent, degree of preservation, and significance of disparate archeological, and buried architectural, resources. Timely consultations take place among representatives of NPS, the Maryland State Historic Preservation Officer, and the Advisory Council on Historic Preservation, to insure mutual understanding and agreement concerning necessary measures that have, or may have, adverse effects on resources, mitigated by a programs of data recovery excavations, and enhanced future preservation, all of this formalized by signed memoranda of agreement (MOAs). The contractual arrangements whereby much of the work gets done are established in a businesslike, bid-and-negotiate fashion, both of the parties to the contract having a strong interest in the work being performed well and profitably.

There are obvious benefits to this process — it does, after all, reflect the professionalization of cultural resource management (CRM) archeology, along with the increasing technical and managerial sophistication of the businesses and agencies involved in CRM — but problems remain, among them the difficulty that archeologists frequently have of moving from arcane interpretations of what is being accomplished, to interpretations that might be more readily understood, and appreciated, by non-professional audiences. Further, in many instances we have created situations of diminishing returns: having succeeded, collaboratively, in avoiding impacts on major resources, we sometimes find ourselves engaged in the investigation of minor resources, significant, but of little general interest, which nonetheless must be documented due to the necessity, and

acceptability, of their loss or degradation. The harm that can result from this approach — not only the incremental loss of resources and of resource-integrity, but the sometimes diminished support for archeology among those who make decisions concerning the establishment, development, maintenance, and use of parks — may be unavoidable, if not acceptable, in the short term, but there is a danger that archeology could end up with an ever smaller role to play in providing meaningful new information and interpretations concerning the very resources which parks are established to preserve and protect, knowledgeably, as well as to restore and interpret.

There will, regardless of the perception of past efforts, continue to be a role for archeology at Fort McHenry, and its future status is likely to be determined more by the cogency of investigations yet to be performed than by the ambiguities of what has thus far been accomplished. The suggestions regarding potential future research topics which follow are presented with this in mind: archeology at Fort McHenry needs to address basic questions concerning the site's history if the incremental nibbling-away of resources, which undoubtedly will continue, is to be made acceptable. This might sometimes necessitate field studies that are more extensive, and costly, than might seem to be required, minimally, for compliance purposes, based simply on the direct impacts of the undertaking at hand. Those responsible for managing the site will need to evaluate carefully the justifications for all undertakings, developments which affect resources and the archeology that responds to development alike, to determine if an appropriate balance of factors — resource preservation, interpretation, accessibility, and fiscal responsibility — can be achieved.

5.2 Potential Future Research

The objectives of potential future archeological research at Fort McHenry, whether done for compliance or purely interpretive purposes, will likely fall into two basic categories: first, basic documentation of architectural features and feature complexes, and second, the acquisition and analysis of data to address anthropological questions. The first category would supply information needed for restoration, interpretation, and resource management (including the avoidance or other mitigation of the impacts of construction). Resources other than those associated with the fort and the World War I hospital, including prehistoric artifacts and features, evidently exist at the site, but because of the pervasive nature of ground disturbances stemming from development of the fort and the hospital, and from removal of the hospital and establishment of the national monument, there is little likelihood that substantial investigations concerning such resources could be successfully pursued.

The architectural-feature oriented research would focus on the technology (and materials) used to build, modify, repair and maintain the fort, and on

the responses of those involved in these activities both to broad changes in technology nationally and internationally and to evolving national imperatives. Archeologically, these issues would be addressed with the evidence of the various features and feature-complexes themselves, of the fill deposits and now-buried surfaces associated with them, and of the artifacts from these deposits and surfaces.

Anthropological research would presumably concentrate on the portable artifacts used by the individuals at the fort, with a focus on military technology and its social and cultural milieu. Questions about the material-cultural reflection of the status of the groups living at the fort, both military and civilian personnel, would be among those which, depending on the preservation and acquisition of suitable data, might be addressed. The provisioning of the fort could also be addressed by archeological evidence, as could sanitation and health issues, given the appropriate artifact deposits and contexts. Certain anthropological topics might also be addressed using architectural and landscape-architectural data: the influence on human thought and behavior of the designed, information-laden environments within which people live and work, and the reflections of behavior intentionally and unintentionally built into structures, while sometimes obvious (and as a result ignored as an area of potential study), are in truth both more pervasive and less well understood than is frequently imagined. With each of these major topics, comparative research, with consideration given to the resources, findings, and interpretations at other forts from different time periods, could also be pursued.

The sections that follow outline specific, primarily architectural, research needs, derived from the review of previous research presented in sections 3 and 4. Following this, a few potential comparative issues, and some very general anthropological research issues, are briefly considered.

5.2.1 Architectural Features: Star Fort Components

5.2.1.1 Fort Whetstone

Fort Whetstone, Fort McHenry's Revolutionary War predecessor, is very poorly known. It is generally assumed, if not stated, that evidence of the earth-and-sod star redoubt of this early fort was destroyed or buried during construction of the existing fort. Fort Whetstone may be represented in the probable ground surface found buried in the rampart by the 1989 NPS excavations in the area of the postern.³³ Any future repair or rehabilitation of the postern tunnel will need to take into consideration that this may be one of the few places where information on the early fort is preserved. Recognition of archeological evidence of Fort Whetstone should be given a high priority, although efforts to find such evidence should not be at the expense of architectural or archeological resources of the later fort. If

confirmed in the postern area, or elsewhere in the fort's rampart, such evidence would need to be carefully studied to determine, among other things, the context's potential extent.

5.2.1.2 Star Fort

The below-grade physical characteristics of the fort proper are fairly well understood, in large part because of archeological research. Although the basic configuration of the fort's rampart is understood, however, there are some components that have yet to be studied., including the interior of the scarp wall, and the characteristics of the fill of the rampart below the top of the wall. Only the very top of the interior side of the scarp wall has been previously examined. Cores through the walls near its bottom verified that the brick face is over a stone wall. So far as is known, the cores have not been measured to determine the relative thickness of the brick and stone parts. Counterforts have been exposed on four of the fort's curtain walls, but their presence (or absence) and other attributes at the location of the postern tunnel and to either side of the sally port remain to be determined.

Except along the sally port face, the upper surface of the parapet has probably been as well defined as is possible, given its continual erosion historically, and the impacts of 1830s and later construction. In 1994, however, the interior slope of the parapet, which was previously thought to have been entirely destroyed by the breast-height wall's construction, was found to be relatively well preserved at the end of the right flank of bastion 1, where it joined the parapet of the curtain.³⁴ It is likely to be preserved at other bastion-curtain angles as well, due to alteration of the radius of the curvature of the parapet's interior edge at those angles when the breast-height wall was built. Our understanding of the fort's original parapet could be improved by additional study. Similarly, one of the fort's twenty pre-1813 embrasures was documented by excavation in 1994,³⁵ and it is likely that study of other embrasures would be beneficial.

The surface of the fort's terreplein has undergone a sequence of alteration that has yet to be fully disentangle within the stratigraphy found in the numerous excavation previously made on this component of the fort. The focus on drainage, and on study of the context of the 1837-39 breast-height wall and of associated features, has detracted from a more comprehensive examination of the terreplein. Now that it is evident that the interior slope of the parapet is likely to be preserved at the bastion-curtain angles, it may be possible that the elevations of the surfaces of terreplein between ca. 1800 and ca. 1836 might also be determined at these locations, along with the characteristics of the fort's original banquettes, situated where the terreplein adjoined the parapet. Other pre-1836 attributes of the terreplein (e.g., the extent of filling ca. 1813), and interrelationships between surfaces and associated early features (ca. 1834 gun emplacements, the ca. 1813 traverse

over the postern, the bastion drains, ca. 1803 tree-planting pits), could very likely be elucidated with additional, well-conceived investigations. At the very least, more work should be done to test the models of the terreplein's developmental history presented in section 3.2.4.

The original layout of the parade and its original surface are also candidates for further research. While the 1803 plan suggests that the layout – the division of the parade into grassy and graveled areas – is original, confirmation of its age and configuration would be worthwhile securing. It should at least be possible to determine which, of two previously identified candidate strata, is the actual original surface of the parade ground. There is less of a need for research concerning the modified, ca. 1840 layout, which is relatively well documented.

The interior drainage system of the fort has been the focus of a number of studies intended to identify the original drainage scheme. As a result it is virtually certain that the original scheme was a simple gravity drainage system — open, brick, V-shaped surface drains or gutters in a number of locations in the fort, with surfaces and the drains themselves sloped to take water to a outlet at the location of the postern. However, the basic purpose of the early, deeply buried subsurface drains found in the parade ground and gorge remains to be confirmed. It is conjectured above that all of the cellars below the fort's residential buildings, and possibly the magazine's crawl space and the cistern, were interconnected with this drainage system, but whether or not this is true only additional study could determine.

Investigation of the parapet over the postern tunnel in 1993 demonstrated the absence in that area of an anticipated repair trench.³⁶ This suggests (although nearly tangentially) that there may have been a different sequence of development and modification of the postern tunnel than has been previously thought. Closer examination of textual and cartographic documents suggests this as well. There is, unfortunately, little likelihood that direct evidence for the earliest stage of the alternative sequence, discussed above, has survived. Consequently, any investigation in the vicinity of the postern, or exterior to it, will need to recognize the importance of indirect and negative, as well as positive, evidence for evaluating hypothetical models of the construction sequence here.

No archeological investigations have specifically focused on the star fort's gun emplacements. While one of the twenty embrasures of the original fort was documented in an excavation in 1994, these features generally have yet to be adequately investigated; also in need of study are the bastion platforms of 1813-14, which allowed the guns to be fired en barbette, and thereby permitted the filling of the embrasures. Gun traverses were planned and apparently installed along the curtains between bastions 3 and 5 ca. 1834. None of these has been fully exposed.

The traverse circles and pintle of one of the 1830s gun emplacements located at the shoulders of the bastions have been exposed and studied. Other gun-emplacements features are also preserved. An excavation made in 1993 interior to the left flank of bastion 3 disclosed the presence there of remnants of a Civil War gun platform,³⁷ and a possible mortar platform was found in 1989 near the right angle of bastion 5.³⁸ Also, ceremonial Rodman gun supports were located at the shoulders of bastion 5, and the remnants of one of these have been identified in an archeological excavation. Further investigation of gun-emplacements and of other armament-related features would be appropriate, but in the interest of preservation study would need to be limited to a carefully selected sample.

In summary, our understanding of many features and feature complexes within the star fort would be improved by further archeological investigation. Others, however, would best be preserved from archeological excavation, unless impacts on them, associated with some essential undertaking, were anticipated.

5.2.1.3 Sally Port

The earliest features immediately exterior to the fort's entryway through the sally port have not been identified, except for stone brackets, which supported successive bridges, found to have been incorporated into the scarp wall beneath the exterior portal of the sally port. With the 1813-14 construction of the ravelin, the ramped roadway over the glacis would have been destroyed, along with the elevated causeway across most of the breadth of the moat, in what is now the gorge. The earliest surface of the moat here has likewise not been identified, and it may not have survived due to the grading associated with the ravelin's construction. However, no investigations have, by transecting its width, specifically investigated the gorge. Such a strategy might resolve a variety of questions regarding historical changes of grade in this locale. Documentation (beyond what could be accomplished in 1982³⁹), of the relationship between, on the one hand, surviving buried surfaces and, on the other, the piers for the 1814-39 entranceway bridge, remnants of which have been identified, would be particularly worthwhile. The 1839 entrance ramp, however, and its brick revetment walls, survive in modified form, and portions of the original fill within it have been identified. Its internal features, and its articulation with other site components, appear to be well-understood, and no additional archeological work is needed here.

The floor of the sally port has also been thoroughly investigated.⁴⁰ Additional excavations there are unnecessary. However, the original configuration of the roof of the sally port has not been investigated, and it remains uncertain if the sally port was originally a covered passageway. Whether or not archeology could address this issue, given the degree of

architectural development here, is equally uncertain. The 1813 traverse on the parade interior to the sally port has been exposed and recorded in detail. However, additional investigation of its builders' trench in relation to the original surface of the parade may be informative.

There have also been excavation on the rampart to either side of the sally port, beyond the guardhouses adjacent to it, on the southeast side by Smith in 1958, and on the northwest side by JMA in 1993.⁴¹ These investigations have documented the presence of set of features – asphalt coated concrete “roofs” and brick drains – that possibly derive from the modification of the bombproofs beneath these areas in 1861, when they were converted to magazines. Additional investigation is needed, however, to fully document these features, and to determine more reliably if they were in fact built in 1861, and not earlier. Excavation in 1993 on the ramp to the terreplein northwest of the sally port disclosed the presence of humic soils, substantially below existing grade, which appear likely, given the two prehistoric pottery fragments and the 1775 half-penny that were retrieved from them, to represent the original and the late eighteenth century surfaces of the area.⁴² This is clearly a significant component of the site, and unless there are overriding research or mitigation needs, it should for the present be preserved without further investigation.

In summary, the construction and use-history of the sally port passageway, and of features within the post-1836 gorge, are relative well documented. The earlier history of the moat, however, and the relationship of the early ground surfaces to contemporaneous, and later, features, are poorly understood, and would benefit from further investigation. The relationship between the traverse interior to the sally port and the parade surface could also be usefully investigated. The features within the rampart above the bombproofs likewise require additional investigation. Consideration might also be give to the feasibility of archeological investigation to determine if the vaulted roof of the sally port is original. The remnants of early contexts beneath the ramp northwest of the sally port should for the present simply be preserved. Future investigation of the latter contexts might nonetheless be justified upon development of a research plan that takes into account, and focuses on, the possible preservation of remnants of Fort Whetstone within the rampart of the existing fort, with attention give to the vicinities of both the postern and the sally port.

5.2.1.4 Star Fort Interior Structures

Part of the parade ground magazine's interior was investigated in 1958, but the purposes of the investigation were limited. Further exploration of the relationships among the magazine's various floors would be useful, as would determinations of the depth of the original crawl space and of the presence or absence of a drainage outlet. The 1813 traverse has been

studied sufficiently and does not require additional investigation. The pre-1806 barrier wall, however, which may have functioned as both a traverse and a privacy screen, could benefit from further study, to determine its relationship to the original parade surface, if such evidence has survived.

Most of the structural features located at the same basic site between the two enlisted men's barracks, interior to bastion 4 – the sequentially built and replaced cistern, guardhouse, and shot furnace – have been thoroughly investigated. Further work there is not needed, except for additional investigation of a brick foundation, located between the cistern and parade wall, which may derive from the shot furnace believed to have been in operation during the 1814 bombardment, but which previously yielded ambiguous evidence of a more recent origin. Immediately north of the site of the cistern, guardhouse, and shot furnace, the 1813 well and part of its surrounding 1814 bombproof have been exposed and documented by archeology, but additional research on the bombproof might reveal its relationship to the original parade surface. The Civil War-era artesian well and steam pump, although documented in a monitoring report, have not been specifically investigated. Excavations would be necessary to document its location and articulation with the parade surface.

The four residential structures on the parade are fairly well understood from an architectural viewpoint. Renovations which joined an early guardhouse to the commanding officers quarter's have also been investigated and recorded. Although one of the filled cellars has been excavated, the interconnections between two drainage features in that cellar and other drainage features within the fort have not been documented. Excavations could provide evidence of connections between drains from all of the cellars and the deep drain below the parade ground, as well as architectural information on the construction and alteration of the buildings.

The so-called commanding officer's and the junior officers' privies have been excavated and do not require additional investigation. However, the privy that was found in bastion 4 in 1835, which had most likely been abandoned and buried beneath fill ca. 1813, has not been investigated. Likewise, the reputed water closet behind enlisted men's barracks 2, which apparently dates to the late nineteenth or early twentieth century, was documented during monitoring in 1975, but has not been excavated.

The location of the fort's original flagstaff, which is believed to have been the 1814 flagstaff's location as well, has been excavated, and the flagstaff brace recovered. It is unlikely that reexcavation would contribute additional information on this feature.

In summary, while many structures in the parade have been subjected to archeological investigations, certain additional work could prove worthwhile. Investigation of portions of the pre-1806 magazine barrier

wall, of the 1813-14 well and bombproof, and of the 1861 artesian well, to determine their relation to the parade surface, would be appropriate, as would a study of the probable relationship of the residential buildings' original cellar drains to the fort's early, deeply buried parade drain. The latter investigation might yield additional architectural data as well, along with data concerning grade alterations and landscaping. The enigmatic brick foundation, not documented on any plan of the fort, situated near the one known shot furnace interior to the fort, should be further explored to define its relation to the parade and its possible function, as it may derive from a shot furnace believed to have been in operation during the 1814 bombardment. All investigations within the parade would need to be attentive to possibly subtle stratigraphic evidence for different landscape treatments of surfaces in different areas, reflecting the apparently complex ca. 1803 design of this small-scale environment.

5.2.1.5 Moat

While it is not known precisely when the fort's moat was completed, the 1803 plan indicates that the moat, and the glacis, were then only absent along the fort's southeast front, exterior to the curtain between bastions 4 and 5, where any attack would have been hindered by low ground. The moat and glacis in that area were evidently completed in 1813-14, in preparation for an anticipated British assault, at the same time that other improvements were made: the ravelin, the postern, a caponniere, a set of tenailles, and a palisade, all of which is documented by the 1819 plan of the fort.⁴³ The moat, at least along the southeast front and in the vicinity of the ravelin, was again altered in the 1830s, when the water battery was constructed, the ravelin entrance passageway closed, and drainage improvements made. Nineteenth century moat surfaces have been documented in several locations by previous investigations, beginning with the earliest work performed at the fort in 1958, up to the most recent in 1998-99.⁴⁴ The latter work, along the southeast front, found evidence of substantial alterations of grade, primarily filling associated with the 1813-14 completion of the moat, and with the 1836-39 construction of the water battery, but also negative evidence suggestive of grading or removal of soils. Also found in 1998 was evidence of the 1813-14 banquette.

Much of the archeology in the moat, however, has aimed at documenting drainage features, and in that regard has usually met with disappointment. Although evidence of the moat's central drainage ditch or cunette has been revealed, none of the cunette's outlets – over the postern drain, near the salient angles of bastions 1 and 3, and at the base of the counterscarp opposite the salient of the ravelin – are likely to have survived. Testing to locate the drainage outlets at bastion 1 and the ravelin's salient has yet to be done, however; such testing would be futile over the postern drain due to subsequent development. The probable loss of these features is most

likely due to development of the World War I hospital, although other construction episodes may also have contributed to their degradation.

Also now destroyed is much if not all of the ca. 1814 tenaille at base of the scarp (the inner edge of the moat) on the fort's landward side, discovered during archeological investigations conducted in 1984 and 1988, but otherwise previously undocumented. This feature was impacted by the installation of a perimeter drainage line in 1989-90. Its characteristics, however, had been recorded in several locations prior to this.

Among the moat-related resources that remain to be documented are, on the fort's northwest or landward side, those associated with the late 1830s renovations, such as the cunette there, and, on the fort's southeast side, the ca. 1813-14 feature complex – the palisade, tenaille, and caponniere. A 1998 effort to locate remnants of the palisade, at its center, failed to do so; trenching in 1989 to document the tenaille was likewise unsuccessful in that regard, although it may have revealed the stump of one of the palisade posts. It seems likely that negative evidence – the absence of predicted features, and of artifacts deriving from early periods of the fort's history – may be as important a key to an understanding of the moat's evolution as are the surviving surfaces, features and artifact deposits there.

The moat around the ravelin has a slightly different history than that around the star fort. Partial information on the moat has been gathered by three excavations, including that made in 1998, which revealed evidence of the moat, counterscarp, and glacis on the ravelin's north side. The precise relationship of the ravelin's moat to the gorge and the remainder of the star fort's moat has yet to be ascertained.

Although much of the historical moat may be poorly preserved, we do not know the extent of destruction or preservation of certain crucial features, or the effects of the late 1830s renovations on the north side of the fort. The possibility of preservation of various early features in the vicinity of the curtain between bastions 4 and 5 should be explored further, in part because even the absence of these features may be a reflection of important aspects of the moat's history. The relationship between the gorge and the ravelin moat, and the nature of the moat's alteration upon construction of the ravelin, should also be investigated further.

5.2.2 Architectural Features: Outworks and Grounds

5.2.2.1 Ravelin

The ravelin's scarp wall foundation, original entrance passageway, parapet, breast-height wall, and terreplein are all relatively well understood features, having been studied, for the most part individually, during archeological

investigations conducted in 1978, 1980, 1984, 1993 and 1994. The 1993-94 work also provided documentation of the remnants of the entrance road, and of the builders' trench of magazine 1, within the ravelin's terreplein; of the footings of the breast-height wall and of a gun emplacements' traverse circle; and of the ravelin's banquette remnants. The builders' trench for the magazine has been identified in the area of the gorge, as well, but the only other archeologically documented excavation at the magazine was made to examine the condition of the exterior surface of the magazine's vault. Given the availability of historical plans, and the fact that the magazine has been little modified, it is unclear what more could be gained from additional archeological investigation of the structure.

Except for documentation of a traverse circle footing, there has been no archeological investigation of the ravelin's armament. Noteworthy in this regard is the possibility of the survival, interior to the ravelin's salient angle, of remnants of the original revetment and gun emplacements, which had been supplanted by a realigned revetment and a Rodman gun in 1865. Investigation of the foundation of the ravelin's scarp has yielded no evidence of original drainage-related attributes or features, and, as noted above, it is unlikely that the ca. 1840 cunette's outlet drain opposite the ravelin's salient has survived. Testing that has been performed in the vicinity of the outlet indicates that there had been substantial alterations of historical grade there, but testing at the location of the drain itself has yet to be done.⁴⁵ Additional archeological investigation of the drain may in the future be warranted.

In summary, the ravelin has been relatively well studied. Future study of the fort's armament, however, should include closer examination of the ravelin's emplacements, particularly the abandoned emplacements that may be present beneath the interior edge of the parapet at the salient. The Wadsworth counterfort system should also be investigated further, especially its articulation with the original ravelin entrance.⁴⁶ This counterfort system is significant because it shows the beginning of an American style of fortification construction, and represents the development of the native school of engineering which was beginning to diverge from the European models provided by the French military architects of the First and Second Systems. Furthermore, usage of this system may have been more widespread than is currently realized, and it may be present in a number of Third System forts.

5.2.2.2 Water (Outer) Battery

The water (outer) battery has not been extensively investigated, but the basic features – the parapet, the episodically constructed breast-height wall, and the gun emplacements – are relatively well understood, in part as a result investigations conducted by JMA in 1993-94, and by Pousson in

1995. The 1993-95 investigations provided the basis both for a more complete and accurate interpretation of the construction sequence of the breast-height wall, and for an improved understanding of the development of the battery itself.⁴⁷ Although further investigation of the wall and its context may prove necessary in the future, until new research questions arise, the existing understanding of this feature, and of the stratigraphy associated with it, is adequate. It is noteworthy, particularly in light of modern reconstruction of much of the breast-height wall, that portions of the original wall are likely to remain buried beneath the parapet where newer sections of wall were constructed, along with the Rodman gun emplacements, as well as beneath the two traverses (including the traverse extension of the mound over magazine 3). If further investigation of the wall prove necessary, it is in these areas that it would be most worthwhile.

Only 20 of the battery's original 39 gun emplacements are known to be preserved in place. Seventeen of the original emplacements were displaced, and for the most part destroyed, in 1865-66, with construction of the Rodman gun emplacements, the bombproofs, and the traverses; two more were reported lost during reconstruction of part of the revetment wall several years ago. Three original emplacements may be at least partially preserved beneath the traverses, however, and certain construction details might be more reliably ascertained there than elsewhere. The footings of the traverse-circle elements of the emplacements in the water battery may be similar to the footing, composed of shell-aggregate, trench-poured concrete, exposed on the ravelin in 1993.⁴⁸

Excavations made in 1993 and 1998 at magazines 2 and 3, and bombproofs 1 and 2, provided new data concerning grade changes associated with the 1866-67 construction of these underground vaults, and of the earth mounds over them.⁴⁹ The work also provided a basis for refining interpretation of the complex early nineteenth development of the site of the water battery and of the moat interior to it. Previous to the work performed in 1990s, the only investigations at the underground structures were small test pits on the earth mounds of bombproof 1 and magazine 3 in 1983, and the monitoring of reconstruction of the bombproof 2 revetment wall in 1975.⁵⁰ Minimal investigation was also made in 1993 at and near the sites of two shot furnaces built in the water battery ca. 1842, and removed ca. 1865. The foundation of the furnace east of bastion 5, and its stratigraphic context, were found to be relatively well preserved in one of these excavations, but the site of the furnace south of bastion 4 is now evidently occupied, at least in part, by the northeast entrance of magazine 3, and the furnace foundation there is unlikely to be intact. The only additional work at any of the above structures that may be needed in the short term would be compliance-related investigation, in the event of ground disturbances. However, consideration might be given in the future to an interpretive exhibit incorporating the shot furnace foundation east of bastion 5, in which case substantially more investigation of that foundation would be necessary.

In summary, there is a complex, but in places ambiguous, stratigraphic record of the developmental history of the southeast front of the fort beneath and interior to the water battery. There is also a significant, presently-buried, but readily-interpreted archeological resource in the area in the form of the foundation of the shot furnace east of bastion 5. Due to the importance of shot furnaces within early through mid-nineteenth century seacoast defenses, further investigation of the foundation may in the future be justified. Investigation of the technology and construction techniques associated with the original, and the Rodman, gun emplacements might also provide useful information. Given that, in the past, buried armament-related resources have on occasion been destroyed, without mitigation having been performed, and in view of the fundamental importance to the fort of its armament, it would be appropriate for priority to be assigned to securing better basic documentation not only of representative extant emplacements, but also of the remnants of non-extant emplacement, both interior and exterior to the fort.⁵¹

5.2.2.3 Upper and Lower Water Batteries

Smith's 1958 investigations demonstrated the general lack of integrity in the soil contexts where historically the fort's upper and lower water batteries had been located. Further, his report provides a concise discussion of the late-1920s removal of the 1870s earthen water battery in the area, an event which, along with the battery's construction, and the 1949 installation of a 48 in. diameter city water main through the area, accounts for the massive quantities of relatively modern fill deposits and disturbances he observed. Smith gave less attention, however, to the earlier developmental history of the area, and did not distinguish between those parts of the area that had been occupied by the parapet of the 1870s battery, and those where a low-elevation terreplein had been situated, immediately interior to the parapet. It is now apparent that the elevated parapet of the 1870s battery had been built up by deposition of fill over the earlier ground surface of the area; moreover, the removal of the parapet of the 1870s battery apparently had little additional impact on the soils and features beneath it, as evidenced by the documented preservation of features and strata there.

Among the features preserved beneath the parapet of the 1870s battery was a set of brick footings which Smith himself discovered. Smith apparently concluded that, since this feature had also been situated beneath an angle of the parapet of the 1790s-1820s lower water battery, it could only derive from a more recent, otherwise undocumented structure. Smith failed to note the possibility of it having been associated with the very first water battery on the site, constructed, with a somewhat different configuration than latter, in 1776. In short, while it is true, as Smith determined, that the archeological potential of much of the area formerly occupied by the upper and lower water batteries has been destroyed, the implication that some

might draw from this, that none of the resources in the area are likely to retain sufficient integrity or interpretability to be significant, is not true.

The survival of remnants of the early batteries themselves is nonetheless very unlikely. Grading done ca. 1829 began the process of the batteries' obliteration, and probably included the complete salvaging of brick from the lower battery's parapet revetment wall, for construction of the second stories of the fort's residential buildings. More massive grading appears to have accompanied the 1836-40 development of the existing water battery. It is nonetheless possible, if the gun platform of the lower battery's central section was supported by posts, that evidence of these posts remain. There is, as well, the set of footings which Smith discovered, which as a result of excavation is now divorced from any archeological context; despite the greatly reduced likelihood of determining conclusively the origins of the features, their potential significance — as the sole surviving material reflection of Fort Whetstone's 1776 lower water battery — suggests that they should be reexcavated, and the stratigraphy nearby documented.

Evidence may also have survived of three small structures located interior to the lower battery, in areas which, as depicted on the 1819 plan, were less-elevated than the batteries themselves. Two of the structures were possibly shot furnaces, the other, a bombproof or magazine. In addition, remnants of the ground surface of the low areas behind the lower water battery may have survived; retrieval of artifacts from such a context would provide especially important data concerning the material culture of the fort's occupants at an early stage of its history.

The upper water battery proper, like the lower battery, has almost certainly been obliterated. However, the 1963 discovery of one of the "old barracks," depicted interior to the upper battery on the 1803 plan of the fort, suggests that evidence of some additional structures associated with this battery might also have survived. Further investigation of the barracks could be beneficial, but preservation of this structure's remnants from further harm would be a more appropriate objective. Of greater potential value for archeological study, depending on the circumstances of its 1820s abandonment, is a feature that appears to have been a well, depicted on the 1819 plan about 93 ft. east of the ravelin's salient; deposition of miscellaneous debris, within a context that assures preservation, often accompanies the abandonment of a well. Remnants of another of the old barracks of 1803 might have survived beneath the rampart of the ravelin's salient, but the third barracks was presumably destroyed during the creation of the terreplein of the 1870s water battery. Evidence of what may have been a magazine built prior to 1814 (which in 1834 was an abandoned bakehouse), and possibly of another early shot furnace, might also have survived, along with remnants of the contemporaneous ground surface. Evidence of the 1814-15 magazine, however, was probably destroyed during construction of the 1870s battery.

5.2.2.4 Additional Structures on the Original Grounds of Fort McHenry

Historical documentation indicates that, aside from the upper and lower water batteries, there were a variety of additional structures within the original grounds of Fort McHenry, and remnants of some of them have been archeologically investigated, as discussed above. Of those that have not been investigated, some were almost certainly obliterated during the course of the fort's mid- to late-nineteenth century development, or during construction and demolition of the World War I hospital, but remnants of others are likely to have survived. Further investigation of some structures that have been investigated previously could also prove to be worthwhile.

Among the structures that have been destroyed is the fort's original cemetery, on a knoll south of bastion 4; it was graded to depths in excess of 8 ft. below the original surface (following the removal of the burials there), during work done in 1836-37 for construction of the water battery. Likewise destroyed was the ca. 1813 barracks/quarters situated northeast of the ravelin, as depicted on plans from 1819 through 1864; this structure was removed shortly after the Civil War, and its site graded during the development of the 1870s water battery. The archeological remains of various other fort-associated buildings located within the original grounds, but constructed in the later part of the nineteenth century, very likely have also been destroyed, as a result of development of the World War I hospital, but for compliance purposes the assumption should generally be that remnants of these structures (e.g., the successive sutler's stores southeast of bastion 4, or the successive stables, storehouses and shops southwest of bastion 3) have survived, until investigation has demonstrated otherwise.

There are two early structures in particular, about which nothing is known archeologically, the sites of which should be investigated in an effort to better understand the characteristics of the early development of the fort's grounds, and, in the case of one of these structures, to provide data that could be useful for anthropological study of the material culture of the fort's occupants. Such investigation should, of course, be accompanied by, and coordinated with, additional historical investigation. The 1819 plan of the fort depicts an officer's quarters (so-identified on the basis of the 1834 plan), presumed to have been constructed after 1814, located roughly 280 ft. north of the ca. 1813 barracks. The developed landscape originally associated with this building included what is likely to have been a drill ground, extending south to the barracks, and, to the northwest, a small, enclosed yard, with what is likely to have been a flagstaff along its northwest edge, as the yard's apparent focal point. Due to uncertainty regarding the chronology of development of this particular component of the site, and of its landscape, the flagstaff there, if that is indeed what the 1819 plan depicts, could have been erected either shortly before, or, more likely, shortly after, the 1814 bombardment. The quarters would continue

in use into the mid-1870s, along with a second officers' quarters situated directly to its southwest by the time of the Civil War, but its landscape was simplified; the flagstaff and drill ground only appear on the 1819 plan.

The second early structure which it would be particularly beneficial to document archeologically is another of those shown on the 1819 plan. Bradford's 1958 report notes that there is documentation for a laboratory (or successive laboratories) at the fort in 1812 and 1814, and that another (replacement?) was built in 1816.⁵² A small structure in a relatively isolated location along the shoreline northeast of the fort may have been the 1816 laboratory, and possibly the site(s) of the earlier laboratories. The direct role played by laboratories in maintaining the quality of gunpowder in early nineteenth century fortifications suggests that documentation of this site would be worthwhile.

Three of the structures within the fort's original grounds that have been investigated previously, specifically the gun shed, the storehouse, and the hospital, are not likely to be appropriate targets for additional investigation, due either to the basic reliability of the documentation that has been acquired (in the case of the gun shed and storehouse), or to the apparent extent of previous disturbance, and resulting obscurity and possible "fragility" of what remains (in the case of the hospital). Unless outweighed by as yet undefined interpretive or restoration program needs, or compliance requirements, preservation of the remnants and associated contexts of these structures should be the objective for management.

It would be appropriate, however, to reinvestigate another set of features which Smith documented during his 1958 investigations – a rectangular area of stone pavement, with a surrounding stone edging or footing, discovered interior to the boundary wall north of bastion 2. This set of features may derive from a ca. 1794-97 magazine or bombproof, and additional investigation could yield the data needed to determine whether or not this interpretation is true. If it is true, the features may be the only surviving material reflection of Rivardi's plan for the rehabilitation of the works of Fort Whetstone, a project which, under Foncin's direction, resulted in the development of Fort McHenry.

The vicinity of the southwestern end of the early boundary wall should also be investigated further, to document more reliably than was possible before, whether or not remnants of this significant structure survive in that area, and, if so, their locations.

Archeological data with substantial interpretive value could derive from reinvestigation of the married soldiers' quarters and its vicinity. The work performed on an emergency basis in 1975, when the remnants of this structure were discovered, was limited to documenting its basic characteristics, and did not include exposure of all representative

architectural and landscape-architectural components. Further, excavations were not of sufficient extent to determine what ancillary structures or features might be present, and whether or not the artifact deposits in the vicinity might distinctively reflect the composition and status of the households occupying the quarters. It is possible, although far from certain, that given the composition of the households — married soldiers and their families, and later officers, with living, cooking, eating, and sleeping quarters separate from those of common soldiers — a diversity of artifacts and features might be present which upon analysis and interpretation would enrich our understanding of lifeways at Fort McHenry in the second and third quarters of the nineteenth century.

The final previously-investigated structure within the original grounds of the fort that it would be appropriate to investigate once more is the seawall. The primary, although not the only, purpose of investigation would be to determine if the seawall is indeed the original structure, and not a replacement. On the basis of ambiguous documentary evidence, the report of the previous investigation suggested, most likely mistakenly, that the existing seawall might not be the original structure. Additional excavations would determine if counterforts, which the 1819 plan indicates were associated with the original seawall, are present where depicted. The extent of the feature interpreted as having been the footing of a target butt, the location of which coincides with one of the original counterforts, would be established so as to clarify its interpretation. The location of the wing-wall at the seawall's north end would also be investigated. Closer study of the stratigraphy associated with the wall might also yield a improved understanding of where, and to what extent, original construction involved substantial excavation, leaving remnants of earlier cultural and natural strata accessible archeologically behind the wall, in contrast to areas where original construction primarily involved filling, with earlier strata, in some cases, at depths greater than could be exposed archeologically without shoring and dewatering of excavations. It might also be possible, despite the various episodes of repair and reconstruction, to better characterize the differences in the stonework between newer and older sections of the wall.

5.2.2.5 Structures within the 1836-37 Addition to the Fort's Grounds

Only three structures within the area of the 1836-37 addition to Fort McHenry's grounds — the 1790s tavern, the ca. 1850 (?) addition to the stable and store house, and the Civil War magazine — have been the subject of investigations that resulted in substantial, relatively well-reported findings; the store house addition has been discussed above, along with the storehouse itself. The prospective value of further investigation of the tavern site is most uncertain, due in part to ambiguity in the record of earlier investigations, and in part to previous ground disturbances at the site, associated with the construction of later buildings, landscape features.

and utilities. While portions of the tavern's cellar, and of the fill within it, presumably retain a significant degree of integrity, the prudent resource-management policy here would be preservation of the site from further disturbance, and deferring additional investigation until it is made necessary by overriding restoration, interpretation, or compliance needs.

The 1837 boundary wall and gateway, although modified, remain in existence. There is evidence of substantial ground disturbances immediately interior to the wall, and the degree of development exterior to the wall suggests there is an even greater likelihood of disturbances along that side. At present, the only specific research question pertinent to the existing boundary wall concerns the possible establishment, ca. 1858, of high-water benchmarks at either end of the wall, to serve as vertical survey control datums. If such benchmarks were in fact established, and if they remain in existence, their exposure and documentation by archeological means could provide an improved basis for interpretation of information about elevations on historical plans of the fort. Otherwise, archeology (presumably in the form of archeological monitoring) would only be needed along the wall in conjunction with any undertaking in that vicinity which involved excavations to a depth greater than 1 or 2 ft. below grade; this precaution is advised because of the various guardhouses, hospital outbuildings, and other structures that historical plans indicate stood adjacent to the wall.

Archeological monitoring of the installation of utilities at the Civil War magazine in 1974-75 documented the presence of associated features which apparently served as the grounds for the building's lightning rods, as well as the characteristics of the foundation of the curtain wall surrounding the magazine. Similar, compliance-related archeological investigation may be needed in the future; at present, the availability of detailed historical plans of this structure, the fact that no major alterations of it have occurred, and the apparent absence of previous structures at the site, as evidenced by historical maps and plan, together result in there being no specific research questions concerning the structure. Consequently, while the monitoring of ground disturbances at and in the vicinity of the magazine is recommended, there is little if any need for more intensive archeological investigation.

5.2.2.6 Comparative Research

The architectural and landscape-architectural features at Fort McHenry could usefully be compared with those at other early (colonial and First System) forts. Although construction of each fort was planned and directed by a different military engineer for different purposes, all of them derived from the Vauban tradition of military fortification.⁵³ Comparative research could focus on the differences among the forts and how these differences were expressions of different purposes, local conditions, and the architects' own background. Comparison could be the basis for study of how common

principles were applied in different situations, with different materials and workforces. It would be particularly useful to examine masonry forts from this period. Crucial issues such as drainage, however, could be examined in masonry and non-masonry forts.

It might also be worthwhile to compare the First American System forts with those constructed by the British and French in North America which are derived from the same fortification traditions as the First-System forts.⁵⁴ Many such forts exist in the Northeast, old Northwest, and Canada.

Within Fort McHenry, an interesting structural comparison can be made between the First and Second-System ramparts represented by the star fort and the ravelin, respectively. The switch from a European-model counterfort system to an American-designed cellular system in the ravelin is significant from various perspectives. It represents a typically American response to a technological issue, i.e., as Decius Wadsworth reported to his commanding officer, it would be both cheaper and better. Further, this design feature may have been implemented in some of the casemated forts that were built during the Second and Third-System forts.⁵⁵

There has been no coordinated study from an archeological perspective of the structural remains of the armaments of any of the three systems of fortifications. Such a study would be most appropriate for the First- and Second-System forts since most of their guns were located on earthen parapets which might retain traces of the different gun platforms, traverse, carriages, and supports for the armaments. Fort McHenry is particularly well suited for such a study since it seems to retain traces of most of the major shifts in armaments which occurred during the nineteenth century.

5.2.3 Anthropological Research Topics

This section briefly reviews some of the anthropological research topics that could be addressed by existing artifact collections or by artifact deposits which have not yet been collected. These research questions should also, of course, be informed by historical research concerning Fort McHenry, and other forts. These research questions are intended to suggest the potential value of the archeological resources at the fort in this regard; while they do not provide a plan for research, they do outline topics that might be addressed.

The first of these topics concerns how the social status of the basic components of the fort's garrison — the officers, the non-commissioned officers, the married soldiers, and the common, unmarried soldiers — and of others who live at the fort, may have been both reflected and reinforced by the kinds of artifacts they had access to, and an inclination to use. One previous study at the fort was intended to address this topic, and the so-

called commanding officer's and junior officers' privies were excavated with the expectation that they would contain relevant data. However, upon excavation it became apparent that these privies had been modified from the original versions of them, that in modified form they had remained in use by different components of the garrison into the early twentieth century, and that their nineteenth century content had been removed prior to their final filling and abandonment. It might be worthwhile, nonetheless, to reexamine the artifacts from these features, to determine the formation processes which led to their deposition, and whether or not they might contribute in any way to addressing status issues. It is unlikely, although not inconceivable, that the as-yet unexcavated late nineteenth-early twentieth century water closet behind enlisted men's barracks 2 could be used to address this issue as well.

The ravelin privy has also been excavated, but only partially. Previous investigation indicates that there are well-preserved deposits at the bottom of the privy, which was in use briefly during the post-Civil War period. Although the intact privy deposits consisted of only a .25-ft.-thick layer, their high degree of preservation suggests that they could contribute to study of such research topics as: health and sanitation, with information derivable from parasitology; diet, with information from floral and faunal remains; military technology, with information from military artifacts; and general information on the lifeways in the fort, with information from the general range of recovered artifacts. The ravelin privy was almost certainly used by enlisted men, although not exclusively. There are unfortunately no known deposits of the same period at the fort with which to compare it for study of relative status. The unexcavated privy within bastion 4, dating to ca. 1800-1813, may contain material which could be compared to that of the ravelin privy. This comparison could be used to trace the evolution of health and sanitation and to address provisioning topics.

Other deposits of floral and faunal material, useful in studying diet, may be found behind the quarters and barracks inside the fort, and possibly in the deposits within the cellars, which were originally used as kitchens. Bone material has been reported by a number of investigators in these areas. While some archeologists have questioned whether this material comes from the preparation of the meals the troops, or is unrelated fill from elsewhere, until such questions are addressed by more investigation, these areas of the fort should be preserved and protected. The artifacts and other materials they contain could be among the more significant left at the fort.

Research concerning the provisioning of troops could address such questions as the speed with which new material was issued and the continued use of obsolete material. Data relevant to this issue would not be restricted to particular deposit types, but could come from different kinds of deposits.

To assess the feasibility of addressing a number of these topics, the existing artifact collections at the fort should be inventoried and examined. The examination not only would identify what collections exist, from what investigations, but also would establish the connections between distinct elements of the collections and specific types of deposits, that is, their archeological context. Further, and in some cases most importantly, it would aid in determining the formation processes of the archeological contexts, through study of the characteristics of the artifacts.⁵⁶ The study ultimately would provide a basis for deciding which research topics might best be addressed with additional research in previously excavated areas.

In summary, certain areas of the fort contain data that could be employed to address anthropological research issues. The post-Civil War ravelin privy is known to contain well-preserved deposits, and additional study of it might be particularly beneficial. The turn-of-the-century water closet behind enlisted men's barracks no. 2, and early nineteenth century privy in bastion 4 may contain similar deposits, but have not been excavated. Additionally, the areas behind the quarters and barracks on the parade could contain information about the nineteenth-century lifeways in the fort and should not be disturbed until this is ascertained. Finally, the existing artifact collections at the fort might also be used to address specific research issues. While the questions addressed would depend on the nature of the deposits from which the collections were extracted, the examination of collections would presumably aid in clarifying deposits' characteristics, and in determining what areas it might be appropriate to investigate further in pursuing research.

END NOTES

1. Smith 1958.
2. Cotter and Nelson 1958.
3. National Park Service 1958/Part1:1
4. Cotter 1961.
5. Carson 1963; Campbell 1963.
6. Cotter 1964a and 1966b; Powell 1964:1.
7. Campbell 1964a, 1964b.
8. Cotter 1966a.
9. Cotter 1966b.
10. Thompson and Newcomb 1974; Rutsch 1974.
11. Nelson 1961.
12. Stokinger 1976a.
13. Stokinger 1975a, 1975b.
14. Stokinger 1976b.
15. Stokinger and Blades 1979a.
16. Stokinger and Blades 1979b.
17. Aivazian 1978, 1982; Stokinger et al. 1980, 1982.
18. Stokinger 1982; Orr et al. 1982.
19. Stokinger 1983a, 1983b, 1983c, 1983d, 1983e, 1983f.
20. Cheek and Joseph 1984; Joseph and Cheek 1985.
21. Cheek et al. 1989.
22. Kurtz 1989.
23. Blades 1984.
24. Field records and correspondence on file, Fort McHenry Library, Special Collections. It is noteworthy that resistivity had been employed once before at the fort, unsuccessfully, in connection with Carson's 1963 investigation of the Upper Water Battery (Ravelin) Barracks.
25. Orrence et al. 1988; Brown and Long 1986.
26. Henry 1989.
27. GWWO 1992. Anthony Donald, the Denver Service Center's initial project manager for the effort, and John Tyler, the park's superintendent at that time, were together responsible for emphasizing the role of archeology.
28. Cheek and Balicki 1992, 1993.
29. Abel 1994.
30. Abel and Cheek 1996; Cheek et al. 1999; Pousson 1996a.
31. Pousson 1996b, 1997.
32. Pousson 1999a. Included in this report is an appendix which conveys Pousson's observations, made during 1998, of stratigraphy and features exposed within the star fort's parapet during reconstruction of large sections of the breast-height wall.
33. Kurtz 1989.
34. Cheek et al. 1999:31-36.
35. Cheek et al. 1999:44-50.
36. Cheek et al. 1999:36-40.
37. Cheek et al. 1999:53-56.
38. Kurtz 1989:99-101.
39. Stokinger 1982, 1983b.
40. Orr et al. 1982.
41. Smith 1958:67; Cheek et al. 1999:25-30.
42. Cheek et al. 1999:23-25.
43. The identification, based on the 1819 plan, of tenailles at the base of the scarp wall interior to the palisade, is very uncertain. The 1939 historical base map of the park indicated that the tenailles were, in fact, the somewhat broader areas adjacent to the palisade. The features adjacent to the scarp wall may have been a set of narrow berms, slightly elevated above the moat (or the tenailles), rather than entrenchments.
44. Smith 1958; Pousson 1999a, 1999c.
45. Joseph and Cheek 1984:25-30. A mistaken assertion was made in a previous draft of this overview, that the cunette outlet drain opposite the tip of the ravelin had been destroyed; in the absence presently of data from excavation at the drain's location, its survival should be assumed.
46. Additional documentation of the ravelin's counterfort system was acquired in 1997 (Pousson 1997), but only a minimal section of the top of one edge of the passageway was exposed. Tentative identification was made of the top of a very slightly battered revetment wall, similar to, but somewhat less wide in section than, the counterfort cross-walls.
47. Cheek et al. 1999:89-101; Pousson 1996a.
48. Cheek et al. 1999:67.
49. Cheek et al. 1999:72-89; Pousson 1999a, 1999c.
50. Joseph and Cheek 1984; Stokinger 1976b.
51. In particular, the reported destruction in the 1980s, without recordation, of the remnants of at least two gun emplacements toward the southwest end of the battery, suggests that there is a need to conduct precautionary excavation and recordation of such features.
52. At the same time, however, Bradford (1958:65, n. 31; Figure 14) mistakenly (?) identified the officers' quarters as having been the 1816 laboratory.
53. Herman 1992.
54. See Herman (1992:79-114) for illustrations of some of these forts and a discussion of the application of the Vauban tradition to the New World.
55. The design of these forts were based on the theories of Montalembert (Herman 1992:71-74;134-139;160).
56. See Schiffer 1987, especially pp. 265-303.

6. REFERENCES

- Abel, Elizabeth J.
1994 *Archeological Investigations at Fort McHenry National Monument and Historic Shrine, Baltimore, Maryland*. Management Report. Prepared by John Milner Associates, Inc., Alexandria, Virginia. Submitted to National Park Service, Denver Service Center, Eastern Applied Archeology Center, Silver Spring, Maryland.
- Abel, Elizabeth J., and Charles D. Cheek
1996 *Phase III Data Recovery Investigations at Fort McHenry National Monument and Historic Shrine (18BC13), Baltimore, Maryland*. Management Report. Prepared by John Milner Associates, Inc., Alexandria, Virginia. Submitted to National Park Service, Denver Service Center, Eastern Applied Archeology Center, Silver Spring, Maryland.
- Aivazian, Bryan W.
1979 Preliminary Report, Archeological Investigations at Fort McHenry National Monument and Historic Shrine, Baltimore, MD. National Park Service, Denver Service Center, Denver Colorado. Ms. on file, Fort McHenry National Monument and Historic Shrine, Baltimore.
1982 Archeological Investigations at Fort McHenry National Monument and Historic Shrine in 1978. In *Archeological Investigations at Fort McHenry National Monument and Historic Shrine 1978, 1980* by Bryan L. Aivazian, William Stokinger, Patricia Rubertone, and Lawrence E. Babits; edited by Kathleen Fiero. Denver Service Center, Mid-Atlantic/North Atlantic Team, National Park Service, United States Department of the Interior, Denver, Colorado.
- Aivazian, Bryan W., William A. Stokinger, Patricia E. Rubertone, and Lawrence E. Babits
1982 *Archeological Investigations at Fort McHenry National Monument and Historic Shrine, 1978, 1980*, edited by Kathleen Fiero. Denver Service Center, Mid-Atlantic/North Atlantic Team, National Park Service, United States Department of the Interior, Denver, Colorado.
- Akerson, Louise E.
1988 American Indians in the Baltimore Area. Baltimore Center for Urban Archeology, Technical Series No. 3. Baltimore.
- Anonymous
1803 [Plan of] Fort McHenry. Record Group 77, Drawer 51, Sheet 1. Cartographic and Architectural Branch, National Archives and Records Administration, College Park, Maryland.
1834? Project and Estimate for Substituting a Stone Revetment for the Earthen Slope of the Rampart of Fort McHenry. Record Group 77, Drawer 51, Sheet 4. Cartographic and Architectural Branch, National Archives and Records Administration, College Park, Maryland.
- 1837? Plan of Buildings within Fort McHenry, Md., 1834. Record Group 77, Drawer 51, Sheet 7. Cartographic and Architectural Branch, National Archives and Records Administration, College Park, Maryland.
- 1861? Artesian Well at Fort McHenry. Record Group 77, District Office, Baltimore District Office, Fort McHenry Series, R13. Section drawing. Cartographic and Architectural Branch, National Archives and Records Administration, College Park, Maryland.
- 1864 [Plan of] Fort McHenry, Md., showing Armament. Fort Carroll Office. Record Group 77, Drawer 51, Sheet 26. Cartographic and Architectural Branch, National Archives and Records Administration, College Park, Maryland.
- 1864? Detached Magazine, Fort McHenry. [Civil War Magazine.] Record Group 77, Baltimore District Office, Fort McHenry series, R47. Cartographic and Architectural Branch, National Archives and Records Administration, College Park, Maryland.
- 1873a [Plan of] Fort McHenry, Md. Record Group 94, Records of the Adjutant General's Office, Medical History, Buildings at Fort McHenry, Roll 42. National Archives and Records Administration, Washington, D.C.
- 1873b Plan of Artesian Well at Fort McHenry, Md., with proposed Steam Engine. Record Group 77, Miscellaneous Fort File, Series B, 13. Cartographic and Architectural Branch, National Archives and Records Administration, College Park, Maryland.
- 1873c [Plan of] Fort McHenry, Md. Record Group 77, Miscellaneous Fort File, Series B, 45. Cartographic and Architectural Branch, National Archives and Records Administration, College Park, Maryland.
- 1890? Plan and Reservation, Fort McHenry, Baltimore, Md. Record Group 92, Blueprint File, 1. Cartographic and Architectural Branch, National Archives and Records Administration, College Park, Maryland.
- 1898 Ft. McHenry Improvements, February 4, 1898. Record Group 77, District Offices, Baltimore District Office, Fort McHenry Series, R68. Cartographic and Architectural Branch, National Archives and Records Administration, College Park, Maryland.
- 1917 [Map of] Fort McHenry Park, Baltimore, Maryland. Record Group 92, Blueprint File, 9. Cartographic and Architectural Branch, National Archives and Records Administration, College Park, Maryland.
- 1975 Archeological Observations at Fort McHenry, November 1974– July 1975. Ms. on file, Fort McHenry National Monument and Historic Shrine, Baltimore.
- 1984 [Records of resistivity investigation, bastions 3 and 4, and parapet of curtain between bastions 3 and 4, October 1984.] Ms. on file, Fort McHenry National Monument and Historic Shrine, Baltimore.
- Armistead, W. K.
1817 Letter to J. G. Swift, 31 December 1817. Record Group 107, Records of the War Department, Office of Chief of Engineers, Selected Correspondence Relating to Fort McHenry. National Archives and Records Administration Washington, D. C.
- Ashcraft, Allan C.
1964 Fort McHenry in the Civil War. *Maryland Historical Magazine* 59(3):297-301.
- Bancroft, E. A. (?) [Post Quarter Master]
1867? Plan of Buildings at Fort McHenry, Md. Record Group 77, Miscellaneous Forts File, Series B, 1. Cartographic and Architectural Branch, National Archives and Records Administration, College Park, Maryland.
- Benatec Associates, Inc.
1984 *Report of Preliminary Findings for the Drainage System at Fort McHenry National Monument and Historic Shrine Baltimore, Maryland*. Prepared by Benatec Associates, Inc., Camp Hill, PA. Submitted to The United States Department of the Interior, National Park Service.
- Berthier, Louis Alexander
1781 *Rade et Port de Baltimore*. Berthier Papers, #16(8), Princeton University Library, Princeton, New Jersey.
1782 *Port et Rade de Baltimore*. Rochambeau Collection, No. 13, Geography and Maps Division, Library of Congress, Washington, D.C.
- Blades, Brooke S.
1984 Field Trip Report, May 14-16, 1984. Ms. on file, National Park Service, Mid-Atlantic Regional Office Philadelphia, Pennsylvania.
- Bradford, S. Sydney
1958 The Outer Works of Fort McHenry, September 12-14, 1814. In *Fort McHenry: Historical and Archeological Research Project, 1957-1958*, by NPS, Part II / Section IV. Ms. on file, Fort McHenry National Monument and Historic Shrine, Baltimore.
- Brown, Sharon, and Susan Long
1986 *Historic Structure Report; Administrative, Historical and Architectural Data Sections; Seawall*. National Park Service, Denver Service Center.

- Brewerton, Henry
1861 [Plan of] Fort McHenry, Md., Showing Positions of Guns Etc. Record Group 77, Drawer 51, Sheet 23. Cartographic and Architectural Branch, National Archives and Records Administration, College Park, Maryland.
- Brick, Samuel
1958 Plan and Sections of Drill Ground at Fort McHenry. Record Group 77, Drawer 51, Sheet 21. Cartographic and Architectural Branch, National Archives and Records Administration, College Park, Maryland.
- Butler, R. Q.
1840a? [Plan of] Fort McHenry. Record Group 77, Drawer 51, Sheet 12. Cartographic and Architectural Branch, National Archives and Records Administration, College Park, Maryland.
1840b Plat of the Lotts of Land Belonging to the General Government on which Fort McHenry is Erected. Record Group 77, Drawer 51, Sheet 13. Cartographic and Architectural Branch, National Archives and Records Administration, College Park, Maryland.
1840c Plan and Elevation of the Hospital at Fort McHenry. Record Group 77, Drawer 51, Sheet 15. Cartographic and Architectural Branch, National Archives and Records Administration, College Park, Maryland.
1840c Plan and Elevations of the Stables at Fort McHenry. Record Group 77, Drawer 51, Sheet 16. Cartographic and Architectural Branch, National Archives and Records Administration, College Park, Maryland.
1840d Plans and Elevations of the Soldiers Barracks [Enlisted Men's Barracks Nos. 1 and 2] at Fort McHenry. Record Group 77, Drawer 51, Sheet 17. Cartographic and Architectural Branch, National Archives and Records Administration, College Park, Maryland.
- Campbell, J. Duncan
1963 Archeological Excavations, Fort McHenry, Md. Ms. on file, Fort McHenry National Monument and Historic Shrine, Baltimore.
1964a? Archeological Report, Armistead Statue Project. Ms. on file, Fort McHenry National Monument and Historic Shrine, Baltimore.
1964b Archeological Report, Fort McHenry, Baltimore, Maryland. 1814 Boundary Wall, Gun Shed, Stable/Store House, and Hospital. Ms. on file, Fort McHenry National Monument and Historic Shrine, Baltimore.
- Carson, Hamilton H.
1963 Archeological Investigations at Fort McHenry, 1963. Ms. on file, Fort McHenry National Monument and Historic Shrine, Baltimore.
- Cheek, Charles D.
1966b Archeological Observations on the Kitchen Excavation, Fort Building E. Ms. on file, Fort McHenry National Monument and Historic Shrine, Baltimore.
1973 Archeological Observations on Materials from Harbor Tunnel Test Borings at Fort McHenry, August 30, 1973. Ms. on file, Fort McHenry National Monument and Historic Shrine, Baltimore.
- Cheek, Charles D., and Joseph Balicki
1993 Review and Synthesis of Archeological Documentation, Fort McHenry National Monument and Historic Shrine, Baltimore Maryland. Draft report (95 percent submission). Prepared by John Milner Associates, Inc., West Chester, Pennsylvania. Submitted to National Park Service, Denver Service Center, Eastern Applied Archeology Center, Silver Spring, Maryland. Ms. on file, Fort McHenry National Monument and Historic Shrine, Baltimore.
- Cheek, Charles D., Joseph Balicki, and Elizabeth J Abel
1999 *Archeological Testing and Data Recovery at Fort McHenry National Monument and Historic Shrine (18BC13), Baltimore, Maryland. Technical Report.* Prepared by John Milner Associates, Inc., Alexandria, Virginia. Submitted to National Park Service, Denver Service Center, Applied Archeology Center, Silver Spring, Maryland.
- Cheek, Charles D., Joseph Balicki, and J. W. Joseph
1989 *Archeological Investigations of the Moat and Drainage Features at Fort McHenry National Monument and Historic Shrine Baltimore, Maryland.* Prepared by John Milner Associates Inc., West Chester, Pennsylvania. Submitted to National Park Service, Mid-Atlantic Regional Office, Philadelphia, Pennsylvania.
- Cotter, John L.
1961 Report on location of Brick Drain Under Fort McHenry Courtyard. Ms. on file, Fort McHenry National Monument and Historic Shrine, Baltimore.
1964a Observation of Back Hoe Test Area of Supposed 1819 Road. Ms. on file, Fort McHenry National Monument and Historic Shrine, Baltimore.
1964b Preliminary Archeological Report on Store and Gun House and Stable and Store House Sites to Identify Areaway Between. Ms. on file, Fort McHenry National Monument and Historic Shrine, Baltimore.
1966a Transmittal of Archeological Report on Grounds Development. [Archeological observations during the preparation of the Sites of the Gun Shed and Storehouse; the Tavern; and, the 1814 Hospital for Interpretive Marking on the Grounds of Ft. McHenry.] Ms. on file, Fort McHenry National Monument and Historic Shrine, Baltimore.
- Cotter, John L., and Lee H. Nelson
1958 Addendum to Archeological Report by G. Hubert Smith, Archeologist, 1958. In *Fort McHenry: Historical and Archeological Research Project, 1957-1958.* Ms. on file, Fort McHenry National Monument and Historic Shrine, Baltimore.
- Craighill, William D.
1866a Sheet No. 1. Plan of Water Battery at Fort McHenry, showing progress and position of improvements of which details are given below, and on Sheet No. 2. Record Group 77, Drawer 51, Sheet 38. Cartographic and Architectural Branch, National Archives and Records Administration, College Park, Maryland.
1866b Sheet No. 2. Plans and Sections of Service Magazines for Exterior (Water) Batteries at Fort McHenry. Record Group 77, Drawer 51, Sheet 39. Cartographic and Architectural Branch, National Archives and Records Administration, College Park, Maryland.
- Delafield, Richard
1836 [Project for an Exterior Battery to Fort McHenry.] Record Group 77, Drawer 51, Sheet 8. Cartographic and Architectural Branch, National Archives and Records Administration, College Park, Maryland.
- Dozer, Donald Marquand
1976 *Portrait of The Free State.* Tidewater Publishers Cambridge, Maryland.
- Duane, William
1810 *A Military Dictionary.* Philadelphia.
- Duffy, Christopher
1975 *Fire and Stones: The Science of Fortress Warfare, 1660-1860.* David and Charles, London.
- Engineer Department
1857 Fort McHenry. Sketch of Proposed Changes in Prisons. Additions in Red. Record Group 77, Drawer 51, Sheet 20. Cartographic and Architectural Branch, National Archives and Records Administration, College Park, Maryland.

- Faust, J. Frederick
1985 Anglo-Indian Aggression and Accommodation along the Mid-Atlantic Coast, 1584-1634. In *Cultures in Contact*, edited by William W. Fitzhugh, pp. 225-268. Anthropological Society of Washington Series. Smithsonian Institution Press, Washington, D.C., and London.
- Feest, Christian F.
1978 Nanticoke and Neighboring Tribes. In *Northeast*, edited by Bruce G. Trigger, pp. 271-281. Handbook of North American Indians, vol. 15, William G. Sturtevant, general editor. Smithsonian Institution, Washington, D.C.
- Foli, A. P.
1792 Plan of the town of Baltimore and its Environs. Peale Museum, Baltimore.
- Funk, Robert E.
1978 Post-Pleistocene Adaptations. In *Northeast*, edited by Bruce G. Trigger, pp. 16-27. Handbook of North American Indians, vol. 15, William G. Sturtevant, general editor. Smithsonian Institution, Washington, D.C.
- Gratiot, C.
1835 Details for Fort McHenry, Engineer Department. Record Group 77, Drawer 51, Sheet 6. Cartographic and Architectural Branch, National Archives and Records Administration, College Park, Maryland.
- Gooding, S. James
1988 An Introduction to British Artillery in North America. *Historical Arms Series*, No. 4. Museum Restoration Service, Alexandria Bay, New York.
- Grievess Worrall Wright & O'Hatnick
1992 *Fort McHenry National Monument and Historic Shrine, the Comprehensive Plan: Fabric Analysis and Treatment Recommendations*. Prepared by Grievess Worrall Wright & O'Hatnick, Baltimore, Maryland, with Robert Silman Associates, P.C., New York, and Michael F. Trostel, FAIA, Baltimore, Maryland. Submitted to National Park Service, Denver Service Center, Eastern Team, Falls Church, Virginia.
- Henry, William
1989 Archeological Base Map, Fort McHenry National Monument and Historic Shrine Baltimore, Maryland. Set of two maps. Prepared by John Milner Associates Inc. West Chester, PA. Submitted to National Park Service, Mid-Atlantic Regional Office Philadelphia, Pennsylvania. Fort McHenry National Monument and Historic Shrine, Baltimore.
- Herman, Marguerita Z.
1992 *Ramparts: Fortifications from the Renaissance to West Point*. Avery Publishing Group, Inc., Garden City Park, New York.
- Herskovitz, Robert M.
1978 Fort Bowie Material Culture. *Anthropological Papers of the University of Arizona*, Number 31. The University of Arizona Press, Tucson, Arizona.
- Hinton, J. M.
1907 [Map of] Fort McHenry, Maryland. Record Group 92, Blueprint File, 4. Cartographic and Architectural Branch, National Archives and Records Administration, College Park, Maryland.
1908 [Map of] Fort McHenry, Maryland. Record Group 92, Blueprint File, 5. Cartographic and Architectural Branch, National Archives and Records Administration, College Park, Maryland.
1910 [Map of] Fort McHenry, Maryland. Record Group 92, Blueprint File, 7. Cartographic and Architectural Branch, National Archives and Records Administration, College Park, Maryland.
- Historical and Archeological Research Project (HARP)
1957-58 Historical and Archeological Research Project. Collected copies of documents, and of repository research reports, on file, Fort McHenry National Monument and Historic Shrine, Baltimore.
- Jennings, Francis
1978 Susquehannock. In *Northeast*, edited by Bruce G. Trigger, pp. 362-367. Handbook of North American Indians, vol. 15, William G. Sturtevant, general editor. Smithsonian Institution, Washington, D.C.
- Joseph, J. W., and Charles D. Cheek
1985 Archeological Investigations of Drainage and Construction Features at Fort McHenry National Monument and Historic Shrine, Baltimore, Maryland. Prepared by John Milner Associates Inc. West Chester, Pennsylvania. Submitted to National Park Service, Mid-Atlantic Regional Office Philadelphia, Pennsylvania.
- Kanarek, Harold
1978? *The Mid-Atlantic Engineers: A History of the Baltimore District, U.S. Army Corps of Engineers, 1774-1974*. U.S. Government Printing Office, Washington, D.C.
- Kurtz, James E.
1989 (Draft Report) 1989 Archeological Investigations at Fort McHenry National Monument and Historic Shrine. Prepared by National Park Service, Mid-Atlantic Regional Office Philadelphia, Pennsylvania. Ms. on file, Fort McHenry National Monument and Historic Shrine, Baltimore.
- Lee, Thomas I.
1834 [Plan of] Fort McHenry. Record Group 77, Drawer 51, Sheet 5. Cartographic and Architectural Branch, National Archives and Records Administration, College Park, Maryland.
- Lewis, Emanuel Raymond
1970 *Seacoast Fortifications of the United States: An Introductory History*. Pictorial Histories Publishing Company, Missoula, Montana.
- Livermore, William R.
1869 Sketch Showing Condition of Slides, Etc. upon Exterior Slope of Water Battery Ft. McHenry and Mode of Repairing Same. Record Group 77, Drawer 51, Sheet 41. Cartographic and Architectural Branch, National Archives and Records Administration, College Park, Maryland.
- MacKenzie, George C.
1958 Report on Brace Forming Probable Base of 1803 Flagpole. Ms. on file, Fort McHenry National Monument and Historic Shrine, Baltimore.
- Manucy, Albert
1985 *Artillery Through the Ages: A Short Illustrated History of Cannon, Emphasizing Types Used in America*. Division of Publications National Park Service, United States Department of the Interior, Washington, D. C.
- Maurice T. W.
1816 Letter to W.K. Armistead, 6 November 1816. Record Group 77, Office of the Chief of Engineers, Reports, July 1812-October 1823. National Archives and Records Administration, Washington, D.C.
- McGarry, Thomas E.
1981 *Archeological Investigations for the Restoration of Old Fort Washington, Maryland National Capital Parks-East, 1977-1979. Volume I: The Excavations*. National Capital Team, National Park Service, Denver Service Center, Denver, Colorado.
- Moore, R., and John L. Cotter
1964 Store & Gun House and Stable & Store House (Partial), Visitor Center Area, Fort McHenry National Monument, Maryland. Drawing on file, Fort McHenry National Monument and Historic Shrine, Baltimore.
- Moore, Robert R.
1864 [Sketch Plan of Fort McHenry, with letter of July 17, 1864.] Kansas State Historical Society and Department of Archives. Topeka. Reproduced in "Fort McHenry in the Civil War," by Allan C. Ashcraft, *Maryland Historical Magazine* 59(3):297-301.
- Mullaly, Franklin R.
1958 The Battle of Baltimore September 12 Through September 14, 1814. In *Fort McHenry: Historical and Archeological Research Project, 1957-1958*, by NPS. Part II / Section II. Ms. on file, Fort McHenry National Monument and Historic Shrine, Baltimore.

National Park Service (NPS)

- 1958a *Fort McHenry: Historical and Archeological Research Project, 1957-1958*. Ms. on file, Fort McHenry National Monument and Historic Shrine, Baltimore.
- 1958b Location of Archeological Diggings Outside of Star Fort, Fort McHenry National Monument. Set of plans (2 sheets) on file, Fort McHenry National Monument and Historic Shrine, Baltimore.

Nelson, Lee H.

- 1958a Architectural Research and Explorations at Fort McHenry National Monument and Historic Shrine Baltimore, Maryland. Conducted as a Part of the Historic American Buildings Survey at Fort McHenry, June-December, 1958. In *Fort McHenry: Historical and Archeological Research Project, 1957-1958*, by NPS. Part III / Section V. Ms. on file, Fort McHenry National Monument and Historic Shrine, Baltimore.
- 1958b Diagrammatic Sketch showing Location of Areas Selected for the Series of Architectural Investigations at Fort McHenry, October 7-31, 1958. Drawing on file, Fort McHenry National Monument and Historic Shrine, Baltimore.
- 1961 *Historical American Building Survey: An Architectural Study of Fort McHenry*. Department of the Interior, National Park Service, Eastern Office, Division of Design and Construction, Philadelphia, Pennsylvania.

Noel Hume, Ivor

- 1970 *A Guide to Artifacts of Colonial America*. Alfred A. Knopf, New York.
- 1987 *Historical Archaeology*. Alfred A. Knopf, New York.

Office of the Chief of Engineers.

- 1886a [Description and history of Defenses of Baltimore, Md., including Forts McHenry and Carroll and proposed Batteries at Lazaretto and Hawkins Points, together with 2 Maps of Forts McHenry and Carroll, showing work as proposed by Board of Engrs. 1870-1872.] Manuscript. Record Group 77, Drawer 51, Sheet A. Cartographic and Architectural Branch, National Archives and Records Administration, College Park, Maryland.
- 1886b [Plan of] Fort McHenry as proposed by the Board of Engineers, 1870-1872. Record Group 77, Drawer 51, Sheet A. Cartographic and Architectural Branch, National Archives and Records Administration, College Park, Maryland.
- 1918 *Engineer Field Manual, Parts I-VII*. Professional Papers of the Corps of Engineers. U. S. Army, No. 29. Government Printing Office, Washington.

Office of Engineer of Harbor Defenses

- 1866 *Proposed Service Magazines for Fort McHenry. Prepared to Accompany the Report of the Board of Engineers with References to Fort McHenry*. Record Group 77, Drawer 51, Sheet 36. Cartographic and Architectural Branch, National Archives and Records Administration, College Park, Maryland.

Office of the Inspector General

- 1822 Inspection Report of Fort McHenry, September 1822. Record Group 159, War Department, Office of the Inspector General, Selected Pages from Inspection reports, 1814-1842. National Archives and Records Administration Washington, D. C.

Office of the Quartermaster General

- 1888 Plan of Fort McHenry. Record Group 92, Records of the Office of the Quartermaster General. National Archives and Records Administration. Copy on file, Fort McHenry National Monument and Historic Shrine, Baltimore.

Orr, David G., Brooke S. Blades, and Douglas V. Campana

- 1982 Final Completion Report--December, 1982: Archeology of Sally Port Paving Project. Fort McHenry National Monument and Historic Shrine, Baltimore, MD. Ms. on file, Fort McHenry National Monument and Historic Shrine, Baltimore.

Orrance, Karen L., Paula A. Zitzler, and Heather H. Bouslog

- 1988 *Historic Structure Report; Archeological Data Section; Seawall*. Denver Service Center, Eastern Team, Applied Archeology Center, Rockville, Maryland.

Peterson, Harold L.

- 1969 *Round Shot and Rammers*. South Bend Replicas, Inc., South Bend, Indiana.

Poussin, William Tell

- 1819 Reconnoitering of Chesapeake Bay, State of Maryland. [Plan and Sections of Fort Covington, Redoubt.] Plan and Profile of Fort McHenry. Record Group 77, Drawer 51, Sheet 2. Cartographic and Architectural Branch, National Archives and Records Administration, College Park, Maryland.

Pousson, John F.

- 1996a Supplementary Archeological Data Recovery, Water Battery Breast-Height Wall, Fort McHenry National Monument and Historic Shrine. Management Report. In *Phase III Data Recovery Investigations at Fort McHenry National Monument and Historic Shrine (18BC13), Baltimore, Maryland* by Elizabeth J. Abel and Charles D. Cheek. Prepared by John Milner Associates, Inc., Alexandria, Virginia.

- 1996b Archeological Observations at the Site of the New Maintenance Shop, 1996. Fort McHenry National Monument and Historic Shrine (18BC13). Ms. on file, Fort McHenry National Monument and Historic Shrine, Baltimore.

- 1997 Memorandum Report: Documentation of Counterfort System of the Northern Scarp Wall of the Ravelin. Ms. on file, Fort McHenry National Monument and Historic Shrine, Baltimore.

- 1999a Archeological Investigations, The Southeast Front (Water Battery Vicinity), and Ravelin Dry Moat, Package No. FOMC 276B, Fort McHenry National Monument and Historic Shrine (18BC13). Ms. on file, Fort McHenry National Monument and Historic Shrine, Baltimore.

- 1999b Archeological Monitoring of the Installation of a New Underground Electrical Line, Fort McHenry National Monument and Historic Shrine (18BC13). Ms. on file, Fort McHenry National Monument and Historic Shrine, Baltimore.

- 1999c Archeological Monitoring, Construction under Package No. FOMC 276B, 1999, Fort McHenry National Monument and Historic Shrine (18BC13). Ms. on file, Fort McHenry National Monument and Historic Shrine, Baltimore.

Powell, B. Bruce

- 1964 Archeological Report, Armistead Statue Project. Ms. on file, Fort McHenry National Monument and Historic Shrine, Baltimore.

Reinhardt, Juergen, and William P. Crowley

- 1979 *Geologic Map of the Baltimore East Quadrangle*. Maryland Geological Survey, Baltimore.

Rice, Howard C., Jr., and Anne S. K. Brown (eds.)

- 1972 *The American Campaigns of Rochambeau's Army 1780, 1781, 1782, 1783. Vol. II: The Itineraries, Maps and Views*. Princeton University Press, Princeton, New Jersey, and Brown University Press, Providence, Rhode Island.

Robinson, Willard B.

- 1977 *American Forts. Architectural Form and Function*. Amon Carter Museum of Western Art, Fort Worth, Texas. University of Illinois Press, Urbana, Illinois.

Rutsch, Edward S.

- 1974 *Archeological Investigations of Original Drainage System of Fort McHenry National Monument and Historic Shrine, Baltimore, Maryland*. Prepared by Historic Conservation and Interpretations, Inc., Montague, New Jersey. Submitted to National Park Service, Denver Service Center, Denver, Colorado.

- Sarles, Frank B., Jr.
1968 The Kitchen of Building E, No. 2 Soldiers Barracks Fort McHenry National Monument and Historic Shrine, Md. Historic Structures Report, Part II Historical Data Section. Ms on file, Fort McHenry National Monument and Historic Shrine, Baltimore.
- Scheel, Heinrich O.
1984 *De Scheel's Treatise on Artillery*. Reprint of 1800 edition, translated by Jonathan Williams, edited by Donald E. Graves. Museum Restoration Service, Alexandria Bay, New York.
- Schiffer, Michael B.
1987 *Formation Processes of the Archaeological Record*. University of New Mexico Press, Albuquerque, New Mexico.
- Sheads, Scott S.
1986 *The Rockets Red Glare*. Tidewater Publishers, Maryland.
1990 A Report on the Step-Around-The-Mast Platform. (Revision of original 1982 report.) Ms. on file, Fort McHenry National Monument and Historic Shrine, Baltimore.
1995 *Fort McHenry*. Nautical and Aviation Publishing Company of America. Baltimore.
1997 A Park Improvement Report: A Historic Study of the NE Earthworks & the Road to Fort McHenry. Ms. on file, Fort McHenry National Monument and Historic Shrine, Baltimore.
- Smith, Fred A.
1840 Fort McHenry Baltimore, from Dimensions Furnished by Capt. Henry A. Thompson. Record Group 77, Drawer 51, Sheet 14. Cartographic and Architectural Branch, National Archives and Records Administration, College Park, Maryland.
- Smith, G. Hubert
1958 Archeological Explorations at Fort McHenry, 1958. In *Fort McHenry: Historical and Archeological Research Project, 1957-1958* Part IV:1-83. Ms on file, Fort McHenry National Monument and Historic Shrine, Baltimore.
- Stokinger, William A.
1975a Archeological Observations of Battery Walkway Installation. Ms., present repository unknown.
1975b Archeological Observations of the Scarp Wall French Drain Installation. Ms., present repository unknown.
1976a Fort McHenry National Monument and Historic Shrine, Detached Magazine, Archeological Investigations, 1974-1975. Ms. on file, Fort McHenry National Monument and Historic Shrine, Baltimore.
- 1976b Fort McHenry National Monument and Historic Shrine, Detached Battery Bombproof B, Archeological Investigations, 1975. Ms. on file, Fort McHenry National Monument and Historic Shrine, Baltimore.
- 1982 Preliminary Report: 1982 Archeological Investigations, Water-main Installation. Fort McHenry National Monument and Historic Shrine, Baltimore, Maryland. Ms. on file, Fort McHenry National Monument and Historic Shrine, Baltimore.
- 1983a Parade Ground Gas Leaks, March-April 1983. Fort McHenry National Monument and Historic Shrine. Ms. on file, Fort McHenry National Monument and Historic Shrine, Baltimore.
- 1983b Brick Walks, Historic Fort Area, March-June 1983. Fort McHenry National Monument and Historic Shrine. Ms. on file, Fort McHenry National Monument and Historic Shrine, Baltimore.
- 1983c Septic Tank Installation; Orpheus Grove, May 1983. Fort McHenry National Monument and Historic Shrine. Ms. on file, Fort McHenry National Monument and Historic Shrine, Baltimore.
- 1983d 24" Water Main Project, Seawall Road Temporary Relocation and 48"/24" Water Main Reducer Anchors. Fort McHenry National Monument and Historic Shrine. Ms. on file, Fort McHenry National Monument and Historic Shrine, Baltimore.
- 1983e Conduit Installation, Parade, Sally Port and Gorge Corridor, Fort McHenry National Monument and Historic Shrine. Ms. on file, Fort McHenry National Monument and Historic Shrine, Baltimore.
- 1983f Electric Pole Installation, Flag Day, Historic Reservation, 1983. Fort McHenry National Monument and Historic Shrine. Ms. on file, Fort McHenry National Monument and Historic Shrine, Baltimore.
- Stokinger, William A., and Brooke S. Blades
1979a Archeological Observations of the Rehabilitation of the Terreplein Wall. Fort McHenry National Monument and Historic Shrine. Ms. on file, Fort McHenry National Monument and Historic Shrine, Baltimore.
1979b Archeological Observations at Fort McHenry, June-July 1975. Ms. on file, Fort McHenry National Monument and Historic Shrine, Baltimore.
- Stokinger, William A., Patricia E. Rubertone, and Lawrence E. Babits
1981 Archeological Investigations at Fort McHenry National Monument and Historic Shrine. Ms. on file, Fort McHenry National Monument and Historic Shrine, Baltimore.
1982 Archeological Investigations at Fort McHenry National Monument and Historic Shrine in 1980. In *Archeological Investigations at Fort McHenry National Monument and Historic Shrine 1978, 1980* by Bryan L. Aivazian, William Stokinger, Patricia Rubertone, and Lawrence E. Babits; edited by Kathleen Fiero. Denver Service Center, Mid-Atlantic/North Atlantic Team, National Park Service, United States Department of the Interior, Denver, Colorado.
- Stone, C. H.
1912 [Topographic Map of] Fort McHenry. Record Group 77, War Department Map Collection, 6²-Maryland. Cartographic and Architectural Branch, National Archives and Records Administration, College Park, Maryland.
1914 [Topographic Map of] Fort McHenry. Record Group 77, War Department Map Collection, 6³-Maryland. Cartographic and Architectural Branch, National Archives and Records Administration, College Park, Maryland.
- Svejda, George J.
1969 Fort McHenry Military Structures, Historic Structures Report. Part I. United States Department of the Interior, National Park Service. Ms on file, Fort McHenry National Monument and Historic Shrine, Baltimore.
- Thompson, Erwin, and Robert Newcomb
1974 *Historic Structures Report, Fort McHenry: Historical and Architectural Data*. National Park Service, Denver Service Center, Denver, Colorado.
- Thompson, Henry A.
1837a Letter to General Gratiot, 24 October 1837. Record Group 107, Office of Civil Engineer, "SC FT-MC". 1811-1837. National Archives and Records Administration, Washington, D. C.
1837b [Plan of] Fort McHenry, Md., 1837, with the additional battery ordered by the Chief Engineer in Sept. 1836. Record Group 77, Drawer 51, Sheet 9. Cartographic and Architectural Branch, National Archives and Records Administration, College Park, Maryland.
1839a Letter to Colonel Totten, 17 October 1839. Record Group 77, OCE, Letters Received, T-294. National Archives and Records Administration, Washington, D. C.
1839b Arrangement of Traverse Circle and Pintle Bed for a Barbette Gun for the Parapet in the Figure; Giving a Traverse of 69 degrees with the wheel on, and 96 degrees with the wheel off; and allowing a depression of 6 degrees. Record Group 77, Drawer 51, Sheet 10. Cartographic and Architectural Branch, National Archives and Records Administration, College Park, Maryland.

- 1839c Plan of the Exterior Battery, Fort McHenry, with its Armament. Record Group 77, Drawer 51, Sheet 11. Cartographic and Architectural Branch, National Archives and Records Administration, College Park, Maryland.
- Toltz, Max
1918 General Hospital No. 2, Fort McHenry, Topographical Map. Record Group 92, Completion Report Fort McHenry (1917-1919). Fort McHenry National Monument and Historic Shrine, Baltimore.
- 1927 General Hospital No. 2, Fort McHenry, Water and Sewer System. Revised/marked-up blueprint, on ca. 1919 base, on file at Fort McHenry (1917-1919). Fort McHenry National Monument and Historic Shrine, Baltimore.
- Trigger, Bruce G. (editor)
1978 *Northeast*. Handbook of North American Indians, vol. 15, William G. Sturtevant, general editor. Smithsonian Institution, Washington, D.C.
- Tuck, James A.
1978 Regional Cultural Development, 3000 to 300 B.C. In *Northeast*, edited by Bruce G. Trigger, pp.28-43. Handbook of North American Indians, vol. 15, William G. Sturtevant, general editor. Smithsonian Institution, Washington, D.C.
- Turnbull, Charles M.
1864a Magazine at Fort McHenry. Plan [Sections and Elevations]. Record Group 77, Drawer 51, Sheet 28. Cartographic and Architectural Branch, National Archives and Records Administration, College Park, Maryland.
- 1864b Sketch of Fort McHenry Showing Out Buildings. Record Group 77, Drawer 51, Sheet 29. Cartographic and Architectural Branch, National Archives and Records Administration, College Park, Maryland.
- 1865 Fort McHenry, Sketch Showing Positions of 15" Guns. Record Group 77, Drawer 51, Sheet 33. Cartographic and Architectural Branch, National Archives and Records Administration, College Park, Maryland.
- Turnbull, Charles M.(?) [Engineer Department]
1864 Fort McHenry, Sketch Showing Positions of 15" Guns. Record Group 77, Drawer 51, Sheet 27. Cartographic and Architectural Branch, National Archives and Records Administration, College Park, Maryland.
- 1865a General Design for Service Magazines for Water Batteries at Fort McHenry. Elevation and Details of Service Magazines for Fort McHenry. Record Group 77, Drawer 51, Sheets 30 and 31. Cartographic and Architectural Branch, National Archives and Records Administration, College Park, Maryland.
- 1865b Modification of the Breast-Height Wall around the 15" Platforms. Record Group 77, Drawer 51, Sheet 34. Cartographic and Architectural Branch, National Archives and Records Administration, College Park, Maryland.
- United States Government
1914 Public Law 108, United States Statutes at Large XXXVIII, part 1, chapter 100, pp. 382-383.
- Volkes, Harold E., and Jonathan Edwards, Jr.
1968 *Geography and Geology of Maryland*. Maryland Geological Survey. Baltimore.
- Wade, Arthur P.
1977 *Artillerists and Engineers: The Beginnings of American Seacoast Fortifications 1794-1815*. Ph.D. dissertation, Department of History, Kansas State University, Manhattan. University Microfilms, Ann Arbor.
- Wadsworth, Decius
1814 Letter to John Armstrong, Secretary of War, 16 August 1814. Record Group 156, OSA, SPLSW 1812-17. National Archives and Records Administration, Washington, D. C.
- Walbach, John deB. (?)
1806 [Plan of Fort McHenry.] The New York Historical Society, New York, New York.
- Walsh, W. Richard
1958 The Star Fort, September, 1814. In *Fort McHenry: Historical and Archeological Research Project, 1957-1958*, by NPS. Part II / Section III. Ms on file, Fort McHenry National Monument and Historic Shrine, Baltimore.
- Wansteben, William A.
1903 Topographical Map of Military Post, Fort McHenry, Baltimore, Md. Record Group 26, Coast Guard, Lighthouse Bureau, Lazaretto Point, Md., No. 4. Cartographic and Architectural Branch, National Archives and Records Administration, College Park, Maryland.
- Wesler, Kit W., Dennis J. Pogue, Aileen F. Button, Gordon J. Fine, Patricia A. Sternheimer, and E. Glyn Furgurson
1981 *The M/DOT Archaeological Resources Survey Volume 3: Piedmont*. Maryland Historical Trust Manuscript Series, Number 7. Maryland Historical Trust, Annapolis, Maryland.
- Wilke, Steve, and Gail Thompson
1977 *Prehistoric Archeological Resources in the Maryland Coastal Zone: A Management Overview*. Report prepared for and funded by the Maryland Department of Natural Resources, Energy and Coast Zone Administration, under a Coastal Zone Management Program
- Development Grant from the National Oceanic and Atmospheric Administration. [National Oceanic and Atmospheric Administration?, Seattle]
- Wilson, J. L.
1894 Plan of Fort McHenry. Record Group 92, Blueprint File, Fort McHenry, 2. Cartographic and Architectural Branch, National Archives and Records Administration, College Park, Maryland.
- Wood, W. Raymond, and Donald Lee Johnson
1978 Disturbance Processes in Site Formation. In *Advances in Archaeological Method and Theory, Volume 1*, edited by Michael B. Schiffer, pp. 315-381. Academic Press, New York.
- Yarrow, H. C.
1870 Report to Surgeon General. Record Group 94, Medical History of Fort McHenry, 1868-74. National Archives and Records Administration Washington, D.C.

APPENDIX A

Annotated Bibliography of Archeological Research at Fort McHenry

This annotated bibliography provides very brief summaries of most of the existing archeological reports concerning Fort McHenry National Monument and Historic Shrine; excluded are preliminary reports which were superseded by final reports (e.g., Abel 1994, and Abel and Cheek 1996, superseded by Cheek et al. 1999), a few ancillary documents (Campbell 1964a, MacKenzie 1958, and Sarles 1968), and two reports concerning monitoring projects which have not been located (Stokinger 1975a and 1975b). Certain invaluable historical and architectural research reports are also excluded, although it should be evident from this overview that our understanding of the site's archeology would be poorer without them (Bradford 1958; Nelson 1958a, 1961; Sheads 1986, 1995; Thompson and Newcomb 1974; and Walsh 1958). The bibliography is intended to compliment the text by providing summaries of the findings of the individual investigations conducted at the fort over the past forty years. The reports, many of them manuscripts, are on file at Fort McHenry National Monument and Historic Shrine, or the National Park Service's Regional Office; copies of several of the printed reports are also archived at the Denver Service Center's Technical Information Center.

Author(s), Date: **Bryan W. Aivazian, 1982**

Title: *Archeological Investigations at Fort McHenry National Monument and Historic Shrine in 1978.*

Aivazian's investigations, conducted in 1978, were made to locate, identify, and evaluate the physical condition of several features dating to the early and mid-nineteenth century: an 1814 well, a ca. 1800 cistern, an 1837 shot furnace, and a ca. 1819-35 guardhouse, all located more-or-less between the two enlisted men's barracks (buildings D and E); the commanding officer's privy on the east side of the parade magazine (building B); a passageway addition to the north (rear) of the commanding officer's quarters (building A); and a post-Civil War privy in the dry moat adjacent to the southeast scarp wall of the ravelin. The research generally was expected to contribute to the park's interpretive program, while artifact analysis was expected to help characterize social and economic differences of three social ranks (enlisted men, junior officers, and commanding officer). Field investigations involved the excavation of 78 test units. Most test units were 4 ft. square, but several partial test units were excavated. All test units were excavated by hand. The excavators screened all soil matrix except verified twentieth century fill deposits. Artifact analysis included cleaning, identification, and conservation. No analysis was undertaken on the bone recovered, however.

Investigations of the commanding officer's privy confirmed that the privy's footprint matched that shown on Lee's 1834 plan of the fort. The privy had

two rooms, and was aligned with the terreplein wall, rather than the parade magazine wall. The privy was in use from pre-1834 to World War I; its vault had been cleaned and filled with soil from elsewhere. Abandoned water and sewer line indicated its conversion to a water closet in the late-nineteenth century. Portions of the wall footings were damaged during installation and later modification of these utilities. The stratigraphic sequence for the privy fill was recorded. A buried surface drain was identified between the privy and the parade magazine. Annotation of the excavation plan suggests that a brick floor within one of the privy's rooms was about 8 in. below grade, and that grade exterior to the privy was about 10 in. below grade.

Excavations at the rear of the commanding officer's quarters uncovered and recorded the footprint of a passageway addition. This ca. 1829 passageway connected the quarters to a stairway hall built the same year between the quarters and a formerly detached kitchen 10 ft. to the east; the structure's second story was also built in 1829. The passageway was in effect a covered exterior hallway. The dimensions of the passageway were determined to have been 4 ft. by 14 ft. 3 in. The historic ground surface was found 15 in. below the modern surface. Excavations along the foundation of the commanding officer's quarters show that while the exposed walls of the two separate buildings were bonded, the unexposed portions of the foundation abutted.

Testing adjacent to the southeast side of the ravelin, to locate a ca. 1870-75 privy, was limited due to the high water table of the vicinity and to the walkway and drain line over the foundation of the privy. One corner of the privy was exposed and its length was determined. The depth of the top of the foundation of the ravelin's scarp was also determined, and a 1930s repointing trench was identified adjacent to the scarp wall. Late nineteenth through twentieth century fill soils predominated above and adjacent to the top of the privy foundation. The vault of the privy would be excavated during a separate investigation, by Stokinger et al. (1982), conducted in 1980.

The excavations between enlisted men's barracks 1 and 2, to identify, record, and evaluate archeological resources associated with various structures that have been located in that area, succeeded in discovering deposits and features associated with a ca. 1800 cistern, an 1814 well, a ca. 1819-1835 guardhouse, and a shot furnace built ca. 1837 and removed in the 1870s. Based on historic maps, the cistern was determined to be 16 ft. wide. The length could not be determined. The east end of the cistern has been heavily damaged by construction of a septic tank in 1934. The superstructure of the cistern was removed between 1814 and 1819, when a guardhouse was constructed at this location. Remnants of the guardhouse foundation were documented. The shot furnace foundation is 7 in. below the present ground surface. The cistern foundations are 1 ft. below the present ground surface. A possible ca. 1813-14 shot furnace was also discovered. (Aivazian, however, believed that this feature post-dated 1851, because of an associated, although possibly intrusive, artifact.) A buried brick surface drain is located over this feature. This drain was tentatively dated to the 1880s, but could be much earlier (i.e., ca. 1820?).

Excavations were also made at the site of the 1814 well and bombproof, on the parade between, but in front, of enlisted men's barracks 1 and 2, which located the footing of one portion of the bombproof that had stood over the well, and remnants of the pump platform, along with the well's shaft. The brick-domed top of the shaft had two surface openings, one of them for the pump and the other for maintenance and repairs. A buried historic brick walk covers portions of the well opening and the pump platform remnants. The uppermost deposits in the well indicate it had been open and receiving artifacts, at least temporarily, in the early twentieth century. The brick walk, 8 in. below the ground surface, is associated with a cobble stratum dating to the 1850s-1870s. Above the brick wall and cobble stratum are strata representing the placement of oyster shell on the parade ground.

Author(s), Date: **Anonymous, 1975.**

Title: *Archeological Observations at Fort McHenry, November 1974 - July 1975.*

This brief report, possibly prepared by Brooke Blades or Bill Stokinger, noted the areas of investigation and the salient discoveries made during implementation of a number of projects, four of which would later be reported in greater detail by Stokinger (1975a, 1975b, 1976a, 1976b), and by Stokinger and Blades (1979a, 1979b). Among the discoveries noted were: the early brick drain on the terreplein interior to bastion 4, and the robbed foundation trenches of the ca. 1813-19 structure above the upper end of the postern tunnel (Stokinger and Blades 1979a); the presence of traverse-circle foundation stones, originally employed during the 1830s, located intermixed with stone rip-rapping along the fort's seawall, and repositioned at the surface of newly deposited rip-rap during a seawall rehabilitation project; remnants of a lightning rod system and of two stone foundations in the Civil War Magazine's vicinity (Stokinger 1976a, where note is made of granite rubble, but not of stone foundations); remnants of an early (ca. 1800-30) enlisted men's privy, and the foundation of a ca. 1917-25 powerhouse, in the area of the dry moat between the fort and the water battery; and the foundations of the married soldier's quarters and of a post-1836 addition to the fort's 1808 stable and storehouse (Stokinger and Blades 1979b). The recovery during implementation of the latter project of a "very rough-worked aboriginal axehead and a sleeve button of the First Regiment U.S. Artillery from the period 1802-08" is also noted.

Author(s), Date: **Brooke Blades, 1984**

Title: *Field Trip Report, May 14-16, 1984*

Blade's letter report provides a record of the exposures made, during archeological monitoring, of brick drains in the gorge near the sally port and of the cross-wall counterfort system of the north scarp wall of the ravelin.

One of the two overlapping brick drains, located in the vicinity of the left shoulder of bastion 5, served to remove water from the south sally port bombproof. The drain showed evidence of extensive twentieth-century repair. The second, deeper drain, 4.1 ft. below the modern gorge surface, resembled the drain which lies several feet below the parade ground, documented by Cotter (1961) and Cheek et al. (1989), and appears likely to be a continuation of it..

The resetting of a coping stone on the north face of the ravelin offered an opportunity to examine part of the scarp wall's counterfort system.. One brick cross-wall, 1.5 ft. wide, was exposed between the outer scarp wall, 3 ft. wide, and a parallel counterfort wall, 2.45 ft. wide, 1.5 ft. interior to the outer wall. The space between the walls was filled with mixed clay and mortar. (See also Joseph and Cheek 1985:45-48, Figures 20-22, Appendix B.)

Author(s), Date: **J. Duncan Campbell, 1963**

Title: *Archeological Excavations, Fort McHenry, Md.*

Campbell's 1963 investigation expanded the exposure, documented earlier in 1963 by Carson, of the foundation of a barracks determined to have stood within Fort McHenry's upper water battery ca. 1803-1806, and of associated features. The foundation was determined to extend from 40 ft. to nearly 90 ft. east of the salient of the ravelin, between 2 ft. and 6.5 ft. below existing grade. The northwest and southwest corners were exposed, along with remnants of a doorway, an exterior walkway, and an interior floor. The patterning of the interior floor varied, and the floor was interrupted by regularly-spaced gaps that may reflect the former locations of timber features. The artifacts found were consistent with an approximate 1795-1812 period of existence for the structure.

Author(s), Date: **J. Duncan Campbell, 1964b**

Title: *Archeological report, Fort McHenry, 1814 Boundary Wall, Stable and Store House/Gun Shed.*

The objectives of Campbell's 1964 investigations were (1) to provide an accurate basis for siting a hedgerow, to be planted for interpretive purposes, along the alignment of the 1814 boundary wall separating the U.S. Government ground from that owned by a Mr. Schwartzhauer; (2) to further expose the foundations of the gun shed and the store house (previously documented by Powell, 1964, and Cotter, 1964b) to determine the dimensions of these buildings; and (3) to locate the 1814 hospital.

Campbell did not find remnants of the boundary wall to the west and northwest of bastion 2; this may have been, as Campbell suggested, due to discrepancies in its location, between the base map for the park and the 1819

plan of the fort, but is more likely attributable to the inaccuracy of both of these documents, compared with Lee's 1834 plan. Campbell did find remnants of the boundary wall's footing northeast of bastion 2, where the 1819 and 1834 plans agreed on the wall's alignment. Remnants of the footing, located 10 in. below grade, were described simply as "a distinct mortar-broken brick zone 20 in. wide."

Excavations at the gun shed and store house sites resulted in exposure of three corners of the foundations of each of these adjacent structures, and of several associated features indicative of structural modifications and additions that had been made to these buildings. A stone slab covered drain (possibly similar to an 1866 drain from bombproof 1 to the seawall) was discovered in the area between the gun shed and store house, adjacent to a wall which Cotter (1966a) later interpreted as representing an addition to the gun shed.

Excavation at the site of Fort McHenry's 1813-40 hospital (which subsequent to 1840 served as the post's commanding officer's quarters) revealed the survival of several of the footings for brick piers which had supported the 1829 north porch of the hospital (documented by Lee's 1834 plan), but no unambiguous remnants of the original structures were discovered, either by Campbell or later by Cotter (1966a). However, portions of brick footings of late-nineteenth century additions to the structure were present.

Author(s), Date: **Hamilton H. Carson, 1963**

Title: *Archeological Investigations at Fort McHenry, 1963.*

Carson's investigation was initiated due to the exposure of a displaced brick wall segment during rehabilitation of a drain line. Enlargement of the construction excavation associated with this chance discovery documented the presence of foundations, and of a complexly-patterned brick floor. A resistivity survey of the vicinity was conducted in an attempt to determine the extent of the foundations. Carson suggested caution in relying on the results of the resistivity, and in fact Campbell's subsequent investigation of the site (1963) revealed that the results of the resistivity survey were misleading.

Author(s), Date: **Charles D. Cheek, Joseph Balicki, and Elizabeth J. Abel, 1999**

Title: *Archeological Testing and Data Recovery at Fort McHenry National Monument and Historic Shrine (18BC13), Baltimore, Maryland.*

The investigations implemented by John Milner Associates, Inc. (JMA), in 1993 and 1994 examined the potential effects of restoration activities on archeological resources at the fort, and mitigated effects after their identification. In the star fort the investigations addressed the ramparts of the

north sally port curtain, the ramp to the terreplein, one of the embrasures in bastion 3, the parapet over the postern tunnel, and the breast-height wall and its relation to the terreplein. In the ravelin the investigation explored the relation of the current parapet and terreplein to the original passage through the ravelin, and the relation of the breast-height wall to the terreplein. In the water battery the excavations investigated the sites of the hot shot furnaces, bombproof 1, and magazine 3 as well as the western end of the water battery's revetment and glacis. The investigations indicated that significant archeological resources would not be affected by early-phase elements of the Package 276 rehabilitation project.

The relationship of the original parapet and terreplein surfaces to the ca. 1837-39 documentation of grade changes was clarified, as were the characteristics of the fort's original embrasures. Ambiguities concerning the sequence of development of the water battery, and in particular of the revetment of its parapet, were to a large extent resolved. New information was secured concerning features associated with the 1814 sally port bombproofs, although questions concerning the configuration and chronology of concrete structures situated above the bombproofs remains to be answered. The discovery of an early, perhaps original, ground surface on the ramp west of the sally port supports Kurtz's 1987 suggestion regarding the possible preservation of such contexts within the fort's ramparts.

Author(s), Date: **Charles D. Cheek, Joseph Balicki, and J.W. Joseph, 1989**

Title: *Archeological Investigations of Moat and Drainage Features at Fort McHenry National Monument and Historic Shrine, Baltimore, Maryland.*

The primary goal of this 1988 investigation was to study the characteristics of the dry moat and of other drainage, or drainage-related, features at the fort. The field investigations were divided into 5 operations (Op.), each of which addressed different goals. The goal of Op. 1 was to determine if the foundations of the fort's scarp wall at bastion 3 incorporated elements of an original drainage system. Op. 2 was to determine the shape of the original dry moat and whether it could have aided in draining the walls of the fort. The Op. 3 investigation was to determine the function of a previously identified brick drain on bastion 4 (Stokinger and Blades 1979; Joseph and Cheek 1985). The goal of Op. 4 was to locate a brick drain first identified by Cotter (1961). The goal of Op. 5 was to investigate a known drain from the southeast sally port bombproof, in the gorge between the sally port ramp and the left flank of bastion 5.

Archeological investigations included mechanically excavated trenches as well as hand excavated test units. The soil matrix from all test units was screened to ensure the uniform recovery of artifacts. The mechanical excavation of trenches was monitored and observed diagnostic artifacts were collected. The results are presented below by numbered "Op."

Op. 1.

Archeological investigations included trenches and test units excavated to the foundation footer of the scarp wall along bastion 3. No drainage features of any type were located along the scarp wall or footer. It was noted that subsoil is impermeable clay thus preventing the percolation of water through the foundation. A remnant of the scarp wall builder's trench was identified in several locations, either the builder's trench had been destroyed or footer stones were set against or pressed into subsoil. A trench was identified which paralleled the right face and flank of bastion 3. This feature was also identified paralleling the curtain wall between bastions 1 and 2 (Joseph and Cheek 1985). Based on accounts of the 1814 bombardment and the archeological evidence the trench is interpreted as a defensive position (tenaille) occupied by the fort's infantry during the bombardment of the fort. The trench lies below the strata interpreted as the dry moat and in places does not abut the wall of the fort. Artifacts recovered from the trench fill include a bomb fragment which matches the dimensions of a 10-in. British mortar. This significant feature may parallel the scarp wall along the entire landward side of the fort.

At the beginning of the Civil War a palisade was constructed to protect the southwest flank of the water battery from ground attack (Brewerton 1861). A remnant of this palisade and a ditch which parallels it were uncovered in a test unit at the left shoulder of bastion 3 in the dry moat. The excavations were limited to identifying the feature, and the palisade remnant was left in place. Archeological evidence for the 1935 WPA repointing of the scarp wall was present in the form of a 2 to 2.5 ft. wide trench that runs the entire length of the bastion extending down to the top of the footer.

Op. 2

A stratum interpreted as the surface of the original dry moat, into which the ca. 1838-40 cunette had been dug, was identified opposite the left face of bastion 3. This stratum had previously been found by Rutsch (1974), and resembles deposits encountered by Joseph and Cheek (1985) along the curtain wall between bastions 1 and 2. No counterscarp was identified in trenches excavated across its alignment; it most likely had been removed ca. 1917. Early twentieth-century hospital construction and destruction destroyed substantial portions of the dry moat surface around bastion 3. The top of the dry moat surface correlates to the top of the scarp wall footer.

Interpretation of the stratigraphic sequence and recovered artifacts suggests that the dry moat was constructed between 1813 and 1829-37. Rutsch (1974) proposed that the dry moat and apparently dry-laid scarp wall foundation acted to drain the ramparts; this interpretation was determined to be incorrect. An effort to locate a drain opposite the point of bastion 3, as depicted on Smith's 1840 plan, was unsuccessful. Early twentieth-century construction probably destroyed all evidence of this drainage feature.

Op. 3

Approximately 70 percent of a brick drain in the bastion 4 vicinity, previously documented by Stokinger and Blades in 1979, and by Joseph and Cheek in 1985, was exposed. The drain extends 33.5 ft. from the terreplein wall. The drain was partially beneath the breast-height wall. Remnants of what may have been an intake or drop box were present at the end of the drain, which had been damaged by construction of the breast-height wall in 1837. The drain was interpreted as part of the original drainage system of the fort, although uncertainty remains. [In the body of this report, it is argued that it may have been associated with the gun platform in bastion 4 built in 1813-14.] A similar drain was found by Kurtz (1989) in the vicinity of bastion 3.

The excavations enabled the examination of the stratigraphic sequence of the bastion, including original construction (ca. 1800); additions related to the filling of the embrasures and raising the guns to fire enbarbette (1813); construction of the breast-height wall (1837); the addition of an infantry banquette, gun emplacement, and the raising of the breast-height wall (1839); and the addition of fill and restoration and repairs from 1839 to the present.

Op. 4

Cotter (1961) initially identified a brick drain under the parade ground and suggested that this feature dated to the late nineteenth century. Operation 4 investigations on the parade ground located the drain and its trench in two locations and gathered evidence of the drain's age. The drain was found to slope from west to east, most likely exiting the fort beneath the sally port passageway, but possibly beneath the southeast sally port bombproof. Cotter suggested the course of the drain was through the sally port. Stratigraphic interpretation indicates that the drainage feature is earlier than Cotter believed and may date to the early nineteenth century. A similar drain documented in the gorge by Blade in 1984 may be a continuation of this parade drain.

The stratigraphic analysis of the parade ground incorporated and built upon the sequence presented by Stokinger (1983a). Evidence for the original parade ground surface was found. Additionally, evidence for construction of an 1861 parade well and associated pumps was found.

Op. 5

A brick drain extending through the scarp wall footing from the southeast sally port bombproof was uncovered in the gorge adjacent to the scarp. Upon excavation, it was discovered that the original drain had been replaced by a clay pipe. It is unclear when the original drain was constructed and the excavations did not assist in dating the drain. Evidence of repair work to the drain and its replacement by a clay pipe was collected. The repointing trench excavated in 1935 by the WPA was identified. Neither the excavation of the trench nor the repointing of the scarp wall had an impact on the drain.

Author(s), Date: **John L Cotter, 1961**

Title: *Report on location of Brick Drain Under Fort McHenry Courtyard.*

The report documents the discovery of a brick drain beneath the courtyard (parade ground) of the fort, the trench for which was found during the installation of a water line. Cotter suggested that the brick drain, 9 ft. 2 in. below the present parade surface, dated to the latter half of the nineteenth century, based on the apparent stratigraphic context of its trench. The report briefly presents a detailed description of the portion of the drain uncovered, and includes three photographs. The brick drain's trench was recorded by Stokinger (1982), partially beneath the 1813 sally port traverse; further investigation of the drain in 1988 also made possible reinterpretation of its age, by Cheek et al. (1989:61-68). It is now believed to have a very early nineteenth century origin, or to be an original feature of the fort. A similar drain documented in the fort's gorge by Blade in 1984 may be a continuation of this parade drain.

Author(s), Date: **John L Cotter, 1964a**

Title: *Observation of Back Hoe Test Area of Supposed 1819 Road.*

The report documents excavation of a trench across the alignment of the original road into the fort, an alignment documented by plans dating to 1803, 1806, 1819, and 1834. A profile of the excavation, and a record of its location, are contained on a separate drawing in the park's files (Moore and Cotter 1964). Cotter concluded that the earlier road into the fort was not evident, and that schist and granite split gravel road ballast found between depths of about .4 ft. and 1.4 ft. derived from the twentieth century, pre-1962 drive to fort.

Author(s), Date: **John L Cotter, 1964b**

Title: *Preliminary Archeological Report on Store and Gun House and Stable and Store House Sites to Identify Areaway Between.*

The report documents archeological testing performed to locate a archeologically-safe corridor for a drainage line. The report is a brief letter report which provides a minimum of information. The two-day field work was restricted to locating the building foundations and documenting a (supposed) 5-ft.-wide areaway between them. The areaway was to be used as a right-of-way for the drainage line. The northwest walls of both structures coincided with the fort's original boundary, and an infill wall between what was thought to be the north corner of the gun shed and the west corner of the store house provide for the continuity of the boundary wall when it was built. (As determined later in 1964 by Campbell, the areaway had been 10 ft. wide, both originally and at the time of construction of the boundary wall.) The

boundary wall was not described in detail. The report is illustrated with several photographs; a plan of excavations is provided in a separate drawing on file at the park (Moore and Cotter 1964). (See also Powell 1964.)

Author(s), Date: **John L Cotter, 1966a**

Title: *Transmittal of Archeological Report on Grounds Development*. [Archeological observations during the preparation of the Sites of the Gun Shed and Storehouse; the Tavern; and, the 1814 Hospital for Interpretive Marking on the Grounds of Ft. McHenry.]

This brief report documents the monitoring of supplementary excavations which Cotter directed to assist in marking (with foundation-like, at-grade brick strips and angles) the locations of the gun shed, store house, tavern, hospital, and upper water battery barracks. The report is a typescript draft, marked "not proof read," which may explain some of its ambiguities and inconsistencies. Observations concerning the excavations at the gun shed and store house were generally straightforward, and consistent with Campbell's 1964 observations. Cotter was apparently unaware, however, or chose to ignore, the uncertain role of the wall in the areaway between the gun shed and the store house. Although it had not been the gun shed's original end wall, it was used as the basis for marking the original end wall.

The marking of the tavern's location was apparently similarly confused, due in part to the incomplete nature of Smith's investigation of the site in 1958, as well as to various late-nineteenth through mid-twentieth century disturbances. Only a portion one northwest-southeast aligned wall, extending from 3 ft. to more than 6 ft. below grade, was located. (The report references a drawing which presumably recorded the location of the wall, but a copy of the drawing was not included in the report, and its whereabouts is unknown.) Brick masonry debris, and plaster fragments, located adjacent to the northeast side of the wall, implied that the wall derived from the southwest foundation of the tavern. In the absence of a continuation of cellar deposits to the northeast, however, it was uncertain which side of the tavern the wall represented; as a consequence it was arbitrarily (and contradictorily) decided that it would serve as the basis for marking the alignment of the northeast side of the tavern. A late-nineteenth century brick walkway was also discovered in the vicinity of the tavern site, along its southeast edge; this walkway had been associated with the post's turn-of-the-century administration building. (Stokinger, in his 1982 report concerning the monitoring of installation of a new water main, noted that the 1966 brickwork misrepresents the tavern's location.)

Additional excavation of the site of the 1813 hospital was no more successful than Campbell's 1964 investigation in locating remnants of the structure itself; ambiguous evidence of a possible wall was found, although not investigated, below the water table in the vicinity of the structure's south corner, and the foundations of late-nineteenth century additions were also

exposed. Cotter consequently chose to rely on the porch footings discovered by Campbell, and on Lee's 1834 building plan, to mark the location of the hospital, making it 75 ft. long by 28 ft. wide. Unfortunately, the 1 in. = 20 ft. graphical scale of Lee's plan, which Cotter relied on, is erroneous. The "15 ft. -- 1 in." stated scale of the drawing is correct, and the 1834 building plan, correctly interpreted, indicates that the hospital was in fact only 57 ft. long by 20 ft. wide.

Due to its depth, the upper water battery barracks site was not reexcavated, and marking of its location at grade relied only on Campbell's 1963 report.

Author(s), Date: **John L Cotter, 1966b**

Title: *Archeological Observations on the Kitchen Excavation, Fort Building E*.

Cotter monitored the 1966 removal of fill from the kitchen cellar beneath the north end of building E, enlisted men's barracks no 2, to provide this record of his observations. The excavations were undertaken to restore the cellar for exhibit purposes. The report is in letter form and presents a brief review of the project, archeological deposits observed, and interpretations of the stratigraphy. Photographs of the cellar walls accompany the report, but no drawings or photographs of the stratigraphy are included.

The fill within the 8 ft. deep cellar represented several different episodes. Modern fill, from the twentieth-century army restoration, comprised the first foot of the deposit. Beneath this deposit were at least 5 differentiated strata of fill, most if not all deposited in 1837 when the cellar was abandoned for good. A previous excavation in the cellar had located a fireplace and a brick floor (Cotter and Nelson 1958:7-8), confirming the cellar's existence. Except in front of the fireplace, the brick floor had been robbed prior to the filling of the cellar. The floor brick had been set in a 2.0-in. bed of sand, overlying the original clay floor. Charcoal fragments were embedded into the surface of the clay floor, but no artifacts were recovered from it.

The need for drainage of infiltrating groundwater, encountered 3 to 4 ft. below the ground floor door sill, was recognized as a complication to the restoration of the cellar, and it was suggested that the inlet of the postern drain behind building E (referred to as a 'sunken drain') could be employed as the outlet destination of a new cellar drain line. A drain through the foundation at the floor line in the southeast (south) corner of the cellar, observed by Cotter and Nelson in 1958, could represent an historical attempt to direct drainage to the ca. 1813-14 (?) postern drain, prior to the cellar's abandonment. Another drainage feature—a sump in the cellar's southwest (west) corner—was noted but not investigated; an exterior drain line from this location may have led to the deeply buried, early brick drain below the parade. (See also Cotter and Nelson 1958 and Sarles 1968.)

Author(s), Date: **John L Cotter, 1973**

Title: *Archeological Observations on Materials from Harbor Tunnel Test Borings at Fort McHenry, August 30, 1973*.

The report documents the examination of soil cores collected from the twenty-two test borings made on the ground of Fort McHenry during planning for construction of the Fort McHenry Tunnel. The borings, 1.5 ft. in diameter, were made to depths of 75 ft. at varying intervals (roughly 100-300 ft.) along two east-west transects. The soil cores were collected in 5-ft.-long increments, to depths of 25 ft. Of the 101 soil core samples collected, however, only 54 retained location designations; the boring i.d. numbers, depth increments, soil colors and textures, and gross artifactual content of the latter samples are listed in the report, which also contains a map showing the locations of the borings. Cotter's brief discussion of the results of his examination of the soil core samples acknowledges that the inclusion of artifacts in a several samples from depths of 5 to 10 ft. and 10 to 15 ft., and in one from depths of 15 to 20 ft., does not necessarily indicate the presence of artifacts at those depths; the only pattern noted was the apparent clustering of borings which yielded artifacts within deeper samples. No artifacts or soil were retained in the park collections.

Author(s), Date: **John L. Cotter and Lee H. Nelson, 1958**

Title: *Addendum to Archeological Report by G. Hubert Smith, Archeologist, 1958*.

Exploratory excavations were undertaken in 1958 adjacent to the residential buildings within the star fort at an element of their architectural investigation. The excavations were not archeological in nature (and the methodology followed is not indicated), but were studied by Cotter after they had been made. A blueprint plan is attached to the report, and a separate drawing documenting the locations of the excavations is on file at the park (Nelson 1958b). No profiles or photographs accompany the text, but photographs are found in Nelson 1961. Generalized soil descriptions are provided. The excavations resulted in exposure of: the four cellar windows and window-wells at the commanding officer's quarters; two cellar windows and the cellar entrance of the junior officers' quarters; two cellar windows of enlisted men's barracks 1, and the stone foundation of an addition to that building; four cellar windows and window wells at enlisted men's barracks 2, and portions of the original floor, fireplace, and walls within the cellar.

The discovery within the cellar of enlisted men's barracks 2 of fireplaces assigned a kitchen function to the cellars. The original floor of the cellar was located 7.5 ft. below the top of the present brick floor. (See also Cotter 1966b and Sarles 1968.)

Author(s), Date: **J. W. Joseph and Charles D. Cheek, 1985**

Title: *Archeological Investigations of Drainage and Construction Features at Fort McHenry National Monument and Historic Shrine, Baltimore, MD.*

JMA's 1984 investigations focused on drainage features and drainage problems. They were undertaken in six operations (Op.) each of which examined a different research question or area of the fort. Op. I examined the dry moat and curtain wall between bastions 1 and 2. Op. II excavations were positioned in the dry moat at the tip of the ravelin. Op. III examined the postern drain at the seawall. Excavations connected to Op. IV included 11 trenches on the parapet of the star fort (a least 1 trench on each curtain wall and bastion) and 1 trench on the top of the south flank of the ravelin. Op. V involved the monitoring of NPS excavations at magazines 1, magazine 2, a trench between bombproof 1 and magazine 2, and a trench west of magazine 3. Op. VII investigated a brick drain on bastion 4. The results are presented below by numbered Op. (Note, however, that there is no Op. VI.) The investigations were conducted by means of both mechanically excavated trenches and hand-excavated test units. As the primary goal of the investigations was to uncover architectural features with known dates, the screening of all soil matrix was not considered essential. The excavators did collect all observed diagnostic artifacts, however, and the soil matrix from one stratum in Op. I was screened. (See also Cheek et al. 1989; Rutsch 1974; Stokinger and Blades 1979a.)

Op. I

Investigation along the curtain wall between bastions 1 and 2 consisted of the hand excavation of a 5 by 50 ft. trench abutting the base curtain wall. The stratigraphic sequence at this location was recorded. No drainage features were identified on the scarp wall or foundation, which was determined to be mortared. The historical dry moat surface was represented by a stratum abutting the top of the scarp wall foundation. Also evident were: a 1935 WPA repointing trench along scarp wall; a trench paralleling the curtain wall, later interpreted to represent an 1814 tenaille (see Cheek et al. 1989: 38-41); and a concrete steam box.

Op. II

A 10 ft. square excavation was made to determine if historical drains were evident. No drainage features were identified on the ravelin foundation and based on the excavation it was concluded that no adequate drainage system was provided along the ravelin foundation. A stratum representing the dry moat was identified abutting the top of the ravelin foundation.

Op. III

Investigation of the 1836 postern drain line involved the mechanical excavation of a trench over the drain on the exterior of the star fort, near the seawall. A section the 18 in. cast iron drain was exposed and its condition evaluated. The stratigraphic sequence was not recorded.

Op. IV

Twelve 3-ft.-wide trenches were excavated from the revetment (breast-height wall) to the scarp wall coping stone, eleven on the parapet of the star fort and one on the parapet of the ravelin, to assess construction history and drainage damage. All trenches were excavated to a level equal with the top of the inner fort wall (the stone wall behind the brick outer wall). Additional probing was undertaken in order to locate counterforts at bastion 3 and along the curtain wall between bastions 3 and 4. The excavations revealed the stratigraphic history of the parapet; strata include the 1803 surface, 1837 construction of the revetment wall, 1839 fill, early twentieth century fill, and 1917 utility trench intrusions. It was confirmed that counterforts had been incorporated into the construction of Fort McHenry. A trench across the southern flank of the ravelin recorded its stratigraphic sequence, and revealed a distinct, possibly unique, counterfort system, an innovation of Col. Decius Wadsworth. Strata representing the original 1814 embankment, 1837 additions and repairs (i.e., construction of the revetment wall and replacement of the coping stones), and late nineteenth- through early twentieth-century surfaces were identified.

Op. V

This investigation consisted of monitoring of excavation of six 4-ft.-square units by NPS personnel. The excavations were to expose and record: the exterior of the masonry vaults of magazine 1, bombproof 1, and bombproof 3, all of which were built in 1866; and the back (parapet) side of the 1837-39 water battery revetment (breast-height wall) at two locations. (One inconsequential unit was positioned beyond magazine 3.) The outer surfaces of the vaults of the bombproof and magazines were found to have been coated with bitumen, which was in good condition. Investigation of the revetment uncovered evidence which suggested that reconstruction of the revetment wall in 1839 had left the original 1837 revetment preserved behind it. This interpretation was later determined to be incorrect (Cheek et al. 1998).

Op. VII

In 1975, Stokinger and Blades had recorded a drain extending from the direction of the left flank of bastion 4, terminating at the terreplein wall (1979a). Excavations made in 1984 consisted of a 5 by 7 ft. unit positioned to uncover the drain along the left flank revetment wall. The terminus of the drain on the bastion was not located (see Cheek et al. 1989, however, for further investigation of this drain). Stratigraphic interpretation suggests that the drain was placed on the bastion during the fort's initial construction episode, although uncertainty remained. (Investigation by Kurtz in 1989 of a similar drain in the bastion 3 vicinity yielded evidence which suggested non-original construction.)

Author(s), Date: **James E. Kurtz, 1989**

Title: *(Draft Report) 1989 Archeological Investigations at Fort McHenry National Monument and Historic Shrine.*

Kurtz's 1989 effort, involving examination of historical records and archeological testing, was intended to improve our understanding of the fort's early drainage facilities. The work was an outgrowth of the results and recommendations of a 1988 investigation by John Milner Associates, Inc. (Cheek et al. 1989). The testing methods were a combination of mechanically excavated trenches and hand-excavated test units.

Excavations within the star fort focused on testing to locate drains, with excavations made on the terreplein adjacent to the revetment at the angles where the fort's curtains and bastion flanks joined. Only one drain, in addition to the one previously documented in the bastion 4 vicinity, was found. It was located at the curtain angle of the left flank of bastion 3; in this regard, and in most other respects, this drain resembled the one at bastion 4. Its stratigraphic position was higher, however. Although neither the beginning nor the terminus of the drain was located, and the profile does not show the position of the drain relative to foundation of the breast-height wall, it may be inferred from its height and apparent alignment that the drain's upper end was removed during the 1836 construction of the breast-height wall.

In the test unit at the curtain angle of the right flank of bastion 5, a wooden feature was found which cartographic research indicates may derive from a Civil War era mortar platform (although not necessarily a functional firing platform). Artifacts recovered in association with this feature included a brass buckle and an artillery-shell fragment. A manhole associated with utility lines (electric) was identified in the vicinity of a mechanically excavated trench at the curtain angle of the left flank of bastion 1.

Both mechanical and hand excavations were also undertaken to examine the collapse of a portion of the terreplein above the postern tunnel. The stratigraphic history of the terreplein at this location was recorded, and a possible repair trench for the postern was encountered. The exterior top of the postern was exposed by mechanical expansion of the collapse. A coat of cement covered the top of the postern, presumably to seal it. A brick traverse circle and an associated builder's trench were exposed by the collapse of the terreplein, but were not examined in detail. A gun emplacement at this location is depicted on one historical plan (Gratiot 1835). A stratum interpreted as having possibly been the original ground surface of Whetstone point was encountered near the base of the excavation over the postern, beyond the limits of the builder's trench, at a depth of 7-7.5 ft. below the terreplein's surface. A hand-excavated unit was positioned adjacent to the breast-height wall in the vicinity of the postern to examine the stratigraphic sequence of the terreplein. The infantry banquette along the breast-height wall, which was exposed on the surface to at least 1920, was not identified.

Archeological investigations were conducted exterior to the fort, in the vicinity of water battery magazine 2, primarily to test for a drain depicted, as a proposal, on an 1836 plan (Delafield 1836), and for a ca. 1813-20 tenaille and caponniere, both depicted on Poussin's 1819 plan. Excavations involved four trenches, two adjacent to the scarp wall. The foundation was exposed in the latter trenches, and the builders trench for the scarp and the WPA repointing trench were both identified. Water gushed from between the foundation stones upon removal of the soil matrix abutting them. The nineteenth-century moat surface was located in only one trench. The majority of moat deposits date to the twentieth century. Possible evidence of a cunette, similar to the one identified opposite bastion 3 (Cheek et al. 1989), was also identified in the moat. The mechanically excavated trench positioned the right shoulder of bastion 5, to locate the drain depicted in 1836, failed to locate the drain, but it did reveal remnants of a possible post along the alignment of a palisade depicted on Poussin's 1819 plan. No evidence of the tenaille or the caponniere were found in any of the excavations, however; the excavations were hampered by modern disturbances and inclement weather.

Author(s), Date: David G. Orr, Brooke S. Blades, and Douglas V. Campana, 1982

Title: Final Completion Report - December, 1982; Archeology of Sally Port Paving Project. Fort McHenry National Monument and Historic Shrine, Baltimore, MD.

The report contains a brief review of sally port construction and the results of excavations conducted in the sally port passageway and at the location of the 1813-14 traverse on the parade interior to the sally port. The report contains draft plans, profiles, and photographs.

The excavations documented several features at the sally port and in its vicinity. Evidence was found of two successive surface drains, deriving from the fort's original surface drainage system which encircled the parade at the base of the terreplein's original sloping revetment. The deeper and earlier drain may have been removed when the traverse was built; the later drain would have been removed when the parade wall was built in 1834. The transverse slope of the remnant original surface of the sally port passageway, down toward the middle of the passageway, suggested that there may have been a drain there as well.

The trench-poured mortar foundation of the gateway traverse, constructed in 1813, reportedly of brick, to impede enfilading artillery fire, was approximately 13 ft. long by 8 ft. wide. The date of the removal of the traverse is unknown, but as its function was rendered redundant with the 1813-14 construction of the ravelin, it was very likely removed ca. 1814-15. At the exterior portal of the sally port, remnants of two stone brackets, bonded into the scarp wall, were encountered, beneath the fill of the post-1839 ramp there. Four such brackets had supported both for the original, ca. 1800-13 bridge

into the fort, and its 1814-38 successor(s). Additionally it was noted that the remnant original surface (1839) of the earth ramp into the fort had survived, between utility trenches, with brick dust on it indicative of pavement. Within the sally port passageway, adjacent to the south sally port bombproof entrance, evidence was found of what was interpreted as a repair trench dating from between 1815-44. Two post holes which appear to date to ca. 1815 were identified flanking the interior portal of the sally port; they presumably contained posts for a gate, scaffolding, or falsework, but their precise function could not be determined.

The report also documents the disturbance caused by historic and modern utility trenches. Utility lines have altered most of the sally port passage and destroyed parts of the scarp wall below the entrance. The report concludes with recommendations that further work be undertaken between the ravelin and the sally port. These excavations were undertaken by Stokinger (1983b).

Author(s), Date: Karen L. Orrence, Paula A. Zitzler, and Heather H. Bouslog, 1988

Title: Historic Structure Report, Archeological Data Section, Seawall.

A seawall rehabilitation project was preceded by excavation of ten archeological units and twenty backhoe trenches, to provide basic documentation of the wall's characteristics, to examine its stratigraphic context, and to determine whether or not significant features or concentrations of artifacts were present in areas that would be disturbed during construction. The work was implemented by the Cooperative Parks Studies Unit for Archeology, a cooperative endeavor of the Denver Service Center's Applied Archeology Center and The American University of Washington, D.C.

Concentrations of early nineteenth century artifacts were encountered within fill deposits interior to the seawall northeast of the fort beginning at depths of roughly 2 ft. below grade. These deposits date to the period of, and in some instances prior to, construction of the seawall, and the artifact varieties and densities, and the common presence of bone, reflect the incorporation of kitchen and other refuse into the deposits. Also found was extensive use of oyster shell as fill directly behind the wall; a concentration of building stone in the vicinity of the channel beacon tower, which at first was believed to represent a possible foundation, but which proved upon further investigation to be part of the seawall; and a stone feature which may have been the footing of a late-nineteenth through early twentieth century target butt, adjacent to the seawall southwest of the fort. (One of the original counterforts of the seawall was at the same location as the target butt, a fact not recognized by the investigators; this introduces the possibility of an alternative interpretation concerning the feature's origins.) Several military buttons were also recovered, and bullets were common in the target butt's vicinity. The results of an experimental attempt to determine the composition of the target butt(s)

are presented in an appendix. The data collected from the experiment were insufficient to make such a determination, however.

While the report suggests, based on the implication of an 1829 remark concerning an old brick seawall, that the existing granite seawall is not original, this is very unlikely to be the case. It is much more likely that the remark reflected a misunderstanding about the origins of another feature entirely (i.e., the 1813-14 revetment of the lower water battery).

Author(s), Date: John F. Pousson, 1996a.

Title: Management Report: Supplementary Archeological Data Recovery, Water Battery Breast-Height Wall, Fort McHenry National Monument and Historic Shrine.

Following the completion of data recovery investigations by JMA in 1994, it became clear that additional architectural and contextual data was needed, either to implement an existing design for reconstruction of portions of the water battery's breast-height wall, or to develop an alternative design. At issue was the manner in which the original, 1837 component of the wall had been incorporated into the 1839 component, and the resulting structural composition of the wall. To supply the needed data, Pousson in 1995 directed excavation of a backhoe trench into the battery's parapet southwest of magazine 3, to a depth slightly below that of the footing of the wall, and aided in the partial demolition of a small portion of the wall. The exposure of the parapet side of the wall to its base, and of its stratigraphic context, together with examination of the wall's mortar joints in cross-section, revealed that the 1839 component of the wall consisted exclusively of the uppermost 3.5 ft. of the wall's face and the upper 1.5 ft. of its body. The base of the wall was determined to be entirely of 1837 origin, footed within fill soils deposited beginning in 1836. The stratigraphy of the lower section of the parapet excavation mirrored the stratigraphy of a unit excavated in 1994 at the face (opposite side) of the wall nearby. The pre-1836 ground surface of the area, containing a scatter of early nineteenth century artifacts, was revealed at the base of excavation in both the 1994 unit and the 1995 trench.

Author(s), Date: John F. Pousson, 1996b.

Title: Archeological Observations at the Site of the New Maintenance Shop, 1996. Fort McHenry National Monument and Historic Shrine (18BC13).

Excavations made during 1996 for construction of a new maintenance shop in the extreme western corner of the fort's grounds were accompanied by monitoring, resulting in documentation of a few features, including a 12-in. (?) diameter iron pipe, a buried stack of once stockpiled firebrick, electrical conduit, corrugated drainage pipe, a valve key (?) within a vertical pipe, and the builders' trench of a 1930s maintenance structure. The stratigraphic

context consisted almost entirely of early to mid-twentieth century fill soils; earlier strata that had been heavily disturbed. In one location, in the vicinity of the north corner of the new structure, subsoil was evident directly beneath disturbed soils. No intact nineteenth century surface was observed. Historical documentation of the area's elevations (Brick 1858), along with the finding of subsoil in one location, suggested that the relative height of the boundary wall in this area had been reduced at some point in the past.

Author(s), Date: **John F. Pousson, 1997.**

Title: *Memorandum Report: Documentation of Counterfort System of the Northern Scarp Wall of the Ravelin.*

Rehabilitation of portions of the northern scarp wall of the ravelin in 1997 involved removal of the face of the wall, to a depth of 4.5 ft. below the top of the wall's coping along a 34 ft. section, and to a depth of 2 ft. below the coping along a 20 ft. section. In both sections the core of the scarp wall's counterfort system was revealed, consisting of cross-walls which connected parallel, front (face) and back sections of the wall, at an approximate 4.5 ft. interval, with 3-ft.-wide earth-filled cells between them. The counterfort system had been revealed initially during the course of the park's resetting of a coping stone in early 1984 (Blades 1984), and was more thoroughly documented and interpreted during investigations by JMA later in 1984 (Joseph and Cheek 1985:45-48, Figures 20-22). The 1997 exposure, although limited to relatively small parts of the vertical plane of the interface of the back side of scarp wall's face with the cross walls and earth cells, was otherwise more extensive than previous exposures. Pousson's memorandum report conveyed his observations and a sketch diagram of the partially dismantled wall showing the cross-walls.

Author(s), Date: **John F. Pousson, 1999a.**

Title: *Archeological Investigations, The Southeast Front (Water Battery Vicinity), and Ravelin Dry Moat, Package No. FOMC 276B, Fort McHenry National Monument and Historic Shrine (18BC13).*

Archeological investigations were implemented in 1998 in advance of, and to provide mitigation for, repair and replacement of drainage systems and reconstruction of bombproof 1's revetment wall. Additional data was acquired concerning the substantial modifications of grade associated with the completion, in 1813-14 of the fort's moat and glacis. Notably, southwest of bastion 4, remnants of the banquette or firing step which had been located adjacent to the fort's counterscarp were identified, as were the counterscarp itself and the original surface of the moat opposite the north face of the ravelin. The characteristics of multiple modifications of grade at the site of bombproof 1 were clarified, and questions concerning excavations associated with construction of the bombproof were resolved. A late nineteenth century

drain line was discovered at the entrance of the bombproof. (See also Pousson 1999c.)

Author(s), Date: **John F. Pousson, 1999b.**

Title: *Archeological Monitoring of the Installation of a New Underground Electrical Line, Fort McHenry National Monument and Historic Shrine (18BC13).*

This brief report documented a number of small excavations made in 1999 in connection with the directional-drilling installation of an electrical line to a new maintenance building, through an area developed primarily during the World War I hospital period. A brick walkway to a set of late-nineteenth century non-commissioned officers' quarters and filling associated with nineteenth and twentieth road improvements and landscaping were identified.

Author(s), Date: **John F. Pousson, 1999c.**

Title: *Archeological Monitoring, Construction under Package No. FOMC 276B, 1999, Fort McHenry National Monument and Historic Shrine (18BC13).*

The final report prepared by Pousson in 1999 conveyed observations of features and strata exposed (and artifacts collected) during implementation of drainage repair and replacement work in the vicinity of the ravelin and water battery, and reconstruction of the revetment wall at bombproof 1. Among the features were: remnants of a ca. 1813-14 (?) brick drop inlet for a drain line beneath the postern tunnel, a line which had been thought previously, on the basis of historical documentation, to date to 1834-37; adjacent to the drop inlet, the lower end of an early brick drain from the cellar of enlisted men's barracks no. 2; remnants of a ca. 1795 brick walkway northwest of the upper water battery barracks' west corner; elements of the ca. 1930 and 1963 drainage systems in the ravelin vicinity; and dressed stone from a gun emplacement incorporated into the 1866 poured-concrete footing of bombproof 1. It was suggested that a stratum identified northwest of the ravelin could have been associated in some fashion with the fort's 1814-39 entrance road. (See also Pousson 1999a.)

Author(s), Date: **B. Bruce Powell, 1964.**

Title: *Archeological Report, Armistead Statue Project [Preliminary Investigation of Boundary Wall, Gun Shed, and Stable/Store House Sites.]*

Powell's exploratory-trench investigation was performed on an emergency basis to locate and document the footing of the fort's 1817-37 boundary wall,

so that impacts on the footing could be avoided during construction of a plaza east of the park's then new visitor center. Three test trenches were excavated across the alignment of the wall, as depicted on the historical base map of the fort, and in each trench, remains of walls were revealed. The wall remnants in two of the trenches derived, however, as Powell understood, from the northwestern foundations of the gun shed and the store house. In the remaining trench, located just beyond the northeast end of the store house, the footing of the boundary wall itself was found, consisting of a rubble filled ditch. Powell extended his excavation over the gun shed's foundation in a northeasterly direction to a point at which the foundation's width changed. Although Powell suggested that the change reflected the location of the west corner of the store house, it in fact marked the location of the original north corner of the gun shed, as would be determined during further investigation of the area by Campbell (1964b) and Cotter (1964b).

Author(s), Date: **Edward S. Rutsch, 1978**

Title: *Archeological Investigations of Original Drainage System of Fort McHenry National Monument and Historic Shrine, Baltimore, Maryland.*

The purpose Rutsch's investigation was to help determine the drainage conditions at Fort McHenry, in order to alleviate and hopefully arrest the continuous water damage to walls and buildings. Excavations to examine the postern drain were positioned in two locations, at an inlet to it on the interior of the fort, and where it exits the fort, along the curtain wall between bastions 4 and 5. Excavations were also undertaken along the scarp wall on the exterior of bastion 3, and a park excavation in the moat between bastions 2 and 3 was monitored.

Investigations at the postern drain resulted in the determination that no non-modern deep drains entered the present inlet interior to the fort. However, excavation were not undertaken to the base of the drain because of complications caused by water run-off. Excavations at the salient of bastion 3 gathered information on the dry moat and its role in draining the fort. The investigators hypothesized that the dry moat carried off water that drained through the apparently dry-laid foundation and that this system originally drained all the ramparts. Further investigations at bastion 3 by Cheek et al. (1989) determined that this hypothesis was incorrect. The excavations also uncovered stratigraphic evidence for the construction/destruction sequence of the World War I hospital structures located adjacent to bastion 3. Additionally, a trench dug by WPA workers during the re-pointing of the scarp walls in 1935 was identified. Archival research yielded information pertaining to the original drain of bombproof 1 in the water battery, and its repair in 1939, and a note about a 1949 photograph taken of the exposure, during installation of a city water main, of a small, vault-roofed brick drain, which probably corresponds to the "sewer" depicted on Lee's 1834 plan, extending from the lower end of the caponniere to the seawall.

The report concludes that the fort has a simple but effective surface drainage system, designed to drain the interior of the fort using a combination of gutters and landscaping. The report incorrectly assigns a drainage function to the scarp wall foundation. (See also Aivazian 1982:52-54; Cheek et al. 1989:30, 33-48, and 81-85; Joseph and Cheek 1985: 22-25 and 58-63.

Author(s), Date: **G. Hubert Smith, 1958**

Title: *Archeological Explorations at Fort McHenry, 1958.*

Smith's investigations were undertaken as part of a multi-disciplinary effort (the Historical and Archeological Research Project, or HARP) to increase the National Park Service's understanding of the developmental history of the fort, in order to proceed with planning for a more accurate restoration of the fort. The focus was on the fort's early history, particularly 1813-15, and on features that reflecting the locations and other characteristics of early nineteenth century structures at the fort. Smith targeted his investigations on resources in three areas: the sites, east of the ravelin, of the upper and lower water batteries; the sites, north and west of bastion 2 of the fort's boundary wall and of an early tavern; and miscellaneous locations within the star fort, including that of the probable 1814 flagstaff. The report does not contain a general plan showing the locations of the excavations, but there is a separate plan (NPS 1958b, FOMC/AR1958/2023/001/D20), on file at the park, which show the locations of the excavations exterior to the fort. (See also MacKenzie 1958; Aivazian 1982:23 and Stokinger et al. 1982:66-91.)

The trenches excavated across the sites of the upper and lower water batteries documented the pervasiveness of ground disturbances associated with the construction, ca. 1872-75, of part of a large earthen water battery, and more so with the Battery's ca. 1929 removal. Nothing that could be clearly attributed to either of the two early batteries was discovered, but one complex, enigmatic brick feature was found. Although Smith concluded that this feature had not been associated with the lower water battery, in hindsight it appears more likely to derive from the original, ca. 1776-94 battery than from any later structure. The feature may have comprised footings for a ramp, as discussed above. Another of the features discovered in the same general area, a wall-like alignment of brick, may also have had an early origin. Also revealed were footings of a World War I hospital building, a modern drain line, and a large trench for the 1949 city water main.

The initial trench excavated to locate the boundary wall in the vicinity of the salient of bastion 2 also documented the dry moat and the glacis there. The footing of a section of the boundary wall, located about 75 ft. north of the bastion, evidently continued only a short distance to the northwest of where it was found, but extended about 80 ft. to the southwest, at which point it had apparently been destroyed during construction of one of the World War I hospital building. Another early but enigmatic feature--a stone slab with remnants of a stone footing (?) at its perimeter--was discovered immediately

interior to the boundary wall about 50 ft. from bastion 2's salient. Smith himself did not speculate on the feature's original function, but it may derive from a ca. 1794-98 magazine or bombproof, which, in 1794, Rivardi had recommended be built within the demi-bastion of a hornwork he had also recommended. The northeast wall of the tavern was located very nearly intersecting with the east corner of hospital building no. 54; the corners of the tavern were not exposed, however. Testing of the area of the basement yielded a variety of artifacts, including, in the fill, bomb fragments thought to derive from the 1814 bombardment. Smith's plan also documented a steam line which crossed the foundation of the hospital building, which may also have crossed very nearly over the top of the west corner of the tavern.

Within the star fort, two areas--one in the vicinity of the parade magazine and the other at the site of the ca. 1800-1820 flagstaff--were excavated more-or-less methodically. The report briefly describes non-archeological excavations made in a few other locations--at the southeast corner of enlisted men's barracks no. 1, at the south corner and northeast end of enlisted men's barracks no. 2, and at two locations above the southeastern sally port bombproof. Also noted are small excavations adjacent to the scarp wall of the fort, one at each of its twenty-five angles. A partial record of the elevations of the top of the scarp wall footing is contained in NPS 1958b

The excavation made to locate the flagstaff depicted on 1803 and 1806 plans of the fort was begun as a 10 ft. square but was expanded during excavation and was about 10.4 ft. by 14 ft. when completed. At approximately 7.5 ft. below the parade ground surface, the wooden cross-brace for the base of the flagstaff was exposed. The builder's trench for the brace, only cursorily examined due to ground water, consisted of cross trenches just wide enough for the arms of the brace. There is no indication of the original parade ground surface. The flagstaff brace is currently on exhibit at Fort McHenry.

Investigations at the parade magazine uncovered the remains of a privy along its southwest side, the foundation of a traverse, built in 1813, at its entrance (southeast end), and the footing of an early curtain wall. There was also a small excavation made on the magazine's interior. Smith noted that the privy was not the same structure as had been depicted on an 1834 plan of the fort, but was unable to determine its construction date; the presence of iron and ceramic sewer lines and of a water line, all abandoned, was noted, and the World War I era filling of the privy was evident from the artifacts within the fill. The traverse foundation was 12 ft. in length; its original width (in excess of the surviving 6.4 ft.) could not be determined due to disturbance of its southeast side. Evidence for the early curtain wall, which had enclosed areas on both side of the magazine from ca. 1806 until ca. 1813-14, consisted of alignments of brick.

The excavations at the enlisted men's barracks were made to expose portions of their foundations, and, at the northeast end of enlisted men's barracks no. 2, to investigate a filled areaway exterior to the entrance of that building's cellar. The first of two excavations on the terreplein above the southeast sally

port bombproof (termed dungeon #2), was abandoned when concrete, presumed to be modern, was encountered; a second trench, at the southeast end of this underground structure, resulted in exposure of brickwork, which is noted but not described. The concrete was, in fact, a nineteenth century element of the structure as determined during a 1993 investigation of the northwest sally port bombproof (Cheek et al. 1996). Only modern artifacts were found in the small excavations at the angles of the scarp, suggesting that the dry moat was open to the footer as recently as 1929-30.

Author(s), Date: **William A. Stokinger, 1976a.**

Title: *Fort McHenry National Monument and Historic Shrine, Detached Magazine, Archeological Investigations, 1974-1975.*

The report, a draft, concerns archeological monitoring of the excavation of several trenches and pits for installation of utilities to the Civil War Powder Magazine. It contains sections on background research, historic context, and results of the archeological monitoring; it includes sketch plans and profiles.

The foundation of the magazine curtain wall was documented. The above-grade brick wall and pilasters rest on a slate footing which, in turn, was built upon a poured concrete foundation. No builder's trench was observed, but a possible re-pointing (or slate installation) trench was identified. Additional features identified include concrete pole supports that probably date to the World War I hospital period, and remnants of the magazine's lightning rod grounds. Several abandoned utility lines were encountered. (The pole supports were more fully exposed during installation of conduit to the magazine in May of 2000, revealing that they had a different form and were more massive than they appeared to be when encountered in 1974.) The installation of an alarm system to the magazine involved excavation of a narrow, shallow trench that originated at the park's visitors center, in the vicinity of which a foundation was exposed and identified as that of a World War I hospital kitchen.

Author(s), Date: **William A. Stokinger, 1976b.**

Title: *Fort McHenry National Monument and Historic Shrine, Detached Battery Bombproof B, Archeological Investigations, 1975.*

Archeological monitoring was undertaken during the reconstruction of the revetment and arched entrance of bombproof B. Reconstruction was necessitated by water damage which caused the walls to bow and to begin to unravel. The report, a draft with draft-quality graphics, summarizes the monitoring of the construction and presents results of the background research. The original revetment wall was removed, a new foundation poured over the old foundation and a new brick-fronted cement block wall was constructed. Observed artifacts were collected and photographs were taken

of demolition and construction. Artifacts and photographs are on file at the fort. The original revetment was a 25 in. wide brick veneer wall. The interior of the wall was constructed of a concrete core. (The latter characteristic was not observed at bombproof 1 in 1999, however.) The interior side of the revetment was faced with brick. The original foundation was a rough poured, concrete footing, utilizing stone, gravel, and brick rubble for bulk. The footing was 33-34 in. wide and 14 in. thick. No builder's trench was observed. The initials "D. A. Was[h?]...." was discovered engraved into the concrete by a workman who had been employed during construction of the original revetment. The initials were destroyed during the reconstruction.

The removal and subsequent rebuilding of the entrance arch was monitored. The architectural features of the arch were recorded. Construction exposed portions of the bombproof roof. The roof was constructed of concrete and then covered with bitumen. The bitumen covering was intended to waterproof the bombproof. (See also Anonymous 1975; Joseph and Cheek 1984:48-50; Pousson 1999c.)

Author(s), Date: **William A. Stokinger, 1982.**

Title: *Preliminary Report: 1982 Archeological Investigations, Water main Installation, Fort McHenry National Monument and Historic Shrine, Baltimore, MD.*

This report documents monitoring of the installation of a comprehensive park-wide water supply system. The archeological investigations were to mitigate impacts through pre-construction design changes and the recording of any archeological features that lay within the pipeline's path. The excavations were restricted to the pipeline right-of-way, approximately 4000 linear ft. of trench. Ninety-four excavation units were defined and recorded. The investigations identified over 390 features, including: bridge abutment and pier system between the sally port and the ravelin; traverse base on the sally port's parade side; steam engine house on the parade; Civil War magazine curtain wall; an early nineteenth-century abatis trench or privy in the dry moat; a non-extant segment of the 1834 parade wall; and the 1839 entrance ramp surface. (See also Orr et al. 1982; Stokinger 1983b; Cheek et al. 1989:33-48 and 81-85.)

The report includes 2 brief sections: project background and synopsis of results. The bulk of the report consists of illustrations of historic maps and xerox copies of field profiles. The report does not define the size of the excavation units, nor is there a base map showing individual locations of excavation units. The large number of features necessitated a change in the investigation strategy. The recovery of field data became the priority at the expense of laboratory analysis and report preparation. As a result the report presents lists of features and in general lacks detailed analysis. The field investigations recovered a large amount of stratigraphic data. However, the report only minimally synthesizes this information.

Author(s), Date: **William A. Stokinger, 1983a.**

Title: *Parade Ground Gas Leaks, March-April, 1983. Fort McHenry National Monument and Historic Shrine.*

The report details the archeological monitoring of utility line excavations undertaken to repair leaking gas lines. The report includes sections on historic background, methodology, field results, and three appendices (feature inventory, artifact inventory, and photographic inventory). Augmenting the text are historic maps, plans of the excavations and stratigraphic profiles. However, the information provided by the plan map is minimal. There is no profile or photograph of the one intact segment of parade-ground stratigraphy located in trench 4. The work was generally confined to previously disturbed ground, existing trenches and pits directly associated with prior gas line installation. The goal of the monitoring was to minimize the impact of construction on undisturbed segments of the parade. Once a trench was dug, it was cleaned and the profile examined. Basic data, height, depth, length, coordinates, and soil descriptions were recorded. The report does not provide a detailed map of the location of the trenches. Five trenches were excavated. Since excavations were limited to previously excavated trenches the deposits were considered secondary; thus, none of the soil matrix was screened. The report includes a section on the developmental history of archeological deposits and utility disturbances on the parade. (See also Cheek et al. 1989.)

Trench 1 recovered evidence for the parade ground steam engine pump house. Trenches 2, 3 and 5 encountered deposits associated with modern utility trenches. Finally, trench 4 encountered 20 separate utility lines and a small stratigraphic segment of the original parade ground. In general, the monitoring enabled the repair trenches to be confined to previously disturbed areas. However, in one location undisturbed parade ground stratigraphy was observed and the stratigraphic sequence recorded. The report concludes that due to the large amount of utility-line excavation on the parade, little of the developmental parade ground stratigraphy remains.

Author(s), Date: **William A. Stokinger, 1983b.**

Title: *Brickwalks, Historic Fort Area, March-June, 1983. Fort McHenry National Monument and Historic Shrine.*

Repaving of the sally port entrance was accompanied by archeological monitoring, as this report documents. The report is divided into several sections, including background to the project, monitor location, project impacts, monitor methodology, historic background, prior investigations, results, and conclusions and recommendations. Three appendices are included (feature inventory, artifact inventory, and photographic inventory). The text is illustrated with numerous historic maps, photographs and field drawings. The field drawings include plans and profiles. The field drawings

have not been redrawn for the report. (See also Orr et al. 1982, Stokinger 1982, Stokinger et al. 1982.)

The field work included mechanically excavated trenches and hand-excavated units. The size, shape, and depth of the excavations were determined by the repair work to be performed. Soil matrix was not screened. Monitor trench (MT) 1 was 34.9-ft. backhoe trench from south sally port bombproof to ravelin. The trench excavation identified evidence for 10 paving sequences dating to the 1840s. Several historic and modern utility lines were encountered. MT2 was 30.4-ft. backhoe trench from the north sally port bombproof to the ravelin. Examination of the trench recovered evidence of the paving sequence as well as the remains of stairways leading to the ravelin terreplein. MT3 consisted of the entire area to be repaved in front of the sally port ramp, 20-25 ft. north/south by 120 ft. maximum east/west. The depth varied from 0.3 to 1.4 ft. below ground surface. MT3 was mechanically excavated. Features encountered during the excavation of this area are all related to the paving of the entrance way, modern drainage, and historic and modern utility trenches. MT4 is a mechanically excavated trench 20 by 10 ft. in dimensions adjacent to the ravelin bombproof entrance. Features exposed included paving, ravelin stairway base, and utility lines. MT5 was a hand excavated trench. The trench was 32.5 ft. long, averaged 1.1 ft. wide and averaged 1.7 ft. deep. The excavation of MT5 encountered only utility trenches. MT6 was a 3.5-by-1.7-ft. pit excavated to a depth of 1.7 ft. The purpose of the pit was to place a catchment placement for drainage of the ravelin magazine stairways. Several utility trenches were encountered. MT7 was a 3.7-by-2.2-ft. pit excavated to a depth of 1.9 ft. The purpose of the pit was to place a catchment placement for drainage of the ravelin magazine stairways and the ravelin sump-pump. Excavation exposed a portion of the base of the stairway to the ravelin terreplein and several drainage features. MT8 consisted of a hand and mechanically excavated trench for a drain. The trench led from MT7 to an existing catch basin/culvert. The ravelin terreplein stairway, entrance paving, and gutters were noted during the excavation of the trench. MT10 documented the repaving of the area along the ravelin's east flank. Only the top bricks were removed during this construction, no features were encountered.

Investigations monitored work undertaken on the entrance ramp. Two possible historic road grades were identified. It was found that utility trenches have destroyed the majority of the paving sequence. The repaving of the sally port was also monitored, with the excavated foundations of the sally port arch recorded. Within the fort, repairs were made to the area between the terreplein wall and the sally port. Since archeological work had been undertaken at this location no further information was collected.

All pavement features identified either within the sally port entrance or in the gorge post date the 1830s. No evidence of the original entrance to the fort were found.

Author(s), Date: **William A. Stokinger, 1983c.**

Title: *Septic Tank Installation; Orpheus Grove, May 1983. Fort McHenry National Monument and Historic Shrine.*

Excavation for installation of a septic tank in the Orpheus Grove vicinity of the park, southwest of the statue of Orpheus, was accompanied by archeological monitoring, the results of which are documented in this report. The excavation revealed the presence of a major late-nineteenth century landfill component, containing an abundance of artifacts, as well as ash and building debris. Also revealed was the concrete foundation of the west corner of building no. 29 of the World War I hospital, which had served as a ward. Plan and profile drawing are included by way of documentation. Only limited analysis of the artifacts retrieved could be accomplished, and the report argues strenuously that the absence of archeological testing in advance of construction had been a mistake, and that testing could have resulted in avoidance of impacts on resources. The report argues further that the absence of a detailed history of development of the grounds of the fort, which could have formed the basis for planning and testing, is a serious deficiency.

Author(s), Date: **William A. Stokinger, 1983d.**

Title: *24" Water Main Project, Seawall Road Temporary Relocation and 48" / 24" Water Main Reducer Anchors. Fort McHenry National Monument and Historic Shrine.*

This report documents the monitoring of excavations made during the course of modification of a 1949 city water main in the Whetstone Point vicinity. The report is a hand-printed draft manuscript, with sketch drawings of the locations of excavations and features. The results of the monitoring were ambiguous. While it was apparent, from the elevation of what was evidently subsoil, that substantial grading or erosion had occurred, the possibility of the survival in the vicinity of Civil War era or earlier features could not be ruled out. The most notable features that could be identified were remnants of the foundation of building no. 42, a ward, of the World War I hospital. The report suggests that an investigation of landscape changes on the grounds of the fort, specifically topographic changes, ought to be implemented, and that in the absence of sufficiently detailed background information, the establishment of utility corridors cannot be assumed to have resulted in the complete loss of preserved, significant resources along them

Author(s), Date: **William A. Stokinger, 1983e.**

Title: *Conduit Installation, Parade, Sally Port, and Gorge Corridor, Fort McHenry National Monument and Historic Shrine.*

This monitoring report, a hand-printed draft manuscript, documents that installation of conduit at the fort, between July of 1982 and May of 1983, was confined to alignments disturbed previously by the installation of the park's 1982 water main. The report suggest that archeological monitoring is generally appropriate, with few exception, whenever exiting utility alignment are being employed for installation of new utilities through areas of known archeological sensitivity, because of the likelihood of inconsistencies between the documentation and the as-built characteristics of the alignments, and the possibility, in the absence of monitoring, of the loss of archeological data.

Author(s), Date: **William A. Stokinger, 1983f.**

Title: *Electric Pole Installation, Flag Day, Historic Reservation, 1983. Fort McHenry National Monument and Historic Shrine.*

This report conveys the results of the monitoring of excavations made to install five poles for electric lines for the park's 1993 Flag Day events. The excavations, in the northeast corner of the park, revealed a concentration of historical artifacts in the vicinity of the seawall, near where a set archeological excavations would later be made (Orrence et al. 1988), and detailed, intact stratigraphy directly southwest of the Baltimore Harbor fireboat facilities, very near the site of an early nineteenth through early twentieth century stable. The report suggest that, given the developmental history of the area, pre-1790s resources could be preserved there.

Author(s), Date: **William A. Stokinger and Brooke S. Blades, 1979a**

Title: *Archeological Observations of the Rehabilitation of the Terreplein Wall. Fort McHenry National Monument and Historic Shrine.*

The investigation consisted of archeological monitoring of the reconstruction of about one-quarter of the terreplein (parade) wall, together with limited archeological testing. The project had 6 goals: (1) record details of construction of the terreplein wall; (2) record previously unexposed stratigraphy of the terreplein behind the wall; (3) record any remains of the brick structure shown above the postern on the 1819 map; (4) record any evidence relating to the drainage system of the fort; (5) record any other significant features unexpectedly revealed; and (6) recover and catalogue all artifacts excavated during the project. The sections of the wall that were reconstructed were those behind enlisted men's barracks no. 2 and the southeast end of enlisted men's barracks no. 1. The report records and interprets the exposures of strata and features behind the wall and at its base, and presents historic data on the construction of the wall, as well as archeological data and conclusions. Profiles, plans, and photographs complement the text.

Among the features discovered were: a brick drain which originated at the left flank of bastion 4; robbed foundation trenches for a ca. 1814-20 structure above the postern, depicted on the 1819 Poussin plan; a brick foundation associated with an early twentieth century water closet; and a possible planting feature. (Concerning the bastion 4 drain, see also Joseph and Cheek 1985; Cheek et al. 1989.)

Author(s), Date: **William A. Stokinger and Brooke S. Blades, 1979b.**

Title: *Archeological Observations at Fort McHenry National Monument and Historic Shrine, June-July, 1975.*

A program of archeological observations and limited test excavations was implemented at Fort McHenry in June and early July 1995, during the installation of buried electrical lines for City of Baltimore bicentennial events to be staged July 3-4. A major part of the work consisted of the monitoring of extensive, although narrow and shallow, construction excavations by park staff, which resulted in the exposure of the remains of numerous structures, mostly the concrete foundations of World War I hospital buildings. The report concerns two nineteenth century structures which were impacted by construction excavations, and at which limited test excavations were made: a post-1836 addition to the fort's 1808 stable and store house, which had been investigated previously in the mid-1960s (Campbell 1964b), and an 1820s structure which was first cartographically documented on the 1834 plan of the fort, at which time it served at married soldiers' quarters.

Investigation of the addition to the stable and store house, confined to excavation on either side of the structure's north end wall, revealed distinctive stratigraphy on either side of the wall, some strata predating the addition's construction, others associated with the structure and its mid-through late nineteenth century utilization; three loamy strata were found to have accumulated subsequent to the deposition of a layer of mortar fragments which marked the removal of the building. Numerous artifacts were recovered from the builders' trench, including early nineteenth century ceramic and bottle fragments, and at least one button.

Investigation of the foundation of the married soldiers' quarters focused on documentation of two of its three H-shaped, back-to-back chimney structures (the quarters contained a total of six single room apartments). The perimeter wall foundation was also documented, by small excavations at its north and west corners and at three other locations, as was the presence of remnants of a brick walkway southeast of the entrance to the structure's two southwest rooms. The stratigraphy, along with the preserved features, was indicative of a substantial degree of integrity of the site, despite intrusive modern utilities. Between 1872 and 1929 the site was covered by the earth-fill parapet of a massive water battery.

Author(s) and Date: **William A. Stokinger, Patricia E. Rubertone, and Lawrence E. Babits, 1982.**

Title: *Archeological Investigations at Fort McHenry National Monument and Historic Shrine in 1980.*

The goals of the investigations were to examine five historically documented features: (1) original bridge entrance through the ravelin, (2) ravelin or enlisted men's privy, (3) magazine or junior officers' privy (4) bastion flagstaff base, and (5) the flagstaff base on bastion 5. The report includes introduction, methodology, site history, excavation results, conclusions, recommendations, three appendices (maps reviewed, project reports, and artifact inventory), glossary, and references cited. Four locations were investigated to examine four historically document features. The text includes detailed maps which show the position of individual test units. Based on documentary research, no test units were excavated on bastion 5, the location of the flagstaff base.

Thirty-six 4-by-4-ft., hand-excavated test units were excavated. Based on field evaluations, a determination was made as to whether a particular soil matrix was screened. Consequently, not all of the soil matrices were screened. Soil samples were saved for floatation. Artifact analysis included, cleaning, identification, and conservation.

Investigations at the ravelin privy expanded on those undertaken in 1978. Excavation was undertaken at three locations: exterior of the privy to determine overall depth and look for a drain; interior to recover artifacts and record information on the stratigraphy of the privy; and around the foundation, to determine the lay-out of the privy. The privy overall was 20 ft. long by 7 ft. 10 in. wide; its vault was 17.3 ft. long by 4 ft. wide. It was 7.5 ft. deep from the remnant top of the foundation to the bottom of the vault. A modern terra-cotta drain pipe intersected the southeast corner of the privy. This pipe dates to the 1930s and drained the moat and magazine sump-pump. The stratigraphic sequences for both the interior of the privy and the moat were recorded. The privy had been cleaned at the time it was abandoned. The interpretation of the moat stratigraphy included the assigning of exposed strata to particular episodes of fort construction and repair history. Only a one-tenth of the interior of the privy was excavated. Undisturbed privy deposits were encountered only on the bottom 3 in. of the privy. The analysis of social and economic differences was precluded by the small number of artifacts recovered from undisturbed context.

Five test units were excavated to investigate the ravelin bridge entrance. The test units were located on the ravelin's north side, at the top of the parapet. The location of the test units was guided by cartographic research. The excavations reached a depth of 8 ft. below the ground surface. Four architectural features were encountered: present scarp erected in 1813, ravelin bridge passageway, ravelin bridge gateway, and 1938 scarp fill. Passageway wall had been whitewashed and had been robbed upon abandonment. The

supports for the gates of the ravelin were identified. The text is illustrated with profile and plan drawings, and historic maps showing the ravelin passage. There are no illustrations of the excavations nor are there artifacts photographs. All architectural elements were robbed, including the floor of the passageway. Artifacts recovered were of little use in interpreting the features. No drainage system was encountered.

Cartographic research indicated there were several episodes of latrine construction on the south flank of the parade magazine. These construction episodes date from the second quarter of the nineteenth century through the first quarter of the twentieth century. A privy on the south flank of the parade magazine was excavated by Smith in 1958. Subsequent loss of Smith's field notes and the brevity of the report made a re-evaluation of the privy necessary. The excavations were limited to locating the structure, confirming its size and shape, and evaluating the integrity of any structural remains.

A grid of 16 test units was laid out. The brick paving and 1958 backfill was removed to expose the privy. No soil matrix was screened during this segment of the excavation. The privy is oriented parallel to the parade magazine and 3 ft. 3 in. to the south. The privy foundation walls are 10 ft. long and parallel the parade magazine. The north and south walls are 8 ft. long. The privy contained three compartments: main trough, deck, and urinal. The main trough is 3 ft. 8 in. deep. The top courses of the foundation have a black staining on them. This discoloration represents the lime cinder mix used in the mortar, not evidence of a fire as Smith (1958) believed. The investigations recovered evidence for a robbed and filled ca. 1830s privy. This privy may have burned in 1842.

The investigators also intended to excavate on bastion 5. These excavations were designed to investigate the location of a flagstaff shown on historic maps. In 1980 the outline of a flagstaff was outlined in the brick paving on bastion 5. Documentary research indicated that the first evidence of a flagstaff on bastion 5 is in 1834. In 1932 a steel flagstaff was positioned on the location of the 1834 flagstaff. Because no documentary evidence exists for a flagstaff on bastion 5 during the bombardment, and because the location was disturbed in 1934, no archeological field testing was undertaken.

APPENDIX B

Annotated Bibliography of Selected Historical Maps and Plans of Fort McHenry

Maps and plans have been selected for brief comment here based on their generally broad coverage of the site and the historical importance of the physical development they document. Several notable plans that pertain to particular structures or components of the fort are not discussed, despite the contribution they make to an understanding of those features/components; most if not all such plans, however, are noted in the relevant sections of the report, and are listed, together with other documents, in the references section of the report, by authorship and year. Also ignored here is the multitude of NPS plans which document the post-1933 developmental history of the park. Information concerning the repositories of the plans may be found in the list of references. Bracketing of titles or titles parts indicates that these titles/ title parts do not appear on the maps and plans.

Author(s), Date: **Louis Alexander Berthier (?), Jul.-Aug. 1782**

Title: *Port et Rade de Baltimore [Baltimore, Harbor and Roadstead]*

This map, in the Rochambeau Collection, Geography and Maps Division, Library of Congress (no. 13), is the more polished of two maps of the vicinity of Baltimore by Berthier. The other, "Rade et Port de Baltimore," dated 1781, is in the Berthier Papers, #16 (8), Princeton University Library (Bradford 1958:2, note 7). The dating and attribution of the LC map is based on the inclusion within it, at a smaller scale, of a copy of Berthier's plan of a 1782 encampment (Rice and Brown 1972:180). Fort Whetstone, the earthen star redoubt which preceded Fort McHenry on Whetstone Point, is depicted on both maps. The finer shading of the 1782 map conveys a clearer, more accurate impression of the site's topography. Particularly interesting is its depiction of what looks like a roadway interconnecting the fort's upper and lower water batteries and star redoubt, and of knolls along the point's southeastern shore. These features were again noted by Rivardi in 1794 (Bradford 1958, Appendix 1), and one of the knolls also appears on early nineteenth century plans of Fort McHenry (Poussin 1819, Lee 1834, Delafield 1836). The 1781 map, but not the 1782, depicts a flagstaff at the site.

Author(s), Date: **Anonymous, Nov. 9, 1803**

Title: *[Plan of] Fort McHenry*

The oldest surviving plan of the Fort McHenry. It depicts the water batteries, configured somewhat differently than in 1782, as well as the masonry star

fort, but its coverage does not extend to shoreline. Lightly drawn lines depict incomplete portions of the upper water battery. Usage of structures is indicated by a legend. Color is used to differentiate among landscape surfaces, and shading conveys a limited indication of relief. The plan depicts the original configuration of structures within the fort (including a cistern, a smaller commanding officer's quarters, a smaller magazine, and a smaller enlisted men's barracks no. 1), along with details of the parade ground. The upper water battery is notably labeled the "Old Battery," while the lower water battery is termed the "New Battery"; the barracks within the upper water battery are likewise termed "Old Barracks." Water conduits are shown beneath the rampart at the later site of the postern tunnel, beneath the glacis opposite bastion 1 (which the map labels "3") and bastion 3 (labeled "5"), and beneath the parapet of the northernmost face of the lower water battery. Scale is approx. 1 in. = 7.5 *toises* (45 ft.)

Author(s), Date: **Capt. John deB. Walbach, 1806**

Title: *Plan of Fort McHenry*

This plan uses the 1803 plan as its base, and is very similar to it. Additional, presumably new structures depicted within fort are a guardhouse east of commanding officer's quarters and a barrier wall around the magazine. Fewer trees are shown on the ramparts than in the 1803 plan. The use of dotted lines in the depiction of one of the exterior barracks indicates it is "unfinished" (or removed?).

Author(s), Date: **Capt. William Tell Poussin, 1819**

Title: *Reconnoitering of Chesapeake Bay, State of Maryland: Plan and Profiles of Fort McHenry*

An invaluable detailed plan, which shows various new structures and improvement made ca. 1806-1819 (particularly ca. 1813-15); the plan lacks a legend, however. Hachures, indicative of relief, stippling, iconic vegetation, and blank areas are used to differentiate among landscape surfaces. The profiles indicate the approximate relative elevations of the fort's components, but their vertical scaling is imprecise. Red detailing is used to indicate masonry components (e.g., revetments) of composite structures. Scale is 1 in. = 50 ft.; the original of the plan is split into two sheets.

Author(s), Date: **Anonymous, ca. 1834**

Title: *[Plan of] Fort McHenry, Md.*

A heavily annotated working drawing for the 1833-34 construction of the fort's parade wall, with one cross-section of wall as designed, and a cost

estimate. The plan depicts star fort and ravelin, but not the grounds or exterior structures. Annotations pertain to a variety of work proposed or implemented ca. 1834-35. It is likely to have been used by, and may have been drawn by, Lt. Henry A. Thompson, at the fort. Scale of 1 in. = 50 ft.

Author(s), Date: **Lt. Thomas I. Lee, 1834**

Title: *[Plan of] Fort McHenry*

A three-part plan of the fort and grounds, of buildings within the fort (with a partial elevation and cross-section of a typical residential bldg.), and of three exterior buildings (with elevations). The plan of fort and grounds (at a scale of 1 in. = 100 ft.) indicates usage of all (substantial) existing buildings by means of a legend; hachures are used to indicate relief. The plans of buildings (at a scale of 1 in. = 15 ft., although accompanied by an erroneous graphical scale of 1 in. = 20 ft.) are annotated to indicate room dimensions and specialized, non-residential functions (kitchen, ward, etc.). The plans generally show existing conditions immediately before a far-reaching program of improvements, ca. 1835-40.

Author(s), Date: **Gen. C. Gratiot, Nov. 25, 1835**

Title: *Details for Fort McHenry*

Sketch plan of fort, dry moat, and proposed outer battery, based on the 1819 plan. The outer battery, and an interim plan of the fort armament, appear to be the primary concerns. Annotated with dimensions, this plan may have been employed at the beginning of the survey of the fort and grounds made during 1836 (Delafield 1836). Judging by the plan's use of the 1819 plan as its base, it is unlikely to be fully consistent with existing conditions. Most of the proposed (?) gun emplacements shown within the fort were built, however, including five along curtain between bastions 4 and 5; the latter emplacements were evidently abandoned by 1837. Scale of 1 in. = 50 ft.

Author(s), Date: **Capt. Richard Delafield, 1836**

Title: *[Project for an exterior battery to Fort McHenry.]*

An annotated plan and profile which incorporates a topographic survey of the fort and more particularly of its southeast, south, and southwest grounds; it conveys the completed design for the outer battery, beyond what was first presented in the 1835 Gratiot plan, along with specific details concerning revetment walls, banquettes, grading of site, etc. Except for an advanced ditch and a drain line, which were not built, the design shows basically what would be constructed in 1836-37. The then-existing site topography on the plan is indicated by spot elevations and 3 ft. interval contour lines; the vertical

datum is 'level of high water,' but it appears to be approximately equivalent to modern mean sea level. The profile indicates both existing and proposed grades (with minimum and maximum planes of cutting and filling). Scale of plan is 1 in. = 50 ft., of profile, 1 in. = 20 ft. (A small cross-section detail depicts covered way arranged for infantry at scale of 1 in. = 10 ft.)

Author(s), Date: **Anonymous [Lt. Henry A. Thompson ?], ca. 1837**

Title: *Plan of Buildings within Fort McHenry, Md. 1834.*

A copy of Lee's 1834 plan of the buildings within the fort, superimposed on which are the shot furnace (at the site of the 1834 guardhouse), the sally port bombproofs, and the two 1835 guardhouses built over the bombproofs. An annotation, probably not original to the drawing, indicates that the earlier guardhouse, and the bombproof over the well to its north, were 'pulled down 1837.' Scale of 1 in. = 15 ft.

Author(s), Date: **Henry A. Thompson, 1837**

Title: *[Plan of] Fort McHenry, Md., 1837, with the additional battery ordered by the Chief Engineer in Sept. 1836.*

Plan depicts the fort, dry moat, ravelin, and outer battery, showing progress made on construction of the latter. Certain details on plan (e.g., gun emplacements), very likely had yet to be built, while others (e.g., shot furnaces, magazines) were apparently sketched onto the plan following its preparation. Three profiles show relative elevations of component structures of the fort and battery. The dimensions annotated on profiles (together with elevations above high water) do not precisely match those of the drawings, however. Scale of plan is 1 in. = 50 ft., of profile, 1 in. = 10 ft.

Author(s), Date: **Lt. R. Q. Butler, ca. 1840 (1840a)**

Title: *[Plan of] Fort McHenry.*

A plan of the complete site of the fort, as enlarged in 1836-37; the fort itself is depicted in the same manner as on Smith's 1840 plan, but in less detail. Most of the buildings exterior to the fort (their usage not indicated) are the same as those on Lee's 1834 plan. Three structures which no longer existed were the two ca. 1815 powder magazines, and an unused bakehouse. There are also three new buildings, all within the newer section of the fort: the ca. 1840 hospital, adjacent to the 1837 boundary wall, and two of the three ca. 1840-43 stables. (The hospital, the stables, and the enlisted men's barracks within the fort were the subjects of other Butler plans of 1840). Spot elevations throughout the site, and possibly the three-foot-interval contour lines in the vicinity of the fort, between the outer battery and the seawall, are

likely to have been added to the plan in the 1860s or 1870s; the spot elevations in the area of the 1836-37 addition to the property of the fort appear to derive from Brick's 1858 plan. Pencil (?) markings northwest of the fort appear to reflect planning for alternative horn works, which were proposed in 1861. Scale of 1 in. = 100 ft.

Author(s), Date: **Lt. R. Q. Butler, June, 1840 (1840b)**

Title: *Plat of the Lotts of Land Belonging to the General Government on which Fort McHenry is Erected.*

Plat of lots 34, 35, and 60-76, conveyed to the U.S. between 1795 and 1836, on land at Whetstone Point originally named 'Upton Court'; shown on the plat are two roadways (one 'Fort Ave.,' the other a 'paper' road) which intersected at the later location of Fort McHenry's original gateway. Included are a metes-and-bounds survey, referencing monuments incorporated into the 1837 boundary wall, and a tabulation of former owners, lots owned, acreage, and dates of conveyances. Prepared following 1836-37 enlargement of fort. Scale of 1 in. = 5 perches. (Smaller scale versions of the plat and of the property conveyances table are contained in RG 77, Fortifications Map File, Dr. 189, Md. 2-1--2.5.)

Author(s), Date: **Capt. Fred A. Smith, May 5, 1840**

Title: *[Plan of] Fort McHenry, Baltimore, from dimensions furnished by Capt. Henry A. Thompson.*

One of the most detailed plans and set of profiles of the fort ever produced. Like Thompson's 1837 plan, it depicts the fort, dry moat, ravelin, and water battery, but with numerous dimension lines around fort. Except, apparently, for the outer battery's shot furnaces, which are shown on the plan, but were not actually built until 1842, the plan depicts the as-built characteristics of the fort following the completion of the 1835-40 program of improvements. The profiles are annotated with dimensions that differ slightly from drawings. Included as details are a profile and cross-section of the postern tunnel, and a plan and cross-section of the parade magazine. Annotations concerning dry moat drainage system convey additional data concerning relative elevations. The materials of structures, and of landscape surfaces, indicted by color, are given by the legend, which also indicates the usage of buildings. The caliber of ordnance to be mounted is noted for each position. Use of the plan at the beginning of the Civil War is indicated by sketched lines showing proposed modifications of certain gun emplacements, and by the abatis, built in 1861, sketched on two of the profiles. Scale of plan is 1 in. = 50 ft., of profile (and details), 1 in. = 10 ft.

Author(s), Date: **Lt. Samuel Brick, Feb. 27, 1858**

Title: *Plan and Sections of Drill Ground at Fort McHenry.*

The descriptive subtitle of this plan, which encompasses the 1836-37 addition to the ground of the fort, indicates that it "including ordnance store-rooms, stables, hospital grounds, hospital, and graveyard"; the plan shows roughly two-third of the fort itself, in outline, but does not shown most of the original grounds. A legend is provided which indicates the usage of structures, together with an explanation of the "leveling" and boundary survey which the plan also conveys. Spot elevations, above a high water datum, are given at grid-intersection intervals of 100-200 ft. Most basically, the plan show the status of development of the addition to the grounds prior to the Civil War. Sketched on the plan, more clearly than on Butler's ca. 1840 plan, are the alternative horn works proposed for construction in 1861. Scale of the plan, and horizontal scale of the sections, is 1 in. = 100 ft.; vertical scale of the sections is 1 in. = 25 ft.

Author(s), Date: **Col Henry Brewerton, Sept. 17, 1861**

Title: *[Plan of] Fort McHenry, Md., Showing positions of the guns, etc.*

Outline plan of the fort, ravelin, and outer battery, showing locations of all the fort's armament, including those not mounted, but stockpiled on a rack on the glacis north of the fort. A legend identifies armament by type and caliber (A more detailed listing of the armament is in Brewerton's letter of Sep. 17, 1861 to Gen. Totten, which transmitted the plan; see Thompson and Newcomb 1974:61-63). Plan reflects changes made in the deployment of guns at the beginning of the Civil War. Scale of 1 in. = 50 ft. (The bastions on this plan are numbered differently than they are at present, bastion 1 being equivalent to bastion 5, bastion 5 to bastion 1, etc.)

Author(s), Date: **Pvt. Robert R. Moore, July 17, 1864**

Title: none

Although more of a sketch than a plan, and very distorted in its rendering of the size and layout of structures, Moore's drawing is perhaps the most informative concerning the Civil War period construction on the grounds of the fort. Various tents, as well as buildings, are depicted, and the uses of structures are indicated by a legend. Also shown are the palisades and abatis at the fort. Moore's letter of July 17, 1864, with which he sent the drawing to his mother, provides additional descriptive information concerning the fort. (Ashcraft 1964). No scale.

Author(s), Date: **Anonymous, Oct. 17, 1864**

Title: *[Plan of] Fort McHenry, Md., showing Armament.*

Armament plan which depicts the 1862-64 changes in the arrangement of guns at the fort. The plan indicates that several rifled 32-pndrs. had been mounted, and that consideration was being given to the construction of emplacements (shown in red) for six 15-in. Rodman guns, two of them in the fort, four in the outer battery. (A plan dated Oct. 24, 1864-- RG 77, Dr. 51, Sht. 26--and sketches dated May 26 and 28, 1865--RG 77, Dr. 51, Shts. 33, 34--conveyed the final plan and construction details for the five 15-in. gun emplacements that were built in 1865, one in the ravelin and four in the outer battery.) No scale. (Additional armament plans, "armament sheets," and plans of the fort's "covering lines" for 1865 through 1902 are contained in RG 77 Dr. 251, Sht. 24-1 to 24-25, and Dr. 259, Shts. 84 and 121.)

Author(s), Date: **Capt. Charles M. Turnbull / Engineer Dept., Nov. 15, 1864**

Title: *Sketch of Fort McHenry Showing Out Buildings.*

This general plan was prepared and transmitted along with a plan of the detached (Civil War) magazine (RG 77, Dr. 51, Sht. 28). It is somewhat less distorted, but also less detailed, than Moore's 1864 sketch; it omits a depiction of the ca. 1855 chapel, and misidentifies the commanding officer's quarters as being the chapel. Color is used to differentiate between frame and brick structures; nearly all frame structures are described as temporary, including a few on the original grounds of the fort that were nearly fifty years old. A legend indicates uses of structures. Ordnance storerooms near cemetery are foundations only, but one of them is the site "proposed for artillery shed." Scale of 1 in. = 100 ft.

Author(s), Date: **Maj. Wm. D. Craighill / Corps of Engineers, June 30, 1866(1866a)**

Title: *Sheet No. 1. Plan of Water Battery at Fort McHenry, showing progress and positions of improvements.....*

Together with sheet no. 2 of this set of two drawings (Plans and Sections of Service Magazines...; RG 77, Sht. 51, Dr. 39), this plan documents the as-built characteristics of the underground structures within the fort's outer (water) battery, and modifications (both already made and proposed) of grades and drainage systems. New drains, one from bombproof 1 extending in the direction of seawall, another from west entrance of magazine 3 to the cunette, are shown in red. A profile through the water battery's parapet, breast-height wall, and terreplein, is color-coded for differentiation, in the legend, among

originally planned, existing, and proposed grades. Scale of plan is 1 in. = 50 ft., of profile 1 in. = 5 ft.

Author(s), Date: **E.A. Bancroft (?), Post Quarter Master, ca. 1867**

Title: *Plan of Buildings at Fort McHenry, Md.*

Another sketch plan showing the approximate locations, sizes, and configurations of building in the fort itself and on the grounds. A number key used by the legend to identify (and locate) buildings. The plan documents the construction of new officers' quarters ca. 1865-66, as well as various other new construction/building modification. No scale given but it is approximately 1 in. = 100 ft.

Author(s), Date: **Anonymous, 1872-73**

Title: *[Plans, elevations, and sections of buildings.]*

A set of simple building plans, etc., most of them evidently by the same drafter, which appear to have been prepared as basic documentation of characteristics of structures following a period of development--construction of new bldgs. and enlargement of old. (RG 77, Misc. Forts File, Series B, 11-44.) Included are plans of the commanding officer's quarters (1813 hospital), officers' quarters (1865-66), barracks (var. dates), the ca. 1840 hospital, the artesian well with a proposed steam engine (1873), shops, the ca. 1855 chapel, a boathouse, stables, etc. Scales, where indicated, vary from 1 in. = 5 ft. to 1 in. = 20 ft. A general sketch plan of the fort, with a key which identifies the buildings by function (Anonymous 1873c; RG 77, Misc. Forts File, Series B, 45), provides the basis for determining the locations and use of the buildings.

Author(s), Date: **Anonymous, 1873 (1873a)**

Title: *[Plan of] Fort McHenry, Md.*

Yet another sketch plan of the fort and its buildings, documenting the removal of various older structures in the vicinity of the "new water battery in course of construction," as well as the addition of new structures. Although lacking a scale, and distorted, the plan is very detailed, with a number/letter key to identify structures (including such minor structures as privies and hydrants), and a symbol key to identify the location of a 3 in. water line (ca. 1861), roadways (and paths), and "trees in boxes." Fences and walls are also depicted, many of them identified by annotation on the plan. Added to the legend after the plan's original drafting is a note that the shot furnace in the fort had been "torn down." (RG 94, Records of the Adjutant General's Office, Records of the Record and Pension Office[?], Medical History, Buildings at Fort McHenry, Roll 42. A negative photostat copy is on file at

park (FOMAC, HS1873, 017, D9. A copy of a very similar plan dating to 1874 is also on file at the park)

Author(s), Date: **Anonymous, 1873 (1873c)**

Title: *[Plan of] Fort McHenry, Md.*

A sketch plan similar to others of the period, with a number key employed to identify and locate structures; the same number key is also used to identifying structures on the individual bldg. plans in the Series B, 11-44 set (RG 77, Misc. Forts File). Scale of 1 in. = 100 ft.

Author(s), Date: **Anonymous, var.**

Title: *[Plans, elevations, and sections of buildings: plans and sketches of other structures.]*

Plans, etc., many of them detailed, depicting structures built or modified during the 1875-1908 period, primarily in the 1878-99 period. (RG 77, Misc. Forts File, Series B, 46-47, 66-77, 79-103.) Included are plans for: additions to the commanding officer's quarters (1875, 1887); a proposed schoolhouse, which became the post's chapel (1879); hospital steward's quarters (1886); alteration of the former junior officers' quarters in the fort into post bakery (1894), a new post hospital (1895), etc. A few plans of landscape features (wharf, target range, brick walks) are also included in the series. Scales vary.

Author(s), Date: **Office of the Chief of Engineers, Aug. 1886 (1886b)**

Title: *[Plan of] Fort McHenry as proposed by the Board of Engineers, 1870-71.*

A detailed, relatively accurate plan of the entire fort site, with one profile. The entire proposed 25-gun water battery is depicted in detail, as is the fort itself. Various existing, and a few non-existing (e.g., shot furnace) structures are shown, while a few others (e.g., commanding officer's quarters) still existing are omitted. Details appear to derive from earlier plans, ca. 1870-71. The basic purpose of the plan is to depicts the seacoast defensive elements of the fort, existing and proposed together, in the 1870-86 period. The profile, annotated with elevations above high water, extends from the parade; through the fort's terreplein, ramparts, and dry moat, the old outer battery, and a portion (one not built, but depicted as if it had been) of the new water battery; out to the seawall. The three traverses of the water battery that had been built are numbered; the outlines of the concrete magazines incorporated into the traverses are depicted in red. Scale of plan is 1 in. = 50 ft., of profile, 1 in. = 50 ft. A letter report which accompanies the plan provides a capsule history of the fort, and brief discussions of the 1873-76 construction of the new water

battery, and of the cession of the northern corner of the fort's grounds for construction of a dry dock. It also describes the gun emplacements in the fort -- '8 old f[ront] p[intle] platforms - abandoned; 2 old wooden center pintle platforms for old 10 in. columbiads' -- and the armament mounted -- '5 15" guns in water battery, 1 10" columbiad on no. 5 - main work [right face, bastion 3], 3 10" siege mortars in exterior battery [on outer battery terreplein west of magazine 3] (wood platforms - for drill purposes only), 1 8" siege mortar - main work [bastion 4 center].' Another version of the plan, also dated 1886 but differently formatted (at a scale of 1 in. = 100 ft.), is in RG 77, Misc. Forts File, Series B, 78.

Author(s), Date: **Office of the Quartermaster General (?), Dec. 1888**

Title: *Plan of Fort McHenry.*

The first of a series of detailed, accurate, existing-conditions plans that continued to be produced at an irregular interval until the fort's closure in 1912, and beyond. The plan documents, among other things, the extension of a water main from the City of Baltimore's system into the fort, and the branching of the water supply system throughout the fort; the installation of sewer lines between most occupied structures, or nearby water closets, and the seawall; the system of walkways and roadways (brick sidewalks, as well as brick buildings, are differentiated in the original); and fenced yards. The incomplete water battery is also depicted. Scale is 1 in. = 50 ft. (The plan is very similar to RG 92, Blueprint File, Fort McHenry, 1, an undated ink-on-paper plan drawn at a scale of 1 in. = 100 ft.)

Author(s), Date: **Lt. J. L. Wilson, 1894**

Title: *Plan of Fort McHenry.*

Among the clearest, most complete, and most detailed topographic plans of the fort and its grounds ever produced. The plan is ink on paper (despite its Blueprints File grouping), and is similar, overall, to the 1888 plan of the fort, but more finished. It depicts additional changes in the array of structures and utilities at the fort, as well as roads, walkways, fences, etc. The material of the structures is indicated, and the plan also depicts the site's topography, with contour lines at a 3 ft. interval. Scale of 1 in. = 50 ft.

Author(s), Date: **William A. Wansteben, Jan. 1903**

Title: *Topographical Map of Military Post, Fort McHenry, Baltimore, Md.*

Additional documentation of the fort in the early twentieth century. The map, an annotated blueprint, shows the fort, gun emplacements, buildings, utilities, roads, a proposed wharf, etc. Scale is 1 in. = 75 ft.

Author(s), Date: **J. M. Hinton, 1907 - 1910**

Title: *[Map of] Fort McHenry, Maryland.*

A series of three annotated blueprint maps authored by Hinton, dated 1907, 1908, and 1910. The annotations concern new roads and buildings, and building alterations. Scale is 1 in. = 100 ft.

Author(s), Date: **C. H. Stone, 1912, 1914**

Title: *[Topographic Maps of] Fort McHenry.*

The final two general maps/plans of the fort, prior to the brief period of development of recreational facilities by the City of Baltimore, 1915-17, and of U. S. Army General Hospital No. 2, 1917-20. The maps show site topography, fort, buildings, utilities, roads, walkways, an athletic field, a band stand, etc. Also shown is the property, 3.25 acres, transferred to serve as site of the Port of Baltimore's U.S. Immigration Station. Scale is 1 in. = 100 ft.

Author(s), Date: **Max Toltz, 1917 - 1918**

Title: *Fort McHenry, Topographical Map.*

The maps credited to Toltz, the supervising engineer for construction of General Hospital No. 2, document the physical development of the hospital in considerable detail, and provided the base for special-purpose plans developed at the same time (e.g., Rutsch 1974, Figure 15). A number key is incorporated into the plan, to locate and identify building. Topography is conveyed by 1-ft.-interval contour lines. The specific whereabouts of the originals of these maps, copies of which are on file at the park, is at present uncertain, although they are undoubtedly in the collections of the National Archives. The source of the park's copy of the 1918 map is listed, further, as having been the 'Completion Report, Fort McHenry (1917-1919).' Scale is 1 in. = 50 ft.

An annotated blueprint of a utilities-plan variant of the Toltz map, with a date of March 15, 1927, on file at the park [FOMAC, WW27, 006, D6], indicates that the U.S. Army continued to employ Toltz's plans during the ca. 1925-27 removal of the hospital, at the beginning of the period of the army's restoration of the fort.

APPENDIX C

**A Tabular Chronology of Archeological Investigations at
Fort McHenry National Monument and Historic Shrine**

Year	Areas / Features Investigated	Report Author(s) / Date	Park Accession No.¹	Year	Areas / Features Investigated	Report Author(s) / Date	Park Accession No.¹
1958	Boundary wall, tavern, upper and lower water batteries, 1803 flagstaff, powder mag., misc. other features/locales	Smith 1958 (see also MacKenzie 1958)	Acc 103 & Acc 150 (Acc 150 is assigned to flagstaff brace)	1984	Star Fort, Dry Moat, and Water Battery	Cheek and Joseph 1984; Joseph and Cheek 1985	Acc 235
1958	Star Fort Residential Bldgs.: Cellar window wells, areaways, and cellar of Bldg. E.	Cotter and Nelson 1958	Acc 107	1984	Star Fort Rampart (Remote Sensing)	Anonymous 1984	no collection
1961	Brick Drain beneath Parade Ground	Cotter 1961	Acc 144 ²	1986-87	Seawall	Orrence et al. 1988	Acc 298
1963	Upper Water Battery (Ravelin) Barracks	Carson 1963; Campbell 1963	Acc 116	1988	Star Fort and Dry Moat	Cheek et al. 1989	Acc 297
1964	1819 Entrance Road	Cotter 1964a	Acc 144?	1989	Star Fort and Dry Moat	Kurtz 1989	Acc 315
1964	Boundary Wall, Gun Shed, Store House, and Hospital	Powell 1964; Campbell 1964a?, 1964b; Cotter 1964b	Acc 142 (Powell) (Acc 139?; Acc 144?)	1993-95	Star Fort, Dry Moat, and Water Battery	Abel 1994; Abel and Cheek 1996; Pousson 1996a; Cheek et al. 1999	Acc 340 and 350
1966	Gun Shed, Store House, Hospital, Tavern, and Upper water Battery Barracks	Cotter 1966a	Acc 139 ³	1996	New Maintenance Building Construction Monitoring	Pousson 1996b	no collection
1966	Bldg. E Kitchen (Cellar)	Cotter 1966b	Acc 139	1997	Ravelin Scarp Wall	Pousson 1997	no collection
1973	(various locations)	Cotter 1973	no collection	1998	Star Fort Breasts-Height Wall Construction Monitoring	Pousson 1999a, Appendix C	Acc 370
1974	Dry Moat Drainage / Postern Drain	Rutsch 1974	no collection?	1998	Dry Moat, Water Battery and Ravelin Vicinities; Postern Drain	Pousson 1999a	Acc 371
1974-75	Civil War Powder Magazine	Stokinger 1976a	Acc 358?	1999	Various Locations - Construction Monitoring	Pousson 1999b	Acc 371
1975	Parade Wall	Stokinger and Blades 1979a	Acc 358?	1999	Dry Moat, Water Battery and Ravelin Vicinities; Postern Drain - Construction Monitoring	Pousson 1999c	Acc 371
1975	Battery Walkway, Scarp Wall French Drain (Construction Monitoring)	Stokinger 1975a, 1975b	Acc 358? (Acc 144?)				
1975	Bombproof B (Bombproof 2)	Stokinger 1976b	Acc 358?				
1975	Stable (Store House) and Married Soldiers Quarters	Stokinger and Blades 1979b	Acc 358				
1978	Star Fort and Ravelin Structures	Aivazian 1978, 1982	Acc 183-185 (& 199?)				
1980	Star Fort and Ravelin Structures	Stokinger et al. 1980, 1982	Acc 190				
1982	Sally Port Paving Project	Orr et al. 1982	Acc 271				
1982-83	Various Construction Monitoring Projects	Stokinger 1982, 1983a, 1983b, 1983c, 1983d, 1983e, 1983f	Acc 243, Acc 271?, & Acc 295?				
1984	Brick Drain in Gorge / Ravelin Scarp Wall	Blades 1984	no collection?				

¹ This listing of accession numbers is based on sometimes ambiguous entries in the accession ledger, and it has not been checked against the contents of the particular collections and associated records.

² Acc 144 was initially assigned ca. 1966 to a box of artifacts, presumably received from Cotter, containing artifacts collected ca. 1961-1965. Among tags included in accession folder is one marked "1961 - water line in fort"; also included were tags for miscellaneous finds made during the 1970s and 1980s, including one marked "1975 - French Drain, Curtain #5."

³ Acc 139 was explicitly assigned to material from Cotter's 1966 investigations, but other material may also have been included.

The watermark on the front cover of this report is a detail from *A View of the Bombardment of Fort McHenry*, an 1816 drawing by John Bower. The image on the back cover is from *Bombardment of Fort McHenry, September 13, 1814*, a watercolor by an unknown artist, depicting Fort McHenry (lower right), the Lazaretto at Gorsuch Point (lower left), the boom and sunken ships blocking the channel into Baltimore Harbor, and, in the distance, the British fleet engaged in the attack on the fort. The watercolor is undated but is believed to have been made during or soon after the bombardment. The originals of both images are in the collections of the Maryland Historical Society, Baltimore.

