

BUILDING DESIGN FOR HOMELAND SECURITY

Unit X

Building Design Guidance



FEMA

Unit Objectives

Explain architectural considerations to mitigate impacts from blast effects and transmission of chemical, biological, and radiological agents from exterior and interior incidents.

Identify key elements of building structural and non-structural systems for mitigation of blast effects.



FEMA

References

FEMA Building Vulnerability Assessment Checklist, Chapter 1, page 1-46, FEMA 426

Building Design Guidance, Chapter 3, FEMA 426

FEMA 430, Primer for Incorporating Building Security Components in Architectural Design

Unit Objectives (cont.)

Compare and contrast the benefit of building envelope, mechanical system, electrical system, fire protection system, and communication system mitigation measures, including synergies and conflicts.

Apply these concepts to an existing building or building conceptual design and identify mitigation measures needed to reduce vulnerabilities.



FEMA

Layers of Defense

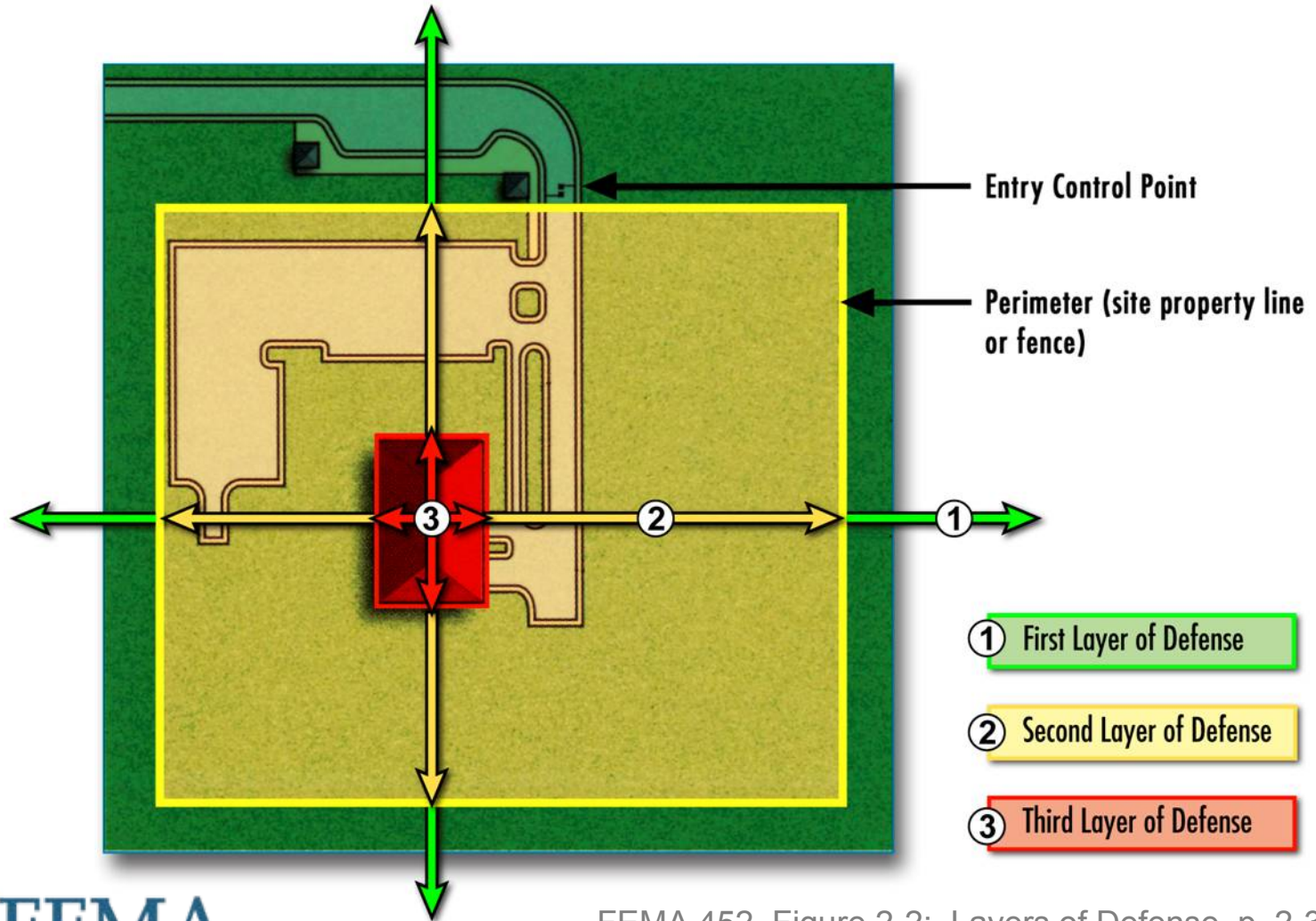

FEMA

FEMA 452, Figure 2-2: Layers of Defense, p. 2-3

BUILDING DESIGN FOR HOMELAND SECURITY

Unit X-4

Third Layer of Defense

Stand-off Distance – primary impact on design and construction of building envelope and structure against design basis threat (explosives)

To protect against unauthorized vehicles approaching target buildings

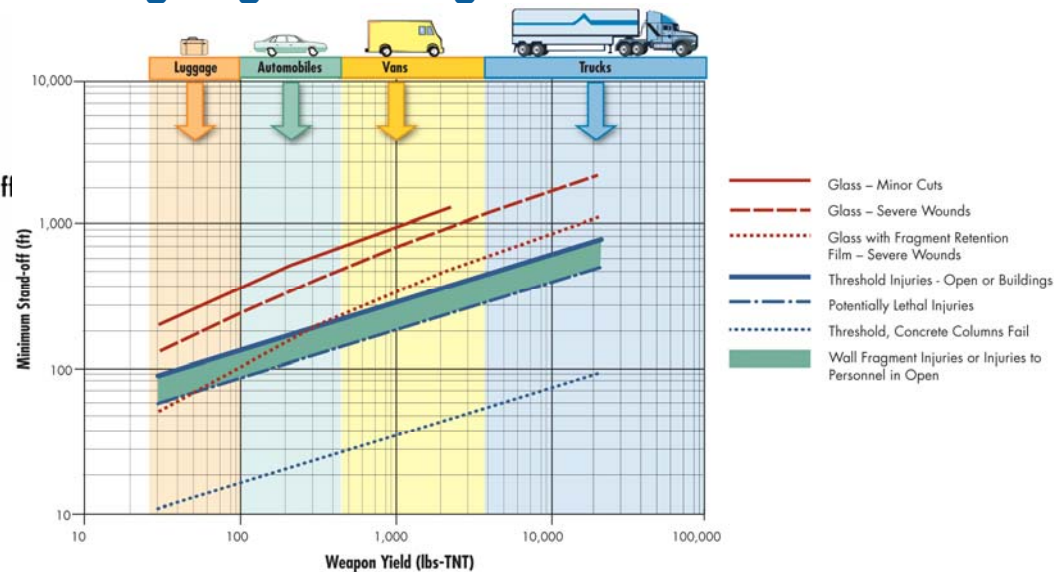
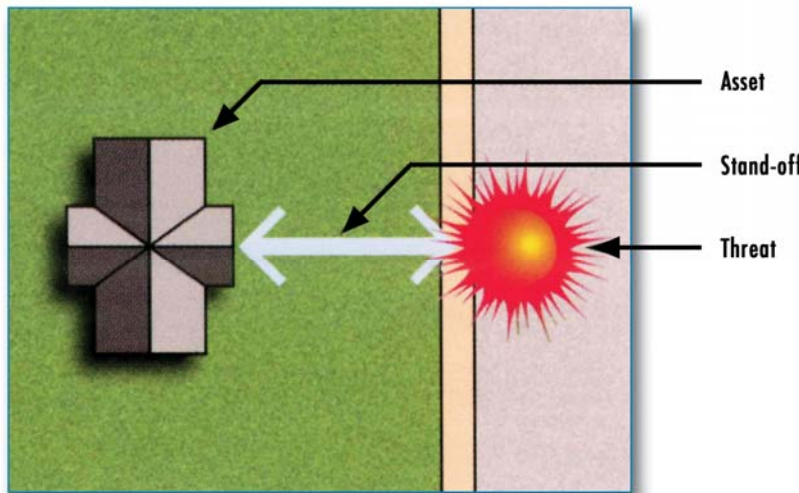

FEMA

FEMA 426, Figure 2-8: Concept of stand-off distance, p. 2-22 (left)
FEMA 426, Figure 4-5: Explosive blast range to effects, p. 4-11 (right)

Third Layer of Defense

Stand-off versus Given Hardening

- Red – Very severe damage, possible collapse
- Yellow – Very unreparable structural damage
- Green – Moderate repairable structural damage

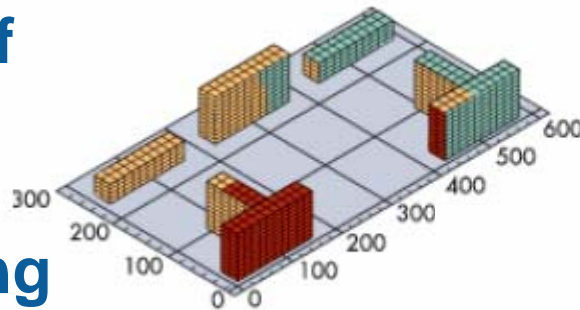

Detonation at 80 feet

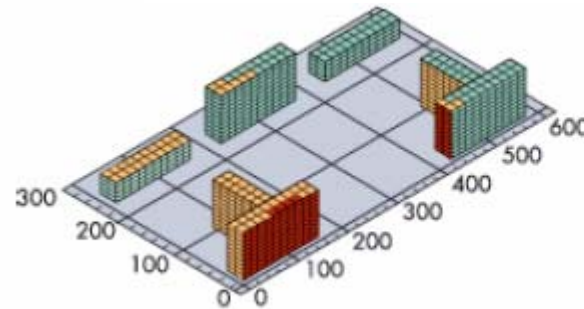

**Detonation at
171 feet**

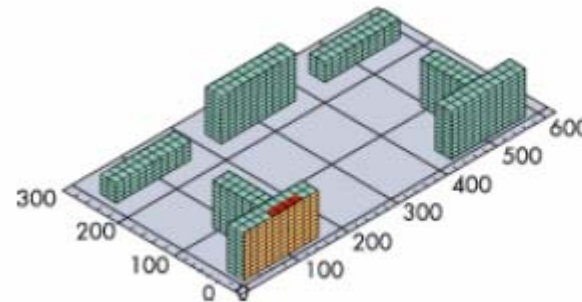

**Detonation at
400 feet**

FEMA 426, Figure 4-9: Stand-off distance versus blast impact
– Khobar Towers, p. 4-15



FEMA

Third Layer of Defense

Hardening

Less stand-off requires

- More mass
- More steel
- Thicker and stronger glass
- Better door and window frame connection to building/wall



FEMA

Third Layer of Defense

Layers of Defense	Architecture	Structural Systems	Building Envelope	Utility Systems	Mechanical & Electrical Sys	Plumbing & Gas Systems	Fire Alarm Systems	Comm - Info Technology Sys	Equipment Ops & Maint	Security Systems
First Layer										
Second Layer										
Third Layer										



FEMA

Third Layer of Defense

When hardening a building, the following should be considered:

- Progressive collapse
- Appropriate security systems
- Hardening the building envelope
- Appropriate HVAC systems to mitigate CBR
- Hardening the remaining structure
- Hardening and location of utilities



FEMA

Architecture – Building Configuration

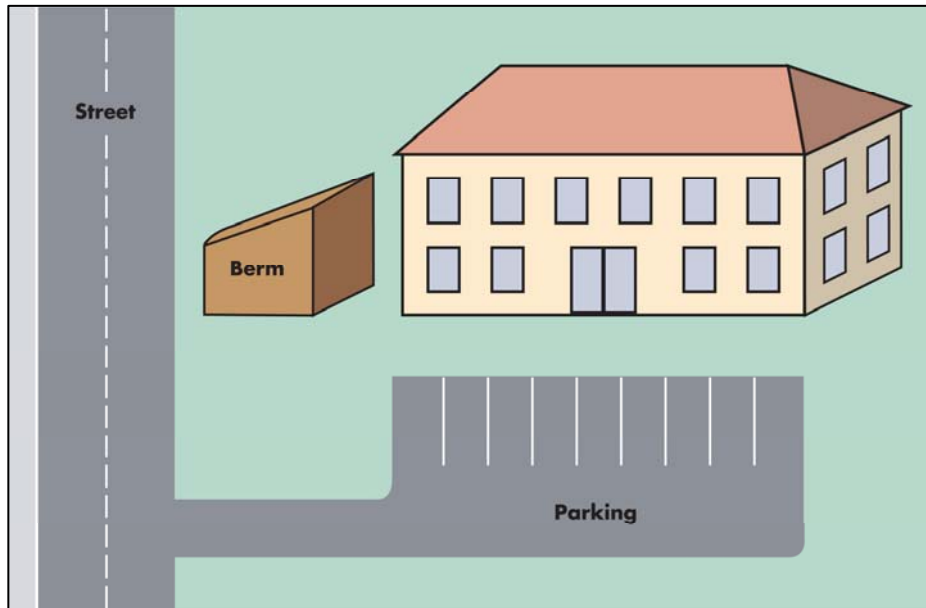

Low, Large Footprint

Tall, Small Footprint

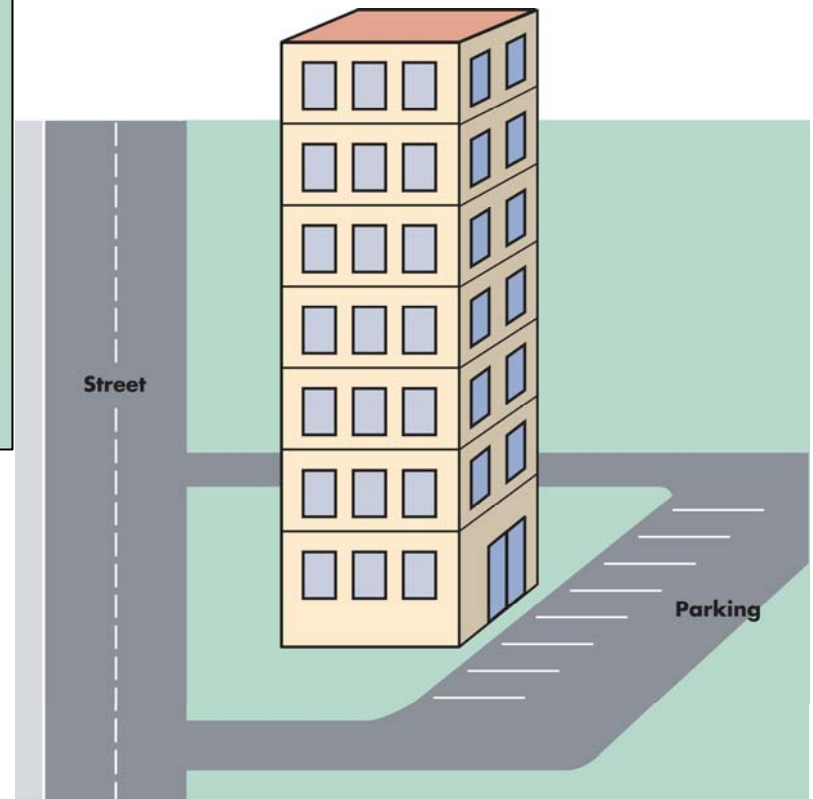

FEMA

Architecture – Building Configuration

Rectangular versus
“U”, “L” or “E”

Avoid re-entrant corners

Flush face versus eaves
and overhangs

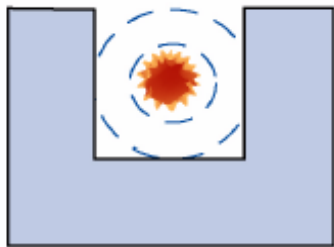
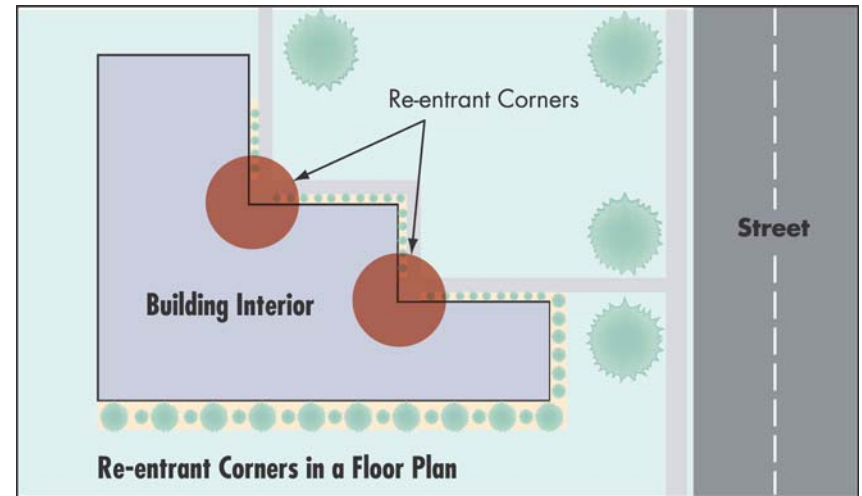

Plan

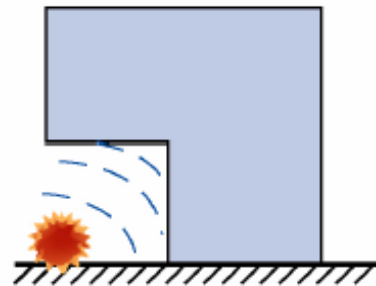

Elevation

**Shapes That
Accentuate Blast**



FEMA

FEMA 426, Figure 3-2: Re-entrant corners in a floor plan, p. 3-6
FEMA 427, Figure 6-3: Effects of building shape vs. air blast, p. 6-9

Architecture – Building Configuration

Hardening – Story height vs Stand-off

- Hardening of first three floors is critical as these take brunt of blast
- At third through sixth floor, hardening can be reduced due to reflection angle
- Above the sixth floor, conventional construction may be sufficient depending upon design threat and reflections off adjacent buildings

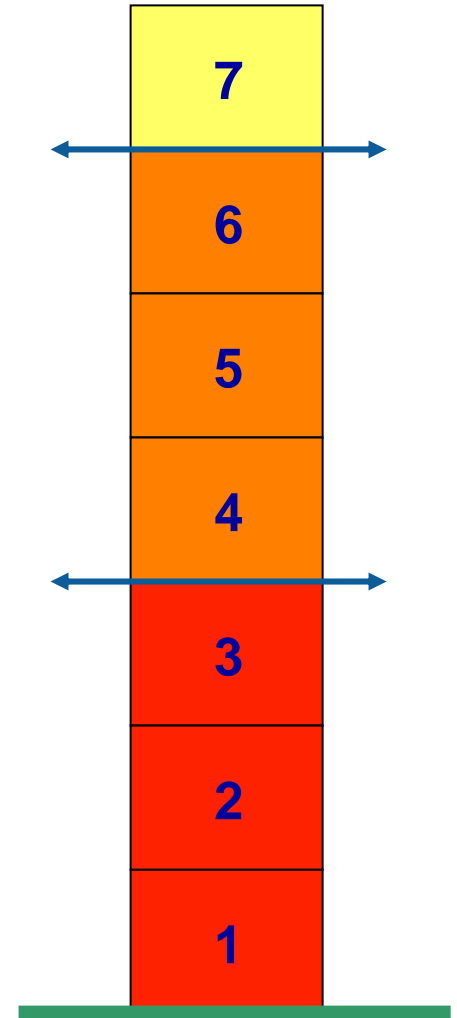

FEMA

Architecture – Building Configuration

Ground floor elevation 4 feet above grade

Orient glazing perpendicular to principal threat direction

Avoid exposed structural elements

Pitched roofs and pitched window sills

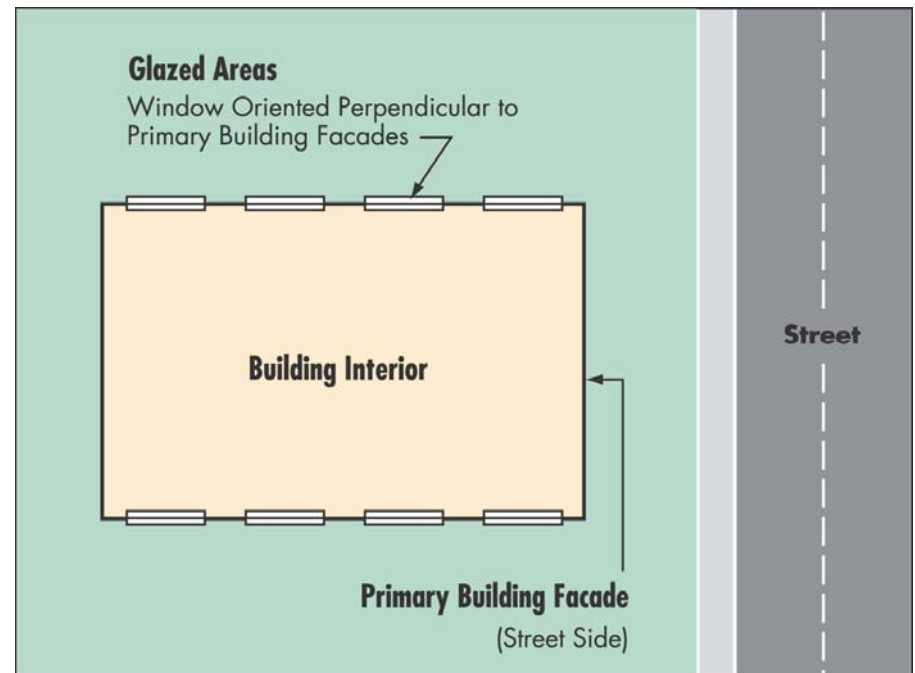

FEMA 426, Figure 3-1: Glazed areas perpendicularly oriented away from streets, p. 3-5



FEMA

Architecture – Building Configuration

Loading Docks

- Avoid trucks parking in or underneath buildings
- Design to prevent progressive collapse
- Ensure separation from critical systems, functions, and utility service entrances
- Separate loading docks from building critical functions

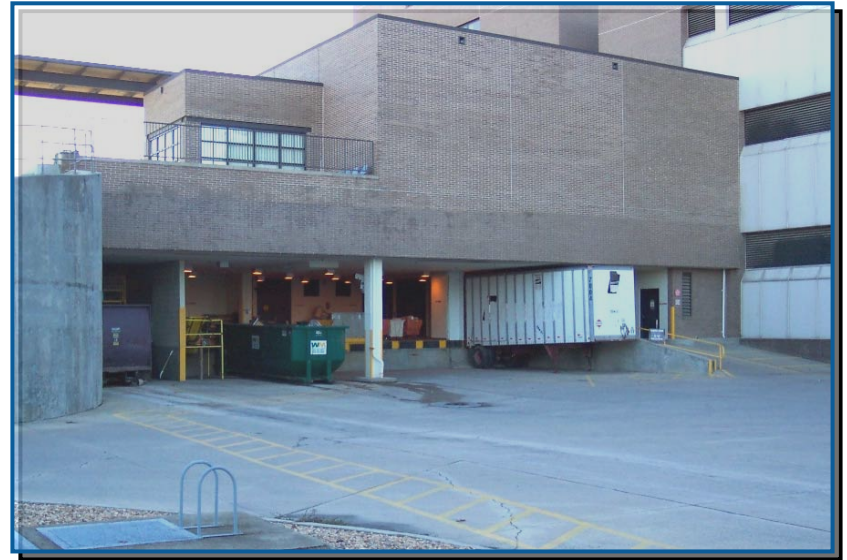

- Provide sufficient area for screening vehicles and packages
- Keep dumpsters away from buildings



FEMA

Architecture – Building Configuration

Parking Considerations



- Garage elevators service garage only to unsecured zone of lobby



- Restrict parking underneath buildings
- Well-lit, security presence, emergency communications, and/or CCTV
- Apply progressive collapse hardening to columns when parking garage is in building



FEMA

Architecture – Space Design

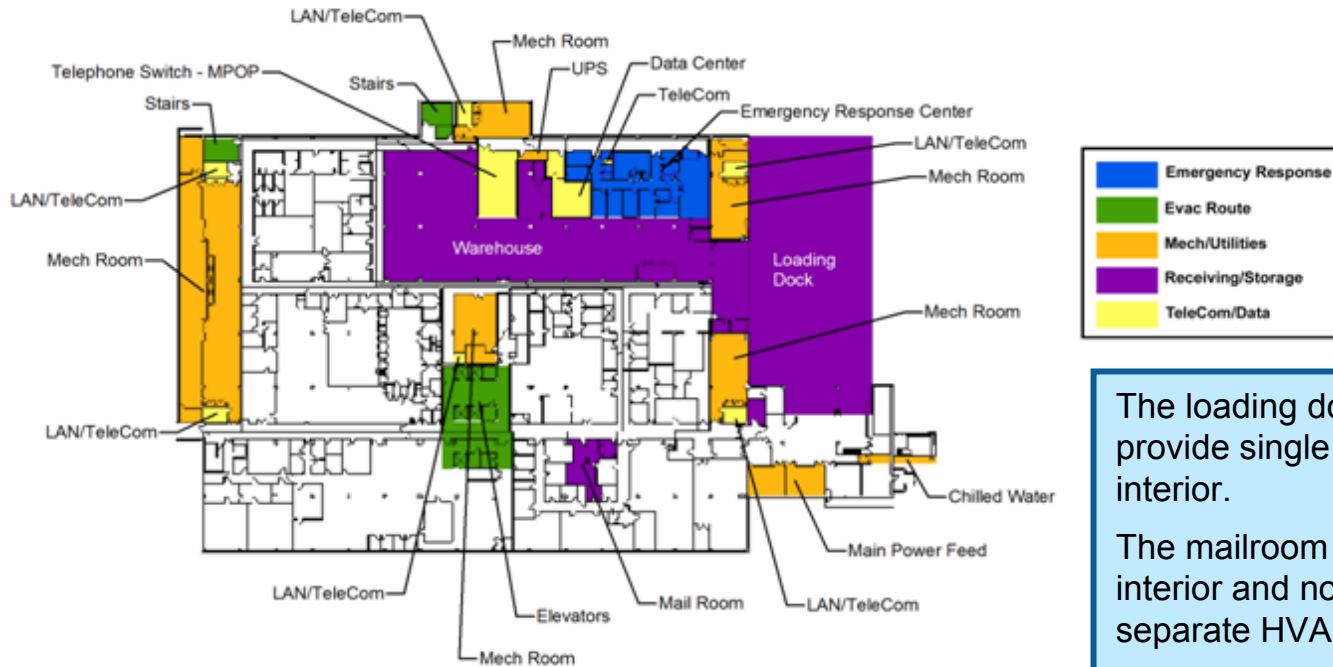

The loading dock and warehouse provide single point of entry to the interior.

The mailroom is located within the interior and not on exterior wall or separate HVAC system.

The telecom switch and computer data center are adjacent to the warehouse.

The trash dumpster and emergency generator are located adjacent to the loading dock.



FEMA

FEMA 426, Figure 1-10: Non-redundant critical functions collocated near loading dock, p. 1-41

Architecture – Space Design

Place unsecured or high risk areas outside building footprint

Do not mix high risk and low risk tenants in same building

Locate critical assets into interior of building

Separate areas of high visitor activity (unsecured) from critical assets

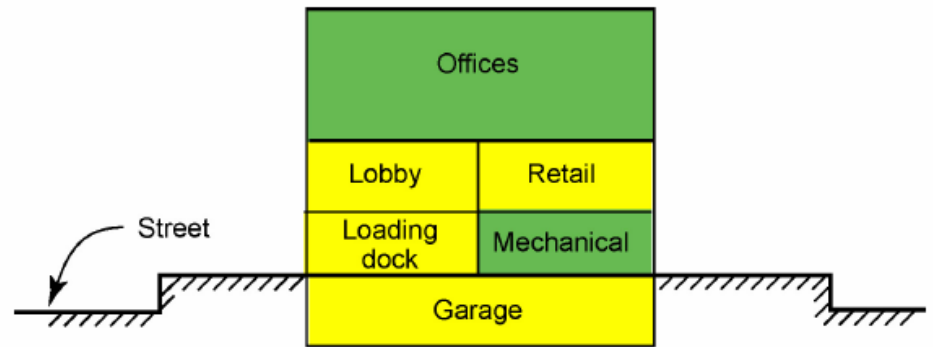

ORIGINAL LAYOUT

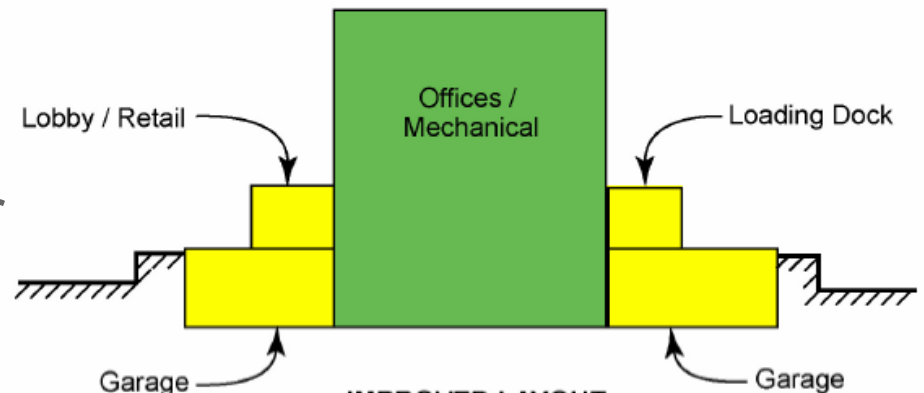

IMPROVED LAYOUT

FEMA 427, Figure 6-4: Improving layout of adjacent unsecured and secured areas, p. 6-10



FEMA

Architecture – Space Design

Eliminate hiding places

Interior barriers

Offset doorways

Minimize glazing, particularly interior glazing near high-risk areas

Lobby with security procedures configured to contain incidents (blast, CBR, armed attack)

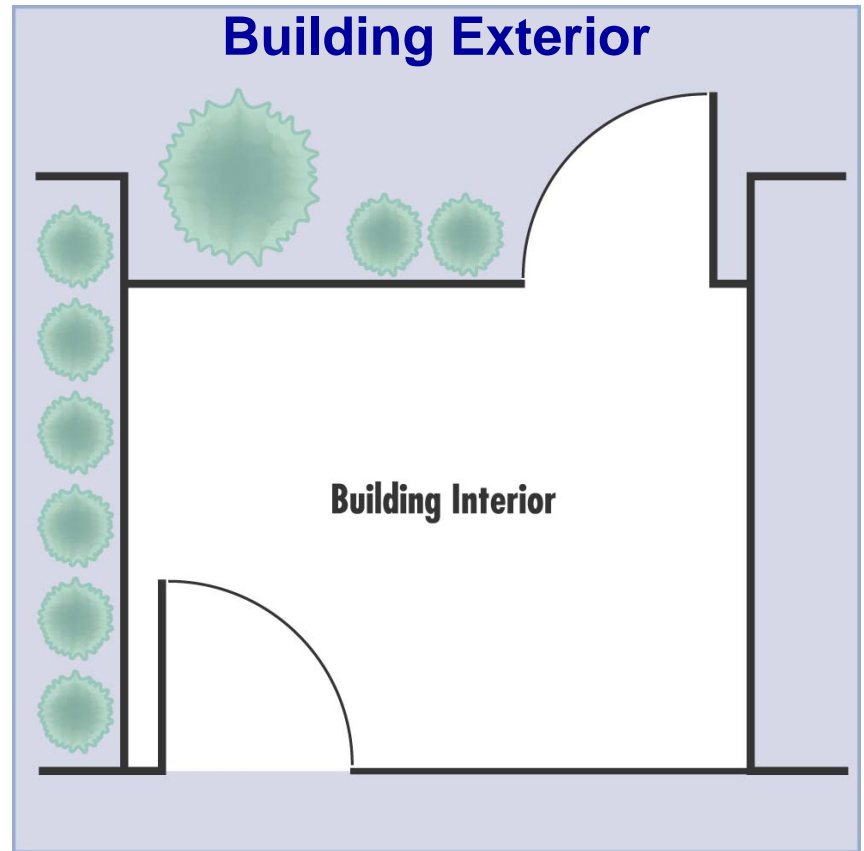

FEMA

FEMA 426, Figure 3-3: Offset doors through foyer, p. 3-7

BUILDING DESIGN FOR HOMELAND SECURITY

Unit X-18

Architecture – Other Location Concerns

- Safe havens / shelters
- Office locations
- Public toilets and service areas
- Retail spaces
- Stairwells
- Mailroom



FEMA

Structural Systems

Progressive Collapse Design

GSA Progressive Collapse Analysis and Design Guidance for New Federal Office Buildings and Major Modernization Projects

DoD Unified Facilities Criteria - Minimum Antiterrorism Standards for Buildings



FEMA

Structural Systems

Progressive Collapse Concept

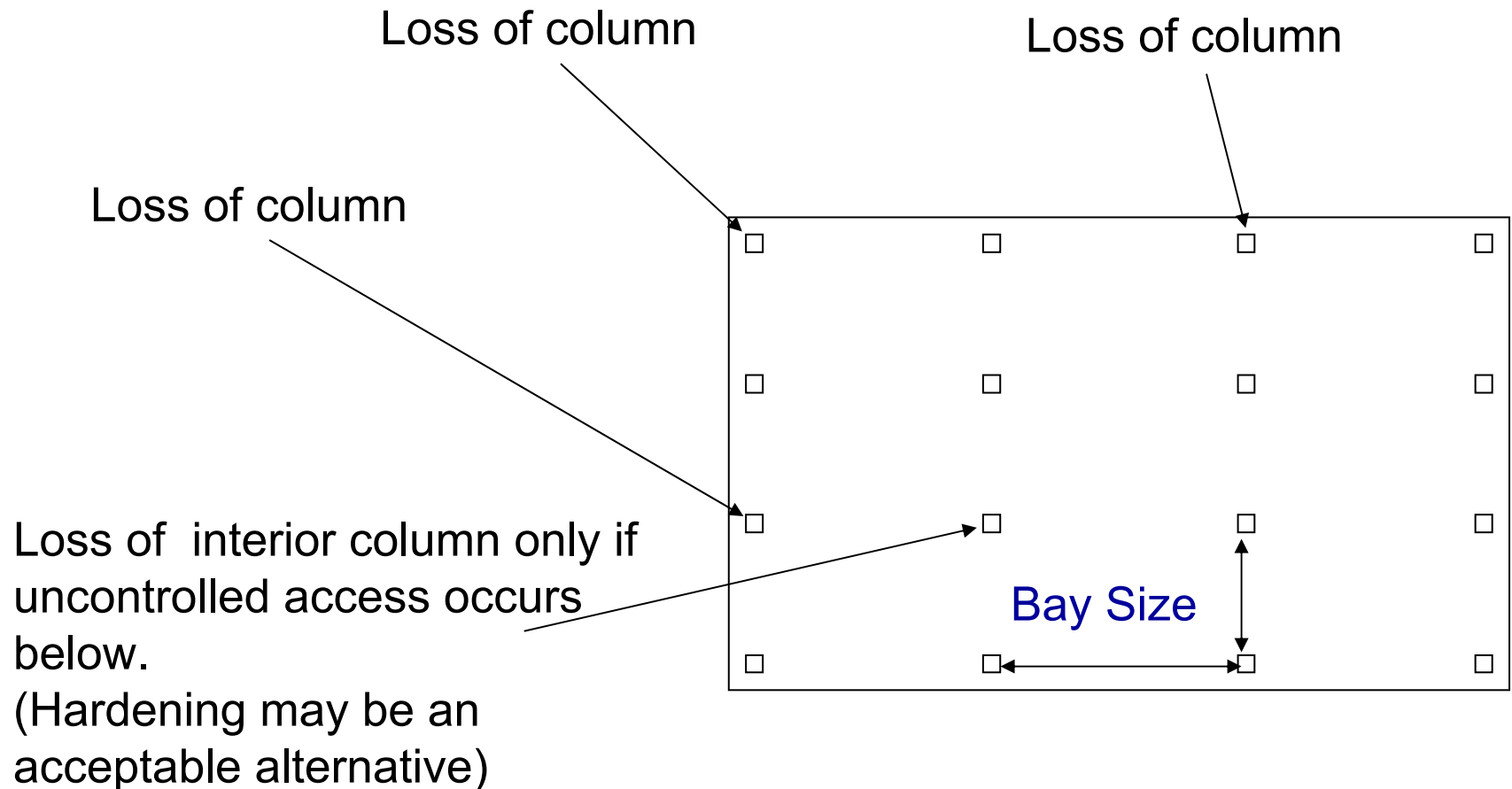

FEMA

BUILDING PLAN

Structural Systems -- Collapse

GSA and DoD criteria do not provide specific guidance for an engineering structural response model

These organizations are working toward Interagency Security Committee consolidated guidance

Owner and design team should decide how much progressive collapse analysis and mitigation to incorporate into design.



FEMA

Structural Systems -- Loads and Stresses



Murrah Federal Building,
Oklahoma City

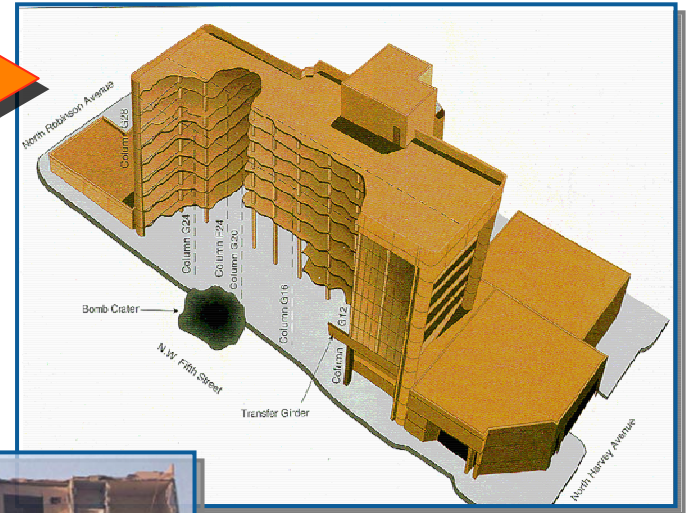

Ronan Point,
London



Khobar Towers,
Dhahran



FEMA

Structural Systems – Best Practices

Consider incorporating active or passive internal damping into structural system (sway reduction in high-rise)

Use symmetric reinforcement, recognizing components might act in directions opposite to original or standard design – flooring especially

Column spacing should be minimized (≤ 30 feet)



FEMA

Structural Systems – Best Practices (cont.)

Stagger lap splices and other discontinuities and ensure full development of reinforcement capacity or replace with more flexible connections – floors to columns especially

Protect primary load carrying members with architectural features that provide 6 inches minimum of stand-off

Use ductile detailing requirements for seismic design when possible



FEMA

Building Envelope

During actual blast or CBR event, building envelope provides some level of protection for people inside:

- Walls
- Windows
- Doors
- Roofs

Soil can be highly effective in reducing damage during an explosive event

Minimize “ornamentation” that may become flying debris in an explosion.



FEMA

Building Envelope – Walls

Design should ensure a flexible failure mode

Resist actual pressures and impulses acting on exterior wall surfaces from design basis threats

Withstand dynamic reactions from windows and windows stay connected to walls

Use multiple barrier materials and construction techniques – composites can add ductility and strength at savings

As desired Level of Protection increases, additional mass and reinforcement may be required



FEMA

Building Envelope – Best Wall Practices

Use symmetric reinforcement, recognizing that components might act in directions opposite to original or standard design

- Lobbies and mailrooms

Use wire mesh in plaster – reduces spalling / fragmentation

Floor to floor heights should be minimized (≤ 16 feet)



FEMA

Building Envelope – Best Wall Practices (cont.)

Connect façade from floor slab to floor slab to avoid attachments to columns (one-way wall elements)

- Limits forces transferred to vertical structural elements

No unreinforced CMU – use fully grouted and reinforced construction



FEMA

Building Envelope – Windows

Balanced Window Design

Glass strength

Glass connection to window frame (bite)

Frame strength

Frame anchoring to building

Frame and building interaction



FEMA

Building Envelope – Windows

Glass (weakest to strongest)

- Annealed (shards)
- Heat Strengthened (shards)
- Fully Thermally Tempered (pellets)
- Laminated (large pieces)
- Polycarbonate (bullet-resistant)

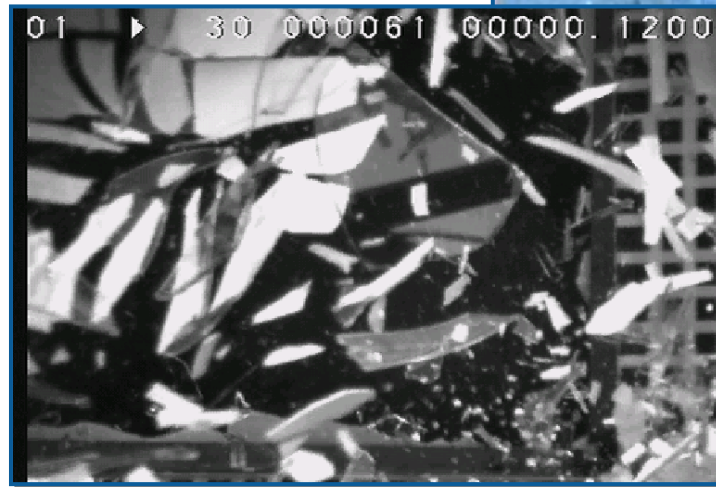

“Balanced Design”



FEMA

Building Envelope – Windows

GSA Glazing Performance Conditions

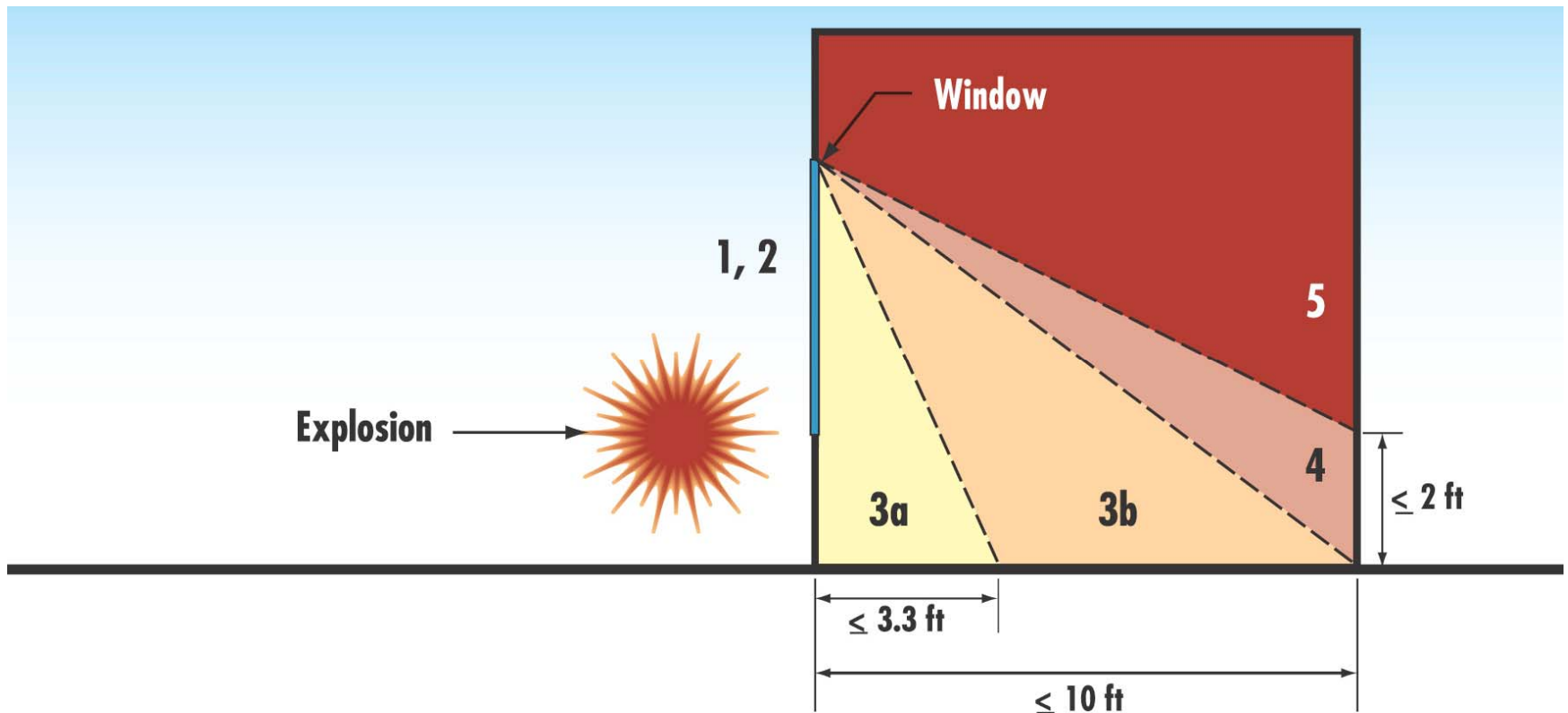

FEMA 426, Figure 3-4: Side view of a test structure illustrating performance conditions of Table 3-2, p. 3-22



FEMA

Building Envelope - Window Frames

Goal: transfer load from glass to frame and retain glass in frame

Bite: 1/2 inch minimum

Structural sealant:
1/4 inch bead or wet glaze

“Balanced Design”

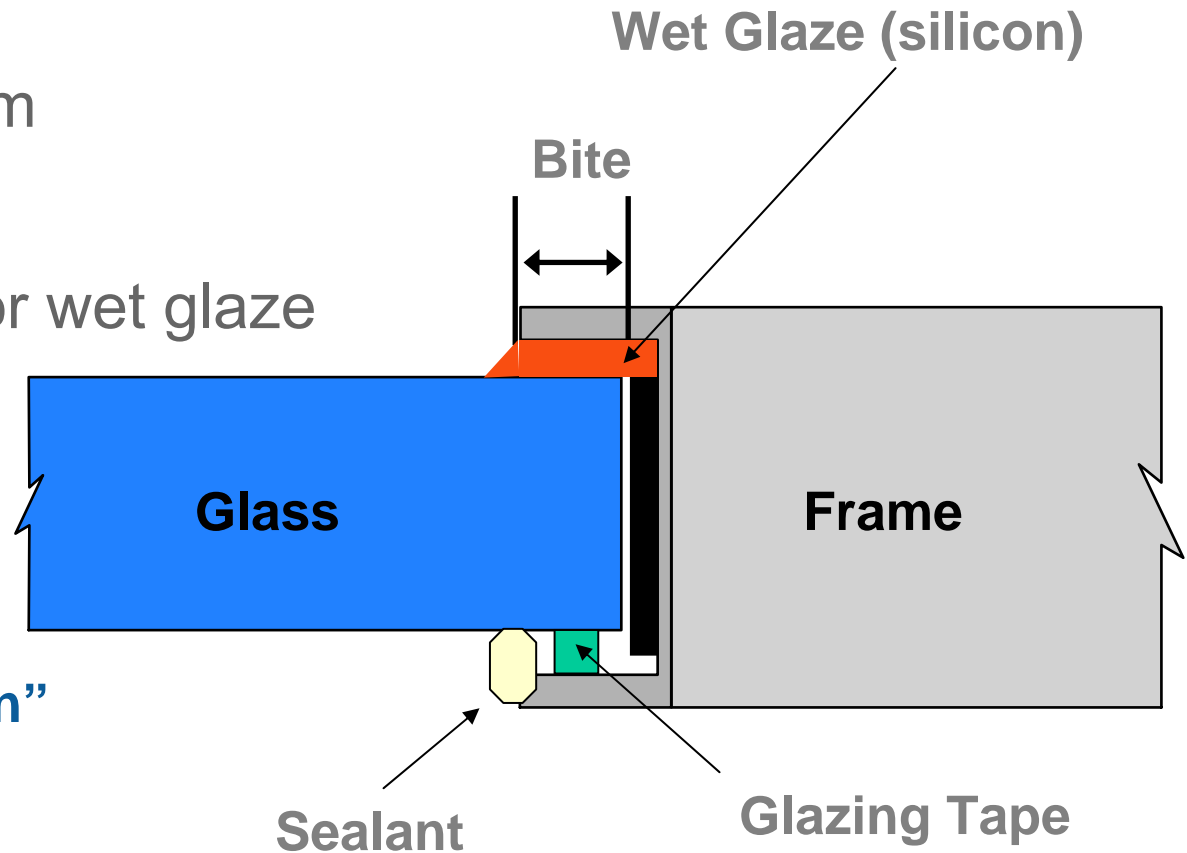

FEMA

Building Envelope - Window Frames

Goal: transfer load to building structure

Balanced strength:
glass, frame,
and connection
of frame to wall

“Balanced Design”

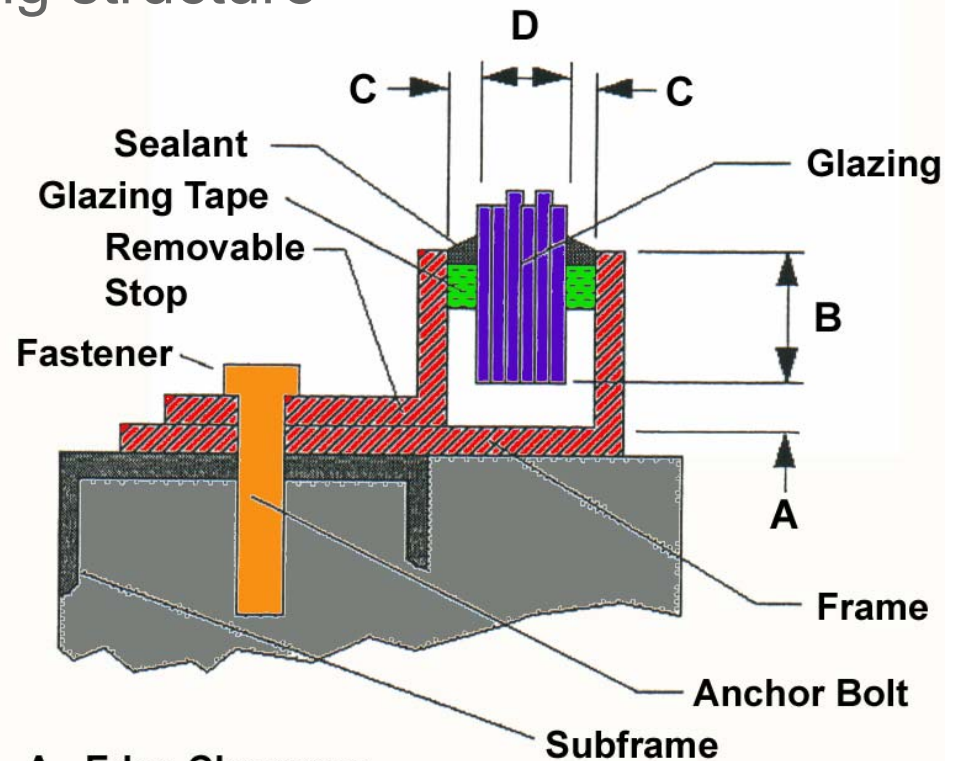

- A - Edge Clearance
- B - Bite-edge Engagement
- C - Face Clearance
- D - Glazing Thickness



FEMA

Building Envelope - Fragment Retention Film

Clear tough polyester film attached to inside of glass surface with strong pressure-sensitive adhesive

Also known as shatter-resistant film, safety film, or protective film

Relatively low installation costs

Level of protection varies with thickness of film and method of installation

Limited life for FRF

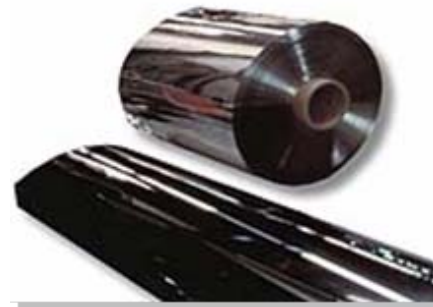

FEMA

Building Envelope - Fragment Retention Film

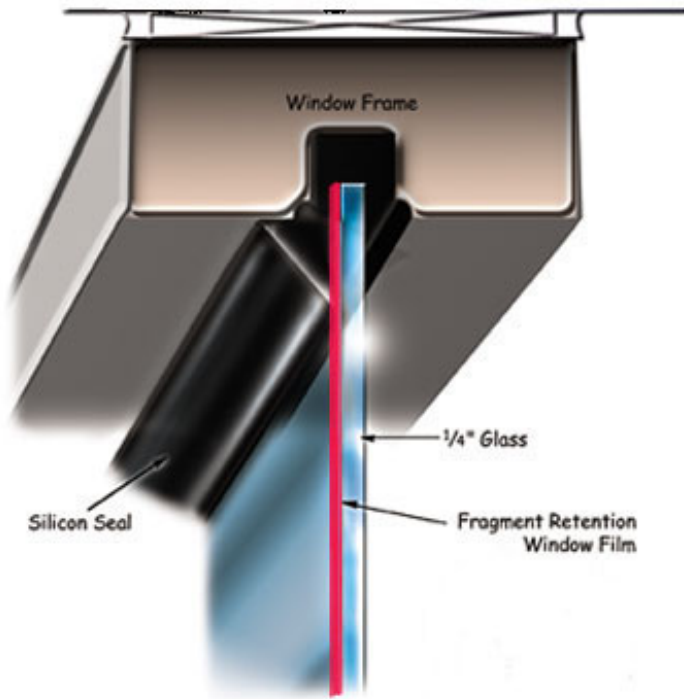

“Wet Glazing” (edge to edge)

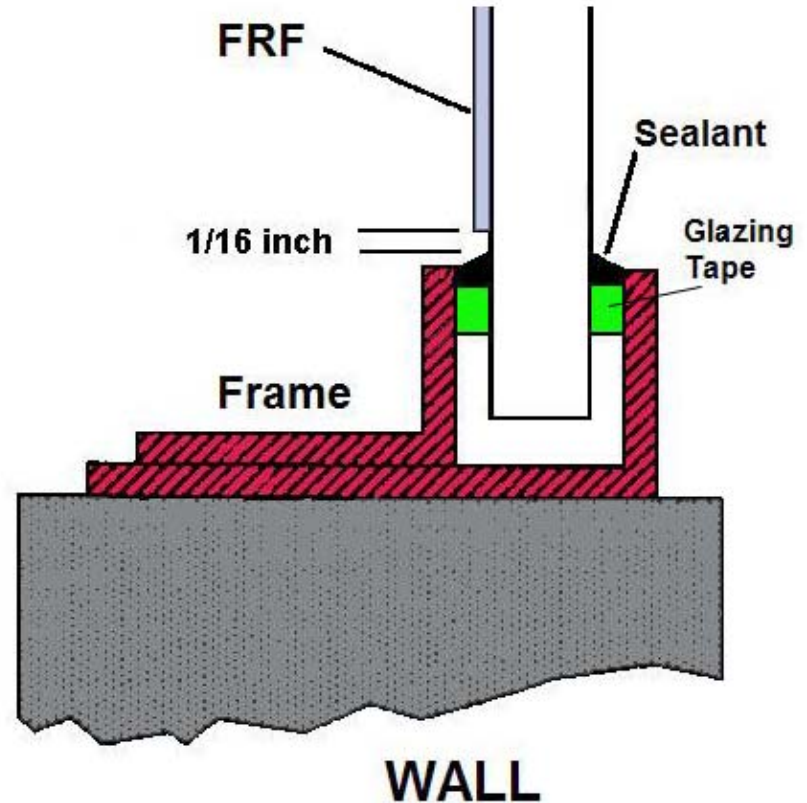

“Daylight Application”



FEMA

Building Envelope - Blast Curtains

Invented by British during
WW II

Kevlar curtains

Allow venting of blast
wave while “catching”
fragments

May be augmented with
FRF



FEMA

Building Envelope - Catch Bar

Must be centered on window and window panes

FRF must be thick enough to hold the fragments (≥ 7 mil)

Laminated glass should have
60 mil interlayer



Plan View

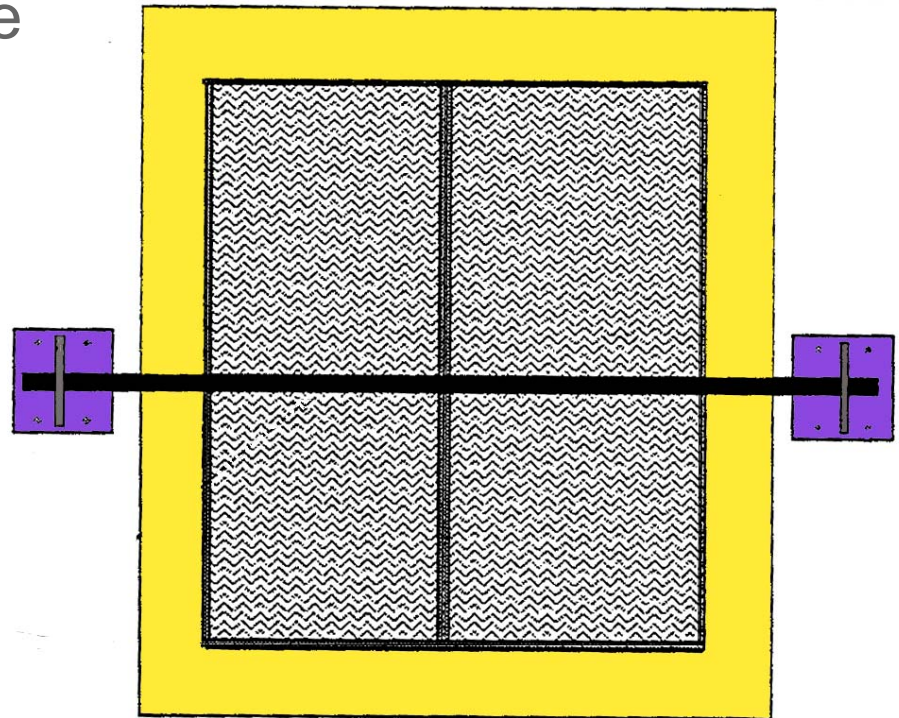

FEMA 427, Figure 6-7: Safe laminated glass systems and failure modes, p. 6-29



FEMA

Building Envelope – Best Window Practices

No windows adjacent to doors

Minimize number and size of windows - watch building code requirements

Laminated glass for high-occupancy buildings

Stationary, non-operating windows, but operable window may be needed by building code

Steel versus aluminum window framing



FEMA

Building Envelope – Doors

Balanced strength

- Door
- Frame
- Anchorage to building

Hollow steel doors or steel-clad doors

Steel door frames

Blast-resistant doors available

- Generally heavy
- Generally expensive



FEMA

Building Envelope – Roofs

Preferred – poured in place reinforced concrete

Lower protection – steel framing with concrete and metal deck slab

Sloped sacrificial roof over protected roof/ceiling

Sandbags or dirt layer

Restrict access to roof

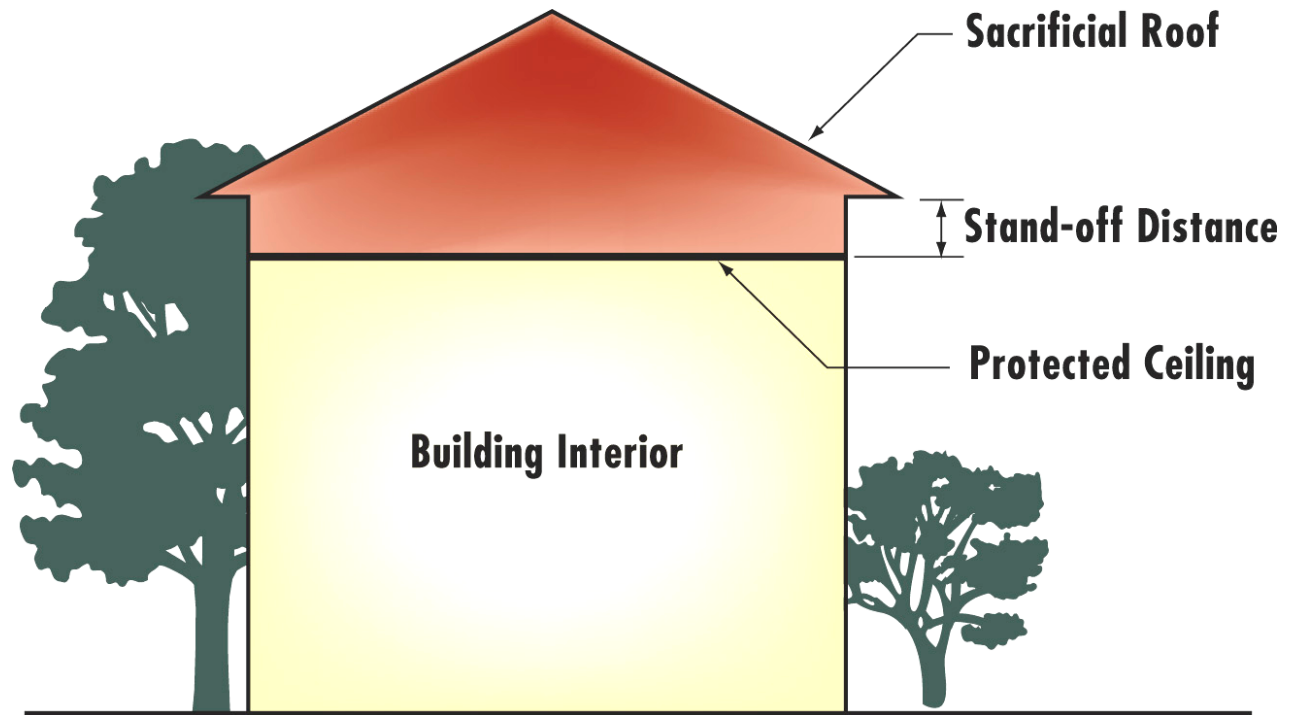

FEMA

Utility Systems

Building Service

- Electric – commercial and backup
- Domestic water
- Fire protection water
- Fuel – coal, oil, natural gas, or other
- Steam heat with or without condensate return
- Hot water heat



FEMA

Utility Systems

Building Service (cont)

- Sewer – piping and sewage lift stations
- Storm drainage
- Information
- Communications
- Fire alarm
- Security systems and alarms



FEMA

Utility Systems

Entrances

- Proximity to each other
- Aboveground or underground
- Accessible or secure

Delivery capacity

- Separate
- Aggregate

Storage capacity

- Outage duration
- Planned or historical



FEMA

Mechanical & Electrical Systems

Functional layout – physical separation or hardening

Structural layout – systems installation

Do not mount utility equipment or fixtures on exterior walls or mailrooms

Avoid hanging utility equipment and fixtures from roof slab or ceiling



FEMA

Mechanical & Electrical Systems

Overhead components, architectural features, and other fixtures > 14 kilograms (31 pounds), especially in occupied spaces

- Mount to resist forces $0.5 \times W$ in any direction and $1.5 \times W$ in downward direction (DoD Unified Facilities Criteria)
- Plus any seismic requirements



FEMA

Mechanical & Electrical Systems

Distribution within building

- Looped or multiple radial versus single radial
- Pipe chases – horizontal and vertical – cross impacts

Normal and emergency equipment locations

- Generators versus commercial switchboard or transfer switch
- Electric fire pumps versus diesel fire pumps

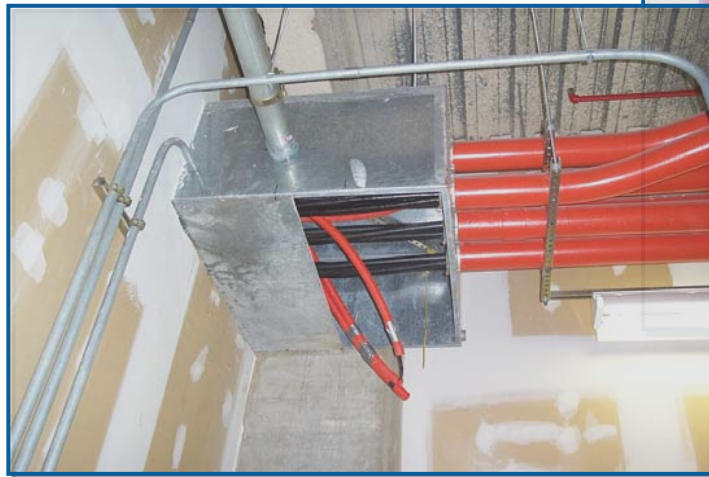

FEMA

Mechanical & Electrical Systems

Restrict access - locks / alarms / surveillance

- Utility floors / levels
- Rooms
- Closets
- Roofs
- Security locks/interlocks comply with building code
- Building information
- Also consider for other systems



FEMA

Mechanical & Electrical Systems

Building lighting and CCTV compatibility

- Intensity
- Resolution
- Angle
- Color

Exit lighting – consider floor level, like airplanes

Emergency lighting – battery packs have their place



FEMA

Mechanical & Electrical Systems

Ventilation and Filtration – HVAC Control Options

- Building specific
- System shutdown – configuration and access
 - HVAC fans and dampers
 - Include 24/7 exhausts, i.e. restrooms
- Zone pressurization
 - Doors and elevator use
 - Shelter-in-place



FEMA

Mechanical & Electrical Systems

Ventilation and Filtration – HVAC Control Options

- Specialized exhaust for some areas – i.e., lobbies and mailrooms
 - Air purge (e.g., 100 percent outside air if internal release)
 - CBR filters to trap and prevent spread elsewhere
- Pressurized egress routes (may already exist)
 - Filtered air supply or shutdown if release external



FEMA

Plumbing and Gas Systems

Same considerations as electrical and mechanical systems

Added concern is fuel distribution

- Heating sources / open flames / fuel load

Interaction with other systems during an incident

- Fuel versus alarms / electric / fire protection water / structure
- Water versus electronic / electric



FEMA

Fire Alarm Systems

Considerations similar to information and communications systems, but tighter building codes

- Centralized or localized
- Fire alarm panel access for responding fire fighters or fire control center
- Interaction with other building systems
 - Telephone / IT
 - Energy management
 - HVAC controls
- Off-premises reporting and when



FEMA

Communications - Information Technology Systems

Looped versus radial distribution

Redundancy

- Landline, security, fire watch
 - Copper
 - Fiber optics
- Cell phones (voice, walkie-talkie, text)
- Handheld radios / repeaters
- Radio telemetry / microwave links
- Satellite



Mass notification

- Loud speakers
- Telephone hands-off speaker
- Computer pop-up
- Pager



FEMA

Communications - Information Technology Systems (cont.)

Empty conduits

- Future growth
- Speed repair

Battery and backup power for IT

- Hubs, switches, servers, switchboards, MW links, etc.
- VOIP, building ops, alarms, etc.

Fire stopping in conduits between floors



Secure dedicated lines between critical security functions

Backup control center with same capability as primary



FEMA

Equipment Operations and Maintenance

Preventive Maintenance and Procedures

- Drawings indicating locations and capacities are current?
- Maintenance critical to keep systems operational
 - Critical systems air balanced and pressurization monitored regularly?
 - Periodic recommissioning of major systems?
- Regularly test strategic equipment
 - Sensors, backup equipment and lighting, alarms, and procedures tested regularly to ensure operation when needed?
 - Backup systems periodically tested under worst case loadings?



FEMA

Equipment Operations and Maintenance

Maintenance Staff Training

- System upgrades will require new training
- Specific instructions for CBR event (internal vs external release)
- Systems accessible for adjustment, maintenance, and testing



FEMA

Security Systems

Electronic Security Systems

Purpose is to improve the reliability and effectiveness of life safety systems, security systems, and building functions.

- Detection
- Access control
- Duress alarms
- Primary and backup control centers – same procedures



FEMA

Security Systems

Entry Control Stations

Channel visitors entering building to access control in lobby

Signs should assist in controlling authorized entry

Have sufficient lobby space for security measures (current or future)

Avoid extensive queuing, especially outside building

Proper lighting, especially if manned 24 hours/ day

Hardened against attack based upon security needs



FEMA

Security Systems

Emergency Plans

All buildings should have current plans

- Building evacuation with signage & emergency lighting
- Accountability – rally points, call-in
- Incorporate CBR scenarios into plans
 - General occupant actions
 - Response staff actions – HVAC and control centers

Exercise the plans to ensure they work

- Coordinate with local emergency response personnel
- Test all aspects



FEMA

Practical Applications

What can be done with a reasonable level of effort?

End of Chapter 3, FEMA 426 listing of mitigation measures

- Less protection, less cost, with less effort
- Greater protection, greater cost, at greater effort



FEMA

Building Materials: General Guidance

All building materials and types acceptable under building codes are allowed.

Special consideration should be given to materials having inherent flexibility and ability to respond to load reversals.

Careful detailing is required for materials (such as pre-stressed concrete, pre-cast concrete, and masonry) to adequately respond to design loads.

Construction type selected must meet all performance criteria of specified protection level.



FEMA

Desired Building Protection Level

Component design based on:

Design Basis Threat

Threat Independent approach

Level of Protection sought

Leverage natural hazards design/retrofit

Incorporate security design as part of normal capital or O&M program

Use existing tools/techniques, but augment with new standards/guidelines/codes



FEMA

Summary

Building Design Guidance and Mitigation Options

Using the FEMA 426 Checklist will help identify vulnerabilities and provide recommended mitigation options.

There are many methods to mitigate each vulnerability.

Relatively low cost mitigations significantly reduce risk.



FEMA

Unit X Case Study Activity

Building Design Guidance and Mitigation Measures Background

Emphasis:

- Providing a balanced building envelope that is a defensive layer against the terrorist tactic of interest
- Avoiding situations where one incident affects more than one building system

FEMA 426, Building Vulnerability Assessment Checklist

Requirements

Assign sections of the checklist to qualified group members

Refer to Case Study, and answer worksheet questions

Review results to identify vulnerabilities and possible mitigation measures



FEMA