

Our World is **ENGINEERED**

Engineering at NSF

**NSF Regional Grants Conference
Omaha, Nebraska
October 20-21, 2008**

Dr. Usha Varshney

Program Director

Electrical, Communications and Cyber Systems

Directorate for Engineering

National Science Foundation



Presentation Outline

- ◎ **Overview of Directorate for Engineering (ENG)**
 - > **Mission and Vision**
 - > **Organizational Structure**

- ◎ **Funding Opportunities**
 - > **Programs**
 - > **Initiatives**

- ◎ **Funding Success**



Organizational Structure

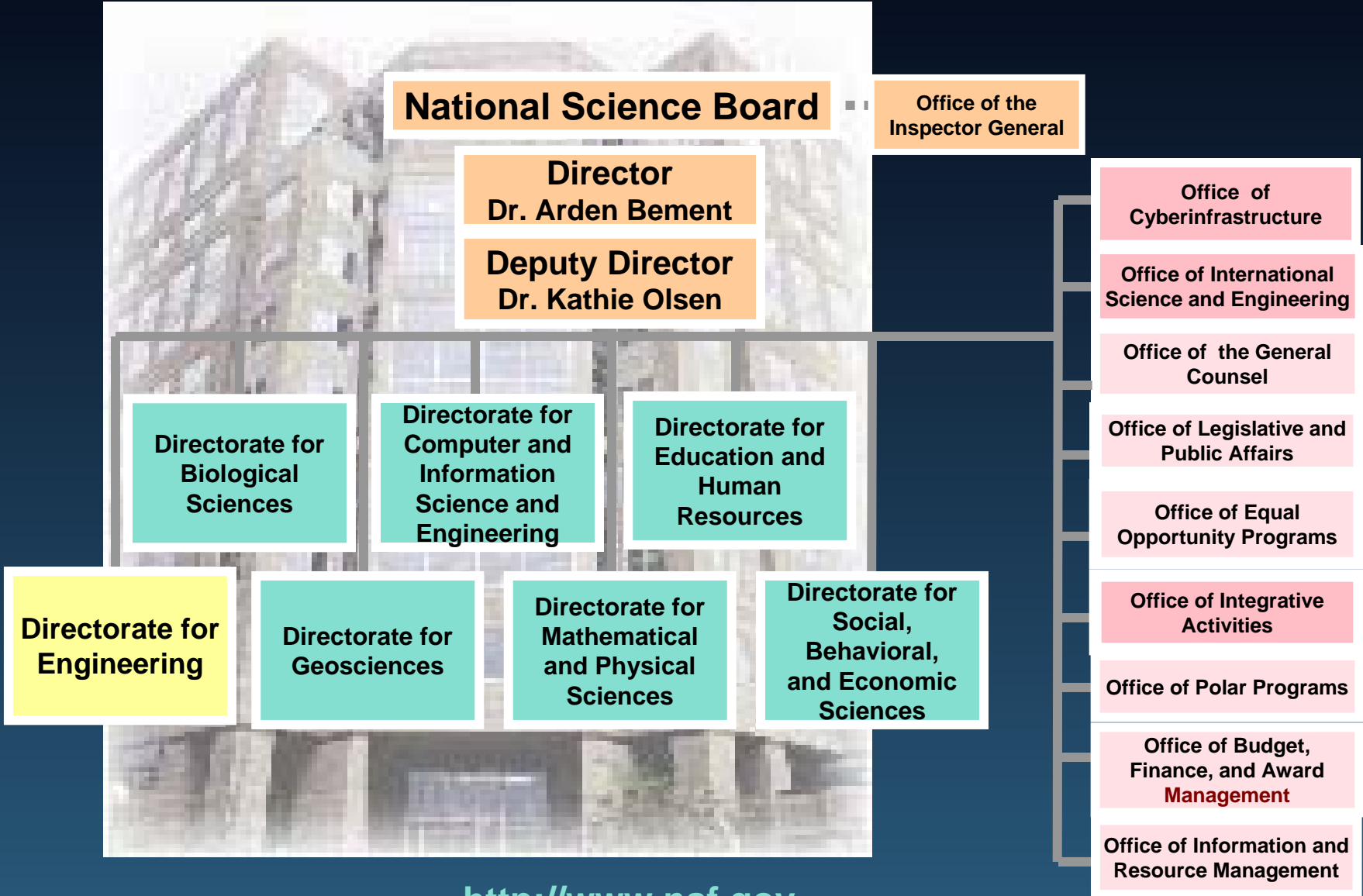



ENG Mission and Vision

- ◎ **Mission:** To enable the engineering and scientific communities to advance the frontiers of engineering research, innovation and education, in service to society and the nation.
- ◎ **Vision:** ENG will be the global leader in advancing the frontiers of fundamental engineering research, stimulating innovation, and substantially strengthening engineering education.



NSF Budget by Research Directorate

Dollars in Millions

Directorate	FY 2007 Actual	FY 2008 Estimate	FY 2009 Request	FY 2009 Request			
				Change over FY 2007 Actual		Change over FY 2008 Estimate	
				Amt	%	Amt	%
BIO	\$608.54	\$612.02	\$675.06	\$66.52	10.9	\$63.04	10.3
CISE	526.68	534.53	638.76	112.08	21.3	104.23	19.5
ENG (less SBIR/STTR)	521.33	527.50	632.33	111.00	21.3	104.83	19.9
SBIR/STTR	108.67	109.37	127.00	18.33	16.9	17.63	16.1
GEO	745.85	752.66	848.67	102.82	13.8	96.01	12.8
MPS	1,150.73	1,167.31	1,402.67	251.94	21.9	235.36	20.2
SBE	214.54	215.13	233.48	18.94	8.8	18.35	8.5
OCI	182.42	185.33	220.08	37.66	20.6	34.75	18.8
OISE	40.36	41.34	47.44	7.08	17.6	6.10	14.8
OPP	438.43	442.54	490.97	52.54	12.0	48.43	10.9
IA	219.45	232.27	276.00	56.55	25.8	43.73	18.8
U.S. Arctic Research Commission	1.45	1.47	1.53	0.08	5.5	0.06	4.1
Research & Related Activities	\$4,758.44	\$4,821.47	\$5,593.99	\$835.55	17.6%	\$772.52	16.0%



Directorate for Engineering

Research and Education Themes

Engineering research spans the frontiers

- To support fundamental research and education, ENG identifies research and education themes.
- The five themes represent a convergence of fields, disciplines, and frontier research opportunities that cut across divisions, and provide general guidance on potential future directions of engineering research.
- Themes will evolve over time, reflecting the maturation of certain fields, the emergence of new fields, and engineering's crucial role in addressing increasingly complex challenges, touching every sector of society.

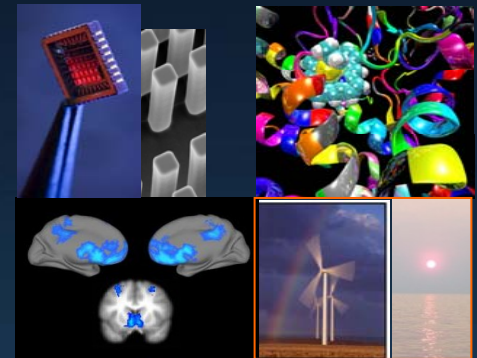

Engineering contributes at all scales. Examples are nanotechnology, computational simulation, health, and alternate energy.



Cognitive Engineering

Invests in improving understanding of the brain and nervous system to enable the engineering of novel systems and machines

○ **Examples include:**

- > **Devices that augment the senses**
- > **Intelligent machines that analyze and adapt**

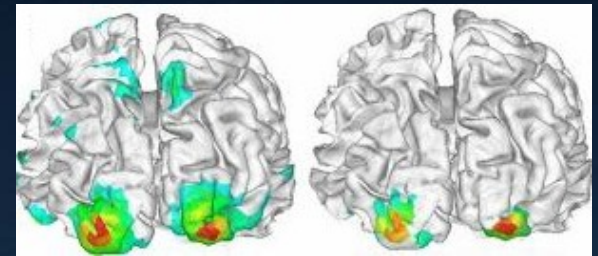

Combining EEG with functional MRI data (left image is EEG, right image shows both) enables precise mapping of brain activity. *He, 0411898.*



Competitive Manufacturing and Service Enterprises

Enables research to catalyze multiscale manufacturing, from fundamental metrology through atomic-scale control of raw materials

- **Examples include:**
 - **Developing quality-engineered nanomaterials in necessary quantities**
 - **Achieving perfect atomic- and molecular-scale manufacturing**



Nanoparticles compose a lightweight biocompatible material for bone implants.
Groza, 0523063.



Complexity in Engineered and Natural Systems

Addresses unifying principles that enable modeling, prediction, and control of emergent behavior in complex systems

- ◎ **Examples include:**
 - > Improving structural performance during disasters through advanced materials
 - > Advancing quantum information processing

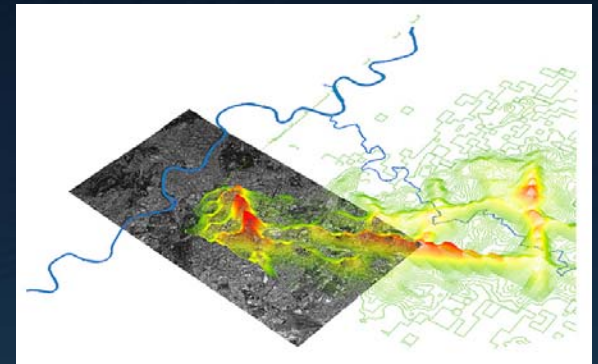

Combining maps (gray square) and density of cell-phone usage (shown as red and yellow 3-D peaks) can yield information about how a complex system responds to unplanned events. *Dahleh, 0735956*.



Energy, Water, and the Environment

Supports breakthroughs essential to the provision of energy and water in an environmentally sustainable and secure manner.

⦿ **Examples include:**

- > Increasing the use of alternative energy sources through research in materials
- > Developing quantitative understanding of energy–environment interactions (including water)

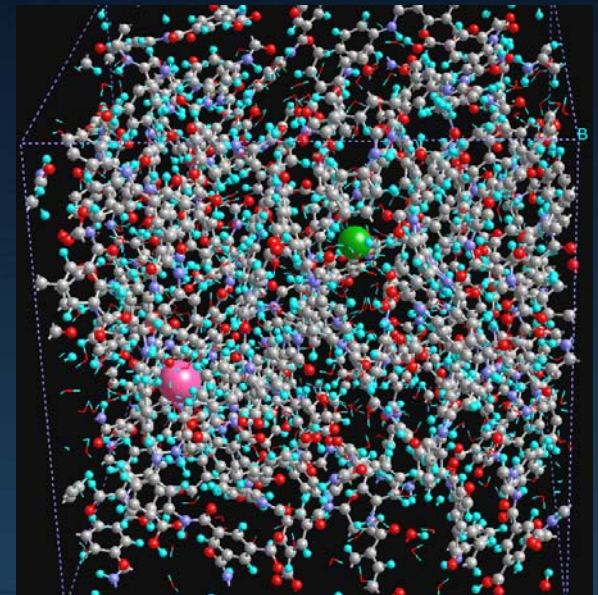

Advanced water purification and desalination begins with understanding of how ions in water interact with purification membranes. This dynamic computer simulation shows sodium (pink) and chlorine (green) ions inside a polyamide membrane. *Shannon, 0120978.*



Systems Nanotechnology

Supports fundamental research that leads to the development of active and complex nanosystems and their integration with biology, energy, and other fields

○ Examples include:

- > Developing high-specificity sensors for national security
- > Developing tools to move into the 3rd dimension and into time resolutions of chemical reactions

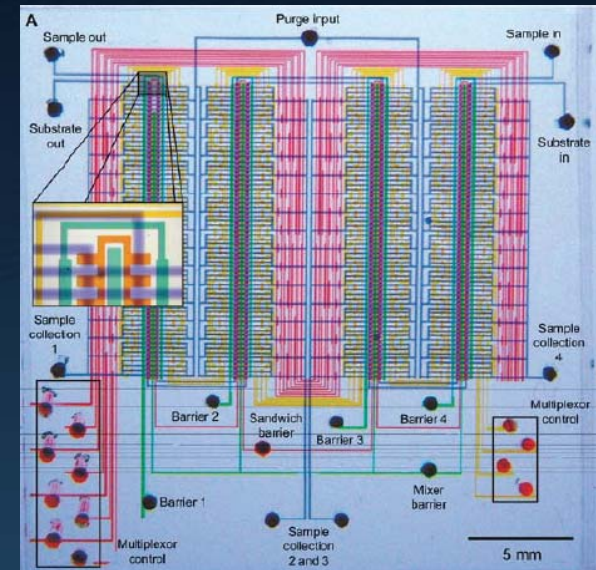

Integrated circuits that are smaller and faster are possible with microfluidics systems built from or incorporating nanocomponents. *Ferreira, 0328162.*



Single vs. Multiple Investigator Awards

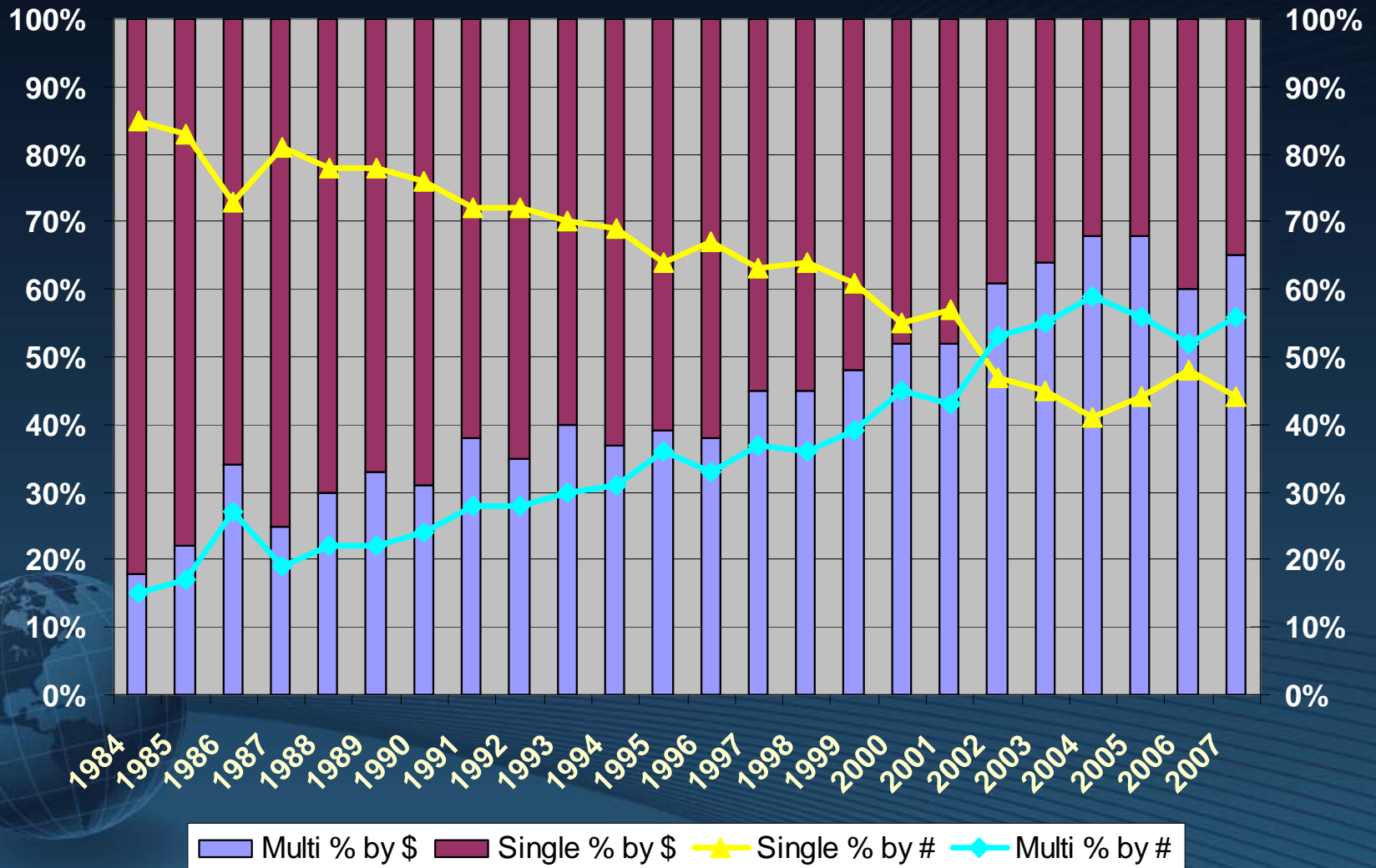



ENG Organizational Structure & Division Programs



Credit: Top Row: John C. Phillips photo/ASU Research Magazine; Microsoft; Microsoft; Microsoft; Microsoft; Microsoft; Microsoft. Middle Row: Microsoft; Microsoft; Kellar Autumn, Lewis and Clark College; Microsoft; NASA. Bottom Row: Raymond A. Adomaitis, University of Maryland - College Park; Microsoft; Kalinichev, A.G. and Kirkpatrick, R.J., University of Illinois at Urbana-Champaign; Microsoft; Microsoft.



ENG Divisions

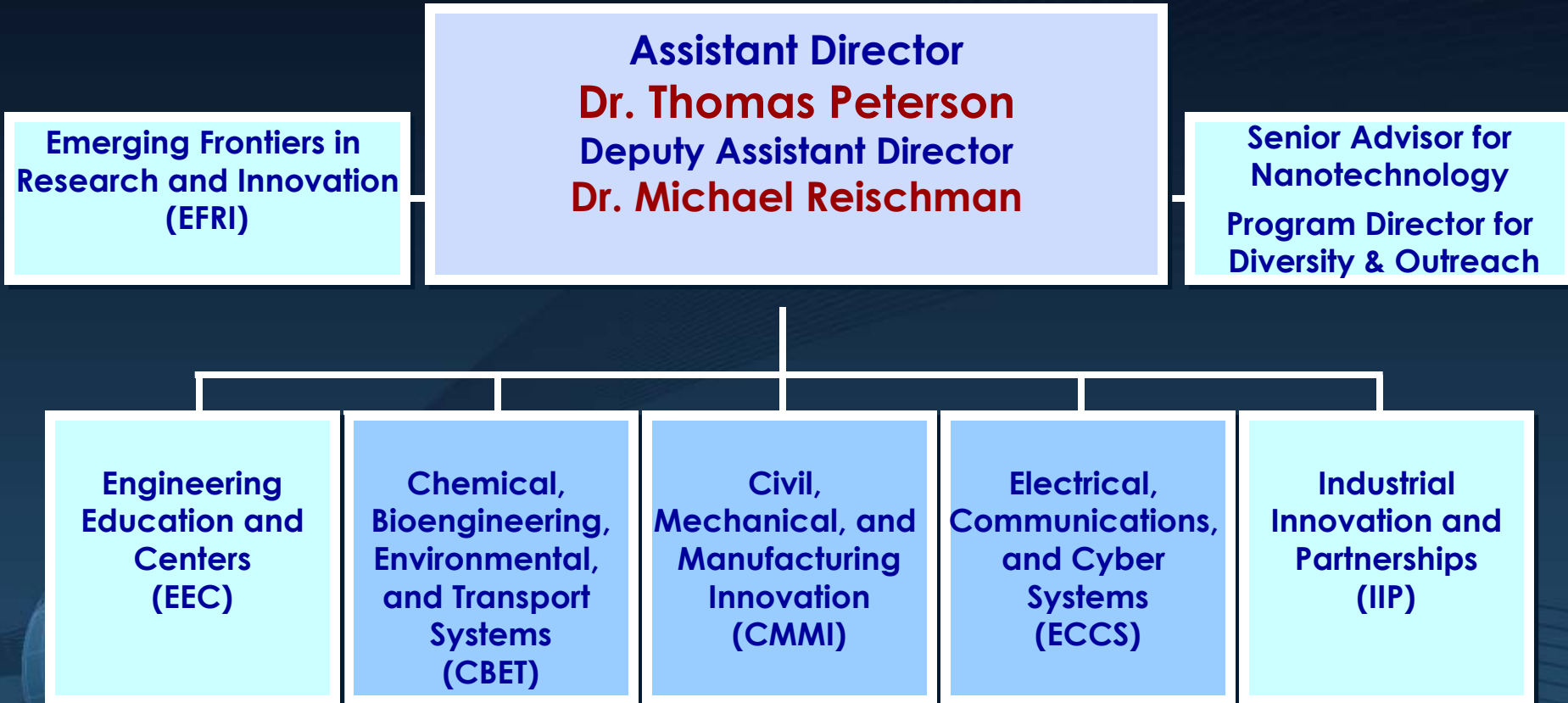



ENG Disciplinary Divisions

- **Chemical, Bioengineering, Environmental, and Transport Systems (CBET)**
- **Civil, Mechanical, and Manufacturing Innovation (CMMI)**
- **Electrical, Communications, and Cyber Systems (ECCS)**



Funding Opportunities

◎ Core programs

- › Investigator Initiated Unsolicited Proposals
- › Faculty Early Career Development (CAREER) program
- › Small Grants for Exploratory Research (SGER)
- › Supplements (REU, RET, Instruments, GRS, IREE)
- › Workshops & Conferences

◎ Major Research Instrumentation (MRI)

◎ Crosscutting and NSF-wide programs



ENG Core Programs

- ◎ Proposals may be **unsolicited** or in response to a **solicitation**
- ◎ Submission windows and processes vary by Division
- ◎ Awards are typically \$270-330K for three years



Chemical, Bioengineering, Environmental, and Transport Systems (CBET)

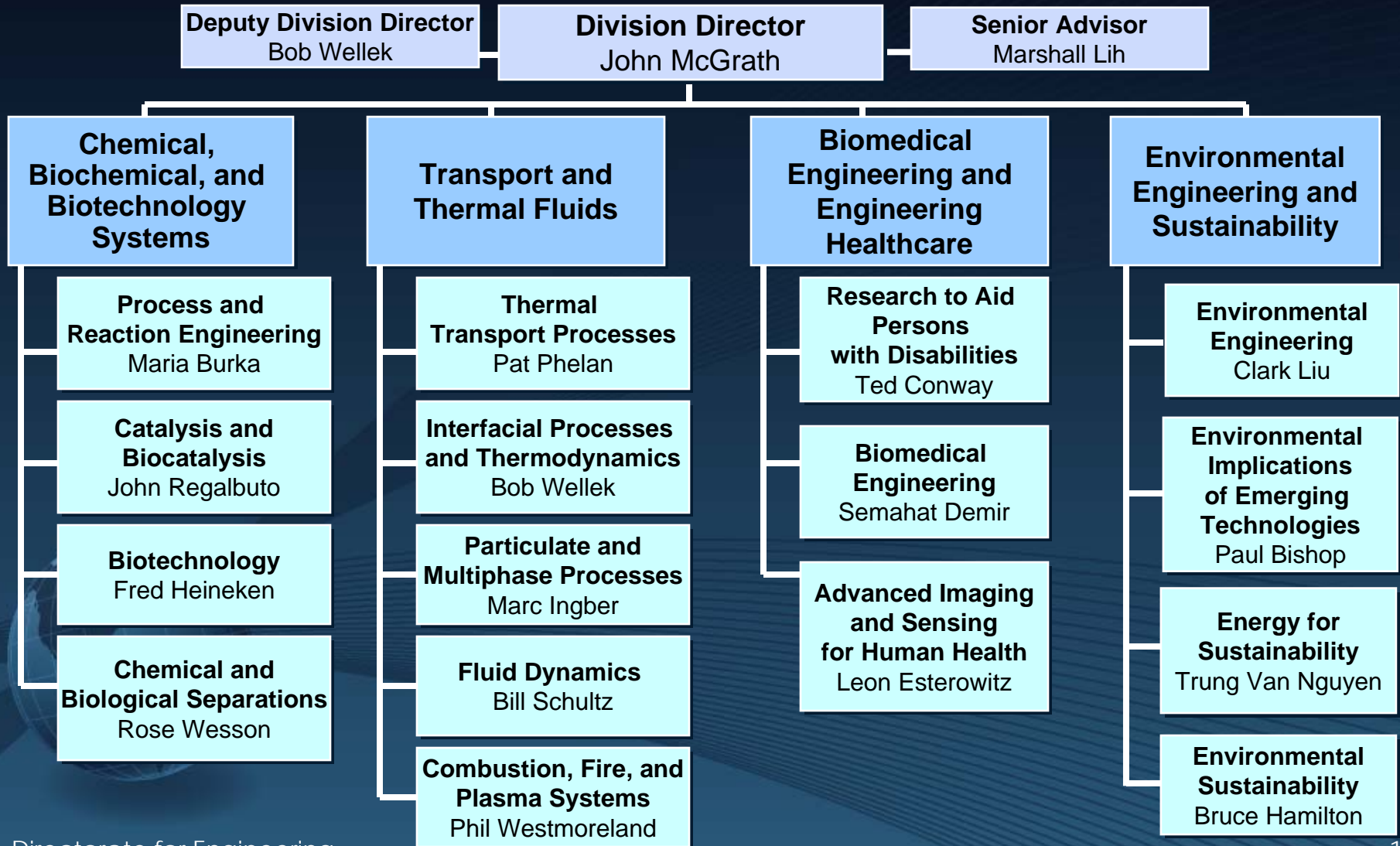



CBET Areas of Interest

- **Chemical, biochemical, and biotechnology:** research on the processing and manufacture of products by effectively utilizing chemical and renewable resources, often with the aid of bioinformatics from genomic and proteomic information
- **Biomedical engineering and engineering healthcare:** research to develop novel projects that integrate engineering and life sciences to solve biomedical problems that serve humanity
- **Environmental engineering and sustainability:** research that aims to reduce adverse effects of solid, liquid, and gaseous discharges into land, water, and air that result from human activity and impair the ecological value of those resources
- **Transport and thermal fluids phenomena:** research on thermal, mass, and momentum transport that enable new technological solutions to understand pressing issues in energy, the environment, manufacturing, healthcare, and other fields

Two submission windows per year: Aug.15 - Sept.15 and Feb.1- Mar.1



Civil, Mechanical, and Manufacturing Innovation (CMMI)

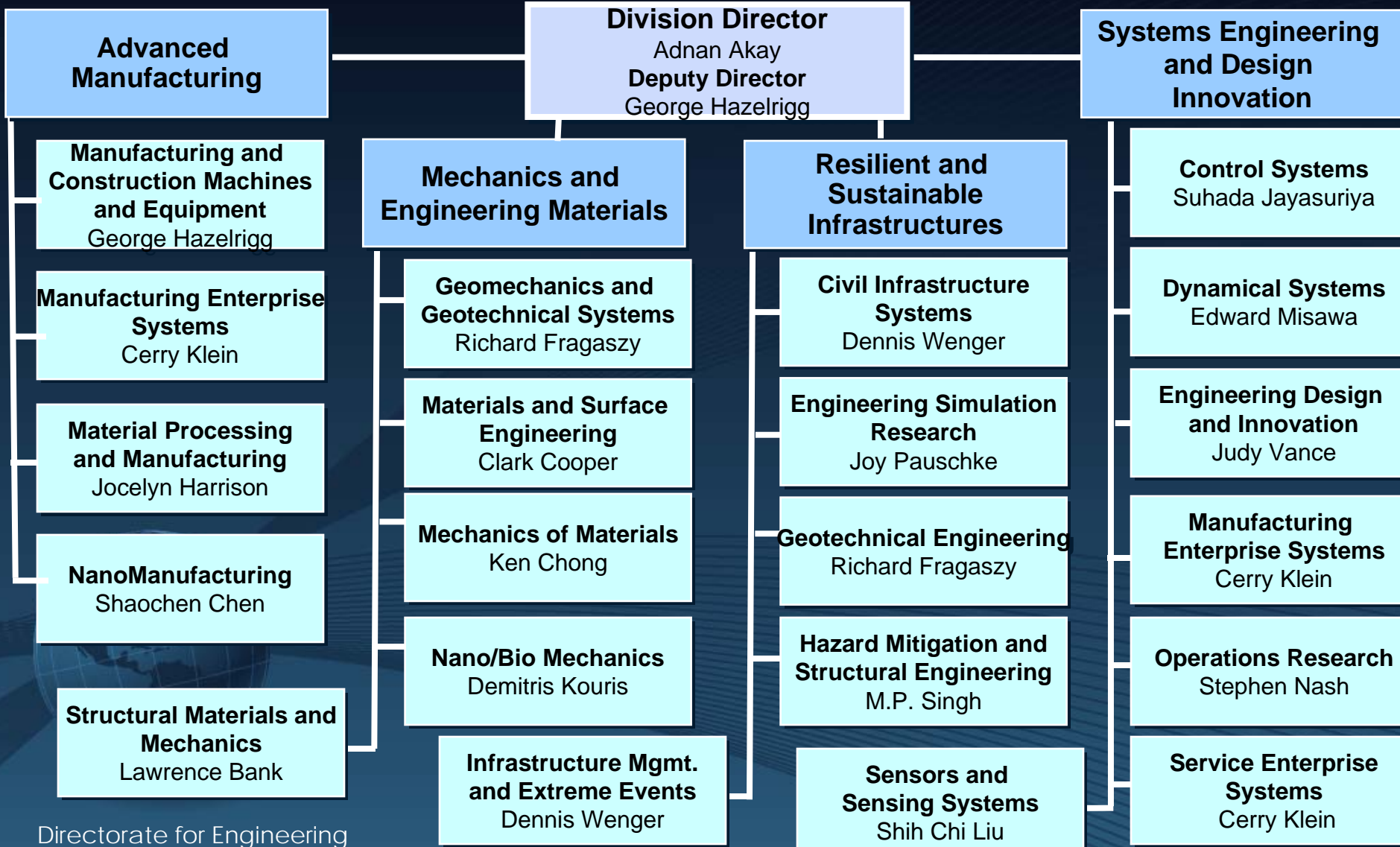



CMMI Areas of Interest

- **Advanced manufacturing:** research leading to transformative advances in manufacturing and building technologies, with emphases on efficiency, economy, and sustainability
- **Mechanics and engineering materials:** research aimed at advances in the transformation and use of engineering materials efficiently, economically, and sustainably
- **Resilient and sustainable infrastructures:** research to advance fundamental knowledge and innovation for resilient and sustainable civil infrastructure and distributed infrastructure networks
- **Systems engineering and design:** research on the decision-making aspects of engineering, including design, control, and optimization

Two submission windows per year: Sep.1-Oct.1 and Jan.15- Feb.15



George E. Brown, Jr. Network for Earthquake Engineering Simulation (NEES) Research

- ◎ **NEES is a network of 15 earthquake engineering experimental equipment sites available for experimentation on-site or in the field**
- ◎ **Advance knowledge discovery and innovation for:**
 - › **Earthquake and tsunami loss reduction of our nation's civil infrastructure**
 - › **New experimental simulation techniques and instrumentation for NEES**

~\$9M investment for 8–12 awards

Joy Pauschke

Preliminary Proposal Submission deadline is Oct.1, 2008, NSF 08-574



Electrical, Communications and Cyber Systems (ECCS)

Senior Advisor
Lawrence Goldberg

Acting Division Director
Lawrence Goldberg

Electronics, Photonics, and Device Technologies

Optoelectronics; Nano-photonics; Ultrafast/Extreme Ultra-Violet Technologies

Eric Johnson

Micro/Nanoelectronics; NEMS/MEMS; Bioelectronics; Sensors

Rajinder Khosla

Micro/Nanoelectronics; Molecular, Spin, and Organic Electronics; Micromagnetics; Power Electronics

Pradeep Fulay

Microwave Photonics; MMIC; Millimeter, Sub-millimeter and Terahertz Frequency Devices and Components

Usha Varshney

Integrative, Hybrid, and Complex Systems

RF and Optical Wireless and Hybrid Communications Systems; Inter and Intra-chip Communications; Mixed Signals

Andreas Weisshaar

Micro and Nano Systems; Systems-on-a-chip; System-in-a-Package; Diagnostic and Implantable Systems

Yogesh Gianchandani

Cyber Systems; Signal Processing

Scott Midkiff

Power, Controls, and Adaptive Networks

Embedded, Distributed and Adaptive Control; Sensing and Imaging Networks; Systems Theory; Telerobotics

Radhakistan Baheti

Power and Energy Systems and Networks and their Inter-dependencies; Power Drives; Renewable/Alternative Energy Sources

Dagmar Niebur

Adaptive Dynamic Programming; Quantum and Molecular Modeling and Simulations; Neuromorphic Engineering

Paul Werbos



ECCS Areas of Interest

Electronics, Photonics, and Device Technologies EPDT

- ✓ Bioelectronics
- ✓ Electromagnetics
- ✓ Flexible Electronics
- ✓ MEMS/NEMS
- ✓ Micro/Nanoelectronics
- ✓ Micro/Nanomagnetics
- ✓ Microwave Photonics
- ✓ Molecular Electronics
- ✓ Nanophotonics
- ✓ Optoelectronics
- ✓ Power Electronics
- ✓ Sensors and Actuators
- ✓ Spin Electronics

Power, Controls, and Adaptive Networks PCAN

- ✓ Adaptive Dynamic Programming
- ✓ Alternate Energy Sources
- ✓ Embedded, Distributed and Adaptive Control
- ✓ Neuromorphic Engineering
- ✓ Power and Energy Systems and Networks
- ✓ Quantum and Molecular Modeling and Simulation of Devices and Systems
- ✓ Sensing and Imaging Networks
- ✓ Telerobotics

Integrative, Hybrid, and Complex Systems IHCS

- ✓ Cyber Systems
 - Signal Processing
- ✓ Nano and Microsystems
 - System-on-a-chip
 - System-in-a-package
- ✓ RF and Optical Wireless and Hybrid Communications Systems
 - Inter- and Intra-chip Communications
 - Mixed Signals

Two submission windows each year: Sep. 7- Oct. 7 and Jan. 7- Feb. 7



Cyber-Physical Systems (CPS) Program

CPS aims to reveal cross-cutting fundamental scientific and engineering principles that underpin the integration of cyber and physical elements across all application sectors.

Research advances that promise to transform our world with systems that respond more quickly, are more precise, work in dangerous or inaccessible environments, provide large-scale distributed coordination, are highly efficient, augment human capabilities, and enhance societal wellbeing.

Research challenge themes include:

- > Foundations of new scientific and engineering principles
- > Methods and Tools to bridge the gap between cyber and physical elements
- > Hardware and Software Components, Run-time Substrates and engineered Systems

◎ \$30M, 30-40 Awards

- > Small projects \$200K/Year for up to three years
- > Medium projects \$500K/year for up to three years
- > Large projects \$1.00M/year for up to five years
- > One Virtual Organization \$200K/Year for up to five years

ENG
Scott Midkiff

Proposals Submission Deadline: Feb. 27, 2009, NSF 08-611



Faculty Early Career Development (CAREER) Program

Foundation-wide activity that offers NSF's most prestigious awards in support of junior faculty members within context of their early career development activities

➤ **Requires:**

- ✓ Career Development Plan
- ✓ Research Plan and Integrated Educational Activities
- ✓ Departmental Endorsement

Most meritorious new CAREER awardees, showing exceptional potential for leadership at the frontiers of knowledge, are eligible for Presidential Early Career Awards for Scientists and Engineers (PECASE)

- > \$80M invested each year for 425 new awards
- > ENG awards are \geq \$400K for 5 years
- > Deadlines vary by Directorates

ENG
Ken Chong
Sharon Middledorf

ENG Proposals Submission Deadline: July 22, 2009



Small Grants for Exploratory Research (SGER)

High-risk research in the fields of science, engineering, and education:

- ⦿ Preliminary work on **untested and novel ideas**
- ⦿ Ventures into **emerging and potentially transformative research ideas**
- ⦿ Application of **new expertise or new approaches** to research topics
- ⦿ Quick-response research on **unanticipated events**
- ⦿ **Efforts to catalyze** rapid and innovative advances
 - > Submit to individual programs
 - > Strongly encouraged to discuss with Program Directors before submitting the proposal for appropriateness
 - > Project description no more than five pages
 - > Maximum award amount not to exceed \$200K for 2 years
 - Normally the award size is \$50-75k for 1 year
 - Number of awards is limited





Broadening Participation Research Initiation Grants in Engineering (BRIGE)

Goal is to increase the number of researchers in their early careers in engineering disciplines with encouragement of underrepresented groups, engineers from minority serving institutions and persons with disabilities

Eligible candidates must meet the following requirements:

- › U.S. Citizen or National or Permanent Resident of the United States.
- › Holds doctoral degree in an NSF ENG-supported field.
- › New investigator on a full time tenure-track faculty position or equivalent research appointment for no longer than three years.
- › Has not previously served as Principal Investigator or Co-Principal Investigator on federal research grants totaling more than \$50,000.
- › Award Size and Duration: \$175,000 for 24 months, Awards: 25 to 30, \$4M

Proposal Submission Deadline: Feb.13 2009, NSF 08-606



ENG Collaborative and Crosscutting Activities

- ◎ **Engineering Education and Centers (EEC)**
- ◎ **Industrial Innovation and Partnerships (IIP)**
- ◎ **Office of Emerging Frontiers in Research and Innovation (EFRI)**





Engineering Education and Centers (EEC)

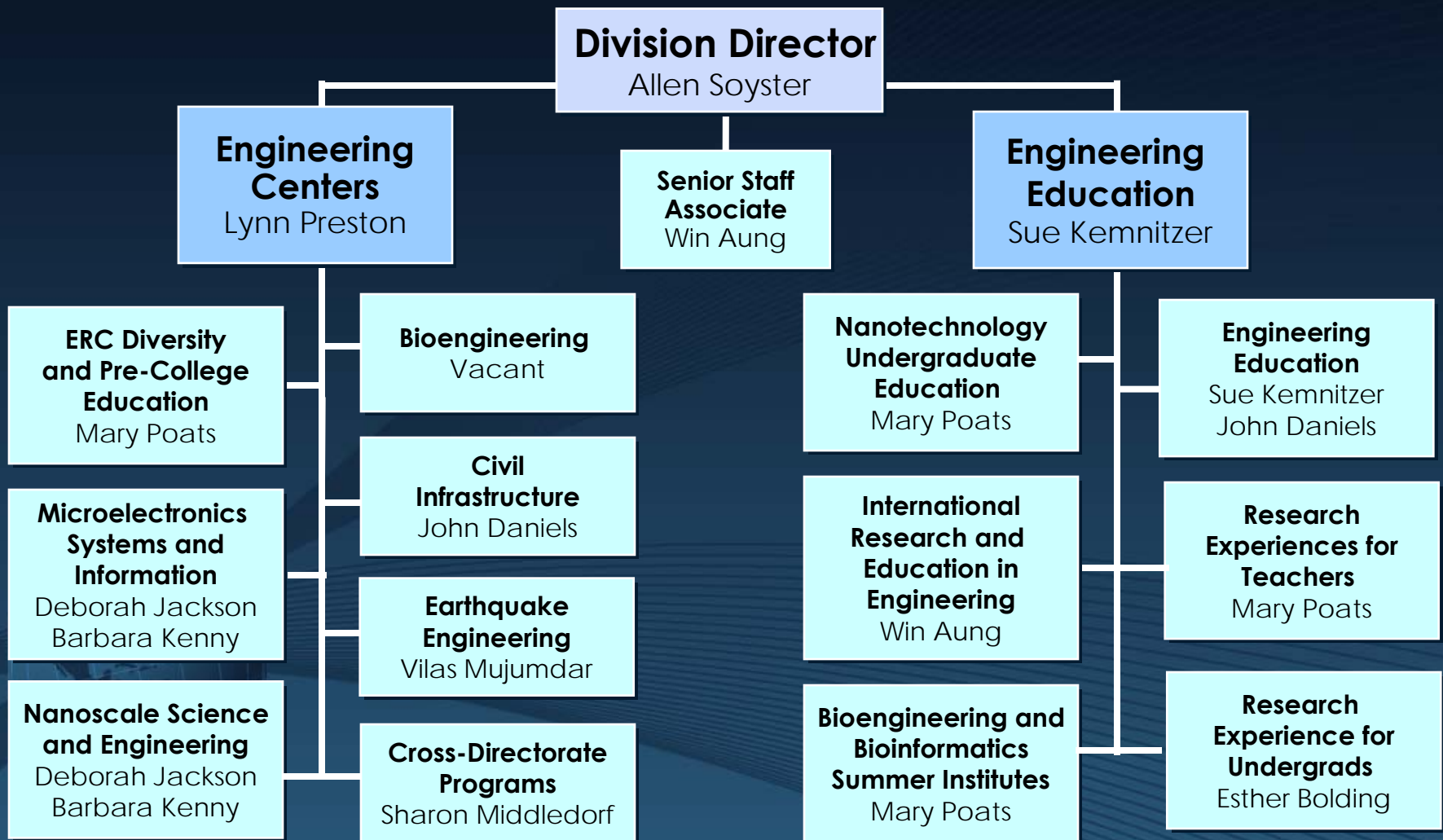



Engineering Research Centers (ERCs)

Supports collaboration with industry to promote innovative research and education

- Join discovery with advancement of engineered systems and innovation
- Prepare adaptive, creative and innovative engineers for success in global economy
- Partnerships with industry, small firms, pre-college institutions, and foreign universities

15 ERCs underway @ \$3.25 to \$4.0 per year for up to 10 years

Next Class to be funded in FY 2011, 2-year process

<http://www.erc-assoc.org>

Lynn Preston



Engineering Education Research

Addresses educational goals of the engineering community by supporting focused efforts that integrate research into advances in undergraduate and PhD engineering education, and partner with K-12 pipeline innovators

- › **Unsolicited education proposals**
- › **Nanotechnology Undergraduate Education**
- › **Bioengineering and Bioinformatics Summer Institutes**

New solicitations in 2008



Innovations in Engineering Education, Curriculum and Infrastructure (IEECI)

Supports research which addresses four aspects of engineering education:

- How students best learn the ideas, principles, and practices to become creative and innovative engineers, and how this learning is measured
- How application of cyber learning resources of networked computing and communication, interactive visualization capabilities, and well designed user interfaces can be used to develop easily transportable tools and systems with low barriers to adoption which significantly improve learning
- Integration of sustainability into engineering education
- Future directions of U.S. engineering doctoral programs

\$8M, 35-40 awards, Exploratory projects up to \$150K and Expansion projects up to \$400K

Proposals due March 11, 2009, NSF 08-610



Human Resource Development

Research Experiences for Undergraduates (REU): Supports active involvement of undergraduate students in on-going research programs

- **Sites**

- > Requires an independent proposal
- > Average award size \$300K for a duration of 3 years

- **Supplements**

- > To active NSF awards
- > Maximum 2 undergraduate students per grant
- > \$10M/year available for engineering

Deadlines in June each year

Research Experiences for Teachers (RET): Supports the active involvement of K-12 teachers and community college faculty in engineering research in order to bring knowledge of engineering and technological innovation into their classrooms

- **Sites**

- > Requires an independent proposal
- > Award size \$450K maximum for a duration up to 3 years

- **Supplements**

- > To active ENG awards including SBIR/STTR
- > Award size \$10K for a duration up to 1 year and 2 teachers per grant

Deadlines in Nov. each year



NSF-wide Education Programs

- ◎ **Integrative Graduate Education and Research Traineeship (IGERT)**

- > ~20 awards each year

Pre-proposals due in April, full proposals due in Oct.

- ◎ **Graduate Teaching Fellows in K-12 Education (GK-12)**

- > ~20 awards each year

Letters of Intent due in May, full proposals due in June

- ◎ **Graduate Research Fellowships (GRF)**

- > ~1000 fellowships awarded each year

Engineering proposals due Nov. 12, 2008; interdisciplinary proposals due Nov. 3, 2008



Industrial Innovation and Partnerships (IIP)

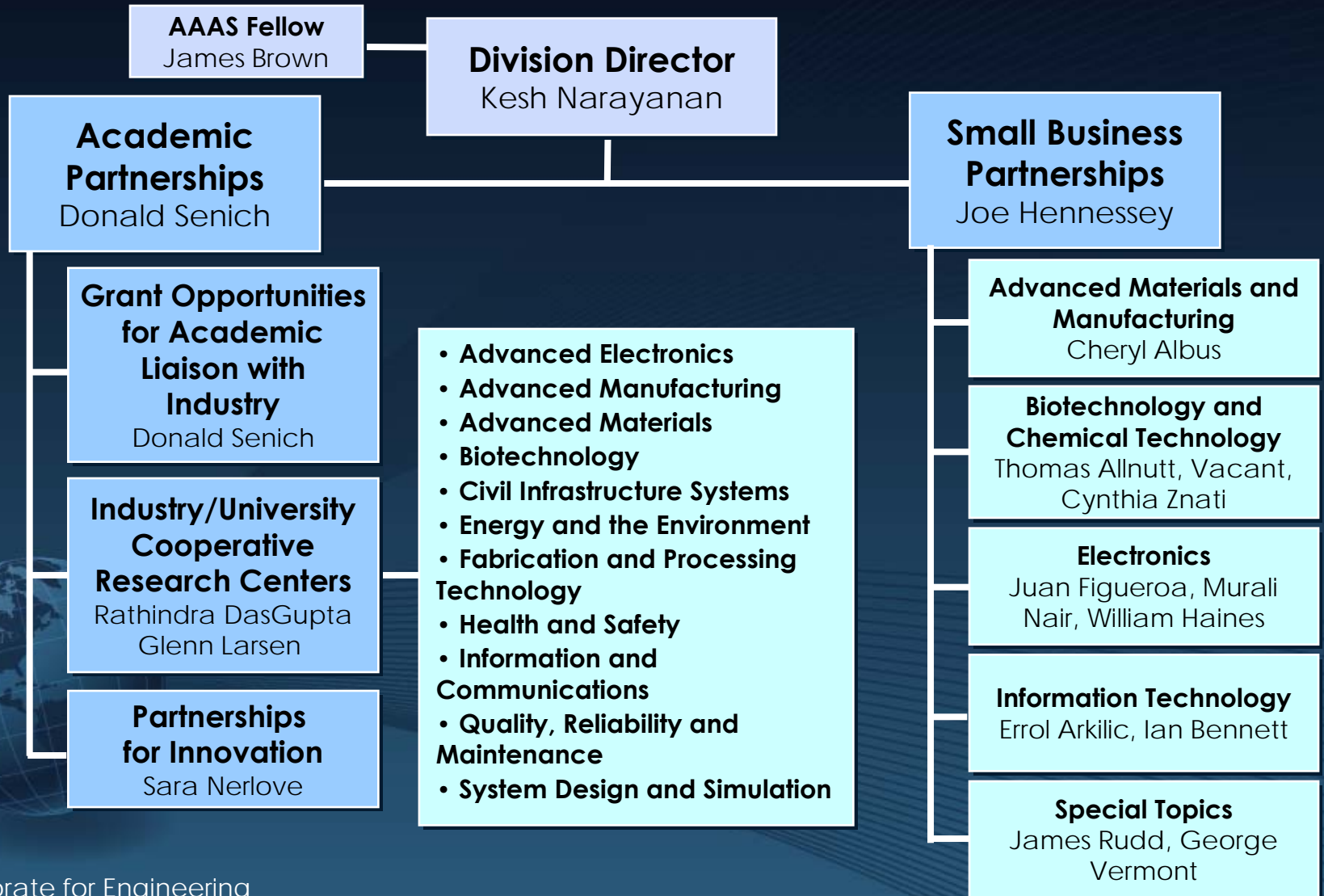



Grant Opportunities for Academic Liaison with Industry (GOALI)

Effectively promotes the transfer of knowledge between academe and industry, student education, and the exchange of culture

- **Aims to synergize university- industry partnerships by enabling eclectic linkages through:**
 - **Faculty and students in industry (≤ 1 year)**
 - **Industry engineers/scientists in academe (≤ 1 year)**
 - **Industry-university collaborative projects (≤ 3 years)**
- ◎ **\$5M total funding supported by all NSF Directorates**



Industry/University Cooperative Research Center (I/UCRC) Program

Promotes long-term partnerships among industry, academe, and government

- Centers are catalyzed by a small investment from NSF and are primarily supported by industry center members during their development and evolution
- \$6-9M to fund 2 to 8 full center awards and 4-12 planning grant awards annually

**Letters of Intent deadline in Jan. 2, 2009 and June 26, 2009,
Full Proposal March 6, 2009 and September 25, 2009, NSF 08-591**



Partnerships for Innovation (PFI)

Catalyzes partnerships among colleges and universities, the private sector, and governments

Goals of the Program are to:

- stimulate the transformation of knowledge created by the research and education enterprise into innovations that create new wealth; build strong local, regional and national economies; and improve the national well-being;
 - broaden the participation of all types of academic institutions and all citizens in activities to meet the diverse workforce needs of the national innovation enterprise;
 - catalyze or enhance enabling infrastructure that is necessary to foster and sustain innovation in the long-term.
- **\$9.5M to fund 12–15 awards each year; grants are up to \$600,000 for 2–3 years**

**Letters of Intent due Oct. 31; full proposals due Dec. 31, Annually Thereafter,
NSF 08-583**



Small Business Innovation Research (SBIR) & Small Business Technology Transfer (STTR) Programs

SBIR and STTR encourage small firms to undertake cutting-edge research with the potential for significant economic and public benefits

Subtopics include:

- > Bio-inspired Materials and Systems (BMS)
- > Materials for Sustainability (MS)
- > Nanostructured Materials (NM)
- > Smart Materials and Structures (SMS)

Modes of support:

- > SBIR Phase I - \$12.5M, 125 Awards, 4 Phase I Proposals per Company
- \$100K for 6 Months
- > STTR Phase I - \$5.00M, 35 Awards, 4 Phase I Proposals per Company
- \$150K for 12 Months
- > SBIR/STTR Phase II - \$500K for 24 Months based on Phase I award

Letter of intent STTR due by Jan. 14, 2009, and for SBIR Dec. 4, 2008

NSF 08-608



Emerging Frontiers in Research and Innovation (EFRI)

Hydrocarbons from Biomass (HyBi)

Hydrocarbon biofuels such as green gasoline are an attractive alternative to ethanol; their production in a network of rural biorefineries can be accompanied by the distributed generation of electricity.

BioSensing & BioActuation: Interface of Living and Engineering Systems (BioSA)

Develop and employ bio-derived and bio-inspired technologies to engineer a new generation of devices and systems for sensing and detection, monitoring, actuation and control of stimuli and the environment.

Total funding \$25 million for 4-year awards at \$500K per year

Letter of Intent : October 14, 2008, NSF 08-599

Sohi Rastegar



Major Research Instrumentation (MRI) Program

Program designed to increase access to scientific and engineering equipment for research and research training in our Nation's organizations of higher education, research museums, and non-profit research organizations

- Provides support for acquisition (up to 3 Yrs) or development (up to 5 Yrs) proposals of major state-of-the-art research instrumentation
- Awards for single instruments, large systems of instruments or multiple instruments that share a common or specific research focus
- Awards range from \$100K to \$4M
- Less than \$100K for non-PhD granting organizations, disciplines of mathematical science or social, behavioral, and economic science at any eligible organization
- Mandatory 30% cost-sharing has been reintroduced

~\$110M investment for approximately 225 awards

ENG
Lawrence Goldberg



National Nanotechnology Infrastructure Network (NNIN)

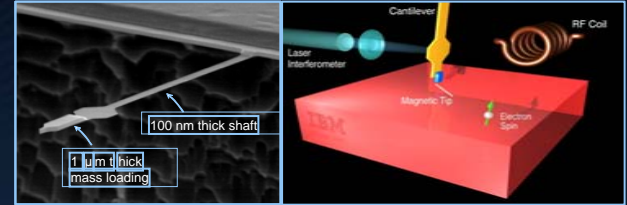
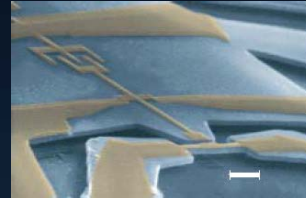
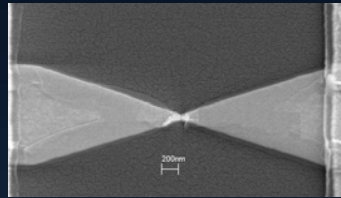
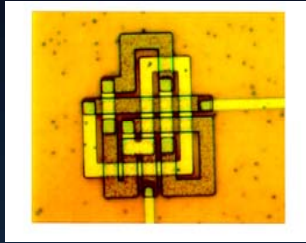

Single Electron Spin Detection using Magnetic Resonance Force Microscopy, Rugar *et al.*, *Nature* 430, July (2004)

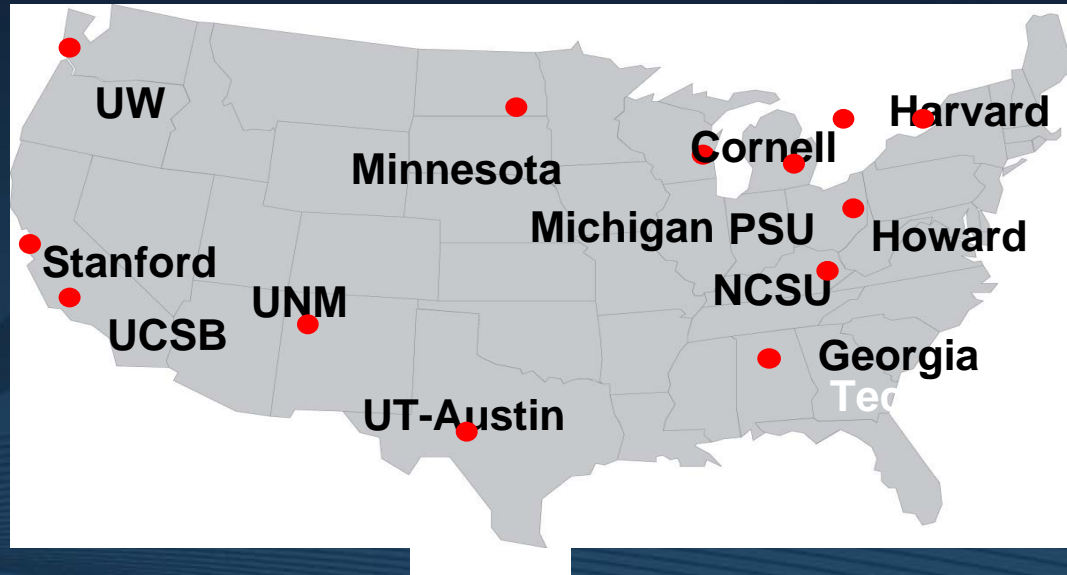
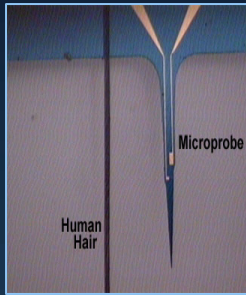

- Cornell U.*
- Stanford U.*
- U. of Michigan*
- Georgia Institute of Technology*
- U. of Washington*
- Pennsylvania State U.*
- U. of California-Santa Barbara*
- U. of Minnesota*
- U. of New Mexico*
- U. of Texas -Austin*
- Harvard U.*
- Howard U.*
- North Carolina State U.*

An integrated national network of user facilities providing researchers open access to resources, instrumentation and expertise in all domains of nanoscale science, engineering and technology



Network for Computational Nanotechnology (NCN)

A National resource to accelerate the transformation of nanoscience to nanotechnology through theory, modeling and simulation, and collaboration enabled by cyberinfrastructure

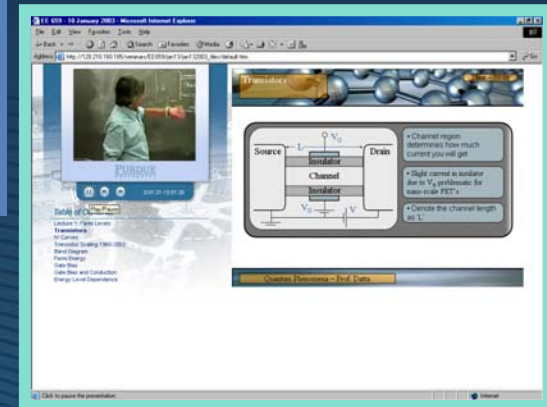
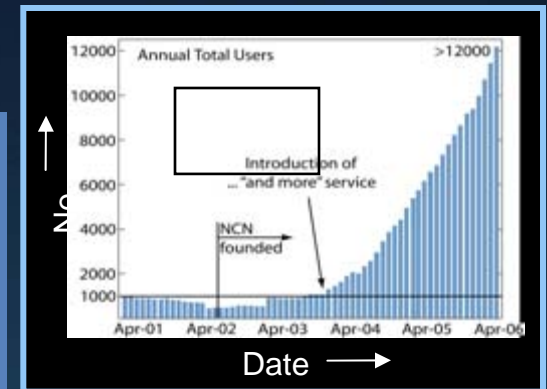
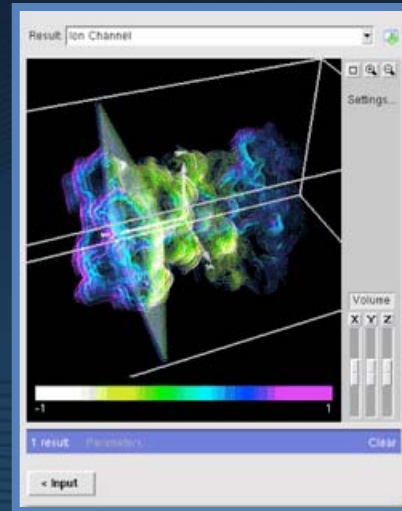
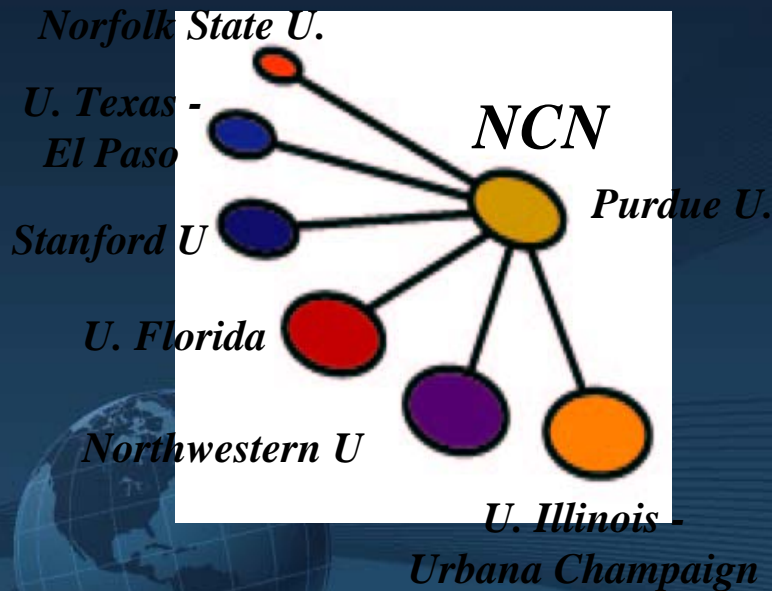

NSF Infrastructure and Research Network

www.nanoHUB.org



Cyber-Enabled Discovery and Innovation (CDI)

Goal is to create revolutionary science and engineering research outcomes made possible by innovations and advances in computational thinking defined to encompass computational concepts, methods, models, algorithms and tools.

Seeks ambitious, transformative, multidisciplinary research proposals within or across the following three thematic areas:

- **From Data to Knowledge:** enhancing human cognition and generating new knowledge from a wealth of heterogeneous digital data
- **Understanding Complexity in Natural, Built, and Social Systems:** deriving fundamental insights on systems comprising multiple interacting elements
- **Building Virtual Organizations:** enhancing discovery and innovation by bringing people and resources together across institutional, geographical and cultural boundaries.

Support for two types of awards: Limit of 2 proposals per PI

- > **Type I for three years** - Two investigators with two graduate students; and their collective research needs .
- > **Type II for four years** - Three investigators with three graduate students; one or two senior personnel and their collective research needs.



Accelerating Discovery in Science and Engineering through Petascale Simulation and Analysis (PetaApps)

Aims to develop the future simulation and analysis tools that can use petascale computing to advance the frontiers of scientific and engineering research

- ◎ Seeks proposals that:
 - > Capitalize on emerging petascale computing architectures
 - > Emphasize implementation and exploitation of forefront techniques
 - > Demonstrate that they have a research problem that requires and can exploit petascale computing capabilities
 - > Are from or include junior researchers

◎ ~\$18M investment for 11–16 grants

ENG
Clark Cooper
Scott Midkiff
Phillip Westmoreland

Proposal Submission Deadline Oct. 30, 2008, NSF 08-592



Domestic Nuclear Detection Office/NSF Academic Research Initiative (ARI)

Focused on detection systems, individual sensors or other research potentially relevant to the detection of nuclear weapons, special nuclear material, radiation-dispersal devices, and related threats

Possible topics include:

- **Detector materials, concepts and designs for new sensors and sensing systems**
- **Non-intrusive active interrogation systems; particle generators and accelerators, associated detectors, and algorithms for improved data analysis**

- **Nuclear forensics and attribution**

- > Anticipated Funding Amount is \$58M over five-year period from 2007-2011
- > Estimated Number of Awards is 7- 8
- > Award Size is \$400,000 annually per award for a maximum duration of five years with a maximum total award size \$2M, inclusive of both direct and indirect costs

Full proposals due April 2009

**ENG
Rajinder Khosla**



ADVANCE: Increasing the Participation and Advancement of Women in Academic Science and Engineering Careers

- **Institutional Transformation (IT)** - for academic institutional transformation to promote participation and advancement of women scientists and engineers in academe
8 Awards \$2-6 M for 5 years
- **Institutional Transformation Planning Grants (IT-Start)** - for basic data collection and analysis functions necessary to understand the status of women faculty in academic science and engineering at institutions seeking institutional transformation
\$100-200K up to 2 Years, 10 Awards
- **Partnerships for Adaptation, Implementation, and Dissemination (PAID)** - for analysis, adaptation, dissemination and use of existing innovative materials and practices that have been demonstrated to be effective in increasing representation and participation of women in academic science and engineering careers
1-5 years, award size depends on the scope of the project, 20 Awards



DOs and DON'Ts for Funding Success

Credit: Top Row: University of Illinois, Graduate School of Library and Information Science; © 2004 Hybrid Medical Animation; Daniel Cardenas from Wikipedia Commons; Chris Jacobs, Rolf Mohr, and Dean Fowler, NASA. Middle Row: Latika Menon and Donald O'Malley, Northeastern University; Hatsukari715 from Wikipedia Commons; Vika from Wikipedia Commons; NASA. Bottom Row: NASA; DOE; Cohesion from Wikipedia Commons; NASA/MSFC; © 2005 UCLA Healthcare



Funding

Proposals must address NSF Strategic Outcome goals

- ◎ **Discovery:** Foster research that will advance the frontiers of knowledge, emphasizing areas of greatest opportunity and potential benefit and establishing the nation as a global leader in fundamental and transformational science and engineering.
- ◎ **Learning:** Cultivate a world-class, broadly inclusive science and engineering workforce, and expand the scientific literacy of all citizens.
- ◎ **Research Infrastructure:** Build the nation's research capability through critical investments in advanced instrumentation, facilities, cyberinfrastructure and experimental tools.
- ◎ **Stewardship:** Support excellence in science and engineering research and education through a capable and responsive organization.



Merit Review Criteria

I. What is the Intellectual Merit of the Proposed Activity?

- > Importance of the proposed activity in advancing knowledge and understanding
- > Qualifications of the proposer (individual or team)
- > Intent to explore creative, original, or **potentially transformative** concepts
- > How well conceived and organized is the proposed activity ?
- > Sufficient access to resources

II. What are the Broader Impacts of the Proposed Activity?

- > Advance discovery and understanding while promoting teaching, training, and learning
- > Broaden participation of underrepresented groups
- > Enhance the infrastructure for research and education
- > Disseminate broadly to enhance scientific and technological understanding
- > Provide benefit to society



Transformative Research

Describes a range of endeavors which promises extraordinary outcomes

- › Revolutionizing entire disciplines
- › Creating entirely new fields
- › Disrupting accepted theories and perspectives
- › Those endeavors which have the potential to change the way we address challenges in science, engineering, and innovation.





Reasons a proposal is declined

- **The proposed work is not innovative (incremental)**
- **Does not explain clearly why this proposed work is unique and much better than the state-of-the-art**
- **Missing the citation of relevant and important previous work**
- **Proposed work lacks strong SCIENCE component**
- **Does not have enough evidence to convince reviewers that the proposed technique is feasible**
- **The PI does not have previous experience in the proposed research topic**
- **Did not discuss the results of related awards received in last 5 years**



Reasons a proposal is declined

- **Topic does not fit to the targeted program interest**
- **The proposal is too ambitious (impossible to be done in 3 years)**
- **The proposal lacks focus (laundry list)**
- **Several topics in the same proposal but they are not coherent and well connected**
- **Weak educational and outreach plan**
- **Does not have adequate equipment and facility to conduct the proposed work**
- **Preliminary results do not support the feasibility of the proposed work**
- **Overlap between the proposed work and previous sponsored research (by NSF or other agencies)**



Key to success

- **Out-of-box thinking and innovative ideas (revolutionary, transformative)**
- **Strong preliminary results**
- **Theoretical estimation and convincing extrapolation on the potential of the proposed technique**
- **Be quantitative and use numbers if possible, to convince reviewers that your idea is superior**
- **Clearly discuss specific research challenges and ways to overcome them**
- **Innovative educational and outreach plan with specifics and details if possible**
- **Photographs and figures always help, must be clear with captions and scales**
- **Clearly explain why this proposed work is much better than any existing technique**



How to approach your Program Manager

- **Make appointment**
- **Get to know program interest and emphasis**
- **Be prepared with clear ideas on what you want to do**
- **Be brief (15 – 20 minutes)**
- **Follow-up with supporting materials**





Reviewers

- **Proposal review is an important service to NSF and to your community**
- **There's no better way to see how the system works**
- **There's no better way to understand what makes a winning proposal**
- **Contact the Program Directors in the area of your expertise, e-mailing brief description of your research expertise with key words**
- **Requires about 40 hours of work to read proposals and write comments, plus a 2-3 day trip to NSF for panel review**
- **NSF pays for travel (within government limits) and expenses (flat-rate compensation)**



Resources

Directorate for Engineering:

<http://www.nsf.gov/eng>

Funding Opportunities:

<http://www.nsf.gov/funding/>

Thank You

Dr. Usha Varshney

Program Director

Electrical, Communications and Cyber Systems

Directorate for Engineering

National Science Foundation

